

# YihE Kinase Is a Central Regulator of Programmed Cell Death in Bacteria

Angella Dorsey-Oresto,<sup>1,2,6</sup> Tao Lu,<sup>1,3,6</sup> Michael Mosel,<sup>1,2</sup> Xiuhong Wang,<sup>1,4</sup> Tal Salz,<sup>1</sup> Karl Drlica,<sup>1,2</sup> and Xilin Zhao<sup>1,2,5,\*</sup>

<sup>1</sup>Public Health Research Institute Center

<sup>2</sup>Department of Microbiology and Molecular Genetics

New Jersey Medical School, UMDNJ, Newark, NJ 07103, USA

<sup>3</sup>Key Laboratory for Microbial Resources of the Ministry of Education, Yunnan Institute of Microbiology, Yunnan University, 2 North Cui Hu Road, Kunming, Yunnan Province, 650091, China

<sup>4</sup>Department of Biochemistry, Harbin Medical University, 194 Xuefu Road, Nangang District, Harbin, Heilongjiang Province, 150081, China

<sup>5</sup>School of Public Health, Xiamen University, South Xiang-An Road, Xiang-An District, Xiamen, Fujian Province, 361102, China

<sup>6</sup>These authors contributed equally to this work

\*Correspondence: [zhaox5@umdnj.edu](mailto:zhaox5@umdnj.edu)

<http://dx.doi.org/10.1016/j.celrep.2013.01.026>

## SUMMARY

Stress-mediated programmed cell death (PCD) in bacteria has recently attracted attention, largely because it raises novel possibilities for controlling pathogens. How PCD in bacteria is regulated to avoid population extinction due to transient, moderate stress remains a central question. Here, we report that the YihE protein kinase is a key regulator that protects *Escherichia coli* from antimicrobial and environmental stressors by antagonizing the MazEF toxin-antitoxin module. YihE was linked to a reactive oxygen species (ROS) cascade, and a deficiency of *yihE* stimulated stress-induced PCD even after stress dissipated. YihE was partially regulated by the Cpx envelope stress-response system, which, along with MazF toxin and superoxide, has both protective and destructive roles that help bacteria make a live-or-die decision in response to stress. YihE probably acts early in the stress response to limit self-sustaining ROS production and PCD. Inhibition of YihE may provide a way of enhancing antimicrobial lethality and attenuating virulence.

## INTRODUCTION

The increasing prevalence of antimicrobial resistance now threatens many aspects of medical treatment, particularly treatments that involve invasive procedures. New approaches that enhance pathogen killing may help improve the efficacy of antimicrobial therapy, since enhanced killing rapidly reduces the pathogen population size and thus restricts new resistance from arising (Stratton, 2003). In this regard, stress-mediated programmed cell death (PCD) has emerged as an important theme in bacterial physiology because it may be possible to manipulate PCD to enhance pathogen killing. The observation that lethality from harsh forms of stress increases with activation of the MazF toxin suggested that cellular factors, in addition to stress-induced lesions, are involved in stress-mediated cell

death (Hazan et al., 2004; Lewis, 2000; Rice and Bayles, 2003; Sat et al., 2001). Harsh stress in the form of lethal antimicrobials was subsequently linked to a cascade of reactive oxygen species (ROS), with hydroxyl radical being the lethal agent (Dwyer et al., 2007; Kohanski et al., 2007). Thus, many lethal stressors act through a common biochemical mechanism that is reminiscent of ROS involvement in eukaryotic apoptosis (Jung et al., 2001; Matés and Sánchez-Jiménez, 2000; Simizu et al., 1998). More recently, the Cpx and aerobic respiration control (Arc) stress-response systems were implicated as potential stress signal transducers that act upstream from the ROS cascade (Davies et al., 2009; Kohanski et al., 2008). Moreover, antibiotic-induced bacterial cell death appears to exhibit features characteristic of eukaryotic apoptosis (Dwyer et al., 2012). Thus, a case is building for the existence of bacterial PCD, which may provide bacterial populations a way to actively eliminate damaged members. However, before we can consider stress-mediated PCD to be a common rather than a rare developmental property of bacteria, two key questions must be answered. First, how is the lethal stress response regulated? It must be triggered only by situations in which stress is very harsh to avoid unintended elimination of bacterial populations by moderate, transient stress. Second, is there a point of no return after which a self-sustaining death system takes over, even if the initial stress has dissipated? Control of triggers and checkpoints is an essential criterion for PCD.

As a starting point for identifying the control elements of PCD, we assumed that stress responses restrict the consequences of damage rather than prevent the occurrence of additional primary lesions. If so, we should be able to identify genes that are involved specifically in the response to lethal consequences of stress by using antimicrobial probes whose lethal effects are readily distinguished from the primary bacteriostatic damage they cause. For example, the rapid lethal activity of the older quinolones can be separated from the formation of the drug-gyrase-DNA complexes that block bacterial growth (Chen et al., 1996). Thus, mutant libraries can be screened for hypersusceptibility to lethal stress and counterscreened for wild-type (WT) susceptibility to bacteriostatic stress (Han et al., 2010). The counterscreen eliminates from consideration mutants with altered drug uptake, drug efflux, and target affinity, each of

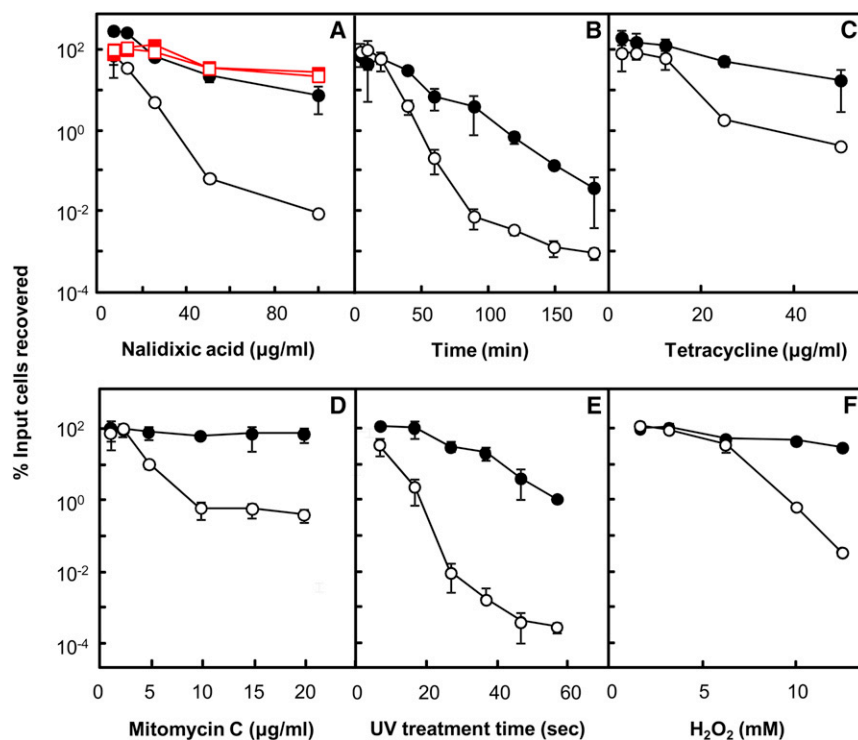

**Figure 1. YihE Protects *E. coli* from Lethal Stress**

(A–F) Survival of WT (3084, filled circles) and  $\Delta yihE$  mutant (3086, empty circles) *E. coli* following treatment with (A) nalidixic acid at the indicated concentrations for 2 hr, (B) 50  $\mu\text{g/ml}$  nalidixic acid for the indicated times, (C) tetracycline at the indicated concentrations for 2 hr, (D) mitomycin C at the indicated concentrations for 40 min, (E) UV light at 0.14  $\text{mW/cm}^2$  for the indicated times, and (F) hydrogen peroxide at the indicated concentrations for 10 min. (A) also shows the effect of plasmid-borne *yihE* (pACYC184-*yihE*) on WT (filled squares) and  $\Delta yihE$  mutant (empty squares) cells. Strains containing the pACYC184 vector alone, which did not confer protection with either the WT or  $\Delta yihE$  mutant strain (Figure 2A), were omitted from the figure for clarity. Error bars indicate SEM. See also Figure S1 and Table S2.

which affects the formation of primary lesions. The outcome of such a screen is a collection of genes whose products are involved in protecting bacteria specifically from lethal damage. One of those genes might encode a general regulator of stress-mediated bacterial PCD.

In this work, we used nalidixic acid to screen for mutants that render *Escherichia coli* hypersusceptible to the lethal effects of the drug without affecting bacteriostatic activity. One of the genes identified was *yihE*, which encodes a eukaryotic-like serine-threonine protein kinase (Zheng et al., 2007). Although *yihE* had long been thought to participate in stress responses because its promoter region contains a binding site for CpxR (Pogliano et al., 1997), a positive regulator of the Cpx envelope stress-response system (Raivio and Silhavy, 2001), no other connection had been obvious. We found that YihE restricts stress-stimulated ROS accumulation and bacterial cell death mediated by the MazEF toxin-antitoxin (TA) system. These results, plus data from *katG* and *cpx* mutants, are explained by YihE serving as a negative regulator of the MazEF-Cpx-ROS pathway that constitutes a live-or-die response of bacteria to stress. Because exposure to antimicrobials and host defense systems constitutes harsh stress to bacterial pathogens, artificially antagonizing YihE may be a way of improving antimicrobial action and attenuating virulence.

## RESULTS

### Absence of YihE Kinase Increases Stress-Mediated Lethality

When we examined a Tn5tac1 transposon insertion mutagenesis library of *E. coli*, screening identified a deficiency of *yihE* as

increasing the lethal activity of nalidixic acid without affecting bacteriostatic activity. Insertion of Tn5tac1 into *yihE* reduced the survival of *E. coli* by 100-fold following nalidixic acid treatment (Figure S1A), but the minimal inhibitory concentration (MIC), a common surrogate for measuring growth inhibition, was unaffected (MIC was  $\sim 3 \mu\text{g/ml}$  for both the WT [strain 1045] and the *yihE* mutant [strain 2562]; see Table S1 for strain descriptions). The hypersusceptibility to lethal action in the absence of an effect on growth, which we term hyperlethality, was readily transferred to other *E. coli* strains by bacteriophage P1-mediated transduction. To establish that the hyperlethal phenotype was characteristic of a *yihE* deficiency, as opposed to arising from an intrinsic effect of transposon insertion (Wu et al., 2008), we prepared an in-frame deletion of *yihE* (Baba et al., 2006) in a different WT background (strain 3084) and used the  $\Delta yihE$  mutant (strain 3086) in subsequent experiments.

As expected, the  $\Delta yihE$  mutant had the same MIC for nalidixic acid as the corresponding WT strain (Table S2), whereas treatment with various concentrations of nalidixic acid for 2 hr (Figure 1A) or with 50  $\mu\text{g/ml}$  of nalidixic acid for various times (Figure 1B) reduced mutant survival by  $>100$ -fold relative to that of the WT strain. This hyperlethality was eliminated by expression of WT *yihE* cloned into plasmid pACYC184 ( $\sim 10$ – $15$  copies per cell; Sambrook et al., 1989) using the native *yihE* promoter (Figure 1A). We conclude that the absence of YihE is responsible for the hyperlethal response to nalidixic acid. This result indicates that WT YihE normally protects *E. coli* from the lethal action of this quinolone without affecting other factors (e.g., drug uptake, efflux, and target affinity) that confer MIC changes.

YihE also lowered the lethal action of other stressor types. With the  $\Delta yihE$  mutant, tetracycline (Figure 1C), mitomycin C (Figure 1D), and ampicillin (Figure S1B) each exhibited elevated lethality with no change in MIC (Table S2). Moreover, when WT and  $\Delta yihE$  mutant cells were exposed to two environmental

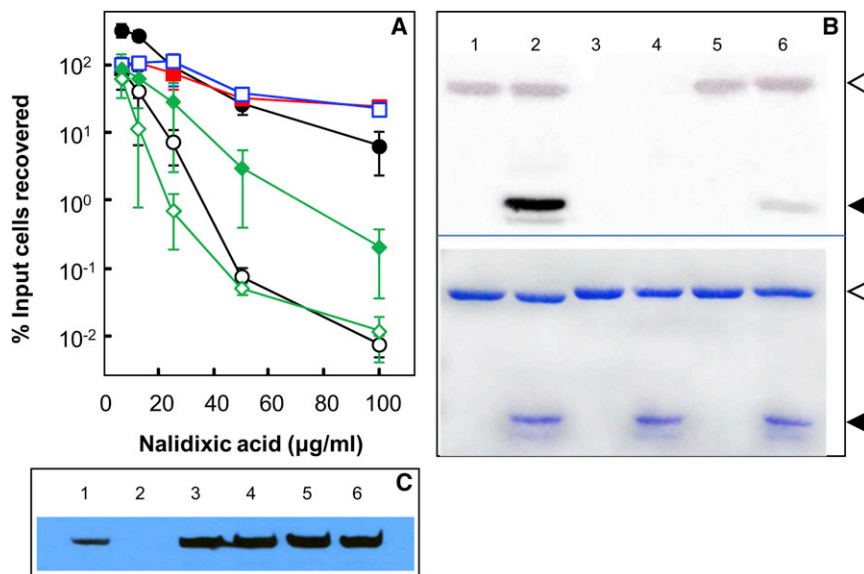

**Figure 2. Kinase Activity Is Responsible for YihE-Mediated Protection from Lethal Stress**

(A) Survival of *E. coli* following treatment with the indicated concentrations of nalidixic acid for 2 hr. Filled circles: WT plus pACYC184 (strain 3337); empty circles:  $\Delta yihE$  plus pACYC184 (strain 3340); filled squares: WT plus pACYC184-*yihE* (strain 3336); empty squares:  $\Delta yihE$  plus pACYC184-*yihE* (strain 3341); empty diamonds:  $\Delta yihE$  plus pACYC184-*yihE*-D217A (strain 3343); and filled diamonds:  $\Delta yihE$  plus pACYC184-*yihE*-S36A (strain 3342). Error bars indicate SEM.

(B) Kinase activity of YihE. SDS-polyacrylamide gel following electrophoresis of kinase reaction products was subjected to Phosphorimager analysis to reveal phosphorylated proteins (upper panel) or to Coomassie Brilliant Blue staining to reveal total proteins (lower panel). Reaction mixtures contained WT YihE (lanes 1 and 2), YihE-D217A (lanes 3 and 4), YihE-S36A (lanes 5 and 6). MBP was also present in lanes 2, 4, and 6. Positions of YihE and MBP are indicated by empty and filled arrowheads, respectively.

(C) Western blot for quantitation of YihE protein in strains used for the measurements shown in (A). Lane 1: WT *E. coli* plus pACYC184 (strain 3337); lane 2:  $\Delta yihE$  mutant plus pACYC184 (strain 3340); lane 3: WT plus pACYC184-*yihE* (strain 3336); lane 4:  $\Delta yihE$  mutant plus pACYC184-*yihE* (strain 3341); lane 5:  $\Delta yihE$  mutant plus pACYC184-*yihE*-D217A (strain 3343); lane 6:  $\Delta yihE$  mutant plus pACYC184-*yihE*-S36A (strain 3342). Anti-YihE antiserum (prepared by Lampire Biological Laboratories, Pipersville, PA) was used at a 1:10,000 dilution.

stressors, UV light (Figure 1E) and hydrogen peroxide (Figure 1F), the  $\Delta yihE$  mutation increased lethal susceptibility. However, no  $\Delta yihE$ -mediated hyperlethality was observed with exposure to high temperature (Figure S1C) or to rifampicin (Figure S1D). Thus, YihE protects *E. coli* from many, but not all, types of stress.

### Protein Kinase Activity Is Responsible for YihE-Mediated Protection from Lethal Stress

During the course of this work, an X-ray crystal structure of YihE was reported, and the protein was shown to be a eukaryotic-like Ser/Thr protein kinase (Zheng et al., 2007). However, little was revealed about the biological function of YihE. The X-ray structure of YihE suggested that amino acids Asp-217 and Ser-36 are important residues in the YihE active site, and Asp-217 was shown to be essential for kinase activity (Zheng et al., 2007). To assess the importance of YihE kinase activity in protection from lethal stress, we replaced Asp-217 or Ser-36 with Ala in plasmid-borne copies of *yihE* and then examined the effect of the mutations in *trans* on complementation of the hyperlethal phenotype associated with the  $\Delta yihE$  mutant. Full complementation of  $\Delta yihE$ -mediated hyperlethality for nalidixic acid was achieved with plasmid-borne WT *yihE* (Figure 2A, empty squares). In contrast, single-base substitutions that abolished (D217A) or reduced (S36A) kinase activity (Figure 2B) exhibited either no complementation (D217A; Figure 2A, empty diamonds) or only partial complementation (S36A; Figure 2A, filled diamonds). Western blot analysis showed that protein abundance was unaffected by these amino acid substitutions (Figure 2C). The observation that kinase activity paralleled the ability of plasmid-borne *yihE* to complement a chromosomal *yihE* deficiency shows that the kinase activity of YihE is responsible for reducing the effects of lethal stress.

### YihE Mitigates Stress-Mediated Cell Death by Dampening MazEF TA Function

Previous work suggested that MazEF promotes stress-mediated cell death for many of the stressors we examined (Engelberg-Kulka et al., 2006; Hazan et al., 2004; Sat et al., 2001). That work is controversial (Christensen et al., 2003; Pedersen et al., 2002; Tsilibaris et al., 2007), and indeed we failed to detect an effect of a  $\Delta mazEF$  mutation on lethality (Figures 3A and 3B, empty triangles), perhaps due to differences in the strain background, growth medium, and/or severity of the stress. Nevertheless, we combined a  $\Delta yihE$  mutation with a deletion of *mazEF* to determine whether YihE acts through MazEF. If such is the case, the absence of a functional *mazEF* gene pair should eliminate the hyperlethality normally exhibited by the  $\Delta yihE$  mutant during stress. With both nalidixic acid (Figure 3A) and UV irradiation (Figure 3B), a *mazEF* deletion suppressed the effect of  $\Delta yihE$ . These data suggest that the hyperlethality associated with a *yihE* deficiency results from MazF-mediated toxicity. The loss of hyperlethality seen with the  $\Delta yihE$ - $\Delta mazEF$  double mutant was reversed by transduction of WT *mazEF* back into the double mutant, effectively regenerating the  $\Delta yihE$  strain (Figures 3A and 3B, diamonds). Thus, suppression of  $\Delta yihE$  was due to deletion of *mazEF*, not to spontaneous suppressors that might have arisen during transduction analysis. We conclude that YihE protects *E. coli* from stress-mediated cell death by having a negative effect on MazF.

### MazEF and YihE Are Associated with Oxidative Stress Pathways

MazF has been implicated in stimulating toxic ROS accumulation (Kolodkin-Gal et al., 2008), and many lethal antimicrobials, including the older quinolones, appear to kill bacteria via

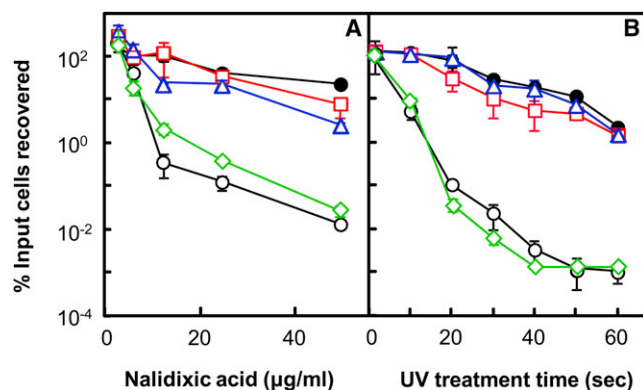

**Figure 3. YihE Mitigates Stress-Mediated Cell Death by Dampening MazEF TA Function**

(A) Survival of *E. coli* following treatment with the indicated concentrations of nalidixic acid for 2 hr. Filled circles: WT (strain 3084); empty circles:  $\Delta yihE$  mutant (strain 3086); triangles:  $\Delta mazEF$  mutant (strain 2458); squares:  $\Delta yihE\text{-}\Delta mazEF$  double mutant (strain 3344); diamonds:  $\Delta yihE\text{-}\Delta mazEF$  backcrossed by WT *mazEF* (strain 3345).

(B) Survival following UV irradiation at 0.14 mW/cm<sup>2</sup> for the indicated times; symbols as in (A). Error bars indicate SEM.

hydroxyl radical action (Kohanski et al., 2007; Wang and Zhao, 2009; Wang et al., 2010). Thus, we suspected that YihE-mediated restriction of MazF activity might limit stress-stimulated, MazF-mediated surges of ROS. If so, YihE could be in the same genetic pathway as KatG, an enzyme that is known to protect against surges in ROS (Hassan and Fridovich, 1979). Indeed, the hyperlethal antimicrobial susceptibility observed in a  $\Delta katG$  mutant was similar to that associated with deletion of *yihE* (Wang and Zhao, 2009; Figure 4A). Moreover, a  $\Delta yihE\text{-}\Delta katG$  double mutant exhibited a hyperlethal phenotype similar to that observed with the  $\Delta yihE$  and the  $\Delta katG$  single mutants (Figure 4A). These data indicate that *yihE* and *katG* are epistatic, i.e., they act in the same genetic pathway.

To further evaluate the involvement of ROS in YihE function, we examined the effects of treatment with a combination of 2,2'-bipyridyl and thiourea (BT), both of which inhibit hydroxyl radical accumulation (Kohanski et al., 2007). Treatment of the WT and  $\Delta yihE$  mutant strains with subinhibitory concentrations of BT blocked the ability of nalidixic acid to kill *E. coli* (Figure 4B). These data are consistent with the idea that both nalidixic acid-mediated lethality in WT cells and the hyperlethal effect in the  $\Delta yihE$  mutant are achieved through accumulation of hydroxyl radical. As expected, BT also eliminated killing by nalidixic acid with the  $\Delta katG$  mutant (Figure 4B).

If  $\Delta yihE$ -mediated hyperlethality is caused by excess accumulation of hydroxyl radical, a stressor that does not rely on hydroxyl radical to kill bacteria should not exhibit hyperlethality with a *yihE*-deficient strain. The investigational fluoroquinolone PD161144 is such a stressor (Wang et al., 2010). This compound exhibited no hyperlethality with the  $\Delta yihE$  mutant (Figure 4C).

As another test of the idea that  $\Delta yihE$ -mediated hyperlethality is due to elevated accumulation of ROS, we treated cells with

2',7'-dichlorodihydrofluorescein diacetate (H2DCFDA), a cell-permeable dye that is converted intracellularly to an impermeable cognate that becomes fluorescent if it is oxidized by ROS. When WT and  $\Delta yihE$  mutant cells were treated with nalidixic acid in the presence of H2DCFDA, they became fluorescently labeled. Analysis by fluorescence-activated cell sorting (FACS) revealed a peak shift from low to high fluorescence intensity with both WT and  $\Delta yihE$  mutant cells (Figure 4D). The fluorescence intensity increase was greater with the  $\Delta yihE$  mutant, indicating greater ROS accumulation in the mutant (Figure 4D). This experiment, together with the three described above, indicates that a deficiency of *yihE* facilitates bacterial killing through a stress-induced cascade of ROS similar to that observed with *katG*-deficient cells.

### Relationship between YihE and Cpx

*yihE* is located in an operon that is positively regulated by CpxR (Pogliano et al., 1997), the response regulator of the Cpx envelope stress-response system. Consequently, we expected that deletion of *cpxR* would increase quinolone lethality, since loss of CpxR would prevent upregulation of *yihE* and thereby allow more MazF activity. Surprisingly, a *cpxR* deficiency reduced rather than increased the lethal effect of nalidixic acid (Figure 5A). With UV irradiation, which was also expected to be more lethal in the *cpxR*-deficient mutant, no effect was seen (Figure 5B). For both stressors, a  $\Delta yihE\ \Delta cpxR$  double mutant exhibited the hyperlethality seen with the  $\Delta yihE$  single mutant, not the protective effect (or lack of effect) seen with the  $\Delta cpxR$  mutant (Figures 5A and 5B). Thus, the hyperlethality due to  $\Delta yihE$  overrides the protective effect of  $\Delta cpxR$  on lethal stress. These data indicate that (1) YihE is an essential element of the MazEF-Cpx-ROS pathway (see Discussion), (2) *yihE* may be controlled by regulators other than CpxR, and (3) the protective effect of the *cpxR* mutation with nalidixic acid depends on YihE function.

### YihE Controls Stress-Mediated PCD

PCD was previously referred to as an active death process that requires the presence of a particular protein or proteins (Engelberg-Kulka et al., 2006). Such a definition may be inadequate for stress-mediated bacterial PCD, because death from the original stressor per se and death from stress-triggered PCD are not distinguished in the traditional killing assay. Consequently, the total cell death readout may derive from either the primary lesion or lesion-triggered PCD, or both. A more accurate definition of PCD requires cells to continue along the death pathway even after the initial PCD-triggering stressor is removed. To our knowledge, no such self-sustaining poststress PCD has been demonstrated.

To establish an assay that can distinguish poststress PCD from overall stress-mediated killing, we assumed that bacterial PCD involves ROS, because that is the case with eukaryotic apoptosis (Jung et al., 2001; Matés and Sánchez-Jiménez, 2000; Simizu et al., 1998). If poststress PCD exists and it relies on ROS to execute killing, removal of the initial stressor should not block PCD that has already been triggered by the initial stress. In contrast, if we remove the initial stressor and also scavenge ROS, poststress PCD should be blocked. As a test

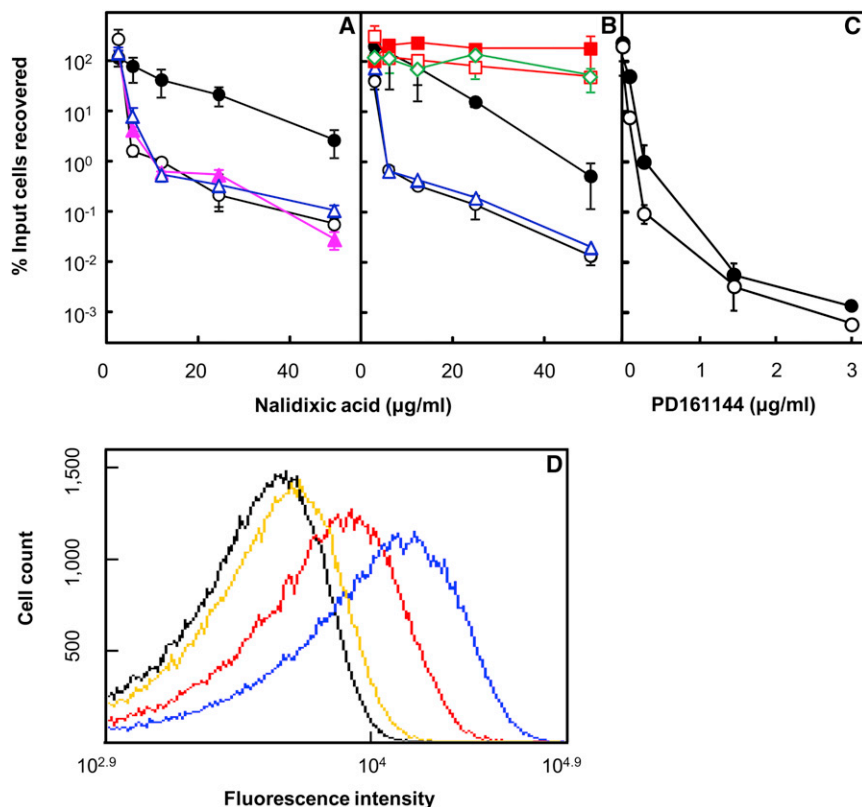

**Figure 4. YihE Protects *E. coli* from Lethal Stress by Interfering with Production/Accumulation of ROS**

(A) Survival of *E. coli* after treatment with the indicated concentrations of nalidixic acid for 2 hr. Filled circles: WT (strain 3084); empty circles:  $\Delta yihE$  mutant (strain 3086); empty triangles:  $\Delta katG$  mutant (strain 3418); filled triangles:  $\Delta yihE$ - $\Delta katG$  double mutant (strain 3419).

(B) Survival of *E. coli* after a 10 min pretreatment with subinhibitory concentrations (1/2 MIC) of 2,2'-bipyridyl and thiourea (BT) followed by treatment with nalidixic acid as in (A). Symbols are as described in (A) but with additional treatments (filled squares: WT + BT [both at 1/2 MIC]; empty squares:  $\Delta yihE$  + BT; diamonds:  $\Delta katG$  + BT).

(C) Survival of *E. coli* after treatment with the indicated concentrations of fluoroquinolone PD161144 for 45 min. Filled circles: WT (strain 3084); empty circles:  $\Delta yihE$  mutant (strain 3086).

(D) Intracellular ROS accumulation. Exponentially growing WT (strain 3084) and  $\Delta yihE$  mutant (strain 3086) cells were pretreated with 10  $\mu$ M H<sub>2</sub>DCFDA for 30 min before cultures received nalidixic acid (50  $\mu$ g/ml) for 90 min. Samples taken immediately before and after nalidixic acid treatment were subjected to FACS analysis. The strains and treatments were WT *E. coli* before nalidixic acid treatment (black curve);  $\Delta yihE$  mutant before nalidixic acid treatment (yellow curve); WT after nalidixic acid treatment (red curve); and  $\Delta yihE$  mutant after nalidixic acid treatment (blue curve).

Error bars indicate SEM. See also Figure S2 and Table S2.

of these ideas, we treated WT and  $\Delta yihE$  mutant cultures with nalidixic acid and then removed the stressor by spreading a small amount of culture on agar, which was expected to dilute the drug to noninhibitory concentrations (quinolones are known for rapid reversal of activity upon removal of the drug from the medium (Goss et al., 1965; M. Malik and K.D., unpublished observation)). Half of the agar plates contained thiourea to scavenge hydroxyl radical and block ROS-mediated poststress PCD. Viable counts from these thiourea-containing plates revealed the drop in survival that occurred before plating (i.e., overall stress-mediated killing minus poststress PCD). The remaining agar plates lacked thiourea to reveal the drop in survival that occurred both before and after plating (i.e., overall stress-mediated killing). The ratio of percent survival in the presence and absence of thiourea served as an indicator of ROS-mediated poststress PCD. With the  $\Delta yihE$  mutant, the ratio was 97 (Figure 6), which strongly indicates the existence of poststress PCD in the mutant (the ratio would be close to one if no poststress PCD occurred). With WT cells under conditions that matched the extent of killing to that of the  $\Delta yihE$  mutant in the absence of thiourea, the PCD indicator ratio was ~10. Thus, ROS-mediated PCD also exists in WT cells, but it is 10-fold lower than with  $\Delta yihE$  mutant cells. When similar experiments were performed with ciprofloxacin (Cip), a more potent quinolone than nalidixic acid, poststress PCD was 25-fold lower with the WT than with  $\Delta yihE$  mutant cells (Figure 6). We conclude

that quinolones initiate PCD through a pathway that culminates in cell death via hydroxyl radical accumulation even after removal of the initial stress stimulus.

## DISCUSSION

In this work, we identify the YihE protein kinase of *E. coli* as a central factor in limiting the self-destructive response of bacteria to lethal stress. Moreover, we provide evidence for poststress PCD (i.e., once triggered by an initial stress event, cells continue along a death pathway even after the initial stress dissipates). Deletion of *yihE* increased PCD and the lethal action of stressors such as peroxide, UV irradiation, and several antimicrobial classes. For the antimicrobials, the absence of YihE had no effect on bacteriostatic activity; consequently, YihE must affect the response to the lethal consequences of stress rather than the initial events that block growth. The crystal structure of YihE indicates that the protein is a eukaryotic-like Ser/Thr protein kinase (Zheng et al., 2007), and we found that loss of kinase activity paralleled the increase in nalidixic acid-mediated lethality. Therefore, the protective effect of YihE is due to its kinase activity. Since YihE is the first bacterial protein kinase to mitigate lethal stress, we suggest that YihE be renamed stress response kinase A (SrKA). Below, we discuss stress-mediated interactions among YihE, the TA module MazEF, the Cpx two-component envelope stress-response system, superoxide, and

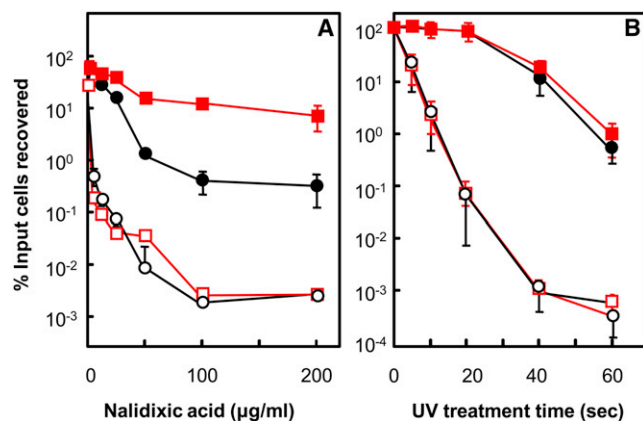

**Figure 5. Relationship between YihE and Cpx**

(A) Effect of adding  $\Delta yihE$  to a  $\Delta cpxR$  mutant when treated with quinolone. Survival of *E. coli* was measured after treatment with the indicated concentrations of nalidixic acid for 2 hr. Filled circles: WT (strain 3084); empty circles:  $\Delta yihE$  mutant (strain 3086); filled squares:  $\Delta cpxR$  mutant (strain 3357); empty squares:  $\Delta yihE$ - $\Delta cpxR$  double mutant (strain 3371).

(B) Effect of adding  $\Delta yihE$  to a  $\Delta cpxR$  mutant when treated with UV irradiation. Survival of *E. coli* was measured after exposure to UV irradiation at 0.14 mW/cm<sup>2</sup> for the indicated times. Symbols as in (A). Error bars indicate SEM.

KatG, a catalase/peroxidase that limits the cascade of ROS (see Figure 7).

### YihE Acts through the MazEF TA System

Removal of the *mazEF* operon from a  $\Delta yihE$  strain abolished  $\Delta yihE$ -mediated hyperlethality to stressors; thus, the hyperlethal response seen in the  $\Delta yihE$  mutant appears to occur through a MazF-mediated death pathway. YihE may normally act as a governor of the MazF endoribonuclease, which could allow cells time to repair stress-mediated damage. The YihE-MazF interaction appears to be indirect, since no phosphorylation of MazE, MazF, or MazG (discussed below) was observed when these proteins were purified and examined as substrates for the kinase activity of YihE (A.D.-O. and X.Z., unpublished data). Thus, passage of regulatory information from YihE to MazF is likely to be complex.

In addition to antagonism of MazF function by YihE, there are several other ways in which MazF is negatively controlled. One is inhibition of MazF activity by binding of MazE (Aizenman et al., 1996), and another is the negative effect of MazE and MazF on the activity of their own promoter (Marianovsky et al., 2001; Zhang et al., 2003a). A third one involves MazG, a protein that acts during nutritional stress (Gross et al., 2006). When bacterial cells are starved for nutrients, upregulation of *relA* and/or *spoT* results in the generation of guanosine 3',5' bispyrophosphate (ppGpp). This nucleotide, which accumulates rapidly, inhibits transcription and leads to rapid proteolytic degradation of the MazE antitoxin. MazG cleaves ppGpp, elevates levels of MazE, and indirectly neutralizes MazF. A fourth one may derive from MazF being able to generate special "stress ribosomes" that can selectively translate leaderless messenger RNA (mRNA) generated by MazF endoribonuclease activity (Vesper et al.,

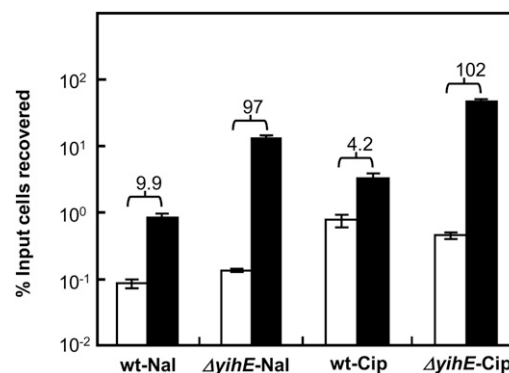

**Figure 6. YihE Protects against Stress-Induced, ROS-Mediated, Poststress PCD**

Exponentially growing *E. coli* cells were serially diluted into prewarmed LB medium to obtain a cell density of  $\sim 10^5$ - $10^6$  colony-forming units (cfu)/ml, treated with 50  $\mu$ g/ml nalidixic acid (Nal) for 45 min ( $\Delta yihE$  (strain 3086) or 90 min (WT, strain 3084) or with 0.1  $\mu$ g/ml ciprofloxacin (Cip) for 15 min ( $\Delta yihE$ ) or 40 min (WT), and plated onto LB agar containing (filled bars) or lacking (empty bars) thiourea at 125 mM (1/2 MIC). The ratio of cell survival determined with thiourea relative to that in the absence of thiourea is indicated above paired columns. Drug treatment times were adjusted so that WT and  $\Delta yihE$  mutant cells had similar levels of survival in the absence of thiourea. Error bars indicate SEM. See also Table S2.

2011). Such translation may produce survival or death proteins that mitigate or exacerbate MazF-mediated lethality (Amitai et al., 2009). The existence of multiple negative controls over the MazF toxin is consistent with this protein having a potentially serious detrimental effect in bacteria.

### YihE and MazF Are Connected to Factors Influencing ROS Surges

Several lines of evidence indicate that YihE suppresses the effects of lethal stress that occur through accumulation of ROS, especially hydroxyl radical. First, deletion of *katG*, which encodes catalase/peroxidase, was epistatic to a deletion of *yihE* when quinolone-mediated cell death was measured. Second, treatment of *E. coli* with subinhibitory concentrations of BT, which consists of two agents that inhibit hydroxyl radical accumulation (Kohanski et al., 2007; Wang and Zhao, 2009), blocked quinolone lethality even when *yihE* or *katG* was deleted. Third, a fluoroquinolone stressor that does not depend on ROS to kill bacteria (Wang et al., 2010), exhibited no hyperlethality due to a *yihE* deficiency. Fourth, treatment of *E. coli* with nalidixic acid increased intracellular ROS levels more for a  $\Delta yihE$  mutant than for WT cells.

MazF also influences the accumulation of ROS. For example, with *Bacillus subtilis*, deletion of the MazF-like toxin (NdoA) eliminates a surge of hydrogen peroxide associated with kanamycin and moxifloxacin treatment. Moreover, this deletion partially protects against the lethal action of both antimicrobials (Wu et al., 2011). With *E. coli*, deletion of MazEF does not by itself reduce the lethal action of antimicrobials, probably because negative regulation by factors such as YihE normally keeps MazF at such low levels that the effects of a *mazEF* deletion are not obvious. Nevertheless, the absence of *mazEF* does

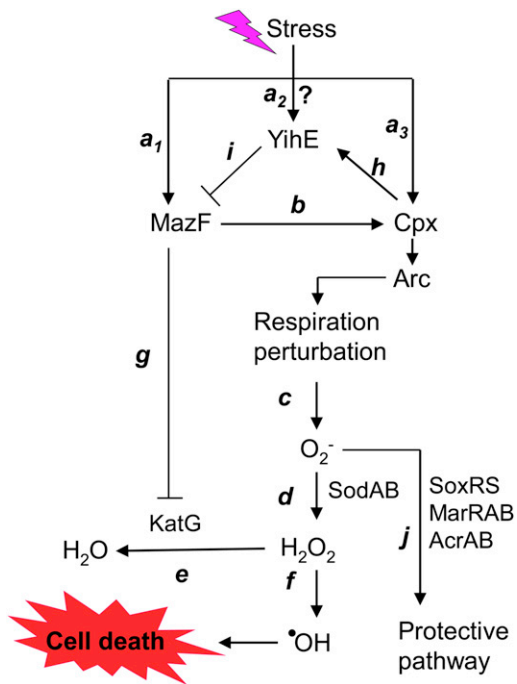

**Figure 7. Schematic Representation of Stress-Response Regulation**

(A) Stress stimulates MazF ( $A_1$ ), possibly YihE ( $A_2?$ ), and the Cpx system ( $A_3$ ).  
 (B) Activation of the MazF toxin cleaves mRNA, generating truncated mRNAs and subsequently misfolded, truncated peptides. Some of the truncated peptides lodge in the cell membrane and activate the Cpx-Arc pathway, which perturbs the respiratory chain.  
 (C) Perturbation of respiration stimulates the generation of superoxide, a byproduct of normal aerobic respiration.  
 (D) Superoxide can be converted to hydrogen peroxide by SOD and by spontaneous dismutation.  
 (E) Hydrogen peroxide is detoxified to water and oxygen by catalase/peroxidase (KatG).  
 (F) Hydrogen peroxide is converted to highly toxic hydroxyl radical, which leads to macromolecular damage and cell death.  
 (G) MazF degrades *katG* mRNA, which enhances pathway F.  
 (H) Activation of Cpx by MazF or by stress upregulates YihE.  
 (I) YihE mitigates MazF toxicity.  
 (J) Moderate accumulation of superoxide, either from stress or from TA-mediated *sod* mRNA depletion, stimulates a SoxRS-MarRAB-AcrAB-mediated protective pathway.

decrease the amount of protein carbonylation, a product of ROS-mediated oxidization of cellular proteins (Cattaruzza and Hecker, 2008; Maisonneuve et al., 2009; Wong et al., 2008), that is associated with antimicrobial treatment (Kolodkin-Gal et al., 2008). Moreover, BT reduced protein carbonylation following treatment of *E. coli* with antimicrobials (X.W. and X.Z., unpublished data). Collectively, these results fit with the idea that YihE inhibits MazF-mediated hydroxyl radical accumulation, possibly by reducing degradation of *katG* mRNA by MazF (a >2-fold reduction in the *katG* mRNA level was observed when the  $\Delta yihE$  mutant was treated with nalidixic acid; Figure S2).

### Interplay among YihE, MazF, and Cpx

Stress leads to mRNA cleavage by MazF and the accumulation of truncated mRNA (Kohanski et al., 2008; Zhang et al., 2003b).

Translation of truncated mRNA then generates abnormal proteins, some of which may lodge in the cell membrane and activate the Cpx system (Kohanski et al., 2008). Cpx activation upregulates YihE (Pogliano et al., 1997), which would in turn downregulate MazF function and reduce the generation of truncated mRNAs and proteins. Cpx also upregulates the degradative enzyme DegP and the protein-folding facilitator DsbA to remove/renature abnormal proteins lodged in the membrane (Raivio and Silhavy, 2001). These activities would eventually halt the induction of Cpx and reset the response system when stress dissipates. Thus, the MazEF and Cpx systems allow cells to respond protectively to low-to-moderate levels of lethal stress, as seen with the MazEF ortholog of *B. subtilis* (Wu et al., 2011).

Because a *cpxR*-deficient mutant exhibits lower susceptibility to lethal stress rather than the hypersusceptibility expected from the absence of a positive regulator (Kohanski et al., 2008), *yihE* is probably regulated by other factors in addition to CpxR. However, such factors have not been identified. The protective effect of a *cpxR* deficiency indicates that Cpx can also play a detrimental role in the response to stress. When lethal stress is high and persistent (e.g., exceeding a point of no return; Amitai et al., 2004), the continued production of truncated proteins arising from MazF action is likely to lead to an interaction between the Cpx and Arc two-component system that perturbs the respiratory chain (Kohanski et al., 2008). Interruption of oxidative phosphorylation is expected to allow the accumulation of superoxide, which would increase peroxide levels through spontaneous dismutation, dismutation via superoxide dismutases (SOD), and perturbation of iron-sulfur clusters (Kohanski et al., 2007). When the resulting increase in peroxide overwhelms the KatG catalase/peroxidase system, the levels of lethal hydroxyl radical will rise.

Several other observations fit with a connection among YihE, MazF, and Cpx. One is the absence of  $\Delta yihE$ -mediated hyperlethality with high temperature. If high temperature causes extensive protein denaturation that overwhelms the Cpx system, the contribution of toxin-mediated membrane protein truncation to envelope stress will be small, and the  $\Delta yihE$  effect will be masked. Another observation is the absence of  $\Delta yihE$ -mediated hyperlethality for rifampicin. Rifampicin inhibits transcription initiation, which would deplete RNA substrates for MazF-mediated RNA cleavage, reduce the mRNA and protein truncation that triggers the Cpx-Arc-ROS cascade (Kohanski et al., 2008), and thereby nullify a  $\Delta yihE$  effect. Finally, hydroxyl radical causes damage to DNA, protein, and lipid. Such macromolecular damage could serve as a secondary stress input that triggers more hydroxyl radical accumulation. Such a destructive cycle is expected to be self-amplifying once a critical level of hydroxyl radical accumulates. This would explain how death can continue to occur even after lethal quinolone-mediated stress is removed unless hydroxyl radical accumulation is blocked by thiourea. MazF may contribute to self-sustaining hydroxyl radical production by degrading *katG* mRNA, thereby pushing peroxide and hydroxyl radical levels beyond the critical threshold.

### Generality of Dual-Function Stress-Response Factors

The observations described above indicate that the Cpx stress response system participates in both protective and destructive

activities. Superoxide also appears to have a dual function. Although superoxide is part of the ROS cascade that leads to hydroxyl radical production and cell death, accumulation of superoxide also induces the protective SoxRS and MarRAB regulons (González-Flecha and Demple, 2000; Liochev et al., 1999; Miller et al., 1994). Activation of SoxS by superoxide may activate MarRAB-AcrAB efflux pumps and other SoxS-controlled protective genes that mitigate stress (Blanchard et al., 2007; Chen et al., 2006; Miller et al., 1994; Pomposiello et al., 2001). A protective effect for superoxide is supported by the finding that a *sodA-sodB* double mutant, which spontaneously accumulates higher levels of superoxide than WT cells (M.M., K.D., and X.Z. unpublished data), exhibits increased rather than decreased survival with three classes of lethal antimicrobials (Wang and Zhao, 2009). Moreover, sublethal concentrations of plumbagin, a metabolic generator of superoxide, reduce the lethal effects of the DNA-damaging agent bleomycin (Burger and Drlica, 2009). Plumbagin and paraquat, another generator of superoxide, also protect *E. coli* from the lethal action of antimicrobial classes represented by ofloxacin, ampicillin, and kanamycin (Wu et al., 2012; M.M. and X.Z., unpublished data). Moreover, deletion of *nfo*, a repair gene controlled by *soxRS*, increases the lethal activity of a variety of lethal stressors (M.M., K.D., and X.Z., unpublished data).

The protective effect of superoxide may also derive from the susceptibility of iron-sulfur clusters to this oxygen radical (Flint et al., 1993; Gardner and Fridovich, 1991). Because many dehydrogenases in the tricarboxylic acid (TCA) cycle contain iron-sulfur clusters that may be damaged by low-to-moderate concentrations of superoxide, moderate exposure to superoxide may halt the aerobic TCA cycle and force cells to undergo glycolysis to avoid lethal ROS accumulation. On the other hand, high concentrations of superoxide may generate excessive hydrogen peroxide and release free iron from damaged iron-sulfur clusters. The accumulation of peroxide and the release of free iron provide two components for the Fenton reaction, which generates highly toxic hydroxyl radical. Thus, superoxide concentration may help determine whether the effects of lethal stress are dampened by protective pathways or amplified by hydroxyl radical accumulation.

Dual functionality has also been reported with regard to a toxin deficiency in *B. subtilis*. In this organism, the MazF ortholog, NdoA, protects against low levels of UV irradiation but has a destructive effect when irradiation levels are high (Wu et al., 2011). Moreover, NdoA protects cells from antimicrobial stress but sensitizes them to the effects of high temperature and nutrient starvation. The generality of dual-function stress-response elements (e.g., TA modules, Cpx, and superoxide) helps resolve the controversy concerning opposing functions of the MazEF TA module (Christensen et al., 2003; Engelberg-Kulka et al., 2006; Tsilibaris et al., 2007): they both occur depending on conditions.

## CONCLUSIONS

One can identify genetic factors involved in the response to lethal stress by screening for defective genes that increase lethal stress without affecting bacteriostatic activity. YihE is the first

to be studied in detail (14 others have been identified; Han et al., 2010). YihE fits within the general view that lethal stress factors have two functions. At low-to-moderate levels of stress, the MazEF TA pair, the Cpx response system, and levels of superoxide are protective, whereas at high levels of stress, each system contributes to a cascade of ROS that ends with accumulation of toxic hydroxyl radical and cell death. At least three safety valves protect against the ROS cascade: YihE restricts MazF, KatG converts peroxide to water, and superoxide leads to induction of protective pathways. Why exposure to stress would trigger a genetically programmed death pathway in unicellular bacteria is open to speculation. Self-destruction may provide a selective advantage to bacterial populations by eliminating seriously damaged cells that might otherwise utilize scarce resources. It may also reduce the risk of hypermutation and loss of genetic integrity arising from massive, error-prone damage repair. Regardless of the reason, the existence of PCD provides an opportunity to enhance antimicrobial activity.

## EXPERIMENTAL PROCEDURES

### Bacterial Strains and Growth Conditions

*E. coli* K-12 strains (Table S1) were grown at 37°C in Luria-Bertani (LB) medium. Susceptibility to stress was measured with exponentially growing cultures unless indicated otherwise. A Tn5 mutagenesis library was constructed by infecting strain AB1157 with defective bacteriophage lambda carrying Tn5tac1, and kanamycin-resistant colonies were screened for nalidixic acid susceptibility via both killing and growth-inhibition assays. Strains were constructed by bacteriophage P1-mediated transduction. Recombinant plasmids containing *yihE* or other target genes were constructed by inserting PCR-amplified gene fragments into the appropriate plasmid vectors (Table S3). A detailed description of the materials and methods used in this work can be found in the Extended Experimental Procedures.

### Antimicrobial Susceptibility

MIC was assayed by overnight incubation of *E. coli* in a series of tubes containing sequential 2-fold increases in drug concentration. Lethal activity was determined by incubating bacteria with various concentrations of antimicrobial or other stressor followed by plating on drug-free agar. Poststress death was assessed by plating aliquots of stress-exposed cultures on LB agar containing or lacking thiourea at 125 mM (1/2 MIC).

### Site-Directed Mutagenesis of *yihE*

pACYC184-*yihE* was used as a template in a mutagenic PCR with the primers listed in Table S3. Nucleotide sequence determination confirmed the presence of the targeted mutations.

### Expression and Purification of Proteins

Plasmid carrying *yihE*, *mazE*, *mazEF*, or *mazG* (see Table S1 for plasmid list and details) was introduced into competent *E. coli* BL21 (DE3) or Rosetta 2 cells by bacterial transformation. Transformants were grown to  $A_{600} = 0.5$  and then treated with isopropyl- $\beta$ -D-thiogalactopyranoside (IPTG) for an additional 2 hr to induce expression of 6xHis-tagged proteins. Cell lysates were clarified by centrifugation, and proteins were purified from supernatant fluids using QIAGEN Ni-NTA Fast Start kits as described by the manufacturer.

### Kinase Activity Assay

Kinase activity was measured by incubating YihE with myelin basic protein (MBP) in kinase buffer (25 mM Tris-Cl pH 7.5, 2 mM MgCl<sub>2</sub>, 1 mM dithiothreitol) with or without 10  $\mu$ Ci [ $\gamma$ -<sup>32</sup>P] ATP at 37°C for 30 min. Proteins were separated by SDS-PAGE. Gels were stained with Coomassie Brilliant Blue to locate proteins, and exposed to a PhosphorImager screen to measure incorporation of radioactivity.



### Measurement of Intracellular ROS

*E. coli* cells were grown to early exponential phase, treated with 10  $\mu$ M H<sub>2</sub>DCFDA for 30 min, treated with nalidixic acid (50  $\mu$ g/ml) for 90 min, and then subjected to FACS analysis (Liu et al., 2012).

### SUPPLEMENTAL INFORMATION

Supplemental Information includes Extended Experimental Procedures, two figures, and three tables and can be found with this article online at <http://dx.doi.org/10.1016/j.celrep.2013.01.026>.

### LICENSING INFORMATION

This is an open-access article distributed under the terms of the Creative Commons Attribution-NonCommercial-No Derivative Works License, which permits non-commercial use, distribution, and reproduction in any medium, provided the original author and source are credited.

### ACKNOWLEDGMENTS

We thank Babak Baseri, Liping Li, Yulin Qu, and Yuzhi Hong for technical assistance, and Marila Gennaro, Ming Lu, David Perlin, Richard Pine, Issar Smith, and Sanjay Tyagi for critical comments on the manuscript. This work was supported by grants from the National Institutes of Health (1-DP2-OD007423, 1-R01-AI 073491, and 1-R21-AI 068014-01A2) and the National Natural Science Foundation of China (30860012 and 30973596).

Received: October 12, 2012

Revised: January 15, 2013

Accepted: January 22, 2013

Published: February 14, 2013

### REFERENCES

- Aizenman, E., Engelberg-Kulka, H., and Glaser, G. (1996). An *Escherichia coli* chromosomal "addiction module" regulated by guanosine [corrected] 3',5'-bispyrophosphate: a model for programmed bacterial cell death. *Proc. Natl. Acad. Sci. USA* 93, 6059–6063.
- Amitai, S., Yassin, Y., and Engelberg-Kulka, H. (2004). MazF-mediated cell death in *Escherichia coli*: a point of no return. *J. Bacteriol.* 186, 8295–8300.
- Amitai, S., Kolodkin-Gal, I., Hananya-Meltabashi, M., Sacher, A., and Engelberg-Kulka, H. (2009). *Escherichia coli* MazF leads to the simultaneous selective synthesis of both "death proteins" and "survival proteins". *PLoS Genet.* 5, e1000390.
- Baba, T., Ara, T., Hasegawa, M., Takai, Y., Okumura, Y., Baba, M., Datsenko, K.A., Tomita, M., Wanner, B.L., and Mori, H. (2006). Construction of *Escherichia coli* K-12 in-frame, single-gene knockout mutants: the Keio collection. *Mol. Syst. Biol.* 2, 2006.0008.
- Blanchard, J.L., Wholey, W.Y., Conlon, E.M., and Pomposiello, P.J. (2007). Rapid changes in gene expression dynamics in response to superoxide reveal SoxRS-dependent and independent transcriptional networks. *PLoS ONE* 2, e1186.
- Burger, R.M., and Drlaca, K. (2009). Superoxide protects *Escherichia coli* from bleomycin mediated lethality. *J. Inorg. Biochem.* 103, 1273–1277.
- Cattaruzza, M., and Hecker, M. (2008). Protein carbonylation and decarboxylation: a new twist to the complex response of vascular cells to oxidative stress. *Circ. Res.* 102, 273–274.
- Chen, C.R., Malik, M., Snyder, M., and Drlaca, K. (1996). DNA gyrase and topoisomerase IV on the bacterial chromosome: quinolone-induced DNA cleavage. *J. Mol. Biol.* 258, 627–637.
- Chen, J.W., Sun, C.M., Sheng, W.L., Wang, Y.C., and Syu, W.J. (2006). Expression Analysis of Up-Regulated Genes Responding to Plumbagin in *Escherichia coli*. *J. Bacteriol.* 188, 456–463.
- Christensen, S.K., Pedersen, K., Hansen, F.G., and Gerdes, K. (2003). Toxin-antitoxin loci as stress-response-elements: ChpAK/MazF and ChpBK cleave translated RNAs and are counteracted by tmRNA. *J. Mol. Biol.* 332, 809–819.
- Davies, B.W., Kohanski, M.A., Simmons, L.A., Winkler, J.A., Collins, J.J., and Walker, G.C. (2009). Hydroxyurea induces hydroxyl radical-mediated cell death in *Escherichia coli*. *Mol. Cell* 36, 845–860.
- Dwyer, D.J., Kohanski, M.A., Hayete, B., and Collins, J.J. (2007). Gyrase inhibitors induce an oxidative damage cellular death pathway in *Escherichia coli*. *Mol. Syst. Biol.* 3, 91.
- Dwyer, D.J., Camacho, D.M., Kohanski, M.A., Callura, J.M., and Collins, J.J. (2012). Antibiotic-induced bacterial cell death exhibits physiological and biochemical hallmarks of apoptosis. *Mol. Cell* 46, 561–572.
- Engelberg-Kulka, H., Amitai, S., Kolodkin-Gal, I., and Hazan, R. (2006). Bacterial programmed cell death and multicellular behavior in bacteria. *PLoS Genet.* 2, e135.
- Flint, D.H., Tuminello, J.F., and Emptage, M.H. (1993). The inactivation of Fe-S cluster containing hydro-lyases by superoxide. *J. Biol. Chem.* 268, 22369–22376.
- Gardner, P.R., and Fridovich, I. (1991). Superoxide sensitivity of the *Escherichia coli* 6-phosphogluconate dehydratase. *J. Biol. Chem.* 266, 1478–1483.
- González-Flecha, B., and Dimple, B. (2000). Genetic responses to free radicals. Homeostasis and gene control. *Ann. N Y Acad. Sci.* 899, 69–87.
- Goss, W.A., Deitz, W.H., and Cook, T.M. (1965). Mechanism of action of nalidixic acid on *Escherichia coli*. II. Inhibition of deoxyribonucleic acid synthesis. *J. Bacteriol.* 89, 1068–1074.
- Gross, M., Marianovsky, I., and Glaser, G. (2006). MazG—a regulator of programmed cell death in *Escherichia coli*. *Mol. Microbiol.* 59, 590–601.
- Han, X., Dorsey-Oresto, A., Malik, M., Wang, J.Y., Drlaca, K., Zhao, X., and Lu, T. (2010). *Escherichia coli* genes that reduce the lethal effects of stress. *BMC Microbiol.* 10, 35.
- Hassan, H.M., and Fridovich, I. (1979). Superoxide, hydrogen peroxide, and oxygen tolerance of oxygen-sensitive mutants of *Escherichia coli*. *Rev. Infect. Dis.* 1, 357–369.
- Hazan, R., Sat, B., and Engelberg-Kulka, H. (2004). *Escherichia coli* mazEF-mediated cell death is triggered by various stressful conditions. *J. Bacteriol.* 186, 3663–3669.
- Jung, U., Zheng, X., Yoon, S.O., and Chung, A.S. (2001). Se-methylselenocysteine induces apoptosis mediated by reactive oxygen species in HL-60 cells. *Free Radic. Biol. Med.* 31, 479–489.
- Kohanski, M.A., Dwyer, D.J., Hayete, B., Lawrence, C.A., and Collins, J.J. (2007). A common mechanism of cellular death induced by bactericidal antibiotics. *Cell* 130, 797–810.
- Kohanski, M.A., Dwyer, D.J., Wierzbowski, J., Cottarel, G., and Collins, J.J. (2008). Mistranslation of membrane proteins and two-component system activation trigger antibiotic-mediated cell death. *Cell* 135, 679–690.
- Kolodkin-Gal, I., Sat, B., Keshet, A., and Engelberg-Kulka, H. (2008). The communication factor EDF and the toxin-antitoxin module *mazEF* determine the mode of action of antibiotics. *PLoS Biol.* 6, e319.
- Lewis, K. (2000). Programmed death in bacteria. *Microbiol. Mol. Biol. Rev.* 64, 503–514.
- Liochev, S.I., Benov, L., Touati, D., and Fridovich, I. (1999). Induction of the soxRS regulon of *Escherichia coli* by superoxide. *J. Biol. Chem.* 274, 9479–9481.
- Liu, Y., Liu, X., Qu, Y., Wang, X., Li, L., and Zhao, X. (2012). Inhibitors of reactive oxygen species accumulation delay and/or reduce the lethality of several anti-staphylococcal agents. *Antimicrob. Agents Chemother.* 56, 6048–6050.
- Maisonneuve, E., Ducret, A., Khoueiry, P., Lignon, S., Longhi, S., Talla, E., and Dukan, S. (2009). Rules governing selective protein carbonylation. *PLoS ONE* 4, e7269.
- Marianovsky, I., Aizenman, E., Engelberg-Kulka, H., and Glaser, G. (2001). The regulation of the *Escherichia coli* mazEF promoter involves an unusual alternating palindrome. *J. Biol. Chem.* 276, 5975–5984.

- Matés, J.M., and Sánchez-Jiménez, F.M. (2000). Role of reactive oxygen species in apoptosis: implications for cancer therapy. *Int. J. Biochem. Cell Biol.* 32, 157–170.
- Miller, P.F., Gambino, L.F., Sulavik, M.C., and Gracheck, S.J. (1994). Genetic relationship between *soxRS* and *mar* loci in promoting multiple antibiotic resistance in *Escherichia coli*. *Antimicrob. Agents Chemother.* 38, 1773–1779.
- Pedersen, K., Christensen, S.K., and Gerdes, K. (2002). Rapid induction and reversal of a bacteriostatic condition by controlled expression of toxins and antitoxins. *Mol. Microbiol.* 45, 501–510.
- Pogliano, J., Lynch, A.S., Belin, D., Lin, E.C., and Beckwith, J. (1997). Regulation of *Escherichia coli* cell envelope proteins involved in protein folding and degradation by the Cpx two-component system. *Genes Dev.* 11, 1169–1182.
- Pomposiello, P.J., Bennis, M.H., and Demple, B. (2001). Genome-wide transcriptional profiling of the *Escherichia coli* responses to superoxide stress and sodium salicylate. *J. Bacteriol.* 183, 3890–3902.
- Raivio, T.L., and Silhavy, T.J. (2001). Periplasmic stress and ECF sigma factors. *Annu. Rev. Microbiol.* 55, 591–624.
- Rice, K.C., and Bayles, K.W. (2003). Death's toolbox: examining the molecular components of bacterial programmed cell death. *Mol. Microbiol.* 50, 729–738.
- Sambrook, J., Fritsch, E., and Maniatis, T. (1989). *Molecular Cloning* (Cold Spring Harbor, NY: Cold Spring Harbor Press).
- Sat, B., Hazan, R., Fisher, T., Khaner, H., Glaser, G., and Engelberg-Kulka, H. (2001). Programmed cell death in *Escherichia coli*: some antibiotics can trigger *mazEF* lethality. *J. Bacteriol.* 183, 2041–2045.
- Simizu, S., Takada, M., Umezawa, K., and Imoto, M. (1998). Requirement of caspase-3(-like) protease-mediated hydrogen peroxide production for apoptosis induced by various anticancer drugs. *J. Biol. Chem.* 273, 26900–26907.
- Stratton, C.W. (2003). Dead bugs don't mutate: susceptibility issues in the emergence of bacterial resistance. *Emerg. Infect. Dis.* 9, 10–16.
- Tsilibaris, V., Maenhaut-Michel, G., Mine, N., and Van Melderen, L. (2007). What is the benefit to *Escherichia coli* of having multiple toxin-antitoxin systems in its genome? *J. Bacteriol.* 189, 6101–6108.
- Vesper, O., Amitai, S., Belitsky, M., Byrgazov, K., Kaberdina, A.C., Engelberg-Kulka, H., and Moll, I. (2011). Selective translation of leaderless mRNAs by specialized ribosomes generated by MazF in *Escherichia coli*. *Cell* 147, 147–157.
- Wang, X., and Zhao, X. (2009). Contribution of oxidative damage to antimicrobial lethality. *Antimicrob. Agents Chemother.* 53, 1395–1402.
- Wang, X., Zhao, X., Malik, M., and Drlica, K. (2010). Contribution of reactive oxygen species to pathways of quinolone-mediated bacterial cell death. *J. Antimicrob. Chemother.* 65, 520–524.
- Wong, C.M., Cheema, A.K., Zhang, L., and Suzuki, Y.J. (2008). Protein carbonylation as a novel mechanism in redox signaling. *Circ. Res.* 102, 310–318.
- Wu, X., Wang, H., and Zhao, X. (2008). Antimicrobial studies with the *Pseudomonas aeruginosa* two-allele library require caution. *Antimicrob. Agents Chemother.* 52, 3826–3827.
- Wu, X., Wang, X., Drlica, K., and Zhao, X. (2011). A toxin-antitoxin module in *Bacillus subtilis* can both mitigate and amplify effects of lethal stress. *PLoS ONE* 6, e23909.
- Wu, Y., Vulić, M., Keren, I., and Lewis, K. (2012). Role of oxidative stress in persister tolerance. *Antimicrob. Agents Chemother.* 56, 4922–4926.
- Zhang, J., Zhang, Y., and Inouye, M. (2003a). Characterization of the interactions within the *mazEF* addiction module of *Escherichia coli*. *J. Biol. Chem.* 278, 32300–32306.
- Zhang, Y., Zhang, J., Hoeflich, K.P., Ikura, M., Qing, G., and Inouye, M. (2003b). MazF cleaves cellular mRNAs specifically at ACA to block protein synthesis in *Escherichia coli*. *Mol. Cell* 12, 913–923.
- Zheng, J., He, C., Singh, V.K., Martin, N.L., and Jia, Z. (2007). Crystal structure of a novel prokaryotic Ser/Thr kinase and its implication in the Cpx stress response pathway. *Mol. Microbiol.* 63, 1360–1371.