

# Ionospheric radars development

Enrico Zuccheretti, Umberto Sciacca

*enrico.zuccheretti@ingv.it - umberto.sciacca@ingv.it*

*Istituto Nazionale di Geofisica e Vulcanologia - Rome, Italy*

The following slides were presented during the lectures of the course "**Desarrollo de radares ionosféricos**" held within the post graduate course on "**Geofísica espacial**" organised by the Universidad Nacional de Tucumán - Facultad de Ciencias Exactas y Tecnología - Departamento de Posgrado in Tucumán on 4 – 7 October 2010.



# Module 1

## Basics of radar theory and design elements

## Introduction

- Amongst the big variety of techniques used to study the geophysical environment, methods using electromagnetic waves occupy a very prominent position.
  - These techniques exploit radio waves modifications when they interact with the medium they pass through.
- 
- The ionosphere is no exception: the most common way to study its behaviour is to emit radio wave pulses into the ionosphere and to study the backscattered echo.
  - The echo signal contains information about the layers in which it may be refracted, reflected or absorbed.
  - Also signals coming from satellites (NNSS, GPS) or from terrestrial emitting station (VLF emitters) can be used. They do not exploit the radar technique but their properties are affected by the medium they pass through.

## Radio Frequencies Bands

ELF	SLF	ULF	VLF	LF	MF	HF	VHF	UHF	SHF	EHF
3 Hz	30 Hz	300 Hz	3 kHz	30 kHz	300 kHz	3 MHz	30 MHz	300 MHz	3 GHz	30 GHz
30 Hz	300 Hz	3 kHz	30 kHz	300 kHz	3 MHz	30 MHz	300 MHz	3 GHz	30 GHz	300 GHz

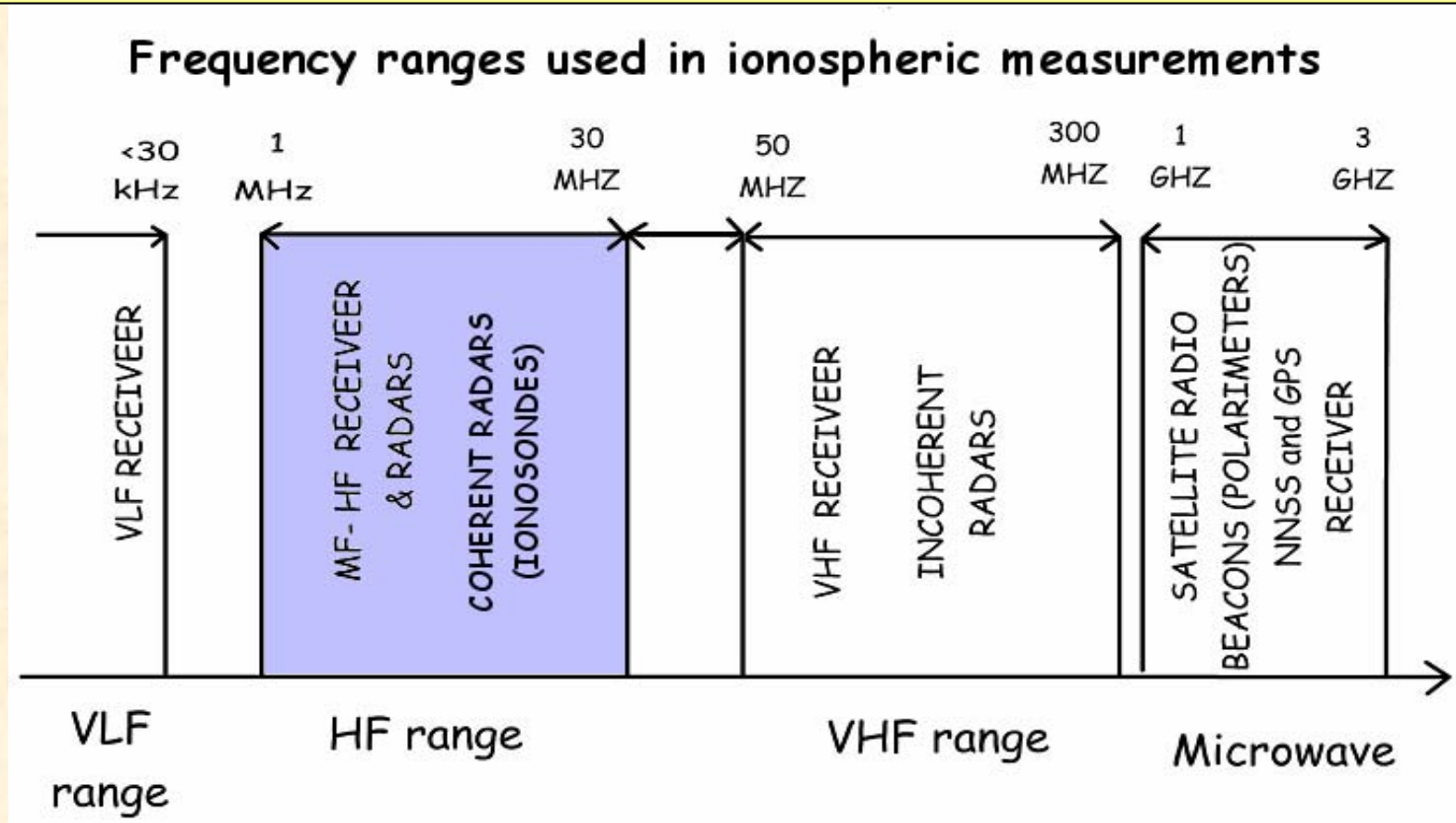

## The vertical sounding technique

- The measure technique is based on sending pulses of energy at **different frequencies** towards the ionosphere and in measuring the backscattered **echo delay** to properly evaluate the position of ionospheric layers.
- In transmitting and receiving energy we assume the usage of antennas (TX and RX ones).
- The instrument able to perform such a measurement is called "ionosonde" and can be considered the radar's "ancestor".
- The first vertical sounding with pulse technique was performed in 1925 with a system developed by Breit e Tuve. However the existence of the ionosphere and the ionospheric reflection had been experienced some years before.
- The direct product of the vertical sounding is the ionogram: plot of echo's delay times (or heights) versus frequency.
- Next step is to work around the ionogram to retrieve the main ionospheric parameters and the density profile.



## Radio Detection And Ranging (radar)

Using e.m. pulses of proper frequency and amplitude it is able to find targets and to reveal the distance from the radar itself.

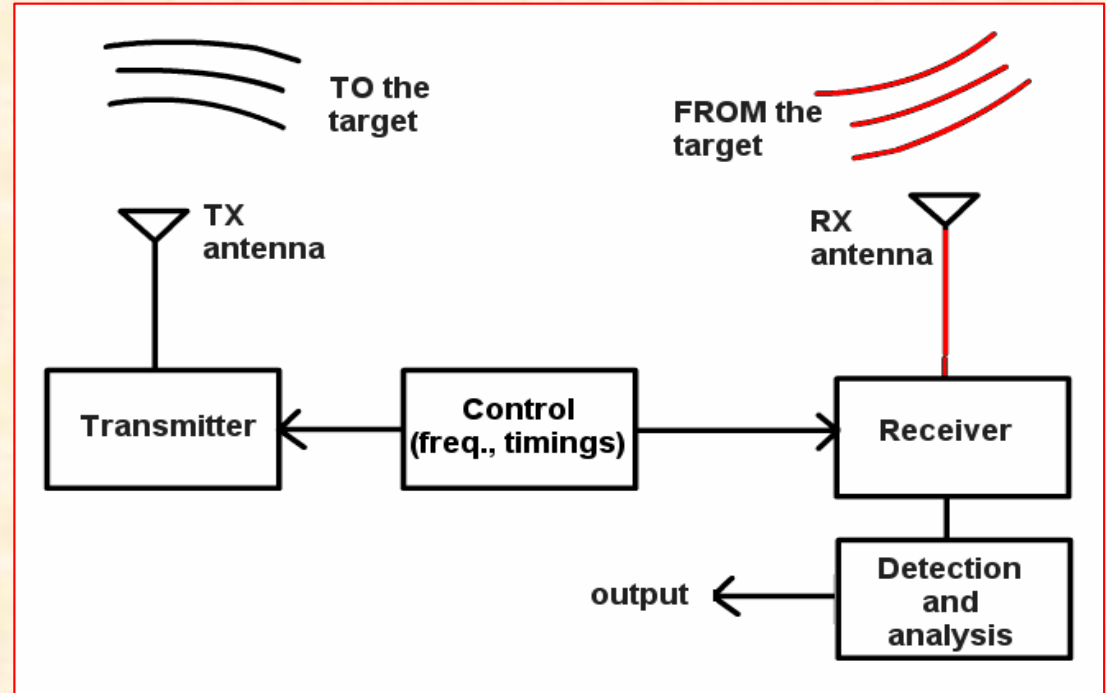

bistatic: two antennas

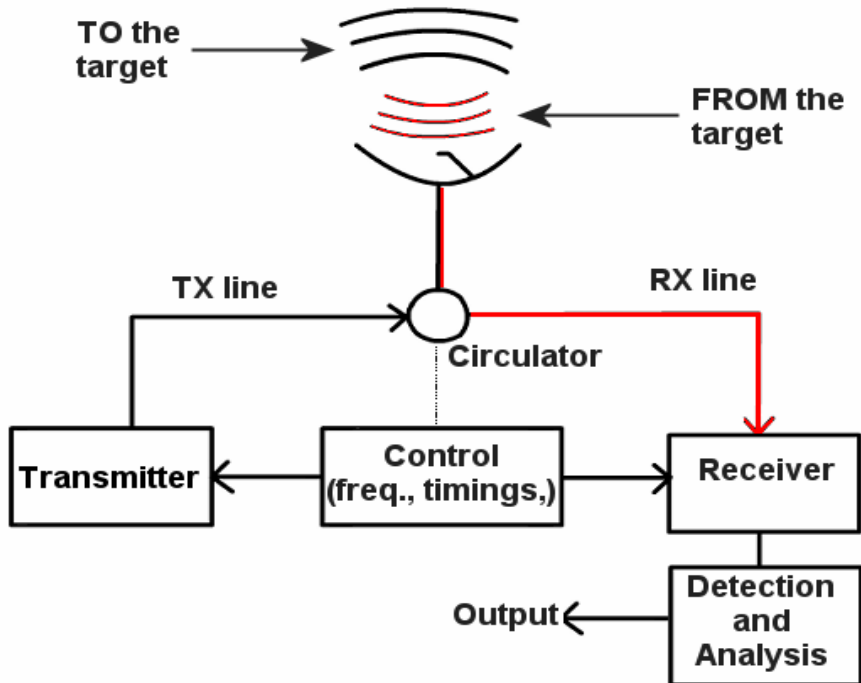

monostatic: one antenna (circulator to direct energy)

Independently of the type the control section communicates with both the TX and RX section so that the receiver can be tuned properly.

## Radar equation

$$P_r = \frac{\lambda^2 G_t G_r \sigma P_{rad}}{(4\pi)^3 r^4}$$

Parameter	Definition	Unit
$P_r$	Power at the receiver input	W
$\lambda$	Wavelength	m
$G_t, G_r$	TX and RX antenna directive gains	
$\sigma$	Radar cross section (describes the target capability to reflect the energy)	m <sup>2</sup>
$P_{rad}$	Emitted power (power dissipated in the antenna characteristic impedance)	W
$r$	Distance between the radar and the target	m

## Radar cross section

Radar cross section is the area able to catch the incident wave and to scatter the energy in the surrounding space isotropically:

$$\sigma = 4 \pi r^2 \frac{P_s}{P_i}$$

where

$r$  distance;

$P_i$  incident density power on the target;

$P_s$  scattered density power at a distance  $r$  from the target.



## Envelope technique (1/3)

Pulses of proper amplitude and duration are emitted by proper antenna in the target direction.

After a time "t" a possible echo reaches the receiver of the radar.

The evaluation of the distance is performed measuring the delay time between the emitted and the received pulse.

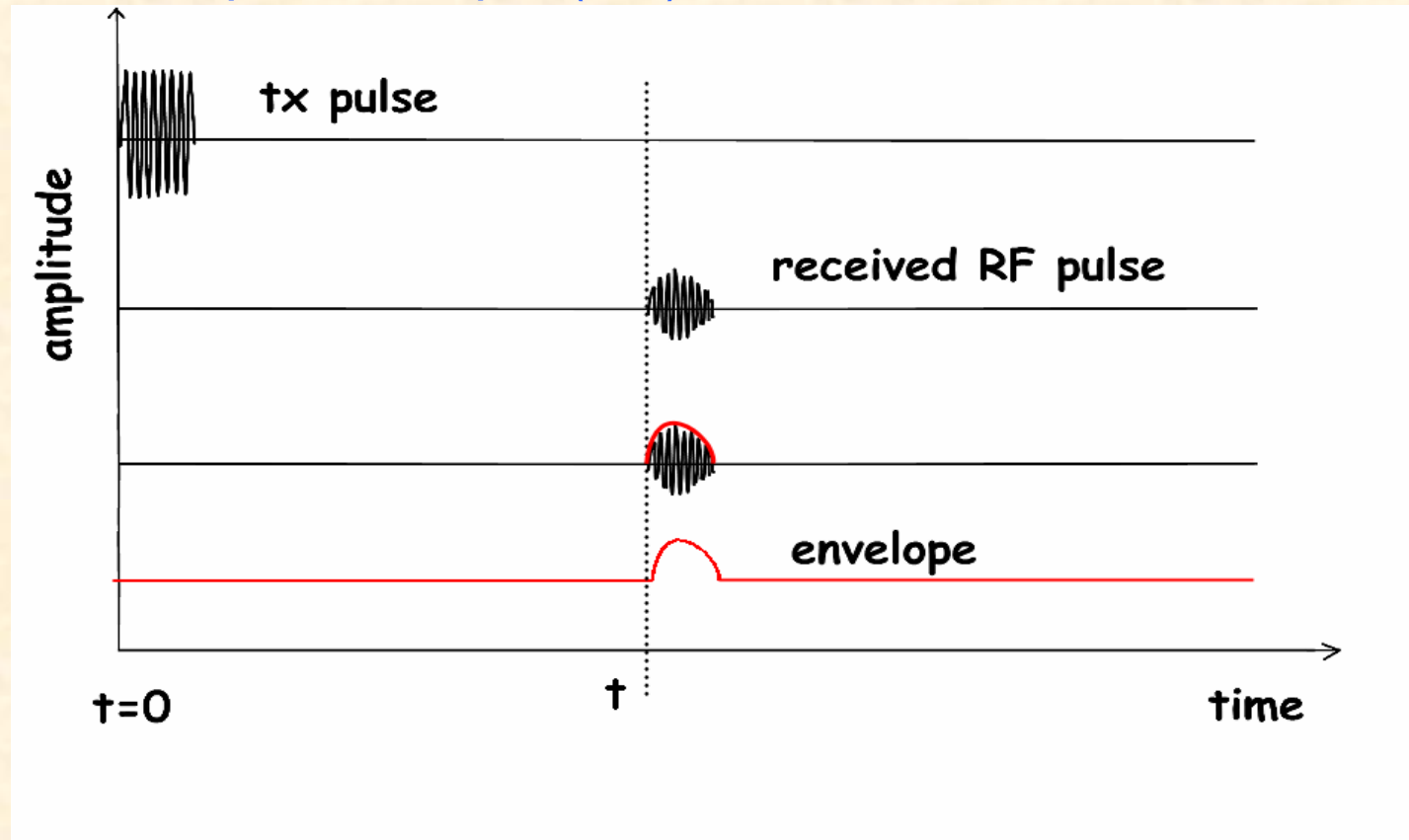

The early model of radars were based on the envelope technique.

The receiver that is tuned on the emitted frequency is able to follow the relative maxima of the signal generating an electric signal that "envelopes" the received echo.

$$d = \frac{v \cdot t}{2}$$

## Envelope technique (2/3)

- Pulses of length equal to  $\tau$  seconds repeated every  $T$  seconds are emitted through a transmitting antenna.
- The power has to be adequate so that a detectable signal is obtained (design requirement).
- Reflected and attenuated energy from the target is received through RX antenna after an interval  $\Delta t$ .

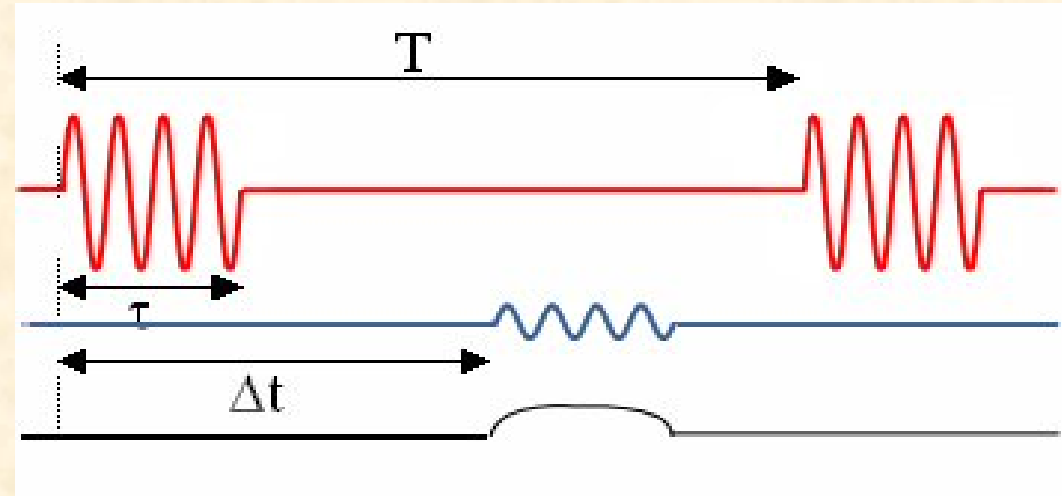

- Using the envelope technique the receiving system generates a pulse whose length is approximately  $\tau$ .

According to this simple model we can derive the main features of an envelope radar:

•Target's distance .....

$$d = \frac{c \cdot \Delta t}{2}$$

•Minimum distance .....

$$d_{\min} = \frac{c \cdot \tau}{2}$$

## Envelope technique (3/3)

- To evaluate a radar's resolution we need to remember that 2 echoes can be distinguished if the arriving times are so that  $t_2 - t_1 > \tau$

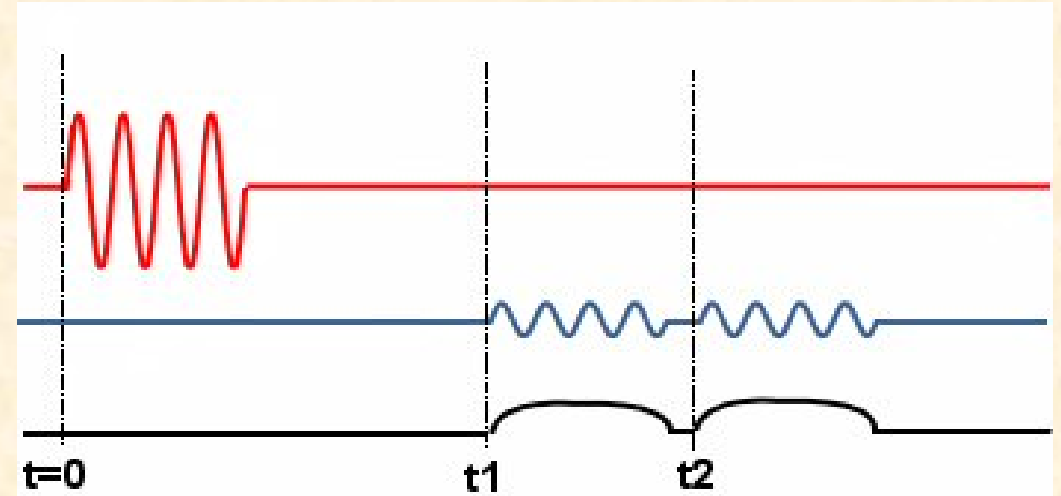

- Minimum distance between 2 targets (spatial resolution) .....

$$\delta d = \frac{c \cdot \tau}{2}$$

- Maximum target distance.....

$$d_{\max} = \frac{c \cdot T}{2}$$

- Energy from a P power amplifier.....

$$E = P \cdot \tau$$

### Advantages

- Very simple TX and RX systems.
- There is the possibility of a complete analog receiver (no PC is needed).

### Disadvantages

- Compromise for  $\tau$  is needed.
- Sometimes we have a limited resolution.
- High power to get a good SNR.

## Overcoming the compromise: the pulse compression idea

The compromise between energy and resolution was for long time a challenge.

Technological limitations may affect peak power: it is easier to develop a pulse of 2 kW peak for 100  $\mu$ s than to provide 20 kW peak for 10  $\mu$ s, even if the pulse energy is the same in both cases.

To overcome the point we can remind that the resolution depends on the **bandwidth** of the pulse we use.

$$\delta d \approx \frac{c}{B}$$

If we increase the band we could afford longer pulses with the same resolution.

A form of modulation is superimposed to the long pulse, increasing its bandwidth getting the same resolution than a short pulse would give: we compress the pulse.

## Pulse compression: phase modulation

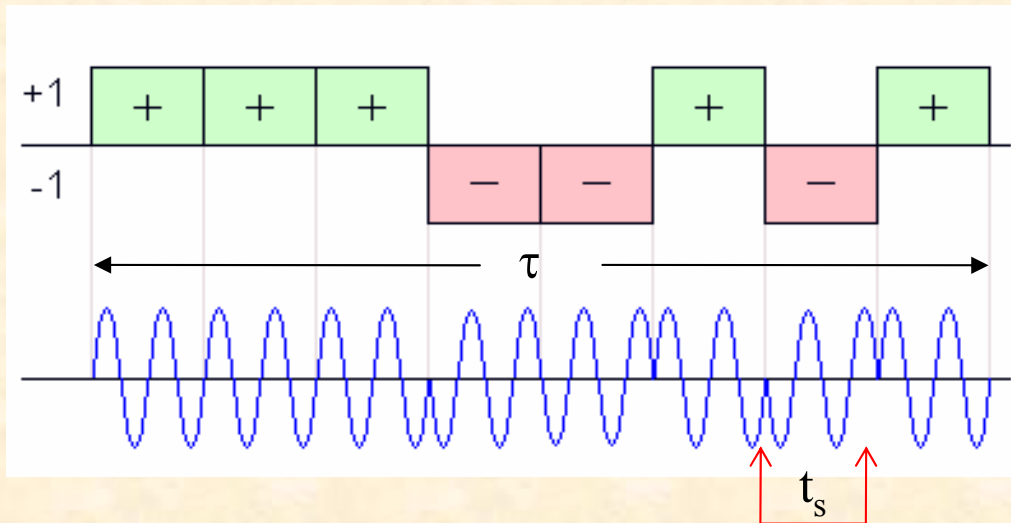

- This kind of modulation is obtained repeatedly varying the **phase** of the carrier inside a pulse  $\tau$  (the sequence is the CODE).
- $t_s$  is the minimum time interval in which the phase is kept constant (sub pulse).

- When the code is found, in the receiver, a mathematical process of **correlation** creates a pulse with an evident peak whose width is  $t_s$  with some side lobes.
- The resolution of the process is not related to  $\tau$ , but is similar to the one compatible with a pulse  $t_s$  (“pulse compression”).

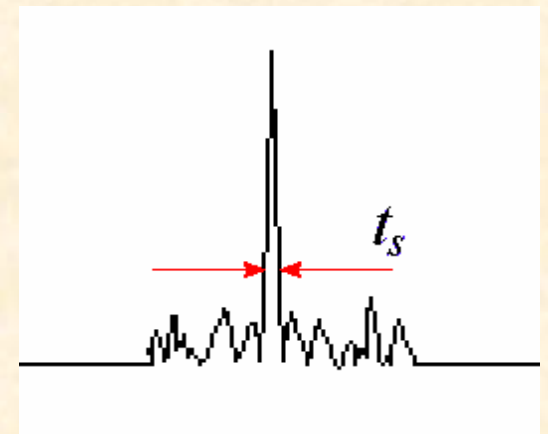



## Pulse compression: frequency modulation (chirp)

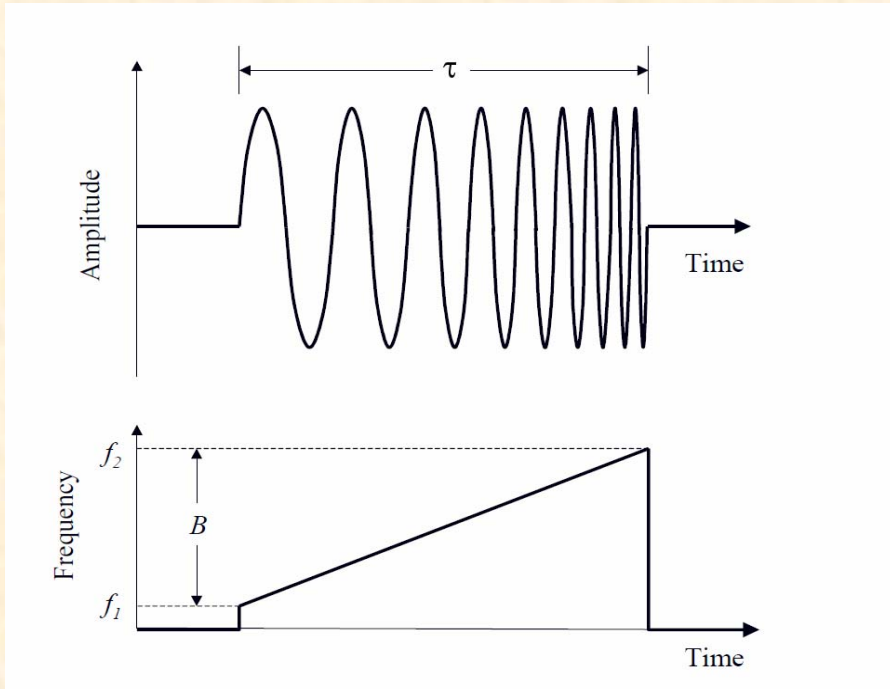

- Linearly varying the **frequency** inside of a pulse  $\tau$ , from a frequency  $f_1$  up to a frequency  $f_2$  ( $f_2 - f_1 = B$ ), the resolution in the receiving process only depends on  $B$ .

- This kind of frequency modulation is a sort of **CODE**.

- Also here a **correlation** process looking for the code in the received echo exists. When the code is found a sort of “sinc” is generated whose width is  $1/B$ .

- It is a robust process highly immune to the noise.

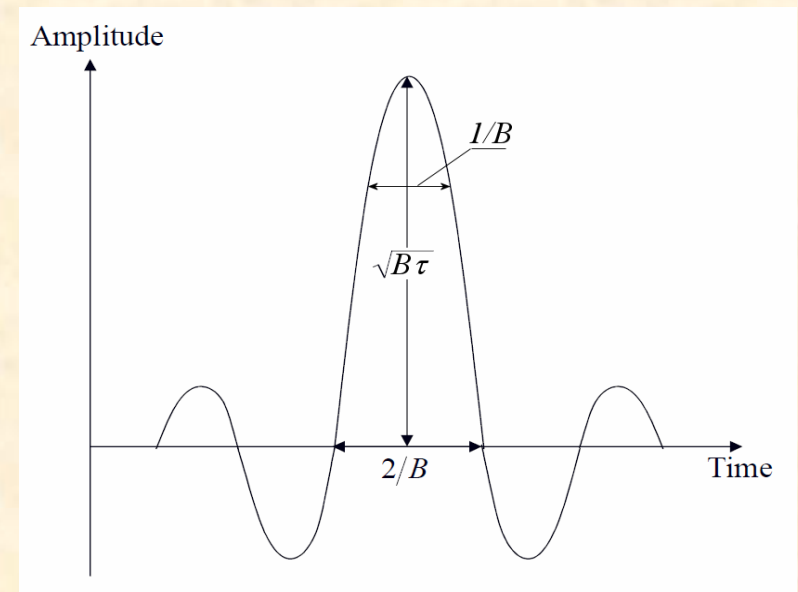



## Compression techniques comparison

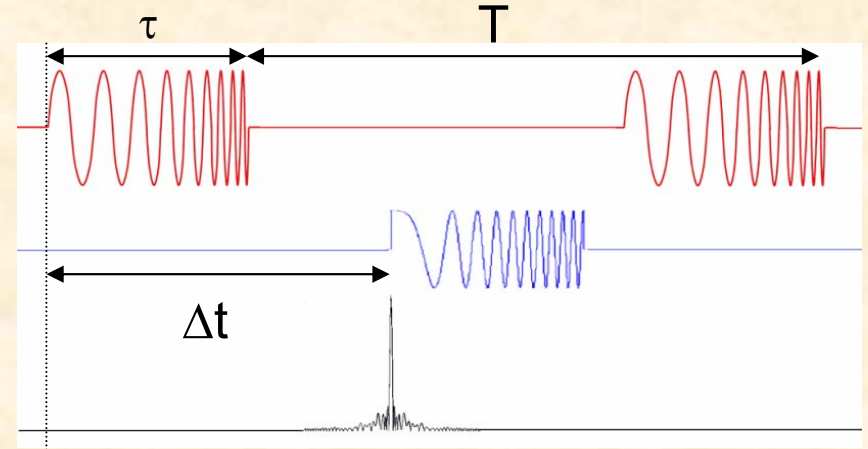
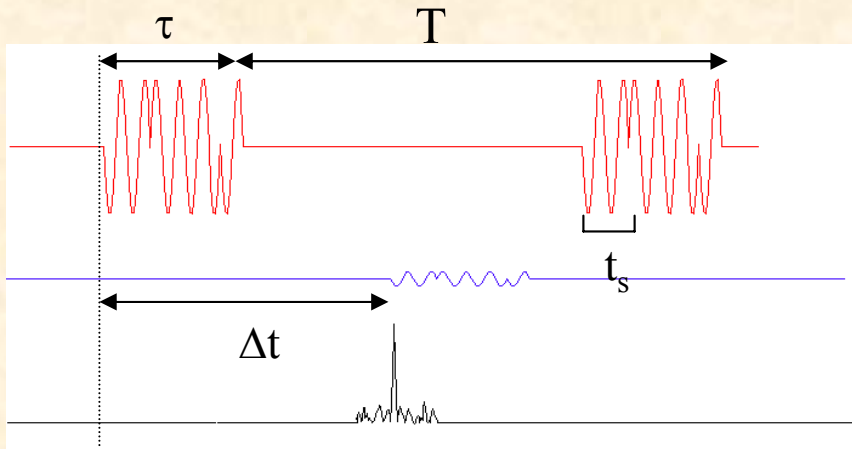

$$d = \frac{c \cdot \Delta t}{2}$$

Distance of the target

$$d = \frac{c \cdot \Delta t}{2}$$

$$d_{\min} = \frac{c \cdot \tau}{2}$$

Minimum distance

$$d_{\min} = \frac{c \cdot \tau}{2}$$

$$\delta d = \frac{c \cdot t_s}{2}$$

Spatial resolution

$$\delta d = \frac{c}{2B}$$

$$E = P \cdot \tau$$

Energy

$$E = P \cdot \tau$$

$$d_{\max} = \frac{c \cdot T}{2}$$

Maximum distance

$$d_{\max} = \frac{c \cdot T}{2}$$

# Why pulse compression works

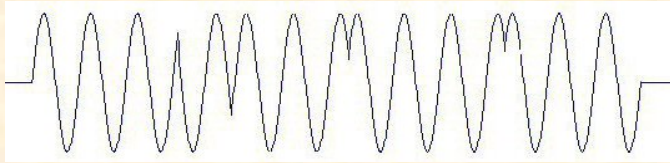

Pulse width 480  $\mu$ s  
 Repetition rate 60 Hz  
 CODE  
 Band width ~66 kHz

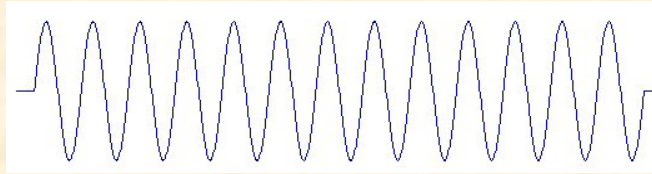

Pulse width 480  $\mu$ s  
 Repetition rate 60 Hz  
 NO CODE  
 Band width ~4 kHz

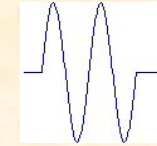

Pulse width 30  $\mu$ s  
 Repetition rate 60 Hz  
 NO CODE  
 Band width ~66 kHz

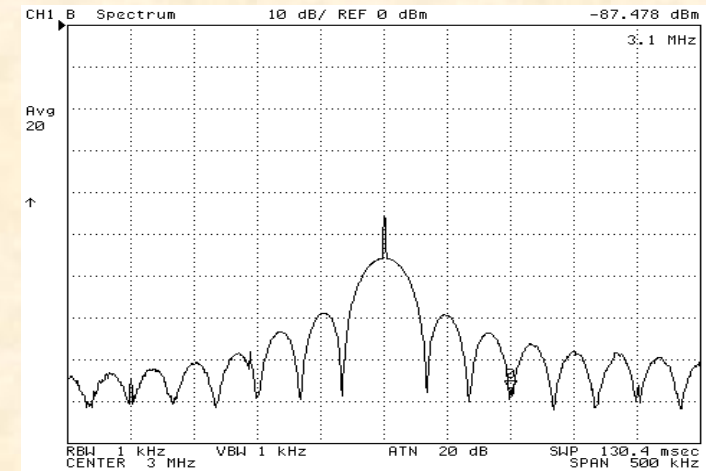
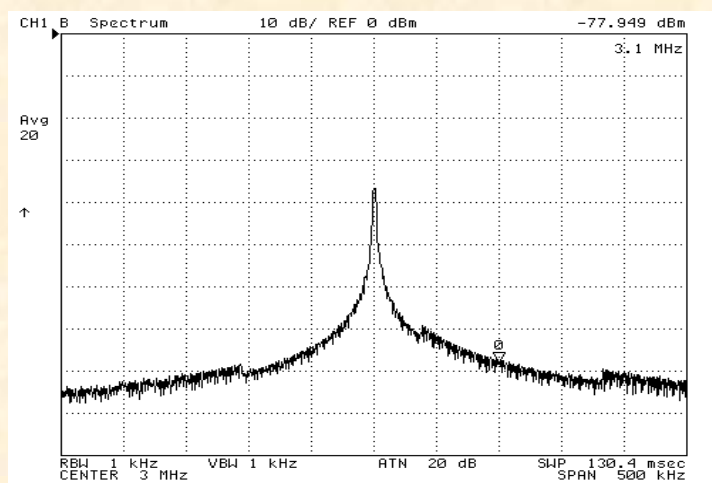
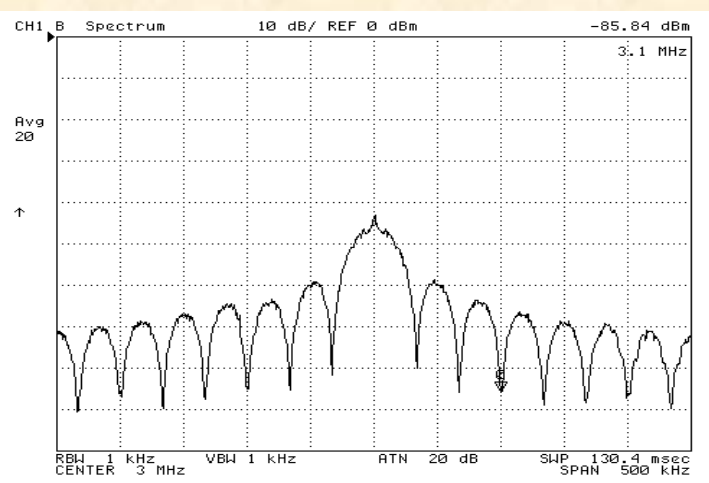

## Advantages

- Resolution depends on B or  $t_s$  only
- Higher values for  $\tau$  that is less power for the same energy.
- Higher SNR at the output.

## Limits

- More complexity in TX pulse generation.
- More complex analysis to detect the target.
- A mathematical process is necessary.

## A particular radar: the ionosonde

A radar is designed to fulfil some requirements depending on the target and the phenomena we want to highlight.

frequency range: (1 - 20) MHz

frequency step : 50 kHz or 100 kHz

resolution: should be < 20 km

minimum height: in the interval 50 -100 km

maximum height: > 600 km

the target is an infinite reflecting planes (ionized layers) more than single scattering points (radar cross section). This yields the equation radar to become

$$\cancel{P_r = \frac{(G_d \lambda)^2 \sigma P_{rad}}{(4\pi)^3 r^4}} \quad \longrightarrow \quad P_r = \frac{(\lambda G_d)^2 P_{rad}}{(4\pi r)^2}$$

We suppose the antennas to be identical, so  $G_d$  is used

## Signal attenuation (1/5)

- Concerning the attenuation in the previous equation we considered only the geometric attenuation that is always present. A more complete version of the radar equation for ionosonde is

$$P_r = \frac{(\lambda G_d)^2 P_{rad}}{(4\pi r)^2 L}$$

L summarizes other possible contributions that are:

- **non deviative**
- **deviative**
- **polarization**
- **focusing**
- **shielding**
- **system losses**
- **antennas**

- **geometric attenuation** due to the travelling of the energy to the target and back. Can be evaluated by the radar equation in which other losses are neglected (if  $G_d=1$ ,  $L=1$ ,  $r=2h'$ )

$$P_r = \frac{(\lambda G_d)^2 P_t}{(4\pi r)^2 L} \longrightarrow \frac{P_r}{P_t} = \frac{\lambda^2}{(8\pi h')^2} = \left( \frac{c}{8\pi h' f} \right)^2$$

$$Att = 20 \cdot \text{Log} \left( \frac{8\pi h' f}{c} \right) \text{ dB}$$

Geometric attenuation increases with frequency increasing both for  $f$  and for  $h'$  (reflection comes from higher heights).



- **ionospheric medium absorption** (called "non deviative"), due to the fact that radio waves pass through ionised media.

It is proportional to  $N\nu/f^2$ , where  $N$  is the electron density,  $\nu$  the frequency of collision between electrons and neutral particles,  $f$  the radio wave frequency.

Ionospheric absorption decreases with frequency and increases with density  $N$  (attenuation is high in D region).

Geometric and non deviative attenuations combination (simulated qualitative behavior).

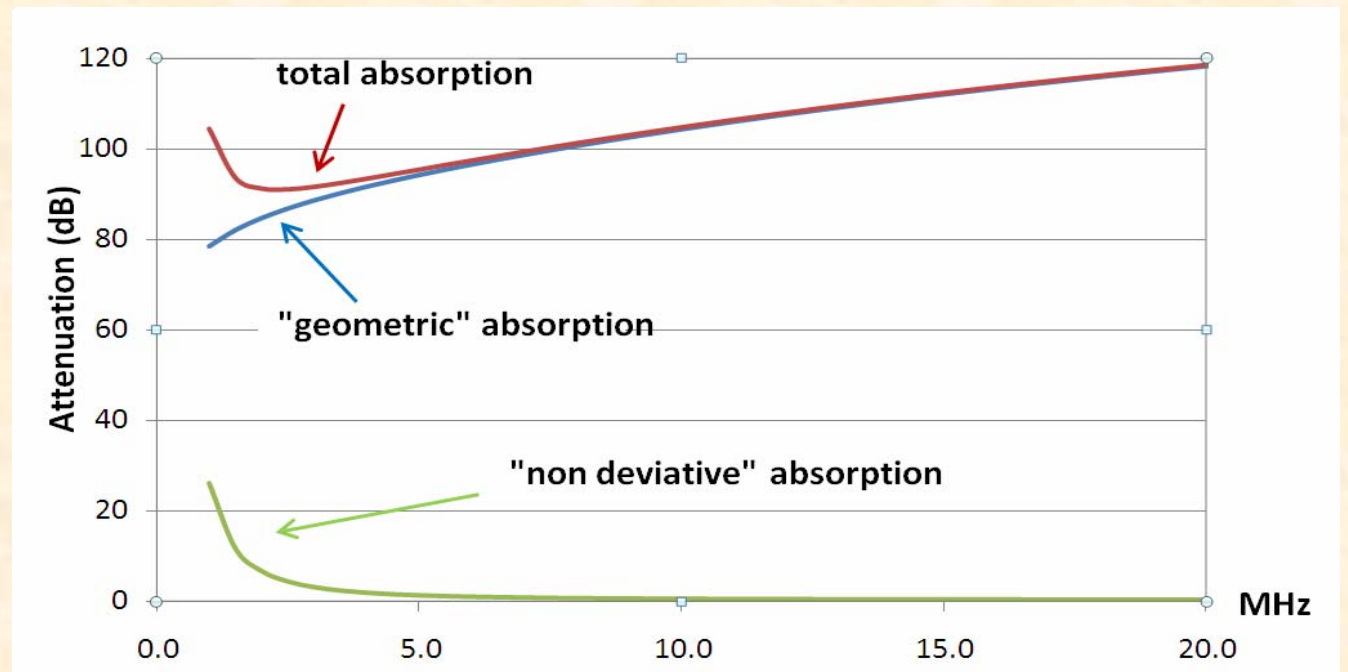



- **deviative attenuation:** takes place at the top of the trajectory where the bending of the ray starts happening;
- **polarisation decoupling:** due to the rotation of the polarisation plane of the reflected wave with respect to the orientation of the receiving antenna;

- **focusing effects:** due to the fact the reflecting surfaces are not perfectly plane but can act as focusing or defocusing mirror-like surfaces (so they can give also a gain!);

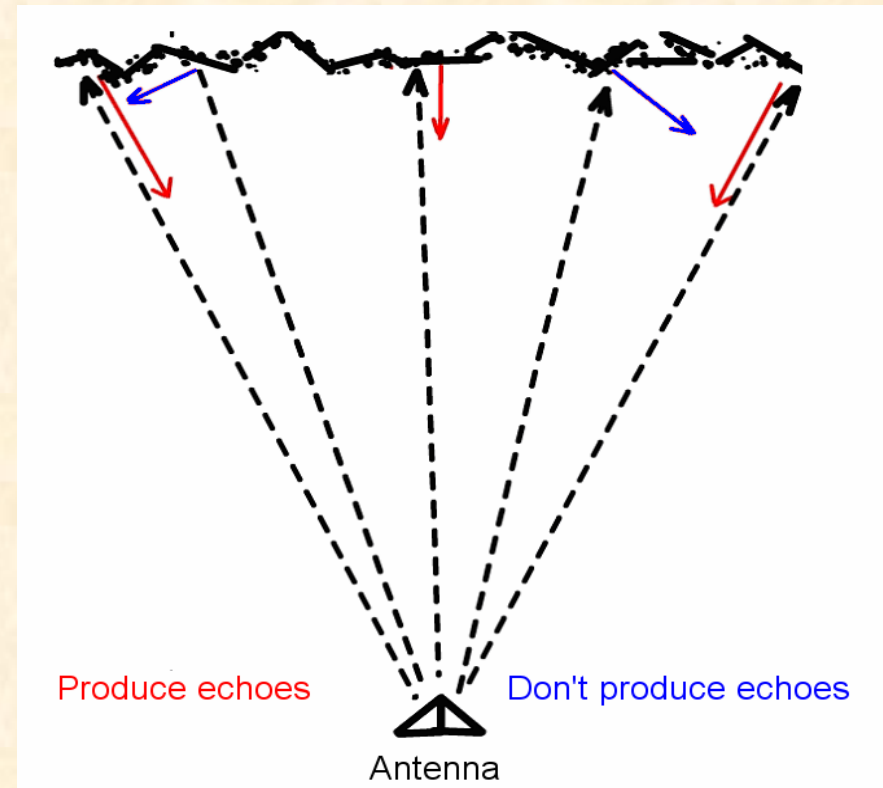

- **ionospheric layer shielding:** a layer can mask the reflection from higher layers (usually E layer).
- **system losses:** are caused mainly by mismatching effects and the attenuation in the cables (to TX and from RX); when minimized they can still contribute as in the table;
- **antennas:** they have a behaviour varying with the frequency.

Parameter	Level (dB)	
	Min.	Max.
Geometric (composite)	80	120
Ionospheric absorption	1	20
Polarization decoupling	3	6
Focusing effects	-8	8
Deviative attenuation	1	2
System losses	1	2
Layer shielding	0	2
Antennas gains	-4	0
<b>Total attenuation</b>	<b>74</b>	<b>160</b>

The high dynamic that the attenuation exhibits should be considered carefully: the worst condition of a parameter rarely corresponds to the worst case of the other ones.

## Noise sources (1/4)

- Noise is **any cause** of degradation of the useful signal due to other signals, coming from various sources.
- Usually the term is used only referring to signals with a stochastic nature, i.e. not deterministic; we shall use the term in the more general sense, including also the deterministic signals coming from transmitters, other than the ionosonde.
- We can distinguish between internal sources (generated inside the system) and external source (natural and interferences).

## Noise sources (2/4)

**Internal noise:** it is the noise generated inside the system with a Gaussian distribution and a stochastic behavior (thermal noise, shot noise, flicker noise, etc.). Amongst them the most important contribution comes from the thermal noise

$$P_{tn} = kTBF$$

This quantity refers to a noise measured in a given point in the receiving chain. A typical ionospheric sounder might have:

$k = 1.38 \cdot 10^{-23} \text{ J} \cdot \text{K}^{-1}$  the Boltzmann constant

$T \cong (280 \div 310) \text{ K}$  the absolute temperature

$B \cong (30 \div 70) \text{ kHz}$  the bandwidth (limited by some kind of filtering),

$F \cong 10 \div 16$  the noise figure

Typical values are

$P_{tn} \cong (1.2 \cdot 10^{-15} \div 4.8 \cdot 10^{-15}) \text{ W}$  (corresponding to  $-119 \div -113 \text{ dBm}$ ).

## Noise sources (3/4)

**Natural noise:** the cosmic and the atmospheric noises give marginal effects: cosmic noise in Europe has a power less than **-100 dBm**; atmospheric noise is a bit greater, **-80 dBm**,

both can be considered as a weak sources of noise.

**Interferences and man-made disturbances:** are generated by all sources of radiofrequencies radiated by devices and machineries, usually (but not strictly) located near the ionosonde receiver.

Generation is not intentional, and is due to not perfect shielding or suppression of spurious effects in RF systems.

Interferences rise each time an emission of radio waves is captured by the receiver of the ionosonde; this event is not rare, considering that the range of frequencies in which the ionosonde works comprises all the bands used by radio communication in MF and HF fields.

It is very difficult to predict the intensity of such disturbances; as an order of magnitude, they can reach **-50 dBm** below 10 MHz .



## Noise sources (4/4)

Summarizing table :

Noise type	Level (dBm)
Internal (thermal)	-113
cosmic	-100
atmospheric	-80
man-made	-50

In the band of the ionospheric vertical sounding the man made noise in the form of interferences is the biggest contribution by far.



## Required parameters

frequency range: (1 - 20) MHz

frequency step: 50 kHz or 100 kHz

resolution  $\leq 5$ km  $t_s$  or  $\tau \leq 33 \mu\text{s}$

minimum height  $\leq 90$  km  $\tau \leq 600 \mu\text{s}$

maximum height = 750 km  $T > 5$  ms (PRF  $< 200$  Hz)

listening time  $> 5$  ms

very high loss  $\frac{R_x \text{ power}}{T_x \text{ power}} = 10^{-13} \rightarrow -130 \text{ dB}$

## Ionosonde design basics (1/4)

To start the design of a radar we need to know which are the ingredients of the recipe.

Imagine to be in a point of the of the receiver where you decide about the presence of an echo having the following picture in mind:

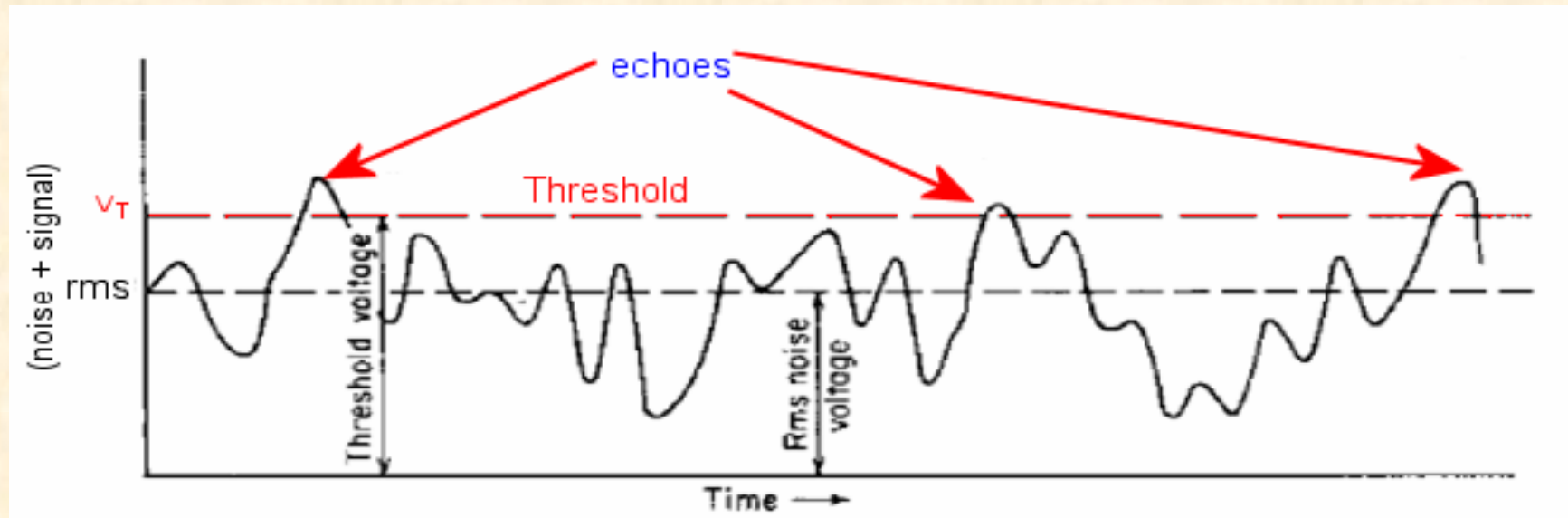

Every time the signal + noise exceeds the threshold an “echo” is detected.

## Ionosonde design basics (2/4)

We can define

**$P_d$  probability of detection:** probability of that an echo is detected, when present

**$P_{fa}$  probability of false alarm:** probability that a noise fluctuation is mistaken for a signal.

$P_d$  and  $P_{fa}$  are both functions of  $V_T$ , signal and noise

The idea of probability comes from the fact that the radar signal process detection is basically statistical in nature due to the nature of the noise voltage that is always present in the receiver circuit.

This two parameters are enough to describe all possible cases.

	targets in the reality	
targets' detection	present	absent
present	ok ( $P_d$ )	no ( $P_{fa}$ )
absent	no ( $1-P_d$ )	ok ( $1-P_{fa}$ )

We want to have high  $P_d$  and low  $P_{fa}$

## Ionosonde design basics (3/4)

The designer is helped by some graphical aids like the following

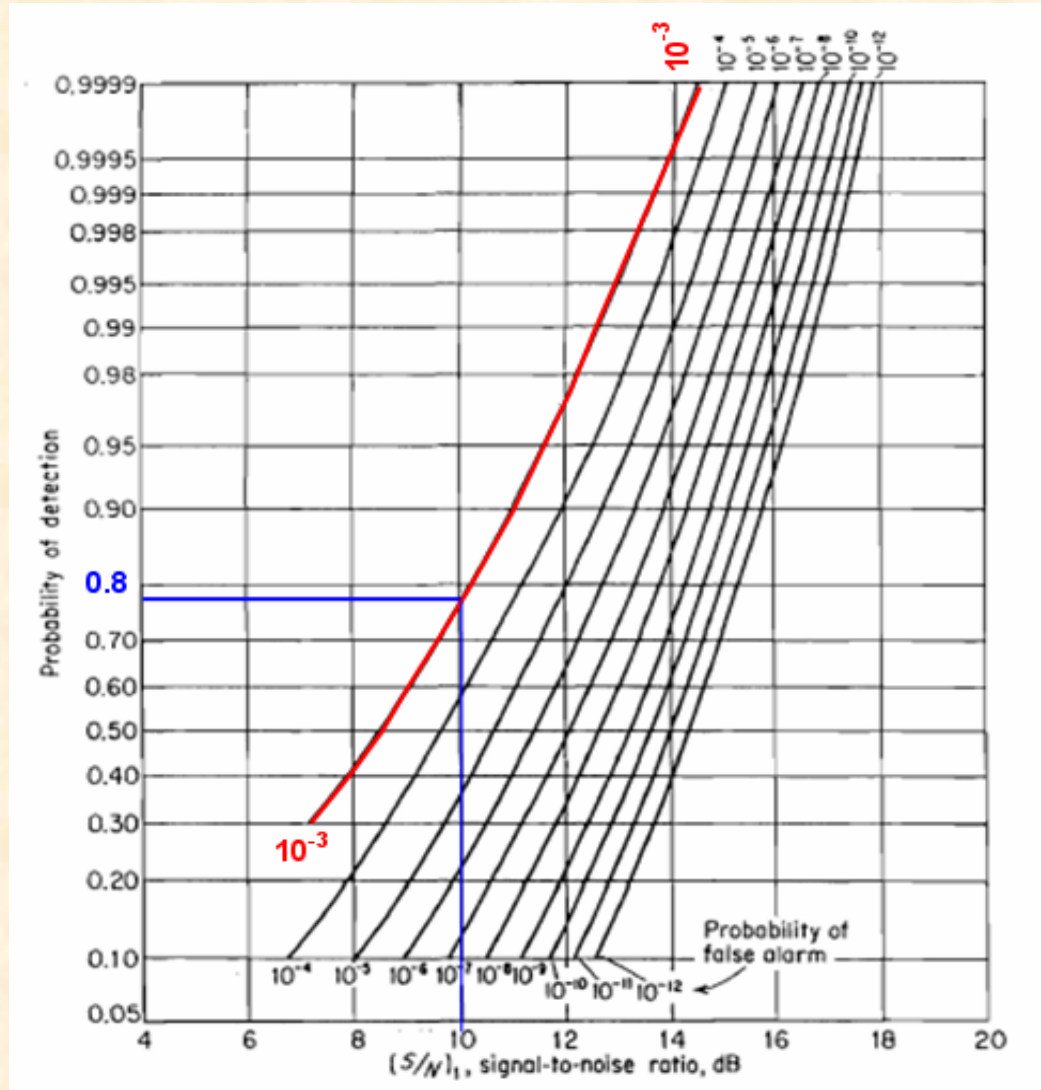

Fix the  $P_{fa} = 10^{-3}$  and  $P_d = 0.8$ .

In the ionosonde design this parameters are quite flexible, but we fix these values to start a design.

In these conditions for a **single pulse** we get

$$\text{SNR} = 10 \text{ dB}$$

Maintaining SNR constant the improvement of  $P_d$  is obtained by increasing the  $P_{fa}$  (lowering the  $V_T$ ).

## Ionosonde design basics (4/4)

We suppose to set our design at **SNR=10 dB**.

We also fix a **noise** level reference of **-70 dBm**.

So we suppose to want  **$P_r = -60 \text{ dBm}$**  that is  **$P_r = 1 \text{ nW}$** .

Now the first step is to calculate the required TX power to get the desired SNR.

Two examples are partially developed: envelope radar or pulse compression radar.

## Envelope radar parameter choice

For a resolution of 5 km we have

$$\tau = \frac{2 \cdot \delta d}{c}$$

$$\tau = \frac{2 \cdot 5 \text{ km}}{3 \cdot 10^8 \text{ km / s}} \cong 33 \mu \text{ s}$$

For  $P_r = 1 \text{ nW}$  the received energy  $E_r$  is

$$E_r = P_r \cdot \tau$$

$$E_r = 10^{-9} \text{ W} \cdot 33 \mu \text{ s} = 33 \cdot 10^{-15} \text{ J}$$

For an attenuation of 130 dB (that is  $10^{13}$ ) the transmitted energy was

$$E_t = 33 \cdot 10^{-15} \cdot 10^{13} \text{ J} = 33 \cdot 10^{-2} \text{ J}$$

The power for this energy in a pulse of  $\tau$  width was

$$P_t = E_t \cdot \tau$$

$$P_t = \frac{33 \cdot 10^{-2} \text{ J}}{33 \mu \text{ s}} = 10^4 \text{ W}$$



For a resolution of 4.5 km we have

$$t_s = \frac{2 \cdot \delta d}{c}$$

$$t_s = \frac{2 \cdot 4.5 \text{ km}}{3 \cdot 10^8 \text{ km/s}} \cdot s \cong 30 \mu s$$

The received energy  $E_r$  corresponding to 1 nW is

$$E_r = P_r \cdot t_s$$

$$E_r = 10^{-9} \text{ W} \cdot 30 \mu s = 30 \cdot 10^{-15} \text{ J}$$

For an attenuation of 130 dB (that is  $10^{13}$ ) the transmitted energy was

$$E_t = 30 \cdot 10^{-15} \cdot 10^{13} \text{ J} = 30 \cdot 10^{-2} \text{ J}$$

To obtain this energy in a pulse of with  $\tau = 480 \mu s$  the power was

$$P_t = E_t \cdot \tau$$

$$P_t = \frac{30 \cdot 10^{-2} \text{ J}}{480 \mu s} = 625 \text{ W}$$

The difference of TX power amplifier are evident and make us to choose the pulse compression solution.

## Phase modulation

The first step is to choose which kind of code and number of sub pulses to use.

The usage of the code always implies the usage of a matched filter, often a correlator, that operates the compression of the pulse. The consequence is the creation of the correlation shape with a high central peak and side lobes.

Side lobes are an undesirable outcome of pulse compression either in range or time.

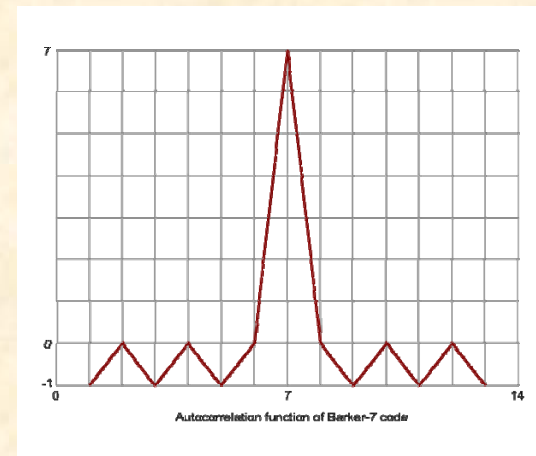
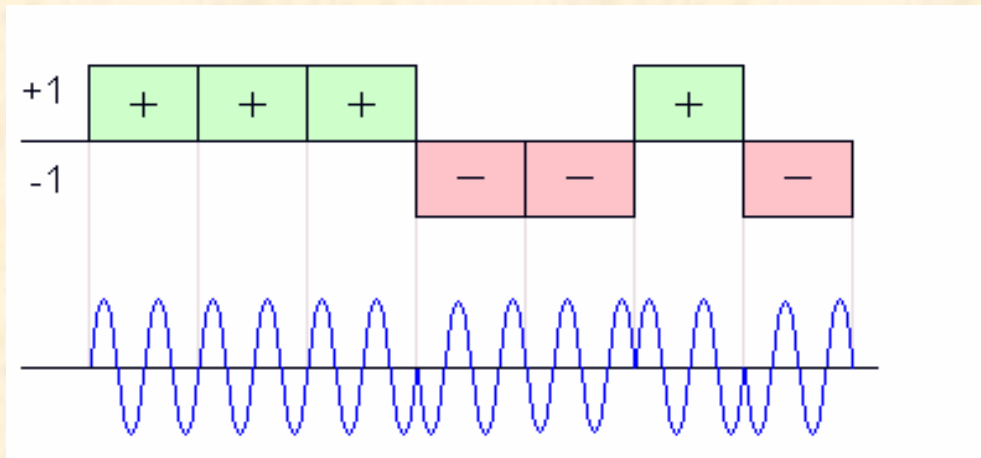

The Barker 7 bit sequence would produce a shape like this.

## Choice of the code (1/4)

Since the side lobes of a strong target may mask weak returns from a nearby target, it is preferable to reduce or delete the side lobes.

In case of ionospheric radar we want to observe second reflections we have chosen a code system that would provide “no” side lobes correlation shape, in principle: the complementary codes.

Two series of bit, half of which is opposite in sign:

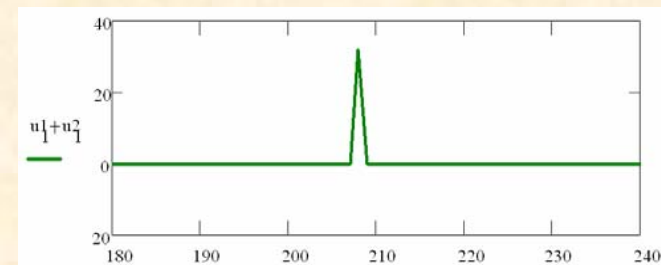
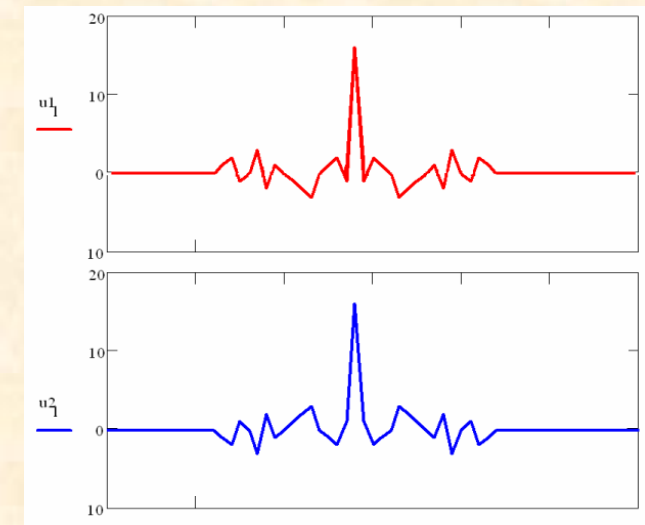
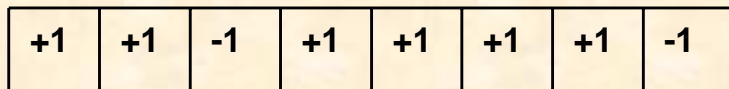
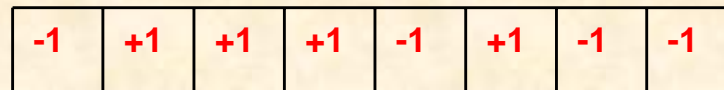
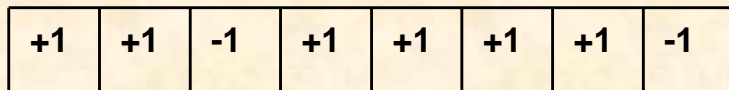

The pulse shape of each is so that the sum of them will eliminate side lobes increasing the central peak.

## Choice of the code (2/4)

The complementary codes give the maximum effect of cancelling the side lobes when the phases of the echo are constant: they need to be referred to the same target.

Considering that the targets are ionospheric layers and that can be considered steady the use of complementary codes is possible.

The usage of such a solution would have been forbidden for airborne radars (for instance for glaciers survey).

## Choice of the code (3/4)

The length of the code is important too. In fact the gain of the process in using the code is strictly related to the number of sub pulses composing the pulse length  $\tau$ .

Consider two cases in which the resolution in time is ( $\tau$ ), using a single short pulse (uncoded) and a long pulse (coded).

The coded pulse is obtained with  $M$  bit so the length is  $M \cdot \tau$ .

In both conditions we use a  $P$  power amplifier.

single short pulse	long coded pulse
$E = P \cdot \tau$	$E' = P \cdot M \cdot \tau$

The energy gain is  $\frac{E'}{E} = M$  corresponding to  $10 \cdot \text{Log } M$  in dB

## Choice of the code (4/4)

According to Golay's theory complementary couples of all length are possible but:  
**short sequences** give less gain but are fast to be processed;  
**long sequences** give high gain at the price of long processing time

Long sequences are not suitable for fast varying targets; in the ionospheric radars a frequent choice is to use 16 sub pulses complementary couple.



## RF coding

Coding is performed practically by changing the sign of the sine waveform.

This can be accomplished with a multiplier as shown below (this is theory).

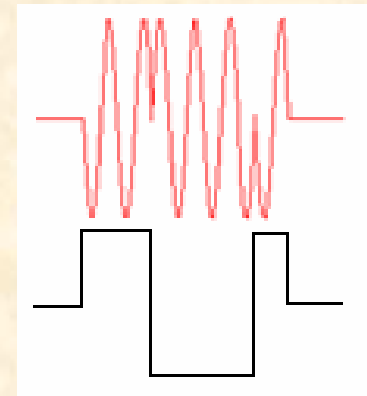
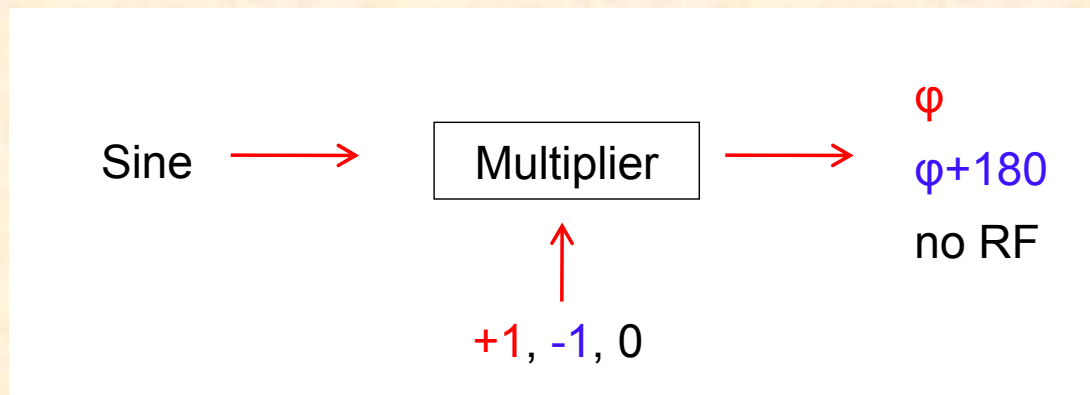

Multiplication by "0" can be used to gate the signal.

In the module #2 we will see how practically we can code the RF.

## Final choices

Remembering that:

the TX pulse width  $\tau$  has to be  $< 600 \mu\text{s}$  (due to minimum distance);

that  $t_s$  should be around  $33 \mu\text{s}$  (due to resolution);

the complementary code 16 sub pulses is requested;

the listening time is about 5 ms;

our final choice is

$$t_s = 30 \mu\text{s},$$

number of bit=16

$$\tau = 480 \mu\text{s} \quad (16 * t_s)$$

$$T < 200 \text{ Hz}$$

The band pass of the signal is about 66 kHz useful to design the receiving stages.

## A typical ionosonde structure (1/2)

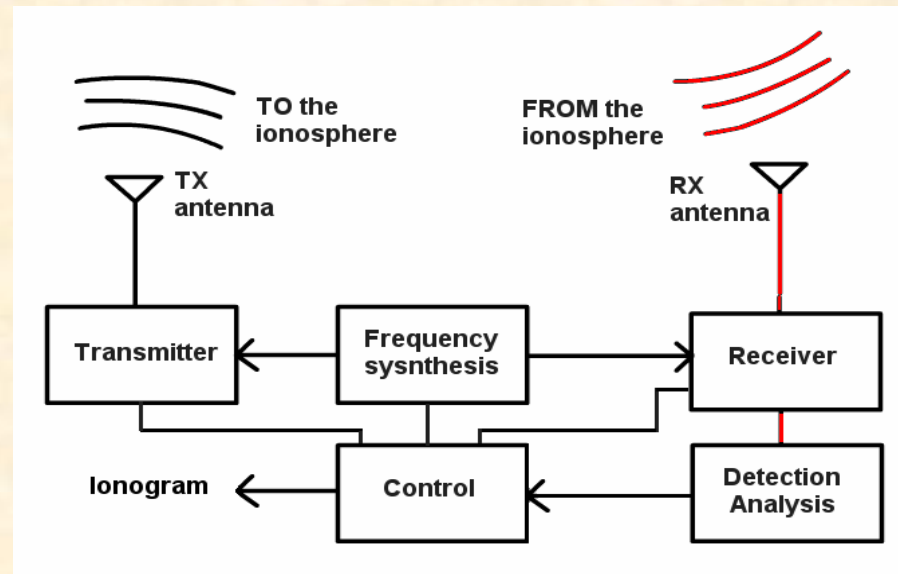

The ionosonde is, generally, a bistatic radar, with distinct antennas in the same site (often on the same mast). The blocks sketched above are common to all ionosondes; the way in which those functions are accomplished differentiates the ionosondes.

**Control system:** enables the TX to emit energy; then enables the during the "listening time".

**Frequency synthesizer:** generates the frequency to transmit tuning the receiver on that frequency.

## A typical ionosonde structure (2/2)

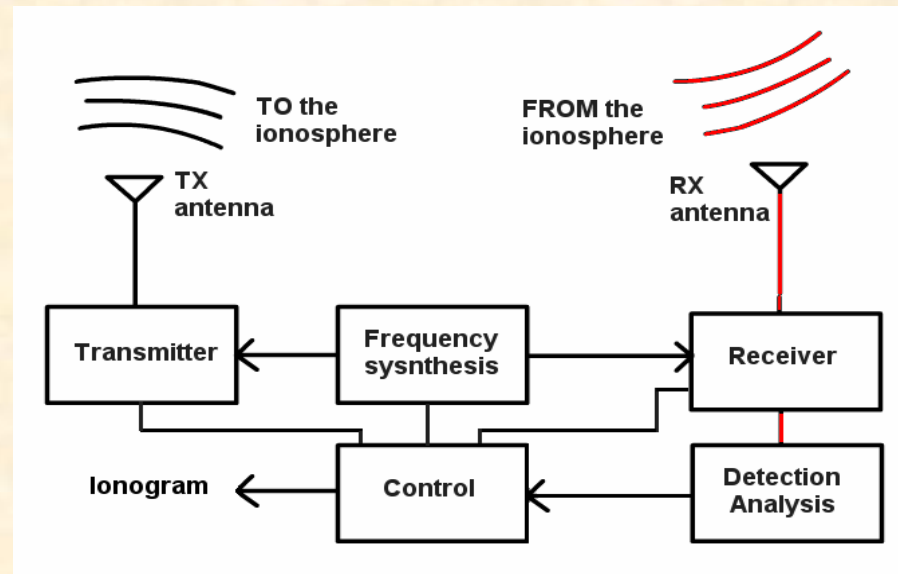

**Transmitter:** amplifies small signals to a proper amplitude.

**Receiver:** converts information at different frequencies to a more comfortable value (superheterodyne principle).

**Detection and Analysis:** recognizes good echoes in the noise evaluating their delay times.

## Frequencies generation (1/4)

Modern methods of frequency generation are based on the Direct Digital Synthesis (DDS) technique.

DDS is a digital technique for generating a variable frequency sine wave from a fixed-frequency clock source.

The basic idea is to consider a table with  $2^N$  cells, where  $N$  is the number of bit constituting the digital word.

We enter the table with an angle ( $0 - 2\pi$ ) and we get the corresponding sine amplitude.

The minimum step corresponds to  $\frac{2\pi}{2^N}$

$2^N$  steps

Angle (radians)	Amplitude
0	0
0.09818	0.09802
0.19635	0.19509
0.29452	0.29029
0.39270	0.38268
...	...
...	...
...	...
5.89049	-0.38268
5.98866	-0.29028
6.08684	-0.19509
6.18501	-0.09802
$2\pi$	0

## Frequencies generation (2/4)

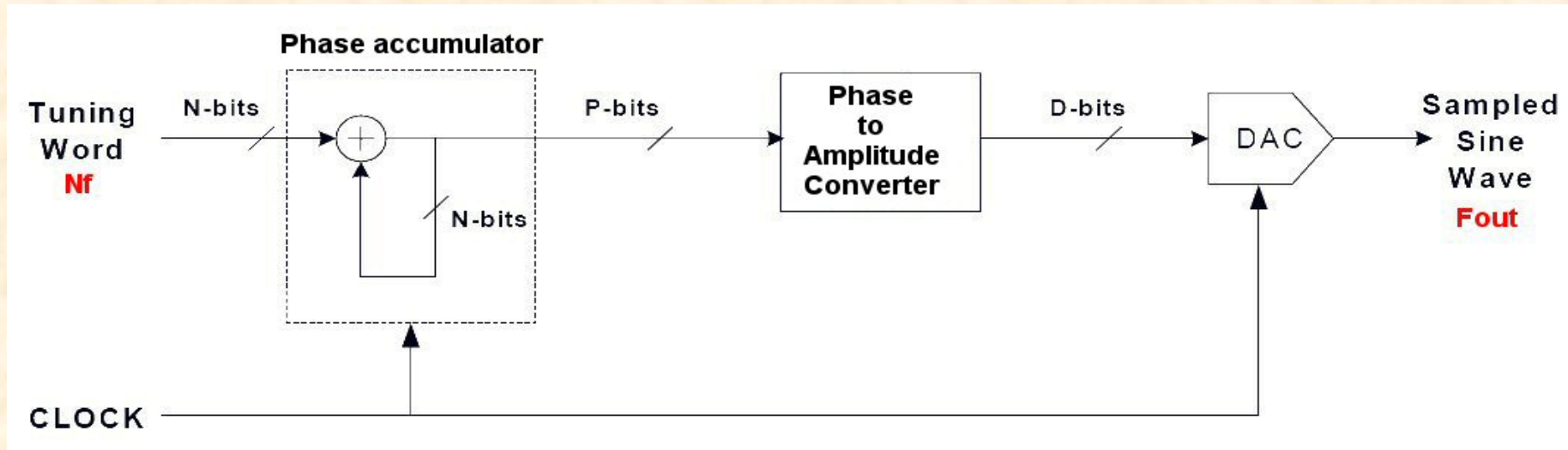

Basic DDS block diagram

For every clock pulse the phase is increased by  $N_f$  and an amplitude's value is generated

$$\omega = \frac{\Delta\varphi}{\Delta t} = \frac{N_f \cdot \frac{2\pi}{2^N}}{\frac{1}{f_{CLK}}}$$

$$\omega = \frac{N_f \cdot 2\pi \cdot f_{CLK}}{2^N}$$

$$F_{out} = \frac{N_f \cdot f_{CLK}}{2^N}$$

The higher is  $N_f$  the shorter is the time to complete a period, the higher is the frequency of the sine wave



## Frequencies generation (3/4)

$$F_{out} = \frac{N_f \cdot f_{CLK}}{2^N}$$

where  $F_{OUT}$  = the output frequency of the DDS  
 $N_f$  = the binary tuning word  
 $f_{CLK}$  = internal reference clock frequency  
 $N$  = the length in bits of the phase accumulator

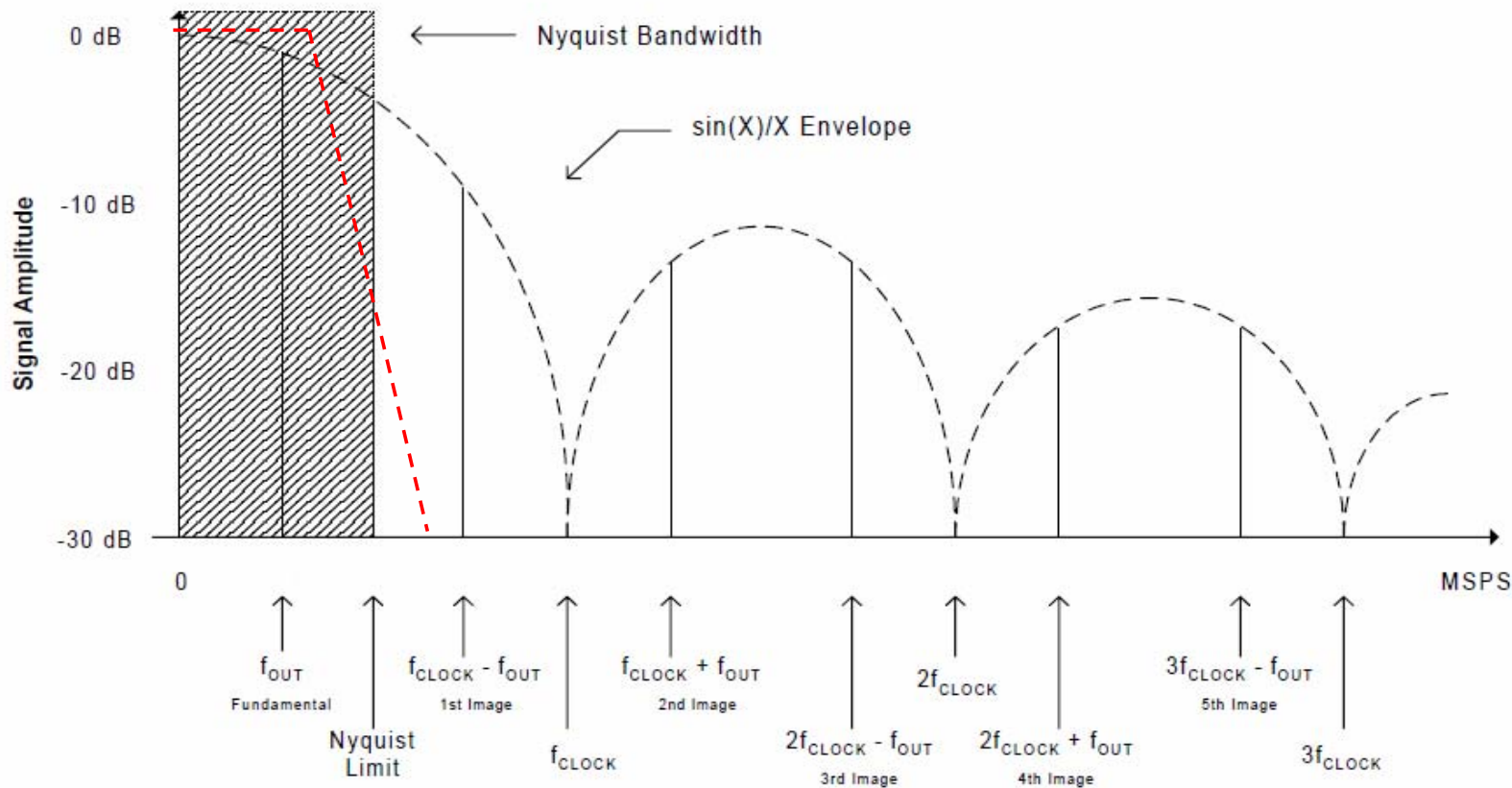

$F_{out}$  is not the only frequency component that is produced.

The sine wave is digitally generated by using sampling techniques and it is not spectrally "pure", and filters must be used.

## Frequencies generation (4/4)

### DDS advantages

FREQUENCY digitally tunable (typically with sub-Hertz resolution).

PHASE is digitally adjustable, as well,

NO ERRORS from drift due to temperature or aging of components.

Two generators from the same clock will have phase locked frequency.

### DDS restrictions

FREQUENCY must be less than or equal to  $1/2$  the clock source frequency.

The sine wave AMPLITUDE is generally fixed.

The sine wave is not spectrally “pure”, and filters must be used.

## Frequency conversion

Frequency conversion is a process to bring the information contained in a signal at a frequency to a signal at a different frequency maintaining the information as much complete as possible.

It can be used to work at a more comfortable frequency, usually a lower frequency, or to transform different frequencies to the same suitable frequency (superheterodyne).

The basic idea is contained in the multiplication of 2 sinusoidal signals at different frequencies:

$$v_1(t) = A_1 \cdot \sin(\omega_1 t)$$

$$v_2(t) = A_2 \cdot \sin(\omega_2 t)$$

we can disregard the phase, for simplicity's sake

Their product will give:

$$v(t) = \frac{A_1 \cdot A_2}{2} \cdot [\cos(\omega_1 - \omega_2) - \cos(\omega_1 + \omega_2)]$$

The result will contain 2 frequencies in case of a perfect multiplier.

## Mixer basics

The product is obtained by a non linear device, such as a diode or, better a mixer having 2 inputs, RF and LO, and 1 output, IF.

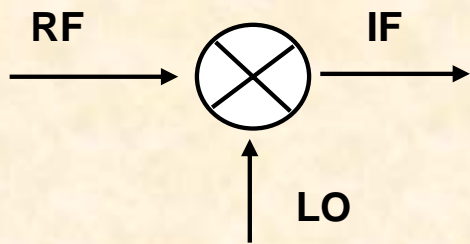

In a real device, even in case of RF and LO pure sine waves, the output frequencies are not only  $RF+LO$  and  $|RF-LO|$ . A general rule is that the frequency lines from the output follow the relationship  $m*LO \pm n*RF$ ,  $m, n = 0, 1, 2...$

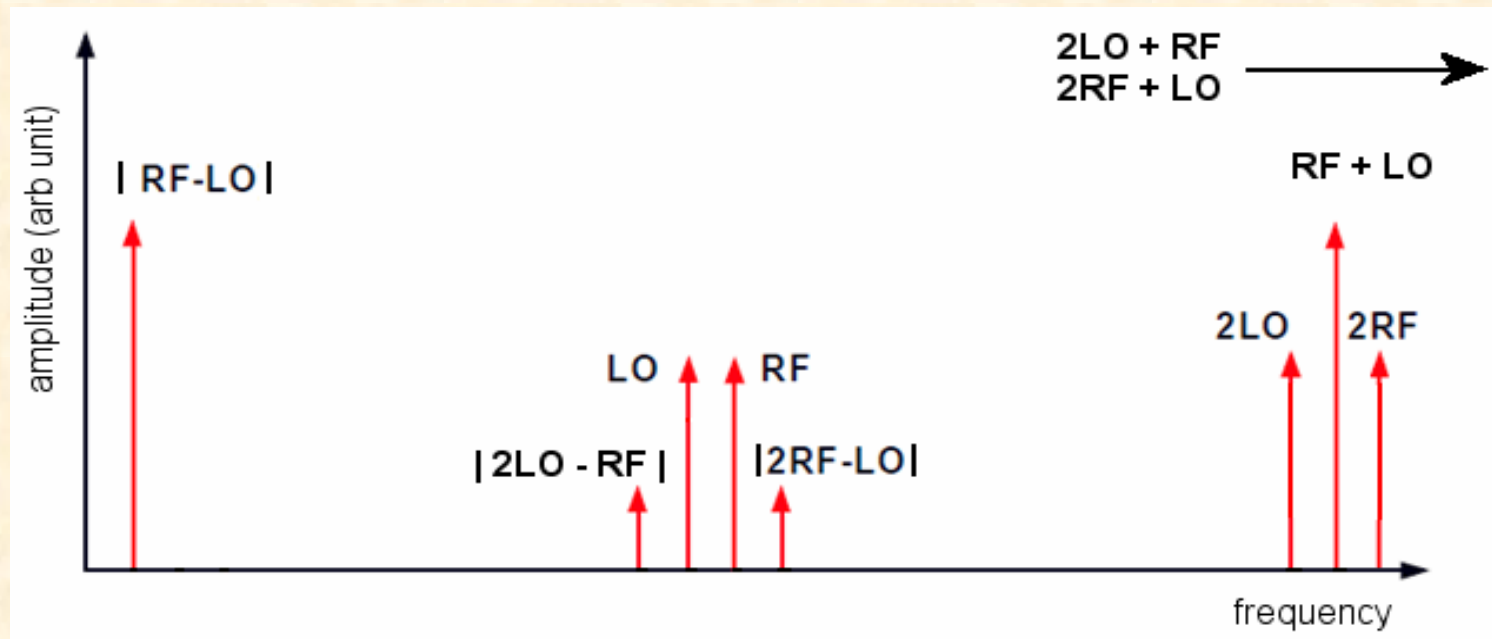

The amplitude decreases at higher level products

## Superheterodyne concepts (1/3)

Consider the simple case of a perfect multiplier

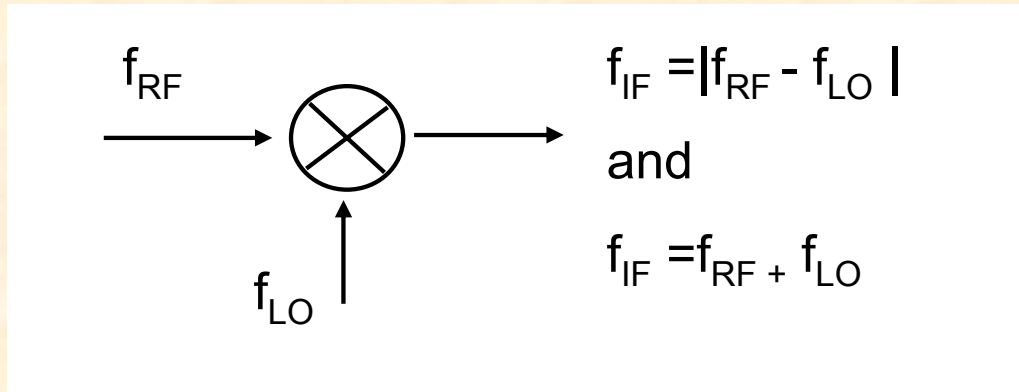

The output is filtered to get summation or difference of frequencies.

Varying the local oscillator properly we apply the Super heterodyne receiver principle

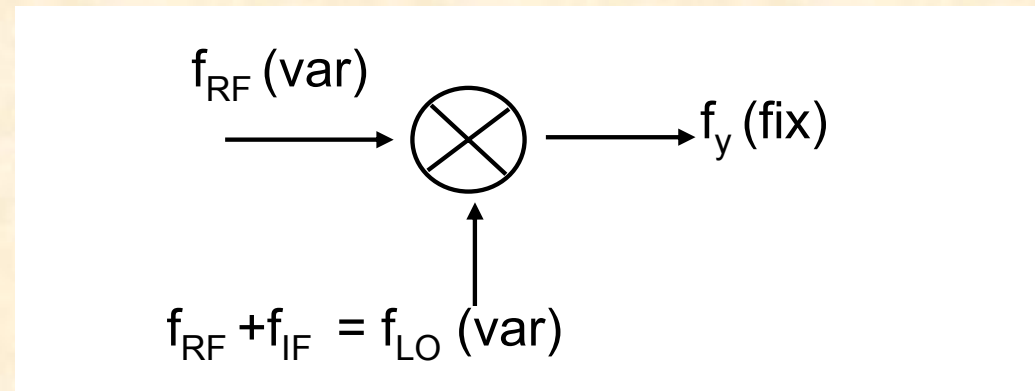

The advantage is that after the conversion we can design a unique stage to process different frequencies.



## Superheterodyne concepts (2/3)

Going to the final low frequency directly is not always the best thing:

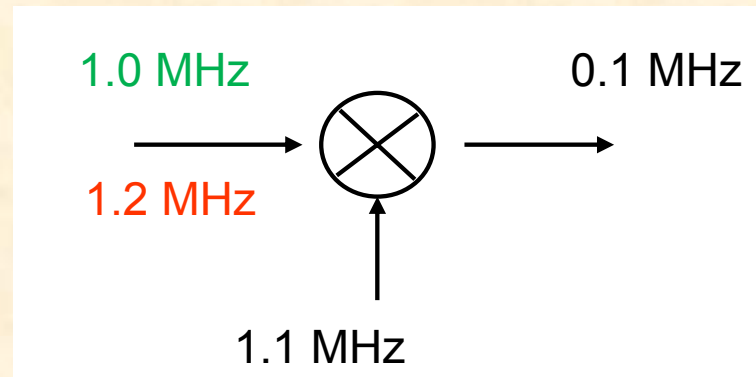

We want to DOWN CONVERT 1.0 MHz (green = signal) to 0.1 MHz using 1.1 MHz LO.

Is there any other **unwanted** signal that would produce the same IF?

1.2 MHz (red = unwanted) will produce the same IF. It is not possible to separate them at the output.

It should be separated at the input: is not always easy (they are very close).



## Superheterodyne concepts (3/3)

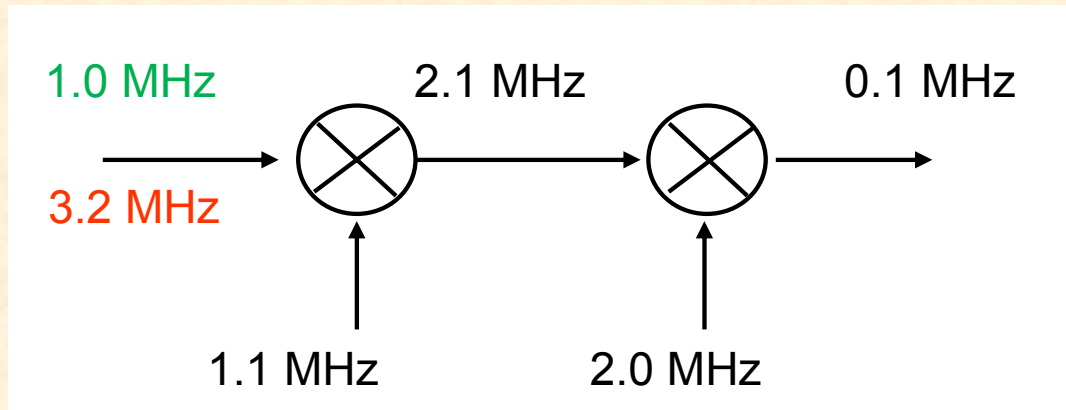

Again we have 1.1 MHz LO and 1.0 MHz signal (green) but we **UP CONVERT** to 2.1 MHz before.

Now the unwanted (red) frequency is 3.2 MHz far from 1.0 MHz and easily removed.

A further **DOWN CONVERSION** brings us to 0.1 MHz

Down conversions number is an important point in a receiver design (highest is the number, less are the interference, but the complication increases).

The last IF should fulfill the following requirements:

- it has to be low enough to be handled comfortably without limiting the band width of the information (the code);
- it shouldn't exceed the useful bandwidth too much not to degrade SNR;
- it should be designed to get the baseband with a proper sampling.

## Antennas for vertical ionospheric sounding

Antennas for vertical ionospheric sounding are a crucial element in the general design.

The following requirements should be satisfied for both TX and RX antennas:

- they have to be wide band to accept the wide frequency range (a simple dipole is not allowed due to its resonance);
- the main radiation lobe needs to be directed upwards;
- they need to have a good gain because the ionospheric attenuation and the geometrical loss reduce greatly the signal amplitude.

A simple solution is the "rhombic antenna" as the picture suggests you.

It is composed by 4 radiating elements plus a load resistor.

Each side of antenna has a length corresponding to some wavelength (from 1 to 5  $\lambda$ ) at a chosen frequency (usually the mid frequency: 10 MHz correspond to 30 m).

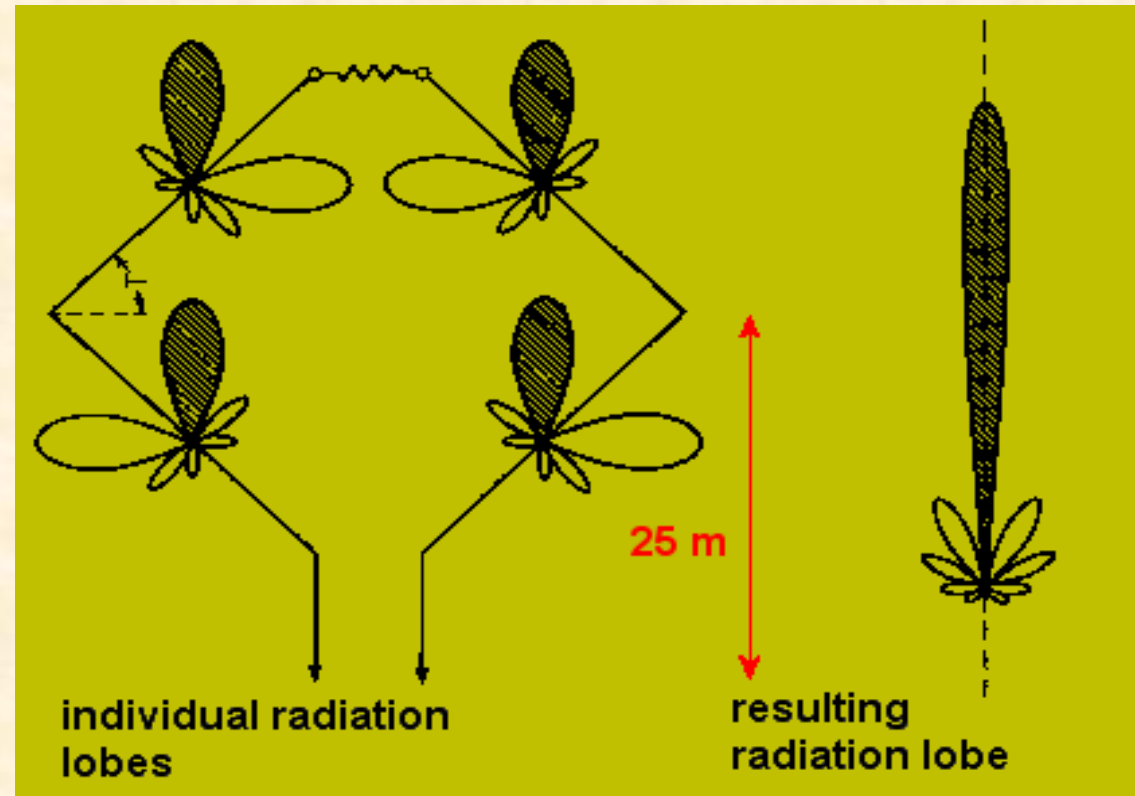

The angle between the radiant elements is chosen to make the total lobes be directed towards the load as much as possible: the shadowed lobes are added, while the others eliminate.

## Rhombic antenna (2/2)

The presence of the load creates “progressive waves” travelling from the source to the load.

This makes this antenna almost broad band.

Each side of the antenna is a resonating element which has been loaded with a resistive load at the top to widen the band.

The band B is the Full Width at Half Maximum (FWHM).

The resistive load at the top of the antenna dissipates energy making the FWHM larger (B').

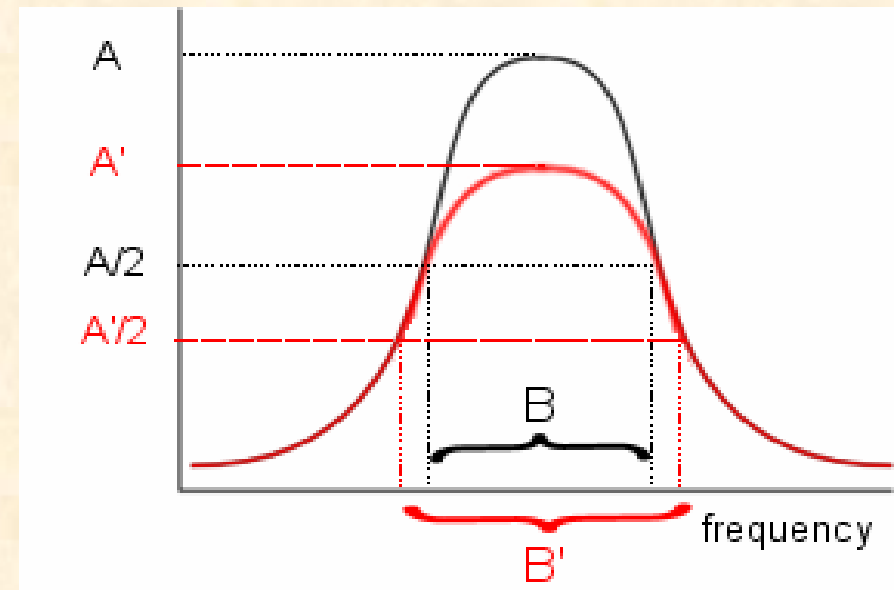

The presence of the load lowers the efficiency of this kind of antenna

## Delta antenna (1/2)

A simplified version of rhombic antenna is the so called "delta" antenna.

- According to antenna theory, a delta antenna on a infinite ground plane (earth) is equivalent to a rhombic antenna.

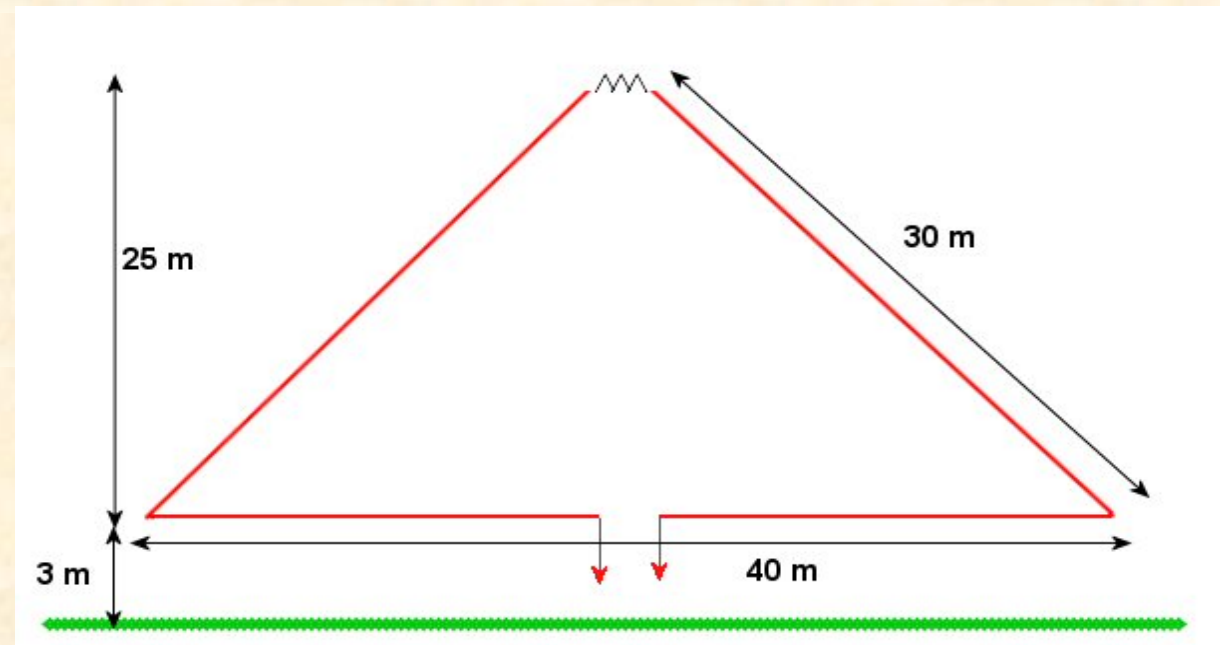
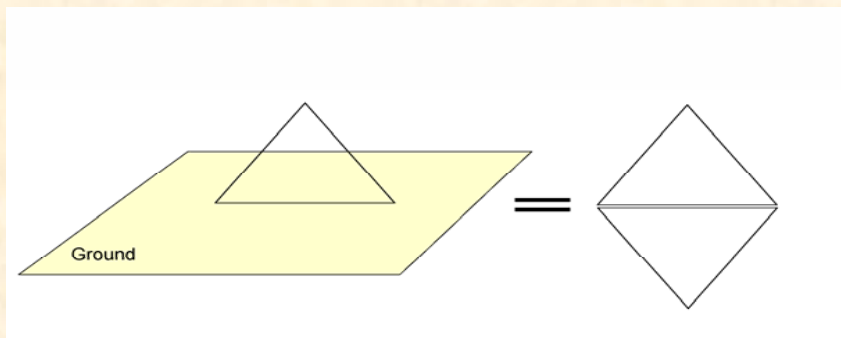

- The final lobe composition and the widening effect of resistive load are similar to the rhombic.
- It is easier to be built than rhombic antenna.
- The radiation lobe is around  $60^\circ$  (350 km diameter circle at 300 km height).
- Whatever comes from that area is practically indistinguishable.



## Delta antenna (2/2)

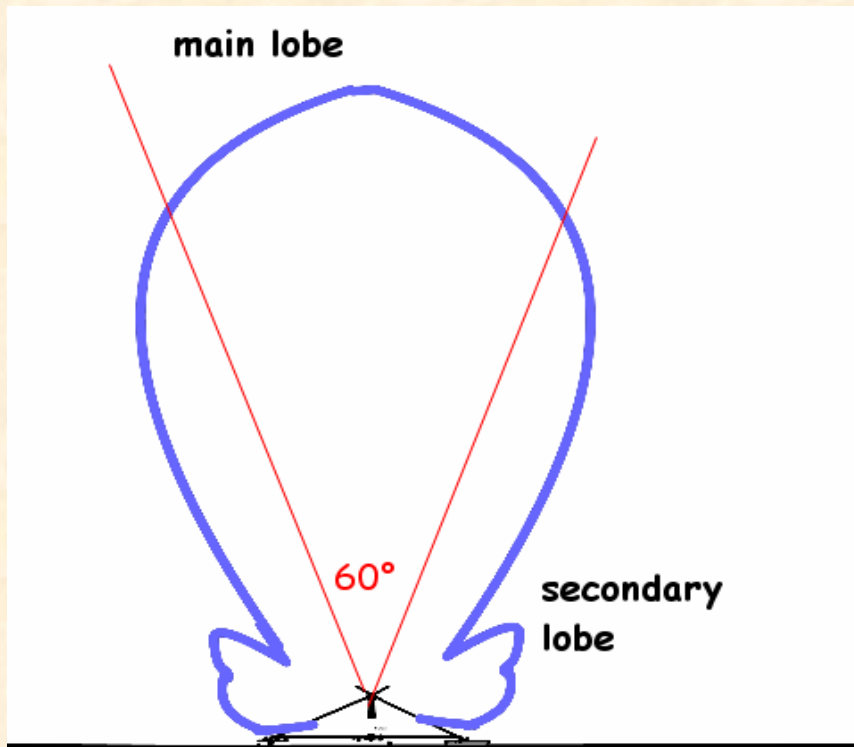

We can arrange two antennas (TX and RX) on a single mast, 90 degrees shifted to limit cross talking.

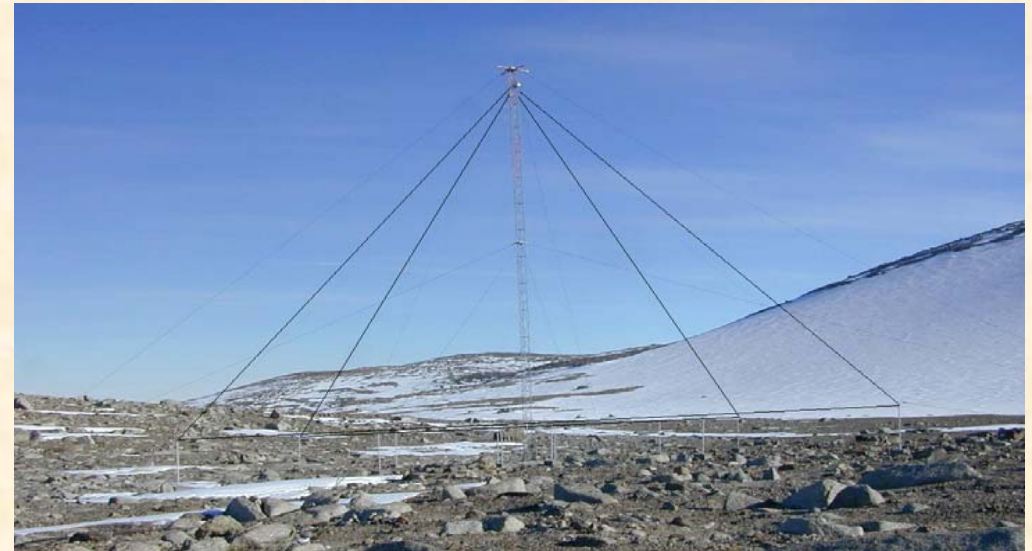

### Advantages

- Impedance and gain vary slightly with the frequency (wide band concept).
- Building them is very simple though dimensions could limit their diffusion.

### Disadvantages

- Dimensions.
- Small directive gain.
- Part of the electrical power is wasted on the resistive load.



## Balun (1/3)

In rhombic antenna or in delta one we have to transfer energy from and to antenna facing two problems:

- to go from unbalanced signal (ground referenced) to symmetric lines (balanced);
- to transfer energy between two objects with different impedances.

Matching of the impedance is important to optimize the energy transfer without damaging the amplifier in TX line, and not to waste the very few energy in RX chain.

This double task is realized with special transformers called balun. Baluns are devices connecting **BAL**anced terminals to **UN**balanced ones.

We can imagine the balun as a sort of transformer

Consider the resistance at the primary side  $R_p$   
at the secondary side  $R_s = R_L$ .

The relationship with  $N_p$  and  $N_s$

$$\left( \frac{N_s}{N_p} \right)^2 = \frac{R_s}{R_p}$$

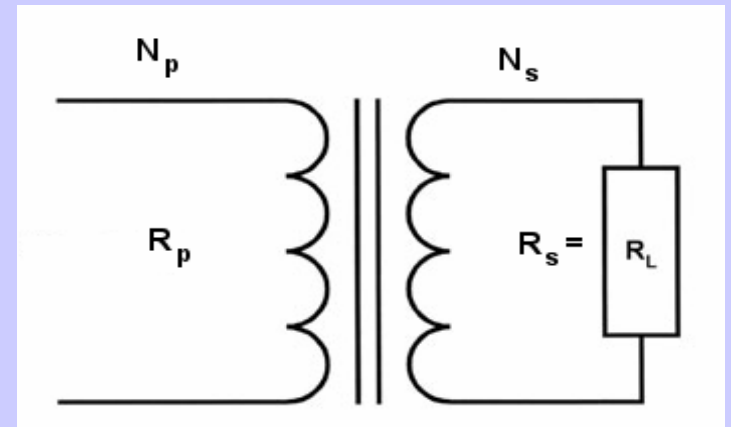

Matching of the impedance cannot be realized exactly for all frequency range (we are dealing with real devices!!!) but it is possible to reach good compromises.

There are a lot of possible schemes that can be applied (it is a sort of art) depending on the antenna type and the particular application.

Considering the frequencies at which we work the material we use is another important detail.

Considering the very few losses we desire, toroids of high permeability alloys are used, like **permalloy**.

Very high magnetic permeability gives high efficiency in energy transfer.

## Signal processing: introduction

We can assume that the signal processing starts after the last IF. The following operations are aimed to keep the information as much complete as possible and are:

- to sample IF during the listening time usually getting phase and quadrature channels. The amplitude is the amplitude of the phasor (kind of vector);
- to apply the proper procedures to find the code (use of matched filter);
- to use proper algorithms to increase SNR to make the detection safer (filtering, integration);
- to give to the targets a spatial position related to the delay of the echoes.

In analog old ionosondes most of the previous operations are performed in a hardware mode (matched filters, integrations) but in modern digital system all of them are accomplished in a numerical way.

# ADC sampling

This process brings us from analog world to digital one.

To maintain the information as much complete as possible we need the amplitude and the phase of the last IF.

To do this we sample the IF signal in two moments  $90^\circ$  shifted in time to obtain the base band.

The "I" (black) and the "Q" (red) values are used in the amplitude calculation.

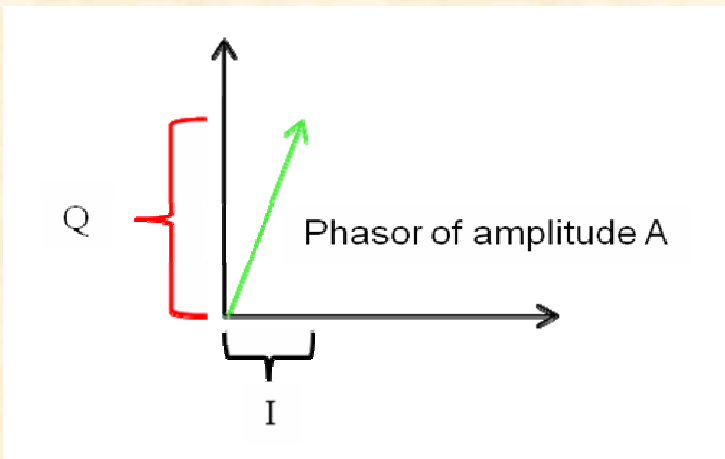
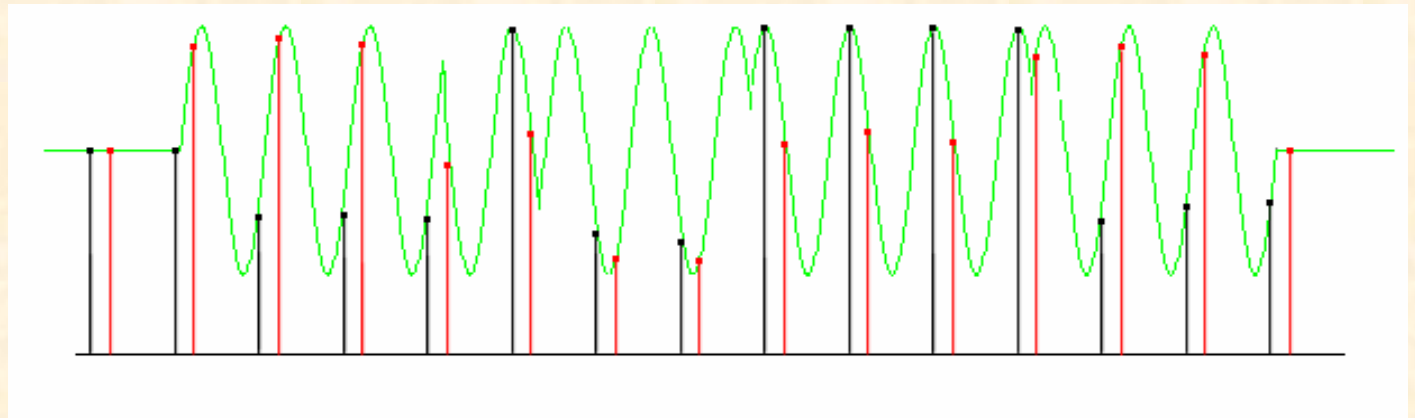

I and Q values are the components of a vector representing the amplitude.

# Reconstructing the code

The listening time is represented by M samples (in the example M=512);  $I_k$  and  $Q_k$  satisfy the following relationship (90° shifted):

$$A_k = \pm \sqrt{(I_k^2 + Q_k^2)}$$

$$k = 1, \dots, M$$

the sign is chosen according to the sign of  $I_k$  (for instance).

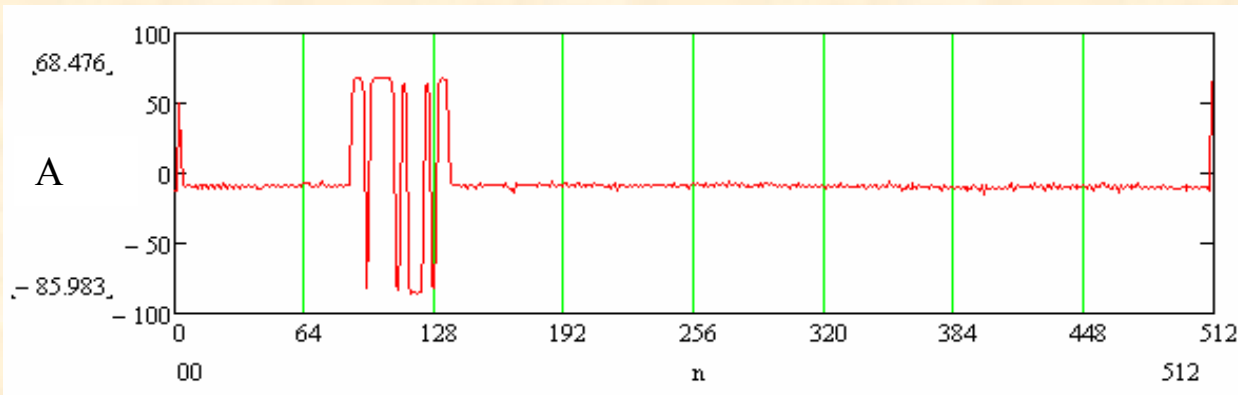
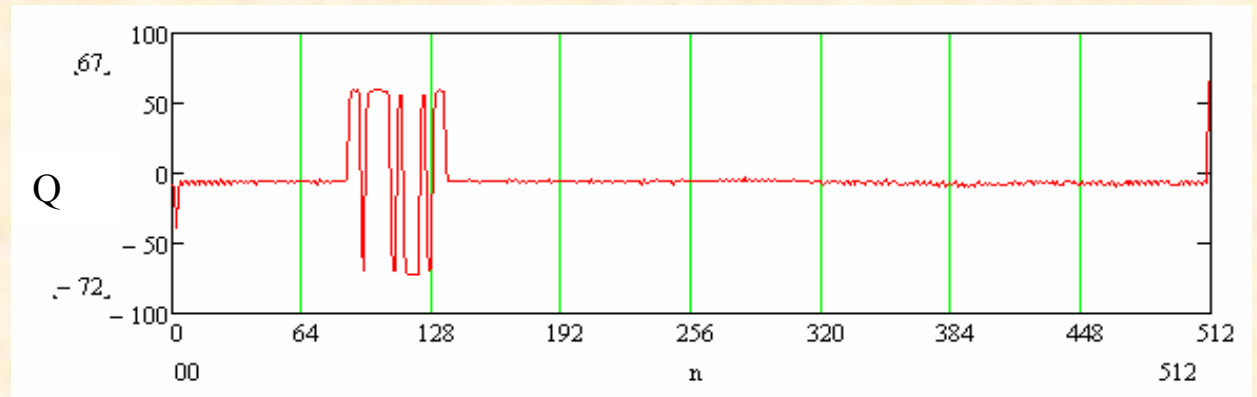
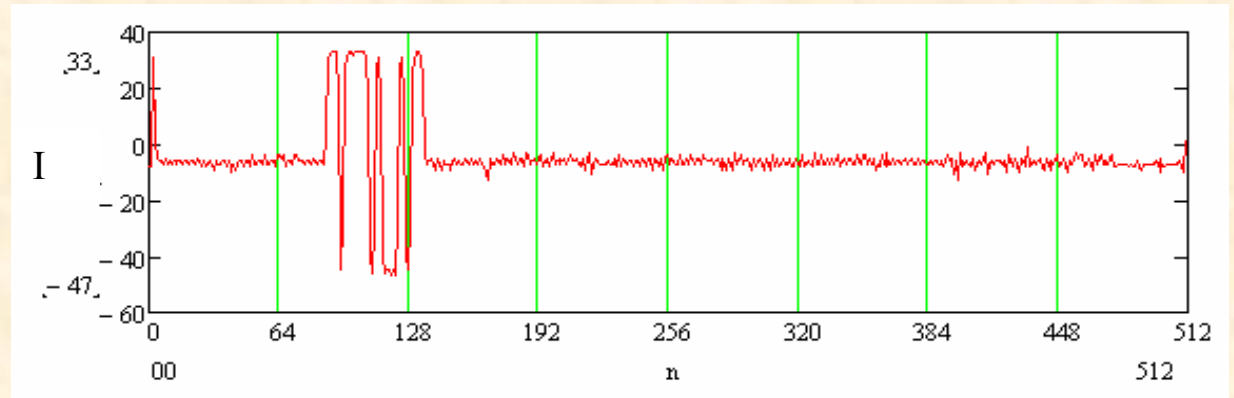

the variation of amplitude is the code.



## Matched filter (1/2)

The previous example showed a quasi ideal case, in which noise is almost zero and the code is easily visible.

In the general case we need a method to detect the presence of the code and to evaluate the delay time.

This subject can be considered as a special case of filter and convolution theory: the problem of finding a short template signal inside a long time series.

The idea is to use a filter that is able to maximize SNR when the template is detected; such a filter is called a **matched filter**.

## Matched filter (2/2)

The matched filter is the optimal linear filter for maximizing SNR in the presence of additive stochastic noise. It works convolving the unknown signal (received signal) with a conjugated time-reversed version of the template (CODE).

Practically this is equivalent to correlate the template, with the unknown signal to detect the presence of the code.

The correlation operation can be executed both in time domain and in frequency domain, where the operation is simpler, because it is achieved by simply multiplying the spectra. In the following we will discuss only the time domain operations.

# Correlation

received  
signal

$$A_k = \pm\sqrt{(I_k^2 + Q_k^2)}$$

$$k = 1, \dots, M$$

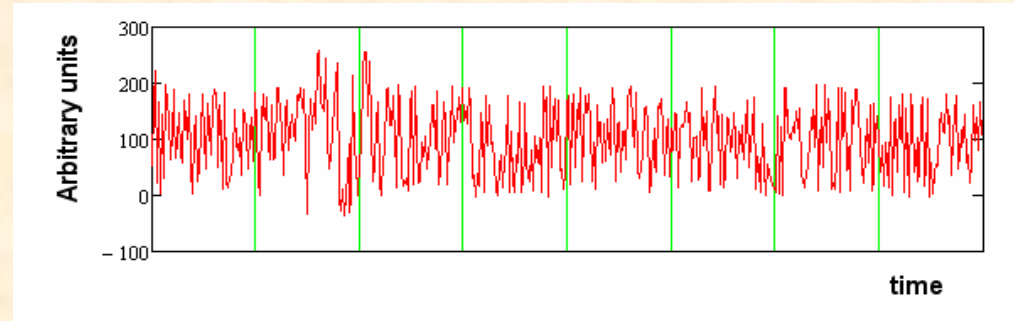

code

$$C_j$$

$$j = 1, \dots, 8$$

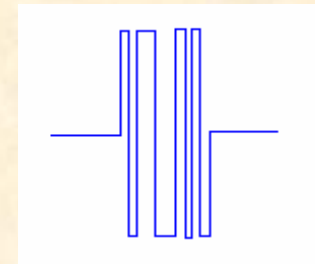

output

$$y_k = \sum_{j=1}^8 A_{k+j} C_j$$

$$k = 1, \dots, M - 8$$

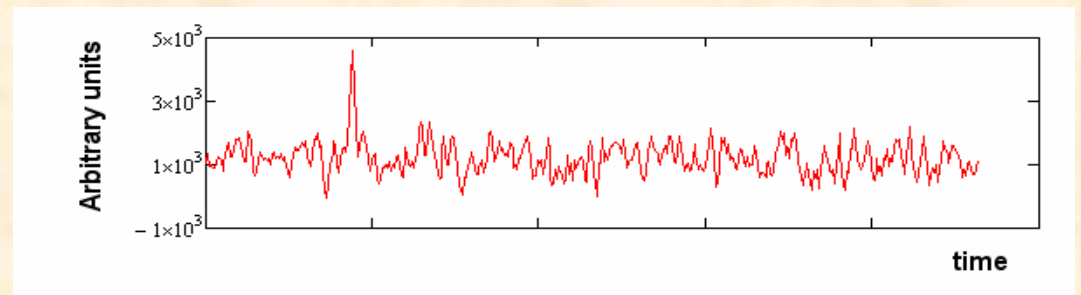

Except very rare case of a extremely good SNR a single pulse is not enough to allow the proper and safe detection of a target.

So we usually use the integration technique to increase the SNR and to get a good  $P_d$ .

In the radar technique we can distinguish between COHERENT and INCOHERENT integration related to the moment at which we perform the summation of the pulses contribution:

**COHERENT** we integrate before the detection, that is when the phase of each pulse is still available and usable;

**NON COHERENT** the integration is performed after the detection.

The **coherent integration** is performed working on the components of the phasor, separately, maintaining the phase information.

Suppose that the target is well steady and each phasor of the echo has phase =  $\varphi$  and amplitude =  $A$  (disregard the noise).

Integrating  $K$  samples **coherently** we will get a signal amplitude of  $K \cdot A$ . The noise is statistically summed (powers are summed).

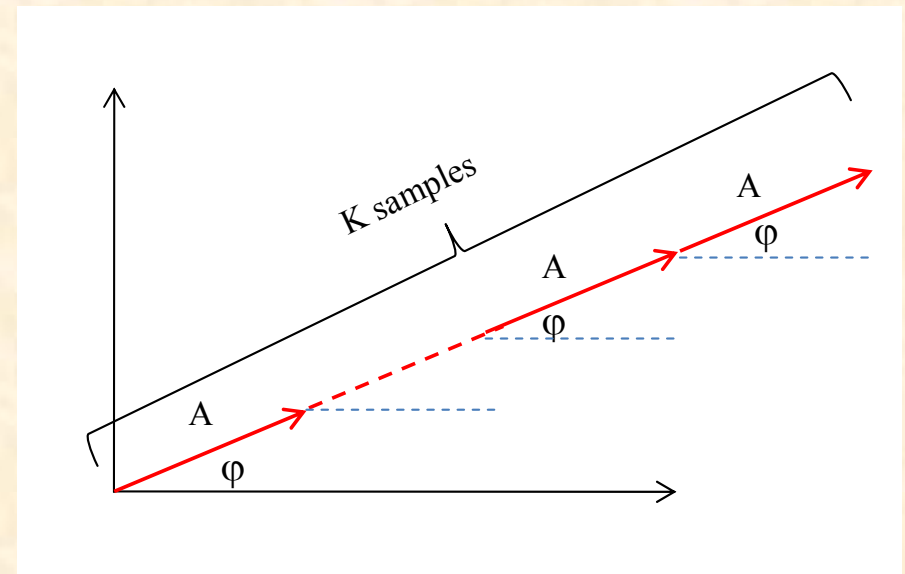

Consider one phasor:  $A^2$  is the power of the **signal** and  $N$  is the power of **noise**: the SNR of a phasor  $SNR_1$  is

$$SNR_1 = \frac{A^2}{N}$$

After  $K$  coherent samples  $(KA)^2$  is the power of the signal and  $KN$  is the power of noise and the SNR of  $K$  samples  $SNR_k$  is

$$SNR_k = \frac{(KA)^2}{K \cdot N}$$

$$SNR_k = K \cdot SNR_1$$

The process gain is  $10 \cdot \text{Log } K$

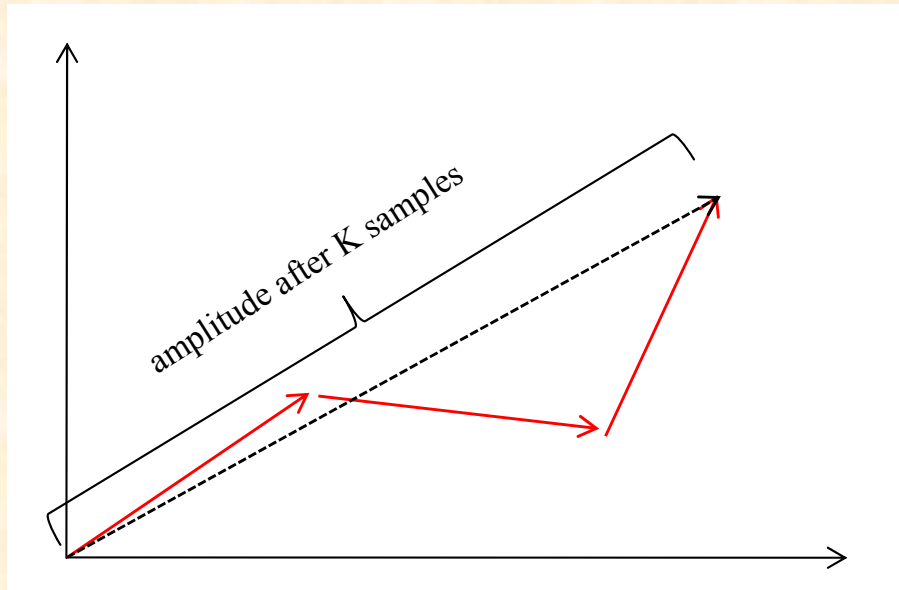

If the phase is not constant the final total vector has amplitude  $< K \cdot A$  so the process is less efficient.

If the target is moving too much during integration time this kind of integration cannot be applied efficiently.

It is not easy to understand when the phase change starts degrading the process (the measure of the phase itself is affected by the noise).

A possible strategy is to integrate for a time along which target is assumed to be stable.



## NON coherent integration

- After the detection process, the phases of the signals are lost, so both signal and noise are integrated summing their power: in this condition the SNR would remain the same, in principle.
- In practice system increases its performances because of the reduction of the variance of the received signal plus noise.

Minimum SNR (detectability factor) to have a given  $P_d$  and  $P_{fa}$  decreases when number of integrations increase.

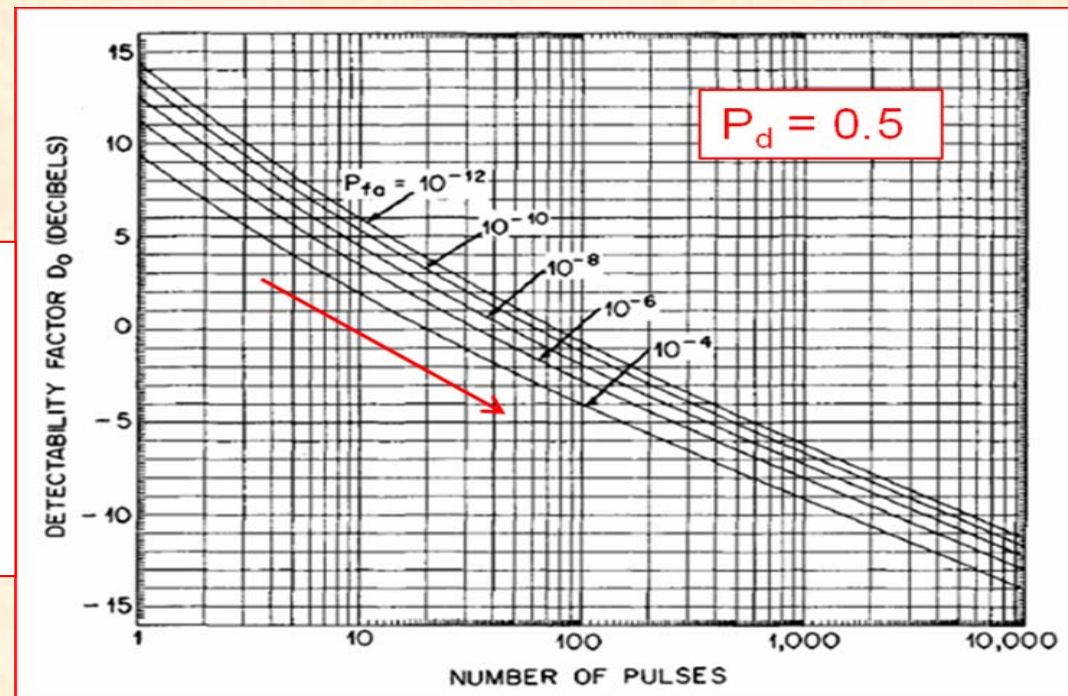

- In some cases, when the amplitudes of the received signals vary rapidly this type of integration is the only possibility.

After performing the integration the output signal in time domain could appear like the following:

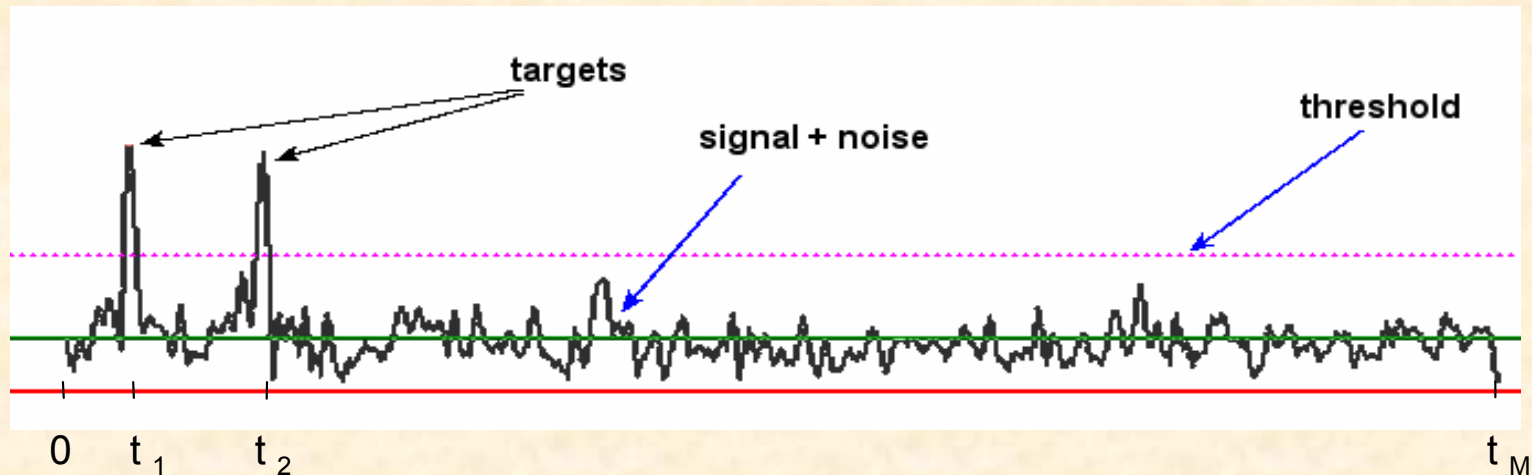

Two peaks are passing the threshold corresponding to 2 targets. Their position is related to the delay in time respect to a  $t=0$  time

$$d = \frac{h_M - h_m}{t_M} t + h_m$$

where  $h_m$  (minimum height) is the height corresponding to  $t=0$ ;

$h_M$  (maximum height) is the height corresponding to  $t=t_M$

## Determining the threshold

After the modulus calculation we have to determine the cited threshold, exceeding which any return can be considered to probably originate from a layer.

**Threshold low:** more targets will be detected, increasing numbers of false alarms too.

**Threshold high:** fewer targets will be detected, and the number of false alarms will also be small.

We cannot use a fixed threshold because the noise level changes in time during the sounding. A changing threshold can be used, where the threshold level is raised and lowered to maintain a constant probability of false alarm. This is known as **constant false alarm rate** (CFAR) detection.



# A tangible example: Advanced Ionospheric Sounder (AIS-INGV)

(Italian patent in 2004)

PC

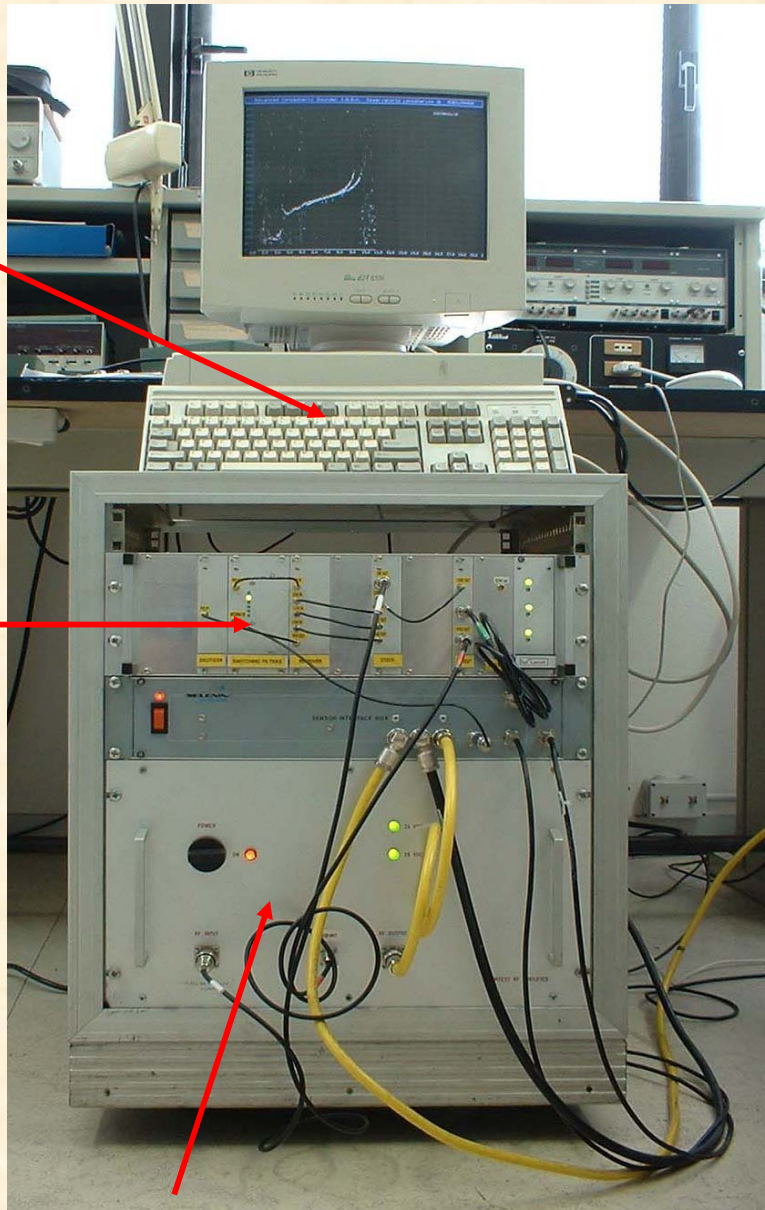

Main unit

Power amplifier

Gibilmanna  
Roma



Mario Zucchelli Station  
(Terra Nova Bay)



S. Miguel de Tucumán  
(Argentina)



# A more detailed view of the AIS-INGV system

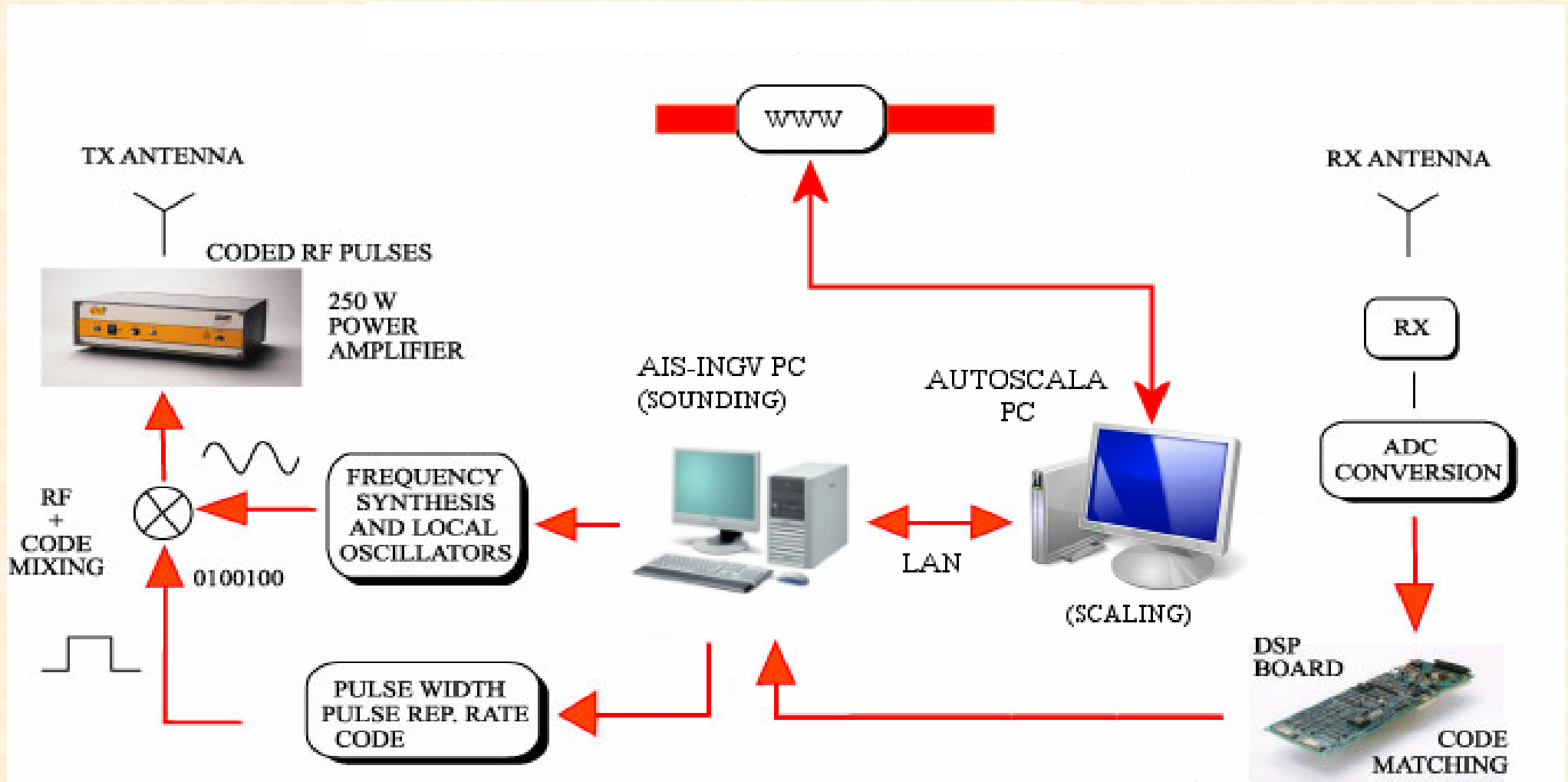

## AIS-INGV ionosonde Inventors' list

<b>James A. Baskaradas</b> james.baskaradas@ingv.it	DSP programming, FFT algorithm development, sounding software.
<b>Cesidio Bianchi</b> cesidio.bianchi@ingv.it	Ionosphere, radio propagation, antennas, project general guidelines.
<b>Michael Pezzopane</b> michael.pezzopane@ingv.it	Ionospheric physics, automatic scaling software development, spreading of data through the net.
<b>Umberto Sciacca</b> umberto.sciacca@ingv.it	Analog and radio frequency design, project general guidelines.
<b>Carlo Scotto</b> carlo.scotto@ingv.it	Ionospheric physics, automatic scaling software development.
<b>Giuseppe Tutone</b> giuseppe.tutone@ingv.it	Antennas, balun, final setup, mechanical arrangements
<b>Enrico Zuccheretti</b> enrico.zuccheretti@ingv.it	General and digital design, technical supervision, sounding software.



## Comparison between AIS-INGV and an envelope ionosonde

	<b>Envelope</b>	<b>Pulse Compression</b>
<b>Frequency Range</b>	1 – 20 MHz	1 – 20 MHz
<b>Height Range</b>	90 – 700 km	90 – 700 km
<b>Pulse width (t)</b>	100 $\mu$ s	480 $\mu$ s (sub pulse 30 $\mu$ s)
<b>TX power</b>	> 5 kW	250 W
<b>Vertical resolution</b>	15 km	5 km
<b>Pulse Repetition Frequency (1/T)</b>	100 Hz	60 Hz
<b>Receiver</b>	Analog (envelope)	Digital (correlation)
<b>Output</b>	paper or film	file

## Vertical sounding (1/4)

- Let's have a look to the principle which the measure is based on.
- Ionosphere is characterized by an electron density profile, that is the distribution of  $N$  along the height.
- In the picture two samples of profile are:

**night** profile with less peaks (only E and F2 regions) and with lower values of  $N$ ;

**day** profile with an increased number of regions, and higher values for  $N$ .

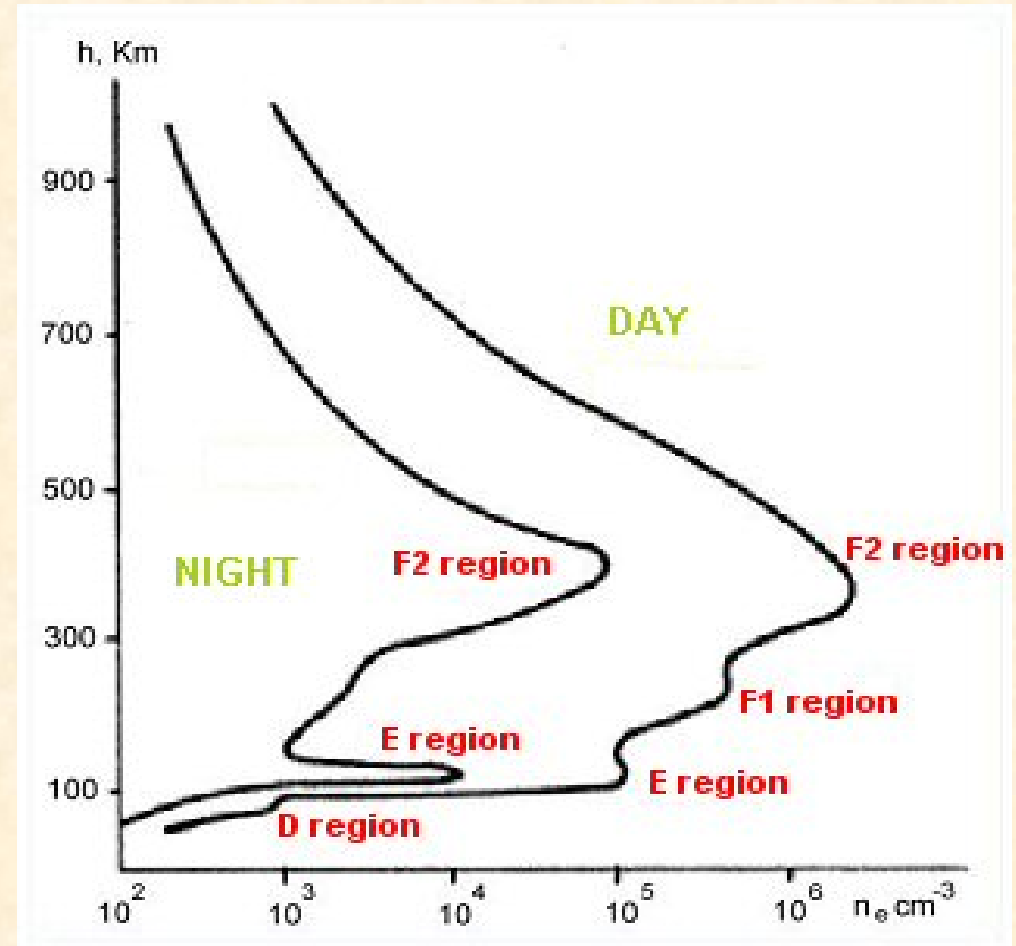

## Vertical sounding (2/4)

- We can consider the ionosphere as a plasma whose plasma frequency is:

$$f_p = \sqrt{\frac{Ne^2}{4\pi^2 \epsilon_0 m}} \approx 9\sqrt{N}$$

- For the propagation is useful to recall the expression of  $n$  (refraction index) in its simplest form:

$$n^2 = 1 - \left(\frac{f_p}{f}\right)^2$$

note that  $n$  depends on  $f$  and on  $N$

## Vertical sounding (3/4)

- The sounding is a way to find the “position” of the ionospheric layers.
- For every used frequency  $f$ , the reflection will happen when the refraction index  $n = 0$ , that is when  $f_p = f$
- The plasma frequency depends on  $N$  that varies with the height; using a variable frequency is a convenient method to investigate the position of the layers.

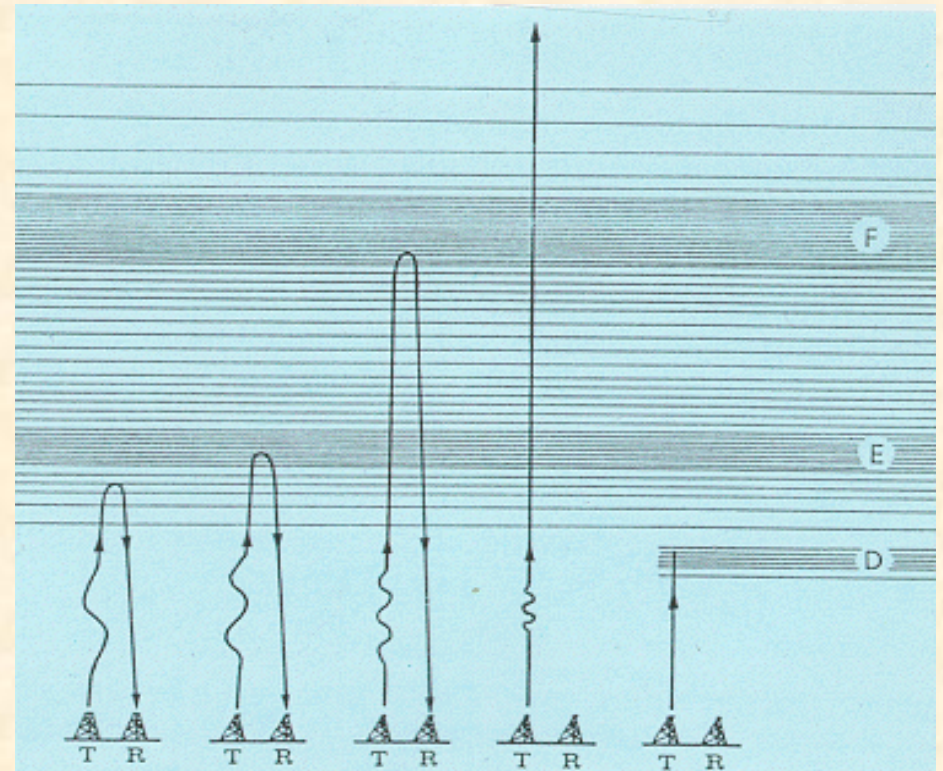
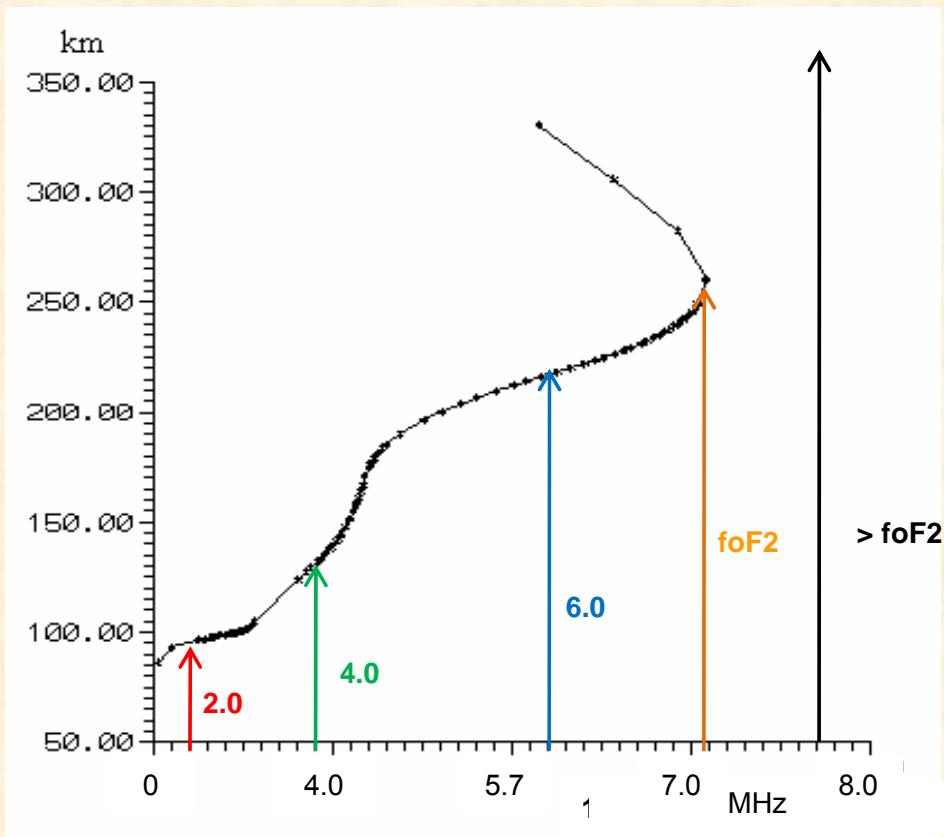

## Vertical sounding (4/4)

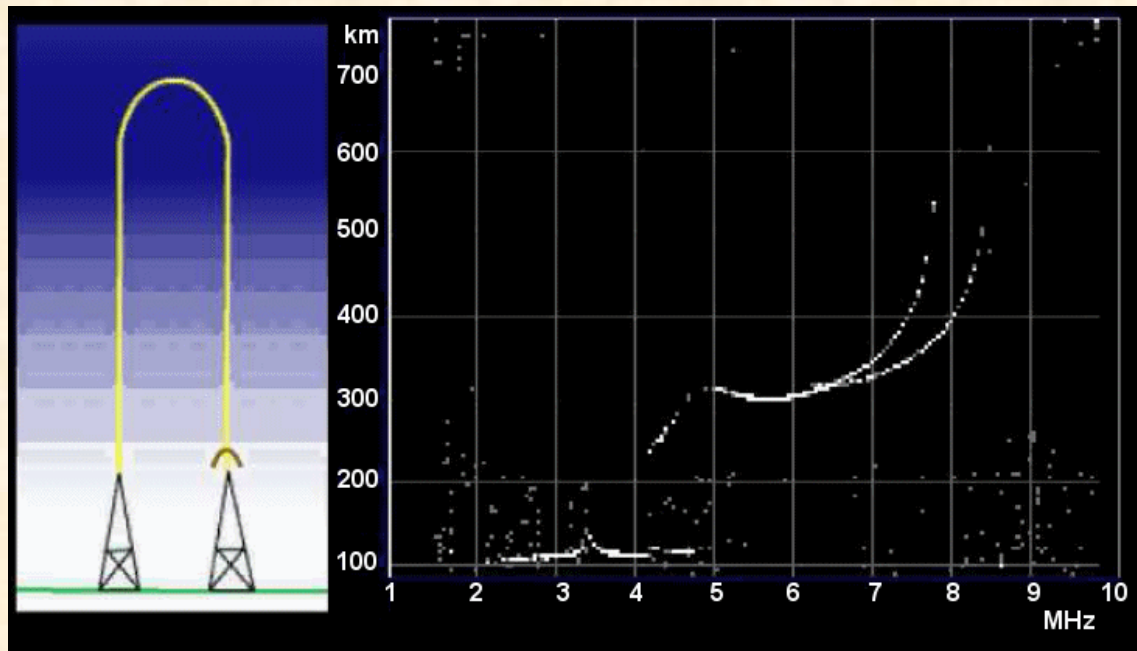

- A sounding is composed by some steps that are:
  - choose a frequency and emit energy (pulses);
  - switch on the receiver and wait for the proper time (listening time);
  - process the received signal storing the results;
  - stay on the same frequency and repeat the previous step (integrate);
  - detect the echoes position and put it on the ionogram;
  - change the frequency and repeat up to the ending frequency.



## Planning a sounding

Whatever ionosonde is used some parameters need to be decided to plan a sounding

- Frequency limits:**  $f_{\min} \geq 1.5$  MHz (broad casting, anthropic noise)  
 $f_{\max}$  depends on the site, the season, the solar cycle.
- Frequency step:** from 50 kHz to 100 kHz (rarely 25 kHz).  
**(frequency resolution)**
- Time integration:** from fractions of seconds up to few seconds.
- Sounding duration:** can last from few seconds to 2 - 3 minutes .
- Soundings scheduling:** depends on sounding application;  
routine manually scaled every hour;  
routine automatically scaled every 15 min;  
special campaign every 5 min.



It is a plot in which the **virtual heights** of reflection on the ionospheric layers is sketched versus frequency.

We use the term "virtual" because we are not measuring the real position of the layer.

The instrument converts the delay time into kilometres using the light speed in the vacuum (constant) and the relationship

$$h' = \frac{c \cdot \Delta t}{2}$$

While penetrating the plasma the speed decreases until it becomes 0 before changing verse, so that

$$h < h'$$

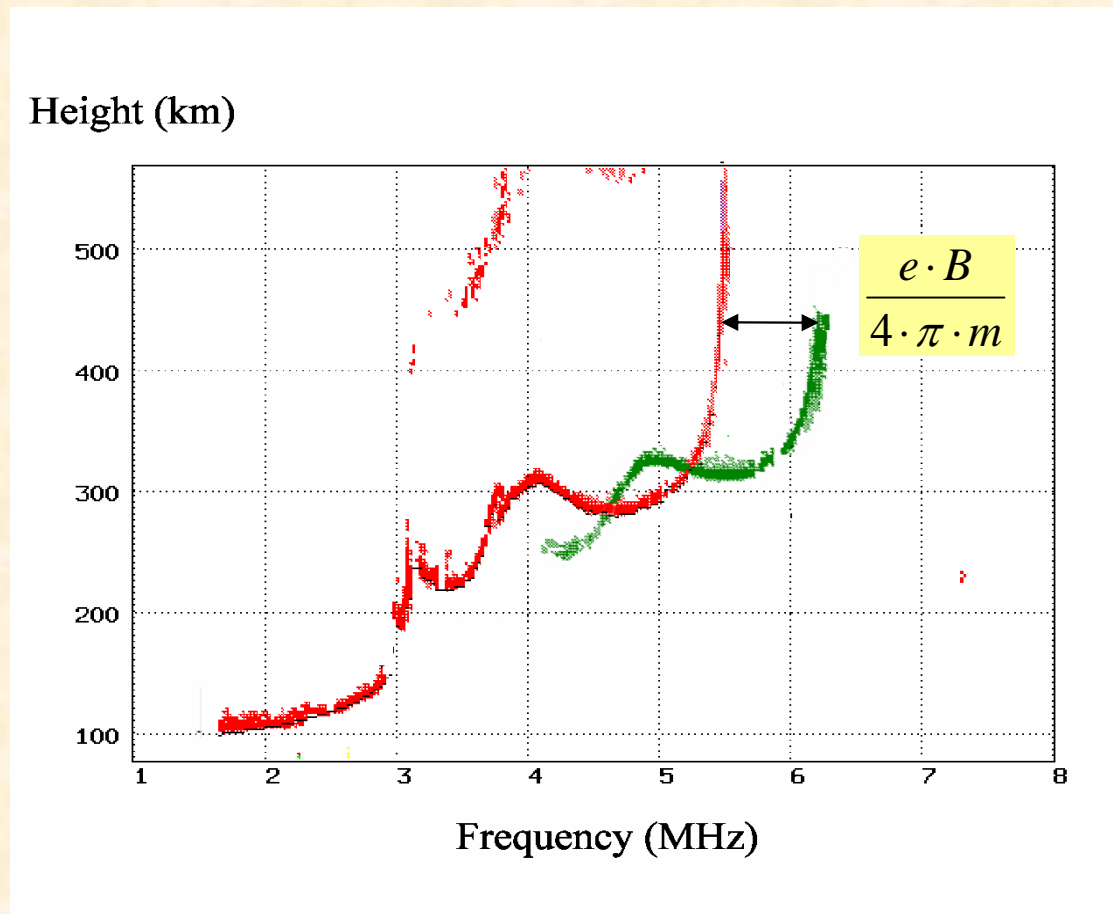

The existence of earth magnetic field makes a second path possible: the extraordinary trace, whose separation depends on B.

# Some nice cases (1/3)

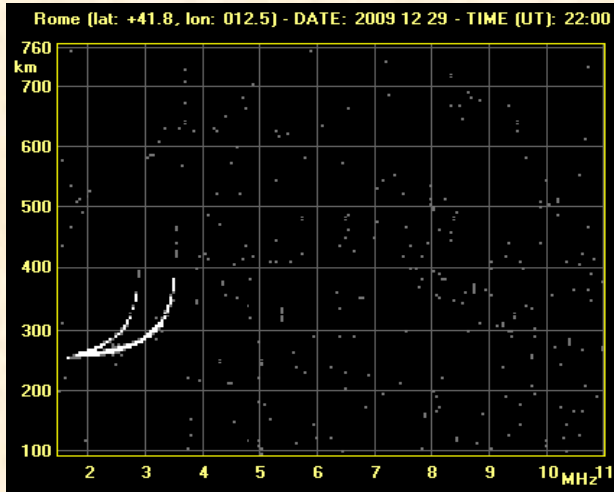

midlatitudes – night  
only F layer is present

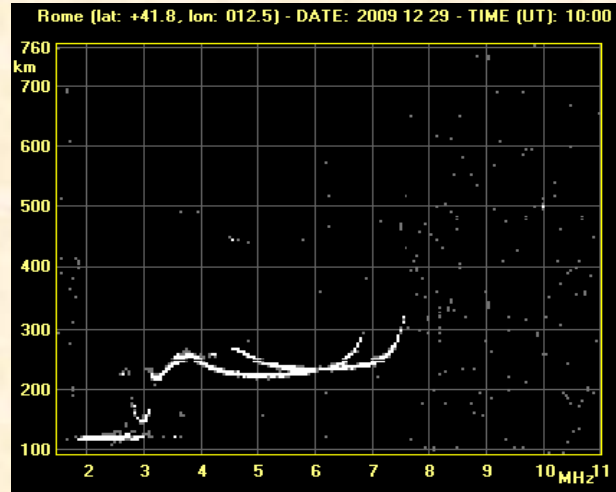

midlatitudes – day  
E and F layers are present

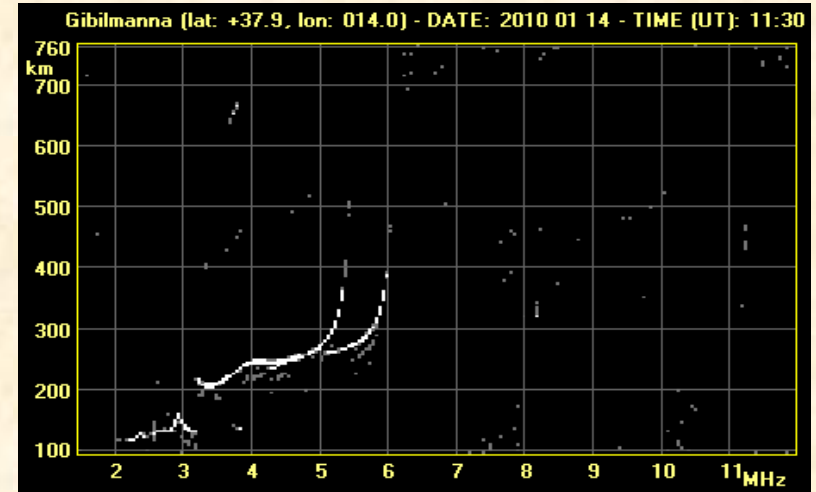

midlatitudes – day

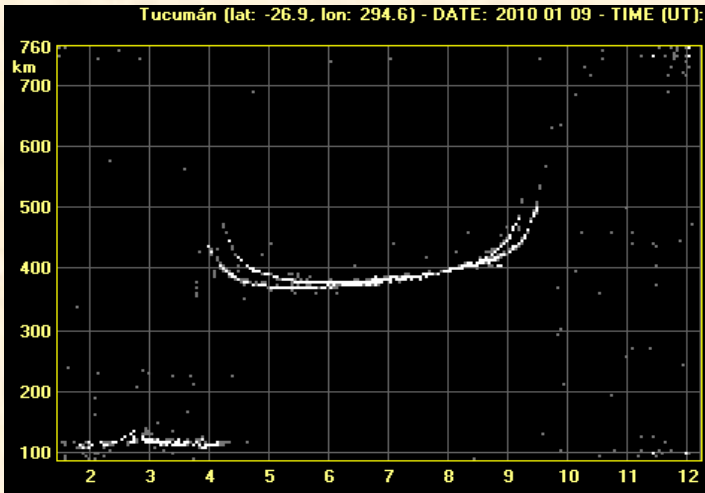

equatorial latitudes  
note height of the layer and the  
OX separation

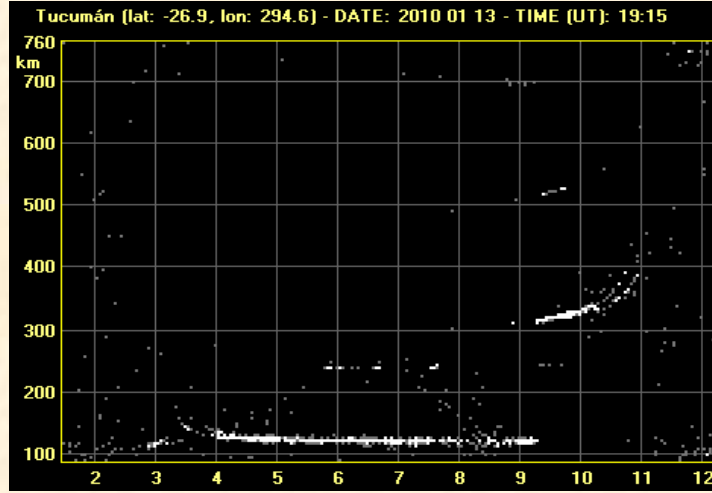

equatorial latitudes – early night  
partially blanketing Es

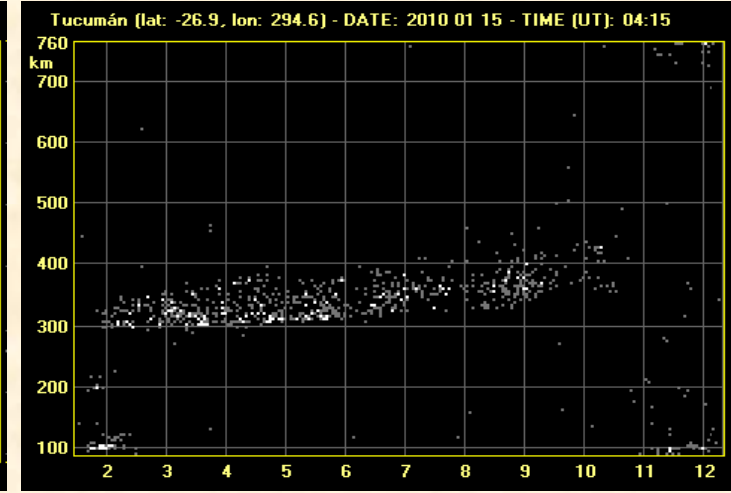

equatorial latitudes – night  
spread

# Some nice cases (2/3)

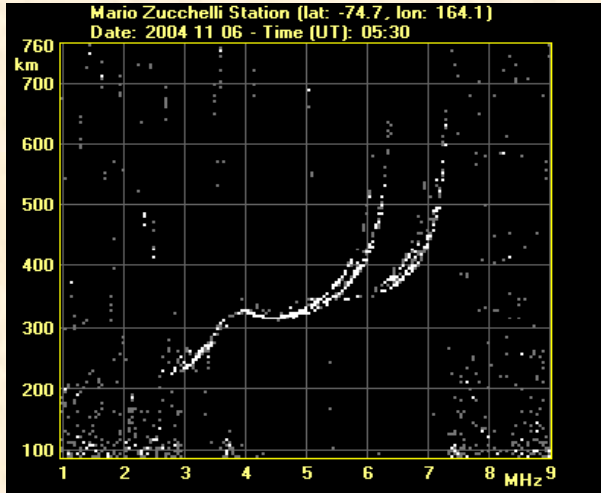

polar latitudes– day

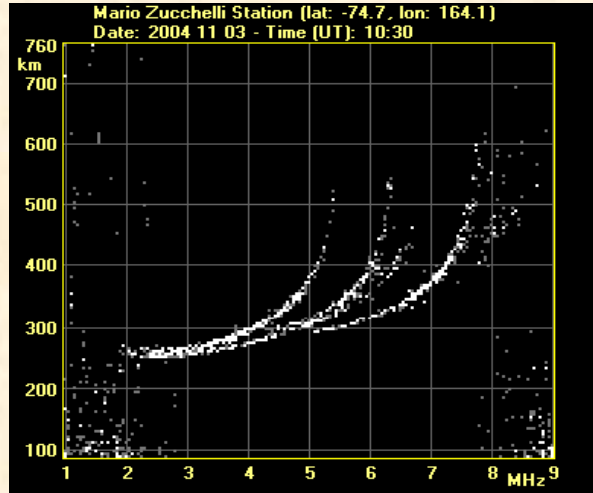

polar latitudes – night  
Z ray

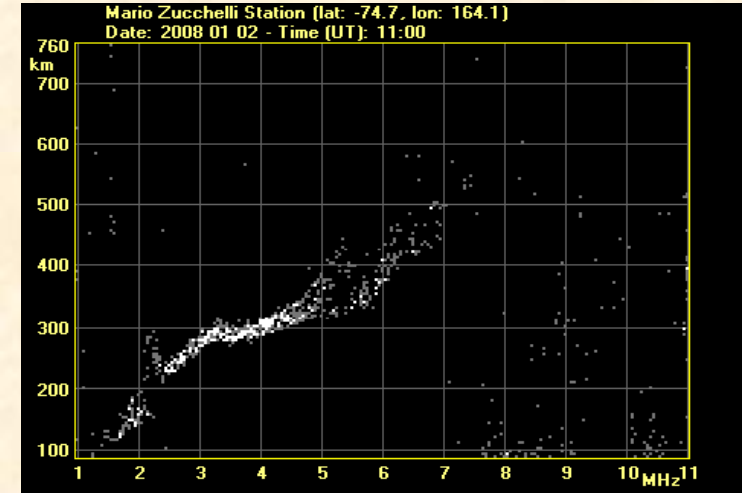

polar latitudes – night  
spread F

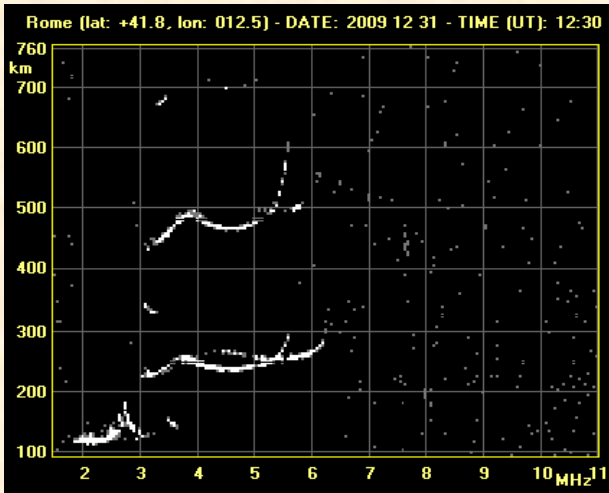

midlatitudes – day  
double reflection

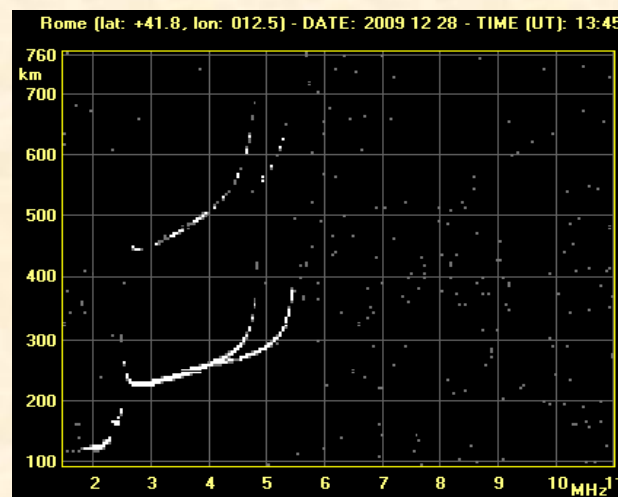

midlatitudes – day  
double reflection

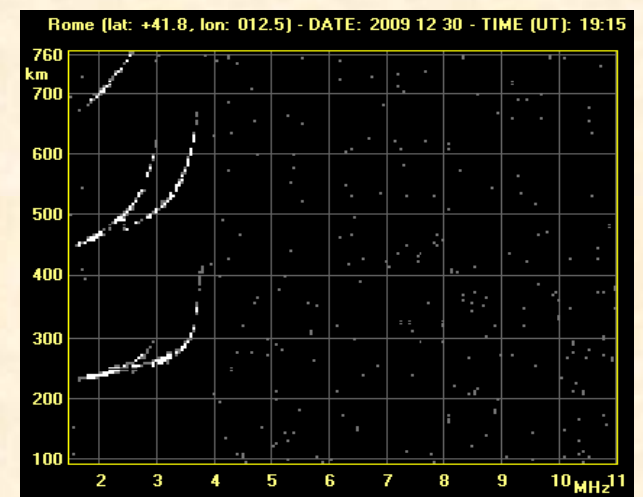

midlatitudes – night  
triple reflection

# Some nice cases (3/3)

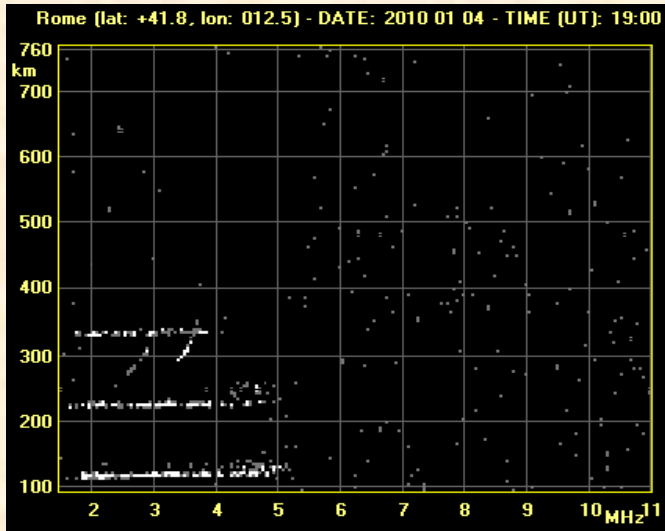

midlatitudes – night  
3 reflections on Es layer

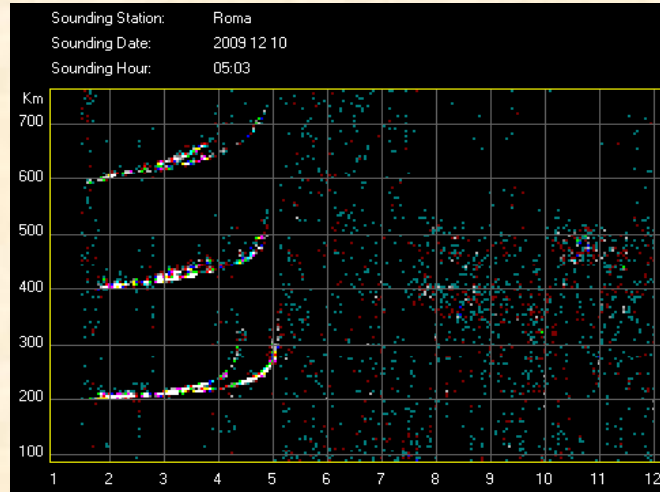

midlatitudes – night  
3 reflections on F layer

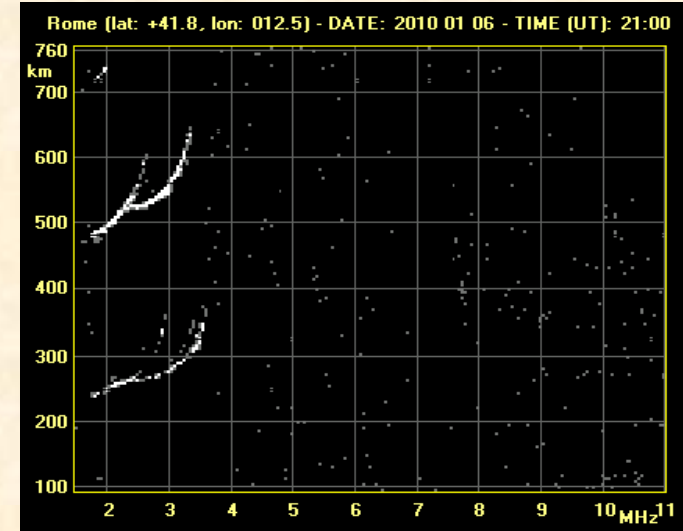

midlatitudes – night  
2 reflections (2° is stronger)

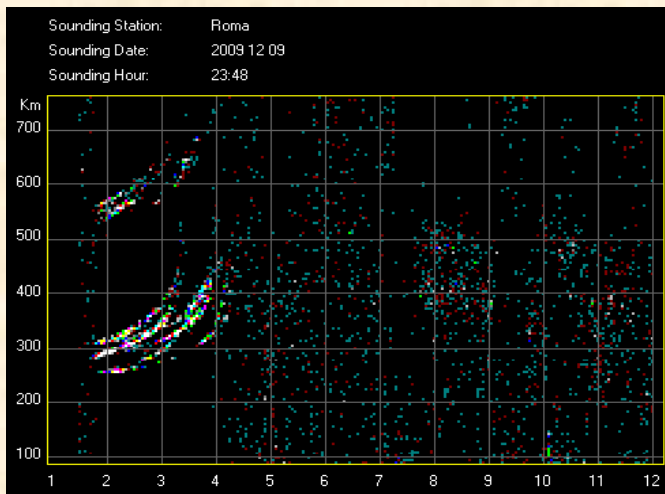

midlatitudes – night  
???????

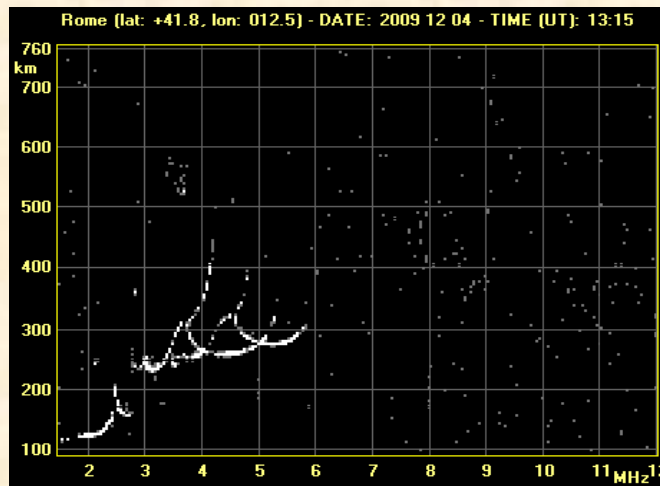

midlatitudes – day  
fork

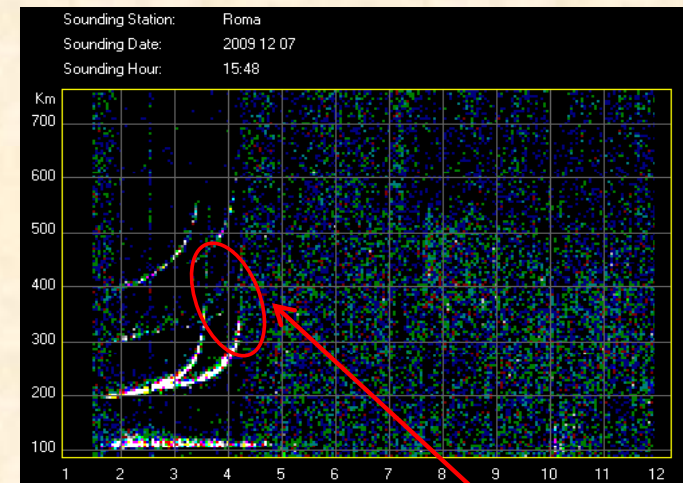

midlatitudes  
double reflection + ?

Once we get the ionogram the first step is to obtain the ionospheric characteristics (ionogram scaling).

Critical frequencies that correspond to cusps, maxima or asymptote

- foE      critical freq. of E layer (ordinary)
- foF1     critical freq. of F1 layer (ordinary)
- foF2     critical freq. of F2 layer (ordinary)
- fxI      critical freq. of X trace ( it is also the maximum visible freq)

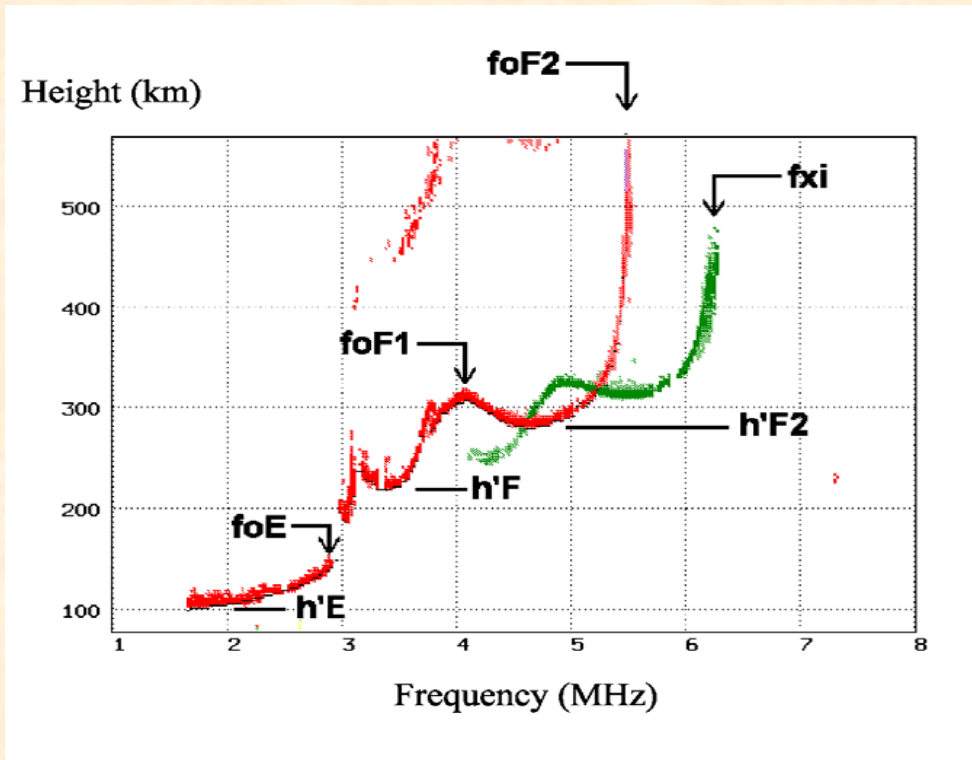

Virtual heights of the layer that correspond to relative minima on the ionogram

- h'E      virtual height E layer
- h'F      virtual height F layer
- h'F2     virtual height F2 layer

These parameters are stored to create the history of a ionospheric observatory and are used in models to produce the ionospheric forecasts.



## From ionogram to the density profile

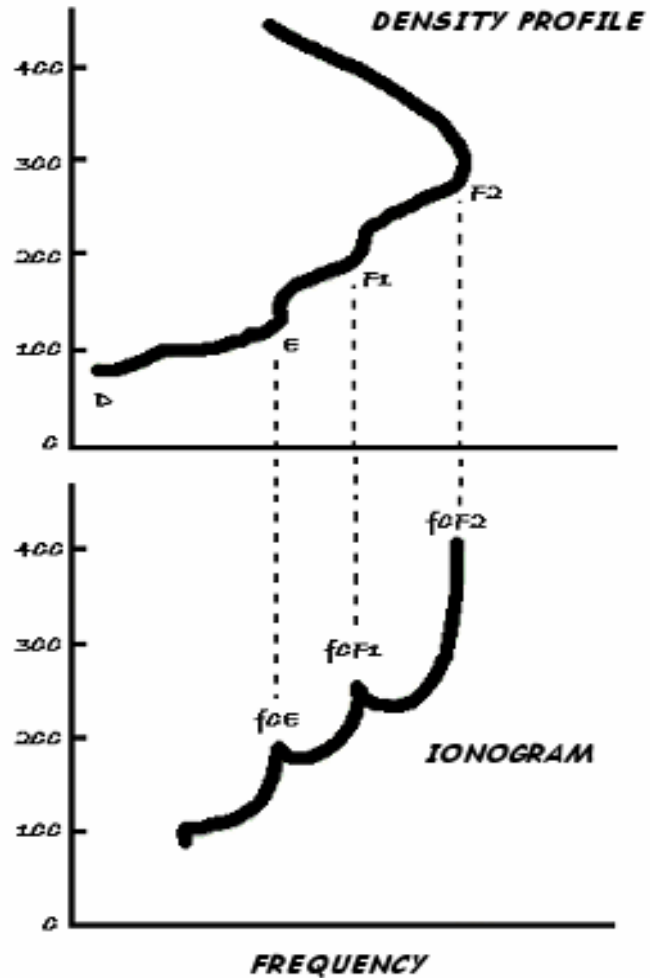

To better describe the ionosphere we need to know the electron density profile that is strictly related to the ionogram.

The height on the ionogram is a **virtual** one while we are interested to the **real height**.

Inversion processes are necessary to go from ionogram to density profile.

We can individuate two kind of methods.



### Polynomial inversion method

- We start from the digitized ionogram considering it as  $(f, h')$  couples.
- There are models partially empirical able to describe analytically the different ionospheric regions from helio - geophysical and ionospheric quantities (POLAN by Titheridge).

### Successive approximation method

- We generate a starting density profile and a corresponding synthetic ionogram;
- a comparison between it and the measured ionogram is performed;
- the profile is varied in some convenient way producing another synthetic ionogram to compare;
- when the synthetic ionogram is similar (some criteria) to the measured one the process ends giving the density profile.
- This is a convenient method executable after a sounding.

## New role for a vertical sounding system

- The classic role of an ionosonde is to perform continuous sounding of the ionosphere to gather data for studying the physics of the ionosphere and forecasting of parameters useful for radio links.
- Ionospheric models at medium latitudes are able to foresee the ionospheric behaviour in quiet conditions some weeks in advance, nevertheless **occasional variations** due to variability of ionosphere are possible.
- Modern digital ionosondes allow to scale the ionogram within few minutes after sounding. As an example, graphs like the one aside are produced, called “F plot”. It represents the hourly trend during a day of the foF2 frequency, comparing the measured values (red) to the modelled ones (white).
- So the new role of the ionosonde is to be a **monitoring system of ionospheric short term** behaviour (“**nowcasting**”), often in net configuration, to allow corrections to models, obtaining a complete regional map of the ionosphere closer to the reality.

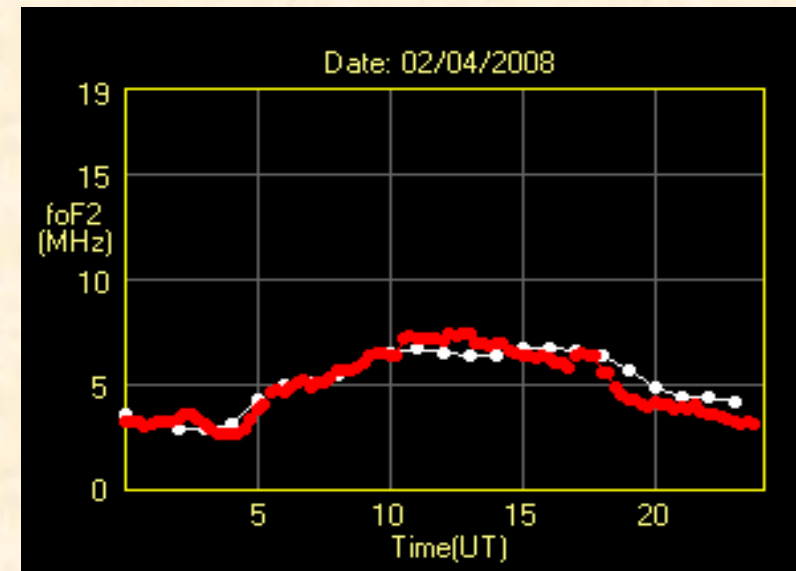

## Halloween storm at Gibilmanna (1/2)

Halloween Storm is the name given to the intense solar and resulting terrestrial activity that occurred from October 22 to November 04 2003.

This Halloween Storm spawned auroras that were seen over most of North America. Extensive satellite problems were reported; a huge solar storm has impacted the Earth, just over 19 hours after leaving the sun revealing effects also at medium latitudes.

As an example the next slides report the foreseen (blue) and measured (magenta) values for foF2 at ionospheric station of Gibilmanna, (37.9 N 014.0 E), Italy. It is possible to see that measured values distribute around the the modelled ones, during days October 25, 26 and 27.

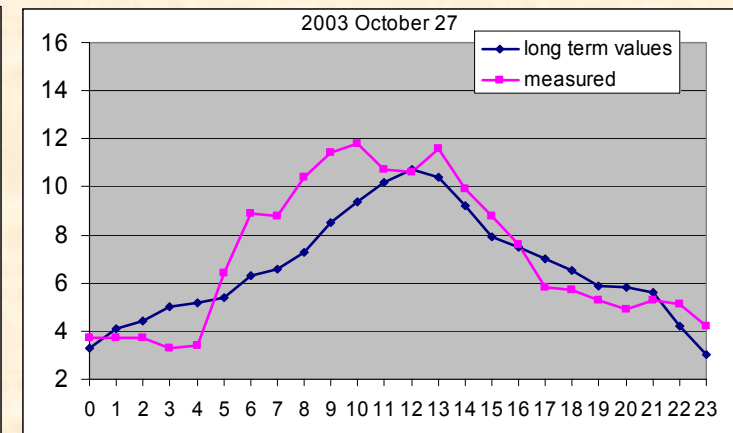
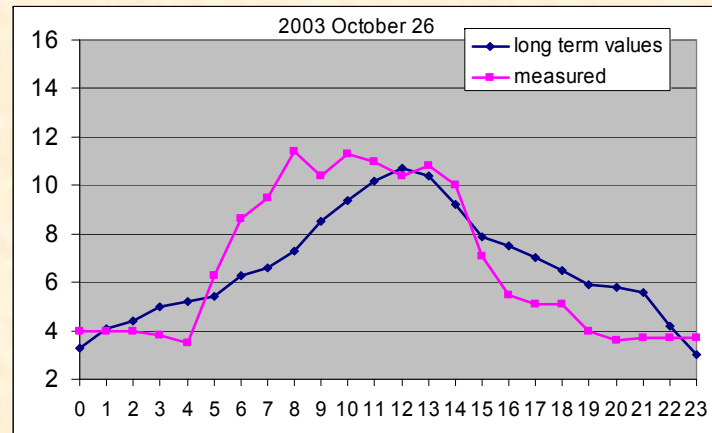
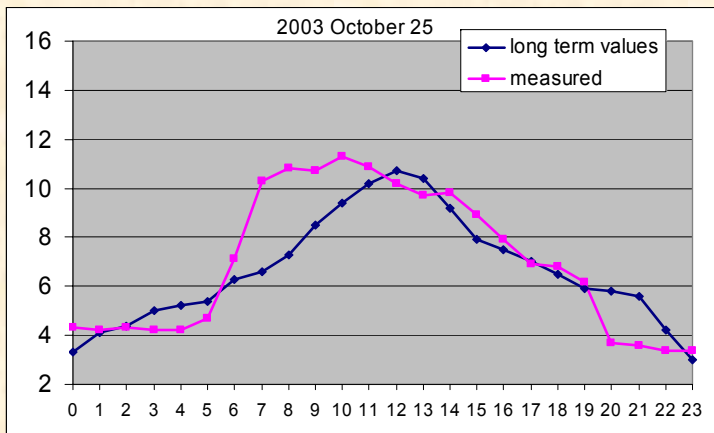

Then most of values exceed the foreseen behaviour giving raise to the positive phase of the magnetic storm (+), followed by a negative phase (-) in which all measurements are below the corresponding modelled values.

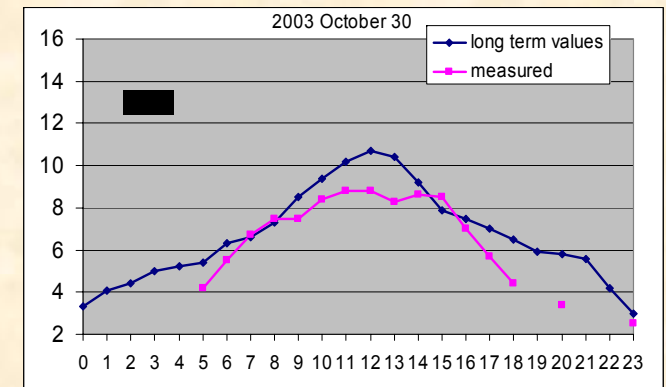
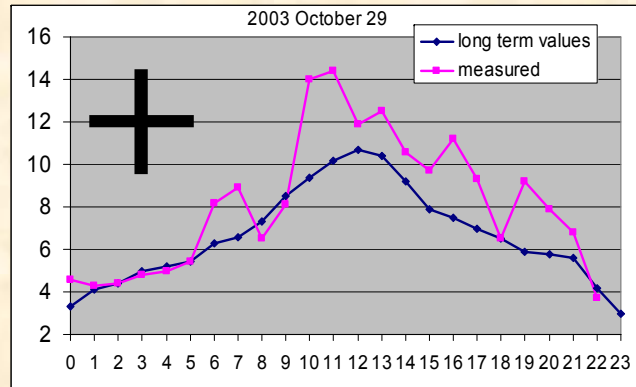
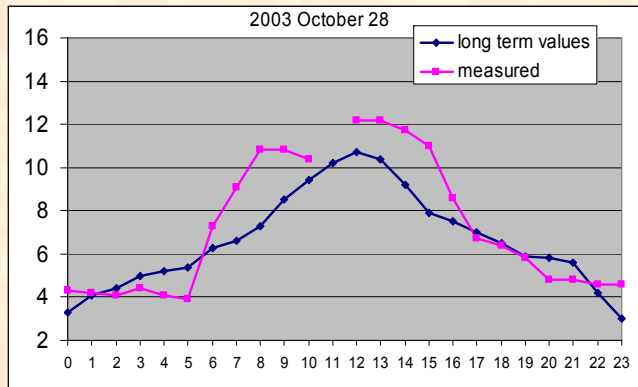

On 31 October the negative phase is still in progress, followed by days in which the situation is coming back to the quiet status.

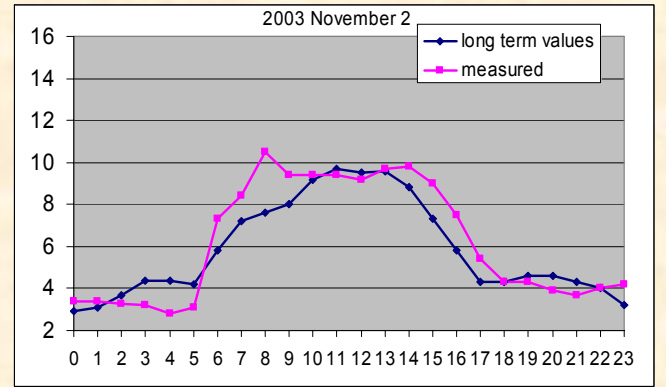
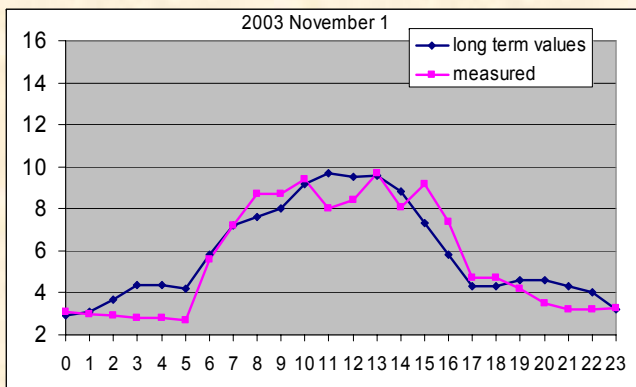
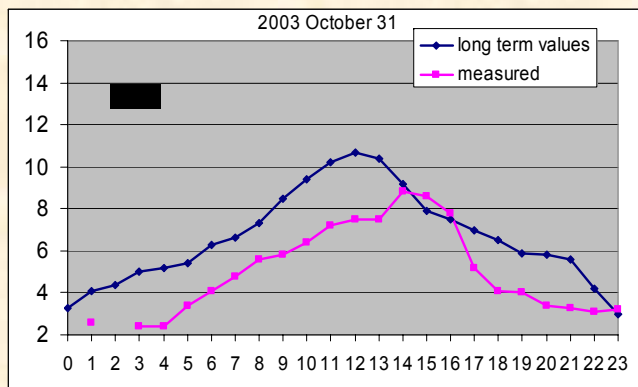

## Bibliography

- Barton D. K., Leonov S. A. (editors), **Radar Technology Encyclopedia**, Artech House Inc., 1998.
- Budden K.G., **Radio wave in the ionosphere**, Cambridge Univ. Press UK, 1966.
- Davies K., **Ionospheric Radio**, published as IEE Electromagnetic Waves Series No, 31 Peter Peregrinus Ltd London, UK, 1990.
- McNamara L. F., **The ionosphere: communications, surveillance and direction finding**, Krieger Publishing Company, 1991.
- Hunsucker R. D., **Radio techniques for probing the terrestrial ionosphere**, Springer-Verlag, 1991.
- Skolnik M., **Radar handbook**, Mc Graw Hill, 1990.





# Module 2

## The AIS-INGV and Tucumán system



PC

Main unit

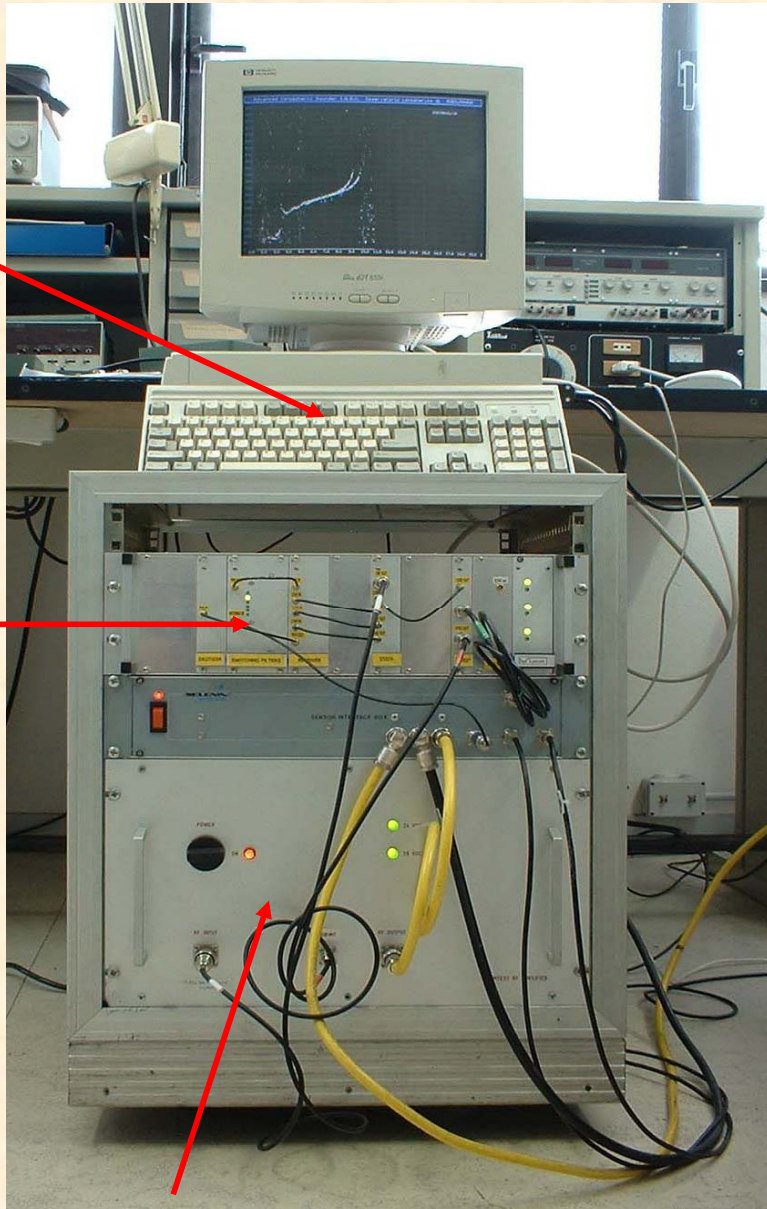

Power amplifier

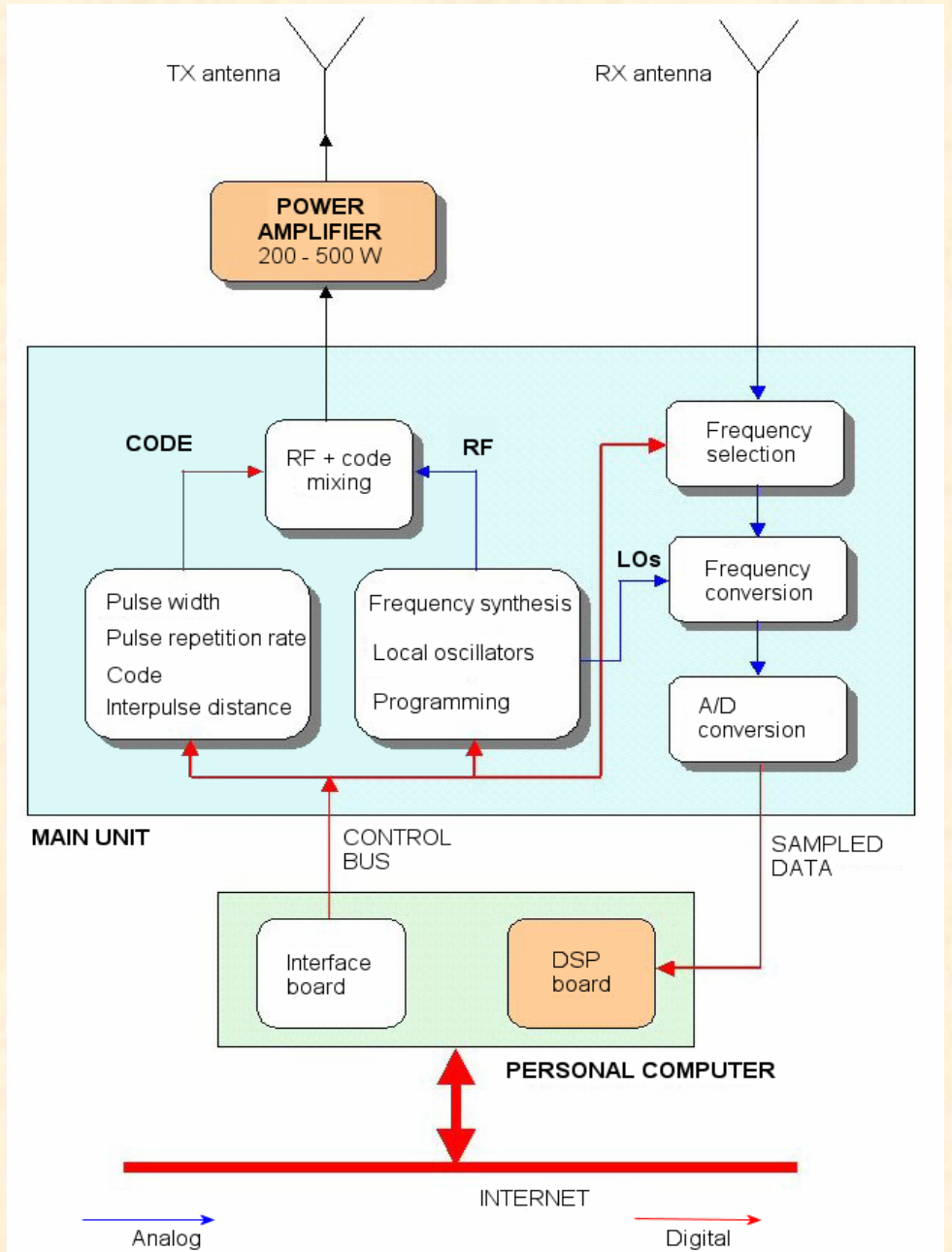

# AIS-INGV block diagram

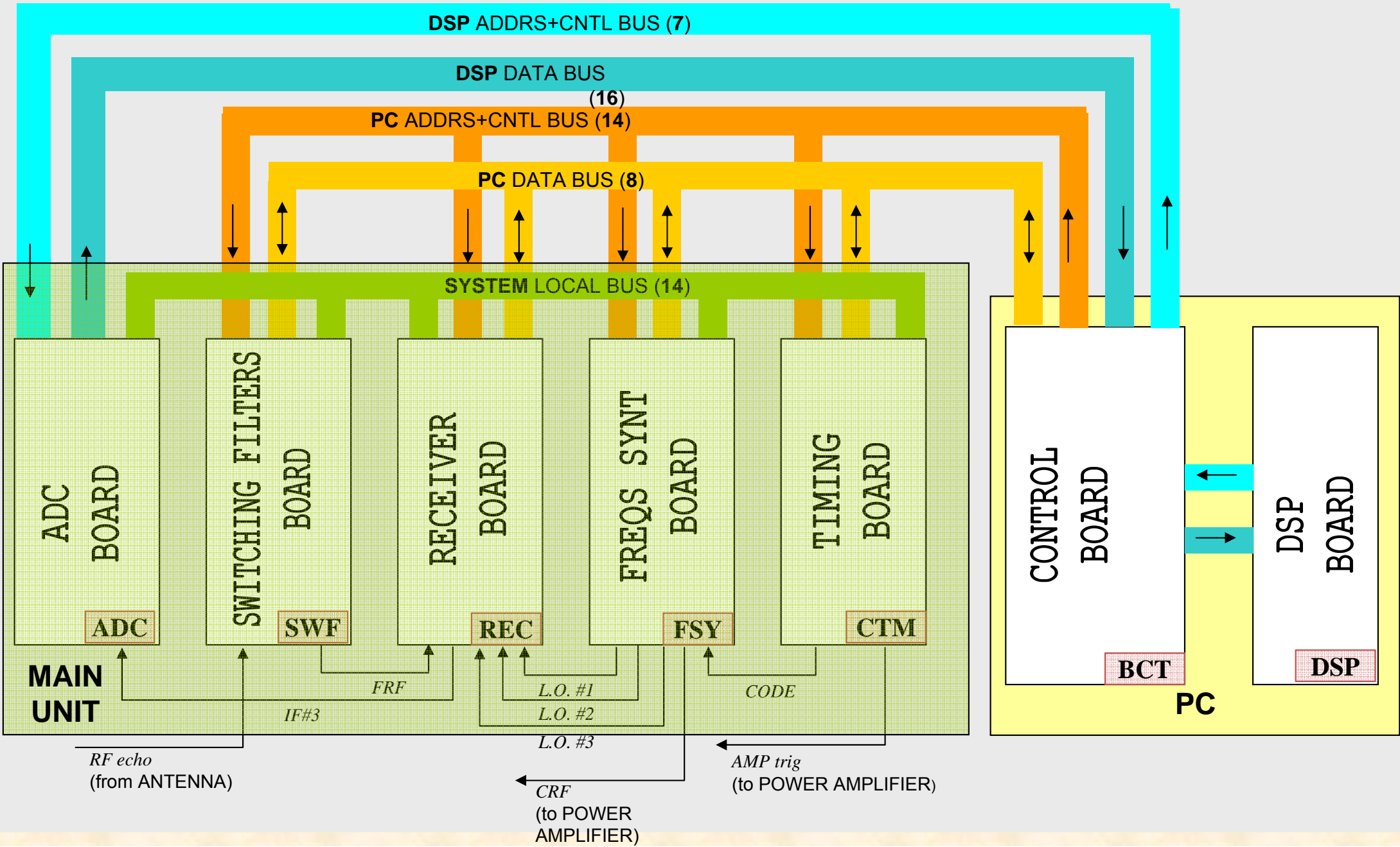

# Main unit block diagram

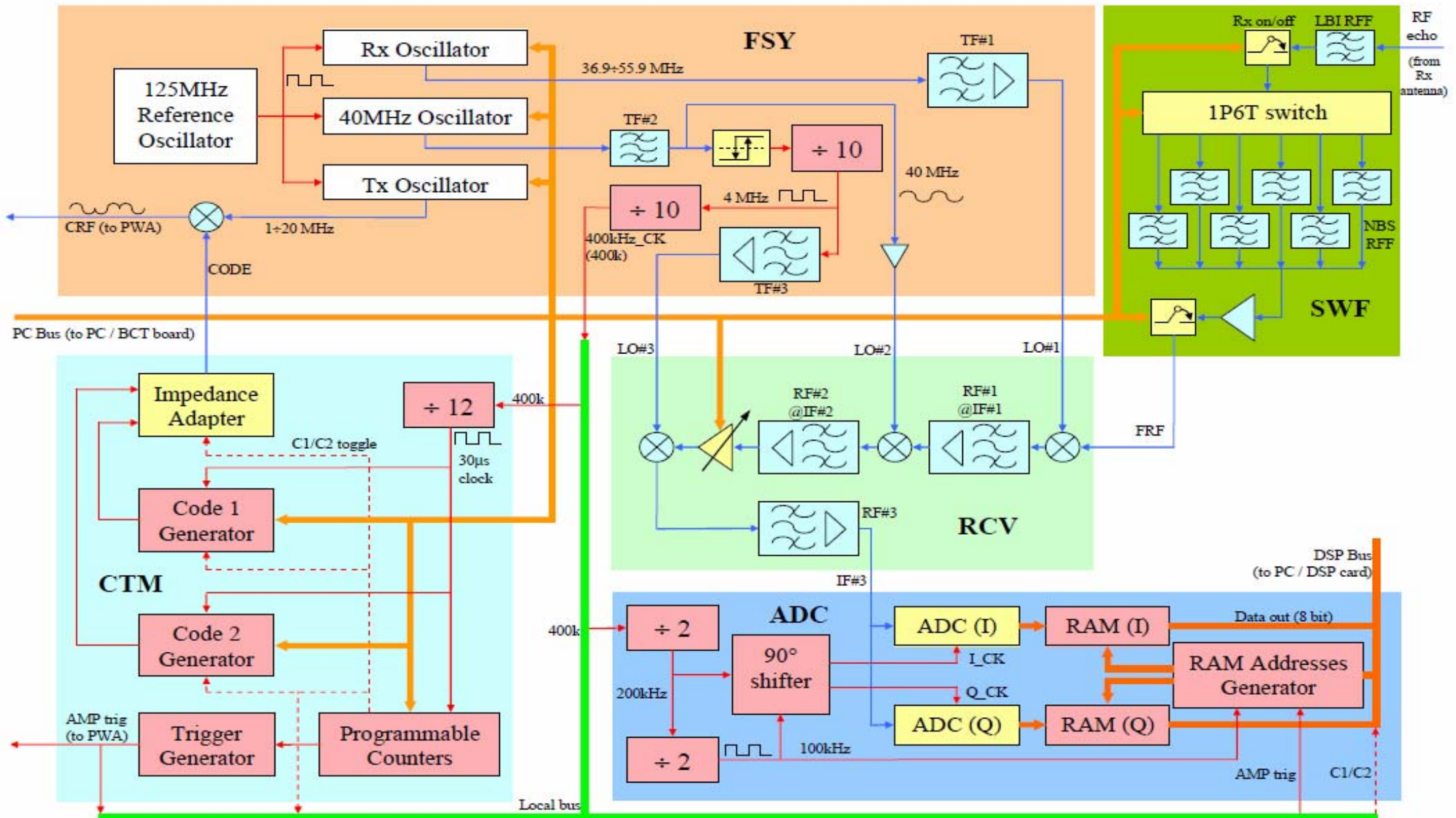



# Main Unit overview

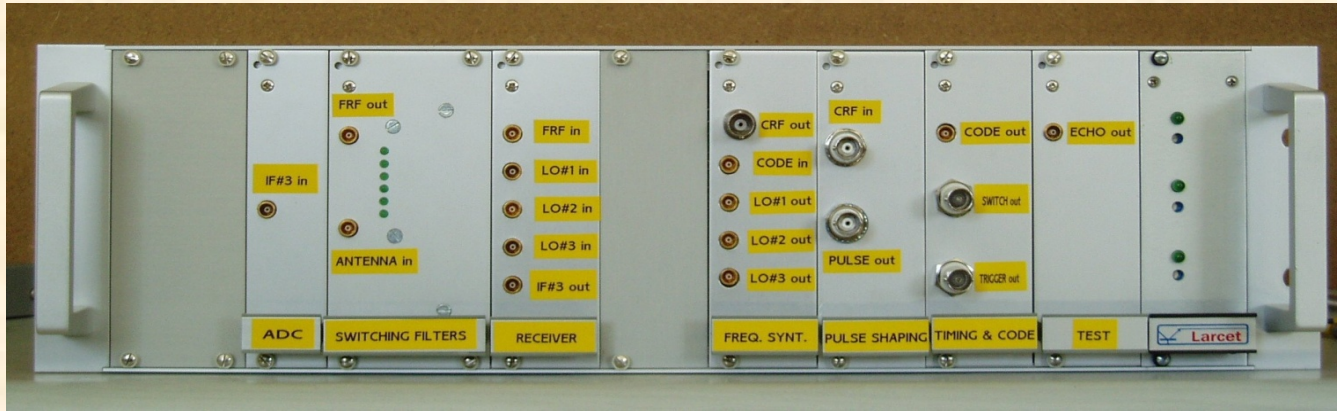

boards

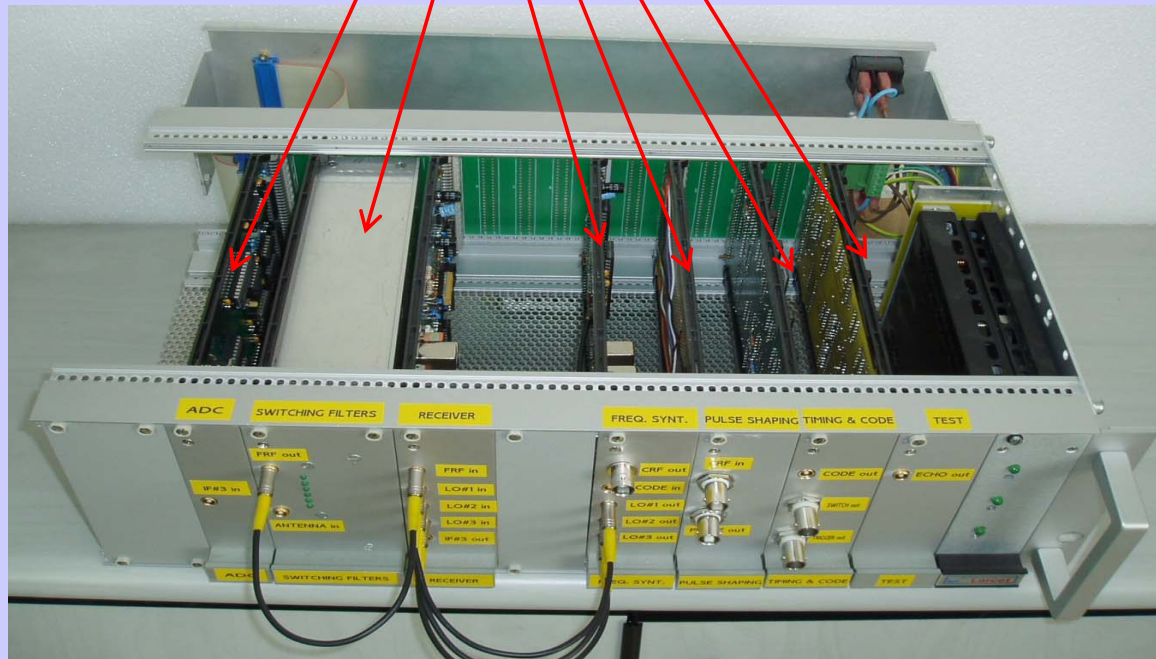



# Switching filters (1/6)

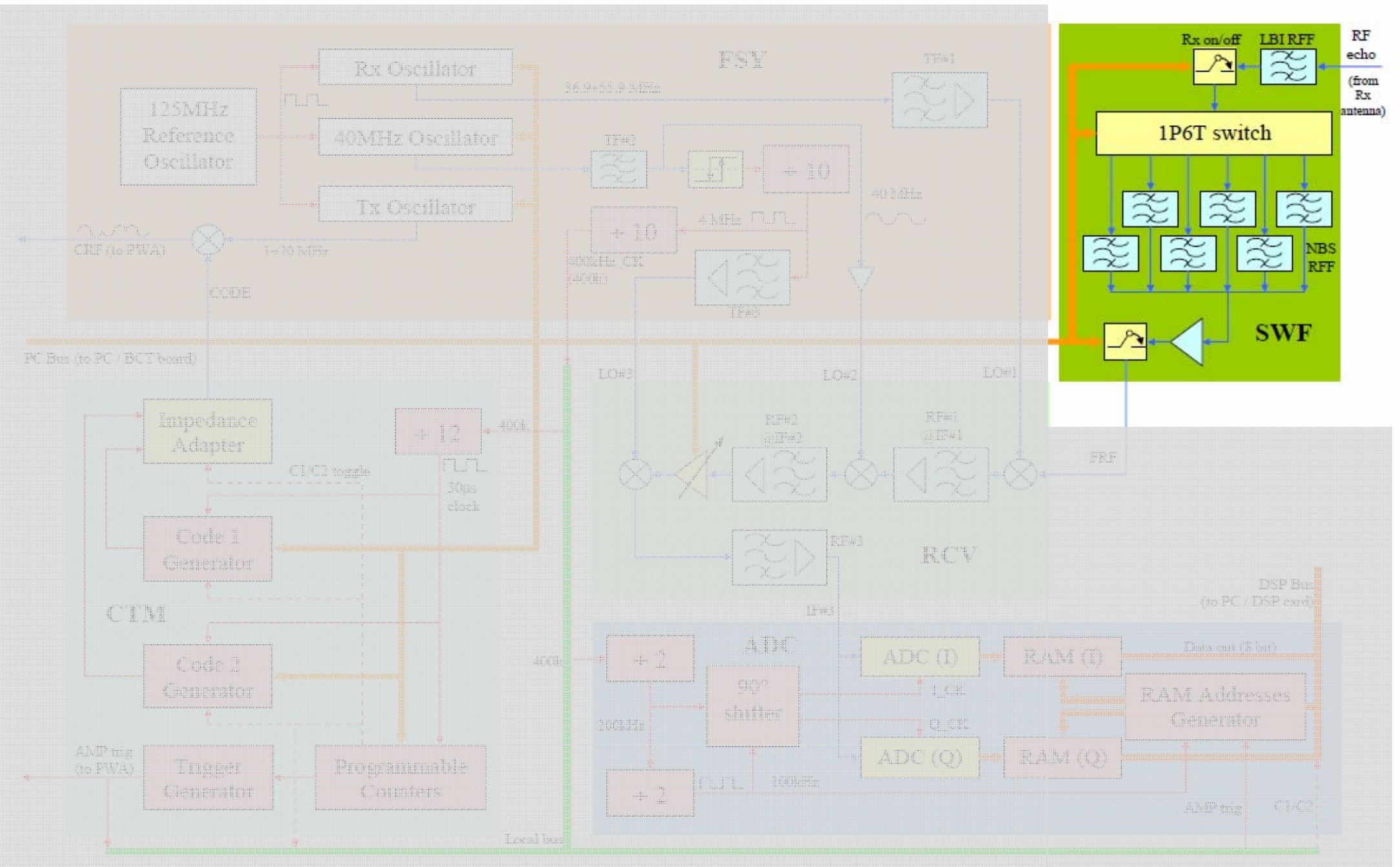



# Switching filters (2/6)

## Functions and blocks

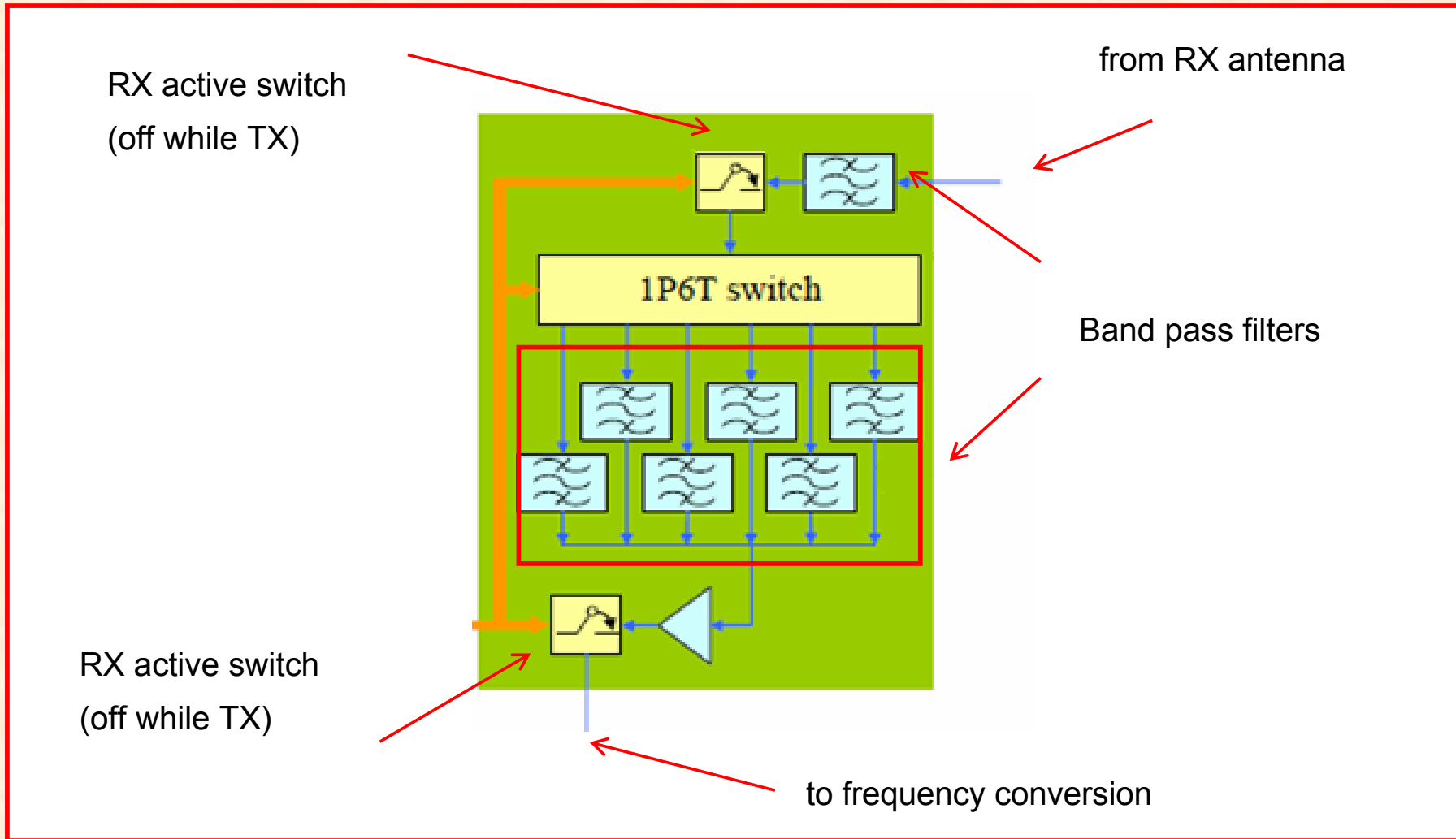

**Tasks** : to reduce band for input frequencies (noise reduction)  
to isolate the receiver during the TX phase.

This is accomplished by:

- n. 1 filter 1÷20 MHz pass band to limit the whole band;
- n. 6 filters that are enabled or disabled electronically during the sounding swept to reduce the band further.

Each filter is a **constant Q** 5<sup>o</sup> order Chebyshev filter.

$$Q = \frac{B}{f_0} = k$$

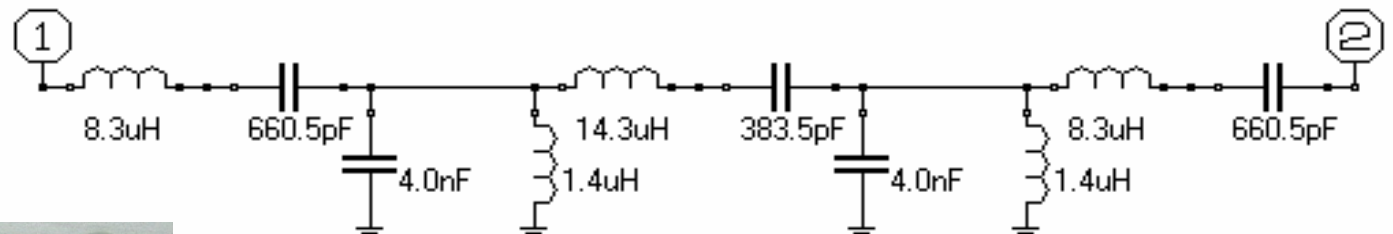

Central frequency: 2.2 MHz

Band: 1.1 MHz

They share common input and output lines, but they are not active contemporary.

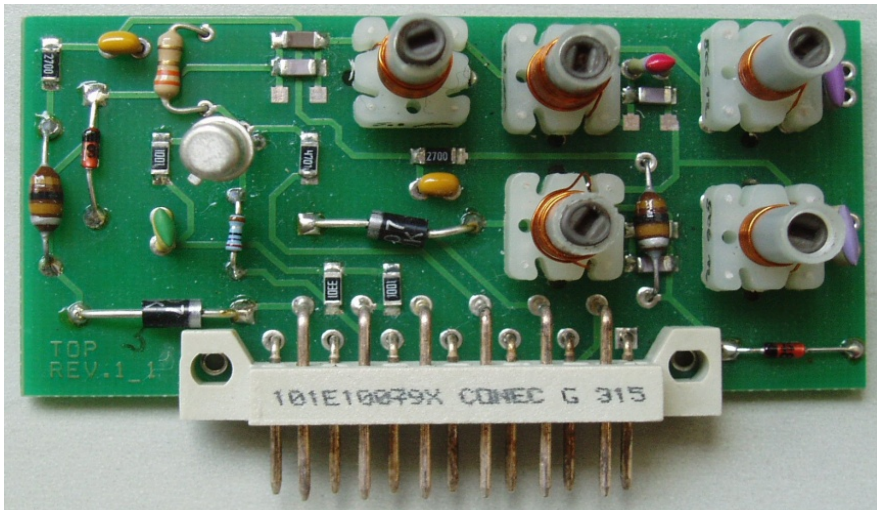

## Filters shape

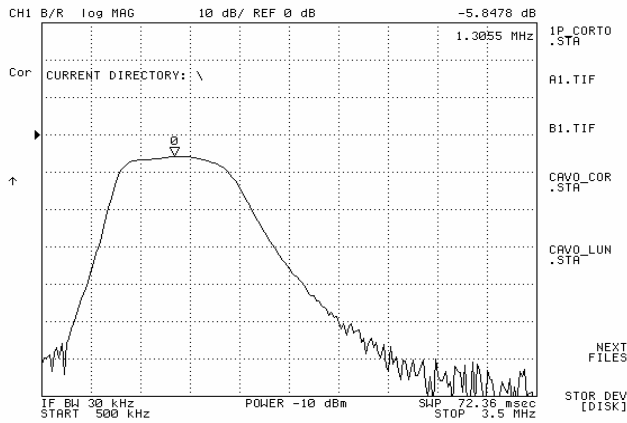

$f_0=1.3$  MHz,  
 $B=0.6$  MHz

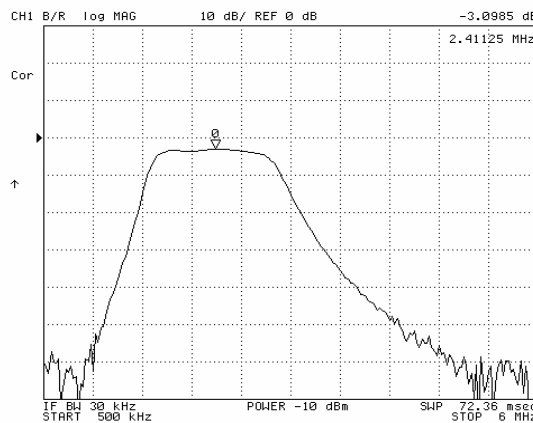

$f_0=2.2$  MHz,  
 $B=1.1$  MHz

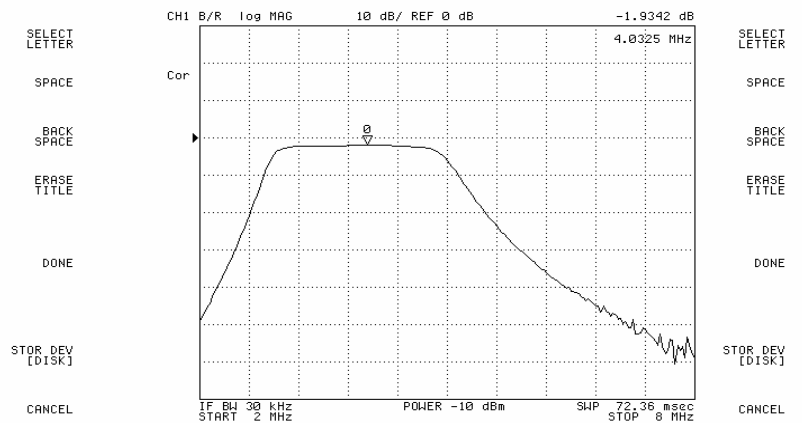

$f_0=3.6$  MHz,  
 $B=1.8$  MHz

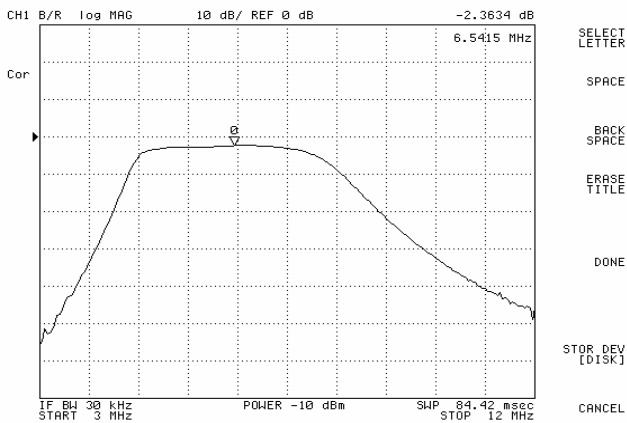

$f_0=6.0$  MHz,  
 $B=3.0$  MHz

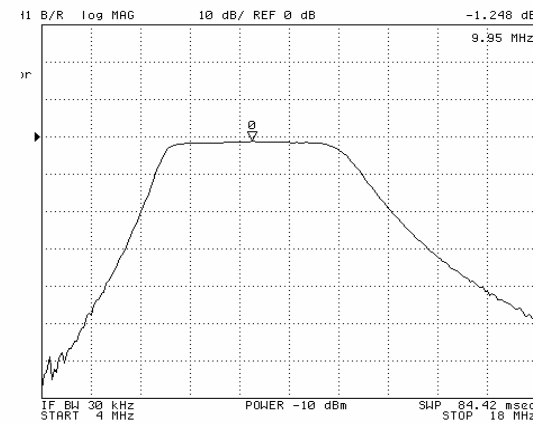

$f_0=10.0$  MHz,  
 $B=5.0$  MHz

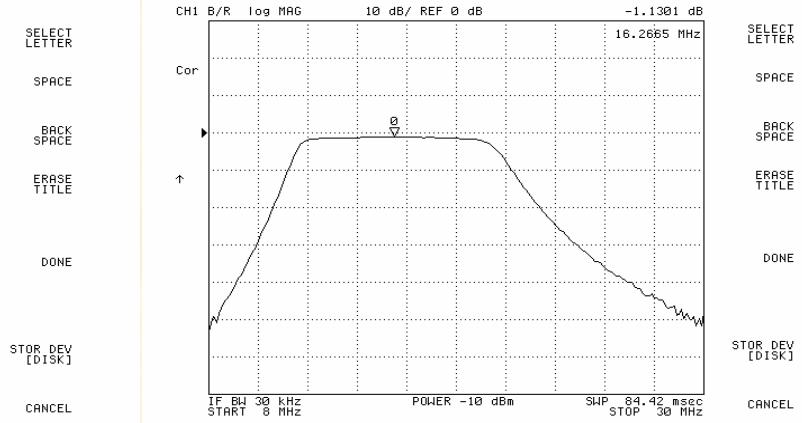

$f_0=16.7$  MHz,  
 $B=8.5$  MHz

## Filters overlapping

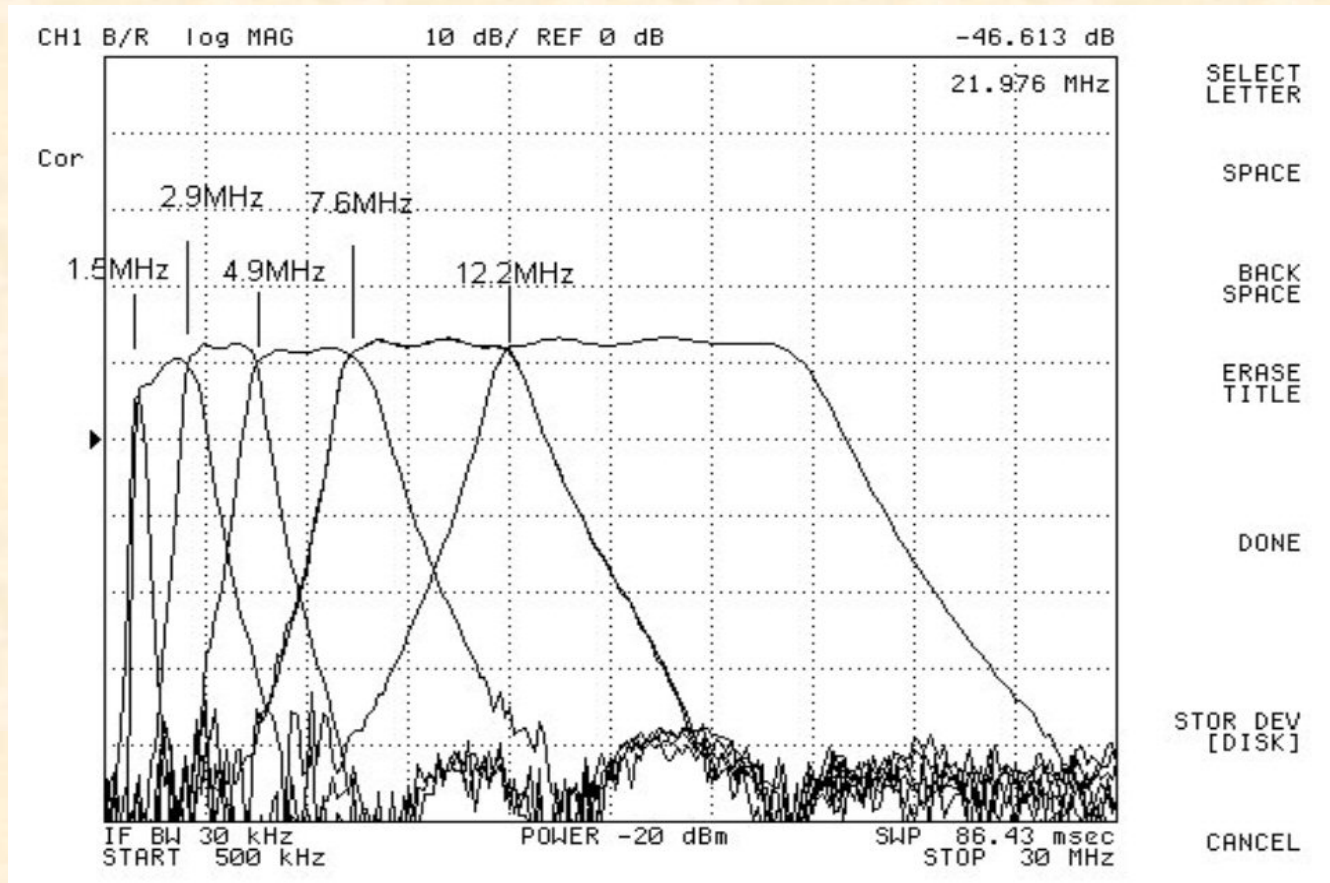

They cover the range from 1 to 20MHz.

Inequalities in gain are corrected with variable attenuator in the receiver.



# Switching filters (6/6)

## Practical arrangement

The filters are hosted in a shielded box to limit the interference

1 ÷ 20 MHz #1 #2 #3 #4 #5 #6

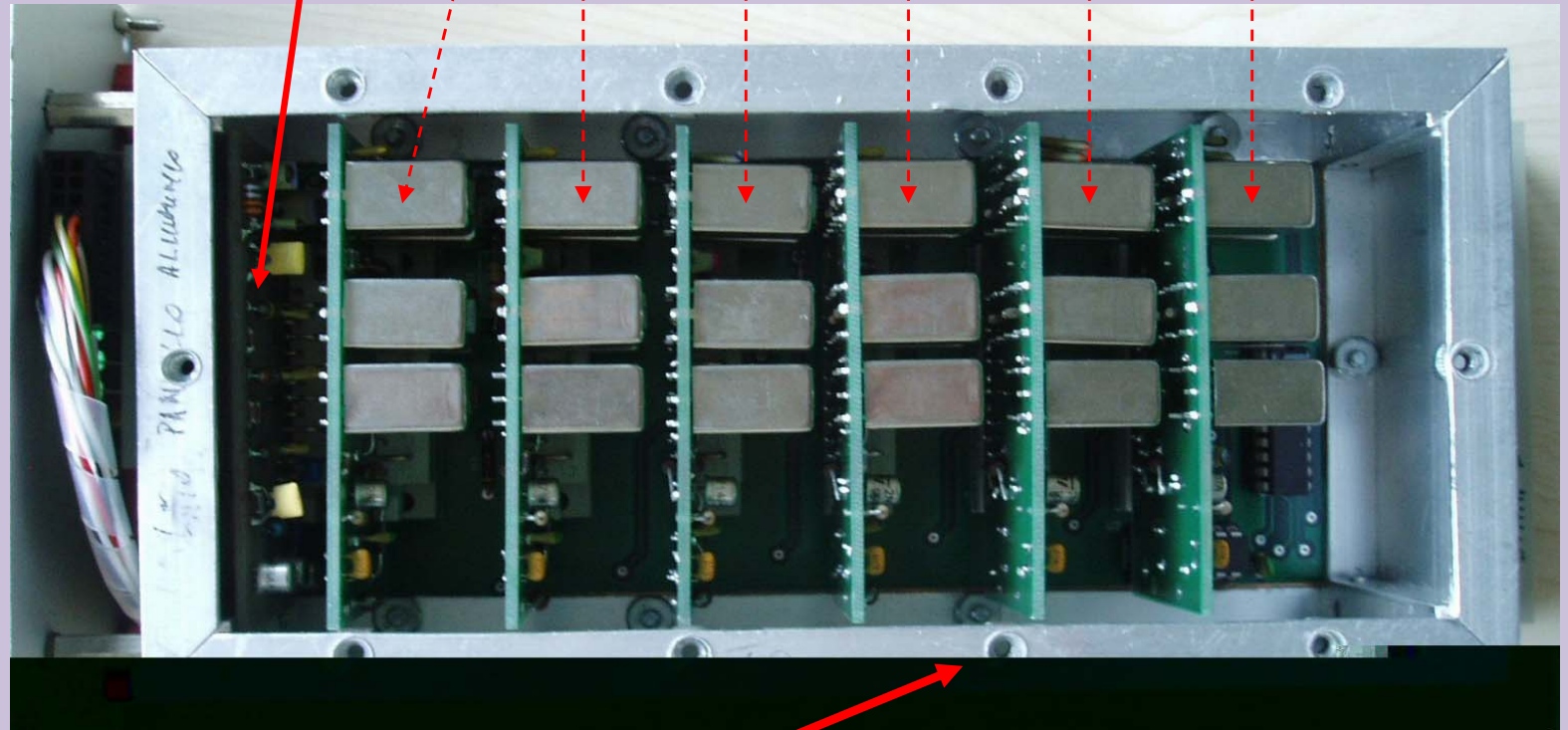



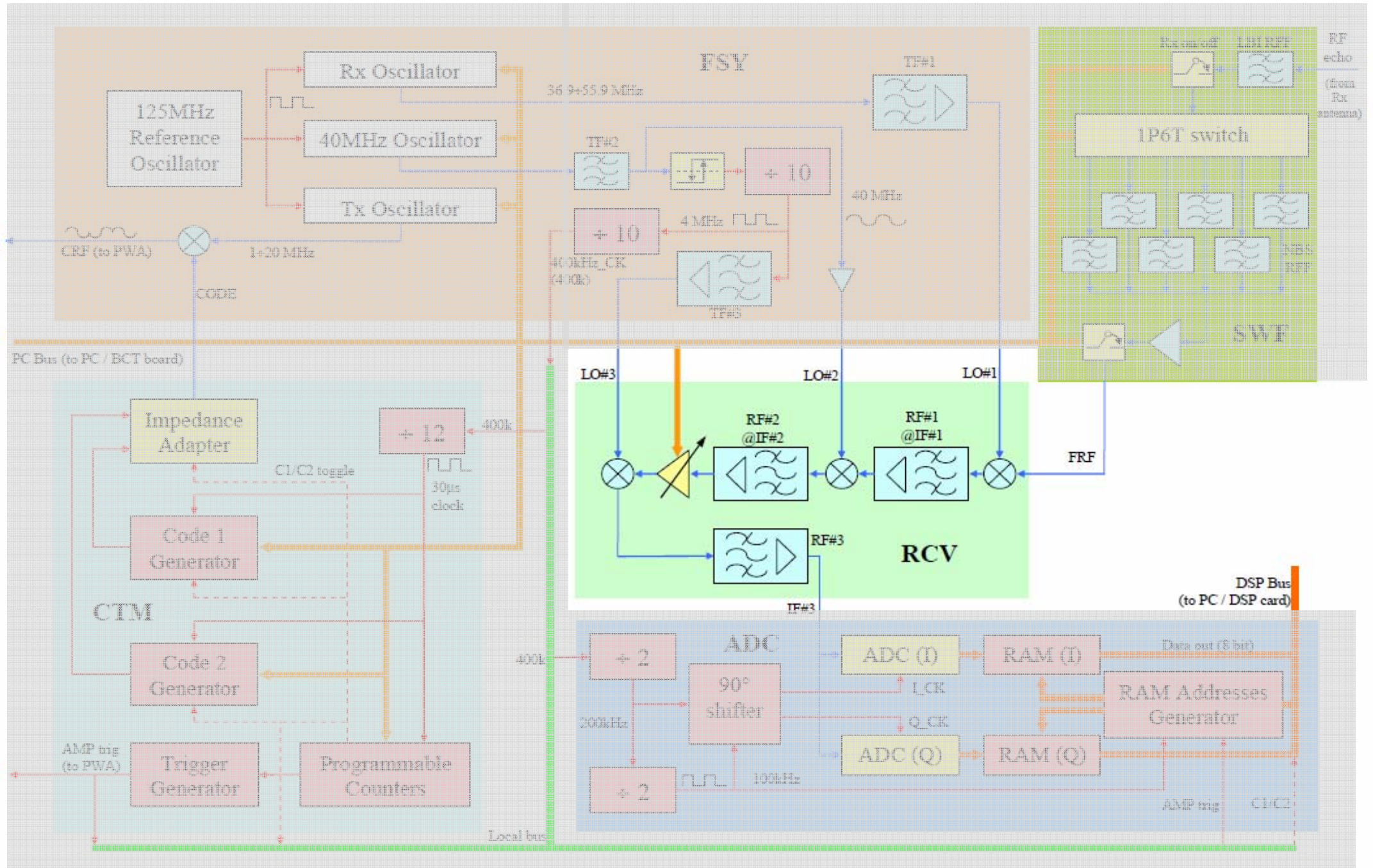

# Receiver (2/5)

## Functions and blocks

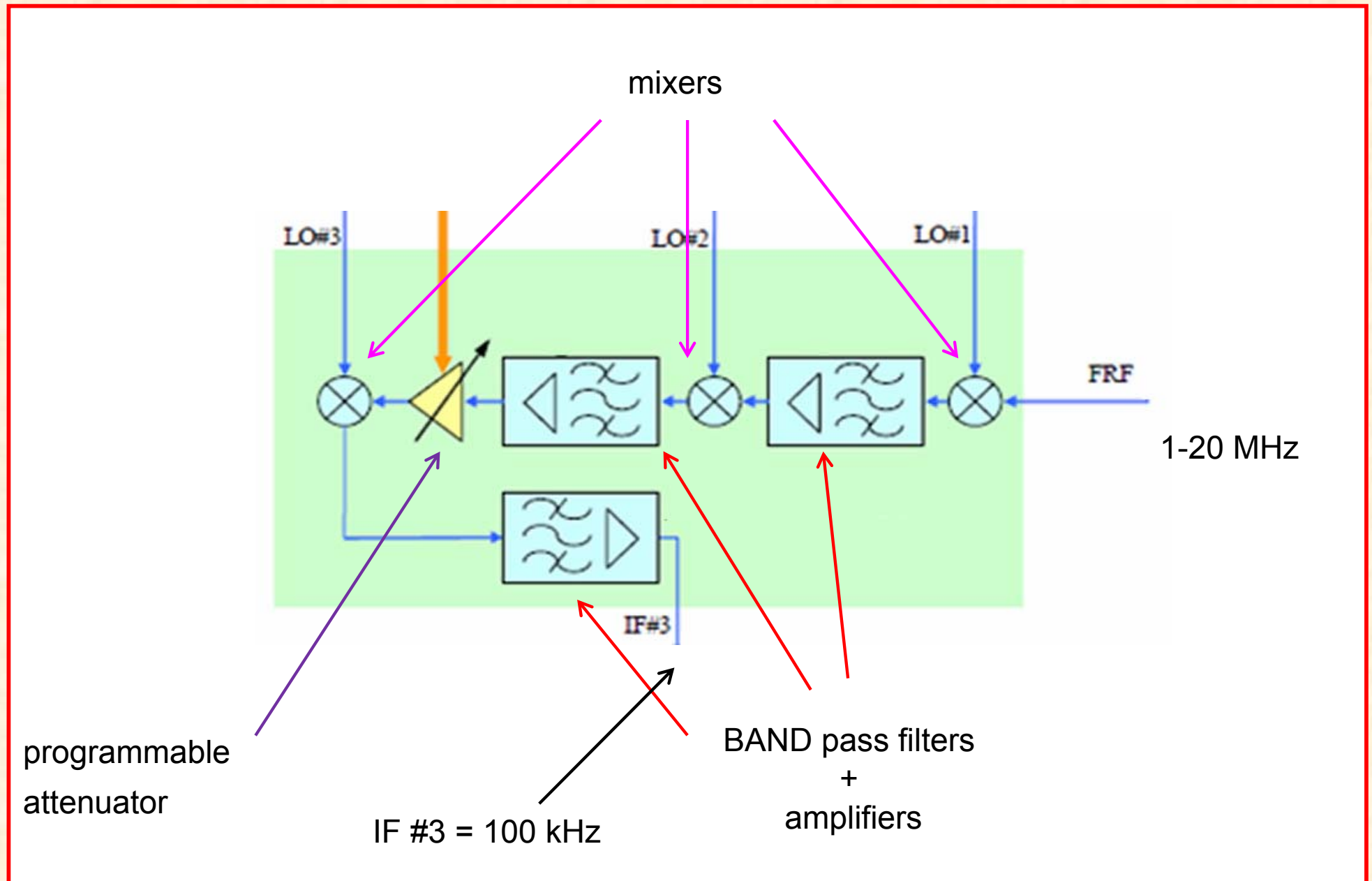

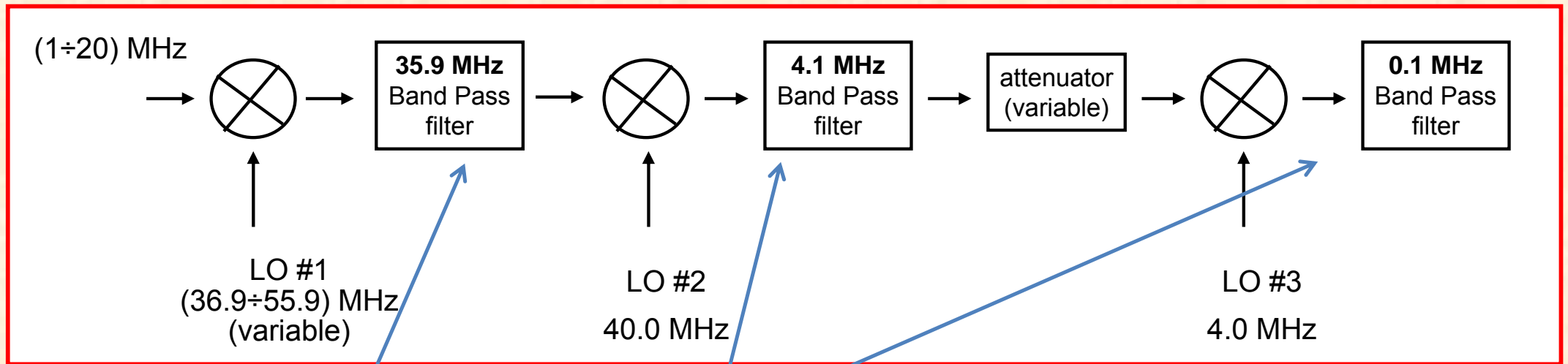

There is one UP conversion and two DOWN conversions

The success of pulse compression technique is based on the phase stability of the transmitted signals and the receiving process (remember that the code corresponds to phase shift).

The only way to maintain phase locked is to generate **all** LOs from a **common** clock.

A programmable attenuator is inserted in the receiving chain to vary the gain of the process (to equalize single switching filters, ....).



IF values and corresponding filters (the information occupies about 65 kHz)

3<sup>rd</sup> order chebyshev band pass

central freq. 35.9 MHz

band 2.5 MHz

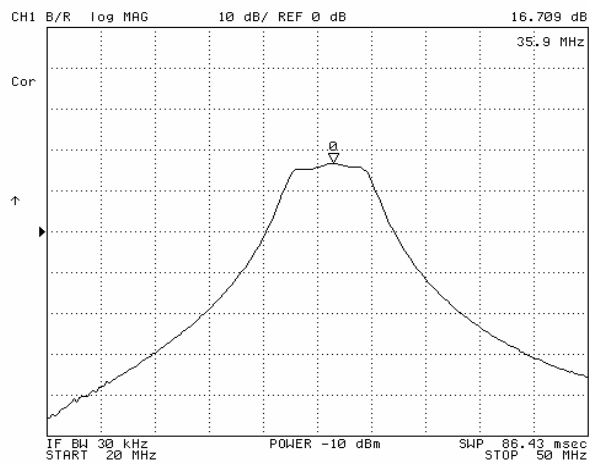
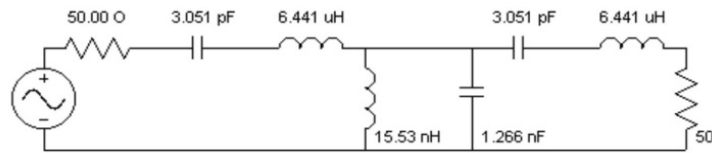

3<sup>rd</sup> order chebyshev band pass

central freq. 4.1 MHz

band 0.2 MHz

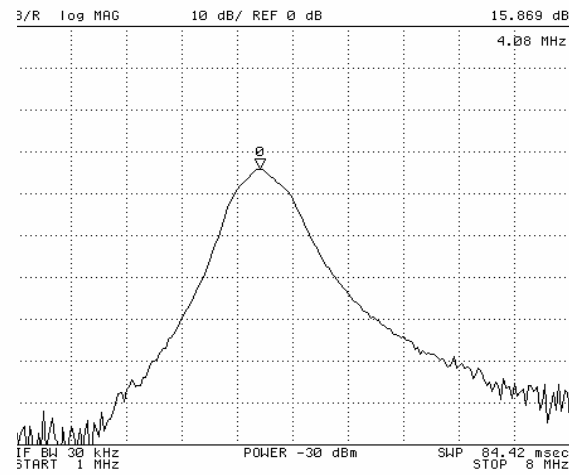
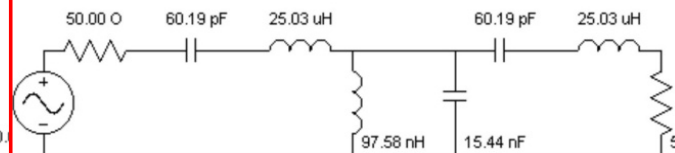

4<sup>th</sup> order elliptic band pass

central freq. 0.1 MHz

band 66 kHz

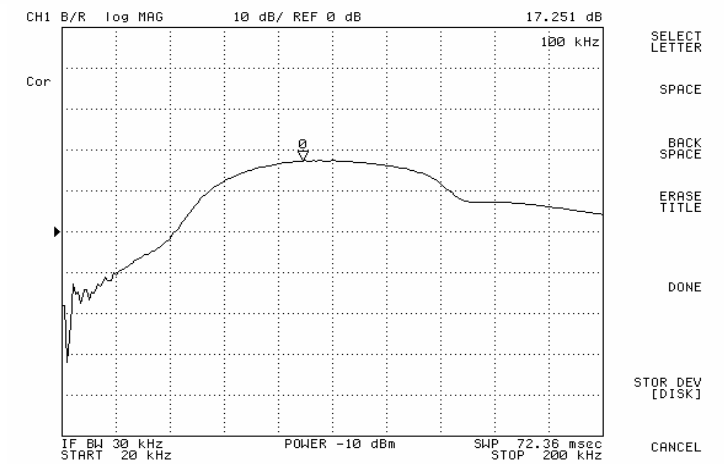
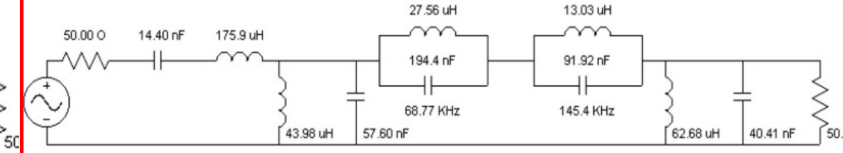

- SELECT LETTER
- SPACE
- BACK SPACE
- ERASE TITLE
- DONE
- STOR DEV [DISK]
- CANCEL

# Receiver (5/5)

## Practical arrangement

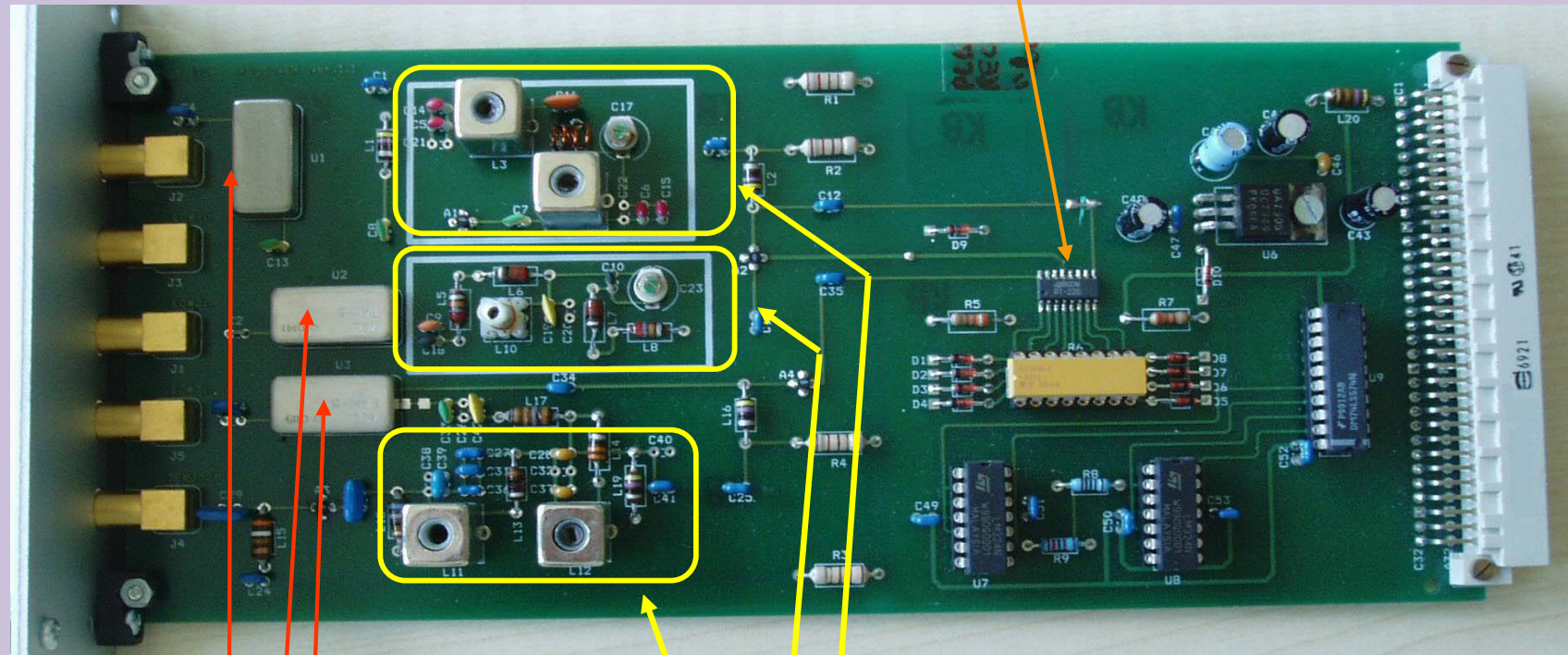
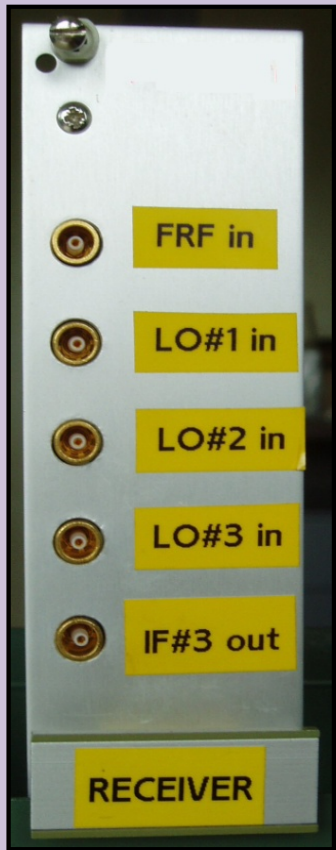

mixers

filters



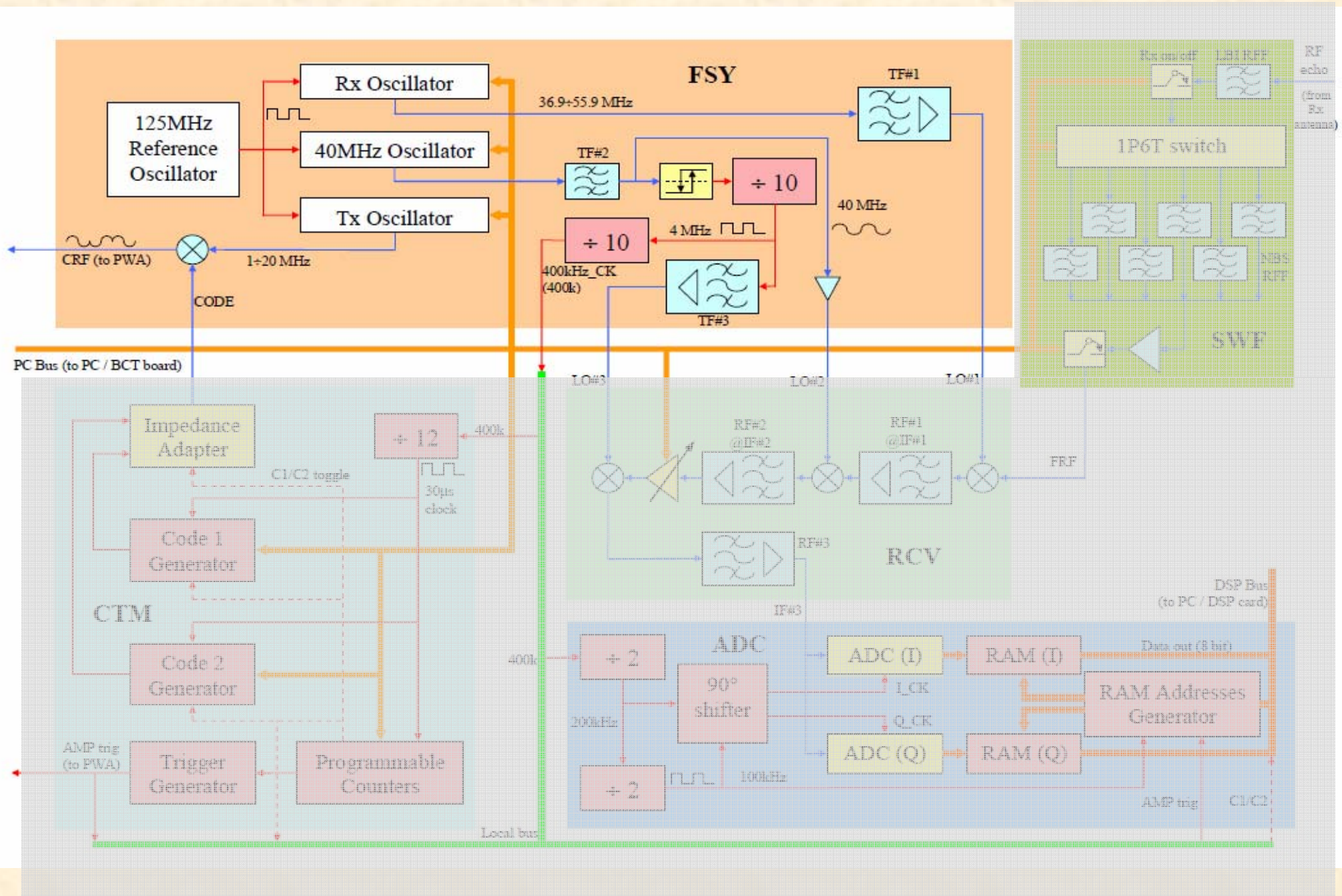

# Frequency synthesis (2/7)

## Functions and blocks

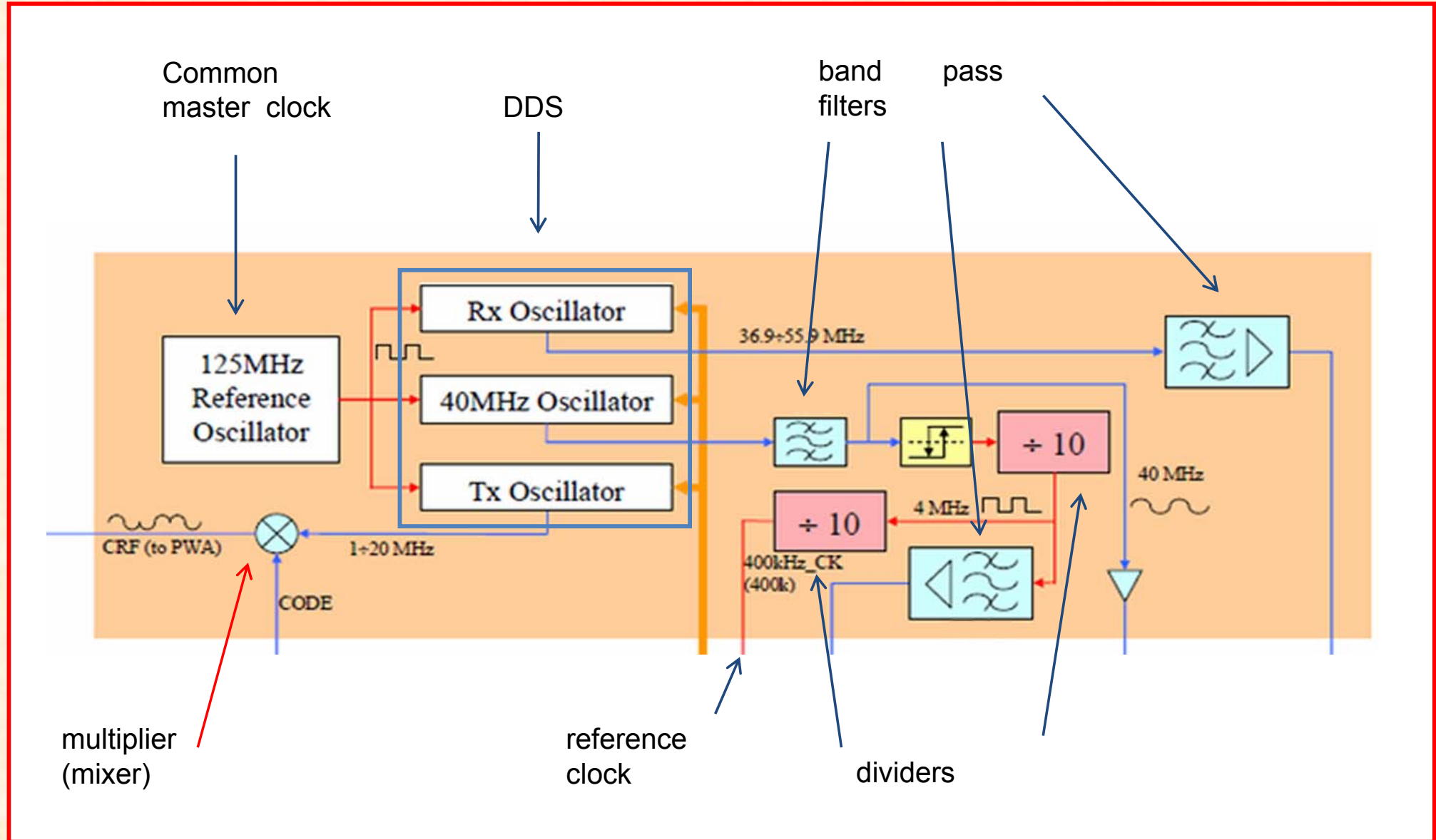

## Frequency synthesis (3/7)

**Tasks:** generates transmitting frequency (sine wave),  
creates the coded RF pulses to be transmitted,  
generates local oscillators (LO) for the receiver,  
generates the reference clock to have a phase locked process.

It has 3 DDS sine wave generators with a common clock

- DDS #1 TX frequency (1÷20) MHz
- DDS #2 LO #1 accordingly with TX frequency (variable)
- DDS #3 LO #2 (fix) and through a digital division process generates also LO #3 (fix)

DDS with a common master clock (125 MHz) allow a well known relationship between sine waves.

Another important function is the generation of a reference time base for the complete design.

Starting from the LO #3 (4 MHz) a 400 kHz square wave is generated being the common time for the digital function.



Local oscillators outputs are required to be as pure as possible, so filters are used

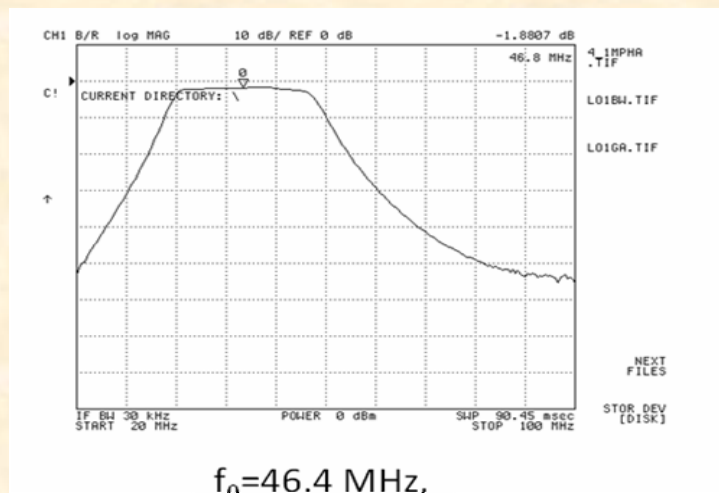

$f_0=46.4$  MHz,  
 $B=28.0$  MHz

3<sup>rd</sup> order Butterworth band pass

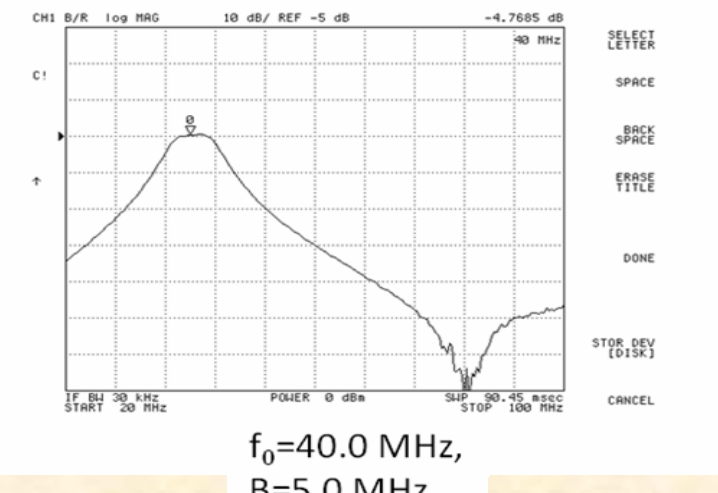
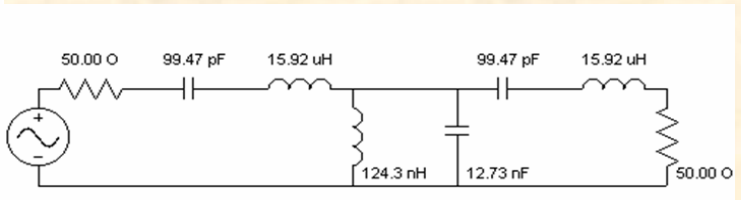

$f_0=40.0$  MHz,  
 $B=5.0$  MHz

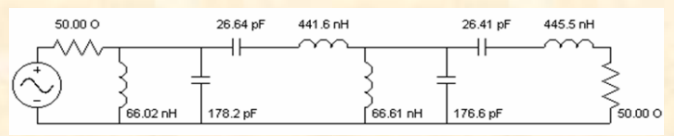

4<sup>th</sup> order Chebyshev band pass

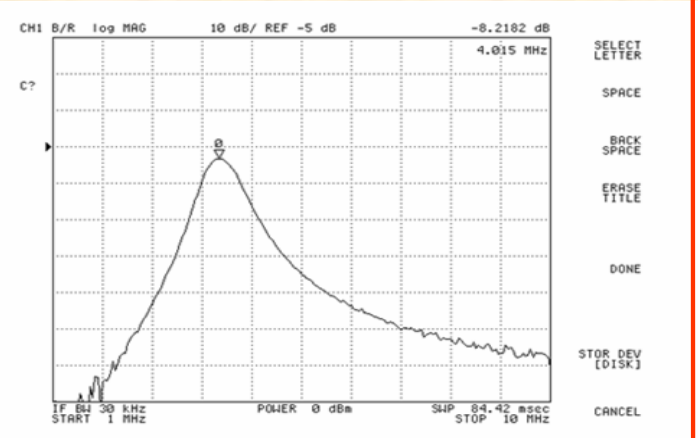

$f_0=4.0$  MHz,  
 $B=0.5$  MHz

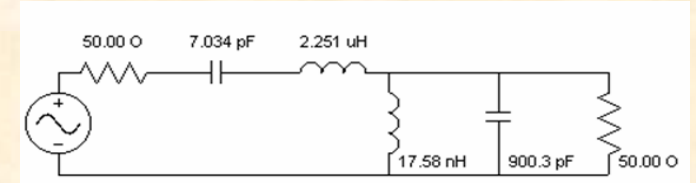

2<sup>nd</sup> order Butterworth band pass

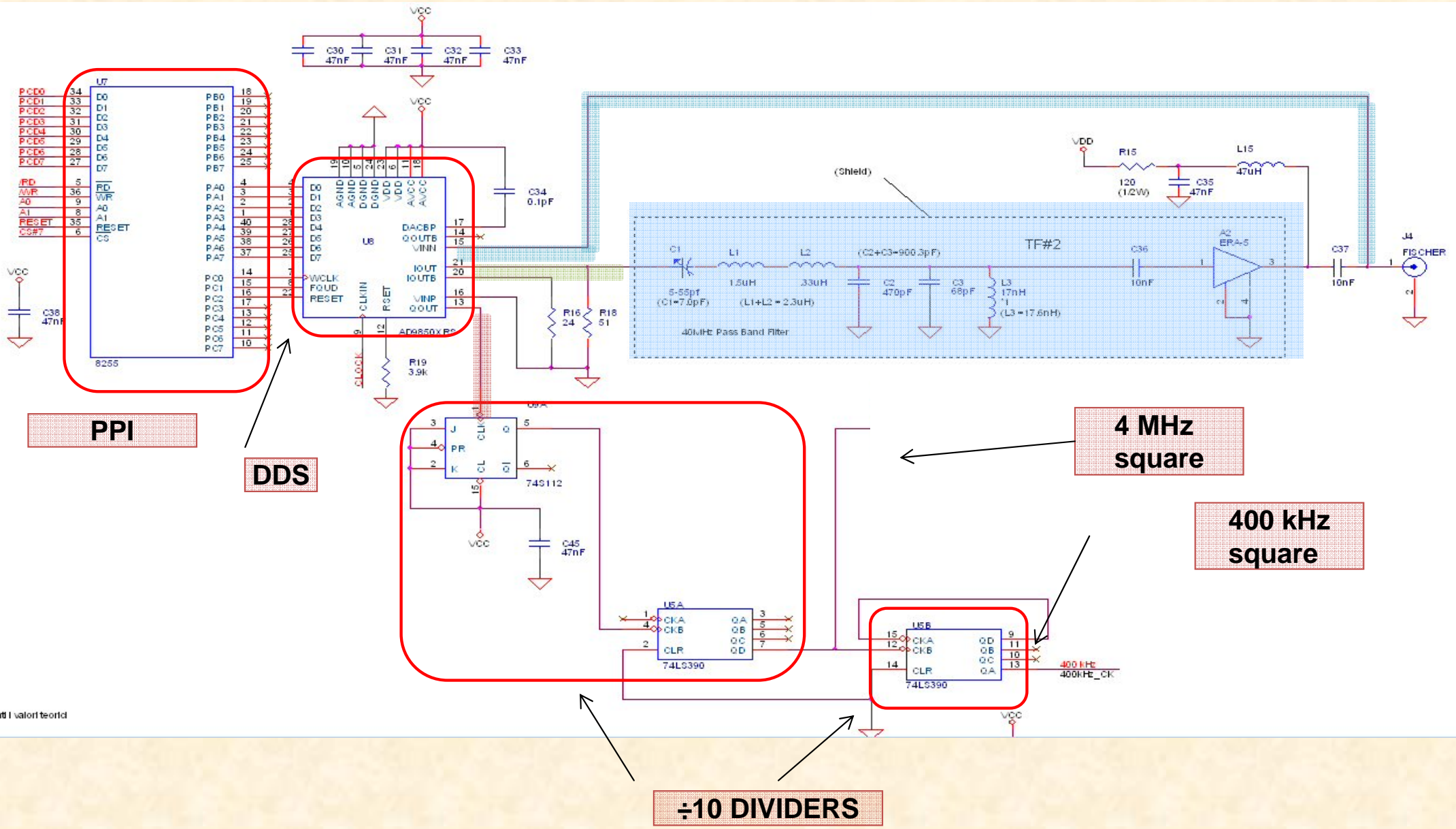



## Frequency synthesis (6/7)

Through mixer used as a multiplier we get coded pulses (codes coming from another board)

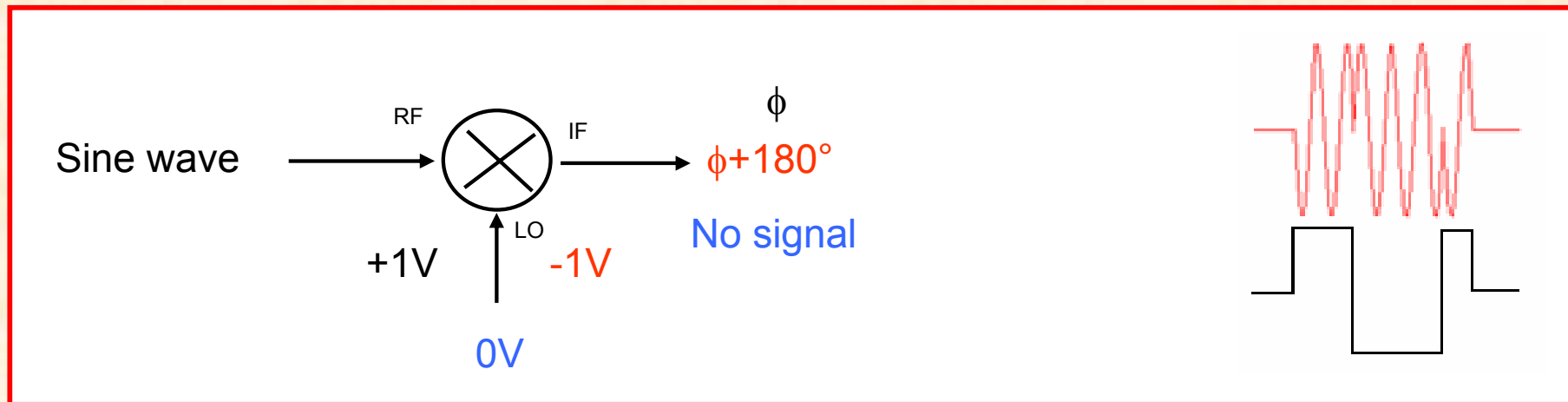

When the code is applied at LO input automatically a coded burst of energy is created.

Out of the code the sine wave has very low amplitude (gating of the burst).

# Frequency synthesis (7/7)

## Practical arrangement

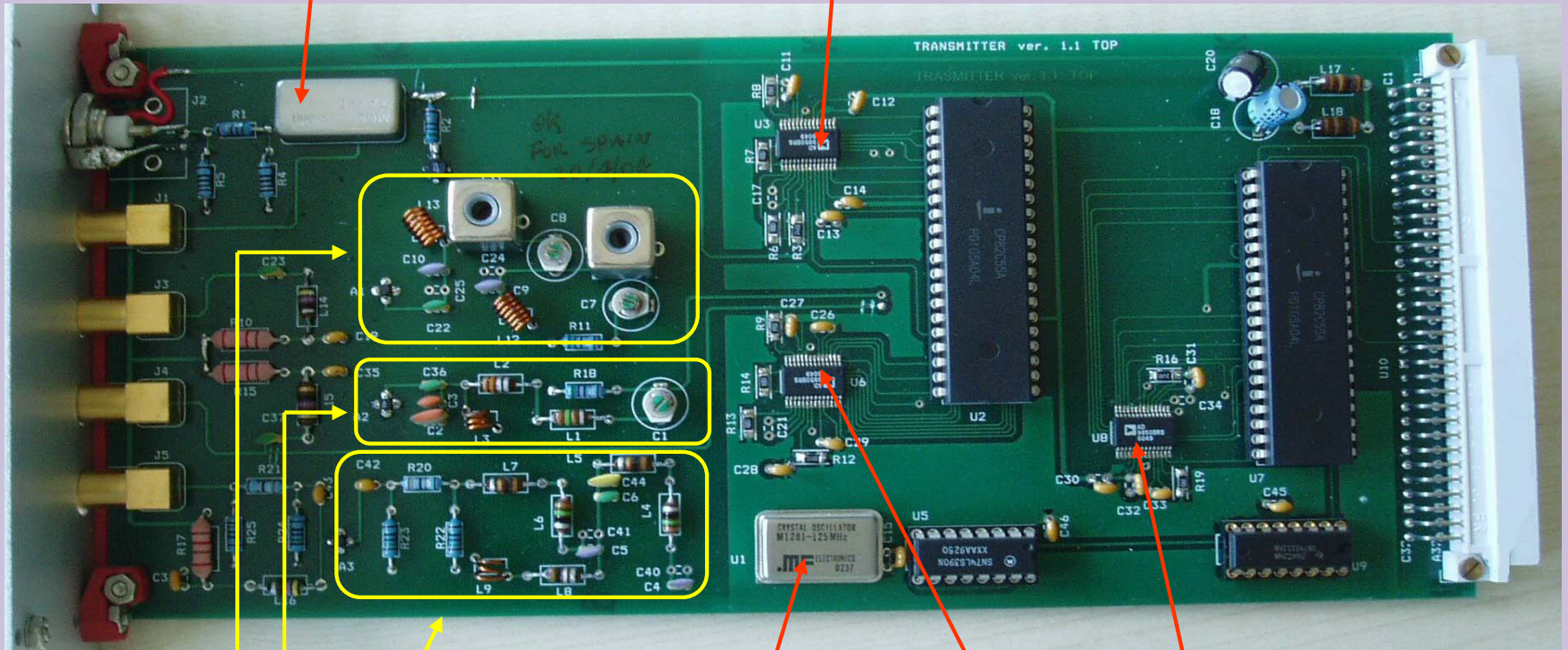
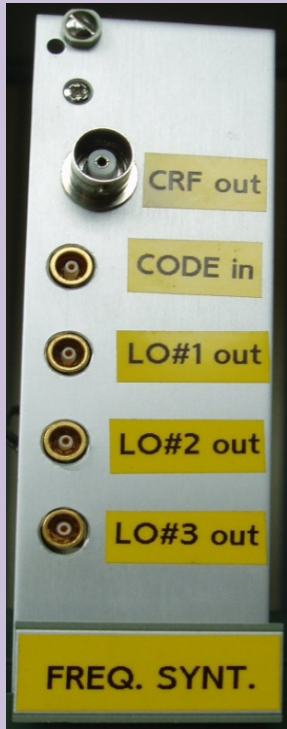

filters

Master Clock  
125 MHz

DDS #2

DDS #3



# Code and Timing generation (1/6)

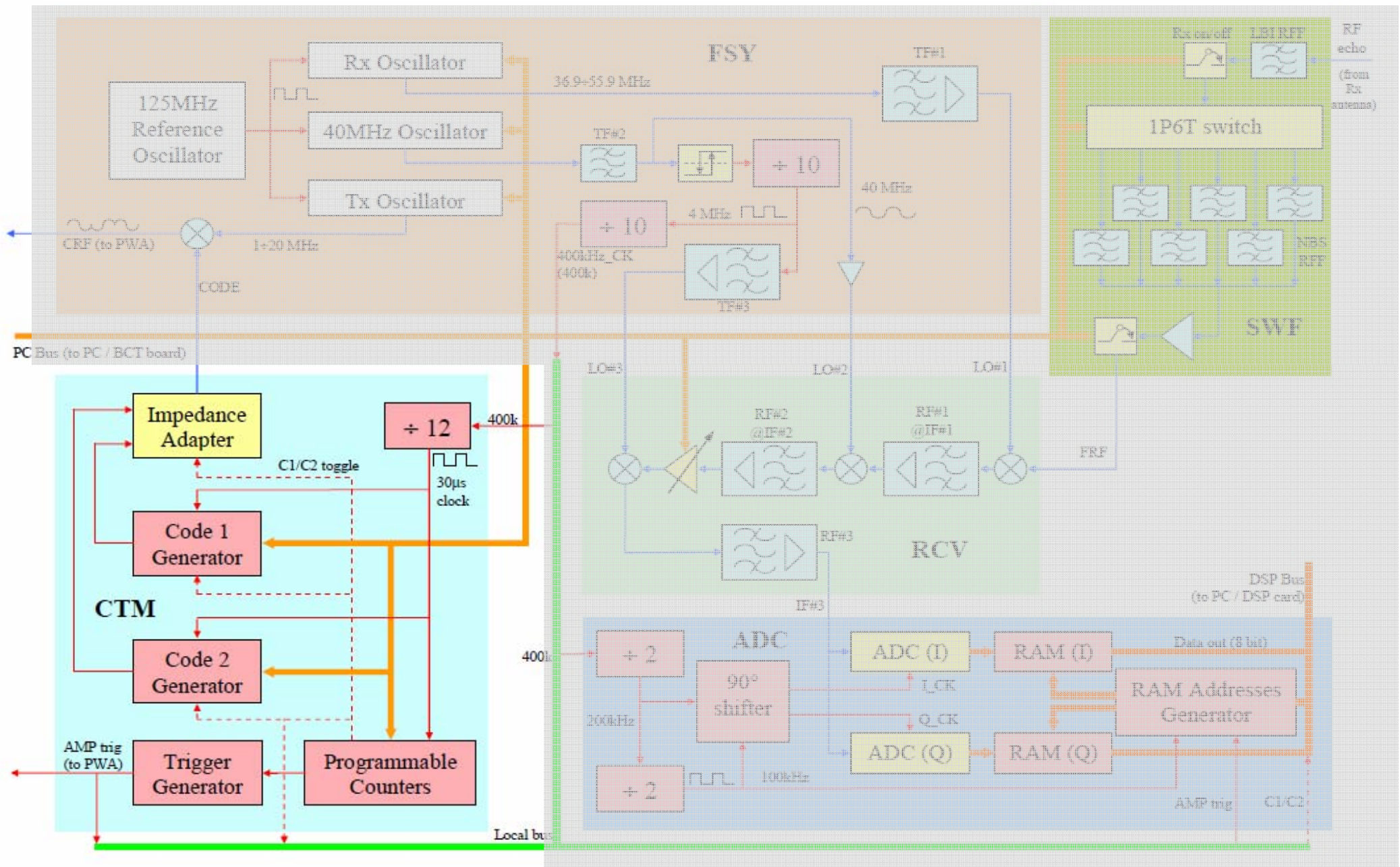

## Code and Timing generation (2/6)

### Functions and blocks

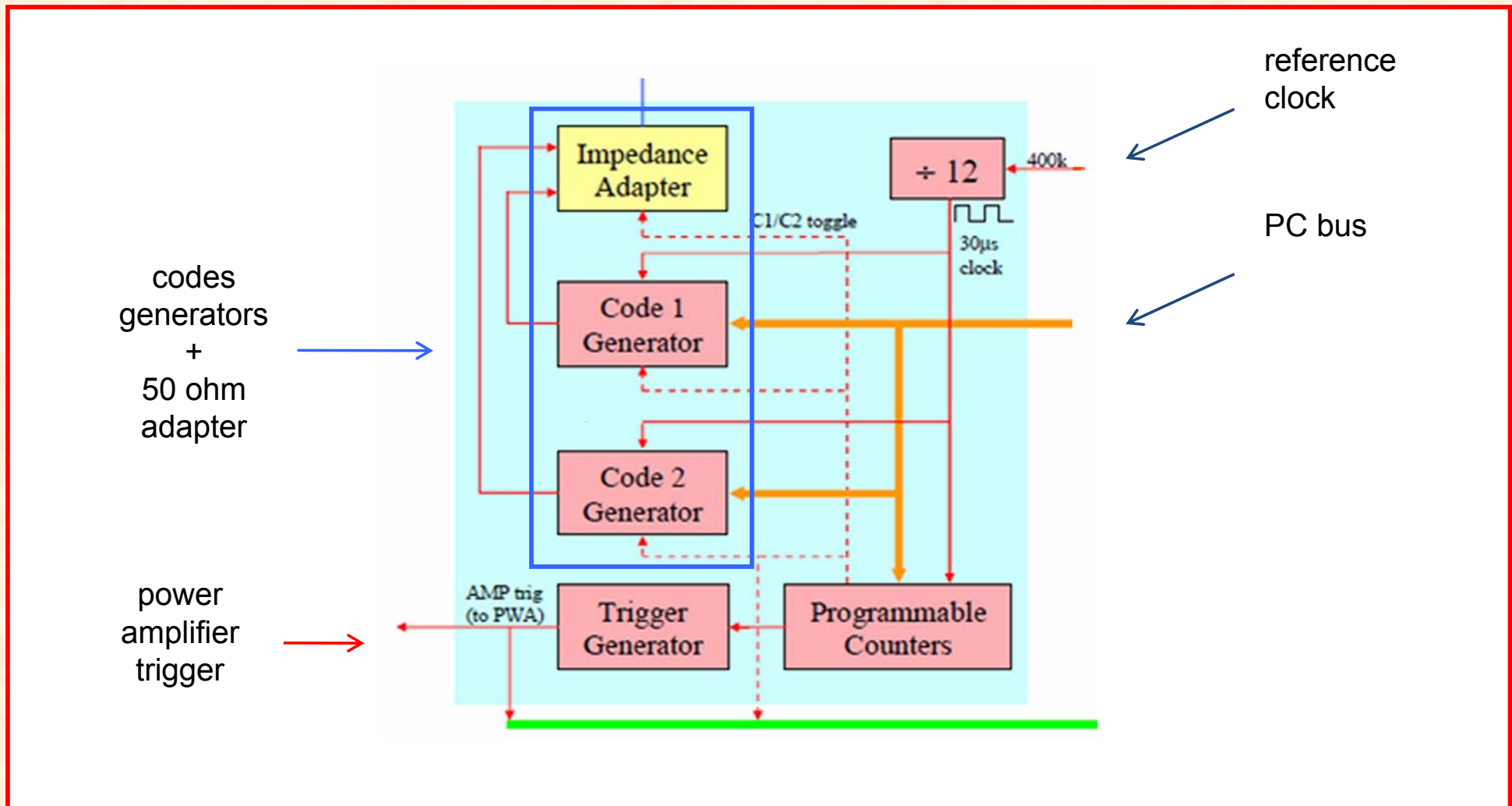

**Tasks:** creates the codes to modulate the sine wave,  
creates the timing and the delays for the whole system.

2 codes of 16 bit codes are generated by parallel to serial converters;

timing and delays are created with programmable dividers from a reference clock (400 kHz).

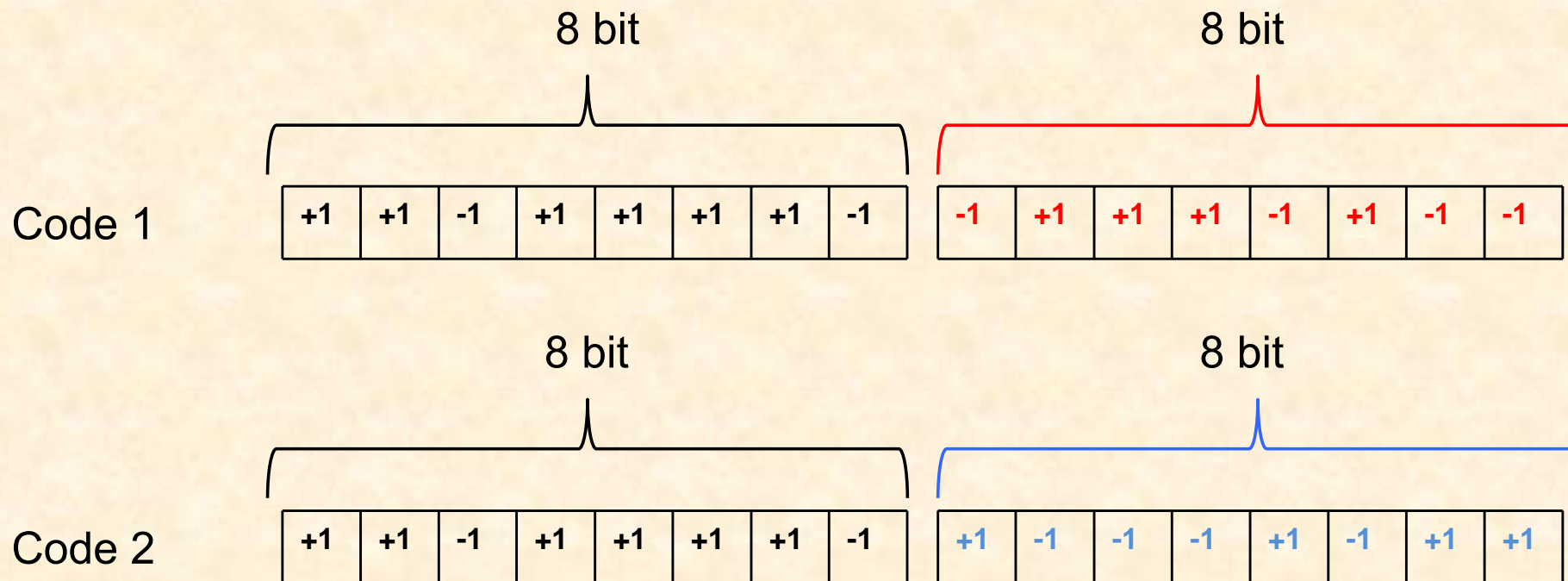



## Code and Timing generation (4/6)

A common reference clock ( $2.5 \mu\text{s} \leftrightarrow 400 \text{ kHz}$ ) is the input for programmable counters; so every generated time interval or delay is a multiple of the reference clock period .

For instance the sub pulse time is  $30 \mu\text{s}$  ( $2.5 \mu\text{s} \times 12$ )

This guarantees that all signal in AIS are phase locked.

We can program: pulse repetition frequency, distance between the codes, the codes themselves, number of bit representing the code and the pulse width.

## Code and Timing generation (5/6)

The code is present in a sequence that is summarized by the following sketch.

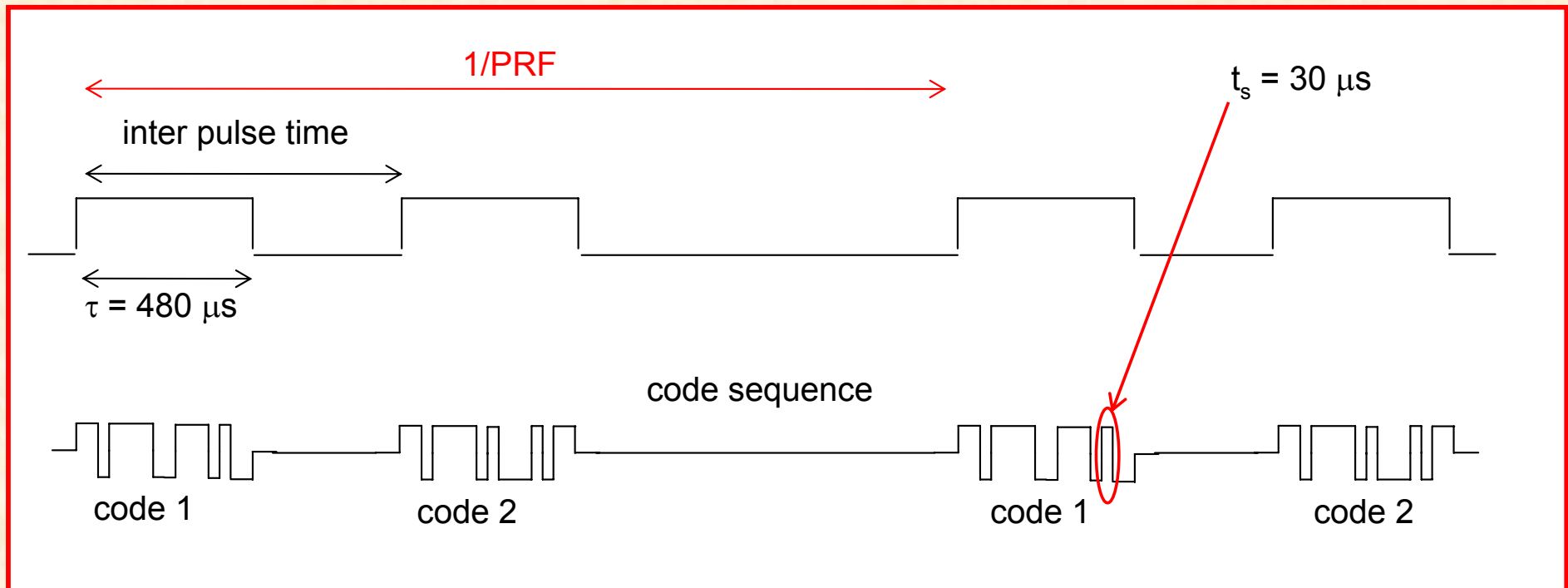

## Practical arrangement

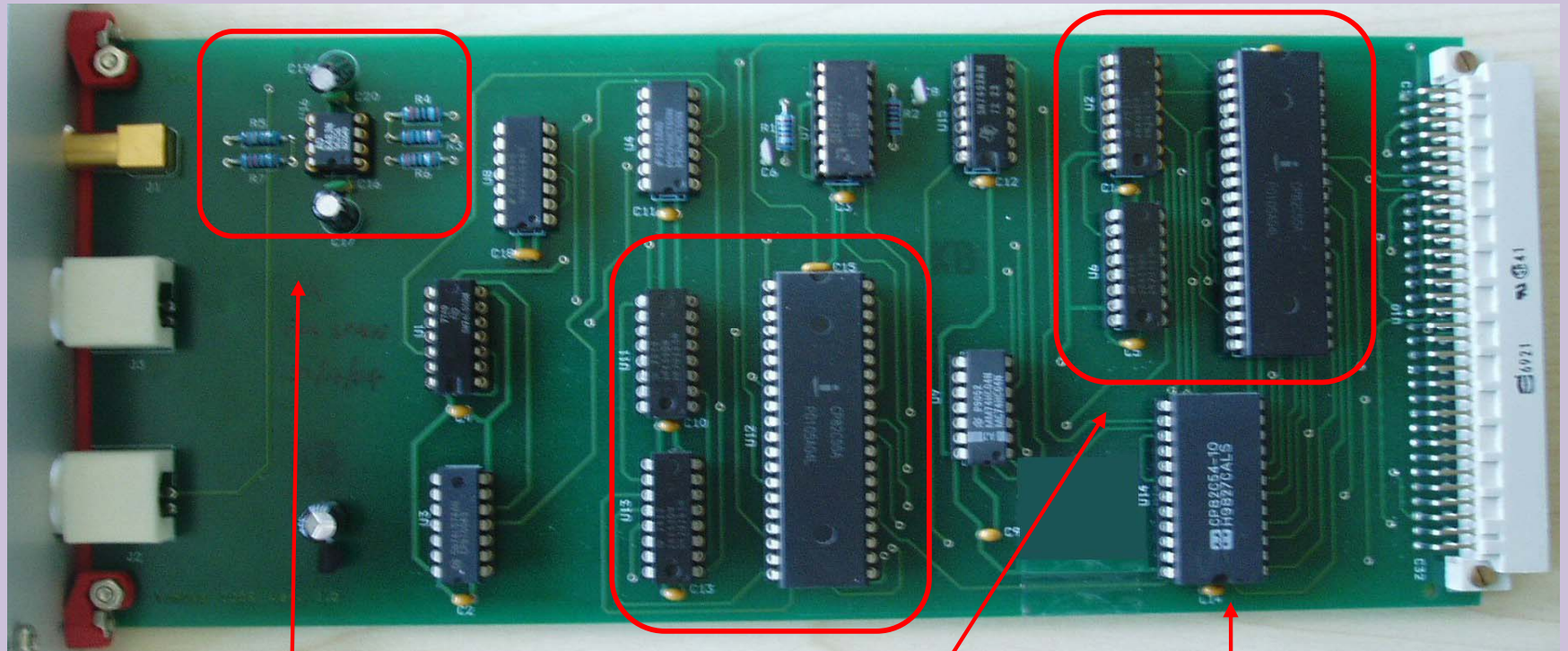

impedance (50 ohm)  
adapter

Codes generators

Programmable counter



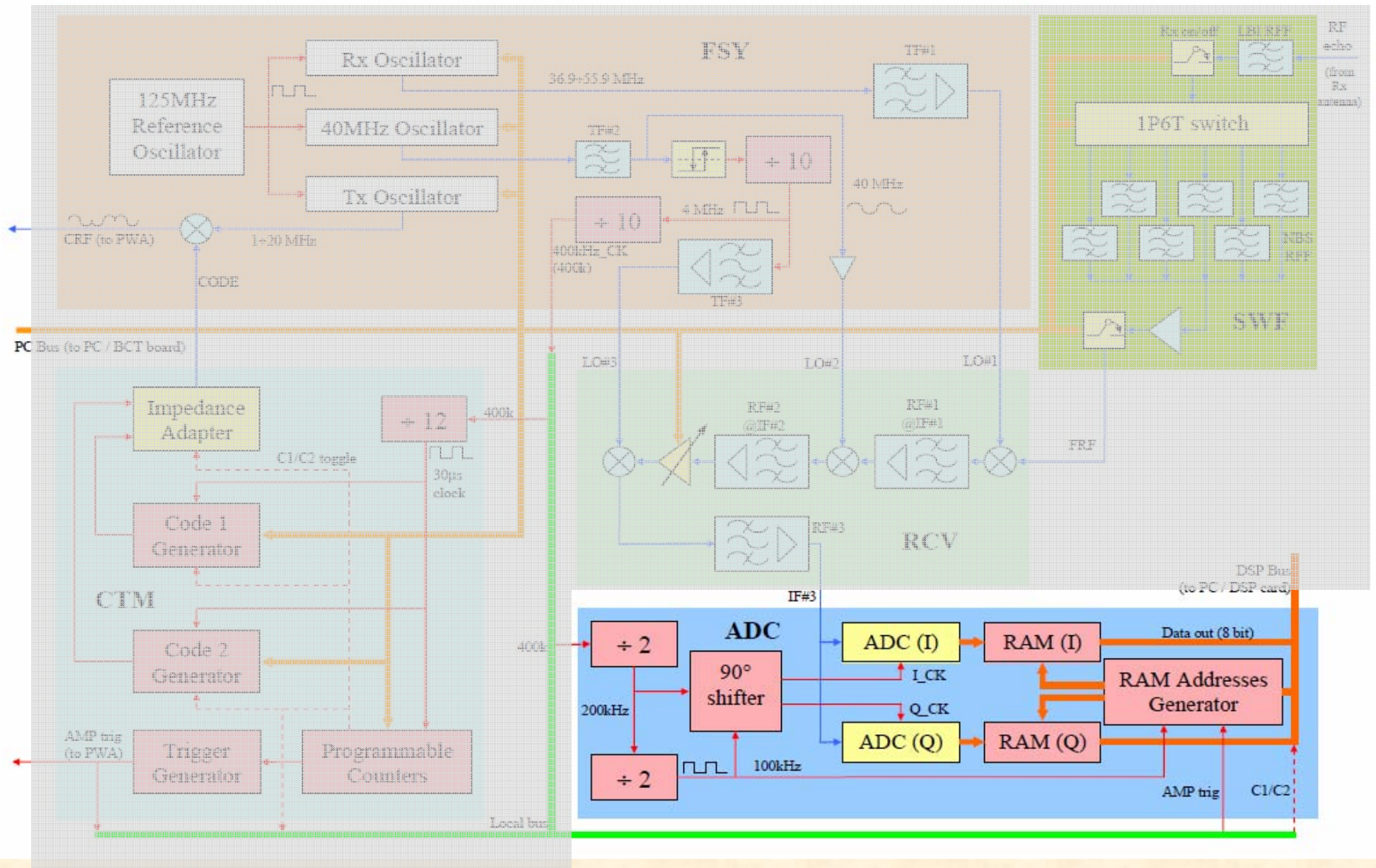



# Analog To Digital conversion (2/5)

## Functions and blocks

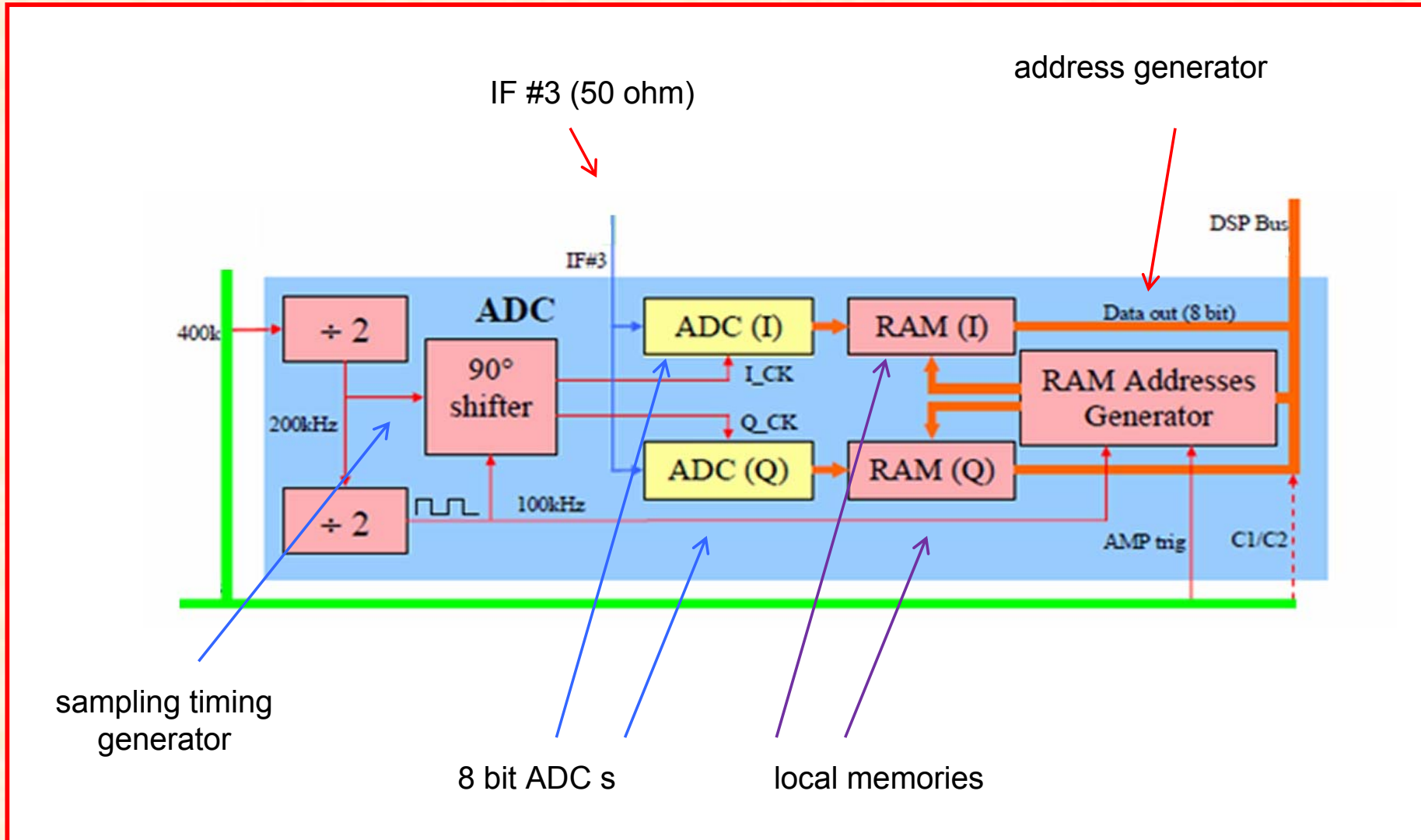

## Analog To Digital conversion (3/5)

**Task:** sample the analog signal IF #3 (100 kHz) to go to baseband;  
store data in temporary memories to be read by DSP card.

**How:** 2 ADCs properly driven (100 kHz 90° shifted = 2.5  $\mu$ s);  
2 local memories.

The basic idea is to sample signal in quadrature using 2 digitizers synchronously with the input signal obtaining the base band.

The "I" ADC gives 2 bytes representing "I" values (black) stored in the "I" memory, the "Q" ADC driven 90 degree phase shifted generates "Q" bytes (red) stored in the "Q" memory.

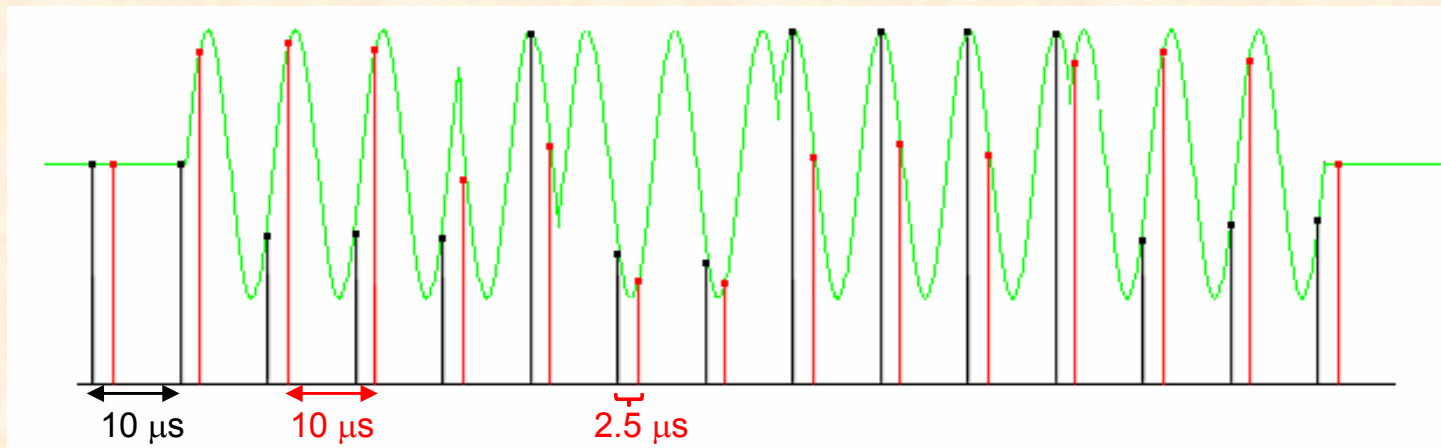

Note: the sketch aside highlights the samples timing and is not representative of a particular code.

## Analog To Digital conversion (4/5)

After a pulse is emitted the **listening time** starts: during this time IF #3 (100 kHz) is digitized at the the same frequency, getting the baseband.

During this time 512  $I_k$  values and 512  $Q_k$  values are sampled and stored in two local memories; consequently the listening time lasts 5.12 ms.

While samples are generated by ADCs memories are addressed synchronously.

After completion of this phase, the processing signal starts in DSP board.



## Practical arrangement

On board memories

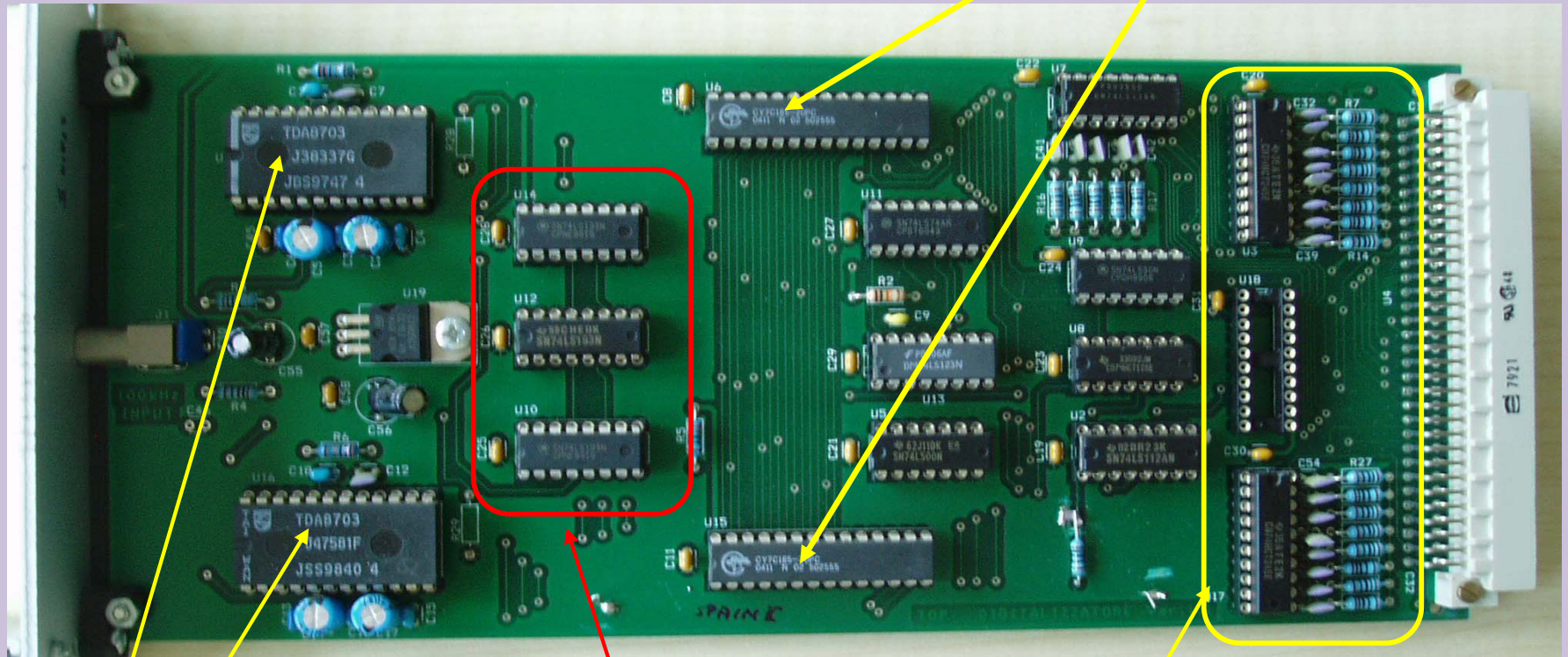

ADCs

Address generator

Buffers/Latches



# Control Board (1/5)

## Functions and blocks

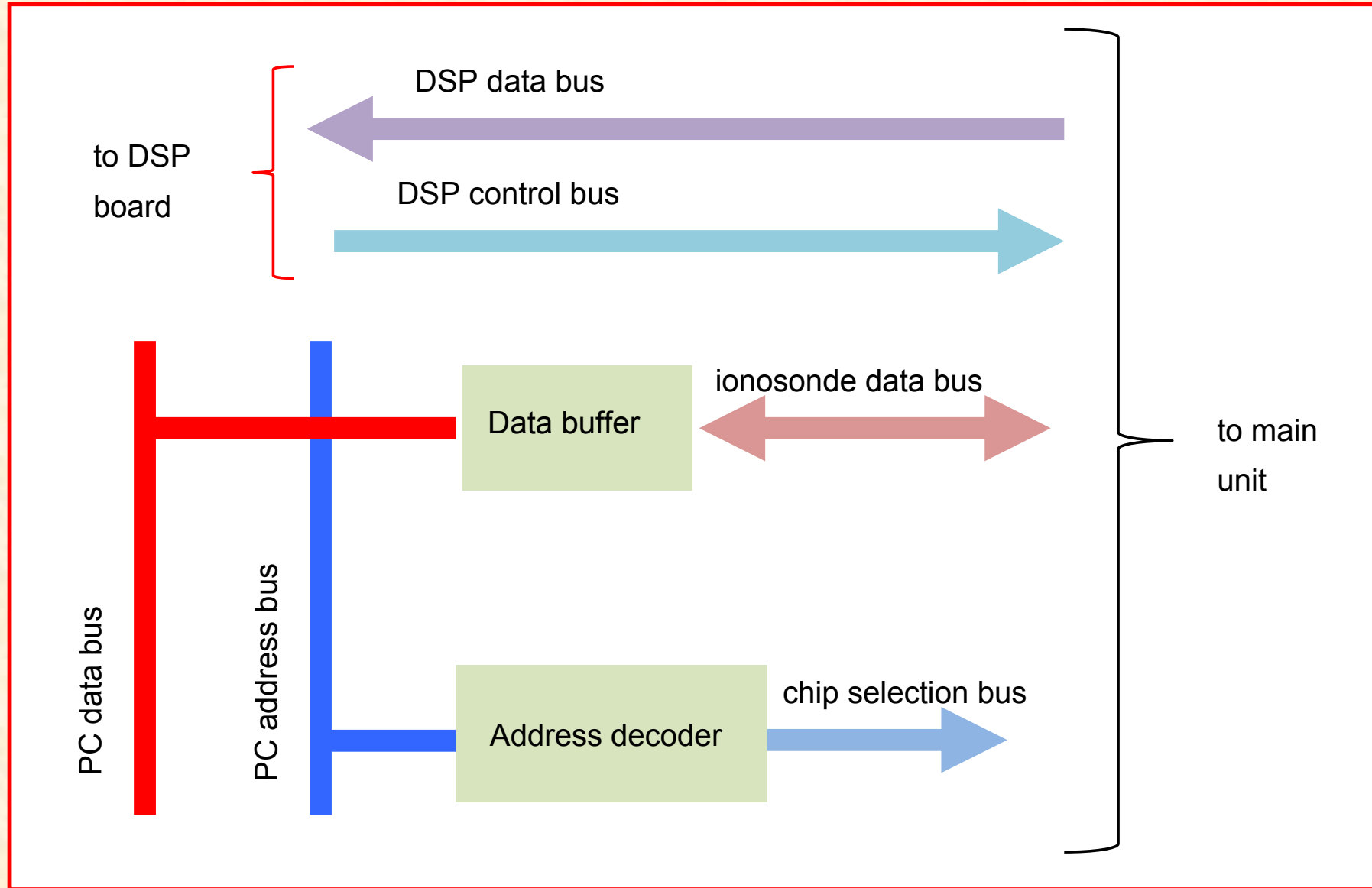

## Control Board (2/5)

- Task:**
- to program ionosonde 's devices;
  - to join PC and DSP data busses (single cable communication);
  - to allow data bus of ionosonde communicating with PC data bus.

It is a card inserted in the PC ISA bus.

It corresponds to a group of addresses not conflicting with other peripherals.

Valid addresses are programmable.

## Control Board (3/5)

Almost all devices in the ionosonde are connected to the bus by devices called PPI (parallel port interfaces) requiring 3 control signals:

- Chip select, CS, active low to activate that device
- address lines ,  $A_0$ ,  $A_1$ , for internal registers control

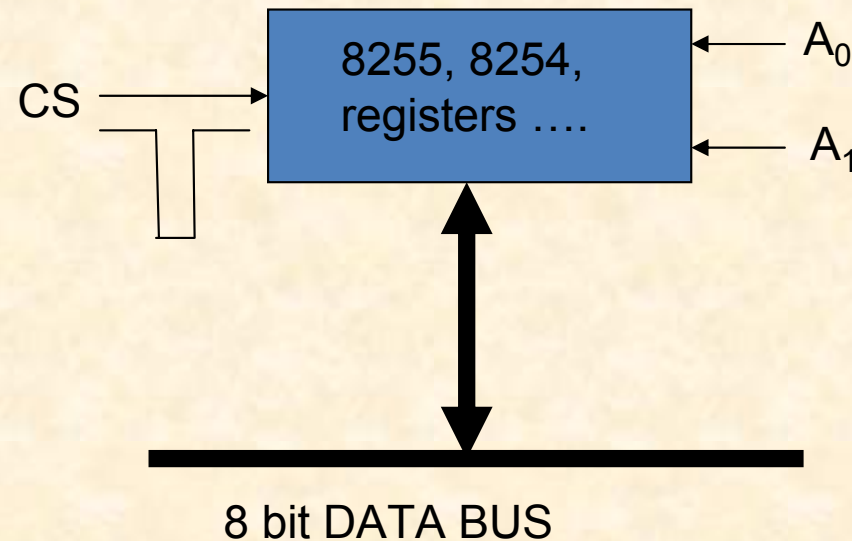

The task of the control board is to create the CS lines to address the ionosonde 's devices.

## Control Board (4/5)

PC address lines

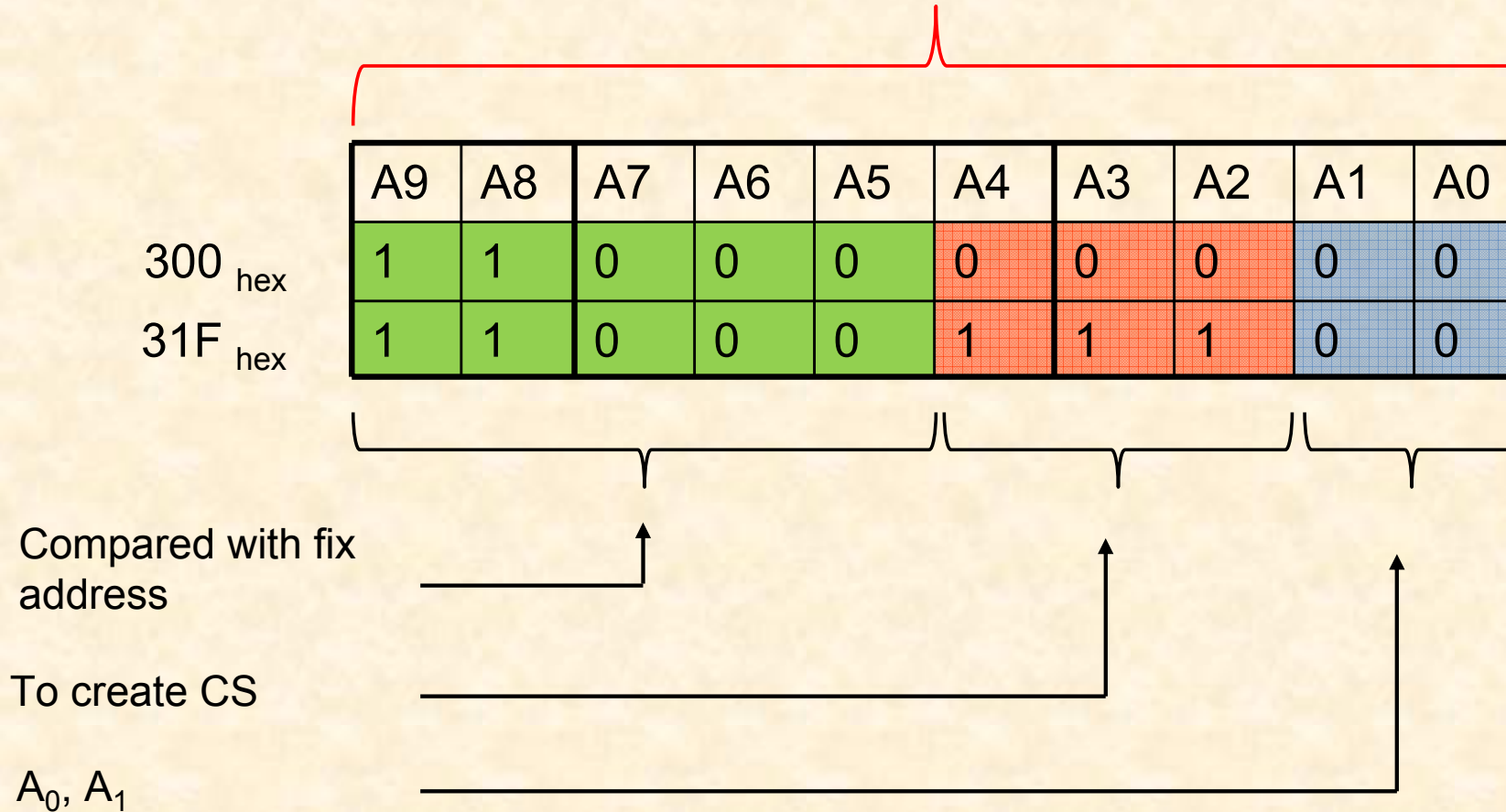

Different devices correspond to different CS number. We have 8 independent devices, but 32 independent addresses.

Typical instruction: **outport (0x30C , 20) ;**



# Control Board (5/5)

## Practical arrangement

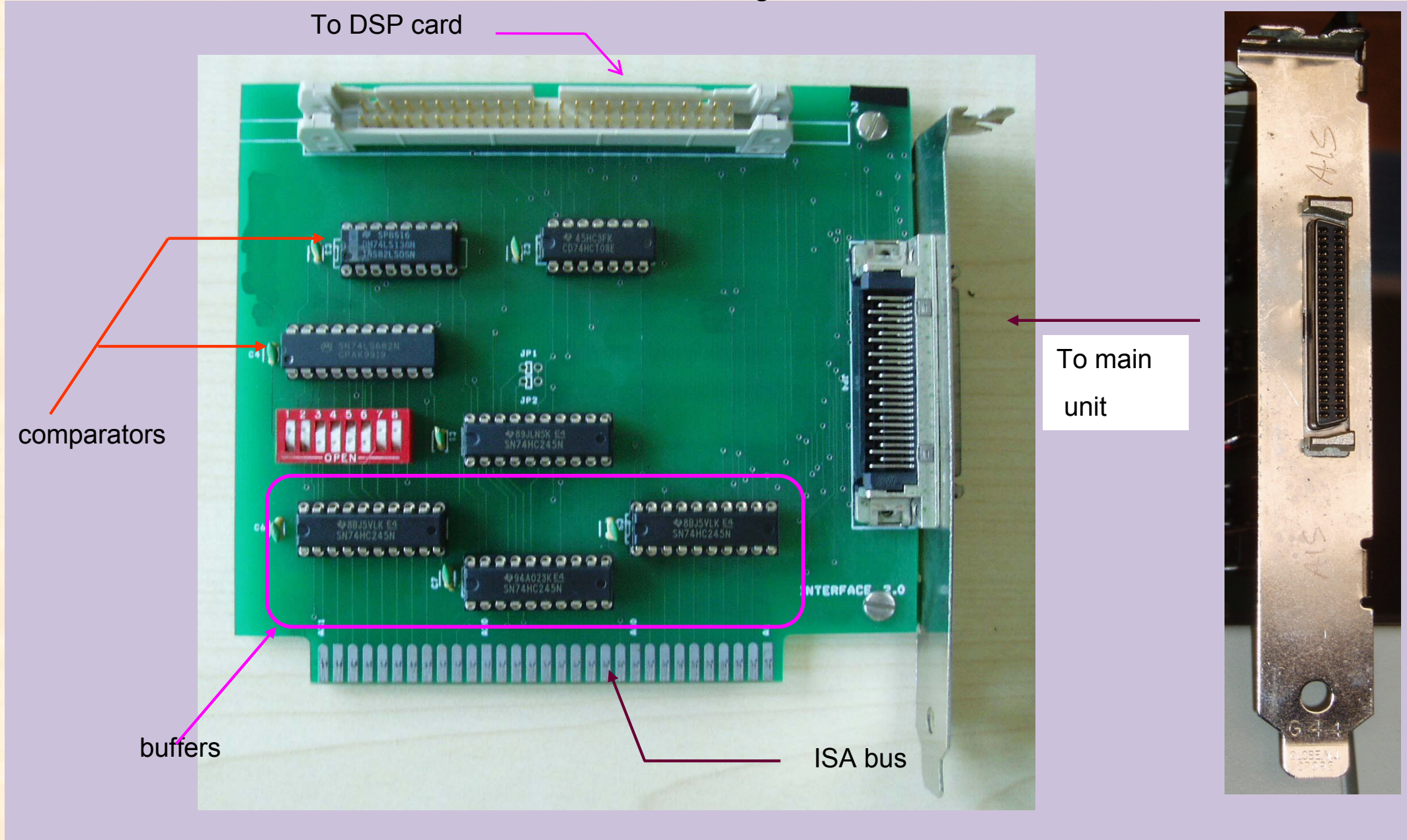

**Task:** to perform the analysis of the received echo to detect the codes and to find the height of the layer.

This task is accomplished with a program, running inside the board, loaded at the beginning of the sounding, that is independent of the main sounding software.

The complete process from echo to a dot on the screen goes through some steps:

- at the end of listening time, ADC card calls DSP that starts operation;
- DSP reads 512 samples (16 bit words), and start the analysis (code reconstruction, CFFT, filtering, correlation, integration, codes summation);
- when the programmed number of integration is reached DSP calls PC that will complete the analysis (CIFFT, threshold choice) creating the ionogram dot by dot.

DSP dialogues with ADC directly through a connection with interface board so to use one cable only.



# DSP board (2/2)

## Practical arrangement

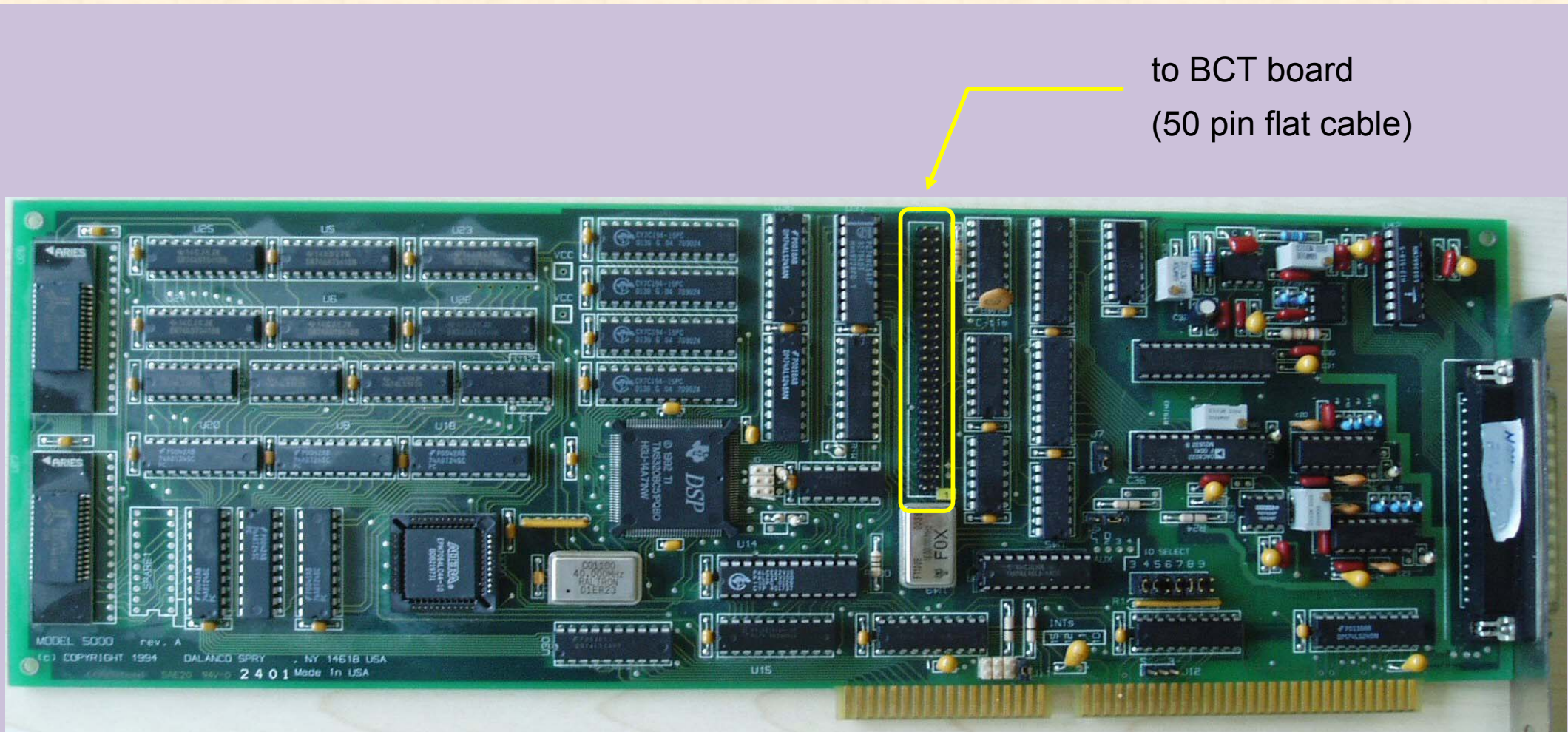

to BCT board  
(50 pin flat cable)

EISA bus

# Signal processing (1/6)

Time domain I and Q samples from ADC

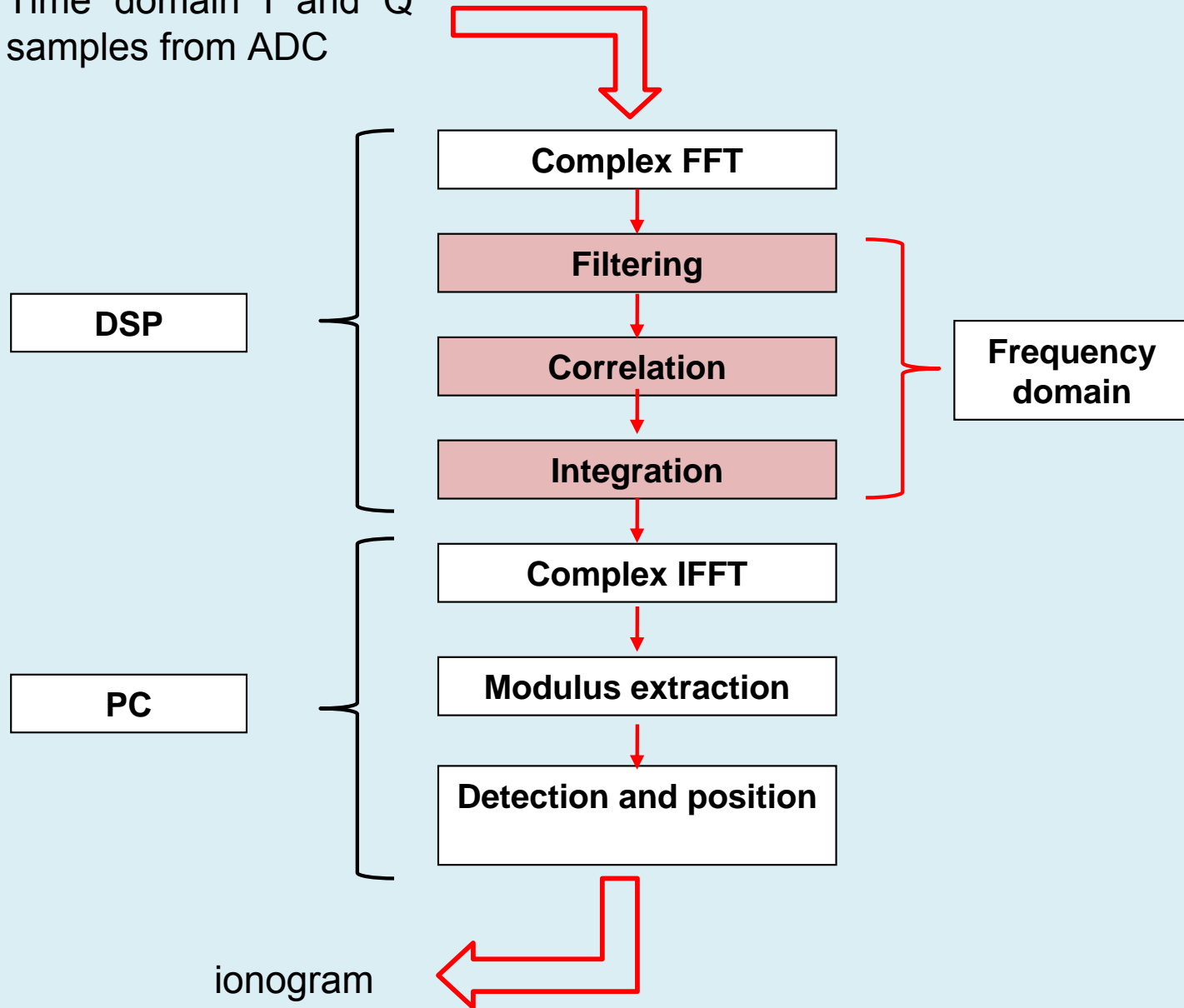



## Signal processing (2/6)

For every pulse we suppose to have 512  $I_k$  samples and 512  $Q_k$  with  $k$  ranging from 0 to 511.

$I_k$  and  $Q_k$  are Real and Imag part for a complex FFT to go in the freq domain (FD).

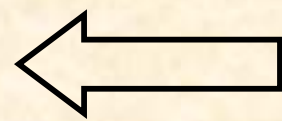
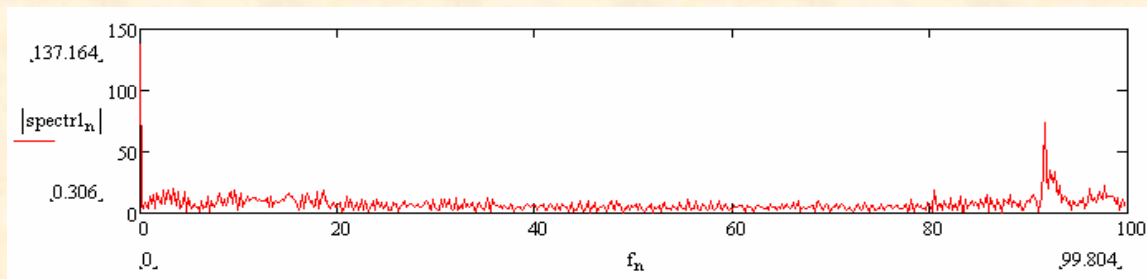
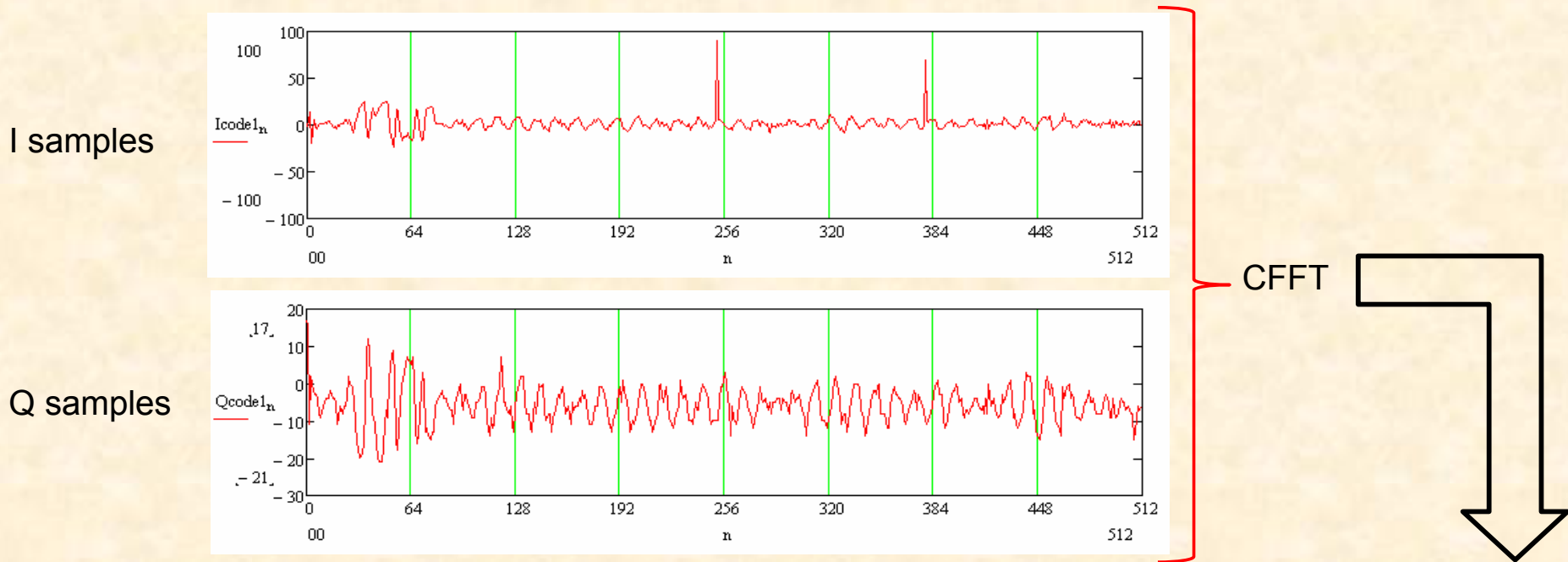

**FILTERING**

- Band limiting
- Amplitude scaling

In the frequency domain the correlation process with code is simply multiplication between spectra (in the graphs below only the modulus of the spectra is reported).

rx (code1)  
spectrum

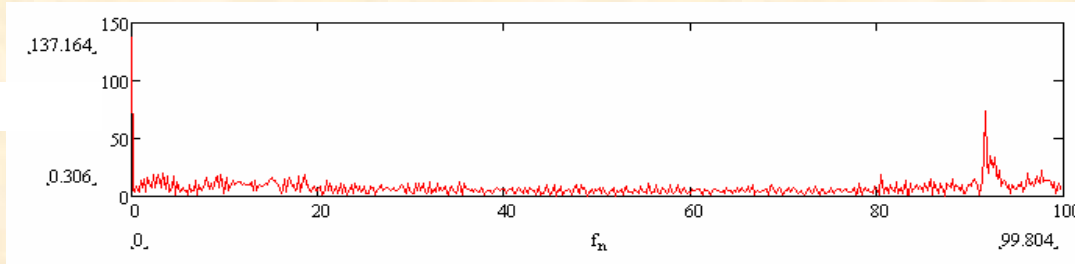

code1  
spectrum

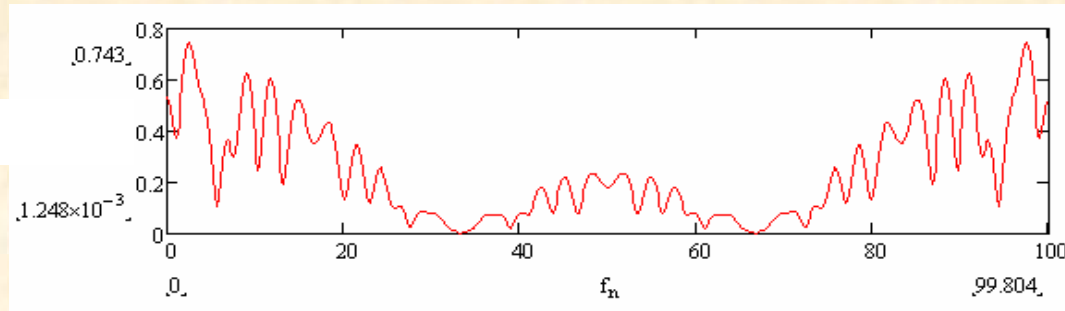

Complex multiplication



correlated  
rx-code1  
spectrum

*Spec*  $_{rx1}$

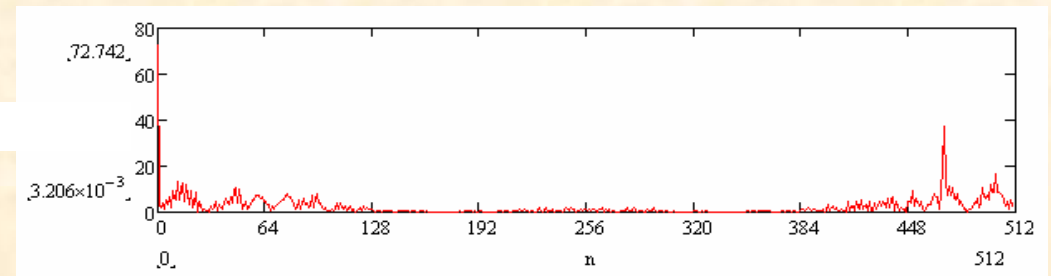

## Signal processing (4/6)

We do the same with code 2 pulse obtaining the correlated code 2 spectrum:

correlated  
rx-code2  
spectrum

$Spec_{rx2}$

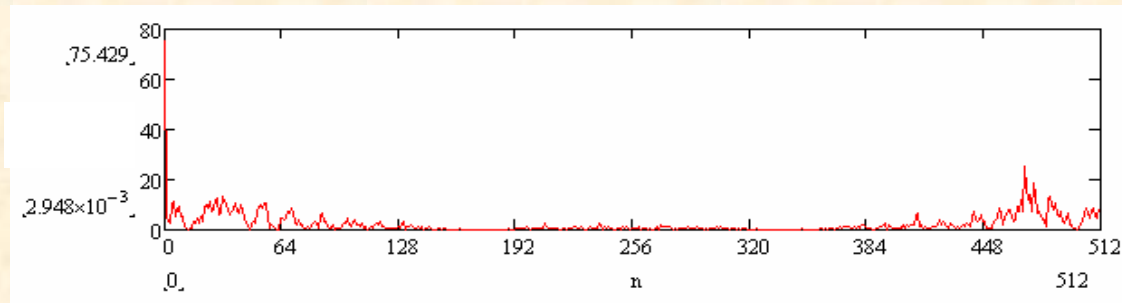

Then the integration (summation) and the combination of code 1 and code 2 will follow until the desired number of integration  $K$  is reached.

$$\sum_{i=1}^K (Spec_{rx1,i} + Spec_{rx2,i}) =$$

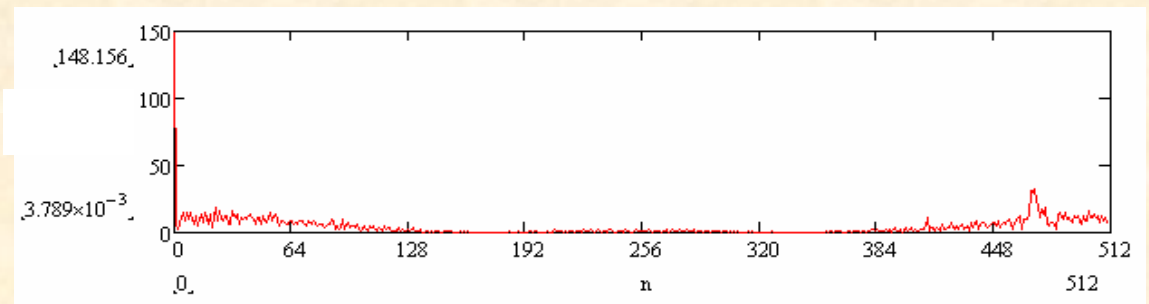

The sum of spectra (amplitude and phase) corresponds to coherent integration.

At this point a complex IFFT operation will bring us back to the time domain where the extraction of the modulus gives us the correlation peak and its position.

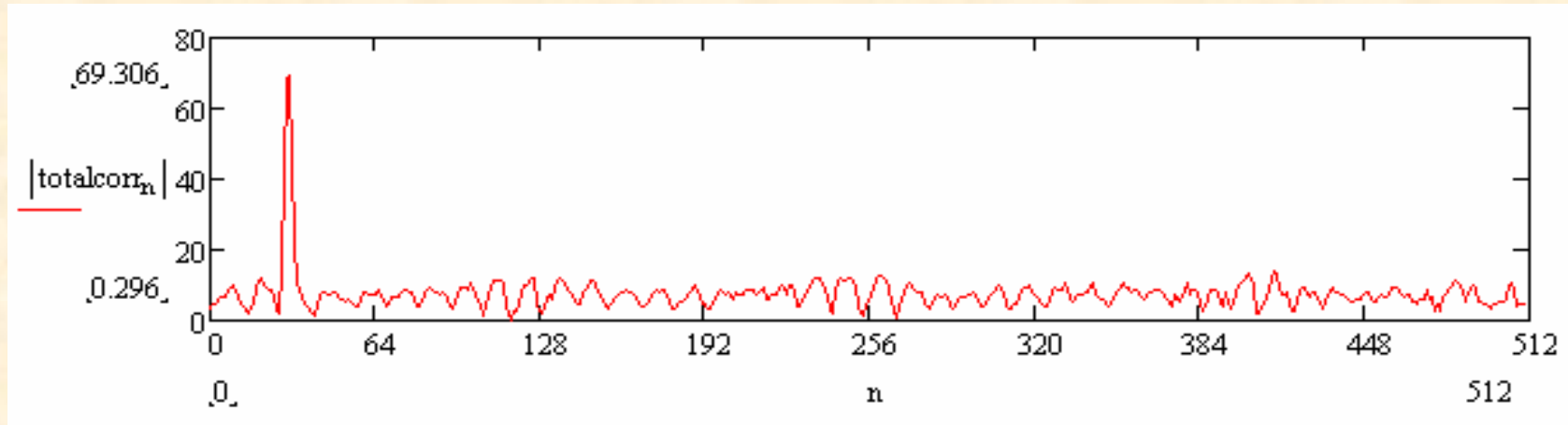



After the modulus calculation the signal contains useful echoes and noise. We can detect echoes from ionospheric layers assigning a threshold, according to the CFAR (Constant False Alarm Rate) criterion.

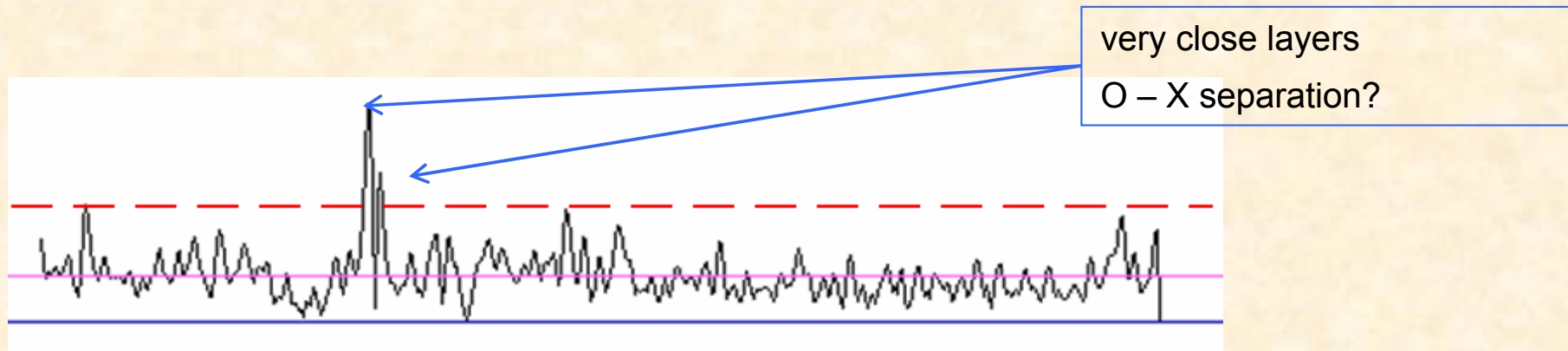

In the following slides we will see some practical cases.

## Real cases (1/2)

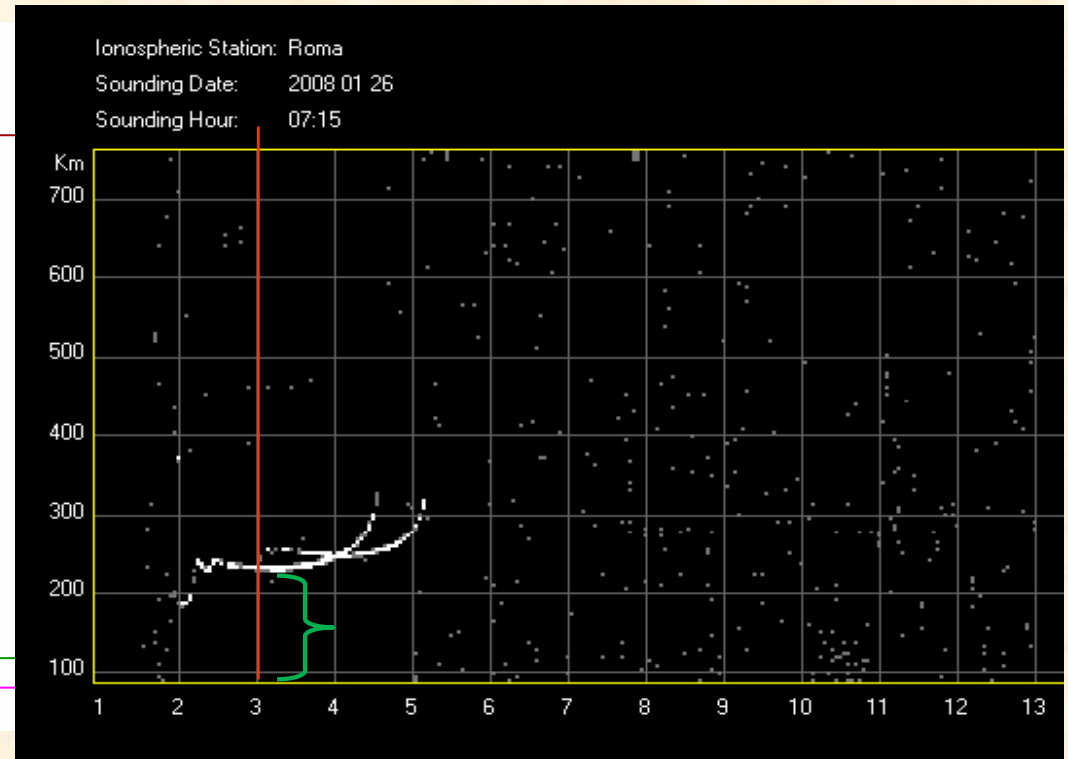
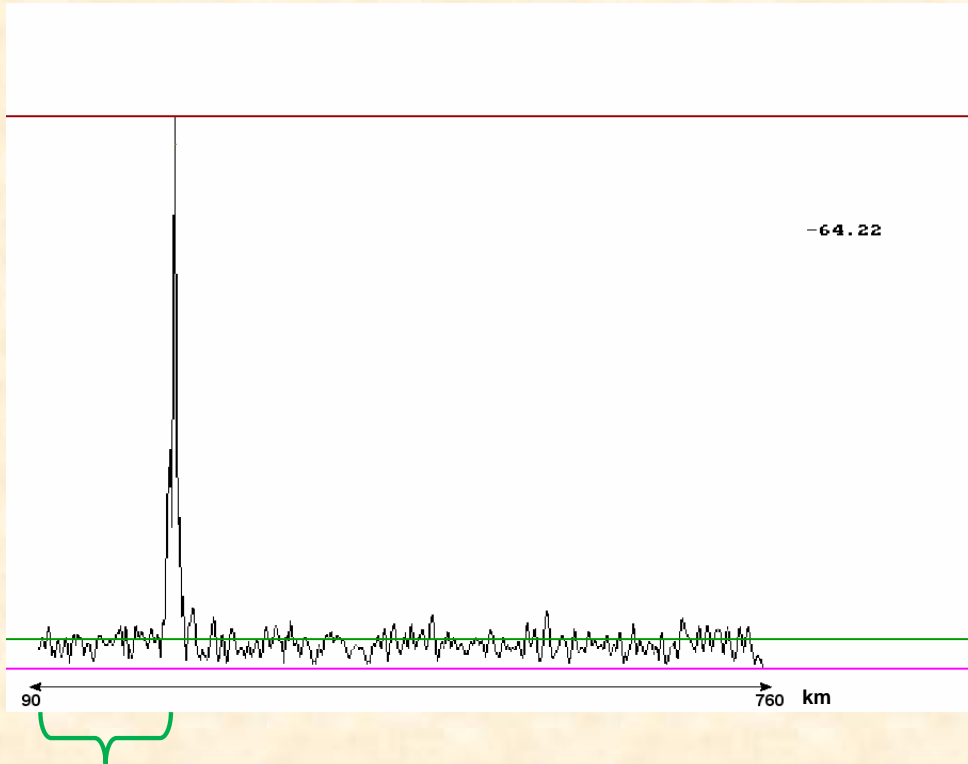

The position of the peak is related to the reflection height, and amplitude is related to energy.

# Real cases (2/2)

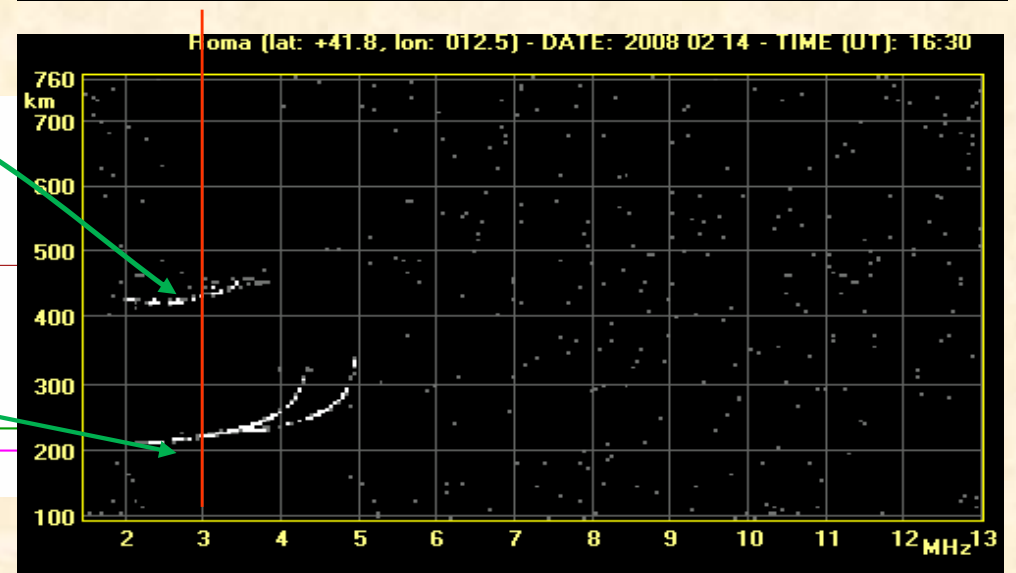
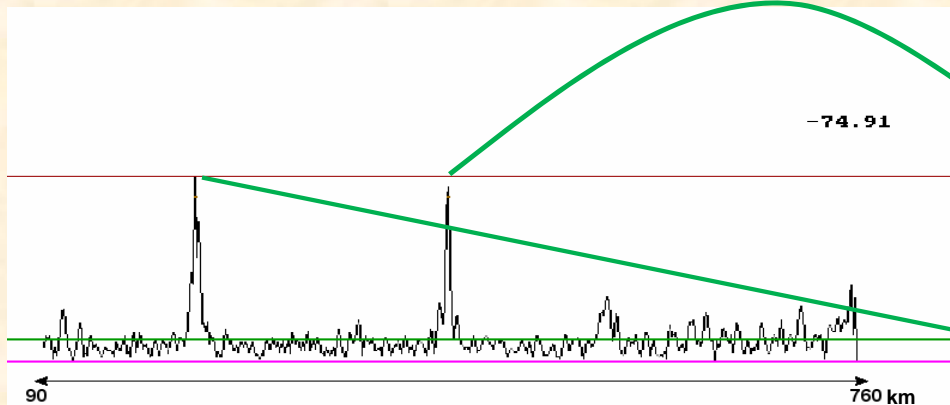
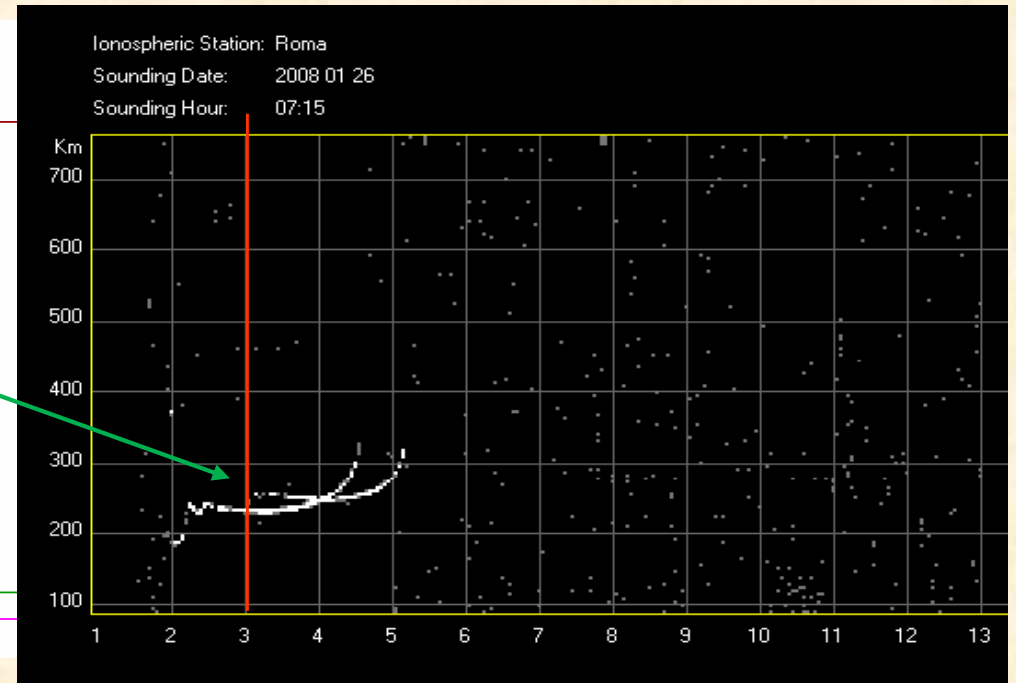
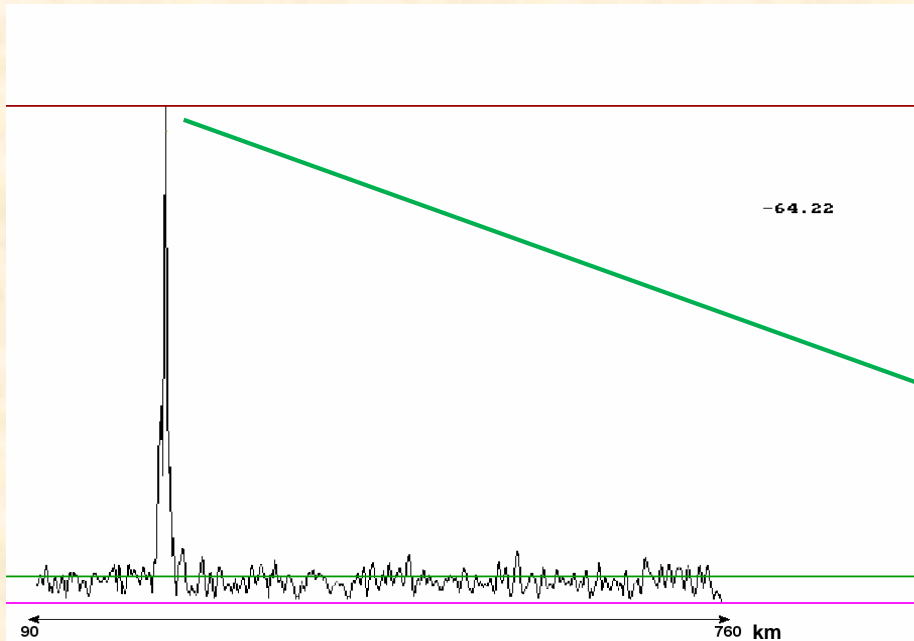

# AIS-INGV ionosonde at Universidad Tecnológica Nacional Facultad Regional Tucumán San Miguel de Tucumán



Power amplifier

Main unit

PC

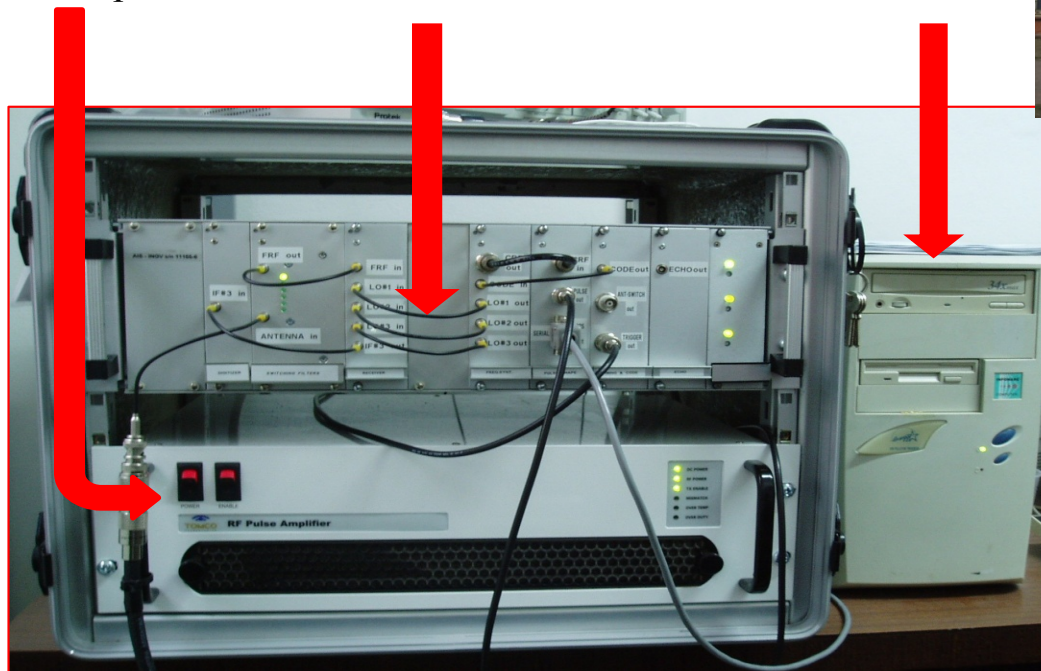



## Installation data

Here below there are the location and time of the installation of the new ionospheric observatory with the AIS-INGV ionosonde and a new antenna system.

**Where:** in San Miguel de Tucumán, Argentina

geographical : 26.9 S, 294.6 E

magnetic : 15.5 S, 003.8 E

**When:** at the end of August 2007, on the 50th anniversary of the Ionospheric Laboratory in the Physics Department of the Facultad de Ciencias Exactas y Tecnología, Universidad Nacional de Tucumán

**Note:** The location of the new observatory is particularly interesting because it is close to the southern peak of the equatorial anomaly.



## System features

AIS-INGV ionosonde at Tucumán observatory:



Parameter	Requirement
Height range	90 ÷ 750 km
Height resolution	4.5 km
Transmitted power peak	200 - 500 W
Receiver sensitivity	~ -85 dBm for 0 dB S/N
Dynamic range	~ 80 dB
Frequency range	1 ÷ 20 MHz
Frequency resolution (step)	25, 50, 100 kHz
Frequency scan duration	3 minutes (for 50 kHz step sounding and 1 ÷ 15 MHz frequency range)
Acquisition sampling rate	100 kHz
Acquisition quantization	8 bit

The system is equipped with Autoscala, a software able to perform an automatic scaling of the ionogram.

## Antenna system (1/7)

The antenna system was designed by INGV and built by engineers from the Facultad Regional Tucumán (FRT) of the Universidad Tecnológica Nacional (UTN). It is constituted by two crossed delta antennas (RX and TX) 22 m high and 42 m wide.

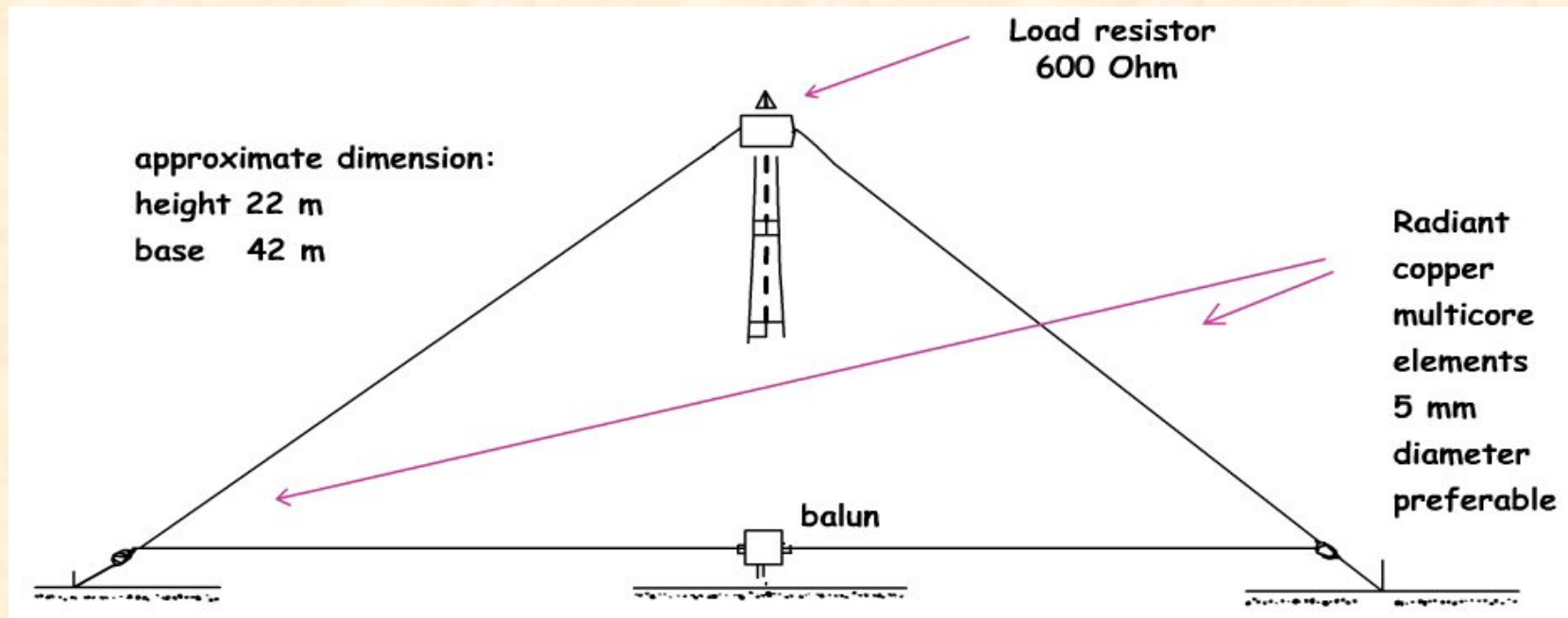



## Antenna system (2/7)

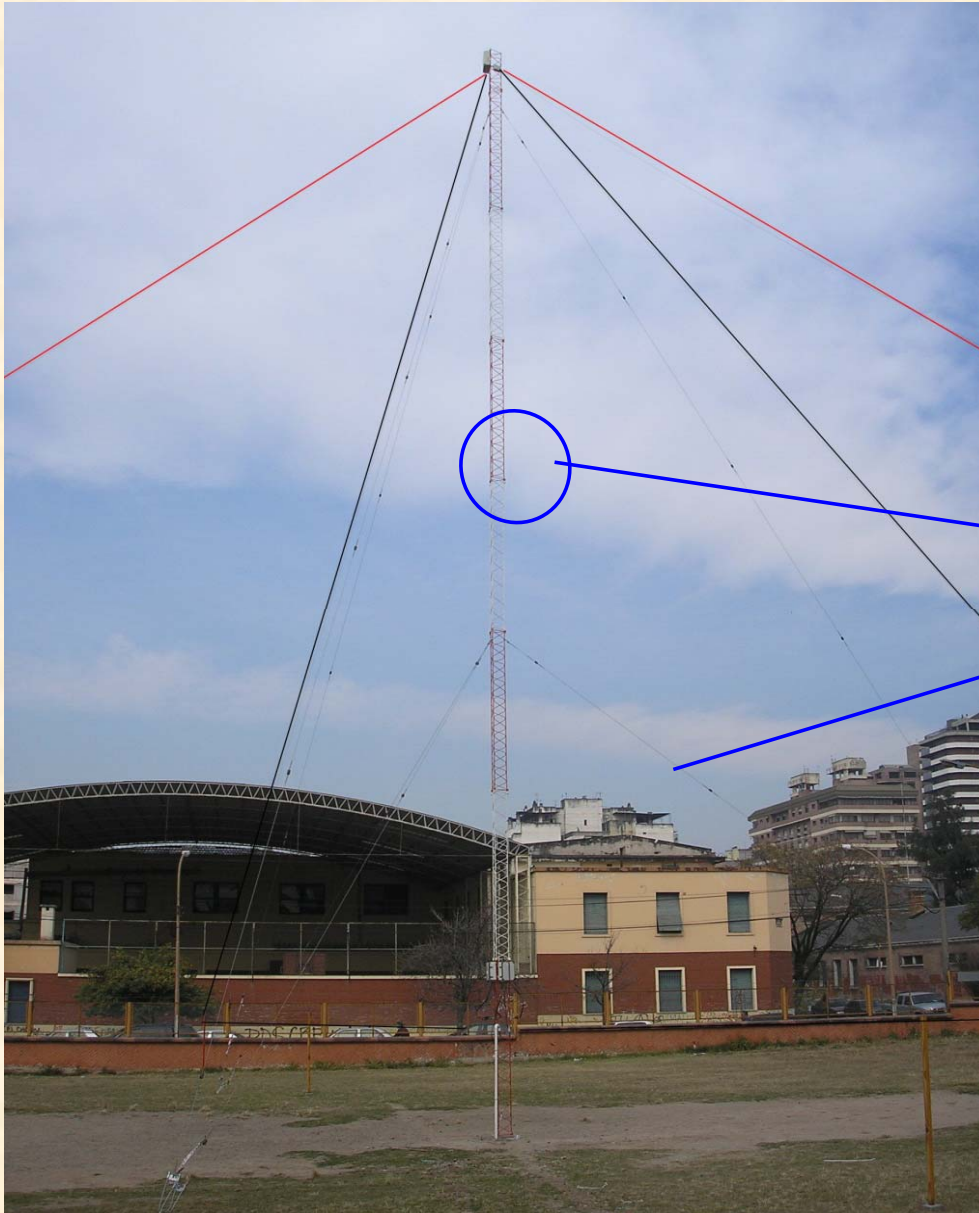

TX and RX antennas are highlighted in the picture (in red and black).

An iron framework sustains the radiating elements, and is fixed by a two orders backstays system.

Baluns and resistor loads, again built at UTN, complete the antenna system.



## Antenna system (3/7)

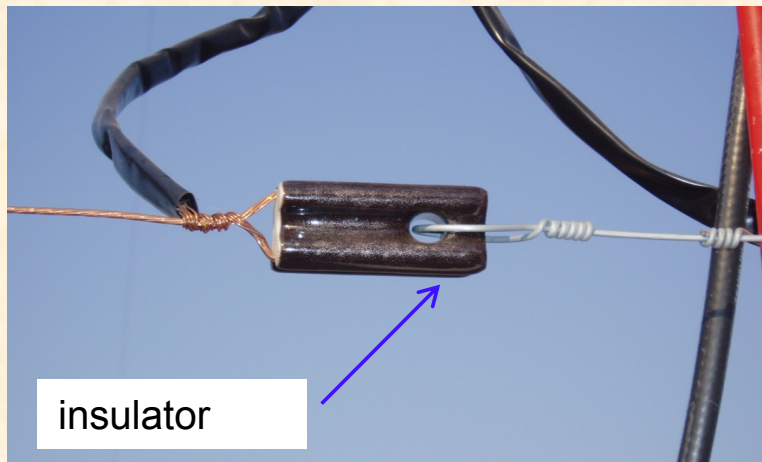

Ceramic or glass insulators are necessary to connect the radiating wires to metallic frame with NO electrical contact.

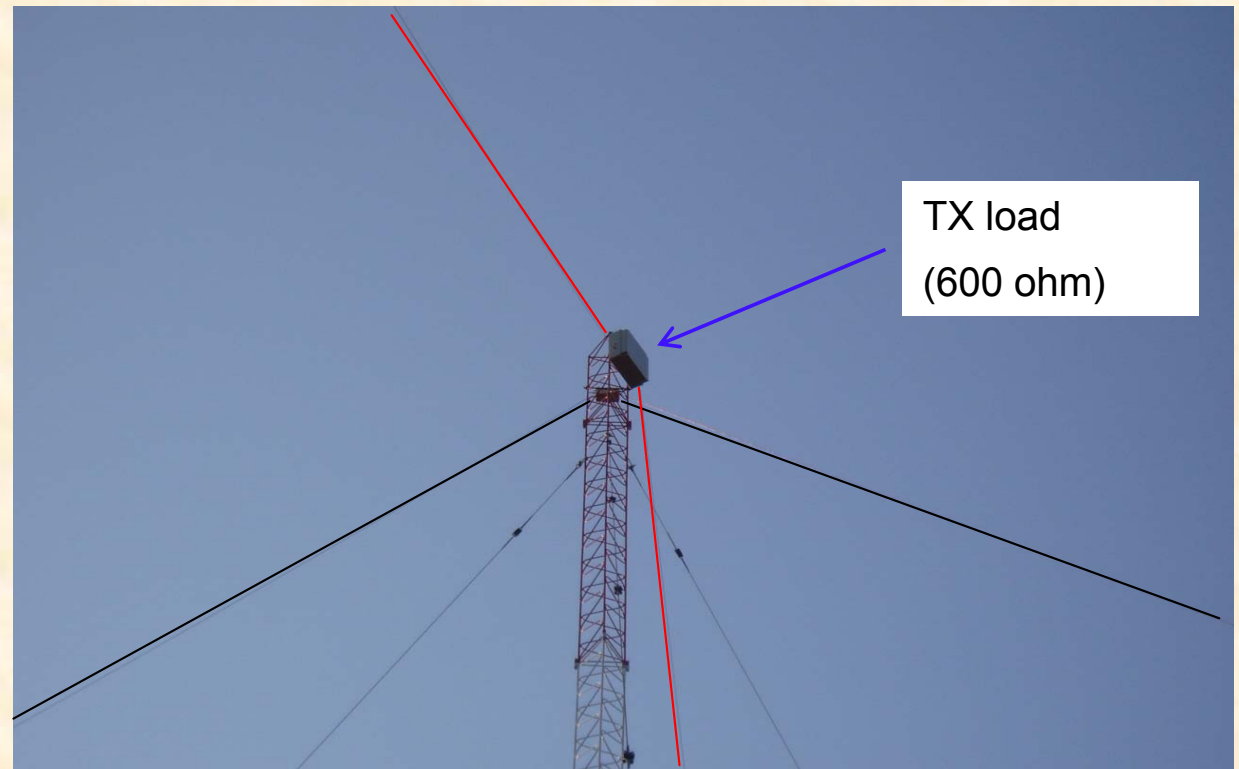
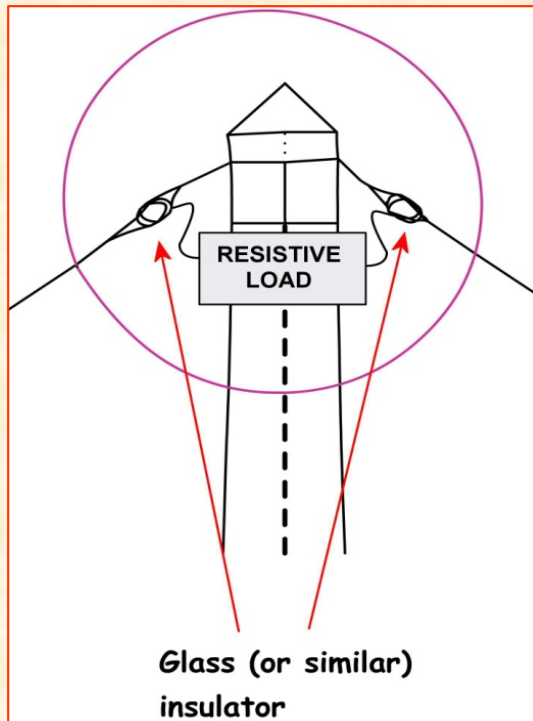

## Antenna system (4/7)

The impedance of the antenna is given by the resistive load on the top of the mast. The output of the power amplifier as well the input impedance of the receiver is 50 ohm. So an impedance adapter is needed (BALUN), which also transforms the reference from unbalanced to balanced.

Consider the ionosonde at the primary side  $R_p = 50$  ohm and the antenna at the secondary side  $R_s = R_L = 600$  ohm .

$$\left( \frac{N_s}{N_p} \right)^2 = \frac{R_s}{R_p} \quad \text{da cui} \quad \frac{N_s}{N_p} = \sqrt{12} \approx 3.5$$

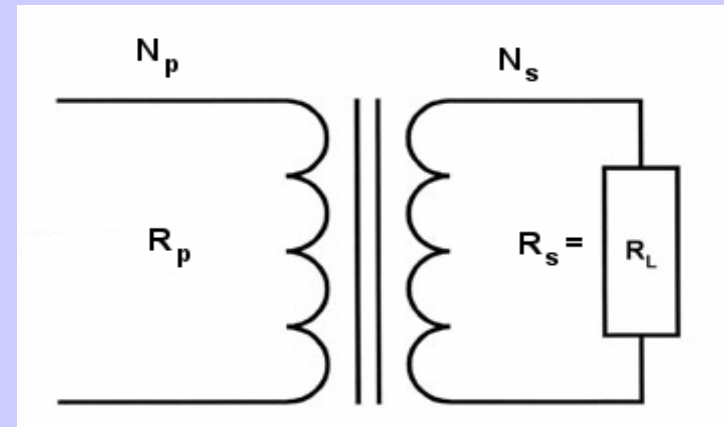

The work frequency is  $> 1$  MHz and very few turns for the primary are enough, reducing the resistive effect of the wire, and, consequently, the energy loss.

At the end

$$N_p = 2$$

$$N_s = 6$$

## Antenna system (5/7)

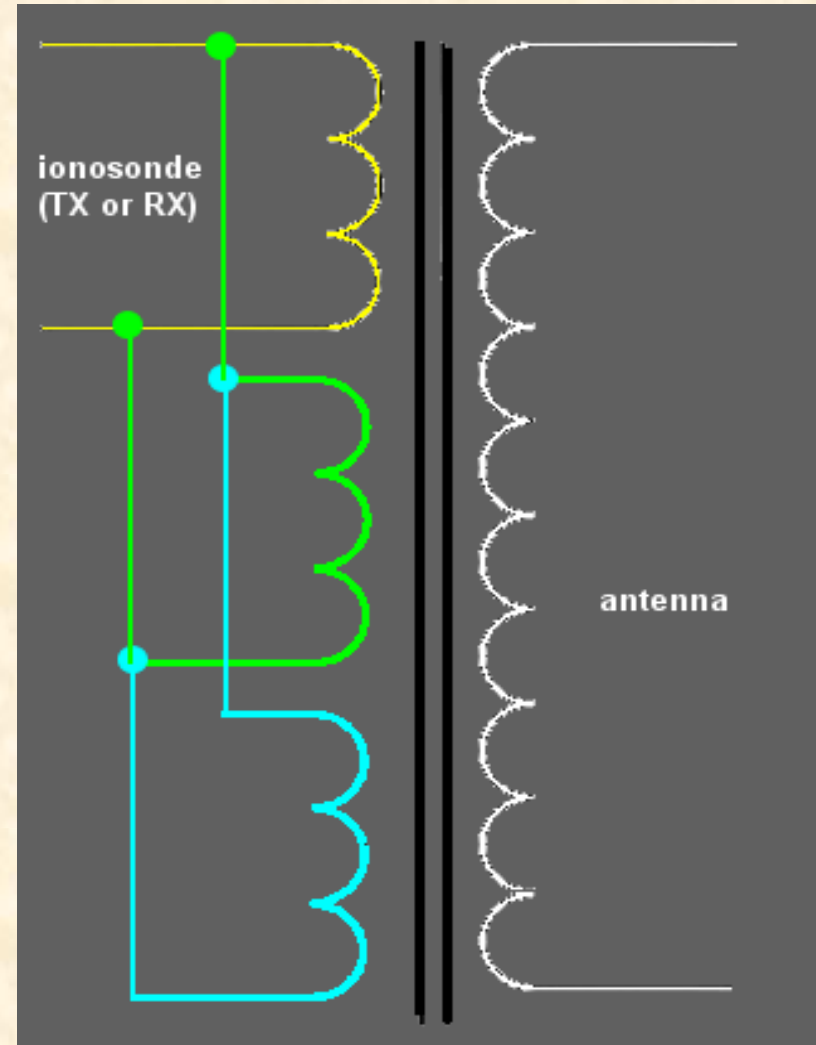
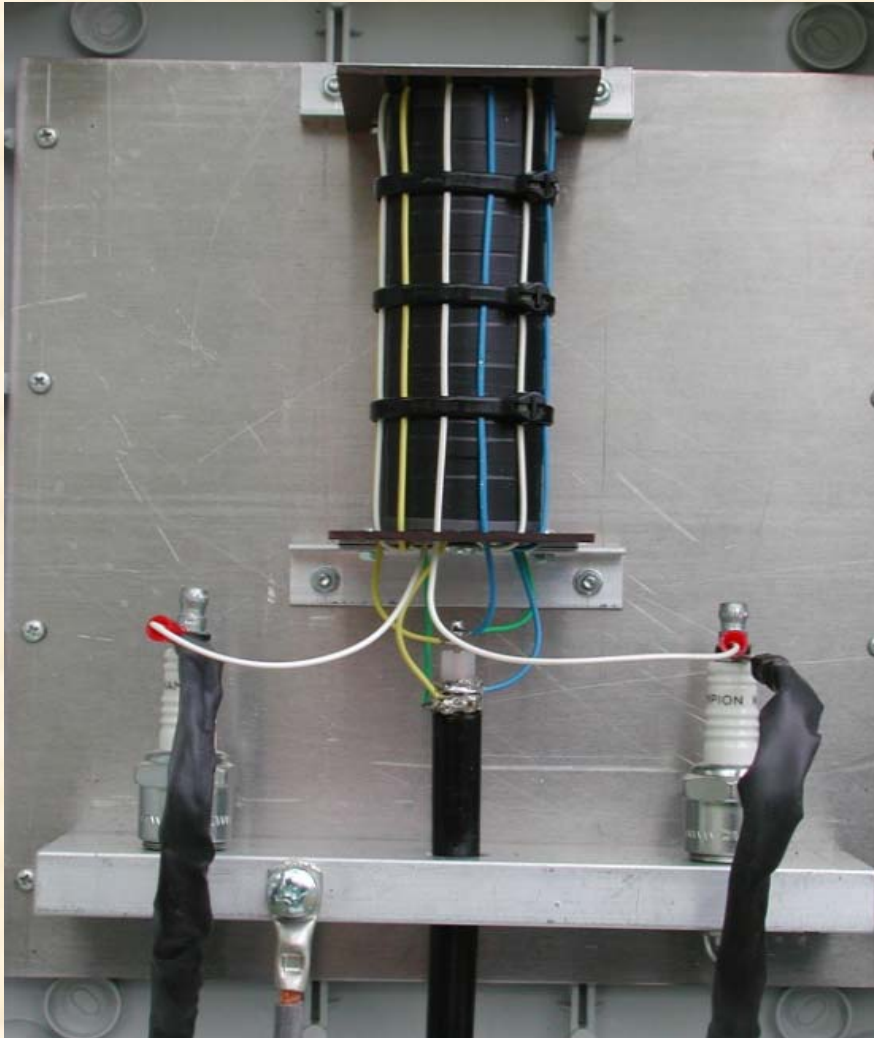

To better distribute the energy limiting the losses the primary is built with 3 identical windings in parallel, along the toroid (blue, green and yellow wires).

## Antenna system (6/7)

The secondary winding is constituted by a single white wire interleaved by the 3 “primaries”.

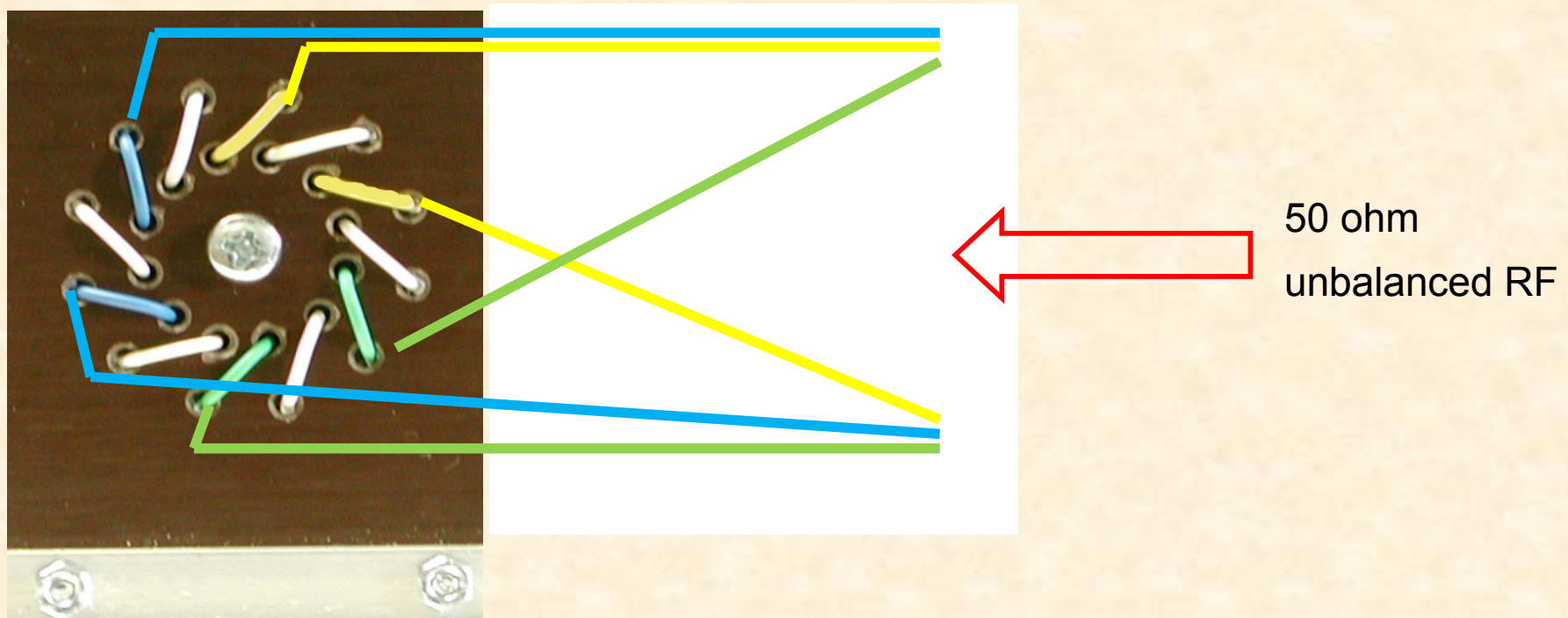



## Antenna system (7/7)

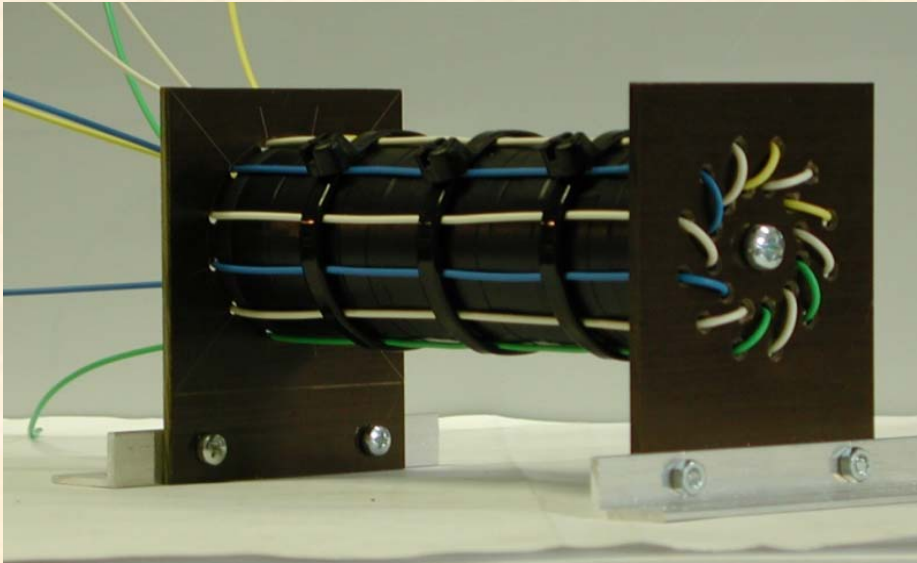

To limit the induced currents (eddy currents) the preferred solution is to stack some toroids introducing gaps.

There is also a practical reason, that is to increase the mechanical robustness of the device.

The final arrangement:

Secondary circuit  
(balanced 600 ohm)

Primary circuit  
(unbalanced 50 ohm)

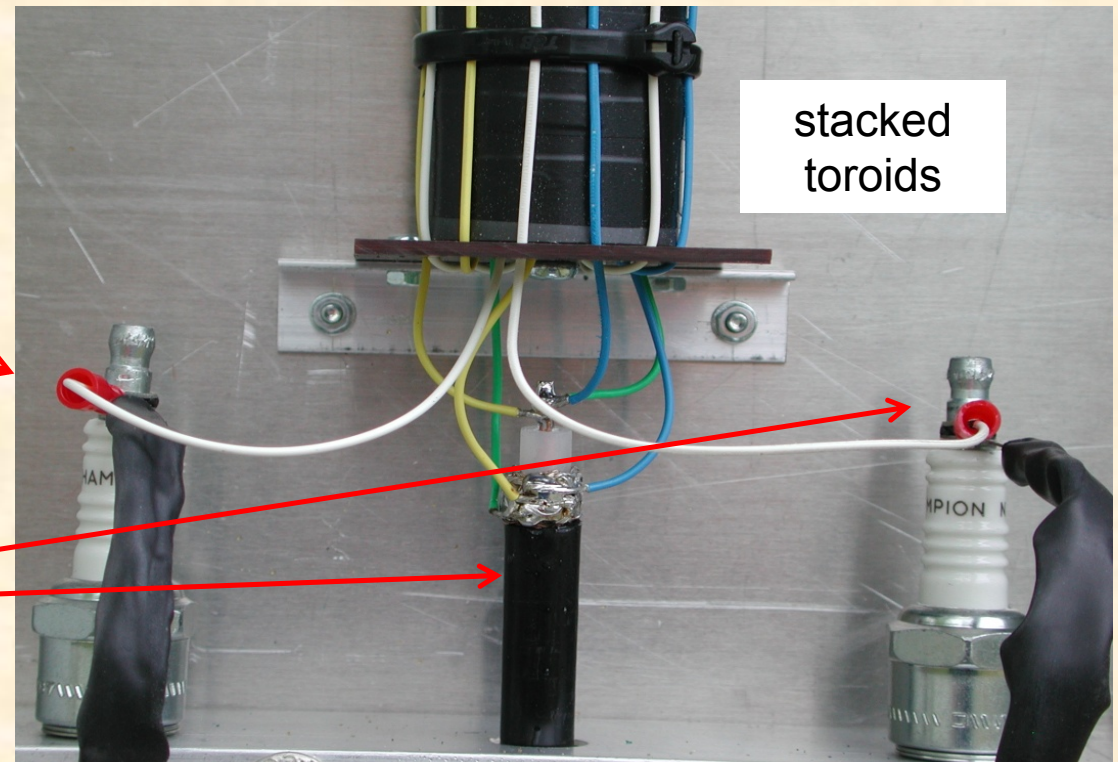

## Data spreading (1/3)

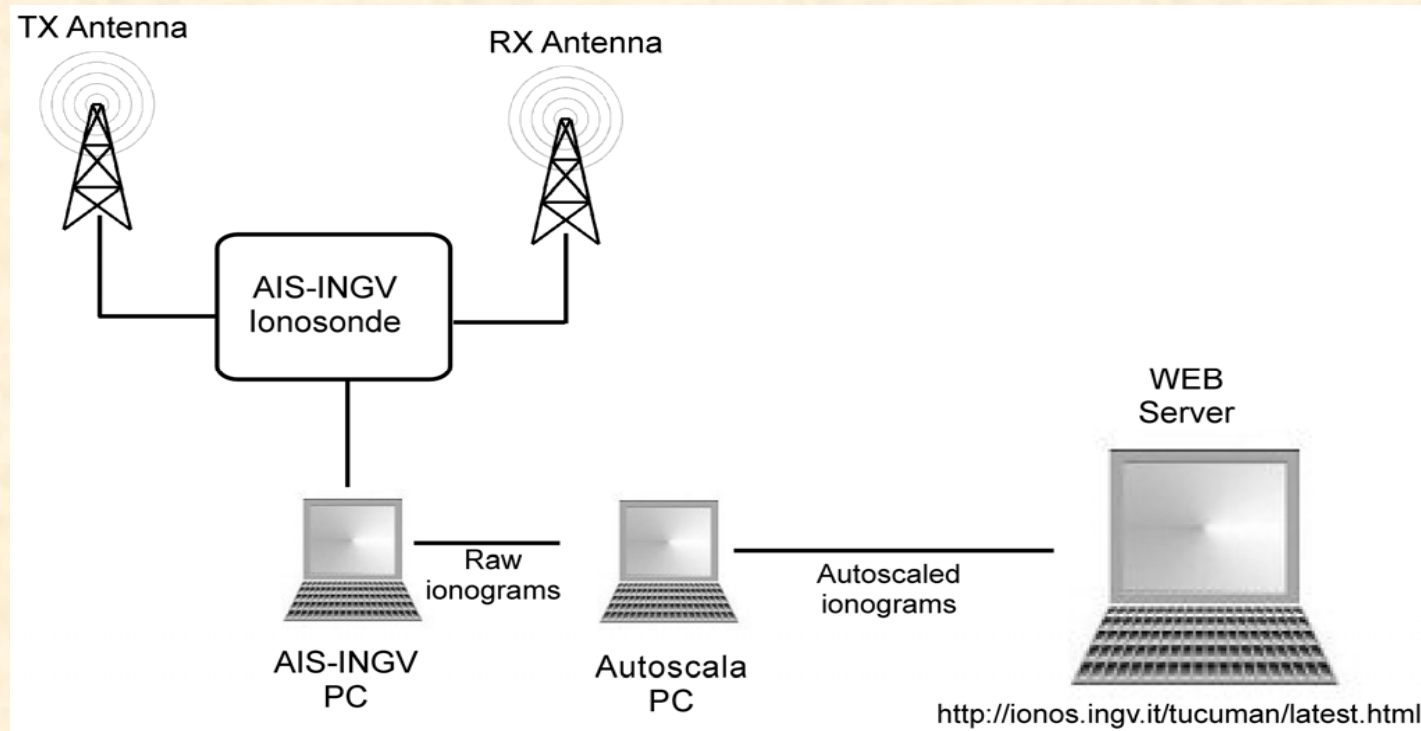

**AIS-INGV PC** manages the soundings raw files;

in order to scale the recorded ionogram **Autoscala PC** runs the proper software giving as output the ionospheric data and the ionogram pictures to be sent to the web site;

all the files are collected in a web server in Rome, at INGV, where results become available.

Ionospheric Station of Tucumán (Argentina) - Microsoft Internet Explorer

File Modifica Visualizza Preferiti Strumenti ?

Indirizzo <http://ionos.ingv.it/Tucuman/latest.html>

## Ionospheric Station of Tucumán (Argentina) - Latest Ionogram

Latitude 26.9 S      Longitude 294.6 E

*Facultad Regional Tucumán - Universidad Tecnológica Nacional*

This page reports the real time ionograms recorded at Tucuman Observatory by the AIS-INGV ionosonde. The ionospheric characteristics given as output were automatically scaled by Autoscala program. The AIS-INGV/Autoscala system was developed at the Istituto Nazionale di Geofisica e Vulcanologia (INGV), Rome, Italy.

---

Tucuman (lat: -26.9, lon: 294.6) - DATE: 2007 10 13 - TIME (UT): 16:00

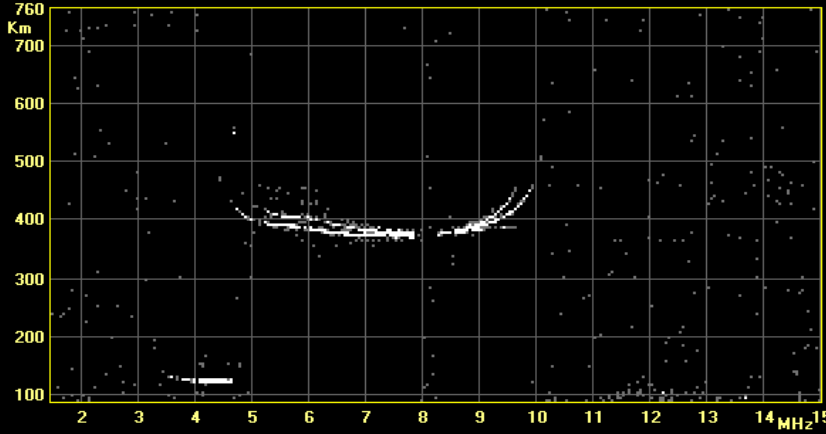

foF2	9.9 MHz
MUF(3000)F2	28.4 MHz
M(3000)F2	2.87
fxl	10.2 MHz
foF1	4.6 MHz
ftEs	4.6 MHz
h'Es	122 km

Last six daily plots: [foF2](#) -- [MUF\(3000\)F2](#) -- [M\(3000\)F2](#) -- [ftEs](#) -- [foF1](#) ←

[PREVIOUS IONOGRAMS](#) ←

The new ionospheric station of San Miguel de Tucumán home page shows the latest ionogram recorded by the station. The red and the blue arrows indicate the links to see the previous ionograms and the last six daily plots of some characteristics.

## Ionospheric Station of Tucumán (Argentina) - foF2 plots

Latitude 26.9 S

Longitude 294.6 E

*Facultad Regional Tucumán - Universidad Tecnológica Nacional*

- foF2 Monthly Median Expected Value
- | N/A: foF2 Not Available  
(insufficient information for Autoscala)
- foF2 autoscaled by Autoscala

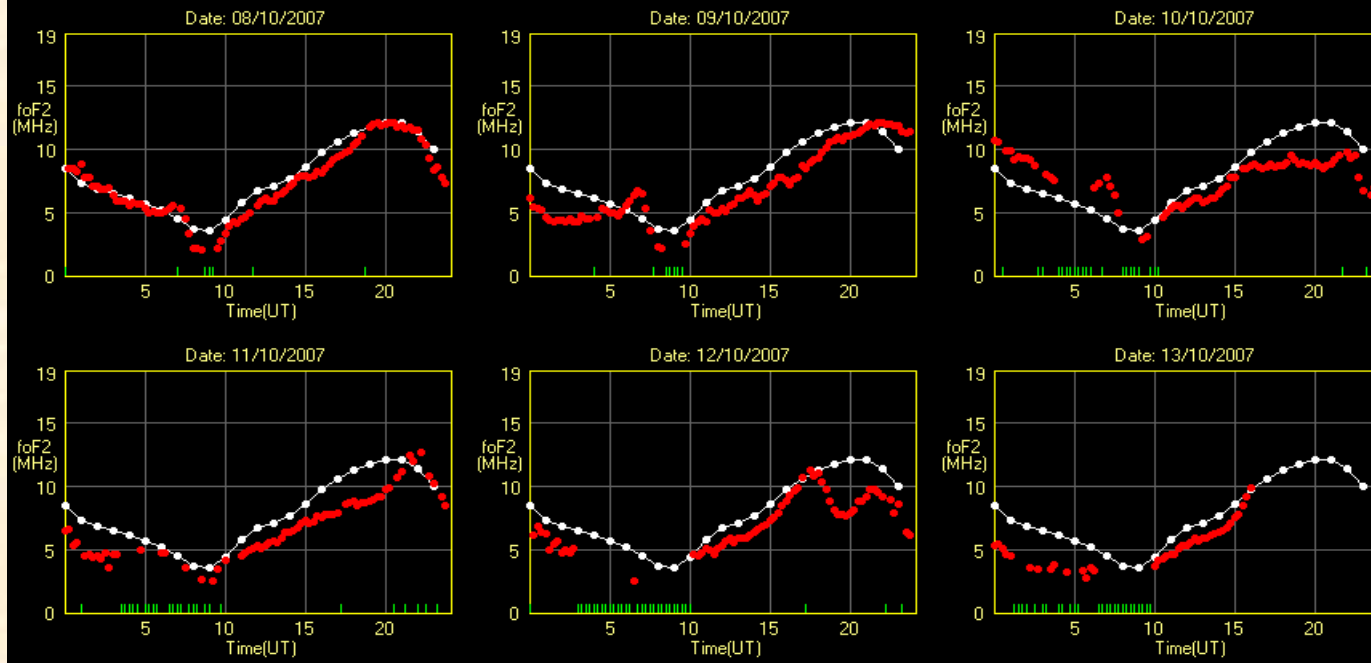

Fplot in which values for a ionospheric parameter are plotted along a day. Red dots represent the measured values, while the white dots are the monthly median values for foF2 parameter.



## Importance of Tucumán data (1/2)

The importance of Tucumán observatory is due to its contribution to global real time ionospheric mapping generated by IPS (Ionospheric Prediction Service by the Australian Space Weather Agency).

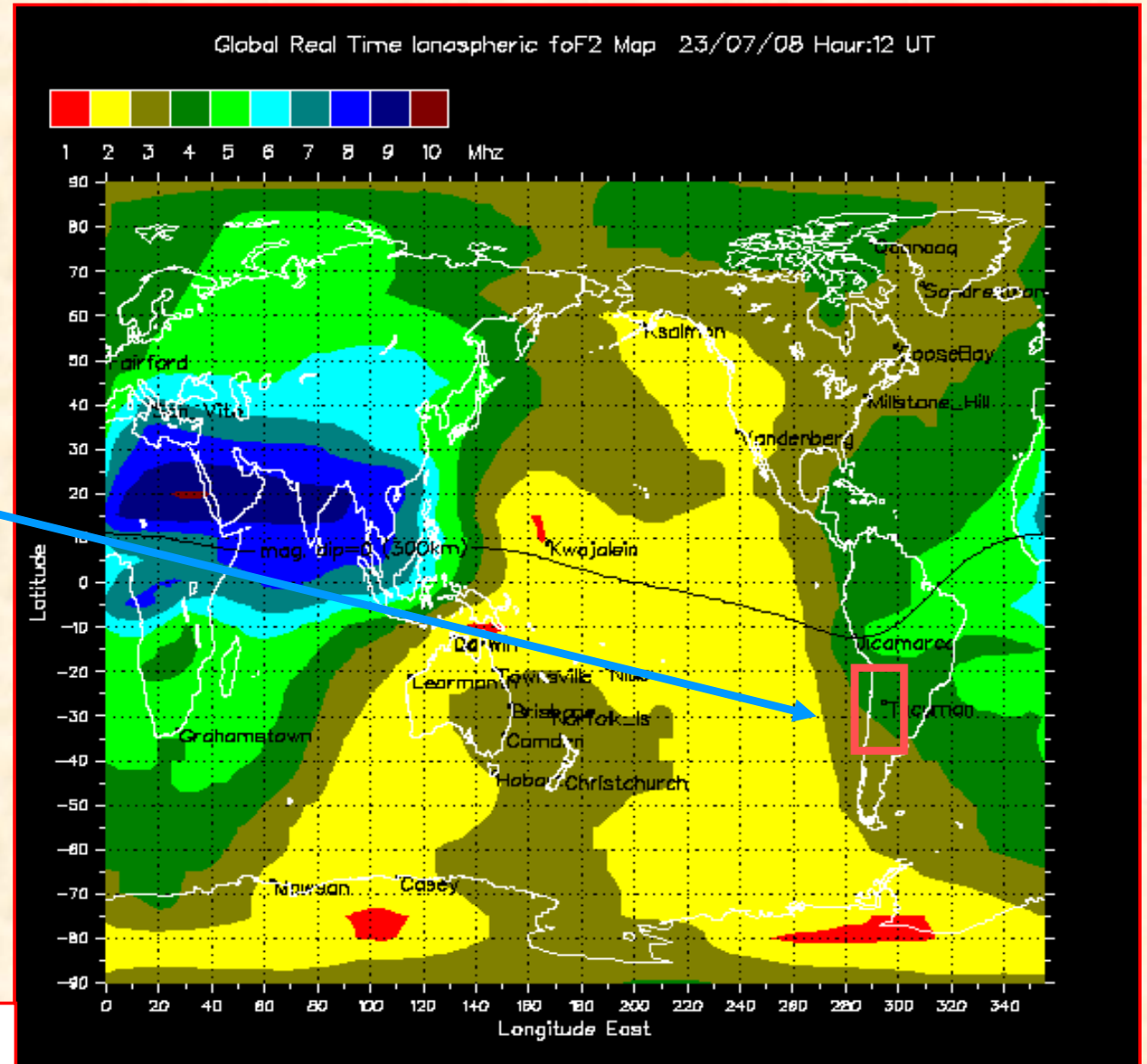

## Importance of Tucumán data (2/2)

Data made available by the Tucumán ionospheric group are also used for a civil usage in the communications with the airlines over the Bolivia.

In the figure below it is represented an example of MUF and skip distance prediction on the region.

