

Title	Fault-tolerant automobile steering based on diversity of steer-by-wire, braking and acceleration
Author(s)	Hayama, Ryouhei; Higashi, Masayasu; Kawahara, Sadahiro; Nakano, Shirou; Kumamoto, Hiromitsu
Citation	Fault-tolerant automobile steering based on diversity of steer-by-wire, braking and acceleration (2010), 95(1): 10-17
Issue Date	2010-01
URL	<a href="http://hdl.handle.net/2433/86177">http://hdl.handle.net/2433/86177</a>
Right	c 2009 Elsevier Ltd. All rights reserved.
Type	Journal Article
Textversion	author

# Fault-tolerant automobile steering based on diversity of steer-by-wire, braking and acceleration

Ryouhei Hayama, Masayasu Higashi, Sadahiro Kawahara, Shirou Nakano<sup>a</sup>,  
Hiromitsu Kumamoto<sup>b</sup>

<sup>a</sup>*R&D Center, JTEKT Corporation, Nara, 634-8555, Japan*

<sup>b</sup>*Graduate School of Informatics, Kyoto University, Kyoto, 606-8501, Japan*

---

## Abstract

Steer-by-wire (SBW) systems, which have no mechanical linkage between the steering wheel and front wheels, are expected to improve vehicle safety through better steering capability. SBW system failures, however, can cause hazardous driving situations. This paper introduces fault-tolerant architecture based on diversified steering mechanisms consisting of SBW backed up with steering by braking and acceleration during SBW failures. These backup steering functions are chosen according to driver's intention of deceleration and acceleration. A loss of SBW function during front-obstacle avoidance on a straight highway is investigated by driving simulator experiments. The results show that the driver can maneuver the vehicle by the steering wheel during the SBW failures. Both cost and volume increase by excessive redundancy within SBW is avoided by the diversified design, thus facilitating SBW application on new-generation vehicles.

*Key words:* automobile, steer-by-wire, fault-tolerant, diversification

---

## 1. INTRODUCTION

Steer-by-wire (SBW) systems, which have no mechanical linkage, are expected to improve both passive safety and active safety. Concerning passive safety, impact to the driver via the mechanical linkage during front-end collisions is reduced, and concerning active safety, vehicle stability and steering maneuverability are improved by electronic control [1].

SBW system failure, on the other hand, can lead to unsafe driving situations. In the case of airplanes, significant redundancy in fly-by-wire systems

is effective avoiding hazardous failures. In the case of mass-produced passenger vehicle, however, it is difficult to install SBW systems with sufficient redundancy because of the increased cost, volume and weight.

Electronic stability control (ESC) has been developed to enhance vehicle stability via braking force control. Many vehicles are now equipped with ESC, which is recognized as a useful device to improve vehicle stability. In the near future, a new automobile regulation will require every vehicle to be equipped with ESC.

Some vehicles are equipped with a driving-torque distribution (DTD) device to enhance vehicle stability but via driving-torque (acceleration) [2-4].

Vehicles with an electric motor on each wheel are now being developed to achieve innovative vehicle movement by independent control of braking force and driving-torque [5].

However, these devices assume in normal driving conditions without steering system failure.

This paper proposes a fault-tolerant architecture including ESC, DTD and SBW to cope with SBW failures. Driving simulator experiments are performed to evaluate the integrated architecture under SBW failure.

## 2. BASIC STRUCTURE OF SBW SYSTEM

Figure 1 shows an example of a basic SBW system architecture. It consists of steering wheel angle sensor 1; resistance torque actuator 2; steering actuator 3; front wheel angle sensor 4; electronic controllers (ECUs) 5; and some conventional sensors 6 to monitor vehicle speed, lateral acceleration and yaw rate.

### 2.1. *Steering actuator*

A typical steering actuator, like the one shown in Figure 1, consists of a ball screw and an electric motor in a concentric arrangement with a steering rod axis between front wheels. Other types of steering actuators consist of rack and pinion mechanism and electric motor with a reduction gear. The ball screw type steering actuator exhibits more accurate and quicker response with less friction, less backlash, and higher stiffness.

## 2.2. Resistance torque actuator

The resistance torque actuator consists of a steering shaft and an electric motor with a reduction gear for resistance torque against the driver's steering maneuvering. This portion of SBW is light in weight and small in volume, contributing to a comfortable cabin and a flexible cockpit design as compared with conventional power steering.

## 2.3. Basic control

Figure 2 shows an example of a basic control diagram. Front wheel angle reference  $\delta^* = K_\delta(V) \cdot \delta_h$  is determined from steering wheel angle  $\delta_h$  and vehicle speed  $V$ . The virtual gear ratio  $K_\delta(V)$  can be realized without requiring mechanical elements. Resistance torque reference  $T_r^*$  is determined from steering wheel angle  $\delta_h$  and vehicle speed  $V$ .

The flexible reference signals  $\delta^*$  and  $T_r^*$  are one of the advantages of the SBW system[6, 7].

## 3. STEERING ACTUATOR FAILURE

A failure of the steering actuator causes a loss of steering. Figure 3 shows a state transition diagram of the baseline structure of Figure 1. Symbol "A" denotes the normal state. When the steering actuator fails in state "A", the SBW loses steering function and transits to state "B", where the driver cannot steer the vehicle. The baseline structure is not fault-tolerant for steering actuator failure.

Failure of the resistance torque actuator in state "A" causes the SBW to transition to state "C", where the driver can still steer the vehicle without resistance force. State "C" is not so serious as state "B".

Fault-tolerant capability must be implemented. The SBW system should be able to maintain steering in degraded modes under component failures. A redundancy system is an approach to coping with the component failures [8]. In the subsequent section, we discuss backup architectures for steering actuator failure having serious influence.

## 4. REDUNDANCY AND DIVERSITY OF ARCHITECTURE

Section 4.1 presents a mechanical backup diversity and Section 4.2 presents a motor redundancy. Section 4.3 combines these two architectures, resulting

in a structural complication due to addition of the mechanical diversity. Section 4.4 gives a less complicated diversification by using on-board systems outside the SBW. This diversification is described in Section 5 and thereafter.

#### *4.1. Mechanical backup*

A mechanical connection between the steering wheel and steering actuator is established when the steering actuator fails.

The steering wheel shaft and the steering actuator can be connected via a mechanical linkage as shown in Figure 4 comprising the cable wire 1 and pulleys and clutch 2. The clutch connects the steering wheel shaft with the pulley axis during steering failure. The steering force from the driver can now be transmitted to the front wheels via the wire.

The resistance torque actuator can be used to assist the driver's steering force in similar conventional electric power steering. The driver can be informed of the steering actuator failure by a haptic signal such as small vibrations of the steering wheel. The controller detects the steering actuator failure by a comparison between front wheel angle measurement as actuator output and electric motor current as actuator input.

#### *4.2. Electric motor backup*

This architecture is shown in Figure 5 with two redundant motors and ECUs. In the case of a failure of principal motor 1, the SBW system can be operated by standby motor 3.

#### *4.3. Mechanical cable wire and electric motor backup*

To cope with multiple failures, an architecture based on diversity [9] must be considered. An architecture with mechanical and electric redundancies is shown in Figure 6. Figure 7 shows a state-transition diagram for the architecture. Even when two steering actuators fail simultaneously by a common cause transition from "A" to "E" or from "C" to "F", the SBW system can maintain the steering function in state "E" or "F", where the driver can steer the vehicle by cable wire.

#### *4.4. Backup with systems outside the SBW*

An elaborate solution to decrease SBW failure with higher redundancy and diversity than the one in Figure 6 increases cost, weight, and volume for SBW systems.

A backup of SBW by an another preexisting on-board system, is necessary to further increase steering reliability, to avoid cost increase by an excessive redundancy, and to facilitate SBW systems on a commercial basis.

## 5. YAW MOMENT MANAGEMENT

We now propose a fault-tolerant steering architecture based on yaw moment management with SBW, ESC and DTD shown in Figure 8. This can be called yaw-moment integrated-control. The steering wheel can now be regarded as a component that not only steers the front wheels, but also manages the vehicle yaw moment by ESC and DTD.

The integrated architecture mitigates the effects of steering actuator failures. In other words, the integration alleviates requirements for steering actuator reliability. The duplex redundancy for the steering actuator becomes practical, because the third backup is provided by the ESC and DTD.

### 5.1. Operation

Figure 9 shows operation in terms of state-transition in the integrated control architecture starting with SBW failure. ESC or DTD initiated failures in state "A", "B", "C" and "D" can be easily dealt by stopping the vehicle after nullification of the corresponding functions. These transitions are not shown to simplify the diagram. The failures in state "E" or "F" cause a transition to state "G".

State "A" is the normal state. Abnormal events are continuously monitored. A transition to state "B" with standby actuator occurs automatically without significant delay when principal steering actuator fails. The driver is advised to stop the vehicle to confirm the principal actuator failures for safety.

A transition from the state "B" to the state "B'" occurs when the driver voluntarily stops the vehicle.

A transition to state "E" occurs when the standby steering actuator fails in state "B". In state "E", the driver can voluntarily steer and stop the vehicle by using integrated control.

Some drivers continue driving in state "E". A transition to state "F" occurs when the resistance torque actuator fails.

Loss of steering function occurs when both ESC and DTD fails.

### 5.2. Priority on driver's operation

During vehicle stability control, active braking control decrease the vehicle speed. However, during real driving situations, the driver's judgment and operation should have first priority. For instance, consider the following situation shown in Figure 10.

There are two vehicles around subject vehicle (I) on a straight highway. One is following (II) and the another is on the right side (III).

Suppose that the subject driver detects a front obstacle in state "E" or "F" of Figure 9. The driver avoids the obstacle and rear-end collision with the vehicle (II) by following maneuvering.

1. Acceleration to a velocity higher than vehicle (III) on the right side.
2. Lane change toward the front of vehicle (III).
3. Vehicle (I) stops in the far right lane.

The system has to generate the yaw moment by DTD during the lane change because the vehicle must accelerate. An algorithm is installed to activate a suitable control mode, as shown in Figure 11.

In normal state, neither ESC nor DTD is operated. Vehicle yaw rate is controlled solely by steering actuator (i). When principal and stand-by steering actuators fail (ii), the driver's intention is examined (iii). In the case of acceleration, yaw moment is controlled by DTD for acceleration (iv). Otherwise, ESC is activated (v).

A forward collision warning system may facilitate the initiation of obstacle avoidance. The driver's operation should override a lane departure prevention system if it is installed.

## 6. VEHICLE DYNAMICS SIMULATION

The proposed architecture was examined by a driving simulator. A test participant is a man in middle thirties, who has no special skill except for over 10 years driving experience.

### 6.1. Driving simulator

The driving simulator used for the driver-vehicle closed-loop simulation test is shown in Figure 12. Cockpit motion is simulated by a 6-axis actuator. Visual information is presented to the driver on a spherical screen, and the vehicle behavior is calculated by a familiar four-wheel vehicle model.

## 6.2. Driving task

The driver's maneuvering during the front obstacle avoidance situation is shown in Figure 10. Simultaneous failures of steering actuators occur when vehicle (I) is on a straight highway section of Figure 10. A test participant is instructed to make a lane change to stop the vehicle on the far right lane avoiding front obstacle and rear-end collision with vehicle (II) and (III). This type of maneuvering is the only way to avoid an accident in the dangerous situation shown in Figure 10. He isn't informed of the time of SBW failure nor the time of obstacle appearance. The vehicle speed is at 27.8 m/s (100km/h) and the state is "E".

The problem is whether the integrated control enables the driver to execute the instruction safely by using the steering wheel, acceleration pedal and brake pedal in an ordinary way.

## 6.3. Simulation results

Figure 13 shows time series data regarding the acceleration pedal position (a), brake pedal position (a), steering wheel angle (b), longitudinal force (c), yaw rate (d), vehicle speed (e), lateral displacement (f) and warning signal (g).

First, the driver operates the acceleration pedal in order to overtake the vehicle (III) to its right (Fig.13 a-1). Second, the steering wheel is operated to carry out lane change (Fig.13 b-2). As a result, yaw rate is generated by DTD (Fig.13 d-3) and overtaking is achieved (Fig.13 f-4). After generating enough yaw rate, the driver counter-steers the steering wheel in order to straighten the vehicle. The brake pedal is then applied in order to stop the vehicle (Fig.13 a-5). According to these operations, the yaw rate is decreased by ESC (Fig.13 d-6). The vehicle is stopped safely (Fig.13 e-7).

The result shown in Figure 13 is the one for the single participant. This indicates a potential feasibility of the fault-tolerant automobile steering in accident-prone situations with serious steering failures. A few other subjects participated in the experiment. All of them could avoid the accident although their trajectories were not so smooth as Figure 13. A more elaborate study such as a quantification of avoidance probability is a future subject.



## 7. CONCLUSION

1. Fault-tolerant yaw moment management is realized by SBW, ESC and DTD. Either ESC or DTD is activated according to the driver's intentions during SBW failures.
2. The driver-vehicle closed-loop simulation shows feasibility to cope with the loss of SBW during front-obstacle avoidance on a straight highway with vehicles following and to the right.
3. The proposed architecture has a potential to improve vehicle safety and reliability by diversification of steering mechanisms without excessive redundancy inside the SBW system.

This architecture is expected to facilitate use of SBW, an indispensable system for passenger vehicles of new generation.

## References

- [1] S Nakano, M Segawa, K Katou, H Higashimura: A Study of Vehicle Stability Control System with Active Front-Wheel Angle Control (in Japanese), Transaction of JSAE, 20014050 (2001).
- [2] R Kunii, A Iwazaki, Y Atsumi, A Mori: Development of SH-AWD (Super Handling-All Wheel Drive) System, Honda R&D Tech Rev, 16 (2004) 2.
- [3] J He, D Crolla, M Levesley, W Manning: Integrated active steering and variable torque distribution Control for Improving Vehicle Handling and Stability, SAE 2004-01-1071 (2004).
- [4] S Mohan, A Sharma: Torque vectoring axle and four wheel steering: A simulation study of two yaw moment generation mechanisms, SAE 2006-01-0819 (2006).
- [5] Y Hori: Future vehicle driven by electricity and control-research on four-wheel motored "UOT Electric March II", Industrial Electronics, IEEE Transactions, 51 (2004).
- [6] S Nakano, T Takamatsu, O Nishihara, H Kumamoto: Steering Control Strategies for the Steer-by-Wire System (in Japanese), Transaction of JSAE, 20004187 (2000).

- [7] M Segawa, K Nishizaki, S Nakano: A study of vehicle stability control by steer by wire system, Proceeding of AVEC (2000).
- [8] G Zuo, H Kumamoto, O Nishihara, R Hayama, S Nakano: Quantitative reliability analysis of different design alternatives for steer-by-wire system, Reliability Engineering and System Safety, 89 (2005) 241.
- [9] H Kumamoto: Satisfying safety goals by probabilistic risk assessment, Springer (2007).

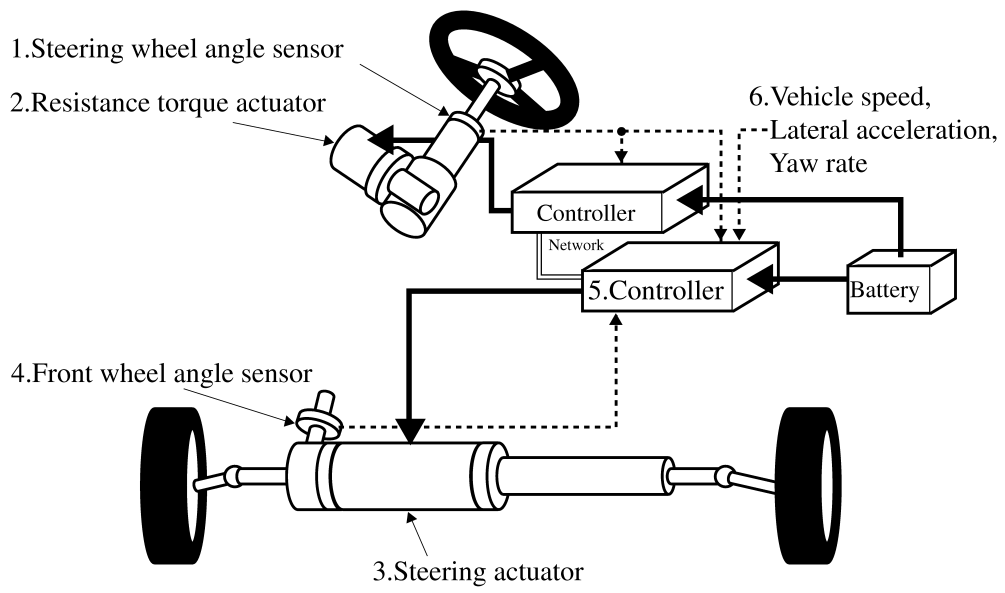

Figure 1: Baseline SBW system structure

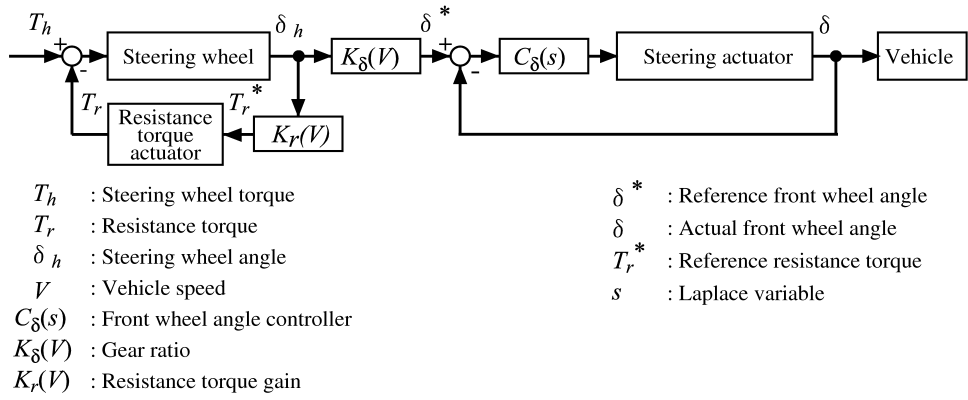

Figure 2: Basic control diagram

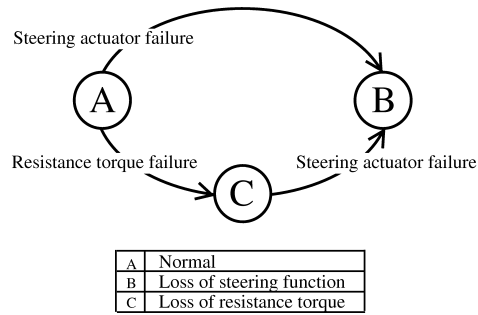

Figure 3: State transition of baseline SBW

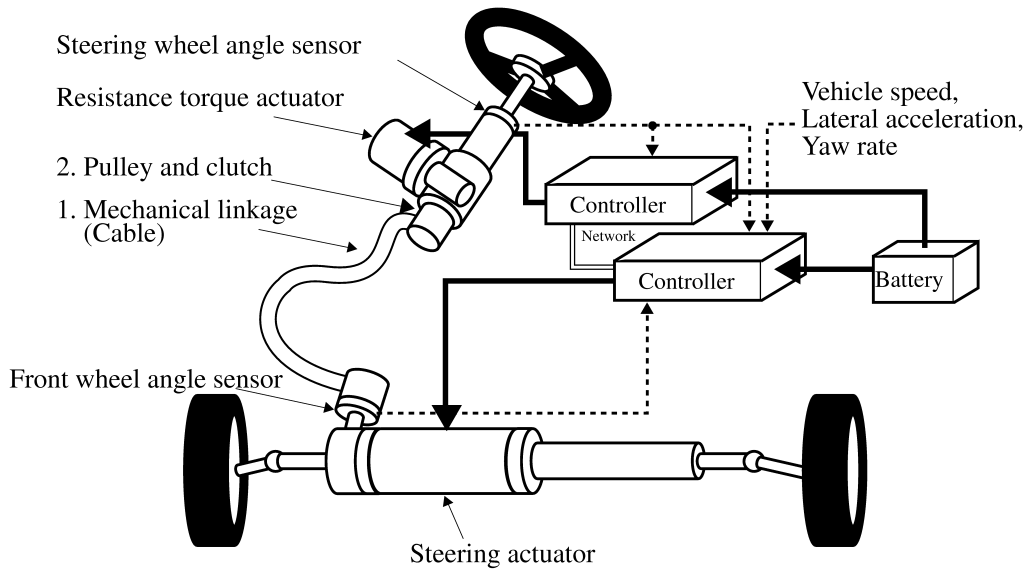

Figure 4: Mechanical cable wire backup design

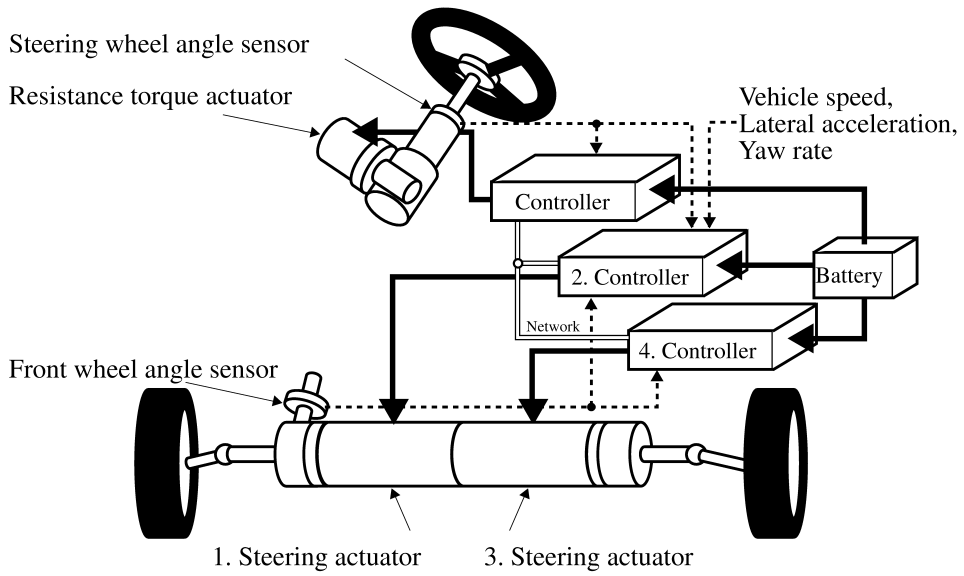

Figure 5: Electric motor backup design

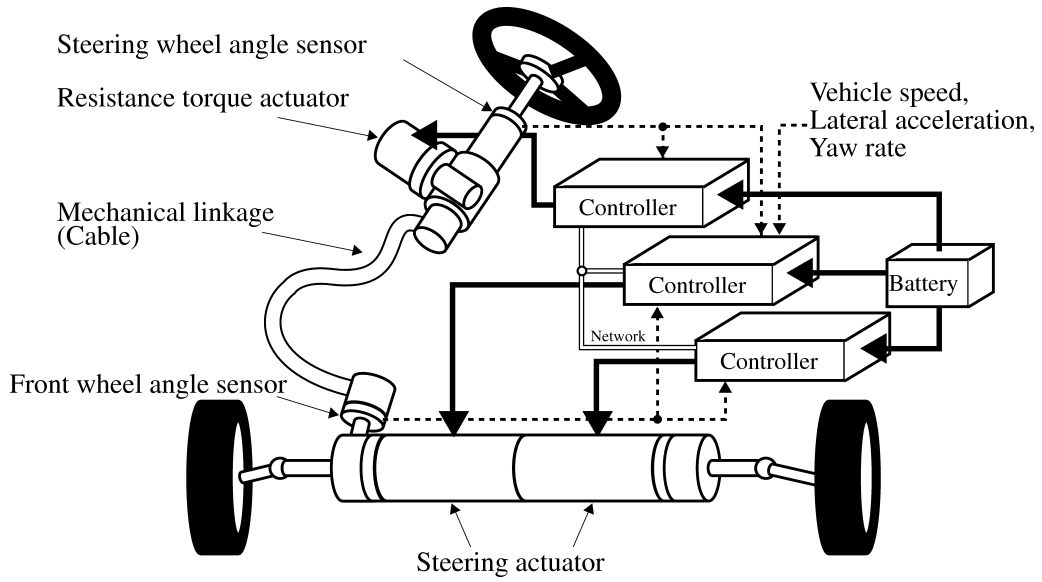
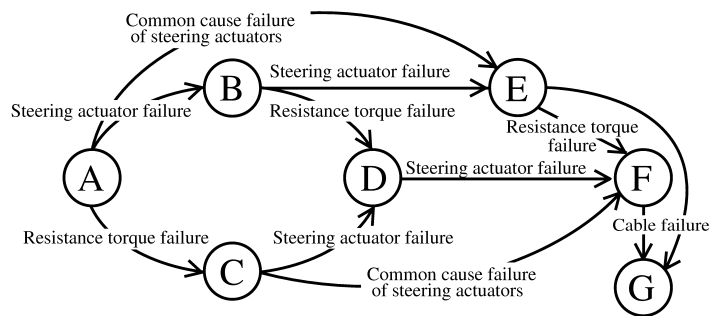

Figure 6: Diversified backup (mechanical and electrical)



A	Normal
B	Steering by standby actuator
C	Loss of resistance torque
D	Steering by standby actuator without resistance torque
E	Steering by cable wire with resistance torque
F	Steering by cable wire without resistance torque
G	Loss of steering function

Figure 7: State transition of diversified backup



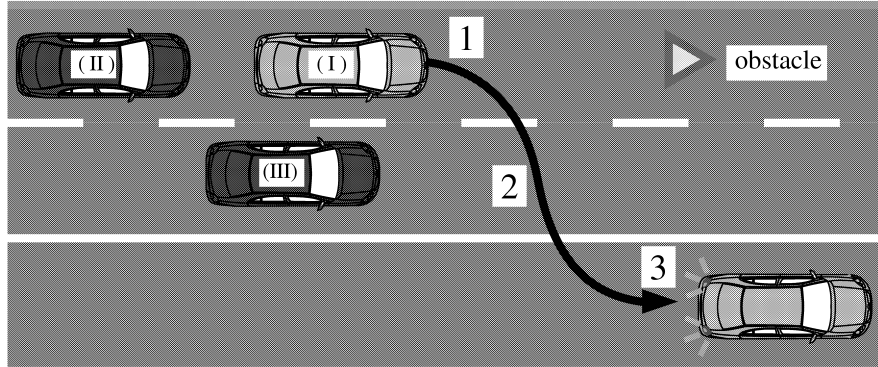

Figure 10: Front obstacle avoidance situation

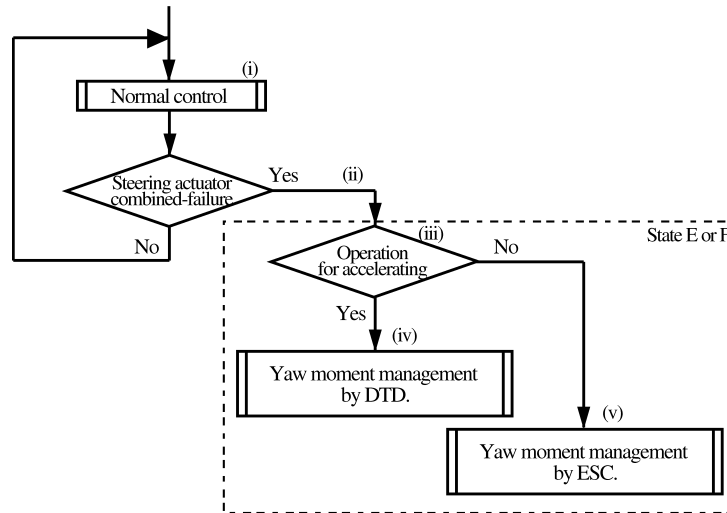

Figure 11: Activation of suitable control mode



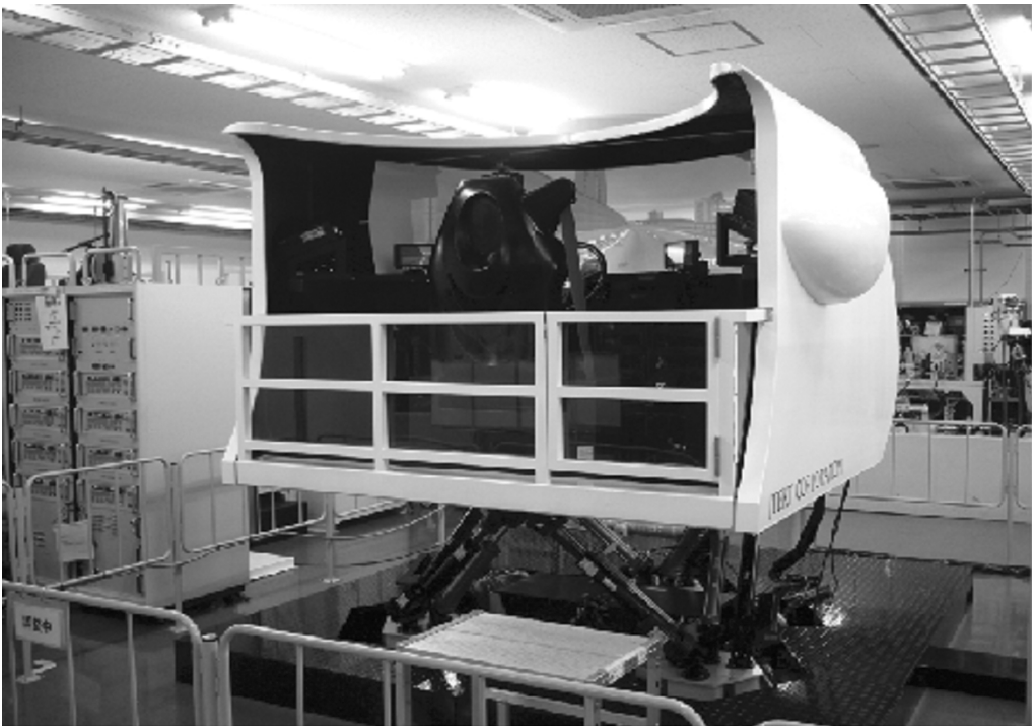

Figure 12: Driving simulator

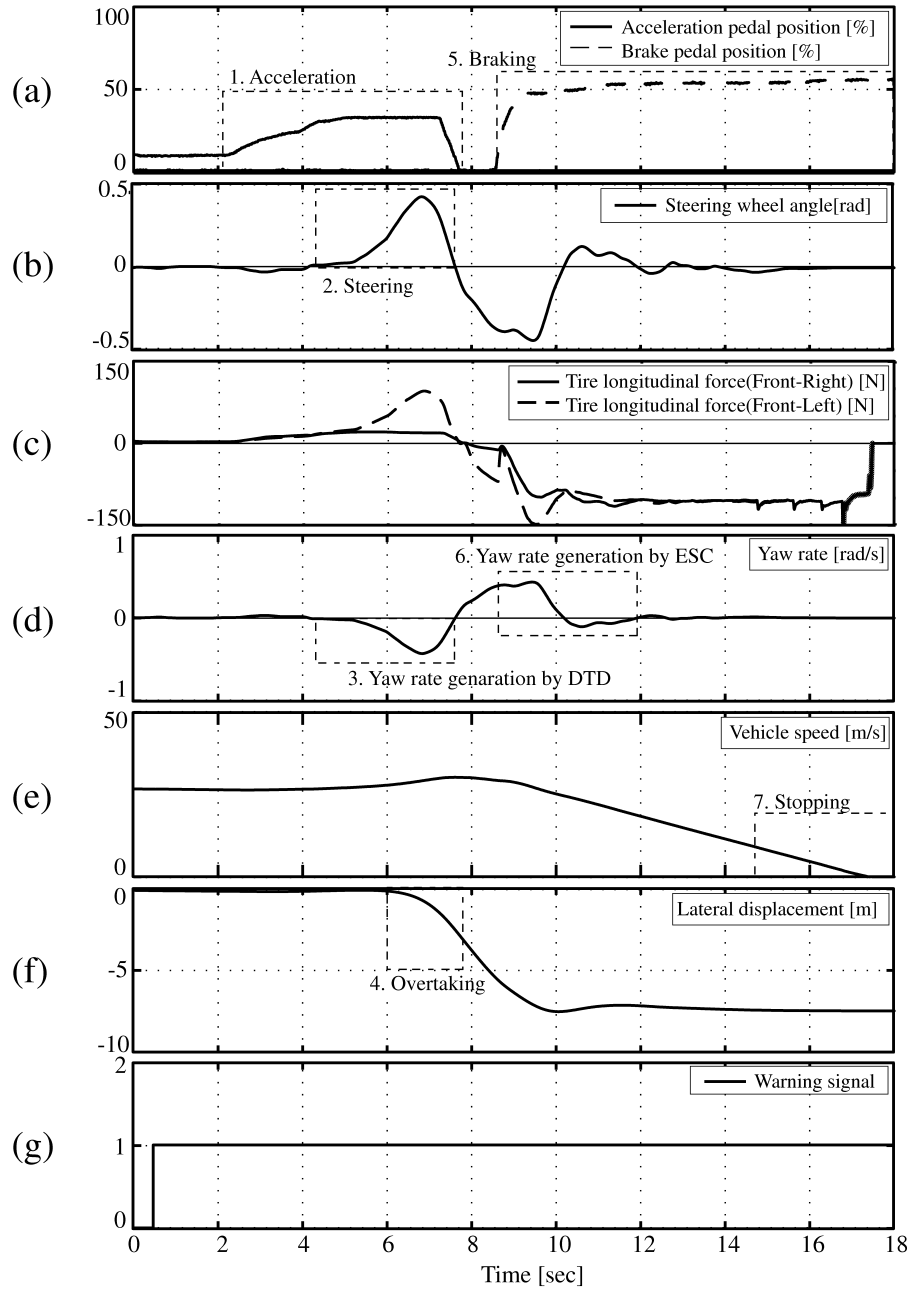

Figure 13: Simulation test result