

The Smallest Neo-Assyrian Combat Unit

FABRICE DE BACKER

*Aloïs Musil Center for Oriental Studies
University of Vienna*

Abstract: For more than two centuries, scholars have thought that the Neo-Assyrians sorted their battle lines according to the classes of the fighters: firstly the chariots, then the horsemen, then the infantrymen. So far, few attempts were realized to understand and illustrate why the Neo-Assyrian warriors mentioned in the texts and / or depicted on the visual evidence fight as small groups of inter-disciplinary specialists. This paper will investigate both the organization and the chain of command of the Neo-Assyrian army engaged in combat.

Keywords: Infantry, Cavalry, Chariotry, Spearman, Archer, Slinger

Introduction

The Neo-Assyrian army relied on the combined employment of specialists, mainly archers and shield-bearers, and on three main vectors: foot, chariot, horse.

The textual evidence demonstrates a complex hierarchical system for the Neo-Assyrian army, although some questions might still be asked. Ranks as Captain, General in Chief and Assistant Body Guard are known from the written materials, and have been identified in the visual sources since the paper of J. Reade, but not only.¹

The identification of particular units might be realised by a deeper research on the military *urigalli*, held on chariots, that were both discovered in archaeological excavations and depicted in visual materials as well.

The Neo-Assyrian army was organised in Combat units, that is proved by the *pirru* lists, the letters and census but so far scholars were hardly interested in the composition of these units.² While the ranks as Chief of Ten, Chief of Fifty

¹ Reade 1972.

² See the bibliography.

and Chief of One Hundred are known, no ranks mention the type of troops that are commanded, i.e. archers, slingers, or shield-bearers.

Instead of following that modern fancy to see every piece of Neo-Assyrian art as either propaganda or ideology, this paper intends to have a more pragmatic, and archaeological approach to the smallest Neo-Assyrian Combat Unit, employing the cross-study of visual and written sources.

1) Composition of the Infantry

Infantry, A.SIG5,³ is the most basic component of any army, as this is usually the only vector available to the poorest people engaged in a combat situation. The Neo-Assyrian infantry is composed of archers and shield-bearers (Figure 1-2).⁴ Slingers sometimes are depicted during sieges, although the permanent existence of such a type of specialist in the Neo-Assyrian standing army nowadays still remains under discussion.

a) Chiefs of Ten

The Chief of Ten command, *rab eširtu*, is the first rank a private can reach in the hierarchy, thus it represents a very interesting function in the Neo-Assyrian army.⁵ Actually, texts do not tell what is represented by the amount of ten, so one can believe this rank is reached by seasoned warriors, as for the centurions of the Roman army. The panoply of the Guards depicted on foot or on horseback, close to the king might provide a base for the equipment of those soldiers (Figure 3-4). Another good reason to believe so lies within their ability to adopt a *testudo*-style formation as soon as the reign of Ashurnasirpal II (Figure 5).

According to the visual materials left by their kings, the Neo-Assyrian soldiers fought side by side, in couples composed of a mix of archers and shield-bearers.⁶ One could then consider four different proposals, divided in two different groups according to the speciality of its members: the simple and the combined.

In the simple hypothesis, the Chief of Ten leads either ten archers or ten shield-bearers to the fight (Figure 6-7). The only problem with that point is that these groups are too small to be really effective on the tactical level, are never clearly identified on the visual materials and lack the assets of the other's

³ Malbran-Labat 1982: 118.

⁴ For further discussion, see De Backer 2009-2011: 266-286.

⁵ Malbran-Labat 1982: 120-121.

⁶ De Backer 2008a.

weapon. Moreover, the very scarce depictions of single soldiers usually appear in the last phases of the combat, and thus are subject to caution, as charioteers and cavalrymen, even during sieges, are always acting as such couples (Figure 8-10).⁷ This fact is strongly demonstrated during the whole Neo-Assyrian period and certainly played a major role in the victories of the army, from that period down to the reign of Ashurbanipal (Figure 11).

According to his visual materials, Shalmanezar III seems to be the first Assyrian king to have employed the ancient tactics of siege-fire teams in pitch battles (Figure 12-13).⁸ The very fact that the name for the shield-bearer in the Neo-Assyrian sources insists on the fact that the shield seems to be the first weapon, to the contrary of a spearman, whose first weapon is a spear.

In the combined hypothesis, the Chief of Ten leads ten men, organized in five groups of one archer and one shield-bearer, providing the assets of each one to another but lacking a sufficient amount of soldiers to be really effective on the battlefield (Figure 14). Then, one could consider, with the help of both the texts and the visual materials, that the Chief of Ten was in charge of ten couples, each one composed of one archer and one shield-bearer (Figure 15-18). From Tiglath-Pileser III to the end of the period, this will be the most basic and effective Multi-Purposes Combat Group, according to the same concept as devoted to huger units, and will be employed to protect the king during the hunts of Ashurbanipal as well (Figure 19).⁹

b) Chiefs of Fifty

The Chief of Fifty, *rab haššâni* or *rab hanšu*,¹⁰ has already a particular amount of soldiers at his orders, and thus one could conceive this type of officer has a mean to see them all and move quickly to gather up and give his orders to the troopers (Figure 20).¹¹

A horse would appear as the cheapest and basic mean of transportation for a Junior Officer of this kind on the battlefield, as it is also depicted on the reliefs of Ashurbanipal, while shouting something to his fellows by the top of his shoulders (Figure 21).

⁷ For further discussion, see De Backer 2008b.

⁸ De Backer 2010 and 2013.

⁹ De Backer 2009: 69-115; Barnett 1976: pl. VI.

¹⁰ Kinnier-Wilson 1972: 56; Malbran-Labat 1982: 121.

¹¹ Malbran-Labat 1982: 121.

c) Chiefs of Seventy

The chief of Seventy, *rab ? 70*, only appears once in the Neo-Assyrian textual materials, and it is very hard to find some depiction of soldier that could be associated with it.¹²

2) Composition of the Chariotry

Chariotry was one of the first means of transportation adapted to warfare by the ancient Near Eastern people we know about today. Although the first war wagon were very heavy, slow and hard to manoeuvre, the huge improvements made in this technology between the end of the 3rd and the first half of the 2nd millennium B.C. changed it into a fast, light and dangerous shooting platform.

Since the beginning, and for obvious reasons, chariots were mainly reserved to nobles, rich people or elite fighter, but this doctrine was nearly totally left over by the beginning of the 8th century B.C., at least in Assyria. Thus, being a charioteer, *narkâbtu*,¹³ was certainly a highly researched position in the Neo-Assyrian army, as the presence of standards on poles attached to the platform of the vehicle might show, as they never appear for Cavalry or Infantry (Figure 22-26).

a) Chariot-Drivers

In the Neo-Assyrian army, the *mukil apâte*, chariot driver, certainly had a particular status (Figure 8-9; 22-23).¹⁴ By the way, they had to be quiet under the fire, strong under pressure, resilient in long time duration, highly motivated and smart enough to keep their vehicle and teams fit for fighting duty.¹⁵ More than that, they needed a deep knowledge of their horses's behaviour and a very good eyesight to avoid accidents and the fall over of their chariots.

b) Chiefs of Chariot

The Chief of Chariot, *bêl narkabti*, was certainly equal to a lower Junior Officer, having at his disposal the strength of three or four men and the speed of four horses (Figure 27-31).¹⁶ The main part of this task force under the chariot

¹² Malbran-Labat 1982: 121.

¹³ Malbran-Labat 1982: 115.

¹⁴ Malbran-Labat 1982: 118.

¹⁵ De Backer 2009-2010: 29-46.

¹⁶ De Backer 2013.

master orders during the Sargonid period was the two shield-bearers, embarked to protect the archer during charges and pitch battles.

c) Officers of Chariot

Somehow, the many chariots belonging to sub-units during war operations were to be commanded by Officers of Chariots, the *rēš narkabâti* (Figure 32).¹⁷ The present author would rather translate their title as Officers of Groups of Chariots. This would sustain as well the presence of standards on the chariots (Figure 8; 22-26).

In Late Bronze Age texts, the basic unit of chariotry seems to be composed of two chariots, but these evidences already show how powerful such one single war vehicles might be.¹⁸ Anyways, texts and other sources cannot provide the scholars with further data for the moment, a reason for which the present author would encourage research to go in that direction as well.

3) Composition of the Cavalry

Cavalry was quite an innovation as a fighting vector since the 9th century B.C., at least. The soldier chosen to be trained as a rider, a *pithallu*, also received lands to sustain his horse and himself during the year, as a medieval knight or squire would have in feudal Europe (Figure 9; 17; 35).¹⁹

While fighting as couples of an archer and a shield-bearer was the standard tactics for the main troops of the standing army, to the contrary of the Guard, the experience gathered in horse-riding will enable the riders of Tiglath-Pileser III to fight alone, either as archers or as shield-bearers (Figure 33-35). With the reign of Sargon II down to the end of the empire, the mounted horse-archers-shield-bearers composed the Neo-Assyrian cavalry (Figure 36-38). One could pretend that no visual material from the Sargonid period presents horsemen with shields, but then that person should read the report of the Eighth campaign and see that Sargon II mentions that his horse-guards were equipped with a shield as well, although it never appears on his reliefs (Figure 36).²⁰

By the way, Cavalry will rise at the peak point of the fighting machine of the Neo-Assyrian army during the 8th and 7th centuries B.C., whose mounted archers-shield-bearers will rule the ancient Near Eastern army system, until the arrival of the Macedonian phalanxes and Companions of Alexander the Great.

¹⁷ Malbran-Labat 1982: 123.

¹⁸ De Backer 2009-2010: 29-46.

¹⁹ Malbran-Labat 1982: 115; Général Bardin 1851: 1490-1491.

²⁰ Thureau-Dangin 1912: 51.

a) Chiefs of Ten in the Cavalry

The Chief of Ten was called the *emanthulu*, LÚ.GAL 10,²¹ in the Cavalry. As a matter of fact, the reliefs of Ashurnasirpal II show riders fighting by couples composed of one archer and one shield-bearer (Figure 10). During the reigns of Ashurnasirpal II and Shalmanezar III, cavalymen were fighting as couples, so here one wonders again if the number was the amount of soldiers, or the amount of couples of soldiers once again, although the visual sources sustain the latter idea (Figure 39-41).²² In this particular case, the Chief of Ten in the Cavalry can possibly be equipped with the same panoply as the basic horse-guards (Figure 3-4; 36; 42).

During the reign of Tiglath-Pileser III, the improvements in horse riding allowed the king to experiment the constitution of troops of either archers or shield-bearers in the Cavalry of the standing army (Figure 34-35). Thus, the Chief of Ten in the Cavalry for this period commanded a company of ten riders, equipped with scale-armours to enhance their resilience on the battlefield (Figure 43-44). The best fighters, able to act in both ways, were then kept for the core of the King's Guard, as was the case for the charioteers during the previous reigns (Figure 8; 45-46).²³

b) Captains of Cavalry

Cavalry could surely also be organised in smaller detachments, in order to protect, survey, and guard particular areas, which could then be given to the command of a Chief of Cavalry, the *rab kišir ša pithalli*.²⁴ In this respect, one could consider that the basic appearance of this Officer could be related with a mounted horse-guard with the distinctive "eunuch"-style hairdressing (Figure 17; 33; 35; 47-51).

Conclusion

The smallest Neo-Assyrian combat unit can possibly be traced back to the organization of the chariot troops during the Third Millennium B.C., and would have been placed under the command of a Junior Officer. At the beginning of the 9th century B.C., this rank lied with a feudal status quite equal to a knight

²¹ Malbran-Labat 1982: 124.

²² See above in the paragraph dedicated to the Chief of Ten command in the Infantry for further discussion.

²³ De Backer 2011: 1-29.

²⁴ Malbran-Labat 1982: 123.

bachelor of a knight banneret in the European Middle Ages, bringing a few troops as his estates can afford him on the battlefield.²⁵ This comparison finds its support in the similarity of the title of Chief of Ten Command with the Knight Banneret status in the medieval Europe, created by the king and wearing particular items of his rank, like torcs, bracelets, or the spurs.²⁶

The reign of Shalmanezer III had showed his successors how dangerous these private militias could be for the authority of the king. In this respect, one could compare the military reforms of Tiglath-Pileser III with the creation of the *Compagnies d'Ordonnance* of Charles VIIth of France, to reinforce the loyalty of soldiers, against their loyalty to the dangerous Neo-Assyrian aristocracy and lower the costs of the standing army.²⁷ This could also explain why the main point of Tiglath-Pileser III's military reforms lies with the development of these shield-bearers in his units, thus cutting off his reliance on the seasoned warriors issued by the nobility's private companies.²⁸ His reign remains a transition period between a more feudal systems, with several troops equipped with different types of weapons and armours, and the emergence of a more state army. That assumption would also find some support in the perennial depiction of the troops by the nobility level of the soldiers's weapons : first the chariot, then the cavalry, and finally the infantry.

With the military business of Sargon II, this tactic proved to be highly valuable, for the visual materials from this reign show only fire-teams and a particular standardization of the shield-bearers's equipment. As an archer needed a long period to be trained, and a shield-bearer took far less time to know how to hold a shield and handle the spear, one could think that the shield-bearers, issued by the *pirru* system, were added to the archers of the standing army during campaigns.

The noble weapon of the Near East had long been the bow, at least since the Middle Bronze Age, thus the shield-bearers certainly acted like a kind of squire to the archers, an idea sustained by the several depictions of weapon holders of the King in the context of siege-redoubts depictions.²⁹

For this reason, the research on the link between textual sources quoting military ranks, and the visual materials should be deepened, for the number of stripes on certain soldiers's helmet can certainly find its relation with the troops they commanded or were part of.

²⁵ Chéruel 1855: 54 and 61; Général Bardin 1851: 88-89.

²⁶ Adolphus 1818: 473.

²⁷ Clément 1866: 101-104; Chéruel 1855: 34.

²⁸ De Backer 2012.

²⁹ De Backer 2008b.

On another aspect, the decoration of particular soldier after the count of the booty, with a bracelet can certainly be linked with the promotion of soldiers after the battle, and the research on this topic, already explored by J. Postgate, should be deepened as well.³⁰

Bibliography

- Adolphus, J., 1818: *The Political State of the British Empire, vol. I*. London.
- Albenda, P., 1986: *Le palais de Sargon d'Assyrie*. Paris.
- Général Bardin, É. A., 1851: *Dictionnaire de l'armée de terre II*. Paris.
- Barnett, R. D., 1976: *Sculptures from the North Palace of Ashurbanipal at Nineveh (668–627 B.C.)*. London.
- Barnett, R. D. / Falkner, M., 1962: *The Sculptures of Aššur–Nasir–Apli II (883–859 B. C.), Tiglath–Pileser III (745–727 B.C.), Esaraddon (682–669 B.C.) from the Central and South-West Palaces at Nimrud*. London.
- Barnett R. D. / Bleibtreu, E., et alii, 1998: *The Sculptures from the South-West Palace of Sennacherib at Nineveh*. London.
- Curtis, J., 2008: *The Balawat Gates of Ashurnasirpal II*. London.
- Chéruel, A., 1855: *Dictionnaire historique des institutions, moeurs et coutumes de la France. Première partie*. Paris.
- Clément, P., 1866: *Jacques Coeur et Charles VII*. Paris.
- De Backer, F., 2008: “Note sur les lanceurs de pavés”, *Ugarit Forschungen* 38: 63-86.
- 2008b: “The Neo-Assyrian Siege-Archers: Some Remarks”. In G. Wilhelm (ed.): *Proceedings of the 54th Rencontre Assyriologique Internationale*. Würzburg, pp. 20-25.
- 2009: “Some Basic Tactics of Neo-Assyrian Warfare 1) Pitch Battle”, *Ugarit Forschungen* 39: 69-115.
- 2009-2010: “Evolution of War Chariot Tactics in the Ancient Near East”, *Ugarit Forschungen* 41: 29-46.
- 2009-2011: “Some Basic Tactics of Neo-Assyrian Siege Warfare”, *State Archives of Assyria Bulletin* 18: 266-286.
- 2010: “Neo-Assyrian Siege - Redoubts: Some Issues”, *Historiae* 7: 1-25.
- 2011: “Siege-Shield and Scale-Armour: Reciprocal Predominance and Common Evolution”, *Historiae* 8: 1-29.
- 2012: “Le casque bombé à cimier dans les techniques de combat néo-assyriennes”, *Historiae* 9: 31-69.

³⁰ Postgate 1994: 235-245.

- 2013: “Notes on the Neo-Assyrian Siege-Shield and Chariot”. In J. Sanmartin et alii (eds.): *Proceedings of the 56th Rencontre Assyriologique Internationale, Barcelona, 26th – 30th July 2010*. Winona Lake, pp. 69-78.
- Dezsö, T., 2001: *Near Eastern Helmets of the Iron Age*. London.
- Fales, F. M., 1990: “Grain Reserve, Daily Rations, and the Size of the Assyrian Army: A Quantitative Study”, *State Archives of Assyria Bulletin* IV, 1: 23-34.
- 2009: “The Assyrian Word for ‘(Foot) Soldier’”. In G. Galil et alii (eds.): *Homeland and Exile. Biblical and Ancient Near Eastern Studies in Honour of Bustenay Oded*. Leiden, pp. 71-94.
- Gassier, J., 1814: *Histoire de la Chevalerie française*. Paris.
- King, L., 1915: *Bronze Reliefs from the Gates of Shalmaneser King of Assyria B.C. 860-825*. London.
- Kinnier-Wilson, J., 1972: *The Nimrud Wine List*. London.
- Malbran-Labat, F., 1982: *L’armée et l’organisation militaire de l’Assyrie d’après les lettres des Sargonides trouvées à Ninive*. Paris.
- Mattila, R., 2000: *The King’s Magnates. A Study of the Highest Officials in the Neo-Assyrian Empire*. Helsinki.
- Mayer, W., 1995: *Politik und Kriegeskunst des Assyrer*. Münster.
- Parker, B., 1997: “Garrisoning the Empire: Aspects of the Construction and Maintenance of Forts on the Assyrian Frontier”, *Iraq* 59: 77-87.
- 2001: *The Mechanics of Empire: The Northern Frontier of Assyria and a Case Study of Imperial Dynamics*. Helsinki.
- Postgate, J. N., 1994: “Rings, Torcs and Bracelets”. In P. Calmeyer et alii (eds.): *Beiträge zur Altorientalischen Archäologie und Altertumskunde. Festschrift für Bartel Hrouda*. Wiesbaden, pp. 235-245.
- 2001: “Assyrian Uniforms”. In W. H. Van Soldt (ed.): *K. Veenhof Anniversary Volume*. Leiden, pp. 373-378.
- Reade, J., 1972: “The Neo-Assyrian Court and Army: Evidence from the Sculptures”, *Iraq* 34: 87-112.
- Thureau-Dangin, F., 1912: *Une relation de la huitième campagne de Sargon*. Paris.
- Von Luschan, F., 1943: *Die Kleinfunde von Sendschirli*. Berlin.
- Wallis-Budge, E., 1914: *Assyrian Sculptures in the British Museum Reign of Ashur-Nasir-Pal, 885–860 B.C*. London.

Figures



Fig. 1: Archers of the Infantry under the reign of Ashurnasirpal II
(Wallis-Budge 1914: pl. XIII, b)

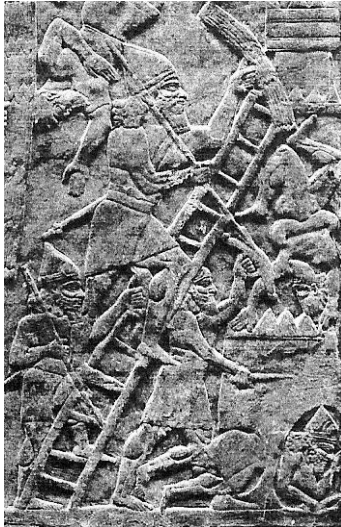

Fig. 2: Shield-Bearers of the Infantry under the reign of Ashurnasirpal II
(Wallis-Budge 1914: pl. XXIII, b)

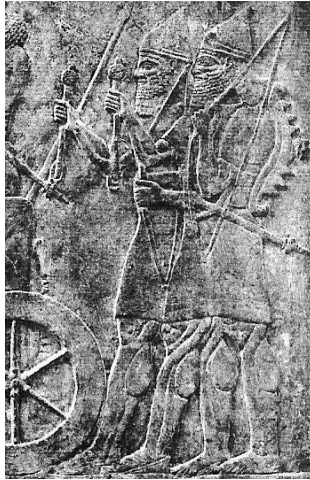

Fig. 3: Archer-Shield-Bearer of the Foot Guard of Ashurnasirpal II
(Wallis-Budge 1914: pl. XVIII, b)



Fig. 4: Archer-Shield-Bearer of the Horse Guard of Ashurnasirpal II
(Wallis-Budge 1914: pl. XVII, a)



Fig. 5: Archer-Shield-Bearers of the Horse Guard of Ashurnasirpal II in a *testudo*-like formation (Wallis-Budge 1914: pl. XII, b)

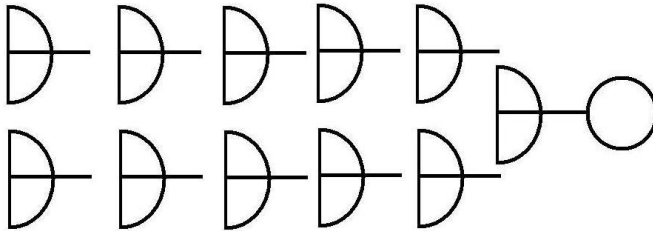

Fig. 6: Schematic illustrating the Chief of Ten Command in the Infantry according to the simple hypothesis with ten archers (Drawing by the author)

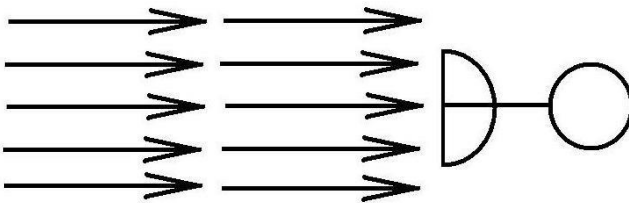

Fig. 7: Schematic illustrating the Chief of Ten Command in the Infantry according to the simple hypothesis with ten shield-bearers (Drawing by the author)



Fig. 8: Royal Chariot in action under the reign of Ashurnasirpal II
(Wallis-Budge 1914: pl. XVIII, a)



Fig. 9: Siege-Archers redoubt under the reign of Ashurnasirpal II
(Wallis-Budge 1914: pl. XIII, a)



Fig. 10: Archer and Shield-Bearer couple in the Cavalry under the reign of Ashurnasirpal II (Wallis-Budge 1914: pl. XV, a)



Fig. 11: The archer and shield-bearer couple in action in pitch battle during the reign of Ashurbanipal (Barnett 1998: pl. 295, n° 382b)



Fig. 12: Siege-Archer redoubt during the Third Millenium B.C. (Drawing by the author)

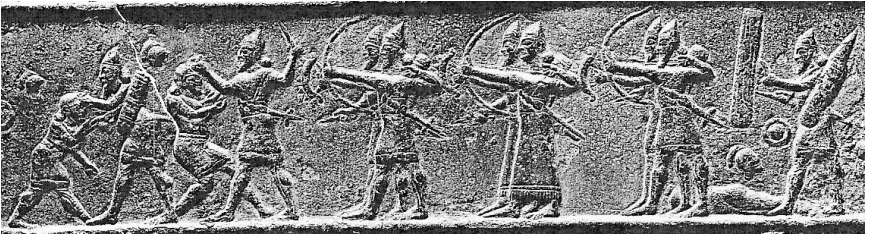

Fig. 13: Siege-Archers redoubts employed in pitch battle under the reign of Shalmanezzer III (King 1915: pl. XL, Bd. VII.4)

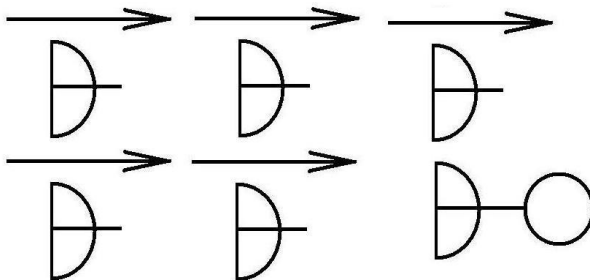

Fig. 14: Schematic illustrating the Chief of Ten Command in the Infantry according to the combined hypothesis with five archers and five shield-bearers (Drawing by the author)

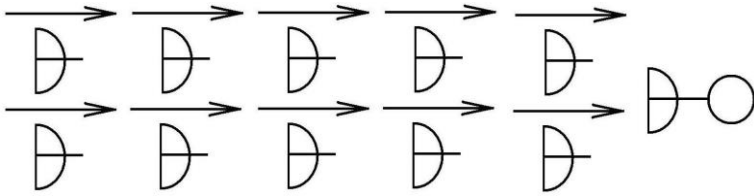

Fig. 15: Schematic illustrating the Chief of Ten Command in the Infantry according to the combined hypothesis with ten archers and ten shield-bearers (Drawing by the author)



Fig. 16: Archers and Shield-Bearers couples in the Infantry of the standing army adopting a *testudo*-like formation under the reign of Tiglath-Pileser III (Barnett 1962: LI)



Fig. 17: Possible depiction of a Chief of Ten in the Infantry of Sargon II (Albenda 1986: pl. 138)



Fig. 18: Archer and Shield-Bearer couple in the Infantry of the standing army adopting a *testudo*-like formation under the reign of Senacherib (Barnett 1998: pl. 231, n° 318)



Fig. 19: Archer and Shield-Bearer couples in the Infantry of Ashurbanipal (Barnett 1976: pl. VI)

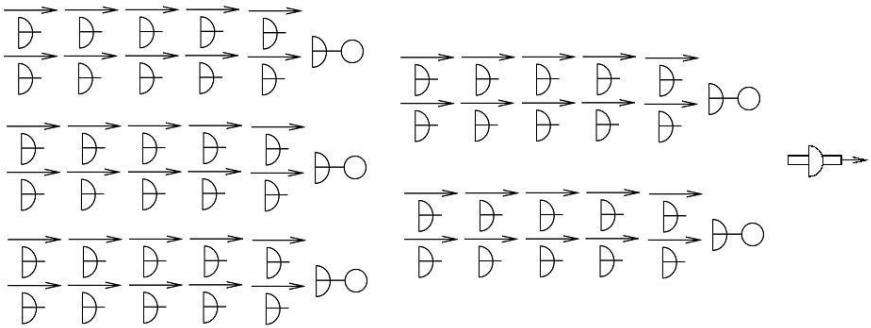

Fig. 20: Schematic illustrating the Chief of Fifty Command in the Infantry according to the combined hypothesis with five troops of ten archers and ten shield-bearers (Drawing by the author)



Fig. 21: Archer-Shield-Bearer of the Cavalry of Ashurbanipal shouting (Barnett 1976: pl. LXVIII)

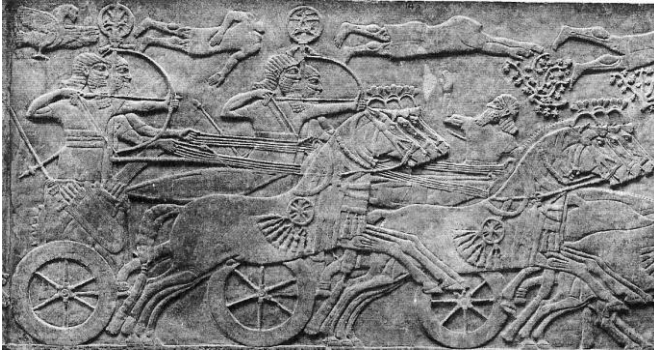

Fig. 22: Standards on the vehicles belonging to the Chariotry of Ashurnasirpal II (Wallis-Budge 1914: pl. XVII, b)



Fig. 23: Standards on the vehicles belonging to the Chariotry of Shalmanezzer III (King 1915: pl. LXXIV, Bd. XIII.3)



Fig. 24: Standard with the image of Assur or Ninurta as depicted on the reliefs of Sargon II (Albenda 1986: pl. 114)

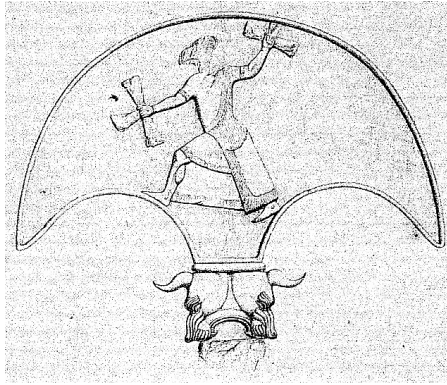

Fig. 25: Standard with the image of Nergal as depicted on the reliefs of Sargon II (Albenda 1986: pl. 115)

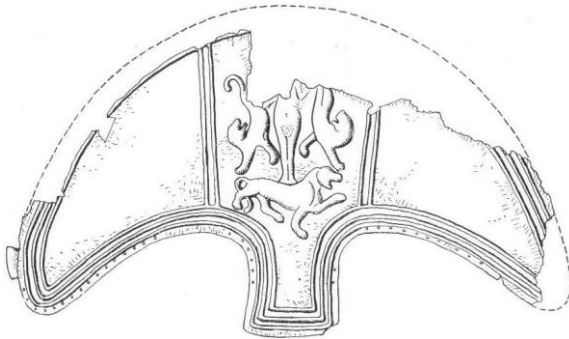

Fig. 26: Standard with the image of Ishtar as recovered during the excavations of Zindjirli (Luschan 1943: 75, fig. 83)

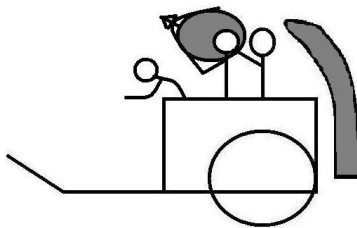

Fig. 27: Schematic illustrating a chariot in action during a pitch battle during the Neo-Assyrian period (Drawing by the author)

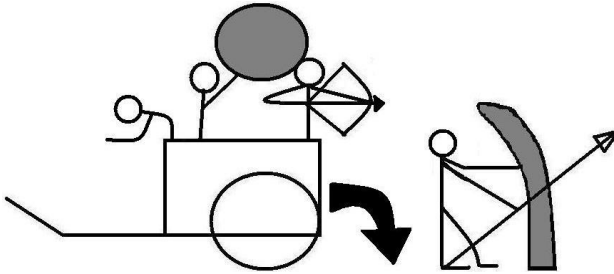

Fig. 28: Schematic illustrating a chariot-team acting as mechanized infantry, creating a light siege-archer redoubt during the Neo-Assyrian period (Drawing by the author)

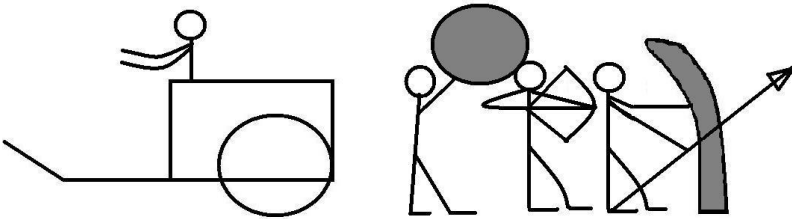

Fig. 29: Schematic illustrating a chariot-team acting as mechanized infantry, creating a heavy siege-archer redoubt during the Neo-Assyrian period (Drawing by the author)

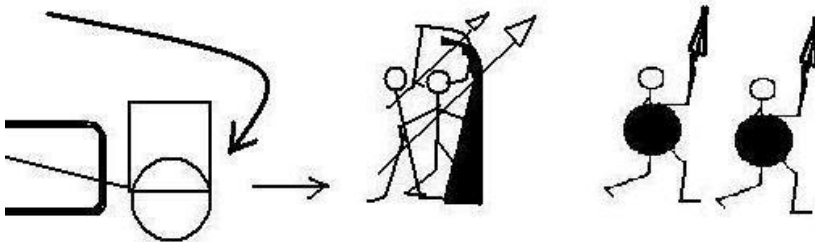

Fig. 30: Schematic illustrating a chariot-team acting as mechanized infantry, creating a light siege-archer redoubt protecting the advance of the two shield-bearers of the chariot team during the Neo-Assyrian period (Drawing by the author)

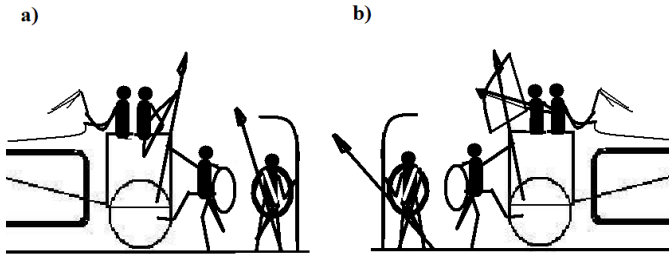

Fig. 31: Schematic illustrating a chariot-team acting as mechanized infantry, getting off (a) and on (b) the chariot during the Neo-Assyrian period (Drawing by the author)

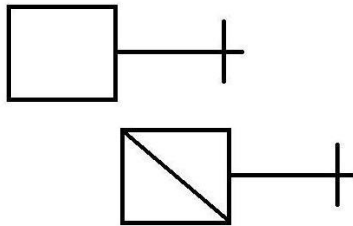

Fig. 32: Schematic illustrating the Chief of Group of Chariots Command during the Neo-Assyrian period (Drawing by the author)



Fig. 33: Archer of the Cavalry in the standing army of Tiglath-Pileser III (Barnett 1962: 109)



Fig. 34: Shield-Bearer of the Cavalry in the standing army of Tiglath-Pileser III (Barnett 1962: 116)



Fig. 35: Possible depiction of a Chief of Ten of the Cavalry in the standing army of Tiglath-Pileser III (Barnett 1962: 117)

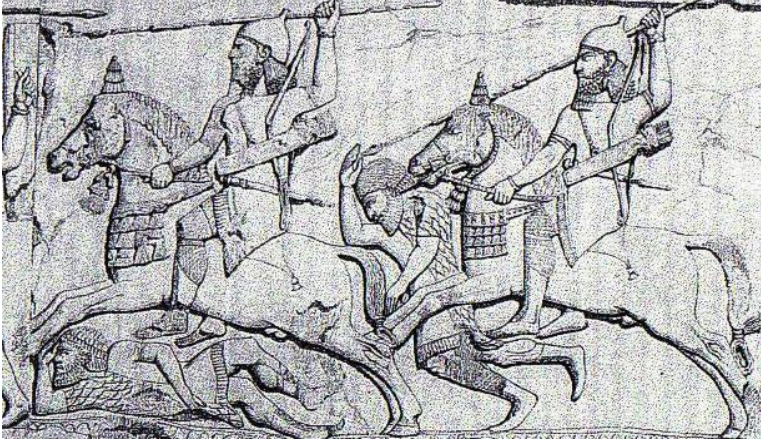

Fig. 36: Archer-Shield-Bearers belonging to the Horse Guard of Sargon II
(Albenda 1986: pl. 121).



Fig. 37: Archer-Shield-Bearers belonging to the Horse Guard of Senacherib
(Barnett 1998: pl. 231, n° 319)



Fig. 38: Archer-Shield-Bearer belonging to the Horse Guard of Ashurbanipal (Barnett 1976: pl. 294, n° 383 b).



Fig. 39: Archer and Shield-Bearer couple of the Cavalry during the reign of Shalmanezzer III (King 1914: pl. LXXII, Bd. XIII. 1)

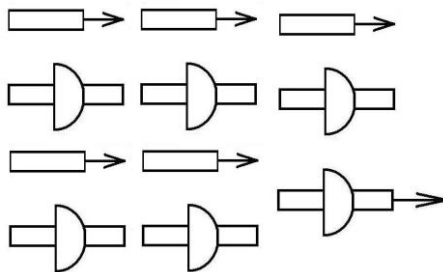

Fig. 40: Schematic illustrating the Chief of Ten Command in the Cavalry with five couples of one archer and one shield-bearer during the reigns of Ashurnasirpal II and Shalmanezzer III (Drawing by the author)

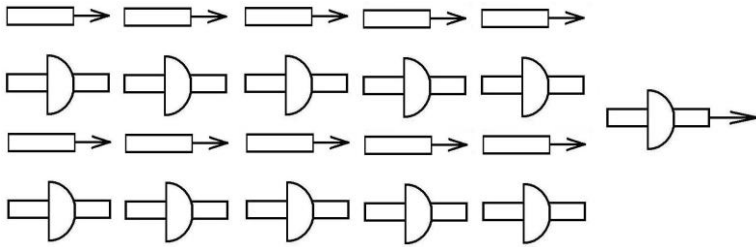

Fig. 41: Schematic illustrating the Chief of Ten Command in the Cavalry with ten couples of one archer and one shield-bearer during the reigns of Ashurnasirpal II and Shalmanezar III (Drawing by the author)



Fig. 42: Basic horse-guard during the reign of Shalmanezar III (King 1915: pl. XVII, Bd. III.5)

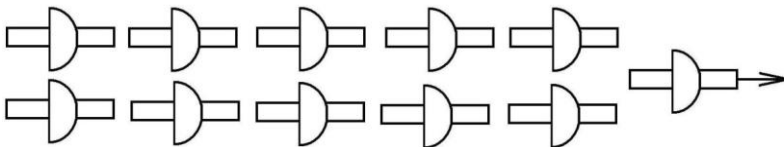

Fig. 43: Schematic illustrating the Chief of Ten Command in the Cavalry with ten archers during the reign of Tiglath-Pileser III (Drawing by the author)

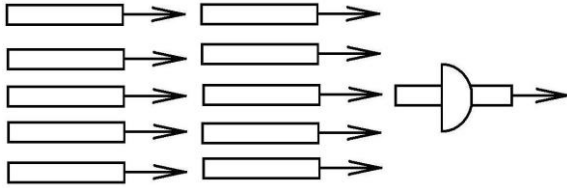

Fig. 44: Schematic illustrating the Chief of Ten Command in the Cavalry with ten shield-bearers during the reign of Tiglath-Pileser III (Drawing by the author)



Fig. 45: The best fighters were kept in the Guard of Tiglath-Pileser III and equipped with scale-armours to improve their resilience in combat (Barnett 1962: pl. LVIII)

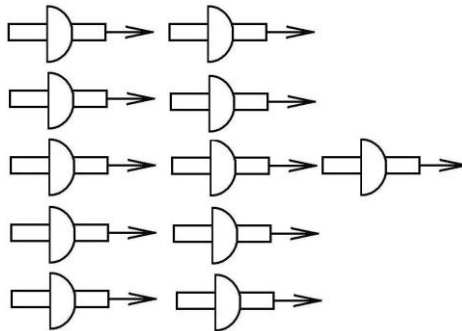

Fig. 46: Schematic illustrating the Chief of Ten Command in the Cavalry with ten archers-shield-bearers during the reigns of Sargon II and those of his successors (Drawing by the author)



Fig. 47: Horse-Archer with the distinctive “eunuch”-style hairdressing during the reign of Ashurnasirpal II (Wallis-Budge 1914: pl. XV, a)

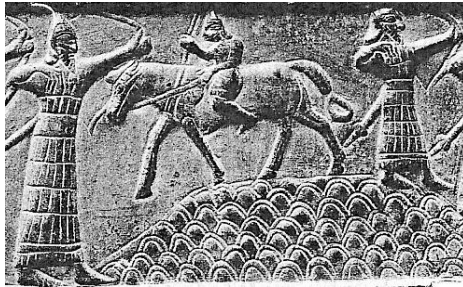

Fig. 48: Horse-guard with the distinctive “eunuch”-style hairdressing during the reign of Shalmanezir III (King 1914: pl. XLIII, Bd. VIII, 1)



Fig. 49: Horse-guard with the distinctive “eunuch”-style hairdressing during the reign of Sargon II (Albenda 1986: pl. 103)



Fig. 50: Horse-guard with the distinctive “eunuch”-style hairdressing during the reign of Ashurbanipal (Barnett 1998: pl. 305, n° 385b)

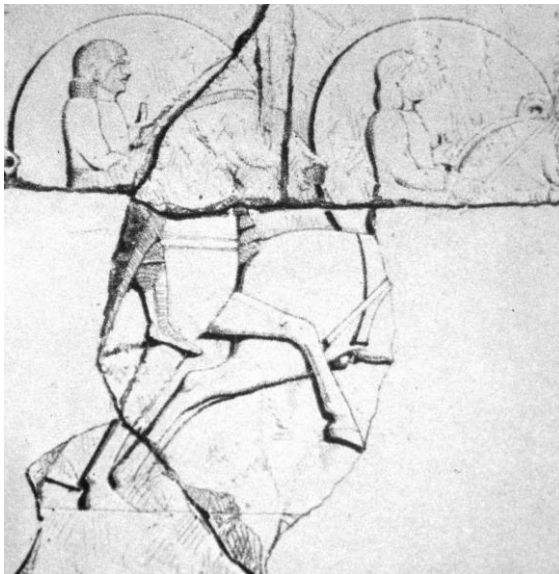

Fig. 51: Horse-guard with the distinctive “eunuch”-style hairdressing during the reign of Ashurbanipal (Barnett 1976: pl. XLVI)