



Title	Co-expression of a prophage system and a plasmid system in <i>Bacillus subtilis</i>
Author(s)	Ho, KM; Lim, BL
Citation	Protein Expression And Purification, 2003, v. 32 n. 2, p. 293-301
Issued Date	2003
URL	http://hdl.handle.net/10722/54338
Rights	Creative Commons: Attribution 3.0 Hong Kong License

Co-expression of a prophage system and a plasmid system in
Bacillus subtilis

Running title: Prophage and plasmid expression system

Ka M. Ho and Boon L. Lim*

Department of Zoology, the University of Hong Kong, Pokfulam Road, Hong Kong,
China.

*To whom correspondence should be addressed: Department of Zoology, the
University of Hong Kong, Pokfulam Road, Hong Kong, China.

Tel: (852) 22990826

Fax: (852) 25599114

E-mail: bllim@hkucc.hku.hk

Keywords: Amylase, dual expression, *Bacillus subtilis*, lipase, plasmid, prophage,
protease.

Abstract

A dual expression system for overexpressing two proteins by a single cell strain has been developed in *Bacillus subtilis*. This dual expression system combines the ϕ 105MU331 prophage system and a plasmid system within a single cell. Protein expression by the prophage system is heat inducible, while that of the plasmid system is constitutive. Three candidate genes, *BPN*, *BT*, and *amyE*, all of *Bacillus* origin, were used as test models. Seven strains (BPN, BT, AMY, BS168K, MU331K, BPNK, and BTK) were constructed to investigate the influences of the prophage system and the plasmid system on each other, and to compare the efficiency of the individual expression systems with that of the dual expression system. Individually, the yield of the plasmid system is higher than that of the prophage system, which could be attributed to the constitutive nature of the expression of the plasmid system. Nonetheless, for the dual expression strains, the expression of two enzymes in a single fermentation run can reduce costs in facilities, manpower, and utilities. Fed-batch fermentation of BPNK strains confirmed the feasibility of applying this dual expression system in industrial-scale production.

Introduction

More than one enzyme is usually involved in an industrial process. Therefore, for industrial enzyme production, a dual expression system, which is able to overexpress two enzymes simultaneously by a single bacterial strain, has an obvious advantage over an expression system that can only produce a single enzyme in a fermentation run.

In a previous report, a dual expression system based on cloning two enzyme genes in tandem into the $\phi 105\text{MU}331$ prophage system was developed in *Bacillus subtilis* [1]. However, in this system, the expression level of the second insert, which is farther away from the promoter, is lower than that of the first insert. Both genes have lower levels of expression in the dual expression system than is found in the same system expressing either gene individually.

In view of the inadequacy of this reported system, a new dual expression system in *B. subtilis* was developed in this study. In this system, a plasmid system was used in combination with the $\phi 105\text{MU}331$ prophage system to create a dual expression *B. subtilis* strain, in which the expression by the prophage system is heat inducible, whereas that of the plasmid system is constitutive.

The $\phi 105\text{MU}331$ prophage system [2] employed in this study was based on the *B. subtilis* phage $\phi 105$ [3]. In this prophage system, a lacZ-cat cartridge is inserted into the lysogenic prophage, facilitating the integration of target genes into the host

chromosome via homologous recombination. The *cts-52* mutation in the ϕ 105MU331 strain renders the ϕ 105 repressor temperature sensitive so that protein expression is induced by temperature shift. Upon heat induction, the ϕ 105 repressor protein falls off, the promoter is derepressed, and transcription is commenced. Lysis of the host cell after induction of the prophage is prevented in this system, since the gene encoding for the holin proteins [4] that cause lesions in the cytoplasmic membrane is deactivated by the insertion of the cloning cartridge [5]. As disruption of the host cells is prevented, the excreted proteins can be collected easily in the culture media, which reduces the need for purification steps.

Plasmid pKTH10 was used as the plasmid expression system in this study [6]. pKTH10 is a high copy number plasmid, constructed using pUB110 as the backbone, with the *amyE* gene from *Bacillus amyloliquefaciens* as the insert. pUB110 is a 4.5 kb multicopy plasmid carrying neomycin- and phleomycin-resistant genes; it has been widely used in recombinant DNA experiments in *Bacillus* strains.

Three enzyme genes, the *BPN* gene [7] which codes for subtilisin protease (GenBank accession no. X00165) the *BT* gene [8] which codes for lipase (GenBank accession no. AF134840), and the *amyE* gene [6] which codes for α -amylase (GenBank accession no. V00092), were chosen as test models for the dual expression system.

Subtilisin BPN (EC 3.4.21.62) is an extracellular serine endopeptidase that catalyzes

the breakdown of large and complex protein molecules into peptides and amino acids.

It has been studied extensively because of its wide applications, especially as an additive to laundry detergents, to help to remove proteinaceous stains. Lipases (EC 3.1.1.3) catalyze the hydrolysis of ester bonds of triacylglycerols to yield free fatty acids at the interface between an insoluble substrate and water. The lipase employed in this study was isolated from a thermophilic *Bacillus* strain [8]. Thermostable lipases have been widely used, particularly in the laundry industry, in which the addition of lipase can enhance the cleaning power of detergents by its hydrolyzing activities towards fats and lipids. α -Amylase (EC 3.2.1.1) catalyzes the breakdown of starch to glucose. Similar to proteases and lipases, it has been widely used in industrial processes, especially in the laundry industry. Therefore, the dual expression system developed in this study could be applied to the manufacture of laundry detergents.

Materials and methods

Bacterial strains

In this study, a total of seven *B. subtilis* recombinant strains were constructed; these were designated as BPN, BT, AMY, BS168K, MU331K, BPNK, and BTK strains, respectively (Table 1). In BPN, BT, AMY, BS168K, and MU331K strains, only one enzyme is overexpressed, whereas in BPNK and BTK strains, two enzymes are overexpressed. *B. subtilis* 168, *B. amyloliquefaciens* (ATCC 23844), and *Bacillus thermoleovorans* (ATCC 43506) were used as the source of chromosomal DNA.

Construction of the prophage vectors

Polymerase chain reaction (PCR) was performed with four pairs of primers (Table 2). The first pair of primers, SubE-S and SubE-A, was used to amplify the signal peptide of the *subtilisin E* gene from *Bacillus subtilis* 168. The other three pairs of primers, BPN-S/BPN-A, BT-S/BT-A, and AMY-S/AMY-A were used to amplify the *BPN*, *BT*, and *amyE* genes from *B. amyloliquefaciens*, *B. thermoleovorans*, and *B. amyloliquefaciens*, respectively. PCR was carried out for 30 cycles, with each cycle composed of 4 minutes at 94 °C (denaturation), 40 seconds at 53 °C (annealing), 3 minutes at 75 °C (extension); *Pfx* DNA polymerase (Invitrogen, Hong Kong) was employed to safeguard the fidelity of the reaction. The PCR fragments were purified

by phenol/chloroform extraction and ethanol precipitation. The DNA fragments obtained by the SubE primers, BPN primers, BT primers, and AMY primers were subjected to *NdeI/BamHI*, *NotI/BamHI*, *NotI/BamHI*, and *NdeI/XbaI* restriction enzyme digestion, respectively. The coding sequence of subtilisin E signal peptide was subcloned into the *NdeI* and *BamHI* sites of the cloning vector pSGt [1] to create pSG-E, in which a *NotI* site was engineered. The coding sequences of the *BPN* and *BT* genes were cloned into the *NotI/BamHI* sites of the pSG-E vector to create pSG-BPN and pSG-BT, respectively, and the full-length *amyE* gene was cloned into the *NdeI/XbaI* sites of the pSGt vector to create pSG-AMY (Fig. 1). The ligation mixes were transformed into *E. coli* (Top 10) by electroporation and colonies grown on a LB-agar plate with ampicillin (100 μ g/ml) were screened by PCR.

Creation of Bacillus expression strains BPN, BT and AMY

pSG plasmids extracted from *E. coli* were used for *Bacillus* transformation. *B. subtilis* MU331 cells were streaked onto a LB-agar plate with erythromycin (5 μ g/ml) (LE plate) and incubated at 37 °C overnight. Preparation of *B. subtilis* MU331 competent cells and plasmid transformation were carried out according to Osbome et al [9]. Positive transformants were selected on LB-agar plates with chloramphenicol (5 μ g/ml) (LC plates). The plates were incubated at 37 °C overnight and each single

colony was transferred to a LE plate and a LC plate the following day to screen for Cm^REr^S colonies. PCR screening was performed on the colonies by using a promoter-specific primer, phi-105, and one of the protease/amylase specific antisense primers (Table 2).

Creation of Bacillus expression strains BS168K, MU331K, BPNK, and BTK

The pKTH10 plasmid, constructed by Palva [6] using pUB110 as the backbone with the full-length *amyE* gene from *B. amyloliquefaciens* as the insert, was obtained from Dr Thomas Leung (Department of Applied Biology and Chemical Technology, Polytechnic University of Hong Kong). This kanamycin-resistant vector was transformed into competent *B. subtilis* 168, MU331, BPN, and BT strains using the same transformation method mentioned above, to create BS168K, MU331K, BPNK, and BTK strains, respectively. Positive transformants were selected on LB agar plates supplemented with 5 µg/ml kanamycin (LK plates). The colonies were selected for PCR screening using a pair of primers P-S/P-A (Table2).

Shake flask studies

The frozen glycerol stock of BPN, BT, or AMY strains was streaked onto pre-warmed LC plates, while that of BS168K, MU331K, BPNK, or BTK strains was streaked onto

pre-warmed LK plates. 5 ml seed medium was prepared in 100 ml shake flasks. The seed medium contained BHY (bovine brain heart infusion 37 g/L and yeast extract 5 g/L) supplemented with 5 mg/L kanamycin and/or 5 mg/L chloramphenicol. A single colony was picked from the agar plates and inoculated onto the seed media. The seed culture was shaken at 37 °C and 280 rpm overnight. On the following morning, 1 ml of the seed culture was transferred into 20 ml of expression medium in 250 ml flasks. The expression medium contained BHY with 10 g/L soluble starch (unless otherwise specified) and was supplemented with 5 mg/L kanamycin and/or 5mg/L chloramphenicol. The expression cultures were shaken at 37 °C and 280 rpm. Samples were collected at various intervals to measure the cell density at OD₆₀₀ using a spectrophotometer. Cells were diluted with sterilized water before reading the OD so that the readings falls within the linear range of 0.1–1.0. Heat induction was performed at OD₆₀₀ 5.0–6.0 by vigorously shaking the flasks in a preheated 50 °C water bath for 5 minutes. After heat induction, the flasks were returned to the 37 °C shaking incubator and shaken overnight.

Fed-batch fermentation of BPNK and BTK

A volume of 120 ml BHY medium containing 10 g/L potato starch, 5 mg/L kanamycin and 5 mg/L chloramphenicol was prepared in a 2 L shake flask. A single

colony from the LK plate was inoculated and the seed culture was incubated at 37 °C and 280 rpm overnight. Fed-batch fermentation was carried out in a 2 L fermentor (Biostat® B, B. Braun Biotech International) containing 1.2 L modified FB medium [10] supplemented with 5 g/L glucose, 2.5 g/L yeast extract, 5 g/L potato starch and 5 mg/L kanamycin. The feeding medium contained 100 g/L glucose, 50 g/L yeast extract, and 20 g/L potato starch. Glucose in the feeding medium was autoclaved independently, but was mixed with yeast extract and potato starch before feeding. The fermentor was prepared and operated according to the standard operation manual. The overnight seed culture was inoculated into the fermentor to initiate the process. DO-stat control strategy [11] was employed, in which the feeding rate of the feeding medium was adjusted to compensate for the O₂ increase caused by glucose depletion. The dissolved oxygen concentration was maintained at 20% air saturation by manually adjusting the feeding rate and automatically adjusting the agitation speed. The temperature of the culture broth was controlled at 37 °C, the pH at 7.0, minimum stirrer speed at 300 rpm, and air flow rate at 10 L/min. Heat induction was carried out at different OD₆₀₀ in each fermentation run to investigate its effect on enzyme production. During heat induction, the fermentation broth was heated to 50 °C and then cooled down to 37 °C with the internal temperature control system of the fermentor. On average, it took 10 minutes for the temperature to increase from 37 °C

to 50 °C and 30 minutes to drop from 50 °C to 37 °C.

Amylase assay

The α -amylase assay was derived from the DNS method [12]. 0.9 ml of 0.2% (w/v) soluble starch in 0.1 M Glycine-NaOH buffer (pH 9) was used as the substrate. The samples were diluted in the same buffer and 0.1 ml of this buffer was mixed with the substrate in duplicate. The reaction mixture was then incubated at 50 °C for 15 minutes. 1 ml DNS solution was then added and the solution was boiled for 5 minutes. The quantity of reducing sugar was determined by measuring the absorbance at 540 nm in a spectrophotometer. One international unit (IU) of α -amylase activity was defined as the amount of enzyme that produced 1 μ mol reducing sugar per min at 50 °C and pH 9. To construct a standard curve, the OD_{540} readings were taken for a range of glucose concentrations that had reacted with DNS, with the linear region falling between 0 and 1.0.

Protease assay

A colorless synthetic substrate, succinyl-Ala-Ala-Pro-Phe-p-nitroanilide (SucAAPF-pNA), can be converted into a yellowish product, p-nitroanilide (pNA), by protease activity [13]. A 0.5 mM stock of SucAAPF-pNA was prepared in a 0.1 M Tris-HCl buffer containing 10 mM $CaCl_2$ (pH 8.6), and the enzyme-containing samples were

diluted in the same buffer. 10 μ l diluted enzyme was mixed with 190 μ l substrate in duplicate in a 96-well plate. A blank was prepared by mixing 10 μ l buffer with 190 μ l substrate. OD readings at 405 nm were taken after 20 minutes' incubation at 25 °C. One unit of protease activity was defined as the amount of enzyme that produced 1 μ mol pNA per minute at 25 °C and pH 8.6.

Lipase assay

Lipase was assayed as previously described [14], with some modifications. *p*-nitrophenyl ester (PNPE) trilaurin (C12) in 10 mM acetonitrile was used as the substrate; this can be converted to the yellow-colored *p*-nitrophenol (PNP) by lipase. The working substrate was prepared by mixing PNPE stock, ethanol, and buffer (50 mM Tris-HCl, pH 9.0) in the ratio 1:4:95 (v/v/v), giving a final concentration of PNPE of 0.1 mM. The enzyme-containing samples were diluted in the same buffer. 60 μ l diluted enzyme was mixed with 180 μ l substrate in duplicate, added to the wells of a 96-well ELISA plate, and incubated at 25 °C. A blank was prepared by mixing 60 μ l Tris-HCl buffer with 180 μ l substrate. OD readings at 405 nm were taken at 20 minutes, and 1 IU of lipase activity was defined as the amount of enzyme that produced 1 μ mol PNP per min at 25 °C and pH 9. To construct a standard curve, a 10 mM PNP stock was serially diluted and OD₄₀₅ readings were measured, with the linear region falling between 0 and 2.0.

RESULTS

Generation of the recombinant Bacillus strains

The pSG vectors pSG-AMY, pSG-BPN, and pSG-BT were transformed into the host *B. subtilis* strain 1A304 to create AMY, BPN, and BT strains, respectively. The genotype of the host *B. subtilis* strain 1A304 (ϕ 105MU331) is *ind-125cts-52 Ω* (*lacZ'*[ClaI]-*ermC*-*cat'*[NcoI])331 Δ (DI:1t)trpC2metB52xon-1 SPB(S), in which an engineered temperate bacteriophage ϕ 105MU331 has been incorporated into the bacterial genome [1,2]. The pSG vectors and the *B. subtilis* 1A304 (ϕ 105MU331) chromosomal DNA contain homologous regions. The enzyme inserts were flanked by a ϕ 105 fragment (approximately 600 bp) and a complete *cat* gene in the plasmid (Fig. 1), whereas an *ermC* gene was flanked by the same ϕ 105 fragment and a truncated *cat'* gene in the *B. subtilis* 1A304 (ϕ 105MU331) chromosomal DNA [1,2]. After the plasmid had been taken up by the competent *B. subtilis* 1A304 (ϕ 105MU331) strain in its late exponential phase, homologous double crossover recombination occurred. Therefore, the transformants should express the phenotype Cm^REr^S. As the pSG vectors contain no replication origin for the binding of *B. subtilis* DNA polymerase, they cannot autonomously replicate unless stably integrated into the bacterial DNA. In contrast, vector pKTH10 is a high copy number plasmid that can replicate extra-chromosomally in *B. subtilis* [6]. Its transformation into *Bacillus subtilis* strains

168, 1A304, BPN, and BT created the kanamycin-resistant strains BS168K, MU331K, BPNK, and BTK, respectively. Extra-chromosomal replication of the pKTH10 vector in these strains was proven by isolation of plasmids from these strains by a plasmid preparation procedure. Strains MU331K, BPNK, and BTK were chloramphenicol and kanamycin resistant, confirming the co-existence of the prophage construct and the plasmid within the same cell.

Feasibility of the dual expression system

In shake flask cultivation of strains BS168K, BPN, BPNK, BT, and BTK (Fig. 2a), it can be seen that whereas only amylase was overexpressed by the plasmid system in BS168K and only protease was overexpressed by the prophage system in BPN, both enzymes were simultaneously expressed in BPNK. Similarly, amylase and lipase were simultaneously overexpressed by BTK but not by BT. Although the amount of amylase produced by BPNK and BTK was lower than that by BS168K, the amount of protease produced was higher in BPNK than in BPN, and, similarly, the amount of lipase produced was higher in BTK than in BT (Table 3). The data show that two heterologous enzymes can be overexpressed simultaneously in this dual expression system.

Starch is the inducer of amylase production by pKTH10

The expression of the plasmid system is affected by the concentration of starch in the culture medium. An expression study on BPNK showed that both the amylase and protease expression levels were at their highest when 10 g/L soluble starch was added to the medium (Fig. 2b). In general, the yields of amylase increased with the amount of starch in the media (Table 4). Good cell growth that resulted from the presence of starch also enhanced protease expression. A concentration of 50 g/L starch may have been too high, resulting in the presence of high levels of glucose, converted from starch by the amylase, which in turn inhibited further production of amylase.

Comparison of the plasmid system and the prophage system

The expression of the plasmid system is constitutive, whereas that of the prophage system is heat inducible. The time course of enzyme production of BPNK is shown in Fig. 3a. The graph shows that amylase production increased gradually throughout the course of cultivation, while protease was produced only after heat induction.

The capacity for enzyme production in the plasmid system is higher than that in the prophage system. Fig. 3b shows that the amount of amylase produced by the BS168K strain was higher than that by the AMY strain. This was probably due to the fact that amylase production in BS168K was constitutive, whereas in the AMY strain, amylase

was only produced after heat induction. The high copy number of the plasmid may have also contributed to the higher enzyme yield.

Moreover, the cell growth of the AMY strain was largely affected by heat induction. Although the cell density of the AMY strain continued to increase after heat induction (Fig. 3b), it ceased to multiply on LC plates after heat induction (Table 5). This shows that the induction of the prophage exerts negative effects on the physiology of the cells.

Although the prophage system has a lower enzyme yield and growth performance, it is more stable than the plasmid system. The prophage system showed about 100% stability, whereas plasmid stability was only 87% in samples taken before heat induction (Table 5).

Influences of the plasmid system on the prophage system

The plasmid system helps to improve the yield of the prophage system. Fig. 4a shows the differences in growth rate and protease expression between BPN and BPNK. From the graph, it is obvious that, in the overnight samples, both the cell densities and protease activities were higher in BPNK than in BPN, although their growth and protease activities were similar during the initial 8 hours of cultivation. This is probably because the amylase produced by the plasmid system in BPNK gradually

broke down the starch in the medium into glucose, which provided additional nutrients for cell growth. This could explain why BPNK grew faster than BPN afterwards, at which point the glucose originally present in the medium had become limiting. An improved cell growth and a higher cell density mean that more cells were involved in enzyme secretion; this resulted in the higher level of protease activity in BPNK. A similar result is shown in Fig. 4b, where BT is compared with BTK, supporting the above explanation.

Influences of the prophage system on the plasmid system

The growth and amylase production of BS168K, MU331K, and BPNK strains were compared. In Fig.5a, it can clearly be seen that when heat induction was performed, BS168K exhibited the highest growth rate and amylase expression of the three strains. This shows that the prophage system has negative effects on the growth and expression of MU331K and BPNK strains. This may be due to the fact that, after heat induction, the prophage system was activated but at the same time cell growth was retarded. As shown in Table 6, heat induction had no apparent effect on the amylase expression of BS168K, but the amylase expression of MU331K and BPNK was obviously suppressed. This suggests that heat induction has no effect on cells that do

no carry the prophage system, but affects the expression of the plasmid-encoded genes in cells that carry the prophage system.

Although the prophage system has negative effects on cell growth and plasmid enzyme expression, it helps the cells to maintain plasmid stability. The plasmid stability of BS168K, MU331K, and BPNK was 87%, 100%, and 100%, respectively, in samples taken before heat induction. This shows that in the presence of the prophage system, plasmid stability in the cells was higher.

Fermentation studies

Six fed-batch fermentations of BPNK were carried out. At each fermentation run, heat induction was performed at various cell densities: when OD_{600} reached 17, 20, 25, 31, and 35, and no heat induction. It can be seen from Table 7 that when heat induction was performed at OD_{600} 25, expression of both amylase and protease was highest in the overnight samples. When heat induction was carried out at OD_{600} 17 or 20, the number of cells involved in expressing the heterologous enzymes was low. However, when heat induction was performed at OD_{600} 31 or 35, the cells might have already reached the late stationary phase of growth and were not sufficiently active to express the enzymes. These fermentation studies show that the dual expression system can be applied in industrial scale production.

Discussion

B. subtilis has been a paradigm for the genetics of Gram-positive bacteria for about 40 years. Its genome has been fully sequenced and the mechanisms for gene expression and protein secretion have been extensively studied. *B. subtilis* is regarded as an appropriate workhorse for heterologous gene expression [15,16]. It is able to secrete large quantities of proteins into culture media and has been widely used for the production of industrial enzymes in large-scale fermentation processes [17].

Many reports on using *Bacillus* strains as expression hosts were based on plasmid vectors, such as pUB110, pE194 [18], and pHY300PLK derivatives [19]. The only exception is the heat-inducible prophage expression system studied in this project [1,2,5]. Various strategies have been employed to enhance the yield of the *Bacillus* expression system, e.g. development of protease-deficient strains [15], adoption of stronger promoters [20], improvement of protein folding by co-expression of chaperones [21,22], and improvement of secretion efficiency by engineering signal peptides [23] or by co-expression of components in the secretory machinery [24]. In this study, we explored the possibility of improving the yield of *Bacillus* expression by incorporating a prophage expression and a plasmid expression system in the same cell. Our results confirmed the feasibility of this approach. In general, the yield of the plasmid system was higher than that of the prophage system. There are two possible

explanations for this. Firstly, in the plasmid system, the enzyme is expressed constitutively, while in the prophage system the enzyme is expressed only after heat induction. Secondly, heat induction of the prophage system exerts a negative influence on the physiology of the cells. In spite of these effects, the feasibility of this approach has been proven in both shake flask studies and in fermentation studies. The BPNK strain has been grown up to OD90 in a 50 L fermentor and the yields of both enzymes were elevated with increasing OD (data not shown).

In summary, the current approach could have great potential as an industrial application. Theoretically, the expression of two products simultaneously in a single fermentation run can reduce costs in production facilities, manpower, depreciation, and utilities costs including energy, water, waste management, etc. Of course, the cost saving is greatly dependent on the value of the products.

Acknowledgements

This work was supported by a grant from the Innovation and Technology Fund (Project UIM69) of the Hong Kong Special Administrative Region Government, China. We would like to thank Mr. Gary Chan for his technical support in fermentation studies.

Table 1 The construction of BPN, BT, AMY, BS168K, MU331K, BPNK and BTK recombinant strains

Constructed strain	Host strain	Prophage system (candidate gene)	Plasmid system (candidate gene)
BPN	<i>B. subtilis</i> MU331	√ (<i>BPN</i> gene)	×
BT	<i>B. subtilis</i> MU331	√ (<i>BT</i> gene)	×
AMY	<i>B. subtilis</i> MU331	√ (<i>amyE</i> gene)	×
BS168K	<i>B. subtilis</i> 168	×	√ (<i>amyE</i> gene)
MU331K	<i>B. subtilis</i> MU331	√ (empty vector)	√ (<i>amyE</i> gene)
BPNK	<i>B. subtilis</i> MU331	√ (<i>BPN</i> gene)	√ (<i>amyE</i> gene)
BTK	<i>B. subtilis</i> MU331	√ (<i>BT</i> gene)	√ (<i>amyE</i> gene)

Table 2 Oligonucleotides

Primer	Sequence (5'→3')	R.E. site	Template
SubE-S	GCGATCGCAT ATG AGAAGCAAAAAATTGTGGATCAGC	NdeI	Signal peptide for subtilisin E
SubE-A	GCGGATCCGCGGCCGCCTGCGCAGACATGTTGC	BamHI, NotI	Signal peptide for subtilisin E
BPN-S	GCGATATCGCGGCCGCAGGAAATCAAACGGGGAA	NotI	Mature <i>BPN</i> gene
BPN-A	GCGGATCCACTTGGCCGTTACGGGACT	BamHI	Mature <i>BPN</i> gene
BT-S	AAATAGCGGCCGCAGCYACGCGCCAAYGATGC	NotI	Mature <i>BT</i> gene
BT-A	ATGGATCCTTAAGGCCGCAAACCTCGCCA	BamHI	Mature <i>BT</i> gene
AMY-S	GAAGCTTCAT ATG ATTCAAAAACGAAAGCGGACAG	NdeI	Full-length <i>amyE</i> gene
AMY-A	GCTCTAGACCTTGTGCATACGGCTGAA	XbaI	Full-length <i>amyE</i> gene
phi-105	ATAGACAATCGGCGGTTAAC	Nil	phi-105 promoter
P-S	GCTCCTTTTTAGGTGGCACA	Nil	pKTH10 plasmid
P-A	CCGCATTGAAGTAGAGGGAA	Nil	pKTH10 plasmid

Restriction sites are underlined. Initiation codon ATG is shown in bold type.

Table 3 Enzyme activities of BS168K, BPN, BPNK, BT and BTK

	BS168K	BPN	BPNK	BT	BTK	Negative control
Amylase (U/ml)	368.61	-2.97	265.55	5.41	223.19	14.92
Protease (U/ml)	0.02	8.12	14.50	0.07	0.12	-0.06
Lipase (U/ml)	0.00	0.00	-0.01	2.77	4.11	0.00

Samples were taken from the overnight cultures of shake flask cultivation. Expression medium used was BHY with 10g/L soluble starch.

Table 4 Amylase and protease produced by BPNK in different soluble starch concentrations

	BHY	BHY+ 1g/L SS	BHY+ 10g/L SS	BHY+ 50g/L SS	Negative control (BT cultivated in BHY + 10g/L SS)
Amylase (U/ml)	52.87	72.08	238.37	185.57	5.41
Protease (U/ml)	6.32	11.26	16.81	15.8	0.07

Samples were taken from the overnight cultures of the shake flask cultivation.

SS: Soluble starch.

Table 5 Stability of the plasmid system and the prophage system before and after heat induction

	Pre Heat Induction			4hr Post Heat Induction		
	LK plate	LB plate	LK/LB	LK plate	LB plate	LK/LB
BS168K	54×10^6	62×10^6	87%	62×10^6	78×10^6	79%
	LC plate	LB plate	LC/LB	LC plate	LB plate	LC/LB
AMY	49×10^6	47×10^6	104%	0	20×10^5	0%

The numbers shown were the average values of two experiments.

Table 6 Final yields of amylase produced by BS168K, MU331K and BPNK with and without heat induction

		BS168K	MU331K	BPNK
Amylase activity (U/ml)	With heat induction	368.30	149.22	238.37
	No heat induction	368.61	222.24	301.91

Samples were taken from the overnight cultures of shake flask cultivation.

Table 7 Final yields of enzymes produced by strain BPNK at various induction OD_{600}

		No heat induction	OD_{600} 17	OD_{600} 20	OD_{600} 25	OD_{600} 31	OD_{600} 35
Amylase	(U/ml)	371.14	357.87	368.61	1253.16	969.90	819.42
Protease	(U/ml)	0.03	12.23	46.36	62.39	43.05	29.78

Figure legends

Figure 1. The plasmid maps of pSGt, pSG-E, pSG-BPN, pSG-BT and pSG-AMY.

The heterologous gene is inserted into the multicloning site (MCS) of the vector. The vector carries a pBR 322 replication origin (ORF) for *E. coli*, a promoter and a Shine-Dalgarno (SD) sequence of the prophage ϕ 105 MU331, the terminator of *B. licheniformis* α -amylase (term), a *cat* gene for chloramphenicol resistance, and a *bla* gene for ampicillin resistance.

Figure 2. (a) Enzyme production by various strains in shake flask studies. Lanes 1, 2, 3, 4, and 5 were collected from BS168K, BPN, BPNK, BT, and BTK strains, respectively. Lane 6 is the negative control. (b) Expression levels of BPNK strain in medium containing different starch concentrations. Lanes 1, 2, 3, and 4 were samples collected from culture medium containing BHY with 0, 1, 10, and 50 g/L soluble starch, respectively. Lane C is a commercial sample from NovoNordisk (protease + amylase) (2 mg/ml). Lane M is the molecular weight markers. A 20 μ l sample was loaded in each lane.

Figure 3. (a) The time course of amylase (\blacktriangle) and protease (\blacksquare) production in BPNK. (b) Time profiles of cell densities and amylase activities of strains BS168K (\square, \blacksquare), and

AMY (Δ, \blacktriangle). Open symbols represent the cell density, closed symbols represent amylase activity. The arrow indicates the time of heat induction. The expression medium used was BHY with 10 g/L soluble starch.

Figure 4. (a). Time profiles of cell densities and protease activities of BPN (\circ, \bullet) and BPNK (Δ, \blacktriangle). (b) Time profiles of cell densities and lipase activities of BT (\circ, \bullet) and BTK (Δ, \blacktriangle). Open symbols represent the cell density and closed symbols represent protease/lipase activities. The arrow indicates the time of heat induction. The expression medium used was BHY with 10 g/L soluble starch.

Figure 5. Time profiles of cell densities and amylase activities of BS168K (\square, \blacksquare), MU331K (\circ, \bullet), and BPNK (Δ, \blacktriangle) with (a) and without (b) heat induction. Open symbols represent the cell density, closed symbols represent amylase activity. The arrow indicates the time of heat induction. The expression medium used was BHY with 10 g/L soluble starch.

References

- [1] A.Y. Chan, M. M. Chan, H. M. Lo, Y. C. Leung, B. L. Lim, A dual protein expression system in *Bacillus subtilis*, *Protein Express. Purif* 26 (2002) 337-342.
- [2] S.J. Thornewell, A.K. East, J. Errington, An efficient expression and secretion system based on *Bacillus subtilis* phage phi 105 and its use for the production of *B. cereus* beta-lactamase I, *Gene* 133 (1993) 47-53.
- [3] D.M. Ellis, D.H. Dean, Nucleotide sequence of the cohesive single-stranded ends of *Bacillus subtilis* temperate bacteriophage phi 105, *J. Virol.* 55 (1985) 513-515.
- [4] R. Young, U. Blasi, Holins: form and function in bacteriophage lysis, *FEMS Microbiol. Rev.* 17 (1995) 191-205.
- [5] Y.C. Leung, J. Errington, Characterization of an insertion in the phage phi 105 genome that blocks host *Bacillus subtilis* lysis and provides strong expression of heterologous genes, *Gene* 154 (1995) 1-6.
- [6] I. Palva, Molecular cloning of α -amylase gene from *Bacillus amyloliquefaciens* and its expression in *B. subtilis*, *Gene* 19 (1982) 81-7.
- [7] J.A. Wells, E. Ferrari, D.J. Henner, D.A. Estell, E.Y. Chen, Cloning, sequencing, and secretion of *Bacillus amyloliquefaciens* subtilisin in *Bacillus subtilis*, *Nucleic. Acids. Res.* 11 (1983) 7911-7925.
- [8] A.R. Cho, S.K. Yoo, E.J. Kim, Cloning, sequencing and expression in *Escherichia coli* of a thermophilic lipase from *Bacillus thermoleovorans* *ID-1*, *FEMS Microbiol. Lett.* 186 (2000) 235-238.
- [9] M.S. Osburne, R.J. Craig, D.M. Rothstein, Thermoinducible transcription system for *Bacillus subtilis* that utilizes control elements from temperate phage phi 105, *J. Bacteriol.* 163 (1985) 1101-1108.
- [10] Y. S. Park, K. Kai, S. Lijima, T. Kobayashi, Enhanced beta-galactosidase production by high cell-density culture of recombinant *Bacillus subtilis* with glucose concentration control, *Biotech. Bioeng.* 40 (1992) 686-696.

- [11] T. Kobayashi, T. Yano, H. Mori, S. Shimizu, Cultivation of microorganisms with a DO-stat and a silicone tubing sensor, *Biotechnol. Bioeng. Symp.* (1979) 73-83.
- [12] E.G. Fischer, E.A. Stein, α -amylase from human saliva, *Biochem. Prep.* 8 (1961) 27-33.
- [13] C. Mitchinson, J.A. Wells, Protein engineering of disulfide bonds in subtilisin BPN', *Biochemistry* 28 (1989) 4807-4815.
- [14] D. Lee, Y. Koh, K. Kim, B. Kim, H. Choi, D. Kim, M.T. Suhartono, Y. Pyun, Isolation and characterization of a thermophilic lipase from *Bacillus thermoleovorans ID-1*, *FEMS Microbiol. Lett.* 179 (1999) 393-400.
- [15] S.L. Wong, Advances in the use of *Bacillus subtilis* for the expression and secretion of heterologous proteins, *Curr. Opin. Biotechnol.* 6 (1995) 517-522.
- [16] C.R. Harwood, *Bacillus subtilis* and its relatives: molecular biological and industrial workhorses, *Trends. Biotechnol.* 10 (1992) 247-256.
- [17] M.V. Arbige, B.A. Bultuis, J. Schultz, D. Crabb, A.L. Sonenshein, J.A. Hoch J A, Losck (Eds.) *Bacillus subtilis* and other gram-positive bacteria: biochemistry, physiology, and molecular genetics, American Society For Microbiology, Washington DC, 1993, pp. 871-897.
- [18] S. Horinouchi, B. Weisblum, Nucleotide sequence and functional map of pE194, a plasmid that specifies inducible resistance to macrolide, lincosamide, and streptogramin type B antibiotics, *J. Bacteriol.* 150 (1982) 804-814.
- [19] H. Ishiwa, H. Shibahara-Sone, New shuttle vectors for *Escherichia coli* and *Bacillus subtilis*. IV. The nucleotide sequence of pHY300PLK and some properties in relation to transformation, *Jpn. J. Genet.* 61 (1986) 515-528.
- [20] R. Ye, J.H. Kim, B.G. Kim, S. Szarka, E. Sihota, S.L. Wong, High-level secretory production of intact, biologically active staphylokinase from *Bacillus subtilis*, *Biotechnol. Bioeng.* 62 (1999) 87-96.

- [21] V.P. Kontinen, M. Sarvas, The *PrsA* protein is essential for protein secretion in *Bacillus subtilis* and sets a limit for high-level secretion, *Mol. Microbiol.* 8 (1993) 727-737.
- [22] S.C. Wu, R. Ye, X.C. Wu, S.C. Ng, S.L. Wong, Enhanced secretory production of a single-chain antibody fragment from *Bacillus subtilis* by coproduction of molecular chaperones, *J. Bacteriol.* 180 (1998) 2830-2835.
- [23] V. Nagarajan, R. Ramaley, H. Albertson, M. Chen, Secretion of streptavidin from *Bacillus subtilis*, *Appl. Environ. Microbiol.* 59 (1993) 3894-3898.
- [24] L. Leloup, A.J. Driessen, R. Freudl, R. Chambert, M.F. Petit-Glatron, Differential dependence of levansucrase and alpha-amylase secretion on *SecA* (Div) during the exponential phase of growth of *Bacillus subtilis*, *J. Bacteriol.* 181 (1999) 1820-1826.

Fig. 1.

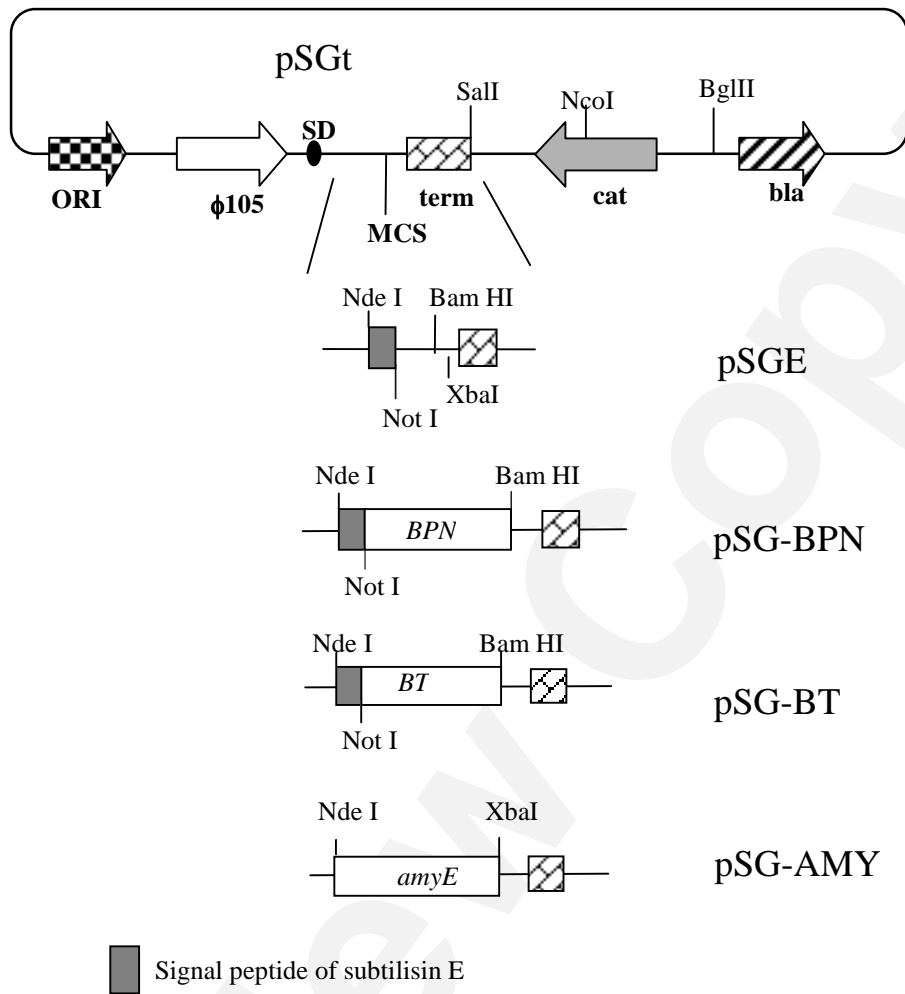

Fig. 2

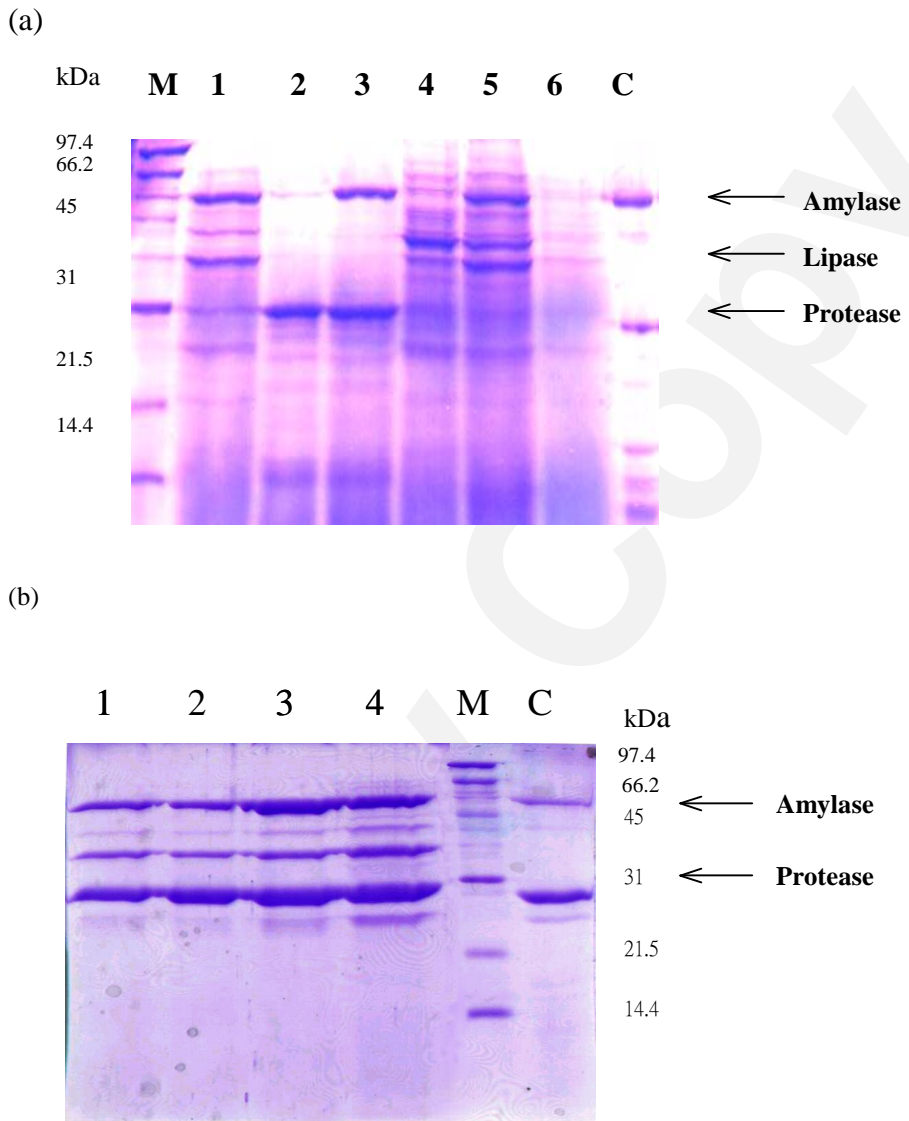
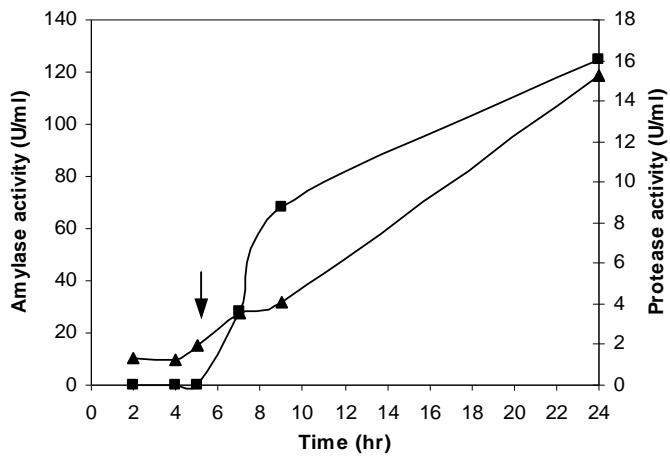

Fig. 3

(a)



(b)

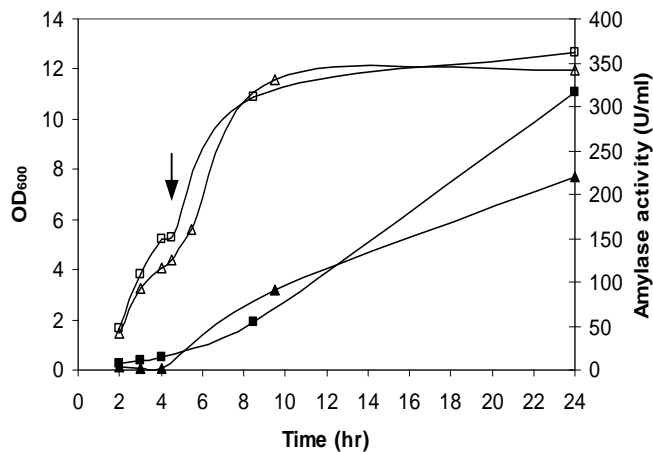
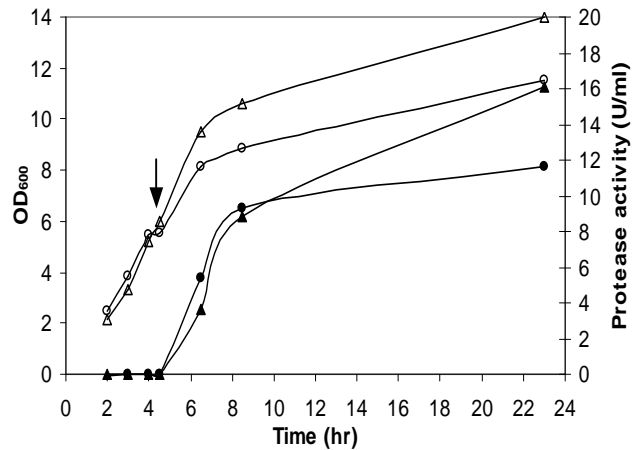

Fig. 4. (a)



(b)

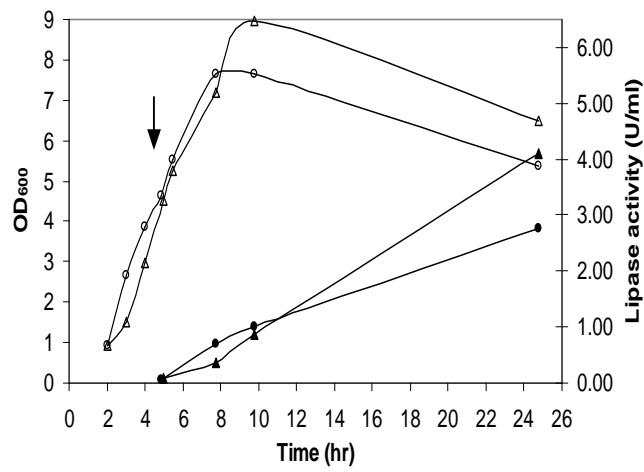
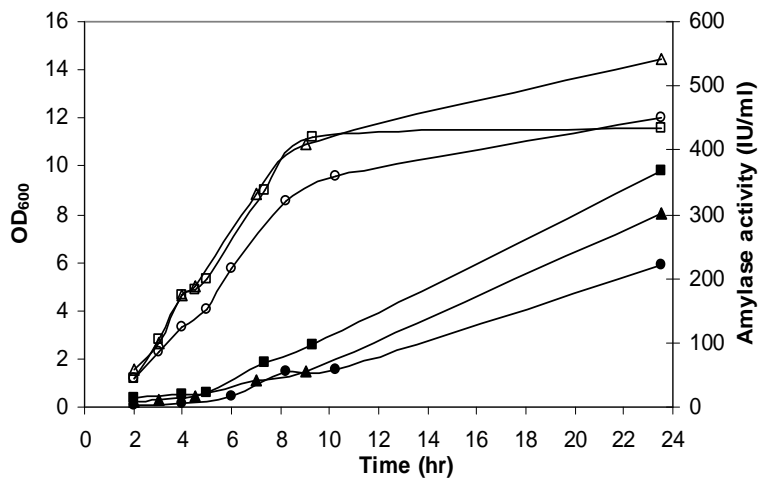

Fig. 5. (a)



(b)

