

CONTROVERSIAL ASPECTS IN SEISMIC ASSESSMENT AND RETROFIT OF STRUCTURES IN MODERN TIMES: UNDERSTANDING AND IMPLEMENTING LESSONS FROM ANCIENT HERITAGE

Stefano Pampanin¹

SUMMARY

Several alternative seismic retrofit and strengthening solutions have been studied in the past and adopted in practical applications ranging from conventional techniques, utilizing braces, jacketing or infills, to more recent approaches such as supplemental damping devices or advanced materials (e.g. Fibre Reinforced Polymers, FRP, or Shape Memory Alloys, SMA). A series of controversial issues are implicit in the complex decision-making process of seismic retrofit, where both rational and counter-intuitive solutions can satisfy some of the most critical aspects of multi-level performance-based seismic retrofit criteria. Interesting and fascinating suggestions and lessons can be obtained by reviewing the current trends in new design (i.e. innovative solutions for the future generation of buildings systems) as well as the architectural solutions used by the ancients. While walking this “bridge of knowledge” of our cultural heritage with the critical eyes of a curious and passionate observer, we can observe surprising commonality in engineering problems and their successful (and recently attempted) solutions. Understanding and implementing this heritage could lead to a uniquely stable platform for major breakthroughs in the development of “new solutions” in seismic design and retrofit.

INTRODUCTION: MOVING TO A PERFORMANCE-BASED SEISMIC RETROFIT APPROACH

In the relatively recent past, the crucial need for strengthening or retrofitting existing modern structures designed with substandard details, in order to withstand seismic loads without collapsing or with relatively moderate damage, has been further emphasized by the catastrophic effects of earthquake events (Turkey, Colombia and Taiwan, 1999, India 2001).

Alternative seismic retrofit and strengthening solutions have been studied in the past and adopted in practical applications ranging from conventional techniques, which utilize braces, jacketing or infills, to more recent approaches including base isolation, supplemental damping devices or advanced materials (e.g. Fibre Reinforced Polymers, FRP, or Shape Memory Alloys, SMA). Most of these retrofit techniques have evolved in viable upgrades; however, issues of costs, invasiveness, and practical implementation still remain the most challenging aspects of any intervention.

Moreover a proper assessment of the seismic vulnerability of the structure is a crucial step before selecting the most appropriate retrofit strategy.

Based on recent lessons learned from earthquake damage and extensive experimental and analytical investigation in the past few decades, it is becoming more and more evident that major controversial issues can arise when, for example, a) deciding whether the retrofit is needed and in what proportions, b) assessing and predicting the expected seismic response with alternative analytical/numerical tools and methods, c) evaluating the effects of the presence of infills,

partitions or “non-structural” elements on the seismic response of the overall structure, d) deciding to weaken a part of the structure to strengthen the full structure e) adopt a selective upgrading to independently modify strength, stiffness or ductility capacity, f) relying on the deformation capacity of an under-designed member to comply with the displacement compatibility issues imposed by the overall structure, g) define a desired or acceptable level of damage the retrofit structure should sustain after a given seismic event, i.e. targeting a specific performance level after the retrofit.

Due to improper assumptions or approaches during either the assessment or the retrofit strategy phase, dramatic consequences could occur during the seismic response; conceptual and numerical examples would in this contribution be given referring to apparently safe structures revealing to be prone to suffer major damage or even total collapse as well as to improper retrofit interventions which could condemn the structure to an avoidable collapse.

Finally, considerations on cost-effectiveness, invasiveness, and architectural aesthetics further complicate such a complex decision-making process, along with issues related to the socio-economical consequences of excessive damage and related downtime due to a limited or interrupted functionality of the structures after the seismic event.

Advanced performance-based seismic retrofit approaches should thus be defined and implemented, following current trends in seismic engineering for the seismic design of new structures. At this scope, the critical role of residual or permanent deformations (offset of the structure after the seismic response) as a valuable damage indicator has recently

¹ Senior Lecturer, University of Canterbury, Christchurch, New Zealand (Member)



a)



b)

Figure 1. Dramatic representations of historical seismic events: a) destruction of Sparta in 464 B.C., frame by Egisto; b) volcanic eruption and ground shaking in Pompei, 79 A.D. (from NISEE Image Collection).

been recognized in literature (MacRae and Kawashima, 1997, Pampanin et al., 2002), emphasizing and promoting the enhanced efficiency of re-centering solutions, which rely on the use of post-tensioning techniques, isolator/dissipation devices (i.e. unbonded brace systems, friction pendulum) or advanced materials (i.e. SMA with super-elastic behaviour).

In this contribution, the framework for a multi-level (performance) retrofit strategy relying on the use of either FRP composite materials or a low-invasive metallic haunch connection, will be summarized, based on experimental and analytical investigations carried out on a series of as-built (pre-1970s design) and retrofitted beam-column joint subassemblies and on two three storey frame systems. The aforementioned controversial issues will be briefly addressed with the intent to stimulate and promote discussion on partly yet un-solved debates.

As a support of this overview of major issues related to the seismic assessment and retrofit, fascinating lessons can be learned from a less recent past, by observing with critical eyes the major achievements of the ancient architecture in the attempt to preserve glorious examples of their culture for posterity, while having to regularly deal with and learn by themselves with the earthquake phenomena (Figure 1). It will be more clear how by properly understanding and, sometimes unconsciously, implementing these lessons via modern technology, major breakthroughs in the development of “innovative” solutions could be achieved.

SEISMIC VULNERABILITY OF EXISTING R.C. BUILDINGS DESIGNED PRIOR TO THE 1970S

Recent extensive experimental-analytical investigations on the seismic performance of existing reinforced concrete frame buildings, mainly (if not only) designed for gravity loads, as typically found in most seismic-prone countries before the introduction of adequate seismic design code provisions in the 1970s (Aycardi et al., 1994; Beres et al., 1996, Hakuto et al., 2000, Park, 2002; Pampanin et al., 2002; Bing et al., 2002; Calvi et al., 2002a,b) have confirmed the expected inherent weaknesses of these systems observed in past earthquake events (Figure 2).

As a consequence of poor reinforcement detailing, lack of transverse reinforcement in the joint region, as well as the absence of any capacity design principles, brittle failure mechanisms are expected either at local level (e.g. shear failure in the joints, columns or beams) or global level (e.g. soft storey mechanism). In particular, a significant vulnerability of exterior beam-column joints has been recognized due to the intrinsic lack of alternative and reliable

sources of shear transfer mechanism within the panel zone region after cracking.

Moreover, the presence of infills (e.g. typically un-reinforced masonry) can lead to unexpected and controversial effects due to the interaction with the bare frame (Crisafulli et al., 1997, Magenes and Pampanin, 2004).



Figure 2. Observed global and local damage in under-designed existing R.C. frame buildings with infills (left and top right, Izmit-Kocaeli and Athens earthquakes in 1999, from NISEE Image Collection; centre and bottom right: Molise event 2002).

The behaviour of beam-column joints: the devil is in the details

The complexity of the behaviour of beam-column joints has been well recognized in the past as confirmed by the major effort, dedicated worldwide in the past thirty-four years to the development of appropriate seismic design guidelines and criteria. Particularly, when capacity design principles were introduced in the standard seismic design philosophy, the idea of dealing with “the weakest link of the chain” naturally promoted a higher sensibility to the need to properly protect this part of a frame structure.

However, when dealing with an existing structure, the lack of information on the structural detailing, on the material properties and on the original design can be crucial for a correct assessment of its vulnerability under a seismic event and the subsequent definition of an adequate retrofit strategy.

Minor differences in the structural details could improve or degrade the expected behaviour under seismic loading, significantly enough to lead to a marginal survival or, on the other extreme, to a sudden collapse of the whole structure. Different damage or failure modes are in fact expected to occur in beam-column joints depending on the typology (exterior or interior joint) and of the adopted structural details (i.e. total lack or presence of a minimum amount of transverse reinforcement in the joint; use of plain round or deformed bars; alternative bar anchorage solutions), as shown in Figure 3 for exterior tee-joint with no transverse reinforcement (mostly typical of older construction).

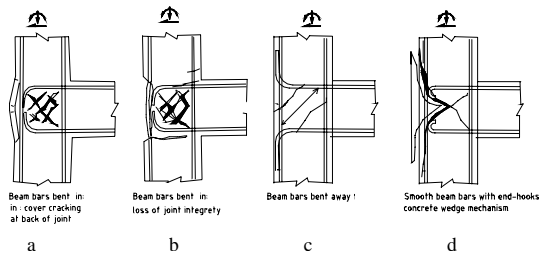

Figure 3. Alternative damage mechanisms for exterior tee-joints: a,b) beam bars bent inside the joint region; c) beam bars bent outside the joint region; d) plain round beam bars with end-hooks: “concrete wedge” mechanism (Pampanin et al., 2002).

After diagonal cracking, the shear transfer mechanism in the joint region has to basically rely on a compression strut mechanism, whose efficiency is critically related to the anchorage solution adopted for the longitudinal beam reinforcement. When beam bars are bent into the joint (Figure 3a, b), they can provide a limited resistance against the horizontal expansion of the joint, until the hook opens under the combined action of the diagonal strut and the pulling tension force in the beam reinforcement, leading to a rapid joint degradation. When beam bars are bent away from the joint (Figure 3c), as typical of older practice in New Zealand and Japan, no effective node point is provided for the development of an efficient compression strut mechanism, unless a significant amount of transverse column hoops is placed immediately above and below the joint core. A rapid joint strength degradation after joint diagonal cracking is expected. The worst scenario is however provided by the solution shown in Figure 3d, typical of the Mediterranean construction practice (but also common in New Zealand in the 1950s), where plain round bars with end hook anchorage were used. As recently shown by experimental tests on beam-column joint specimens and a three storey frame system (Pampanin et al., 2002, 2004), the combination of strut action and of a concentrated compression force at the end-hook anchorage, due to slippage of the longitudinal beam bars, can lead to the expulsion of a “concrete wedge” (Figure 4), with rapid loss of bearing-load capacity.

The controversial effects of masonry infills on the seismic response: an open debate

The effects of infills still represents an open topic, with a critical need of further investigations for the seismic vulnerability assessment of extensive classes of existing buildings. Controversial effects on the global inelastic

mechanism can be expected depending on the infill properties (mechanical characteristic and distribution) and on the joint damage mechanism.

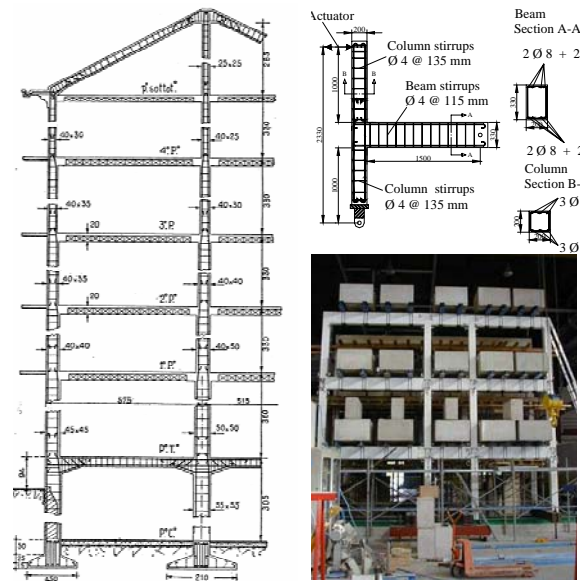

Figure 4. Experimental quasi-static cyclic tests on a frame system and joint subassemblies: observed “concrete wedge” damage mechanism in exterior tee-joint (Pampanin et al., 2002).

In recent studies, (Magenes and Pampanin, 2004, Pampanin et al., 2006) the interaction between un-reinforced masonry infills and R.C. frame systems, when appropriately considering the joint zone non-linear behaviour, has been investigated through pushover and non-linear time-history analyses on 2-D and 3-D multi-storey frame systems under uni-directional or bi-directional input motions.

A simplified and reliable analytical model, based on a concentrated plasticity approach, has been validated on different experimental tests on beam-column joints and frame systems (with and without infills) and proposed for extensive studies on seismic vulnerability of existing buildings (Pampanin et al., 2002).

The presence of infills can guarantee higher stiffness and strength, reducing the inter-storey drift demand, while increasing the maximum floor accelerations. A further positive influence of the infills can be recognized in the reduction of column interstorey shear contribution as well as in the possible delay of a soft-storey mechanism which might instead develop in a bare frame solution.

On the other hand, as mentioned and shown in Figure 5, the interaction between un-reinforced masonry infills and R.C. frames can lead to unexpected or peculiar effects when compared with the response of the bare frame, either at a local level (e.g. shear failure in columns, Figure 2a; damage to joint region, Figure 2b) or on the global seismic response (e.g. soft storey mechanism, Figure 2c).

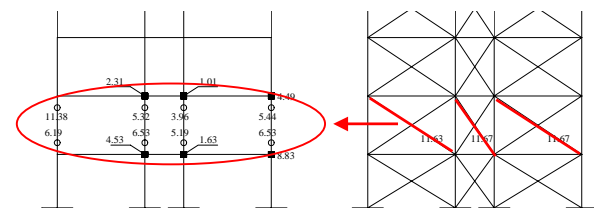

Figure 5. Damage mechanism in a pre-1970s R.C. frame with uniform distribution of masonry infills: soft storey at the second floor after damage to the infills (Magenes and Pampanin, 2004).

Moreover, the sudden reduction of storey stiffness due to the damage of the infills can lead to the formation of an unexpected soft storey mechanism. It is worth noting that, due to the interaction with the joint damage, this soft storey mechanism can occur at a higher storey level than the first one, either in the case of a regular or irregular distribution of the infills along the elevation. Similarly, when investigating the response of 3-D frames under either uni-directional or bi-directional earthquake input excitation, inelastic torsion mechanisms can occur due to the irregular distribution of damage to the infills.

Shear hinges, plastic hinges and global response

Based on experimental evidences and numerical investigations, the concept of a shear hinge mechanism has been proposed as an alternative to the well-known flexural plastic hinge for beam and column elements (Pampanin et al. 2002, 2003). The concentration of shear deformation in the joint region, through the activation of a so-called “shear hinge”, can reduce the deformation demand on adjacent structural members, postponing the occurrence of undesirable soft-storey mechanism Figure 6)

The drawback of this apparently favourable effect on the global response is the increase in shear deformations in the joint region which can possibly lead (depending on the joint typology and structural details adopted) to strength degradation and loss of vertical load-bearing capacity. The post-cracking behaviour of the joint depends, in fact, solely on the efficiency of the compression strut mechanism to transfer the shear within the joint. Thus, while rapid joint strength degradation after joint diagonal cracking is expected in exterior joints, additional sources of lateral loading carrying capacity can be provided by an interior joint even after first cracking

A critical discussion on the effects of damage and failure of beam-column joints in the seismic assessment of frame systems has been given in Calvi et al. (2002a). Limit states based on joint shear deformations have recently been defined and are reported in Pampanin et al. (2003). Based on a detailed assessment of the local damage and corresponding global mechanisms, a more reliable seismic rehabilitation strategy can be defined.

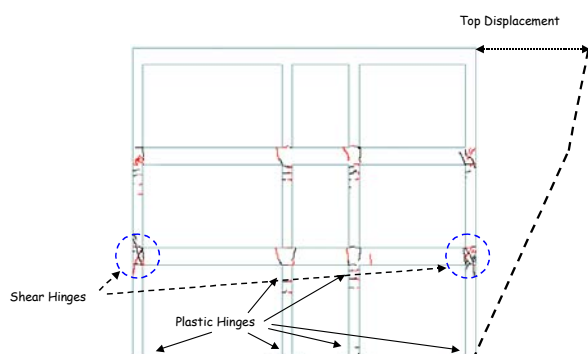

Figure 6. Frame response global mechanism: plastic hinges and shear hinges (top drift 1.6%, Calvi et al. 2002b).

MULTI-LEVEL RETROFIT STRATEGY: A RATIONAL COMPROMISE WITH REALITY

According to a multi-level retrofit strategy approach suggested by Pampanin and Christopoulos (2003), alternative objectives can be targeted in terms of hierarchy of strength within the beam-column-joint system, depending on the joint

typology (interior or exterior) and on the structural details adopted.

As discussed by the above authors, the ideal retrofit strategy would in fact not only protect the beam-to-column joints that were identified as the major deficiency in these frames, but would further upgrade the structure to exhibit the desired weak-beam strong-column behaviour which is at the basis of the design of new seismic resistant RC frames. However, due to the disproportionate flexural capacity of the beams when compared to the columns this is difficult to achieve in all cases and for all beam-to-column connections without major interventions. This is especially true for interior beam-to-column connections where the moment imposed on interior columns from the two framing beams is significantly larger than for exterior columns. As mentioned before, interior joints are less vulnerable than exterior joints and exhibit a much more stable hysteretic behaviour with hardening after first cracking. It is thus conceivable, in a bid to protect the interior columns from excessive curvature demand, we can tolerate some joint damage prior to hinging of the columns.

Two levels of retrofit can therefore be considered, depending on whether or not interior joints can be fully upgraded. A complete retrofit would thus consist of a full upgrade by protecting all joint panel zones and developing plastic hinges in beams while columns are protected according to capacity design principles. A partial retrofit would consist of protecting exterior joints, forming plastic hinges in beams framing into exterior columns, while permitting hinging in interior columns or limited damage to interior joints, where a full reversal of the strength hierarchy is not possible.

Ultimately, the viability of the partial retrofit strategy must be investigated on a case by case basis to assure that the localized damage to interior joints does not severely degrade the overall response of the structure or jeopardize the ability of the interior columns to safely carry gravity loads.

SEISMIC ASSESSMENT PHASE: THE FUNDAMENTAL AND DELICATE ROLE OF AN APPROPRIATE DIAGNOSIS

Prior to and irrespective of the technical solution adopted, the efficiency of a retrofit strategy strongly depends on a proper assessment of the internal hierarchy of strength of beam-column joints as well as on the expected sequence of events within a beam-column system, (i.e. shear hinges in the joints or plastic hinges in beam and column elements). The effects of the expected damage mechanism on the local and global response should also be adequately considered. As in any diagnosis phase, a simple but reliable analysis procedure should be able to provide useful preliminary information as a support of any retrofit intervention, maybe only temporary due to lack of time, knowledge, technology or funds as well as due to the anticipation of possible changes due to expected loads, boundary conditions or state of the structure.

Performance-domain: capacity vs. demand

A simple procedure to compare the internal hierarchy of strengths within a beam-column-joint system has been proposed in Pampanin et al. (2004). The evaluation of the expected sequence of events can be carried out through comparison of capacity and demand curves within a M-N (moment-axial load) performance-domain. Figure 7 shows, as an example, the M-N performance domain adopted to predict the sequence of events and the level of damage in the joint panel zone expected for the exterior specimen T1 (shown in Figure 4). The capacities of the beam, column and joint are referred to a given limit state (e.g. for the joints: cracking, equivalent “yielding” or extensive damage and

collapse, associated to increase level of principal tensile or compression stresses) and evaluated in terms of equivalent moment in the column at that stage, based on equilibrium considerations within the beam-column joint specimen (Pampanin et al. 2003, 2004).

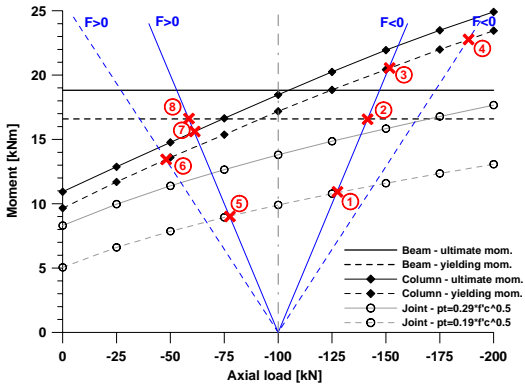

Specimen T1 (as-built)			
Type of lateral force	N°	Event	Lateral force [kN]
Open joint F<0	1	Joint cracking and deterioration starting $p_r = 0.19\sqrt{f_c}$	-10.94
	2	Beam yielding	-16.59
	3	Upper column yielding	-20.50
	4	Lower column yielding	-22.75
Close joint F>0	5	Joint failure	9.37
	6	Lower column yielding	13.50
	7	Upper column yielding	14.50
	8	Beam yielding	16.59

Figure 7. Evaluation of hierarchy of strengths and sequence of events: M-N Performance-Domain (exterior Tee-joint T1 in the as-built configuration Pampanin et al., 2006b).

Hierarchy of strength and sequence of events: a dangerous equivalence

Given the aforementioned considerations, major consequences can be derived by mistaking the concept of hierarchy of strength, better represented by capacity curves and independent of the demand, for the actual sequence of events (evaluated only when and if the correct demand is considered). As a general example, a set of beam-column joint subassemblies, having the same geometric and mechanical properties but being located at different floor levels within different building frame configurations, would have the same capacity curves (inherent hierarchy of strength) while resulting in a completely different sequence of events, due to the demand curves.

Importance of accounting for the variation of axial load due to the lateral loads

Similarly, demand curves should account for the variation of axial load due to the effects of lateral loads on a frame system, for either opening or closing of the joint, as shown in Figure 7 (as-built exterior specimen T1). Incorrect and non-conservative assessment of the sequence of events can otherwise result, leading to inadequate, and not necessarily conservative, design of the retrofit intervention.

In the case of the as built exterior joint specimen T1, a pure shear hinge mechanism, with extensive damage of the joint, prior to any hinging of beams or columns, was in fact expected and predicted, using a proper demand curve, (Table in Figure 7) as confirmed by the experimental tests. However, the order and “distance” of the events strongly depends on the assumption on the demand curve. If a constant axial load curve was used (in this case $N = -100$ kN as shown in Figure 7), as typical of experimental tests and analytical assessment practice in the literature, only a minor increase in the column strength (in addition to the joint

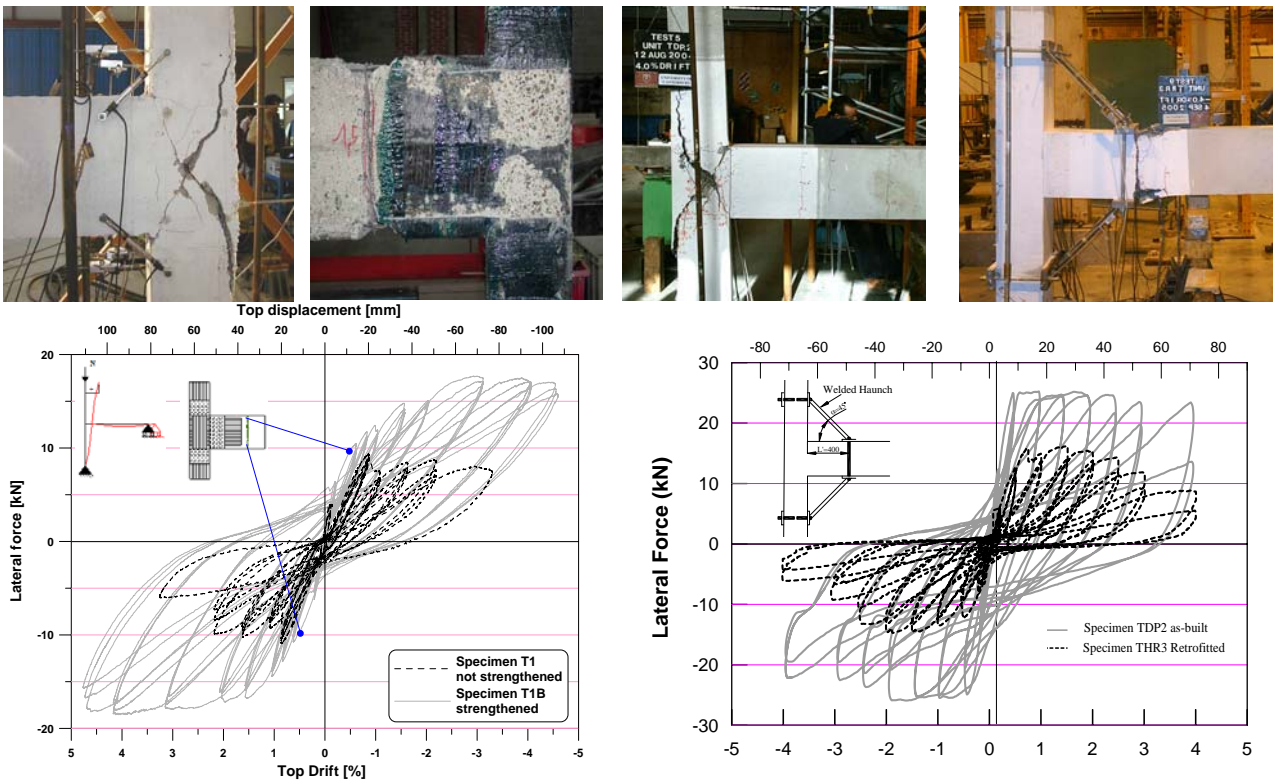

Figure 8. Protection of joint and inversion of the hierarchy of strength on an exterior joint subassembly, using a FRP or haunch retrofit solution. (Pampanin et al. 2006b, c)

strengthening) would have appeared necessary for the retrofit intervention. In reality, such a strengthening solution would lead to column hinging occurring before the formation of a beam hinge, thus resulting in a quite high risk of developing a soft storey mechanism even after the (maybe quite expensive and invasive) retrofit intervention.

IMPLEMENTATION OF THE MULTI-LEVEL RETROFIT STRATEGY USING ALTERNATIVE SOLUTIONS

The feasibility and efficiency of two alternative retrofit solutions, following the proposed multi-level retrofit strategy approach and relying either on the use of FRP composite materials or on a low-invasive metallic haunch connection, has been recently presented in the literature (Pampanin 2005, Pampanin et al. 2006b, c), based on experimental and analytical investigations carried out on a series of as-built and retrofitted 2-D beam-column joint subassemblies and on two three storey frame systems. As shown in Figure 8, the occurrence of brittle mechanisms at local or global level was adequately protected and a more desirable hierarchy of strengths and sequence of events achieved (i.e. plastic hinge in the beam), with both the selected interventions leading to more ductile and dissipating hysteresis behaviour.

Strengthening or weakening as basis of a retrofit strategy

It is worth noting that the increase of the global strength of the tested subassemblies is due to the development of an improved and more favourable inelastic mechanism, through a change of the load path (particularly in the haunch solution, see Figure 9) rather than to a real “strengthening” intervention of the structure.

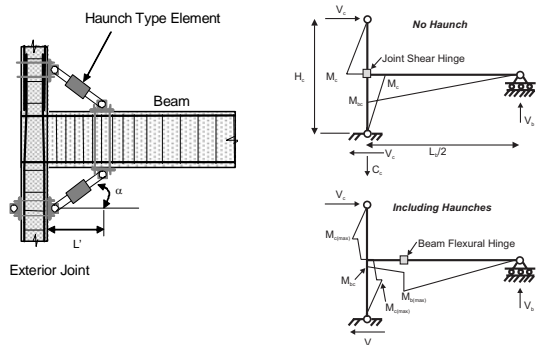

Figure 9. Modification of internal force diagrams and stress flow in an exterior joint retrofitted with the proposed diagonal haunch solution (Pampanin et al. 2006c).

The concept of strengthening and retrofit are in fact too often associated together, although sometimes improperly. Advanced retrofit techniques proposed by Elnashai and Pinho (1998) could in fact selectively improve either the stiffness or strength or ductility of a single member.

Furthermore, based on the advanced controlled rocking solutions presented in the following paragraphs, it could also be suggested that a selective weakening is, counter intuitively, performed in order to achieve the desired performance within a retrofit. More details will be given in the following paragraphs.

Feasibility, low-invasiveness and reversibility of the intervention

It is worth recalling that, once a satisfactory structural performance is guaranteed, issues related to practicality as

well as, in general, to cost-benefit analysis should be evaluated. Both accessibility of the joint region, invasiveness of the intervention, maintenance and reversibility will also have to be considered in real applications based on a case-by-case evaluation. It is worth however noting that a typical geometrical and plan configuration of existing buildings designed for gravity load only in the 1950s-1970s period might consist of frames running in one direction only and lightly reinforced slabs in the orthogonal direction, the latter being quite typical of the construction practice in Mediterranean countries. In these cases, the adoption of the proposed retrofit intervention can be somehow facilitated, when compared with more recently designed buildings with frames in both directions and cast-in-situ concrete slabs providing flange effects. An example of application in situ of FRP on an exterior (corner) beam-column joint is shown in Figure 10.



Figure 10. In situ FRP-retrofit of the exterior face of a corner beam-column joint

EMERGING TRENDS ON THE DESIGN OF HIGH PERFORMANCE SEISMIC RESISTING SYSTEMS

Major advances have been observed in the last decade in seismic engineering with further refinements of performance-based seismic design philosophies and definition of the corresponding compliance criteria. Following the worldwide recognized expectation and ideal aim to provide a modern society with high (seismic) performance structures able to sustain a design level earthquake with limited or negligible damage, emerging solutions have been developed for high-performance, still cost-effective, seismic resisting systems, based on an adequate combination of traditional materials and available technology.

In particular, recent technological solutions for precast/prestressed concrete buildings, originally developed under the PRESSS Program (Figure 11) and further refined (Priestley et al., 1999, Pampanin et al., 2005, Pampanin et al., 2006a) rely on the use of unbonded post-tensioned tendons with re-centering capability (negligible residual displacements) and are capable of significantly reducing the expected damage after a moderate-to-strong earthquake event. In these dry jointed ductile solutions, opposite to wet and strong connection solutions, precast elements are jointed together through unbonded post-tensioning tendons/strands or bars. The inelastic demand is accommodated within the connection itself (beam-column, column to foundation or wall-to-foundation critical interface), through the opening and closing of an existing gap (rocking motion) while a reduced level of damage, when compared to equivalent cast-in-place solutions (Figure 12), is expected in the structural precast elements, which are basically maintained in the elastic range. Moreover, the self-centering contribution due

to the unbonded tendons can lead to negligible residual deformations/displacements, which, as mentioned, should be adequately considered as a complementary damage indicator within a performance-based design or assessment procedure [Pampanin et al. 2002, Christopoulos and Pampanin, 2004]. Additional energy dissipation capacity can be provided, in a hybrid system (Stanton et al. 1997, Figure 11) through non-prestressed (mild) steel or additional external devices.

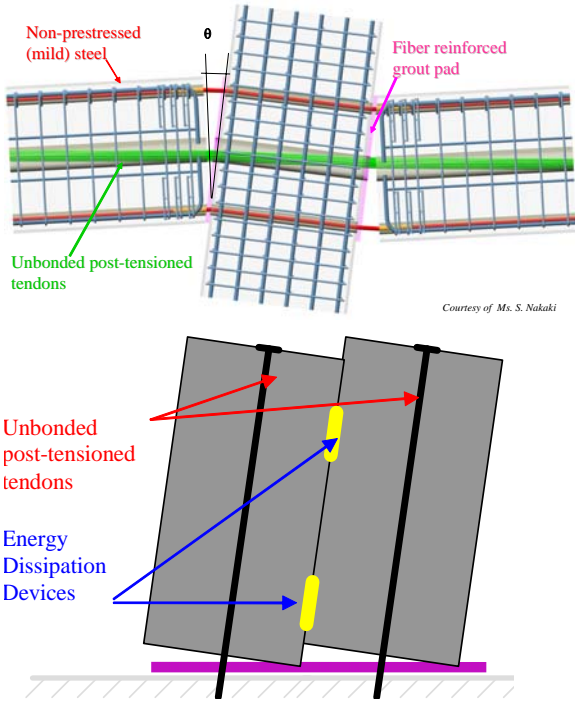

Figure 11. Jointed precast “hybrid” frame and wall systems developed in the PRESS-Program.

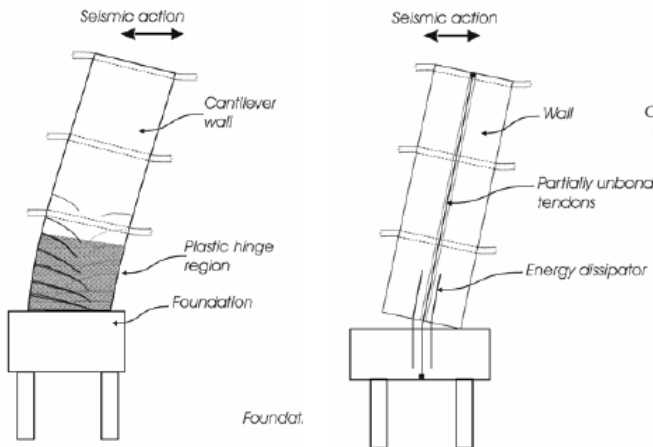

Figure 12. Comparative response of a traditional monolithic system (damage in the plastic hinge) and a jointed precast (hybrid) solution (damage limited to the fuses and negligible residual deformations (fib, 2003)

In a hybrid system, a sort of “controlled rocking” motion of the beam or wall panel occurs, while the relative ratio of moment contribution between post-tensioning and mild steel governs the so-called “flag-shape” hysteresis behaviour (Figure 13).

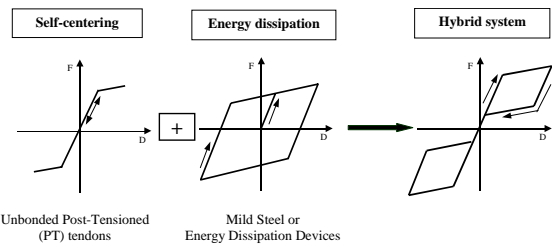

Figure 13. Idealized flag-shape hysteric rule for a hybrid system (fib, 2003).

Application of hybrid connections to bridge systems

The extension of the concept of a hybrid system to bridge piers and systems (either cast-in-situ or segmental precast), with the introduction of the an alternative definition of “controlled rocking”, has been presented by Palermo et al. 2004 (Figure 14), following or complementing previous/parallel work on unbonded post-tensioned solution for bridge piers carried out by Mander and Chen (1997), Hewes and Priestley (2001), Kwan and Billington (2003).

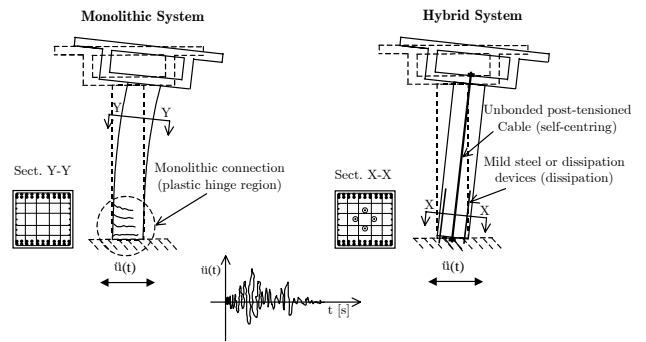

Figure 14. Concept of hybrid system applied to bridge piers and systems (Palermo et al., 2005).

Historical developments in seismic engineering

The introduction of jointed ductile systems, assembled by post-tensioning and able to undergo a severe seismic event with minor structural damage, certainly represent a major achievement in seismic engineering in the last decade if not a fundamental milestone in the historical development in the field as shown in Figure 15. The conceptual innovation introduced by capacity design principles as part of the design approach for ductile systems has led in the mid-1970s to revolutionary advancements of seismic design philosophies. Similarly, the development, started in the early 1990s, of ductile connections able to accommodate high inelastic demand without suffering extensive material damage appear as a promising step forward for the next generation of high-performance seismic-resisting systems, based on the use of conventional materials and techniques.



Figure 15. Evolution of seismic resisting connections: performance of beam-column joints designed according to pre-1970 codes (shear damage in the joint); following capacity design principles as per the NZS3101:1995 (beam plastic hinge) and adopting hybrid jointed ductile connections as per NZS3101:2006 (controlled rocking system).

SUGGESTIONS FOR ADVANCED RETROFIT SOLUTIONS

The recent emphasis given to the re-centering capability (negligible residual deformations) as well as to the limited level of damage, both achieved by the aforementioned controlled rocking systems, is already resulting into the development and proposal of advanced seismic retrofit strategies and technology able to provide an higher performance with a limited level of damage and negligible permanent deflections.

Use of SMA alloys devices or post-tensioning systems

Unbonded brace systems have been developed using traditional solutions, while the unique properties of Shape Memory Alloys have been exploited to develop a self-centering and dissipating device (with a typical flag-shape behaviour) to be used either in series with a typical brace (Figure 16) or as a dissipater and re-centering system in a base isolation intervention (Dolce et al. 2000).

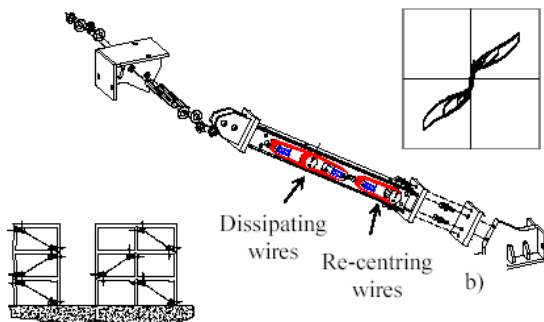

Figure 16. Brace system based on re-centring and dissipating Shape Memory Alloys wires (Dolce et al., 2000)

SMA have also been used in the form of post-tensioning for the seismic rehabilitation of monuments and historical buildings as in the cases of the Basilica di San Francesco in Assisi (Figure 17, Croci et al., 2000), damaged after two consecutive earthquake shocks in the 1997 Umbria-Marche earthquake or the Bell Tower of the S. Giorgio Church in Trignano (Figure 18, Indirli, 2000, DesRoches and Smith 2003), damaged after the 1996 Modena and Reggio earthquake in Emilia.



Figure 17. Basilica of S. Francis in Assisi: damage to the tympanum after the main earthquake event of September 26, 1997; retrofit intervention at the tympanum-roof connection with three groups of SMA devices (Croci et al, 2000)

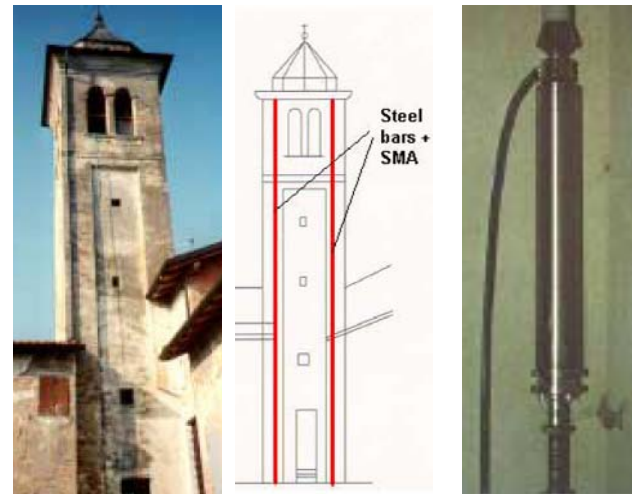

Figure 18. Bell Tower of S. Giorgio Church in Trignano; retrofit intervention with vertical SMA wires in series with prestressed steel tendons and detail of the device (Indirli 2000)

Selective weakening and structural disconnection

The significant advantages of hybrid or controlled rocking systems (in terms of limited level of damage, control of the stress level acting as a fuse) could, as briefly anticipated, suggest the use of a selective weakening intervention for either beam-column joints or wall systems (Ireland et al., 2006). By saw-cutting the longitudinal bottom reinforcement of a gravity load dominated beam or of a shear-dominated

wall, better control of the overall mechanism can be achieved, in accordance with the hierarchy of strength principles. A flexure-dominated rocking mechanism can be activated, which is able to guarantee a limited level of damage in the structural member as well as an upper limit level of stress (fuse action) directed to the beam-column joint panel zone or to the existing foundation protecting weak links of the fuse. Moreover, shear walls with low aspect ratio in existing buildings could be suggested to be split into two adjacent rocking coupled walls, with significant reduction of shear failure concerns as well as overturning demand to the foundation (Figure 19).

Further enhancement of the behaviour could also at this stage be achieved by using advanced energy dissipation devices (e.g. viscous-elastic, friction, SMA, combined in advanced flag-shaped systems, Marriott, 2006).

Acknowledging that monolithic behaviour might imply (if as a result of a cast-in-situ technique) imply damage, a low-damage retrofit or new design approach could be used to appropriately “isolate” the floor system from the lateral load resisting frame or wall systems, (Jensen et al., 2006). In so doing, not only displacement incompatibility issues could be controlled and reduced but also undesirable higher mode effects due to the interaction between the floor and the seismic resisting frames could be controlled by the fuse action of lateral shear collector, e.g. dissipating mechanical couplers.

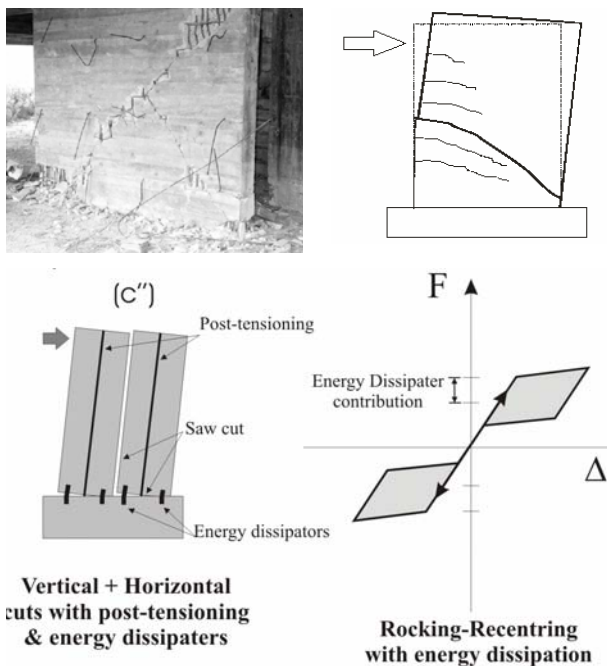

Figure 19. Typical shear failure mechanism of an existing under-designed R.C. wall and conceptual application of the proposed selective weakening technique (Ireland et al., 2006)

LOOKING AT THE PAST: THE KNOWLEDGE HERITAGE FROM THE ANCIENTS

In the following concluding pages, a few self-explanatory examples of lessons from the ancient architecture will be shown, looking at traditional construction techniques in seismic regions, as well as at the original development of the above mentioned concept for high seismic performance of either newly designed or retrofitted/repared structures.

Intentionally, only minimum text will be used in the titles and figure captions, letting the reader enjoy a naturally complex reaction, a mix of possible different emotions: a) fascinating

surprise for the achievement of our ancestors already two thousands year ago, without the advanced technology available nowadays, b) sincere curiosity and desire to learn more about those ages, c) hidden pride for the confirmation of the efficiency of a brilliant and independent idea of our modern times; d) genuine enthusiasm for a new idea for further developments and studies, e) ultimate recognition that science and research might be really based on a “cyclic process” with periods of 20-30 years for “frequent” or “rare event”, but maybe on a multiple of that, up to 2000-3000 years, for more “very rare” breakthrough “events”.

Seismic performance of a gravity-load dominated multi-storey frame made of Roman Concrete with clay masonry infills: the example of the Colosseum

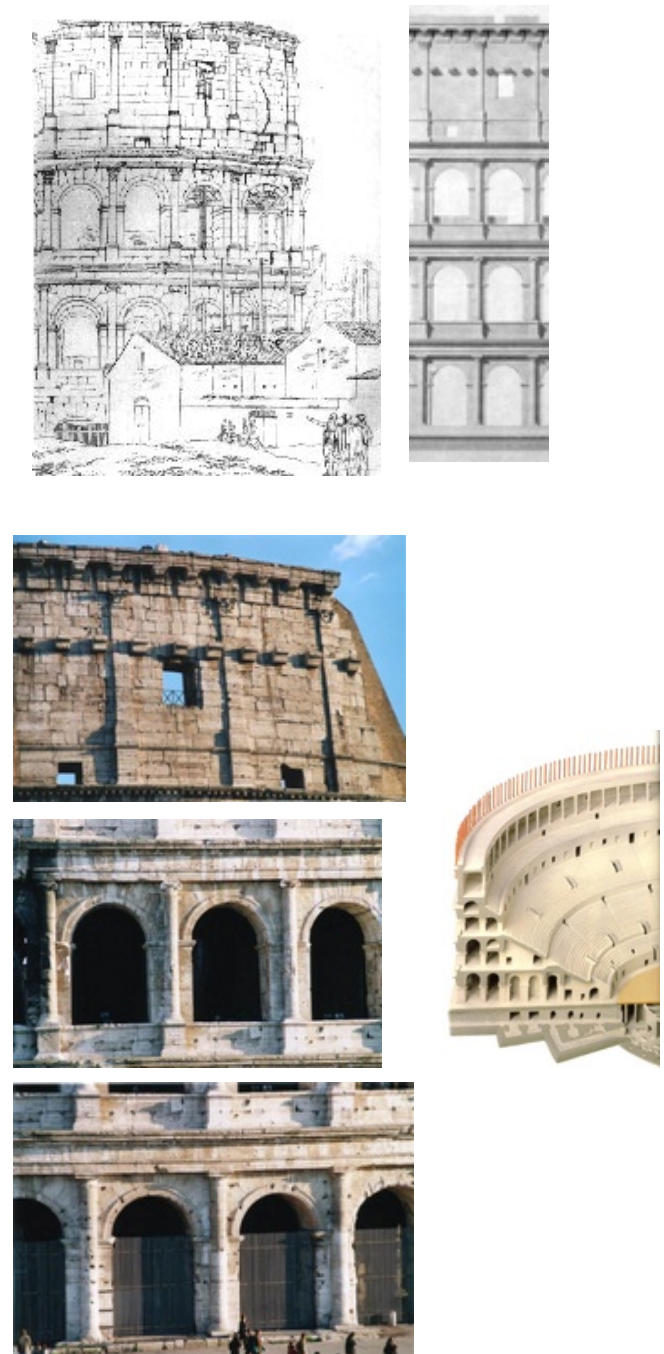

Figure 20. The Colosseum; representation of structural damage due to historical earthquakes; model and images of a peculiar multi-storey frame systems in a low-moderate seismic region

The real origin of rocking systems, self-centering and limited damage response under earthquake loading

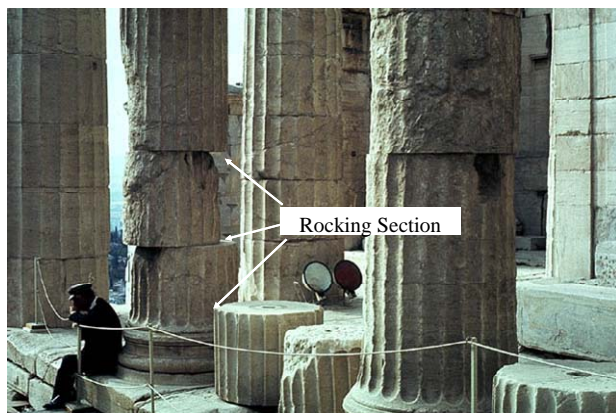

Figure 21. Typical use of rocking systems and segmental (multi-block) construction in the practice of ancient Greek and Roman Temples: axial load for re-centring; use of a lead element as shear and torsion key

The use of post-tensioning in the centuries for retrofit strategies:



Figure 22. -Top left: Seismic resisting solutions for masonry buildings used in the XIX century and performing well under the June 29, 1873 Belluno earthquake. Use of wooden rafters and beam passing through the full thickness of the walls and well anchored at the edge.

Top right: Example of a timber beam post-tensioned as a chain.

Centre and bottom: Example of retrofit intervention on churches or building facades using post-tensioned chain in the 19th and 20th century



Figure 23. Manual post-tensioning of a post-tensioning “chain” for retrofit

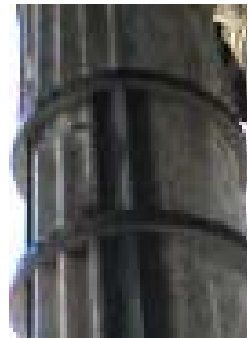
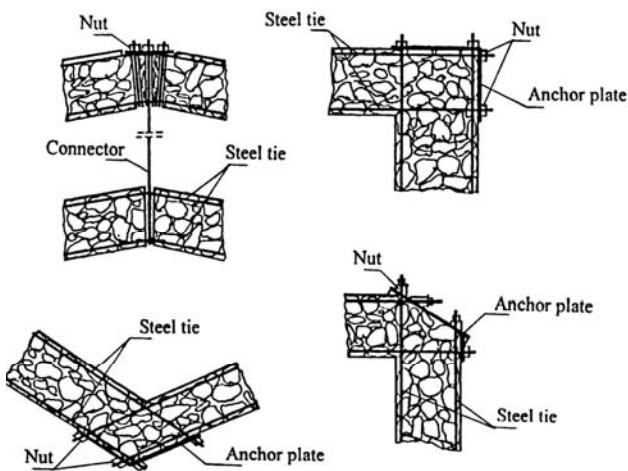

Figure 24. Post-installed anchors and ties to provide 3-D behaviour between perimeter walls (plan view, Tomazevic, 1999): note the behaviour as a beam-column joint in a modern sense,

Figure 26. Post-confinement applications on columns for retrofit intervention in the past centuries (e.g. by architect Giuseppe Valadier in 19th century, Vesta Temple) through iron or steel chains and advanced solution using FRP composite materials on circular columns



Figure 25. Transverse external post-tensioning for the retrofit of a masonry building



Figure 27. Left: typical representations of collapse of towers during historical seismic events (Napoli, 1806, Tuscany, 1896): awareness of their intrinsic vulnerability. Modern use of a half-collapsed medieval tower as a residential private house in Pavia, Italy
 Right: application of a temporary retrofit intervention based on transverse post-tensioning and confinement of the corners to a medieval tower in Pavia, after the collapse of the Cathedral Bell Tower in 1989.
 Far Right: Implementation of similar intervention by using FRP composite materials



Figure 28. Left: Representation of the ruins of a Greek temple after an earthquake event. Reduced stability due to the loss of axial load contribution from the above temple. Centre and right: Experimental shake table test on multi-block ancient-type column specimens adopting vertical SMA wires (Manos et al., 2000) in order to improve the structural stability and capacity to sustain future earthquake eventson a square column.

REFERENCES

- Aycardi, L., E., Mander, J., B. and Reinhorn, A.M., 1994. "Seismic Resistance of R.C. Frame Structures Designed Only for Gravity Loads: Experimental Performance of Subassemblages", *ACI Structural Journal*, Vol. **91** (.5), 552-563.
- Beres, A., Pessiki, S., White, R. and Gergely, P., 1996. "Implications of Experimental on the Seismic Behaviour of Gravity Load Designed RC Beam-Column Connections", *Earthquake Spectra*, Vol. **12** (2), May, pp. 185-198.
- Bing, L., Yiming W. and Tso-Chien P., 2002. "Seismic Behaviour of Non-Seismically Detailed Interior Beam-Wide Column Joints. Part I: Experimental Results and Observed Behaviour", *ACI Structural Journal*, Vol. **99**(6).
- Calvi G.M., Magenes G. and Pampanin S., 2002a. "Relevance of Beam-Column Damage and Collapse in RC Frame Assessment". *Journal of Earthquake Engineering (JEE)*, Vol. **6** (2), pp.75-100.
- Calvi, G.M., Magenes, G. and Pampanin, S., 2002b. "Experimental Test on a Three Storey R.C. Frame Designed for Gravity Only", *12th ECEE*, London, paper n. 727.
- Crisafulli, F., Carr, A. and Park, R., 1997. "Analytical Modelling of Infilled Frame Structures – a General Review", *Bulletin of the NZNSEE*, **33**(1), 30-47.
- Christopoulos, C. Pampanin S., 2004. "Towards performance-based design of MDOF structures with explicit consideration of residual deformations", *ASET Journal of Structural Engineering*, Special Issue **41**(1).
- Croci, G., Bonci, A., and Viskovic, A., 2000. "Use of Shape Memory Alloy Devices in the Basilica of St Francis of Assisi." *ISTECH Project-Proc. of Final Workshop*, Italy pp. 110-133.
- DesRoches, R., and Smith, B., 2004. "Shape Memory Alloys in Seismic Resistant Design and Retrofit: A Critical Review of their Potential and Limitations." *Journal of Earthquake Engineering*, Vol. **8**(3), 415-429.
- Dolce, M., Cardone, D. and Marnetto, R., 2000. "Implementation and testing of passive control devices based on shape memory alloys". *Earthquake Engineering and Structural Dynamics*, Vol. **29**(7), 945-968.
- Elnashai, A.S. and R. Pinho 1998. "Repair and Retrofitting of RC Walls using Selective Techniques", *Journal of Earthquake Engineering*, Vol. **2** (4), 525-568.
- fib (Federation International du Beton) 2001. "Externally Bonded FRP Reinforcement for RC structures", fib Bulletin n.14, Lausanne.
- fib, 2003. "Seismic design of precast concrete building structures", Bulletin 27, Lausanne.
- Hakuto, S., Park, R. and Tanaka, H., 2000. "Seismic Load Tests on Interior and Exterior Beam-Column Joints with Substandard Reinforcing Details", *ACI Structural Journal*, Vol. **97** (1), 11-25.
- Hewes, J.T. and Priestley, M.J.N., 2001. "Experimental Testing of Unbonded Post-tensioned Precast Concrete Segmental Bridge Columns", *Proc. of the 6th Caltrans Seismic Research Workshop Program*, Sacramento, California.
- Indirli, M., 2000. "The Demo-Intervention of the ISTECH Project: The Bell-Tower of S.Giorgio in Trignano (Italy)." *ISTECH Project-Proceedings of Final Workshop*, Italy, 134-146.
- Ireland, M., Pampanin, S., Bull, D.K., 2006. "Concept and Implementation of a Selective Weakening Approach for the Seismic Retrofit of R.C. Buildings" Proceedings of the Annual NZSEE Conference, Napier, March.
- Kam W-Y, Pampanin, S., Palermo, A., Carr, A., 2006. "Advanced Flag-Shape Systems for High Seismic Performance", Proceedings of the 1st ECEES, Geneva, Switzerland, Sept.
- Jensen, J., Bull, D.K., Pampanin, S., 2006. "Conceptual Retrofit Strategy for Existing Hollowcore Seating Connections", Proceedings of the Annual NZSEE Conference, Napier, March.
- Kwan, W.-P. and Billington, S., 2003. "Unbonded Post-Tensioned Bridge Piers II: Seismic Analyses". *ASCE Journal of Bridge Engineering*, Vol. **8**(2), 102-111.
- Mander, J.B. and Chen, C.T., 1997. "Seismic Resistance of Bridge Piers based on Damage Avoidance Design", *Technical Report NCEER-97-0014* (National Centre for Earth. Eng. Research), State University of New York, Buffalo.
- Magenes, G. Pampanin, S., 2004. "Seismic Response of Gravity load Designed Frame Systems with Masonry Infills", 12th WCEE, Vancouver, August, Paper n.4004.
- Manos, G.C., M. Demosthenous, V. Kourtidis, J. Evison-Manou, 2000. "Study of the Dynamic and Earthquake Behaviour of Ancient Columns and Colonnades with and without the Inclusion of wires with Energy Dissipation Characteristics", *12th World Conference on Earthquake Engineering*, Auckland.
- MacRae, G.A. and Kawashima, K., 1997. "Post-Earthquake Residual Displacements of Bilinear Oscillators", *Earthquake Engineering and Structural Dynamics*, Vol. **26**, pp.701-716.
- Marriott, D., 2006. "Use of Advanced Materials and Systems for the Performance-Based Seismic Design and Retrofit of Reinforced Concrete Structures, Department of Civil Engineering", *University of Canterbury, Christchurch, Ph.D. Thesis*, under preparation.
- NZS 3101:2005. "Standards New Zealand, Appendix B: Special Provisions For The Seismic Design Of Ductile Jointed Precast Concrete Structural Systems".
- Palermo A., Pampanin, S., Calvi, G.M. 2005. "Concept and development of Hybrid Systems for Seismic-Resistant Bridges", *Journal of Earthquake Engineering*, Imperial College Press, Vol. **9** (6), pp. 899-921.
- Pampanin, S., Calvi, G.M. and Moratti, M., 2002. "Seismic Behaviour of R.C. Beam-Column Joints Designed for Gravity Loads", *12th ECEE*, London, paper n. 726.
- Pampanin, S., Christopoulos, C., 2003. "Non-invasive Retrofit of Existing RC Frames Designed for Gravity Loads only", fib2003 Symposium on Concrete Structures in Seismic Regions, Athens.

- Pampanin, S., Magenes, G. and Carr, A., 2003. "Modelling of Shear Hinge Mechanism in poorly Detailed RC Beam-Column Joints", Proceedings of the fib Symposium Concrete Structures in Seismic Regions, Athens, paper n. 171.
- Pampanin, S., Christopoulos, C. and Chen T.-H., 2006a. "Development and Validation of a Metallic Haunch Seismic Retrofit Solution For Existing Under-Designed RC Frame Buildings", *Earthquake Engineering & Structural Dynamics*, in press.
- Pampanin, S., Bolognini, D., Pavese, A., 2006b. "Performance-based Seismic Retrofit Strategy for Existing Reinforced Concrete Frame Systems using FRP composites", *ASCE Journal of Composites in Construction, Special Issue "Recent International Advances in FRP Research and Application in Construction"* (Guest Editor: Rudi Seracino), in press.
- Park, R., 2002. "A Summary of Results of Simulated Seismic Load Tests on Reinforced Concrete Beam-Column Joints, Beams and Columns with Substandard Reinforcing Details". *Journal of Earthquake Engineering*, Vol. 6, No. 2, 1-27.
- Palermo, A., 2004. "The Use of Controlled Rocking in the Seismic Design of Bridges", Ph.D. Dissertation, Department of Structural Engineering, *Technical University of Milan*, Italy.
- Pampanin, S., Christopoulos, C. and Priestley M.J.N. 2002. "Residual Deformations In The Performance-Based Seismic Assessment Of Frame Systems", ROSE Research Report 2002/02, *European School on Advanced Studies on Reduction of Seismic Risk*, Pavia, Italy.
- Pampanin, S., Pagani, C., Zambelli, S., 2004. "Cable-Stayed and Suspended Post-Tensioned Solutions for Precast Concrete Frames: The Brooklyn System"; *Proc. of NZ Concrete Industry Conference*, Queenstown.
- Pampanin, S., 2005. "Emerging Solutions for High Seismic Performance of Precast/Prestressed Concrete Buildings", *Journal of Advanced Concrete Technology (ACT)*, Invited paper for Special Issue on "High performance systems", Vol. 3 (2), pp. 202-223.
- Pampanin, S., Palermo, A. Amaris, A., 2006a. "Implementation and Testing Of Advanced Solutions For Jointed Ductile Precast Concrete Seismic Resisting Frames", 2nd fib Congress, Naples.
- Pampanin, S., Bolognini, D., Pavese, 2006b "Performance-based Seismic Retrofit Strategy for Existing Reinforced Concrete Frame Systems using FRP composites", *ASCE Journal of Composites for Construction*, Invited Paper for Special Issue on "Recent International Advances in FRP Research and Application in Construction", in press
- Pampanin, S., Christopoulos, Chen, T.-H., 2006c "Development And Validation of a Haunch metallic Seismic Retrofit Solution for Existing Under-Designed RC Frame Buildings", *Earthquake Engineering and Structural Dynamics*, in press.
- Priestley, M.J.N., Sritharan, S., Conley, J.R. and Pampanin, S., 1999. "Preliminary Results and Conclusions From the PRESSS Five-Storey Precast Concrete Test Building", *PCI Journal*, Vol. 44, No. 6, pp. 42-67.
- Stanton, J.F., Stone, W.C., and Cheok, G.S., 1997. "A hybrid reinforced precast frame for seismic regions", *PCI Journal*, Vol. 42, No. 2, pp.20-32.
- Sugano, S., 1996. "State of the art in Techniques for Rehabilitation of Buildings", Proceedings of the 11th WCEE, Acapulco, Mexico, paper n. 2175.
- Tomazevic, M., "Earthquake-resistant design of masonry buildings", Series on Innovation in Structures and Constructions, Vol. 1, Imperial College Press, London