

**PROCEEDING INTERNATIONAL CONFERENCE ON ENVIRONMENT AND  
HEALTH : “INTEGRATING RESEARCH COMMUNITY OUTREACH AND SERVICE  
LEARNING”**

**© Soegijapranata Catholic University, 2013**

Soegijapranata Catholic University Press

Pawiyatan Luhur Street IV/1, Bendan Dhuwur, Semarang, Central Java, Indonesia

Phone. (+62) 24-8316142-441555 (hunting), ext. 121, Fax. (+62) 24-8415429, 8445265

e-mail : penerbitan@unika.ac.id

**ISBN 978-602-8011-53-2**

# **International Conference on Environment and Health**

Integrating Research Community Outreach and Service  
Learning

At

Soegijapranata Catholic University,

May 22<sup>nd</sup> - May 23<sup>rd</sup>, 2013

**Supported By:**



Published By

Soegijapranata Catholic University Press

© 2013

# CONTENTS

	PAGE
Preface	1
<b>Keynote.</b> Nurturing Solidarity Through Ecology: The Use of Footprint-Based Indices <i>Budi Widianarko</i>	2
WFE I Class	
<b>WFE I-1.</b> Sourdough Bread : Processing, Flavor and Health Benefits ( <i>Victoria Kristina Ananingsih and Laksmi Hartayanie</i> )	17
<b>WFE I-2.</b> Utilization of <i>Stevia rebaudiana</i> and Its Health Benefits ( <i>Vincent Kevin Tejo and Victoria Kristina Ananingsih</i> )	28
<b>WFE I-3.</b> The Potential Chito-Oligosaccharide (COS) and Rice Bran As A Source of Natural Prebiotic and the Synbiotic Effect in Functional Food ( <i>Agnes Sri Harti, Anis Nurhidayati, and Desi Handayani</i> )	35
<b>WFE I-4.</b> Bifidobacteria As Potential Probiotic In Yogurt ( <i>Laksmi Hartayanie and Victoria Kristina Ananingsih</i> )	41
<b>WFE I-5.</b> Initiation of Callus Cultures of Cantaloupe Melon ( <i>Cucumis melo</i> L.) and Detection of Its Beta-Carotene Content ( <i>Tjie Kok, Xavier Daniel, The Sandy Kristianti</i> )	56
<b>WFE I-6.</b> Characterization of the Polymerisation of Furfuryl Alcohol during Roasting of Coffee ( <i>Yuliana Reni Swasti and Michael Murkovic</i> )	61
<b>WFE I-7.</b> Integrating Research in Food and Health: A Case of Promoting Health by Glucosinolates in Brassica Vegetables ( <i>Probo Y. Nugrahedi, Novita Ika Putri, R.Verkerk, M.Dekker, and B. Widianarko</i> )	70
EDS II Class	
<b>EDS II-2.</b> The clinic laboratory smart phone application ( <i>Rosita Herawati, Suyanto EA, and Shinta Estri Wahyuningrum</i> )	77
<b>EDS II-3.</b> Game Development for Environmental Preservation ( <i>Viena Patrisiane, Stephani Inggrit S.D, and Ridwan Sanjaya</i> )	81
<b>EDS II-4.</b> Design Concepts of Sustainable Coastal Tourism Development in Indonesia ( <i>Gerarda Orbita Ida Cahyandari</i> )	87
<b>EDS I-3.</b> A conceptual framework of the Application of Game Theory on carbon tax between Annex I Country and non Annex I country by maximizing value of the ICES model ( <i>Noor Syaifudin</i> )	95

<b>EDS II-5.</b> Relationship Between Rob and Basic Sanitation Facilities Condition in Sub District Bandarharjo and Sub-District Tanjung Mas, Semarang City ( <i>Heru Nugroho, Budiyo, Sri Winarni, and Sutopo Patria Jati</i> )	<b>104</b>
--	------------

#### WFE II Class

<b>WFE II-2.</b> Green Manufacturing Implementation Base On Small and Medium Entrepreneurs' Perception ( <i>Augustine Eva Maria Soekesi</i> )	<b>112</b>
<b>WFE II-4.</b> E-Health Drinking Water Refill Quality Assurance Towards The Healthy Indonesia ( <i>Dewi Agustini Santoso and Dwi Eko Waluyo</i> )	<b>120</b>
<b>WFE II-5.</b> Blue ratio: Millenium Approach Over Water Efficiency Measurement ( <i>King Yuwono and Y. Andry Putranto</i> )	<b>128</b>
<b>WFE II-6.</b> Handling of Heavy Metals in Liquid Waste Metal Coating Industry with Microbes ( <i>Mardiyono</i> )	<b>135</b>
<b>WFE II-7.</b> Metals contamination in aquaculture ponds of Semarang - Indonesia: food safety consideration ( <i>Bernadetha Soedarini</i> )	<b>144</b>

#### ESL Class

<b>ESL-1.</b> Environment and Health: The educational and multiplier aspect ( <i>Aloysius Rusli</i> )	<b>155</b>
<b>ESL-3.</b> Implementation of Service Learning for Environmental Action in Civil Engineering Dept. Soegijapranata Catholic University ( <i>Rudatin Ruktiningsih and Budi Santosa</i> )	<b>161</b>
<b>ESL-4.</b> Application of Organic Agricuture in the Sukun District Malang As A Strategy For Health and Environmental Education ( <i>Kukuk Yudiono</i> )	<b>170</b>
<b>ESL-5.</b> Using Service-Learning in an Agricultural Area in Gintungan to Address Environmental Issues ( <i>Rully Adi Nugroho and Sucahyo</i> )	<b>178</b>
<b>ESL-6.</b> Improving Learning Output of Science Education Course Through Service Learning Program In SDK Sengkan and SDK Kalasan, Yogyakarta ( <i>A.Tri Priantoro and Silverio R.L. Aji Sampurno</i> )	<b>183</b>
<b>ESL-7.</b> Growing Student Sense of Caring on Community Health Problems Within Nutrition and Health Science Course ( <i>Luisa Diana Handoyo</i> )	<b>190</b>
<b>ESL-8.</b> Service Learning in Smallholder Dairy Farming Area : Case Study on Sidomakmur I Farmer Group, Gedang Anak Village, East Ungaran District, Semarang Regency ( <i>Lutfi Aris Sasongko and Helmy Purwanto</i> )	<b>196</b>

#### EDS I Class

<b>EDS I-1.</b> Interrelationship Among Educational Attainment, Poverty Incidence, Life Expectancy and Health with Environmental Quality Index ( <i>Irdam Ahmad</i> )	<b>202</b>
---	------------



<b>EDS I-2.</b> Measuring the Impact of Environmental Degradation to the Indonesian Economy ( <i>Dhany Setyawan</i> )	<b>209</b>
<b>EDS I-4.</b> The Concept of Green Manufacturing ( <i>Rekzy Yunanto, Meiryana, and Rustina Untari</i> )	<b>225</b>
<b>EDS I-5.</b> Natural Dyes in Java Batik : Local Knowledge on Green Manufacturing ( <i>Rustina Untari</i> )	<b>233</b>
EIJ Class	
<b>EIJ-1.</b> Analysis of The Lapindo Mudflow in Sidoarjo – East Java ( <i>Daniel Sugama Stephanus and Taufik Chairudin</i> )	<b>236</b>
<b>EIJ-2.</b> Execution of the Mediation Agreement Out of Court on the Environmental Conflict ( <i>Hassanain Haykal and Finalia</i> )	<b>246</b>
<b>EIJ-3.</b> Criminal And Administrative Law Enforcement For Business Actors As An Effort To Minimalize Environmental Pollution ( <i>Hassanain Haykal and Vincent Leo Saputra</i> )	<b>254</b>
<b>EIJ-4.</b> Environment-Based Budget Policy for Sustainable Development in Indonesia ( <i>Joko Tri Haryanto</i> )	<b>263</b>
EHE& EHP Class	
<b>EHE-1.</b> Myopic Models of Addictive on Cigarette in Indonesia ( <i>Noor Syaifudin</i> )	<b>270</b>
<b>EHE-2.</b> Case Study: Correlation Between Climate Variability and Dengue Hemorrhagic Fever (DHF) Incidence in Semarang City During 2002-2011 ( <i>Riska Khausarani Minanda, Budiyo, Sri Winarni, and Sutopo Patria Jati</i> )	<b>279</b>
<b>EHP-1.</b> Effectiveness of Mindfulness-Based Stress Reduction Therapy in High School Environment ( <i>Agustina Ari Handayani</i> )	<b>287</b>
<b>EHP-2.</b> The Impact of Knowledge and Attitude Toward Green Cosmetic Purchase Decision ( <i>Lina and Devinta Fulvia Alvianji</i> )	<b>292</b>
<b>EHP-3.</b> Mother's perception of the operating system, product attributes and the decision making process to buy green product ( <i>Posmaria Sitohang</i> )	<b>303</b>

EDM Class

- EDM-1.** The Inevitability of Vulnerable Road Network in Urban and Regional Planning and Development (*FX Pranoto Dirhan Putra*) 308
- EDM-2.** Barriers to Energy Efficiency in Indonesia: A COMPARISON Across 3 Asian Countries (*Dhani Setyawan*) 314
- EDM-4.** The Disaster Risk Management for Women Home Based Workers (*Daniel Sugama Stephanus*) 327
- EDM-5.** Impact of Climate Change on Human Health (*Yonathan Suryo Pambudi, Angelika Jeany Nathalia, Fransiska, and Purwanti Asih Anna Levi*) 334
- WFE II-1.** The Quality Changes of Black Tiger Shrimp (*Penaeus monodon*) During Handling By Seafood Service Establishments(*Inneke Hantoro, Ita Sulistyawati, and Novia Natalie*) 343

## PREFACE

This Conference Proceedings contains the written versions of all full paper contributions presented in the International Conference on Environment and Health ([www.inceh.org](http://www.inceh.org)). The conference took place at the Theater Room, Thomas Aquinas Building, Soegijapranata Catholic University campus in Semarang – Indonesia, May 22–23, 2013.

The conference was intended as a forum for the discussion of the scientific findings in the area of environment and health and their implementation in the community. Special session is dedicated to environment service learning featuring a number of service learning projects in leading universities in Indonesia as part of SLEA (Service Learning for Environmental Action) projects. Participants at this conference included a wide spectrum of audiences (policy makers, representative of industry, non-governmental organizations, researchers, academicians and students), which have interest on environment and health.

The conference covered a wide variety of environment and health concerns, therefore topics include among others but not limited to:

- Environmental Health and Epidemiology
- Environment and Health Psychology
- Environment and Disaster Management
- Environmental Inequalities and Justice
- Environment Degradation and Social Problems
- Water, Food, and Environment
- Environmental Service Learning

We would like to thank all participants for their contributions to the Conference program and for their contributions to this Proceedings. It is our pleasant duty to acknowledge the financial support from the United Board for Christian Higher Educations in Asia (UBCHEA). We do hope that International Conference on Environment and Health (INCEH) will become annual event hosted by Soegijapranata Catholic University

### **The Editors,**

*Prof. Dr. Y. Budi Widianarko, M.Sc*  
*Probo Yulianto Nugrahedi, STP., MSc*  
*Novita Ika Putri, STP*  
*Irayudi Lazuardi*  
*Dr. Bernadeta Soedarini, MP*

## NURTURING SOLIDARITY THROUGH ECOLOGY: THE USE OF FOOTPRINT-BASED INDICES

**Budi Widianarko**

Graduate Program on Environment and Urban Studies, Soegijapranata Catholic University, Semarang,  
Indonesia  
[widianarko@unika.ac.id](mailto:widianarko@unika.ac.id)

### ABSTRACT

Driven by the need for a tool to compare the extent of current depletion of ecosystem's products or services between various human activities as well as geographical areas the past decade has witnessed a prolific derivation and utilization of footprint based environmental indices (FEIs). Scientists, activists and policy makers engaged with environmental issues are all now familiar with FEIs, such as ecological footprints, carbon footprints, water footprints and virtual water. The most distinctive feature of FEIs is their comparability. FEIs facilitate a quantitative and yet simple comparison of environmental burden of different human activities - expressed in terms of "consumption" of ecosystem's components (water, land, carbon, etc). Although several critics have pointed out FEIs' weaknesses, their quantitative and straight-forward nature, however, keep them exciting in practice. Ecology is not just an academic and scientific discipline. It also serves as an ethical principle. In ecology, coexistence is regarded as the most important aspect of life. One core value to support coexistence is solidarity. It is therefore imperative to promote the value of solidarity in ecological study. Comparison of one or more FEIs values among countries as well as among contrasting segments of population within a country may serve as an excellent trigger for awareness of ecological-solidarity. To optimize the nurture of solidarity through the ecological study the use of *service-learning* methodology is a viable option.

**Keywords:** FEIs - *ecology* – *service learning* - *solidarity*

### INTRODUCTION

As environmental problems is becoming more and more globalized, accordingly there is a need for common yardsticks which can be used for comparison across geographical as well as socio-economic zones. To compare the extent of current depletion of ecosystem's products or services by regions or areas and by various human activities common indices are needed. The past decade has witnessed a prolific derivation of such environmental

yardsticks, in particular those based on footprint calculation. Scientists, activists and policy makers engaged with environmental issues are all now familiar with FEIs, such as ecological footprints, carbon footprints, water footprints and virtual water. Currently, FEIs enjoy high popularity, not only in developed countries but also in developing countries, including Indonesia (see e.g. nation-wide water footprints assessment report by Bulsink *et al.*, 2009).

The use of FEIs is attractive because its single value can describe a complex phenomenon, i.e. human consumption. As mentioned earlier, these indices open possibilities for comparisons – e.g. between countries, regions, community and even households or individuals. FEIs facilitate a quantitative and yet simple comparison of environmental burden of different human activities - expressed in terms of “consumption” of ecosystem’s components (water, land, carbon, etc). In other words, comparability is the most distinctive feature of FEIs. Moreover, in the light of more globalized media, news on world rank of a country’s FEIs easily attracts public attention. A news from Reuter entitled “*Indonesia world's No. 3 greenhouse gas emitter: report*”, for example, looks more eye catching than news on solid wastes disposal into a river (Widianarko, 2012).

One ethical implication of comparing environmental burden or emission of different regions and human activities is solidarity. Climate change for instance, is not a uniform process, especially in terms of causes and impacts. Carbon footprints of countries vary. Likewise, different countries will face different impacts, depending on their geographical position and features. In this case, countries with larger carbon footprints do not necessarily

face a higher impact. This is why involving the value solidarity in climate change discourse is highly relevant.

Ecology as the main pillar of environmental science is not just an academic and scientific discipline. Ecology also serves as an ethical principle. Ecological ethics is part of applied ethics which looks at the moral basis of our responsibility toward the environment. Many authors, e.g. Capra (1982, 1996, 2002); Goldsmith (1998); Cairns (2002) and Bordeau (2004) asserted that ecological world view as a way to circumvent the environmental crisis. Ecological world view was seen by its proponents as a new paradigm to unravel public problems (Capra, 1982; Goldsmith, 1998). Although the term *environmental service learning* is rather new (Madigan, 2000), environmental science (ES) and *service-learning* (SL) seem to be a perfect pair. Ward (1999) stated that these two fields have a natural fit. Since ES and SL are both value laden, ecological studies employing service learning methodology will drive the learners to also learn their roles as citizens. In fact, ESL promotes good environmental citizenship values, including solidarity.

The present paper highlights the strengths and weaknesses of FEIs, as pointed out by

their critics. The potential use of FEIs in nurturing the value of solidarity through the study of ecology is also discussed. In this paper only two FEIs will be used as the illustration, namely *carbon footprint* and *virtual water*.

### **STRENGTHS AND WEAKNESSES OF FEIs**

The most important strength of FEIs is their quantitative and straight-forward nature which keeps their application exciting. In practice, an FEI is attractive because its single value can describe a complex phenomenon, i.e. human consumption. In addition, comparability is the most distinctive feature of FEIs. FEIs facilitate a quantitative and yet simple comparison of environmental burden of different human activities - expressed in terms of “consumption” of ecosystem’s components (water, land, carbon, etc).

However, the underlying concepts or theories of these indices still need to be scrutinized (see e.g. Widianarko, 2012).

*Ecological footprint* is among the first derived FEIs. Other FEIs, such as carbon footprint and water footprint, are actually derived from *ecological footprint*. Initially, *ecological footprint* was proposed by Wackernagel and Rees as a measure of the sustainability of consumption by human

population (Ewing *et al.*, 2008). *Ecological footprint* converts human consumption into land used in production, along with the hypothetical land area needed to assimilate the corresponding wastes. The use of *ecological footprint* is attractive due to the fact that it condenses a complex set of consumption down into a single number, i.e. global hectares.

However, the assumption behind *ecological footprint* calculations have been extensively criticized (Fiala, 2008). When analyzing the connection between development and environmental impact using *ecological footprint*, Moran *et al.* (2008) found that there is a striking relationship between the countries’ stage of development and their footprints. The finding of this analysis that Cuba is the only country which has a minimally sustainable footprint along side with its minimum level of development has triggered many criticisms.

One of the problems with *ecological footprint* calculation related to the dominance of energy which typically constitutes more than 50% of the footprints of most high and middle income countries. This dominance is due to the land area needed to sequester greenhouse gases. While there is an actual need to assimilate greenhouse gases, from an

environmental standpoint it is unclear whether all greenhouse gases should be assimilated or eliminated (Fiala, 2008).

Another strong criticism is related to the fact that *ecological footprint* calculation is based on *ex-post* static input-output analysis, while what is needed is an *ex-ante* scenario (Ferng, 2009). Moreover, Ferng (2009) asserted that *ecological footprint* calculation failed to take into account the land multipliers factor. The relationship between the level of output of a sector and its land requirement may differ between sectors. Crop production is usually proportional to the cultivated land, assuming similar fertility and cultivation practices. However, the same does not hold for manufacturing, commercial buildings and infrastructures usually do not necessarily change proportionally with the output. In short, FEIs actually still suffers from a number of scientific drawbacks.

## **CARBON FOOTPRINT AND VIRTUAL WATER**

An FEIs which has received a world-wide greater attention is *carbon footprint*. One way to measure an individual, organization or nation's contribution to climate change is by means of *carbon footprint*. It has become a widely used term and concept in the discourse on global climate change.

The term carbon footprint is rooted in the concept of an ecological footprint. The ecological footprint concept was established by Mathis Wackernagel and William Rees at the University of British Columbia in the early 1990's. The ecological footprint calculation is designed to embody the human consumption of biological resources and the generation of waste in terms of a utilized ecosystem area, as compared to the biosphere's productive capacity in a given year (Ewing *et al.*, 2008).

*Carbon footprint* stands for a certain amount of gaseous emissions that are relevant to climate change and associated with human production or consumption activities (Wiedmann & Minx, 2008). While its baseline definition is widely accepted, so far there is no consensus on how to quantify *carbon footprint*. It is ranging from direct CO<sub>2</sub> emissions to full life-cycle greenhouse gas emissions - and no standard unit of measurement agreed upon.

*Virtual Water* is another example of FEIs. The concept of *virtual water* has been in place since 1996 initiated by Profesor J.A. Allan (Qadir *et al.*, 2003; SIWI, IFPSRI, ISUCN, IWMI, 2005). Essentially, the *virtual water* concept is based on a premise: "*Trade in food is literally also*

*trade in water*". Water is needed to produce food, accordingly SIWI, IFPSRI, ISUCN, IWMI (2005) stated that "*The total amount of water used to produce a crop is referred to as virtual water*". The international food trade can therefore consequently be equated to virtual water

flows". Table 1 below shows the *virtual water* contents of several food materials and products. *Virtual water* is the water that is virtually embedded in traded commodities. It refers to the *water footprint* of a commodity in the place of production (www.waterfootprint.org).

Table 1. Virtual Water contents of several food-stuffs and products

Product/Foodstuff	Virtual Water	Product/Foodstuff	Virtual Water
Wheat (l/kg)	1150	Beef (l/kg)	15977
Bread (l/kg)	1333	Hamburger (l/kg)	16000
Rice (l/kg)	2656	Chicken meat (l/kg)	2828
Corn (l/kg)	450	Egg (l/kg)	4657
Potato (l/kg)	160	Milk (l/kg)	865
Potato Crisp (l/kg)	925	Cheese (l/kg)	5288
Soybean (l/kg)	2300	Apple (l/kg)	700
Coffee (l/l)	1120	Apple Juice (l/l)	900

FAO & IFAD (2006); Hoekstra & Chapagain (2007)

The underlying motivation of *virtual water* derivation is the rapidly increasing world's population which leads to increasingly scarce water resources in the world. In this case, food production is considered as the largest user of the world's water, i.e. more than 80%. To compensate for the deficit of water and food needs, many countries have chosen to import food from abroad. In this context, water contained in imported food referred to as *virtual water* (Hoekstra and Hung, 2005). In recent years, the interpretation of *virtual water* has been expanded which refers to the water required to produce agricultural commodities and industrial goods. The volume and pattern of consumption and the *virtual water* per ton of product of the

products consumed are the main factors determining the *water footprint* of a consumer (Hoekstra & Mekonnen, 2012). Consumption patterns therefore affect the use of water. A comparison of different consumption patterns can then be expressed in terms of *virtual water*.

## **ECOLOGY, SERVICE LEARNING AND SOLIDARITY**

Ecology is not just an academic and scientific discipline. It also serves as an ethical principle. In ecology, coexistence is regarded as the most important aspect of life. One core value to support coexistence is solidarity. It is therefore imperative to promote the value of solidarity in ecological study. Comparison of one or



more FEIs values among countries as well as among contrasting segments of population within a country may serve as an excellent trigger for awareness of ecological-solidarity. To optimize the nurture of solidarity through the ecological study the use of SL methodology is a viable option.

SL is recently becoming an attractive learning method which has been applied across educational levels, including higher education. The growing interest on SL among universities is most likely due to its multitude promises, i.e. the learning outcomes, beyond conventional learning. As formulated by EPA (2002) SL is a method of encouraging student learning and development through active participation in considerately organized service that is conducted in, and meets the needs of, a community. Seifer & Connors (2007) stated that SL presents the students with “transformational learning experiences” for it increases community understanding among faculty and brings new directions and confidence to the teaching and scholarly pursuits of the faculty involved; moreover it can contribute to social-economic benefits to the community partners.

Despite of its multitude pedagogical advantages, it is only quite recently that SL

has been applied in natural science education. SL has, for quite a while, been associated merely with social sciences and underrepresented in natural sciences (Curry *et al.*, 2002). However, when it comes to environmental studies (ES) SL seems to be the perfect match. Ward (1999) even stated that these two fields have a natural fit. The combination of these two is frequently referred to as environmental service-learning (ESL) (Madigan, 2000). Through this amalgamation, the notion of community is broadened, not only limited to human community but also embracing natural community.

Both SL and ES are two value laden domains. Interestingly, these values are compatible. As mentioned earlier, through SL students will not only learn a subject while providing direct community service but they will also learn their roles as citizens. In fact, SL promotes good citizenship values, in terms of rights and responsibilities of individual in his or her community (Madigan, 2000).

Ecology as the main pillar of ES is not just an academic and scientific discipline. Ecology also serves as an ethical principle. Ecological ethics is part of applied ethics which looks at the moral basis of our responsibility toward the environment.

Several thinkers, e.g. Capra (1982, 1996, 2002); Goldsmith (1998); Cairns (2002) and Bordeau (2004) put their hopes on ecological world view as a way to get out of the environmental crisis deadlock.

Ecological world view was seen as a new paradigm to solve public problems (Capra, 1982; Goldsmith, 1998). As a substitute for mechanical world view, ecological or system paradigms place the total above the parts, process above structure, and relativity above the absolute understanding of external world, knowledge network and information and acclaim. Assumptions in system paradigm require new set of ethics, which are more supporting of life instead of destroying, recognizing interconnectedness of every objects and knowing of humans' place in the network. According to Merchant (1994) human perspective is shifting from mechanistic reductionist – as the product of the ethics of domination of nature of the Enlightenment – towards an ecological world view which is based on interconnectedness, process, and open system.

As defined by Kinne (1997, 1998, 2001, 2002) in Cairns (2002) eco-ethics refer to the principal importance of ecological dynamics for all forms of life on earth. Without natural environment, no human

will be able to survive. Rigoberta Menchu, a Nobel Peace Laureate from Guatemala, once said that “nothing is larger than life coexistence” (see Widianarko, 2007). Everyone would agree that in their entire history *Homo sapiens* depend entirely on the biosphere as a life support system, either as natural capital or ecosystem service (Hawken *et al.*, 1999). Along with the spirit of life coexistence, each human person has responsibilities toward his or her immediate as well as larger community, i.e. global ecosystem. To protect global ecosystem a collaborative global response is required. Leadership and acceptance of differentiated responsibilities must be at the heart of any global environmental agreement (see e.g. Widianarko, 2010).

If peaceful and equitable life coexistence is the ultimate vision of the global community, education has a deep moral obligation to promote the value of solidarity. Solidarity is certainly not a new concept in any religious teachings. In Catholicism, Pope John Paul II pled for solidarity in his address, “From the Justice of Each Comes Peace for All” for the celebration of World Day of Peace, 1 January 1998 wrote

“.....*We are on the threshold of a new era which is the bearer of great hopes*

*and disturbing questions. What will be the effect of the changes taking place? Will everyone be able to take advantage of a global market? Will everyone at last have a chance to enjoy peace? Will relations between States become more equitable, or will economic competition and rivalries between peoples and nations lead humanity towards a situation of even greater instability?*

*For a more equitable society and a more stable peace in a world on the way to globalization, it is an urgent task of the International Organizations to help promote a sense of responsibility for the common good. But to achieve this we must never lose sight of the human person, who must be at the centre of every social project. Only thus will the United Nations become a "family of nations", in accordance with its original mandate of "promoting social progress and better standards of life in larger freedom". This is the path for building a world community based on "mutual trust, mutual support and sincere respect". The challenge, in short, is to ensure a globalization in solidarity, a globalization without marginalization. This is a clear duty in justice, with serious moral implications in the organization of the economic, social, cultural and political life of nations."*

Climate change and other global environmental challenges have confronted the global community with the challenge of building an equitable society. To achieve an equitable society we cannot rely only on international organizations, although they have managed to promote a sense of responsibility for the common good among nations. The global community has a duty to ensure "a globalization in solidarity, a globalization without marginalization".

In the case of climate change, for example, Stern & Noble (2008) endorsed three basic criteria of global action, i.e. effectiveness, efficiency, and equity. To respect the value of life coexistence, equity should be in the heart of all environmental decision making. Wealthy countries are responsible for the bulk of past emissions. The same holds true for wealthy families or individuals in a country. The deficiency of the global agreement of on climate change, has clearly demonstrated how countries are still imprisoned by their own interests, rather than seeking for a mutual win-win solution (Widianarko, 2010). In other words, the fight against climate change is more a problem of ethics rather than merely a technical obstacle.

While the discourse on climate change has occupied so much space in both the local

and global arena, the solidarity dimension is somewhat neglected. At the global level, climate change is not a uniform process, especially in terms of causes and impacts. The contribution to the carbon footprint by countries varies. Likewise, different countries will face different impacts, depending on their geographical position and features. Ironically, countries with larger carbon footprints do not necessarily face a higher impact.

The challenges posed by climate change are significant and demand strong commitment and leadership at all levels of government and society. Moreover, the interconnectedness of the environmental, economic, political, social, and spiritual challenges is becoming increasingly obvious, there is urgent need for what Flemming (2009) called as “shared vision of basic values to provide an ethical foundation for the emerging world community”. According to Flemming (2009) such a vision can be found in the Earth Charter which provides sixteen “interdependent principles for a sustainable way of life as a common standard by which the conduct of all individuals, organizations, businesses, governments, and trans-national institutions is to be guided and assessed”.

Principle 14 of the Earth Charter emphasizes the need to “integrate into formal education and life-long learning the knowledge, values, and skills needed for a sustainable way of life” (Hessel, 2002). According to Flemming (2009) education is critical in the promotion of sustainable development and improving the capacity of people to address environmental and developmental issues. Education is also critical in achieving environmental and ethical awareness, values and attitudes, skills and behavior coherent with sustainable development, and for effective public participation in decision-making. As a special case, universities are “an integral part of the global economy, and since they prepare most of the professionals who develop, manage and teach in society’s public, private and non-government institutions, they are uniquely positioned to influence the direction we choose to take as a society” (The Talloires Declaration 1990 - Association of University Leaders for A Sustainable Future quoted in Flemming, 2009).

ESL seems to answer the above call. The combination of ES and SL will, in fact, nurture two compatible values, i.e. societal and ecological citizenships. Ward (1999) further notes that through ESL students can see more clearly the impacts of environmental negligence and witness

policy implications at a grassroots level. Moreover, environmental studies require an outlook beyond students' immediate or local community but should also incorporate international engagement to promote significant learning in higher education (Parker *et al.*, 2004). As suggested by Madigan (2000) promising practices of ESL may include: (1) encourages youth leadership and decision-making; (2) integrates and values the community voice; (3) fosters civic stewardship; (4) provides opportunities for cross-cultural connections; and, (5) plans for the long-term sustainability.

### THE APPLICATION

One way to measure an individual, organization or nation's contribution to

climate change is by calculating its "carbon footprint". It has become a widely used term and concept in the discourse on global climate change. The term *carbon footprint* is rooted in the concept of *ecological footprint* (Ewing *et al.*, 2008). Regardless its limitation, however, the *carbon footprint* accounting now serves as a tool for identification and comparison of carbon contribution by individuals, organizations or nations. Recently, Hertwich & Peters (2009) proposed a new calculation method which is based on a single, trade-linked model of the global economy. The model is claimed to offers the most consistent global comparison across countries currently available.

Table 2. Per Capita GHG Footprint of a Selection of Asian Countries in 2001  
(Widianarko, 2010 adapted from Hertwich & Peters, 2009)

	Hong Kong	Japan	Taiwan	Korea	Thailand	Indonesia	Philippines
Footprint [tCO <sub>2</sub> e/p]*	<b>29.0</b>	<b>13.8</b>	<b>11,3</b>	<b>9.2</b>	<b>3,2</b>	<b>1.9</b>	<b>1,9</b>
Domestic Share	17%	68%	68%	75%	78%	89%	76%
Population (million)	7.2	126.8	22.3	47.6	62.8	213.3	79.9
Construction	13%	14%	10%	11%	11%	8%	8%
Shelter	8%	12%	17%	15%	12%	20%	13%
Food	7%	11%	14%	12%	21%	28%	36%
Clothing	28%	4%	2%	3%	4%	1%	1%
Manufactured products	20%	15%	16%	12%	8%	4%	5%
Mobility	11%	22%	21%	32%	25%	22%	17%

Service	9%	18%	15%	19%	17%	16%	17%
Trade	7%	8%	7%	7%	2%	1%	4%

\*) tCO<sub>2</sub>e/p = tons of CO<sub>2</sub> equivalent per capita

Based on Hertwich & Peters (2009) calculation, we can see that there is a great variation of per capita GHGs footprint between countries in Asia (Table 2). The Per capita carbon footprint of Hong Kong, for example, is about 14 times higher than those of Indonesia and the Philippines. Globally, carbon dioxide emissions per person are also very unequal and the gap is widening. According to the concept of equitable ecological space the “per capita right to emit carbon dioxide” for a sustainable carbon future is estimated at 1.8 tons CO<sub>2</sub> (MacGregor & Vorley, 2006). This estimate represents the

estimated absorptive capacity of natural carbon sinks, both on land and at sea.

Similarly, a closer look at each country will probably reveal a highly unequal distribution of carbon footprints between segments of the population. So, carbon footprint gaps can, indeed, be found between countries, as well as between the segments of a population within a country, i.e. due to economic status, geographical settlements or occupations.

A service-learning based study in three different settlements revealed the effectiveness of *carbon footprint* to trigger the need for solidarity (Figure 1).

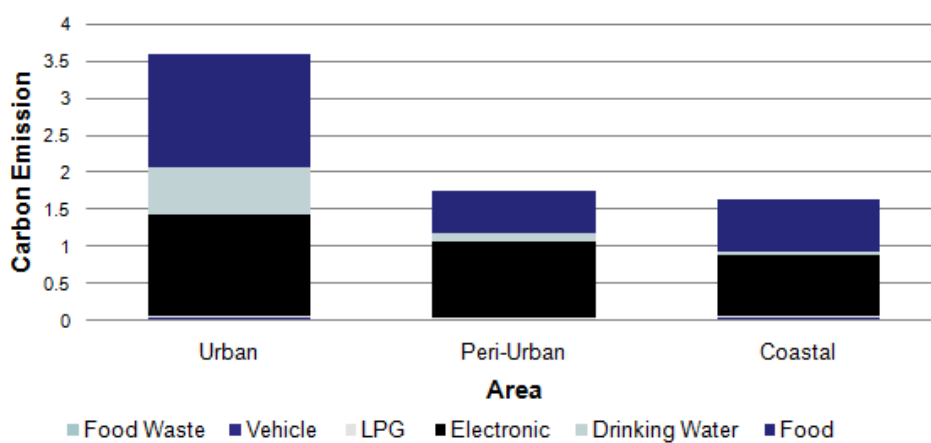

Figure 1. Comparison of per capita carbon footprint (tonnes CO<sub>2</sub>/year) between urban, peri urban and coastal settlements (Widianarko *et al.*, 2010)

Several lessons can be learned from this SL activity (Widianarko *et al.*, 2010). In general, two objectives of this project were met, namely (1) to train students to master the *carbon footprint* calculation and (2) to put the results of the carbon calculation into the context of solidarity. The second objective of the activity was met after the repeated reflection session, when a larger proportion of student participants have been starting to grasp how and what the carbon footprint reflection is all about. The successful application of the outcome of this project, i.e. a new syllabus for *carbon footprint* and Solidarity course, is not improbable. The deliberate choice of Service Learning approach has proven to

enable students to gain expertise in carbon footprint calculation, and at the same time to be able to make a reflection on the solidarity aspect of *carbon footprint*.

Similar to *carbon footprint*, *virtual water* is another potential solidarity triggering FEI. Two parallel studies on food consumption of students from two economically-contrasting high schools in Semarang, Indonesia revealed significantly different values of *virtual water* per capita, expressed in liters of virtual water consumed per week (Feronica, 2011 & Pragnunadi, 2011).

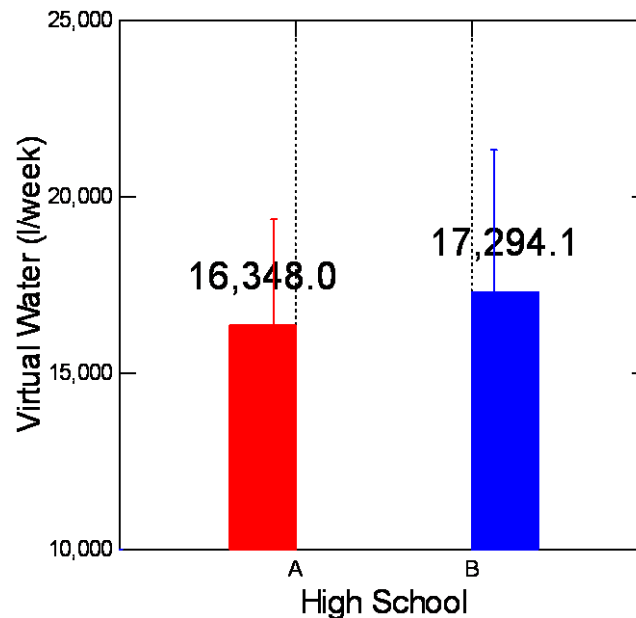

Figure 2. Comparison of Food-based Virtual Water of Students from Two High School in Semarang

\*) VIRTUAL WATER values are significantly different ( $p < 0.01$ ) based on the two-sample t-test with Benferroni adjustment, sample sizes are, respectively 80 and 100 for High School A and B. The figure is adapted from Feronica (2011) and Pragnunadi (2011).

Figure 2 showed that the gap of *virtual water* between students from two economically contrasting schools economically is almost 1,000 liters or approximately 50,000 liters annually. This difference can be explained by the differences in consumption patterns (Feronica, 2011 & Pragunadi, 2011). Learning from the *carbon footprint* study, it can be anticipated that application of SL methodology in *virtual water* or *water footprint* study will provide an opportunity to instill the spirit of solidarity among the learners. If a reflection session is properly designed, the technical issue *water footprint* gap can be naturally shifted to the notion of solidarity.

### **EPILOGUE**

Ecology is not just an academic and scientific discipline. It also serves as an ethical principle. In ecology, coexistence is regarded as the most important aspect of life. One core value to support coexistence is solidarity. It is therefore imperative to promote the value of solidarity in ecological study.

Although several critics have pointed out FEIs' weaknesses, their quantitative and straight-forward nature, however, keep them exciting in practice. Comparison of one or more FEIs values among countries as well as among contrasting segments of

population within a country may serve as an excellent trigger for awareness of ecological-solidarity.

One ethical implication of comparing environmental burden or emission of different regions and human activities is solidarity. Carbon emission or water consumption, for instance, is not a uniform process, especially in terms of causes and impacts. Footprint based ecological assessment, i.e. evaluation of environmental burden of different human activities - expressed in terms of "consumption" of ecosystem's components, provides opportunity for straight forward comparison. Along this line, gap of footprint can also be easily determined.

Employing SL methodology in FEIs focused ecological studies may provide an opportunity to instill the spirit of solidarity among the learners. If a reflection session of SL is properly designed, the technical issue of FEIs gap can be naturally shifted to the notion of solidarity.

### **REFERENCES**

- Bourdeau, Ph. (2004). The man-nature relationship and environmental ethics. *Journal of Environmental Radioactivity* 72 : 9–15
- Bulsink,F., A.Y. Hoekstra & M.J. Booij (2009). The Water Footprint of Indonesian Provinces related to the Consumption of Crop Products. Value of Water Research Report



Series No. 37. UNESCO-IHE Institute for Water Education, University of Twente and Delft University of Technology.

Cairn Jr, J. (2002). Sustainability and sacred value. *Ethics in Science and Environmental Politics* 2002: 15-27.

Capra, F. (1982) *Turning Point - Science, Society and the Rising Culture*. Flamingo-HarperCollins Publishers. London.

\_\_\_\_\_ (1994). Systems theory and the new paradigm. In C. Merchant (ed.): *Ecology, Key Concepts in Critical Theory*. Humanities Press. New Jersey. p. 334-341.

\_\_\_\_\_ (1996). *The Web of Life – A New Synthesis of Mind and Matter*. Flamingo-Fontana Paperbacks. London.

\_\_\_\_\_ (2002). *The Hidden Connections – A Science for Sustainable Living*. HarperCollins Publishers. London.

Curry, J.M., G. Heffner & D. Warners (2002). Environmental Service-Learning: Social Transformation through Caring for a Particular Place. *Michigan Journal of Community Service Learning*. Fall 2002: 58-66

EPA (2002). *Service-Learning. Education beyond Classroom*. Washington D.C. Environmental Protection Agency. 32 p.

Ewing B., S. Goldfinger, M. Wackernagel, M. Stechbart, S. M. Rizk, A. Reed & J. Kitzes (2008). *The Ecological Footprint Atlas 2008*. Global Footprint Network. Oakland.

FAO & IFAD (2006). *Water for food, agriculture and rural livelihoods*. In UN-Water: *Water – A Shared Responsibility*. The United Nations World Water Development Report 2. UNESCO & Berghann Books. Paris – New York. p. 243-273

Ferng, J-J (2009). Applying input-output analysis to scenario analysis of ecological footprints. *Ecological Economics* 69: 345-354

Feronica, S. (2011). *Study of Virtual Water Based on Food Consumption among Karangturi Senior High School Students in Semarang*. BSc. Thesis. Food Technology Department – Soegijapranata Catholic University. 63 p.

Fiala, N. (2008). Measuring sustainability: Why the ecological footprint is bad economics and bad environmental science. *Ecological Economics* 67: 519-525

Fleming, M.L. (2009). Ecological sustainability: What role for public health education? *Int. J. Environ. Res. Public Health* 6: 2028-2040.

Goldsmith, E. (1998). *The Way: An Ecological World-View*. Revised and Enlarged edition. The University of Georgia Press. Athens.

Hawken, P., A. Lovins & L.H. Lovins (1999). *Natural Capitalism: Creating Next Industrial Revolution*. Little, Brown & Co. London.

Hessel, D.T. (2002). *The Earth Charter: Guide to a sustainable way of life*. In Biodiversity Project: *Ethics for A Small Planet*. Biodiversity Project. Madison.

Hertwich, E.G. & G.P. Peters (2009). Carbon footprint of nations: A global, trade-linked analysis. *Environ. Sci. Technol.* 43: 6414-6420.

Hoekstra, A.Y. & P.Q. Hung. (2005). Globalisation of Water Resources: International Virtual Water Flows in Relation to Crop Trade. *Global Environmental Change* 15: 45–56

Hoekstra, A.Y. & A. K. Chapagain (2007). Water footprints of nations: Water use by people as a function of their consumption pattern. *Water Resource Management* 21:35–48

Hoekstra, A.Y. & M. M. Mekonnen (2012). The water footprint of humanity. *PNAS* 109(9): 3232-3237

John Paul II (1998). *From the justice of each comes peace for all*. Message of His Holiness

Pope John Paul II for The Celebration of The World Day of Peace, 1 January 1998.

MacGregor, J. & B. Vorley (2006). Fair Miles? The concept of “food miles” through a sustainable development lens. *Sustainable Development Opinion*. The International Institute for Environment and Development (IIED). London

Madigan, P. (2000). *The Environmental Service-Learning Research Project*. Washington DC: Corporation for National Service National Service Fellowship Program. 89 P.

Moran, D.D., M. Wackernagel, J. A. Kitzes, S.H. Goldner & A. Boutaud (2008). Measuring sustainable development - Nation by nation. *Ecol. Econ.* **64**:470-474.

Parker, J., R. Wade & H. Atkinson (2004). Citizenship and community from local to global: Implications for higher education of a global citizenship approach. In J. Blewitt & C. Cullingford (Eds.), *The sustainability curriculum: The challenge for higher education*. Sterling, VA: Earthscan.

Pragunadi, N.G. (2011). Virtual Water Study Based on Food Consumption among Mataram Senior High School Students. BSc. Thesis. Food Technology Department – Soegijapranata Catholic University. 74 p.

Qadir, M., Th. M. Boers, S. Schubert, A. Ghafoor & G. Murtaza (2003). Agricultural water management in water-starved countries: Challenges and Opportunities. *Agricultural Water Management* **62**: 165-185

Seifer, S.D. & K. Connors (Eds.) (2007). *Community Campus Partnerships for Health. Faculty Toolkit for Service-Learning in Higher Education*. Scotts Valley, CA: National Service-Learning Clearinghouse.

SIWI, IFPRI, IUCN, IWMI (2005). Let It Reign: The New Water Paradigm for Global Food Security. Final Report to CSD-13.

Stockholm International Water Institute. Stockholm.

Stern, N. & I. Noble (2008). Achieving low carbon growth for the world: Key elements for a global deal. *Development Outreach* 10(1): 4-7.

Ward, H. (1999). Why is service-learning so pervasive in environmental studies programs?. In H. Ward (Ed.), *Acting locally: Concepts and models for service-learning in environmental studies*. Sterling, VA: Stylus.

Widianarko, B. (2007). Can Hydrospirituality Ensure Water Sustainability?. *Global Spiral* (e-publication of Metanexus Institute. Philadelphia).

\_\_\_\_\_. (2010). Paving pathway to sustainable Asia: Enhancing the roles of Christian Higher Education Institutions. Keynote Speech at the Biennial Conference, General Assembly of ACUCA. Keimyung University, Daegu, 1 Nov 2010.

\_\_\_\_\_. (2011). Service Learning in Environmental Sciences: Nurturing Two Compatible Values. Workshop on Service Learning for Environmental Action". Soegijapranata Catholic University & UBCHEA. Semarang, August 2, 2011.

\_\_\_\_\_. (2012). The Dilemma of Global Environmental Measures. Colloquium on “Environmental Ethics in Practice: Climate Change, Nuclear Energy and Care”, Soegijapranata Catholic University, July 21, 2012.

Widianarko, B., W. Hadipuro, S. Weru & D.S. Djati (2011). *Coping with Climate Change: Integrating Carbon Footprint Solidarity into University Education through a Service Learning Approach*. Report of a UB Sponsored Project. Soegijapranata Catholic University. 14 p.

## **SOURDOUGH BREAD: PROCESSING, FLAVOR AND HEALTH BENEFITS**

**Victoria Kristina Ananingsih and Laksmi Hartayanie**

Department of Food Technology, Soegijapranata Catholic University, Semarang, Indonesia  
[victoriakristina@yahoo.com](mailto:victoriakristina@yahoo.com)

### **ABSTRACT**

Sourdough is an ingredient containing cereal components, liquids and active microorganisms which are lactic acid bacteria (LAB) and yeast. Traditional sour dough bread technology is based on a spontaneous fermentation process from LAB and yeast that occurring naturally in flour. Classic sourdough preparation is a multiple stage process that starts with a mixture of flour and water left for a specific period of time. Temperature, dough consistency, and dough resting time at each stage determine the development of active microflora. The modern biotechnology of baked goods largely uses sourdough as a natural leavening agent because of the many advantages it offers over baker's yeast especially in the development of the characteristic flavour of bread that resulting in a final product with high sensory quality. Organic acids together with alcohols, esters, carbonyl compounds and others, strongly affect the flavor of sourdough bread. Furthermore, sourdough fermentation has several health benefits which are reducing antinutritional compounds, enhancing nutritional values, converting toxic compounds and producing antimicrobial substances.

**Keywords:** *sourdough, bread, processing, flavor, health benefits*

### **INTRODUCTION**

The modern biotechnology of baked goods largely uses sourdough as a natural leavening agent because of the many advantages it offers over baker's yeast especially in the development of the characteristic flavour of bread that resulting in a final product with high sensory quality.

Sourdough is an ingredient containing cereal components, liquids and active microorganisms which are lactic acid bacteria (LAB) and yeast. A general procedure of the entire manufacturing process used in sourdough bread production is shown in Figure 1 (Hansen & Schieberle, 2005). The generation of sufficient amounts of volatile

compounds during sourdough fermentation needs a multiple step process of about 12–24 h, while fermentation by bakers yeast alone is finished within a few hours. Sourdough bread has a higher content of volatiles and, also, achieves higher scores in sensory tests compared to bread chemically acidified with lactic and acetic acid (Hansen & Hansen, 1996). In recent years there has been a growing interest in sourdough bread production because of its health benefits (Diowksz & Ambroziak, 2006).

### **MICROORGANISMS IN SOURDOUGH**

The traditional production of sourdough is based on spontaneous fermentation due to the development of microflora naturally present in

the raw material. At the very beginning of the fermentation process, bacteria from the family Enterobacteriaceae are dominant. They produce mainly hydrogen (H<sub>2</sub>) and carbon dioxide (CO<sub>2</sub>) and small amounts of organic acids: lactic, acetic, formic, and succinic acids. After this stage, in which the preliminary acidification takes place, the number of gram-negative bacteria decreases, and gram positive bacteria and yeast start to dominate (Gobbetti, 1998).

### Lactic acid bacteria

LAB isolated from traditional sourdough belong mainly to four genera: *Lactobacillus*, *Pediococcus*, *Leuconostoc*, and *Weissella*. In most cases lactobacilli are the dominating bacteria. They are gram positive, nonmotile rods, anaerobes and acid tolerant. These bacteria have complex nutritional requirements for amino acids, peptides, vitamins, minerals, fatty acids, and carbohydrates. Their proteolytic activity and the metabolic profile depend on growth temperature. The optimal temperature for growth is 30 -35 °C (Meuser et al, 1990).

On the basis of dominant carbohydrate metabolic pathway, lactic acid bacteria can be divided into two groups (Martinez-Anaya et al, 1994): (1) homofermentative, which produce mainly lactic acid; and (2) heterofermentative, which produce, apart from lactic acid, considerable amounts of ethanol, acetic acid, and carbon dioxide (Figure 2). Homofermentative lactic acid bacteria dominate spontaneously fermenting

sourdough. Homofermentative LAB strongly influence crumb porosity and elasticity but have limited influence on the sensory qualities of sourdough bread (Sugihara, 1985). Heterofermentative LAB plays the main role in creating bread flavor due to characteristic of their metabolites (Damiani et al, 1996). Sourdough lactobacilli, consisting of obligately and facultative heterofermentative, and obligately homofermentative can be seen in Table 1.

### Yeast

In the course of fermentation, yeast plays several important roles. First, it produces carbon dioxide, which expands the dough, resulting in the proper porosity of the crumb and the proper volume of the bread. Besides, yeast produces a lot of side products such as aldehydes, aliphatic and isoaliphatic alcohols, acids, keto acids, and esters, which alone or in combination with other compounds can create specific and unique flavors of bread (Hansen & Hansen, 1996).

Several yeasts are found in sourdoughs but *Saccharomyces cerevisiae* is considered the dominant organism for leavening of bread (Corsetti et al., 2001). *Saccharomyces cerevisiae*, characteristic mainly for sourdough, is a top fermenting yeast with an optimum growth temperature of 26-32 °C. It is an aerobe or facultative aerobe. It utilizes glucose, maltose,

galactose, sucrose, and partly raffinose (Gobbetti, 1998). The frequently dominant *S. cerevisiae* is often introduced through the addition of baker's yeast. Important yeasts in sourdough starters include *Saccharomyces exiguous* (physiologically similar to *Candida milleri*), *Candida krusei*, *Pichia norvegensis* and *Hansenula anomala*. The extensive variability in the number and type of species found depends on several factors, including degree of dough hydration [dough yield (DY) = weight of dough/weight of flour · 100], type of cereal used, leavening temperature, and sourdough maintenance temperature (Gobbetti et al., 1995).

### **Mixed cultures of LAB and yeasts**

Mixed cultures of LAB and yeasts vary in composition in sourdough sponges. The use of mixed cultures has a number of important advantages, such as improved flavour and texture and retained freshness for longer compared to baker's yeast bread (Meignen et al., 2001). In such mixed cultures, yeasts act mainly as leavening agents, while LAB contribute mainly to the flavouring compounds of bread.

## **FLAVOR**

Sourdough fermentation is essential to achieve an acceptable flavour, since a comparison between chemically acidified bread and sourdough bread showed that the latter possessed a superior sensory quality (Kirchhoff & Schieberle, 2002).

### **Types of flavouring compounds in sourdough breads**

There are two categories of flavour compounds, produced during sourdough fermentation. Non-volatile compounds including organic acids produced by homo- and heterofermentative bacteria which acidify, decrease pH and contribute aroma to the bread dough. The second category is volatile compounds of sourdough bread - includes alcohols, aldehydes, ketones, esters and sulphur. All these compounds are produced by biological and biochemical actions during fermentation and contribute to flavour (Spicher, 1983).

Microbial metabolisms verify production of different volatile compounds for hetero- and homo-lactic LAB fermentations. Abundant products of yeast fermentation are 2-methyl-1-propanol, 2,3 methyl-1-butanol and other iso-alcohols. Heterofermentative LAB products are dominated by ethyl acetate and certain alcohols and aldehydes whereas major homofermentative LAB products are diacetyls and carbonyls.

### **Effect of ingredients and processing on the sourdough flavor**

The LAB strains of sourdough vary in metabolism and aroma compounds. Monoculture fermentation of dough for 15 h at 30 °C, followed by mixing and a further 10 h fermentation has shown increase in the production of sourdough volatile compounds (Merotha et al., 2004). Using only yeasts in wheat bread, seven volatiles were found abundant: acetaldehyde, acetone, ethyl acetate, ethanol, hexanal, isobutyl alcohol, and propanol. The quantity of volatile flavour compounds can be improved by the addition of glucose and sucrose less by maltose. Addition of enzymes to sourdough sponges can also enhance bread volatile compounds (Martinez-Anaya, 1996).

Low temperature (25°C) and sour dough firmness are appropriate for LAB souring activities but limited yeast metabolism. Raising the temperature to 30 °C and semi-fluid sour doughs gave more complete volatile profiles. At 3 h leavening time, the sour dough is mainly characterized by iso-alcohols. An increase of leavening time up to 9 h gave a total amount of volatiles about three times higher than that at 5 h and strengthened the LAB contribution. The additions of fructose and citrate to the dough enhanced the acetic acid and volatile synthesis by LAB, respectively. After baking, the ethanol disappeared, 2-methyl-propanal is synthesized, lactic and acetic acids remained constant, the total amount of volatiles is

reduced to a level <12.5% of the initial and an increase in the relative percentage of iso-alcohols and aldehydes are detected (Gobbetti et al, 1995).

### **Contribution of lactic acid fermentation to bread flavor.**

The ratio between lactic and acetic acid, defined as the fermentation quotient (FQ), is an important factor that might affect the aroma profile, although it is also relevant for the structure of final products. Acetic acid, produced by heterofermentative LAB, is responsible for a shorter and harder gluten while lactic acid can gradually account for a more elastic gluten structure (Lorenz, 1983). Compounds strongly affecting bread flavour are mainly organic acids, alcohols, esters and carbonyls (Kirchhoff & Schieberle, 2002). In order to generate sufficient amounts of volatile compounds, the generation process needs multiple steps of about 12–24 h; when baker's yeast is used the fermentation is completed within a few hours (Hansen & Schieberle, 2005).

Sourdoughs made with both LAB and yeasts resulted in more aroma compounds as compared to sourdoughs made from single starter based either on LAB (e.g. *Lb. brevis*) or yeast (e.g. *S. cerevisiae*). Sourdoughs with a higher relative percentage of yeast-derived fermentation products are produced if a combination of *S. cerevisiae* with *Lb. sanfranciscensis* and *Lb. plantarum* is used during the sourdough fermentation process (Gobbetti, Corsetti, & Rossi, 1995). This

observed increased production of aroma compounds in a mixed-starter process appears to be related to the proteolytic activity of LAB.

## HEALTH BENEFITS

### Reduction of antinutritional compounds

Cereal grains are important sources of minerals such as iron, potassium, magnesium and zinc, but also contain phytic acid or myo-inositol hexakiphosphate, which is considered to be an anti-nutritional factor for humans. Its anti-nutritional property is due to the central hexaphosphate ring that acts as a chelator of dietary minerals preventing their absorption and thus reducing their bioavailability (Lopez et al., 2001). Phytases are widely present in plant materials such as wheat and rye flours, whose level depends on variety and crop year, but generally reported to be insufficient to significantly decrease the amount of phytic acid. However, it has been recently published that a moderate decrease of pH by sourdough fermentation is sufficient to reduce phytate content of whole wheat flour through endogenous phytase activity (Leenhardt et al, 2005).

A study on the characterization of phytase activity of sourdough microorganisms showed that combining selected yeasts and LAB it is possible to reach high level of phytate biodegradation and the best combination are *S.cerevisiae/Lb. plantarum/Leuconostoc mesenteroides* (Chaoui, Fais, & Belhcen, 2003). These results emphasize microbial potential in improving the nutritional quality

of cereal-based products. Phytate degradation in sourdough, resulting from LAB and yeast development, effectively prevents deficiencies of zinc, calcium, iron, and other essential minerals (Lopez et al, 2001)

### Enhancement of nutritional values

It is worth stressing that sourdough technology allows production of 100% rye and whole meal breads, which are considered to possess increase nutritive value, mainly due to the elevated level of dietary fiber. Regular consumption of such bread reduces the risk of variety of chronic diseases such as cardiovascular disease, diabetes, and some forms of cancer and prevents premature death (Linko et al, 1997).

Sourdough bread digestibility is enhanced by enzymatic processes that take place during fermentation and increase the content of easily available carbohydrates and proteins. Health benefit of LAB development in sourdough are based mainly on lactic acid production, which results in a decrease in pH below the point at which undesirable bacteria can grow. In the human digestive tract this factor controls the quality of intestinal microflora, ensuring the proper course of digestion and excretion. Consumption of lactic-acid containing products is advised in intestinal tract malfunctions such as chronic gastritis, hyperacidity, chronic colitis, or diarrhea of unknown etiology. Lactic acid is permitted in liver, kidney or pancreas malfunction (Hammes & Tichaczek, 1994).

Sourdough can be effective in lowering serum triglyceride and cholesterol levels as well as improving the ratio between HDL and LDL fractions. This effect may result from exopolysaccharide production occurring during sourdough fermentation (Tieking et al, 2003). In addition, acetic acid in sourdough bread can enhance the salty taste, which reduces the amounts of salt used for bread production. This factor is for great importance, especially in the case of kidney problem and hypertension.

The use of bakery starter cultures enables nutrient enrichment of bread. LAB and yeast convert minerals from the culture medium into bioavailable organic forms. Selenium supplementation may serve as a good example of elevating the content of an element deficient in the diet via sourdough bread enrichment (Diowksz et al, 2000).

### **Conversion of toxic compounds**

Sourdough bread owes its popularity to its naturalness and tradition, however, due to its gluten content, it is toxic to people affected by celiac sprue (CS), also known as gluten-sensitive enteropathy, an autoimmune disease of the small intestinal mucosa. Ingestion of gluten causes self-perpetuating mucosal inflammation and subsequent loss of absorptive villi and hyperplasia of the crypts. The list of proteins that liberate toxic peptides also includes high molecular weight glutenins. Further proteolysis of such toxic peptides is made difficult by the position and abundance of proline residues (Hausch et al, 2003). For

the above reasons, persons affected by CS cannot ingest gluten-containing products such as bread or pasta. Lactobacilli have been shown to possess an outstanding potential in decreasing the CS-inducing effects of gluten. Di Cagno et al. (2004) demonstrated active hydrolysis of various Pro-rich peptides, including the 33-merpeptide mentioned above, by some Lactobacillus species. Following this, the mixed starter composed of *Lb. alimentarius*, *Lb. brevis*, *Lb. sanfranciscensis* and *Lactobacillus hilgardii* was shown to almost completely hydrolyze gliadin fractions and consequently the resulting bread was tolerated by CS patients (Di Cagno et al., 2004).

### **Production of antimicrobial substances**

In general, LAB play a crucial role in the preservation and microbial safety of fermented foods, thus promoting the microbial stability of the final products of fermentation (Caplice & Fitzgerald, 1999). Since LAB naturally occur in various food products, they have traditionally been used as natural food biopreservatives. Apart from lactic acid, other by products such as acetic acid, formic and propionic acids, ethanol and CO<sub>2</sub> inhibit the growth of spoilage microflora, preventing the growth of pathogens and putrid microorganisms. This effect is intensified by oxygen removal, which prevents the growth of acid-tolerant molds (De Vuyst & Vandamme, 1994). Protection of foods is also due to the production of antifungal compounds such as fatty acids or phenyllactic acid, bacteriocins



and antibiotics such as reutericyclin (De Vuyst & Vandamme, 1994). Lactic acid bacteria substances of bacteriocin character effectively inhibit the development of pathogens such as *Listeria monocytogenes* or *Bacillus subtilis* that cause defects in bread during storage and are potentially dangerous to human health. This strong antimicrobial effect of sourdough eliminates the use of artificial preservatives (Caplice & Fitzgerald, 1999). Fundamental features of an antimicrobial substance to be active under food conditions is that it is produced at active concentrations and that the effect is not masked by food components.

## CONCLUSION

The metabolic activities of sour dough lactic acid bacteria (LAB) and yeasts are involved in the development of the characteristic bread flavor. Organic acids together with alcohols, esters, carbonyl compounds and others, strongly affect bread flavour. Even though precursors are present in wheat flour and the largest amount of flavor substances are formed during baking, sourdough fermentation is essential to achieve an acceptable flavour, since chemically acidified bread failed in the sensory quality. Furthermore, sourdough fermentation has several advantages which are reducing antinutritional compounds, enhancing nutritional values, converting toxic compounds and producing antimicrobial substances.

## REFERENCES

- Caplice, E., & Fitzgerald, G. F. (1999). Food fermentations: role of microorganisms in food production and preservation. *International Journal of Food Microbiology*, 50, 131–149.
- Corsetti, A., & Settanni, L. (2007). Lactobacilli in sourdough fermentation. *Food Research International*, 40, 539–558.
- Corsetti, A., Lavermicocca, P., Morea, M., Baruzzi, F., Tosti, N., & Gobbetti, M. (2001). Phenotypic and molecular identification and clustering of lactic acid bacteria and yeasts from wheat (species *Triticum durum* and *Triticum aestivum*) sourdoughs of Southern Italy. *International Journal of Food Microbiology*, 64, 95–104.
- De Vuyst, L., & Vandamme, E. J. (1994). Antimicrobial potential of lactic acid bacteria. In L. De Vuyst & E. J. Vandamme (Eds.). *Bacteriocins of lactic acid bacteria: microbiology, genetics and applications* (pp. 91–142). London: Blackie Academic and Professional.
- Di Cagno, R., De Angelis, M., Auricchio, S., Greco, L., Clarke, C., & De Vincenzi, M. (2004). Sourdough bread made from wheat and nontoxic flours and started with selected lactobacilli is tolerated in celiac sprue patients. *Applied and Environmental Microbiology*, 70, 1088–1096.
- Diowksz, A & Ambroziak, W. (2006). Sourdough. In *Bakery Products Science and Technology*. Blackwell Publishing. Iowa, USA.
- Diowkz, A., Peczkowska, B., Włodarczyk, M., & Ambroziak, W. (2000). Bacteria-yeast and plant biomasses enriched in Se via bioconversion process as a source of selenium supplementation in food. *Food Biotechnology*, 17, 295.
- Gobbetti, M., Corsetti, A., & De Vincenzi, S. (1995). The sourdough microflora. Characterization of homofermentative lactic acid bacteria based on acidification kinetics and impedance tests. *Italian Journal of Food Science*, 2, 91–102.

- Gobbetti, M., Simonetti, M. S., Corsetti, A., Santinelli, F., Rossi, J. & Damiani, P. (1995). Volatile compound and organic acid productions by mixed wheat sour dough starters: influence of fermentation parameters and dynamics during baking. *Food Microbiology*, 12, 497-507.
- Gobbetti, M. (1998). The sourdough microflora: Interactions of lactic acid bacteria and yeast. *Trends in Food Science Technology*, 9, 267.
- Hammes, W. P., & Tichaczek, P. S. (1994). The potential of lactic acid bacteria for the production of safe and whole some food. *Z Lebensm Unters-Forsch*, 198, 193.
- Hammes, W. P., & Vogel, R. F. (1995). The genus *Lactobacillus*. In B. J. B. Wood & W. H. Holzappel (Eds.), *The Genera of Lactic Acid Bacteria* (pp. 19–54). London: Blackie Academic and Professional.
- Hansen, A., & Hansen, B. (1996). Flavour of sourdough wheat bread crumb. *Zeitschrift fuer Lebensmitteluntersuchung und -Forschung*, 202, 244–249.
- Hansen, A., & Schieberle, P. (2005). Generation of aroma compounds during sourdough fermentation: applied and fundamental aspects. *Trends in Food Science & Technology*, 16, 85–94.
- Hausch, F., Shan, L., Santiago, N. A., Gray, G. M., & Khosla, C. (2003). Intestinal digestive resistance of immunodominant gliadin peptides. *American Journal of Physiology*, 283, 996–1003.
- Kirchhoff, E., & Schieberle, P. (2002). Quantitation of odor-active compounds in rye flour and rye sourdough using a stable isotope dilution assay. *Journal of Agricultural and Food Chemistry*, 50, 5311–5378.
- Linko, Y. Y., Javanainen, P., & Linko, S. (1997). *Biotechnology of bread baking*. *Trends in Food Science and Technology*, 8, 239.
- Lopez, H. W., Krespine, V., Guy, C., Messenger, A., Demigne, C., & Remesy, C. (2001). Prolonged fermentation of whole wheat sourdough reduces phytate level and increases soluble magnesium. *Journal of Agriculture and Food Chemistry*, 49, 2657.
- Lorenz, K. (1983). Sourdough processes. *Methodology and biochemistry. Baker's Digest*, 55, 85–91.
- Martinez-Anaya, M. A., Llin, M. L., Macias, M. L. and Collar, C. (1994). Regulation of acetic acid production by homo and heterofermentative lactobacilli in whole-wheat sourdoughs. *Z Lebensm Unters Forsch*, 199, 186.
- Martinez-Anaya, M. A. (1996). Enzymes and bread flavour. *Journal of Agriculture and Food Chemistry*, 44, 2469 - 2480.
- Merotha, C. B., Hammes, W. P., & Hertela, C. (2004). Characterisation of the microbiota of rice sourdoughs and description of *Lactobacillus spicheri* sp. nov. *Systematic and Applied Microbiology*, 27, 151 - 159.
- Meuser F, Faber C, Vollmar A, Spicher G. (1990). Studies on acid formation and growth of microorganisms in a continuously operating sour dough fermenter. *Food Biotechnology*, 4, 185.
- Spicher, G. (1983). Baked goods. In J. H. Rehm, & G. Reed (Eds.), *Biotechnology* (pp. 1-80). Weinheim: Verlag Chemie.
- Sugihara, T. F. (1985). The lactobacilli and streptococci: Bakery products. In: Gilliland SE, editor. *Bacterial Starter Cultures for Foods*. Boca Raton, FL: CRC Press.
- Tieking, M., Korakli, M., Ehrmann, M. A., Ganzle, M. G., and Vogel, R. F. (2003). In situ production of exopolysaccharides during sourdough fermentation by cereal and intestinal isolates of lactic acid bacteria. *Applied Environmental Microbiology*, 69, 945.
- Vogel, R. F., Ehrmann, M. A., & Ganzle, M. G. (2002). Development and potential of starter lactobacilli resulting from exploration of the sourdough ecosystem. *Antonie van Leeuwenhoek*, 81, 631–638.

**Table 1.** Lactobacillus species generally associated with sourdough fermentation or found in fermented sourdough (Corsetti & Settanni, 2007)

Obligately heterofermentative	Facultative heterofermentative	Obligately Homofermentative
<i>Lb. acidifarinae</i>	<i>Lb. plantarum</i>	<i>Lb. amylovorus</i>
<i>Lb. brevis</i>	<i>Lb. pentosus</i>	<i>Lb. acidophilus</i>
<i>Lb. buchneri</i>	<i>Lb. alimentarius</i>	<i>Lb. delbrueckii subsp. delbrueckii</i>
<i>Lb. fermentum</i>	<i>Lb. paralimentarius</i>	<i>Lb. farciminis</i>
<i>Lb. fructivorans</i>	<i>Lb. casei</i>	<i>Lb. mindensis</i>
<i>Lb. frumenti</i>		<i>Lb. crispatus</i>
<i>Lb. hilgardii</i>		<i>Lb. johnsonii</i>
<i>Lb. panis</i>		<i>Lb. amyolyticus</i>
<i>Lb. pontis</i>		
<i>Lb. reuteri</i>		
<i>Lb. rossiae</i>		
<i>Lb. sanfranciscensis</i>		
<i>Lb. siliginis</i>		
<i>Lb. spicheri</i>		
<i>Lb. zymae</i>		

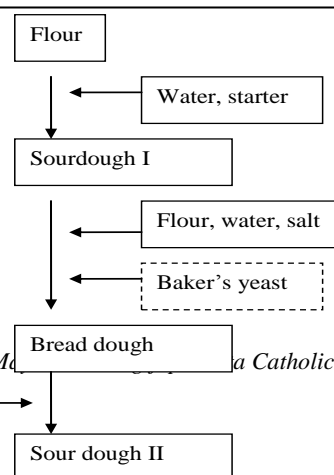
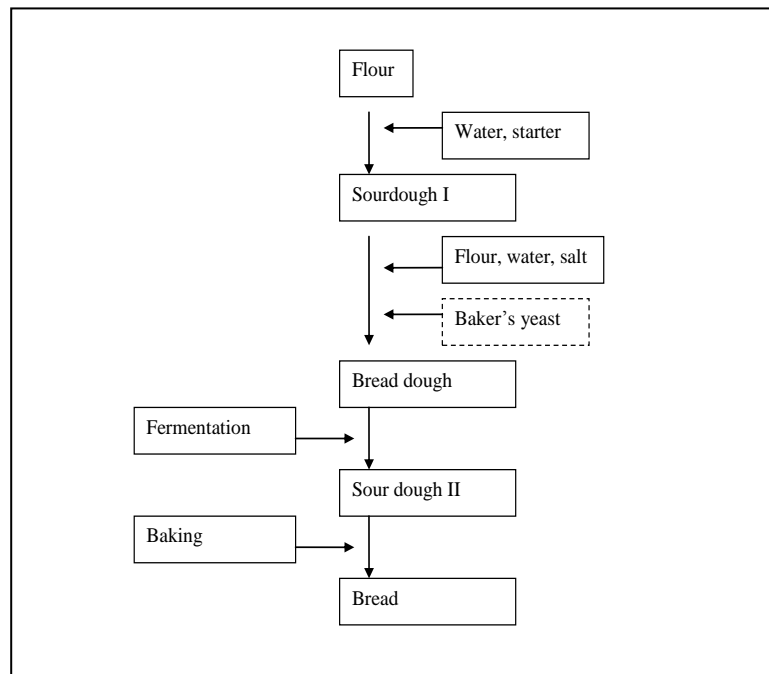

**Figure 1.** Scheme of sourdough bread production; baker's yeast may be added.

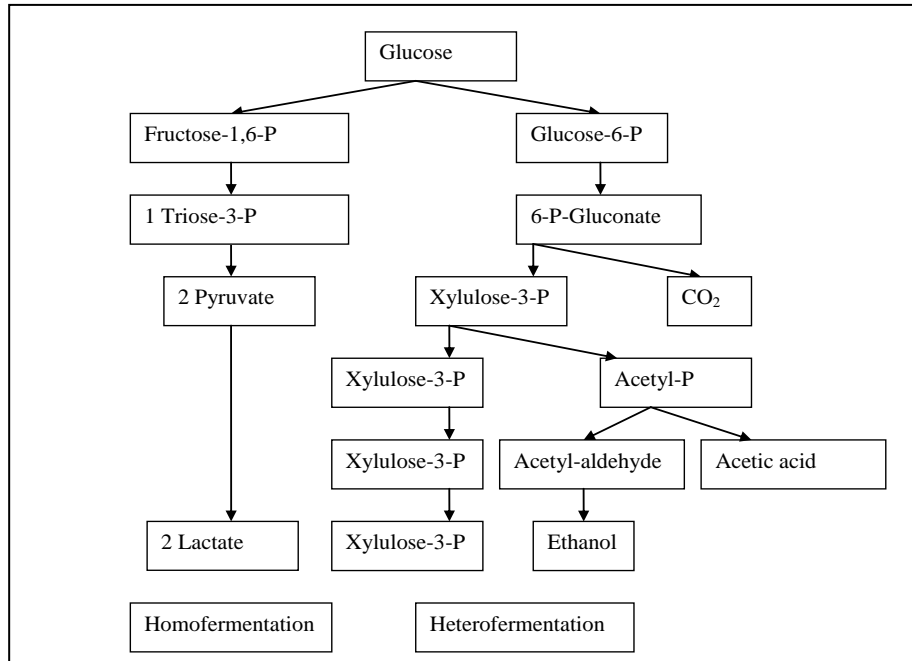

**Figure 2.** A simplified scheme of major pathways of glucose fermentation in LAB

## UTILIZATION OF *STEVIA REBAUDIANA* & ITS HEALTH BENEFITS

Vincent Kevin Tejo, Biondy Adiyoga, and Victoria Kristina Ananingsih

Department of Food Technology, Soegijapranata Catholic University, Semarang, Indonesia  
[centz\\_tejo@live.com](mailto:centz_tejo@live.com)

### ABSTRACT

Nowadays, health become a main concern for people around the world. Many people have turned their backs around into healthy and natural food when many health issues increased every year. As a result, many people not only looking for food with good taste but also looking for food which have many functional component. There is one natural plant-derived sweetener which have many functional component known as stevia. Stevia is natural sweetener from Paraguay and Brazil and rapidly replace artificial sweeteners among food products around the world recently. Stevia have many benefits, its level of sweetness is 250 times sweeter than sucrose, zero calories, and very beneficial for many health problems like diabetics, obesity, hyperactivity, hypertension, carbohydrate cravings, hypoglycaemia, hypertension, indigestion, tooth decay, and will not affect blood glucose or insulin respons. It becomes an alternative to calorie conscious consumers who want to enjoy a sweet taste without added calories or glycemic response, adding extra pounds, and excellent treat for children to avoid tooth decay and possible hyperactivity. Then, stevia not only used as food ingredient but also used as non-food ingredient such as toothpaste and mouthwash. Related to stevia functional component, stevia leaves contain many functional component such as protein, fiber, carbohydrates, oil, phosphorus, vitamin A, vitamin C, zinc, magnesium, sodium and iron. About its safety, stevia has become GRAS or generally recognized as safe by JECFA since 2009. So, stevia has all the benefits as natural sweeteners and none of the drawbacks.

**Keywords:** *health, natural, stevia, GRAS, benefit*

### INTRODUCTION

*Stevia Rebaudiana* is an herb in the Chrysanthemum family which grows wild as a small shrub in parts of Paraguay and Brazil. This wondrous herb is also known as “Honey-Leaf”, “Sweet-Leaf” and “Sweet-Herb”. Stevia is 200-250 times sweeter than regular sugar and it contains no calories, so it is suitable for diabetics and those with high blood pressure. Children can also enjoy it without health concerns and it does not cause tooth cavities. This herbal sweetener is heat

stable and thus could be used for cooking and baking. Stevia extract is a great alternative for synthetic sweeteners. It can be easily blended with other sweeteners such as honey. Stevia was widely and safely consumed by many countries around the world for decades [1].

Leaves of stevia contain glycoside and other compounds such as protein, fiber, carbohydrates, phosphorus, potassium, calcium, magnesium, sodium, iron, vitamin A, vitamin C, and also oil [2].

Stevia have many advantages than other artificial sweeteners, which is stable at high temperatures (100 ° C), the pH range of 3-9, and does not cause the dark color after the cooking [2].

However, some people experience a bitter aftertaste when consuming products with addition of stevia sweetener. This bitter taste is due to the presence of essential oils, tannins and flavonoids which are similar to the compounds that make tea and coffee bitter, but give them their phytochemicals.

The crude of stevia leaves and herbal green powder is 10-15 times sweeter than sucrose while refined stevia extracts are 200 to 300 times of sweetness level [3]. Unlike some other high-intensity sweeteners, stevia is light, heat and acid stable, which makes it ideal for acidic juice drinks and pasteurised dairy products [4]. *Stevia rebaudiana* leaves are commercially available in many countries including Japan and several South American countries as sweetener for a variety of foods and beverages [5]

### **SAFETY STANDARD FOR STEVIA**

Steviol glycosides were extracted from *Stevia rebaudiana* leaves to act as natural sweetener for food, beverages, and

confectionery in many countries. According to European Food Safety Authority (EFSA), many countries such as Europe, Australia, and New Zealand have evaluated and approved steviol glycosides as GRAS or Generally Recognized as Safe with Codex Alimentarius number E-960 as food additive.

The establishment of ADI (Acceptable Daily Intake) in Europe, Australia, and New Zealand for steviol glycosides is 4 mg / kg body weight / day (expressed as steviol equivalent). EFSA with JECFA (Joint FAO / WHO Expert Committee on Food Additives) also approved the establishment of NOAEL or No Observed Adverse Effect Level for 2,5% stevioside in food application equal to 967 mg stevioside / kg body weight / day (approximately 388 mg steviol equivalents / kg body weight / day). This level was determined based on two years carcinogenicity study in rat and 100-fold uncertainty factor. Then, EFSA panel concluded that human consumption or daily doses of the steviol glycosides can exceed from 1000 mg/person/day equivalent to 16.6 mg/kg bw/day for a 60 kg person with normal glucose metabolism or type-2 diabetes mellitus.

In order to evaluate steviol glycosides as food additive, chemical specification of steviol glycosides is necessary. The establishment of chemical specification in steviol glycosides as food additive in Europe should comply with JECFA. Chemical specification of steviol glycosides consist of pH, purity, loss on drying, total ash, solubility, residual solvents, arsenic, and lead [11]. Chemical specification of steviol glycosides presents at Table 1.

**Table 1. Chemical specification of steviol glycosides**

No.	Parameter	Limit
1.	pH	4,5 – 7,0
2.	Purity	Not less than 95% of the total of seven named steviol glycosides in dry basis
3.	Loss on drying	Not more than 6 % (105°C in 2 hours)
4.	Total ash	Not more than 1%
5.	Solubility	Soluble in water
6.	Residual solvents	Not more than 200 mg / kg methanol and 5000 mg / kg ethanol
7.	Arsenic and lead	Not more than 1 mg / kg

Steviol glycosides have used in many food application after EFSA with JECFA evaluated and approved ADI and NOAEL for steviol glycosides. Maximum levels of steviol glycosides in food has been made on ADI 4 mg / kg body weight / day (expressed as steviol equivalent) [13]. Some food products with steviol

glycosides as natural sweetener present at Table 2.

**Table 2. Food uses and levels of steviol glycosides**

No	Food	Steviol glycosides	Steviol equivalents
1.	Water-based flavoured drinks without added sugar	600 mg/L	198 mg/L
2.	Breakfast cereals with fibre content more than 15 % and without added sugar	1000 mg/kg	330 mg/kg
3.	Soybean sauce, fermented or non-fermented	500 mg/kg	175 mg/kg

Determination of steviol equivalent based on Food Standards Australia New Zealand (FSANZ) for steviol glycosides established in 2009. Steviol equivalent was obtained by multiplying the conversion factor of each steviol glycosides with the concentration of total steviol glycosides in food [12]. Then, EFSA state that steviol equivalent was obtained by dividing the value of maximum use levels of steviol glycosides with the conversion factor 0,33 of rebaudioside A as dominant component of steviol glycosides besides stevioside [11].

Adsorption, metabolism, and fate of steviol glycosides in human body was analyzed and reviewed by many researchers to study about its biological and toxicological characters. Fate of

steviol glycosides in human metabolism has been analyzed by using a single dose of 375 mg of stevioside in human male during 60 until 180 minutes [10]. After this incubation time, stevioside concentration in human blood was 0,11 g / ml, there were no free steviol, epoxide or 15-oxosteviol in blood plasma and most of free steviol primarily found in faeces. Another research about fate of steviol glycosides in human body was reviewed by EFSA. EFSA state that only few steviol glycosides found in feces and most of aglycone steviol in steviol glycosides were metabolized by human intestinal flora. Then, sixty percent of metabolized steviol glycosides were excreted out as steviol glucuronide in amounts of up to 318 mg or 205 mg steviol equivalents every 24 hour of human urine [11].

### **HEALTH BENEFITS OF STEVIA**

For people who are suffering from diabetes, obesity, high blood pressure, heart disorders and high cholesterol, stevia can be a good alternative as sweetener. Whether it is used as a dietary supplement or a sugar substitute, this wonder herb can be very beneficial to our body. It's also rich in nutrients such as phosphorus, calcium, proteins, vitamins, magnesium, zinc,

sodium and other minerals that are necessary for human body. By replacing sugar with stevia, it can also control the sugar intake. Consuming beverages and foods with stevia sweetener can become a part of a healthful diet and lifestyle.

Scientific research indicates that stevia effectively regulates blood sugar for people with diabetes and hypoglycemia to normal level. Studies have indicated that stevia tends to lower elevated blood pressure while not affecting people with normal blood pressure and stevia do not affect blood glucose levels or interfere with insulin.

Sugar molecules namely steviol glycosides, pass through the human alimentary canal without being altered by digestive processes. Then, they were demonstrating a remarkable stability. They cannot be broken down into their metabolites under normal gastric conditions. As a result, the sugar molecules pass unchanged through the human gastrointestinal tract and are not absorbed into the blood, producing no calories [8]. Due to the zero calories of stevia sweetener, it can be useful for people with diabetes to get a greater variety and flexibility in budgeting total calorie intake and assisting with weight management.



## **APPLICATION OF STEVIA**

Stevia widely used in bakery process. Bakery products with stevia sweetener do not brown too much. Stevia also can be added to other sweeteners like honey to lower their caloric content. People incorporate it into honey or molasses to increase the sweetening power in smaller quantities. Stevia also works well particularly on dairy products, fruit dishes, beverages and fresh desserts.

Unlike most artificial sweeteners, stevia does not break down under food processing. Stevia has properties to withstand against high temperatures while it cooks and at low temperatures when it is frozen. It is also compatible with salt and organic acids and natural sweeteners such as barley malt, honey, fructose and sorbitol. Stevia can be used safely and effectively as a substitute for sugar in all recipes where sugar and low calorie sweeteners would be normally used. Stevia sweetener can be used in beverages and foods such as desserts, sauces, yogurt, pickled foods, breads and confections. Stevia can also inhibits the growth and reproduction of oral bacteria and other infectious organisms. Besides its application for food products, it also has

been used as a Subsequently, an increasing number of toothpaste manufacturers are now using stevia in their products [9]. Apart from this, a facial mask made of stevia leaves helps in smoothing and rejuvenating the skin. It has also been used for treating other skin disorders, such as eczema and dermatitis [14].

## **FEASIBLE STUDY ON STEVIA APPLICATION IN INDUSTRY**

Artificial sweeteners, such as saccharin, aspartame, cyclamate and neotame has been widely used in food industry for processed food products such as baked goods, beverages, canned foods, fruit products dairy products and powder drinks. They are so ubiquitous in our food products and the safety of this artificial sweeteners has been controversial since their invention. Animal studies have linked artificial sweeteners to not only weight gain but also a wide variety of serious health hazards, and some studies have noted similar health hazards in humans. Another important consideration is the fact that today's products often contain a combination of many of these artificial sweeteners, the potential interactions, and health risks of which are largely unknown and difficult to assess [9].

Stevia can be implemented in food products, it can replace those artificial sweeteners with better health factors. Since its sweet intensity is 250 times sweeter than sucrose, it is definitely decreasing the production cost comparing to sugar as the sweeteners. However, if it is compared to those artificial sweeteners whose sweet intensity is almost similar to stevia, the production cost will be almost the same or even higher. In the other hands, with the shift of food consuming lifestyle from taste to health, using stevia in food products will give many benefits for both industry and consumers. It can boost consumer health perspective towards the food brand. Moreover, it can also change the image of the food brand itself which is up-to-date dan health concerning product.

## CONCLUSION

Stevia is an excellent natural alternative for sugar replacer since it has many benefits regarding its composition. Also, it has health benefits compared to those many artificial sweeteners that now has been widely used. Furthermore, it has been stated as GRAS (Generally Recognized as Safe) for use as a general purpose sweetener by many countries like Europe (EFSA), JECFA, and FSANZ (Australia and New Zealand) and can be applied in

various foods and beverages products. With the shift of food consuming lifestyle from taste to health, using stevia in food products will give many benefits for both industry and consumers to develop the food brand.

## REFERENCES

- [1] Richard, Laura. *The Secret to Low Carb Success*. 2004
- [2] (2010) Stevia website. [Online]. Available: <http://www.stevia.com/>
- [3] Cramer B, R Ikan. *Sweet glycosides from the Stevia Plant*. Britain, 1986
- [4] Watson, Elaine. *EFSA opinion paves way for EU approval of stevia-based sweeteners*. Available: Foodnavigator.com, 2010
- [5] Kinghorn, A.D., and Soejarto, D.D. *Current status of stevioside as a sweetening agent for human use*. Academic Press. London, 1985
- [6] (2011) Food Additive Safety website. [Online]. Available: <http://www.fda.gov>
- [7] Carakostas, M.C., Curry, L.L., Boileau, A.C., Brusick, D.J., Overview: *the history, technical function and safety of rebaudioside A, a naturally occurring steviol glycoside, for use in food and beverages*, *Food and Chemical Toxicology*. 2008
- [8] Helen K. Chang. (2010). *STEVIA - General Discussion*. Available: <http://www.dcnutrition.com/>
- [9] (2008) Stevia – Natural and Healthy. Available: <http://www.vitalah.com/>
- [10] Brusick, D.J. *A critical review of the genetic toxicity of steviol and steviol glycosides*. *Food and Chemical Toxicology* Vol. 46: S83–S91. 2008
- [11] European Food Safety Authority. *Scientific Opinion on the safety of steviol*

*glycosides for the proposed uses as a food additive. EFSA Journal* Vol. 8(4): 1537. 2010

[12] (2009) Food Standards Australia New Zealand. *Application A1037 Steviol Glycosides – Increase In Permitted Use Levels Explanatory Statement*.  
<http://www.comlaw.gov.au/Details/F2011L01415/8ccfc0d2-2620-4711-a73e-c4b3f18da528>

[13] European Food Safety Authority. *Revised exposure assessment for steviol glycosides for the proposed uses as a food additive. EFSA Journal* Vol. 9(1): 1972. 2011

[14] (2012) Properties of Stevia: Natural Recipes. [Online]. Available:  
[www.justrec.com/properties-of-stevia-natural-recipes/](http://www.justrec.com/properties-of-stevia-natural-recipes/)

# THE POTENTIAL CHITO-OLIGOSACCHARIDE (COS) AND RICE BRAN AS A SOURCE OF NATURAL PREBIOTIC AND THE SYNBIOTIC EFFECT IN FUNCTIONAL FOOD

**Agnes Sri Harti, Anis Nurhidayati, and Desi Handayani**

Kusuma Husada Institute of Health Science, Surakarta, Central Java, Indonesia.  
[agnessriharti@yahoo.com](mailto:agnessriharti@yahoo.com)

## ABSTRACT

Chito-oligosaccharides (COS) is a glycoprotein that has 1.4 glucosamine bond and synthesized from waste shells of crabs and shrimp are abundant in Indonesia. COS has a specific compound because it is policationic so to protect the protein and reduce the growth of potentially pathogenic bacteria, therefore has potential as an alternative antibiotic that has safely without causing residual value. Rice bran is a by product of rice milling, is obtained from the outer layer of rice kariopsis. Rice bran contain carbohydrates, protein, minerals, fat, vitamin B complex, inositol, phytate, gamma orizanol, phytosterols, tocotrienols, amino acids, unsaturated fatty acids , nitrilosid (anti-cancer) and dietary fiber. The concept of synbiotic (probiotics and prebiotics) recently used for the characterization of foods for improved health and biosuplemen. Chito-oligosaccharides (COS) and rice bran derived from fisheries and agricultural waste as an alternative source of natural prebiotic. The research objective was to determine the potential of chito-oligosaccharide (COS) and rice brain; also synbiotic effect in functional foods. The results showed that the Chito-oligosaccharides and rice bran as a potential source of natural prebiotic and synbiotic effects in vitro that can be used as biosuplemen, food additive, alternative antibiotics and immunostimulants which is safe without causing residue, economical and multifunctional especially in the health sector

**Keywords:** *Chito-oligosaccharides (COS), rice bran, functional food*

## INTRODUCTION

Chito-oligosaccharide (COS) is a derivative of the compound chitosan as a result of the process of deacetylation of chitin. Chitin can be obtained through a two-stage process deproteination and demineralization of raw materials such as fish waste shrimp, shells of crabs and other marine animals.

Rice bran contains 14% protein, 18% fat, 36% carbohydrate, 10% ash, 12% crude fiber, as well as various vitamin B complex, inositol, phytate, gamma orizanol, phytosterols,

tocotrienols, amino acids, unsaturated fatty acids, nitrilosid (anti-cancer) and dietary fiber. Although rice bran are abundant in Indonesia, its use for human consumption is still limited. This product is very potential to be developed as a functional food. The concept of synergistic (probiotics and prebiotics) recently used for the characterization of foods as biosuplemen health improvement in functional food. With the combination of both is useful to improve the probiotic bacteria as they pass through the digestive tract and is more

efficient in terms of implantation microbiota colonization, along with stimulating effects of oligosaccharides in the growth and or activity either. Today's research on the use of probiotics and prebiotics (synbiotik) associated with the measurement of cholesterol levels. The results of Liu (2008) and Liong (2005a,b,c,d) shows the synbiotic between *Lactobacillus casei* and prebiotics (Frukto-oligosaccharides and Maltodextrin) can reduce cholesterol *in vitro*.

## MATERIALS AND METHODS)

Stages of research can be described schematically as follows :

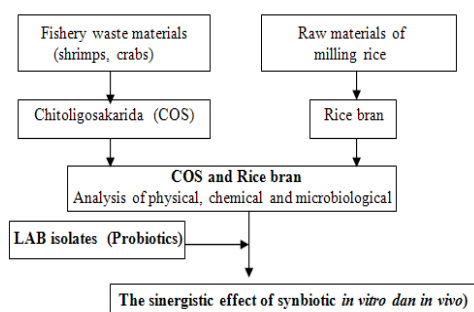

### 1. Location and Time Research

Research sites in Integrated Science Laboratory Kusuma Husada Surakarta Health Science Institute and Central Laboratory Sebelas Maret University Surakarta. The periode research has been 6 months.

### 2. Instrument and Materials Research

The instrument is an incubator, autoclave, centrifuge, membrane filters, oven, analytical balance, pH meter, anaerobic jar, viscometer, ovens, UV-Vis spectrophotometer,

micropipette, petri dishes, test tubes, vortex, micropipette, appendorf, aluminum foil, measuring pipetes.

Materials used were isolates of LAB (*Lactobacillus casei*) from industrial fermentation products, BHI liquid media, NaOH, HCl, acetic acid, NaCl 0,85%, 0.1% peptone buffer.

Samples for the synthesis of COS is waste shrimp shells and crab (*Portunus pelagicus*) were obtained from a catering home in Solo and rice bran obtained from agricultural waste rice milling in Solo.

## 3. Methods :

### Sampling

Shrimp shell and crab shell are washed with water and dried for two days.

### COS synthesis

Waste shells of shrimp, crab ground into flour particle size from 1.77 to 3.25 mm. Then performed the removal of minerals (demineralization) by adding 1 N HCl with ratio 1:7 while heated 90°C for one hour. Mixture was decanted, and washed again until neutral pH and dried. Performed after the removal of dry protein (deproteination) with the addition of 3.5% NaOH solution ratio of 1: 10 and then heated at 90°C for one hour. After it cooled, decanted again, washed with water until neutral pH, and then dried. Bleaching with the addition of 2% H<sub>2</sub>O<sub>2</sub> ratio 1: 10 in order to obtain a white powdery chitin

(Suptijah *et al*, 1992) Production of chitosan or Chito-Oligosaccharide done by deacetylation of chitin flour with the addition of 50% NaOH solution, and then heated at a temperature of 80° C for one hour (Rochima E., 2005)

### Rice bran

As a by product of rice milling karyopsis obtained from the outer layer of rice.

### The synergistic effect of synbiotic

- a. Isolation of LAB (Lactic Acid Bacteria).

Isolation of LAB (Lactic Acid Bacteria) were used from industrial fermentation products or results of the research of Harti *et al* (2009).

- b. Preparation of Prebiotics

COS or rice bran from synthesized and then used as prebiotic. The method of synthesis COS based on research of Harti (2007).

- c. Sinbiotic effect of synbiotic

BHI liquid medium is added with prebiotics (COS, rice bran) and probiotics isolates inoculated (10% v / v) then incubated at 37 ° C for 20 hours. The growth of bacterial cells in liquid media was measured of turbidity.

## RESULTS AND DISCUSSION

Table 1. Absorbance measurements of probiotic growth in BHI liquid medium

Treatment	Absorbance
BHI (control)	0,719
BHI + COS shrimp	1,615
BHI + COS crab	1,926
BHI + chitosan	1,473
BHI + rice bran	1,804
BHI + COS shrimp + rice bran	1,803
BHI + COS crab + rice bran	1,833

From the measurement results of the *in vitro* growth of probiotics in liquid BHI media showed that the COS of shrimp, crab and rice bran can increase significantly the growth of probiotics. Several types of prebiotics are able to use lacto sucrose, soybean oligosaccharida, palatinose, isomaltive oligosaccharida, gluco oligosaccharida, xylo oligosaccharida, lactulose, lactitol and xylitol, sorbitol and mannitol (Budington, 2002). Several groups including prebiotic substrate is starch (cellulose, hemicellulose, lignin) that are not soluble in water, fiber, oligosaccharides and sugar alcohol (Bomba *et al*, 2002)

The results research of Puspita and Agnes (2010) showed Chito-oligosaccharide (COS) from fishery waste can be used as a natural prebiotic and quality analysis Chito-oligosaccharide from the shells of crabs and shrimp shell that the solubility (58.59% and 30.26%), the degree of deacetylation (88.76% and 77.50%) and viscosity (1.22 cp and 1.44 cp). Additionally biopreparation of synbiotic in yogurt provide a synergistic effect as lowering cholesterol levels *in vitro* and *in vivo*. Probiotics and prebiotics ( mixture maltodextrin 2% and Fruktooligosakardia 2% (1:1) was able to suppress the growth of

pathogenic *Escherichia coli*. (Harti *et al*, 2007).

Chitosan role in increasing immunity or Imonoglobulin (Ig)- treated blood of poultry feed containing COS. With the immune system and increasing feed efficiency, increase poultry productivity. COS as a potential material as '*alternative antibiotics*' has a value of more secure without causing residue. Anti-inflammatory activity is influenced by the dose and molecular weight. A single dose of 500 mg / kg body weight can be used as a therapeutic dose of acute inflammation (Wang, 2007). COS has the ability to inhibit pathogenic bacteria, lowering cholesterol levels (hypo cholesterolemia) and is able to stimulate the immune system (immunostimulant). As '*candidates*' substitute for antibiotics, additives should at least have antimicrobial properties. Ability to inhibit the growth of certain pathogenic microbes (narrow spectrum) or the total microbial intruders (broad spectrum) in the digestive tract of poultry is very important so that the digestive process can be maximized (Lin *et al*, 2009)

Chitin can be obtained through a 2-stage process deproteination (removal of protein group) and demineralization (removal of mineral particles) from fishery waste materials such as shrimp heads, shells of crabs and other marine animals (Kazami, 2005). Chitosan has a unique character that is capable of protecting polycationic protein and reduce the rate of growth of pathogenic bacteria. Chitosan can reduce the amount of coliform bacteria and the

concentration of iron in well water (Suptijah *et al* 2008). Chito-Oligosaccharida (COS), a group of complex compounds gliko-binding protein that has a 1,4-b-glucosamine, which is a derivative of chitosan deacetylation of chitin (Kaban, 2009). The effect of chitooligosakarida as antimicrobial activity is highly dependent on the degree of deacetylation and polymerization of the types of bacteria and fungi. COS as a potential material as '*alternative antibiotics*' has a value of more secure without causing residue (Choi, 2006).

Rice bran can be obtained as much as 10 percent of the rice mill, which consists of the aleurone layer of rice (rice kernel), endosperm, and germ as well as carbohydrates, proteins, minerals, fats, vitamin B complex, inositol, phytate, ferulic acid, gamma orizanol, phytosterols, tocotrienols, amino acids, unsaturated fatty acids, and fiber. Rice bran has been used as cattle feed. Not many people know that the outer layer of rice paddy milling results contain bioactive components of food that are beneficial to health (Dewi, 2005).

However, on the other hand the wealth of nutritional value also has a negative side, the rate of damage occurs, for example, easily "rancid" as a result of the decomposition of fats into simpler components such as fatty acids and peroxide by lipase is abundant in the bran and groats. Hipcholesterolemia effects rice bran and some fractions, has been widely observed both in experimental animals and humans. Rice bran oil significantly reduce

blood cholesterol levels, LDL cholesterol, VLDL cholesterol, and can increase blood levels of HDL cholesterol. Ability of rice bran oil lowers cholesterol levels due to the oryzanol and other capabilities of materials that are not saponified. Other studies have shown that ferulic acid also has a role in lowering blood pressure and blood glucose testing both animals and humans. Rice bran to increase the production of erythromycin from culture *Saccharopolyspora erythraea* ATCC 11635 (Nugraheni, 2004). Rice bran contains bioactive components oryzanol, tocopherol, and acids that make felurat potential functional food ingredients. Oryzanol cholesterol lowering function. Tocopherol is vitamin E, which are antioxidants. While felurat acid is known to reduce levels of sugar and blood pressure (Ardiansyah, 2009).

## CONCLUSION(S)

Chito-oligosaccharide (COS) and rice bran has potential as a natural prebiotics and to increase growth of probiotic *in vitro*

## ACKNOWLEDGEMENT(S)

This study was funded by a grant 2013 from DP2M Fundamental the Directorate General of Higher Education

## REFERENCES

Ardiansyah A., Takuya K., Katsumi H, Hitoshi S., Michio K., 2009. Crude Rice Brain Diet Decreases Blood Pressure in Stroke-prone Spontaneously Hypertensive Rats. *Poster presentation on Annual meeting JSBBA 2005* (Japan Society for Bioscience, Biotechnology,

and Agrochemistry) in Sapporo-Hokkaido March 28-30 2005.

Bomba, A., Nemcova, R., Gancarcikova, S., Herich, R., Guba, P., Mudronova, D., 2002, Improvement of the Probiotic Their Effect of Microorganism by Combination with Metodextrins, fructo-oligosaccharides and polyunsaturated Fatty Acid, *British Journal of Nutrition, Volume 88 Supplement September 2002*.

Choi H. J., Ahn J., Kim N.C., Kwak H.S., 2006. The effects of microencapsulated chito-oligosaccharide on physical and sensory properties of the milk. *Asian-Australasian journal of animal sciences ISSN 1011-2367. Volume. 19, No.. 9, page 1347-1353*

Dewi, Tjahjadi, Artini, 2005. Sugar production by *Rhizopus oryzae* Reduction of Substrate bran. *Journal of Biotechnology, Volume 2, No.. 1*

Harti, A.S, Suhartinah, Y. Joko Wiharjo 2010. Biopreparation Chito-oligosaccharide (COS) of Waste Fishing Experience as a Source of Prebiotics in Functional Food. *Applied Research Report, Funded by the Central Java Provincial Education Department, 2010*.

Harti,A.S., 2009. Biopreparation Synbiotic (Probiotics and Prebiotics) In Yoghurt As Immunostimulants and Lowering Cholesterol. *Research Report Competitive Research Grant Program based on National Priority Batch I, 2009*

Harti, a U.S. 2007. Synergistic Effects Assessment Probiotics with Prebiotics to Diaregenik *Escherichia coli*. *Young Lecturer Research Report. Financed by the Directorate General of Higher Education, 2007*.

Kaban , 2009. Chemical Modification of Chitosan and Application of Products Produced in *Inauguration Speech Professors Position in Organic Chemistry In the Faculty of Science, University of North Sumatra, January 24, 2009*.

Naoshi Kazami, Sugahara Yasusato, masakichi Sakaguchi, Masao Kawakita, 2005. Preparation of Chito-oligosaccharides by Two Step Hydrolysis. *Journal Title: Chitin and*



Chitosan Research, *Journal Code: L2321A*  
ISSN :1340-9778. Volume 11; No. 2; Page:  
.170-171 (2005).

Nugraheni E.R, Retno S.S, Umar A.J  
2004. Utilization of rice bran to increase  
the production of erythromycin from  
culture *Saccharopolyspora erythraea*  
ATCC 11635. *Journal: Science and*  
*Sibernetika*, 2004, XVII (3): 2004

Lin, Shih-Bin; Chen, Shan-He; Peng, Kou-  
Cheng, 2009. Preparation of antibacterial  
chito-oligosaccharide by altering the degree of  
deacetylation of  $\beta$ -chitosan in a *Trichoderma*  
*harzianum* chitinase-hydrolysing process  
*Journal of the Science of Food and*  
*Agriculture*, Volume 89, No 2, 30 January  
2009, pp. 238-244 (7)

Liong, M. T., and N. P. Shah. 2005a. Acid and  
bile tolerance and cholesterol removal ability  
of lactobacilli strains. *Journal of Dairy*  
*Science* 88:55-66

Liong, M. T., and N. P. Shah. 2005b. Bile salt  
deconjugation ability, bile salt hydrolase  
activity and cholesterol co-precipitation ability  
of lactobacilli strains. *Int. Dairy J.* 15:391-  
398.

Liong, M. T., and N. P. Shah. 2005c.  
Optimization of growth of *Lactobacillus casei*  
ASCC 292 and production of organic acids in  
the presence of fructo oligosaccharide and  
maltodextrin. *J. Food Sci.* 70: M113-M120.

Liu, XS Piao, SW Kim, L Wang, YB Shen,  
HS Lee and SY Li. , 2008. Effects of chito-  
oligosaccharide supplementation on growth  
performance, nutrient Digestibility, intestinal  
morphology, and fecal shedding of  
*Escherichia coli* and *Lactobacillus* in weaning  
pigs. *Journal of Animal Science*, 86:2609-

2618.

Mirzah, 1998. Improving the Quality of  
Shrimp Waste Meal Nutritional Value  
Through Processing With Steam Heat,  
*Research Journal of Andalas*, 26:7-12

Nugraheni E.R, Retno S.S, Umar A.J 2004.  
Utilization of rice bran to increase the  
production of erythromycin from culture  
*Saccharopolyspora erythraea* ATCC 11635.  
*Journal: Science and Sibernetika*, 2004, XVII  
(3): 2004

Puspita H, Agnes S.H; 2010. Synthesis of  
Chito-oligosaccharide (COS) From waste  
shrimp and crab as well as the Natural  
Resources Prebiotics Sinbiotik *In vitro* effects.  
*Final Report of Student Creativity Research*  
*Program funded by the Directorate of*  
*Research and Community Services, the*  
*Directorate General of Higher Education*  
*Ministry of National Education in 2010.*

Rochima E., 2005. Characterization of Chitin  
and Chitosan Origin Waste Rajungan Cirebon  
in West Java. *Article Publication Research,*  
*Faculty of IPB.*

Suptijah P, Salama E, Sumaryanto H.,  
Purwaningsih S., Santosa J., 1992. The effect  
of various methods of isolation of chitin and  
chitosan from shrimp shells to the levels and  
quality. *The final report of research,*  
*Faperikan, IPB.*

Wang Yan, Zhou Peigen PhD, Jianxing Yu  
MS, MS Pan Xiaorong, Pingping Wang MS,  
Weiqing Shendan Tao Lan MS and MS.  
Antimicrobial effect of Chito-oligosaccharides  
Produced by Chitosanase from *Pseudomonas*  
CUY8. *Asia Pacific Journal of Clinical*  
*Nutrition* 2007; 16 (Suppl 1) :174-177

## BIFIDOBACTERIA AS POTENTIAL PROBIOTIC IN YOGURT

**Laksmi Hartayanie and Kristina Ananingsih**

Department of Food Technology, Soegijapranata Catholic University, Semarang, Indonesia  
[laksmi.87@hotmail.com](mailto:laksmi.87@hotmail.com)

### ABSTRACT

Nowadays, probiotics are considered in the development of “functional food” products due to their benefits to human health. Food products containing bifidobacteria have largely been of dairy origin including yogurts. Yogurt is a fermented milk product that has been prepared traditionally by allowing milk to sour at 40–45°C. Modern yogurt production is a well-controlled process that utilises ingredients of milk, milk powder, sugar, fruit, flavours, colouring, emulsifiers, stabilisers, and specific pure cultures of lactic acid bacteria (*Streptococcus thermophilus* and *Lactobacillus bulgaricus*) to conduct the fermentation process. A number of health benefits have been attributed to bifidobacteria, which are colonization resistance, anticarcinogenic activity, reduction of the risk of colon cancer, stimulation of immune functions, improving digestibility of lactose, improving vitamin and antibiotic activity, and cholesterol-lowering ability

**Keywords:** *bifidobacteria, probiotic, yogurt, health benefits*

## 1. INTRODUCTION

Nowadays, food products containing bifidobacteria have largely been of dairy origin including yogurts. As much as 70% of milk products on the market in some European countries, such as Sweden, contain bifidobacteria.

Recently, in the food industry, probiotics are considered in the development of “functional food” products due to their benefits to human health. Many lactobacilli are used in functional foods. Dairy products appear to be the best vehicles for delivery of them to humans because of the LAB properties of most probiotics (Hattingh & Viljoen, 2004).

Foods fortified with health-promoting probiotic bacteria are mainly produced using fresh milk or milk derivatives such as yogurt, cheese, ice-cream, desserts, etc (Lavermicocca, 2006). It is estimated that there are 80 probiotic-containing products in the world. Some of the commercial dairy products with probiotics are listed in Table 1.

## 2. BIFIDOBACTERIA

### 2.1. Physiology

Bifidobacterium can grow between 20°C to 46°C and dies at 60°C. Optimum pH for growth as 6.5 -7 and no growth at pH < 5.1 or > 8.0. These organisms do not grow in the synthetic medium. Bifidobacteria are able to survive under different oxygen conditions and ferment wide range of substrates. Bifidobacteria are anaerobic organisms, but some species can tolerate oxygen (Arunachalam, 1999). The enzymes like superoxide dismutase and catalase, help the organism to defence against the toxic effects of superoxide an hydrogen peroxide. Some different bifidobacterial species and their origin can be seen in Table 2.

Bifidobacteria do not have aldolase and glucose-6-phosphate dehydrogenase; they thus ferment hexose via a phosphoketolase pathway that is known as the ‘bifid shunt’, where the final products are acetic and lactic acids in a molar ratio of 3:2. The key enzyme in the bifid shunt is fructose-6-phosphate phosphoketolase (F6PPK), which converts fructose 6-phosphate into acetyl 1-phosphate and eritrose 4-phosphate.

### 2.2. Fermentation of Sugars

All Bifidobacteria species can ferment lactose and grow well in milk. *B. adolescentis*, *B. breve*, *B. infantis* and *B.*

*longum* can utilize many carbohydrates while *B. bifidum* can utilize fructose, galactose and lactose. Bifidobacteria ferment glucose via the fructose 6 - phosphate shunt, which has been reported and the key enzyme involved in the hexose metabolism, fructose-6-phosphate phosphoketolase (F6PPK) is present in the cellular extracts and the path way is called as 'bifid shunt'(Figure 1) (Vries & Stouthamer, 1967).

### 3. YOGURT AS PROBIOTIC CARRIER FOOD

Yoghurt is prepared by fermentation of milk using two types of bacteria, namely *Lactobacillus delbrueckii* subsp. *bulgaricus* and *Streptococcus thermophilus* (Tamime and Marshall, 1997). Fermentation contribute to the hydrolysis of milk proteins, pH drops, increase of viscosity, and bacterial metabolites are produced that give the taste and the health promoting properties of yogurt.

Several health benefits have been reported for traditional yogurt (Rachid et al., 2002), and this healthy image is enhanced by supplementation with probiotic bacteria. Fermented foods that have potential probiotic properties are produced worldwide

from a variety of food substrates. Probiotics have been used for the treatment of various types of diarrhoea, urogenital infections and gastrointestinal diseases such as Crohn's disease (Bousvaros et al., 2005).

Good nutrition and health promote the optimum 'balance' in microbial population in the digestive tract (Rybka & Kailasapathy, 1995). The microorganisms primarily associated with this balance are lactobacilli and bifidobacteria. Factors that negatively influence the interaction between intestinal microorganisms, such as stress and diet, lead to detrimental effects in health. Increasing evidence indicates that consumption of 'probiotic' microorganisms can help maintain such a favourable microbial profile and results in several therapeutic benefits (Hattingh & Viljoen, 2001).

In recent years probiotic bacteria have increasingly been incorporated into foods as dietary adjuncts. One of the most popular dairy products for the delivery of viable *Lactobacillus acidophilus* and *Bifidobacterium bifidum* cells is bio-yogurt. Adequate numbers of viable cells, namely the 'therapeutic minimum' need to be consumed regularly for transfer of the 'probiotic' effect to consumers.

Consumption should be more than 100 g per day of bio-yogurt containing more than  $10^6$  cfu mL<sup>-1</sup> (Rybka & Kailasapathy, 1995). Survival of these bacteria during shelf life and until consumption is therefore an important consideration.

Since the renewed interest in probiotics, different types of products are proposed as carrier foods for probiotic microorganisms by which consumers can take in large amounts of probiotic cells for the therapeutic effect. Yogurt has long been recognized as a product with many desirable effects for consumers, and it is also important that most consumers consider yogurt to be 'healthy'. In recent years, there has been a significant increase in the popularity of yogurt (Hamann & Marth, 1983) as a food product, accentuating the relevance of incorporating *L. acidophilus* and *B. bifidum* into yogurt to add extra nutritional-physiological value. The conventional yogurt starter bacteria, *L. bulgaricus* and *Streptococcus thermophilus*, lack the ability to survive passage through the intestinal tract and consequently do not play a role in the human gut (Gilliland, 1979).

### 3.1. Bio-yogurt

Recently, live strains of *L. acidophilus* and species of *Bifidobacterium* (known as AB-cultures) are used in formulation of yogurt products in addition to the conventional yogurt organisms, *S. thermophilus* and *L. bulgaricus*. Therefore, bio-yogurt is yogurt that contains live probiotic microorganisms, the presence of which may give rise to claimed beneficial health effects.

For the production of AB-yogurt, similar processing procedures to traditional yogurt are applied with the exception of the incorporation of live probiotic starter cultures. Heat treated, homogenised milk with an increased protein content (3.6–3.8%) is inoculated with the conventional starter culture at 451 °C or 371 °C and incubated for 3.5 and 9 h, respectively. The probiotic culture can be added prior to fermentation simultaneously with the conventional yogurt cultures or after fermentation to the cooled (41 °C) product before packaging.

### 3.2. Regulatory requirements for starter cultures in a bio-yogurt

Bio-yogurt, containing *L. acidophilus* and *B. bifidum* (AB-yogurt), is a potential probiotic. The number of probiotic bacteria required to produce a beneficial effect has

not been established. Kurmann and Rasic (1991) suggested to achieve optimal potential therapeutic effects, the number of probiotic organisms in a probiotic product should meet a suggested minimum of  $>10^6$  cfu mL<sup>-1</sup>. These numbers required, however, may vary from species to species, and even among strains within a species. One should aim to consume  $10^8$  live probiotic cells per day. Regular consumption of 400–500 g/week of AB-yogurt, containing  $10^6$  viable cells per ml would provide these numbers (Tamime et al., 1995). Ishibashi and Shimamura (1993) reported that the Fermented Milks and Lactic acid Bacteria Beverages Association of Japan has developed a standard which requires a minimum of  $10^7$  viable bifidobacteria cells/mL to be present in fresh dairy products. The criteria developed by the National Yogurt Association (NYA) of the United States specifies  $10^8$  cfu g<sup>-1</sup> of lactic acid bacteria at the time of manufacture, as a prerequisite to use the NYA 'Live and Active Culture' logo on the containers of products (Kailasapathy & Rybka, 1997). The Australian Food Standards Code regulations, requires that the lactic acid cultures used in the yogurt fermentation must be present in a viable form in the final product, the populations are not specified. At the same

time, attainment of pH 4.5 or below is also legally required to prevent the growth of any pathogenic contaminants (Micanel, Haynes, & Playne, 1997). It has been claimed that only dairy products with viable microorganisms have beneficial health effects. However, in the case of lactose tolerance, treatment of acute gastro-enteritis and treatment of candidiases, probiotics used showed the same beneficial effect in viable and non-viable form (Ouwehand and Salminen, 1998).

#### **4. POTENTIAL HEALTH BENEFITS OF BIFIDOBACTERIA**

A number of health benefits have been attributed to bifidobacteria, which are colonization resistance, anticarcinogenic activity, reduction of the risk of colon cancer, stimulation of immune functions, improving digestibility of lactose, improving vitamin and antibiotic activity and cholesterol-lowering ability

##### **4.1. Colonization Resistance**

One of the most common claims associated with dairy foods containing bifidobacteria, and other LAB, is the 'maintenance or re-establishment of healthy intestinal microflora. The normal colonic flora provides an important barrier function

against pathogenesis, often termed ‘colonization resistance.’ Multiple mechanisms may be involved in the exclusion of undesirable organisms by bifidobacteria, including competition for receptor sites or nutrients and production of inhibitory factors or conditions, e.g., organic acids or antimicrobials, as well as physiological factors (lowering of pH or stimulating the immune system)(Mc Cartney, 2003).

The production of organic acids (acetic and lactic acid) by bifidobacteria inhibits the growth of pathogenic organisms (directly and indirectly) and stimulates intestinal peristalsis. Acetic acid is a stronger antagonist against Gram-negative bacteria than lactic

acid. As such, the potential applications of bifidobacteria against microbial perturbation may surpass those of lactobacilli. Additionally, the organic acids produced by bifidobacteria have been shown to inhibit the growth of many nitrate-reducing bacteria (Mc Cartney, 2003).

#### **4.2. Anticarcinogenic Activity**

Increasing evidence, from in vitro experiments and animal studies, indicates the potential protective influence of

probiotic bacteria (including bifidobacteria) against cancer. To date, three conceivable mechanisms have been identified: (1) inhibition of putrefactive organisms that produce carcinogens (such as N-nitroso compounds, phenolic products of tyrosine and tryptophan, and metabolites of biliary steroids); (2) binding and/or inactivation of carcinogens; and (3) inhibition of tumor cell formation. Bacterial enzymes (including  $\beta$ -glucuronidase,  $\beta$ -glucosidase, nitroreductase, and azoreductase) are responsible for converting some procarcinogens into carcinogens. As such, the levels/activities of these enzymes are considered a useful biomarker for cancer risk in humans, enabling noninvasive estimation of carcinogen levels (Mc Cartney, 2003) .

#### **4.3. Reduction of the Risk of Colon Cancer**

Research in the past fifteen years has focused on the potential role of BIB in the prevention of cancer initiation. *B. bifidum* have been shown in human clinical studies to reduce the levels of some colonic enzymes (*I*-glucuronidase, nitroreductase, azoreductase, and glycolic acid hydrolase), which are implicated in the conversion of procarcinogens to carcinogens

such as nitrosamines or secondary bile salts (Ling et al, 1994). Most studies report a decrease in these enzymes during the study period when live BIB were consumed with a return to baseline levels during follow-up when no BIB were consumed. The mechanisms and long-term effects of these changes are not clear. Recent epidemiological studies (Kampman et al, 1994) have found that colon cancer risk was inversely related to the consumption of diets which included fermented milks. Other dietary factors have been considered in the prevention of colon cancer, including fibre and calcium fermented milks may be one factor of many that affect risk of colon cancer.

#### **4.4. Stimulation of Immune Functions**

Several probiotics, including some bifidobacterial strains, are claimed to enhance the immune system in a nonspecific manner, thereby stimulating immunity to a number of antigens. A number of studies have also shown the ability of certain LAB strains to alter

cytokine production and/or increase secretory IgA levels. Preliminary data demonstrate the potential of probiotics in modulating certain immune responses and

indicate their potential role in allergy, autoimmunity, and gastrointestinal disease (Mc Cartney, 2003).

#### **4.5. Lactose Intolerance**

Lactose malabsorption affects large portions of the population (estimated by some to affect over half the world's population), with a higher prevalence in those of Oriental or African ancestry. Symptoms normally include abdominal discomfort, flatulence, and/or diarrhea. However, lactose-intolerant individuals can consume cultured milk products (containing bifidobacteria and/or lactobacilli) without any deleterious effects. Two mechanisms have been proposed for the improved digestibility of lactose in such products: (1) the b-galactosidase activity of the probiotic strains; and (2) stimulation of host mucosal b-galactosidase activity by the ingested strains (Mc Cartney, 2003).

#### **4.6. Nutritional Value**

Bifidobacteria are known to produce thiamine, riboflavin, vitamin B6, and vitamin K. There have also been reports of their ability to synthesize folic acid, niacin, and pyridoxine. These vitamin B complexes are slowly absorbed in the human body. However, the impact on human nutrition of such vitamin synthesis by bifidobacteria in



the colon is unknown. Available information on the nutritional properties of fermented milks containing bifidobacteria indicates that they have lower residual lactose and higher levels of free amino acids and vitamins than non-fermented milks. Additionally, they preferentially contain L(+)- lactic acid (produced by bifidobacteria in addition to acetic acid, whereas lactobacilli produce D/L(-)- lactic acid), which is more easily metabolized by humans. This is particularly important for infants less than 1 year old, in whom metabolic acidosis can be a problem. Consuming bifidobacterial food products may also improve the bioavailability of certain minerals, including calcium, zinc, and iron, by lowering the gastric pH (facilitating ionization of minerals, which is necessary for their uptake).

#### **4.7. Improving Protein Metabolism**

Bifidobacteria have phosphoprotein phosphatase activity which helps in increase absorption of human milk protein by breaking down the casein in human milk. This is thought to contribute to the satisfactory absorption of human milk (91). Nitrogen retention is good in infants with a bifidus microflora; bifidobacteria promotes the aminoacids metabolism. One of the roles

which bifidobacteria fulfil in the intestinal tract of the infants is to suppress the multiplication of putrefactive bacteria thereby stopping losses of nutrients (Arunachalam, 1999).

#### **4.8. Improving Vitamin Metabolism**

Bifidobacteria are predominant in the intestinal microflora of healthy people irrespective of age and the vitamins produced by them needs warrant attention. The values reported for vitamins produced by bifidobacteria are : vitamin B1: 7.5 µg and B2: 25 µg per g dry weight for intracellular bacterial vitamins, and B1: 25 – 250 µg, B2: 100 µg, B12: 0.06 µg, nicotinic acid 400 µg, and folic acid 25 µg per 'litre of medium for vitamins produced outside the bacterial cells. With bifidus microflora it would also be enable the beneficial utilization of the extracellular vitamin B, produced by the bifidobacteria (Arunachalam, 1999).

#### **4.9. Antibiotic Activity**

In vitro, bifidobacteria have been noted to have antibacterial activity against pathogenic *E. Coli*, *Staphylococcus aureus*, *Shigella dysenteriae*, *Salmonella typhi*, *Proteus spp.* and *Candida albicans*. The antibacterial action shown by bifidobacteria

is from the organic acids they produce. Bifidobacteria make 1 mol lactic acid, 1.5 mol acetic acid and small amount of formic acid from 1 mol of glucose. Rasic and Kurmann (1983) reported that the intensity of the antibiotic action varies with acids, for example the minimum pH at which *Salmonella spp.* can grow is 5.4 for acetic acid, 4.4 for lactic acid and 4.05 for citric/hydrochloric acid. Bifidin is stable to heating 100°C for 30 min; it gives a positive ninhydrin reaction, and its main components are phenylalanine and glutamic acid. It shows antibacterial activity against *Micrococcus jlavus* and *Staphylococcus aureus*, by being active at pH 4.8 to 5.5 (Ramakrishna et al, 1985). Ferrari et al. (1980) have shown that the bifidobacterial cells breakdown the conjugated bile acids to free bile acids which intern inhibit the growth of pathogens.

#### 4.10. Cholesterol-lowering Ability

Subsequent in vitro work has demonstrated the ability of bifidobacteria to both assimilate cholesterol and coprecipitate it with deconjugated bile acids. Such observations have led to great interest in the cholesterol-lowering capacity of a diet containing fermented milks. However, much contradictory data exist regarding the effects

of consuming foods containing bifidobacteria on serum cholesterol levels. Confounding the issue has been the use of different strains, dosages, and food vehicles in the various studies carried out so far. Additional criticisms of the current data have included lack of stabilization of baseline cholesterol levels, inadequate size and/or duration of studies, and difficulty in controlling the diet and physical activity of subjects. Influence of yoghurt in human serum cholesterol level can be seen in Table 3.

Consumption of yogurt itself may not help in controlling cholesterol but some factor produced by the yogurt bacteria during fermentation of the milk is responsible. So, there may be some ways to concentrate the active factor(s) into usable volume for practical use.

## 5. CONCLUSION

Results to date clearly indicate the potential benefits of consuming a diet incorporating foods containing bifidobacteria. Bifidobacteria is popular as one of the most important groups of intestinal organisms regarding human health. Dairy products appear to be the best vehicles for delivery of them to humans because of the LAB

properties of most probiotics. Lactic acid bacteria including lactobacilli and bifidobacteria are the most common bacterial species considered as potential probiotics. Bio-yogurt is yogurt that contains live probiotic microorganisms, including species of *Bifidobacterium* that give the beneficial health effects. A number of health benefits have been attributed to bifidobacteria, which are colonization resistance, anticarcinogenic and antibiotic activities, reduction of the risk of colon cancer, stimulation of immune functions, enhancement of nutritional value and lowering cholesterol. Essential to the future of functional foods are adequate studies confirming the safety, efficacy, and viability of such products. Current developments within the scientific community, food industry, and regulatory bodies are all pursuing this end.

## REFERENCES

- Arunachalam, K.D. (1999). Role of Bifidobacteria in Nutrition, Medicine and Technology. *Nutrition Research*, Vol. 19, 10, 1559-1597.
- Bousvaros, A., Guandalini, S., Baldassano, R.N., Botelho, C., Evans, J., Ferry, G.D., Goldin, B., Hartigan, L., Kugathasan, S., Levy, J., Murray, K.F., Oliva-Hemker, M., Rosh, J.R., Tolia, V., Zholudev, A., Vanderhoof, J.A., Hibberd, P.L. (2005). A randomized, double-blind trial of Lactobacillus GG versus placebo in addition to standard maintenance therapy for children with Crohn's disease. *Inflammatory Bowel Disease*, 11, 833–839.
- Champagne, C.P. and Gardner, N.J. (2005). Challenges in the addition of probiotic cultures to foods. *Critical Reviews in Food Science and Nutrition*, Vol 45, pp.61 – 84.
- Ciani, M., Comitini, F. and Mannazzu, I. (2008). *Fermentation. Ecological Processes*. Elsevier Science Ltd.
- Davis, J. G., Ashton, T. R., and McCaskill, M. (1971). Enumeration and viability of Lactobacillus bulgaricus and Streptococcus thermophilus in yogurt. *Dairy Industries*, 36, 569–573.
- FAO, Food and Agriculture Organization of the United Nations and World Health Organization. Evaluation of health and nutritional properties of powdered milk and live lactic acid bacteria. Geneva, Switz., and Agriculture Organization of the United Nations and World Health Organization Expert Consultation Report; 2001 <ftp://ftp.fao.org/docrep/fao/meeting/009/y6398e.pdf>.
- Ferrari, A., Pacini, N., Canzi, E. (1980). A note on bile acids transformations by strains of *Bifidobacterium*. *J Appl Bacterial*, 49, 193-197.
- Gurr, M. I. (1987). Nutritional aspects of fermented milk products. In: *Organizing Committee of the XXII International Dairy Congress (Eds.), Milk The vital force Proceedings of the XXII international dairy congress, The Hague* (pp. 641–655). Dordrecht: D. Reidel Publishing Company.
- Gilliland, S. E. (1979). Beneficial inter-relationships between certain microorganisms and humans: Candidate microorganisms for use as dietary adjuncts. *Journal of Food Protection*, 42, 164–167.
- Hamann, W. T., and Marth, E. H. (1983). Survival of *Streptococcus thermophilus* and *Lactobacillus*

- bulgaricus in commercial and experimental yogurts. *Journal of Food protection*, 47(10), 781–786.
- Hattingh, A.L. and Viljoen, B.C. (2001). Yogurt as probiotic carrier food. *International Dairy Journal*. Vol. 11, pp. 1 – 17.
- Hutkins, R., Moris, H. A., and McKay, L. L. (1985). Galactose transport in *Streptococcus thermophilus*. *Applied and Environmental Microbiology*, 50(4), 772–776.
- Ishibashi, N., and Shimamura, S. (1993). *Bifidobacteria: Research and development in Japan*. *Food Technology*, 47(6), 126, 129–134.
- Kampman E., Goldbohm, R.A., Van Den Brandt, P.A., and Van't Veer, P. (1994). Fermented dairy products, calcium, and colorectal cancer in the Netherlands cohort study. *Cancer Research*, 54, 3186-90.
- Lavermicocca, P. (2006). Highlights on new food research. *Digestive and Liver Disease*, Vol. 38, Supplement 2, pp. S295 – S299.
- Ling, W.H., Korpela, R., Mykknen, H., Salminen, S and Hemiinen, O. (1994). *Lactobacillus strain GG* supplementation decreases colonic hydrolytic and reductive enzyme activities in healthy female adults. *J Nutr*, 124, 18-23.
- Mann, G.V. (1977). A factor in yogurt which lowers cholestremia in man. *Atherosclerosis*, 26, 335-340.
- Matteuzzi D, Crociani F, and Emaldi. (1978). Amino acids produced by *Bifidobacteria* and some *Clostridia*. *Annales de Microbiologic*, 129B, 175-181.
- Mc Cartney, A.L. (2003). *Bifidobacteria in Food*. University of Reading, Reading, UK. Elsevier Science Ltd.
- Micanel, N., Haynes, I. N., and Playne, M. J. (1997). Viability of probiotic cultures in commercial Australian yogurts. *Australian Journal of Dairy Technology*, 52, 24–27.
- Ouwehand, A.C., and Salminen, S. J. (1998). The health effects of cultured milk products with viable and non-viable bacteria. *International Dairy Journal*, 8, 749–758.
- Rachid, M.M., Gobbato, N.M., Valdez, J.C., Vitalone, H.H., Perdigon, G., (2002). Effect of yogurt on the inhibition of an intestinal carcinoma by increasing cellular apoptosis. *International Journal of Immunopathology and Pharmacology*, 15, 209–216.
- Radke-Mitchell, L., Sandine, W. E. (1984). Associative growth and differential enumeration of *Streptococcus thermophilus* and *Lactobacillus bulgaricus*: A review. *Journal of Food Protection*, 47, 245–248.
- Ramakrishna, Y., Singh, R.S., Anand, S.K. (1985). Effect of streptomycin on lactic cultures. *Cultured Dairy Products Journal*, 20(3), 12-13.
- Rasic, J. L. and Kurmann, J. A. (1983). *Bifidobacteria and their role* pp. 12, 13, 21, 42–50, 102–133, 144–158). Basel: Birkhauser.
- Renner, E. (1983). Microbiological aspects of cultured milk products in the diet. In *Milk and dairy products in human nutrition*. Munich: Volkswirtschaftlicher, Verlag.
- Rybka, S. and Kailasapathy, K. (1995). The survival of culture bacteria in fresh and freeze-dried AB yoghurts. *The Australian Journal of Dairy Technology*, 50(2), 51–57.
- Sanders, M.E. (1997). Lactic acid bacteria as promoters of human health. In: Goldberg, L. (Ed.), *Functional Foods*. Chapman and Hall Co., New York, pp. 294–322.
- Shimamura S, Abe F, Ishibashi N, Miyakawa H, Yaeshima T, Araya T, and Tomita M. (1992). Relationship between oxygen sensitivity and oxygen metabolism of *Bifidobacterium* species. *Journal of Dairy Science*, 75, 3296-3306.
- Tamime, A. Y., & Robinson. (1985). *Yogurt: Science and technology*. Oxford: Pergamon Press.

Tamime, A. Y., Marshall, V. M. E., and Robinson, R. K. (1995). Microbiological and technological aspects of milks fermented by bifidobacteria. *Journal of Dairy Research*, 62, 151–187.

Thomas, T. D., and Crow, L. V. (1984). Selection of galactosefermenting *Streptococcus thermophilus* in lactose-limited chemostat cultures. *Applied and Environmental Microbiology*, 48(1), 186–191.

Ventura, M., O'Connell, M.M., Leahy, S., Moreno-Munoz, J.A., Fitzgerald, G.F., Van Sinderen, D. (2007). From bacterial genome to functionality; case bifidobacteria. *International Journal of Food Microbiology*, 120, 2 – 12.

Vries W, and Stouthamer AH. (1967). Fermentation of glucose, lactose, galactose, mannitol and xylose by bifidobacteria. *J Bact*, 96(2), 472-478.



Table 1. Examples of the commercial yogurt products containing probiotic cultures (Champagne &amp; Gardner, 2005)

Examples of commercial products	Microorganisms used mainly as starter	Microorganisms used mainly as a probiotic adjunct culture
Lunebest, Mil-Mil	<i>S. thermophilus</i> <i>Lb. bulgaricus</i>	<i>Lactobacillus</i> , <i>Bifidobacterium</i>
Olifus	<i>S. thermophilus</i> <i>Lc. Lactis</i>	<i>Lactobacillus</i> , <i>Bifidobacterium</i>
Biogarde, Aktifit	<i>S. thermophilus</i>	<i>Lactobacillus</i> , <i>Bifidobacterium</i>
Progurt	<i>Lc. Lactis</i>	<i>Lactobacillus</i> , <i>Bifidobacterium</i>
BA, Biobest, Yoplait Basket	<i>S. thermophilus</i> <i>Lb. bulgaricus</i>	<i>Bifidobacterium</i>
Biokys		<i>Lactobacillus</i> , <i>Pediococcus</i> , <i>Bifidobacterium</i>
Gaio, Praghurt	<i>S. thermophilus</i> <i>Lb. bulgaricus</i>	<i>Enterococcus</i>
Bioghurt	<i>S. thermophilus</i>	<i>Lactobacillus</i>
Bifighurt, Yoke	<i>S. thermophilus</i>	<i>Bifidobacterium</i>

Table 2. Bifidobacteria species and their origin (Ventura, 2007)

Strain	Origin
<i>B. breve</i> , <i>B. bifidum</i> , <i>B. pseudocatenulatum</i>	Infant feces
<i>B. adolescentis</i> , <i>B. catenulatum</i> , <i>B. longum</i> biotype <i>longum</i>	Intestine of adult
<i>B. gallicum</i>	Human feces
<i>B. animalis</i> subsp. <i>Lactis</i>	Yogurt
<i>B. longum</i> biotype <i>infantis</i>	Intestine of infant
<i>B. scardovii</i>	Human blood

Table 3. Influence of Yoghurt in Human Serum Cholesterol Level (Mann, 1977).

Product	Serum cholesterol (mg/l)		
	Before	After	Significant reduction
Whole Milk	196	177	No
Yogurt from Whole milk	193	175	Yes
Yogurt from Skim Milk	211	150	Yes



## INITIATION OF CALLUS CULTURE OF CANTALOUPE MELON (*Cucumis melo* L.) AND DETECTION OF ITS BETA-CAROTENE CONTENT

**Tjie Kok, Xavier Daniel and The Sandy Kristianti**

*Faculty of Biotechnology; University of Surabaya, Indonesia*  
[tjie\\_kok@staff.ubaya.ac.id](mailto:tjie_kok@staff.ubaya.ac.id)

### ABSTRACT

Cantaloupe Melon (*Cucumis melo* L.) is a fruit plant riching in antioxidant beta-carotene. Perhaps, production of beta-carotene can also be achieved by first initiating callus culture of the plant in suitable medium, propagating them, and extracting the compound it produce. This research was a preliminary effort aimed to examine it. The results of this research showed that the optimum medium for callus culture initiation from cotyledon of Cantaloupe Melon and its propagation was Murashige Skoog (MS) with the addition of 1 mg/L benzyl adenine (BA) and 1.5 mg/L naphthalene acetic Acid (NAA). The beginning of stationary phase on calluses' growth curve was chosen as a harvest time of calluses, based on the theory that beta-carotene as a secondary metabolite is usually be produced much at that phase. The results demonstrated that stationary phase began at the end of week fourth, so the time was decided as the harvest time of calluses. Beta-carotene was then extracted from calluses by maceration technique. The existence of the compound in extract was tested using Thin Layer Chromatography (TLC) and Fourier Transformed-Infrared Spectroscopy (FTIR). The data showed that the compound existed in the extract. The concentration of the compound in it was needed to determine further.

**Keywords :** *Cantaloupe Melon, beta-carotene, callus cultures, Thin Layer Chromatography (TLC), Fourier Transformed-Infrared Spectroscopy (FTIR)*

### INTRODUCTION

Cantaloupe melon (*Cucumis melo* L.) is a plant giving many benefits for human in culinary as well as in health, both in tropic and subtropic countries. Its popularity has been increasing further after World Health Organization classified it as one of the world's healthiest fruits due to its abundant antioxidant content, namely beta-carotene.



**Figure 1.** The fruit of Cantaloupe melon (*Cucumis melo* L.)

Beta-carotene can prevent us from suffering a cancer due to its antioxidant activity that hinder free radicals to react with our body tissues. Among all kinds of melon, Cantaloupe is considered as the healthiest melon. The fruits of this melon, orange in color, contain beta-carotene and lycopene in relatively large

amount. In addition to its function as antioxidant, beta-carotene, in our body, can also be changed to vitamin A that is beneficial to maintain eye's health and to increase our body defense's system. The result of research revealed that the risk of the cataract development was reduced by 39 percent (Hidayati&Asmah, 2011).

Plant tissue culture is considered as a technique that can be applied to propagate plants or certain parts of them rapidly in order to obtain certain compounds in large quantity. It is conducted by isolating certain part of plants (e.g. leaves, seeds, shoots) and grow them aseptically in enriched artificial media so that it can develop further to become callus culture, shoot culture, embryo culture and so on (Sukmawati&Efendi, 2009).

In this experiments, callus culture of Cantaloupe melon was initiated and used to propagate cell and to obtain beta-carotene in large amount, in Murashige Skoog Media containing growth hormone of auxin and cytokinine classes (Christiani&Suryowinoto, 1989; Ardiana, 2009).

In this research cotyledon of Cantaloupe melon (*Cucumis melo* L.) in vitro was used as explant. It is expected from the preliminary experiment that beta-carotene can be obtained in a large quantity in the future.

## **MATERIAL(S) AND METHOD(S)**

### **Explant preparation**

The seeds of Cantaloupe melon (*Cucumis melo* L.) were taken, washed with detergent for 2-3 minutes and flushed with flowing water. Afterwards, they were peeled, and immersed in bactericide and fungicide (made by dissolving 10 mL solution of both each in 1 L water) for 15 minutes, and immersed in sodium hypochloride:sterile water (1:1) for 5 minutes in Laminar Air Flow Cabinet (Zulkarnain, 2009).

### **Callus Culture Initiation**

After being sterilized the seeds were cultivated in Murashige Skoog media and incubated at 25°C for 2 weeks until its cotyledons grows. The cotyledons were then transferred to some treatment media, incubated at 25°C in dark condition for 1 month in order to obtain the optimum media for the callus culture initiation.

### **Subculturing and Harvesting of Callus Culture**

Subculturing was conducted every 28 days using the same condition of callus culture initiation and the callus was harvested afterwards. Growth Index, that is ratio between fresh weight of harvested callus and initial weight of callus cultivated, was determined in this step.

### **Extraction of beta carotene**

The fruit's flesh and callus harvested were dried, pulverized, and sieved. 10 grams of powder from both was put in methanol:acetone (1:1) overnight and the filtered. The filtrate was then thickened using

rotary evaporator (Harimbi& Setyawati, 2004).

### Detection of the existence of beta carotene

Detection of the existence of beta carotene was conducted using TLC with silica gel F254 and ethyl acetate:chloroform (2:8) as eluent. The spot was examined under UV lamp 254 nm, and the R<sub>f</sub> of extracted compound were compared to that of beta-carotene (standard). The functional groups of extracted compound were also checked using FTIR spectroscopy and compared to those of beta-carotene as a standard (Gandjar&Rohman, 2009).

## RESULTS AND DISCUSSION

### Callus Culture Initiation

From the callus culture initiation experiments, it was found that Murashige Skoog media with the addition of 1 ppm benzyl adenine and 1.5 ppm naphthalene acetic acid was the optimum media for callus culture initiation.



**Figure 2.** The formation of callus cultures from cotyledons.

### Subculturing and Harvesting of Callus Culture

The results of the observation of callus's growth are shown in **Figure 3**, **Table 1**, and **Figure 4**.



**Figure 3.** The subculturing of callus cultures.

**Table 1.** The average of fresh harvested weight of callus and their respective Growth Index (initial fresh weight was 2 grams)

Growth period (week)	The average of callus's fresh weight (gram)	The average of Growth Index
1	2.90 ± 0.11	1.45
2	4.88 ± 0.27	2.44
3	8.31 ± 0.21	4.16
4	8.57 ± 0.31	4.28
5	7.39 ± 0.61	3.69
6	6.47 ± 0.44	3.24

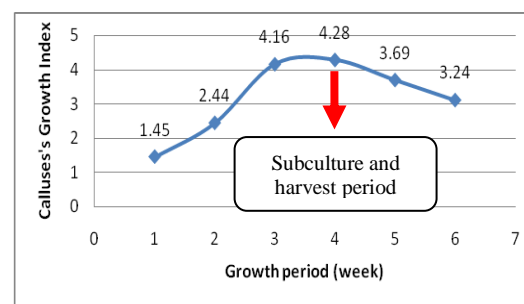

**Figure 4.** Graph of calluses's Growth Index

Growth Index was increasing during week-1 to week-3 and reaching its peak, i.e. 4.28, at the end of week-4, and decreasing afterwards. Therefore, subculturing of the callus culture was performed at the end of week fourth and so was its harvesting.

### Detection of the existence of beta carotene

The result of Rf detection of spot of specific compound in extracts using TLC is listed in **Table 2**.

**Table 2.** Rf value of extract of callus and that of fruit.

	Beta-carotene (standard)	Callus	Fruit's flesh	
			Residue	Filtrate
Rf	0.27	0.27	0.26	0.26

The Rf of spots of callus's extract on TLC, i.e. 0.27, was the same as that of beta-carotene (standard), while both residue and filtrate of fruit's flesh also demonstrated the similar Rf value, i.e. 0.26. This confirmed that beta carotene did exist in callus in addition to the fruit.

Results of functional groups detection of the compounds contained in extract and that of beta-carotene (standard) using FTIR spectroscopy are demonstrated in **Figure 5**, **Figure 6** and **Figure 7**.

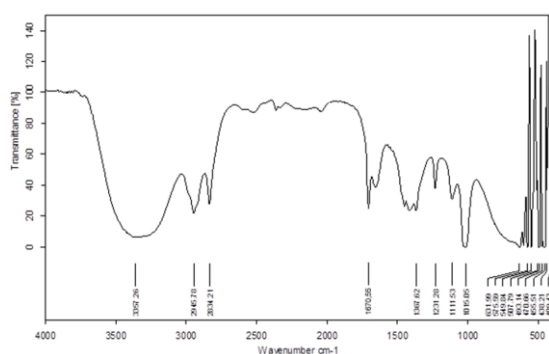

**Figure 5.** Fourier-transformed infrared spectrum of callus's extract

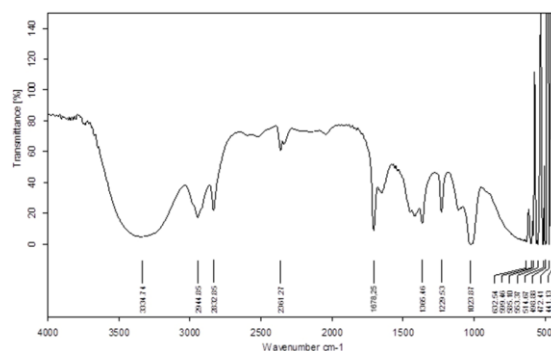

**Figure 6.** Fourier-transformed infrared spectrum of the extract of fruit's flesh

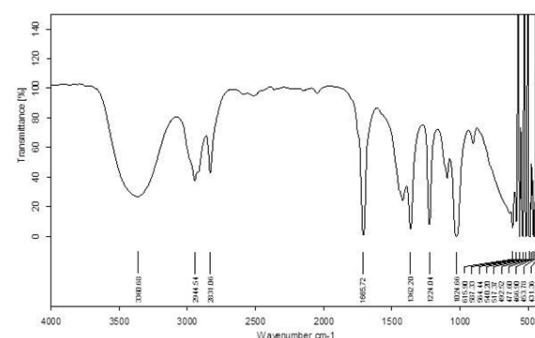

**Figure 7.** Fourier-transformed infrared spectrum of beta-carotene (standard)

The spectra indicated that in the extract of callus and fruit's flesh there were several characteristic functional groups owned by beta-carotene, i.e.:

- Alkane (C-H) group, absorbing within wavenumber  $2850\text{-}2960\text{ cm}^{-1}$ ,  $1350\text{-}1470\text{ cm}^{-1}$
- Alkene (C=C) group, absorbing within wavenumber  $1640\text{-}1680\text{ cm}^{-1}$

Therefore it could be stated that all the extracts contained beta-carotene.

### CONCLUSION(S)

From the results of the research, several conclusions are drawn:

1. Murashige Skoog media with the addition of 1 ppm benzyl adenine and 1.5 ppm

naphthalene acetic acid was the optimum media for callus culture initiation as well as calluses' growth.

2. The existence of beta carotene was indeed detected in the callus of Cantaloupe melon in addition to its fruit's flesh.

## REFERENCES

- Ardiana, D.W. (2009). Teknik Pemberian Benzil Amino Purin untuk Memacu Pertumbuhan Kalus dan Tunas pada Kotiledon Melon (*Cucumis melo* L.). Buletin Teknik Pertanian 14(2):50-53.
- Christiani; Suryowinoto, M. (1989). Respon Penambahan NAA dan Kinetin Terhadap Pertumbuhan dan Perkembangan pada Budidaya Jaringan Melon. BPPS-UGM.
- Gandjar, I.G. dan Rohman, Abdul (2009). Kimia Farmasi Analisis. Yogyakarta: Pustaka Pelajar. Hal.220-255.
- Harimbi, Setyawati (2004). Proses Ekstraksi Beta-Karoten dari Ubi Jalar dengan Pelarut Aseton. Jurnal Teknologi Institut Sains dan Teknologi Akprind. Lembaga Penelitian.
- Hidayati, Asmah (2011). Identifikasi, Karakterifikasi dan Ekstraksi Beta-Karoten dari Ipomea batatas Sebagai Suplemen. Universitas Muhammadiyah Malang.
- Sukmawati, F dan Efendi, D. (2009). Induksi Embrio Somatik Melon (*Cucumis melo* L.) pada Berbagai Media dan Zat Pengatur Tumbuh. Makalah Seminar Departemen Agronomi dan Hortikultura Fakultas Pertanian-Institut Pertanian Bogor.
- Zulkarnain (2009). Kultur Jaringan Tanaman. Cetakan Pertama; Jakarta: PT. Bumi Aksara

## CHARACTERIZATION OF THE POLYMERISATION OF FURFURYL ALCOHOL DURING ROASTING OF COFFEE

Yuliana Reni Swasti<sup>1</sup> and Michael Murkovic<sup>2</sup>

<sup>1</sup>Atma Jaya Yogyakarta University, Faculty of Technobiology, Yogyakarta

<sup>2</sup>Graz University of Technology, Institute of Biochemistry, Petersgasse 12/2, Graz, Austria  
[yulianareni@yahoo.com](mailto:yulianareni@yahoo.com)

### ABSTRACT

Heated foods rich in carbohydrate may form furan derivatives such as furan, furfural, furfuryl alcohol, and 5-hydroxymethylfurfural. Furfuryl alcohol can give specific flavour in processed food and it also can polymerize in acid condition producing polymer that form brown colour. Nevertheless, furfuryl alcohol can become a DNA-reactive substance that has a mutagenic effect. Herein we show that furfuryl alcohol polymerizes in a model system by incubating it in 1 M HCl at room temperature. The results of this model system were used to characterize the polymerization of furfuryl alcohol which is produced during roasting of coffee. The coffee was roasted at 210 °C for 2 until 6 min with a home coffee roaster. Furfuryl alcohol and its dimer were found in roasted coffee after 2 and 3 min of roasting respectively, reaching a maximum amount after 4 min. The dimeric furfuryl alcohol in roasted coffee is conjugated with methylene linkage which has a molecular ion with  $m/z$  179  $[M+H]^+$  and a base peak with  $m/z$  161  $[M-18+H]^+$  that fragments into  $m/z$  133  $[M-46+H]^+$  and  $m/z$  105  $[M-74+H]^+$ . Therefore, the polymer of furfuryl alcohol contribute to the brown colour of roasted foods and it is expected that the mutagenic potential of furfuryl alcohol is reduced by the increased chain of furfuryl alcohol although the monomer of furfuryl alcohol is still high in roasted coffee.

**Keywords:** *furfuryl alcohol, roasted coffee, brown colour*

### INTRODUCTION

Furfuryl alcohol has attracted the safety research because new biological activation reactions have been identified which are also relevant for furfuryl alcohol activation in a way that this compound can become a DNA-reactive intermediate that has a mutagenic effect (Glatt and Sommer, 2006). Primary alcohol have a higher genotoxic activity compared to secondary and tertiary alcohols (Glatt, 2000). Although it polymerizes, the concentration

of the monomeric furfuryl alcohol is still high in heated food products. Furfuryl alcohol gives a burnt sugar odour, cooked-sugar odour, rubber-like odour, and when furfuryl alcohol interacts with dihydroxybenzene or trihydroxybenzene during roasting of coffee it will produce a bitter taste (Lee et al., 2006; Wang & Kays, 2000; Bonvehì, 2005; Karagu-Yüceer et al., 2002; Kreppenhofer et al., 2011). Nevertheless, furfuryl alcohol is used as a flavouring agent with an

acceptable daily intake of 0 – 0.5 mg/kg (Joint FAO/WHO, 2000).

Furfuryl alcohol can be formed by the degradation of 1,2–enediols and quinic acid at high temperatures (Brands & Boekel, 2001; Moon & Shibamoto, 2010). Quantitatively, furfuryl alcohol as a furan derivative is predominating in roasted coffee (Kreppenhofer et al., 2011). Furfuryl alcohol can polymerize in acid conditions by condensation of the hydroxyl group and the hydrogen atom of the heterocycle at carbon 5 producing a polymer with methylene linkages (Dunlop & Peters, 1953) resulting in a brown coloured polymer (Choura et al., 1996). Dimerization of furfuryl alcohol could also occur by condensation of the two hydroxyl groups of furfuryl alcohol producing dimethylene ether linkages. However, in acid conditions this type of condensation releases formaldehyde to form the methylene linkage (Dunlop & Peters, 1953). The brown colour of the aliphatic furfuryl alcohol polymer could be induced by the loss of one hydrogen atom from a central carbon (Choura et al., 1996). It is also possible that the furfuryl alcohol and its oligomers are introduced into the melanoidins – a high molecular mass and brown coloured product. Other heterocyclic aromatic ring systems (e.g. pyridines, pyrazines, pyrroles, and

imidazoles) also contribute to the melanoidin formation (Nursten, 2005). Generally, melanoidin forms by condensation of amino compounds with products from Amadori rearrangements which undergo sugar dehydration and sugar fragmentation (Hodge, 1953). In coffee beverages, melanoidin contributes up to 25 % of the dry matter (Borrelli et al., 2002).

Here the formation of intermediate furfuryl alcohol oligomers during roasting of coffee will be described. This is important because this reaction could contribute to the browning of coffee during roasting and it is expected that with the increased chain length the mutagenic potential of furfuryl alcohol is reduced.

## LITERATURE REVIEW

### Formation of Furfuryl Alcohol

Glucose or fructose in high temperature can undergo isomerisation reaction. The key intermediate in these isomerisation reactions, 1,2–enediol, is considered as the starting intermediate of the degradation by  $\beta$ -elimination producing the unstable compound 3–deoxyaldoketose followed by cleavage producing formic acid and a compound with five carbon atoms (De Bruijn et al., 1986). From this C<sub>5</sub> compound, furfuryl alcohol is produced (Rewicki et al., 1994). Besides that,

heating of quinic acid at 250 °C for 30 min under nitrogen produces furfuryl alcohol 250 µg/g, (Moon & Shibamoto, 2010). Wnorowski and Yaylayan (2000) found that furfural alcohol forms from an intact glucose skeleton. Quantitatively, furfuryl alcohol as a furan derivative is predominating in roasted coffee (Kreppenhof et al., 2011).

### **Polymerisation of Furfuryl Alcohol**

Furfuryl alcohol can polymerize in acid conditions by condensation of the hydroxyl group and hydrogen atom of the heterocycle at carbon 5 producing a polymer with methylene linkages (Dunlop & Peters, 1953) resulting in a brown coloured polymer (Choura et al., 1996). The energy activation during early condensation is low and can be attributed to a self condensation mechanism (Guigo et al., 2007). Moreover, polymerisation of furfuryl alcohol could occur by interaction of furfuryl alcohol with the carbenium ion of another furfuryl alcohol molecule. This condensation is kinetically more preferred than between two furfuryl alcohols (Kim et al., 2011). Polymerization of furfuryl alcohol could also occur by condensation of the two hydroxyl groups producing a dimer with dimethylene ether linkages, but in acid conditions this type of condensation releases formaldehyde to

form a methylene linkage (Dunlop and Peters, 1953).

Colour formation in furfuryl alcohol polymerisation starts with the elimination of water and followed by hydride-ion exchanges from the carbon of the methylene linkage that will change the colour from intermediate green to dark brown (Choura et al., 1996). The intensity of the colour is in line with increased conjugation of the double bonds during furfuryl alcohol polymerisation. Besides the colour formation, the viscosity of the solution furfuryl alcohol in acid condition also increases until it reaches a solid state (Bertarione et al., 2008). The increase of viscosity happened by Diels–Alder cyclo additions between oligomers formed in the previous step and this is also reflected by the increase of activation energies (Guigo et al., 2007).

### **Furfuryl Alcohol in Foods**

The concentration of the monomeric furfuryl alcohol is still high in roasted coffee. Furfuryl alcohol in instant coffee is 267 µg/g and in coffee roasted at 210 °C for 3 min is 564 µg/g (Golubkova, 2011). Medium roasted coffee has higher furfuryl alcohol content than light roasted coffee (Moon & Shibamoto, 2009). Furthermore, furfuryl alcohol is also found in food product like in rice cakes 2 – 2.3 µg/g



(Buttery et al., 1999), bread 187 µg/g (Jensen et al., 2011), honey 1.55 µg/g (Vázquez et al., 2007), toasted almonds cv. Marcona  $5.97 \pm 1.09$  µg/g, toasted almonds cv. Comuna  $8.88 \pm 1.39$  µg/g, toasted almonds cv. California  $4.40 \pm 1.23$  µg/g (Vázquez–Araújo et al., 2008), non fat dried milk stored for 3 months in low humidity at room temperature 14.5 µg/g (Karagu–Yüceer et al., 2002), popcorn 0.0382–0.0821 µg/g (Park & Maga, 2006), corn tortilla chips 0.54 µg/g (Buttery & Ling, 1998), roasted cocoa powder 0.021 µg/g (Bonvehì, 2005), palm sugar was made by using traditional heating process at 210 °C 0.139 µg/g, palm sugar was made by a traditional heating process at 240 °C 0.518 µg/g (Ho et al., 2007), baked “Jewel” sweet potato 0.014 µg/g fresh weight (Wang & Kays, 2000) and citrus honey 0.011 µg/g (Castro–Vázquez et al., 2007). Also, furfuryl alcohol was found in frying oil that was used for beef, veal, and chicken product frying (Takeoka et al., 1996).

### Health Effects of Furfuryl Alcohol

Estimated furfuryl alcohol intake is 130 µg/kg human body weight (Munro & Danielewska–Nikiel, 2006). Furfuryl alcohol is mutagenic to *Salmonella typhimurium* strains TA100 engineered for the expression of human SULT1A1 because sulfotransferase can activate

furfuryl alcohol into the mutagenic compound, 2–sulfooxymethylfuran. The 2–sulfooxymethylfuran is generated intracellularly in proximity to the DNA leading to the formation of 2–methylfuranyl adducts. The covalent 2–methylfuranyl adducts cause mutagenic effects. The mutagenicity of furfuryl alcohol is dose dependent and increases its mutagenicity from 3 to 200 nmol furfuryl alcohol per plate (Monien et al., 2011). The DNA samples of liver, kidney, and lung contain 2–methylfuranyl adducts in mice that received furfuryl alcohol with the drinking water. Rodents exposed to furfuryl alcohol form tumors that contain 2–methylfuranyl (NTP, 1999).

## METHODOLOGY

### Polymerization Furfuryl Alcohol.

40 µl Furfuryl alcohol were mixed with 40 µl aqueous acid (1 M HCl and 40 µl MeOH) and then it was incubated at 22 °C for 6 h. The reaction mixture was then diluted to 25 ml with methanol and then 1 ml of the sample to 5 ml with methanol. The samples were then analysed with the LC–MS Agilent 1100. LC–MS conditions: LiChrospher 100 RP–18 (125 × 3 mm, 5 µm) as column from Agilent Technologies, 5 µl injection volume (for model system), 10 µl injection volume (for roasted coffee extract), 0.6 ml/min solvent flow rate,

gradient elution until 15 min: 25 % MeOH, 73 % water; 2 % acetic acid in water pH 2.5 (constant during 15 min), DAD at 228 nm, ESI, scan mode, positive mode, 70 V, mass range 75 – 200.

### Determination of Furfuryl Alcohol and Its Polymer in Roasted Coffee

40 g Green coffee were roasted in a household coffee roaster (i-Roaster 40211) at 210 °C for 2, 3, 4, 5 and 6 min. 1 g Ground coffee was extracted with 10 ml methanol by vortexing for 2 min. 2 ml of the filtered extract were purified by SPE accucat (conditioned with 5 ml MeOH and 3 ml water). The purified extracts were analysed by LC-MS.

## RESULTS AND DISCUSSION

### Polymerization Furfuryl Alcohol in Model System

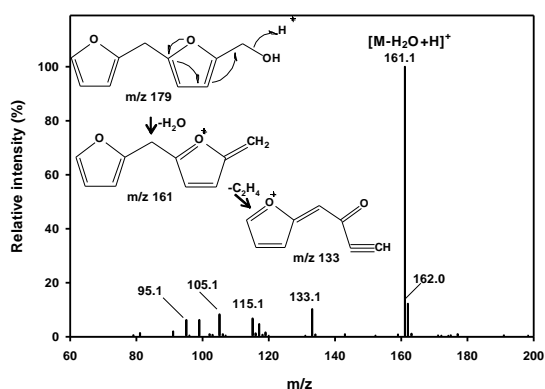

Figure 4.1. Suggested mechanism fragmentation of dimeric furfuryl alcohol in the ESI-MS

The ion 161 is formed by elimination of water  $[M-18+H]^+$ . Elimination of water in vicinal alcohols is common and the molecular ion ( $m/z$  179) cannot be observed in the mass spectrum (Cooks, 1971). After elimination of water from the oligomers, an alkene that is attached to the O-bearing carbon is usually eliminated  $[M-46+H]^+$  followed by elimination  $[M-74+H]^+$  which could be seen in the mass spectrum as  $m/z$  133 and  $m/z$  105 with 70 V fragmentation voltage (Fig. 4. 1).

### Furfuryl Alcohol and Its Oligomers in Roasted Coffee Beans

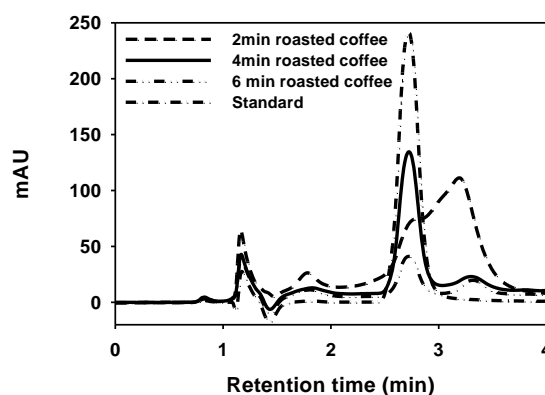

Figure 4.2 HPLC chromatogram of the formation of furfuryl alcohol during roasting of coffee at 210 °C

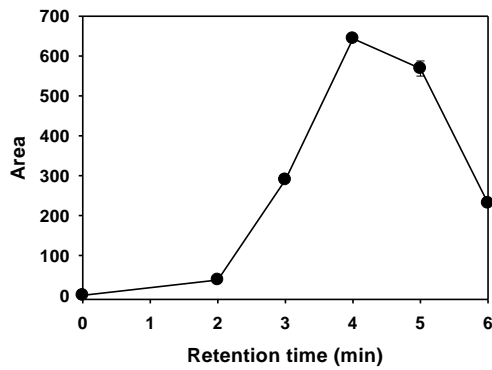

Figure 4.3 The kinetic of production of furfuryl alcohol during roasting of coffee at 210 °C measured by LC-UV

Green coffee (unroasted) does not contain any furfuryl alcohol. However, furfuryl alcohol is formed during roasting. After 2 min of roasting at 210 °C the formation of furfuryl alcohol starts with a significant increase with a decline after 5 min roasting (Figs. 4.2, 4.3). Furfuryl alcohol is formed from glucose or fructose via the intermediate 1,2-enediol (Brands and van Boekel, 2001) or from quinic acid via a different pathway (Moon and Shibamoto, 2010)

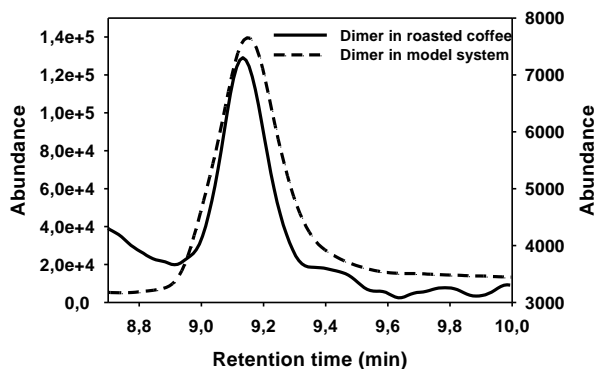

Figure 4.4 The chromatogram of dimeric

furfuryl alcohol in roasted coffee at 210 °C measured by SIM ESI-MS

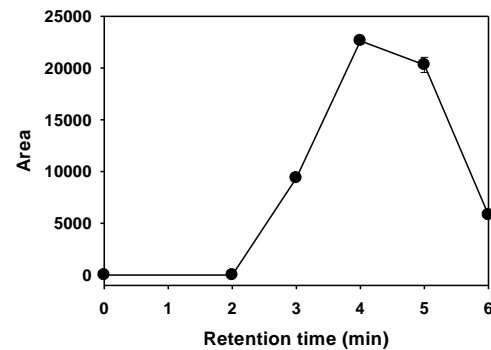

Figure 4.5. The kinetic of the production of dimeric furfuryl alcohol during roasting of coffee at 210 °C measured by SIM ESI-MS

The formation of the dimer starts after 3 min of roasting having a maximum at 4 min; longer roasting results in a decrease of the dimer probably due to further polymerization or degradation (Figs. 4.4, 4.5). This means that furfuryl alcohol polymerizes during roasting in acidic conditions. The low pH may arise through degradation of 1,2-enediols that produces formic acid and also through degradation of 2,3-enediols that produce acetic acid during the heat treatment of sugar containing foods (Brands and Boekel, 2001). Therefore, we conclude that furfuryl alcohol is able to polymerize under these conditions and contributes to the formation of the brown colour.

## CONCLUSION

The polymerization of furfuryl alcohol in acidic conditions leads to the formation of dimer with methylene linkage. The dimer of furfuryl alcohol and furfuryl alcohol itself are both found in roasted coffee. The polymers of furfuryl alcohol can also contribute to the brown colour of roasted coffee.

## REFERENCE

- de Bruijn J. M., Kieboom A. P. G., Van Bekkum H., Van Der Poel P. W. (1986) Reactions of monosaccharides in aqueous alkaline solutions. *Sugar Technol. Rev.* 13, 21-52.
- Glatt H.R., Sommer Y. (2006) Health risk of 5-hydroxymethylfurfural (HMF) and related compounds. Skog K., Alexander J. (Eds) *Acrylamide and other hazardous compounds in heat-treated foods*. CRC press, Boca Raton, USA, pp 328-357.
- Glatt, H., (2000), Sulfotransferases in the Bioactivation of Xenobiotics. *Chemico-Biological Interactions*, 129, 141 – 170.
- Lee, S.M., Seo, B.C. & Kim, Y., (2006), Volatile Compounds in Fermented and Acid-hydrolyzed Soy Sauces. *J. Food Sci.*, 71, 3, 146 – 156.
- Wang, Y. & Kays, S.J., (2000), Contribution of Volatile Compounds to the Characteristic Aroma of Baked ‘Jewel’ Sweetpotatoes. *J. Amer. Soc. Hort. Sci.* 125, 638 – 643.
- Bonvehì J.S. (2005) Investigation of aromatic compounds in roasted cocoa powder. *European Food Research and Technology*. 221, 19-29.
- Karagu-Yüceer Y, Cadwallader K.R., Drake M. (2002) Volatile flavor components of stored nonfat dry milk. *J. Agric Food Chem.* 50, 305-312.
- Kreppenhofer S., Frank O., Hofmann T. (2011) Identification of (furan-2yl) methylated benzene diols and triols as a novel class of bitter compounds in roasted coffee. *Food Chem.* 126, 441-449.
- Joint FAO/WHO expert committee on food additives, (2000). Fifty-fifth Meeting. Geneva. FAO and WHO.
- Brands, C.M.J. & Boekel, M.A.J.S., (2001), Reactions of Monosaccharides during Heating of Sugar-Casein Systems: Building of a Reaction Network Model. *J. Agric. Food Chem.*, 49, 4667 – 4675.
- Moon, J. & Shibamoto, T., (2010), Formation of Volatile Chemicals from Thermal Degradation of Less Volatile Coffee Components: Quinic Acid, Caffeic Acid, and Chlorogenic Acid. *J. Agric. Food Chem.*, 58, 5465 – 5470.
- Wnorowski, A. & Yaylayan, V.A., (2000), Influence of Pyrolytic and Aqueous-Phase Reactions on the Mechanism of Formation of Maillard Products. *J. Agric. Food Chem.*, 48, 3549 – 3554.
- Dunlop, A.P. & Peters, F.N., (1953), In: *The Furans*. Reinhold Publishing Co., New York.
- Choura, M., Belgacem, N.M. & Gandini, A., (1996), Acid-catalysed Polycondensation of Furfuryl Alcohol: Mechanisms of Chromospheres Formation and Cross-Linking. *Macromolecules*, 29, 3839 – 3850.
- Guigo, N., Mija, A., Vincent, L. and Sbirrazzuoli, N., (2007), Chemorheological Analysis and Model-Free Kinetics of Acid Catalysed Furfuryl Alcohol Polymerization. *Phys. Chem. Chem. Phys.*, 9, 5359 – 5366.
- Kim, T., Assary, R.S., Marshall, C.L., Gosztola, D.J., Curtiss, L.A. and Stair, P.C., (2011), Acid-Catalyzed Furfuryl

- Alcohol Polymerization: Characterizations of Molecular Structure and Thermodynamic Properties. *Chem.Cat.Chem.*, 3, 1451 – 1458.
- Bertarione, S., Bonino, F., Cesano, F., Damin, A., Scarano, D. and Zecchina, A., (2008), Furfuryl Alcohol Polymerization in H–Y Confined Spaces: Reaction Mechanism and Structure of Carbocationic Intermediates. *J. Phys. Chem. B.* 112, 2580 – 2589.
- Golubkova, T., (2011), Bildung von Potentiell Toxischen Furanderivaten in Lebensmitteln. Diplomarbeit. Institut für Biochemie TU Graz. Austria. pp. 38 – 40.
- Moon, J. and Shibamoto, T., (2009), Role of Roasting Conditions in The Profile of Volatile Flavor Chemicals Formed from Coffee Beans. *J. Agric. Food Chem.*, 57, 5823 – 5831.
- Buttery, R.G., Orts, W.J., Takeoka, G.R. & Nam, Y., (1999), Volatile Flavour Components of Rice Cakes. *J. Agric. Food Chem.*, 47, 4353 – 4356.
- Jensen, S., Ostdal, H., Skibsted, L.H. & Thybo, A.K., (2011), Antioxidants and Shelf Life of Whole Wheat Bread. *Journal of Cereal Science*, 53, 292 – 297.
- Vázquez, L., Verdú, A., Miquel, A., Burl, F. & Carbonell–Barrachina, A.A., (2007), Changes in Physico–Chemical Properties, Hydroxymethylfurfural and Volatile Compounds During Concentration of Honey and Sugars in Alicante And Jijona Turrón. *Eur. Food Res. Technol.*, 225, 757 – 767.
- Vázquez–Araújo, L., Enguix, L., Verdú, A., García–García, E. & Carbonell–Barrachina, A.A., (2008), Investigation of Aromatic Compounds in Toasted Almonds Used for The Manufacture of Turrón. *Eur. Food Res. Technol.*, 227, 243 – 254.
- Park, D. & Maga, J.A., (2006), Identification of Key Volatiles Responsible For Odour Quality Differences in Popped Popcorn of Selected Hybrids. *Food Chem.*, 99, 538 – 545.
- Buttery, R.G. and Ling, L.C., (1998), Additional Studies on Flavor Components of Corn Tortilla Chips. *J. Agric. Food Chem.*, 46, 2764 – 2769.
- Ho, C.W., Aida, W.M.W., Maskat, M.Y. & Osman, H., (2007), Changes in Volatile Compounds of Palm sap (*Arenga Pinnata*) During the Heating Process for Production of Palm Sugar. *Food Chem.*, 102, 1156 – 1162.
- Castro–Vázquez, L., Díaz–Maroto. L.C. & Pérez–Coello, MS., (2007), Aroma Composition and New Chemical Markers of Spanish Citrus Honeys. *Food Chem.*, 103, 601 – 606.
- Takeoka, G., Perrino Jr, C. & Buttery, R., (1996), Volatile Constituents of Used Frying Oils. *J. Agric. Food Chem.*, 44, 654 – 660.
- Munro, I. C. and Danielewska–Nikiel, B. 2006. Comparison of Estimated Daily Intakes of Flavouring Substances with No–Observed–Effect Levels. *Food Chem. Toxicol.*, 44, 758 – 809.
- Monien, B.H., Hermann, K., Florian, S. and Glatt, H., (2011), Metabolic Activation of Furfuryl Alcohol: Formation of 2–Methylfuryl DNA Adducts in *Salmonella typhimurium* Strains Expressing Human Sulfotransferase 1A1 and in FVB/N Mice. *Carcinogenesis Advance Access*, 32, 1533 – 1539.
- NTP., (1999), Toxicology and Carcinogenesis Studies of Furfuryl Alcohol (CAS No.98–00–0) in F344/N Rats and B6C3F1 Mice (inhalation studies). *Natl. Toxicol. Program Tech. Rep. Ser. NTP – Department of Health and Human Services*, 482.

Cooks, R.G., (1971), in *The Chemistry of the Hydroxyl Group*, ed. S. Patai, Interscience, London, pp. 1045.

## INTEGRATING RESEARCH IN FOOD AND HEALTH: A CASE OF PROMOTING HEALTH BY GLUCOSINOLATES IN *BRASSICA* VEGETABLES

**Probo Y. Nugraedi<sup>1,2)</sup>, Novita I. Putri<sup>1)</sup>, Ruud Verkerk<sup>2)</sup>, Matthijs Dekker<sup>2)</sup> and Budi Widianarko<sup>1)</sup>**

<sup>1)</sup> Department of Food Technology, Soegijapranata Catholic University, Jl. Pawiyatan Luhur IV/1 Bendan Duwur Semarang, Indonesia

<sup>2)</sup> Food Quality and Design Group, Department of Agrotechnology and Food Science, Wageningen University, PO Box 8129, NL-6700 EV Wageningen, The Netherlands  
[probo@unika.ac.id](mailto:probo@unika.ac.id)

### ABSTRACT

Many research findings in the area of food and health cannot be simply disseminated and implemented to have a direct impact on health promotion of the society. There is an interdependency between various types of researches to be considered prior to community outreach. On the other hand, population health is likely to benefit from a food supply of healthier food products, based on their contents of nutrients and health promoting compounds. Many factors should be considered before justifying that a specific food can promote health. Meanwhile, researchers may not comprehend the real needs and capacity of the society to built a well integrated research design. The incomprehensive diffusion of research findings to the society could lead to a very limited, if any, practical application of the knowledge. This paper discusses the integration and expected dissemination of research to the society by using the glucosinolates content in *Brassica* vegetables as a case study. *Brassica* vegetables, *e.g.* cabbages, broccoli, and cauliflower, have been widely investigated for their beneficial effects on human health, especially since *Brassica* vegetables contain glucosinolates. Previous studies reported an inverse association of *Brassica* vegetables consumption and the risk of certain cancers. However, this could not simply be translated into a health claim that increased *Brassica* vegetables consumption will reduce the risk of cancer. There are many factors that could affect the glucosinolates content and bioavailability after harvesting the vegetables, *e.g.* processing and preparation methods. Various processing methods, such as heat treatment and fermentation, considerably decreased the glucosinolates content. In order to preserve the content of glucosinolates, certain measures must be proposed, based on the understanding of the mechanism of glucosinolate degradation during any treatments. These measures must be integrated into practice in order to give a beneficial impact on population health within the community.

**Keywords:** *integration, research, food and health, glucosinolates, Brassica vegetables*

### INTRODUCTION

It has been recognized in few past decades that food does not only provide basic nutrition, but can also prevent diseases and ensure good health. The contribution of the food to promote

health or reduce the risk of disease becomes one of the quality attributes seek especially by the health-conscious type of consumers. The accumulation of scientific evidences which support the vital role of diet in overall health and

well-being increase the consumers interest in healthy food (Rodriguez *et al.*, 2006). Various studies have been focusing on the health promoting compounds in food and how these can promote health or reduce the risk of disease. An example is the studies on *Brassica* vegetables. These vegetables have been widely investigated for their beneficial effects on human health, due to considerable concentration of vitamins, minerals and a special group of phytochemicals, *i.e.* glucosinolates (GSs) (Bellostas *et al.*, 2007).

Despite many research findings in the area of food and health, they cannot be simply disseminated and implemented in order to have a direct impact on health promotion of the society. In Indonesia for example, there can be a gap between the findings and the health promotion activities. The health promoting compounds in the food sometimes fragmentally disseminated, particularly in the popular media, into solely the health efficacy when one consumes the food. For example, informing that broccoli is like a *magic food* which can definitely reduce the risk of cancer (*e.g.* Anonim, 2013; Harmandini, 2010; Febrianindya, 2013). These are intended to promote the consumption of healthy food without further integrating other aspects in food and health. Bridging the information about food and health cannot be simply implemented by informing the efficacy of the compounds in the food. There should be a more comprehensive and holistic view so that consumers will not

perceive the health efficacy of the food solely from the content information.

Moreover, on the other side researchers may not comprehend the real needs and capacity of the society to built a well integrated research design. The incomprehensive diffusion of research findings to the society could lead to a very limited, if any, practical application of the knowledge. This paper aims to discuss the integration of food and health and the expected dissemination of the research to the society, by using the glucosinolates in *Brassica* vegetables as a case study, particularly in the context of Indonesian society.

## FOOD AND HEALTH

Population health is likely to benefit from a food supply of healthier food products, based on their contents of nutrients and health promoting compounds. Various terms have been used interchangeably to designate foods for disease prevention and health promotion. Functional food is the common term to describe the health promoting functionality of the food (Rodriguez *et al.*, 2006). Within the few last decades, however, the term functional as it applies to food has adopted a different connotation—that of providing an *additional* physiological benefit beyond that of meeting basic nutritional needs (Hasler, 1998). The additional physiological benefit may vary for every functional food. It is well known that consumption of plant-based foods, including fruits, vegetables and whole



grains, cereals and nuts as well as intake of marine foods and their long-chain fatty acids is instrumental in health promotion and disease risk reduction (Shahidi, 2009). Overwhelming evidence from epidemiological, in vivo, in vitro, and clinical trial data also indicates that a plant-based diet can reduce the risk of chronic disease, particularly cancer. There are components in a plant-based diet other than traditional nutrients that can reduce cancer risk. Although the vast number of naturally occurring health-enhancing substances are of plant origin, there are a number of physiologically-active components in animal products that deserve attention for their potential role in optimal health. However, the functional foods are not a magic bullet or universal panacea for poor health habits (Hasler, 1998).

It is known that the phytochemical composition can vary markedly as a function of such factors as cultivar, degree of maturity at harvest, climatic or geographic effects, soil composition, cultivation practices, part of the plant utilized. Agronomic and post-harvest handling and processing measures can be taken to insure high levels of these compounds in the diet (Rodriguez *et al.*, 2006). These factors should be integrated in determining the efficacy of phytochemicals in certain food and its effect towards health, as this will be further discussed by using the health promoting compounds, *i.e.* glucosinolates, in *Brassica* vegetables and the impact of processing on the compounds.

## GLUCOSINOLATES

*Brassica* vegetables, *e.g.* cabbages, broccoli, and cauliflower, have been widely investigated for their beneficial effects on human health, especially since these vegetables contain glucosinolates (GSs). GSs are a group of plant secondary metabolites, with a common structure of  $\beta$ -thioglucoside N-hydroxysulphates with a sulphur linked  $\beta$ -D-glucopyranose moiety and side group (R). The side chain R determines the characteristic of GSs, whether it is defined as aliphatic, aromatic or indole. Among other economically important vegetables frequently consumed, *Brassica* vegetables are major sources of GSs (Fahey *et al.* 2001).

In an intact plant tissue GSs are occurred in separate compartments with the enzyme myrosinase. GSs are highly prone to degradation by myrosinase-catalysed hydrolysis upon cell disruption. The activity of myrosinase itself is influenced by intrinsic and extrinsic factors, such as ascorbic acid,  $MgCl_2$ , pH, temperature, and pressure (Ludikhuyze *et al.* 2000).

Based on epidemiological evidence reports, Herr and Büchler (2010) suggested that these vegetables contain chemo-preventive agents against lung, colorectal, breast, prostate, pancreatic, and possibly also gastric cancers. It is the GS content that is assumed to be accountable indirectly to lower the risk of cancer (Verhoeven *et al.*, 1997). Isothiocyanates, one of the GSs breakdown products, can reduce the risk

of cancer by inhibiting phase 1 and inducing phase 2 enzymes during carcinogen metabolism. Isothiocyanates act on the process of carcinogenesis by influencing phases of tumor initiation, promotion and progression, and by suppressing the final steps of carcinogenesis (Traka and Mithen, 2009). However, this could not simply be translated into a health claim that increased *Brassica* vegetables consumption will reduce the risk of cancer.

There are many factors that could affect the glucosinolates content and bioavailability after harvesting the vegetables, *e.g.* processing and preparation methods. (*e.g.* Slominski and Campbell 1989; Rungapamestry *et al.* 2006; Moreno *et al.* 2007; Volden *et al.* 2008). Moreover, the GSs content can vary over 100 fold as a result of variations caused by differences in cultivars, cultivation practices, processing, cooking and preparation methods, and also storage conditions (Verhoeven *et al.* 1997; Verkerk *et al.* 2001; Verkerk and Dekker 2004; Verkerk *et al.* 2009). Each type of processing and storage has its typical condition, even within the same processing type, there are variability of conditions such as time-temperature, ratio of vegetables and medium, and cooking wares conditions. Therefore, different processing and storage may affect in different amounts and profiles of GSs.

## **EFFECT OF PROCESSING**

*Brassica* vegetables are mainly consumed after some types of processing, *e.g.* boiling, steaming, microwave processing, stir-frying, or fermentation. These various processing methods can considerably decrease the glucosinolates (GSs) content. For example during boiling, losses of 5-20% of GSs due to thermal breakdown (Oerlemans *et al.*, 2006; Dekker *et al.*, 2009; Jones *et al.*, 2010) and losses of 25%-75% of GSs due to leaching are typically expected (Rosa and Heaney, 1993; Dekker *et al.*, 2000; Volden *et al.*, 2008). Meanwhile, fermentation was reported to reduce total GSs content substantially. No GSs content was observed in fermented cabbage and stored sauerkraut (Daxenbichler *et al.*, 1980; Ciska and Pathak, 2004). During sayur asin making, fermentation considerably reduced the GSs content in Indian mustard (*Brassica juncea*), particularly after one day of fermentation (Nugrahedi *et al.* paper in preparation).

Nugrahedi *et al.* (2013) currently reviewed the effects of processing on the GSs content in *Brassica* vegetables and analyses these changes of GSs by discussing the relevant mechanisms for each processing method. It was shown that different conditions in processing *Brassica* vegetables can have a significant influence on the final intake of GSs. Processing changes GSs content through several mechanisms, such as enzyme-catalysed breakdown, thermal breakdown, cell lysis, and leaching (Dekker *et al.*, 2000). Each processing method involves

specific conditions, which lead to various degrees of impact of the different mechanisms on the GSs content. In order to preserve the content of GSs, certain measures must be proposed, based on the understanding of the mechanism of glucosinolate degradation during any treatments.

### **INTEGRATING RESEARCHES FOR COMMUNITY OUTREACH**

In the case of GSs in *Brassica* vegetables, the efficacy of *Brassica* vegetables as a functional food depends on many factors. These factors must be integrated in disseminating the research finding that stated that these vegetables can promote health and reduce the risk of disease. One should consider the interdependency between various types of studies prior to community outreach. In order to materialize the full potential of phytochemicals/functional foods, a holistic, concerted, multidisciplinary approach is imperative, involving workers in diverse fields such as nutrition, medical sciences, epidemiology, statistics, immunology, analytical and organic chemistry, biology, biochemistry, agriculture, food science, food technology and engineering (Rodriguez *et al.*, 2006).

A number of factors complicate the establishment of a strong scientific foundation, however. These factors include the complexity of the food substance, effects on the food, compensatory metabolic changes that may occur

with dietary changes, and, lack of surrogate markers of disease development. Additional research is necessary to substantiate the potential health benefits of those foods for which the diet-health relationships are not sufficiently scientifically validated. A convincing scientific relationship between food and its health effects can be established by using the following methods of investigation: epidemiological studies, biological and experimental studies, and intervention trials. No single study design can stand on its own (Rodriguez *et al.*, 2006).

### **CONCLUSION**

Studies on the area of food and health must be integrated in order to give a beneficial impact on population health within the community. In the case of glucosinolates, the health promoting compounds commonly found in *Brassica* vegetables, there are factors, such as the variety, environment, agricultural practices, postharvest handling, and preparation and processing, that must be considered before integrating and promoting the health properties into society.

### **REFERENCES**

- Anonim (2013) Khasiat brokoli. <http://www.berkhasiat.com/2013/01/khasiat-brokoli.html>
- Bellostas, N., Kachlicki, P., Sørensen, J.C., and Sørensen, H. (2007). Glucosinolate profiling of seeds and sprouts of *B. oleracea* varieties used for food. *Sci. Hort.* 114, 234–242.
- Ciska, E. and Pathak, D. R. (2004). Glucosinolate derivatives in stored fermented cabbage. *J Agric Food Chem.* 52: 7938-7943.

Daxenbichler, M. E., Van Etten, C. H., and Williams, P. H. (1980). Glucosinolate products in commercial sauerkraut. *J Agric Food Chem.* 28: 809-811.

Dekker, M., Hennig, K., and Verkerk, R. (2009). Differences in thermal stability of glucosinolates in five *Brassica* vegetables. *Czech J Food Sci.* 27: S85-S88.

Dekker, M., Verkerk, R., and Jongen, W. M. F. (2000). Predictive modelling of health aspects in the food production chain: a case study on glucosinolates in cabbage. *Trends Food Sci Techn.* 11: 174-181.

Fahey, J. W., Zalcmann, A. T., and Talalay, P. (2001). The chemical diversity and distribution of glucosinolates and isothiocyanates among plants. *Phytochemistry* 56: 5-51.

Febrianindya, F. (2013) Cegah Kanker Payudara dengan Konsumsi Bayam dan Brokoli. <http://food.detik.com/read/2013/02/21/092946/2175725/900/cegah-kanker-payudara-dengan-konsumsi-bayam-dan-brokoli?d991104284top>

Harmandini, F. (2010) Brokoli Ampuh Mencegah Kanker Payudara. <http://female.kompas.com/read/2010/05/06/09040044>

Hasler, C.M. (1998). Functional foods: their role in disease prevention and health promotion. *Food Technol.* (52) 11, 63-70

Herr, I. and Büchler, M. W. (2010). Dietary constituents of broccoli and other cruciferous vegetables: implications for prevention and therapy of cancer. *Cancer Treat Rev.* 36: 377-383.

Jones, R. B., Frisina, C. L., Winkler, S., Imsic, M., and Tomkins, R. B. (2010). Cooking method significantly effects glucosinolate content and sulforaphane production in broccoli florets. *Food Chem.* 123: 237-242.

Ludikhuyze, L., Rodrigo, L., and Hendrickx, M. (2000). The activity of myrosinase from broccoli

(*Brassica oleracea* L. cv. *Italica*): influence of intrinsic and extrinsic factors. *J Food Protect.* 63: 400-403.

Moreno, D. A., López-Berenguer, C., and García-Viguera, C. (2007). Effects of stir-fry cooking with different edible oils on the phytochemical composition of broccoli. *J Food Sci.* 72: S064-S068.

Nugrahedi, P.Y., Verkerk, R., Widianarko, B., and Dekker, M. (2013) A mechanistic perspective on process induced changes in glucosinolate content in *Brassica* vegetables: a review. Accepted *Crit. Rev. Food Sci. Nutr.*

Oerlemans, K., Barrett, D. M., Suades, C. B., Verkerk, R., and Dekker, M. (2006). Thermal degradation of glucosinolates in red cabbage. *Food Chem.* 95: 19-29.

Rodriguez, E.B., Flavier, M. E., Rodriguez-Amaya, D. B. and Amaya-Farfán, J. (2006) Phytochemicals and functional foods. Current situation and prospect for developing countries. *Segurança Alimentar e Nutricional, Campinas*, (13) 1, 1-22

Rosa, E. A. S. and Heaney, R. K. (1993). The effect of cooking and processing on the glucosinolate content: Studies on four varieties of Portuguese cabbage and hybrid white cabbage. *J Sci Food Agric.* 62: 259-265.

Rungapamestry, V., Duncan, A. J., Fuller, Z., and Ratcliffe, B. (2006). Changes in glucosinolate concentrations, myrosinase activity, and production of metabolites of glucosinolates in cabbage (*Brassica oleracea* var. *Capitata*) cooked for different durations. *J Agric Food Chem.* 54: 7628-7634.

Shahidi, F. (2009) Nutraceuticals and functional foods: Whole versus processed foods. *Food Sci. Technol.* (20) 9, 376-387

Slominski, B. A. and L. D. Campbell (1989). "Formation of indole glucosinolate breakdown products in autolyzed, steamed, and cooked

*Brassica* vegetables." *J Agric Food Chem.* 37(5): 1297-1302.

Traka, M. and Mithen, R. (2009). Glucosinolates, isothiocyanates and human health. *Phytochemistry Rev.* 8: 269-282.

Verhoeven, D. T. H., Verhagen, H., Goldbohm, R. A., van den Brandt, P. A., and van Poppel, G. (1997). A review of mechanisms underlying anticarcinogenicity by *Brassica* vegetables. *Chem-Biol Interact.* 103: 79-129.

Verkerk, R. and Dekker, M. (2004). Glucosinolates and myrosinase activity in red cabbage (*Brassica oleracea* L. Var. *Capitata* f. *Rubra* DC.) after various microwave treatments. *J Agric Food Chem.* 52: 7318-7323.

Verkerk, R., Dekker, M., and Jongen, W. M. F. (2001). Post-harvest increase of indolyl glucosinolates in response to chopping and storage of *Brassica* vegetables. *J Sci Food Agric.* 81: 953-958.

Verkerk, R., Schreiner, M., Krumbein, A., Ciska, E., Holst, B., Rowland, I., De Schrijver, R., Hansen, M., Gerhauser, C., Mithen, R., and Dekker, M. (2009). Glucosinolates in *Brassica* vegetables: the influence of the food supply chain on intake, bioavailability and human health. *Mol Nutr Food Res.* 53: S219-S265.

Volden, J., Borge, G. I. A., Bengtsson, G. B., Hansen, M., Thygesen, I. E., and Wicklund, T. (2008). Effect of thermal treatment on glucosinolates and antioxidant-related parameters in red cabbage (*Brassica oleracea* L. ssp. *Capitata* f. *Rubra*). *Food Chem.* 109: 595-605.

## THE CLINIC LABORATORY APPLICATION FOR YOUR SMART PHONE

**Rosita Herawati, Suyanto Edward Antonius, and Shinta Estri Wahyuningrum**

Faculty of Computer Science, Soegijapranata Catholic University, Semarang, Indonesia  
[rose.rosita@gmail.com](mailto:rose.rosita@gmail.com)

### ABSTRACT

Clinic laboratory is a laboratory which examines blood, urine, and body fluids. It can identify diseases and illnesses as the results. The lab results cannot immediately generated. It would take (quite) much time. Patient comes to the clinic laboratory and takes medical test as his doctor refers to. Usually patient have to come back again after couple hours only to take the results. Then he visits his doctor again to deciphering the lab results. It's waste time. This paper introduce the smart phone clinic laboratory application to accelerate it. Using App Inventor design tool, this application will be developed as a postman which sending a lab results to the patient. Patient does not necessary need to take the lab results in the clinic laboratory again. By using the generated code which already given at the first time patient takes the medical test, he'll just open the lab results on his smart phone using this application. And he can visit his doctor to discuses it. This application will be low cost and save times.

**Keywords :** *clinic laboratory, a postman medical lab results, smart phone application, App Inventor, Android application*

### INTRODUCTION

Clinic laboratory is a laboratory which examines blood, urine, and body fluids. It can identify diseases and illnesses as the results. Some hospital or others health care facility have their own clinic laboratory. But others did not have it. Doctor usually only give their patient a reference letter to take a medical test at clinic laboratory. Patient will bring the reference letter to the public clinic laboratory and take the medical test. The medical lab results cannot immediately generate, usually it takes (quite) much time. So after taking the medical test, patient will leave the clinic laboratory and come back again after several hours like clinic administration suggest, just

only to take the lab results. Then patient will see his doctor to deciphering the medical lab results. For some people, this process won't be comfortable. Moreover if they are busy people which do not have a lot of time. Or for people who live far away from the clinic laboratory. This process will waste time and money.

This paper will be introduce the project of clinic laboratory application which can access using smart phone. The smart phone is chosen as the mainly tools in this project because of the increasing smart phone popularity. Many people probably rarely using computer, internet and does not have email address, but they more familiar using application on smart phone.

While the mainly objective of this project is to build the clinic laboratory application to solve the lack of time and money. It aim to provide a smart phone application which can show the report of medical lab results to the patient. So patient does not need to come back again just to take the lab results. What they just need is install and run the application, have internet connection and get the lab results. Save money and time.

### CLINIC LABORATORY

A medical laboratory or clinical laboratory[1] is a laboratory where tests are done on clinical specimens in order to get information about the health of a patient as pertaining to the diagnosis, treatment, and prevention of disease. Medical laboratory technicians collect samples and perform tests to analyze body fluids, tissue, and other substances. Clinic laboratory help clinical staff such as doctors, by provides essential analytical information, that enable accurate and rapid diagnosis and treatment of patients. Depending on the kind of medical test performed, most tests are completed and reported to the patient within about 24 hours. Certain tests take several days to weeks.

### APP INVENTOR

App Inventor is[2] an online Android phone application design tool. The App Inventor servers store a work and help programmer keep track of his projects. App Inventor is[3] a mobile applications design tool consisted of two major parts; Component Designer and

Block Editor. Component Designer is used to create the user interface. And the Block Editor is used to specify how the components on user interface should behave.

Instead of the traditional programming language, the App Inventor working use some pieces of block syntax. It assemble program visually. It fitting pieces together, like what component will trigger an event and the algorithm will be used to handle the event occurs. It just like a puzzle. Figure 1 show the design of Clinic Laboratory application using App Inventor's Block Editor.

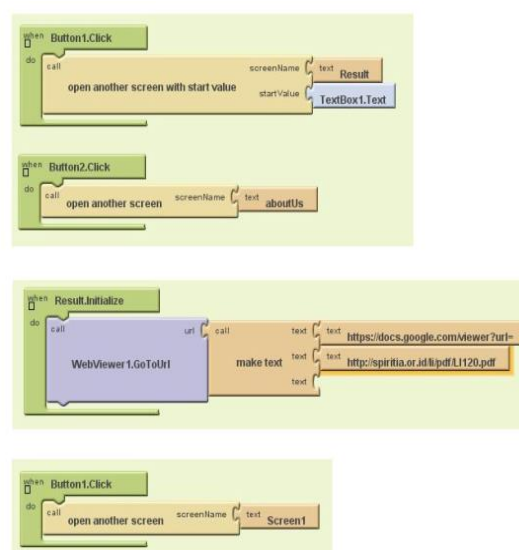
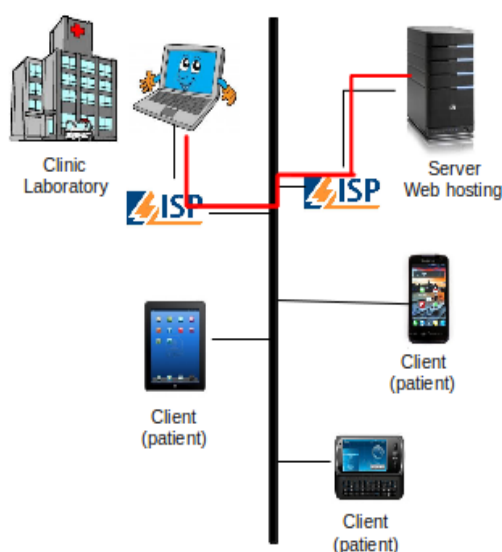

Figure 1: The design of Clinic Laboratory application

### DESIGN SYSTEM

This application is reliable on the internet connection to connected between clinic laboratory and client/patient. To establish this connection, clinic laboratory can use ISP to have internet connection. While data patient

and lab results can be stored in a server by using web hosting. A web hosting is a service that allows individuals and organizations to make their website/data accessible via the internet. The web hosts are companies that provide space on a server just like data center. But the server cannot access without domain name. Usually the web host will provide a free domain name. A domain name is used as an address to access the server/website. While in client side, patient just need a smart phone with internet connection. The figure below describe the whole design system of smart phone clinic laboratory application.



*Figure 2: design system of smart phone clinic laboratory application.*

## RESULTS AND DISCUSSION

The smart phone clinic laboratory application is begin at the first time patient come to the clinic to take a medical test. After the register their personal information, they will get a

verification code which is generated unique and only used once. This code needs to be entered into the smart phone application. Application will send it to the server as a request to open the report of medical lab results. At the server side, the verification code will be used as a keyword to find the matching patient data and the patient's medical lab results. (Here we assume that the the lab results is ready.) If the server finds the matching data, the server will send the report of medical lab results as a PDF document. Then the application will use a Google doc viewer\* to open the lab results.

There are two reasons why using PDF instead of raw text data. The first, this application design without any connection to the original system which already used in clinic laboratory. The second, to avoiding human error while (if) entering the lab results again in a new system. We assume that every clinic laboratory have their own system, and it can save or produce a report medical lab results in PDF. So this application can implement without disturbing the existing system. The clinic laboratory staff just need to gather some personal information form the patient and give the patient a generated verification code. The clinic laboratory staff still can use the existing system to input the lab results. The figure below, show how the smart phone clinic laboratory application is run.

---

\* The google doc viewer is a viewer documents online



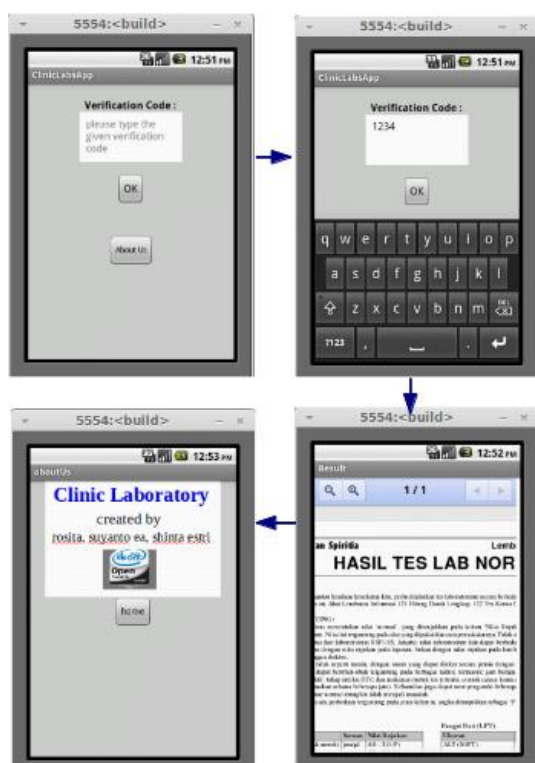

Figure 3: The smart phone clinic laboratory application

## CONCLUSION

The smart phone clinic laboratory application is a postman which sending a lab results to the patient. It accelerate the process of taking a medical test at clinic laboratory. By implementing this system, the clinic laboratory will help patient save money and time. Patient can get the report of medical lab results

without need to go to the clinic again. Not only save money and time, using this smart phone clinic laboratory application will help earth by reducing the amount of carbon dioxide and reduce the traffic jam.

This paper not yet cover about security, and also yet cover the patient notification while the results is ready, which can send through sms getway. We assume that patient will get the notification if the lab result is ready, which is probably send by the clinic laboratory staff.

## REFERENCES

- [1] Medical\_laboratory, "Medical Laboratory", [https://en.wikipedia.org/wiki/Medical\\_laboratory](https://en.wikipedia.org/wiki/Medical_laboratory), access at May 04, 2013, 3:59 PM
- [2] MIT, "App Inventor for Android" <http://appinventor.mit.edu/>, access at May 04, 2013, 6:35 PM
- [3] Kim, Hak. J. and Modell, Jonathan, *Mobile App Design Tool for Smartphones: A Tutorial*, International Journal of Soft Computing and Engineering (IJSCE) ISSN: 2231-2307, Volume-2, Issue-3, July 2012

## GAME DEVELOPMENT FOR ECOLOGICAL PRESERVATION

Viena Patrisiane, Stephani Inggrit S.D and Ridwan Sanjaya

Game Technology Programs of Computer Science Faculty, Soegijapranata Catholic University,  
Semarang, Indonesia  
[tvxq\\_cho@yahoo.co.id](mailto:tvxq_cho@yahoo.co.id)

### ABSTRACT

The environmental damages that occurs in the earth currently is becoming very serious. Degradated community concern makes the environmental condition get worse. For example, serious flood happen every year in Jakarta and the local government is still looking for the solution to solve this problem. On the other hand, some citizens still have a bad habit in throwing trash and garbage into rivers and lakes. This led to the overflow of rivers and the disability of the river to hold the water in high capacity. There are several ways to make people figure out the environmental problem more serious. One of those ways is developing and utilizing the computer games. By using games, there are possibilities for everyone to learn the environmental preservation while they use their free time to play games. It is an alternative way to promote and increase the awareness of importance to protect the environment. In this paper, the strategy to bring the idea of environmental preservation into a game will be discussed. The hard part to realize the idea is keeping the game still fun for the players but is still able to stimulate the players to learn and understand the message in the game. As the result, the public awareness to have a better environment will increase and they are willing to act to keep the environment.

**Keywords** : *ecological, education, environmental, games, preservation*

## I. INTRODUCTION

Environmental damage is in a very serious condition. It gives a lot of bad impact for its habitat. Based on Oxford English Dictionary, ecology is the branch of biology that deals with the relations of organisms to one another and to their physical surroundings. [3].

Nowadays, ecological damages give us a clear view how greedy human is. Several of them took everything from the nature without giving any feedback. In the end, it gives bad impacts for the environment [4]. For example, when people chop woods from the forest, they often left the forest without re-planting program. Mostly, there is no action from government or the authority.

In the other hand, most of people who lives in city tend to throw rubbish on the street or river, not on the trash can. Those trashes made bad smell that is not good for our health [5]. Even though a lot of trash can on the street, they still throw the rubbish in wrong place.

From those facts, we could see that human awareness about their environmental preservation is low. Seminars or directive counseling given by the government or authority could not help at all because of the low awareness and interest to participate in the implementation.

Those facts made the game developers and some environmental organizations develop games to increase people's awareness on their environment. Those games should not just for fun, but also able to increase environmental

awareness and give information for those who play the games.

Before it is discussed further, there are some games that are used for environmental preservation:

- Physical games that will help people who play the games to use tactics and their physics ability to play the games.
- Video games that can be played through computer or console games.

## II. CONCEPT

Sometimes people think that there's no relation between the environmental preservation and games. But if people look it further, they will know that games have a great impact on someone's mindset [6]. This fact is used by environmental organizations and game developers to make environmental games. An online questionnaire is used to proof this hypothesis. And from the questionnaire-result, about 70% correspondent said that they prefer to use games to learn more about the environment.

### *A. Environmental Education with Seminars or Counseling*

The result of first question, "What is your opinion about ordinary socialization with a discussion between informants and participants?" could be seen on the table below. There are 20 correspondents are involved in this questionnaire.

TABLE I: RESPONDENTS REACTION OF ENVIRONMENTAL EDUCATION WITH ORDINARY SOCIALIZATION (SUCH AS SEMINARS/COUNSELINGS)

Name	Age	Environmental Education with Ordinary Socialization (Seminars/Counseling)	
		Boring	Fun
Febry	16-20	√	
Fajar	16-20	√	
Dita	16-20	√	
Devi	16-20	√	
Elanda	16-20	√	
Lily	16-20	√	
Yulia	16-20	√	
Goda	20-25	√	
Yuli	16-20		√
Aliynta	20-25		√
Petra	16-20		√
Yonsu	16-20	√	
Wishnu	16-20		√
Widhy	16-20		√
Yosef	16-20	-	-
Rio	20-25	-	-
Anmar	16-20		√
Ester	16-20	-	-
Raina	16-20	-	-
Sissy	16-20	√	

From the result, 10 out of 20 (50% from the total) think that environmental education with ordinary socialization such as seminar or counseling is boring. While six respondents think that those methods are fun. And the rest had a notion that it is boring or not based on situation.

### B. Ecological Preservation Games

The figure below is the summary of respondents' opinion about the importance of games as an environmental education media.

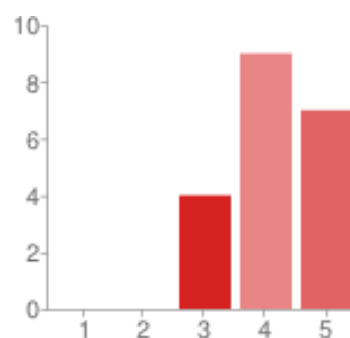

Figure 1. Graphic of questionnaire result

Explanation : 1 = Not important

5 = Very important

Based on the graphic, it can be concluded that all of the respondents think that games have important role on ecological preservation. From the table and graphic, it can be concluded that games can be important media for ecological preservations.

### C. The Reasons

These are respondents' reasons about the reason of games can be the important media for ecological preservation and environmental education.

TABLE II: RESPONDENTS REASONS

Name	Rating	Reason
Febry	4	So the participants won't get bored
Fajar	5	Gamers' mindset can be influenced to love and aware about the environmental/ecological issues indirectly.
Dita	3	The players won't get bored and they will get information about the environment in fun way.

Name	Rating	Reason
Devi	4	It'll be more interesting if in the seminars, they make a variation with game.
Elanda	4	It is better to play than just to list the talk, so the gamers and participant can understand better about the issue.
Lily	5	It won't be boring.
Yulia	5	The participants will understand better about the purpose of that seminar.
Goda	4	Games can be played by everyone.
Yuli	5	We can know about the purpose of the ecological preservation better.
Aliynta	3	So I won't get bored even if the games are about science.
Petra	5	Won't get bored.
Yonsu	3	Help the gamers to understand the issue.
Wishnu	4	It's easy to learn about environment from games.
Widhy	4	So the participant (especially kids), will have good understanding about their environment.
Yosef	4	Preservation with games as education media can be influenced the gamers indirectly.
Rio	4	It's More fun and will not make me bored.
Anmar	5	More variety.
Ester	4	More fun.
Raina	4	With games as ecological preservation media, we can get learn about the environment not just in seminars but anywhere and everywhere.
Sissy	3	Everyone knows games and love to play games. That's why games can be good media.

Explanation:

Rating: The level of the important role of games as ecological preservation media? (Scale 1-5)

Based on the table above, it can be concluded that games have an important role as environmental education media for ecological preservation especially for young generation.

### III. IMPLEMENTATION

From the table above, it can be concluded that the respondents consider the games as important media for environmental education about ecological preservation. Because of games, young generation will get information about the environment indirectly in a fun way. Games also give better impression for people than seminar and counseling.

Games for environmental education can be divided into two kinds of games:

#### A. Video Games

*Video games* are the programs that can be played through personal computer (PC), notebook, PSP or another electronic media. In this era, video games are very popular between kids, teenager and even grown-up people [5].

Games have been used for various purposes, for example: NASA use games to give information about space and galaxy. Not just for giving information, video games can also help young generation to understand the environment. These are some video games that

can help to educate young generation to know more about their environment and preserve it.

- *Plant It Green*, an online game from National Geographic, made especially for kids. In this game, gamers will be introduced to some ecological term such as: *eco home*, *eco retail*, and *zero energy home*.



Pic 1

Screen capture from Plant It Green

- *Recycling Games*, a game that can be played online from website *Action for Green*. This game is simple; gamers should throw the trash into the trash can.

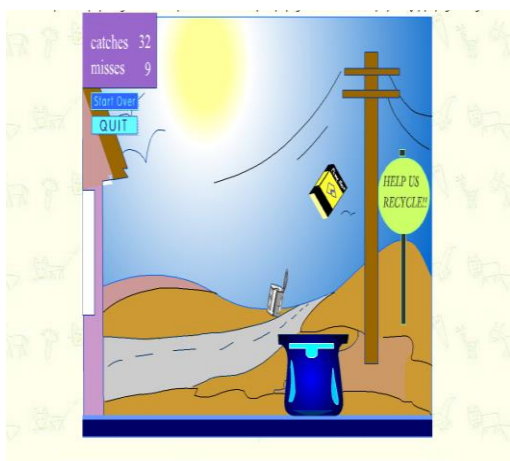

Pic 2

Screen capture from Recycling Games

- *Brighter Mind Venture Arctica* is a simulation game focused on climate change from polar bear point of view.



Pic 3

Screen capture from *Brighter Mind Venture*

## B. Physical Games

Environmental education for ecological preservation with physical games will help people to keep healthy with physical activities and have fun while learning about nature and environment around them. Physical games are also good for kids. This kind of games can be used as media to introduce and teach kids about ecology and environment. Some example of physical games related with ecology and environment are:

- *Eco Monopoly*

Monopoly game was made by Annisa Hasanah. The rules of eco monopoly are same as the ordinary monopoly but involve ecological house and information.

- *Eco Snake and Ladders*

*Eco Snake and Ladders* is the same as ordinary snake and ladders game; you can play it with your friends in a group. If you

got different color from your group's color, the gamers will have to answers some questions about ecology and environment.

#### IV. CONCLUSION

From the tables and graphic above, it can be concluded that games can help people for understanding our environment better, especially for young generation. The reason behind, games can be played anywhere, anytime, and by anyone who want to play it. The players will not be limited by time and we do not have to attend seminars just to get environmental education. Also, with games, we can participate in ecological preservation.

#### ACKNOWLEDGEMENTS

The authors gratefully acknowledged to Beasiswa Unggulan scholarship support from Bureau for Planning and International Cooperation, Ministry of Education and Culture of Indonesia.

#### REFERENCES

- [1] (2013) The Jakarta Post Website. *Jakarta Braces for more Flooding*. [Online]. Available: <http://www.studymode.com/essays/Cause-Of-Flood-In-Jakarta-655267.html>
- [2] (2013) The Christian Science Monitor Website. [Online]. Available: <http://www.csmonitor.com/World/Asia-Pacific/2013/0118/Jakarta-Indonesia-s-megacity-of-10-million-is-under-water-video>
- [3] J. Simpson, Oxford English Dictionary, Wellington Square, United Kingdom: Oxford University Press, 1884. [Online]. Available: [oxfordenglish-dictionary](http://oxforddictionaries.com/words/the-oxfordenglish-dictionary)
- [4] (2010) Switchboard Website. [Online]. Available: [http://switchboard.nrdc.org/blogs/jschmidt/illegal\\_logging\\_in\\_indonesia.html](http://switchboard.nrdc.org/blogs/jschmidt/illegal_logging_in_indonesia.html)
- [5] (2011) Study Mode Website, Cause of Flood in Jakarta. [Online]. Available: <http://www.studymode.com/essays/Cause-Of-Flood-In-Jakarta-655267.html>
- [6] (2013) Defence News Website, Headshot! How Video Games Influence the Military. [Online]. Available: <http://www.defensenews.com/article/2013-02-07/TSJ01/302070020/Headshot-How-Video-Games-Influence-Military>

# STRATEGY OF SUSTAINABLE COASTAL TOURISM DEVELOPMENT IN INDONESIA

**Gerarda Orbita Ida Cahyandari**

Department of Architecture, Engineering Faculty, Atma Jaya Yogyakarta University  
[idach@mail.uajy.ac.id](mailto:idach@mail.uajy.ac.id)

## ABSTRACT

The coastal tourism is one of the growing industries in the world. Extensive development has been conducted in coastal area to enhance its potential tourism activities. When risk and conflict happen, people start to be aware of the impact of excessive exploitation. Conflicts take place in such inequality situation between social, economic, natural, and cultural environments. The sustainable coastal tourism is one of strategies to address the problem. Indonesia, as a developing country, highly depends on the coastal biodiversity and aesthetics. The archipelago must implement the sustainable coastal tourism according to its coastal potentials. To formulate the action of conservation and development, the strategy would include integrated coastal zone management (ICZM) in term of land use planning. The concepts focus on enhancing tourism demands and conserving natural, cultural, and built environment, together with reducing the impacts. The method of this study is to integrate precedence of sustainability, coastal tourism, and ICZM. The result of this paper emphasizes the importance of community-based tourism in creating the balance of environment, economic, and socio-cultural aspects.

**Keywords:** *coastal, tourism, sustainable development, integrated coastal zone management*

## INTRODUCTION

Coastal area has the important role to accommodate many activities. Pujotomo (2009, p.1) asserts that coastal areas facilitate three economic aspects, which are natural resources, development activities, and aesthetical value. These aspects cause coastal zones as the most preferable areas for settlement, wherein 60% world's populations live in coastal regions (Kononenko & Shilin 2003; Twigg 2004, p. 9; Poniman cited in Book 1 Training Module 2011). Coastal areas have over-3-million population in their 70% coastal cities in the world. Hence, coastal area is a preferable area and, as a result, it experiences high-density population with a

great dependency on primary resources for livelihood, industry, tourism, recreation and transportation. (Kononenko & Shilin 2003; ADPC 2011, pp. 14 & 15)

Coastal tourism is an important part of recent growing industries. It offers different economic activities through the interaction between human need and natural resources in term of recreation (European Commission, 2012). Aesthetic value is another reason to put a coast into tourism industry. In other words, coastal tourism uses natural biodiversity and its aesthetics to attract visitors and investors. The potentials of a coast need appropriate management, regulation, and development planning in order to affect views of visitors



and local people about environmental sustainability. As always, economic benefit goes to people side, which is local society, This competitive situation generates risk and conflict on the environment as a subtle victim. The inequality between environmental conservation and economic benefit might give impact on social and cultural conditions. Furthermore, the impact is often overlooked until the critical situation happens.

The growing coastal tourism and its problem also take place in Indonesia. Being maritime and archipelagic country, Indonesia is one of the most popular tourist destinations. There are 42 municipalities and 181 regencies situated in the coastal area (Pujotomo 2009, p. 1). It means that the people have high dependency to the coastal environments, but the consequence is that coastal zones become vulnerable areas. Thus, the environmental sustainability becomes important policy to accommodate environment needs and economic needs in equilibrium.

Indonesian government has included 'sustainable development' in the policy and regulation of coastal exploration and development. The aims are to integrate the development and the environment along with minimizing the risk and conflict. However, implementation of the strategy is apparently difficult because of the wide range of coastal area typology and characteristics.

This paper proposes the design concept of sustainable coastal tourism development in

government, and stakeholder, whereas the impact goes to the environment.

accordance with characteristics of coastal area in Indonesia. The objectives of this paper are:

1. To determine the factors of coastal characteristic in Indonesia which are applicable for coastal tourism
2. To integrate the precedence of sustainable coastal tourism development

The discussion starts with the definition and boundary of coastal area and coastal tourism. The next part discusses the references of sustainable development in coastal tourism. Finally, the conclusion relates the characteristics of coastal areas in Indonesia and sustainable coastal tourism development.

## **DEFINITION OF COASTAL ZONE**

Coastal zone is an interface of sea and land in three main areas, which are beach, shore and coast (Kononenko & Shilin 2003; Book 1 Training Module 2011). The Indonesian Coastal and Small Island Management (CSIM) Law no. 27/2007 defines "coastal zone" as "the shifting area between the terrestrial and marine territories, influenced by changes on the land and sea". Similarly, the Australian Commonwealth Coastal Policy explained the coastal zone as a focus on the land-sea interface. The US Federal Coastal Zone Management Act in 1990 mentioned the examples of the interface, which were islands,

transitional and intertidal areas, salt marshes, wetlands and beaches.

Figure 1 illustrates the precincts of coast, beach and shore. The coastal area begins with the breaker zone towards the mainland and ends at the coast. A shore is a zone between the average of low tidal-line and high tidal-line near the coastline, whilst a coast begins with coastline towards the mainland until the area where marine influences exist.

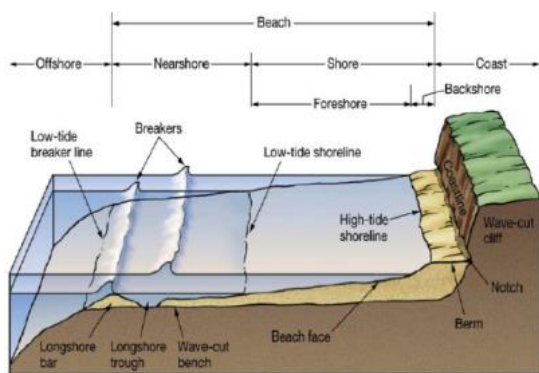

Figure 1. The precincts of coastal area

Source: Lecture handout of the Coastal Ocean, Millersville University of Pennsylvania (2006) cited in ADPC (2011, p. 19)

A coastal zone is an integrated ecological, social and economic system. Each system has key elements.

Table 1. Ecological, social and economic analysis of coastal systems

Coastal sub-systems	Key elements for planning analysis
Ecological and geographical subsystem	Biodiversity, description of biotopes, characteristics of landscape, mineral resources
Social and economic subsystem	Cultural diversity, economic structure, social and demographic structure, specificity of

	nature management
Administrative and legal subsystem	Political and administrative structure, non-governmental organisations (NGOs), mass media

Source: Kononenko & Shilin (2003, p. 12)

The elements prove that coastal environment is obviously important for human and nature. Development in coastal areas must include the sub-systems and key elements.

### COASTAL TYPOLOGY IN INDONESIA

Materials from shore to coast possibly consist of muds, sands, sea sands, stones, hard stones, white sands, or mixed materials. Characters of the materials dominantly create coastal typology. The research of Khakim, et al (2008) elaborates seven categories of coastal typology in Yogyakarta, i.e.: land erosion coast, land sedimentation coast, volcanic coast, structural coast, wave erosion coast, sea sediment coast, and organic coast. Coastal materials and typology determines appropriate development in coastal areas. Coastal tourism development defines activities on site based on the typology.

Khakim et al (2008) proposes coastal development strategy for Indonesia coastal area with Yogyakarta initiative, namely ‘managed realignment’ and ‘move seaward’. The managed realignment is applicable for coastal area with settlement and shelters along the coastline. This strategy concerns with the risk of flood or high tide or even tsunami. The local government has started this strategy

since the regulation of buffer zone which is 200 m from high tide. The resettlement has been set up after the buffer. The strategy of 'move seaward' is conducted to response the existence of sand dunes. The sand dunes are important because of aesthetic function and protection function. This is part of environmental preservation and conservation. The other strategy is 'hold the line' which is to build buffer in form of vegetation or concrete, along the coastline to protect the coast of abrasion.

## **COASTAL TOURISM IN INDONESIA**

The growth of tourism industry is influenced by three main factors, namely prosperity, transportation systems, and public awareness by means of communication (United Nations Environment Programme , 2009). The three factors are still growing and creating groups of tourists with different backgrounds and needs. Trend to experience wild nature and adventures is increasing recently and this situation confirms the dependency of tourism to nature. The trends has been growing in the uses of marine and coastal resources intensively for tourism resources.

According to UN Report in 2008, the length of coastline in Indonesia is 95.181 kilometers which is the fourth longest in the world (Mukhtar, 2009). The numbers of islands are 17.480 and the area of sea is three quarter of land (Farhan & Lim 2010). The economic potential of the seas is totally 140 milliard dollars AS per year. The coastal potentials are

diverse, such as agriculture, fisheries, water supplies, aquaculture and tourism. Countries with coastlines are the most popular tourist destination.

Tourism in Indonesia was begun with Bali Island as natural and cultural tourism destination (Wong, 1998). Together with other Southeast Asia coastal tourism destinations, tourism development and accommodation grew extensively in Bali, followed by Sulawesi, Sumatra, Java, Papua, and Nusa Tenggara.

Surprisingly, the investors in coastal tourism are mostly foreigners. Research had been conducted by Andaria et al (2013) on the group of stakeholders in Bangka Island tourism. Three group of stakeholder are investors, government, and local people. Different background and knowledge with the local people are potentially becoming the drivers of conflicts. Local people have been already familiar with natural environment in their own way, similarly the stakeholders have been increasing their professional capacity in tourism.

Identification of problem in coastal tourism in Indonesia reveals that the relationship between local community and tourism investors is the base problem, followed by the conflict in accessing and using spaces and natural resources because of unplanned coastal development. These problems are becoming the drivers for unequal benefit and less economic contribution for local people. (Wong 1998; Andaria, et al. 2013)

To bridge the gap, the stakeholder designed tourism program in a way that local people can contribute their knowledge by means of conservation activities. For example in Bangka Island, tourists can participate in coral reefs conservation program. The investors have the willing to contribute to the knowledge of local people in management and biodiversity. This is the starting point of community-based tourism development. (Andaria, et al. 2013; United Nations Environment Programme 2009)

## **SUSTAINABLE COASTAL TOURISM DEVELOPMENT**

Definition of ‘sustainable coastal tourism development’ refers to definition of sustainable development which is to create the balance of environmental, economic and socio-cultural aspects in coastal tourism area for the availability of resources in the future. UNEP (2009) proposed 12 aims for sustainable tourism development that are economic viability, local prosperity, employment quality, social equity, visitor fulfilment, local control, community wellbeing, cultural richness, physical integrity, biological diversity, environmental purity, and resource efficiency. The aims and definition subsequently constitute principles of sustainable coastal tourism, i.e.:

- 1) To determine the space size of designated level of sustainable tourism
- 2) To take into account the key elements of coastal systems, i.e. biodiversity, cultural

diversity, economic structure, social-demographic structure, and administrative-organisation structure.

- 3) To give opportunities for local communities to develop the knowledge of environment and cultural conservation and increase economic capability
- 4) To identify the distinctiveness due to natural elements, historical land uses, landscape characteristics or particular attractions
- 5) To identify the risks and conflicts

These principles contribute to the formulation of tools such as Strategic Environmental Assessment (SEA), Carrying Capacity Assessment (CCA), Environmental Impact Assessment (EIA), and sustainability indicators. Each tool has specific circumstances to be applied at the proper stage of tourism development planning for specific objectives. To fulfil the objectives and to be applicable, the principles are approached by integrated coastal zone management (ICZM). (Western Australian Planning Commission 2013; United Nations Environment Programme 2009)

## **Integrated Coastal Zone Management (ICZM)**

In the early 1970s, integrated coastal zone management (ICZM) was recognized as a strategy for addressing coastal area problems, such as resource degradation, conflict management, and community prosperity (Wong 2009). The significant approaches in

achieving the integration are ‘natural resource management’, ‘environmental based approach’, ‘economic based approach’ and ‘public participation approach’ (Book 1 Training Module 2011, pp. 87 & 98). Similarly, the Charleston workshop determined the ICZM principles as a continuous process, decision-making process, government’s support and networking among coastal systems in definitive geographic boundary (Farhan & Lim 2010).

The essence of ICZM is set on the hypothesis that healthy environment is able to reduce the impact of natural hazard and create sustainable development. For example, the Intergovernmental Oceanographic Commission (IOC) recommended coastal ecosystems such as coral reef, sand dunes, and coastal vegetation for reducing strong wave and erosion. (Wong 2009; UNEP 2011)

The Indonesian government firstly implemented ICZM in 1987. In 1992, the Indonesian State Ministry of Environment sponsored the ICZM regarding to the Agenda 21 agreement. Subsequently, the Ministry of Marine Affairs and Fisheries was established in 1999. The wide-ranging regulations of ICZM were stated in 2002 under the Ministry of Marine Affairs and Fisheries decree no. 10/2002 about the guidelines for integrated coastal planning and had been renewed in decree no. 16/2008 entitled “the planning and management of coastal area and small islands”.

The broad definitions and principles of ICZM concludes that every country had specific coastal characteristics. Prior to the implementation, each country has to understand the coastal elements and the diversity.

### **Strategy of sustainable coastal tourism development in Indonesia**

The strategy of ‘sustainable coastal tourism development’ integrates the ICZM principles, sustainable development principles, and the factors of coastal area in Indonesia.

Land use planning is the first stage of strategy, that includes few objectives, i.e.:

1. To identify risk and conflicts, biodiversity, terrestrial ecosystem, abiotic-biotic elements, and other potential
2. To optimize the service of coastal ecosystems
3. To stimulate mutual relationship and dependency between environment, people, government, and investors
4. To use participatory management approach conducted by government within the collaboration of stakeholders and local people
5. To integrate mitigation, conservation, and development
6. To propose community-based tourism

The land use planning requires assessment and identification of certain variables. Therefore, the complete assessment will collect variables.

Each coastal area embraces different variables in accordance with the characteristics.

Table 2. The variables of sustainability strategy

The approaches of integration	Assessment and identification
Administrative and legal	Local government regulation
Natural resources management	Environmental assessment Vulnerability assessment
Ecological	Vulnerable ecosystem identification Hazard assessment
Economic	Conflict identification
Social	Risk identification
Public participation	Emergency-response identification
Infrastructure functions	List of priority

Source: Analysis

The category of coasts in Indonesia is based on the waves, nature elements, socio-cultural values, risk, and physical characteristics.

## CONCLUSION

Sustainable tourism development requires participation of all stakeholder, communities, and government in the process of monitoring and introducing the views of sustainability. The approach to the sustainable coastal tourism development is integrated coastal (zone) management (ICM or ICZM). Sustainable coastal tourism in Indonesia must consider mitigation, conservation, coastal characters, community, government, and investors to formulate the appropriate strategy for land use planning. The community-based tourism can be developed by means of tourism conservation programs.

## REFERENCES

Andaria, K. S., Marsoedi, Arfiati, D., Hakim, L., & Soemarno. (2013). Stakeholder Analysis for Coastal Tourism Development in Bangka Island, North Sulawesi Indonesia. *Journal of Basic and Applied Volume 3 No.1, 3*, 1043-1050.

Asian Disaster Preparedness Center (ADPC), *Regional Training Manual on Disaster Risk Reduction for Coastal Zone Managers*, with financial and technical contributions from ISDR – UNEP – European Commission, viewed 17 August 2011, <[http://www.preventionweb.net/files/13219\\_13190AIDCOCORegionalTrainingManual1.pdf](http://www.preventionweb.net/files/13219_13190AIDCOCORegionalTrainingManual1.pdf)>

Book 1 Training Module, *Capacity building to integrate Disaster Risk Reduction into Coastal Management in Indonesia*, co-organized by UGM – MFF – Ministry of Marine and Fisheries Affairs, with financial and technical contributions from UNEP – EC – ISDR, viewed 2 August 2011, <<http://www.unep.org/ConflictsAndDisasters/LinkClick.aspx?fileticket=BWqXF0i1s0I%3D&tabid=4813&language=en-US>>

European Commission. (2012). *Challenges and Opportunities for Maritime and Coastal Tourism in the EU, Discussion Document for Public Consultation*.

Farhan, AR & Lim S. 2010. 'Integrated coastal zone management towards Indonesia global ocean observing system (INA-GOOS): review and recommendation', *Ocean & Coastal Management*, Elsevier, vol. 53, pp. 421-27, viewed 30 July 2011, <<http://www.gmat.unsw.edu.au/snap/publications/farhan&lim2010a.pdf>>

Khakim, N., Soedharma, D., Mardiasuti, A., Siregar, V., & Boer, M. (2008). Analisis Preferensi Visual Lanskap Pesisir Daerah Istimewa Yogyakarta untuk Pengembangan Pariwisata Pesisir Menuju pada Pengelolaan WilayahPesisir Berkelanjutan. *Forum Geografi, Vol. 22, No. 1 Juli*, 44 - 59.

- Kononenko, MR & Shilin MB. (2003). *Integrated coastal management planning strategies*, St. Petersburg Russian State Hydrometeorological University Publishing House, p. 181
- Mukhtar. (2009). *Garis Pantai Indonesia Terpanjang Keempat di Dunia*.
- Pujotomo, MS. (2009). *Coastal changes assessment using multi spatio-temporal data for coastal spatial planning Parangtritis Beach Yogyakarta Indonesia*, Thesis Double Degree M.Sc. Program, Gadjah Mada University and International Institute for Geo-Information Science and Earth Observation, February
- Twigg, J. (2004). *Good Practice Review. Disaster risk reduction. Mitigation and preparedness in development and emergency programming*, no. 9, March, HPN Humanitarian Practice Network at ODI, Overseas Development Institute, London, managed by Humanitarian Policy Group
- UNEP, U. N. (2008). *Handbook on Sustainable Tourism in Coastal Zones: the ICZM, International Task Force on Sustainable Tourism Development – Marrakech Process*. Paris: UNEP.
- United Nations Environment Programme , (2009). *Sustainable Coastal Tourism: An integrated planning and management approach*.
- United Nations Environment Programme, *Opportunities in Environmental Management for Disaster Risk Reduction: recent progress. A practice area review: in contribution to the Global Assessment Report on Disaster Risk Reduction*, in collaboration with the UNISDR Partnership for Environment and Disaster Risk Reduction, viewed 4<sup>th</sup> August 2011, <<http://www.preventionweb.net/english/hyogo/gar/background-papers/documents/Chap5/thematic-progress-reviews/UNEP-Environmental-Management-for-DRR.pdf>
- Western Australian Planning Commission. (2013). *Coastal Tourism Framework*.
- Wong, P. (1998). Coastal Tourism Development in Southeast Asia: Relevance and Lesson for Coastal Zone Management. *Ocean and Coastal Management Vol. 38* , 89 - 109.
- Wong, P.P. (2009). ‘Rethinking post-tsunami integrated coastal management for Asia-Pacific’, *Ocean & Coastal Management*, Elsevier, vol. 52, pp. 405–10

**A CONCEPTUAL FRAMEWORK OF THE APPLICATION OF GAME THEORY ON  
CARBON TAX BETWEEN ANNEX I COUNTRY AND NON ANNEX I COUNTRY BY  
MAXIMIZING VALUES OF THE ICES MODEL**

**Noor Syaifudin**

Fiscal Policy Office, Ministry of Finance of Republic of Indonesia  
[soib2000@yahoo.com](mailto:soib2000@yahoo.com)

**ABSTRACT**

In relation to the issue of climate change financing, the current nature of the relationship between developed and developing countries remains unclear. It is apparent that until today the Nationally Appropriate Mitigation Action and Commitments (NAMACs) for Annex I countries and Nationally Appropriate Mitigation Action (NAMAs) of the non annex I have not been enacted yet. This study attempts to provide a frame work to explain the relationship of the two groups of countries within a framework of game theory. This study will also prepare framework of each country group to establish a pay-off of every step they take. Carbon tax as a policy acknowledge in the ICES model (a CGE model), can calculate how the impact of the adoption of carbon tax policy of a state to the world economy. Some assumptions in game theory models and CGE models are applied in the preparation of the conceptual framework in this study.

**Keywords:** *system thinking, game theory, carbon tax, ICES model*

**Background**

The dynamics of engagement of UNFCCC member countries in the Kyoto Protocol are extremely diverse. The first, from the beginning the nature of the participation of developed countries in the Kyoto Protocol is not entirely round. The second is the protocol dynamics. At the time of the 191 countries comprising the entire United Nations member countries involved as parties in the UNFCCC. While the United States also signed but not ratified within the country and Canada to participate but withdrew in 2011. Some countries (Belarus, Kazakhstan and Ukraine) stated that they likely will withdraw or at least will not ratify the UNFCCC for the second period. Meanwhile, Japan, New Zealand and

the Russian involved in the first round of the Kyoto Protocol, but have not set a target for the second round of the Kyoto Protocol. While the first round of protocol is completed, an evaluation of the protocol and the countries involved in the protocol is not clear. While in the second round of the protocol is not legally defined.

On the other hand, the discussion about the steps undertaken and commitments (the Nationally Appropriate Mitigation Action and Commitments - NAMACs) by the countries that in the Annex I Parties to the present there has been no legal basis. Meanwhile, countries that are not incorporated in the Annex I Parties are also not immediately set a Nationally Appropriate Mitigation Action (NAMAs).



These things are becoming interesting to be explored and to study.

### **Objective of Study**

This study attempts to provide a frame work to explain the relationship of the two groups of countries within a framework of game theory. Adapun nilai pay-off dari masing-masing pelaku diperoleh dari nilai yang dihitung dari ICES. ICES memungkinkan untuk menghitung nilai dari setiap langkah yang diambil oleh masing-masing parties. Adapun beberapa kebijakan yang dapat dilakukan di dalam ICES adalah pengenaan carbon tax dan penetapan target emisi.

### **Literature Review and Discussion**

The discussion on the Decision Theory is assuming that specific elements which related with decision making can be acquired from decision setting and summarized in a standard structure. First, it is assumed that the decision maker can define all the alternatif of decision or the strategies which will be conducted. Second, the decision maker can define the states of nature for its decision setting. This reflects several conditions which can influence the consequences of one decision that has been made. The important thing is the condition does not under the decision maker control. Third, it is assumed that the decision maker can predict the benefit or cost of choosing one alternatif under one state of nature. The consequences must be available to be quantified and usually reflects the criteria which are usually used by the decision maker to measure and evaluate the performance of

the process of an activity. The quantified consequences are expressed in a table which called as payoff table or payoff matrix. Pay off matrix is a table or matrix which their rows express every decision and the columns express state of nature, and the payoff value appears in the elements of the matrix.

After the matrix payoff can be determined, the next factor, and this is the most important factor to complement the description of a decision making system is the likelihood of several different states of nature. There 3 kinds of decision making process, i.e.:

1. Under conditions of certainty: at this situation, the full certainty of states of nature which will be occurred.
2. Under conditions of uncertainty: at this situation, the decision maker has no knowledge on the possibility on the occurrence of particular states of nature.
3. Under conditions of risk: at this situation, the decision maker has sufficient knowledge about the state of nature which therefore knows the probability of the occurrence of the conditions.

From the above categorization, it is clearly seen that the higher the level of knowledge regarding the likelihood of various conditions or states of different nature, the situation increasingly moving towards complete certainty. In this situation, the probability of occurrence of these conditions can be determined objectively. Conversely, the less knowledge, the more risky a decision, in

which the probability will be determined in the subjective way. Decision-making in situations such as that described above is called decision-making in the face of 'passive opponents', because it is very fortunate on the possibility and not the various conditions or states of different nature. Game Theory is a method of decision-making when dealing with 'active opponents'. That is, there are two parties decision makers, each of which competes with each other, and the decision of the party will be answered by the decision of the other party with respect to strategies and actions of their rivals. Competitive conditions in general this is what leads to the 'games', and analysis of the competitive situation is called 'Game Theory'.

#### Two-Person Non-Zero-Sum Games

In general form, the theory of the game that is non-cooperative solution is fundamentally formulated by John Nash in his doctoral dissertation. Not like solving a cooperative in which it is assumed that each player can communicate with each other, to form a coalition and negotiate - in short, do the deal outside the formal structure of the game - solving Nash (Nash's solution) is not translated in the form of payoffs, but rather in the form of a set of strategies that owned by each player. This is a generalization or a direct extension of the concept of strategic equilibrium properties, i.e. properties of the equilibrium state is reached when the saddle point in our discussion in the previous section. This condition is more commonly known as equilibrium point.

Basic definition is simple and intuitive. Suppose  $H_i(s_1, s_2, \dots, s_n)$  is the payoff of player  $P_i$  is a function of all the strategies that exist in the game, including its own strategy. An equilibrium is a vector of strategies  $(s_1^*, s_2^*, \dots, s_n^*)$  are such that for each  $i = 1, 2, \dots, n$ , apply:

$$H_i(s_1^*, s_2^*, \dots, s_i, \dots, s_n^*) = \max_{s_i} H_i(s_1^*, s_2^*, \dots, s_i, \dots, s_n^*)$$

Or, in words, a point of equilibrium is a vector of strategies such that no single player, regardless of the strategy of other players, can improve the acquisition. In the case of two players, the balance point is the condition in which no one player that can improve his payoff by unilateral movement (by changing its strategy). Another classic example is known as The Prisoner's Dilemma. Two inmates accused of crimes together, but prosecutors did not have sufficient evidence to file a decent amount of punishment meted out. The prosecutor then separating the two prisoners, and to each of the inmates filed the following offer. If one claim the inmate who claimed to be given leniency and he will be rewarded in prison for one year only. While other inmates were not admitted guilt but will partner indicated by inmates sentenced to the maximum, which is 10 years. If none admitted, then the evidence is in the hands of prosecutors to punish just enough that the two inmates with a sentence of 2 years imprisonment. Whereas if both confess, each will get a reward of 5 years in prison. Payoff matrix of the above issues can be made as follows:

		Prisoner B	
		Confess	Not Confess
Prisoner A	Confess	(5,5)	(1,10)
	Not Confess	(10,1)	(2,2)

The first number in the pair of payoffs in the matrix values above indicate the length of the punishment to be meted out to inmates A, while the second number is the length of the punishment to be meted out to inmates B. It is clear that the balance point in this case is the element (5,5), where both prisoners confess and were rewarded sentenced to 5 years in prison. Another strategy pairs did not show a balance because if one prisoner claimed (or expected claim), then the best strategy for the other inmates are also claimed, as did when one of the prisoners was not claimed (or are expected to plead not), then to the other inmates, remains an option to claim the best option. If possible coordination between the two inmates, the state of balance that will happen is the element (2,2) in which they agreed not to confess. If both the inmate can show the way for building strategies agreed jointly (ie confess), and, more importantly, they have a way to force the partner comply with the agreement, the two inmates that will better-off. Because if one betrayed and failed to confess, the other inmates will be rewarded a lot longer (to the worse-off) and he will be punished the treacherous lighter (better-off).

The second example above him, it is easy to reflect that in the economy, coordination and cooperation among the various parties competing to improve the welfare of the economy as a whole.

About the equilibrium point is reached, in a game between two players who are non-zero-sum, the balance is known to some terms:

1. Pareto equilibrium: occurs when both players get the best payoff value of all the possible payoff value.
2. Nash equilibrium: occurs when each player has the possibility to increase the value of its payoff with a unilateral movement (change strategy), under a strategy that has been set by his opponent.

About ICES

ICES is a CGE model with a base that was developed by the Fondazione Eni Enrico Mattei (FEEM) in 2002. As a recursive dynamic models that can run for years 2004 - 2050, ICES using baseline data from the GTAP 7 with base year 2004. ICES-multisector multicountry models in the international trading system, the transaction appeared in five major countries of ASEAN, namely Indonesia, Malaysia, Thailand, Philippines and Vietnam. Given Indonesia in this model makes it possible to measure the impact of international policies on the Indonesian economy. ICES has several advantages such as include some type of gas that have an impact on the greenhouse effect (CO<sub>2</sub>, N<sub>2</sub>O, and CH<sub>4</sub>). In addition, it also incorporates elements of the production of biofuels and renewable energy such as solar

energy, wind and water. Another plus is the ICES also incorporate elements of land supply by way of grouping based on groups of countries.

#### ICES basic data

No	Countries Group
1.	USA
2.	WEURO: EU 15
3.	EEU: EU 10
4.	KOSAU: Korea South Africa
5.	CAJANZ: Canada Japan New Zealand
6.	TE: Economies in transition
7.	MENA: Middle East North Africa
8.	SSA: Sub Sharan Africa
9.	SASIA: South Asia
10.	CHINA: China
11.	EASIA: East Asia
12.	IND: India
13.	IDN: Indonesia
14.	MYS: Malaysia
15.	PHL: Phillipines
16.	THA: Thailand
17.	VNM: Viet Nam
18.	LACA: Latin and Central America

Source: ICES

The sectors / industries are grouped into 17 groups of sectors / industries as in the table below:

No	Sector/ Industry
1.	Rice
2.	Oth_Crops
3.	Veg_Fruits
4.	Livestock
5.	Timber
6.	Coal
7.	Oil
8.	Gas
9.	Oil_Pcts
10.	Biofuels
11.	Nuclear
12.	Solar
13.	Wind
14.	Hydro
15.	OtheEly
16.	Heavy_Ind
17.	Light_Ind
18.	Services

Source: ICES

#### ICES Structure of Production

In the ICES countries grouped into 18 groups of countries and states. The country group as contained in the following table:

#### Country Group in the ICES

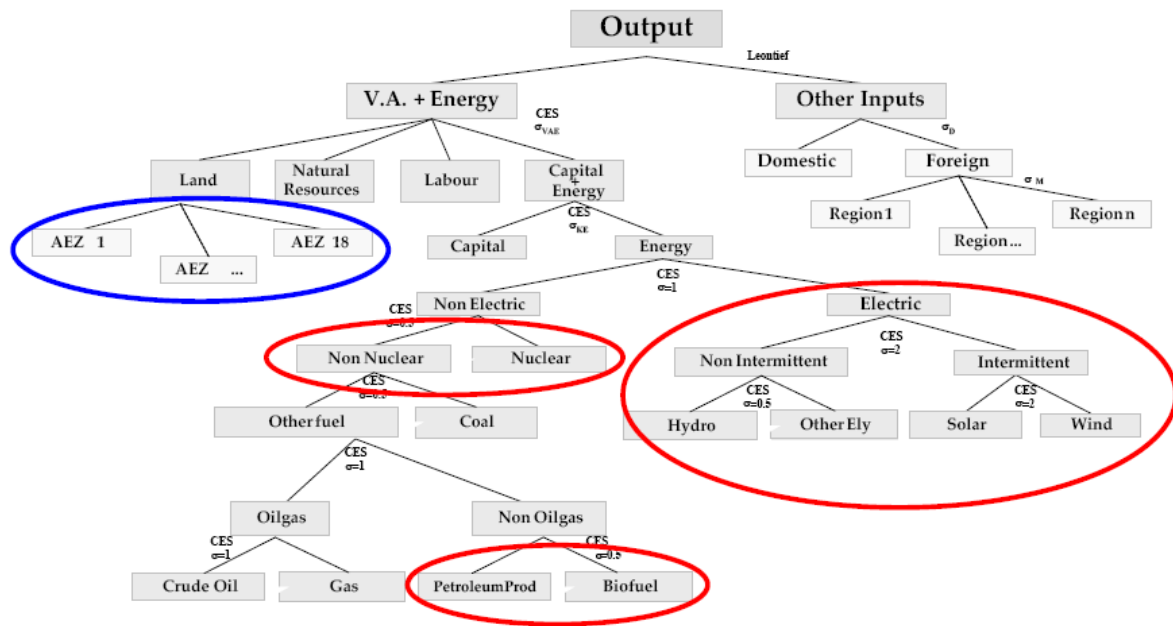

Source: ICES

The picture above shows that the structure of the production function can be explained through several levels. At the top level, the picture explains that the total output produced by a sector is a combination of value added and energy with other inputs by following Leontief function, in which all the constituent factors assumed to be perfectly complementary.

At the second level, value added and energy value of each production sector consists of Land, Natural Resources, Labour and Capital plus Energy. Preparation of value added value of each sector's production function following constant elasticity of substitution (CES). In this case, all inputs are substitutes and the production of each sector ie Land, Natural Resources, Labour and Capital plus energy can be exchanged with certain coefficients. At the third level, Land consists of a collection of zoning areas around the world are divided

into 18 groups of regions as listed in table above. Preparation of the area was done by groups Agro Ecological Zoning (AEZ) that recognize climate and soil characteristics berdasar methodology undertaken by FAO. While Capital and Energy Capital and Energy prepared on the following functions of constant elasticity of substitution (CES). At the fourth level, divided into Non Electric Energy and Electric by following CES function.

Back on the second level, on the other inputs, other inputs total is a combination of domestic and foreign inputs. In total the preparation of other inputs is assumed that all constituent complement perfectly that follows function Cobb-Douglas function, where domestic inputs will be inversely proportional to the foreign inputs

**Result**

The decision makers

The decision makers are defined as the persons who are involving in the game. At this study, the countries of Annex I and the countries of non Annex I can be assigned as the decision makers.

The action to be taken

In this study, the action is imposing carbon tax both for the Annex I country and non Annex I country.

According to prisoner dilemma, there are several combinations of actions which are taken by the decision makers. The actions are:

1. Both parties admitting for the maximum value, thus the actions are taken by both parties. Either the Annex I or non Annex I, they impose the carbon tax. In this stage, the coordinative imposing carbon tax of Annex I and non Annex I in ICES can be applied.

2. At this stage, the Annex I is imposing carbon tax but the non Annex I is not imposing carbon tax. The un-coordinative carbon tax policy at Annex I in ICES can be applied while there is no same policy for the non Annex I.
3. At this stage, the non Annex I is imposing carbon tax but the Annex I is not imposing carbon tax. The un-coordinative carbon tax policy at non Annex I in ICES can be applied, and no action for Annex I.
4. At this last stage, there is no action among the participants. Thus, the Business as Usual scenario in ICES can be applied.

In terms of value for the matrix, it can be derived from the value of the GDP of each group or the emission that can be reduced. This is due to the ultimate target of the actions for each group. Whether they still prioritize their economic performance or they will be focusing on the emission reduction target.

Thus the simulation can be sintesized:

		Non Annex I Countries	
		Carbon Tax	No Carbon Tax
Annex I Countries	Carbon Tax	Simulation I	Simulation II
	No Carbon Tax	Simulation III	Simulation IV

Simulation	Non Annex I	Annex I	Remark	Result*)
I	New Equilibrium	New Equilibrium	Cooperative	(A1,X1)
II	BAU	New Equilibrium	Not Cooperative	(A2,Y1)
III	New Equilibrium	BAU	Not Cooperative	(B1,X1)
IV	BAU	BAU	Not Cooperative	(B2,Y2)

\*) nilai pay off dapat berupa GDP atau persentase penurunan emisi

A1 is the payoff value obtained for Annex I Parties have teamed up with the non-Annex I countries to implement a carbon tax in their respective countries.

X1 is the payoff value obtained Non Annex I countries have been working together with Annex I Parties to implement a carbon tax in their respective countries

A2 is the payoff value obtained non-Annex I countries for not cooperating with Annex I Parties to implement a carbon tax. In this stage, non-Annex I countries do not apply the carbon tax to pay off the obtained value is the value of BAU

Y1 is the payoff value obtained for Annex I Parties do not work with non-Annex I countries in implementing a carbon tax.

B1 is the payoff value obtained for Non Annex I Parties do not work with Annex I countries in implementing a carbon tax.

X1 is the payoff value obtained Annex I countries for not cooperating with non-Annex I Parties to implement a carbon tax. In this stage, non-Annex I countries do not apply the carbon tax to pay off the obtained value is the value of BAU.

B2 is the payoff value obtained Annex I countries for not cooperating with non-Annex I Parties to implement a carbon tax. In this stage, Annex I countries do not apply the carbon tax the pay off value obtained is the value of BAU.

X2 is the payoff value obtained Non-Annex I countries for not cooperating with Annex I Parties to implement a carbon tax. In this stage, non-Annex I countries do not apply the carbon tax the pay off value obtained is the value of BAU.

## References

- Bosello, Fransesco. Ramiro Parrado, Renato Rosa. 2010. *The economics and environmental effects of an EU ban on illegal logging imports. Insights from a CGE assessment*. Venice. Italy.
- Brodjonegoro, B. (1992). AHP . Departemen Pendidikan dan Kebudayaan Antar Universitas Studi ekonomi
- David W. Pearce and R. Kerry Turner, 1990, *Economics of Natural Resources and The Environment*. John Hopkins University, USA.
- Fachruddin, Kemas. 2007. Peranan Pajak Emisi Gas CO2 Bahan Bakar Fosil dalam Mengurangi Dampak Lingkungan. "Suatu Perspektif untuk Indonesia". Disertasi Doktor Sekolah Pasca Sarjana Institut Pertanian Bogor. Bogor
- IPCC. 2007. *Climate Change 2007: Synthesis Report*. IPCC. Geneva. Switzerland.
- Peterson, S. (2003). *CGE Models and Their Application for Climate Policy Analysis*. Kiel Institute for World Economics, Germany. Preparatory Lecture, 1st International Workshop on Integrated Climate Models: An Interdisciplinary Assessment of Climate Impacts and Policies.
- Poundstone, W. (1992), *Prisoner's Dilemma*, Doubleday: New York.
- Romp, G. (1997), *Game Theory: Introduction and Applications*, Oxford University Press: Oxford.
- Stern, N. (2007). *The Economics of Climate Change*. Cambridge: Cambridge Univerity Press.

Yusuf, AA. and B.P. Resosudarmo. (2007). On the Distributional Effect of Carbon Tax in Developing Countries: The Case of Indonesia. Papers No. EEN0706, Economics and Environment Networks, the Australian National University.



## **RELATIONSHIPS BETWEEN ROB AND BASIC SANITATION FACILITIES CONDITION IN SUB DISTRICT BANDARHARJO AND SUB DISTRICT TANJUNG MAS, SEMARANG CITY**

**Heru Nugroho, Budiyo, Sri Winarni, Sutopo Patria Jati, and Praba Ginanjar**

Faculty of Public Health, Diponegoro University, Semarang, Indonesia  
[kenang92@yahoo.com](mailto:kenang92@yahoo.com)

### **ABSTRACT**

*Rob* is a kind of flood which caused by the overflowing of sea water into the land. *Rob* in North Semarang is influenced by changes in land use in the coastal area, land subsidence of coastal region and sea level rise as the effects of global warming. This was a cross sectional study to determine the relationship between the height of *rob*, and the distance of the house from the shoreline and the conditions of basic sanitation facilities in the Sub-district Bandarharjo and Sub-district Tanjung Mas. The minimum samples was 95 household, determined by accidental method. The research found out that the difference height of *rob* since 2002-2012 was 41.37 cm, in 2012 poor floor conditions found in 66 houses (69.5%), poor conditions of the wall 78 (82.1%), poor latrine conditions 77 (81.0%), poor condition of sewage is 90 (94.7%), poor physical quality of fresh water is 0%. A significant correlation between height of *rob* and basic sanitary conditions with p-value 0.006 ( $p < 0.05$ ). There was no significant correlation between distance of the sea to house and basic sanitary conditions with p-value 0.316, ( $p > 0.05$ ). Conclusion, basic sanitation condition getting worse (2002-2012) and the height of *Rob* has a significant relationship with basics sanitation condition. This research suggests to identify potential risks of basic sanitation facilities and improving basic sanitation as a pilot.

**Keywords:** *rob height, floor condition, latrine condition, wall condition, physical quality of fresh water*

### **INTRODUCTION**

*Rob* is flooding due to raise of sea tide overflowing into an area, especially coastal areas, which located lower than average sea level. *Rob* in North Semarang influenced by: a. changes in land use in coastal area, such as fish pond and swamp that can naturally accomodate tides now become residential and industrial areas, b. decrease in land subsidence in coastal

areas, it happened as a result of excessive use of ground water, c. sea level rise as the effect of global warming (Bakti LM, 2010; Suryanti dan Marfia, 2008).

Based on data of tidal, within the document of Drainage Masterplan in 2007, highest tide height against mean surface level (MSL) is 68. Because the position of Semarang MSL is 23 cm below Java Island's MSL, the position of Semarang's

HHWL is 45 cm above Semarang MSL. The land around beach that has under 45 cm height is expected to be submerged by rob (Bakti, 2010)

Rob in Semarang in 2011 was 1538.8 Ha. North Semarang is largely affected by rob, i.e. 508.28 Ha (Ramadhany et.al, 2012). District of North Semarang is located 0-1 meter above sea level. The district consists of 9 villages as follow: Bandarharjo, Bulu Lor, Plombokan, Purwosari, Panggung Lor, Panggung Kidul, Kuningan, Dadapsari, Tanjung Mas (Suprihanto, 2011). Location mostly threatened by rob comprises of Tanjung Mas and Bandarharjo (Ramadhany et al, 2012). Compare to other villages, Bandarharjo and Tanjung Mas underwent the most decreased in sea level, reaching 4 cm/year (Adhy, 2007).

Rob impact on damage of fondations, floors and walls of the house. Floor is generally flooded and forced many residents to left their houses. Rob also causes fractured and tilted of the building. Many houses need water-retaining dam in front of them to avoid flood entering the house. Additionally, rob affect the quality of clean water in the community (Waskito, 2008:77-92).

Our previous study in Bandarharjo (2007) showed only 16 out of 39 water sampel

(41.0 %) met the quality of health standard, while other 23 sampel (59.0 %) remained below the standard (Budiyono, 2007). But, another study showed 71.8% of water sampel (71,8%) had met the requirements (Budiyono and Arie W, 2007). Study in Bandarharjo, North Semarang reveales permanent physical loss of building due to rob ranged IDR 5,700,000 to 16,300,000 (Bakti, 2010).

Data from Primary Health Care of Bandarharjo showed basic sanitation coverage that examined from 400 houses in Bandarharjo and Tanjung Mas (include sanitary latrines, trash bins and water waste management) was 8.43 % and 5.26 % respectively (Puskesmas Semarang Utara, 2011). The standard for coverage of basic sanitation is 100 %, therefore in both areas the basic sanitation has not met the coverage requirement.

## **MATERIAL AND METHOD**

Study population consisted of 1892 households (HH) based on data profile of Bandarharjo and Tanjung Mas Sub-Districts in 2011. Sample was 95 households. Criteria for determining RW (duh, RW boso inggrise apaan): rob affected more than half of the area. Criteria for determining RT (ini juga ndak tau): more than 50% of houses in the area

affected by rob, slum, and most of houses have not been renovating in the last 10 years. Criteria for determining household: house influenced by rob, respondent/informant lived at least 10 years in the house, capable to communicate. Number of households from each RT selected by *proportional random sampling* in order to assure the representativeness of all rob households (Sugiyono, 2009). Subject was selected by accidental sampling, consisted of all subject that met by accident and fulfill the criteria (Sugiyono, 2002).

Kolmogorov-Smirnov showed the data are not normally distributed, so we used Rank-Spearman analysis (Riwidikdo, 2012).

## RESULTS AND DISCUSSION

Mean of rob height difference between 2012 and ten years ago according to respondents' memory was 40.79 cm. Another research found out that most respondents (78%) said the average of water height that flooded into the house during rob was 0-10 cm or foot-high point. The rest (22%) admitted water height could reach 11-50 cm into their houses (Ali, 2010).

The mean distance from respondents' house to the shoreline during low tide was

Data collection used questionnaire (data of demography, income, expenditure to pile up the land etc). To determine the point or line of rob height changes, we used the signs that are still remembered by respondents, for example height of wall, floor, road etc. To measure the distance from respondent's houses from shoreline, we used meter equipment. Each variable of basic sanitation then given mark and summed to obtain composite value as condition of basic sanitation.

The result of test of normality by 506,32 meter. The mean frequency of respondent elevating the house in the past ten years was 2.24 times. The cost to elevate houses, according to 41 out of 95 respondents (43,1%) ranged IDR 1,000,000 to 1,900,000, with average IDR 1,912,630. Houses flooded by rob in 2002 was 52 (54.7%), and the increased in 2012 into 85 (89.5%). In 2012, almost all respondents (97.9%) have elevated their houses to overcome rob height.

### A. Basic sanitation

#### 1. Floor condition

Our result showed more than half of houses had poor floor condition. There were 57 houses with poor floor condition ten years ago. The number increase to 66 houses in 2012.

Table 1 Frequency distribution of floor condition in 2002 and 2012

Floor condition	Year 2002		Year 2012	
	Frequency	Percentage	Frequency	Percentage
Poor	57	60.0	66	69.5
Good	38	40.0	29	30.5
Total	95	100.0	95	100.0

## 2. Wall condition

Our finding revealed 62 houses with poor wall condition ten years ago and increased to 78 houses in 2012.

Table 2 Frequency distribution of wall condition in 2002 and 2012

Wall condition	Year 2002		Year 2012	
	Frequency	Percentage	Frequency	Percentage
Poor	62	65.3	78	82.1
Good	33	34.7	17	17.9
Total	95	100.0	95	100.0

## 3. Latrine condition

Poor latrine in 2002 was observed in 68 houses. In 2012, the number increased into 77 houses with poor latrine.

Table 3 Frequency distribution of latrine condition in 2002 and 2012

Latrine condition	Year 2002		Year 2012	
	Frequency	Percentage	Frequency	Percentage
Poor	68	71.6	77	81.0
Good	27	28.4	18	19.0
Total	95	100.0	95	100.0

## 4. Waste water sewage condition

Poor sewage was 59 (62.1%) ten years ago and increased to 90 (94.7%) in 2012.

Table 4 Frequency distribution of waste water sewage condition in 2002 and 2012

Sewage condition	Year 2002		Year 2012	
	Frequency	Percentage	Frequency	Percentage
Poor	59	62.1	90	94.7
Good	36	37.9	5	5.3
Total	95	100.0	95	100.0

## 5. Fresh water condition

According to our visual observational, all the fresh/clean water was in good condition, either in 2002 or 2012.

Table 5 Frequency distribution of daily fresh water condition based on physical characteristic in 2002 and 2012

Water condition	Year 2002		Year 2012	
	Frequency	Percentage	Frequency	Percentage
Poor	0	0.0	0	0.0
Good	95	100.0	95	100.0
Jumlah	95	100.0	95	100.0

### B. Relationship between rob height difference and basic sanitation condition

Rank spearman analysis showed p value 0,006, ( $\alpha=0.05$ ), which indicated significant relation between rob height difference (2002-2012) and basic sanitation condition in Bandarharjo and Tanjung Mas. In this case, rob elevation will aggravate basic sanitation condition of respondents. According to Ali (2010), length of water flooded the house during rob ranged 1-12 hours in 57 out of 100 respondents. Most of respondents did not do anything to prevent the rob flooding into their houses, therefore their sanitation facilities did not work during rob (Ali, 2010).

PERKA BNPB number 2/2012 classified flood threat into three categories: low risk (flood height less than 0.75 m), medium risk (0.75-1.5 m) and high risk (more than 1.5 m) (BNPB, 2012). Rob height difference between 2002 and 2012 (40.79 cm) was categorized as low risk, according

to flood threat classification. But despite of its low risk classification, the effect on basic sanitation condition was prominent.

Loss of building function due to rob from all 20 houses observed in Bandarharjo showed only 0.5-16.9% houses functioned properly. Utility components such as waste water sewages, septic tanks, and latrines were all flooded by rob, and eventually did not work (Ali M, 2010).

Rob affects residences in coastal area as the area was flooded for hours, even days, which may lead to the damage of infrastructure in the region such as foundation, floor, wall and building damages. Rob caused many buildings and houses needed to be elevated at least 10-50 cm once every 5 years. Therefore when a building reached the age of 15 years, it usually had a very short wall. Low income people sometimes have to survive with existing condition. While high income people may completely overhaul or rebuild their houses. Either way, the

condition indicated that in an area flooded with rob, we can predict in the next 15 years the residence may loss 50-100 % component of their houses (Ali, 2010).

Sanitation facilities such as septic tank is highly affected by rob height. Rob height causes the increase of septic tank wall around 1.5-2.0 m. Inundation of septic tank will facilitate water contamination by faecal material in it. In this case, rob may lowering health, evidenced by many people suffered from hives on the skin. Other facilities affected by rob was drainage that also need elevation or even required an application of polder system equipped with automatic pump (Waskito, 2008).

Previous study showed the flooding rob disrupted daily activities like work and household chores that could not be done normally. It was difficult to access transportation to travel other places during rob, due to flooded road and houses. 22.5% of respondents were on able to continue their daily activities in the rob (Suryanti and Marfia, 2008).

### **C. Relationship between distance of house to shoreline with basic sanitation condition**

Rank Spearman analysis resulted p value of 0.316, ( $\alpha=0.05$ ), which indicated no significant relation between distance of house to shoreline and basic sanitation condition. Regardless the distance to shoreline, area of Bandarharjo and Tanjung Mas that located 0-1 m above the sea level, remain affected by rob inundation (Suprihanto, 2011). Geographically, the closer an area to shoreline, the higher flooded rob entering houses. However, our finding showed different phenomena. This due to environmental modification. People in rob area tend to elevate the road, building and other environment to prevent rob flooding into their houses. So, although a place has closer distance to the shoreline, when it has a higher area, then the rob will flow to lower ones regardless the distance. According to Ali, people in Bandarharjo tried to prevent rob by closing drainage (26%) and created yard barrier (35%) (Ali, 2010).

Other study showed 86% performed house renovation due to rob, while the rest 14% did not do anything. Off respondents performed renovation during the last 15 years, most of them have done it three times with IDR 5-10 million cost (Ali M, 2010). This is similar swith our finding that most respondents adapted to rob by elevating their house once every five

years, which cost them almost IDR 2 million for each elevation. According to cultural ecology expert, adaptation is a strategy to response social and environmental changes (Alland et al, in Gunawan, 2008). People in rob area remains living in the environmental, mostly due to their job as fisher.

Other condition affecting people's ability to adapt is economy status. Middle and high income society have more option to adapt, for example house renovation, build a two-storey house, or even move to other places. In contrast, the low income society tend to not having many options rather than remain stay in rob area (Berina, 2011).

## ACKNOWLEDGEMENT

## CONCLUSION

Compare to 2002, there are a rise of rob height in 2012 (the difference is 41.37cm). Poor condition of basic sanitation in rob area, including floor, wall, latrine, sewage and fresh water statistically increase from 44 houses (46.3%) in 2002 to 55 houses (57.9%) in 2012. Statistical analysis showed significant relationship between rob height and basic sanitation condition ( $p=0.006$ ).

## REFERENCES

- Bakti LM, 2010. Study of Tidal Inundation Potential at Semarang City and Its Solutions, UNDIP, Semarang:p25-28
- Suryanti ED, Marfia MA, 2008. Adaptasi Masyarakat Kawasan Pesisir Semarang Terhadap Bahaya Banjir Pasang Air Laut (Rob). Jurnal Kebencanaan Indonesia. 2008 November 2008;Vol. 1 No. 5. p335-346
- Apriliawan Setiya Ramadhany, Agus Anugroho DS, Petrus Subardjo, 2012. Daerah Rawan Genangan Rob di Wilayah Semarang. Journal Of Marine Research. Volume 1, Nomor 2, Tahun 2012, p174-180.
- Suprianto H, 2011. Data Monografi Kecamatan Semarang Utara Juli - Desember 2011.
- Adhy DS, 2007. Evaluation Study On The Success Of Polder Building At Kota Lama Semarang In Coping With Tidal Flood. Jurnal Pondasi. 2007;Vol. 13 No. 1 :p14-26.
- Waskito, 2008. Pengaruh Banjir Rob Terhadap Pemukiman Kawasan Pantai Kota Semarang Sebagai Efek Penggunaan Lahan. Majalah Ilmiah Pawiyatan. 2008;Vol : XVII, No : 3 September.:p77-92
- Budiyono, 2007. Hubungan Kualitas Bakteriologis Air Bersih dengan Kejadian Diare pada Balita di Bandarharjo Kota Semarang. Media Kesehatan Masyarakat Indonesia 2007;Vol.6 No.2. Oktober.P45-49
- Budiyono, Wuryanto A, 2008. Hubungan Praktik Penggunaan Fasilitas Sanitasi dan Praktik *Personal Hygiene* dengan Kejadian Diare Pada Balita di Kelurahan Bandarharjo Kota Semarang. Jurnal Promosi Kesehatan Indonesia. 2007;vol 2 no 1.Januari:P32-38

Puskesmas Semarang Utara, 2011. Data Persentase Keluarga Dengan Kepemilikan Sarana dan Sanitasi Dasar tahun 2011, Semarang

Sugiyono, 2009. Metode Penelitian Kuantitatif Kualitatif R&D. Bandung: Alfabeta.

Sugiyono, 2002. Statistik Untuk Penelitian. Bandung, Alfabeta.

Riwidikdo H, 2012. Statistik Kesehatan. Yogyakarta: Nuha Medika.

Ali M, 2010. Kerugian Bangunan Perumahan Akibat Rob Dan Arah Kebijakan Penangannya Di Kelurahan Bandarharjo Kota Semarang. Semarang: UNDIP; 2010:p71-72

BNPB, 2012, Pedoman Umum Pengkajian Risiko Bencana. Peraturan Kepala Badan Nasional Penanggulangan Bencana No. 2 Tahun 2012

Gunawan, B., (3 November 2008). Kenaikan Muka Air Laut Dan Adaptasi Masyarakat.

[http://www.walhi.or.id/index.php?option=com\\_content&view=article&id=520:kenaikan-muka-airlaut-dan-adaptasi.artikel.html](http://www.walhi.or.id/index.php?option=com_content&view=article&id=520:kenaikan-muka-airlaut-dan-adaptasi.artikel.html).

Berina D, 2011. Strategi Dan Biaya Adaptasi Masyarakat Teluk Jakarta Terhadap Dampak Banjir Rob Akibat Perubahan Iklim. Bogor: IPB:p1



# **IDENTIFICATION OF GREEN MANUFACTURING IMPLEMENTATION BASED ON SMALL AND MEDIUM ENTREPRENEURS' PERCEPTION**

**Agustine Eva Maria Soekesi**

Management Department, Economics and Business Faculty, Soegijapranata Catholic University,  
Semarang - Indonesia  
[eva\\_agt@yahoo.com](mailto:eva_agt@yahoo.com)

## **ABSTRACT**

Basically the company produces products to fulfill the needs and wants of the people as consumers. However, ideally in products producing should consider the balance of the environment. It means not only eco friendly in product, but the overall production system should pay attention to the environment, even to the processing of waste. Attention to the overall production system that care about the environment, known as green manufacturing. This paper displays the results of a survey of 35 small and medium scale business entrepreneurs in Semarang and surrounding areas, regarding their perceptions of the implementation of green manufacturing. Production system variables that were used in this survey are material, production process, packaging, and waste management. The result of survey shows that most (60%) of the business in the field of food and beverage, 25.71% in the field of souvenir or accessory, and others (14.29%). Not all entrepreneurs perceive that they have implemented green manufacturing in variables such production system. But there is only one variable, two variables, three variables, and some have yet to implement green manufacturing perceive at all. Implementation of green manufacturing in the production system variables are: the production process (54.29%), raw materials (34.29%), packaging (31.43%), and waste management (25.71%). While that has not been implemented at all is 11.43%. In this case, although they have not been implemented in green manufacturing, but they have had to apply discourse.

**Keywords :** *green manufacturing, small and medium businesses, entrepreneur, production system*

## **I. INTRODUCTION**

Green manufacturing is the issue of business cases that should be aware by all of the people, especially related entities. There are many firms produce products to fulfill all of the people needed and wanted (as their consumers and customers). Some of them do not pay attention to the balance of environment. It covers the materials, product processing, product (include all the attributes such as packaging), even the waste management and product delivery to the consumers.

In some cases they only focus on how to get the high profit and sometimes they can do everything to achieve it. In small and medium enterprises/ businesses (include micro enterprises), commonly they are in condition of limited production capacity. So, it's relatively difficult to produce products in a big quantity. Based on the total cost norm, if they produce in a relatively few product, the total cost per unit will be relatively high. The implication of this case, the profit will be limited or in the worth condition, they will loss.

This is one reason why I do take an interest to investigate deeply to discover the green manufacturing issue in the production system of small and medium businesses. But I have done the pre-survey only. In the next opportunity, I will apply my research proposal to Indonesian Higher Education Commission (Ditjend Dikti) or other institutions related. Hopefully, the result of my survey will be my supporting empirical data to make my research proposal 'talk'.

## II.LITERATURE REVIEW

### 1.Green Manufacturing Concept

Currently, green manufacturing concept is in the public domain area. In brief, the production system; start from supplier – inputs (materials and others) – production process – output (products) – consumer delivery, should pay attention to the balance of environment.

Refer to [www.cleantechnica.com](http://www.cleantechnica.com) (anonymous, April 15th, 2012) the term “green” manufacturing can be looked at in two ways: the manufacturing of “green” products, particularly those used in renewable energy systems and clean technology equipment of all kinds, and the “greening” of manufacturing — reducing pollution and waste by minimizing natural resource use, recycling and reusing what was considered waste, and reducing emissions.

The term “green” manufacturing can be looked at in two ways: the manufacturing of “green” products, particularly those used in

renewable energy systems and clean technology equipment of all kinds, and the “greening” of manufacturing — reducing pollution and waste by minimizing natural resource use, recycling and reusing what was considered waste, and reducing emissions (Deif, 2011).

### 2.Small and Medium Enterprises/ Businesses Criteria

Based on Republic of Indonesia Regulation Number 20 / 2008 about Micro, Small, and Medium Enterprises, chapter IV, section 6:

(1) Criteria of Micro Enterprises:

- a. Have a maximum nett asset IDR 50 million, exclude enterprise's land and building; or
- b. Have a maximum annual omzet IDR 300 million

(2) Criteria of Small Enterprises:

- a. Have a nett asset between (more than) IDR 50 million up to IDR 500 million, exclude enterprise's land and building; or
- b. Have a maximum annual omzet between (more than) IDR 300 million up to IDR 2,5 billion

(3) Criteria of Medium Enterprises:

- a. Have a nett asset between (more than) IDR 500 million up to IDR 10 billion, exclude enterprise's land and building; or

- b. Have a maximum annual omzet between (more than) IDR 2,5 billion up to IDR 50 billion

(4) As for the criteria in paragraph (1) a, and b, in paragraph (2) a, and b, and in paragraph (3) a, and b, the nominal value can be adjusted, according to the economic condition that managed by Indonesian President Regulation.

### **3. Entrepreneur and Entrepreneurship Concept**

John Baptise Say (1800) that cited from Frinces (2004) defined the entrepreneur is a person who shifts economic resources out of an area of lower productivity into an area of higher productivity and higher yield.

Based on the above definition, Peter Kilby (Entrepreneurship and Economic Development, 1971) that cited from Frinces (2004) defined the entrepreneurship is the attempt to create value to recognition of business opportunity, the management of risk-taking appropriate to the opportunity, and to the communicative management skills to mobilize human, financial, and resources necessary to bring a project to fruition.

### **4. Variables in Survey**

Based on observation period, the variables used in the survey refered to the production system, but limited in raw material, production process, packaging, and waste management only. The reason in choosing these variables was its significantly tangible to represent the

implementation of green manufacturing in micro, small, and medium enterprises; and easier to be understood and identified by the respondents (entrepreneurs). It did not take the finished product/goods (in the case of content) as another variables, because it is a function of raw materials and production process in production system.

## **III. SURVEY METHOD**

### **1. Object of Survey**

The object of survey is enterprises/ businesses/firms in Semarang and surrounding areas that meet the Republic of Indonesia Regulation Number 20 / 2008 about Micro, Small, and Medium Enterprises, chapter IV, section 6.

But I used the annual omzet criteria only, because some of them do not understand how to define their asset. They do not know the indicator of asset and how to count it. Even some of them have not a balance sheet appropriately. That was the consideration that I used the annual omzet criteria only, this criteria is easier to be counted / predicted by the owner and/or the management of those enterprises. It means the annual omzet under 50 billion (in average).

To make sure that green manufacturing can be investigated completely in production system spectrum, only the manufacture enterprises were used in the survey. It means I did not take the service enterprises because the product is intangible. Trading enterprises

(distributors) also did not used in the survey, because the production process tends to buy and sell the finished product/goods.

## 2. Sample and Sampling Technique

Currently there is no the appropriate number of micro, small, and medium enterprises in Semarang of Central Java. Every institution has a different number of each, it caused by those enterprises have not been operating continuously. Even some of them changed their product easily and frequently. It tends to the micro and small enterprises, because they have limitation in many things (in management perspective).

According to the condition above, I used 35 sample in my survey. I considered it according to the common statistical norm that minimum sample number is 30 to represent something related. The excess 5 sample will replace it, if some of them were not adequate (it can be rejected), preventively. Sampling technique in the survey was accidental sampling, that means the appropriate object found during the survey period and they were prepared to be a sample, it will be taken.

As the note, I did not determine the quantity of each micro, small, and medium enterprises proportionally. It caused by I did not find the exactly population each. But every scale of enterprises above are representated.

## 3. Type of Data, Data Resource, and Data Recruitment Method

All of the data in my survey is primary data both qualitative and quantitative data. Data resources were coming from the physical manufacturing environment and entrepreneur of the survey sample. Entrepreneur in this case is the owner of the micro, small, and medium enterprises that used in the survey. They have been involving in the business management. So the survey results represent the real condition of green implementation, based on the entrepreneurs' perception.

The data recruitment method is observation to see that the production system is adequate and appropriate to be investigated deeply. The other method is depth interview to found all the data needed. I prefer depth interview to questionnaire form because it more effective and could prevent the respondents' bias interpretation of some variables and/or indicators.

## IV. RESULTS AND INTERPRETATION

### 1. General Profile of Respondents

The general profile of 35 sample as respondents as shown in the table 1 and table 2:

Table 1. Type of Product

Type of product (field of business)	Quantity	
	enterprise	%
Food and/or beverage	21	60.00
Accessory and/or souvenir	9	25.71
Others (garment, construction material, etc)	5	14.29
<b>TOTAL</b>	<b>35</b>	<b>100.00</b>

Source : Primary data (2013)

According to table 1, most of respondents are in the field of food and/or beverage (60%),

accessory and/or souvenir is 25,71%, and others (14,29%). Food and/or beverage mostly chosen because it has a repetitively buying and the impact of cash flow to working capital is relatively in the very short term (daily). The argument of most respondents in this area was it can be managed easily and has less risk than other fields/products.

The annual business omzet as the criteria of respondents (in average) as shown in table2.

Table 2. Average Annual Omzet

Average annual omzet	Quantity	
	entreprise	%
Maximum 300 million	16	46,00
More than 300 million up to 2.5 billion	15	43,00
More than 2.5 billion up to 50 billion	4	11,00
<b>TOTAL</b>	<b>35</b>	<b>100,00</b>

Source : Primary data (2013)

Table 2 above shows that business/ entreprise in the micro scale (maximum annual omzet in average is 300 million) and in the small scale (annual omzet in average is more than 300 million up to 2.5 billion) is almost balance, 46% and 43% each. The medium scale enterprises is 11% only.

## 2. Implementation in Green Manufacturing

Based on the entrepreneurs perception, the implementation of green manufacturing can be seen in table 3. According to the limitation in production system that implemented by the enterprises, the variables are raw materials,

production process, packaging, and waste management.

Table 3. Implementation of Green Manufacturing in Some Variables of Production System

Variable in Production System	Freq	
	entreprise	%
Raw materials	12	34.29
Production process	19	54.29
Packaging	11	31.43
Waste management	9	25.71
Not at all	4	11.43

Source : Primary data (2013)

Based on table 3, production process is the most variable that implemented in green manufacturing (54.29%). The next in a sequence is raw materials (34.29%), packaging (31.43%), and waste management (25.71%). It means some enterprises can implement more than one variable in green manufacturing. But there is still 11,43% that have not been implementing the green manufacturing at all. But they have had to apply discourse in the years to come.

Further in investigating about the understanding of each variable based on entrepreneurs' perception can be collected during the depth interview period. The result can be seen in the table 4.

Table 4. The Understanding of Variable in Production System

Variable in Production System	Freq	
	entreprise	%
<b>1. Raw materials (12 respondents)</b>		
a. Use less or no chemical material	12	100.00
b. Keep all of the material in clean condition	8	66.67
c. Reduce/less/no		

additive material/essence	12	100.00
d. Control the durability of material	5	41.67
<b>2. Production Process (19 respondents)</b>		
a. Keep all the facilities (machine and tools) in clean condition	19	100.00
b. Reduce the electric and fuel (tend to replace it to the bio energy)	15	78.95
c. Keep the 'line floor' in clean condition	18	94.74
d. Keep the labour in health and safety (e.g masker, glove, etc)	10	52.63
e. Instruction in facilities management (grouping, returning in the right place – after it's used, etc)	7	36.84
f. Use the air vacuum to ensure the durability of the product inside the packaging	16	84.21
g. To be controlled by the related institution periodically	8	42.10
<b>3. Packaging (11 respondents)</b>		
a. Less/no plastic	10	90.90
b. Put the durability period on the wrapper	8	72.72
c. Put the tag such as 'halal' and other eco labelling symbols.	11	100.00
d. Use the recycle materials as wrapper	11	100.00
To be continued on the right side column...		
<b>Variable in Production System</b>	<b>Freq</b>	
	<b>enterprise</b>	<b>%</b>
<b>4. Waste management (9 respondents)</b>		
a. Clean the scrap and trash in all of the factory	9	100.00
b. Manage the product rejected	8	88.88
c. Waste/cesspit processing	5	55.55

Source : Primary data (2013)

According to table 4, there are many interpretations of green manufacturing based

on every variable in production system. In the raw materials 100% respondents that have been implementing in it, use less or no chemical and some additive essence. Even 41.67% always control the durability of the raw materials used.

In production process, 100% respondents that implement this variable, keep all the facilities in clean condition, 94.74% also do it on 'line floor'. They also use the air vacuum to ensure durability of the product (84.21%). Some of them tend to replace electric and fuel to bio energy. Even 42.10% be controlled by the related institutions periodically.

The packaging as another variable, 100% respondents of its put the tag of 'halal' and eco labelling symbols, and also use the recycle materials as wrapper. Some of them (90.90%) agree to reduce even they do not use plastic.

Nine respondents (100%) always clean the scrap and trash in all of the factory, and 55.55% have already waste/cesspit processing. It sounds good in the trend of green manufacturing.

The survey also tried to dig the entrepreneurs' perception about the influence of green manufacturing to get the profit. The result as shown below:

Table 5. The Influence of Green manufacturing Implementation to Get the Profit\*)

The Influence of Green Manufacturing Implementation to Get the Profit	Quantity	
	entreprise	%
Influential positively	15	48.00
Influential negatively	9	29.00
Have no influence	3	10.00
Hesitant	1	3.00
They do not know	3	10.00
<b>TOTAL</b>	<b>31</b>	<b>100.00</b>

Source : Primary data (2013)

\*) Total respondents in this case is 31, because 4 respondents have not been implementing the green manufacturing (see table 3)

The above table shows the good signal, 48% respondents believe in green manufacturing implementing have a positive influence to the profit exactly. Their reason was many consumers have a high awareness in the balance of environment. So they will buy what they need, especially if the product is produced in the green manufacturing implementation. But 29% respondents were in opposite perception, green manufacturing implementation exactly rises the high cost such as to get the eco materials and processing. It will difficult to be adjusted in production cost that influence the product price.

## V. CONCLUSION

Based on the data interpretation, the conclusion of the survey is:

- Most of the respondent is in the field of food and beverage (60%). Because it has a repetitively buying and the impact of cash flow to working capital is relatively in the very short term (daily).

- The enterprises as sample in the survey are in the micro and small scale, 46% and 43% each.
- Production process is the most variable of production system to be implemented in green manufacturing (54.29%).
- A hundred percent respondents have been implementing the green manufacturing of production process by keeping all the facilities in clean condition, and 94.74% also do it on 'line floor'.
- Fourty eight percent respondents agree that green manufacturing implementation have a positive influence to get the profit, exactly.

## VI. ACKNOWLEDGEMENT

In this occasion, I would like to say thank you so much to United Board for Christian Higher Education in Asia (UBCHEA) that already been funded my research in 2011, in the topic of environment and health. That was my first topic in environment and health that rise my passion to do another researches in the same topic. I wish I will contribute my research result to develop some methods in keeping the green manufacturing implementation.

## REFERENCES

Anonymous (April 15th, 2012), Renewable Energy and Clean Technology : Keys to a Revitalization of U.S. Manufacturing and Job Creation. Accessed from [www.cleantechnica.com](http://www.cleantechnica.com)

Deif, Ahmed M (2011), A System Model for Green Manufacturing. *Advances in Production Engineering and Management (APEM) Journal*, p 27-36. Accessed from [www.maja-uni-mb.si](http://www.maja-uni-mb.si)

Frinces, Z. Heflin (2004), *Kewirausahaan dan Inovasi Bisnis*, Publisher: Darussalam and STIE Mitra Indonesia, Yogyakarta.

Republic of Indonesia Regulation Number 20 / 2008 about Micro, Small, and Medium Enterprises



# E-HEALTH QUALITY ASSURANCES OF DRINKING WATER REFILL TOWARDS HEALTHY INDONESIA

**Dewi Agustini Santoso<sup>1</sup>, Dwi Eko Waluyo<sup>2</sup>**

<sup>1</sup> Industrial Engineering Department, Technique Faculty, Dian Nuswantoro University

<sup>2</sup> Management Department; Economy Faculty; Dian Nuswantoro University  
[dewyntha@yahoo.co.id](mailto:dewyntha@yahoo.co.id)

## ABSTRACT

Water as the basic needs is essential for human life. Drinking water is needed to maintain the cellular metabolism in human body and to maintain people's health. Indonesian people has changed their lifestyle in drinking water by taking water from refill station. The problem is that the information about drinking water quality contained in refill station has not been broadly delivered to public as consumers. For that reason, some stakeholders need to be involved in the quality assurances of drinking water refill system to avoid consumer loss. E-health of quality assurance of drinking water refill is designed to support the Healthy Indonesia Program. This study begins with the process of identifying the quality assurance of drinking water refill station, the data obtained then statistically processed. Using 30 samples are tested, 4 of them contain colifecal. The processed data then used as a baseline in the development of e-health quality assurance information systems using web and mobile phone based on techno-industrial cluster (integration among DAMIU, society and Regional Health Laboratory). The study was conducted at the depot of drinking water refill (DAMIU) area of Semarang city which incorporated in Aspami (Association of Water Depot Refill). This Information system will be transferred to user by web and mobile phones media for free. Sustainability of the process is supported by Aspami that wishing to conduct a quality assurance to enhance its brand image.

**Keywords:** *e-Health, quality assurance, drinking water, techno-industrial clusters*

## INTRODUCTION

All of living things on the earth need water; including human who needs clean water which is mainly consumed as drinking water. As a fundamental requirement, availability of drinking water in Indonesia is managed by the state. The existence of PAM as a water company is still relatively small compared to the national drinking water needs.

Drinking water needs are increasing time by time, especially in urban areas. It causes the consumption system switching from Local

Drinking Water Company (PAM) to drinking water refill station which resulted in the amount of drinking water refill station in many locations, especially in densely populated areas, rapidly grow up. However, the water distributed by drinking water refill station still needs to be investigated in order to control its quality that affect the public health (Athens, 2009).

Quality testing to the periodically produced water should be done by refill station itself, unfortunately they are somehow not fully

perform this obligations regularly (Asfawi, 2004). Consumers also do not obtain clear information about the quality of drinking water they buy. It surely will make an impact on their health and also on public's health nationally.

Water testing procedures should be performed in accordance with SNI 01-3554 on how to test bottled water. While drinking water testing methods must be done in accordance with SNI 06-4162-1996 on methods of testing silver content in water by atomic absorption spectrophotometer in carbon furnace and SNI 06-2472-1991 on methods of testing cobalt content in the water with the atomic absorption spectrophotometer furnace carbon.

According to Health Ministry Regulation No.492/Menkes/Per/IV/2010 chapters 4,5 and 6 states that the government is obligated to supervise the quality of drinking water that will be consumed by public. Monitoring methods that exist today tend to give leeway and opportunity to harm people who consume drinking water from refill station. Thus, it is needed an integration between the public as consumer, the government as supervisor on drinking water quality and drinking water refill station (DAMIU) as seller or distributor.

Based on the decree of Health Minister of Republic of Indonesia Number: 907/MENKES/SK/VII/2002 about the terms and condition in monitoring drinking water quality, it is stated that drinking water is the water that has been through processing or no processing which meet the health qualification

and can be drunk directly. Another description about drinking water can also be seen on the Decree of the Minister of Industry and Trade of Republic Indonesia Number: 651/MPP/Kep/10/2004 about the technical requirements of drinking water refill station and its trade. The decision stated that drinking water is raw water that has been processed and can be drink safely. From those understandings, it can be concluded that drinking water is water that can be drunk directly without causing health problems.

AMIU processing flow chart of the raw water reservoir until the water is ready to be packed as shown in Figure 1.

Drinking water refill station is obligated to maintenance the equipment and check the quality of water periodically in purpose of guarantee. Checks can be performed in regional clinical laboratories (Labkesda). Information on the quality of drinking water consumed should be the rights of consumers as well as label on the drinking water packaging.

## RESEARCH METHODS

The development of Information system of e-health quality assurance of drinking water refill was developed with prototyping method. The software was incomplete version, it will be corrected until completely perfect on the next research. Using business process analysis of quality assurance of drinking water refill,

the proposed system is designed using use case diagrams.

## RESULTS AND DISCUSSION

Most of drinking water refill station conducts a quality assurance 2 ways; quality assurance procedures and water quality testing process in the laboratory. From now on there are few of them do the process consistently and periodically.

In the Regression test result as the part of this research showed the one which gives great influence is water treatment processing that has a priority in the improvement of drinking water refill quality.

Results of laboratory examination of the content of bacteriological water refill in the city of Semarang showed that of the 30 samples contained 11 samples were positive for coliform bacteria, 4 samples positive for bacteria colifecal, but all of them are free of the bacteria *Escherichia coli*. Content of coliform bacteria highest 96 / 100ml, whereas bacteria content colifecal is 38/100ml. Highest sample such are found from the location samples the same. Results highest sample which obtained can be diidentikkan with water who not yet processed, because the amount of bacteria content which allowable for water drinking is 0/100ml good for bacteria coliform, colifecal and *Escherichia coli*.

The bacteria test results as evidence of the importance of information quality refill drinking water delivered to consumers. Need

for quality assurance agency for the quality of drinking water refill or for public information center that can be trusted to help consumers know the quality of drinking water is consumed. E-health in this study takes as a medium of public information for service consumers to be aware of the quality of drinking water is consumed.

The Use Case for the prototyping software is in Figure 2. Detail activity of actor can see in Table 1.

For all those activities, it could be designed the database relationship diagram for that system in Figure 3.

Good monitoring systems require a systematic regulation as a policy regarding health standards that can be tolerated. In addition to standard numeric results of laboratory tests are also necessary regulatory policies that monitor the treatment and management of drinking water refill depot set out in government policy such as the design in Figure 4.

Prototype system of e-health as in Figure 5, Figure 6 and Figure 7. Input data for the current security set up form filling data can only be performed by authorized as shown in figure 8.

## CONCLUSION

The information system can gather all of the necessary data to inform all of the public needs about the quality assurance of water refill.

The information system of e-health quality assurance of drinking water refill should be supported by the government to ensure the success of the Indonesian health program.

## REFERENCES

Asfawi, S. 2004. Analisis Faktor yang Berhubungan Dengan Kualitas Bakteriologis Air Minum Isi Minum Ulang Tingkat Produsen di Kota Semarang. Thesis.

Athena. 2009. Kualitas Air Minum dari Depot Air Minum Isi Ulang di Jakarta, Tangerang dan Bekasi. Thesis.

Irtanto, O. 2010. Perbandingan Uji Bakteriologi Air Antara Air Minum Isi Ulang

Dengan Air minum Kemasan di kota Surakarta, Thesis.

Peraturan Menteri Kesehatan Republik Indonesia No. 242/MENKES/PER/IV/2010.

Sitorus. 2009. Analisis Kualitas Air Minum Melalui Proses Ozonisasi, Ultraviolet dan Reserve Osmosis (RO). Jurnal Kimia Mulawarman. Vol.6 No.2

Sulistiyandari. 2009. Faktor-Faktor Yang Berhubungan Dengan Kontaminasi Deterjen Pada Air Minum Isi Ulang di Depot Air Minum Isi Ulang di Kabupaten Kendal. Thesis.

Wahyono. H. D. 1999. Pengembangan Sistem Informasi Teknologi Pengolahan Air. Badan Pengkajian & Penerapan Teknologi. Jakarta

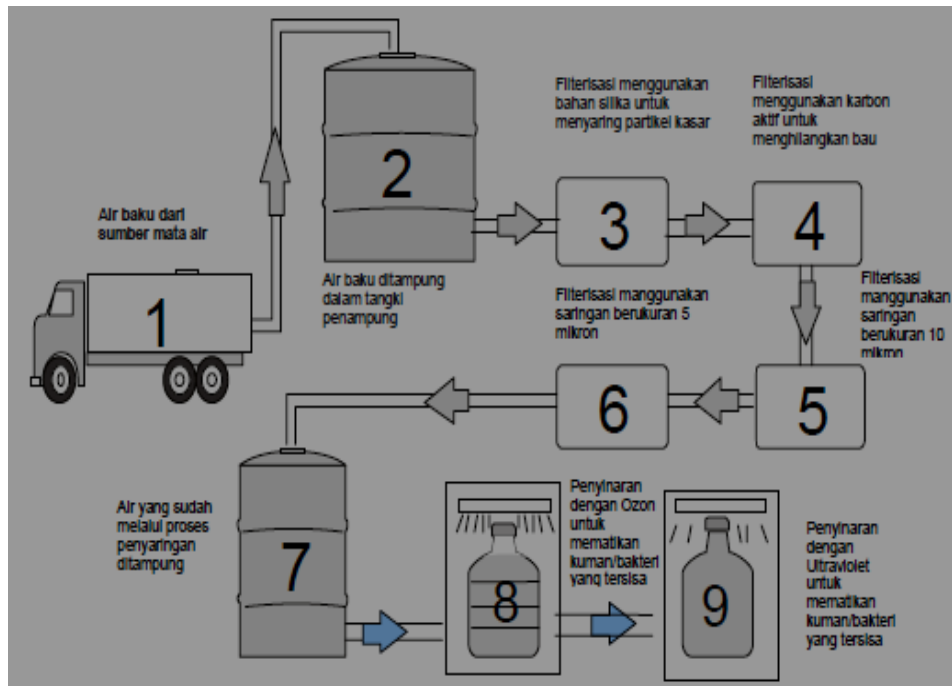

Figure 1 : Flowchart refill drinking water treatment

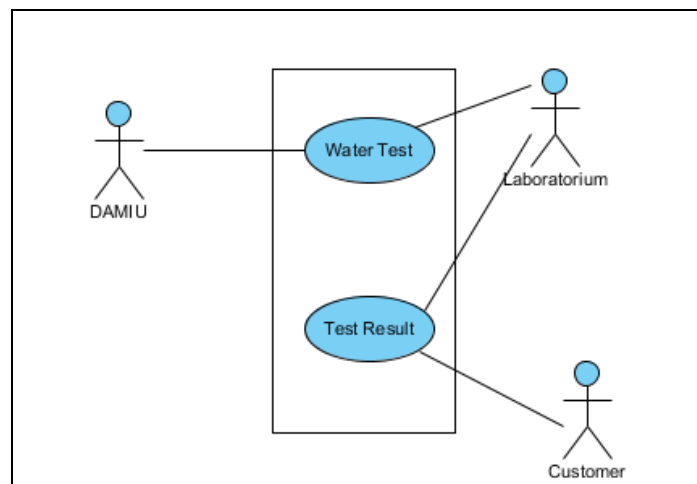

Figure 2 : use case diagram

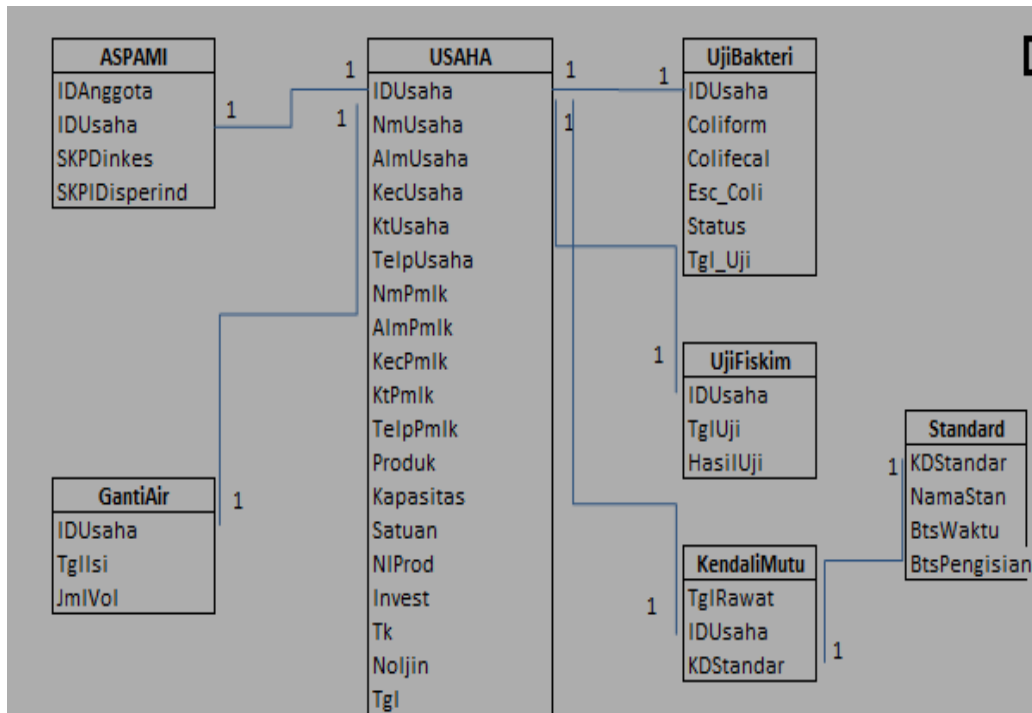

Figure 3 : database design



Figure 4 : e-health system design

The screenshot shows the E-Health System interface for Dian Nuswantoro University. The header includes the system name and navigation links: HOME, SEARCH LOCATION, CONTACT, and ABOUT. A left sidebar contains a menu with 'Dept of Health', 'ASPAMI Association', 'Laboratory', and 'Quality Control Unit'. The main content area is titled 'Add ASPAMI Member List' and contains a form with the following fields: Member ID, Business ID, Decision Letter Number of Dept of Health, and Decision Letter Number of Dept of Trade and Industrial. At the bottom of the form are 'Submit' and 'RESET' buttons.

Figure 5 : design input ASPAMI member

The screenshot shows the E-Health System interface for Dian Nuswantoro University. The header and sidebar are identical to Figure 5. The main content area is titled 'Add Biology Test Record for Member' and contains a form with the following fields: Business ID (pre-filled with 'BSN028172'), Coliform, Colifecal, Esc Coli, Status, and Test Date. At the bottom of the form are 'Submit' and 'RESET' buttons.

Figure 6 : design input biology test

The screenshot shows the E-Health System interface for Dian Nuswantoro University. The header and sidebar are identical to Figure 5. The main content area is titled 'Add Drinking Water STANDARIZATION' and contains a form with the following fields: ID Standarization, Standarization Name, Coliform, Colifecal, Esc Coli, Time Limit, and Time Refuel. At the bottom of the form are 'Submit' and 'RESET' buttons.

Figure 7 : design input drinking water standarization

## **BLUE RATIO: MILLENIUM APPROACH OVER WATER EFFICIENCY MEASUREMENT**

**King Yuwono and Y. Andry Putranto**

Department of Accounting, Faculty of Economics, STIE MUSI, Palembang, Indonesia  
[yuwono.king@ymail.com](mailto:yuwono.king@ymail.com)

### **ABSTRACT**

Water stress is one of the main environmental issue in this millennium era. Water is a vital resources required for human being to stay alive. Twentieth century water resources planning and development relied on projecting future populations, per capita water demand, agricultural production, and levels of economic productivity (Gleick,2000,128).Water efficiency measurement has ever been done in previous researches, most noticeably water accounting and virtual water trading. Water accounting only focus on hydrological aspect meanwhile virtual water trading only focus on how much water is used during producing an agricultural commodity. Thus, combination between these concepts will derive such new concept which is comprehensive. Blue ratio is a new water efficiency measurement concept which is a blend from water accounting and virtual water trading concept. Further, blue ratio can be used to forecast future water supply in such proper perspective. This paper aimed to measure water efficiency through blue ratio, which is derived from a modified physical water flow statement and interpret it to forecast future water supply in Indonesia by one forth of 2012. References study was taken as method for this paper. Secondary data obtained from various sources to manage comprehensive water statement. The result is that Indonesian blue ratio is 1,85 meaning in one forth of 2012, 1,85 liter water asset can be used to cover 1 liter water demand.

**Keywords:** *water efficiency, measurement, blue ratio, water management, millennium approach.*

### **INTRODUCTION**

Water stress is one of the main environmental issue in this millenium era. Water is a vital resources required for human being to stay alive. The availability of fresh water supply is a basic human rights that a government should provide. Twentieth century water resources planning and development relied on projecting future populations, per capita water demand,

agricultural production, and levels of economic productivity ( Gleick, 2000,128).

Depending on the conditions of each users system, non-exclusive definitions of water use efficiency can be achieved simultaneously. In any case, it is clear that efficient water use should be approached in a multi objective, cross-sectional and comprehensive manner. Economic efficiency seeks to derive the maximum economic benefit for the society. Institutional efficiency qualifies the functions of an institution



regarding its water-related tasks. Social efficiency strives to fulfill the needs of the user community. Environmental efficiency looks at natural resource conservation. Finally, technological efficiency refers to the process of finding ways for extracting more valuable products from the same resources (Garduño and Cortés, 1994).

Several studies had ever been done over measuring water efficiency. Most noticeably virtual water trading and water accounting. Virtual water trading concept was brought by Professor John Anthony Allan. Virtual water is the water 'embodied' in a product, not in real sense, but in virtual sense. It refers to the water needed for the production of the product (Haddadin, 2003). Once a country imports several agricultural commodities, there will be a virtual water inflows. Otherwise, when a country exports some, there will be a virtual water outflows.

However, this concept only focus on how much water is used during producing an agricultural commodity. Evaporation level and other losses involved during the process have not been concerned within this concept. Some studies have suggested that the losses to non-beneficial evapotranspiration at the river basin level are between 10–20% of the total supply (Seckler et al., 1998; Molden and Bos, 2005). Thus, evapotranspiration must have been taken into account when measuring such water efficiency.

Meanwhile, water accounting is a concept brought by Sakhadativel and Molden on 1992. Furthermore, this concept then developed and had been taken into account by Australian government through Exposure Drafts Australian Water Accounting Standards I. Here, water treated as an asset not a public goods that can be used anytime with no concern about future availability. This concept focused on hydrological perspective which is quite complex. Economic perspective such trading that brought by virtual water trading concept had not been taken into such account. While as we know, importing and exporting such commodities meaning importing and exporting such water too.

Thus, combination between these concepts will give such comprehensive approach over water efficiency measurement. Efficiency ratio will be derived from modified physical water statement required by Exposure Drafts Australian Water Accounting Standards I. Physical water flow statement will be modified by adding virtual water as an asset. Further, this statement will be called comprehensive water statement. Efficiency ratio derived from the statements will then be called blue ratios. This paper aimed to measure water stress through blue ratio which is derived from "then called" comprehensive water statement and give such interpretations to forecast water supply conditions in Indonesia by one forth of 2012.

## LITERATURE REVIEW

### a. Water Accounting

Water accounting is based on the water balance approach and focused on the hydro-social cycle. The objective is to provide a large amount of data by disaggregating water inflows and outflows per supply source and demand sector, so that specific water accounting indicators can be calculated, as well as more sophisticated estimations of water use efficiency and productivity can be performed (A., G., & A., 2007,251).

This concept first introduced by Sakthivadivel and David Molden on 1992. Then, taken into such account by Australian Government through the making of Exposure Drafts Australian Water Accounting Standards I. This concept so far implemented by water company there. Three general purposed statements must be made, consist of a statement of water assets and water liabilities, a statement of changes in water assets and water liabilities, and a statement of physical water flows.

### b. Virtual Water Trading

Virtual water trading is a concept introduced by Professor Tony Allan. Virtual water is the water 'embodied' in a product, not in real sense, but in virtual sense. It refers to the water needed for the production of the product. Virtual water has also been called 'embedded water' or 'exogenous water', the

latter referring to the fact that import of virtual water into a country means using water that is exogenous to the importing country. Exogenous water is thus to be added to a country's 'indigenous water' (Haddadin, 2003).

For instance, once a country imports commodities to their country, then there is a virtual water inflow to the country. Otherwise, once they export commodities there will be a virtual water outflows. However a lot of researchers arguing this concept claiming its irrelevance and its lack of depth. If there is a small opportunity cost over this decision taken by a government then there mostly be no policy relevance. Then, this concept is seemingly cannot overcome water scarcity problem (Wichelns, 2009,2). However, this concept has built such recognition over water scarcity within its trading scheme.

### c. Current Methods over Water Efficiency Measurement

Current measurement over water efficiency commonly used water efficiency rate. It is commonly intended that achieving water efficiency consists of optimizing water use. Indeed, different points of view should be considered when investigating water use efficiency. Absolute or physical efficiency means using the least possible amount of water for any activities ( Billi, A., et.al, 2007,228).

Economic efficiency seeks to derive the maximum economic benefit for the society. Institutional efficiency qualifies the functions of an institution regarding its water-related tasks. Social efficiency strives to fulfill the needs of the user community. Environmental efficiency looks at natural resource conservation. Finally, technological efficiency refers to the process of finding ways for extracting more valuable products from the same resources (Garduño and Cortés, 1994).

## RESEARCH METHODOLOGY

This paper used references study as a methodology. Simple tabulation will be done to make a comprehensive water statement. Such analysis will be done over the number stated on comprehensive water statement. Blue ratios derived from the statements made, then calculated based on the formula formulated and analyzed to meet the paper goal. The data used in this paper is secondary ones. Several assumptions and modification made to meet Exposure Drafts Australian Water Accounting Standards and virtual water trading criteria.

### Research Result

Several assumptions made to implement comprehensive water statement. Those assumptions are:

1. Surface water resource comes from surface water and rainfall only.

2. Surface water, rainfall and also virtual water has been calculated with representational faithfulness.

3. Agriculture is the only industry in Indonesia.

4. Rice, wheat, and maize are the only commodities traded.

5. There is a characteristic similarity on evaporation pattern and rainfall frequency in every province in Indonesia.

6. There is no beginning asset of water in period.

Comprehensive Water Statement  
From January to March 2012

<b>Water assets increasing</b>		
Rainfall	3071807375000	
Surface water	3906476	
Physical water increasing		3071811281476
Virtual water inflows	4787158050	
Total water increasing	3076598439526	
<b>Water assets decreasing</b>		
Evaporation	1654050125000	
Household consumption	4651696467,6	
Physical water decreasing		1658701821467,6
Virtual water outflows	37197000	
Total water asset decreasing	1658739018467,6	
Net water asset	1417859421058,4	

(In thousand liters)

**Figure 1.** Comprehensive water statement

Blue ratio resulted from a blend concept between water accounting and virtual water trading. Water accounting done by modifying physical water statement formed by Australian Water Accounting Standards Board through Exposure Drafts Australian Water Accounting Standards I. This blend brought a more comprehensive calculation over water efficiency rate. International trading that consist of import and export calculated in this approach as whether an input or output.

Rainfall and surface water classified as an asset for availability certainty that it has. Both happen as an increasing once the inflows happening. Virtual water inflows come from agricultural commodities imported. Commodities itself consist of rice, wheat, and also maize.

**Table 1.** Commodity imported and exported by Indonesia by one forth of 2012

Commodity	Import (tons)	Export (tons)
Rice	770307	102
Wheat	1533701	13312
Maize	450823	21022

Source: BPS, modified

As in Indonesia, the rainfall frequency and surface water source, which is based on the Surface Water Availability on Indonesian River Report made by Indonesian Central of Water Resources Development and Research

made an aggregate 3.071.811.281.476.000 liters physical water assets. This number resulted from the multiplication of 91 days as day span from January to March 2012 and approximate Indonesian area of 5.193.250.000.000 m<sup>2</sup> also 6,5 mm/day rainfall frequency. The importing of rice, wheat and maize on one forth of 2012 as can be seen on table 1 makes an aggregate 4.787.158.050.000 liters virtual water inflow. This number comes from the multiplying between the number of commodities imported and water footprint contained on each commodity. Water footprint contained on each commodity can be seen on table 2 below.

**Table 2.** Water footprint for several agriculture commodities

Commodity	Water footprint (liters)
1 cup of coffee	140
1 litre of milk	1000
1 kg of wheat	1350
1 kg of rice	3000
1 kg of maize	900

Source: Source: UNESCO-IHE - Water Footprint

The sum between physical water outflows and virtual water outflows creates total water outflows of 1.676.950.411.011.200 liters by the end of March 2012. The quarrel between total asset increasing and total asset decreasing resulting total water asset.

Water asset decreasing happens as water source outflow for certain purpose, whether it is intended or not. As can be seen on figure 1 evaporation and household consumption make an aggregate 1.658.701.821.467.600 liters physical water outflows. Household consumption resulted from multiplication of estimated use of 200 liters of water per day, estimated Indonesians of 255.587.718 and 91 days, which is day span from January to March 2012. Meanwhile, evaporation resulted from estimated evaporation level of 3,5mm/day in Java multiplied by 91 days and estimated Indonesian area of 5.193.250.000.000 m<sup>2</sup>. Meanwhile the exporting rice, wheat, and tons of maize cause 37.197.000.000 virtual water outflows.

Within the statement, simply blue ratio can be formulated as below:

$$\text{Blue ratio} = \frac{\text{total water increasing}}{\text{total water decreasing}}$$

A more complex formula formulated as below:

$$\text{Blue ratio} = \frac{\text{Surface water} + \text{rainfall} + \text{virtual water inflows}}{\text{Total usage} + \text{evaporation} + \text{virtual water outflows}}$$

Total water increasing considered as an input because the increasing will either be used or keep to fulfill fresh water demand. Meanwhile, total water asset decreasing considered as output because it is an accumulation of water used. Thus, assuming zero growth on usage, it will be the water that forever will be consumed to meet daily need.

When we apply the number from comprehensive water statement to the formula, the water efficiency rate will be

1,85. This number means in one fourth of 2012, there is 1,85 liter of water available to fulfill a liter of water demand. Assuming any other condition is constant, Indonesian water demand can still be meet with its supply.

## CONCLUSION

This paper aimed to measure water efficiency in Indonesia through blue ratio and give such interpretations to forecast future water supply conditions. Comprehensive water statement is a blend concept between water accounting and virtual water trading. The inflows of surface water source and rainfall result in total physical water asset. Meanwhile importing agricultural commodities result in increasing virtual water asset than when summed with total physical water asset result in total water asset increasing.

Evaporation and household consumption result in decreasing on physical water asset while exporting agricultural commodities result in decreasing water asset. When summed, both of these aspects result in total water asset decreasing. Net water asset comes as a quarrel between total water asset increasing and total water decreasing.

Further, blue ratio calculated as a division between total water asset increasing as an input and total water asset decreasing as an output. Based on the comprehensive water statement made, Indonesian blue ratio is 1,85. This index indicating such a good efficiency, meaning in one fourth of 2012,

1,85 liter of water asset can be used to cover  
1 liter of water demand.

## References

(n.d.).

(2013). Retrieved April 1, 2013, from  
<http://www.antaranews.com>:  
<http://www.antaranews.com/berita/319805/pe-layanan-air-bersih-indonesia-terburuk-asean>

A., B., G., C., & A., Q. (2007). The economics of water efficiency: a review of theories , measurement. *Série B. Etudes et Recherches* , 251.

Gleick, P. H. (2000). The Changing Water Paradigm A Look at twenty-first Century Water Resources Development. *Water International* .

Hatmoko, W., Radhika, Amirwandi, S., Herwindo, W., & Fauzi, M. (2012). *Ketersediaan Air Permukaan*. Kementerian Pekerjaan Umum.

Hoekstra, A. (2008). Globalization of Water.

Indonesian Agriculture Ministry. (2012). *Statistik Makro Sektor Pertanian*. Data Center and Agriculture Information System. Khadafi, R. (2012, October 15).

*KPU: Jumlah penduduk Indonesia 255 juta*. Retrieved April 3, 2013, from [nasional.sindonews.com](http://nasional.sindonews.com):  
<http://nasional.sindonews.com/read/2012/10/15/12/679990/kpu-jumlah-penduduk-indonesia-255-juta>

Australian Bureau of Meteorology. (2010). Exposure Drafts Australian Water Accounting Standards I.

D., M., & Sakthivadivel, R. (1999). Water Accounting to Assess Use and Productivity of Water. *Water Resources Development*, Vol. 15, No. 1-2 , 55-71.

Garduño, H., & Cortés, F. A.-C. (1994). Efficient Water Use. *International Seminar on Efficient Water Use*. Mexico.

*Pelayanan Air Bersih Indonesia Terburuk ASEAN*. (2012, July 4). Retrieved April 3, 2013, from  
<http://www.antaranews.com/berita/319805/pe-layanan-air-bersih-indonesia-terburuk-asean>:  
<http://www.antaranews.com/berita/319805/pe-layanan-air-bersih-indonesia-terburuk-asean>

R., S., Fraiture, C. D., Molden, D. J., Perry, C., & Kloezen, W. (1999). Indicators of Land and Water Productivity in Irrigated Agriculture. *Water Resources Development* vol. 15 .

*The Concepts of Water Footprint and Virtual Water*. (2013, March 29). Retrieved April 2, 2013, from [gdrc.org](http://www.gdrc.org): 1.  
<http://www.gdrc.org/uem/footprints/water-footprint.html>

Wichelns, D. (2009). Virtual Water: A Helpful Perspective, but not a Sufficient Policy Criterion. *Water Resour Manage* , 2.

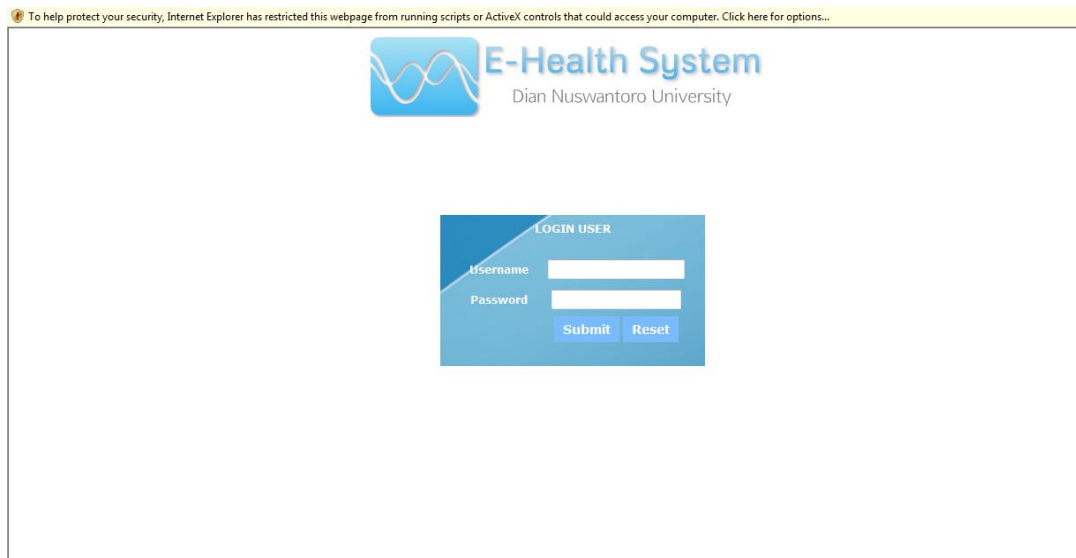

**Figure 9** : design login system

**Table 1: Acticity of use case**

Actor	Activity
DAMIU	Periodically to test the drinking water refill to the laboratory
Laboratorium	Conduct an examination of drinking water refill includes bacteriological test, physical test and chemical test results through the system and inform the public
Customer	Monitoring public information provided by laboratories regarding drinking water quality refill it consumes.

## HANDLING OF HEAVY METALS LIQUID WASTE METAL COATING INDUSTRY WITH MICROBES

**Mardiyono**

Faculty of Pharmacy, Setia Budi University, Indonesia  
[mardiyono.md@gmail.com](mailto:mardiyono.md@gmail.com)

### ABSTRACT

The aim of this study was to reduce/eliminate the content of heavy metals in the liquid waste of metal coating industry using the microbes, such as fungi and bacteria, before those liquid waste were dumped to the free environment water, so that our water avoided from the pollution of heavy metals. First step of this study was begin with the qualitative analysis to ensure the existence of the heavy metals, which is contained in the liquid waste of metal coating industry, with the atomic absorption of spectrophotometry (AAS) method. The existence of the heavy metals in the liquid waste of metal coating industry by observing the metal coating process which using the chemical contains heavy metals. The reduced/removal testing of heavy metals in the liquid waste of metal coating industry is done in the laboratory, by processing those liquid waste by way of adding microbes from fungi, such as *Saccharomyces cerevisiae* and *Rhizopus oryzae*, whereas the bacteria is using *Pseudomonas aeruginosa* and *Bacillus subtilis*. The levels of heavy metals before and after were given preferential treatment by the addition of a small set of the AAS method. After the addition of *Rhizopus oryzae*, *Saccharomyces cerevisiae*, *Pseudomonas aeruginosa*, and *Bacillus subtilis*, with the variations of volume and time of curing by 48 hours (2 days), so that by which is obtained the percentage of decrease in most good for Ni with the addition of *Bacillus subtilis* with a percentage decrease in 15 ml 65,10%, whereas for the Cr with the addition of *Pseudomonas aeruginosa* 20 ml with declining 29.16%.

**Keywords :** *decrease/disappearance, heavy metals, metal plating liquid waste, microbes, AAS*

### INTRODUCTION

The negative impact of metal plating industry is the generation of waste waters containing heavy metals which are toxic. A variety of treatment either in the physical, chemical, or a combination of both has long been used to remove heavy metals from industrial waste. In these days, there is an alternative method of processing industrial waste that is considered more beneficial and safe for the environment

that is the biological wastewater treatment process by using microbes.

According to Octaviani (2005), *Yarrowia lipolytica* are able to live well in media containing ion cadmium (Cd) to 200 ppm. Within 10 hours of incubation on waste containing cadmium, *Yarrowia lipolytica* can absorbed cadmium by 50%. Pamungkas (2006) confirm that *Pseudomonas aeruginosa* can decrease 81,3% of copper (Cu) on metal plating industry liquid wastes.



Mardiyono et al. (2006), has conducted research on the reduction of heavy metal chromium (VI) in liquid waste textile industry with several bacteria, including *Pseudomonas aeruginosa*, *Escherichia coli*, and *Klebsiella pneumonia*. These bacteria can reduce the levels of chromium (VI). Later, Mardiyono et al. (2009) has also found that *Saccharomyces cerevisiae* can decrease the levels of chromium (VI) in liquid waste textile industry.

The aim of this study is to reduce the level of heavy metals in the metal plating industrial waste by utilizing microbes of bacteria and fungi before coating metals waste water discharged into waterways.

## MATERIAL AND METHODS

### A. Instrument

This research used several instrument, such as Atomic Absorption Spectrophotometer (AAS), Erlenmeyer 100 ml and 250 ml, 25 ml measuring pipette, volumetric flask 100 ml and 500 ml, glass funnel, electric heating, 40 Whatman filter paper with a pore size of 0.42  $\mu\text{m}$  diameter, centrifuges, pumpkin spray, 10 liter jerrycans, plastic bottles, entkas, vial.

### B. Material

The material used in this study including the microbial preparations of *Saccharomyces cerevisiae*, *Rhizopus oryzae*, *Pseudomonas aeruginosa*, *Bacillus subtilis*; distilled water,

aquabidest, HBI media, metal plating industry wastewater,  $\text{HNO}_3$  (concentrated), standard solution of chrome and nickel, and acetylene gas ( $\text{C}_2\text{H}_2$ ).

### C. Research Procedures

#### 1. Sampling

Industrial metal plating waste water samples taken from the outlet of waste disposal in Mojosoongo, Jebres, Surakarta, Central Java.

- a. The making of heavy metals main solution (Cr, Ni) 1000 mg / L

Heavy metals powders carefully weighed as much as 0.5 g and inserted into the 500 ml pumpkin flask, dissolved with 2 ml of concentrated  $\text{HNO}_3$  and aquabidestilata is added to the limit.

- b. Preparation of heavy metals standard solution (Cr, Ni) 10 mg / L

The main solution of heavy metals is pipetted as much as 5 ml and inserted into the 500 ml pumpkin flask, then add aquabidestilata to the limit.

- c. Preparation of working solution of heavy metal

Heavy metals solution are pipetted as much as 1 ml; 2 ml; 5 ml; 10 ml; and 20 ml of the standard solution, and then inserted into 100 ml pumpkin flask, and the aquabidestilata to the limit in order to obtain the metal cadmium concentration

of 0,1mg/L ; 0,2 mg/L ; 0,5 mg/L ; 1,0 mg/L dan 2,5 mg/L.

d. Procedures and the making of calibration curves

Atomic Absorption Spectrophotometer (AAS) is optimized in accordance with the instructions, then the standard solution is prepared one by one into the AAS, then note its absorbance at the wavelength corresponding to the maximum of each heavy metal, further created calibration curve to obtain the equation of regression lines between concentration and absorbance.

e. Initial test sample preparation

Initial sample test mixed until homogen and inserted into Erlenmeyer as much as 200 ml, then added HNO<sub>3</sub> concentration as much as 5 ml and heated until almost dry, afterwards added aquabidestilata as much as 50 ml and inserted into 100 ml volumetric flask through a filter paper and matched with 100 ml aquabidestilata.

f. Making suspension of bacteria and fungi test

Bacterial and fungi testing pure cultures on each medium were taken 2-3 ose put in 100 ml of BHI medium, and then incubated at 37<sup>0</sup>C for 24 hours.

g. Provision of bacteria and fungi in the test sample

200 ml sample is inserted into the bottle. Each was given preferential treatment by the addition of bacterial and fungal test as much as (ml): 0.0; 1.0; 5.0; 10.0; 15.0 and 20.0 and incubated for 3

x 24 h, pH 7.4 ± 0.2 at room temperature and then set back the levels of metals weighed.

h. The test samples without the addition of bacteria and fungi test

As many as 200 ml early sample is inserted into bottle and incubated at room temperature for 3 x 24 hours. Samples that have been incubated then centrifuged with a speed of 2000 rpm for 10 minutes and then added as much as 5 ml of concentration HNO<sub>3</sub> and this sample solution test is heated until almost dry, plus as many as 50 ml of aquabidestilata inserted into 100 ml pumpkin flask through Whatman filter paper and matched 100 ml with aquabidestilata. The test solution is then transferred into the vial. This solution test is ready to be tested by using Atomic Absorption Spectrophotometry.

i. Testing after an incubation period

Incubated samples were centrifuged at 2000 rpm for 10 minutes and filtered with Whatman paper and then added as much as 5 ml HNO<sub>3</sub> and then heated in an electric heater until almost dry . Later, add 50 ml of distilled water, then put in a 100 ml flask through the filter paper and matched 100 ml with distilled water. Finally, the solution is ready to be tested by using Atomic Absorption Spectrophotometer.

## RESULTS AND DISCUSSION

### A. Results

The percentage decrease in the concentration of Ni with various microbes can be seen in the graphic below.

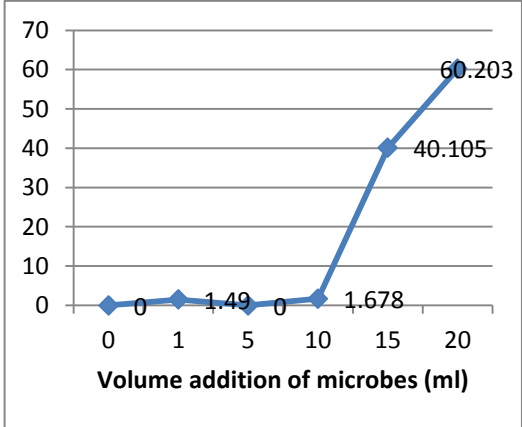

**Graph 1.** Percentage decrease in Ni concentration with *Pseudomonas aeruginosa*

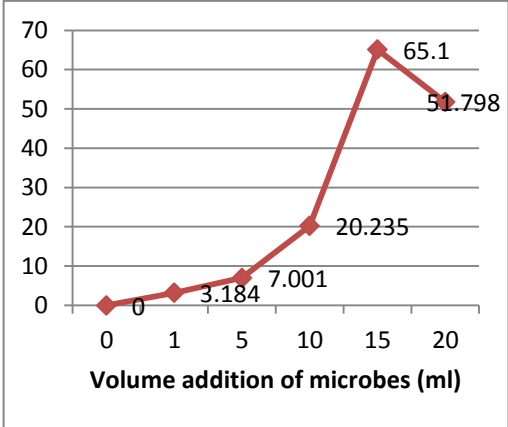

**Graph 2.** Percentage decrease in Ni concentration with *Bacillus subtilis*

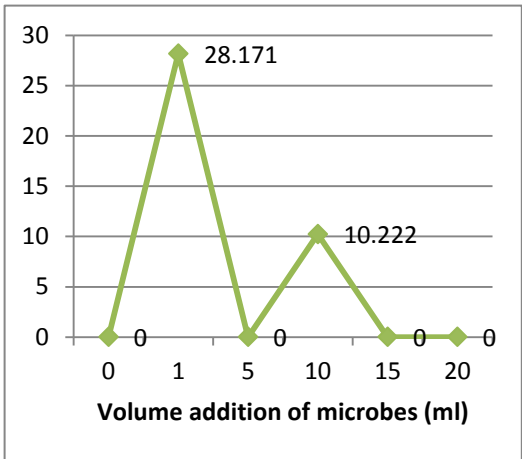

**Graph 3.** Percentage decrease in Ni concentration with *Rhizopus oryzae*

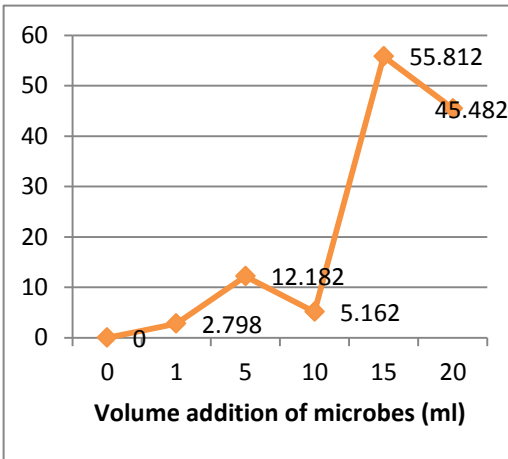

**Graph 4.** Percentage decrease in Ni concentration with *Saccharomyces cerevisiae*

Meanwhile, the percentage decrease in the concentration of Cr with various microbes can be seen in the image below.

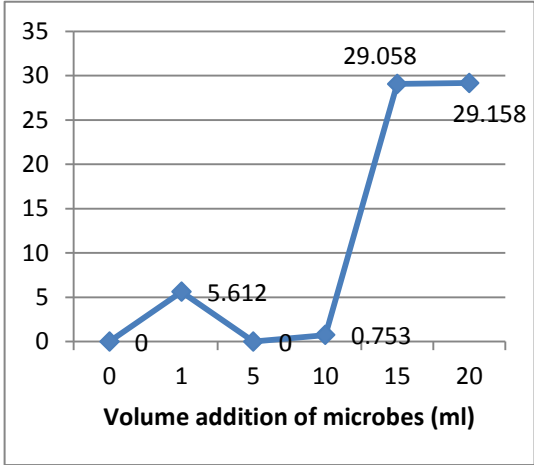

**Graph 5.**  
Percentage decrease in Cr concentration with *Pseudomonas aeruginosa*

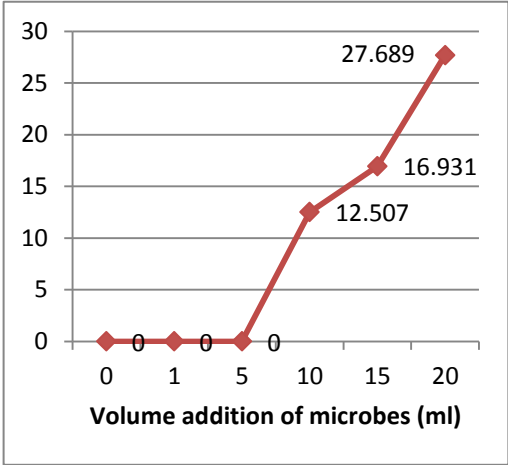

**Graph 6.**  
Percentage decrease in Cr concentration with *Bacillus subtilis*

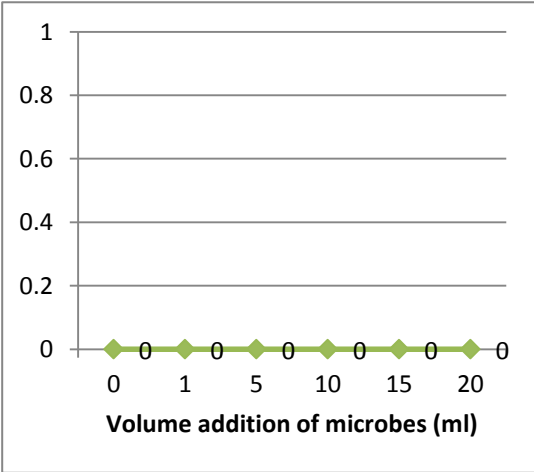

**Graph 7.**  
Percentage decrease in Cr concentration with *Rhizopus oryzae*

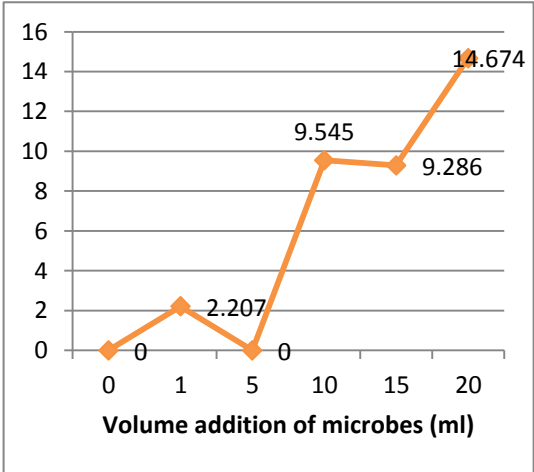

**Graph 8.**  
Percentage decrease in Cr concentration with *Saccharomyces cerevisiae*

B. Discussion

1. Analysis of Heavy Metal Ni

Hypothesis is tested using the two-way ANOVA, because the concentration of Ni is influenced by two factors, such as the volume

addition of microbes and types of microbes. When the value of significance (sig.) is smaller than 0.05, we conclude that there is a significant difference on Ni concentration. Results of the analysis are presented as follows.

**Table 1.** Results Analysis of Two-Way ANOVA Ni

Source	Type III Sum of Squares	df	Mean Square	F	Sig.
Corrected Model	7.565 <sup>a</sup>	23	.329	471.655	.000
Intercept	42.752	1	42.752	61307.711	.000
MIKROBA	3.648	3	1.216	1743.868	.000
VOLUME	2.184	5	.437	626.249	.000
MIKROBA*VOLUM	1.733	15	.116	165.681	.000
Error	.033	48	.001		
Total	50.350	72			
Corrected Total	7.598	71			

a. R Squared = .996 (Adjusted R Squared = .993)

On volume addition of microbes, the significance value is 0.000. This value is smaller than 0.05, it can be concluded that there are significance differences in the concentration of Ni. On the interaction between microbes and microbial volume used (written Mikroba \*

Volume) visible significance value is 0.000. This value is smaller than 0.05, it can be concluded that there is significant interaction between microbes and microbial volumes used were studied.

**Table 2.** Levene's Test results of Ni  
**Levene's Test of Equality of Error Variances<sup>a</sup>**  
 Dependent Variable: KONSENTRASI

F	df1	df2	Sig.
2.258	23	48	.009

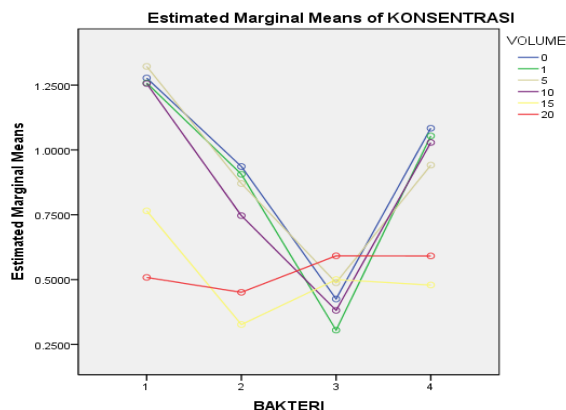

**Graph 9.** Ni levels with microbial Volume Variation

## 2. Analysis of heavy metals chromium (Cr)

Same as the heavy metals Ni, hypothesis is tested using the two-way ANOVA. When the value of significance (sig.) is smaller than 0.05,

we conclude that there is a significant difference on Cr concentration. Results of the analysis are presented as follows.

**Table 3.** Results Analysis of Two-Way ANOVA Cr

Source	Type III Sum of Squares	df	Mean Square	F	Sig.
Corrected Model	10.931 <sup>a</sup>	23	.475	272.465	.000
Intercept	419.057	1	419.057	240249.519	.000
MIKROBA1	6.138	3	2.046	1173.027	.000
VOLUME1	3.100	5	.620	355.419	.000
MIKROBA1 * VOLUME1	1.693	15	.113	64.702	.000
Error	.084	48	.002		
Total	430.071	72			
Corrected Total	11.014	71			

a. R Squared = .992 (Adjusted R Squared = .989)

On volume addition of microbes, the significance value is 0.000. This value is smaller than 0.05, it can be concluded that there are significance differences in the concentration of Cr. On the interaction between microbes and microbial volume used (written Mikropa \*

Volume) visible significance value is 0.000. This value is smaller than 0.05, it can be concluded that there is significant interaction between microbes and microbial volumes used were studied.

**Table 4.** Levene's Test results of Cr

**Levene's Test of Equality of Error Variances<sup>a</sup>**

Dependent Variable:KONSENTRASI1

Tabel Dependent Variable:KONSENTRASI1

F	df1	df2	Sig.
2.294	23	48	.008

Advanced test results for Cr concentration and volume of microbial microbial factors indicate that there is a significant difference between the

volume and the addition of microbes to reduce levels of microbial Cr concentration. The result can be seen in the following graph.

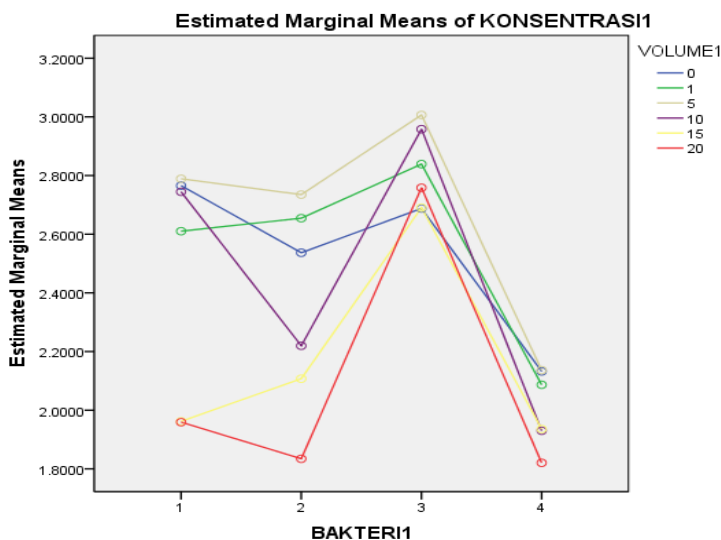

**Graph 10.** Cr levels with microbial Volume Variation

## CONCLUSIONS

## RECOMMENDATIONS

### A. Conclusion

1. The sample of metal plating industry waste water in Mojosongo X, Jebres, Surakarta contains heavy metals nickel (Ni) and chromium (Cr).
2. After the addition of *Saccharomyces cerevisiae*, *Rhizopus oryzae*, *Pseudomonas aeruginosa*, and *Bacillus subtilis*, with variations in volume 0 ml, 1 ml, 5 ml, 10 ml, 15 ml, 20 ml and 72 hours curing time (3 days), we concluded that the percentage decrease is best for Ni with the addition of 15 ml of *Bacillus subtilis* and the percentage of this decline 65.10 %. While for Cr, the addition of 20 ml *Pseudomonas aeruginosa* decents the Cr level up to 29.16%.

### B. Recommendation

1. Further research is needed with the application of these results to the industries that emit waste

## AND

containing heavy metals such as Ni, Cr and other heavy metals.

2. Futher reseach also needed to design and create a model of simple Waste Water Treatment Plant (WWTP) that can be lowered / eliminate the concentration of heavy metals in the industry that produces liquid waste containing heavy metals by utilizing eco-friendly microbes.
3. The government are expected to establish the policies for environmental management in accordance with industry and local conditions, so that the environment is not polluted by the results of industrial wastewater containing metal coating especially heavy metals.

## ACKNOWLEDGEMENTS

The present work was conducted by means of financial support from Kopertis VI Region Ministry of Education and Culture, which has funded the implementation of the study in accordance with the Implementation Agreement

Contract Research Competitive Grant Number:  
019/006.2/PP/SP/2012.

Setyaningsih. 2002. Kajian tentang Kemampuan Saccharomyces cerevisiae dalam Mendegradasi Warna Limbah Cair Industri Tekstil Surakarta. UNS Press. Surakarta.

## REFERENCES

Anonim. 2009. *UU RI No. 32/2009 tentang Pedoman Pengelolaan Lingkungan Hidup*. Kementrian Negara Lingkungan Hidup.

Anonim. 2008. *Bacillus subtilis* *The Free Encyclopedia*. <http://google.com>.

Adiyani, N. O. 2006. *Penurunan Kadar Ni Menggunakan Pseudomonas aeruginosa dalam Limbah Cair Industri Lapisan Logam*. Universitas Setia Budi Surakarta.

Departemen Perindustrian. 1989. Standar Nasional Indonesia-19-1132. *Cara Uji Kadar Krom dalam Air*.

Mardiyono, Nony Puspawati, Nur Hidayati. 2006. Penurunan Kadar Logam Berat Krom(VI) dengan *Pseudomonas sp*, *Klebsiella sp*, dan *Escherichia sp* pada Limbah Cair Industri Tekstil. *Jurnal Farmasi Indonesia*. Volume 3, No. 1, Februari 2006.

Mardiyono, Nony Puspawati, Nur Hidayati. 2009. Aplikasi Mikroba *Saccharomyces cerevisiae* dalam Mereduksi Kadar Logam Berat Krom(VI) pada Limbah Cair Industri Tekstil. *Jurnal Biomedika*. Volume 1, No. 2, September 2009.

Nanang Besmanto, Endang Sutariningsih Soetarto, Sri Widodo. 2003. *Detoksifikasi Krom Limbah Cair Penyamakan Kulit oleh Pseudomonas sp*. *Jurnal Teknosains*. 16 (2).313-328

Octaviani, Artanti M. 2005. *Biosorpsi Logam Kadmium Menggunakan Ragi Yarrowia lipolytica strain H.222*. *Skripsi*. Jurusan Kimia Universitas Negeri Yogyakarta.



# METALS CONTAMINATION IN AQUACULTURE PONDS OF SEMARANG-INDONESIA: FOOD SAFETY CONSIDERATION

**Bernadeta Soedarini**

Department of Food Technology, Soegijapranata Catholic University, Semarang, Indonesia  
[bsoedarini@gmail.com](mailto:bsoedarini@gmail.com)

## ABSTRACT

Semarang is one of the largest coastal cities in Indonesia with good resources for aquaculture. The rapid residential growth, industrial expansion and agricultural intensification in the hilly area of Semarang have contributed to increasing metal pollution in the Semarang rivers and coastal areas. In this study, we examined the metal concentrations of pond sediments along the Semarang coastline. Sediment samples were taken from ten aquaculture ponds in spring 2009. Copper concentrations at several sites were found to be up to twice the local background concentration, which is approximately 40- $\mu\text{g/g}$  dry weight. Some sites close to the intercity highway and the Semarang harbor were polluted by lead. According to Sediment Quality Guidelines (SQGs) applied in Australia and New Zealand, Hong Kong and the Netherlands, Semarang coastal pond sediments were categorized to be *mid-range (medium range) contaminated*. Natural erosion of Mount Ungaran flowing down through the rivers and canals and the use of copper-based chemicals in manufacturing industries, agriculture, fisheries and household wastes are possible sources of anthropogenic copper. Lead most likely originated from automobile exhaust. Considering concentrations of other trace metals (Cr and Ni) also were increased in some sites, food safety consideration should be taken into account. Possible consequence for seafood safety is further discussed in this paper.

**Keywords:** *metals, aquaculture pond, Semarang, SQGs, background concentration*

## INTRODUCTION

Increasing industrial activities, large population density and agricultural intensification always raise the level of anthropogenic pollutants. Coastal areas could be the most affected places among potential polluted sites, as pollutants in any water will end up in the coastal areas and the sea. Since coastal areas are used for growing several edible species, pollution may affect these organisms. The effects of pollution may not only include reduction of the productivity. Also the bioaccumulation of pollutants in animal organs, especially in the edible parts,

will have consequences for food quality and food safety.

Metals are known anthropogenic pollutants, which tend to be persistent in the environment and cause bioaccumulation problems in many organisms (Luoma and Rainbow, 2008). The *Itay-itay* disease, which occurred in the Toyama Prefecture in Japan in 1950, is an example of dramatic metal (Cadmium) poisoning via seafood consumption (Inaba *et al.*, 2005). Another example is Minamata disease caused by mercury-contaminated fish eaten by Japanese fishermen and their families around the Minamata bay in 1950s (Takeuchi,

*et al.*, 1962). There are many more, less dramatic, examples of metal bioaccumulation in seafood (Pourang, 1995; Malm *et al.*, 1995; Madany *et al.*, 1995) that exceed the legal safety limits defined by FAO (Nauen, 1983) and ANHMRC (Maher, 1985).

Aquaculture plays an important role for the economy of Indonesia. Referring to the state of aquaculture issued by FAO (2006), Indonesia takes the sixth position among the top ten aquaculture producers in the world. Indonesian aquaculture products are essential not only for the local food supply but also for export. Considering that aquaculture products are traded as a food commodity, quality and safety are important considerations. Not only pathogenic microorganisms but also chemical contaminants, such as persistent organic pollutants and potentially toxic metals, are major concerns for seafood safety in that they may pose a risk to consumer health.

Semarang is one of the coastal cities of Indonesia, which has good resources for aquaculture. About 42% of the Semarang coastline is utilized for aquaculture. Milk fish (*Chanos chanos*) and tiger prawn (*Penaeus monodon*) are the two favorite seafood commodities cultured in the coastal ponds. With the city's increasing activities, metal pollution is also increasing as was already found in the rivers of Semarang urban area some 10 years ago (Widianarko *et al.*, 2000a; Widianarko *et al.*, 2000b; Takarina *et al.*, 2004). Metal contamination in the aquaculture ponds of the Semarang coast line is therefore

of concern, but so far there are no data available on metal concentrations in these ponds.

The objectives of the present study were (1) to determine physical characteristics and metal concentrations in the Semarang coastal pond sediments, (2) to compare the metal concentrations found in the sediments with the local background concentration and internationally accepted Sediment Quality Guidelines, and (3) to provide information on the possible sources of the metals and their potential risk for food quality and safety.

## METHODS

### 1. Study Area

Semarang, the capital city of the province of Central Java, is the fifth largest city of Indonesia. It is located at South Latitude 6°56'08'' to 7°06'57'' and East Longitude 110°16'17'' to 110°30'31'' (Marfai and King, 2008). The city has a special geography, consisting of a hilly area to the South and a coastal lowland area to the North. The Semarang municipality covers an area of about 373.7 km<sup>2</sup> in which the northern parts are adjacent to the Java coast line (Lubis, *et al.*, 2011). Semarang is situated in a tropical region and has a tropical climate with alternating rainy and dry seasons. The annual rainfall is about 2065–2460 mm with maximum rainfall in December and January (Marfai and King, 2008). The climate generally is hot with temperatures between 24°C and 30°C, and an average annual

temperature of 28.4°C. Two rivers from the Mount Ungaran run through the city, one on the east side (East Canal) and one through the west side (West Canal).

The Semarang coastal area was originally fringed with mangrove forests, but is now highly developed for multi-use purposes, including major industrial sites, fisheries, and a harbor. The land use pattern and physical environment in Semarang are uncontrolled and changing rapidly neglecting the environmental carrying capacity both in the upland and in the lowland area. The average population density of Semarang has reached 1,010 people per square kilometer. Agricultural is intensifying as well as industrial activity. The number of industrial enterprises has reached 4,678 units in Central Java (Central Java Province Statistical Central Bureau, 2009).

## 2. Sampling schedule

The sampling locations, marked with “blue dots” in Figure 1, are aquaculture areas along the Semarang coast line. The sampling sites fall under the influence of different rivers and canals, with different levels of human interference and a variable degree of exposure to metal contamination. Surface sediment (5-10 cm) samples were collected using a plastic grab sampler at ten locations during the late rainy season, February through March 2009. The water level in the ponds varied from 50 to 150 cm at the time of sampling. In each pond three samples were taken, consisting of about 2 kg of wet sediment. The wet material was stored in 5-L plastic bags, sieved in the

laboratory and the fraction passing through a diameter size of 5 mm was dried at 105°C for 48 hours. Before extraction, the dried material was ground using a porcelain mortar and again sieved through a plastic sieve with diameter size of 0.5 mm. The fine dried sediments were stored in a plastic bag under dry conditions until chemical analysis.

## 3. Metal analysis

Dried homogenized sediment samples of 100 mg were digested in 2.0 ml of a mixture of HNO<sub>3</sub> (Sigma-Aldrich, 65%) and HCl (Riedel-de-Haën, 37%) in a ratio of 4:1, in closed teflon bombs placed in an oven with a constant temperature of 140°C for 7 hours. The digests were diluted with milli-Q water to a volume 10 ml and analyzed for seven different metals (Cd, Cr, Cu, Fe, Ni, Pb and Zn) by flame atomic absorption spectrophotometry (Perkin-Elmer AAnalyst 100). Quality control of the analyses was maintained by digesting certified reference material ISE 989. The recoveries of the different metals in the reference material were 103-108% of the certified reference values.

## 4. Sediment characterization

To determine pH, 5.0 g sediment was shaken with 25 mL 0.01 M CaCl<sub>2</sub> for 2 hours at 200 rpm. The pH was then measured using a Consort P907 pH meter. Organic matter content was determined as the Loss on Ignition (%LoI). The weight difference before and after burning sediment for 6 hours at 500 °C was the amount of organic matter. The Cation

Exchange Capacity (CEC) is determined using the silver thiourea method (Dohrmann, 2006) with some modifications. Principally, all positive ions bound to negatively charged colloid surfaces, mineral and organic alike compounds are replaced by the strong affinity monovalent silver thiourea complex (AgTU) cation. The dried sediment was constantly mixed with a 0.01M AgTU solution in Milli-Q water under end-over-end shaking for 4 hours, followed by centrifugation (MSE Falcon 6/300, UK) for 15 minutes at 3000 rpm. The supernatants of samples and blanks were diluted 100 times and the concentration of silver was measured by flame atomic absorption spectrophotometry (Perkin-Elmer AAnalyst 100). Quality control of the analysis was maintained by determining CEC of the LUFA 2.2 standard soil (Speyer, Germany). The CEC measured in Lufa 2.2 soil was 70-77% of the certified value.

## 5. Statistical analysis

All computations were done using the statistical software package SPSS 16.00. Comparisons between metal concentrations in the sediments from different sites were done by analysis of variance (one way ANOVA) with probability of 95% followed by Tukey's post-hoc test. The possible relationship between different metals was pair-wise estimated by determining Pearson correlation.

## RESULTS AND DISCUSSION

### 1. Physicochemical characteristics of sediments

The pH, organic matter content and CEC of the ten sampling sites are shown in Table 1. All sediments were slightly basic with pH-CaCl<sub>2</sub> ranging from 7.4 to 8.1. Such characteristics are typical, as normal pH of surface water (including seawater) is neutral to basic. The high pH may, however, also be a consequence of lime application. In ponds constructed in mangrove areas, oxidation of pyrite causes release of acid sulfate, and liming is applied to neutralize the acid (Gräslund and Bengtsson, 2001). All sediments contained relatively high organic matter contents (>4%), which are considered normal as the sampling sites were located in estuarine areas with mangroves growing on some sites. Sediments had fairly high CEC levels, which were similar to values of soils along the Semarang coast line. CEC often is correlated with organic matter, clay and silt contents (Asadu *et al.*, 1997).

### 2. Metal concentrations

Metal concentrations found in the aquaculture pond sediments that higher than the local background concentrations are presented in Figure 2. Concentrations of cadmium in all samples were below the detection limit (0.03 µg/g). Zinc, nickel and iron concentrations varied among the locations but were considered low. Widianarko *et al.* (2000a) proposed local background concentrations of Cu, Pb and Zn for Semarang coastal area of 40.7 µg/g, 25.6 µg/g and 132 µg/g, respectively. Only copper levels in all samples exceeded the local background concentration. In three sampling sites located close to

Beringin River, East Canal-1 and Siangker River, copper concentrations were 178% to 181% the local background concentration, suggesting pollution due to anthropogenic activities. Lead concentrations in sediments taken from East Canal-1 ( $112 \pm 14.7 \mu\text{g/g}$ ) and East Canal-2 ( $81.3 \pm 30.2 \mu\text{g/g}$ ) were significantly higher compared to the other locations (Tukey's post-hoc test;  $p < 0.05$ ). Lead most likely originated from automobile exhaust since both sites are located less than 50 meters away from the intercity highway (Jalan Arteri Utara) and around 2 km from the Semarang harbor.

### 3. Possible sources of the anthropogenic copper

Metals contamination of aquaculture ponds can be unintentional and sometimes even unavoidable due to water quality problems (Gräslund and Bengtsson, 2001). Boyd (1990) cited by Yang *et al.* (2007) stated that copper pollution often results from copper sulfate. Copper sulfate is the most commonly used algacide, normally applied in the aquatic farming of fish, mollusks, crustaceans and aquatic plants. Copper sulfate application is the only algal control method for shrimp ponds recommended by FAO (GESAMP, 1997).  $\text{CuSO}_4 \cdot 5\text{H}_2\text{O}$  is known as an effective, relatively inexpensive algacide, which is also useful as an anti-parasitic agent (Watson and Yanong, 2006). Considering that waters along the north coast of Central Java normally are turbid and eutrophic (Takarina *et al.*, 2004), fish farmers in Semarang coastal ponds may be expected to use the copper-based algacides

to control water quality and to combat parasites.

Copper is an essential mineral for animals and plants, so it is commonly used for fortification in the food and feed manufacturing industry. Copper contaminated waste water may be produced by food factories in Semarang - including among others for the production of noodles, biscuits and bakery products, dairy products, candy and frying oil. Also these processes may contribute to the anthropogenic copper pollution of rivers and canals.

Copper is also known as antifouling agent for boats (Warnken *et al.*, 2004) and often used as wood-preserved (Freeman and McIntyre, 2008) in plywood and furniture. Semarang harbour (Tanjung Mas) is a trade port where many ferries and boats often lie at anchor for several days. Considering the local government did not ban copper-based antifouling yet, relatively high copper concentrations may be found in the port area. Furthermore, a large plywood factory is operating in Semarang together with many small-scale furniture producers, which may use copper-based wood preservatives. These activities may also contribute the increasing anthropogenic copper levels.

Application of copper-based dyes in Semarang textile and porcelain industries can be another source of anthropogenic copper pollution. Copper-based dye for textile, paints, porcelain and even the cosmetic industry has been patented in the US (United State Patent, 1987).

In developing countries, including Indonesia, 70% of the industrial waste is dumped untreated into water bodies (WWAP, 2000). As any effluent discharged into the environment eventually finds its way to a river, pond or sea, aquatic animals may be most vulnerable to the toxic effects of pollutants. Considering that some aquatic animals are consumed and traded as food, pollution in the aquaculture ponds may eventually also pose a risk to human health.

#### **4. Hazard potency of copper to seafood quality and safety**

Metal concentrations found in sediment are not necessarily available for organisms. Physical and chemical characteristics of the sediments, like organic matter content, chelating agents, humic substances, ligands, pH and metal interactions may influence the bioavailability of metals in sediment (Simpson *et al.*, 2004; Luoma & Rainbow, 2008). Metal bioavailability can affect living organisms via bioaccumulation and biomagnifications processes. Some aquatic species are very sensitive to pollutants, so they can be applied as bioindicators for environmental quality assessment and monitoring (Widianarko, *et al.*, 2000b; Klkylođlu, 2004; Storelli & Marcotrigiano, 2004). Such indicators could show metal bioaccumulation, like found for grey mullets published by Chen & Chen (1999).

Copper is an essential trace metal, which has a role in blood component formation (hematopoietic) and in numerous Cu-

dependent enzymes of crustaceans (Lee and Shiau, 2002). Although copper is essential, it is required only in small doses for metabolic functions. At a certain level, copper can be toxic to organisms depending on several biotic factors, including among others species-specific tolerance, size and life stage (Wang, 1987; Luoma & Rainbow, 2008). In addition, at increased exposure levels, copper levels in organisms may increase, leading to a possible risk for their consumers.

Elevating awareness on seafood safety in the global society is quite logical as seafood consumption per capita has increased remarkably over the last two decades (Einarsson & Emerson, 2009). Evidence of copper-contaminated seafood products sold in the local markets has been reported by several authors from various countries (Maher, 1985; Han, *et al.*, 1994; Hashmi *et al.*, 2002; Canli & Atli, 2003; Pourang *et al.*, 2005; Mishra *et al.*, 2007; Sivaperumal *et al.*, 2007). The European Copper Institute proposed a legal limit of copper in foodstuff of 5 mg/kg wet basis (Van Lysebetten *et al.*, 2010). The World Health Organization (WHO) and the Food and Agricultural Administration (FAA) suggest the intake of copper should not exceed 12 mg/day for adult males and 10 mg/day for adult females. Some clinical features of copper toxicity include among others, fatigue, depression, headaches, cold extremities, lack of concentration and poor memory (Nolan, 1983).

Although there is evidence that copper may accumulate in seafood products, it still is uncertain whether the increase concentrations found in Semarang coastal pond sediments indeed to pose a risk for seafood quality and safety. The fact that also other metals, like Cr and Ni, show increased sediment concentrations asks for further research to assess the risk for seafood consumers and therefore for human health.

## CONCLUSIONS

1. Compared to the SQG values for copper and lead, Semarang coastal ponds sediments are categorized as *mid-range* contaminated. In addition to copper and lead, also nickel and chromium at some sites show elevated sediment concentrations.
2. Metal pollution in Semarang coastal pond sediments can at least partly be attributed to anthropogenic input.
3. The pond sediments along the Semarang coast line are slightly basic, relatively high in organic matter contents, and have fairly high CEC values. As a consequence, metal bioavailability may be reduced.
4. Nevertheless, copper and lead contamination in Semarang coastal ponds may threaten local aquaculture practices and may pose a risk for the quality and safety of seafood products.

## ACKNOWLEDGEMENTS

My sincere gratitude to my promoters: Prof. NM. Van Straalen, Dr. CAM. Van Gestel and Prof. B. Widianarko for their wonderful support throughout the years of my study in the Vrije Universiteit, Amsterdam – the Netherlands. I highly appreciate Mr. Felix Soleh Khuntoro and Mr. Rudo Verweij for the field and laboratory works supports. The study was fully supported by the Directorate General of Higher Education, Indonesia.

## REFERENCES

- Asadu, C.L.A; Diels, J; Vanlauwe, B. (1997). A comparison of contributions of clay, silt, and organic matter to the effective CEC of soils of Subsaharan Africa. *Soil Science* 162, 785-794.
- Canli, M; Atli, G. (2003). The relationships between heavy metal (Cd, Cr, Cu, Fe, Pb, Zn) levels and the size of six Mediterranean fish species. *Environmental Pollution* 121, 129-136.
- Central Java Province Statistical Central Bureau (2009). <http://jateng.bps.go.id/2006/index06.html>. Consulted on March 2011 (in Indonesian language)
- Chapman. P.M; Allard, P.J; Vigers, G.A. (1999). Development of sediment quality values for Hong Kong administrative region: a possible model for other jurisdictions. *Marine Pollution Bulletin* 38, 161-169.
- Chen, M.H; Chen, C.Y. (1999). Bioaccumulation of sediment bound-heavy metals in Grey Mullet (*Liza macrolepis*). *Marine Pollution Bulletin* 39, 239-244.
- Crommentuijn, T; Sijm, D; de Bruijn, J; van den Hoop, M; van Leeuwen, K; van de Plassche, E. (2000). Maximum permissible and negligible concentrations for metals and metalloids in the Netherlands, taking into account background concentration. *Journal of Environmental Management* 60, 121-143.

- Dohrmann, R. (2006). Cation exchange capacity methodology II: a modified silver-thiourea method. *Applied Clay Science* 34, 38-46.
- Einarsson, H; Emerson, W. (2009). International seafood trade: challenges and opportunities. Food and Agriculture Organization of the United Nations. Rome. Italy.
- FAO, 1998. Integrated coastal area management and agriculture, forestry and fisheries. Food and Agriculture Organization of the United Nations. Rome.
- FAO, 2006. State of world aquaculture. Food and Agriculture Organization of the United Nations. Rome. Italy.
- Freeman, M.H; McIntyre, C.R. (2008). A comprehensive review of copper-based wood preservative. *Forest Product Journal* 58, 4-22.
- Garver, J.I; Royce, P.R; Smick, T.A. (1996). Chromium and Nickel in shale of the taconic foreland: a case study for the provenance of fine-grained sediments with an ultramafic source. *Journal of Sedimentary Research* 6, 100-106.
- GESAMP (1997). Towards safe and effective use of chemicals in coastal aquaculture. IMO / FAO / Unesco / WMO / WHO / IAEA / UN / UNEP Joint Group of Experts on the Scientific Aspects of Marine Pollution. Report and studies no. 65.
- Gräslund, S; Bengtsson, B.E. (2001). Chemicals and biological products used in South-East Asian shrimp farming, and their potential impact on the environment – a review. *The Science of the Total Environment* 280, 93-131.
- Han, B.C; Jeng, W.L; Hung, T.C; Jeng, M.S. (1994). Copper intake and health threat by consuming seafood from copper-contaminated coastal environments in Taiwan. *Environmental Toxicology and Chemistry* 13, 775-780.
- Hashmi, M.I; Mustafa, S; Tariq S.A. (2002). Heavy metal concentrations in water and tiger prawn (*Penaeus monodon*) from grow-out farms in Sabah, North Borneo. *Food Chemistry* 79, 151-156.
- Inaba, T; Kobayashi, E; Suwazono, Y; Uetani, M; Oishi, M; Nakagwa, H; Nogawa, K. (2005). Estimation of cumulative cadmium intake causing *Itai-itai* disease. *Toxicology Letters* 159, 192-201.
- Külköylüoğlu, O. (2004). On the usage of ostracods (*Crustacea*) as bioindicator species in different aquatic habitats in the Bolu region, Turkey. *Ecological Indicator* 4, 139-147.
- Lee, M.H; Shiau, S.Y. (2002). Dietary copper requirement of juvenile grass shrimp, *Penaeus monodon*, and effects on non-specific immune response. *Fish Shellfish Immunology* 13, 259-270.
- Luoma, S.N; Rainbow, P.S. (2008). Metal contaminations in aquatic environments. Cambridge University Press, Cambridge.
- Lubis, A.M; Sato, T; Tomiyama, N; Izesaki, N; Yamanokuchi, T. (2011). Ground subsidence in Semarang-Indonesia investigated by ALOS-POLSAR satellite SAR interferometry. *Journal of Asian Earth Sciences* 40, 1078-1088.
- Madany, I.M; Wahab, A.A.A; Al-Alawi, Z. (1995). Trace metals concentrations in marine organisms from the coastal areas of Bahrain, Arabian Gulf. *Water, Air and Soil Pollution* 91, 233-248.
- Maher, W.A. (1985). Trace metal concentrations in marine organisms from St. Vincent Gulf, South Australia. *Water, Air and Soil Pollution* 29, 77-84.
- Malm, O; Branches, F.J.P; Akagi, H; Castro, M.B; Pfeiffer, W.C; Harada, M.Bastos, W.R; Kato, H. (1995). Mercury and Methylmercury in fish and human hair from Tapajös river basin, Brazil. *The Science of the Total Environment* 175, 141-150.
- Marfai, M.A; King, L. (2008). Coastal flood management in Semarang, Indonesia. *Environmental Geology* 55, 1507-1518.



- Mishra, S; Bhalke, S; Saradhi, I.V; Suseela, B; Tripathi, R.M; Pandit, G.G; Puranik, V.D. (2007). Trace metals and organometals in selected marine species and preliminary risk assessment to human beings in Thane Creek area, Mumbai. *Chemosphere* 69, 972-978.
- Nan, Z.B. (1995). Fungicide seed treatments of sainfoin control seed-borne and root-invading fungi. *New Zealand Journal of Agricultural Research* 38, 413-420.
- Nauen, C.E. (1983). Compilation of legal limits for hazardous substances in fish and fishery products. FAO Fisheries Circular No. 764, 102. Food and Agriculture Organization of the United Nations. Rome, Italy.
- Nolan, K.R. (1983). Copper toxicity syndrome. *J. Orthomolecular Psychiatry*, 12:4, p.270-282.  
<http://orthomolecular.org/library/jom/1983/pdf/1983-v12n04-p270.pdf>
- Pourang, N. (1995). Heavy metal bioaccumulation in different tissues of two fish species with regards to their feeding habits and trophic levels. *Environmental monitoring and Assessment* 35, 207-219.
- Pourang, N; Tanabe, S; Rezvani, S; Dennis, J.H. (2005). Trace elements accumulation in edible tissues of five sturgeon species from the Caspian Sea. *Environmental Monitoring and Assessment* 100, 89-108.
- Simpson, S.L; Batley, G.E; Chariton, A.A; Stauber, J.L; King, C.K; Chapman, J.C; Hyne, R.V; Gale, S.A; Roach, A.C; Maher, W.A. (2006). Handbook for sediment quality assessment. Centre for Environmental Contaminants Research, CSIRO New South Wales. Australia.
- Simpson, S.L ; Angel, B.M ; Jolley, D.F. (2004). Metal equilibration in laboratory-contaminated (spiked) sediments used for the development of whole-sediments toxicity tests. *Chemosphere* 54, 597-609.
- Sivaperumal, P; Sankar, T.V; Nair, P.G.V. (2007). Heavy metal concentrations in fish, shellfish and fish products from internal market of India vis-a-vis international standards. *Food Chemistry* 102, 612-620.
- Storelli, M.M; Marcotrigiano, G.O. (2004). Bioindicator organisms: heavy metal pollution evaluation in the Ionian sea (Mediterranean sea – Italy). *Environmental Monitoring and Assessment* 102, 159-162.
- Takarina, N.D; Browne, D.R; and Risk, M.J. (2004). Speciation of heavy metal in coastal sediments of Semarang, Indonesia. *Marine Pollution Bulletin* 49, 854-874.
- Takeuchi, T; Morikawa, N; Matsumoto, H; Shiraishi, Y. (1962). A pathological study of Minamata disease in Japan. *Acta Neuropathologica* 2, 40-57.
- United State Patent (1987). Patent Number 4,704,133: Process for photochemical stabilization of synthetic polyamide fibre materials with water-soluble copper complex dye.
- United State Patent (1995). Patent Number 5,401,379: Chrome plating process.
- Van Lysebetten, J; Delbeke, K; Servin, G. (2010). Short literature review on the copper content in food, processed in copper vessels. European Copper Institute, Brussels.
- Wang, W. (1987). Factors affecting metal toxicity to (and accumulation by) aquatic organisms – overview. *Environment International* 13, 437-457.
- Warnken, J., Dunn, R.J.K., Teasdale, P.R. (2004). Investigation of recreational boats as a source of copper at anchorage sites using time-integrated diffusive gradients in thin film and sediment measurements. *Marine Pollution Bulletin* 49, 833-843.
- Watson, C; Yanong, R.P.E. (2006). Use of copper in freshwater aquaculture and farm ponds. Fact Sheet FA-13 Department of Fisheries and Aquatic Sciences, Florida Cooperative Extension Service, Institute of Food and Agricultural Sciences, University of Florida.
- Widianarko, B; Verweij, R.A.; Van Gestel, C.A.M; Van Straalen, N.M. (2000a). Spatial distribution of trace metals in sediments from urban streams of Semarang, Central Java,

Indonesia. *Ecotoxicology and Environmental Safety* 46, 95-100.

Widianarko, B; Van Gestel, C.A.M; Verweij, R.A. and Van Straalen, N.M. (2000b). Associations between trace metals in sediment, water, and guppy, *Poecilia reticulata* (peters) from urban streams of Semarang Indonesia. *Ecotoxicology and Environmental Safety* 46, 101-107.

WWAP, 2000. Water pollution, environment degradation and disasters. World Water Assessment Programme. [www.unwater.org/statistic\\_polu.html](http://www.unwater.org/statistic_polu.html). Consulted on May, 2011.

Yang, Z.B; Zhao, Y.L; Li, N; Yang, J. (2007). Effect of waterborne copper on the microstructures of gill and hepatopancreas in

*Eriocheir sinensis* and its induction of metallothionein synthesis. *Archives of Environmental Contamination and Toxicology*, 52, 222-228.

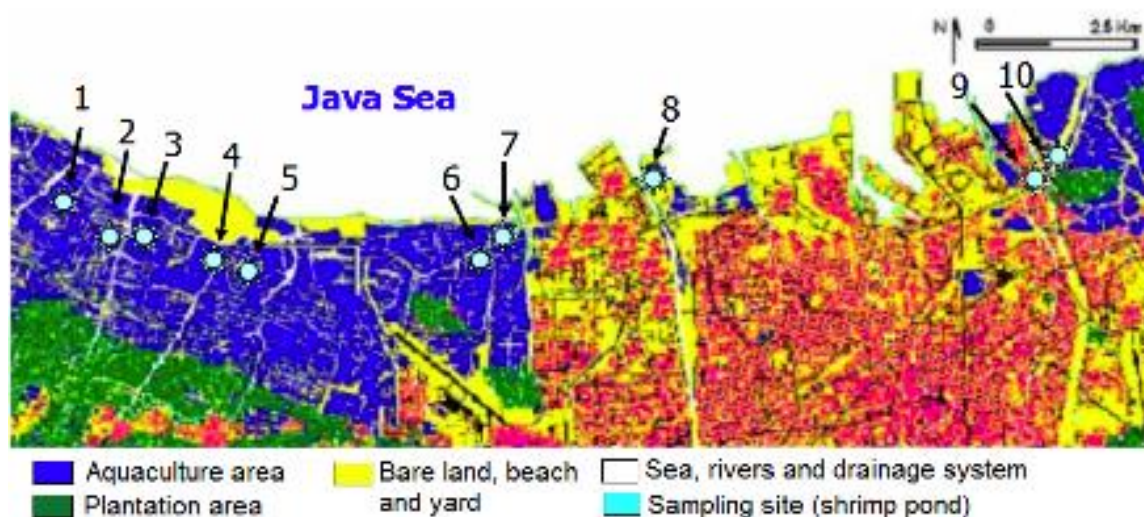

**Figure 1.** Semarang area and its land use (Marfai and King, 2008 – with permission). The numbers indicate the aquaculture ponds sampled for this study. The sampling sites include:

- |                        |                     |
|------------------------|---------------------|
| 1. Beringin River      | 6. Siangker River-1 |
| 2. Kyai Gilang River-1 | 7. Siangker River-2 |
| 3. Kyai Gilang River-2 | 8. West Canal       |
| 4. Tapak River-1       | 9. East Canal-1     |
| 5. Tapak River-2       | 10. East Canal-2    |

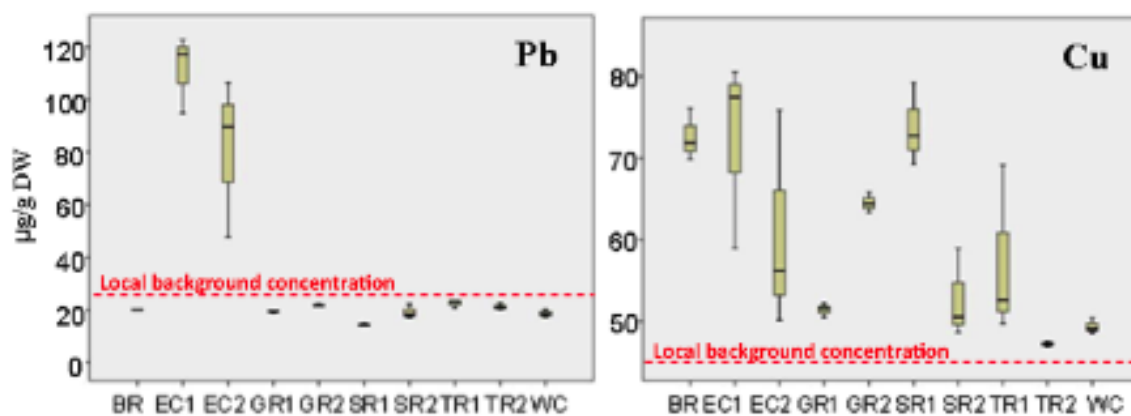

**Figure 2.** Heavy metal concentrations found in sediments collected from ten aquaculture ponds along Semarang coast line in the period of February – March 2009.

**Table 1.** Metals (Cu and Pb) concentration of Semarang coastal pond sediments compare to several Sediment Quality Guidelines.

Source of data	Cu (mg/kg) d.w.	Pb (mg/kg) d.w.	Reference
Semarang pond sediments	47.3 – 73.7	18.7 – 112	The present study
Sediment Quality Guideline (SGQ):			
Low	34 <sup>a</sup> ; 36 <sup>b</sup> ; 65 <sup>c</sup>	50 <sup>a</sup> ; 75 <sup>c</sup> ; 85 <sup>b</sup>	a. ANZECC-ISQG for Australia and New Zealand in Simpson et al. (2006)
High	190 <sup>b</sup> ; 270 <sup>a,c</sup>	218 <sup>c</sup> ; 220 <sup>a</sup> ; 530 <sup>b</sup>	b. SQO for the Netherlands in Crommentuijn et al. (2000) c. ISQV for Hong Kong in Chapman et al. (1999)

# ENVIRONMENT AND HEALTH: THE EDUCATIONAL AND MULTIPLIER ASPECT

**Aloysius Rusli**

Physics Department, Faculty of Information Technology and Sciences, Parahyangan Catholic University, Bandung, Indonesia  
[aloyusius.rusli@yahoo.com](mailto:aloyusius.rusli@yahoo.com)

## ABSTRACT

The importance of environment and health are increasing on this lonely blue planet, due to the ability of mankind to engineer the natural habitat and medical expertise. To contribute, integrating research, community outreach and service learning should not neglect the student education aspect. By effectively taking the environment and health issue into our classrooms, the student multiplier effect can ease the ground for a better future. This report describes a generic tool to help motivate students in their studies and in building up proper attitudes. That tool was developed empirically in the classroom, improved from semester to semester, based on weekly feedback from students. The tool consists of a one page weekly report to be submitted by the students, individually or in pairs. Its latest version has 5 points to be included, namely a summary of latest week's lecture(s), one question with a guess at its answer, a reflection on the advantages, and the risks contained in the material or topics of the latest week's lecture(s), and one small concrete action intended to be done based on that reflection. Past and latest results show that this tool produces positive responses. It is hypothesized that such weekly activity could help develop positive attitudes in students, in looking towards a better future, individually or communally.

**Keywords:** *education, educator, reflection, activation, attitudes*

## INTRODUCTION

This International Conference on Environment and Health is a worthy effort to discuss scientific findings on environment and health, two important aspects for humanity and the common good on this little, lonely blue planet. 'Little' is pointing to the fact that the Earth's size is much smaller than the Sun's size, which in turn is much smaller than the size of the solar system, which in turn again is much smaller than the size of the Milky Way galaxy, which in turn once again is much smaller than the size of the visible Universe. A quick look at Wikipedia [1] data shows the following

estimated numbers, to give some quantification to the claim of that 'little, lonely Earth':

- a. Earth's diameter is ~ 13 000 kilometers ~ 13 megameters.
- b. The Sun's diameter is ~ 1,4 million kilometers ~ 1 400 megameters.
- c. The Earth – Sun's distance is ~ 150 000 megameters ~ 10 light-minutes (distance traveled by light in 10 minutes). The Solar Systems's radius is ~ 4,5 light-hours.

- d. The nearest star is  $\sim 4$  light-years away; the size of our Milky Way galaxy is  $\sim 100\,000$  light-years in diameter, containing  $\sim 300$  billion (thousand million) stars.
- e. The size of the visible Universe is  $\sim 92$  billion lightyears, containing  $\sim 100$  billion galaxies, while its age is  $\sim 14$  billion years. Space itself seems to be expanding.

The Earth looks blue from space, due to the huge amount of ocean seen on it, and caused by the scattering of sunlight by the water molecules, similar to the blueness of the sky which is caused by scattering of sunlight by atmospheric air molecules.

Due to that littleness and loneliness of Earth, caring for the environment and health of the Earth is very proper, even very urgent, as the human race has not yet the ability to predict with sufficient certainty, any future behavior of the climate, besides not having the ability, financially or technically, to migrate *en masse* to another suitable planet. To increase awareness of this very urgent matter, we should pay sufficient attention to the university students being in our care, at least as they will be Earth's future administrators, on a small or even on a large scale.

This educational aspect, presented in this paper, is also very significant as its multiplier effect (or aspect) can be huge. Caring for this aspect will give long range impact, for better or for worse. This attention should encompass

the time spent in lecture rooms, using those hours to increase awareness of the problem of environment and health, building up critical reflection ability and nurturing an attitude of needed leadership in handling this Earth.

This presentation reports on such efforts done since about year 1993 [2], initially to improve involvement in learning, and later on to start to influence attitudes and point the way on what to do, starting with any little step or concrete effort.

These efforts comprise two main aspects: Attitude of the lecturer, and a variety of weekly short reports to involve students in studying activity, and as tool for feedback.

This paper will firstly describe the main weekly reports to be submitted by each student, then focus on the lecturer's role in leading the way for the student. A conclusion will summarize the main points.

While this paper describes mainly the method for a physics lecture, but adapting these to other kind of lectures will surely be possible, including paying attention to the environment and health.

### **THE METHOD: THE WEEKLY SHORT REPORTS AND THE ATTITUDE**

The main tool developed since year  $\sim 1993$  was the weekly report [2], initially meant to obtain feedback from students. It should be short, to adjust to the common trend in attitude of students [3], being of short span of attention, and of usually having the habit of

copying tasks from each other. That report is, then till now, of one page of size ~A4 paper, allowed to use the blank backside of used paper, noting an attitude of 'save the trees!'. Its content would be, besides data like student's name and registration number, course title, class number (if applicable), group letter (if applicable), date of submission, a summary of last week's lecture(s) content and one question with a guessed answer.

If the class is small, each student should do the weekly report. If the class is large, say at least 30 students, they should group themselves in pairs (students prefer choosing their partner themselves; it is stressed that this partnership will remain fixed for the semester; at least as a very useful experience of doing reports together); the lecturer then will designate the groups by, say, the letters A, B, C, etc. Usually this is done in the second week, based on the sorted (according to the smaller student registration number in the group) pile of reports. Every first lecture of the week (if there are two sessions each week), within the first 15 minutes (to avoid diverting attention during the lecture due to finishing the report during class), the reports should be submitted, sorted by group letter. This will ease the lecturer's effort to register submissions after class.

To exercise some discipline as habit, usually a discount of 50% is applied to the report's score if some incompleteness is discovered in the report (50% for the first error, 25% for the second error, 25% for any further errors). This rule usually breaks the ice, causing laughter

and upping a friendly atmosphere in the class; this is also supportive to the lecture's aims.

Explanation is given for the reasons of the report (this usually takes ~100 minutes, to be able to answer any questions on the organization of this report): The summary will show the lecturer which points were understood, and which points were lost on the students. This is good feedback, and corrective action can be done at the following lectures.

The one question also shows the level of understanding, and shows the lecturer which points were unclear to some students. Limiting to one question also helps avoid trivially fabricated or copied questions, which will contradict the aim of instilling a critical attitude. A large effort on the lecturer's side is in answering, succinctly but still clearly, those questions; this is an important way to show that every question, even the most simple one, will be appreciated and answered. This answering of questions seem to be appreciated, and helps opening up students to ask during lectures (and outside class and in future).

The guessed answer will also show the level of general understanding of the student: it helps the lecturer judge what a more effective answer would be, correcting some misunderstanding along the way. If the guessed answer is quite correct, the lecturer can then also just write "Correct" or "OK" or "Excellent" as appropriate. This saves time as well. Another reason for this guessing is that a well-posed question usually will point the way to its answer, meaning that doing these

'predictions', will nurture a habit of solving problems themselves.

The author usually succeeds (at least for the first half of the semester), in writing short answers on the reports before returning them to the students in the following (if possible the next) weeks. Sometimes taking time to answer questions in class will also help loosening up the students in asking questions; however some students object to the "haphazard hopping between topics" in answering questions. They feel difficulty appreciating the 'real' nature of solving problems, which sometimes have a haphazard way, not always just doing a routine job. Another usefulness of doing the answering of questions is the increasing ability to present short and sufficiently clear answers to the students.

A third point was later on also asked for the one-paged report: Each report should contain the group's (or personal) opinion about the latest week's lecture. This too is good feedback for the lecturer, to judge effectiveness of his/her lecture. It also instills an attitude of making up one's mind about an experience, instead of just drifting along without regular stopping to reflect and do an evaluation.

Starting two semesters ago, the opinion statement was expanded into 3 points:

1. A reflection should be reported on the positive aspect of last week's lecture topic.

2. Another reflection should be done on the negative, or riskfulness of that topic.
3. A small concrete action should be planned for the group or its members, for putting into practice some part of last week's lecture topic, for the improvement of the common good, especially for the weaker members of society.

The 5 points comprising the weekly report remains limited to the one page condition. This lightens the lecturer's load of reading through them, and trains the students to be succinct while making an effort to be lucid.

The last three points were a result of a workshop held at Parahyangan Catholic University for (mostly) the young lecturers, by Fr Paul Suparno, SJ in July 2012 using the Jesuit "Reflective Pedagogy" [4]. A temporary assessment is that the students are getting started on the reflective path of living, trying to discern the good and the bad sides of a topic, and starting to put into personal action some small step for improving the common good and paying attention to the weaker members of the community.

This weekly report should be attended by an appropriate attitude of the lecturer, to avoid the weekly report becoming just a routine activity without a spiritually enlivening experience. This attitude comprises a constructive way of handling the students, showing impartiality, objectivity, but showing

also that rules are for men, not the other way around. This means that the rules announced and explained during the full whole first lecture of two hours, are allowed to be bent in response to a student's protest or case of inexperience. The author is used to showing appreciation when there are protests, using them as an opportunity to show that disagreeing can help discovering the deeper truth, and loosening up feudal attitudes of 'the senior one knows better' and 'it is impolite to disagree'. The long range aim is to make the student aware of the joy and feeling of goodness when experiencing some difficulty, while still appreciating the importance to play by the rules, as best as possible.

Another aspect of the lecturer's attitude is in presenting the lectures: Those lectures should distinguish the important parts from supplementary parts, which and which are more important and essential, and which are more of illustrative and technical content (for a physics-like lecture, at least, which usually do not stress technicalities too much, as essential concepts and essential procedures are considered more important and of more long-range validity; the latter are sometimes called 'generic skills or transferable skills'). This is not meant to neglect presenting concrete examples illustrating application (also of modern ones) of essential concepts.

Another appropriate attitude is a constructive attitude towards the students: Appreciating their dignity as humans (not just assuming them to be passive and not trustworthy),

listening to their complaints, explaining the use and importance of following rules, etc.

## RESULTS AND DISCUSSION

Having developed this weekly report since ~year 1993 has made the author to value it as an essential tool for getting feedback from the student classes he conducts. The insistence to answer the questions seem to make him known as 'who can answer all questions', which is certainly not true. It can also be used to show that not knowing the answer is no problem, as answers can be looked for in the books, and nowadays there is the google.com tool, and Wikipedia can very often give quite accurate (~99%?) and up to date answers, which can then be further researched using more reliable sources using its references, <http://scholar.google.com>, the libraries, etc.

So the usefulness of this method for the lecturer is clear; how to manage the time to be spent answering questions is another problem. But showing the proper attitude, of stressing the good intentions, giving good first impressions, following up with proper attitudes, seems to show a positive effect, including the necessity to be meek of heart in acknowledging lateness of answering questions and unclarity of lecturing, while staying firm with the good intentions.

From the student's side, while complaining about the many tasks to be done, especially initially, but some acknowledging that it should be beneficial for the students, they then comply and it seems the brevity of the reports



do not show the need for the copying habit, except once in a while.

The sanction of 50% lowering of scores still often happens, mostly to older repeating-class students who are also more often absent from lectures.

Doing research on these weekly reports would also be able to show deficiencies in understanding of lecture content, and pertinent questions which, when appropriate, should be incorporated into the lectures.

A hypothesis that this treatment will have long-lasting positive effects, like positive attitudes and looking positively towards the future in students, seems at least not give contradictory signs. Expecting that such treatment will change many things would not be realistic. However through the grace of God, even small efforts in the right direction should be better than not doing anything at all.

## CONCLUSION

A weekly report has been described, which seems to show that it is effective in clarifying lecture content, and nurturing future attitudes in students. This tool can be used to remind students of the environment and the health aspects in life, starting them to think about the positive and negative aspects, and what to do

using small but concrete steps. As these students will become future leaders, either at small scale or some even on larger scale in community life, this tool can have an unexpected and huge effect.

## ACKNOWLEDGEMENT

Financial support from the Research and Community Service Institution, Parahyangan Catholic University, Bandung is gratefully acknowledged, as is the opportunity given by the INCEH Committee to present this paper.

## REFERENCES

- [1] Wikipedia (2013). Earth. Solar System. Galaxy. Universe. Retrieved 2 May 2013
- [2] A Rusli (2008). Improving the Learning Process of Under- and Postgraduate Students: Some Study Results. Proceedings of the 2<sup>nd</sup> International Conference on Mathematics and Natural Sciences (ICMNS). 1314 - 1320
- [3] A Rusli (2010). A Format for the Basic Physics Lecture – Aiming at Science Awareness: Some Study Results. Proceedings of the 3<sup>rd</sup> International Conference on Mathematics and Natural Sciences (ICMNS). 579 - 586
- [4] J Subagya (2012). Paradigma Pedagogi Reflektif – Mendampingi Peserta Didik Menjadi Cerdas dan Berkarakter, edisi revisi”, translation of *Ignatian Pedagogy, A Practical Approach*, G S Prakash, India. Kanisius, Jogjakarta.

# IMPLEMENTATION OF SERVICE LEARNING FOR ENVIRONMENTAL ACTION IN CIVIL ENGINEERING, SOEGIJAPRANATA CATHOLIC UNIVERSITY

**Rudatin Ruktiningsih and Budi Santosa**

Civil Engineering Department, Soegijapranata Catholic University, Semarang, Indonesia  
[budisan7@gmail.com](mailto:budisan7@gmail.com)

## ABSTRACT

Service-learning is a teaching method which combines community service with academic instruction as it focuses on critical, reflective thinking and social responsibility. The implementation of a service learning into Environmental Impact Assessment (EIA/ AMDAL) course at Soegijapranata Catholic University is discussed within this paper. This initial experience with service learning has produced valuable lessons, which are discussed in the paper, along with the findings and results of the service learning activity. Fifteen Civil Engineering Students lived in Coastal Community Tapak Tugurejo Semarang on March 30th to 31st 2012 to learn, observe, live with coastal community without intervention. Students were divided into groups according to communities (Fisherman, Fish Farmer and Environmental Awareness). From the service learning experience, found that a majority of service-learning students report that they obtained a deeper understanding of subject matter, an understanding of the complexity of environmental and social issues, and that they were better able to apply material they learned in the classroom to real problems as some of the most important benefits of service-learning.

**Keywords:** *service learning, environmental, civil engineering, EIA*

## Introduction

Traditional engineering programs are usually more focused on technical development and not on preparing socially-responsible engineers with a strong sense of citizenship. Service learning is a very viable solution for addressing this issue. Service learning is a pedagogy that provides students with structured opportunities to learn, develop and reflect through active participation in community projects. It is an opportunity to learn numerous non-technical skills. Service learning develops students'

awareness, cultural sensitivity, empathy and a desire to use technical skills to promote peace and human development.<sup>11-14</sup> Tsang classifies service learning as experiential education, and says that it has elements of drama and dilemma, just like the real world.

Service learning as a teaching method combines community service with academic instruction that focuses on critical, reflective thinking and civic responsibility. Service-learning has the potential to engage students in a real life application of the theoretical models they

learn in the classroom, and to reinforce models of learning that will be useful to students as they enter the professional workforce.

Integrating Service Learning within Environmental course at Civil Engineering Department, Soegijapranata Catholic University. Integrated approach incorporated not only to problem solving but the problem definition as well.

Engineering Criteria 2000 formalized the incorporation of “softer” skills to complement the traditional engineering knowledge and skills in preparing graduates for the 21st century. The softer skills identified in ABETS’s Criterion 3, “Program Outcomes and Assessment,” include “an ability to function on multidisciplinary teams,” “an understanding of professional and ethical responsibility,” “an ability to communicate effectively,” “the broad education necessary to understand the impact of engineering solutions in a global and societal context,” a recognition of the need for , and an ability to engage in lifelong learning,” and “ a knowledge of contemporary issues.” Service learning can be an effective pedagogy to meet these program outcomes.

## **Principles of Good Practice for Service-Learning**

Jeffrey Howard of the University of Michigan identified ten principles of good practice with regard to Service learning as a pedagogy to insure full integration of students’ service experiences and course learning. The following principles can serve as a useful checklist as you consider implementing service-learning as part of your course.

Principle 1: Academic Credit is for Learning, Not for Service. Academic credit should not be awarded simply for performing service, but rather for the student’s demonstration of academic and civic learning. Course goals and student learning should be assessed in rigorous manners regardless of whether they are reached through experiential or through more traditional means. Assessment tools should be designed that will measure student learning in multiple contexts.

Principle 2: Do Not Compromise Academic Rigor Students engaged in service-learning should be provided with the same opportunities for academic rigor and should be assessed under equal—if different—criteria as are students engaged in non-service-based courses or projects. Service-learning students must not only master academic material, but also learn

how to learn from unstructured community experiences and merge that learning with the learning from other course resources. This makes for challenging intellectual work, commensurate with rigorous academic standards.

#### Principle 3: Establish Learning Objectives

It is a service-learning maxim that one cannot develop a quality service-learning course without first setting explicit learning objectives that complement specific service opportunities. This principle is foundational to service-learning, as well as to choosing appropriate community partnerships through which learning goals can be met. Learning goals in the service-learning classroom, as in any other classroom, should be articulated clearly, as should criteria for student assessment. When appropriate, students can participate in the creation of learning goals and assessment criteria.

Principle 4: Establish Criteria for the Selection of Service-Placements Requiring students to serve in any community-based organization as part of a service-learning course is tantamount to requiring students to read any book as part of a traditional course. Faculty who are deliberate about establishing criteria for selecting service-learning partnerships will find that students are able to extract more relevant

learning from their respective service experiences, and are more likely to meet course learning objectives, than are students who are engaged in academically inappropriate (if meaningful) service. Partnerships should be chosen with regard to the best fit between the needs of the community partner (as designated by the community partner) and learning goals/outcomes for the specific course.

Principle 5: Provide Educationally-Sound Learning Strategies to Harvest Community Learning and Realize Course Learning Objectives Requiring service-learning students to merely record their service activities and hours is only a beginning, and on its own will not likely provide students with appropriate learning experiences. Careful thought should be given to learning activities that encourage the integration of experiential and academic learning. Activities such as classroom discussions, presentations, journals and paper assignments can support analysis of service experiences in the context of the course academic and civic learning objectives. These activities should be explicit and directed in order to provide students with best learning outcomes.

Principle 6: Prepare Students for Learning from the Community Most students lack experience with both extracting and

making meaning from experience and in merging it with other academic and civic course learning strategies. Even an exemplary reflection journal assignment, therefore, will yield uneven responses without sufficient support. Provide examples of how to successfully complete assignments (e.g., make past exemplary student papers and reflection journals available to current students to peruse). Also, when appropriate, invite community partners to your class to participate in orienting students to the service-project(s).

**Principle 7: Minimize the Distinction Between the Students' Community Learning Role and Classroom Learning Role** Classrooms and communities provide very different learning contexts. Each can seem to require students to assume different learning roles and styles. A goal for reducing the differences lies in shaping the learning environments so that students assume similar learning roles in both contexts. We recommend, for several reasons, re-norming the traditional classroom toward one that values students as active learners. First, active learning is consistent with active civic participation that service-learning seeks to foster. Second, students bring information from the community to the classroom that can be utilized on behalf of others' learning. Finally, we know from recent research in

the field of cognitive science that students develop deeper understanding of course material if they have an opportunity to actively construct knowledge (Eyler & Giles, 1999).

**Principle 8: Rethink the Faculty Instructional Role** If faculty encourage students' active learning in the classroom, what would be a concomitant and consistent change in one's teaching role? Commensurate with the preceding principle's recommendation for an active students learning posture, this principle advocates that service-learning teachers, too, rethink their roles. An instructor role that would be most compatible with an active student role shifts away from a singular reliance on transmission of knowledge and toward mixed pedagogical methods that include learning facilitation and guidance.

**Principle 9: Be Prepared for Variation in and Some Loss of Control with Student Learning Outcomes** For faculty who value homogeneity in student learning outcomes, as well as control of the learning environment, service-learning may not be a good fit. In college courses, learning strategies largely determine student outcomes. In traditional courses, the learning strategies (i.e. lectures, labs, and readings) are constant for all enrolled students. However, in service-learning

courses, given variability in service experiences and their influential role in student learning, it is important to anticipate greater heterogeneity in student learning outcomes and compromises to faculty control.

#### Principle 10: Maximize the Community Responsibility Orientation of the Course

One of the necessary aspects of a service-learning course is purposeful civic learning. Designing classroom norms and learning strategies that not only enhance academic learning but also encourage civic learning are essential to purposeful, engaged academic learning.

### Course Design

In designing the course as a service-learning course, the dual objective was to instruct on the practice and theories of collaborative governance while demonstrating through service to a set of community partners how collaboration can be successfully achieved. Appropriately, the focus of the service project was the development of a set of recommendations to enhance collaborative capacity across sectors and agencies.

The EIA/AMDAL course was selected to achieve service learning experience in the

Department of Civil Engineering at Soegijapranata Catholic University. The main objective of the course was defined as “introducing students to the problems of sustainable environmental”. Students enrolled in this course, were asked to analyze the environmental problems. Because the request was made before the start of the semester, the sequence of topics and early experiences were designed to prepare the students for this service learning component. The concepts of sustainable environmental were addressed.

The course divided into 2 (two) steps, before Ana Rafter mid term test (see fig 1). The course was conducted from 5th March 2012 with 14 meetings and 2 times the Test. Detail of the activity can be seen in the Table 1.

Fifteen Civil Engineering Students lived in Coastal Community Tapak Tugurejo Semarang on march 30th to 31st 2012 to learn, observe, live with coastal community without intervention. Students were divided into groups according to communities (Fisherman, Fish Farmer and Environmental Awareness).

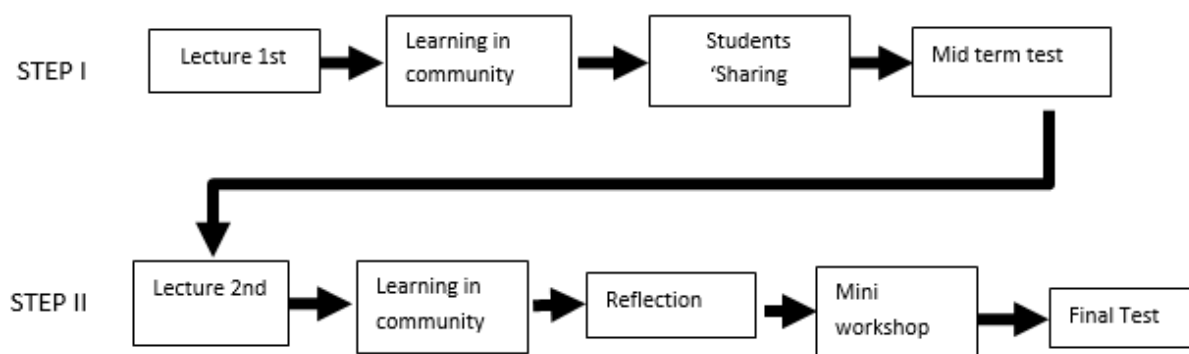

Fig 1. Two Step Course.

Table 1 Detail of activity

STEP	Major Activity	meeting	Subject/ activity	Location/ Persons in charge	outcome
I	Lecture	1 <sup>st</sup>	Introduction of environment	Classroom	Students know enviromental definitions, regulations and problems
			Environmental Regulation and Legislation	Lecturer and students	
			Environmental problems (global, National and Regional)		
	Lecture	2 <sup>nd</sup>	Simple Indicators of environmental problems	Classroom	Students know simple indicators enviromental problems, community organizations and enviromental facilities
			Community organizations	Lecturer and students	
			Nature and artificial environmental facilities		
Lecture	3 <sup>rd</sup>	How to learn in community ?	Classroom Lecturer , students and guide of community	Students know locations, what they must do in locations	
Learning in community	4 <sup>th</sup> ,5 <sup>th</sup> , 6 <sup>th</sup>	Students live in location for 2 days 1 night	Coastal area community  Students, community of coastal area	Students observe about : what the community do in their communities, enviromental problems, and what can students do ?	
Students' sharing	7 <sup>th</sup>	Each Student must tells his/her experience	Classroom  Lecturer and students	Each student learn about their experiences	

	Midterm test		Students must collect their report .	Classroom Lecturer and students	Students can present their observation and what can they do to help community
II	lecture	8 <sup>th</sup>	Alternative solution of enviromental problems	Classroom Lecturer and students	Students know alternative solutions of enviromental problems
	lecture	9 <sup>th</sup>	Alternative solution of enviromental problems in coastal area	Classroom Lecturer and students	Students know alternative solutions of enviromental problems especially in coastal area
	lecture	10 <sup>th</sup>	How to learn in community ?	Classroom Lecturer and students	Students know what they must do in locations
	Learning in community	11 <sup>th</sup> , 12 <sup>th</sup>	Students learning in community again for 1 day  (Students give to the community about their product and discuss it)	Coastal area community  Students and coastal community	Students knows what the community needs
	Reflection	13 <sup>th</sup>	Each student tell to all students his/her feeling when live in coastal area community and tell what will do in the future after know the enviroment conditions in coastal area.	Classroom Lecturer and students	Students can get positif Values when they live in coastal area community
	Mini Workshop	14 <sup>th</sup>	Students tell to all students in civil engineering dept and engineering faculty about their experience in Amdal course	Classroom Lecturers and students	All students and lecturers know the coastal area community conditions and service learning approach in course
	Final test		Students collect their final report and short film.	Classroom Lecturers and students	Students can present their product for the coastal community



The class provided students with the theoretical and practical tools needed to engage successfully in networking and collaboration across sectors. Among the topics covered during the course were network development and evaluation, conflict management, consensus building, and public participation.

The key components of the course included the instructor-prompted reflection discussions, facilitated group work and management, and facilitated consensus process that led to the writing of the final report. These processes allowed for the timely completion of a credible report to the community, while simultaneously permitting advanced student learning. Underlying these processes were standard classroom activities, including lectures, casework, and role-play simulations.

Throughout the semester, students kept a reflection discussion facilitated by the instructor. Questions were intended to provide students an opportunity to specifically draw connections between class tutorials and readings with experiences outside the classroom.

Students were divided into groups according to the social community. Teams of three to four students formed to (1) interview the community, (2) interview non-government organization, (3) conduct a literature review of environmental issues, and (4) conduct “best” practices experience of how the community were interacting to pursue positive outcomes for their problem solving.

In the end of semester, each group needed to collect the final report with a set of recommendations agreed to by all students in their group. To achieve this, each team/group review the findings from each member. The consensus recommendations of the groups were presented to the full

class, at which time the instructor facilitated a decision process to make finalize the recommendations.

## **Reflective Learning**

As part of the reflective learning that should accompany service learning projects, the student teams created electronic presentations that examined the value of the service learning activity and documented the field study through photographs and videos. The electronic presentations were shown and discuss to the class.

The service learning experience enhanced the students understanding of the benefits of sustainable environmental. From the service learning experience, found that a majority of service-learning students report that they obtained a deeper understanding of subject matter, an understanding of the complexity of environmental and social issues, and that they were better able to apply material they learned in the classroom to real problems as some of the most important benefits of service-learning.

## **Acknowledgment**

We would like to express our sincere gratitude to the United Board for Christian Higher Education Asia for their financial contributions, without which this work would not be possible.

We would like do thank Prof. Budi Widyanarcko as a Rector of Soegijapranata Catholic University for encouraging us to implement the service learning course at Civil Engineering Department.

## References

Hapsari and team (2012); Environmental Awareness Group in tapak Tugurejo Semarang; Report of Live in; Supported by United Board of Christian Higher Education in Asia. Soegijapranata Catholic University.

Magai and team (2012); Fish Farmer group in Tapak Tugurejo Semarang;

Report of Live in; Supported by United Board of Christian Higher Education in Asia. Soegijapranata Catholic University.

Rudatin Ruktiningsih (2010); “AMDAL” Course Modul ; Civil Engineering Dept Soegijapranata Catholic University, Semarang, for intern used.

Ryan and team (2012); Fisherman Group in Tapak Tugurejo Semarang; Report of Live in; Supported by United Board of Christian Higher Education in Asia. Soegijapranata Catholic University.

Rudatin Ruktiningsih(2011); “Pengetahuan Lingkungan” Course Modul ; Electrical Dept Soegijapranata Catholic University, for intern used.

Sukesi, A.E.M., T. Rahardjo, R. Ruktiningsih, H. Goeritno, M.S.S. Utami (2011). Urbanization and Environmental Health: Internal Migration and Environmental Degradation in Semarang. A Report of Research Supported by United Board of Christian Higher Education in Asia. Soegijapranata Catholic University. 14 p.

Sukesi, A.E.M., T. Rahardjo, R. Ruktiningsih, H. Goeritno, M.S.S. Utami (2011). Modul Membangun Nilai-Nilai Kepedulian; ISBN : 978-602-8011-31-0 ; Supplement of Internal Migration and Enviromental Degradation in Semarang. A Report of Research Supported by United Board of Christian Higher Education in Asia. Soegijapranata Catholic University.

# APPLICATION OF ORGANIC AGRICULTURE IN THE SUKUN DISTRICT MALANG CITY AS A STRATEGY FOR HEALTH AND ENVIRONMENTAL EDUCATION

**Kukuk Yudiono**

Department of Agricultural Technology, Widya Karya Catholic University, Malang, Indonesia  
[amk\\_yudiono@yahoo.com](mailto:amk_yudiono@yahoo.com)

## ABSTRACT

Entering the 21st century, a healthy lifestyle with the slogan Back To Nature has become the new trend of the world community. Communities are increasingly aware that the use of non-natural chemicals, such as fertilizers and synthetic chemical pesticides and growth hormones, in agricultural production, turned out to have a negative effect on human health and the environment. Organic farming is a farming system that uses very few synthetic chemical inputs or no chemical inputs. In other words, organic farming is designed to be a farming system which follows the principles of nature in order to establish a balance agro-ecosystem that will be beneficial to soil, water, air, plants and all existing living things (including pests) as well as providing healthy food. Currently on Sukun district Malang City there is Farmers Joint Group (Gapoktan) called "Mulyo Santoso" that is engaged in organic vegetable agribusiness field. Gapoktan "MulyoSantoso" is in charge of 2 (two) other farmers groups, namely "Sri Mulyo" and "Nusa Indah" comprising 173 farmers. This service learning (SL) is intended to improve the learning systems through active participation, as a good opportunity to apply skills and knowledge acquired in real life, broaden the horizons beyond the classroom, and is able to reflect on his experience and his work. Method of service learning include: Survey, Preparation and Planning, Live in, Reflection, and Mini Workshop. One of the important benefit sof service learning, especially for students is increasing awareness of the great value and sacrifice of organic farmers in protecting the environment and health food.

**Keywords:** *synthetic chemicals, organic agriculture, health and environment, service learning*

## I. INTRODUCTION

As the world entered the 21<sup>st</sup> century, a lifestyle based on health concerns that carries with it the slogan "Back To Nature" has become the new trend of the world communities. Communities were increasingly aware that the use of non-natural chemicals, such as fertilizers and synthetic chemical pesticides and growth hormones in agricultural production, had turned out to have negative effects on human health and the environment. Such a lifestyle has undergone international institutionalization, fulfilled in the global trade regulations which promote the guarantee that

agriculture products must have food safety and eco labeling attributes. Organic vegetable products are included in the products that meet these attributes. Organic farming is a farming system that uses very few synthetic chemical inputs or no chemical inputs. The main feature of this farming system is to work in harmony with nature in order to yield healthy food products for humanity. In other words, organic farming is designed to be a farming system which follows the principles of nature in order to establish a balance agro-ecosystem that will be beneficial to soil, water, air, plants and all living things (including pests) as well as

providing healthy food. The principles of organic agriculture are based on: 1) Principles of Health; 2) Principles of Ecology; 3) Principles of Justice, and 4) Principles of Protection

Based on the results of the initial survey to the farmers who have adopted organic farming in the region of Malang then Sukun District as a service learning activity. The agricultural land in Sukun District experiences shrinkage due to the shift of much agricultural land into housing projects and shops, which is the general condition of agricultural land in urban areas. The narrowing of agricultural land as well as the increasing awareness of environmental sustainability, has encouraged some farmers of Sukun District to switch to developing organic vegetable cultivation. Currently on Sukun District, Malang City there is Farmers Joint Group (Gapoktan) called "Mulyo Santoso" that is engaged in organic vegetable agribusiness field. This joint group of vegetable farmers was started in 2010, by its chairman Mr. Hary Soejanto who is one of the pioneer farmers in Malang. Gapoktan "Mulyo Santoso" is in charge of 2 (two) other farmer groups, namely "Sri Mulyo" and "Nusa Indah" comprising 173 farmers. Efforts made in the agribusiness field of organic vegetables, such as at Kitri Ayu Kurnia Farm, has absorbed 12 labor who are all native of Sukun District, Malang and its neighboring areas. The existence of the business has confirmed Sukun District as the new site of organic vegetable producers.

This service learning (SL) is intended to improve the learning systems through active participation, as a good opportunity to apply skills and knowledge acquired in real life, broaden the horizons beyond the classroom, and is able to reflect on his experience and his work. For partners in this regard is Kitri Ayu Kurnia Farming Farm and Organic Farmers Group, we expect the spirit to play a role in reducing the negative impact on the environment and to improve the welfare and quality of life in work and business.

## II. LITERATURE REVIEW

### 2.1. Service Learning In Education Health and Environmental Strategies

It is said that every step in the product lifecycle, from raw material extraction to final disposal, places the burden on the environment. It is therefore considered a service-learning project that can help mitigate the impact, like planting a vegetable garden to supply your school cafeteria and then compost leftover food scraps. The resulting compost could even be put back to help the vegetable garden grow (Edina SL, 2013). Through the environmental science project area like this, youths have the opportunity to learn and gain life skills, then use their new-found education and skills to improve their community through service learning (Schulz, 2012). The role of Higher learning is equated with ethical and honorable behavior and acceptance of the notion that the privilege of education also carries with it responsibility for the welfare for those not so privileged (Berry, 1999).

According to Flemming (2009) *in* Widianarko (2012) education is critical in the promotion of sustainable development and improving the capacity of people to address environmental and developmental issues. Education is also critical in achieving environmental and ethical awareness, values and attitudes, skills and behavior coherent with sustainable development, and for effective public participation in decision-making. Ward (1999) *in* Widianarko (2012) even stated that these two fields (environmental studies and service learning) have a natural fit. The combination of these two is frequently referred to as Environmental Service-Learning (ESL) (Madigan, 2000). Through this amalgamation, the notion of community is broadened, not only limited to human community but also embracing natural community. Further stated that through ESL students can see more clearly the impact of environmental neglect and policy implications of the witnesses at the grassroots level. ESL promising practices may include: (1) encourages youth leadership and decision-making; (2) integrates and values the community voice; (3) fosters civic stewardship; (4) provides opportunities for cross-cultural connections; and, (5) plans for the long-term sustainability.

## **2.2. Principles of Organic Farming on Health and Environmental Sustainability**

### **a. Principles of health**

Organic agriculture should sustain and enhance the health of soil, plants, animals, humans and the earth as a whole and

indivisible. This principle suggests that the health of individuals and communities can not be separated from the health of ecosystems; healthy soil will produce healthy plants that can support the health of animals and humans. In particular, organic agriculture is intended to produce high-quality and nutritious foods that support health maintenance and welfare. Bear in mind though that organic agriculture should avoid the use of fertilizers, pesticides, medicines for animals and food additives that can affect the health farm (Jaker PO Indonesia, 2005; IFOAM, 2005).

### **b. Principles of ecology**

Organic Agriculture should be based on ecological systems and cycles of life. Work, emulate and strive to protect ecological systems and cycles of life. Organic management must be adapted to the conditions, ecology, culture and local scale. Ingredients intake should be reduced by reuse, recycling and the management of materials and energy efficient in order to maintain, improve and protect the quality of the natural resources. Also in this principle should also be prudent in the use and management of water and soil. In practice organic farming should also be able to maintain clean air conditions and take advantage of existing biological diversity (Jaker PO Indonesia, 2005; IFOAM, 2005).

### **c. Principles of protection**

Organic agriculture should be managed carefully and responsibly to protect the health and welfare of current and future

generations and the environment. The perpetrators of organic agriculture encouraged to increased efficiency and productivity, but they should not endanger the health and well-being of the farm. Consequently, new technologies and methods that already exist need to be assessed and reviewed. Science is needed to ensure that organic agriculture is healthy, safe and environmentally friendly. Organic agriculture should prevent significant risks by adopting appropriate technologies and rejecting unpredictable technological consequences, such as genetic engineering. The use of additives and supplementary materials must be limited in processing (IFOAM, 2000; IFOAM, 2005).

### **3. METHODOLOGY**

#### **3.1 Selection of Students as participants**

Sixteen (16) students of Agriculture Faculty as to six (6) students from Departements of Food Technology and ten (10) students from Departements of agribisnis. The recruitment of student was conducted through an announcement by Dean of Agriculture Faculty. The success of the recruitment was also supported by the fact that it was integrated in lecturer with subject Organic Agriculture System.

#### **3.1. Investigation and Survey**

Organic farming farmer groups in Malang were first Identified and surveyed, in order to establish an organic farm where the groups could hold service learning activities. Further exploration on the needs of the

community/farmer groups and requirements for their selection are based on the following criteria: relevance to the curriculum, urgency of the interests, and capabilities of the resources.

#### **3.2. Preparation and Planning**

Activities include in this stage are initiating collaboration with partners and making a schedule for the implementation of service learning activities with said partners. After that a debriefing lecture on the topic previously established was held and participants were divided into groups. Each service learning group appoint a group leader. Finally, lecturers and students worked together to make the work program.

#### **3.3. Live in**

Student live at the combined farmer's garden belonged to Mulyo Santosa, located in Sukun District, Malang City. Students were divided into three groups of 5 or 6 each. Each group was assigned to work the land as much as 10 beds with bed size of 1.2 m x 5 m, which was planted three types of vegetables (red spinach, mustard meat, and spinach). Activities shared with the farmers include: cultivating the land, planting seeds, watering, maintenance, eradicating pests and plant diseases, harvesting, packaging and marketing. All activities avoided any residues of synthetic chemicals, both contained in the soil, water and use in the planting process. Students also practice creating their own seed, bokhasi

fertilizer, and natural pesticides. All activities were carried out using simple tools such as hoes, yells, bucket. The duration taken by these activities from land preparation, planting, crop maintenance to take approximately 25 days and was done everyday. The activity Interrupted every one week for evaluation and assessment by the field supervisor was was the organic farmers philosophy, which is: be patient, diligent, hard working, honest and animates.

### 3.4. Reflection

After of the live in activities were completed , the next stage was reflection activity. Basically the guide directed the student to reflect on three things: 1) recollection and sharing of what students had done during the study and during SL activities, 2) awareness, especially related to life as a (organic) farmer of the difficulty and nobleness of the farmers struggle in caring for their life and environment, and 3) commitment to support, implement and develop organic farming systems in our respective regions. The resulting joint commitment by the students is a strong desire to popularize organic farming their respective areas, as they are increasingly aware that organic farming system not only produces healthy food but can also save the earth from damage.

### 3.5. Mini Workshop

Mini-workshop activities are the activities of *service learning* exposure by students to local/organic farmer. The event activities include: 1) welcome speech by the chairman

of service learning activity, 2) the presentation of SL by each students group (3 groups), 3) sharing session between students and organic farmers, and 4) impressions and advice provided by the representative of Sugijapranoto University, Semarang and Chairman Gapoktan Mulyo Santoso. In the event mini-workshop was attended by: 1) organic farmers, 2) chairman of Sri Mulyo farmer groups and members, 3) head of the Women Farmers group and members of the Nusa Indah, 4) head GapoktanMulyo Santoso, 5) representatives of the Department of Agriculture Malang, 6) students, 7) lecturer at the Faculty of Agriculture Widya Karya Catholic University, Malang , 8) Prof Budi Widianarko and Mr.Haryo from Soegijapranata Catholic University, Semarang.

## 4. RESULT

Results ofthe implementation of Service Learning (SL) by sharing participants, are summarized in Table 1.

Table1.Results Activities Service Learning

Activity	Result
1. Investigation and Survey: explore the need and advantages of partners	✓ Universities connected with the community.
2. Preparation: debriefing and planning program	✓ Educate participants about the importance of organic farming to health and environmental sustainability

<p>3. <i>Live in:</i> cultivation and post-harvest</p>	<ul style="list-style-type: none"> <li>✓ Critical thinking and logical</li> <li>✓ Acquiring new skills is to work directly with the public</li> <li>✓ Increase understanding of academic material</li> <li>✓ Work with the community to help the participants aware of the strengths and weaknesses in person</li> <li>✓ Understand that Organic Agriculture is not just a concept in text books but must be applied in everyday life</li> <li>✓ Improving soft skills such as team work, communication, leadership, self-confidence, sense of responsibility</li> <li>✓ Service learning very enjoyable activity</li> <li>✓ Increased empathy and awareness of participants on the weak</li> <li>✓ Participants can learn, see, feel and appreciate the problems, the difficulties faced by the community</li> </ul>
<p>4. Reflection</p>	<ul style="list-style-type: none"> <li>✓ Increased student awareness of the values that made sublime organic farmers, particularly in preserving the environment and health food</li> <li>✓ There was a shared commitment to the development of organic farming</li> </ul>
<p>5. Mini Workshop</p>	<ul style="list-style-type: none"> <li>✓ Getting feed back and</li> </ul>

	<p>suggestions are very valuable as stock if they will work primarily in agriculture</p> <ul style="list-style-type: none"> <li>✓ Encourage participants so they are able and willing to try to open up business opportunities, participants are no longer looking for work (Job Seeker) but is capable of creating business opportunities (Job Creator)</li> </ul>
--	---



Fig. 1. Land cultivation and Planting seeds





Fig.2. Visits monitoring team from Soegijopranoto University



Fig.4. The cleaning process and process of draining



Fig.3. Vegetable harvest activities and the implementation of the sorting



Fig.5. Weighing and Packaging



Fig.6. Reflection and the real development of organic farming to community

#### D. CONCLUSION

From the service learning activities that have been performed it can be concluded that:

1. For student service learning activities are learning method that is particularly useful for developing soft skills, which they do not get in a classroom learning and Increased student awareness of the values that made sublime organic farmers, particularly in preserving the environment and health food
2. Service learning activities have been integrated into the curriculum in FP-UKWK so that they are easier in implementation, despite still being a new learning method.

#### 5. ACKNOWLEDGEMENT(S)

Acknowledgements submitted to the Soegijapranata Catholic University and United Board for Christian Higher Education in Asia which have financed the activities of Service Learning

#### 6. REFERENCE

Berry, Howard A &Chilsom, Linda A., 1999. Service Learning in Higher Education Around the World An Initial Look. The International Partnership for Service Learning, New York, USA.

Edina, 2013. Environmental Service-Learning. Available from: <http://edina.k12.mn.us/service-learning-edina/environmental-service-learning>. Accessed April 23, 2013

IFOAM, 2000. Basic Standard for Organic Production and Processing.IFOAM General Assembly.Swiss.

IFOAM, 2005. Principles of Organic Agriculture.Adelaide.

Jaker PO Indonesia, 2005. Indonesian organic farming standards. Solo

Madigan, P., 2000. *The Environmental Service-Learning Research Project*. Washington DC: Corporation for National Service National Service Fellowship Program.

Schulz,Jody, 2012. Life skills, service learning and project areas: Seeing the connection. Available from: [http://msue.anr.msu.edu/news/life\\_skills\\_service\\_learning\\_and\\_project\\_areas\\_seeing\\_the\\_connection](http://msue.anr.msu.edu/news/life_skills_service_learning_and_project_areas_seeing_the_connection). Accessed April 25, 2013

Widianarko, Budi, 2012. Service Learning in Environmental Sciences Nurturing Two Compatible Values.Graduate Program on Environmental and Urban Studies, Soegijapranata Catholic University (SCU).

## USING SERVICE-LEARNING IN AN AGRICULTURAL AREA IN GINTUNGAN TO ADDRESS ENVIRONMENTAL ISSUES

**Rully Adi Nugroho and Sucahyo**

Faculty of Biology; Satya Wacana Christian University, Salatiga, Indonesia  
[rully.adinugroho@staff.uksw.edu](mailto:rully.adinugroho@staff.uksw.edu)

### ABSTRACT

As the global population continues to increase, consumption patterns and agricultural practices will directly impact the surrounding environment. How well farmers manage natural resources, i.e. land, air, and water within the agricultural areas will directly relate to quality of life, health, and the economy of the communities. Faculty of Biology, Satya Wacana Christian University coordinated and facilitated the environmental service-learning program for our students. The goal of the program was to engage students in environmental stewardship activities to promote behavioral change and greater awareness. Students are introduced to the site, the activities for the day and the application to the course concepts. The students lived with farmers for three days in an agricultural area in Gintungan, Central Java, Indonesia. Daily activities involved assisting the farmers in farming, harvesting fruits, flowers, and vegetables, as well as helping the farmers with some household works (e.g. cooking, cleaning and childcare). After project completion, each student is required to reflect on what they have learned and how their service related to environmental issues, i.e. effects of pesticides on farmers health and the environment, and drew links between the social and personal aspects of the project and the academic curriculum. Excerpts from student reflection activity strongly indicate that participating in service-learning has changed their perception of their role in the environment. Service-learning also enhanced students' valuable academic skills, including communication, team-building, and critical thinking, and built their self-esteem.

**Keywords:** *service-learning, agricultural practices, environmental issues*

### INTRODUCTION

Environmental education faces the challenge of enabling students to see themselves as members of communities encompassing both human and nature and to recognize their responsibility not just to each other, but also as active participants in critical environmental issues. Previous studies suggested that conventional education programs are ineffective because they focus only on knowledge, whereby cognition or knowledge alone is not adequate to produce a change in behaviour (Kollmus and Agyeman, 2002; Pooley and O'Connor, 2000). Knowledge does

not provide citizens with the skills to combat environmental problems (Clifton et al., 1998).

Hunter and Brisbin (2000) found that most students ranked the service experience as the most important part of their overall university education. Therefore, programs may benefit by refocusing their attention on experiential education, such as environmental service-learning where civic skills and knowledge are coupled to provide a comprehensive understanding of environmental issues. Environmental service-learning means a teaching and learning strategy that integrates



meaningful community service with instruction and reflection to enrich the learning experience, teach civic responsibility, and strengthen communities (Hobert, 2010; Madigan, 2000).

To encourage students to apply classroom knowledge to real-world human health and environmental issues through active participation in considerably organized activity in their communities, Faculty of Biology, Satya Wacana Christian University coordinated and facilitated the environmental service-learning program for our students in an agricultural area in Gintungan, Central Java. The goal of the program is to engage students in environmental stewardship activities to promote behavioral change and greater environmental awareness.

## **METHODOLOGY**

Environmental service-learning program was conducted in the campus of Satya Wacana Christian University and in an agricultural area in Gintungan, Central Java (7°12'10.09"S, 110°21'25.93"E). According to the monography of Gintungan village, the ratio of males to females in the population was 0.9 and most of them were farmers and workers (89%). Farmers in Gintungan applied pesticides, herbicides and manures to their horticultural crops that were commonly produced for the market. The crops were sprayed with chemical pesticides until harvest time, and about 37% of the farmers even applied pesticides in mixtures (Ratnasari *et al.*, 2009). It is suggested that farmers use

pesticides without full understanding of their impact on environmental and human health.

The service-learning process consisted of selection of students as participants, program briefing, live-in, reflection, analysis, and evaluation. The relationship between the extent of pesticide-use and signs and symptoms of illnesses due to exposure among farmers of Gintungan and its implication on farmers' health and the environment were assessed descriptively.

## **RESULTS AND DISCUSSION**

Environmental service-learning aimed to provide students with the opportunity to study the impact of agricultural practices on human (farmers) health and the environment. The activities were started with selecting students as participants. Based on their interest and their knowledge on environmental issues, eight out of 25 applicants were selected to join the program. Prior to service-learning activities (i.e. live-in, reflection and mini workshop), all participants received program briefing on environmental service-learning, participatory and field research, the effects of pesticides on human health and the environment, description of study site, reflection method, research reporting and presentation technique.

We realized that choosing a community partner is a crucial step in developing effective service-learning experiences. However, we could build a successful partnership based on our experiences in volunteer service and being

aware of any potential problems. Before live in activity, we shared with farmers a common understanding of goals, operations, and benefits of partnership. Since farmers in Gintungan never become partners in service-learning program before, there were only two farmers offered to become host families and receive students in their home; although at the end of the program, after farmers realized the benefits to participating service-learning, many families offered to become host families for coming program. Farmers felt that service-learning participants helped out with farming and normal housework. Farmers were also proud of being able to take part in coaching student activities.

Every four students stayed in a host family for three days/two nights to get involved with their host in a tangible way by integrating service project with classroom learning. In these days, students explored the agricultural area and assisted the farmers in farming, harvesting fruits, flowers and vegetables, and even selling farmers' agricultural products in traditional market in Bandungan, Semarang. Students also helped the farmers with some household work (like cooking, cleaning and childcare).

After students completed their service-learning project, all of students sit in a circle reflected on what they have learned and how their service related to larger issues, i.e. effects of pesticides on farmers health and the environment, and drew links between the social and personal aspects of the project and the academic curriculum. In this reflection

session, students asked questions, and put facts, ideas, and experiences together to drive new meaning and new knowledge. The reflection was ended with making a personal reflection statement. Reflection has promoted student personal development by enhancing students' self-awareness, understanding of community, and their sense of their own capacities.

In reflection session, it revealed that students participating in service-learning had a tussle after they lived in the Gintungan village; they know some right things to do in agricultural activities but they could not direct the farmers to follow agricultural rules and protocols. For examples, many farmers, especially women farmers do not wear the recommended body protective gear during pesticide spraying, do not thoroughly wash clothes used during pesticide application, and do not rinse all empty pesticide containers properly before disposal. Many farmers do not understand the information displayed on pesticide product label. The information displayed on pesticide product label was not effective in the sense that the farmers do not read the labels let alone understood it. They however preferred the information given by their colleagues. Majority of the farmers keep the pesticides inside their houses, prepare it on the field and discard the empty packages into the field.

Since male farmers were higher than female farmers, students also suggested that women's roles in crop production have been marginalized. Women were more responsible for a large number of reproductive activities,

such as prepare meals, wash clothes, care of elders and children and the other “invisible” tasks that women perform every day. The gender roles in Gintungan seems similar to the gender roles in Northern Thailand (Eisses and Chaikam, 2002).

The service-learning program was closed with a mini workshop to discuss the environmental service-learning program and two results as examples of service-learning to students representing student association of some faculties at Satya Wacana Christian University. At the end of this discussion, service-learning participants stated that they contributed something meaningful through this service-learning and the farmers welcomed them with open arms. By participating in this environmental service-learning project, students are making a difference in their future and the future of our planet. Students gained new skills by working directly with the community. Service-learning also enhanced students’ valuable academic skills, including communication, team-building, and critical thinking, built their self-esteem, and developed their sense of responsibility for decision making. In a similar program, Kusmawan *et al.* (2009) compared a traditional to an active or experiential learning model and found the experiential learners gave environmental protection a greater priority than their non-experiential counterparts. Evidence suggests that service learners have felt that they made a positive contribution to the community they served (Billig & Conrad, 1997). Furthermore, these experiences can challenge students’

existing belief systems as they are confronted by the diverse perspectives of those they collaborate with (King, 2004).

Participants believe that continuing the visits to the farm will not only benefit the farmers, but also the faculty. This type of student learning experience should continue with future students, because as students, there are a lot of things they can learn from such an experience.

## CONCLUSION

Participation in service-learning has changed students’ perception of their role in the environment. Service-learning also provided opportunities for students to enhance students’ valuable academic skills, including communication, team-building, and critical thinking, and built their self-esteem.

## ACKNOWLEDGEMENT

This program was organized by Soegijapranata Catholic University, Semarang and financially supported by United Board for Christian Higher Education in Asia. The authors would like to acknowledge Andreas B. Aji, Juwita Natasia, Ria M.D. Wati, Sundarsih, Dorys Batunan, Gerardinalia Ngamelubun, Teodora G. Destiananda, and Tri K.K. Waruwu from Faculty of Biology Satya Wacana Christian University who participated in this program.

## REFERENCES

Billig S.H. and Conrad J. 1997. Annual report: K-12 service learning and educational reform

in new hampshire. Denver: RMC Research Corporation.

Clifton L., Mauney T., Falkner R. 1998. Take a class outdoors. A guidebook for environmental service learning. Linking learning with life. Clemson SC: National Dropout Prevention Center.

Eisses R. and Chaikam J. 2002. Organic farming and gender roles in Northern Thailand. LEISA Magazine pp. 26-27.

Hobert T.M. 2010. A follow-up study of eco education's environmental service-learning program. Dissertation. Faculty of the Graduate School, University of Minnesota, USA.

Hunter S. and Brisbin R.A.Jr. 2000. The impact of service learning on democratic and civil values. Polit Sci Polit 33: 623-626.

King J.T. 2004. Service learning as a site for critical pedagogy: A case of collaboration, caring, and defamiliarization across borders. J Exper Educ 26: 121-137.

Kollmus A. and Agyeman J. 2002. Mind the gap: Why do people act environmentally and what are the barriers to pro-environmental behaviour? Environ Educ Res 8: 240-260.

Kusmawan U., O'Toole J.M., Reynolds R. and Bourke S. 2009. Beliefs, attitudes, intentions and locality: The impact of different teaching approaches on the ecological affinity of Indonesian secondary school students. Int Res Geogr Environ Educ 18: 157-169.

Madigan P. 2000. The environmental service-learning research project. Corporation for National Service, Washington DC.

Pooley J.A.M. and O'Connor M. 2000. Environmental education and attitudes: Emotions and beliefs are what is needed. Environ Behav 32: 711-723.

Ratnasari D.K., Maskito E., Onthoni C.D., Nugroho R.A. 2009. Peran jender dan perempuan dalam pertanian hortikultura, dan implikasinya bagi kesehatan petani dan lingkungan. Bunga Rampai Karya Ilmiah Mahasiswa 2009. Universitas Kristen Satya Wacana, Salatiga.

## IMPROVING LEARNING OUTPUT OF SCIENCE EDUCATION COURSE THROUGH SERVICE LEARNING PROGRAM IN SDK SENGKAN AND SDK KALASAN, YOGYAKARTA

A. Tri Priantoro<sup>1)</sup>, Silverio R.L. Aji Sampurno<sup>2)</sup>

<sup>1)</sup> Biology Education Study Program, Sanata Dharma University, Yogyakarta

<sup>2)</sup> Center for Environmental Studies, Sanata Dharma University, Yogyakarta  
[trie003@gmail.com](mailto:trie003@gmail.com)

### ABSTRACT

Conventionally, learning process in the Science Education Course of PGSD USD is carried out in the classroom for the whole semester. Cognitive aspect and teaching skill are exercised through lecturing and microteaching. The student achievement of such activities cannot be effective due to students do not face the real school condition. In order to improve learning output of Science Education Course, Service Learning Program has been applied in SDK Sengkan and SDK Kalasan. Activities were designed to give real innovative teaching experiences to PGSD students that enable primary school students to have better understanding and care to the sustainable environment. Observation and the teaching learning process were done in the class (indoor) and or out site of the class (outdoor). Based on these observations, students studied literatures to find concepts and framework for problem solving particularly for rising environmental awareness. Further, students compiled lesson learn material for environmental awareness education and then the results were elaborated in an Action Plan (Proposal) for primary school targets. Six proposals were made by student groups that had been approved for SD Kanisius Sengkan and SD Kanisius Kalasan. Student targets were level 3, 4 and 5. Results indicated that all students found that teaching-learning process through service learning activities was very useful. The program had enabled them to have real experiences in teaching-learning processes. They knew how to deal with many unique students and how to handle class. They were aware that most of primary school students enjoyed learning outside the class to do something. Most members of Science Education Course realized that teaching-learning science could be interesting through exploring and learning by doing. They found that objects of science had to be around us. There fore, it was concluded that learning output of Science Education Course have been improved through Service Learning Program. Service-learning program also gave benefits to the three parties, i.e. PGSD students, primary school students, and teachers in different ways.

**Keywords:** *service-learning, learning-outcome, science-education, innovative-learning/teaching, reflection.*

### INTRODUCTION

Learning outcome can be defined as realization or improvement of potential skill or capacity that belong to someone. It can be seen in someone's behavior as a mirror of knowledge mastering, thought skill, psychomotor skill, and value internalization. Almost all behavior and activities showed by

many people are the result of learning processes (Sukmadinata, 2009; Sudjana, 2010). There are many factors that influence student-learning outcome. These factors basically can be divided into two categories, namely internal and external factors (Slameto, 2010). Internal factor includes biology factors (health, hearing and vision abilities),



psychological factors (intelligence, interest, motivation, and attention). External factor consists of family background, schools/institution, and societies. Improving learning outcome can be achieved through much stimulation so that internal and external factors can be directed to support the success of teaching learning processes.

Conventionally, teaching learning processes of many subjects/courses including Science Education Course in PGSD USD are carried out in site of the classrooms. Students attend the class regularly to receive course material. Delivery model applied usually are lecturing, discussion, and simulation of teaching-learning process of primary school. Such activities can result in high learning outputs, but it includes cognitive aspect only due to students are lack of real experience. To overcome this limitation we applied service-learning program to improve learning outcome of Science Education Course in PGSD USD. The focus was on skill and affective aspects.

Service learning has been seen as a form of experiential education in which students participate in activities that tackle community requests together with coordinated opportunity deliberately designed to encourage student learning and development. Student learn through applied, active, project-based learning that appeals on multiple knowledge sources (academic, student knowledge and experience, and community knowledge) and offers students with plentiful chances for ethical and critical reflection and practice (Hurd, 2006).

## **MATERIAL AND METHOD**

Introduction of service learning program was carried out through regular class meeting. Students of Science Education Class had to attend the classes regularly and received appropriate materials. The core materials were presented including the principal of science education for primary school, teaching learning strategies, teaching learning media, and teaching learning evaluation. Students were expected to have better understanding of the course material before they were sent to real teaching learning experiences through service learning program in the two selected Primary Schools, i.e. SDK Sengkan and SDK Kalasan. Both of them are located in Sleman District. Class members were grouped into 6, of which consisted of 8 students. Student coordinator organized the selections of group members. The first three groups went to SDK Sengkan and the second three groups went to SDK Kalasan. Each group in each school had to deal with one class of primary school students' level 3, 4 and 5 accordingly.

Activities designed in the service-learning program were observation, writing action plan, carrying out the plan, evaluating the activities, reflection, and writing report. It was emphasized that during observation students had to find the understanding and the need of primary school students, teachers, school head master, and students' parents regarding conservation of environmental resources. They had to find out the way on how to meet the various needs and then write an action plan

that reflect school and parents need based on the school curriculum.

## RESULTS AND DISCUSSION

### *a. Observation*

Students of Science Education Class have done observation in primary of SDK Sengkan and SDK Kalasan to identify environmental problems, identify students and parents' understanding related to environmental care. In SDK Sengkan they recognized that the school has been trying to rise up and maintain environmental awareness of students through many activities that would be routine activities and habit of all school members. This included personal cleanness, such as hand wash before and after eating, wearing clean clothes, and hair tidy up; and environmental cleanness such as putting garbage in the right place, class room cleaning, and keeping clean the toilet after using it. This activities have been enhanced through "Clean Friday" i.e. a school mobilization that is carried out every 2 week, every school member has an obligation to reminisce each other about environmental cleanness. Nevertheless, many school members aware that the progress was too slow. Most of students still throw garbage anywhere, lack of self maintenance and lack of environmental awareness; front yard was relatively tidy and clean but backyard was dirty and untidy including unmanaged fish ponds. There were herbal and vegetable gardens but the plants seemed to be not so fresh due to lack of water, no one taking care of the gardens. Parents at home also noticed

than their children were not so much care about plants and environmental cleanness.

In SDK Kalasan they found that actually the school already got award of *Sekolah Adiwiyata Mandiri* in 2010. This indicated that the school had capabilities to maintain environmental programs for 3 years continuously. They saw many supporting facilities for student environmental awareness movement even though the results were not as good as expected. This could be seen that many students still threw garbage everywhere particularly plastic wastes, and used water too much. School back yard was not managed properly.

### *b. Program Planning*

Based on the observations, students studied literatures to find concepts and framework for problem solving particularly for rising environmental awareness. Further, students compiled lesson learn material for environmental awareness education and then the results were elaborated in an Action Plan (Proposal) for primary schools. Six student groups that had been approved for SD Kanisius Sengkan and SD Kanisius Kalasan made six proposals. Student targets were level 3, 4 and 5. Action Plan of PGSD student groups must be completed with Teaching-Learning Activity Plan that indicated Competency Standard, Basic Competency, objectives, indicators, teaching-learning material, approach / method, teaching-learning processes, and evaluation. This instrument was

needed so that they could do implementation of the plan academically and systematically.

### ***c. Implementation of The Plan***

The realization of proposed activities were carried out through the implementation of various teaching-learning model, even though it could not be executed directly due to Easter Break of the schools. Schedules had to be rearranged after Easter break, two weeks later. Because of this, most of activities started in the middle of April and finished at the end of May 2012. Final report of each group was due on 15 June 2012. Table 1 is outline of teaching-learning activities as implementations of the plans of each group of PGSD Students during service learning program.

### ***d. Reflection***

During the time of service learning program, student group members carried out reflection twice, namely after action plan submission and at the end of the program. It was found that in the beginning of the program, most of students still did not know what to do with the program. Service learning approach was something new for them, and they had never thought about it. Fortunately, they enjoyed the work and follow the processes. They have learned a lot in the case of communication, working together, arguing, and teaching learning experiences even though they faced difficulties sometime.

In regard to the subject of science education for primary school, all students found that teaching-learning process through service

learning activities was very useful. The program had enabled them to have real experiences in teaching-learning processes. They knew how to deal with many unique students and how to handle class that was not conducive for teaching learning process. They were aware that most of students enjoyed learning outside the class. One of student said: *“It was beyond my expectation that teaching-learning processes in class was very impressive and enjoyable. Besides I had to learn how to teach, there was something new, I had to manage the teaching time and class interest. Something that made me very happy was that primary school students show me as a real teacher, not just a teacher candidate. They asked me when PGSD student would have similar project for them again. This was a challenge for me and made me eager to be a teacher without hesitate.”*

### ***f. Evaluation***

Evaluation was carried out twice at the end of April and May 2012 through mini workshop. The first workshop was done as a mean for each group to present progress report, to identify difficulties they faced and how they solved the problem. Other groups raised some suggestions for better implementation of the plan. This evaluation was also very important for course controller to make sure that the program was running well and it was not bias.

The second evaluation was carried out with presentation of each student group. They gave presentation of what they found interesting, the respond of parents, primary school

students and teachers; and what they have learned. Most of student groups reported that primary students enjoyed learning by doing, while teachers were happy to see examples of innovative teaching learning processes. In another time, school head master indicated that some student did not work properly due to lack of preparation.

## CONCLUSION

In conclusion, service-learning program was carried out appropriately and gave benefits to the science education students, primary school students, and teachers. Science education students experienced real teaching that improves their learning outcome including cognitive aspect, teaching skill aspect, patient and relatively confident. Environmental awareness of primary school students was increased as the result of interesting and innovative learning. Teachers of SDK Sengkan and SDK Kalasan got an example of innovative teaching-learning processes on science education.

## ACKNOWLEDGEMENT

This service-learning program was funded by United Board for Christian Higher Education in Asia organized by Soegijapranata Catholic University, Semarang.

## REFERENCES

- Slameto, 2010. Belajar dan factor-faktor yang mempengaruhinya. Rineka Cipta, Jakarta.
- Sudjana, Nana, 2010. Penelitian Hasil Proses Belajar Mengajar. PT Remaja Rosdakarya, Bandung.
- Sukmadinata, Nana Syaodih, 2009. Landasan Psikologi Proses Pendidikan. Remaja Rosdakarya, Bandung.
- Hurd, 2006. Is Service Learning Effective? [http://tilt.colostate.edu/sl/faculty/Is\\_Service-Learning\\_Effective.pdf](http://tilt.colostate.edu/sl/faculty/Is_Service-Learning_Effective.pdf) visited 1 May 2013

**Table 1. Outline of Service-learning / teaching-learning activities as implementations of the plans of each group of PGSD Students in SDK Sengkan and SDK Kalasan.**

Student Group	Service-Learning / Teaching-Learning Activity
PGSD1 SDK Sengkan	<ul style="list-style-type: none"> <li>• Introduction to students</li> <li>• Watching video of environmental degradation</li> <li>• Discussing video, so that students could give their thought</li> <li>• Observation of school environment to find out the environmental condition</li> <li>• Watching video of how to cultivate plant</li> <li>• Discussing video to facilitate students for sharing their thought and experiences</li> <li>• Cultivating herbal plants and vegetable plants</li> <li>• Giving real experiences of planting correctly</li> <li>• Writing journal on the development of the plants</li> <li>• Reflection, finding lesson learn and sharing students' feeling</li> </ul>
PGSD2 SDK Sengkan	<ul style="list-style-type: none"> <li>• Socialization of programs in the class level 4</li> <li>• Observation of fish ponds</li> <li>• Discussing about how to cultivate cat fish</li> <li>• Cleaning fish ponds</li> <li>• Cleaning fish ponds</li> <li>• Filling up fish ponds with suitable water</li> <li>• Discussing constrains of cultivating cat fish they would face</li> <li>• Releasing juvenile cat fishes in the ponds</li> <li>• Monitoring and maintaining cat fishes</li> <li>• Monitoring and maintaining cat fishes</li> <li>• Distributing juvenile cat fishes for students personally</li> </ul>
PGSD3 SDK Sengkan	<ul style="list-style-type: none"> <li>• Introduction</li> <li>• Watching video of waste management</li> <li>• Painting garbage bin</li> <li>• Practicum on light characteristic</li> <li>• Making periscope using recycle material</li> <li>• Watching video of photosynthesis</li> <li>• Filling up student work sheet</li> <li>• Creating art from dry leaf</li> <li>• Making mathematic media from used cartoon and pieces of cloth</li> <li>• Making album of student creation from recycle paper</li> <li>• Filling up questionnaire</li> <li>• Sayonara</li> <li>• Giving evaluation results</li> </ul>
PGSD4 SDK Kalasan	<ul style="list-style-type: none"> <li>• Presentation of the action plan</li> <li>• Watching video of environmental care</li> <li>• Making a simple water filter</li> <li>• Observation of school student houses</li> <li>• Meeting with school student parents</li> <li>• Student group evaluation</li> <li>• General evaluation with teachers and school head master</li> </ul>
PGSD5 SDK Kalasan	<ul style="list-style-type: none"> <li>• Presentation of the action plan</li> <li>• Meeting with teachers, school students, and school committee</li> <li>• Introduction</li> <li>• Watching video of environmental care: desa mina dan hutannya.</li> <li>• Writing student journal</li> </ul>

	<ul style="list-style-type: none"> <li>• Finding lesson learn</li> <li>• Home work</li> </ul>
	<ul style="list-style-type: none"> <li>• Energizing</li> <li>• Observation of school environment</li> <li>• Group discussion</li> <li>• Filling up student journal</li> <li>• Presentation</li> <li>• Finding lesson learn</li> <li>• Reflection</li> </ul>
	<ul style="list-style-type: none"> <li>• Cultivating vegetable and fruit plants in school yard</li> <li>• Cultivating vegetable and fruit plants at home garden</li> <li>• Filling up student journals</li> </ul>
	<ul style="list-style-type: none"> <li>• Evaluation: written test, homework/journal</li> </ul>
PGSD6	<ul style="list-style-type: none"> <li>• Preparing teaching learning media and sources particularly waste management</li> <li>• Making student worksheet, reflection sheet, and student journal</li> </ul>
SDK	<ul style="list-style-type: none"> <li>• Introduction to solid waste management</li> <li>• Doing the right thing: put garbage in the right places, waste segregation.</li> <li>• Filling up student work sheet</li> <li>• Student reflection</li> </ul>
Kalasan	<ul style="list-style-type: none"> <li>• Watching video of Wall-E</li> <li>• Student reflection</li> <li>• Household waste collection at home</li> </ul>
	<ul style="list-style-type: none"> <li>• Waste recycling</li> <li>• Increasing student creativity and care</li> </ul>
	<ul style="list-style-type: none"> <li>• Finishing recycled goods</li> <li>• Presentation of the creation</li> <li>• Celebration: singing and fun</li> </ul>

## IMPROVING LEARNING OUTPUT OF SCIENCE EDUCATION COURSE THROUGH SERVICE LEARNING PROGRAM IN SDK SENGKAN AND SDK KALASAN, YOGYAKARTA

A. Tri Priantoro<sup>1)</sup>, Silverio R.L. Aji Sampurno<sup>2)</sup>

<sup>1)</sup> Biology Education Study Program, Sanata Dharma University, Yogyakarta

<sup>2)</sup> Center for Environmental Studies, Sanata Dharma University, Yogyakarta  
[trie003@gmail.com](mailto:trie003@gmail.com)

### ABSTRACT

Conventionally, learning process in the Science Education Course of PGSD USD is carried out in the classroom for the whole semester. Cognitive aspect and teaching skill are exercised through lecturing and microteaching. The student achievement of such activities cannot be effective due to students do not face the real school condition. In order to improve learning output of Science Education Course, Service Learning Program has been applied in SDK Sengkan and SDK Kalasan. Activities were designed to give real innovative teaching experiences to PGSD students that enable primary school students to have better understanding and care to the sustainable environment. Observation and the teaching learning process were done in the class (indoor) and or out site of the class (outdoor). Based on these observations, students studied literatures to find concepts and framework for problem solving particularly for rising environmental awareness. Further, students compiled lesson learn material for environmental awareness education and then the results were elaborated in an Action Plan (Proposal) for primary school targets. Six proposals were made by student groups that had been approved for SD Kanisius Sengkan and SD Kanisius Kalasan. Student targets were level 3, 4 and 5. Results indicated that all students found that teaching-learning process through service learning activities was very useful. The program had enabled them to have real experiences in teaching-learning processes. They knew how to deal with many unique students and how to handle class. They were aware that most of primary school students enjoyed learning outside the class to do something. Most members of Science Education Course realized that teaching-learning science could be interesting through exploring and learning by doing. They found that objects of science had to be around us. There fore, it was concluded that learning output of Science Education Course have been improved through Service Learning Program. Service-learning program also gave benefits to the three parties, i.e. PGSD students, primary school students, and teachers in different ways.

**Keywords:** *service-learning, learning-outcome, science-education, innovative-learning/teaching, reflection.*

### INTRODUCTION

Learning outcome can be defined as realization or improvement of potential skill or capacity that belong to someone. It can be seen in someone's behavior as a mirror of knowledge mastering, thought skill, psychomotor skill, and value internalization. Almost all behavior and activities showed by

many people are the result of learning processes (Sukmadinata, 2009; Sudjana, 2010). There are many factors that influence student-learning outcome. These factors basically can be divided into two categories, namely internal and external factors (Slameto, 2010). Internal factor includes biology factors (health, hearing and vision abilities),

psychological factors (intelligence, interest, motivation, and attention). External factor consists of family background, schools/institution, and societies. Improving learning outcome can be achieved through much stimulation so that internal and external factors can be directed to support the success of teaching learning processes.

Conventionally, teaching learning processes of many subjects/courses including Science Education Course in PGSD USD are carried out in site of the classrooms. Students attend the class regularly to receive course material. Delivery model applied usually are lecturing, discussion, and simulation of teaching-learning process of primary school. Such activities can result in high learning outputs, but it includes cognitive aspect only due to students are lack of real experience. To overcome this limitation we applied service-learning program to improve learning outcome of Science Education Course in PGSD USD. The focus was on skill and affective aspects.

Service learning has been seen as a form of experiential education in which students participate in activities that tackle community requests together with coordinated opportunity deliberately designed to encourage student learning and development. Student learn through applied, active, project-based learning that appeals on multiple knowledge sources (academic, student knowledge and experience, and community knowledge) and offers students with plentiful chances for ethical and critical reflection and practice (Hurd, 2006).

## **MATERIAL AND METHOD**

Introduction of service learning program was carried out through regular class meeting. Students of Science Education Class had to attend the classes regularly and received appropriate materials. The core materials were presented including the principal of science education for primary school, teaching learning strategies, teaching learning media, and teaching learning evaluation. Students were expected to have better understanding of the course material before they were sent to real teaching learning experiences through service learning program in the two selected Primary Schools, i.e. SDK Sengkan and SDK Kalasan. Both of them are located in Sleman District. Class members were grouped into 6, of which consisted of 8 students. Student coordinator organized the selections of group members. The first three groups went to SDK Sengkan and the second three groups went to SDK Kalasan. Each group in each school had to deal with one class of primary school students' level 3, 4 and 5 accordingly.

Activities designed in the service-learning program were observation, writing action plan, carrying out the plan, evaluating the activities, reflection, and writing report. It was emphasized that during observation students had to find the understanding and the need of primary school students, teachers, school head master, and students' parents regarding conservation of environmental resources. They had to find out the way on how to meet the various needs and then write an action plan



that reflect school and parents need based on the school curriculum.

## RESULTS AND DISCUSSION

### *a. Observation*

Students of Science Education Class have done observation in primary of SDK Sengkan and SDK Kalasan to identify environmental problems, identify students and parents' understanding related to environmental care. In SDK Sengkan they recognized that the school has been trying to rise up and maintain environmental awareness of students through many activities that would be routine activities and habit of all school members. This included personal cleanness, such as hand wash before and after eating, wearing clean clothes, and hair tidy up; and environmental cleanness such as putting garbage in the right place, class room cleaning, and keeping clean the toilet after using it. This activities have been enhanced through "Clean Friday" i.e. a school mobilization that is carried out every 2 week, every school member has an obligation to reminisce each other about environmental cleanness. Nevertheless, many school members aware that the progress was too slow. Most of students still throw garbage anywhere, lack of self maintenance and lack of environmental awareness; front yard was relatively tidy and clean but backyard was dirty and untidy including unmanaged fish ponds. There were herbal and vegetable gardens but the plants seemed to be not so fresh due to lack of water, no one taking care of the gardens. Parents at home also noticed

than their children were not so much care about plants and environmental cleanness.

In SDK Kalasan they found that actually the school already got award of *Sekolah Adiwiyata Mandiri* in 2010. This indicated that the school had capabilities to maintain environmental programs for 3 years continuously. They saw many supporting facilities for student environmental awareness movement even though the results were not as good as expected. This could be seen that many students still threw garbage everywhere particularly plastic wastes, and used water too much. School back yard was not managed properly.

### *b. Program Planning*

Based on the observations, students studied literatures to find concepts and framework for problem solving particularly for rising environmental awareness. Further, students compiled lesson learn material for environmental awareness education and then the results were elaborated in an Action Plan (Proposal) for primary schools. Six student groups that had been approved for SD Kanisius Sengkan and SD Kanisius Kalasan made six proposals. Student targets were level 3, 4 and 5. Action Plan of PGSD student groups must be completed with Teaching-Learning Activity Plan that indicated Competency Standard, Basic Competency, objectives, indicators, teaching-learning material, approach / method, teaching-learning processes, and evaluation. This instrument was

needed so that they could do implementation of the plan academically and systematically.

### ***c. Implementation of The Plan***

The realization of proposed activities were carried out through the implementation of various teaching-learning model, even though it could not be executed directly due to Easter Break of the schools. Schedules had to be rearranged after Easter break, two weeks later. Because of this, most of activities started in the middle of April and finished at the end of May 2012. Final report of each group was due on 15 June 2012. Table 1 is outline of teaching-learning activities as implementations of the plans of each group of PGSD Students during service learning program.

### ***d. Reflection***

During the time of service learning program, student group members carried out reflection twice, namely after action plan submission and at the end of the program. It was found that in the beginning of the program, most of students still did not know what to do with the program. Service learning approach was something new for them, and they had never thought about it. Fortunately, they enjoyed the work and follow the processes. They have learned a lot in the case of communication, working together, arguing, and teaching learning experiences even though they faced difficulties sometime.

In regard to the subject of science education for primary school, all students found that teaching-learning process through service

learning activities was very useful. The program had enabled them to have real experiences in teaching-learning processes. They knew how to deal with many unique students and how to handle class that was not conducive for teaching learning process. They were aware that most of students enjoyed learning outside the class. One of student said: *“It was beyond my expectation that teaching-learning processes in class was very impressive and enjoyable. Besides I had to learn how to teach, there was something new, I had to manage the teaching time and class interest. Something that made me very happy was that primary school students show me as a real teacher, not just a teacher candidate. They asked me when PGSD student would have similar project for them again. This was a challenge for me and made me eager to be a teacher without hesitate.”*

### ***f. Evaluation***

Evaluation was carried out twice at the end of April and May 2012 through mini workshop. The first workshop was done as a mean for each group to present progress report, to identify difficulties they faced and how they solved the problem. Other groups raised some suggestions for better implementation of the plan. This evaluation was also very important for course controller to make sure that the program was running well and it was not bias.

The second evaluation was carried out with presentation of each student group. They gave presentation of what they found interesting, the respond of parents, primary school

students and teachers; and what they have learned. Most of student groups reported that primary students enjoyed learning by doing, while teachers were happy to see examples of innovative teaching learning processes. In another time, school head master indicated that some student did not work properly due to lack of preparation.

## CONCLUSION

In conclusion, service-learning program was carried out appropriately and gave benefits to the science education students, primary school students, and teachers. Science education students experienced real teaching that improves their learning outcome including cognitive aspect, teaching skill aspect, patient and relatively confident. Environmental awareness of primary school students was increased as the result of interesting and innovative learning. Teachers of SDK Sengkan and SDK Kalasan got an example of innovative teaching-learning processes on science education.

## ACKNOWLEDGEMENT

This service-learning program was funded by United Board for Christian Higher Education in Asia organized by Soegijapranata Catholic University, Semarang.

## REFERENCES

- Slameto, 2010. Belajar dan factor-faktor yang mempengaruhinya. Rineka Cipta, Jakarta.
- Sudjana, Nana, 2010. Penelitian Hasil Proses Belajar Mengajar. PT Remaja Rosdakarya, Bandung.
- Sukmadinata, Nana Syaodih, 2009. Landasan Psikologi Proses Pendidikan. Remaja Rosdakarya, Bandung.
- Hurd, 2006. Is Service Learning Effective? [http://tilt.colostate.edu/sl/faculty/Is\\_Service-Learning\\_Effective.pdf](http://tilt.colostate.edu/sl/faculty/Is_Service-Learning_Effective.pdf) visited 1 May 2013

**Table 1. Outline of Service-learning / teaching-learning activities as implementations of the plans of each group of PGSD Students in SDK Sengkan and SDK Kalasan.**

Student Group	Service-Learning / Teaching-Learning Activity
PGSD1 SDK Sengkan	<ul style="list-style-type: none"> <li>• Introduction to students</li> <li>• Watching video of environmental degradation</li> <li>• Discussing video, so that students could give their thought</li> <li>• Observation of school environment to find out the environmental condition</li> <li>• Watching video of how to cultivate plant</li> <li>• Discussing video to facilitate students for sharing their thought and experiences</li> <li>• Cultivating herbal plants and vegetable plants</li> <li>• Giving real experiences of planting correctly</li> <li>• Writing journal on the development of the plants</li> <li>• Reflection, finding lesson learn and sharing students' feeling</li> </ul>
PGSD2 SDK Sengkan	<ul style="list-style-type: none"> <li>• Socialization of programs in the class level 4</li> <li>• Observation of fish ponds</li> <li>• Discussing about how to cultivate cat fish</li> <li>• Cleaning fish ponds</li> <li>• Cleaning fish ponds</li> <li>• Filling up fish ponds with suitable water</li> <li>• Discussing constrains of cultivating cat fish they would face</li> <li>• Releasing juvenile cat fishes in the ponds</li> <li>• Monitoring and maintaining cat fishes</li> <li>• Monitoring and maintaining cat fishes</li> <li>• Distributing juvenile cat fishes for students personally</li> </ul>
PGSD3 SDK Sengkan	<ul style="list-style-type: none"> <li>• Introduction</li> <li>• Watching video of waste management</li> <li>• Painting garbage bin</li> <li>• Practicum on light characteristic</li> <li>• Making periscope using recycle material</li> <li>• Watching video of photosynthesis</li> <li>• Filling up student work sheet</li> <li>• Creating art from dry leaf</li> <li>• Making mathematic media from used cartoon and pieces of cloth</li> <li>• Making album of student creation from recycle paper</li> <li>• Filling up questionnaire</li> <li>• Sayonara</li> <li>• Giving evaluation results</li> </ul>
PGSD4 SDK Kalasan	<ul style="list-style-type: none"> <li>• Presentation of the action plan</li> <li>• Watching video of environmental care</li> <li>• Making a simple water filter</li> <li>• Observation of school student houses</li> <li>• Meeting with school student parents</li> <li>• Student group evaluation</li> <li>• General evaluation with teachers and school head master</li> </ul>
PGSD5 SDK Kalasan	<ul style="list-style-type: none"> <li>• Presentation of the action plan</li> <li>• Meeting with teachers, school students, and school committee</li> <li>• Introduction</li> <li>• Watching video of environmental care: desa mina dan hutannya.</li> <li>• Writing student journal</li> </ul>

	<ul style="list-style-type: none"> <li>• Finding lesson learn</li> <li>• Home work</li> </ul>
	<ul style="list-style-type: none"> <li>• Energizing</li> <li>• Observation of school environment</li> <li>• Group discussion</li> <li>• Filling up student journal</li> <li>• Presentation</li> <li>• Finding lesson learn</li> <li>• Reflection</li> </ul>
	<ul style="list-style-type: none"> <li>• Cultivating vegetable and fruit plants in school yard</li> <li>• Cultivating vegetable and fruit plants at home garden</li> <li>• Filling up student journals</li> </ul>
	<ul style="list-style-type: none"> <li>• Evaluation: written test, homework/journal</li> </ul>
PGSD6	<ul style="list-style-type: none"> <li>• Preparing teaching learning media and sources particularly waste management</li> <li>• Making student worksheet, reflection sheet, and student journal</li> </ul>
SDK	<ul style="list-style-type: none"> <li>• Introduction to solid waste management</li> <li>• Doing the right thing: put garbage in the right places, waste segregation.</li> <li>• Filling up student work sheet</li> <li>• Student reflection</li> </ul>
Kalasan	<ul style="list-style-type: none"> <li>• Watching video of Wall-E</li> <li>• Student reflection</li> <li>• Household waste collection at home</li> </ul>
	<ul style="list-style-type: none"> <li>• Waste recycling</li> <li>• Increasing student creativity and care</li> </ul>
	<ul style="list-style-type: none"> <li>• Finishing recycled goods</li> <li>• Presentation of the creation</li> <li>• Celebration: singing and fun</li> </ul>

## **GROWING STUDENT SENSE OF CARING ON COMMUNITY HEALTH PROBLEMS WITHIN NUTRITION AND HEALTH SCIENCE COURSE**

**Luisa Diana Handoyo**

Biology Education; Faculty of Teacher Training and Education; Sanata Dharma University  
[luisadianahandoyo@yahoo.com](mailto:luisadianahandoyo@yahoo.com)

### **ABSTRACT**

Nutrition and health science course is intended for the 5th semester student of Biology Education at Sanata Dharma University Yogyakarta. This course learn about the various nutrients needed by the body to grow and develop properly. After attending this course the students are expected to understand and explain the need for nutrition, healthy eating, the role of nutrition on health and be able to apply the principle of diversification in everyday life. Pos Pelayanan Terpadu (Posyandu) is a routine agenda that held each month in each village in Indonesia. Generally, the activity at posyandu are growth monitoring sessions, weight- height measurement and given supplementary feeding for children under the age of 5 years. There are so many health problems that were found in children, such as less weight or illness that often affects children such as coughs and colds. All of that problems caused by lack of knowledge of the people, especially the mothers about how to make a healthy living. As a Biology Education students who are concerned about these issues and already get a lesson about health and how to make a healthy living, they share their knowledge through the community at Posyandu by making a small program that they designed by themselves. Some of the programs carried out by the student is counseled about how to brush their teeth properly, counseling how to wash childrens hands properly and consultation on healthy foods. From these activities, they can interact directly with the community, find out their problems and provide solutions for improving the health of the community.

**Keywords:** *nutrition and health science , posyandu, healthy living, sense of caring, community health*

### **INTRODUCTION**

Sanata Dharma University (henceforth SDU), as a Jesuit university in Indonesia, participate in developing science, technology and art, in order to support the goals of national education in Indonesia. SDU based their approach to education in promoting human as an subject, rather than as an object lesson. In the process of learning in SDU develop models that stem from the Ignatian Pedagogy has been developed in the tradition of Jesuit education, with primary focus is to develop students into a whole person. In this case the process of learning in SDU is an integral part

of the struggle for humanity in the academic realm for making individuals who have always dreamed of and seek greater common good. SDU students are expected to not only have a good competence but also expected to have a good conscience and compassion as well. An attempt to apply such design to one of the major courses of the BS Biology Education programs was done by blending the usual lecture type of course delivery with service-learning.

Service learning is a method of teaching that combines formal instruction with a related service in the community. Service is integrated

into the course curriculum and requires that students reflect on their service activity. Good definition was given by Bringle et al. (2003):

”Service-learning is a credit-bearing, educational experience in which students participate in an organized service activity that meets identified community needs and reflect on the service activity in such a way as to gain further understanding of course content, a broader appreciation of the discipline, and an enhanced sense of civic responsibility”

During the 5th semester, service-learning design was employed in nutrition and health science course. This course learn about the various nutrients needed by the body to grow and develop properly. After attending this course the students are expected to understand and explain the need for nutrition, healthy eating, the role of nutrition on health and be able to apply the principle of diversification in everyday life.

## **METHODOLOGY**

Service learning was implemented on regular class meeting. The students of Nutrition and Health science gain the necessary theory. Service learning program was student's final project with the main objective to implement the theory that they've got in class to society. Students were divided into 13 groups, which consists of 3-4 students. Phase in this service-learning activity were observation, planning, implementation, reflection, and writing report. Each group of students was asked to make a

program of outreach to the community through a Posyandu that regularly held every month.

This study used a descriptive method of research to look into the different phases of the service learning design employed in Nutrition and Health Science course. This study involved 50 third year college students who were enrolled in the class of Nutrition and Health Science during the first semester of School year 2012-2013. Data and other information needed in this study were gathered mainly through reflections of the students during the informal interview and documentary analysis.

## **RESULT AND DISCUSSION**

### **A. Observation**

Observations carried out by each group at the end of October until the beginning of November 2012. Within observations, they seek Posyandu target where they will make a program. Posyandu to be used as the location for the implementation of the program was in Yogyakarta and surrounding areas. In this observation the students looking for information about the implementation date, place, time, number of children under five and the elderly are served, routine activities held at Posyandu and health problems that are often experienced by young children under 5 years and elderly.

Within this observation students found that Posyandu routinely held in each village on a fixed date each month. Posyandu is served by

a cadre that concised of people around the neighborhood health center voluntarily. Routine activities carried out are weighing, measuring height, write data in *Kartu Menuju Sehat* (KMS = Books Health Card), and supplementary feeding for children under five year. In addition, Posyandu also serve immunization, examination of pregnant women, family planning consultation and blood pressure checks for the elderly. Supplementary feeding activities for toddlers is a routine activity that always involves all of society. Taking turns citizens groups tasked to provide additional food for children that check their health. The cost for the additional food comes from Posyandu subsidies and partly a non-governmental funds. Distributed food was very variated, from green bean porridge, eggs, up to a full meal with rice, side dishes, vegetables and fruit.

Based on interviews with Posyandu administrators, students found several issues relating to public health. They identified a seasonal disease, primarily due to the change of seasons such as cough and influenza that often affects infants and childrens. In some Posyandu there is some cases of malnutrition or poor nutrition. In the elderly, mostly health problems founded was high blood pressure (hypertension).

Obstacles encountered during the of observation is a matter of time. Some Posyandu carry out its activities in the morning along with time college student, so that some groups of students ask for

permission because they can not attend a course on the day of the program. Besides the issue of implementation time, some groups experienced problems in finding a Posyandu where the program will be executed. In addition, from the students, there is one group whose each members seek Posyandu so they have to compromise to determine which one will be used to implement the program.

### **B. Program Planning**

After students identify problems that exist in society, they began to plan programs for solved the existing problems. Based on the literature study and observation they developed a program that is appropriate to address the problems faced by the community. Through discussion concluded that the source of the health problems faced by the community is the lack of public knowledge about health and less knowledge about good and balance nutrition for the children. Students prepare all necessary purposes to run the program, including making leaflets for counseling program. In outline, student programs can be grouped into 2 major groups of activities, namely (1) Counseling regarding a healthy diet and balanced for childrens and (2) Guidance on how to maintain health for childrens.

### **C. Program Implementation**

The program was held in November 2012 in accordance with a schedule each Posyandu as seen at table 1. Students help all activities at



Posyandu ranging from site preparation, set all equipment needed, all purposes are used, for example, setting up tables, stationary, standing and hanging scales, height measuring meter, sphygmomanometer and stethoscope. In the implementation of Posyandu students directly involved in helping all of the activities include weighing, measuring height, the data recorded in the Health Card (KMS), given supplementary feeding, measuring blood pressure for elderly peoples and doing health education in accordance with the planned program.

**Table 1.** Schedule of Program Implementation

Gr p	Place of Posyandu	Date
1	Posyandu Dadap Jingga, Gondomanan, Yogyakarta	17-11-2012
2	Posyandu Apokad II, Jombor, Sleman	17-11-2012
3	Posyandu Ngudi Rahayu 3, Prambanan, Klaten	21-11-2012
4	Posyandu Mawar, Blendengan, Berbah, Sleman	25-11-2012
5	Posyandu Eka Cipta Sari, Muntilan	21-11-2012
6	Posyandu Dusun Kembang, Maguwoharjo	19-11-2012
7	Posyandu Koroulon Kidul	21-11-2012
8	Dusun Demangan Yogyakarta	23-11-2012
9	Dusun Ngabean, Ngaglik, Sleman	22-11-2012
10	Posyandu Kunthi, Kaliwaru, Ngaglik, Sleman	19-11-2012
11	Posyandu Teratai, Banjarbaru, Bantul	18-11-2012
12	Posyandu Salak Pondoh, Sambilegi, Sleman	21-11-2012
13	Posyandu Nangka, Karang Ploso, Maguwoharjo	13-11-2012

Some counseling conducted by the students as follows: (1) Guidance on healthy foods and variations for toddlers as well as the correct

way to cook vegetables, (2) Counseling regarding a healthy and balanced diet for toddlers, (3) Health education and nutrition for babies and toddlers; (4) Socialization to brush teeth properly from an early age, and (5) The importance hand wash habit at an early age.

The programs conducted by the students are very welcomed by community who regularly bring their children to the Posyandu for health checking. Enthusiasm shown by the community as seen in the sharing and discussion with students on the topic of counseled. The cadres also felt happy and was helped by the presence of students. Good reception is very supportive for students to continue a variety of activities that the end goal is for the good and welfare of the community.

#### **D. Reflection**

Reflection conducted at the end of the program. From sharing and documentation known that at the beginning of the activities students are still confused about the program design and where the implementation of the program will executed. Several times the students had to drive around Yogyakarta to find a suitable location for the implementation of this program. Through an ongoing process, at the end the students feel happy and take benefit from the implementation of service learning. These benefits are not only felt by the students, but also felt by the communities they serve. Here are some of the benefits of

service learning activities in the subjects of nutrition and health course:

- Students can socialize with community directly so the ability for communication increased
- Improve their confidence
- Sharpen students' skills in identifying problems and finding solutions
- Students can learn about the implementation of the Posyandu directly
- Provide new knowledge to the students about Posyandu
- Students can find out more about nutritional status of infants and toddlers in the community

Benefits perceived by the cadres and the public include:

- Assisted with the arrival of the students who participated in the activities of Posyandu
- Increasing public knowledge about healthy foods for their children and how to cook vegetables the right way
- Helping one of government program in achieving nutrition-conscious families
- Growing awareness of parents about the importance of dental health for children
- Increase public knowledge about how to maintain the cleanliness and health for children

Some of the results of student reflection, I quote as follows:

- "I was pleased with the Posyandu activity, although initially difficult to find a place for doing the program but at the end I was satisfied because I can share my knowledge to the community"
- "Our group felt less satisfied with the implementation of the counseling because we still can not answer the people questions that asking why carrots should not be cooked together with spinach, but we are trying to deliver the program as best as possible"
- "I get a new experience at Posyandu, because as a child I was never invited to the Posyandu. Apparently there is an activities that help people to maintain their health. Really interesting experience "
- "Sharing the health problems, open our mind that a lot of health problems that children faced every day. Hopefully all of our activities can provide a benefit for the community"
- "Knowledge about good nutrition for infants, children, adults and the elderly are particularly important to maintaining a healthy body"

From that reflection can be seen that the students take a lot of the benefits from service learning activities that they carry out. Sense of awareness for the community began to grow in each student. They try to identify the problem and then try to create a program that can solve the problems. Service learning activities in the

Nutrition and Health science course is a way to foster student awareness of the problems that occur in the community.

Not only stop at such activities, through the nutrition and health science course there is a group of students who care about the community also submitted a proposal to the Department of Higher Education through Student Creativity Program in the field of Community Service. Some of their proposal can be funded by the Department of Higher Education and now still in the process of implementation.

## CONCLUSION

From this study it can be concluded that the concept of Nutrition and Health Science course can be clearly understood by the student if the existing theory can be directly implemented in everyday life. Service-learning activities is one great way for students to apply the theory they have acquired in the class. In addition, with this activity students can also develop a sense of caring on for the health problems that are often faced by the community.

## ACKNOWLEDGEMENT

Author wish to express my gratitude to the Biology Education Study Program that supported this service learning activities which integrated in the Nutrition and Health Sciences course. I am grateful to all my Biology Education students who participated in Nutrition and Health Sciences course.

## REFERENCES

Anonim. (2011). Pedoman Umum Pengelolaan Posyandu. Kementrian Kesehatan RI. Jakarta.

Anonim. (2012). Pedoman Model Pembelajaran Berbasis Pedagogi Ignasian. P3MP-LPM USD. Yogyakarta.

Bringle, R. G., Phillips, M. A., and Hudson, M. (2003). The Measure of Service Learning: Research Scales to Assess Student Experiences. American Psychological Association, Washington, DC.

Kastuhandani, Fidelis Chosa. (2012). Our Dream, Effort, and Reflection: AJCU SLP Participant's Lived Experience. Paper presented in ASEACCU Conference. Wenzao Ursuline College of Languages. Taiwan.

Lunar Bernardo C. (2012). Creating Environmental Awareness and Sensitivity through Service Learning in Ecology Class. Paper presented in ASEACCU Conference. Wenzao Ursuline College of Languages. Taiwan.

## **SERVICE LEARNING IN SMALLHOLDER DAIRY FARMING AREA CASE STUDY ON SIDOMAKMUR I FARMER GROUP, GEDANG ANAK VILLAGE, EAST UNGARAN DISTRICT, SEMARANG REGENCY**

**Lutfi Aris Sasongko<sup>1)</sup>, Helmy Purwanto<sup>2)</sup>**

<sup>1)</sup> Department of Agribusiness, Faculty of Agriculture, Wahid Hasyim University, Semarang, Indonesia

<sup>2)</sup> Department of Mechanical Engineering, Faculty of Engineering, Wahid Hasyim University, Semarang, Indonesia  
[sasongko1976@gmail.com](mailto:sasongko1976@gmail.com)

### **ABSTRACT**

Service-learning (SL) is a teaching and learning strategy that integrates meaningful community service with instruction and reflection to enrich the learning experience, teach civic responsibility, and strengthen communities. In this case study, service learning is implemented in Ruminant Livestock Production lecture. Through these activities students learn the concept of dairy production, dairy processing and eco friendly waste management of livestock. These become the provision of cooperation with Sidomakmur I Farmer Group, Gedang Anak Village, East Ungaran District, Semarang Regency in formulating concepts and action plans to increase farmer incomes that are environmentally friendly. Placement of students on a Smallholder Dairy Farming Group provides an opportunity such as, good communication process, problem analysis, and service through a process of reflection. Reflection concluded the problems occur in the community and how to find alternative solutions. The problems identified include (1) milking dairy products processed traditionally and marketed in the surrounding area, partly sold to the cooperative (2) no data recording and livestock history record, and (3) waste has not managed optimally. Problem-solving made in the placement of participants in the second SL live in, in which participants directly try to provide alternative solutions to problems ranging from livestock management, production management and marketing of livestock. Through Service Learning, farmers can more easily recognize the potential and problem on doing dairy farming business. So, the concept and formulated action plans can be easily implemented as appropriate to the needs of farmer group member.

**Keywords :** *service learning, ruminant livestock production, dairy farming*

### **INTRODUCTION**

Service Learning (SL) as an innovative method of teaching at the Faculty of Agriculture, Wahid Hasyim University offered to students who are actively interested in achieving the learning objectives while developing soft skill competencies for the personality development. Service-learning can help students become better learners, classmates, and citizens, and can help them make a valuable contribution to their communities (RMC Research

Corporation, 2009). Seifer & Connors (2007) stated that service-learning is a teaching and learning strategy that integrates meaningful community service with instruction and reflection to enrich the learning experience, teach civic responsibility, and strengthen communities. It is a method of encouraging student learning and development through active participation in thought-fully organized service that is conducted in, and meets the needs of, a community (EPA, 2011). Seifer &

Connors (2007) stated that SL presents the students with “transformational learning experiences” for it increases community understanding among faculty and brings new directions and confidence to the teaching and scholarly pursuits of the faculty involved; moreover it can contribute to social-economic benefits to the community partners.

SL approach in the Faculty of Agriculture, Wahid Hasyim University was performed and practiced on Ruminant Livestock Production lecture. Livestock is one of the many efforts made by the people of Indonesia who managed both professionally and as a sideline. Farm business prospects are still very promising, because the demand for livestock and livestock products are still not sufficient for the consumer. However, with the development of business activities, the greater livestock animal waste generated which resulted in the decrease of environmental conditions that can affect the activity and public health. Livestock waste can cause pollution both air pollution, water pollution and soil pollution if not managed properly.

One of the cattle businesses that continue to be developed by the government is enterprises of dairy cattle. Dairy cow population in Indonesia is only 495,231 cows with population growth

rate reached 4.32% per year. Spread of dairy cattle population is concentrated in Java (97%) and the average production per cow 10.5 liters / day. The low capacity of dairy cow productivity caused that 95% of dairy cows managed by small farmers with infrastructure conditions are very limited maintenance with business scale 3-4 cows and orientation is still a sideline business (Direktorat Jenderal Peternakan, 2010).

Gedang Anak Village which is one of the villages in the East Ungaran District, Semarang Regency, Central Java Province, which has a majority population of dairy cattle businessmen and are members of the dairy farmers group Sidomakmur I. In general, dairy farming is done by members of Sidomakmur I as a sideline business in traditional way.

## **METHODOLOGY**

Activities conducted in April and May 2012, the lecture conducted at Campus of Wahid Hasyim University and as objects of service is dairy farmers group Sidomakmur I Gedang Anak Village, East Unggaran District, Semarang Regency. Students who engage in this activity amounted to 22 students who were divided into 5 groups, accompanied by 5 lecturers as facilitators.

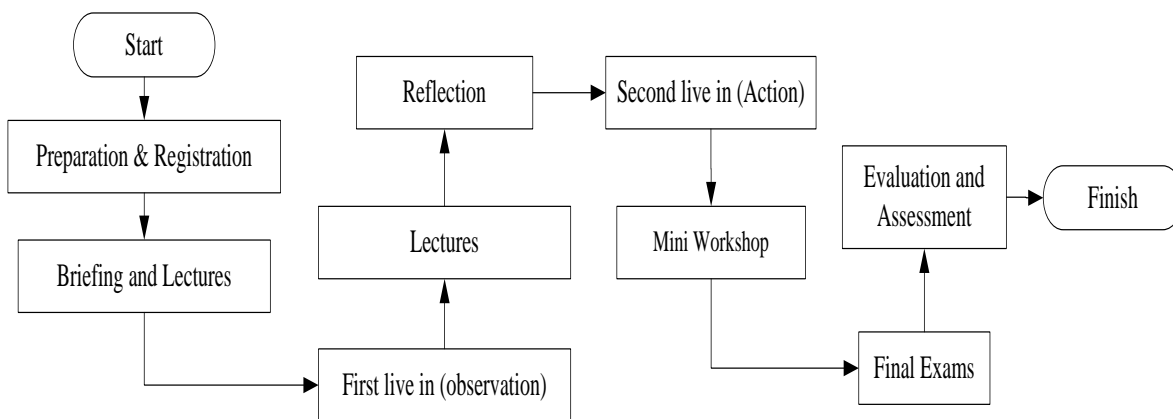

**Figure 1.** Flow Chart of SL Program Activities

Students are given a briefing and introductory lectures on Ruminant Livestock Production and then placed to the community (first SL live in). In this activity students gathered together with the community to investigate the problems faced. Investigation results in the first SL live in used as material for discussion and reflection to solve the problem. Problem

solving recommendation will be realized in the second SL live in that involving dairy farmers group. Further, the whole process of service learning activities presented at the mini workshop attended by participants, facilitators, representatives of dairy farmers and other stakeholders. The process is presented in Figure 1.

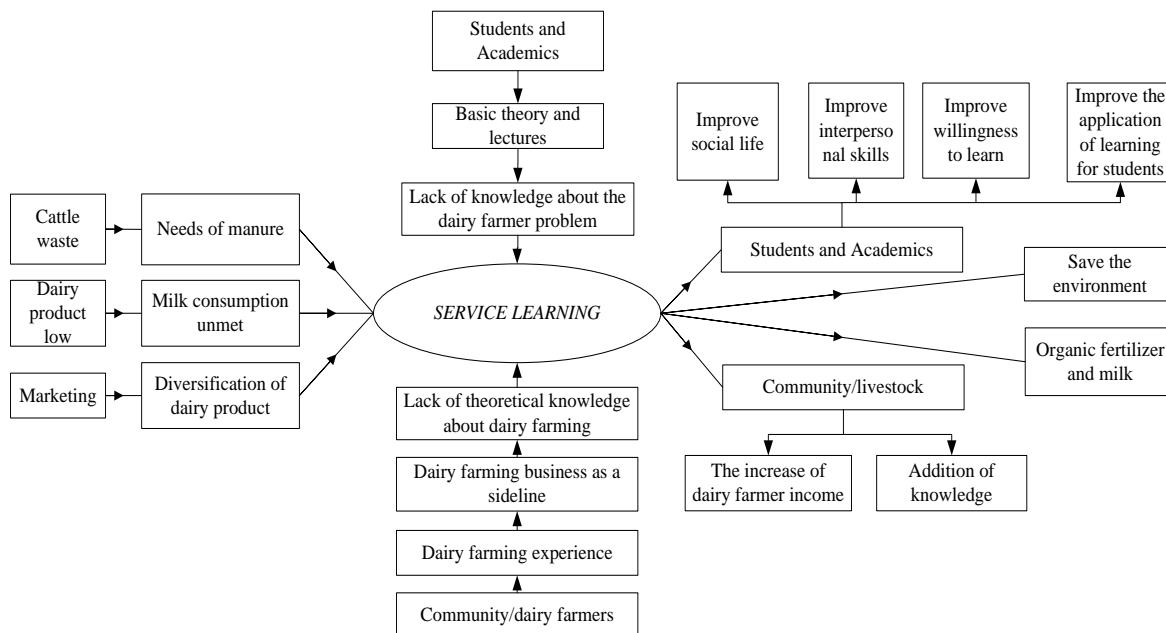

**Figure 2.** Thought Flow Concept and Framework SL Programme

## RESULTS AND DISCUSSIONS

Service Learning in smallholder dairy farming area start with briefing and introductory lecture activity. This is done by providing sufficient material to participants about what is meant by service learning, goals, targets and expected outputs. Participants were given a brief overview of service learning by providing examples of general problems in society. This activity was followed by subsequent lectures. Through these activities students learn the concept of dairy production, dairy processing and eco friendly waste management of livestock.

Result of participant observations that conducted on the first SL live in is that dairy farming business in dairy farmers group Sidomakmur I was still relatively traditional. In general, members of the dairy farmers group Sidomakmur I carry on dairy farming business as a sideline. Enclosure has been made on a location far enough away from the settlement but enclosure conditions are still far from the maintenance requirements of dairy cattle. Feed given to the cattle is grass and sometimes given extra feed in the form of cassava peel waste and other nutrients. Forage nutrient enrichment has not been carried out on a regular basis due to limited maintenance costs. Problems faced by groups such as :

1. Milking dairy products processed traditionally and marketed in the surrounding area, partly sold to the cooperative

Milking is done twice a day, with milking results ranging 16-25 liters / cow / milking. Dairy cow results collected in milk can. By the time the milk out after milking, milk is a pure material, hygienic, high nutritional value and is sterile. However, after a while in the room temperature, the milk is very sensitive to contamination that can degrade the quality of milk. Under normal circumstances, milk only lasted a maximum of 4 hours after milking without damage or loss of quality (Balitbang Pertanian, 1998). Given the perishable nature of milk, dairy farmers prefer to sell their cow milk directly to collectors / middlemen after milking. These situations make dairy farmers have no bargaining power against the sale price of cow milk. Prices depend on middlemen and milk quality milking results.

2. No data recording and livestock history record

Data recording of dairy cows has not done, while recording is very important to know the condition of dairy cows.

3. Waste has not managed optimally

Fases of dairy cow and urine are waste of livestock that has not been used optimally, although in the enclosure area has made equipment to create biogas and composting. Biogas that generated, based on interviews with farmers, only used for enclosure area while for households in residential areas have not been used. Composters are not used because of the high cost of production while composting results can not be sold to cover the

costs of production. So that most of the waste is not utilized and accumulates in the enclosure area that potentially to environmental contamination. Sudiarto (2008) stated that livestock waste is a mainstay ingredient of fertilizer needs. However, due to inadequate management of the majority of farm waste it is still a major cause of environmental pollution.

Based on the result of observations on first SL live in conducted an evaluation through reflection activities undertaken by participants that guided by facilitator. Reflection concluded the problems occur in the community and how to find alternative solutions. It provides the time and opportunity for students and partners to grow and evolve as a result of their experiences within a service-learning course (Seifer & Connors, 2007).

Problem-solving made in the placement of participants in the second SL live in, in which participants directly try to provide alternative solutions to the problems. Problem-solving efforts that conducted on second SL live in are:

1. Conduct training and mentoring related product processing to increase shelf life products so dairy farmer have stronger bargaining position.

To prevent damage of milking product, dairy farmers encouraged to always maintain the cleanliness. In addition, SL participants also train dairy farmers in order to process milk

product to make it has longer shelf life. Based on lecture material that has been acquired, students train dairy farmers to process dairy product through short pasteurization process (temperature 85-95 °C for 1-2 minutes), making yogurt and packaging. With product processing, dairy farmers are expected to enjoy higher prices for manufactured dairy products.

2. Guidance related to the data recording and cattle history record

SL participants with dairy farmers explore the importance of data recording and assisting dairy farmers to make the data recording and cattle history books. Without a well-documented data, farmers often rely on memory-related history of his cattle. Whereas with the complete data that well documented, it would be easy for the dairy farmer to know the history of his cattle especially from the aspect of daily milk yield. This data is also important when the dairy farmer want to sell their cattle. Buyers will be more comfortable buying dairy cattle which its history is clear and well-documented.

3. Conduct training and mentoring of cattle waste utilization

SL Participants introduces the concept of a harmonious balance between production, profits and environmental quality. Waste management system is the correct and proper application, not only can solve the pollution caused, but also expected to give effect to increasing dairy farm profits (Sudiarto, 2008).



Therefore, SL participants assisting dairy farmers to manage cattle waste into compost that environmentally friendly. Sudiarto (2008) stated that environmentally friendly waste management is that management does not lead to a lowering of environmental capacity.

## CONCLUSION

The involvements of participants in the SL program that placed and live together with the dairy farmer (in the first SL live in and the second SL live in) make a special experience for the participants. SL approach that performed and practiced can improve social life, interpersonal skills, willingness to learn, and the application of learning for students. It also provides knowledge/ training of dairy cattle farming, processing technology and livestock waste management for the farmers so make their income increase.

## ACKNOWLEDGEMENT

We would like to thank the institutions and the people who have helped the implementation of this SL Programme, especially to UBCHEA, Unika Soegijapranata and Prof. Dr. Ir. Budi Widianarko, M.Sc.

## REFERENCES

- Badan Penelitian Dan Pengembangan Pertanian, Instalasi Penelitian Dan Pengkajian Teknologi Pertanian (1998). Pasca Panen Susu. Jakarta: Kementerian Pertanian Republik Indonesia.
- Direktorat Jenderal Peternakan. (2010). Statistik Peternakan 2010. Jakarta: Kementerian Pertanian Republik Indonesia.
- Direktorat Jenderal Peternakan. (2012). Pedoman Teknis Pengembangan Budidaya Sapi Perah Pola PMUK. Jakarta: Kementerian Pertanian Republik Indonesia.
- EPA. (2011). Service-Learning. Education beyond Classroom. Washington D.C. Environmental Protection Agency. Downloaded from <http://www.epa.gov/osw/education/pdfs/svclearn.pdf>
- RMC Research Corporation. (2009). K-12 Service-Learning Project Planning Toolkit. Scotts Valley, CA: National Service-Learning Clearinghouse, Updated Edition. Downloaded from [www.servicelearning.org/library/re-source/8542](http://www.servicelearning.org/library/re-source/8542).
- Seifer SD and Connors K. (Eds.) (2007). Community Campus Partnerships for Health. Faculty Toolkit for Service-Learning in Higher Education. Scotts Valley, CA: National Service-Learning Clearinghouse. Downloaded from [http://www.servicelearning.org/file-manager/download/HE\\_Toolkit\\_with\\_worksheets.pdf](http://www.servicelearning.org/file-manager/download/HE_Toolkit_with_worksheets.pdf)
- Sudiarto, B. (2008). Pengelolaan Limbah Peternakan Terpadu Dan Agribisnis Yang Berwawasan Lingkungan. Makalah disampaikan pada Seminar Nasional Teknologi Peternakan dan Veteriner 2008 Downloaded from <http://peternakan.litbang.deptan.go.id/fullteks/semnas/pro08-8.pdf>

# INTERRELATIONSHIP AMONG EDUCATIONAL ATTAINMENT, POVERTY INCIDENCE, LIFE EXPECTANCY AND HEALTH WITH ENVIRONMENTAL QUALITY INDEX

**Irdam Ahmad**

Muhammadiyah Prof. Dr. HAMKA University, Jakarta, Indonesia  
[irdam\\_ahmad@yahoo.com](mailto:irdam_ahmad@yahoo.com)

## ABSTRACT

The objective of this research is to find out interrelationship among educational attainment, poverty incidence, life expectancy and health with environmental quality index. Panel data, consist of 31 provinces during the year of 2008-2010, used in this research. Simple linear regression model is employed to analyse the data. The results show that educational attainment (mean years of schooling) has positive impact on environmental quality index, while poverty incidence (percentage of population below poverty line) has negative impact on environmental quality index. Meanwhile, environmental quality index has positive impact on expectation of life at birth, that every 10 point increase of environmental quality index will increase expectation of life at birth about 1.2 months. While, the environmental quality index has negative impact on percentage of population who fell sick, that every 10 percent increase of environmental quality index in a certain year will decrease percentage of population who fell sick about 3.5 percent in the following year.

**Keywords:** *education, poverty, life expectancy, health, environmental quality index*

## INTRODUCTION

Most of environmental damages that has been occurred so far, caused by human activities and economic development. According to Indonesian Act No. 32, 2009 on Environment Protection and Management, environment is space unity with all things, energy, condition, and creature, including human being and their behaviour that influences the human-being sustainability and other creature's welfare.

From the above concept, it is known that human being is not only part of the environment, but also can influence human being sustainability. Good environment will

create good health and increase productivity, as well as longer life expectancy. In contrast, bad environment can cause many diseases, for example, bad sanitation can cause diarrhea, air pollution can cause bronchitis, etc.

According to Yudhastuti (2012), there are four types of environmental role that can cause diseases; (1) environment as predisposition factor, (2) environment as direct disease factor, (3) environment as transmission media, (4) environment as trigger factor. Meanwhile, there are three sources of environmental changes, they are ; (1) human activities, especially industrial development, transportation, and dwellings, that can

decrease quality of environment, (2) natural disaster ; flood, volcano eruption, earth quake, etc, that can change water quality, air, land and even human being, (3) environmental component that acted as media, which can cause illness incidence.

Another study by Tarigan, Lina (2004), shows that health status are influenced by heredity, nutrition, health services, behaviour and environment. Out of these five factors, environment is the main factor that can influence health status, which can come from dwelling environment, social environment, or working environment.

Human activities, in any development activities, can change environment, either can cause environmental damages or environmental improvement. Therefore, human being should maintain their environment.

There are three possibilities that human being can influence their environment, they are; maintain their environment as it is, can cause environmental damages and improve their environment using man made environment.

There are several factors that can influence human's behaviour on environment, for example ; educational attainment, poverty incidence, local wisdom, etc. Out of these factors, educational attainment is the most important factor that can influence human behaviour on the environment.

Education can increase someone's knowledge about environment, therefore, there is positive relationship between educational attainment and environment.

In addition to educational attainment, poverty can also influence environment. In order to fulfill their basic needs, people who live below poverty line can do anything, including any activities that can damage environment. In his books "The End of Poverty", Sachs (2006) said that the relationship between poverty and environmental damages are the main factors that can improve people's welfare (<http://www.menegpp.go.id>).

Based on the above background, then research question arised in this research are to find out whether ; (1) educational attainment has positive impact on environmental quality index, (2) poverty incidence has negative impact on environmental quality index, (3) environmental quality index has positive impact on life expectancy, and (4) environmental quality index has negative impact on health.

To answer those research questions, the objective of this research are to find out ; (1) the impact of educational attainment on environmental quality index, (2) the impact of poverty incidence on environmental quality index, (3) the impact of environmental quality index on life expectancy, and (4) the impact of environmental quality index on health.

## MATERIAL AND METHOD

This research use panel data, consist of 31 provinces, for the years of 2008-2010. There are five variables used in this research, educational attainment, poverty incidence, life expectancy, health and environmental quality index.

Educational attainment is represented by mean years of schooling, poverty incidence is represented by percentage of population below poverty line, expectation of life at birth (years) and health, which is represented by percentage of population who fell sick.

Meanwhile, environmental quality index (EQI) is a composite index, consists of air quality index (AQI), water quality index (WQI), settlement land quality index (LQI) and population density index (PDI). The range of EQI index is between 0 (the worst quality) and 100 (the best quality).

The formula to calculate EQI and the weighting of each component index is based on the formula of Virginia Environmental Quality Index (VEQI) as follows. The weighting of AQI is 18 and calculated from CO and NOX data. While in order to calculate WQI, this indicator use are nine parameters; BOD, COD, DO, NO3, NH3, pH, TDS, TSS and SO4. The weight for WQI is 13.

The weight for settlement land quality index (LQI) is 10. LQI is calculated based on volume of solid waste that is not managed well and the percentage of households who has septic tank toilet. While the weight for population density is 10.

From the above explanation, then the formula for calculating EQI is as follows;

$$EQI = \frac{18 AQI + 13 WQI + 10 LQI + 10 PDI}{51}$$

Hypothesis testing used in this research are ; (1) educational attainment has positive impact on environmental quality index, (2) poverty incidence has negative impact on environmental quality index, (3) environmental quality index has positive impact on life expectancy, and (4) environmental quality index has negative impact on health.

In order to test those hypothesis, this research employed simple linear regression models. The following figure shows analitical framework which describe interrelationship among variables used in this research (Figure 1).

Figure 1 shows that environmental quality index is the main issue which will be discuss in this research, especially its relationship with

other variables, such as educational attainment (mean years of schooling), poverty incidence,

life expectancy and health.

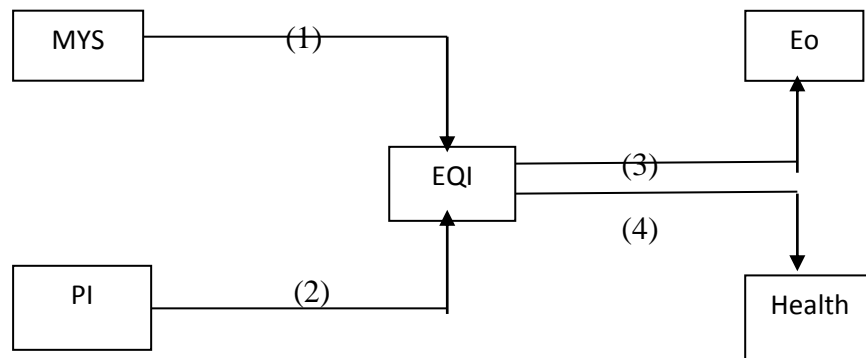

**Figure 1. Interrelationship Among Variables Used In This Study**

Where :

MYS = Mean Years of Schooling (years)

PI = Poverty Incidence (Percentage of Population Under Poverty Line)

EQI = Environmental Quality Index

Health = Percentage of Population who Fell Sick

Eo = Expectation of Life at Birth (years)

$$(2) \text{ EQI} = 235,39 - 10,73 \text{ PI},$$

$$t \text{ stat} = -9,92, p \text{ value} = 0,0000,$$

$$\text{adj } R^2 = 0,748$$

$$(3) \text{ Eo} = 67,75 + 0,01 \text{ EQI},$$

$$t \text{ stat} = 10,12, p \text{ value} = 0,0000,$$

$$\text{adj } R^2 = 0,997$$

$$(4) \text{ Ln Health} = 4,44 - 0,35 \text{ Ln EQI } (-1),$$

$$t \text{ stat} = -3,45, p \text{ value} = 0,0017,$$

$$\text{adj } R^2 = 0,787$$

## RESULTS AND DISCUSSION

The results of this research in simple linear regression models are as follows, including t test, p value, and adjusted  $R^2$ .

$$(1) \text{ EQI} = -509,42 + 73,68 \text{ MYS},$$

$$t \text{ stat} = 10,66, p \text{ value} = 0,0000,$$

$$\text{adj } R^2 = 0,770$$

The results shows that there is positive impact of educational attainment on environmental quality index, and statistically significant. It means that the longer mean years of schooling of people in a certain province, the better the quality of environment in that province.

This result is the same with the result of research by Tarigan, Rosita (2005) in Deli Serdang, North Sumatera, which conclude that there is positive relationship and statistically

significant between educational attainment with people's behaviour in keeping the beach clean. This is reasonable, since the higher the education of people, the wider their knowledge, then their behaviour on the environment will be better.

Another research by Handayani (2011) in Semarang, Central Java, conclude that there is positive relationship and statistically significant between educational attainment with people's behaviour on solving environmental problems in final waste storage in Jatibarang, Semarang.

Meanwhile, in his study in Tasikmalaya, Hermawan (2006) also conclude that there is positive relationship between educational attainment with housewives' behaviour in keeping the environment clean.

In order to test the second hypothesis, the result of this research show that there is negative impact of poverty incidence on environmental quality index, which means that the more the poor people in a certain province, then the worse the quality of environment in that province.

The result of this research is the same with those done by Hastuti (2007), which conclude that if the environmental damage and poverty occurred for long term, they will cause many social impact, such as, hunger, environmental deterioration, lack of clean water, diseases, and many health problems. Poverty will

“force” people doing any things to fulfill their basic needs, including illegal activities, such as illegal logging, etc, which can cause environmental deterioration.

Meanwhile, in order to find out the impact of environmental quality index on life expectancy, the result of this research show that there is positive impact of environmental quality index on expectation of life at birth, and statistically significant. The regression model,  $E_o = 67,75 + 0,01 \text{ EQI}$ , means that if environmental quality index in one province increase by 10 point, then expectation of life at birth of population in that province will become longer about 0,1 years or 1,2 months.

This finding is the same with the result of research done by UK Office for National Statistics (2010) that expectation of life at birth of people who stay in rural area are two years longer that those of people in urban area (<http://setyantocahyo.wordpress.com/category/kesehatan>). Because quality of the environment in rural area is much better that that of urban area.

There are some variables that can influence expectation of life at birth, either endogeneous variables or exogeneous variables. Exogeneous variables consists of nutrition intake, environmental quality, etc. Each variable can influence expectation of life at birth directly or indirectly.

Expectation of life at birth can also reflect health as well as welfare status of population in certain province. The longer the expectation of life at birth of population in a province, the better health and welfare status of population in that province.

Meanwhile, to answer the fourth research question about the impact of environmental quality index on health (percentage of population who fell sick), the result show that there is negative impact of environmental quality index on percentage of people who fell sick, and statistically significant. This means that the better the quality of environment in one province, then the percentage of people who fell sick in that province is become lower. The regression equation,  $\text{Ln Health} = 4,44 - 0,35 \text{ Ln EQI} (-1)$ , means that every 10 percent increase of environmental quality index in certain year in one province, will decrease percentage of people who fell sick in that province about 3.5 percent in the following year.

This finding is very interesting since almost all diseases occurred because of interaction between human being and their environment. In his book, *Health Environment*, Mulia (2005) as quoted by Carina (2011), show that environmental quality can affect people's health status.

## CONCLUSIONS

This research show that there is positive impact of educational attainment (mean years of schooling) on environmental quality index. It means that the longer mean years of schooling of population in one province, the better the quality of environment in that province.

Meanwhile, poverty incidence (percentage of population below poverty line) has negativ impact on environmental quality index, which means that the more poor people in one province, the worse the quality of environment in that province.

In addition to find out the impact of educational attainment and poverty incidence on environmental quality index, this research also aims to search the impact of environmental quality index on expectation of life at birth and health.

The results of this research show that the impact of environmental quality index on expectation of life at birth is positive, which means that the better the quality of environment in one province, then expectation of life at birth of population in that province tend to become longer.

While, the impact of environmental quality index on health is negative and one-year lag, which means that if environmental quality index is become better in certain year, then percentage of people who fell sick in that province will decrease in the following year.

Based on the results of this research, then in order to improve the quality of environment in one province, it is suggested to increase mean years of schooling and to reduce percentage of population below poverty line in that province.

If the quality of environment in certain province is become better, then expectation of life at birth of population in that province will become longer, and the percentage of people who fell sick will become lower.

## ACKNOWLEDGEMENT

Author would like to thank and appreciate to Dr. Budiasih for her valuable input to this research.

## REFERENCES

- Badan Pusat Statistik, 2011, “*Statistik Lingkungan Hidup Indonesia*”.
- Carina, Metty, 2011, “*Hubungan Kesehatan Lingkungan dan Ekspektasi Hidup Manusia*”, Laporan Penelitian, Program Pasca Sarjana Universitas Sriwijaya.
- Handayani, Yuli, 2011, “*Hubungan Antara Tingkat Pendidikan Dengan Upaya Mengatasi Pencemaran Lingkungan Pada Masyarakat Sekitar TPA Jatibarang, Semarang*”, Skripsi, Universitas Negeri Semarang, abstrak.
- Hastuti, 2007, “*Pengentasan Kemiskinan dan Pembangunan Berwawasan Lingkungan*”, disampaikan pada Seminar Nasional Manajemen Dampak Pergeseran Iklim Global Dalam Pelestarian Lingkungan Hidup, di UNY 23 Mei 2007, abstrak.
- Hermawan, Yoni, 2012, “*Hubungan Antara Tingkat Pendidikan dan Persepsi Dengan Perilaku Ibu Rumahtangga Dalam Pemeliharaan Kebersihan Lingkungan*”, Skripsi, Program Studi Pendidikan Ekonomi, Universitas Siliwangi, abstrak.
- Sachs, Jeffry, 2006, <http://www.menegpp.go.id>  
<http://setyantocahyo.wordpress.com/category/kesehatan>
- Kementerian Lingkungan Hidup, Undang-Undang No. 32 tahun 2009 tentang *Perlindungan dan Pengelolaan Lingkungan Hidup*.
- Mulia, Ricki M, 2005, “*Kesehatan Lingkungan*”, Penerbit Graha Ilmu, Yogyakarta.
- Tarigan, Lina, *e-USU Repository* ©2004, Universitas Sumatera Utara, abstrak.
- Tarigan, Rosita, 2005, “*Hubungan Antara Tingkat Pendidikan dan Pengetahuan Lingkungan Terhadap Perilaku Pengelolaan Kebersihan Pantai Percut, Kabupaten Deliserdang, Sumatera Utara*”, Tesis Program Pasca Sarjana, Universitas Negeri Medan, abstrak.
- Yudhastuti, Ririh, 2012, “*Pengaruh Lingkungan Terhadap Kesehatan*”, Departemen Kesehatan Lingkungan, Fakultas Kesehatan Masyarakat, Universitas Airlangga.



# ASSESSING THE CURRENT INDONESIA'S ELECTRICITY MARKET ARRANGEMENTS AND THE OPPORTUNITIES TO REFORM

**Dhani Setyawan**

Centre for Climate Change Financing and Multilateral Policy  
Fiscal Policy Office-Ministry of Finance of Indonesia

Corresponding Author's E-mail: [dhanisetawan83@gmail.com](mailto:dhanisetawan83@gmail.com)

**Abstract:** Existing subsidy arrangements and institutional settings in the Indonesian electricity sector distort investment decisions and lead to higher cost. Electricity supply is characterized by natural monopoly characteristics, requiring different management by governments than sectors with more straightforward market characteristics. Many countries have undergone significant re-structuring of their electricity sectors, away from one, state owned and vertically integrated monopoly supplier to a setting whereby competition has emerged either at the generation level and/or the retail level. Transmission and distribution networks are typically heavily regulated and transparent access arrangements are put in place as part of the restructuring efforts. The analysis showed that the current structure of Indonesia's electricity sector firmly within Model 2 (the single buyer model) and highlights that Indonesia is currently towards the less-competitive end of the spectrum of Model 2, identifying significant potential for efficiency enhancing reforms within this structure. Constitutional limitations have hampered previous efforts to restructure the sector in Indonesia but there is significant room for incremental reform to improve incentives in the sector and reduce the cost of generation in the process.

**Keywords:** *Electricity Market, Reform, Analysis, Indonesia.*

## 1. INTRODUCTION

Since the Asian Financial Crisis the growth in new electricity generation in Indonesia has struggled to keep up with demand. From 1997 to 2007 demand growth averaged 7 per cent per year<sup>1</sup> but the increase in supply has been lagging behind. The slower than necessary pace of investment in new generation capacity means that by 2010 Indonesia had an estimated supply shortfall of 4.5 GW in 2010<sup>2</sup> or an output shortfall of around 100 billion kwh per year.<sup>3</sup> Compounding the challenge posed by the existing supply shortfall, growth in demand for electricity is forecast to average 9.5 per cent per year out to 2029 and beyond with likely higher

---

<sup>1</sup> International Energy Agency (IEA) Report, 2008

<sup>2</sup> Jakarta Globe 12 February 2010 PLN to seal deal with independent power producers as 2<sup>nd</sup> fast track unfolds

<sup>3</sup> In 2009 it was estimated that energy output was some 170 billion KWh well short of the 260 – 290 billion kwh that would have needed to avoid rationing Jakarta Globe July 21 2010 Cutting Off Indonesia's Coming Energy Crisis

rates outside the main Java-Bali grid.<sup>4</sup> In addition to building new supply capacity Indonesia will also have to replace aging infrastructure.<sup>5</sup>

To satisfy this level of demand Indonesia will have to build an additional 7.8 GW of new capacity on average each year for the next 20 years. This is significantly more than the average of less than 1200 MW that were added over the five years to 2009. The capacity to satisfy the projected increase in demand for electricity will be of critical importance to Indonesia as it fuels economic growth. Unmet demand and supply disruptions – which invariably result from less installed capacity than is required – undermine the attractiveness of Indonesia as an investment destination and harm its competitiveness. Supply expansion is also essential to satisfy the GOI's goal of increase electrification rates from around 66 percent in 2008 to 80 per cent by 2014<sup>6</sup> and more than 90 per cent by 2020.

The low electricity tariffs and the high subsidization of the PLN have become one of the biggest structural problems in the Indonesian electricity sector. Those conditions are responsible for developing an inefficient electricity market structure that is also unreceptive to both foreign and domestic investment. With artificially low electricity tariffs, and the government subsidizing the bulk of electricity production costs, most foreign investors and power operators that have the potential to alleviate some of the acute electricity shortages in Indonesia, have kept their distance (Purra, 2010). With the existing tariff levels most power projects are financially unviable particularly for many of the multinational power companies.

Based on the aforementioned background, this study was conducted in order to analyze the Indonesian existing electricity market arrangements and the opportunities to glean lessons from International best practices of efficient arrangements in electricity sector. This study follows the following structure. In the beginning, this study elaborates the concept of natural monopoly. Further, the study provides a brief picture of Indonesia electricity sector arrangements and their history. Then, this paper goes through four different possible electricity industry structures that represent increasing penetration of competition in the Indonesia electricity sector.

## **2. LITERATURE REVIEW**

According to Sherer (1980), a natural monopoly can be found in an industry where a single business firm can produce total output to supply the market at a lower per unit-cost than can two or more firms (subadditivity of the cost functions). Another definition of natural monopoly was that of Baumol (1977), who argued that a natural monopoly exists when a single firm operates in a market in which entrants are incapable of survival, even in the absence of predatory measures by the incumbent monopolist (sustainability of monopoly).

Utilities such as electricity, telecommunication, water and gas are often cited as examples of natural monopoly. These industries confront a relatively high fixed cost structures which the costs needed to produce even a small amount are high. Successively, once the initial investment has been made, the average costs decrease with every unit produced. Competition in these industries is deemed socially undesirable because the existence of a large number of firms would result in needless duplication of capital equipment (Depoorter, 1999).

In the context of the electricity sector, the network component of the supply chain has the strongest natural monopoly characteristics. While generation facilities can feasibly be duplicated (or separated) and compete in a market with sufficient size, the economies of scale associated with

---

<sup>4</sup> Ministry of Energy and Mineral Resources (MEMR), 2012

<sup>5</sup> Reuters has reported that PLN's current generation capacity is around 25,000 MW although actual daily output is far less because most of its plants are old and inefficient. This suggests that there may need to be substantial new investment in supply just to maintain existing output let alone meet new demand.

<sup>6</sup> National Medium Term Plan 2010 - 2014

building and operating a network are such that duplication is unlikely to ever be feasible. For example, Viljainen (2005, p. 2) observes that the most European Union countries follow the model of a competitive or potentially competitive generation sector and a natural monopoly network sector.

This observation implies a different approach to regulating the generation and network elements of the electricity sector. Under the correct market structure (e.g. diversified ownership) and regulatory regime competition in the generation sector can result in economically efficient outcomes and market-determined prices. Conversely, the natural monopoly network sector is likely to require extensive regulation or government involvement to ensure economically efficient outcomes.

This occurs because, as observed by Depoorter (1999), the natural monopoly concept poses a public policy dilemma. On the one hand, a natural monopoly implies that efficiency in production would be better served if a single firm supplies the entire market. On the other hand, in the absence of any competition the monopolist will be tempted to increase prices so as to maximize profits. It is also questionable whether a firm will pursue cost minimization under natural monopoly.

In the context of electricity networks, two broad responses to natural monopoly have been observed. One response is to retain the network in government hands, using public pressure on the government to constrain the network's exercise of its monopoly power. The other is to privatise or corporatize the network (i.e. allow it to operate independently of government and pursue profit-maximisation) but subject it to extensive price and access regulation to ensure economically efficient outcomes.

The different treatments of generation and network elements are reflected in the different models of electricity market structure considered in subchapter below. The models discussed describe a broad evolution from non-competitive to competitive electricity markets, and illustrate how the potentially competitive generation sector is firstly opened to competition, with the retail sector following, whilst the non-competitive network components are regulated separately.

### **3. RESEARCH METHODOLOGY**

This paper utilizes a descriptive methodology analysis. The secondary data are employed to support the analysis. In-depth interviews with some experts and focus group discussions are also part of the research methods employed in this study.

### **4. DISCUSSION AND ANALYSIS**

#### **a) Natural Monopoly in the Indonesian Electricity Sector**

The Indonesian electricity sector is characterised by heavily subsidized tariffs to end consumers. Subsidised tariffs effectively entrench a government monopoly in the supply of electricity to end users (electricity retailing) in Indonesia, as no private entity would compete to supply customers at a loss-making tariff. Consequently the state-owned company PT PLN exclusively retails electricity in Indonesia. The extent to which allowable tariffs are below generation costs. The trend of electricity's subsidy, are shown in the table below and in the appendixes.

**Trend of Electricity Subsidy**

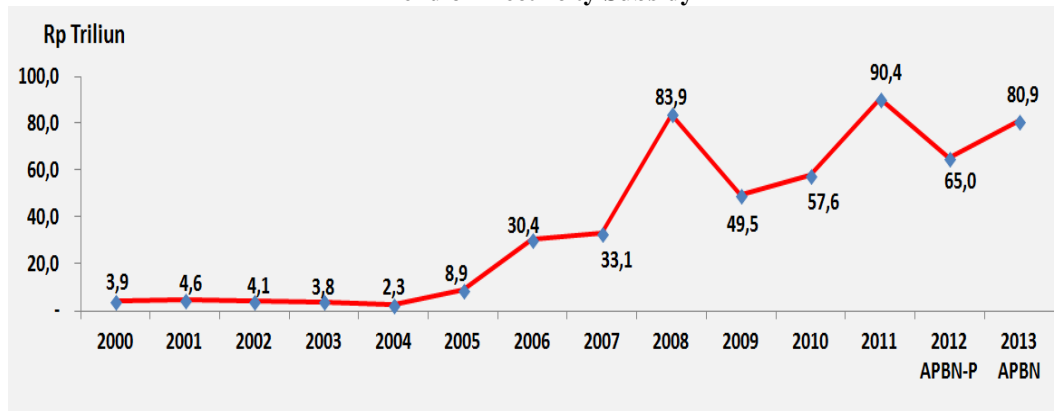

Source: Fiscal Policy Agency, 2013.

For a long time, retail electricity prices have been influenced by political considerations, and therefore future increases from subsidised to cost-reflective levels will likely occur gradually. Further, for political reasons, prices are regulated to be uniform across regions, creating a cross subsidy between Java (where economies of scale make generation costs relatively low) and other islands.

Whilst tariffs differ between user classes, the pattern of tariffs are not cost-reflective and create distortions across consumer classes. A competitive electricity retail environment would require not only the general level of electricity tariffs to be cost-reflective, but also that tariffs for different user classes are also cost-reflective. The breakdown of PLN subsidies by user class in 2010 and 2011 are shown in the appendixes.

Some private participation has gradually emerged in Indonesia's electricity generation sector. Prior to 1985, the power sector was entirely government-led, under the direction of the state-owned company PT PLN. In 1985 the Government issued Law No. 15/1985, allowing the participation of the private sector in electricity generation for its own use and to sell to PT PLN. The law sought to permit limited participation in electricity generation. Essentially, the law allowed for private parties (Independent Power Producers/IPP) to supply electricity in Indonesia which was previously exclusive to PLN. These IPPs were licensed to sell their electricity solely to PLN pursuant to Power Purchase Agreements (PPAs<sup>7</sup>). However, this IPP program was effectively frozen in the late 1990s when the financial crisis hit.

Electricity restructuring in Indonesia began in early 1992 when the Government opened the electricity generation market to competition. Following Presidential Decree No. 37 of 1992, which opened entry into generation markets, a number of permits have been issued for Independent Power Producers (IPP) to build, install and operate power plants, and sell the generated electricity to PT PLN for distribution to the public.

Indonesia's 2002 Electricity Law went further and envisaged competition and private participation in both electricity generation and retailing. However, in December 2004, Indonesia's Constitutional Court annulled the 2002 Electricity Law on the basis that it was in violation of the spirit of article 33 of the Indonesian Constitution. According to the Constitutional Court, electricity is a public good and its generation and distribution should remain under the exclusive control of the government.

<sup>7</sup> A power purchase agreement (PPA) is a contract for the sale of energy, availability and other generation services from an independent power producer (IPP). It is normally developed between the owners of private power plants and the buyer of the electricity.

In effect, the annulment of the 2002 Electricity Law reestablished the 1985 law and limited private participation in the sector to IPPs generating electricity and on-selling to PLN. Whilst IPPs participate in generation, this does not occur under competitive or even quasi-competitive conditions, but rather as an 'out-sourced' element of the PLN monopoly supply chain, meaning that electricity generation in Indonesia effectively operates within an essentially non-competitive structure.

Together, the low electricity tariffs and the high subsidies to PLN have resulted in an inefficient electricity market structure that is also unreceptive to both foreign and domestic investment. With artificially low electricity tariffs, and the government subsidizing the bulk of electricity production costs, most foreign investors and power operators that have the potential to alleviate some of the acute electricity shortages in Indonesia, have kept their distance (Purra, 2010). With the existing tariff levels most power projects are financially unviable particularly for many of the multinational power companies.

In 2009, the government passed a new Electricity Law to strengthen the regulatory framework and provide a greater role for regional governments in terms of licensing and in determining electricity tariffs. The Law firmly justifies the state as the regulator of electricity supply and the PLN as the supplier, as stipulated in the article 33 of constitution<sup>8</sup>. The substantial change is that the law authorizes the provincial governments to publish regulations on electricity. It also permits provinces to adjust electricity tariffs<sup>9</sup>. Whilst these are positive measures to improve the operation of the electricity sector, the monopoly position of PLN remains largely intact.

## **b) Assessing Electricity Market Structure in Indonesia**

There are four basic models for electricity industry structure that represent increasing penetration of competition in the sector:

1. Model 1: Vertically Integrated Monopoly
2. Model 2: Single Buyer Model
3. Model 3: Wholesale Competition
4. Model 4: Retail Competition

As discussed below, the present circumstances in Indonesia place it within the broad definition of Model 2 (the single buyer model). However, variation within this model exists and Indonesia is towards the less-competitive end of the spectrum of single buyer electricity market models.

### **Model 1: Vertically Integrated Monopoly**

This model operates via a geographic monopoly on selling electric power to consumers, where all of the aspects of the electricity supply chain, i.e. generation, transmission, distribution and retailing, are conducted by a single utility within its region (Stănciulescu, 2004; Andika & Dewanda, 2004). In this model, customers have no alternatives except to purchase electricity from their own local utility and so there is no competition at the retail level. Further, the utility generates and distributes all electricity itself, implying no competition between generation sources. Typically electricity sectors take this form in countries that have not pursued market-oriented reforms. Given the evident market power the vertically integrated power company (VIPCO) wields under this model, it is typically government-owned and voluntarily constrains prices for political reasons. Before the enactment of Electricity Law of 1985, Indonesia employed this model with PLN taking the role of the vertically integrated monopoly (as illustrated in Figure 1 below).

---

<sup>8</sup> Articles 3 and 4 of the Electricity Law No. 30/2009.

<sup>9</sup> Article 5 of the Electricity Law No. 30/2009.

**Figure 1. Vertically Integrated Monopoly – Indonesia prior to 1985**

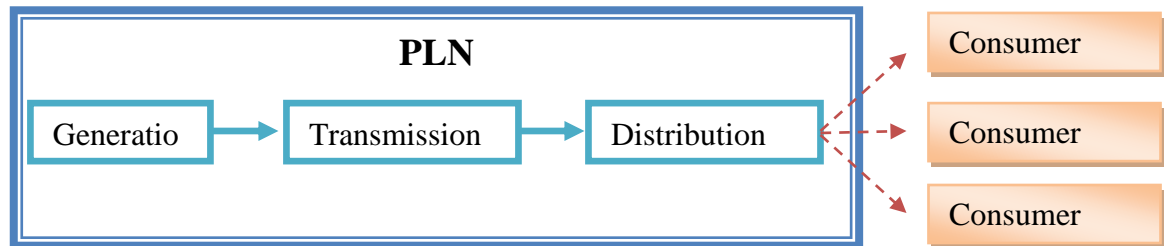

Such an arrangement usually results in implicit or explicit government subsidies to sustain the viability of the entity. In turn, this often creates poor incentives to minimise costs, which are therefore inefficiently high. This observation reflects the experience in Indonesia. In effect the Government of Indonesia has ensured a certain price to protect customers by subsidizing the difference between the true cost and the regulated price. As this subsidy comes from state budget, the ongoing costs damage the GOI's financial position. Although Indonesia has moved from this model to a version of the 'single buyer model' discussed below since 1985, the essential difficulties of the vertically integrated model remain present in Indonesia's electricity sector today.

As an alternative to government-ownership and political constraints on electricity prices, some jurisdictions (notably a range of US states) employ what is called 'rate of return' regulation to set electricity prices charged by a VIPC. This regulation involves estimating in advance the reasonable costs associated with delivering all elements of the electricity supply chain and setting regulated tariffs that allow the operator to earn revenues to recoup these costs, plus a profit margin. The difficulty with this approach is that the VIPC generally perceives such regulation as guaranteeing a mark-up on costs, and it must share the benefits of measures to reduce costs with consumers through future tariff-setting processes. Consequently, the incentive for cost-minimisation is diluted and efficient outcomes are difficult to obtain.

**Model 2: Single buyer/purchasing agency model**

The single buyer/purchasing agency model represents a movement away from the vertically integrated model in the direction of greater competition, but the degree of increased competition varies depending on several specific design elements. Structurally, the key difference is that the VIPC (typically government-owned) diversifies its generation sources by contracting private investors (IPPs) to construct and operate generators. The IPPs sell their output to the VIPC, generally via long-term power purchase agreements (PPAs). Generally the VIPC will continue to operate its own generators in parallel with the IPPs but will be the sole purchasing agency for wholesale electricity. Meanwhile, the VIPC will coordinate dispatch of the various generation sources and maintain the transmission network.

The single buyer model certainly provides an emerging electricity sector with access to private capital and a diversity of generation companies. However, the extent to which it creates competitive pressure is highly dependent on detailed design elements. Designs representing two extremes of the spectrum of competitive outcomes can be identified.

Under the least competitive design of the single buyer model, IPPs are used primarily as a source of additional capital to supplement the generation fleet of the VIPC, which retains overwhelming dominance in generating, dispatching and supplying electricity. There is no centralized or transparent mechanism by which the dispatch of IPPs or the VIPC's own generators are prioritised or coordinated. Consequently, there is no guarantee for IPPs that they will receive equal treatment in dispatch alongside the VIPC generators. In turn, the IPPs generally seek highly structured PPAs that guarantee price and minimise volume risk (known as 'take-or-pay' contracts). The overall

effect is that the dispatch of generators is not driven by competitive pressures as under a market arrangement, but instead is heavily influenced by PPA terms, which are in turn driven by the VIPC's planning requirements rather than a decentralised competitive process. Whilst there is some competitive pressure through investment in new generators, with the VIPC able to compare IPP bids for new power plants by their respective PPA prices, this competitive pressure is largely limited to the initial investment stage and constrained by determining the type and location of plant by the VIPC. In addition, due to the 'take or pay' structure of PPA's the VIPC's ability to manage dispatch efficiently can be negatively affected. Thus, some of the possible economic efficiencies in construction and operation are achieved through the current structure but the benefits of competition are far from exploited under the current structure.

A more competitive form of the single buyer model is described by Lovei (2000). He describes the 'mandatory competitive pool' form of the single buyer model, where generators are not shielded from market risks by government guarantees, and wholesale prices determine dispatch and investment via market rules rather than PPAs. This arrangement is very similar to the wholesale competition model discussed below, with the primary difference being that a single purchaser commits to taking all power sold through the competitive pool, rather than passing this risk on to various distribution or retail companies. As Lovei (ibid.) notes, in that case, the single buyer model captures many of the benefits of the wholesale competition model, but faces specific difficulties associated with incentives to pursue collection of electricity tariff revenues and government interference in market processes.

Since 1985 a less competitive version of the single buyer model has emerged in Indonesia via the gradual engagement of IPPs by PLN. Whilst private investments in the form of IPP projects have helped reduce the risk of power shortages, the absence of a competitive mechanism to coordinate IPP and PLN generation means that the introduction of IPP generators only represents a fairly modest step towards the wholesale competition. In essence, the timing, capacity and fuel supply choice of new generation investments, as well as the day-to-day dispatch of plant, are determined internally by PLN rather than transparently through market prices. This would be very similar to the vertically integrated model described above but may actually be worse because PLN may be constrained in its choice of which plants to dispatch from as a result of take or pay arrangements with IPPs.

**Figure 2. Single Buyer Model / Purchasing Agency as implemented in Indonesia**

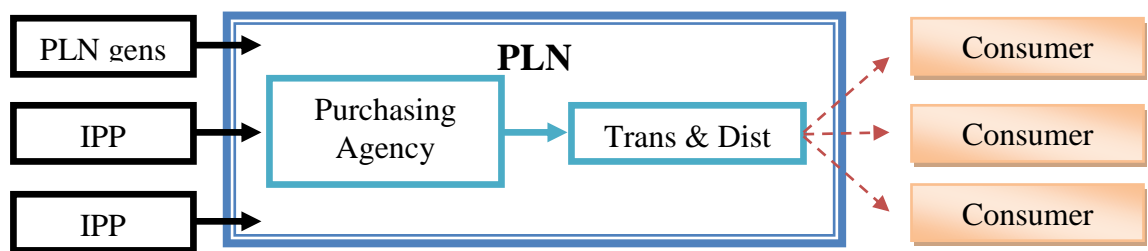

One option for Indonesia would be to improve the way in which IPPs bid to build capacity, improving the efficiency gains available from competition, without affecting the sole buyer position of PLN and consistent with the constitutional ruling in 2002. This is elaborated further in the existing electricity market arrangements chapter.

### **Model 3: Wholesale competition**

Genuine competition is more likely to first emerge at the wholesale level (i.e. generation) rather than in the network element or in retailing. The key difference between this model and the single buyer model is the existence of multiple wholesale purchasers of electricity rather than a single,

central purchasing agency that commits to purchase all electricity delivered to the system. In Figure 3 below these wholesale purchasers are depicted as either distribution companies or large customers that arrange their own wholesale purchases (e.g. smelters). In this market, distribution companies can be thought of as geographic monopolies that exclusively purchase, distribute and sell electricity to small and medium sized customers in a particular region. As the transmission system connects multiple such regions, these distribution companies can choose between generation sources from within and beyond their physical region. This choice, in turn, drives genuine wholesale competition between generation companies to supply the various potential purchasers.

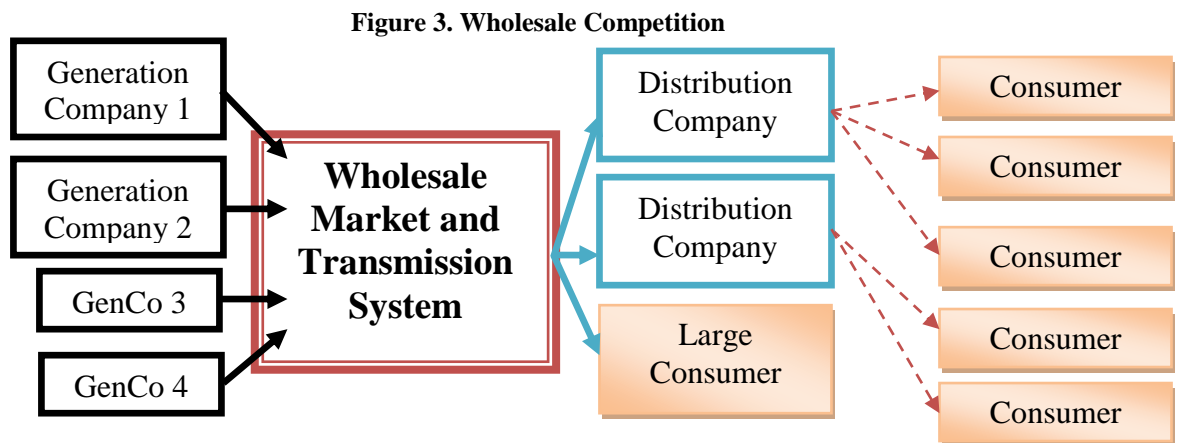

Transactions between generators and wholesale purchasers take place either in a decentralised wholesale market governed by bilateral contracts, through a centralised power exchange or ‘pool’, or a combination of both. In a ‘bilateral’ market, buyers and sellers individually contract with each other for quantities, price, terms and conditions. There is no single transparent market price, and prices are instead determined by the terms of individual contracts. As in traditional market, buyers and sellers interact directly to secure contracts. A bilateral market is similar to less competitive forms of the single purchasing agency model above, with the key difference that generators have a choice of counter-parties with which to agree a PPA for their output, allowing generators and off-takers to negotiate prices that reflect market conditions.

A pool trading system creates a centralised and transparent mechanism through which generators and wholesale purchasers may interact. In its strongest form, this pool is ‘mandatory’ in that all power must be bought and sold through the pool. Generators notionally sell all their output to the pool, rather than a specific buyer and, similarly, buyers are deemed to purchase all their output from the pool. A central Independent Market Operator (IMO) holds regular auctions where generators bid quantities and prices for the specific time period. Generators are dispatched in order of increasing price to satisfy total demand in the relevant time period, and the price of the last bid required to ‘clear’ the market is treated as the market price for that period: all sellers receive and all buyers pay this price in that period. Whilst all generation is notionally dispatched through the pool, mandatory pool markets nevertheless typically develop complementary financial contracts that offer participants much of the price and volume certainty they achieve in a bilateral contracting market.

Bilateral contracting and pool trading can operate in combination. In such markets, contracted quantities are dispatched preferentially irrespective of price, and generation output in excess of contracted quantities is deemed to be sold into the pool and earn the pool clearing price. Similarly, purchases by wholesale customers in excess of their contracted volumes are deemed to be purchased from the pool at the pool clearing price. Under this arrangement, pool trading



essentially acts as a ‘balancing’ market to true-up purchases and output that is above or below contracted quantities.

Indonesia is some distance from approaching this model of wholesale competition. Firstly, wholesale competition requires the creation of multiple potential buyers to allow generators to negotiate market-reflective prices. Secondly, market structure issues and pre-existing contractual arrangements are not conducive to competition between generators. To promote competition, PLN’s share of total generation capacity would need to be reduced through disaggregation into separate companies that would compete with one another, and these companies would need to be separated from PLN’s transmission and wholesale market dispatch functions to ensure fair treatment for competing IPPs. Further, existing PPAs with IPPs may need to be restructured so as to reflect a new competitive environment as well as being transferred from PLN to a new wholesale purchasing entity (possibly a regional electricity distributor).

Nevertheless, the emergence of genuine wholesale competition through market restructuring would offer a number of potential benefits. Firstly, forward-looking wholesale prices can be determined by market processes rather than planning processes. This dynamic motivates potential investors to optimise new entry choices across a range of feasible new generation options. Secondly, the threat of entry from new generators motivates existing generators to minimise costs. Thirdly, centralising dispatch through a pool mechanism increases the likelihood that short-run dispatch decisions minimise operating costs of the existing fleet. However, notwithstanding these benefits, significant market structure and legal barriers (not least the constitutional ruling preserving PLN’s monopoly on the sale of electricity to users) means that moves to wholesale market competition will be slow and tentative in the short-term, likely reflecting adjustments within the broader confines of the single buyer model described earlier than a dramatic move towards genuine wholesale competition.

#### **Model 4: Retail competition**

Under the wholesale competition model described above, small to medium sized customers (i.e. customers not large enough to purchase directly from the wholesale market) do not have a choice of electricity supplier and are dependent on the local monopoly distributor/retailer. Accordingly, this system lacks retail competition and requires regulation of price and access to protect the interest of small customers.

Accordingly, the final stage in developing a competitive electricity market structure is to facilitate competition between the final suppliers of electricity to customers, i.e. retailers. As the distribution of electricity via poles and wires has natural monopoly characteristics, this competition requires, at least, establishing rules that ensure that new entrant retailers that wish to compete with the ‘incumbent’ retailer-distributor has guaranteed access to use of the network on fair and competitive terms or, ideally, fully separating the retail and distribution functions to guarantee equal access rights for all retailers.

This market structure is shown in Figure 4 below, but illustrates only one geographic distribution area. As under wholesale competition, multiple purchasers contract with generators or purchase electricity from the wholesale pool. However, multiple retailers also compete to supply the same customer via the monopoly distribution network, ensuring that consumers have a choice of retailers.

**Figure 4. Retail Competition**

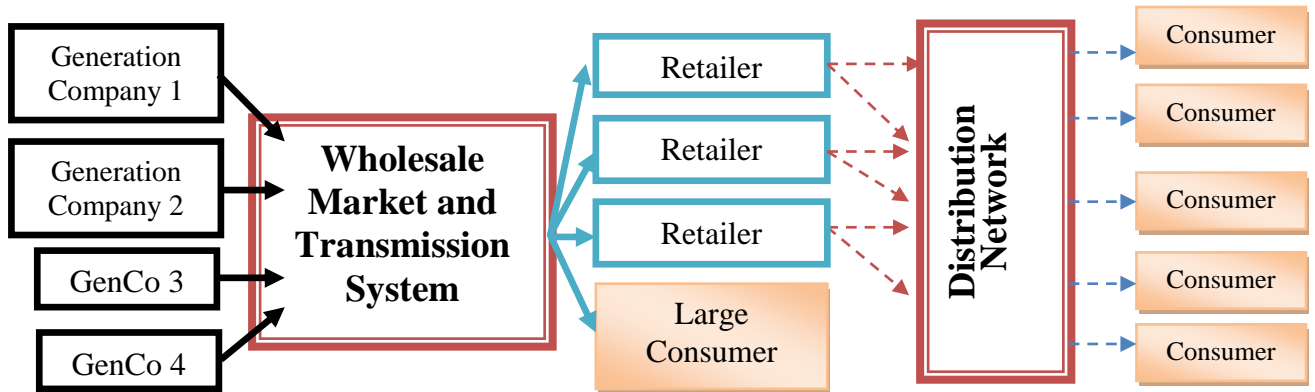

Under genuinely competitive retail market conditions, e.g. where the number of retailers is sufficient to provide genuine price competition, prices can no longer be regulated but can instead be determined by competition between retailers. The retail price no longer has to be regulated because small consumers can change retailer when they are offered a better price. From an economics perspective, this model is the most satisfactory because energy prices are set through market interactions. However, retail competition requires considerable amounts of metering, communication and data processing to function effectively. The cost of the transmission and distribution network is still charged to all their users as it is done on a regulated basis because these networks remain monopolies.

Full retail competition is notionally the end point of restructuring process from monopoly to competition. Where market design is efficient and market structures are balanced and genuinely competitive (e.g. not excessively concentrated in a few company's hands), this model can generate efficiencies in the supply of electricity that both attract capital to the supply side and benefit consumers through low prices. However, while this may be the culmination of the restructuring process described here, reforms in the Indonesian electricity sector can provide many benefits described here without going all the way to full retail competition. See the existing electricity market arrangements chapter in this publication for further details about the suggested course of action.

## **5. CONCLUSION AND RECOMMENDATIONS**

As discussed above, electricity sector reform has the potential to improve economic outcomes and reduce pressure on the budget. Without prejudicing further discussions with other areas of government and line ministries and stakeholders, some ideas about how to tackle electricity sector reform have been considered and potential directions for reform have been identified.

Our analysis of Indonesia's electricity sector indicates that the 'single buyer model' is strongly entrenched (with PLN acting as the monopoly purchaser and reseller of electricity), not least due to constitutional restrictions. However, there is significant scope to achieve more efficient outcomes by incremental reform within this broad structure. Specifically, the interaction between PLN and IPPs (particularly the form of PPAs) can be refined to encourage behaviours more akin to a competitive wholesale market, without relying on the long and uncertain process of reforming the sector to a fully competitive structure.

One option would be to create a distinct funding envelope for new tranches of generation capacity by load centre, perhaps beginning with a portion of new investment in parallel to the crash

program planning model that is currently in operation. IPPs would be invited to bid for a share of the funding by offering the largest amount of capacity at lowest cost (distinguishing peak, shoulder and base load).

This would begin a process by which new capacity is funded in a technology neutral manner and would allow fuel price risk and other operational costs to be allocated to IPPs rather than remaining with the government. This process would also better harness the professional judgement of IPPs with respect to project capacity, design, site and fuel selection, as well as responsibility for upstream (e.g. fuel supply) arrangements. If IPPs made wrong judgement calls about such factors, their profits would be negatively affected, providing strong incentives to get it right, aligning cost-minimisation incentives for the GOI and IPPs.

Under such a model, PLN would coordinate and dispatch generation from a variety of sources and integrate the generation and transmission network planning. It would be desirable to give PLN additional space to focus on transmission – a critical aspect of electricity supply and one that has enormous influence on overall costs. Of course, detailed development of such reforms would require extensive engagement within the government line ministries, PLN and industry stakeholders representing IPP viewpoints.

## References

- Ben W.F. Depoorter (1999), Regulation of Natural Monopoly, *Journal of Economics Literature*
- Sherer, F.M. (1980), *Industrial Market Structure and Economic Performance*, Chicago: Rand McNally.
- Baumol, William J. (1977), 'On the Proper Cost Tests for Natural Monopoly in a Multiproduct Industry', 809 *American Economic Review*.
- S. Ran Kim and A. Horn (March 1999), Regulation policies concerning natural monopolies in developing and transition economies, DESA Discussion Paper No. 8
- Yarrow, G. (1994), *The Economics of Regulation*, in: V.V. Ramanadham (ed.), *Privatization and After: Monitoring and Regulation*, Routledge: London and New York, pp. 35-46.
- Dewey, Donald (1959), *Monopoly in Economics and Law*, Chicago, Rand McNally, 328p.
- Peter Pintz and Andreas Korn (2005) Development of a Competitive Electricity Market in Indonesia, *Energy Studies Review* Volume 13, Issue 2.
- World Bank (2005) *Electricity for All: Options for Increasing Access in Indonesia*
- Song, H., Liu, C.C. and Lawarree, J. (1999). "Decision making of an electricity supplier's bid in a spot market." *Proceedings of the 1999 IEEE Power Engineering Society*.
- Ly-Fie Sugianto (2010), *Simulating a Competitive Electricity Market*, *Proceedings of SIG GlobDev Third Annual Workshop*, Saint Louis, USA
- Dr. Mika M. Purra (2010) *The Indonesian Electricity Sector: Institutional Transition, Regulatory Capacity and Outcomes*
- William w. Hogan (1993), *A Competitive Electricity Market Model*, Harvard University.
- PLN Statistics 2010 (June 2011), PT PLN Persero.
- Fidiarta Andika, Ratna Dewanda (2004) *Social Analysis on Electricity Market Mechanism in Indonesia*
- Ana-Maria Stănciulescu (2004), Definition and regulation of "vertically integrated monopolies", *ERRA Workshop on Legal Regulation Kiev, Ukraine*

Lazlo lovei (2000), The Single-Buyer Model: A Dangerous Path toward Competitive Electricity Markets, World Bank Note.

Doudlas Bohi and Karen Palmer (1996), The Efficiency of Wholesale vs. Retail Competition in Electricity, The Electricity Journal.

Yusri Bin Hassan, Faridah Hussin, Mohd Fauzi Othman (2009), A Study of Electricity Market Models In The Restructured Electricity Supply Industry, University Teknologi Malaysia.

Peter Pintz, Andreas Korn (2005),Development of a Competitive Electricity Market in Indonesia, Energy Studies Review, Issue 2 Volume 13 Article 4.

Fidiarta Andika, Ratna Dewanda (2004), Social Analysis on Electricity Market Mechanism in Indonesia, AUPEC.

Risk Management Unit (2011), Kajian Evaluasi Risiko Fiskal Atas Kebijakan PSO Dan Pembentukan Holding Company, Fiscal Policy Agency Research.

# APPENDIXES

## Average PLN Tariffs

GOLONGAN TARIF	2010		2011	
	PENDAPATAN (Juta Rp)	Subsidi (Juta Rp)	PENDAPATAN	Subsidi (Juta Rp)
S.1 / 220 VA	153	1.559	116	1.273
S.2 / 450 VA	101.276	264.004	100.927	338.668
S.2 / 900 VA	159.799	254.320	167.806	360.433
S.2 / 1.300 VA	115.016	115.850	137.100	178.579
S.2 / 2.200 VA	107.055	93.540	129.344	151.277
S.2 / 3.500 VA s/d 200 kVA	1.036.124	685.812	1.226.513	1.028.658
S.3 > 200 Kva	720.686	408.426	915.249	586.211
<b>JUMLAH S</b>	<b>2.240.109</b>	<b>1.823.511</b>	<b>2.677.054</b>	<b>2.645.099</b>
R.1 / 450 VA	7.767.008	14.003.419	7.849.024	19.045.898
R.1 / 900 VA	11.541.896	10.917.259	12.505.715	17.438.553
R.1 / 1.300 VA	6.460.099	4.246.264	8.601.575	6.807.422
R.1 / 2.200 VA	4.089.127	2.626.665	5.207.934	4.000.516
R.2 / 3.500 VA s/d 5.500 VA	3.292.967	1.412.097	3.804.794	2.157.570
R.3 / 6.600 VA keatas	2.637.533	-	2.859.512	561.791
<b>JUMLAH R</b>	<b>35.788.630</b>	<b>33.205.703</b>	<b>40.828.554</b>	<b>50.011.751</b>
B.1 / 450 VA	153.395	189.522	147.958	261.115
B.1 / 900 VA	366.184	323.945	363.910	483.374
B.1 / 1.300 VA	589.131	377.113	721.560	544.560
B.1 / 2.200 VA s/d 5.500 VA	1.430.397	662.313	2.593.066	1.359.655
B.2 / 6.600 VA s/d 200 kVA	11.347.396	430.491	11.001.767	2.214.562
B.3 / > 200 kVA	9.246.775	1.740.871	10.183.912	4.244.487
<b>JUMLAH B</b>	<b>23.133.278</b>	<b>3.724.256</b>	<b>25.012.172</b>	<b>9.107.753</b>
I.1 / 450 VA	81	115	82	167
I.1 / 900 VA	469	462	470	656
I.1 / 1.300 VA	923	469	1.003	912
I.1 / 2.200 VA	2.953	984	2.568	1.916
I.1 / 3.500 s/d 14 kVA	179.600	-	106.580	49.550
I.2 / > 14 kVA s/d 200 kVA	3.124.578	1.319.042	3.544.726	2.058.504
I.3 / > 200 kVA	23.110.610	11.819.140	27.254.847	18.841.779
I.4 / 30.000 kVA keatas	6.645.263	4.339.239	7.683.198	7.211.048
<b>JUMLAH I</b>	<b>33.064.477</b>	<b>17.479.452</b>	<b>38.593.474</b>	<b>28.164.534</b>
P.1 / 450 VA	12.126	8.731	11.120	12.007
P.1 / 900 VA	26.111	12.629	26.410	20.788
P.1 / 1.300 VA	34.123	16.436	40.303	23.220
P.1 / 2.200 VA s/d 5.500 VA	63.418	25.345	127.318	70.790
P.1 / 6.600 VA s/d 200 kVA	1.345.355	3.903	1.361.338	275.745
P.2 / > 200 kVA	926.405	325.872	1.092.452	540.386
P.3	2.156.509	1.284.316	2.500.075	1.808.696
<b>JUMLAH P</b>	<b>4.564.048</b>	<b>1.677.232</b>	<b>5.159.016</b>	<b>2.751.632</b>
T / > 200 kVA	55.871	33.257	57.208	52.375
C / TM > 200 kVA	83.086	72.880	53.434	55.677
L	1.491.097	92.126	1.688.031	388.920
<b>JUMLAH TOTAL</b>	<b>100.420.596</b>	<b>58.108.418</b>	<b>114.068.944</b>	<b>93.177.740</b>

Source: Fiscal Policy Agency, 2012

## Electricity Subsidies per customer per month

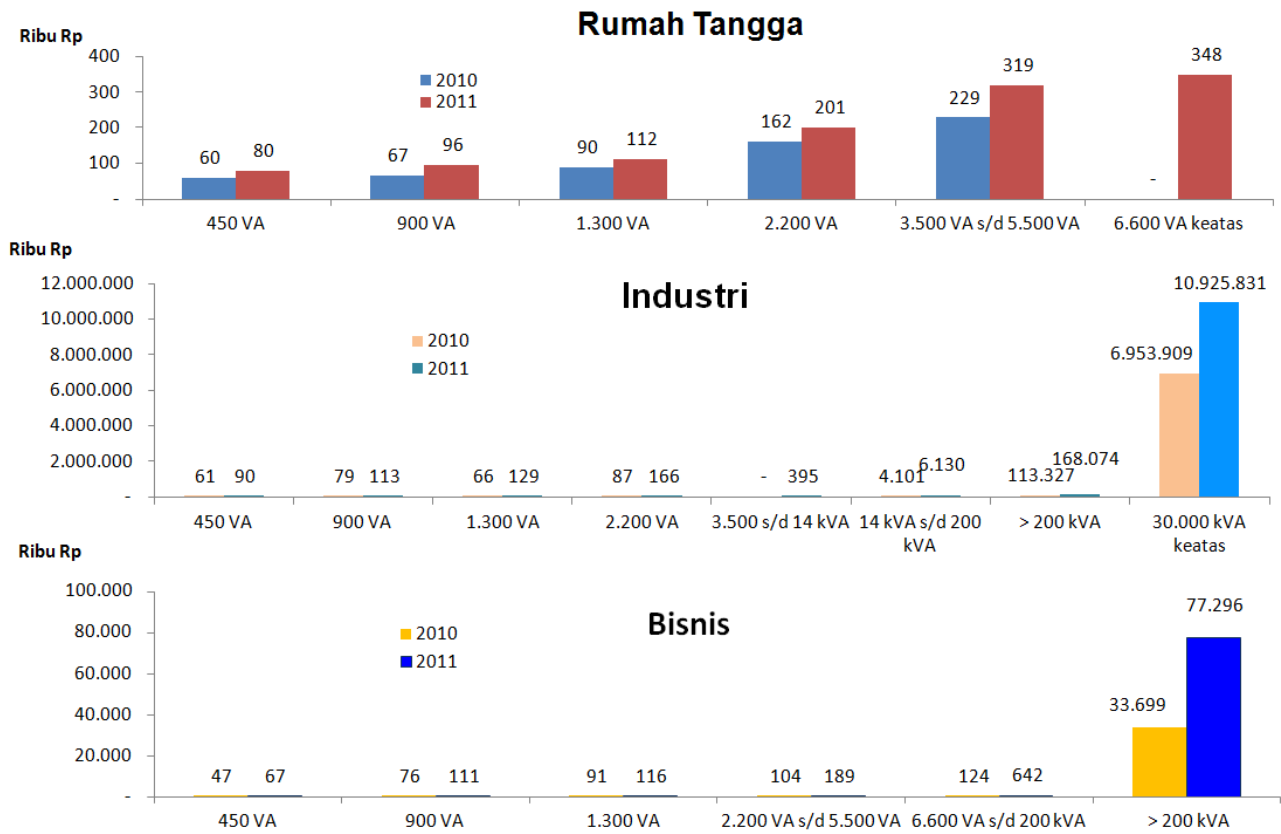

Source: PT PLN (Persero), 2012

### Top Ten Recipients of Electricity Subsidies

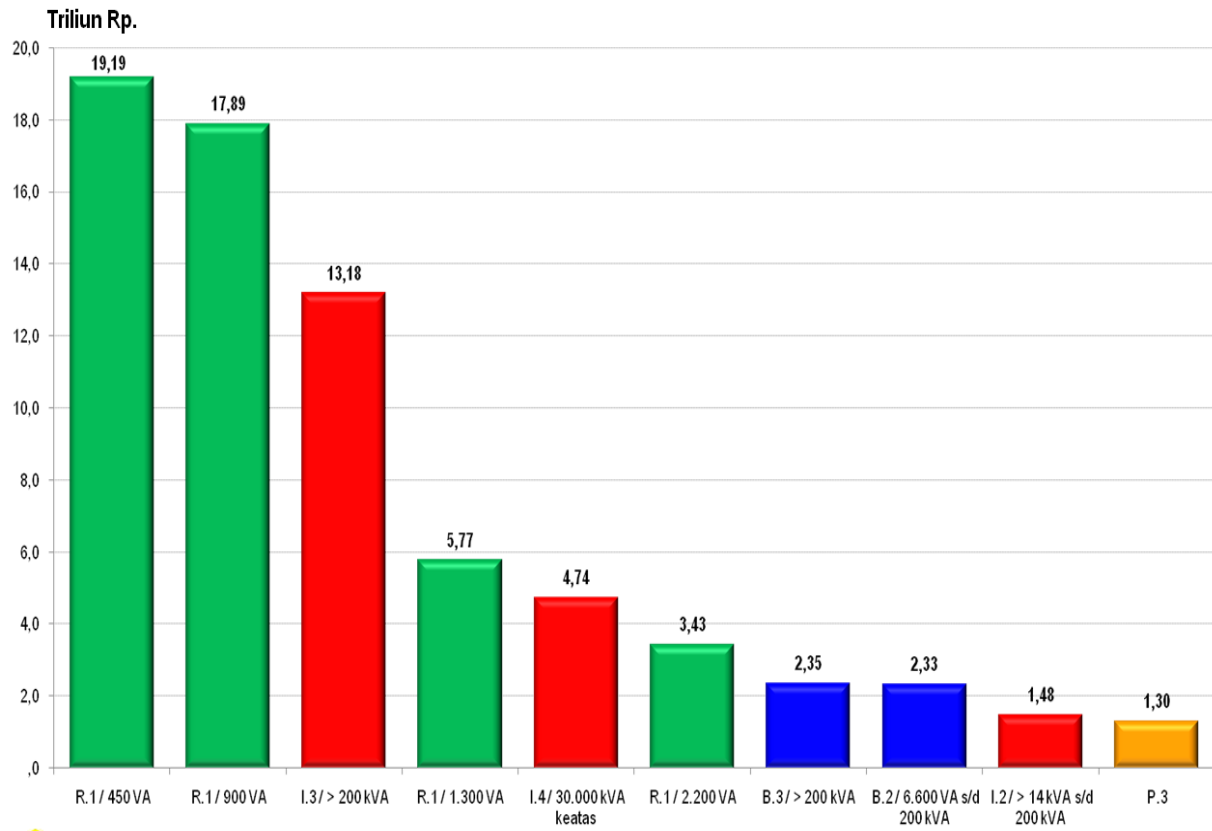

Source: PT PLN (Persero), 2012



## THE CONCEPT OF GREEN MANUFACTURING

**Rekzy Yunanto, Meiryana, and Rustina Untari**

Faculty of Economics and Business, Soegijapranata Catholic University Semarang, Indonesia  
[rekzyyunanto@gmail.com](mailto:rekzyyunanto@gmail.com)

### ABSTRACT

Previously, the company only think about how to produced a quality product at a lowest cost. But now, They have to care the environmental issues. It is because of the rule of the government, NGO's demand or self-consciousness in a company. Then the company needs to figure out how to be more greenness. In general, what we know about the concept of green manufacturing as it only focuses on reducing environmental pollution and waste. But the concept of green manufacturing is also concern to how to reduce the use of operational costs to be more efficient and not a lot of waste. In the model of green manufacturing system there are important steps to reach the high level of greenness of a company. From the results of the company's greenness level then we can plan right things - what things should do., and the next step is to implement the plan The successful of the application of the concept of green manufacturing in a company can be seen from sustanainability of the implementation. It is necessary to make procedures as well as the written guideline to maintain the sustainability of the concept of green manufacturing in the company.

**Keywords:** *green manufacturing, system model for green manufacturing, sustainable green manufacturing*

### INTRODUCTION

Actually, the concept of green manufacturing is a concept that already exist around 1998. Such as Mark Atlas and Richard Florida (1998), which in 1998 had discussed the concept of green manufacturing. Lately, the concept of green manufacturing system becoming a hot topic for discussion. There are many researches on green manufacturing in recent times, especially the last two years. As in the study by Ahmed M. Deif (2011), OECD (2011). Model of green manufacturing system is directed to design eco-friendly manufacturing system. it is done by changing the management of raw materials, energy usage, production process, more time-efficient

technologies, reducing operating costs and reduce adverse impacts on the environment (eco impact). Previously, the manufacture company only think about how to produce a quality product at a low cost. But now, with the urge to care for the environment because of the demands of the rule of the government, NGOs or self-consciousness in a company. then the company needs to figure out how to be more *greenness*.

In Indonesia there are regulations governing the protection and management of the environment in the Law of the Republic of Indonesia No. 32 of 2009. The regulation tells us to be responsible to the environment around us. if a company has implemented the concept

of green manufacturing, the costs for complying regulations regarding the protection and management of the environment can be reduced. if a company has a minimum waste water or has a waste water recycling and can make it as an input, then the company does not need to pay more to be responsible for their waste water. in the concept of green manufacturing there are many discussion about how to process waste, using recycled materials, reuse and etc. Actually, if we apply those concepts, we can save money. so that the company will benefit more. Since there are many demands for company to take care about the environment., this paper will discuss the definition of green manufacturing, green manufacturing system model of green manufacturing and sustainability.

## **MATERIAL AND METHOD**

### **1. Definition of green manufacturing**

According to Porter and Van der Linde (1995) Green manufacturing can cause a decrease in the cost of raw materials (we use waste recycling, rather than purchasing raw materials), increase production efficiency (less energy and water use), reduce environmental load and safety (compliance costs smaller regulations and potential liabilities), and enhance the company image (reduction of environmental impact in the community). According to Ahmed M. Deif (2011) green manufacturing is an attempt to create products

or systems that consume less material and energy, replacing input, reduces unwanted output and convert the output to the input (recycled). According to Zheng Ji-ling and Zou Ping (2005) Green manufacturing system is a system to recycle and reuse resources, it becomes a sector key of the closed loop and play the role of feedback during the process of recycling resources.

By definition which is expressed by the experts, the green manufacturing is not only focused on its impact on the environment, but also thinking about how to reduce the use of operational costs to be more efficient and not wasting. In addition, the application of the concept of green manufacturing can also enhance the company's image.

According to Mark Atlas and Richard Florida (1998). Green Manufactuirng can be divided into five main areas. Which are: (1) changes in the product, (2) changes in production, (3) changes in inputs in the production process, (4) internal waste reuse, and (5) the better household. The following discussion focusing on products that are physicaly changes which can be implemented. Many of the major changes in the production process into the following categories:

- change the dependence on human intervention
- the use of continuous process, rather than batch process
- changing the nature of the steps in the production process

- eliminates steps in the production process
- change the cleaning process.

Input changes are an important tool in the Green Manufacturing materials for large and small product and inputs that contribute to the production, if not incorporated in the final process, it may be worth changing. As an example a minor change input in production may be true and it can reduce the impact on the environment. for example on the use of paint for cars and aircraft production. Introduction of powder-based paint and paint with a high density substantially reduce emissions of volatile organic compounds. We could replace it with the paint using water-based materials to reduce impact on the environment.

internal resources are reused often significantly, for example by reusing the remaining water, energy, chemicals and metals. closed-loop process water recycling system that replaces the single pass is usually more efficient, by using water and chemicals that can be recycled. In some production processes, there may be many ways of flow , for example, the water used in a single step process is also used in another process, a process that is not so stringent quality requirements.

Good housekeeping are generally simple, routine, have non-resource steps intensive to maintain the facility in a good working and orderly environment. These include separating waste, chemical waste and minimize waste,

installing alarms of overflowing, provide automatic shutoff valve, which eliminates leaks and drips and put in place the possibility of collecting the spill. There are also request inspection to identify environmental problems and malfunctions production process

### **Model of green manufacturing system**

Before a brief description in the model of green manufacturing system, there is a step to find out how *greenness* in a company, after it plans what to do, the next is to decide what are the things that need to be changed, the next steps is to implement the plan and keep it off. Ahmed M. Deif (2011) explains that the general objective of developing the system model is to find a high-level framework for understanding certain kinds of systems, sub-systems, and their interactions with related systems. Thus, the objectives of green manufacturing system model is to have a better understanding of green manufacturing in terms of:

- Catch the various activities required to assess the current level of manufacturing systems
- Describe the green transformation plan and control a range of tools and metrics needed for this transformation.
- Describe how to maintain the improvements achievements and build on it to maintain a system that is more eco-efficient.

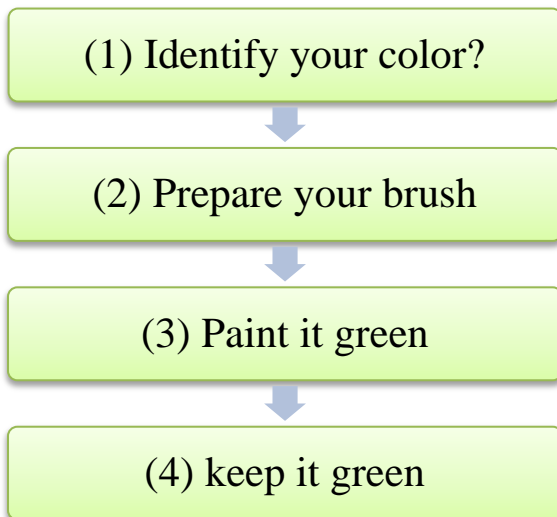

In (1) identify color guide there are several levels of color, from the lowest of the color (black), then there is brown on top level, and the highest level of the color (gray). Assessment to identify the color you see from how *greenness* culture, the level of waste and eco level. In step (2) prepare brush your focus on areas which will be enhanced and where is the order. Improved planning at this stage relating to the management of materials, energy and technology. Once the plan is ready, it is necessary to have (3) paint it green. Green Paint focuses on how to improve the greenness. At this stage the plan is implemented green manufacturing began. Matters relating to the implementation of the process control, recycling, and layout modification technology. Once in the implementation, then we go to step (4) keep it green. At this stage focuses on how to maintain the level of *greenness*. To maintain *greenness* requires organizational approach, ie policy - policy, instructions - instructions and so on.

The core of the model of green manufacturing system that was introduced by Ahmed M. Deif (2011) is directed to design systems that are more environmentally friendly manufacturing. By altering the management of raw material use, energy use, and the production process is more time-efficient technologies, reducing operating costs and reduce adverse impacts on the environment (eco impact). So how to keep a firm can increase the level of their *greenness* or say how it could be green.

## 2. Green manufacturing sustainable

According to the U.S. Commerce Department sustainable manufacturing summarized as "Creation of manufacturing products using processes that minimize negative impacts on the environment, conserve energy and natural resources, which are safe for employees, communities, and consumers and economically". From the results of the development of research conducted by the organization OECD (2011) on sustainable manufacturing. There are several steps that must be performed in order to achieve sustainable manufacturing:

### A. Map your impact and set priorities (preparatory phase)

At this stage, we focus on where to start and where we want to end. The important thing is that we can make sure all is needed to achieve sustainable

manufacturing. The purpose of this first step is to build a common understanding of the positive and negative environmental impacts by mapping our activities and determine which are most affecting our performance.

B. Select indicators and understand the required data (preparation phase)

In this stage we need to know how many indicators that we will use. And what are the specific things we need to know before we make the measurement.

C. Sizes used in production (phase measurement)

The first indicator relates to the determination of raw materials and semi-finished products to be used in the production process to make the product. to see whether the impact of the input materials can have on the environment performance. In general, we can improve the environmental performance of the inputs used. in a way that produces have a win-win benefits and often save costs. In some ways may produce favorable benefits and save costs. The main benefit of input *greenness*:

- Reduce the use of materials, it will affect lower costs incurred for the purchase of materials.
- Minimize hazardous substances, the advantage of minimizing the harmful substances that can reduce the costs

associated with handling the effects of these harmful substances. And reduce storage costs and the cost of treating.

- replacing hazardous materials by using alternatives those have fewer damaging effects. by taking these steps, we will be held accountable for compliance with the lower. Because if we use hazardous materials, often we will be required by the authorities to manage it so as not to impact damage or harm others.

- Increasing the use of renewable materials and can be recycled. By implementing these measures will reduce waste disposal requirements. Can save costs at the same time the use of materials.

To measure the performance of input, there are three indicators used to measure fit. Each indicator measures the intensity with which you will use:

- The intensity of the use of non-renewable materials can lower the assessment results.
- The intensity of using of hazardous substances that may also lower the assessment.
- Recycling / materials used or updated, yet for recycling will increase the assessment.

D. Assess operations of your facility (phase measurement)

In this phase we will see what happens in the facility and the activities undertaken to transform a wide range of input (step C) into final products for shipment and sale (Step E). Here we will focus on the function of the design, manufacturing facility, which is related to the back-office functions as well as the emissions arising from the operation field. Why is it important to assess the operation in the field of sustainable manufacturing? Due to design, manage and surrounding facilities, including operations and production processes have a significant influence on overall environmental performance. Some of the specific benefits to the business of operating a sustainable environment include (main benefit of surgery *greeness*):

- Reducing energy consumption will reduce energy costs
- Reducing waste and emissions that reduce the cost of monitoring, processing and disposal Reduce the loss of the economic value of material inputs
- Process re / recondition and will increase the value of material inputs
- Replace or upgrade equipment or replace equipment production lines that will improve operating efficiency.

Increase biodiversity and native habitat in place will reduce the need for watering, air conditioning and other maintenance

To measure the Performance surgery, there are eight key Performance indicators include:

- Water consumption at the facility will reduce the assessment results
- Energy consumption at the facility will also lower the assessment.
- Use of renewable energy / reuse will increase the results of peniaian.
- greenhouse gases from operations will reduce the assessment results
- Waste generated by operations will reduce the assessment results.
- emissions to air generated by operations will reduce the assessment results.
- Emissions into water generated by operations will reduce the assessment results.
- Closing the facility will naturally raise peniaian results.

E. Product evaluation (phase measurement)

At this step attention to products produced by the facility. Are the products produced by the facility is no impact arising from the composition of the product and at the time of use. With attention to environmental issues and opportunities to create products that are *greeness* brings many benefits, which include:

- Changing the recycled materials will be saving the cost of materials and create products more attractive to some buyers.
- Reduce hazardous substances in products will Lower cost monitoring, cost of treatment and disposal of products is seen as a safer and more desirable.
- Increase the recyclability or biodegradability products will improve the value of material inputs, reduce costs associated with disposal
- Energy that is needed on lower product will reduce usage costs, the desire to improve the product, regulatory requirements and anticipate future standards.
- Increase the durability of the product will reduce the need for non-renewable materials and Improve the product

To measure the performance evaluation of environmental products, there are seven indicators used to measure:

- Recycled / reused content of your product will increase rating results)
- Recycling Your product will raise the assessment.
- The materials used in the product update will raise assessments results.
- Material used is not updated in the product will reduce the assessment results,
- dangerous substances contained in the product will reduce the assessment results.
- Energy consumption in the use of the product will reduce the assessment results.
- greenhouse gas emissions from the use of the product will reduce the assessment results.

#### F. Understand the assessment of the measurement (stage repair)

This step is to know the different ways in reviewing and analyzing the information generated by the indicators to identify options that can improve the performance of the facility.

#### G. Take action to improve Performance (stage repair)

At this stage need to make a decision to set clear targets and creating a real implementation plan based on the results of the measurements that have been understood. Targets and implementation plan is an invaluable tool for identifying what needs to be done, how and when to do it.

### RESULTS AND DISCUSSION

In the concept of green manufacturing there are many discussions about how to process waste, using recycled materials, reuse and so on. Actually, if we apply these concepts, we also have done make savings. so that the company will benefit more. green manufacturing is not only focused on its impact on the environment, but the concept of green manufacturing are also thinking about how to reduce the use of operational costs to

be more efficient and not much going waste. The core of the model of green manufacturing system that is directed to design the manufacturing system to be more environmentally friendly. By altering the management of raw material use, energy use, and the production process that has more time-efficient technologies, reducing operating costs and reduce adverse impacts on the environment (eco impact). To maintain the sustainability of the concept of green manufacturing that has been applied, we should do the procedure as same as written instructions for maintaining the sustainability of the concept of green manufacturing in the company. Measurements were performed in order to achieve sustainable green manufacturing there are 3 stages of measurement. The first step is the measurement on the production rate on input use and how it will impact the environment. assess the second phase of the measurement facility operations. Assessment at this stage relating to the use of energy and the impact of waste on the environment. The last measurement is evaluation. At this stage whether the products produced by the facility no adverse effects on the composition of the product and at the time of use of the product. This paper does not explain in detail about how to perform measurements with quantitative methods concretely at a company. we do not get information about how to apply those measurements on real companies. This paper describes the size is still limited to what you can improve results of the assessment and any measures that can reduce the assessment

results. Suggestions for further research, researchers can show how the form of the procedure and the written instructions of a company that was about to apply the concept of green manufacturing. or further research can apply 3 phase measurements on real companies to make it look clear as to what form of measurement basis if applicable.

### **ACKNOWLEDGEMENT**

This manuscript is fully granted by MP3EI Project on 2013 from the Directorate General of Higher Education of the Ministry of National Education of the Republic of Indonesia.

### **REFERENCES**

- Ahmed M.Deif. 2011. A system model for green manufacturing.
- Zheng Ji-ling, Zou Ping. 2005. Green manufacturing system and system integration based on cycle economy.
- OECD. 2011. Sustainable manufacturing toolkit.
- Mark Atlas and Richard Florida. 1998. Green manufacturing
- Potter, M.E and van der Linde, C. 1995. Green and competitive : Ending the stalemate.



## NATURAL DYES IN JAVA BATIK (LOCAL KNOWLEDGE ON GREEN MANUFACTURING)

**Rustina Untari**

*Management Departement, Faculty of Economics and Business, Soegijapranata Catholic University,  
Semarang, Indonesia*  
[r.untari@gmail.com](mailto:r.untari@gmail.com)

### ABSTRACT

Batik is the art of decorating cloth using wax and dye, has been practised since the 15th century in Java, Indonesia. In the past, natural method was used for coloring process of batik or what we called as dyeing process. People in the past used fruit and plantation for natural resource of colors, such as carrot for orange coloring, pandan for green coloring, mahogany woods for brown colour, indigo for blue colour and so on. Since the born of synthetic dyes, natural dyes for coloring are started to be left behind and almost lost in batik society (SME). This paper will provide the description of batik (history and production process of batik), natural color dyes (history and technology), and the knowledge of natural dyes which known by batik artisan in Java. Those information that we collect by research showed that Java have had have Green manufacturing technology since along time ago.

**Keywords** : *Java, Batik, natural dyes, batik society, SME.*

### INTRODUCTION

Batik is a process of dying method on textiles using wax to create patterns and designs. Batik was established in Java in 15th century (For Royal Family),

In the past, natural dyes were used for coloring process of *batik*. People in the past used fruit and plantation to make a natural resource of colors. Since the born of synthetic dyes substance those natural dyes for coloring are started to be left behind.

Chemical dyeing process also produces highly polluted water, which has become a major source of pollution around the world. Although many technologies have been developed to reduce the pollution

caused by chemical dyes, there is still no satisfactory solution to this problem.

Nowadays, the rule of the government, NGOs, market orientation, or self-consciousness in a company leads Company to seek our local knowledge on coloring.

### METHOD

We observed the production process of natural colour batik and compare it with the concept of green manufacturing.

### RESULTS AND DISCUSSION

#### Batik

#### History of Batik in Java

**In the document of Nomination for inscription on the Representative List in 2009 (Reference No. 00170 )**

<http://www.unesco.org/culture/ich/index.php?RL=00170>, wrote :

Traditional handcrafted textile rich in intangible cultural values, passed down for generations in Java and elsewhere since early 15th Century (Ref. Siksakanda, 1517AD),

**Batik Process will be described below :**

1. Create Design on textile by pencil.
2. Covered The textile (depend on the design) with wax. We can use canting or stamp. Any area that is covered by wax will be covered from dyes.
3. After the image is completed the textile is submerged in a dye bath in order to change the color of any fabric surface that is exposed.

The process of waxing and coloring will be repeated until all of color fixed in textiles

**Green Manufacturing**

*Green manufacturing is a method for manufacturing that minimizes waste and pollution. These goals are often achieved through product and process design.*”(Foster, S. Thomas, 2001.)

Actually, the concept of green manufacturing is a concept that already exist around 1998. (Mark Atlas and Richard Florida, 1998)

In Green Manufacturing, environmental impact of all stages of production is considered. The manufacturer will not use

any materials which are harmful to the ecosystem in the design, production, field application and end of life disposal stages of the product.

According to Zheng Ji-ling and Zou Ping (2005) Green manufacturing system is a system to recycle and reuse resources, it becomes a sector key of the closed loop and play the role of feedback during the process of recycling resources.

According to Porter and Van der Linde (1995) Green manufacturing can cause a decrease in the cost of raw materials (we use waste recycling, rather than purchasing raw materials), increase production efficiency (less energy and water use), reduce environmental load and safety (compliance costs smaller regulations and potential liabilities), and enhance the company image (reduction of environmental impact in the community).

**Natural Dyes**

Some plants and vegetables are directly produce a color when they are boiled, but there are many original materials (plants and vegetables) that indirectly produce a color. We should process the original material to get substance that will produce a color.

Actually, the use of natural raw materials in textile SMEs in Java are not new, in the

past material indigo, turmeric, mahogany, etc. have been used as a natural dyes.

Since the invention of synthetic dyes in 1850, chemical dyes have become popular all over the world and was soon replaced, which has been used for thousands of years (He dan Xiao, 2011)

## CONCLUSION

Natural dyes in Java Batik is one of application of Green Manufacturing.

The use of natural dyes in Java batik can cause a decrease in the cost of raw materials (we use waste recycling, rather than purchasing raw materials), increase production efficiency (less energy and water use), reduce environmental load and safety (compliance costs smaller regulations and potential liabilities), and enhance the company image (reduction of environmental impact in the community).

## ACKNOWLEDGEMENT

This manuscript is fully granted by MP3EI Project on 2013 from the Directorate General of Higher Education of the Ministry of National Education of the Republic of Indonesia

## REFERENCES

- Foster, S. Thomas, 2001 Managing Quality: An Integrative Approach. Upper Saddle River: Prentice Hall.
- He dan Xiao. (2011). Earth-Friendly Dyes. *China Daily*.
- Mark Atlas and Richard Florida. 1998. Green manufacturing
- Zheng Ji-ling, Zou Ping. 2005. Green manufacturing system and system integration based on cycle economy

## ANALYSIS OF THE LAPINDO MUDFLOW IN SIDOARJO-EAST JAVA

Daniel Sugama Stephanus<sup>1</sup>, Taufik Chairudin<sup>2</sup>

<sup>1</sup> Economics and Business Faculty, Ma Chung University, Malang, Indonesia

<sup>2</sup> Reseach and Community Service Institute; Ma Chung University, Malang, Indonesia  
[daniel.stephanus@machung.ac.id](mailto:daniel.stephanus@machung.ac.id)

### ABSTRACT

The Lapindo mudflow that occurred on May 26, 2006 has submerged 9 villages of 3 subdistricts in Sidoarjo. Those are Renokenonogo, Jatirejo, Renokenonogo, Jatirejo, Siring, Kedungbendo and Ketapang. Besides, the damage are neither physically such as buildings, roads, infrastructure nor in economic, social life, culture, education, legal and others. The damage also occurs in person regarding the uncertainty of the refugees' shelter, livelihoods, education for children, health and psychological and social impact of having to move residence resulting in stress.

The solution which focuses on terminating the mudflow (snubbing unit, relief well 1 and 2) as well as discharging into Porong river (spill way) have failed. Though the embankment has been well-built, unfortunately cannot curb the mudflow. These activities are costly. Meanwhile, the handling on social effect is relatively in small portion. Even the compensation process is complicated and many rules imposed, this is contrary to the process of land acquisition for exploration by Lapindo that is simple with no various sorts of conditions. From the beginning, the central and regional government has succumbed to the Lapindo Brantas Inc. (LBI), indicated by simple process of land acquisition and drilling activities which not completed with environmental impact analysis (AMDAL).

**Keywords:** *mudflow, Lapindo Brantas In, snubbing unit, relief well, spill way, environmental impact analysis (AMDAL).*

### INTRODUCTION

The mudflow tragedy by February 2, 2007 has covered 9 villages of 3 subdistricts in Sidoarjo. Those are Renokenonogo, Jatirejo, Siring, Kedungbendo and Ketapang (East).

The damage is neither physically such as buildings, roads, and infrastructure nor in economic, social life, culture, education, legal and others. The damage also occurs in persons regarding the uncertainty of the refugees' shelter, livelihoods, education for children, health and psychological and social impact of having to move residence resulting in stress. In

Addition, the compensation is uncertain and the children have to move to other schools that force them to adapt with a new situation.

The solution which focuses on terminating the mudflow (snubbing unit, relief well 1 and 2) as well as disposal into Porong river (spill way) have failed. Though the embankment has been well-built, unfortunately cannot curb the mudflow. The central and regional governments have succumbed to the Lapindo Brantas Inc. (LBI), indicated by simple process of land acquisition and drilling activity

which is not completed with environmental impact analysis (AMDAL)

### **1. LAPINDO BRANTAS Inc.**

Lapindo Brantas is one of subsidiaries of PT. Energi Mega Persada Tbk. It is founded for oil exploration around the Brantas Block, in this case, Lapindo Brantas/EMP plays its role as operator, while the equity is jointly owned by PT. Energi Mega Persada Tbk, PT. Medko Energi Tbk, and Santos LTD – Australia which owns several oil and gas drilling companies throughout Indonesia. PT. Energi Mega Persada Tbk belongs to Bakrie Family owns 50% on equity and PT. Medko Energi Tbk owned by Panigoro family with 32%, Santos Brantas Indonesia Tbk owned by foreign investor with 18% on equity.

## **2. CRONOLOGY**

### **2.1 Land Acquisition**

There is no socialization and transparency about exploration plan by Lapindo Brantas Inc. The headwoman of Renokenongo socializes that land acquisition used for warehouse of heavy tools. The negotiation is conducted among the landowners and subdistrict officers, while the Lapindo is never appear, even the receipt is not completed with identity of acquirer (Lapindo).

### **2.2 Eruption**

Friday, May 26, 2006, at 3 a.m., the residents of Renokenongo heard loud sirens from drilling site where PT Lapindo operated its

business. There was neither prior communication nor notice provided by PT. Lapindo Brantas/EMP.

Monday, May 29 Mei, 2006, hot mud around the drilling site firstly erupted in Banjar Panji I of Siring village, Porong subdistrict at 5.30 a.m. The malignant material erupted from new spots of cleft that estimated 50 meters away from drilling point where Lapindo Brantas Inc operated its drilling activity, the mud spurt 150 meters high.

Tuesday, May 30, 2006, the drilling site in Banjar Panji I was secured, and the mud spurt increased on the following day. It widely spread and submerged farming area around the Siring village.

Thursday, June 1, 2006, two spots erupted at 7.30 p.m. The first was in residential area and the other one in the farming area. The three spots of mudflow located in Siring and Renokenongo village were northeastern – southwestern orientation. No victims at the time, however the mud had been spread out and submerged several residential areas.

In the first week, the Lapindo/EMP dodged that the three spots were caused by natural factor, exactly the earthquake occurred in Yogyakarta on May 27, 2006. The speculation of Lapindo was condemned by various parties since the information that had been obtained indicated that prior to the mud eruption, the drilling position was in 9297 feet depth equal to 3000 meters, and experienced lost circulation and suddenly produced gas beneath

the surface in periodic time then stuck at the end.

This situation occurred before the earthquake in Yogyakarta on May 27, 2006, so a new speculation came up that the mud spurt caused by underground blow out or gas blow up beneath the surface which triggered over pressure. The volume of mud exceed the lost mud in the drilling, it led to shale and water formation, here known that in 9000 feet depth, Lapindo Brantas/EMP did not assemble 9 5/8 inches case which was the drilling safety standard.

Besides negligent, the geologist found slump layer – unstable moving shale indicator around the operation area of PT Lapindo Brantas. If this layer were penetrated vertically, would lead to hot mud eruption. Experts suggested slant drilling to avoid the slump layer contained in the geology of Brantas block, unfortunately this was ignored by Lapindo Brantas. Besides, the Lapindo did not anticipate the fault zone.

From the beginning, Lapindo never socializes its operation to the residents around the site. Even, Lapindo deceived the residents that the land acquisition used for animal feed company. When hot mud erupted, even, the Lapindo did not provide any explanation with information on what actually happened in the drilling neither in technical nor in solution.

### **3. VIOLATION OF LAW**

1. Permission on Oil exploration that close to residential and public facilities is violation of Law 23/1997 on Environmental Management article 41 and 42 and Law 7/2004 on Water Resources Article 94
2. Untransparent land acquisition
3. No Environmental impact analysis (AMDAL).

#### **3.1 Law and Politic Accountability**

As reported that the East Java Police investigated 7 suspects related to Lapindo hot mud, and expanded the investigation for 2 persons of Vice President DSS (Drilling Share Service) PT. Energi Mega Persada, the primary company of Lapindo Brantas Inc. and Director of PT Medici Citra Nusa on the suspicions (1) the negligent that lead to mudflow (article 187 and 188 Criminal Act (KUHP) as well as article 41 and 42 Law on Environmental Management; (2) the negligent, not stopping the drilling; (3) should know the difference of contract provided by Lapindo from the drilling program. Refer to the three suspicions, there were 9 suspects in the case.

#### **3.2 Civil Accountability**

Drilling site in Banjar Panji-1 located in Brantas block is Lapindo Brantas/EMP concession based on Production Sharing Contract (PSC) with Oil and Gas Regulatory Special Task Force (BP Migas). The Drilling project is the task of drilling department of LAPINDO, and sub-contracted to other party namely PT. Medici Citra Nusantara (MCN).

The shareowners of Brantas block are PT. EMP (50%) and the remaining is jointly owned by Santos LTD, PT. Medco Energi Tbk and Lapindo Brantas/EMP Inc. It means that there are four parties directly related to drilling operation in Brantas block, PT Lapindo Brantas, PT Energi Mega Persada Tbk, PT Medco Energi Tbk, and Santos LTD.

### **3.3 Criminal Accountability**

Theoretically, (Tumbuan, 1988:3 in Siaran Pers Bersama. August 14, 2006) that instead of people, legal entities can only do what is explicitly or implicitly allowed by law and the charter. Many studies (Hamdan, 2000: 63 in Siaran Pers Bersama. August 14, 2006) stated that violation of law in which be applied to corporation are: violations of administrative law, pollution, finance, labor, manufacturing, and trade competition. The first two may be applied to the owner of Brantas block as the subject in criminal case, since the widespread negative impact on every part of people lives.

### **3.4 Political Accountability**

The secretary general of Pro-Democracy in Terbit. Com (July 28, 2006) stated that Coordinating People's Welfare Minister should be non-active in United Indonesia Cabinet to avoid conflict of interest in solving mudflow in Sidoarjo, East Java.

The Responsibility of Oil And Gas Regulatory Special Task Force (BP Migas) in supervision stated in Chapter 7 Article 41 Law No. 22/2001 on Petroleum and Natural Gas: (1)

Responsibility for activities of supervision over jobs and the implementation of petroleum and natural gas related business activities with regard to the compliance to provisions of laws in force shall be at the ministry whose tasks and authority cover petroleum and natural gas-related business activities and other ministries concerned; and (2) The supervision over the implementation of upstream business activities based on joint cooperation contracts shall be executed by the executing agency.

### **3.5 Corporate Crime**

Corporate crime is any criminal act committed by a corporation that is legally prohibited or not performs certain actions as stipulated in the criminal provisions. Even the Law No. 23/1997 on Environmental Management article 45 and 46 clearly stated that criminals (pollution and environmental destruction) is not only imposed on people personally but also includes legal entities.

## **4. IMPACT AND ENVIRONMENTASL DEGRADATION**

### **4.1 Environmental Degradation**

The mud which erupted is either hot or malignant, it increases about 150 thousand meted cubic every day, and until the 90th day the mud volume is about 7 million metes cubic and swamp 300 hectares of people's land.

Refer to the test conducted in ITS laboratory, the amount of dissolved and suspended solids in the mud are very high. This means that they

can only be precipitated in a long time since of utilizing sunshine and wind.

The environmental analysis made by The Environmental Impact Management Agency of East Java (Bapedal), Environmental and Mining Agency of Sidoarjo and Lapindo Brantas/EMP, stated that the mud has submerged 5 villages in Sidoarjo and contains phenol concentration exceed the standard. Massive environmental degradation in Porong and the surrounding areas leads to destruction action and open ecosystem extermination, and even take effect to the surrounding areas if the handling of mudflow does not pay attention to geo-ecology of the area.

The mud that erupts in Porong is either hot or containing poisonous materials (B3) which exceed the threshold. The phenol of mud as mentioned in Government Regulation (Peraturan Pemerintah) No 85/99 on replacement of Government Regulation No 18/1999 on Waste Management that B3 is chronic pollutants. Within 90 days Lapindo mudflow has spurt more than 40 tons of phenol, 8 tons of iron (Fe), 1.4 million tons of suspended solids, 50 thousand tons of chloride compounds.

The Sidoarjo regency administration through the concerned agencies, officially sent the mud sample in two drums to Laboratory of Soil Chemistry to Faculty of Agriculture, Brawijaya University in Malang, this aimed to know the liability of land that has been swamped with the mud for agriculture and settlement.

The conclusion is the land mixed with geological mud is not liable for agriculture. Land with 10 ppm of Chlor is categorized high level, in addition the mud with 10 thousand ppm. Likewise, high levels of Natrium will make the soil particle rupture, and difficult to form into clumps that cause blockage of the air flow and water into soil, the plants will die as a result of aluminum poisoning.

#### **4.2 To the sea: Solving problem by creating disaster**

Disposal to the sea has higher risk on social, economic and environmental disadvantages than special treatment carried out in land. This means that the solution creates new problem either in the scale of affected areas or time of settlement. Why? (Ageung, dkk, 2006)

Firstly, it needs to notice that the Lapindo hot mud neither contaminated with pollutants such as phenol, Chlore, and others, nor suspended solids, which are fine article in great deal of quantity, then, called hot mud. It burst from earth at least 1.8 m<sup>3</sup> /sec or a tank of 5000 liters per 2 seconds.

Secondly, there are 2 key factors that affect the process of mud sedimentation perfectly (separation between mud and water), namely velocity and particle diameter size. The larger diameter then faster in sedimentation and vice-versa, of course this is closely related to velocity as media or the transporter of particles. Thus, the separation of mud over water prior to disposal to sea is impossible in



great deal of quantity. It means that the Lapindo mud will flow to the sea.

Thirdly, if it is seen in oceanographically context, generally the Indonesian water have two primary seasons, west and east, as well as transition season between them. The Indonesian water dynamic make the scoping (limitating the affected areas) difficult to do, and it is surely neither affect the water around Sidoarjo nor will expand to other regions in accordance with ongoing season.

The fourth, there are at least 6 parameters which affect quality and quantity of water resources, are: smell, brightness, turbidity, suspended solids load (TSS, total suspended solids), temperature, oil layers or other contaminants (heavy metals, etc.). The scenario of disposal into sea surely will affect those parameters. The sediment particle in great number cause suspended solids in water increased resulting the turbidity turn higher and the brightness become lower, meanwhile at the same time produce unpleasant smell and significant temperature change. At the end, the sunshine that takes important role in water photosynthesis (related to water fertility) cannot reach the bottom of waters. Thus, it surely decreases waters productivity, while on the other hand consuming fisheries products from this territory endanger people health.

## **5. ECONOMIC, SOCIAL AND CULTURAL IMPACTS**

### **5.1 Economic, Social and Culture**

The 60 degree Celsius heat mud bursts indiscriminately. This spread out fast and swamped rice field, plantations, farms, homes, schools, and houses of worship, factories, and other manufacturing industries. The people who are the most disadvantaged of the Lapindo mudflow are thousands of lower class of farmers, labors, petty traders, as well as low-income society who live and work around the area, they are forced to move.

The Lapindo Brantas was not indeed irresponsible, even took quick action though without smart mitigation, lavish post as a shelter for the victims, they promised to bear all the losses experienced by the surrounding community by providing suitable funds for the victims that should be written on MoU which one of the points stated that the victims would not make any claims against Lapindo Brantas either civil or criminal one.

There are 18.696 homes swamped by mud within a year, 5,675 kilometers length of irrigation and 2.4 kilometers drinking water line damaged. In addition, 376.2 hectares of rice field and sugarcane land 92.31 buried. Residents' activities neither annoyed nor extinct.

The 29 manufacturers which swamped by mud employs more than 2,000 workforces have to stop their operation. Hundreds of leather craftsmen stop working, particularly in Kedungbendo and Renokenongo village because of their equipment have sunk, in

addition, their consumers are reluctant going to the product market in Tanggulangin. Not only craftsmen but also the product showroom became deserted. Congestion on the road of Porong resulting the distribution lines from the east disrupted (Pasuruan and so on as well as from Malang), consequently disrupt export distribution via Surabaya.

Surabaya-Gempol highway was closed repeatedly. If opened, the transportation run slowly. The explosion of the BP Migas pipeline on November 22, 2006 cause the highway completely submerged by the mud finally, even the bridge over the Porong was dismantled due to shift and crack. This aimed to avoid possibility of collapse at any time to road users.

### **5.2 Children Rights Negligent**

1. Right to Adequate Standard of Living.
2. Right to Excellent Health Service.
3. Right to Privilege Protection against conflict of law.
4. Right to Privilege Protection against Exploitation
5. Right to Living with parents.
6. Right to Communication with the parents if separated from one of them.
7. Right to skill training.
8. Right to Creativity.
9. Right to Play.
10. Right to Participating in Art and Cultural
11. Right to Privilege Protection in precarious situation.

12. Right to Privilege Protection as Refugee

13. Right to Freely Elementary Education.

Transportation and Economy in East Java as well as export distribution that should pass Surabaya disrupted, automatically disturb economy in East Java which is based in Surabaya. The cities in Eastern of East Java as well as Southern have difficulty in either people or goods transportation. Consequently, this brings impact to export-oriented companies around Pasuruan.

### **5.3 Public and State Facilities**

The state facilities damaged by Lapindo mudflow are:

1. The damage of Porong-Surabaya Highway.
2. The Rupture of BP Migas gas pipeline that transports natural gas from the Madura to companies in Sidoarjo, Surabaya and Gresik.
3. The Rupture of Regional Water Company (PDAM) water pipeline that transports fresh water from Pandaan to Sidoarjo and Surabaya.
4. The Emigration of State Electricity Substation Installation in Porong and the threat of collapse of tower network SUTET Paiton to Surabaya.
5. The damage of village administration office, the local military command (Koramil) and schools.

6. The damage of infrastructures such as irrigation, water, resident electricity installation, telephone network and the residence.

## **6. TECHNICAL DISASTER MANAGEMENT**

### **6.1 Military Role**

Indonesian Military (TNI) performed the overall disaster management at the early stage of mudflow prior to the National Team established. The Indonesian military represented by Yon Zipur 5 Malang not only focus safety of embankment and mud flow termination facilities but also management (planning and implementation), transportation of refugees as well as public kitchens in New Market Porong. After the National Team established, the embankment built by Yon Zipur 10 replacing Yon Zipur 5 Malang.

### **6.2 Snubbing Unit**

The first scenario mudflow termination is the snubbing unit in which technically continue the drilling to find the center of explosion and then subsequent closure with certain material is made. The Snubbing Unit located in north of mud well and run between July and August 2006. Unfortunately, this has failed since the mudflow is getting wider and makes the snubbing unit sunk.

### **Relief Well**

The second scenario is Relief Well, done by slant drilling along the well beyond the source

of mudflow to insert material over the well. Relief well 1 built in Siring village to block flow from the southern – western, on the other hand, the relief well 2 constructed in Renokenongo village to block mud from North – East well. This effort has failed in addition the sink of relief well 2 since dam breakage as a result of gas pipeline explosion on November 22, 2006. The Relief Well 3 was built in different way from the previous ones. It is located nearby the relief well 1. The closure of mud well using the cement balls in particular size and weight instead of the heavy cement. This effort has failed as well.

### **Mitigation**

To avoid the mudflow become wider, mitigation conducted. The improper handling has been done in the beginning of mudflow. The dam made in the beginning of mudflow as high as the rice field dam. Consequently, when the mudflow gets wider and swamps the rice field in Renokenongo and Siring village, it is unstoppable and reaches the highway. The horizontal conflict among the residents appeared firstly between Kedungbendo and Renokenongo village related to the direction and height of embankment. Besides, those residents tried to break the dam in order to keeping the mud remain in the highway that it would not submerge the village.

After that, the mitigation is conducted in better ways. The embankment built higher and stronger to surround the well and the flow directed to east. Another horizontal conflict occurred, involving residents in west and south

of well (Siring, Besuki, Mindi, Pejarakan, and Kedungcangkring) with residents of north and east well (Renokenongo, Glagah Arum, Permisan, and Sentul). In the Indonesia anniversary eve, the military fired warning shots to separate the people who were ready to fight. The embankment in Besuki village collapsed finally and sank villages in south of well though only muddy water.

The mitigation done in more levels, not only in circumference of mud wells (4 levels) with a height reaches 15 meters, north of the highway, along Renokenongo village, but also the spillway built in Besuki and Pejarakan village to transport the mud into river since the pipeline totally have failed. The embankment along Siring, Jatirejo, Mindi to Pejarakan built to save the road and railway. The mitigation consists of ring 1 around the mud wells, ring 2 to accommodate the mud at the shelter (pond) and ring 3 to keep the highway, roads, railway, as well as settlements in the south and north of the well. Until the gas pipeline explosion BP Migas on 22 November 2006, because of decrease of soil that broke gas pipeline.

## 7. HALFHEARTED MITIGATION

The explosion of a gas pipeline results mudflow widespread to the north and east of well in particular. To avoid the extent of mudflow, the mitigation was done but halfheartedly. In fact, the problem is about lack of funds for the purchase of gravel, gravel transport operations and mitigation activities (heavy equipment). Mitigation done by taking soil from rice field nearby the embankment

such as in Sengon and Renokenongo and Gempolsari village that lead to embankment collapse when the mud increases. Residents in Kali Tengah and Gempol village collect their money to build embankment in their own village though has collapsed today.

Finally, the effort of covering the embankment that collapsed can be established with the quality is not better than previous mitigation. Temporarily, can be controlled and directed toward the spillway, though muddy water continues flowing to the north. Meanwhile the spill way becomes silted and muddy water overflow into settlements around the spillway.

## 8. CLOSURE

Refer to the facts, data and social analysis have been mentioned above, here are recommendations offered:

1. Mitigation should be conducted seriously with no reason of lack of budget for technical operation.
2. Strict supervision by the government in the public facilities such as roads, railway and electrical installation owned by PLN as well as the work implementation as it relates to the security of the people in the villages that threatened by water and mud.
3. Auditing the possibility of fraud and corruption in the implementation of technical work that become *lahan basah* (a financially profitable) in either contractor level, local administration, Satlak or the national team.

4. Immediately realizing compensation either for permanent relocation or for cash and carry without requiring proof of property ownership such as land certificate. The Receipt of letter C, pethok D are sufficient as evidence of ownership.
5. Access to information for the public about dangers of corporate crimes and failures of technology as a national disaster so that the community can take part actively to alleviate social problems that arise and steady for the same disaster without having to make corporate crime and failure of technology as a natural disaster.

Siaran Pers Bersama. 14 Agustus 2006. WALHI, HRWG, IMPARSIAL, KONTRAS, LP3ES, AMAN, JATAM, HuMa, Sawit Watch, WGPSR, YLBHI, POKJA PA-PSDA, KPA, KAU, LS-ADI, WALHI DKI Jakarta.

## 9. REFERENCES

- Ageung , Ivan Valentina; Ridha Saleh; Riza Damanik; dan Torry Kuswardono. 2006. Lembar Fakta Kejahatan Korporasi Lapindo Brantas/Energi Mega Perkasa. WALHI.
- Harian Terbit. Com. Diakses pada 28 Juli 2006
- Kitab Undang-Undang Hukum Pidana
- Kitab Undang-Undang Hukum Acara Perdata
- Peraturan Pemerintah No. 35 tahun 2004
- Peraturan Pemerintah No. 85 tahun 1999 tentang perubahan atas Peraturan Pemerintah No. 18 tahun 1999 tentang pengolahan limbah B3.
- Undang-Undang No. 23 tahun 1997 tentang Pengelolaan Lingkungan Hidup
- Undang-Undang No. 22 tahun 2001 tentang Minyak dan Gas Bumi
- Undang-Undang No. 7 tahun 2004 tentang Sumber Daya Air.
- Undang-Undang No. 24 tahun 2007 tentang Penanggulangan Bencana

## EXECUTION OF THE MEDIATION AGREEMENT OUT OF COURT ON THE ENVIRONMENTAL CONFLICT

**Hassanain Haykal and Finalia**

Business and investment, Faculty of Law, Maranatha Christian University, Semarang, Indonesia  
[haykal\\_doctor@yahoo.com](mailto:haykal_doctor@yahoo.com)

### ABSTRACT

In Principle, conflict that happened in the society, such as companies and communities caused of the activities that affect the environment. So far a dispute in environmental issues tend to be resolved by litigation way. Dispute resolution through litigation in practice may affect the business scope and have an impact on the destruction of good relations between the company and the society. Good relations between companies and people around the company, is an important aspect that needs to be given priority in the sustainability company efforts as well as the welfare of the people around the company. therefore it needs to be developed alternative methods of dispute resolution while maintaining harmonious between the parties, that is by mediation Method. One of the mediation properties that can keeping harmonious between of the parties to the dispute is because the nature of "win-win solution", which is in mediation is not a probability of lose such as in the litigation that Follow the principle win-lose, so that the parties will feel have a chance to win. Mediation is also has been mandated in the Law Number 32 Year 2004 of environment as one of an alternative solutions for dispute over environment outside the litigation. mediation is expected to provide ample opportunity to the parties taken together to find solutions that is acceptable to them. This is because the cases are not only environment-related aspects of the environment itself but also with other aspects such as the legal, economic, social, technological, etc., so that the necessary deliberations in progress that involves several aspects.

**Keywords:** *execution, mediation agreement, environmental*

### A. INTRODUCTION

In the current modern era, the development growing rapidly. It is inevitable that there are positive and negative impacts. The negative impact of the development were related to environmental disputes. Environmental disputes are strife between two or more parties arising from potential activities and / or has been an

impact on the environment<sup>1</sup>. in the previous cases, Disputes that occur in environmental problems tend to be resolved through litigation. Disputes are resolved through litigation, in practice may affect the business scope and have an impact on the destruction of good relations between the company and the society.

Good relations between companies and people around the company, is an important aspect that

---

<sup>1</sup> Law Number 32 Year 2009 concerning the protection and administration of environmental Article 1 Point 25

needs to be given priority in the effort to improve the development, because of good partnership will accelerate the improvement of public welfare. therefore it needs to be developed alternative methods that is pro-partnership. Environmental Disputes are resolved through alternative dispute resolution has also been mandated in the law Number 32 Year 2009 about the Protection and management of the natural environment that is visible in several articles in it.

In Indonesia there are several alternative methods of dispute resolution, such as; negotiation, conciliation, arbitration and mediation. Negotiation is a method by which people settle differences. It is a process by which compromise or agreement is reached while avoiding argument. In any disagreement, individuals understandably aim to achieve the best possible outcome for their position (or perhaps an organisation they represent). However, the principles of fairness, seeking mutual benefit and maintaining a relationship are the keys to a successful outcome. Conciliation is a process of dispute resolution where the parties disputed using the help an independent third party to act as conciliator, conciliator have the authority to make decisions that are advice. Therefore the form of decision of a solution is advice. Arbitration is a method of settling a civil Disputes outside the general court, based on the arbitration agreement that be in writing by the

parties in dispute. Whereas, Mediation a dispute resolution process where the parties disputed using the help an independent third party to act as mediators, in which mediators have no authority to make decisions that have the force of law, but mediators only encourage disputing parties to make the decision. There fore the form of the solution is a peace agreement (litigation) and deed of peace (nonlitigation) between the parties<sup>2</sup>.

One of the alternative dispute resolution that is possible to create a good relationship is mediation. because mediation as a means resolve disputes that has long been recognized in various faith and cultures, especially Indonesia. Then also one thing that characterizes the Indonesian culture is the concept of deliberation for consensus. The concept of deliberation for the consensus is a socio-cultural of Indonesia as stated in the 4th principle of Pancasila<sup>3</sup>. Mediation can also lead the party to make a peace agreement that is permanent and sustainable, because the mediation process puts both parties in the same position, neither side won or defeated party. In the implementation of mediation, the parties in dispute proactive and have full legal authority in taking decisions, but they were assisted by a mediator whose role is keeping the mediation process in order to realize

---

<sup>2</sup> Hassanain Haykal and Demson Tiopan, *Mediation In Realizing Human Development and Social Relations The civilizedsociety*.

<sup>3</sup> Lindawaty S. Sewu and Hassanain haykal, *concretization of national culture through mediation within the framework of the development of the Indonesian legal*

peace agreement. Dispute resolution through mediation very useful, because the parties have reached an agreement to end their dispute in a fair and mutually beneficial. Even in a failed mediation, where the parties have not reached an agreement, actually also gotten the advantage. Additionally Mediation able to eliminate conflict or hostility almost always accompany every judgement that is handed down by a judge in the court or arbitrator in the arbitration institution<sup>4</sup>.

The results of mediation stated in peace agreement (out of court) and The deed of peace (in the court). The peace agreement should have the executorial power to be implemented and undertaken by the parties. to make the peace agreement have the executorial power so it must be approved in court. This also means that the peace agreement applies not only *de jure* but also *de facto* can be run. To be able to run the executions it takes a legal certainty of pre mediation, mediation session, until the post mediation.

## B. MATERIAL AND METHOD

Research methodology used in this research is a method of normative legal research, which examined the law on secondary data in the form of literature data using deductive thinking and coherent<sup>5</sup> criterion of truth<sup>6</sup>. Besides, this

<sup>4</sup> Syahrizal Abbas. *Mediation, In Islamic Law, Customary Law, and the National Law*. Jakarta. Kencana.2011. page 25-26.

<sup>5</sup> Deductive way of thinking is a way of thinking that the conclusion drawn from something of a general

research uses methods statute approach. The method research statute approach is a legal research Reviewing all the Act and regulations relating to the law issue that are being handled. The form of research such as the consistency and suitability between The Act with another the Act, the Act with the Constitution, between regulation with the Act. For academic research is looking for legislators ratio and basic ontological The enactment of Law. Later, capture the content of the philosophy that is behind The enactment of Law and concludes on presence or absence a philosophical collision between the Act with issue at hand<sup>7</sup>.

## C. POSITIVE LAW MEDIATION IN INDONESIA

Etymology of the term mediation is derived from the Latin, meaning *mediare* at the center. This meaning is more emphasis on third party as a mediator to mediate their duties and resolve

---

nature which have been proved that he was right and the conclusions that are aimed for something special, look further in Sedarmayanti and Syarifudin Hidayat. *Research Methodology*. Bandung: Mandar Forward 2002 page.23.

<sup>6</sup> Coherent truth is a knowledge, theory, statement, proposition, or hypothesis is considered correct if it is in line with the knowledge, theory, statement, proposition or other hypothesis, namely that the proposition was confirmed and is consistent with the previous proposition assumed to be true. Further in A. Sonny & Michael Keraf Two. *Science (A Philosophical Review)*. Yogyakarta: 2001 page.68

<sup>7</sup> Peter Mahmud Marzuki, *Legal Research*, New York: Kencana, 2008, page. 96.



the dispute between the parties. Basically legislation in Indonesia has given limits to understanding mediation. It is enshrined in Article 1, point 7 of the Supreme Court Rule Number 1 Year 2008 explains that mediation is a way of resolving disputes through negotiation process to obtain the agreement of the parties with the assistance of mediator. Mediation is one of the way to resolve dispute that more faster and inexpensive. And can giving the access and can provide greater access to the parties to find a satisfactory resolution and sense of fairness. On the other side, the procedural law, Article 130 and Article 154 Rbg HIR, encourage the parties to take the peace process can be intensified by integrating mediation into the litigation procedure in the District Court.

Implementation mediation in the court basically was adopted in Article 4 and Article 7 of the Supreme Court of rule Number 1 Year 2008, which states that all cases filed with the Court of First Instance should first attempted a settlement through mediation except commercial cases, industrial relations court, objected to the Commission's decision and BPSK, where mediation is required as mentioned in the first session which was attended by the parties.

If viewed from the perspective of the perpetrator mediation, the mediation in Indonesia can be categorized into two forms, namely mediation conducted in the justice court, known as Mandated mediation and mediation outside the courts. Formally, the juridical basis for non-

judicial mediation is only based on Law Number 30 Year 1999 concerning Arbitration and Alternative Dispute Resolution. Arbitration institutions in the legislation are discussed in complete and perfect in 80 chapters, whereas alternative dispute resolution only mentioned in chapter 2, namely Article 1, point 10 and Article 6, which consists of 9 verses. Article 1, point 10 states that Alternative Dispute Resolution is a dispute resolution or differences of opinion through the agreed procedures of the parties, the settlement out of court by way of consultation, negotiation, mediation, conciliation, or expert judgment. Based on that provisions, mediation is an alternative dispute resolution. Although it referred clearly, but understanding mediation and other Alternative Dispute Resolution Institute is not explained, because according to the explanation of the law is considered clear.

#### **D. RESOLVE THE ENVIROMENT DISPUTE BY THE LAW NUMBER 32 YEAR 2009 ABOUT PROTECTION AND OF ENVIROMENTAL**

Based on the enviroment dispute by the law Number 32 year 2009 by article 1 general provisions, “the enviroment dispute is conflict between two party or more appear from potential arising or have an impact on the environment”.

Article 84 states in the environmental dispute settlement can be reached through the court or out of court. Environmental dispute resolution options is done voluntarily by the parties to the

dispute. Lawsuit through the courts can only be reached if the settlement of disputes outside the courts chosen otherwise managed by one or more parties to the dispute. Of Article 84, paragraph 1, 2, 3 suggested that the environmental dispute settlement to be resolved out of court first.

According to article 85 mentions environmental dispute resolution outside the court made to reach agreement on:

1. The form and amount of indemnification
2. Recovery actions due to pollution or destruction
3. Specific action to ensure there is no repeat of pollution or destruction
4. Measures to prevent negative impacts on the environment.

The environmental dispute resolution process can be carried out of court by establishing institutions of dispute resolution service provider environment that is both independent and impartial by the community. Besides, the government and local governments can facilitate the establishment of dispute resolution service provider environment that is both independent and impartial.

#### **E. MEDIATION IN THE ENVIRONMENTAL DISPUTE SETTLEMENT**

Based on the definition of the environment dispute according to the Environmental Law

Number 32 Year 2009 at the general provisions of Article 1, "environmental dispute is a dispute between two or more parties arising from the event which have potential and / or an impact on the environment."

Looked at the scope of the environmental that involving the dispute parties, the solution through litigation practically may affect on the business and also impact on the collapse of good relationship between both parties such as between company and the society. While the good relationship between the society and company or communities/organizations and businesses is an important aspect that needs to be prioritized in order to improve the development, due to the strong partnership will accelerate the improvement of public welfare.

There are many methods can be used in the settlement of environmental disputes in Indonesia. A most suitable method with different beliefs and cultures in Indonesia, namely mediation. Mediation also has been known since a long time and one thing that characterizes the culture of the Indonesian nation with the concept of deliberation and consensus so there is a peace agreement, and in accordance with the precepts contained in Pancasila 4th.

Juridical basic for mediation outside the court only based on Law Number 30 Year 1999 concerning Arbitration and Alternative Dispute Resolution, in Article 1, point 10 states that Alternative Dispute Resolution is a dispute

resolution institutions (different opinions) through procedure agreed upon by the parties, the settlement in outside the court by consultation, negotiation, mediation, conciliation, or expert judgment.

Characteristics of extra-judicial Mediation is suitable for a method of solving environmental disputes in Indonesia. It is plainly set forth in Law Number 32 Year 2009 concerning the protection and administration of environmental, Article 83, 84 point 1,2, and 3, and Article 85.

In Article 83 stated "in environmental dispute resolution outside the court can use services of a mediator and arbitrator to resolve the dispute or the environment". These laws regulate the use of mediation as a method of dispute resolution environment and the mediator in the mediation procedure. It is also reinforced in Article 1, point 7 of the Supreme Court Regulation Number 1 Year 2008 states that mediation is a way of resolving disputes through negotiation process to obtain the agreement of the parties with the assistance of a mediator. The mediator is a neutral third party (non-intervention) and behave neutral (as impartial) and received its presence by the disputing parties, his part only assist disputing parties in resolving the problem and did not have the authority to take decision. Mediators commonly called facilitator. Consultation between both parties in resolving the dispute will be more effective in the presence of the mediator in mediation, so this

process will be in accordance with the precepts mandated to 4 Pancasila.

The Law Number 32 Year 2009 Articles 84 states environmental dispute settlement can be reached through court or out of court. Environmental dispute resolution options is carried out voluntarily by the all of disputing parties. From the Article 84, paragraph 1, 2, 3 environmental dispute settlement is suggested to be resolved out of court previously. Gary Goodpaster also asserts that the process of settlement using mediation is also considered to be very effective for disputes involving the public, such as disputes over environmental destruction, land acquisition, labor problem, consumer protection and so on. Because of using mediators, people do not need to go to court in resolving the dispute. In addition to the integration of mediation into the process in the court maybe an effective way to overcome problem piling cases in court and to strengthen and maximize the function of the courts in resolving disputes in addition to decide the case (adjudicative).

This mediation should be "Win-Win Solution", as in Article 85 has given the bottom line for the parties to find a deal. In Article 85 states that the settlement of environmental disputes outside the courts do should reach agreement on:

1. The form and amount of indemnification;
2. Recovery actions due to pollution and / or destruction;

3. Specific action to ensure there is no repeat of pollution and / or destruction
4. The action to prevent negative impacts on the environment.

The same was said by Christopher W Moore that some of the benefits of the results of the mediation including decisions, the quick settlement , a satisfactory outcome for all parties, the comprehensive and customized agreements, as the practice and learning about prosedure to solving problem creatively, a powerful control of the problem and results that can be expected, individual empowerment, preserving the existing relationship or terminate the relationship with a more friendly way, decisions can be implemented, a better deal than just accept a compromise or win-loss procedures, and applicable decisions without knowing the time.

#### **F. OF A PEACE AGREEMENT/DEED EXECUTION PEACE MEDIATION ENVIRONMENT**

In principle, mediation outside the court that are the result of deliberation and consensus in the form of a peace deal which could then be turned into The deed of peace. In Article 1 point 5, the peace agreement is the document that contains the terms agreed by the parties to end the dispute that is the result of efforts to get the peace with the help of a mediator or more based on this rule. While the deed of peace under article1 point 2 is a certificate containing the peace

agreement and judicial decisions that streng then the peace agreement that does not follow the normal legal process or extra ordinary. Based on these provisions can be said that in principle the decision that have the legal provisionin executing is deed of peace. It's based on the adage that Irah-Irahfrom a decision of the court has the power executorial. results of mediation outside the court by the judge can be strengthened through a lawsuit, but the power of execution was not as power mediation results in the execution of court that can be imposed or applied for fiat execution if one party does not carry out the mediation results. So execution mediation outside the court in the end back to the good faith of the parties. This is based on Article 23 The Supreme Of Court Rule Number 1 Year 2008 mentions an agreement out of court by the parties with the assistance of a certified mediator who successfully resolve disputes out of court with the peace agreement. The peace deal allowed for submission to the court is authorized to obtain deed of peace by asking Act law suit. Point 2 states that filing a law suit referred to in point 1 shall be accompanied by or attached to the peace agreement and the documents that prove that there is a legal relationship of the parties to the dispute objects. Point 3 states that the judge in the face of the party will only streng then the peace agreement in the form of deed of peace if only the peace agreement meets the following requirements:

1. The will of the parties

2. Not against the law
3. Not harm third parties
4. can be executed
5. In good faith

## G. CONCLUSION

Mediation is an alternative dispute resolution that can accommodate the interests of the parties. However, there are disadvantages regarding execution for mediation outside the courts, where mediation executions that carried out of court based solely on the good faith of the parties. This is in contrast to the execution of mediation in the court because it has the power that can be imposed executorial.

## SUGGESTION

Mediation is regulated separately in the form of legislation to make it more comprehensive and to provide legal certainty and strength executorial especially for mediation outside the court.

## H. REFERENCES

### *Book*

- Sonny & Michael Keraf Two. Science (A Philosophical Review). Yogyakarta: 2001
- Gary Goodpaster. *Negotiating and Mediating*. Jakarta: Elips Project, 1993
- Moore, W. Christopher. *The Mediation Process: Practical Strategies for*

*Resolving Conflict*, San Francisco: Jossey-Bass Publisher, 1996

- Peter Mahmud Marzuki, *Legal Research*, New York: Kencana, 2008
- Sedarmayanti and Syarifudin Hidayat. *Research Methodology*. Bandung: Mandar Forward 2002
- Syahrizal Abbas. *Mediation (In Islamic Law, Customary Law, and the National Law)*. Jakarta. Kencana. 2011.

### *Regulation*

- The law Number 32 year 2009 about protection and management of environment
- The law Number 30 Year 1999 About Arbitration and Alternative Dispute Resolution
- The Supreme Court Rule Number 1 Year 2008

### *Journal*

- Hassanain Haykal and Demson Tiopan, *Mediation In Realizing Human Development and Social Relations The civilized society*
- Lindawaty S. Sewu and Hassanain haykal, *concretization of national culture through mediation within the framework of the development of the Indonesian legal*

## EXECUTION OF THE MEDIATION AGREEMENT OUT OF COURT ON THE ENVIRONMENTAL CONFLICT

**Hassanain Haykal and Finalia**

Business and investment, Faculty of Law, Maranatha Christian University, Semarang, Indonesia  
[haykal\\_doctor@yahoo.com](mailto:haykal_doctor@yahoo.com)

### ABSTRACT

In Principle, conflict that happened in the society, such as companies and communities caused of the activities that affect the environment. So far a dispute in environmental issues tend to be resolved by litigation way. Dispute resolution through litigation in practice may affect the business scope and have an impact on the destruction of good relations between the company and the society. Good relations between companies and people around the company, is an important aspect that needs to be given priority in the sustainability company efforts as well as the welfare of the people around the company. therefore it needs to be developed alternative methods of dispute resolution while maintaining harmonious between the parties, that is by mediation Method. One of the mediation properties that can keeping harmonious between of the parties to the dispute is because the nature of "win-win solution", which is in mediation is not a probability of lose such as in the litigation that Follow the principle win-lose, so that the parties will feel have a chance to win. Mediation is also has been mandated in the Law Number 32 Year 2004 of environment as one of an alternative solutions for dispute over environment outside the litigation. mediation is expected to provide ample opportunity to the parties taken together to find solutions that is acceptable to them. This is because the cases are not only environment-related aspects of the environment itself but also with other aspects such as the legal, economic, social, technological, etc., so that the necessary deliberations in progress that involves several aspects.

**Keywords:** *execution, mediation agreement, environmental*

### A. INTRODUCTION

In the current modern era, the development growing rapidly. It is inevitable that there are positive and negative impacts. The negative impact of the development were related to environmental disputes. Environmental disputes are strife between two or more parties arising from potential activities and / or has been an

impact on the environment<sup>1</sup>. in the previous cases, Disputes that occur in environmental problems tend to be resolved through litigation. Disputes are resolved through litigation, in practice may affect the business scope and have an impact on the destruction of good relations between the company and the society.

Good relations between companies and people around the company, is an important aspect that

---

<sup>1</sup> Law Number 32 Year 2009 concerning the protection and administration of environmental Article 1 Point 25

needs to be given priority in the effort to improve the development, because of good partnership will accelerate the improvement of public welfare. therefore it needs to be developed alternative methods that is pro-partnership. Environmental Disputes are resolved through alternative dispute resolution has also been mandated in the law Number 32 Year 2009 about the Protection and management of the natural environment that is visible in several articles in it.

In Indonesia there are several alternative methods of dispute resolution, such as; negotiation, conciliation, arbitration and mediation. Negotiation is a method by which people settle differences. It is a process by which compromise or agreement is reached while avoiding argument. In any disagreement, individuals understandably aim to achieve the best possible outcome for their position (or perhaps an organisation they represent). However, the principles of fairness, seeking mutual benefit and maintaining a relationship are the keys to a successful outcome. Conciliation is a process of dispute resolution where the parties disputed using the help an independent third party to act as conciliator, conciliator have the authority to make decisions that are advice. Therefore the form of decision of a solution is advice. Arbitration is a method of settling a civil Disputes outside the general court, based on the arbitration agreement that be in writing by the

parties in dispute. Whereas, Mediation a dispute resolution process where the parties disputed using the help an independent third party to act as mediators, in which mediators have no authority to make decisions that have the force of law, but mediators only encourage disputing parties to make the decision. There fore the form of the solution is a peace agreement (litigation) and deed of peace (nonlitigation) between the parties<sup>2</sup>.

One of the alternative dispute resolution that is possible to create a good relationship is mediation. because mediation as a means resolve disputes that has long been recognized in various faith and cultures, especially Indonesia. Then also one thing that characterizes the Indonesian culture is the concept of deliberation for consensus. The concept of deliberation for the consensus is a socio-cultural of Indonesia as stated in the 4th principle of Pancasila<sup>3</sup>. Mediation can also lead the party to make a peace agreement that is permanent and sustainable, because the mediation process puts both parties in the same position, neither side won or defeated party. In the implementation of mediation, the parties in dispute proactive and have full legal authority in taking decisions, but they were assisted by a mediator whose role is keeping the mediation process in order to realize

---

<sup>2</sup> Hassanain Haykal and Demson Tiopan, *Mediation In Realizing Human Development and Social Relations The civilizedsociety*.

<sup>3</sup> Lindawaty S. Sewu and Hassanain haykal, *concretization of national culture through mediation within the framework of the development of the Indonesian legal*

peace agreement. Dispute resolution through mediation very useful, because the parties have reached an agreement to end their dispute in a fair and mutually beneficial. Even in a failed mediation, where the parties have not reached an agreement, actually also gotten the advantage. Additionally Mediation able to eliminate conflict or hostility almost always accompany every judgement that is handed down by a judge in the court or arbitrator in the arbitration institution<sup>4</sup>.

The results of mediation stated in peace agreement (out of court) and The deed of peace (in the court). The peace agreement should have the executorial power to be implemented and undertaken by the parties. to make the peace agreement have the executorial power so it must be approved in court. This also means that the peace agreement applies not only *de jure* but also *de facto* can be run. To be able to run the executions it takes a legal certainty of pre mediation, mediation session, until the post mediation.

## B. MATERIAL AND METHOD

Research methodology used in this research is a method of normative legal research, which examined the law on secondary data in the form of literature data using deductive thinking and coherent<sup>5</sup> criterion of truth<sup>6</sup>. Besides, this

<sup>4</sup> Syahrizal Abbas. *Mediation, In Islamic Law, Customary Law, and the National Law*. Jakarta. Kencana.2011. page 25-26.

<sup>5</sup> Deductive way of thinking is a way of thinking that the conclusion drawn from something of a general

research uses methods statute approach. The method research statute approach is a legal research Reviewing all the Act and regulations relating to the law issue that are being handled. The form of research such as the consistency and suitability between The Act with another the Act, the Act with the Constitution, between regulation with the Act. For academic research is looking for legislators ratio and basic ontological The enactment of Law. Later, capture the content of the philosophy that is behind The enactment of Law and concludes on presence or absence a philosophical collision between the Act with issue at hand<sup>7</sup>.

## C. POSITIVE LAW MEDIATION IN INDONESIA

Etymology of the term mediation is derived from the Latin, meaning *mediare* at the center. This meaning is more emphasis on third party as a mediator to mediate their duties and resolve

---

nature which have been proved that he was right and the conclusions that are aimed for something special, look further in Sedarmayanti and Syarifudin Hidayat. *Research Methodology*. Bandung: Mandar Forward 2002 page.23.

<sup>6</sup> Coherent truth is a knowledge, theory, statement, proposition, or hypothesis is considered correct if it is in line with the knowledge, theory, statement, proposition or other hypothesis, namely that the proposition was confirmed and is consistent with the previous proposition assumed to be true. Further in A. Sonny & Michael Keraf Two. *Science (A Philosophical Review)*. Yogyakarta: 2001 page.68

<sup>7</sup> Peter Mahmud Marzuki, *Legal Research*, New York: Kencana, 2008, page. 96.



the dispute between the parties. Basically legislation in Indonesia has given limits to understanding mediation. It is enshrined in Article 1, point 7 of the Supreme Court Rule Number 1 Year 2008 explains that mediation is a way of resolving disputes through negotiation process to obtain the agreement of the parties with the assistance of mediator. Mediation is one of the way to resolve dispute that more faster and inexpensive. And can giving the access and can provide greater access to the parties to find a satisfactory resolution and sense of fairness. On the other side, the procedural law, Article 130 and Article 154 Rbg HIR, encourage the parties to take the peace process can be intensified by integrating mediation into the litigation procedure in the District Court.

Implementation mediation in the court basically was adopted in Article 4 and Article 7 of the Supreme Court of rule Number 1 Year 2008, which states that all cases filed with the Court of First Instance should first attempted a settlement through mediation except commercial cases, industrial relations court, objected to the Commission's decision and BPSK, where mediation is required as mentioned in the first session which was attended by the parties.

If viewed from the perspective of the perpetrator mediation, the mediation in Indonesia can be categorized into two forms, namely mediation conducted in the justice court, known as Mandated mediation and mediation outside the courts. Formally, the juridical basis for non-

judicial mediation is only based on Law Number 30 Year 1999 concerning Arbitration and Alternative Dispute Resolution. Arbitration institutions in the legislation are discussed in complete and perfect in 80 chapters, whereas alternative dispute resolution only mentioned in chapter 2, namely Article 1, point 10 and Article 6, which consists of 9 verses. Article 1, point 10 states that Alternative Dispute Resolution is a dispute resolution or differences of opinion through the agreed procedures of the parties, the settlement out of court by way of consultation, negotiation, mediation, conciliation, or expert judgment. Based on that provisions, mediation is an alternative dispute resolution. Although it referred clearly, but understanding mediation and other Alternative Dispute Resolution Institute is not explained, because according to the explanation of the law is considered clear.

#### **D. RESOLVE THE ENVIROMENT DISPUTE BY THE LAW NUMBER 32 YEAR 2009 ABOUT PROTECTION AND OF ENVIROMENTAL**

Based on the enviroment dispute by the law Number 32 year 2009 by article 1 general provisions, “the enviroment dispute is conflict between two party or more appear from potential arising or have an impact on the environment”.

Article 84 states in the environmental dispute settlement can be reached through the court or out of court. Environmental dispute resolution options is done voluntarily by the parties to the

dispute. Lawsuit through the courts can only be reached if the settlement of disputes outside the courts chosen otherwise managed by one or more parties to the dispute. Of Article 84, paragraph 1, 2, 3 suggested that the environmental dispute settlement to be resolved out of court first.

According to article 85 mentions environmental dispute resolution outside the court made to reach agreement on:

1. The form and amount of indemnification
2. Recovery actions due to pollution or destruction
3. Specific action to ensure there is no repeat of pollution or destruction
4. Measures to prevent negative impacts on the environment.

The environmental dispute resolution process can be carried out of court by establishing institutions of dispute resolution service provider environment that is both independent and impartial by the community. Besides, the government and local governments can facilitate the establishment of dispute resolution service provider environment that is both independent and impartial.

#### **E. MEDIATION IN THE ENVIRONMENTAL DISPUTE SETTLEMENT**

Based on the definition of the environment dispute according to the Environmental Law

Number 32 Year 2009 at the general provisions of Article 1, "environmental dispute is a dispute between two or more parties arising from the event which have potential and / or an impact on the environment."

Looked at the scope of the environmental that involving the dispute parties, the solution through litigation practically may affect on the business and also impact on the collapse of good relationship between both parties such as between company and the society. While the good relationship between the society and company or communities/organizations and businesses is an important aspect that needs to be prioritized in order to improve the development, due to the strong partnership will accelerate the improvement of public welfare.

There are many methods can be used in the settlement of environmental disputes in Indonesia. A most suitable method with different beliefs and cultures in Indonesia, namely mediation. Mediation also has been known since a long time and one thing that characterizes the culture of the Indonesian nation with the concept of deliberation and consensus so there is a peace agreement, and in accordance with the precepts contained in Pancasila 4th.

Juridical basic for mediation outside the court only based on Law Number 30 Year 1999 concerning Arbitration and Alternative Dispute Resolution, in Article 1, point 10 states that Alternative Dispute Resolution is a dispute

resolution institutions (different opinions) through procedure agreed upon by the parties, the settlement in outside the court by consultation, negotiation, mediation, conciliation, or expert judgment.

Characteristics of extra-judicial Mediation is suitable for a method of solving environmental disputes in Indonesia. It is plainly set forth in Law Number 32 Year 2009 concerning the protection and administration of environmental, Article 83, 84 point 1,2, and 3, and Article 85.

In Article 83 stated "in environmental dispute resolution outside the court can use services of a mediator and arbitrator to resolve the dispute or the environment". These laws regulate the use of mediation as a method of dispute resolution environment and the mediator in the mediation procedure. It is also reinforced in Article 1, point 7 of the Supreme Court Regulation Number 1 Year 2008 states that mediation is a way of resolving disputes through negotiation process to obtain the agreement of the parties with the assistance of a mediator. The mediator is a neutral third party (non-intervention) and behave neutral (as impartial) and received its presence by the disputing parties, his part only assist disputing parties in resolving the problem and did not have the authority to take decision. Mediators commonly called facilitator. Consultation between both parties in resolving the dispute will be more effective in the presence of the mediator in mediation, so this

process will be in accordance with the precepts mandated to 4 Pancasila.

The Law Number 32 Year 2009 Articles 84 states environmental dispute settlement can be reached through court or out of court. Environmental dispute resolution options is carried out voluntarily by the all of disputing parties. From the Article 84, paragraph 1, 2, 3 environmental dispute settlement is suggested to be resolved out of court previously. Gary Goodpaster also asserts that the process of settlement using mediation is also considered to be very effective for disputes involving the public, such as disputes over environmental destruction, land acquisition, labor problem, consumer protection and so on. Because of using mediators, people do not need to go to court in resolving the dispute. In addition to the integration of mediation into the process in the court maybe an effective way to overcome problem piling cases in court and to strengthen and maximize the function of the courts in resolving disputes in addition to decide the case (adjudicative).

This mediation should be "Win-Win Solution", as in Article 85 has given the bottom line for the parties to find a deal. In Article 85 states that the settlement of environmental disputes outside the courts do should reach agreement on:

1. The form and amount of indemnification;
2. Recovery actions due to pollution and / or destruction;

3. Specific action to ensure there is no repeat of pollution and / or destruction
4. The action to prevent negative impacts on the environment.

The same was said by Christopher W Moore that some of the benefits of the results of the mediation including decisions, the quick settlement , a satisfactory outcome for all parties, the comprehensive and customized agreements, as the practice and learning about prosedure to solving problem creatively, a powerful control of the problem and results that can be expected, individual empowerment, preserving the existing relationship or terminate the relationship with a more friendly way, decisions can be implemented, a better deal than just accept a compromise or win-loss procedures, and applicable decisions without knowing the time.

#### **F. OF A PEACE AGREEMENT/DEED EXECUTION PEACE MEDIATION ENVIRONMENT**

In principle, mediation outside the court that are the result of deliberation and consensus in the form of a peace deal which could then be turned into The deed of peace. In Article 1 point 5, the peace agreement is the document that contains the terms agreed by the parties to end the dispute that is the result of efforts to get the peace with the help of a mediator or more based on this rule. While the deed of peace under article1 point 2 is a certificate containing the peace

agreement and judicial decisions that streng then the peace agreement that does not follow the normal legal process or extra ordinary. Based on these provisions can be said that in principle the decision that have the legal provisionin executing is deed of peace. It's based on the adage that Irah-Irahfrom a decision of the court has the power executorial. results of mediation outside the court by the judge can be strengthened through a lawsuit, but the power of execution was not as power mediation results in the execution of court that can be imposed or applied for fiat execution if one party does not carry out the mediation results. So execution mediation outside the court in the end back to the good faith of the parties. This is based on Article 23 The Supreme Of Court Rule Number 1 Year 2008 mentions an agreement out of court by the parties with the assistance of a certified mediator who successfully resolve disputes out of court with the peace agreement. The peace deal allowed for submission to the court is authorized to obtain deed of peace by asking Act law suit. Point 2 states that filing a law suit referred to in point 1 shall be accompanied by or attached to the peace agreement and the documents that prove that there is a legal relationship of the parties to the dispute objects. Point 3 states that the judge in the face of the party will only streng then the peace agreement in the form of deed of peace if only the peace agreement meets the following requirements:

1. The will of the parties

2. Not against the law
3. Not harm third parties
4. can be executed
5. In good faith

## G. CONCLUSION

Mediation is an alternative dispute resolution that can accommodate the interests of the parties. However, there are disadvantages regarding execution for mediation outside the courts, where mediation executions that carried out of court based solely on the good faith of the parties. This is in contrast to the execution of mediation in the court because it has the power that can be imposed executorial.

## SUGGESTION

Mediation is regulated separately in the form of legislation to make it more comprehensive and to provide legal certainty and strength executorial especially for mediation outside the court.

## H. REFERENCES

### *Book*

- Sonny & Michael Keraf Two. Science (A Philosophical Review). Yogyakarta: 2001
- Gary Goodpaster. *Negotiating and Mediating*. Jakarta: Elips Project, 1993
- Moore, W. Christopher. *The Mediation Process: Practical Strategies for*

*Resolving Conflict*, San Francisco: Jossey-Bass Publisher, 1996

- Peter Mahmud Marzuki, *Legal Research*, New York: Kencana, 2008
- Sedarmayanti and Syarifudin Hidayat. *Research Methodology*. Bandung: Mandar Forward 2002
- Syahrizal Abbas. *Mediation (In Islamic Law, Customary Law, and the National Law)*. Jakarta. Kencana. 2011.

### *Regulation*

- The law Number 32 year 2009 about protection and management of environment
- The law Number 30 Year 1999 About Arbitration and Alternative Dispute Resolution
- The Supreme Court Rule Number 1 Year 2008

### *Journal*

- Hassanain Haykal and Demson Tiopan, *Mediation In Realizing Human Development and Social Relations The civilized society*
- Lindawaty S. Sewu and Hassanain haykal, *concretization of national culture through mediation within the framework of the development of the Indonesian legal*

## **CRIMINAL AND ADMINISTRATIVE LAW ENFORCEMENT FOR BUSINESS ACTORS AS AN EFFORT TO MINIMALIZE ENVIRONMENTAL POLLUTION**

**Hassanain Haykal and Vincent Leo Saputra**

Business and investment, Faculty of Law, Maranatha Christian University  
[hassanain.haykal@gmail.com](mailto:hassanain.haykal@gmail.com)

### **ABSTRACT**

In life, human relies heavily on the environment. Environment as a place to survive must be able to support all the activities and needs of the organs inside, where health is one of the requirements. Today, we have encountered the pollution of the environment in various regions of the earth. The cause of pollution comes from various fields, which one of them was waste that dumped by factories. In fact, the existence AMDAL documents and supervisory roles often unable to accommodate the prevention of environmental pollution. Many businesses have the document, in fact, many of waste disposed are not in accordance with the AMDAL analysis. We must realize that problematic environment will cause problems for other living beings too. Thus, it takes an effort from the government in order to minimize the environmental pollution by implementing normative sanctions for business actors who allegedly pollute the environment. The sanctions that going to be enforced in an effort to minimize the the pollution of the environment that criminal sanctions and administrative sanctions. However, is the existence of these penalties can be enforced in order to minimize the environmental pollution?

**Keywords:** *administrative sanctions, criminal sanctions, business actor, environmental pollution*

### **INTRODUCTION**

Environment is a place for man in implementing various activities in life. If an environment experience damage, for certain situation of mortal in it will also experience damage. In globalization era, environmental contamination problem become a thing that is often we met, where one of the contamination cause is because of man business activity like industry, transportation, and other.

To minimize the contamination of the environment, government had an obligation to protect its citizen. One of governmental effort for the agenda of minimalizes environmental contamination that is by forming regulation which in it arranges sanction stipulating. This meant that business perpetrator are made to obeying law order which has been specified, so that level of contamination can be minimized. Sanction is standing supporting facilities influences behavior of man. Applicable sanction in minimalizes

environmental contamination are criminal sanction and administrative sanction. This scientific paper will study straightening of criminal sanction and administrative sanction for perpetrator effort at corporation scope. With the existence of sanction applied, business perpetrators would expected to realize the long-range impact of damage of area as result of some business actions which they do.

## MATERIAL(S) AND METHOD(S)

### 1. Material

Material applied in writing of this scientific paper refers to secondary material, where secondary material consist of primary law material, secondary , and tertiary.

#### 1. Primary law material

Primary legal materials covers legislation related to environmental management.

#### 2. Secondary law material

Book material comprising information about primary material , consisted of explanation of related [code/law] to explanation of inviters , seminar materials that related to environment.

#### 3. Tertiary law material

Supporter law material that provide clues to primary law material and secondary law material, consisted of : legal dictionary Belanda-Indonesia, *Black's Law Dictionary*, and *Collin Dictionary*.

### 2. Method

The writing of this scientific paper applies method of law normative, that is by examining law area secondary data in the form of litelature data by using deductive<sup>1</sup> and coherent criterion of truth<sup>2</sup> method . Research character applied in this research done is a descriptive analysis which describes the matters relating to the implementation of the Mediation. While the approach that applied is conceptual research approach. In that case assessment and testing was conducted logically to the legal concepts (conceptual approach) regarding criminal penalties and alternative sanctions. The author will

---

<sup>1</sup> Deductive way of thinking is a way of thinking that the conclusion drawn from something of general nature which already proved right and the conclusion was addressed to something special, see further in Sedarmayanti dan Syarifudin Hidayat. *Metodologi Penelitian*. Bandung: Mandar Maju, 2002 hlm.23

<sup>2</sup> Coherent truth is a knowledge, theory, statement, proposition, or hypothesis considered true if aligned with knowledge, theory, statement, proposition or other hypothesis, that is if the proposition was confirmed and consistent with the previous proposition which is assumed true see further in A. Sonny Keraf & Mikhael Dua. *Ilmu Pengetahuan (Sebuah Tinjauan Filosofis)*. Yogyakarta: 2001, hlm.68.

conduct research with reference to the legal principles and doctrines that exist.

### **Factors of the Law Enforcement Legal System in Indonesia**

According to the Lawrence M. Freidman, the legal system has three main components that is legal structure, legal substance, and legal culture. These three components determine each other, as well influence each other, these components consist of:

1. Legal structure includes elements of structure that portray the legal institutions of law enforcement duties and law making.
2. The substance of law includes the rules, norms, and principles of law.
3. Cultural law covers public trust in law, values, ideas, and expectations of society.

Based on these opinions, in the amongst substance of the law, legal structure, and legal culture must be mutually sustainable in order to create a comprehensive law protection that can be realized.

Application component of legal substances in an effort to create a legal protection in regulatory policy in the field of the

environment is influenced by the principles of common law, environmental law principles, and the principles of civil law. First, the principle of common law include justice, expediency, and certainty. Second, the principle of economic law includes the principle of state intervention. And third, the principle of freedom of contract includes civil law, konsensualitas principle, the principle of good faith, the principle of confidentiality, the principle of law equality and the principle of balance. Application components in an effort to create a legal structure relating to the law protection of officials / law enforcement agencies in implementing the regulation in the field of economic policy which is influenced by the general principles of good governance which includes the principle of legal certainty, the orderly administration of the state, public interest, transparency, proporsionalistas, professionalism, accountability, efficiency principle and the principle of effectiveness. Application of law relating to the culture of component of business people in an effort to create a legal protection in the field of the environment is influenced by the principles of business ethics and good corporate governance principles, including transparency, accountability principle, the principle of responsibility, the principle of



independence, and the principle of fairness.

Application component of legal substances in an effort to create a legal protection in regulatory policy in the field of the environment is influenced by the principles of common law, and the principles of environmental laws. First, the principle of common law include justice, expediency, and certainty. Application of law relating to the culture of component of business people in an effort to create a legal protection in the field of the environment is influenced by the principles of business ethics and good corporate governance.

Application of sanctions is part which can not be removed from the embodiment of law enforcement in a law system. As noted by Talcott Parson, the main function of the law system is integrative, it means to reduce the elements of potential conflict in the society and to smooth the process of social interaction. With obeying the legal system, social interaction system will function properly, without the possibility of turning into overt or covert conflict that is chronic. Further stated, for the legal system to run integrative function

effectively, there are four issues that must be resolved first, namely<sup>3</sup>:

1. Legitimacy, that is the factors that will be the foundation for compliance with the rules.
2. Interpretation, that is issues concerning factors . determining the rights and obligations of the subject, through the process of setting certain rules.
3. Sanctions, factors that define whether a sanction will arise if there is compliance and any kind of sanction that would arise in case of denial of the rule, and as well affirm who shall apply the sanctions.
4. Jurisdiction, that is factors that define the lines of authority ruling confirms legal norms.

### **Criminal and Administrative Public Policy In Indonesian Law System Related to Environment**

One of the most important instrument in the enforcement of sanctions that is generated by the law itself. What is meant by a particular sanction is a result that arises or that may be caused by human behavior which can be applied to the perpetrator or actions that is concerned

---

<sup>3</sup> Talcott Parson. *The Social System*. Newyork : The Free Press, 1951

regarding the obligation to abide by the rules of behavior. Legal sanctions are directly related to the effectiveness of the law, namely the ability of legal norms influence human behavior in daily life which rooted in the will of human itself.

The way to entry into force of the rules of law that occur through the imposition of possible law consequences of certain so-called law sanction to a particular person as a result of certain actions. So the law sanction is a certain legal consequences that can be imposed on a person or group of persons regarding the actions abide by or not abide by the rule of law. In general, law enforcement can be interpreted can be interpreted as action to apply peripheral supporting facilities for law that meant to guarantee adhering of applicable law rule.<sup>4</sup>

The element that exists in law enforcement can be divided into two major parts, that is, elements that have a level of relevance which between distant and close one. The element law enforcement can be summarized into three elements: lawmaker, law enforcement and the public. In a simple concept (positivistic understanding), law enforcement already begun by the time the legal regulations made or created (as input). About it, just

<sup>4</sup> Asep Warlan Yusuf, *Penegakan Hukum Administrasi (Artikel)* : disampaikan pada September 2004

needs a bit explanation, and it can be concluded that the law enforcement is a process of realizing what is stated in the law to real life.<sup>5</sup>

Considering the imposition of sanctions may result deprivation of liberty (imprisonment), possessions (foreclosures), honor even one life (death penalty), hence in a state application of legal sanctions law was carried out according to the procedure (process) as outlined in the law criminal procedure. This is done so that the in a state exercised its right to enforce law obedient with regard to the rights of the accused as citizens and as human dignity. It is the embodiment of “Sila Prikemanusiaan” from Pancasila.<sup>6</sup>

In addition to the criminal penalties there are other sanctions are considered able to minimize deviation against norms stipulated in legislation, that is called the administrative sanctions. In the implementation of was rule contains commands, prohibitions, obligations. The rule law has meaning as if it can be imposed upon any person, in the form of action called with sanctions. Sanctions is very important in law, including in an

<sup>5</sup> William J Cambliss & Robert B. Seidman. *Law; Order and Power*. Addison-Wesley: Reading Mass , 1971, page 12-14

<sup>6</sup> Mochtar Kusumaatmadja dan B. Arief Sidharta. *Loc Cit.*

administrative law. The typical administrative law sanctions include:

1. Bestuurdwang (government coercion)
2. The recall decision (decree) favorable (permits, etc.)
3. Imposition of fines.
4. The Forcible imposition of money by the government (dwangsom).

Authority to implement administrative sanctions is basically a "discretionary power" or independent authority.

Therefore, the government was authorized to consider and evaluate whether to use or not of that authority. Government may not use the authority to impose sanctions (non-enforcement) with a variety of considerations, such as for some reason:

1. instrument of coercion is not sufficient;
2. no ability to cause the Forcible;
3. Other efforts which more effective and efficient for a deterrent effect for perpetrators, and;
4. Another reason that does not allow the application of administrative sanctions objectively rational.

However, position and action for "non-enforcement" nor position to apply sanction is not a position without

considering rational and objective measure. It mean, that "they" may specify sanction and may also don't apply sanction that is done subjectively and groundless (reason) strong, logical and responsible. Such attitude is a wrong attitude in applying the "discretionary power". The application of these powers should be done with extra caution and carefully, that in practice is often defined as a wise and prudent policy (discretion is the better part of valor), but without ignoring the function and purpose (enforcement) law itself.<sup>7</sup>

Administrative sanctions that can be shaped after the refusal to permits issued temporary licenses (preventive) or revoke permissions that have been granted (repressive), is much more effective to force people to comply with the provisions of law that govern business and industry and environmental protection than criminal sanctions.<sup>8</sup>

Sanctions are an important part in the law, which is to create consistency of law enforcement. Another aspect of the sanctions aimed at upholding the rule of law, adhered by everyone, so that law can be run in the manner intended, that is to create order, certainty and fairness. In the

<sup>7</sup> Asep warlan Yusuf. *Sanksi Administrasi (Artikel)*. : disampaikan pada Agustus 2004

<sup>8</sup> Mochtar Kusumaatmadja dan B. Arief Sidharta. *Op Cit*, hlm 47

implementation, the rule contains commands, prohibitions, obligations. The rule has the meaning as law when imposed upon any person, in the form of action that called by sanctions.

**Criminal and Administrative Penalties Enforcement In Order To Minimize Environmental Pollution Related to Act No. 32 Year 2009 on Environmental Management.**

According to the Act No. 32, criminal sanctions against business actors that conduct environmental pollution may be subject to criminal sanctions in the form of imprisonment and fines. Criminal sanctions is cumulative sanction, for example is the act contained in Article 97 to 120 Act No. 32 / 2009. Although the sanctions imprisonment and fines varies, it shows the government has the political will to enforce sanctions for business actors that pollute the environment.

Meanwhile, civil penalties stipulated in Law No. 32 of 2009 consists of: a written reprimand, government coercion, environmental license suspension, revocation of environmental permits. Administrative sanctions does not relieve management of the organization and activities of criminal responsibility and recovery. Imposition of administrative

sanctions in the form of suspension or revocation of environmental permits as referred to be done if the business is carrying out government coercion.

Government coercion as referred to in Article 76 paragraph (2) letter b of Law 32/2009 are:

1. temporary cessation of production activities;
2. transfer of production facilities;
3. sewerage or emissions closing;
4. demolition;
5. confiscation of goods or equipment that could potentially cause violations;
6. suspension of all activities, or
7. Other measures aimed at stopping violations and actions to restore environment function.

The imposition of government coercion can be imposed without prior reprimand when violation(s) pose

1. very serious threat to humans and the environment;
2. greater impact if not immediately stopped ; and
3. greater losses to the environment if not immediately stopped .

Keep in mind that the every person in charge of business and / or activities that do not implement the government coercion can be fined for any delays in the implementation of government-imposed sanctions.

## CONCLUSIONS AND SUGGESTIONS

It was concluded that the enforcement of criminal and administrative sanctions are important, especially in efforts to minimize environmental pollution by business actors and so that people abide by the rules set by the government trying to start protecting the environment. The government must be serious in the enforcement of criminal and administrative sanctions involving elements of the apparatus and the role of the people so that criminal and administrative sanctions can be fully enforced. The Government needs to act decisively against the efforts towards collusion and corruption that hinder enforcement sanctions.

## REFERENCES

A. Sonny Keraf & Mikhael Dua. *Ilmu Pengetahuan (Sebuah Tinjauan Filosofis)*, 2001 .Yogyakarta

Prof. Dr. jur. Andi Hamzah, 2005. *Penegakan Hukum Lingkungan* . Sinar Grafika, Jakarta

Jimly Asshiddiqie, *Mahkamah Konstitusi dan Cita Negara Hukum Indonesia: Refleksi Pelaksanaan kekuasaan kehakiman pasca amandemen UUD 1945*. MaPPI-FHUI

Mochtar Kusumaatmadja dan B. Arief Sidharta. *Pengantar Ilmu Hukum (Suatu Pengenalan Pertama Ruang Lingkup Berlakunya Ilmu Hukum.2000 Alumni, Bandung*

*Kitab Undang-Undang Hukum Pidana Indonesia*

Otto Soemarwoto 1988. *Analisis Mengenai Dampak Lingkungan*. Gadjah Mada University Press , Yogyakarta

Sedarmayanti dan Syarifudin Hidayat. *Metodologi Penelitian*, 2002 Mandar Maju , Bandung

Sukanda Husin, S.H., LL.M. 2009. *Penegakan Hukum Lingkungan Indonesia*. Sinar Grafika, Jakarta

Sunarjati Hartono, 1977 *.Apakah Rule of Law itu?*, Gramedia, Jakarta

Prof. Dr. Takdir Rahmadi, S.H., LL.M. , 2011. *Hukum Lingkungan di Indonesia*. RajaGrafindo Persada, Jakarta

Talcott Parson, 1951. *The Social System*. Newyork : The Free Press

UNDANG-UNDANG REPUBLIK INDONESIA. NO. 32 TAHUN 2009. *TENTANG. PERLINDUNGAN DAN PENGELOLAAN LINGKUNGAN HIDUP*

William J Cambliss & Robert B. Seidman, 1971 *Law; Order and Power*. Addison-Wesley: Reading Mass

Indonesian Act 2009 / No . 32 *Protection and Management of Environment ( Undang-Undang Perlindungan Dan Pengelolaan Lingkungan Hidup*

## ARTICLE

Asep warlan Yusuf, Agustus 2004 *Sanksi Administrasi (Artikel)*.

Asep Warlan Yusuf ,September 2004 *Penegakan Hukum Administrasi ( Artikel)*



## ENVIRONMENT-BASED BUDGET POLICY FOR SUSTAINABLE DEVELOPMENT IN INDONESIA

**Joko Tri Haryanto**

Ministry of Finance, Fiscal Policy Unit  
[Djohar78@gmail.com](mailto:Djohar78@gmail.com)

### ABSTRACT

Our State Budget still the burden of energy subsidies in every year. Many observers even analogize the facts of Indonesia's commitment in supporting the economic development of green (green economy). In various international events, gait Indonesia respectable, even the President's speech in The Rio +20 ago received tremendous appreciation from many quarters. The President's commitment to reduce greenhouse gas emissions (GHGs) through the National Action Plan schemes / Regional (RAN / D) by 26% from BAU and 41% with international assistance in 2020, also received a lot of praise. The burden of energy subsidies in the state budget was also assessed in line with the Government's policy objectives in particular the achievement of pro-environment, since most types of subsidized fuel budget is still fossil-fuel pose ecological footprint for environmental sustainability. Though the government budget documents, budget actually has a strategic role in the economy. As a result, many observers have noted that our budget is far from the idea of "green". In Law No. 32 of 2009 on the Protection and Preservation of the Environment (PPLH), clearly stated obligations to the Government and Parliament based budgeting environment (green budget). Hence the idea of a greener state budget allocation (green budget) becomes very crucial and challenging. Basing itself on existing theories, there are some scenarios in creating a greener state budget.

**Keywords:** *green budget, sustainable development, environment based budget policy*

### Background

The government and people representative board together with the local government and its representative board is obliged to allocate sufficient budget for financing the living environment protection and management activities and sustainable development program according to Article 45 of Law No.32/ 2009 about Environment Protection and Management. Moreover, it is a compulsory for the government to allocate sufficient Specific Allocation Fund for Environment to the region with good performace in environment protection and management. The next article further states the

obligation for environmental recovery budget allocation by the central and local government for the restoration when the environment quality is contaminated.

In 2012, the distribution of national budget by function has allocated living environment budget by 11,5 millions Rupiah or 1.2% of total government expenditure or 10% of total GDP. The allocation will increase to 12.2 million Rupiah or 1.1% of total government expenditure and 0.1% of GDP in the national budget draft of 2013. Even so, the allocation is below the baseline for environment protection

and management in Indonesia and is relatively furthering the ideal condition.

The Law does not mention the magnitude and proportion of budget allocation although some institutions have their own versions. An example is the ideal budget according to the Ministry of Environment (2010) is 3-5% of total national budget or total local budget. On the other hand, natural resource depletion and environment degradation in Indonesia because of development is approximately 5% of GDP (Nurkholis, et.al, 2006) and needed to internalize.

### **Objectives**

The GoI has committed to encourage attempts to reduce green gas emission as well as environment protection and management through its various policies. Among them are taxation policy, expenditure or fiscal stimulus policy, and pricing. With regard to this, a study is necessary to examine the implementation of expenditure/budget based on environment to support sustainable development in Indonesia. The proposal attempts to identify the appropriate indicators related to environmental issues for the proposed state budget of 2014 (APBN 2014). The estimation of environmental-based budget is needed for environment protection and management as mandated by the Law No.32/2009.

In particular, the proposal will have two objectives. *Firstly* to examine and evaluate various policies related to environmental-based budget as best practice in public areas. *Secondly*, the proposal will identify several scenarios to build environment based budgeting policy.

### **Theoretical Basis**

#### **State Budget**

Referring to the official international nomenclature, State Budget consists of Revenues and Grants, Expenditure and Financing. This system adopts the I-account budget, which implies the emergence of surplus / deficit significantly. I-account system as well as revise the previous budget system that is T-account, which is loaded with interest the creation of a balanced budget.

In preparation mechanism, the state budget based on several basic assumptions. The basic assumption is useful in shaping the state budget, as well as a benchmark to face economic fluctuations and pressure. The basic assumption in the budget consists of the variables GDP, economic growth, inflation, interest rates SPN-3 months, the exchange rate, oil prices and lifting. Once this assumption is agreed, then the budget is ready to be implemented. In order to create efficiency and effectiveness of the state budget, aspects of monitoring and evaluation (M & E) is absolutely necessary, as the basis for adjustments in the State Budget Changes (Revised).



In terms of financing, the state budget has a significant role in supporting the achievement of a green economy. Green economy in theory can be interpreted as an answer to economic chocolate. Brown economy is an economy which is loaded with carbon, inefficient use of energy, but not enough socially inclusive, which means it does not involve a lot of people in the decision-making process. Green economy trying to encourage the creation of a low-carbon economy, energy efficient and socially involved the participation of the whole society. In some perspective, the green economy is positively correlated with the creation of a clean and transparent government.

Besides being energy subsidy burden, the state budget has not felt the green because of the support budget allocation given the green felt in a variety of activities is still lacking. Direct support is still limited to the Special Allocation Fund (DAK) of Environment and Forestry. According to data from the Ministry of Finance, Environment DAK allocated starting in 2006. Until the year 2011, the total budget allocated Rp2, 0 billion. While DAK Forestry, allocated the first time in 2008, until now the total budget is around Rp850 billion. Education DAK allocation compared with total budget of Rp46, 3 trillion or DAK Health with a total budget of Rp20, 8 trillion, the allocation of the state budget if only not showing partiality towards the development of a green economy.

Provision of various facilities and services tax breaks businesses can actually be calculated as well as the form of budget support to the development of a green economy. Imposition of export taxes on natural resources (NR) Indonesia can also be calculated as a form of budget support for the green economy. However, given the impact was felt not support the allocation of expenditure. Unwise utilization is also an obstacle, because it has not aadanya ear-marking mechanism for taxation returned on preserving the environment. As a result, tax collection and perceived environmental incentives are based on the consideration of potential to increase revenues, not to environmental conservation priority, so the environmental damage that often accompanies exploitation by industry, remains to be an unsolved problem until now.

### **Externalities**

Economic problem stems from the limited resources with unlimited desire. Economic theory teaches people how to determine an efficient choice when faced with a situation of limited resources and unlimited desires. Later, the term was introduced as a means of meeting market economic actors who then will determine their choice. In his book, *An inquiry into the Nature and Causes of the Wealth of Nations*, Adam Smith (1776) introduced the term "invisible hand" as the mechanism that leads economic actors so that they run the option achieve the desired economic results. The result is called market equilibrium.

Meanwhile, the efficiency of the economy measured by the amount of consumer surplus and producer surplus that occurs when market equilibrium is reached. According to Mankiw (2007), "Market do many things well, but they do not do everything well" (p. 203). There are some conditions in which the market mechanism fails to achieve an efficient allocation of resources and ultimately require government intervention to correct the market failure. One of the conditions of the market kegalalan externalities. Externalities occur when a person engages in an activity that affects the welfare of the other party (which is outside activity) and do not pay or receive compensation from the activity (Mankiw, 2007).

There are two kinds of externalities, positive externalities and negative externalities. Negative externality will cause the market to produce goods or services at a rate greater than the public wants. In contrast, positive eksternalistas will lead the market to produce goods or services at a lower level than the public wants.

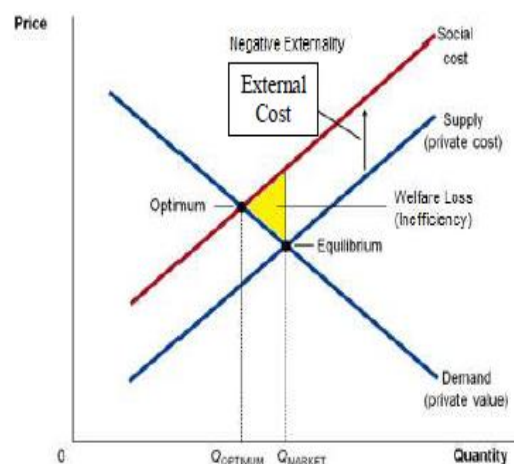

**Diagram 1. Negative Externality**

Source: Mankiw, N. G. (2007). *Principles of economics* (4<sup>th</sup> ed.) page 206

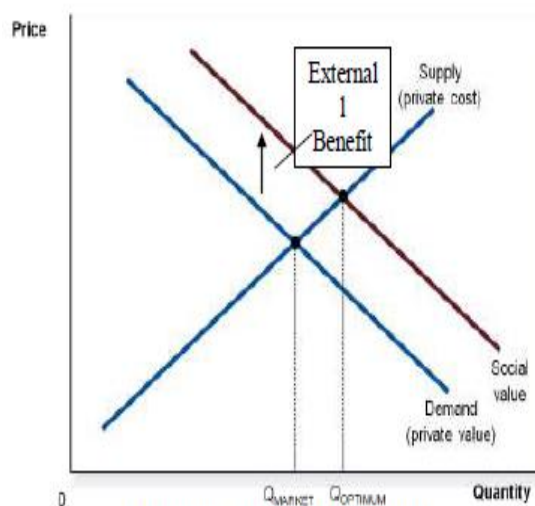

**Diagram 2. Positive Externality**

Source: Mankiw, N. G. (2007). *Principles of economics* (4<sup>th</sup> ed.) page 206

Both negative and positive externalities have a close relationship with environmental aspects. Negative externalities caused environmental damage caused by the impact of economic activity that are not internalized, while conversely, the benefits of positive externalities lead to environmental benefits are

not counted in the economy. While the negative externality itself causes inefficiency. Such inefficiencies will also rise in line with increasing environmental degradation if nothing is done to correct this market failure. World so that economists were looking for a way to correct these market failures.

One way some economists proposed to correct the failure of the Coase Theorem. Coase Theorem explains that during the externalities can be traded in a way that a bargain, then resource allocation will be efficient at that point. However, in terms of the environment, both parties involved are living and inanimate objects. Thus, the environment, as an inanimate object, can not make an offer of the importance of their role to the preservation of the ecosystem and consequently humans can exploit ecosystems without a hitch.

### **Methodology**

This proposal will use qualitative methodology. From qualitative view, it will include collection of materials, document and supporting data that are relevant to environmental based budgeting. Further, the activities involve in depth interview and focus group discussion (FGD) with relevant stakeholders in order to gather issues and inputs related to implementation of environment-based budget.

### **Result and Discussion**

Alternative Policies for Environmental-Based Budget / Green Budget:

1. Allocating at least a percentage of the budget / budget to budget Environment Function (as well as for education and health sectors are regulated by legislation); Existing Minimum Budget Allocation for Functions / Environmental Sector could be modeled:
  - The budget for the education sector (Law no. 20/2003 on National Education System): in addition to salaries of educators and service education expenses, are allocated min. 20% of the budget / budget à 2012 is still 10.74% of the total state budget spending, and dispersed in 19 Ministries / Institutions (K / L)
  - The budget for the health sector (Law no. 36/2009 on Health): min. 5% to 10% for the Centre and the Regions of Total Expenditure excluding salaries) à 2012 was 1.61% of the total state budget spending and dispersed in 1 K / L
  - Budget for function / Environmental Sector LH (Law no. 32/2009 on PPLH): à adequate budget 2012 was 1.19% of the total state budget spending or 0.1% of GDP and scattered in several K / L;
2. Create a new post in the Central Government Expenditure (ie a kind of post "Shopping Environment")
 

Environmental is a budget item expenditures by Function, not budget by Type

  - A difficulty of adjustment in terms of Accounting Standard (both Government

and Commercial) with other types of expenditure, so it is possible to overlap;

- Changing the structure of expenditures, both for the preparation and reporting for state and local budgets;
  - Determination of the minimal amount of budget spending ideal for 3-5% of Total Expenditure Budget / budget or the size of the portion of natural resource depletion and degradation of LH to GDP?
  - Alternatively, enter some of the other expenditure headings to environmental → possible to LH-Based Budgeting is not changed / increased significantly
3. Incorporate "Environmental Indicators" as one of the basic macroeconomic assumptions in the preparation of the State Budget;
- Macroeconomic Assumptions Changes and Their Impact on State Budget Deficit;
  - Problems in the LH indicator Basic Macroeconomic Budget Assumptions.
4. Reforming the budget fiscal policy in order to be more green, both in terms of revenues, expenditures, nor financing
- In an effort to realize a Green Economy, fiscal policy reforms to green budget (pro-environment) is done by maintaining the pillars of pro-growth, pro-job, pro-poor and pro-environment → are often trade-offs, so we need a win-win solution

- Adaptation measures in various regulatory → collaboration with MoF internal and K / L related;
- Adaptation measures in the budget / budget needs to be done in an optimal and integrated inter-sectoral → tracking every revenue and expenditure budget items (eg collaboration with DJA - MoF)
- Reform of various revenues, expenditures, and funding in the state budget / budget inhospitable LH → collaboration with other centers in BKF.

## CONCLUSION

- a) Budget allocation for the Environment is still very low, both the spending and GDP / GDP, while the depletion of natural resources and increasing environmental degradation.
- b) Environmental Indicators that can be used as a reference in determining the budget or budget-based Environment green is the GDP / GDP Green or value depletion of natural resources and environmental degradation.
- c) The need-based Environment minimal budget about 3-5 percent of the total state budget spending / budget that would significantly affect the environment improvement.
- d) In making the budget more green, the main policy priorities are fiscal policy reforms, both in terms of revenue, expenditure, and financing. Thus the most

inexpensive costs incurred and benefits gained most.

## REFERENCES

Danida, 2011. *Rapid Assessment of the readiness of Indonesia to the Environmental Fiscal Reform for Greening Economy*, Jakarta: Pahala Tamba;

Mankiw, N. G. (2007). *Principles of economics (4th ed.)*. USA: Cengage Learning;

Nurcholis, (2012). *Assessment Report of Sustainable Development Indicators*. PKPPIM-UKCCU;

Haryanto, Tri Joko. *Initiating a Greener budget*. Opinion Koran Jakarta, May 22, 2012;

Directorate of Environment, Bappenas. *Indicators of Sustainable Development*. Jakarta 2012;

Law No. 17 Year 2003 on State Finance;

Law No. 1 of 2004 on State Treasury;

Law No. 32 Year 2009 on the Protection and Preservation of the Environment;

## MYOPIC MODELS OF ADDICTIVE ON CIGARETTE IN INDONESIA

Noor Syaifudin

Fiscal Policy Agency, Ministry of Finance of Republic of Indonesia  
[soib2000@yahoo.com](mailto:soib2000@yahoo.com)

### ABSTRACT

Currently, Indonesia is among the countries with high tobacco consumption. Increased purchasing power and weak government policies towards the industry as well as the low price of cigarettes mentioned as a cause of the high consumption of cigarettes. The study focuses on how to approach the level of cigarette consumption in myopic models of addictive. In that model, the current consumption is also determined by the level of consumption in the past. The result finds that the young smoker will be the most vulnerable group to the cigarette. It implies that the role of the government is considered very large in the determination of the required policies.

**Keywords:** *cigarette consumption, myopic model, excise policy*

### A. Introduction

#### Economic Development and Excise Target

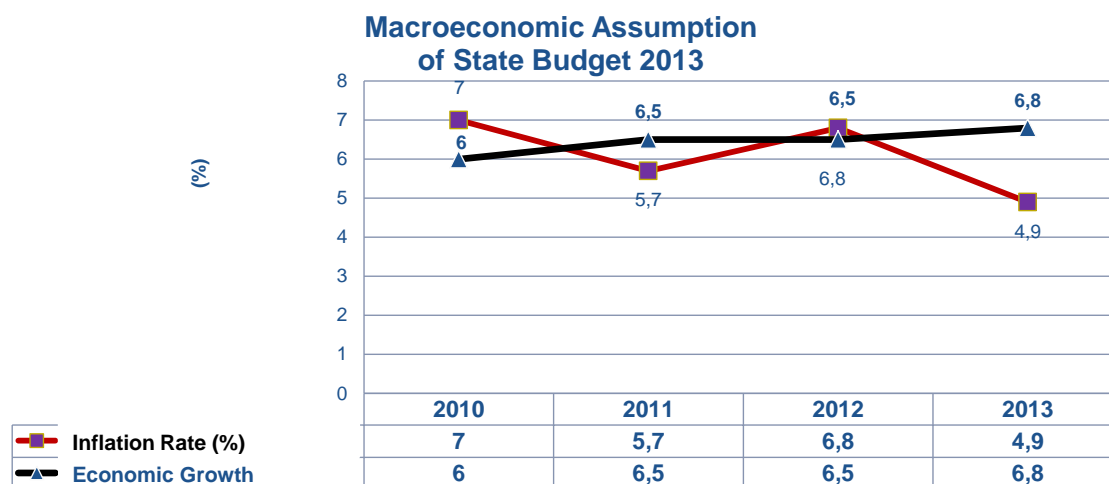

Source: Ministry of Finance

In terms of economic performance, Indonesia is prevailing an impressive achievement. Eventhough the world economic crisis occurs in 2008-2009, the performance seemed to high enough. And it was maintained for 2010 until

2012 and expected to reach a higher economic growth in 2013 by 6.8. On the other hand, the inflation rate is still high. The most problematic issue in Indonesia, since the economic growth is satisfying, yet the inflation

rate is following. The strong commitment by the government is clear in maintaining the inflation target to be met. By combining the fiscal and monetary policy, it is expected that the inflation target will be met. The inflation rate was 7% by 2010 and decreasing in 2011 at 5.7 and increasing in 2012 by 6.8. The target is about 4.9 in 2013 and seems to be ambitious

in the uncertainty on the world economic circumstances by to date, the recovery of United States of America and several European Union countries which currently on the process of bailing out their financial sectors by the support of International Monetary Fund (IMF).

**Figure of tobacco industry in Indonesia**

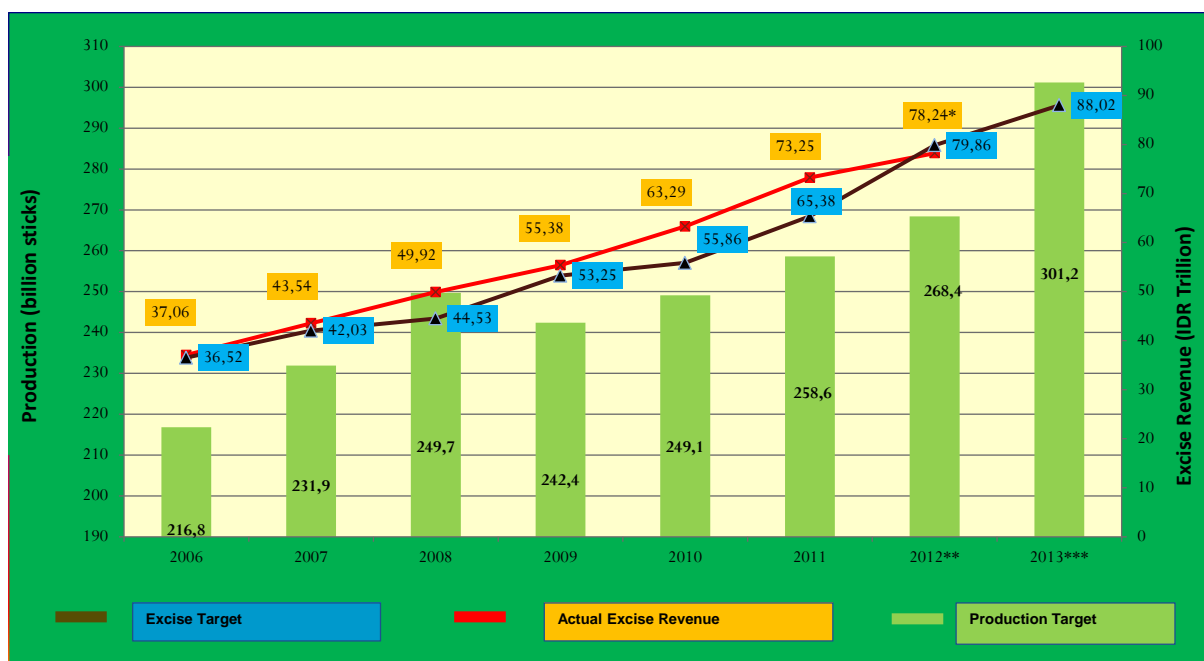

Source: Ministry of Finance

### **The level of production vs excise revenue and target**

The cigarette sector is expected to support the state budget yearly in the very significant amount. Eventhough the object of excise is not cigarette per se, but the excise target from this product is considered to be increasing by year. To follow up the target, then the production target is increasing as well.

In 2006, the excise revenue was about IDR 37,06 trillion more than the target at about

IDR 36,52 trillion. To achieve that target, the production was achieving 216,8 billion sticks of cigarette at that time. The excise revenue and the production tend to increase by year, and the actual revenue more than the target usually, except for the year 2012 which the actual excise revenue was less than the target. In 2012, the excise target was about IDR 79,86 trillion whilst the actual revenue was about IDR 78,24 trillion with the production level at 268,4 billion sticks of cigarette. But again, in

2013 the excise revenue expected to be increase to reach IDR 88,02 trillion with the production 301,2 billion stick of cigarette per year.

### **History of Excise Policy in Indonesia**

For very long time, Indonesia was imposing excise in advalorem rather on specific. This due to its merit such as (Yurekli, 2006):

- a) Tax liability Indexed to cigarette price inflation
- b) Discourages substitution from low-price to high-price brands – and so generates higher revenues
- c) Discourages investment in advertising to make smoking “glamorous”

But it contains several flaws like:

- a) Difficult to collect at retail points of sale
- b) Creates potential for tax avoidance and revenue loss
- c) Smaller health benefits than equivalent specific tax

The advalorem type was still applied until 2006 the Specific excise was introduced firstly. The government considered the benefit of imposing excise on cigarette by introducing the specific with the reasons:

- a) Simplicity

- Tax liability easy to measure
- Taxes prepaid on sales
- b) Health benefits
- External costs of smoking same for high and low price brands – tax rate should be the same

Eventhough the disadvantages are looming:

- a) Revenues do not increase automatically with inflation
- b) Encourages improving “quality” of cigarettes
- c) Encourages substitution to (high-price) imported brands; or smuggled-tax free low-quality alternatives
- d) Increases potential for tax avoidance and revenue loss if tax base set on characteristic of cigarettes (e.g. weight, content, size of cigarettes)

Therefore, the government did not introduce the specific tariff directly and thus, the mixture of advalorem and specific tariff were imposed at the same time since 2006. This policy was running and implemented in the late 2011 whilst the full specific tariff was introduced at the first time. The specific policy was maintained until today by the government.



Period	July 2005 – Nov' 2006	Dec' 2006 – Oct' 2007	Nov' 2007 – Nov' 2009	Nov' 2009 – Dec' 2011	Jan 2012 -24 Dec 2012	25 Dec 2012 -
Excise System	Advalorem	Mix Advalorem & Specific	Mix Advalorem & Specific	Specific	Specific	Specific
Layer of Cigarette Types	10	10	9	19	15	13

Source: Ministry of Finance

### Road map of Tobacco Industry 2007 – 2020

Roadmap of Tobacco Industry is a description of the direction of the policy on cigarette in the future. This roadmap is directed to meet the simple and transparent to control the cigarette consumption according to Law No 39 year 2007 on the amendment of Law No 11 year 1995 on Excise (Ministry of Finance, 2012). This roadmap was established as main consideration to provide a direction of the excise policy by 2007 to 2020. The vision of the roadmap is to meet the policy target on prioritizing the health aspect as the first priority, labor on the second priority and state revenue on the third priority, starting 2015 to 2020.

#### Objectives::

1. To make a more transparent policy formulation process of excise on cigarette, with the purpose to control the consumption.
2. To provide the smoother and to bridging the stakeholders in the policy formulation process.

3. To bring back the excise philosophy that excise imposed on the object of goods not on the subject

4. To simplify the state revenue projection

5. To simplify the excise administration and the supervision

#### The General Policy of the Roadmap:

1. In every year, it is stipulated that the moderate increase of specific excise tariff will be imposed

2. The base line for the next excise tariff will be up to the previous cigarette companies groups

3. The increase of excise tariff will accommodate the macroeconomic assumptions: economic growth, inflation rate and cigarette consumptions.

4. The excise tariff priority will be hand in hand with the roadmap of cigarette industry

5. Simplifying the specific excise tariff by decreasing the layer in each of the cigarette types.

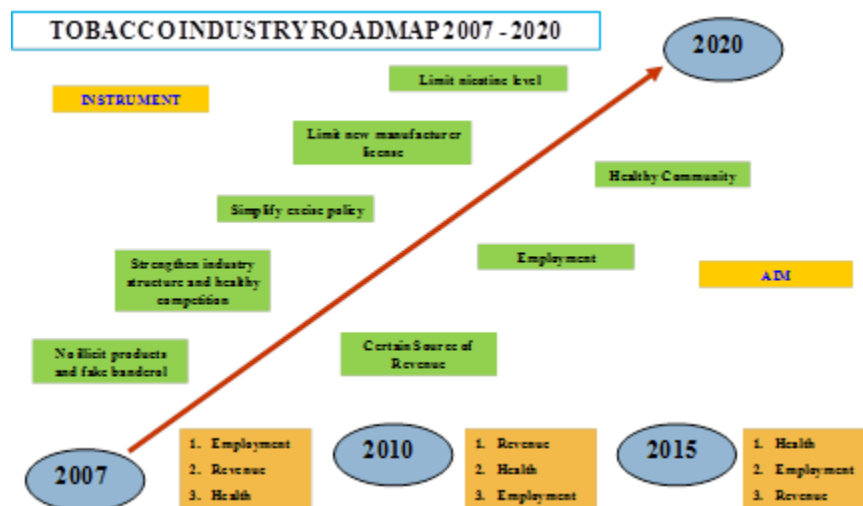

Source: Ministry of Finance

## B. Literature Review: Nature of addictive product

### The conventional model of addictive

Basically, the demand of goods is determined on several factors. Usually the price of products, the ability to pay of the consumer and other factors related with lifestyle, taste and preferences. That model is called the conventional approach of demand of products. In terms of addictive goods thus the Conventional Approach is defined as a model of the common demand model on a certain period (Chaloupka). The model can be described on the equation below:

$$C(t) = g[ P(t), Y(t), Z(t) ]$$

where:

$C(t)$  = consumption of cigarette on period  $t$

$P(t)$  = current price of cigarette on period  $t$

$Y(t)$  = income

$Z(t)$  = vector of variables reflecting tastes

$\epsilon_t$  = error term

In this approach the current consumption of cigarette depends only on current factors and increase in current price will reduce current

consumption where price defined broadly to include monetary price, time costs, expected legal costs, and anticipated health consequences).

### Myopic Models of Addictive

Among the scholars, the conventional approach rises debate due to several reasons:

- Increase in past price and/or anticipated increase in future price will have no impact on current consumption and
- This model does not reflect the dependence of current consumption decisions on past behaviour that characterizes the use of an addictive substance as well.

In order to filling the gap of the debate, the Myopic model was introduced. The Model can be defined as the short distance vision, therefore the basic of the modelling is the behaviour of the cigarette consumption by minding in the short run. Unlike the conventional demand model, the myopic models of addictive also concerned that the decision to consume cigarette today is as the result of the previous consumption, however

when they make their today's decision, they do not mind their consumption in the future. On this model, the previous consumption influenced the current consumption due to the accumulation of the stock of the previous consumption (Chaloupka). This model predicts that the price elasticity on the demand of the cigarette on the long term will be higher than the price elasticity of the cigarette on short run on the absolute value. The demand of cigarette on the certain period was determined by the current period and the previous period variables. The model can be illustrated as follows:

$$C(t) = g[ P(t), C(t-1), Y(t), Z(t) ]$$

Where:

$C(t)$  = Cigarette consumption on period  $t$

$P(t)$  = current price of cigarette on period  $t$

$C(t-1)$  = Cigarette consumption on period  $t-1$

$Y(t)$  = income

$Z(t)$  = vector of variables reflecting tastes

$\epsilon t$  = error term

### C. Objective of study

1. To provide a picture of the economic background of excise policy
2. To provide history of excise policy on cigarette in Indonesia
3. To measure the impact of the government policy and the past consumption and preference on cigarette to the current consumption on cigarette

### D. Methodology

Data was collected for both the primary and secondary. The primary data was collected from the relevant stakeholders, the policy maker as well as the community. In order to collect data and provide a targeted result and audience, thus the Focus Group Discussion was conducted. The secondary data was collected from Ministry of Finance, State Board of Statistics, and relevant Ministries and other institutions. The data then manipulated and processed by utilizing the pooled least square under the myopic model of addictive.

### E. Findings and results

The below table shows the result of the regression. The data was collected since 1999 to 2010 quarterly and manipulated with the pooled least square method. The result shows all variables have expected sign with  $R^2 = 0,88$  and adjusted  $R^2 = 0,88$ .

Dependent Variable: LNCONS?

Method: Pooled Least Squares

Variable	Coefficient	Std. Error	t-Statistic	Prob.
C	0.865569	2.227773	0.388536	0.6982
LN(P)?	-0.369391	0.097467	-3.789927*	0.0002
LN(Y)?	0.634020	0.353233	1.794907**	0.0748
TAX?	-0.072939	0.087794	-0.830791	0.4075
LN(CONS(-1))?	0.651046	0.045411	14.33660*	0.0000
R-squared	0.881228	Mean dependent var		3.248777
Adjusted R-squared	0.877810	S.D. dependent var		0.804189
S.E. of regression	0.281110	Sum squared resid		10.98415
Log likelihood	-19.04524	F-statistic		257.8273
Durbin-Watson stat	0.700154	Prob(F-statistic)		0.000000

Source: the result of calculation

a. The impact of price to the current consumption

The finding shows the coefficient of price is -0,3694, which means that for every increase 1% in price will decrease the current consumption of cigarette by 0,3694%. This result less than the findings by Sayginsoy, et.al (2002) with 3,974% in Bulgaria, but higher than by Djutaharta, et.al.(2005) with -0,265 for year 1970 to 1996.

The results can be understood that the cigarette is considered as one of the addictive goods. The result shows that eventhough cigarette is elastics in terms of its demand but since cigarette is addictive goods, therefore the elasticity is low.

b. The impact of income to the current consumption

The coefficient of income is 0,634, which can be concluded that for every increase in income by 1% the consumption will increase by 0,634%. The coefficient is higher than 0,214

by Djutaharta, et.el (2005) and less than 1,663 of Saygnossy, et.al (2002) for Bulgaria.

The result implies that the consumption will tend to increase due to the economic grwoth in Indonesia. By enlarge, the economic growth that currently is experienced by Indonesia is one of the supporter to the increase demand of cigarette.

c. The impact of excise to the current consumption

The above finding shows that the excise gives an impact to the cigarette consumption. The increase of 1% excise will reduce the consumption by 0,073% of cigarette. The findings is less than Dewi, et.al with 6,628 % for the data from 1983 to 2005.

The finding confirms the Setyawati (2008) that if excise tariff is less than 65% therefore will not so effective in curbing the cigarette consumption. In 2010, the total indirect tax on cigarette (excise and VAT) is about 54,4 in average. Moreover, Law No 39 year 2007 does

not allow the excise tariff to be more than 57% from the selling price.

- d. The impact of the past consumption to the current consumption

The result shows the coefficient is 0,651 which means that for every increase in the past consumption by 1%, the current consumption will increase by 0,651%. This finding is higher than Djutahrata, et.al (2005) for 0,488. Djutaharta, et.al suspected that there is autocorrelation so the result so robust. But, by applying Breusch-Godfrey Serial Correlation test, it was proven that there is no autocorrelation.

The result confirms the finding by Barber (2008) that per capita adult tobacco consumption increased by 9.2 percent between 2001 and 2004. The decision to start smoking is usually made during childhood or adolescence, and children are starting to smoke at earlier ages than in the past. The average age of smoking initiation has declined to 17.4 years in 2004, and 78 percent of Indonesian smokers start before the age of 19 years.

## F. Policy Implications

1. The myopic model of addictive which is employed in this study provides findings that the young smokers is very vulnerable to the attraction of cigarette. Their decision is not mature yet and they will be a very loyal smoker in the future while their ability to pay increasing.
2. The government needs to provide a different approach to this group. The

intervention is purposed to build awareness to the young on the impact of cigarette consumption.

3. The other intervention which can be done is by delimiting the affordability of cigarette to the young. Minimum ages requirement to buy cigarette, limitation of cigarette sponshorships in the young targeted event, and limitation of advertising for the young (including time limitation, view and impression).
4. The other measures can be conducted by government to support the excise policy to curb the aftermath of the impressive economic growth to the young. This due to the economic performance will need a strong and health young generation to continue the impressive economic performance.

## G. References

- Adioetomo, Sri Moertiningsih, Triasih Djutaharta, and Hendratno.(2005). Cigarette Consumption, Taxation, and Household Income: Indonesia Case Study. Economics of Tobacco Control Paper No.26: 1-31
- Barber, Sarah, et.al.(2008). Tobacco Economics in Indonesia. Depok: Lembaga Demografi: Universitas Indonesia.
- Chaloupka, Frank J., John Tauras. "Economic Models of Addiction and Applications to Cigarette Smoking and Other Substance Abuse." National Bureau of Economic Research.
- Chaloupka, Frank J., et.al..(1996). Public Policy and Youth Smokeless Tobacco use. National Bureau of Economic Research.
- Cnossen, Sijbren. (1983). Comparative Tax Studies: Essays in Honor of Richard

- Goode" Rotterdam: North-Holland Publishing Company.
- .(1977). Excise System: A Global Study of the Selective Taxation of Goods and Services. Maryland: The John Hopkins University Press.
- Dewi, Citra Anggar, Syafrial, Rosihan Asmara. Dampak Cukai Rokok Terhadap Ekonomi Tembakau Indonesia
- Kementerian Keuangan. (2012). Indikator Terkini Ekonomi Makro.
- Kementerian Keuangan. (2012). Peraturan Menteri Keuangan No. 179/PMK.011/2012 Tanggal 12 November 2012 Tentang Tarif Cukai Hasil Tembakau
- Ross, Hana., Frank J. Chaloupka. (2002). "Economics of Tobacco Control".
- Yurekli, Ayda.(2007). Design and Administer Tobacco Taxes. World Bank Economics of Tobacco Toolkit

## **CORRELATION BETWEEN CLIMATE VARIABILITY AND DENGUE HAEMORRHAGIC FEVER (DHF) INCIDENCE IN SEMARANG CITY DURING 2002-2011: AN ECOLOGICAL STUDY**

**Riska Khausarani Minanda, Budiyo, Sri Winarni, Sutopo Patria Jati, Praba Ginanjar**

Faculty of Public Health, Diponegoro University, Semarang, Indonesia  
[winditry\\_29@yahoo.co.id](mailto:winditry_29@yahoo.co.id)

### **ABSTRACT**

Several indicator of climate in Semarang city has changed during 2002-2011, the temperature has increased 0.1°C every year and humidity has increased 1.6% every year. It may influence transmission of DHF, because the vector is highly depended on temperature, humidity, rainfall and other conditions of environmental. DHF cases in Semarang city in 2002-2011 also trend to increase every year. The study aimed to analysis the correlation between climate variability with DHF incidence Semarang city, during 2002-2011. This was an observational study with cross sectional design. The population in this study is all patient of DHF in 2002-2011 registered in District Health Office of Semarang. A total of 26,415 cases was used in accordance with data of climate variability from BMKG. Rank Spearman ( $p = 0.05$ ) was used to analyze the correlation. The result showed during 2002-2011 average of rainfall was 193 mm/month, the average of temperature was 27.7°C, the average of humidity was 76% and the average of DHF cases was 220 cases/month. The analysis showed DHF cases in Semarang city (2002-2011) significantly related to rainfall and humidity ( $p=0.001$  and  $p=0.0001$ ) but not significantly related to temperature ( $p=0,235$ ). This study concluded that incidence of DHF in Semarang during 2002-2011 influenced by rainfall and humidity, and suggested to develop an integrated early warning system in climate variability for preventing DHF and improving management of DHF cases in Semarang.

**Keywords** : *climate, DHF, temperature, humidity, rainfall*

### **INTRODUCTION**

Dengue hemorrhagic fever (DHF) is an infectious disease caused by *dengue* virus and transmitted by *Aedes sp.* (WHO, 2009:14). DHF found almost all countries in tropic and subtropic areas, either as endemic or epidemic. In Indonesia, the disease first occurred in 1968 in Surabaya (Ditjen PP & PL Depkes RI, 2009). DHF cases in Semarang trend to increase. According to data from District Health Office of

Semarang, the with incidence rate (IR) of DHF per 100,000 population was as follow: 45.6 (2002), 35.9 (2003), 118.0 (2004), 163.0 (2005), 129.9 (2006), 196.4 (2007), 360.8 (2008), 262.1 (2009), 368.7 (2010) and 73.87 (2011).

Transmission of DHF is highly influenced by climate factors (Hopp MJ and Foley JA, 2001). Climate change may caused by an increase in concentrations of green house gases is expected to raise the global-mean

surface-air temperature. An increase of atmospheric greenhouse gas concentrations leads to an average increase of the temperature of the surface-troposphere system (IPCC, 2001; Alisjahbana, 2008:34). Annual mean temperature in Indonesia has been observed as increasing by around 0.3 degrees Celsius since 1990 (Sari et al, 2007).

Climate change causes changing pattern of rainfall, temperature, humidity, and wind direction that affecting land and sea ecosystem. This may lead to health problem, especially deal with disease vector such as *Aedes*, *Anopheles* etc. (Barrera, 2006). Climate change affects the continuous increased number of vector borne disease (Munasinghe et.al, 2003). Collwell study revealed the effect of climate change to infectious diseases, mainly arthropode poikilothermic borne disease (Collwell et.al, 1998). Increasing temperature shortened reproductive cycle of vectors as well as Average of DHF incidence 2002-2011 was 220/month, rainfall 193 mm/month and humidity 76%. Temperature tends to constant in 27.7 °C, no fluctuation observed (BMKG, 2002-2011).

#### **a. Correlation of rainfall and DHF incidence**

There was significant correlation of rainfall and DHF during 2002-2011 (p-value=0,001 and  $r=0,304$ ). Coefficient correlation ( $r$ )=0.304 indicated positive relation, which

extrinsic development of pathogen in the vector, which may lead to high transmission of several arbovirus disease such as Japanese encephalitis and dengue (WHO, 1990). Our study aimed to analyze the climate variability and its association to the incidence of DHF.

#### **MATERIAL AND METHOD**

This was an observational study with cross sectional design. Study subject was 26.415 cases of DHF registered in DHO. Data of temperature, humidity and rainfall was obtained from Badan Meteorologi, Klimatologi, Geofisika Semarang. As dependent variable was DHF incidence while independent was rainfall, temperature and humidity. Rank Spearman was used to analyze the correlation between climate and DHF (Sugiyono, 2002).

#### **RESULTS AND DISCUSSION**

means increasing of rainfall followed by increasing of DHF incidence. The result was similar with Andriani study, which revealed a significant relationship between climate factors and DHF incidence during 1997-2000 in Jakarta (Andriani, 2000). Consistent results on the relationship between rainfall and DHF have also seen in Southeast Asia. Peak of transmission occurs in high rainfall and temperature when habitat (water storage container) of *Aedes aegypti* is abundant. Although in some places the peak occurs



before rainy season and increase during transitional season (Gubler, 1998).

Rainfall will added puddle of water as mosquito breeding places. In dry season plenty of scraps such as used cans, used plastic glasses, used tired etc was discards or irregularly placed. During transitional season, all the scraps may become water reservoir and act as breeding places. In the rainy season, *Aedes* female mosquitos acquire plenty of freshwater to breed from every curved object or curve of trees. This due to *Aedes* bionomic

that prefers clean water to lay eggs. Especially in cloudy weather when female mosquito stimulated to lay eggs (Irpis, 1972).

An *Aedes* can lay 100-300 eggs, causing mosquito population increase rapidly. Mosquitos need blood for their eggs maturation and there by increasing the probability to bite. That is why the increase in mosquito population in the beginning of rainy season will be followed by the increase of DHF (Irpis, 1972).

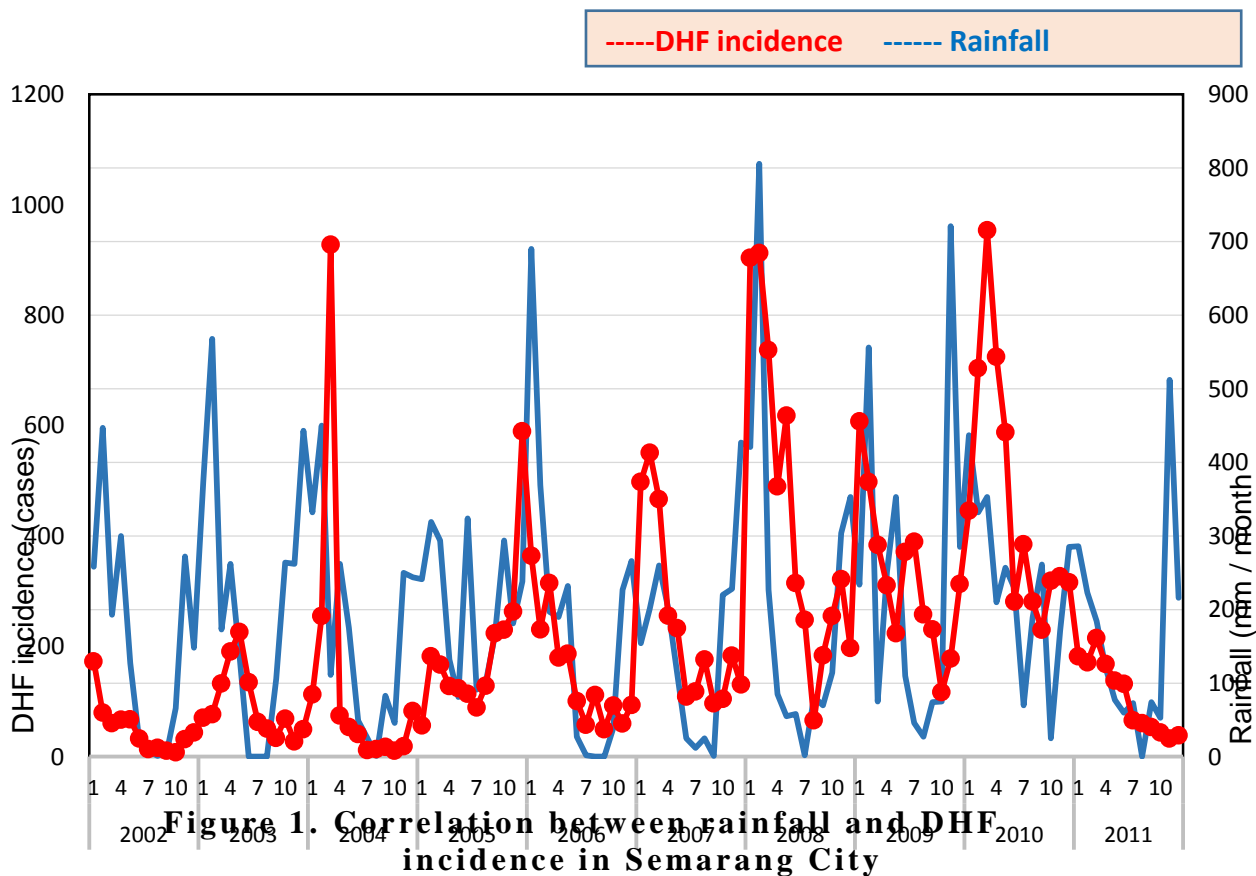

#### b. Correlation of temperature and DHF incidence

The result showed no significant correlation between temperature and DHF incidence during 2002-2011 ( $p$ -value = 0,235 and  $r = -0,109$ ). This is in contrast with Andriani

study that concluded significant relationship of climate factors and DHF incidence in Jakarta (1997-2000). Increase in temperature will affect bionomic change of mosquito population in biting rate. Besides, reproductive activities also change, which characterized by rapid proliferation (Ditjen PP & PL Depkes RI, 2009).

Temperature can also modify vector growth and alter biting rate. Season transitional changes transmission time. Vector may adapt to temperature change by shifting their geographical distribution (WHO, 2003). Increasing temperature shorten time needed to develop from egg to adult. In 26°C, virus need 25 days to reach saliva gland and ready to transmit throughout mosquito lifetime. On the contrary, they only need 10 days in temperature of 30°C. This will speed up the probability of dengue transmission. The faster the mosquito breeding, the higher the risk of epidemik.

Larval development is mainly influenced by temperature and food availability in the breeding places. In the laboratory setting with optimal condition (sufficient food and water temperature of 25-27°C) the larval development need 6-8 hari. When the water temperature is more than 28°C or less than 24°C the larval development become longer. At the temperature of 31°C, 24°C, 20°C, 18°C

and 16°C the larval development is 12, 10, 19, 24 and 29 days respectively. Larvae die in temperature less than 10°C or more than 40°C. In a fluctuative temperature, the development is faster compare to constant temperature (Sungkar, Saleha, 2005).

Mosquitos survive in low temperature, but its metabolism decrease and even stopped in critical temperature. In high temperature (>35°C) physiology process will also decrease. Average optimum temperature for development is 25°C-27°C. Mosquito's development stops in temperature less than 10°C or more than 40°C (Depkes RI, 2000). Environmental temperature affects extrinsic incubation period (EIP) of dengue virus in the mosquito. Increase temperature shorten EIP and increase probability of transmission. Increasing environmental temperature affects rapid eggs hatching (UNDP, 2007). Theoretically, environmental temperature may also affect biting rate (Djunaedi, 2006; Brisbois and Ali, 2010).

However, our study showed no significant correlation of temperature and DHF incidence. This probably due to the condition of Semarang temperature during 2002-2011 that still in optimum range for mosquito growth and development. It is also possible that the mosquito infectivity was low, so it does not affect DHF incidence.

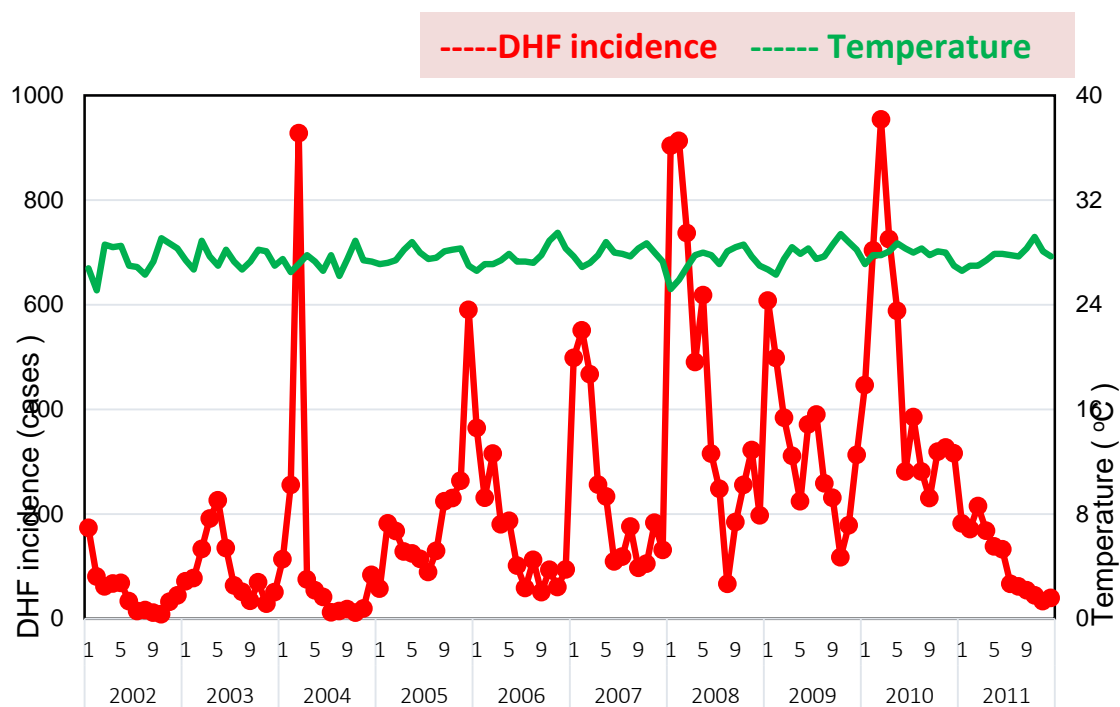
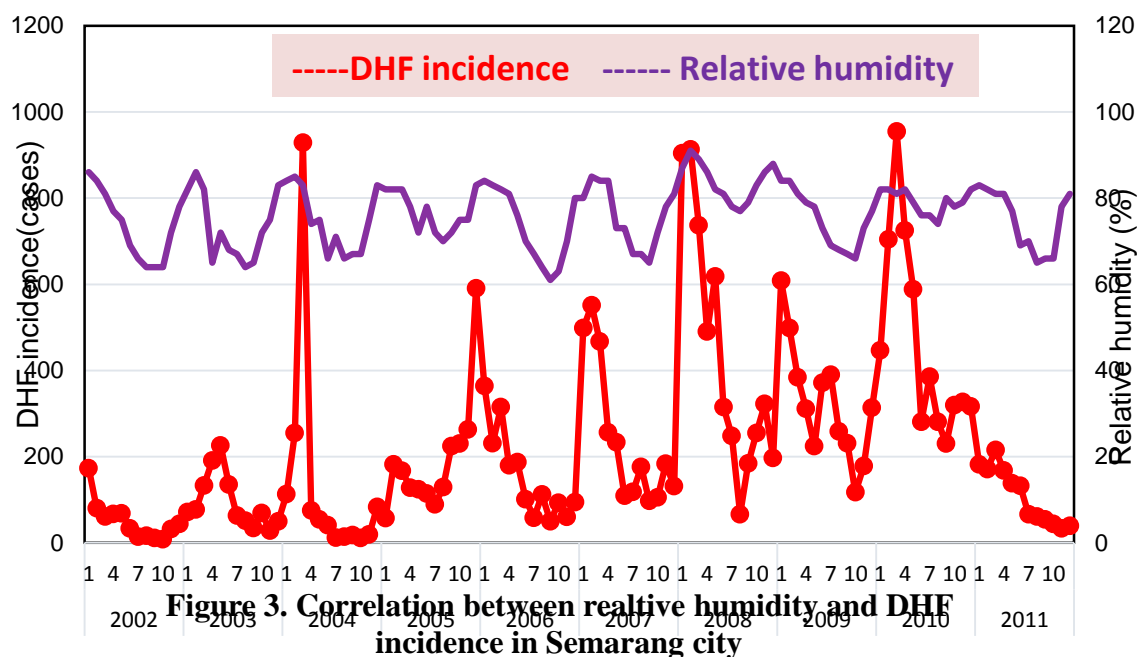

**Figure 2. Correlation between temperature and DHF incidence in Semarang City**

**c. Correlation of humidity and DHF incidence**

Our result showed significant correlation between humidity and DHF incidence during 2002-2011 ( $p$ -value=0,0001 and  $r =0,574$ ). Relative humidity is a determinant of growth, spread and age of mosquitoes. It is closely related to the tracheal respiratory system. Mosquitoes are very susceptible to low humidity. Mosquito species that have forest habitats are more susceptible to changes in humidity of the habitat of species that have a dry climate (Sukowati, 2004)

Average humidity in Semarang is 61%-91%, which is optimal for vector. *Aedes aegypti* grow and develop efficiently in humidity of 70% - 90% (Hopp MJ, Foley JA, 2001: 441–463). Humidity mainly affect egg cycle. In high temperature and humidity, *Aedes* eggs need only 8 days to hatch (Sukowati, 2004). On the contrary, in low humidity egg can reach 3 months to hatch. More than 3 months, the eggs lost their fecundity (unable to hatch). The average time of the hatched rate of *Aedes sp.* eggs in Semarang (Tembalang, Karangrejo, Bandarharjo) is in 2<sup>nd</sup> day. (Budiyono and Roshika U, 2011).



## CONCLUSION

Rainfall and humidity correlated with DHF incidence in Semarang during 2002-2011. The research suggested to develop integrated early warning system in climate variability for preventing DHF and improving management of DHF cases in Semarang.

## ACKNOWLEDGEMENT

We pray to Allah SWT gratitude for the blessings that are given so this research can be done and can be useful for us and others.

Upon completion of this study we would like to thank DHO (District Health Office) Semarang and BMKG.

## REFERENCES

- WHO, 2009. *Dengue: guidelines for diagnosis, treatment, prevention and control -- New edition*. A joint publication of the World Health Organization (WHO) and the Special Programme for Research and Training in Tropical Diseases (TDR), WHO Press, Geneva, Switzerland : p 14
- Ditjen PP & PL Depkes RI, 2009. *Dengue Hemorrhagic Fever (DHF) In Indonesia 1968-2009*. Buletin Jendela Epidemiologi, Volume 2, Agustus 2010: p 1.
- Dinas Kesehatan Kota Semarang (2002-2001). *Diseases data DHF of District Semarang 2002-2011*
- Hopp MJ, Foley JA (2001). *Global-Scale Relationships Between Climate and the*

- Dengue Fever Vector, Aedes Aegypti*. Kluwer Academic Publishers; 48: 441–463.
- IPCC, 2001: *Climate Change 2001: The Scientific Basis. Contribution of Working Group I to the Third Assessment Report of the Intergovernmental Panel on Climate Change* [Houghton, J.T., Y. Ding, D.J. Griggs, M. Noguer, P.J. van der Linden, X. Dai, K. Maskell, and C.A. Johnson (eds.)]. Cambridge University Press, Cambridge, United Kingdom and New York, NY, USA: p94.
- Alisjahbana, Armida S/Bappenas, 2008. *Indonesia Climate Change Sectoral Roadmap – ICCSR*. Kementerian Republik Indonesia, Bappenas, Jakarta:p34.
- Agus P. Sari, Martha Maulidya, Ria N. Butarbutar, Rizka E. Sari, Wisnu Rusmantoro, 2007. *Executive Summary: Indonesia and Climate Change Working Paper on Current Status and Policies*, Bank Dunia : p3
- Barrera, R, M. Amador dan G. G. Clark. *Ecological Factor Influencing Aedes aegypti (Diptera ; Culicidae ) Produktivity in Artificial Containers In Salinas*. Puerto Rico: J. Med Entamol, 2006. 43(3); 484-492.
- Munasinghe, et.al.2003. *Integrating Sustainable Development and Climate Change In The IPCC Fourth Assessment Report*. IPCC: Colombo, p28-29.
- R. Colwell, P. Epstein, D. Gubler, M. Hall,P. Reiter, J. Shukla, W. Sprigg, E. Takafuji, and J. Trtanj, 1989:145. *Global Climate Change and Infectious Diseases, Emerging Infectious Diseases* Vol. 4, No. 3, July–September 1998:p451
- WHO, 1990. *Potential health effects of climate change*, Geneva, Switzerland: p37
- Sugiyono, 2002. *Statistics for research*. Bandung, Alfabeta.
- Badan Meteorologi Klimatologi dan Geofisika. *Data Unsur Iklim Kota Semarang tahun 2002-2011*.
- Andriani, Dina Kemala, 2001. *Correlation between the Climate Change Density Vectors, cases, and the incidence rate of dengue fever in DKI Jakarta 1997-2000*. Fakultas Kesehatan Masyarakat Universitas Indonesia.
- Gubler, D.J. *The Arbovirus Epidemiology and Ecology*. Dengue Newsletter 2, 1998: 45-52.
- Irpis, M. *Seasonal Changes In The Larval Population Of Aedes Aegypti in Two Biotopes In Dar Es Salaam, Tanzania*. Bull: World Health Organ 1972. 47:245-255.
- WHO, 2003. *Climate Change and Human Health Risk and Responses*.
- Sungkar, Saleha. *Eradication Dengue Haemorrhagic Fever*. Majalah kedokteran Indonesia, Vol: 55, N.5, Mei. 2005.
- Departemen Kesehatan Republik Indonesia, 2000. *Pencegahan dan Penanggulangan Penyakit Infeksi*

*dengue dan Infeksi dengue*. Terjemahan dari WHO Regional Publication SAERO No. 29 "Prevention Control of Dengue and Dengue Haemorrhagic Fever". Jakarta: Depkes RI.

*Interdisciplinary Research: Social Science Perspectives on an Environment and Health Controversy*. Ecohealth, Heidelberg: Springer.

UNDP, 2007. *the other side of climate change*. UNDP Indonesia Country Office: Jakarta.

Sukowati, S. *The relationships between Climate and Infectious Diseases (DHF & Malaria)*. Makalah Seminar Sehari Dampak Perubahan Iklim Terhadap Kesehatan, 6 April 2004 di Jakarta.

Djunaedi D, 2006. *Dengue Haemorrhagic Fever (DHF) Epidemiology, Immunopatology, Patogenesis, Diagnosis dan Management*. Malang: UMM Press

Budiyono, Roshika U, 2011. *The Analysis of Micro-environment in the Ovitrap and hatched rate of the Aedes Sp.in Semarang City*. Media Kesehatan Masyarakat Indonesia, Volume 10 Nomor 1, April 2011.

Brisbois BW, Ali SH, 2010. *Climate Change, Vector Borne Disease and*

## EFFECTIVENESS OF MINDFULNESS-BASED STRESS REDUCTION THERAPY IN HIGH SCHOOL ENVIRONMENT

**Agustina Ari Handayani**

AN NUR School of Nursing Grobogan, Central Java, Indonesia  
[moleculargustin@yahoo.com](mailto:moleculargustin@yahoo.com)

### ABSTRACT

Schools have an important meaning for the students. Not only as a place of studying but also as a mental formation of the students. Comfortable physical environment schools can improve student's mental well-being. It makes teens to cope with stress. If the physical school's environment has not been comfort that they provide an intervention to be able to adapt with existing circumstances. Mindfulness Based Stress Reduction (MBSR) therapy was given to maintain the mental well-being. Aim: to analyzed student's distressed after receiving two and eight weeks MBSR Therapy. Methods: Post test only design. Samples were taken at random as many as 32 students. The first group was given MBSR intervention as eight weeks, the second group of two weeks. Student's distressed measured by the GHQ (General Health Questionnaire) 12. Non-paired t test used to determine difference in student's distressed between two treatment groups. Results: The results showed a difference in mean values between the two intervention groups, two ( $4.81 \pm 0.65$ ) and eight weeks ( $9.93 \pm 0.77$ ). Differences in student distressed of both groups showed significant values with p value = 0.000 with 95% of confidence level. Conclusion: This study showed maintaining student's distressed in the uncomfortable school's environment with eight weeks interventions. So it is suggested that promote and integrate mental well-being which is favorable in the way of increasing student's enthusiastic.

**Keywords:** *MBSR, GHQ-12, high school environment*

### INTRODUCTION

Indonesian young people have 7-14% mental disorders (Hamid, 2009). This has not been a particular concern because it's considered taboo. Schools have an important meaning for the students. Not only as a place of studying but also as a mental formation of the students. A complementary health education is to promote health and mental wellbeing. The physical environment in which students spend an effects on their emotional and mental health, and opportunities to choose healthy lifestyles (Bonnell et al, 2011).

Comfortable physical environment schools can improve student's mental well-being. It makes teens to cope with stress. In preliminary study, ten students are being dissatisfied with social (not enough places to stop and chat) and community facilities (such as libraries, social participation (not enough events to get people together). If school's environment has not been comfort, they will be distressed in there. They need an intervention to be able to adapt with existing circumstances.

Mindfulness Based Stress Reduction (MBSR) therapy was given to maintain the student's mental well-being.

MBSR is a practice meditation was developed by Kabat Zinn and used in more than 120 clinics, hospitals, and HMOs in the United States and abroad. It is generally understood that in MBSR instruction, participants receive training in three formal meditation techniques: a body-scan meditation, a sitting meditation, and mindful hatha yoga, which involves simple stretches and postures (Kreitzer and Reily-Spong, 2010).

Mindfulness-Based Stress Reduction (MBSR), one of the most widely used mindfulness training programs, has been reported to produce positive effects on psychological well-being and to ameliorate symptoms of a number of disorders. After they underwent the eight-week program (Hölzel et al., 2011).

Aim: to analyzed student's distress after receiving two and eight weeks MBSR therapy.

## **MATERIALS AND METHODS**

MBSR participants were recruited among 216 sophomore students in four classes at SMK Diponegoro (vocational high school) Penawangan-Grobogan-Central Java. Sampling technique is proportionate stratified random sampling. Sample size is 32 students, consist of 18 female and 14 male with a mean age 17.06 (SD 1.86). Further inclusion criteria were: no ill rehabilitation, no physical limitation, commitment to attend all classes. Exclusion

criteria were: headache, nausea and vomiting. The first group, 16 students were given MBSR intervention as eight weeks and the second group, 16 students were given two weeks.

The MBSR program from Kabat-Zinn with time modification. Briefly, it consists of eight weeks (eight times) and two weeks (two times) group meetings lasting one hour for each. Meditation technique include a body scan, mindful yoga, and sitting meditation. During the body scan attention is observing the whole body without judgmental awareness the sensations in each region and ending with an awareness of the body. The mindful yoga contains gentle stretching exercises and slow movements. The movement often coordinated with the breath and a non-harming attitude towards the body. Sitting meditation practices begin with awareness of the sensations of breathing, then evolve to include awareness modalities (such as sounds, sight, taste, other body sensations, thoughts and emotions). Ending is to open awareness meditation or a simple awareness of one's presence in the here and now (Holzel, 2011).

Participants received audio recordings from [www.soundstrue.com](http://www.soundstrue.com) containing 60 minute guided mindfulness exercises (body scan, yoga, and sitting meditation)

The participants are given a questionnaire about their mental health conditions after MBSR therapy. The scoring method was a



binary scoring. The minimum GHQ-12 total score was 0 and the maximum GHQ-12 total score was 12. The GHQ-12 is a 12-item scale to measure medical distressed students (Yusoff et al., 2009). The GHQ-12 was derived for high school. Reliability analysis (KR-20) and RpBis with CITAS (Classical Item and Test Analysis) were applied to test internal consistency of the GHQ-12 (Thompson, 2009). Reliability analysis is 0.88 (KR-20). RpBis are no less than 0.5. Follow-up tests (non paired t-test) were then conducted within the identified regions to test for significance compared between group eight and two time MBSR therapy. A paired non t-test was then performed in [www.vassarstat.net](http://www.vassarstat.net).

## RESULTS AND DISCUSSION

MBSR participants group of eight weeks was showing mean of GHQ-12, SD 9.93. MBSR participants group of two weeks mean 4.81, SD 0.65. The correlation between intervention and GHQ-12 were significant 0.965.

Non Paired t-tests confirmed significant. Differences in mental well-being of both groups showed significant values with p value = 0.000 with 95% of confidence level. This study demonstrates GHQ-12 differences in student's distress following an eight weeks MBSR therapy compared with a two weeks group. MBSR in eight weeks practice allows individuals to live more flexibly in the moment. As evidenced by the participants' scores on the eight weeks to two weeks comparisons. Rivord (2012), this study suggests the idea that with an increase in mindfulness practice comes a decrease in



**Figure 1.** Mindful Yoga



**Figure 2.** Pose Body Scan and Sitting Meditation

stress symptoms. These results are consistent with what other researchers have found in the previous studies mentioned.

MBSR therapy eight weeks showing morphological increases in regions associated with mental health that such increases represent enduring changes in brain structure. It could support improved mental functioning (Holzel, 2011).

Davidson et al (2003), MBSR incorporates elements of traditional, psychological, and relaxation techniques that elicit the relaxation response. This response reduces autonomic nervous system reactivity.

MBSR was improving the quality of mood and emotions and subsequently improving the quality of life and mental health. The health practitioner who are willing to efficient are recommended to use MBSR practices.

Gradually, MBSR practices help to alter essential physiological factors (breathing synchrony, heart rate, etc.) that are easily disrupted by stress and create a satisfying sense of physical integration. The deliberate slow pacing of mindfulness, as practiced in the MBSR program, provides a wonderful setting for mindfulness practice, offering a wealth of kinesthetic, proprioceptive, and interoceptive cues for focused attention (Omidi et al, 2013).

The students with eight weeks MBSR therapy would have greater context for bring the change in their live. They will be focused attention in their enthusiastic.

## CONCLUSION

This study showed maintaining student's distressed in the uncomfortable school's environment with eight weeks interventions. So it is suggested that promote and integrate mental well-being which is favorable in the way of increasing student's enthusiastic.

## ACKNOWLEDGEMENTS

Authors are grateful to SMK Diponegoro, Penawangan-Grobogan-Central Java and participation of students in the MBSR interventions for their help. Authors also acknowledge their gratitude to An Nur School of Nursing for motivating this research.

## REFERENCES

Bonnel C, Angela H, Helene W, Farah J, Adam F, Mark P, James T, Margaret W, Rona C, Simon M, Laurence M. (2011). Protocol for a systematic review of the effects of schools and school-environment interventions on health: evidence mapping and syntheses. *BMC Public Health*, 11:453

Davidson RJ, Kabat-Zinn J, Schumacher J, Rosenkranz M, Muller D, Santorelli SF, et al.(2003). Alterations in brain and immune function produced by mindfulness meditation. *Psychosom Med.*;65(4):564-70

Hamid AY.(2009). Bunga Rampai Asuhan Keperawatan Kesehatan Jiwa. Jakarta: Penerbit Buku Kedokteran EGC

Holzel BK, James C, Mark V, Christina C, Sita M, Yerramsettia, Tim G, Sara W.L. (2011). Mindfulness practice leads to increases in regional brain gray matter density. *Psychiatry Res.* 30; 191(1): 36–43.

Kreitzer MJ, Reilly-Spong M, Editor: Snyder M and Lindquist R.(2010). Complementary & Alternative Therapies in Nursing. Sixth Edition. New York: Springer Publishing Company. pp: 149-166

Omidi A, Mohammadi A, Fatemeh Z, Hossein A.(2013). Efficacy of Mindfulness-Based Stress Reduction on Mood States of Veterans With Post-Traumatic Stress Disorder. *Archive of Trauma Research*. Copyright Kashan University of Medical Sciences. Published by Kowsar Corp.

Rivord M.(2012). Impact of MBSR on Symptoms of Anxiety, Stress, and on the Degree of Mindfulness. Master of Social

Work Clinical Research Papers. At  
[http://sophia.stkate.edu/msw\\_papers/80](http://sophia.stkate.edu/msw_papers/80)

Thompson NA.(2009). Classical Item and Test Analysis with CITAS. Minnesota: Assessment Systems Corporation.

Yusoff MSB, Ahmad FAR, Mohd JY.(2009). The Sensitivity, Specificity And Reliability of The Malay Version 12-Items General Health Questionnaire (GHQ-12) In Detecting Distressed Medical Students

## THE IMPACT OF KNOWLEDGE AND ATTITUDE TOWARD GREEN COSMETIC PURCHASE DECISION

**Lina and Devinta Fulvia Alvianji**

*Management;Economic;STIE Musi*  
[natayalina@yahoo.com](mailto:natayalina@yahoo.com).

### ABSTRACT

Environmental and health problems that are directly and indirectly caused by human activity, has become a central issue in the world. Concern and awareness of the environment and health, has changed the perspective and lifestyle of the teenagers especially to use green cosmetics. Teenagers' hardly realized the relation of the ingredients of the cosmetics to the health of their skin. Green cosmetics were made to prevent the bad impacts caused by chemical ingredients contained in the cosmetics. These chemical ingredients can cause some reactions on the teenagers' skin which could make some long-term damage towards the skin. The purpose of this paper is to examine the impact of knowledge and attitudes of female teenagers to green cosmetic purchasing decisions in terms of environmentally friendly products are Puteri Cosmetic from PT. Mustika Ratu, Tbk. Data collection method used was a survey by distributing questionnaires consisting of close and open ended questions. The population is female teenagers (age between 15-18 year), who lives in Palembang city. The sample was selected non randomly using purposive sampling technique. The data analysis techniques used in this study consist of regression analysis to examine the impact of quantitative data in each of the independent variables on dependent variable. The results show that knowledge variable and attitudes, has an influence on purchasing decisions on green cosmetics. On the test results shows that the coefficient of determination adjusted R square of 0.151, which means 15.1% purchase decision variable may be influenced by consumer knowledge and consumer attitudes.

**Keywords:** *knowledge, attitude, purchase decision*

### INTRODUCTION

Business and Consumers today confront of the biggest challenges to protect and preserve the earth's resources and the environment. They have become more concerned with the natural environment and are realizing that their production and consumption purchasing behavior will have direct impact on the environment (Gan et al., 2008). In Addition the great majority of our problems (for example: excess garbage, pollution, waste of energy and mineral, etc.) are the result of consumers' consumptive behaviors.

According to McCarty and Shrum (2001), people engage in environmental behavior as a result of their desire to solve environmental behavior as a result of their desire to solve environmental problem, to become role models and a belief that they can help to preserve the environment. However, the consumers' indications of positive attitude towards environmental issues do not necessarily to actual environmentally friendly purchasing behavior (Laroche et al., 2002).

Nowadays, consumers are becoming more educated about their environmental

responsibility and have more willingness to choose a green product. The consumers and product is the challenge of every business and meeting customer needs is a motive of good manufacturing practice. In order to meet the consumers' needs and wants for a product to be acceptable to consumers, quality and cost of product, the product's performance and even environmental issues should be considered (Zakersalehi and Zakersalehi, 2012).

Indonesia, like many other developing countries, in the early days of abundant resources and minimal development pressures, little attention was paid to growing environment protection and conservation. In so far as green product is concerned, it is a very new concept in Indonesia. As of today there has been no empirical research on Indonesians knowledge and attitudes to purchase decision toward green cosmetic for female teenagers subsequently the aim of this research would be toward this issue.

The research shall be focused to the organic cosmetics. These organic cosmetics are also called green cosmetics and bio cosmetics. Eco cert (2003) says, "Bio cosmetics or green cosmetics are considered as cosmetics with a level of superior demand compared to the conventional regulation of cosmetic products. It guarantees environmental conservation all along the production line, consumer's respect and utilization of natural matter with superior ecological quality."

The remainder of this paper is organized as follows. Section 1 introduction; Section 2

review literatures; Section 3 describes the methods research employed; The result and their implication are discussed in section 4; Section 5 provides the conclusions.

## REVIEW LITERATURES

### Consumer Knowledge (CK)

According to Nitisusastro, 2012, Consumer knowledge is the level of knowledge of consumer knowledge, understanding, and confidence of consumers on a product that will affect the consumer in making a purchase. Consumers need to know about the characteristics of the product because when consumers are less informed about the characteristics of a product, he/she can be wrong in making purchasing decisions. Consumer knowledge consist of three types:

#### 1. Knowledge of the characteristics

A product is not different from the other that has certain traits or commonly referred to as character. Character of a product consists of: size, model, color, and scent.

#### 2. Knowledge of the benefits

Consumer needs to know and understand about the benefits inherent in every product purchased, because they will make careful consideration before making a decision to buy or not buy.

#### 3. Knowledge of risk

The degree of risk that consumers perceive and their own tolerance for risk taking are

factors that influence their purchase strategies. The major types of risks that consumers perceive when making product decisions include functional risk, physical risk, financial risk, social risk, psychological risk, and time risk.

### **Attitude (A)**

According to Schiffman and Kanuk, 2007, an attitude is a learned predisposition to behave in a consistently favorable or unfavorable way with respect to a given object. Each part of this definition describes an important property of an attitude and is critical to understanding the role of attitudes in consumer behavior. According to the tricomponent attitude model, attitudes consist of three major components, they are:

1. The cognitive component, is the knowledge and perceptions that are acquired by a combination of direct experience with the attitude object and related information from various sources. This knowledge and resulting perceptions commonly take the form of beliefs, that is the consumer believes that the attitude object possesses various attributes and that specific behavior will lead to specific outcomes.

#### 2. The affective component

A consumer's emotions or feelings about a particular product or brand constitute the affective component of an attitude. These emotions and feelings are frequently treated by consumer researchers as primarily evaluative in nature.

#### 3. The conative component

Conation, the final component of the tricomponent attitude model, is concerned with the likelihood or tendency that an individual will undertake a specific action or behave in a particular way with regard to the attitude object. According to some interpretations, the conative component may include the actual behavior itself.

In marketing and consumer research the conative component is frequently treated as an expression of the consumer's intention to buy.

According to Schiffman and Kanuk, 2007, there are four basic motivational function:

1. Benefit function, we have a certain attitude towards the product in part because of the influence of the brand. If a certain product is useful or helped us in the past, our attitude to it tend. Attitude towards one particular product is to show people that these products can meet the objectives of benefits that may not have occurred to them.
2. Function of ego defense, most people want to protect their self-image of the feelings of self-doubt in their uncertainty they want to deal with a sense of security and confidence.
3. Function value statements, statements or attitudes are a reflection of the values, lifestyles, and the general view of consumers.
4. Knowledge function, the individual usually has a strong need to know and understand the people or things that relate to them. Most knowledge of the product and brand

positioning is an attempt to satisfy the need to know and to improve consumer attitudes towards brands by emphasizing various advantages compared various brands of competitors.

### **Purchase Decision (PD)**

It is important to remember that not all consumer decision situations receive (or require) the same degree of information search. If all purchase decisions required extensive effort, consumer decision making would be an exhausting process that left a little time for anything else. On the other hand, if all purchases were routine, they would tend to be monotonous and would provide little pleasure or novelty. On a continuum of effort ranging from very high to very low, we can distinguish three specific levels of consumer decision making: extensive problem solving, limited problem solving and routinized response behavior.

There are five stages of the process component of decision making model: need recognition, prepurchase search, evaluation of alternatives, purchase behavior, postpurchase evaluation.

The explanation is as follows:

#### **a. Need recognition**

The recognition of a need is likely to occur when a consumer is faced with a problem. Among consumers, there seem to be two different problem recognition styles. Some consumers are actual state types, who perceive that they have a problem when a product fails

o perform satisfactorily. In contrast, other consumers are desired state types, for whom the desire for something new may trigger the decision process.

#### **b. Prepurchase search**

Prepurchase search begins when a consumer perceives a need that might be satisfied by the purchase and consumption of a product. A consumer who senses a need for information on which to base a choice is in this stage. The recollection of past experiences might provide the consumer with adequate information to make a present choice. On the other hand, if the consumer has had no prior experience, he or she may have to engage in extensive search of the outside environment for useful information on which to base choice. Consumers can obtain information from several sources: resource person (family, friends, colleagues, neighbors), commercial sources (advertising, sales force, website, channel, packaging, display), source of the public (the mass media, consumer rating organizations), sources experience (handling, inspection, and use of the product). Negative influence of these information sources varies according to the product and its buyers. In general, the consumer receives the most information about a product from commercial sources are controlled by marketers, but the source is the most effective source of personal, private sources seem to be more important in influencing the purchase of services, usually commercial sources tell the buyer, but

personal sources justify and evaluate product for the buyer.

#### c. Evaluation of alternatives

When evaluating potentials alternatives, consumers tend to use two types of information: the evoked set and the criteria they will use to evaluate each brand. As indicated earlier, the evoked set is generally only a part a subset of all the brands of which the consumer is aware, These brands, in turn, frequently are only a portion of all the brands in the market. Making a selection from a sample of all possible brands is a human characteristic that helps simplify the decision making process.

#### d. Purchase behavior

Consumer makes two types of purchases: trial purchases and repeat purchases. If a consumer purchases a product or a brand for the first time and buys a smaller quantity than usual, this purchase would be considered a trial. Thus, a trial is the exploratory phase of purchase behavior in which consumers attempt to evaluate a product through direct use. If a new brand in an established product category is found by trial to be more satisfactory or better than the other brands, consumers are likely to repeat the purchase.

#### e. Post-purchase behavior

As consumers use a product, particularly during a trial purchase, they evaluate its performance in light of their own expectations. There are three possible outcomes of these

evaluation: 1) actual performance matches expectations, leading to a neutral feeling; 2) performance exceeds expectations, causing what is known as positive disconfirmation (which leads to satisfaction); and 3) performance is below expectations, causing negative disconfirmation and dissatisfaction. An important component of postpurchase evaluation is the reduction of uncertainty or doubt that consumer might have had about the selection.

### **Green Marketing and Green Cosmetic**

Polonsky, 1994, defines green marketing as, set of all the activities designed to generate and facilitate any exchange intended to satisfy human needs or wants, such that the satisfaction of these needs and wants occurs, with minimal detrimental impact on the natural environment. The growing awareness and rising concern towards health and environment is gradually shifting the consumption pattern towards eco-friendly products. The eco-friendly products as the marketers claim have minimum detrimental effect on the environment. Studies show that there is an increasing demand for organic products against the cheap, convenient and seemingly more effective chemical or the conventional products. (Kumar, 2011).

"Organic cosmetic market," (2008) reports, that the consumers have started using organic cosmetics because they have realized that organic cosmetics provide them with better health treatments. Cosmetics have been used



since the beginning of human civilization, Cohen, 1999.

On one hand, pro environmental attitude is gaining pace but on the other hand, there are various bottlenecks too associated with the marketing of organic products. Nielsen, 2007, reports, that many of the early products designed to be environmentally responsible, such as electric cars and recycled paper, disappointed the consumers. Therefore, its difficult now to convince the consumers that what is being offered now is actually green and are worth higher prices. In their search for guidance on consumption choices, people trust each other more than any other source of information.

## **RESEARCH METHODS**

### **Type of Research and Population**

Based on the type of data, this study is a survey research that the researcher distributed questionnaires directly to the intended respondents. According to Sugiyono, 2010, population is a region consisting of generalization objects or subjects that have certain qualities and characteristics are determined by investigators to be studied and then drawn conclusions. In this study, the population are the consumer of PT. Mustika Ratu, Tbk. (all consumers who use cosmetics).

### **Sample**

Number of sample used are 100 people. According to Arikunto, 1998, those number are representative enough in terms of

representing all features and characteristics population possessed. Based on that consideration, we are using purposive simple sampling for this research sampling method. The way sample are taken not based on strata or random but based on specific purpose. This is because the limitation of time, effort and cost.

### **Data Analysis**

We analyze data in this research by using two kinds of analysis techniques appropriate to the objectives to be achieved:

#### **1. Quantitative Analysis Techniques**

Quantitative analysis is a method of analysis with the numbers that can be calculated or measured. Quantitative analysis is intended to quantitatively estimate the magnitude of the effect of changes in one or several other events by using statistical analysis tools. Using SPSS (Statistical Package for social science) for windows 17, the analysis used to test the hypotheses that have been put forward. Processing the data with quantitative analysis through several stages, they are validity test, reliability test, tabulation frequency, and regression test.

#### **2. Qualitative Analysis Techniques**

Qualitative analysis is an analytical method of research that is a description or explanation. This analysis is used to determine the respondents regarding statements contained in the questionnaire where the respondent's answers will be measured using a Likert scale.

## Research Framework

A conceptual framework on knowledge and attitude of green cosmetic developed by Aman et al, 2012, was adopted in this study. For the purpose of this study, Aman et al, 2012 was modified by removing environmental concern and changing green purchase intention in to purchase decision and changing attitude as a mediating in to independent variable because of the time constraint due to the nature of this study. It is noted that Aman et al, 2012 study was a cross sectional study. The conceptualization of the modified framework relating to the green cosmetic. Figure 1 shows a research frame work.

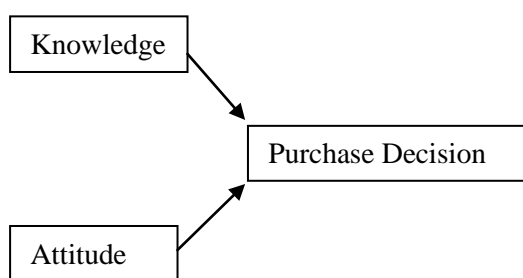

**Figure 1.** Research Framework

## RESULTS AND DISCUSSION

### Respondents' Demographic Analysis

There were 100 respondents of the questionnaire that all indicates their demographics.

**Table 1.** Respondents' Demographic

Characteristics		Percentage (%)
Age	15-16	61
	16.1-17	22
	17.1-18	17
	>18	0
Total		100
Education	Junior High School	23
	Senior High School	66
	Diploma	10
	Others	1
Total		100
Occupation	Student	87
	Entrepreneur	12
	Employee	1
	Others	0
Total		100

Before we analyze data, first of all, we must perform validity test and reliability test. Therefore we continue using regression analysis with SPSS. The goal of using this method is to know the effect of independent variable toward the dependent variable. Result of regression counted can be used to predict value of dependent variable when value of dependent variable determined. Regression analysis used in this research are multiple regression equation, F test (simultaneously) and F test (partially). The results are as shown below.

**Table 2.** Validity Test and Mean

Code	R	r table	Valid	Mean
CK1	0.819	0.196	Valid	3.85
CK2	0.897	0.196	Valid	3.80
CK3	0.762	0.196	Valid	4.25
A1	0.549	0.196	Valid	3.79
A2	0.527	0.196	Valid	4.03
A3	0.700	0.196	Valid	4.16
A4	0.802	0.196	Valid	4.21

PD1	0.726	0.196	Valid	4.42
PD2	0.388	0.196	Valid	4.06
PD3	0.634	0.196	Valid	4.05
PD4	0.646	0.196	Valid	4.28
PD5	0.642	0.196	Valid	4.32

Result of validity test for the consumer knowledge questionnaire are 3 items, attitude are 4 items and purchase decision are 5 items. After we test the validity with product moment correlation, we get that all correlation ( $r$ ) >  $r$  table (0.196). From those numbers, we can conclude that questionnaire for all variable are valid.

Using reliability test for the questionnaire, we get the value of cronbach alpha > 0.6. This number also proved that all the variable are reliable. Detail information can be seen in the following table.

**Table 3.** Reliability Test

	Cronbach alpha	Alpha standard	
Consumer Knowledge	0.894	0.6	Reliable
Attitude	0.857	0.6	Reliable
Purchase Decision	0.786	0.6	Reliable

In this study, regression analysis is used to provide pattern of relationship between the set of independent variables (consumer knowledge and attitude) and independent variable (green cosmetic purchase decision).

If we want to know consumer knowledge and attitude contribution toward green cosmetic purchase decision, we can look in table 4 below for the value of adjusted R square =

0.151 (15.1%). It means that consumer knowledge and attitude contribute 15.1% toward green cosmetic purchase decision. While 84.9% rest contributed by other variable unmentioned in this research.

**Table 4.** Regression Test

Model	R	R Square	Adjusted R Square	Std. Error of the Estimate
1	.410 <sup>a</sup>	.168	.151	2.168

Based on the result of multiple linear regression analysis with SPSS program, the equation is shown as below:

$$Y = 10.436 + 0.262X_1 + 0.182X_2 + e$$

Based on multiple linear regression analysis above, we can conclude that the biggest regression coefficient is consumer knowledge for 0.262. With the reality, the conclusion is the most dominant variable based on multiple linear regression analysis is consumer knowledge variable.

Based on table 5 below, here are the conclusions for the test:

1. The result shows that there is a significant effect between consumer knowledge ( $X_1$ ) toward green cosmetic purchase decision ( $Y$ ). It is proved with  $t$  value = 2.411 with sig 0.18. It means that consumer knowledge can be used as a basis to predict green cosmetic purchase decision. So, we assumed that there is a significant effect between consumer knowledge ( $X_1$ ) toward

green cosmetic purchase decision (Y) is accepted supported by data given.

2. The result shows that there is a significant effect between attitude (X2) toward green cosmetic purchase decision (Y). It is proved with t value = 3.716 with sig 0.00. It means that attitude can be used as a basis to predict green cosmetic purchase decision. So, we assumed that there is a significant effect between attitude (X2) toward green cosmetic purchase decision (Y) is accepted supported by data given.

**Table 5.** T Test

Model	Unstandardized Coefficients		Coefficients Beta	T	Sig.
	B	Std. Error			
1 (Constant)	10.436	2.245		4.648	.000
Total CK	.262	.109	.223	2.411	.018
Total A	.182	.049	.344	3.716	.000

The F test also known as simultaneously hypothesis test. Result from this test can be seen in the table below:

**Table 6.** F Test

Model	Sum of Squares	Df	Mean Square	F	Sig.
1 Regression	92.279	2	46.140	9.818	.000 <sup>a</sup>
Residual	455.831	97	4.699		
Total	548.110	99			

## CONCLUSIONS

1. Research result shows that consumer knowledge and attitude simultaneously has

a significant effect toward green cosmetic purchase decision.

2. Research result shows that there is a significant effect between consumer knowledge toward green cosmetic purchase decision. It means that consumer knowledge can be used as a basis to predict green cosmetic purchase decision.
3. Research result shows that there is a significant effect between attitude toward green cosmetic purchase decision. It means that attitude can be used as a basis to predict green cosmetic purchase decision.
4. Consumer knowledge and attitude contribution toward green cosmetic purchase decision conclude with value of adjusted R square = 15.1%. It means that consumer knowledge and attitude contribute 15.1% toward green cosmetic purchase decision. While 84.9% rest contributed by other variable unmentioned in this research.

## IMPLICATIONS AND LIMITATIONS

This research has provided both theoretical and managerial implication.

In terms of theoretical implication, this research adds support to previous research which showed that consumers purchase decision is relatively influenced by knowledge and attitude. In addition, this research offers a theoretical basis for understanding the impact of knowledge and attitude towards green cosmetics purchase decision.

In terms of managerial implication, the marketers need to make sure that their products are of high quality and competitively priced. The marketers also need to adopt a better marketing mix strategy for their products in order to change consumers' negative perception towards green cosmetics. Successfully green marketing entails much more than simply adding an environmental attribute into a product. It is important that marketers integrate green marketing strategies carefully into the company strategic plan.

While this study provides some important contributions to the green marketing theory and for green marketers, there are also limitations and future research agenda.

Firstly, the sample used in this research was not equally distributed since majority of respondents are female teenagers. The research findings may not be generalized to the entire population. Future studies should use samples which are equally distributed so that more insightful conclusions could be drawn. It would also be interesting to conduct metrosexual studies.

Secondly, the survey has used close and open questions, which may have influenced the answer of the constructs. Future studies should add close questions to each construct to get the real answer.

## REFERENCES

Arikunto, Suharsimi. 1998. *Prosedur Penelitian*. Bina Cipta. Jakarta

Gan, Christopher. Han Yen Wee. Lucie Ozanne. Tzu Hui Kao. 2008. Consumers' Purchasing Behavior Towards Green Product in New Zealand. *Innovative Marketing*. Vol. 4. Issue 1. 93-102.

Kotler, Philip. and Gary Armstrong. 2009. *Prinsip-prinsip Pemasaran*. Erlangga. Jakarta.

Kumar D. Kumar I. Rahman Z. Yadav S. and Goyal P. (2011). Green Marketing Mix: Rethinking Competitive Advantage during Climate Change. *The First International Conference on Interdisciplinary Research and Development*, 31 May - 1 June 2011, Thailand

Laroche, M. Bergeron. J. Tomiul. M, and Barbaro Forleo G. 2002. Cultural Differences in Environmental Knowledge, Attitudes and Behaviors of Canadian Consumers. *Canadian Journal of Administrative Sciences*. 19. (3). 267-283.

McCarty, J. A. and Shrum, L. J. 2001. The influence of Individualism, Collectivism and Locus of Control of Environmental Beliefs and Behavior. *Journal of Public Policy and Marketing*. 20 (1). 93-104.

Mindy Cohen, (1999). *Cosmetics and Perfumes, Egypt, 10,000 BCE*. [http://www.smith.edu/hsc/museum/ancient\\_inventions/hsc01b.htm](http://www.smith.edu/hsc/museum/ancient_inventions/hsc01b.htm) as written by Ty Narada for Dr. Kosso retrieved on 18th Oct 11

Nielsen (2007). Trust in Advertising. *A global Nielsen consumer report*, 2007

*Organic cosmetic market*. (2008). Retrieved on 6th of July.

Polonsky, Michael Jay (1994), "An Introduction to Green Marketing," *Electronic Green Journal*, 1(2), UCLA Library, UC Los Angeles at <http://escholarship.org/uc/item/49n325b7>, pp2.

Schiffman, Leon G. and Leslie Lazar Kanuk.  
2007. *Perilaku Konsumen*. Prentice  
Hall. Inc. New Jersey.

# **MOTHER'S PERCEPTION OF THE OPERATING SYSTEM, PRODUCT ATTRIBUTES AND THE DECISION MAKING PROCESS TO BUY GREEN PRODUCT**

**Anastasia Posmaria Setiaswi Sitohang and Agustine Eva Maria Soekesi**

Management Department, Faculty of Economics and Business, Soegijapranata Catholic University, Semarang, Indonesia  
[posmariasetiasiwisitohang@gmail.com](mailto:posmariasetiasiwisitohang@gmail.com)

## **ABSTRACT**

In this decade, fast growing business or company has to integrate its operation or production system with the marketing function. From the beginning process until the product is made, the company needs to pay attention to the customers; both the intermediaries and also the end user; as the external parties that marketing efforts are directed.(Heizer,2008). It shows that consumers have a very important role that could influence on the managerial policy from overall management to product itself. Consumer could determine what companies should make the products because consumers dictate companies to fulfill their needs and wants. When consumer cares about the environment then this will encourage industry players to conduct the operation system with respect to the environment problems. The business will also cares about how they will produce the goods or services without ruining the balance of nature. In term of gender; there is an opinion that woman is more price sensitive. Public domain states that to gain the product with same characteristic or quality, woman tends to try harder to find cheaper things than man. A published research ([www.emarketergreen.com](http://www.emarketergreen.com)) said that woman tend to choose product that has lower variable cost although its price is high. This research is conducted to find what mother's/housewives perception of the operating system, product attributes and the decision making process to buy green product. Respondents are distinguished based on four categories such as: (1) income; (2) education; (3) occupation; (4) amount of her children. Regarding to these categories, income is the only one category that could become the differentiator factor to distinguish the mother's perception. Mothers that have income have less complexity to decide in buying green product comparing to mothers that have no income.

**Keywords:** *greenproduct, housewife, operating system, product attributes, decision making*

## **INTRODUCTION**

In the recent years we can feel that the air temperature is warmer. BMKG report states that the average temperature during the day increased by 1 degree Celsius. Temperature increase is not only caused by sunlight and the greenhouse effect but humans contributed to the rise in air temperature. Human behavior linked to industrial activity, communication and transportation activity and an increase in population led to global warming. (Boer, Head of Laboratory of Climatology, Department of

Geophysics and Meteorology, Faculty of Mathematics and Natural Sciences, Bogor Agricultural University, 2010).

Human as the highest creation of God has an important role in maintaining the earth and the environment. Humans have the power to transform the earth and everything in it, from simple patterns to a form of modern life as it is today. Unfortunately, people often do not carry a balance between improved quality of life with the preservation of natural resources.

Exploitation is done to only add prosperity but does not consider the environmental damage it causes. Many progresses that has been achieved by humans had a bad impact on environmental sustainability.(Fandi, afand.abatasa.com,2011)

People should use natural resources to meet their needs. Industries are built by utilizing natural resources intended for human well-being in the present and especially the future. In its potential, natural resources processing in industrial activities of agriculture, forestry, mineral, marine and other business sectors business ventures. The natural resources are the raw materials for industry. (Ginting,2007).

In its development business world increasingly stringent trigger products that use more driven by the desire and not out of necessity. It is that impact the exploitation of natural resources and excessive production processes that are less concerned about the environmental balance. When considering only the commercial aspects of the industry alone would be an adverse impact to the environment and the balance of nature.

Consumers can support the preservation of the environment by consuming products that are environmentally friendly.

Operating system in integrated industry has to take notice with consumer (end users and intermediate users) as the final market. (Heizer,2008). It means that consumer has a major influence to business policy such as product policy, production process, material

requirement planning and supplier determination. When consumer awares to environmental sustainability; it would encourage producer to care of natural balance.

In household context, there is a tendency to be practical and instant. Housewife tend to use the electrical equipment to make things easier. Almost all of the household in big city and also suburban area use electrical equipment in their daily life such as washing, cooking, lighting, getting knowledge and entertainment. It would make more usage of electricity.

There is also a trend to use plastic in daily usage; such as wrapping food, household equipment, and so on. As we know, plastics could not be decomposed for many years. And even plastic can be decomposed in almost one hundred years but it is still a polutan for this nature.

People need to move to other place and transportation is needed to fulfill this need. Today, housing area is quiet far from other area. It would make a lot more fuel consumption.

Prasurvey conducted by researcher (2011) shows that electrical equipment is used both by housewife and working housewife. It could be meant that housewife has a huge role to determine or to choose which kind of electrical equipment they will use.

As stated by Ginty,Molly (2006) that woman especially housewife has influence in buying green product. Housewife could become an agent to influence their community, started



from their family. By doing this research, researchers want to know what is the housewife's perception of the operating system, product attributes and the decision making process to buy green product; distinguished by their : (1) income; (2) education; (3) occupation; (4) amount of her children.

## HYPOTHESES

H1: There is a mean difference in perception of green operating system; product attribute; and decision making between housewife and working housewife based on their income.

H2: There is a mean difference in perception of green operating system; product attribute; and decision making between housewife and working housewife based on their education level.

H3 : There is a mean difference in perception of green operating system; product attribute; and decision making between housewife and working housewife based on their occupation.

H4: There is a mean difference in perception of green operating system; product attribute; and decision making between housewife and working housewife based on their amount of children

## RESULTS AND DISCUSSION

This research took 90 respondents to be observed. They had to fill some question that would explore their perception of operating system; product attribute; and decision making

to buy green product. In education perspective, for the most part of housewife - 51.1 percent – are graduate from senior high school. About working housewife; there are 35.6 percent of working housewife had a bachelor degree. Based on amount of children, working housewife has more children than housewife. Products purchased by housewife and working housewife can be seen as follows :

Table 1  
Percentage Green Products Purchased  
(in percent)

Products	Working Housewife	Housewife
Food	100	100
Beverage	100	100
Groceries	42.2	46.7
Cosmetics	11.1	13.3
Detergent	4.4	4.4
Soap	2.2	4.4

Source : data processed

## Result 1

Perception of green operating system; product attribute; and decision making between housewife and working housewife based on their income found as follows :

Figure 1

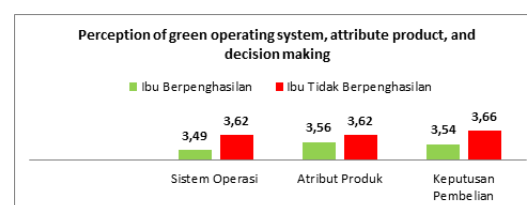

Using SPSS tools; there is a significance result (significance = 0.03) for mean difference between housewife and working housewife in perception of green operating system. It is also found that there is a significance result

(significance = 0.003) for mean difference between housewife and working housewife in perception of decision making to buy green product. But there is no significance level (significance = 0.35) for mean difference between housewife and working housewife in perception of green product attribute. Housewife gives higher valuation that working housewife.

**Result 2**

Perception of green operating system; product attribute; and decision making between housewife and working housewife based on their education found as seen on Figure 2. Using SPSS tools; there is a significance result (significance = 0.04) for mean difference between housewife and working housewife in perception of green operating system. But there is no significance level (significance = 0.35) for mean difference between housewife and working housewife in perception of green product attribute. It is also happened for mean difference between housewife and working housewife in perception of decision making. Bachelor mother gives higher valuation than other educated mother.

Figure 2

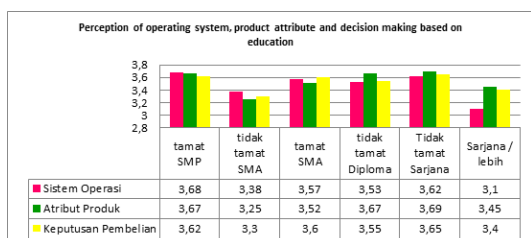

**Result 3**

Perception of green operating system; product attribute; and decision making between

housewife and working housewife based on occupation found as follows :

Figure 3

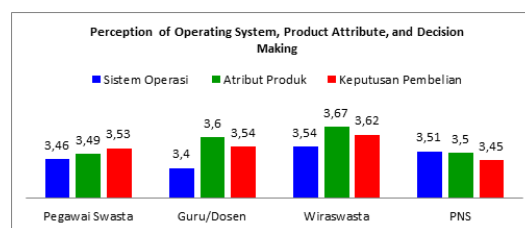

Using SPSS tools; there is no significance result (significance > 0.05) for mean difference between housewife and working housewife in perception for all green variables ( operating system; product attribute; and decision making ).

**Result 4**

Perception of green operating system; product attribute; and decision making between housewife and working housewife based on their amount of children found as follows :

Figure 4

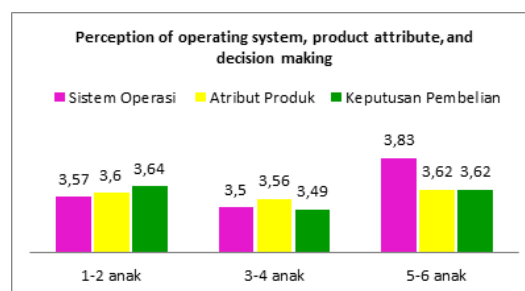

Using SPSS tools; there is no significance result (significance > 0.05) for mean difference between housewife and working housewife in perception for all green variables ( operating system; product attribute; and decision making ).

**CONCLUSION**

Mother's perception of the variable operating system, product attributes, and product

purchasing decisions that are environmentally friendly takes to conclusion as follows: mother has an average approval rate of the strongest in the purchase decision making variable (3.60) than the variable of product attributes (3.59) and the operating system (3,53). Implication of this finding is marketer should convince mother to consider buying environment-friendly products when they want to buy daily use product. Researcher found that housewife who has high school education has more attention to the consumption of eco-friendly products that are used in their household. Thus marketer that intends to promote and campaign for their products that are eco-friendly products can use this group as an endorser (booster) for the group of other group of mothers. Through this group; marketer could expect that the process of diffusion campaigns of environmentally friendly products by word of mouth is quite effective.

## REFERENCES

- Astra International, Tbk : Environment, Health, and Safety Divison (2002); GREEN COMPANY : Pedoman Pengelolaan Lingkungan, Keselamatan dan Kesehatan Kerja (LK3)
- Fandi, 2011, Pengertian Lingkungan, [www.afand.abatasa.com](http://www.afand.abatasa.com)
- Ginting, Perdana (2007), Sistem Pengelolaan Lingkungan dan Limbah Industri, Yrama Widya, Bandung.
- Ginty, Molly. M (19 Juni 2006), Women at Center of Consumer Eco-Push. WeNews Correspondent, [www.womennews.org](http://www.womennews.org) (diakses 3 Maret 2010)
- Heizer, Jay and Barry Render, 2008, Operation Management, Pearson International Edition.
- Kotler Phillip dan Keller, Kevin Lane (2007) Manajemen Pemasaran Jilid I edisi 12, Macanan Jaya Cemerlang
- Santoso, Singgih, 2001, Statistik Non Parametrik, Elex Media Komputindo, Jakarta
- Wada, Yoshi-Nori, The Choice of Regulatory Instruments of Eco-Product Differentiation, [www.rcwob.doshisha.ac.jp](http://www.rcwob.doshisha.ac.jp), (diakses 3 Maret 2010)
- Be Responsible, Start With Eco Products That Are Good For People And The Environment. [www.ecoproduct.org](http://www.ecoproduct.org) (diakses 3 Maret 2010)
- Buying Eco Friendly Products Cheap - Where to Buy & Reviews. [www.ecofriendlyproductscheap.com](http://www.ecofriendlyproductscheap.com); diakses 3 Maret 2010
- Eco-labels impact Consumer Behavior, [www.marketinggreen.wordpress.com](http://www.marketinggreen.wordpress.com) (diakses 3 Maret 2010)

# THE INEVITABILITY OF VULNERABLE ROAD NETWORK IN URBAN AND REGIONAL PLANNING AND DEVELOPMENT

**FX Pranoto Dirhan Putra**

Department of Civil Engineering, Atma Jaya Yogyakarta University  
[noto@mail.uajy.ac.id](mailto:noto@mail.uajy.ac.id)

## ABSTRACT

This paper discusses the importance of the worst scenario of road network system in order to minimize the impact of urban and regional planning and development. Road network system, then, may become vulnerable to disasters or unexpected events such as flood, fire, volcano eruption, pollutions, accidents, structural failure and other environmental degradation. This study focuses on evacuation route on networks in which selected roads may be acted as temporary shelter or collecting people for safety in worst condition. Network, therefore, comes to be indispensable in response to planning and development. The aim is to gain understanding whether planning and development can affect vulnerability of road network. The objective is to determine kind of suggestions for a better network system that cope with what people need in worst situations. Data were collected from some published sources. Then, the worst scenarios can be proposed for future planning and development so as to reduce disaster risks. It can be concluded from this study that most of roads in selected cities are vulnerable to disasters or unexpected events. It is because development of buildings and infrastructures were based on occupancy and traffic capacity rather than the worst scenario in unanticipated occasions. For that reason, this study suggests that road network system should be improved and should be integrated into disaster management program to reduce vulnerability to disasters. This can also be used for learning the influence of housing and infrastructure growth to road network vulnerability.

**Keywords:** *disaster, planning, road network, unexpected event, vulnerable*

## INTRODUCTION

Growing network theory was considered as the basis of dynamic urban development (Masanobu & Kenji, 2012). In addition, regional-based approach of urban management has become more important for growing cities (Srivastava, et al, 2012). This means that infrastructure-based approach is less popular by now. Furthermore, projection shows that developing regions are probably generated by most of megacities in 2100 (Masanobu & Kenji, 2012). So, growing cities in which show rising networks clearly point out

increasing complexities indicated by various theory to approach numerous cases.

However, do they think through the impact of growing network linked to disasters or unexpected occasions? In this context, growing network associated growing cities may produce its own disasters beside natural disasters. Evidence shows that growing networks may have reduced the quality of life and sustainable development (Masanobu & Kenji, 2012). Other evidences also show that most of networks could not provide a route for people to escape; even, there was traffic

congestion (Wolshon, 2002). In other words, do we create vulnerable road network that may affect the product of urban and regional planning and development?

## **POLICY ISSUES**

Urban development has been substantially affected by transport policies (Masanobu & Kenji, 2012). In this perspective, communication and relationship between regulator agency and its inhabitants plays a key role to the success of policies (Carter, et al, 2013). In relation to this, various policies have been made in respond to the growing population and economy such as national strategies on road planning (Indonesian Government, 2007).

Conversely, more policy makers and researchers argued that many more people are living on vulnerable cities related to network (BNPB, 2009). For example, they are disaster preparedness on emergency evacuation (Access Board, 2005), emergency response planning (APTA, 2001), tsunami emergency planning (Australian Government, 2010), regional evacuation planning (BDR, 2009), road vulnerability (Berdica, 2002), urban vulnerability (Bhattarai & Conway, 2010), planning for the evacuation of New Orleans (Wolshon, 2002), national disaster resilience statement (COAG, 2009), routes for evacuation planning (FHWA, 2009), impacts of disasters on highway (Giuliano & Golog, 1998), implementation of disaster management (Indonesian Government, 2007), Shouthern Lousiana hurricane evacuation and sheltering

plan (Lousiana Local Government, 2000), vulnerability of network infrastructure to disruption (Matisziw et al, 2008), transportation in emergencies (Milligan, 2007), evacuation planning (Schwartz & Litman, 2008), networks link under flood (Sohn, 2006), disaster management and road network (Solberg et al, 2003), vulnerability of strategic road network (Taylor et al, 2006) and the role of transit in emergency evacuation (TRB, 2008). These implied that road networks development might have affected vulnerability to disasters or unexpected occasions. Therefore, these findings and policies have conscious effort to reduce the impact of disasters or unexpected events.

Simply, networks as the product of growing cities and population might have produced the increasing of their vulnerability to disruption. Otherwise, integrated policies on planning and development program have anticipated the threat of hazards.

## **LEARNING FROM EXPERIENCES**

Hazards have threatened many cities as a consequence of their sites where located near natural hazards or their people's activities (BNPB, 2009). In this case, disaster occasions occurred in Yogyakarta and New Orleans are shortly discussed just to show network vulnerability.

First, Yogyakarta is located at Southern Central Java with 32.5 km<sup>2</sup> of area and 388,000 populations (BPS, 2010). Hazards, for instance, occurred in this area were volcano

eruption in 2010 and earthquake in 2006 (BNPB, 2009). Volcano is located approximately 25 km from the city center and earthquake center is about 35 km to southern site. Housing development grew rapidly since 1995 in northern area. Question is then “could the growing network provide space for people to be evacuated in disaster event?” Evidence revealed that network system failed to deliver evacuation route; for instance, there was traffic jam in most of roads when the volcano erupted in 2010 (BNPB, 2009). It can be implied that networks in this region are vulnerable to disasters. Is this the impact of urban and regional planning and development that lagged behind the worst conditions?

Second, New Orleans is the poorest city in the U.S. with a 23.2 percent poverty rate in 2000 (Dreier, 2012). Population in this region was 627,525 in 1960 and declined to 462,269 in 2004 (Dreier, 2012). In 2005, the enormous hurricane hit this area and caused the damage of more than 50,000 houses (out of 180,000) (Dreier, 2012). For victims, despite networks had been developed, they were unsuccessful to carry people to safer place when the disaster came (Renne et al, 2008). Again, networks failed to protect people from disaster.

## **DISCUSSION**

In modern word, growing population has been influenced the growing of cities and their networks (Masanobu & Kenji, 2012). These networks must be developed in parallel way to what people’s requirement. This growth also

noticeably stimulated the improvement of urban and regional planning and development.

However, worst conditions of unexpected occurrence were less highlighted in planning and development. Therefore, network systems become more vulnerable to disaster because they could not make evacuation route available on the existing roads in disaster events. They were unsuccessful to provide alternative routes. From few examples above, it can be argued that networks are important to reduce disaster risks.

Unfortunately, we are living on vulnerable network system because most of cities have been designed for economic reasons rather than worst conditions. As well, traffic characteristics dominated most of the products of planning and development.

In theory, network planning can be initially put into words by recognizing hazards that may threats it’s surrounding. From this, worst scenario may be a priority option for best result connected to disaster risk reduction.

In fact, road network is ominous complex to be planned and, further, implemented (Berdica, 2002, Bhattara & Conway, 2010, Matisziw et al, 2008). Therefore, in this case, no single solution or suggestion can be proposed to diminish road network vulnerability. In spite of the fact that most of policy makers and community agree that network vulnerability must be reduced, regulators considerably faced some

limitations, such as cost, economy, laws, culture and social relationships.

So, is it late to go forward for vulnerable cities? The answer depends on how we appreciate threats of hazards. Nevertheless, we must aware with vulnerable networks surrounded us.

## CONCLUSIONS

1. As population growth, cities related to road networks have grown and have generated into urban. This has stimulated the development of urban and regional planning.
2. Network developments were dominated by economic and traffic reasons rather than reducing vulnerability.
3. As case study, networks in selected roads are vulnerable to disaster. This study also finds that networks failed to provide alternative emergency evacuation route.
4. Authorities and communities have come to term with the importance of disaster risk reduction. Therefore, it reflects that the growth of cities must be controlled to ensure that they provide emergency response.
5. Redesign vulnerable networks faces some limitations that tends to difficult to be implemented.
6. The worst scenario for planning and development of networks may reduce vulnerability to disasters or unexpected events.

As suggestion, road networks planning and development should be integrated into disaster management plan in order to reduce disaster risks.

In closing, vulnerable road networks inevitably influence urban and regional planning and development.

## REFERENCES

- Access Board, 2005, Resources on Emergency Evacuation and Disaster Preparedness, Access Board ([www.access-board.gov/evac.htm](http://www.access-board.gov/evac.htm)),
- APTA, 2001, Checklists For Emergency Response Planning And System Security, American Public Transit Association ([www.apta.com/services/safety/checklist.htm](http://www.apta.com/services/safety/checklist.htm)).
- Australian Government, 2010, Tsunami Emergency Planning in Australia, Commonwealth Attorney-General's Department
- BDR, 2009, All-Hazards Regional Evacuation Planning: Workbook, *Homeland Defense Journal*, [www.homelanddefensejournal.com/Courses/2009Courses/All-Hazards-Regional-Evacuation-Plans.html](http://www.homelanddefensejournal.com/Courses/2009Courses/All-Hazards-Regional-Evacuation-Plans.html).
- Berdica, K., 2002, An Introduction to Road Vulnerability, *Transport Policy*, Vol. 9. No. 2 ([www.elsevier.com/locate/tranpol](http://www.elsevier.com/locate/tranpol)), April 2002, pp. 117-127.
- Bhattarai, K., and Conway, D., 2010, Urban Vulnerabilities in the Kathmandu Valley, Nepal: Visualizations of Human/Hazard interactions
- Biro Pusat Statistik, 2010, Sensus Penduduk 2010
- Carter H., Drury, J., Rubin, G. J., Williams, R., Amlôt, R., 2013, "The effect of communication during mass



- decontamination", *Disaster Prevention and Management*, Vol. 22 Iss: 2, pp.132 – 147
- Council of Australian Government (COAG), 2009, National Disaster Resilience Statement, Excerpt from Communiqué, Council of Australian Governments, Brisbane, 7 December.
- Dreier, P., 2012, *Katrina: A Political Disaster*
- FHWA, 2009, *Routes to Effective Evacuation Planning: Routes to Effective Evacuation Planning Primer Series*, U.S. Federal Highway Administration ([www.fhwa.dot.gov](http://www.fhwa.dot.gov))
- FTA, 2006, *Disaster Response and Recovery Resource for Transit Agencies*, Federal Transit Administration in website: ([www.transit-safety.volpe.dot.gov/publications/](http://www.transit-safety.volpe.dot.gov/publications/))
- Giuliano, G. and Golog, J, 1998, Impacts of the Northridge Earthquake on Transit and Highway Use, *Journal of Transportation Statistics*, Vol. 1, No. 2 ([www.bts.gov](http://www.bts.gov)), May 1998, pp. 1-20.
- Indonesian Government, 2004, Law Number 38 Year 2004 on Road, Jakarta
- Indonesian Government, 2007, 'Undang-Undang Nomor 24 Tahun 2007 tentang Penanggulangan Bencana' (Law Number 23/2007 about Disaster Management)
- Indonesian Government, 2008, Government Regulation Number 21/2008 on the Implementation of Disaster Management
- Louisiana, 2000, Southeast Louisiana Hurricane Evacuation and Sheltering Plan, State Of Louisiana ([www.ohsep.louisiana.gov/plans/EOPSupplement1a.pdf](http://www.ohsep.louisiana.gov/plans/EOPSupplement1a.pdf)).
- Louisiana, 2000, Southeast Louisiana Hurricane Evacuation and Sheltering Plan, State Of Louisiana ([www.ohsep.louisiana.gov/plans/EOPSupplement1a.pdf](http://www.ohsep.louisiana.gov/plans/EOPSupplement1a.pdf)).
- Masanobu, Kenji , 2012, *Projecting Global Urbanization and the Growth of Megacities*, in Roger L. Mackett, Anthony D. May, Masanobu Kii, Haixiao Pan (ed.) *Sustainable Transport for Chinese Cities (Transport and Sustainability, Volume 3)*, Emerald Group Publishing Limited, pp.17-42
- Matisziw, T.C., Murray, A.T. and Grubestic, T.H., 2008, *Exploring the Vulnerability of Network Infrastructure to Disruption*, Springer-Verlag
- Milligan & Company, 2007, *Transportation Equity in Emergencies: A Review of the Practices of State Departments of Transportation, Metropolitan Planning Organizations, and Transit Agencies in 20 Metropolitan Areas*, Office of Civil Rights, The Federal Transit Administration ([www.fta.dot.gov/civilrights/civil\\_rights\\_6343.html](http://www.fta.dot.gov/civilrights/civil_rights_6343.html)).
- National Agency for Disaster Management (BNPB), 2009, *National Disaster Management Plan 2010-2014*, Jakarta
- Renne, J.,L., Sanchez, T., W. and Litman, T., 2008, *National Study on Carless and Special Needs Evacuation Planning: A Literature Review*, University of New Orleans Transportation Center ([www.planning.uno.edu](http://www.planning.uno.edu)), for the Federal Transit Administration; at [www.planning.uno.edu/docs/CarlessEvacuationPlanning.pdf](http://www.planning.uno.edu/docs/CarlessEvacuationPlanning.pdf).
- Schwartz, M. and Litman, T., 2008, *Evacuation Station: The Use of Public Transportation in Emergency Management Planning*, *ITE Journal on the Web*, ([www.ite.org](http://www.ite.org)), January 2008, pp. 69-73; at [www.vtpi.org/evacuation.pdf](http://www.vtpi.org/evacuation.pdf).
- Scott, D., Novak, L., Aultman-Hall, and Guo, F., 2006, *Network Robustness Index: A New Method for Identifying Critical Links and Evaluating the Performance of Transportation Networks*, *Journal of Transport Geography*, 14(3):215–227. doi:10.1016/j.jtrangeo.2005.10.003.
- Sohn, J., 2006, *Evaluating the Significance of Highway Network Links Under the Flood Damage: An Accessibility Approach*, *Transportation Research Part A*, 40(6):491–506. doi:10.1016/j.tra.2005.08.006.



- Solberg, S, Hale, D., and Benavides, J., 2003, Natural Disaster Management and the Road Network in Ecuador: Policy Issues and Recommendation, Sustainable Development Department, Inter-American Development Bank, Washington D.C.
- Srivastava N., Prashar, S., Surjan, A., Shaw, R., 2012, Redefining Urban ecosystems, in Noralene Uy, Rajib Shaw (ed.) Ecosystem-Based Adaptation (Community, Environment and Disaster Risk Management , Volume 12), Emerald Group Publishing Limited, pp.145-173
- Taylor, M.A.P., Sekhar, S.V.C. and D'Este, G.M., 2006, Application of Accessibility Based Methods for Vulnerability Analysis of Strategic Road Network, Springer Science + Business Media
- Transport Research Laboratory, 2001, Cost-benefit Analysis of Measures for Vulnerable Road Users, United Kingdom
- TRB, 2005, Public Transportation Security: Volume 7: Public Transportation Emergency Mobilization and Emergency Operations Guide, Transit Cooperative Research Project, Transportation Research Board ([www.trb.org](http://www.trb.org)); at [www.trb.org/publications/tcrp/tcrp\\_rpt\\_86v7.pdf](http://www.trb.org/publications/tcrp/tcrp_rpt_86v7.pdf).
- TRB, 2005, Surface Transportation Security, Volume 6: Guide for Emergency Transportation Operations, National Cooperative Highway Research Program (NCHRP) Report 525, Transportation Research Board ([www.trb.org](http://www.trb.org)); at [http://trb.org/publications/nchrp/nchrp\\_rpt\\_525v6.pdf](http://trb.org/publications/nchrp/nchrp_rpt_525v6.pdf).
- TRB, Committee on the Role of Public Transportation in Emergency Evacuation, 2008, The Role of Transit in Emergency Evacuation, Special Report 294, Transportation Research Board ([www.trb.org](http://www.trb.org)), National Academy Press ([http://books.nap.edu/catalog.php?record\\_id=12445](http://books.nap.edu/catalog.php?record_id=12445)); at <http://onlinepubs.trb.org/Onlinepubs/sr/sr294.pdf>.
- Twigg, J., 2004, Disaster Risk Reduction, Mitigation and Preparedness in Development and Emergency Programming, Humanitarian Practice Network, Overseas Development Institute, London
- Wolshon, B., 2002, Planning for the Evacuation of New Orleans, *ITE Journal* ([www.ite.org/itejournal/index.asp](http://www.ite.org/itejournal/index.asp)), Vol. 72, No. 2, February, pp. 44-49.

# **BARRIERS TO ENERGY EFFICIENCY: A COMPARISON ACROSS 3 ASIAN COUNTRIES**

**Dhani Setyawan**

Centre for Climate Change Financing and Multilateral Policy  
Fiscal Policy Office-Ministry of Finance of Indonesia

Corresponding Author's E-mail: [dhanisetawan83@gmail.com](mailto:dhanisetawan83@gmail.com)

**Abstract:** While many countries have emphasized the development of energy security in domestic energy policy, not only developed countries but also developing countries have realized the importance in huge potentials of energy efficiency to reduce total energy demand from climate and economic perspective. Such trend has been enhanced under uncertainty of fuel price and economic recovery and for achievement of domestic CO<sub>2</sub> reduction targets. In developing countries, energy demand for electricity has been increasing and will increase in line with raising average income levels and improving accessibility to basic needs for the people. This paper conducts comparative analysis of energy efficiency policy in Japan, Thailand and Indonesia to examine effective fiscal policies to promote energy efficiency in a country. Japan and Thailand have made efforts to implement energy efficiency policies while Indonesia recently initiated energy efficiency policies and activities under current socioeconomic conditions. For the analysis of the study, energy and climate policies, institutional arrangements and fiscal instruments in Japan, Thailand and Indonesia are examined. As the findings from the paper, we identified that Asian countries can learn lessons from Japan and Thailand to strengthen energy efficiency with well-designed policy package by linking dedicated finance and innovative financing scheme and regular monitoring and evaluation system.

**Keywords:** *Fiscal Policy, Energy Conservation, Energy Efficiency*

## **1. INTRODUCTION**

Growing attentions to reduce domestic energy consumptions have been observed in many countries along with reaffirming the importance of energy conservation policy as cost-effective measures for the recovery from financial crisis. Climate change mitigation actions in both developed and developing countries and international negotiations under the United Nations Framework Convention on Climate Change (UNFCCC) have also contributed to the increasing importance to implement efficient and effective energy conservations and reduce energy dependency by shifting primary energy sources to less or zero greenhouse gas (GHG) emissions. Energy conservation policy also plays an important role in fiscal policy by promoting effective use of energy sources against increasing fossil fuel prices and accumulated costs of emission reduction measures (A.K. van Harmelen and M.A. Uyterlinde, 1998, GAO 1999). This paper examines potential policies and measures for energy-saving, which Asian countries can apply as cost effective measures for energy security and GHG emission reductions.

This paper focuses on energy conservation policies including fiscal policy in Thailand, Japan and Indonesia. Energy conservation policies in these three countries are characterized individually. Japan has accomplished reduction of energy consumptions over the past decades by encouraging domestic industries to carry out operational improvements and replace the old technologies to more energy efficiency technologies and develop new technologies. Thailand has designed and

developed innovative energy conservation policies and systems. Indonesia has recently set up energy conservation targets and a policy framework to promote efficient and effective management of energy sources, so-called Vision 25/25.

The main research questions on this paper are; a) what efforts have those countries been made for energy conservation so far?; b) what are the effective measures to reduce energy consumptions?; c) what are the roles of fiscal policy?; and d) what are the challenges to implement those energy conservation measures? This paper focuses on two methods of energy conservation: 1) reductions of total amount of energy conservation measures; and 2) shift of energy sources to more efficient and lower energy consumptions and GHG emissions. Assessment of each country is made to analyze the countermeasures to reduce energy demand and energy dependency in response to increasing global market price of fossil fuel. It also explores the innovative or effective fiscal policy to promote energy conservation policies of those three countries. This paper starts with an overview of energy supply and demand and energy conservation strategies in the three countries that have different economic and environmental backgrounds in terms of availability of access to energy resources, GDP, standard of living and industrial structures. It also examines the progresses and challenges of energy policy in Indonesia. It draws some conclusions about lessons learned from Thailand and Japan, and addresses effective energy conservation policy for Asian countries in the conclusion.

## **2. LITERATURE REVIEW**

In general, the concept of energy efficiency is defined as the fulfillment of energy needs by using fewer amounts of energy which keeping the same comfort while consuming less energy. One of the concept that support energy efficiency is called Trias Energetica Concept. This simple and logical concept can be applied as an effort to achieve energy savings as well as to reduce the reliance on fossil fuel in the context of saving the environment. There are 3 fundamental elements of trias energetica concepts i.e. reduce energy demand as much as possible by implementing energy saving measures, utilize renewable energy sources, and use fossil energy as efficiently as possible and only if sustainable sources are inadequate.

There were many studies had been discussed about the concepts of energy efficiency. According to Lovin (1976) the concept of energy efficiency can be defined as the economical usage of energy in order to increase the economic output. In the study, Lovin explaining a large number of energy alternatives, renewable, and more environmentally energy compare to fossil fuel. Soon after its publication, various ideas about energy efficiency began having a significant effect on public policy concept (Golove and Eto, 1996). According to Adam (2004), energy efficiency is defined as how much energy services should be prepared per unit of energy input. Related to economic problems, the economics of energy efficiency is about the question of balancing the costs and benefits. In addition to that, Golove and Eto (1996) mentioned that energy efficiency defined as providing equivalent energy service at lower total cost.

There are some debates on energy efficiency due to consumer decisions over energy use. According to Sanstad and Howarth (1994) the behaviour of energy consumers in deciding energy use is depending on maximization preference. Adam (2004) observed that personal energy user have some considerations i.e. a greater initial cost in buying energy-efficient products over expectation of future cost saving benefit. Other findings from Robinson (1991) the costs and benefits of energy efficiency labelling does not ameliorate decision making of energy user. Moreover, Stern (1986) observed that individuals tend to overvalue the amounts of energy used and technology saved. Another study, Kirsch (1993) discovered that people who do not understand numerical calculations seems difficult to arrive at a right energy-related decisions.

Another debates on energy efficiency is regarding the market barriers. Blumstein, et al. (1980) observed that energy conservation actions probably hampered by social and institutional barriers, even though there are economically logical responses to the energy crises. According to Golove and Eto (1996) there are at least seven market barriers were identified: 1) misplaced incentives, 2) lack of access to financing, 3) flaws in market structure, 4) mis-pricing imposed by regulation, 5) decision influenced by custom, and 6) lack of information or misinformation, 7) gold plating and

Inseparability of Features. Therefore, decision makers need a mix of sound analysis and pragmatism to establish a good energy efficiency policy.

Except the energy efficiency concepts from various researches and studies, the GoI has its own definition in regards of energy efficiency concept. Statutory Government Regulation No. 70 Year 2009 regarding Energy Conservation, the definition of Energy Conservation is systematic efforts, well-planned and integrated in order to conserve domestic energy resources as well as to enhance the efficiency utilization. Efficiency constitutes one of the implementation step in achieving energy conservation. Energy efficiency generally defined as energy savings.

### 3. RESEARCH METHODOLOGY

This paper aims at finding a solution for an contiguous problem facing energy conservation issues policy in related Asian Countries. Library research, cross sectional collection of data for intensive analysis, interviews to some leading experts in the field and a number of Focused Group Discussions were also conducted to construct the policy analysis. Collections of information are compared and developed in order to create a new comparison data among object countries (Japan, Thailand, and Indonesia). This paper includes surveys and fact-finding enquiries through different stake holders in those countries.

### 4. DISCUSSION AND ANALYSIS

#### • Policy Comparisons of Three Countries

Energy balance table of import and export of primary energy sources in Thailand, Japan and Indonesia addresses that Thailand and Japan rely heavily on foreign fuel resources. The net energy imports in Thailand and Japan are high with 40.28% and 80.13% of energy use in 2009 respectively although they have improved the rate from 47.70% and 90.79% in 1973 (Figure 1). Indonesia is the only country of the three with minus 74.18% in net imports of energy use. This figure implies that Thailand and Japan face risks for uncertainty to access to energy sources and vulnerability to changes of market prices of primary energy sources. Therefore, Thailand and Japan have made efforts to reduce these risks by reducing energy consumptions. The shift of primary energy sources from oil to more energy efficient sources was also one of the measures to reduce the risks. In fact, Thailand and Japan has succeeded in reducing dependence on oil in the power generation.

Figure 1. Energy imports, net (% of energy use)

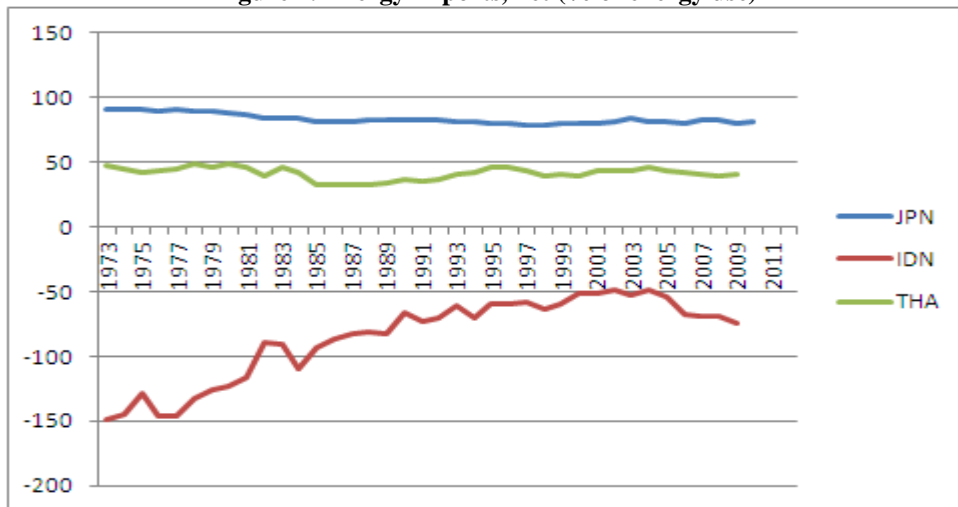

Data Source: World Bank database

In case of Thailand, the government has set up policies to reduce energy consumptions and stabilize the domestic energy prices by establishing a fund to promote energy conservation program and the one to adjust oil prices (Leesombatpiboon, P and F L. Joutz 2010). At first, as the wake of the oil crises of the 1970s, Thailand established Oil Fund in order to increase the resistance against fluctuations in the market price of oil, and to make a shift from oil to natural gas in the power sector. Energy conservation policy came after in 1990s. On the other hand, Japan's efforts to minimize the impact of price changes in fossil fuel was made in strengthening energy conservation policies with various subsidy program in the industry sector. At the same time, energy shift was made from oil to coal and to nuclear that is less GHG emissions and can enhance self-sufficiency ratio for energy supply. Consequently, Japan has reduced energy consumptions in industry sector and shifted to less energy intensity technologies and operations. The significant impact of reducing the energy intensity of the manufacturing sector appeared after the second oil shock with the improvement to 25.89% in 1980 and 44.47% in 1990 from 1973 level (Figure 2). In 2009, energy consumption per unit of production required was also reduced to 40% from 1973 level.

In case of Indonesia, although Indonesia is a net exporter of primary energy supply, the rate of net imports have been dramatically reduced to half from the level of minus 148.65% in 1973 (World Bank databank1) and also faces the risk influenced by the international market prices. When international price of energy was increased in 2004, Indonesia's net imports were reduced to minus 48.29%. This unstable balance of imports and experts of energy was affected to national budget in Indonesia. Therefore, Indonesia also faces the similar challenges to stabilize the energy supply without the financial impact to the national budget.

**Figure 2. Energy intensity in Japan**

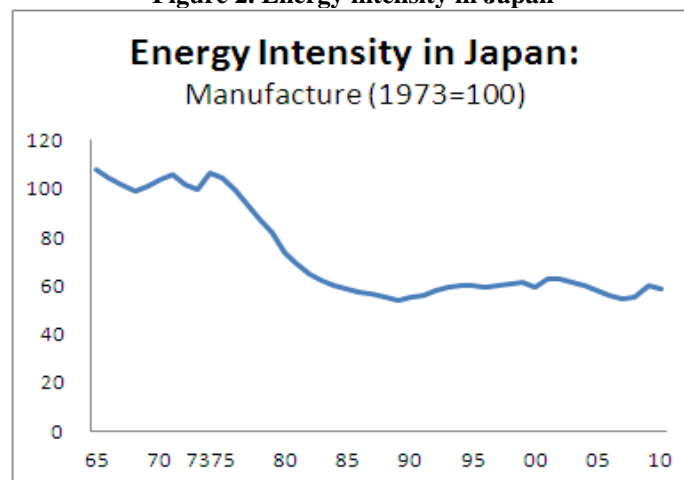

Source: ANRE 2012

Thailand and Japan have faced challenge in the implementation of national energy conservation policies and measures. For example, although Thailand has applied the innovative energy conservation policies and measures carried out since 1990s, it could not have been attributed to reduce total domestic energy consumptions. Thailand has succeeded in the transition of energy use from oil in electricity generation, but Thailand is highly dependent on fossil fuels in power generation and transportation sector. In 2008, 92% of total electricity generation comes from fossil fuels and primarily from natural gas (71%) and coal (21%) (CIF 2009). In addition, the dependence on oil is still huge in industry and transportation sector. Thailand still depends on more than 70% of total imports of primary energy supply that account for more than half of total national primary energy supply. This is mostly used for transportation and industry, especially for transport sector that consume over 70% of petroleum products (CIF 2009).

Challenges in Japan is that although Japan has been promoting energy conservation since the 1970s in large-scale industries and public facilities during the peak growth rate of the economy, the energy intensity in manufacturing has been slightly increased since 1990s because of the

decrease in the capacity of the utilizations rate by slowdown of economic growth and decreasing rate of the operations (ANRE 2012). Challenges are how to reduce energy consumptions in manufacturing that is still dominant for more than 50% of total energy consumptions. In addition, the rest of total energy consumptions including housing, office and transportation sectors has been increased to 218.1%, 275.5% and 188.7% (234.8% for passengers and 142.6% for cargo) in 2010 from 1973.

In terms of GHG reduction, Thailand has rapidly increased GHG emissions in the past 20 years while Japan has already reached high emissions in 1970s as an industries country. However, the trend of the increase of GHG emissions in Japan is slower than other two countries. Now the three countries faced with the needs for transition from fossil fuels to zero-emission fuel such as renewable. Thailand is the seventh largest emitter of carbon dioxide in Asia (EEAS 2007), and per capita CO2 emissions of the capital city, Bangkok, exceed those of cities such as Tokyo and London (BMA 2009). The main sector contributing to CO2 emissions is the electricity sector, which accounts for 37.45% of total CO2 emitted, followed by transportation and manufacturing, which account for 26.32% and 22.96%, respectively (CIF 2009). These three sectors account for more than 86% of Thailand's total CO2 emissions. In light of this increase in CO2 emissions, Thailand has been giving consideration to ways of reducing its emissions, reflecting its realization that climate change can adversely affect Thai businesses.

In case of Japan, although Japan has applied a strategy to enhance GHG emission reductions in shifting to less or zero emission aimed to increase energy security and energy independency, after Fukushima nuclear accident, Japan faces the needs to re-examine and reconsider their strategies for nuclear and to promote other energy sources. Challenges are how to deal with the increasing demand on primary energy of coals and natural gas as alternative energy sources to maintain the economic operations.

Now, common challenges for Thailand and Japan are how to shift fuels to renewable as well as reducing domestic demand of energy. This can be also applied to Indonesia that faces the needs to shift from dependency on fossil fuels to renewable as well as strengthening the domestic energy conservation system to reduce financial burdens to subsidies fossil fuels.

**Figure 3. Trend of GHG emissions  
CO2 emissions (baseline in 1973)**

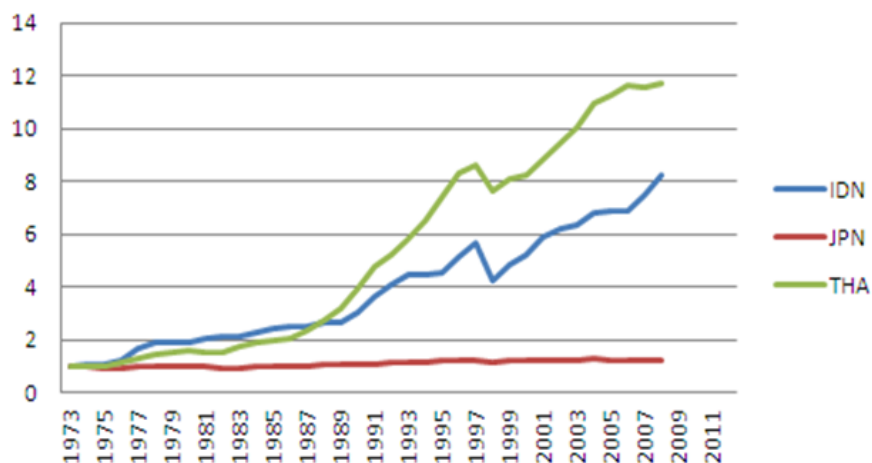

## CO2 emissions (kt)

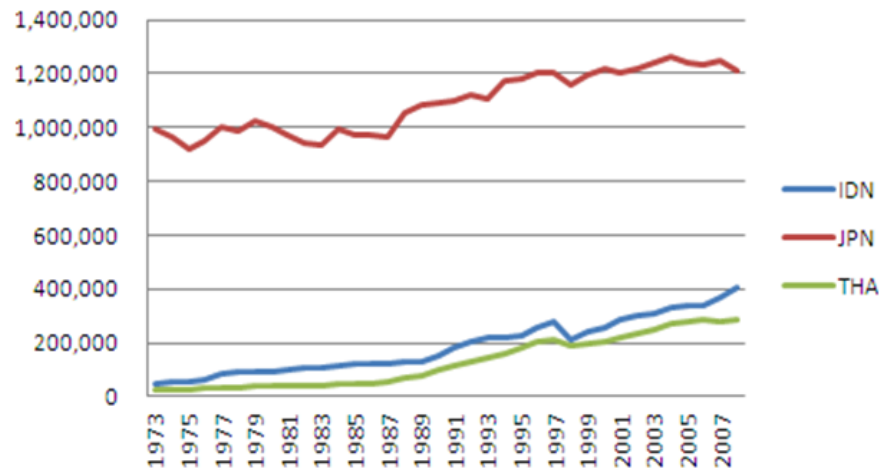

Source: World Bank database

The interesting feature of energy conservation policies in Thailand, through the Asian financial crisis of 1990s and the oil crisis of 1970s, was the establishment of a fund to promote energy conservation under the Energy Conservation Promotion Act. Nevertheless, currently listed issue of energy supply in Thailand still remains in the same dependence on energy resources and the imports. In addition, in order to reduce the energy related risks, as next step, energy mix is required to reduce the dependence on natural gas that account for more than 70% of total primary energy for power generation. Under such circumstances, Thai government set up 20 years energy saving plan (2011-2030) and the national renewable energy development plan (2008-2022) that was a revised version of a 10-year plan (2012-2021). In 2011, Thai government has also submitted to UNFCCC secretariat the statements of their ultimate objective to replace 25% of the energy generated by fossil fuels within the next decade by promoting increased use of renewable and alternative energy in industrial and agricultural sectors (UNFCCC 2011). In addition, through energy conservation and energy efficiency policies, it aimed to reduce the energy intensity up to 25% from the current level (in 2011) within 20 years.

However, the key issue is how this can be effectively implemented. Thailand's confronted challenges are to fill in the gaps in designing and implementing policies and strategies by lessons learned from the past experiences in pollution control.

Operational improvement by reviewing the operational processes and strengthening the monitoring processes are effective approach with the immediate impact in Japan. For example, petroleum such as heavy oil accounted for 21.3% in 1973 in the total energy consumed in the steel industry sector. It halved to 9.5% in 1980 and was significantly reduced to 6.3% in 1985 (Uezono, M, 1997). However, after 1986, the improvement of energy saving has stagnated in Japan. The reason for the stagnation at the time was rather than the technical limit, the decline in energy prices by the appreciation of yen and the depreciation of crude oil that significantly extended payback period of energy-saving equipments.

In addition, although energy saving has been promoted in large-scale industry and public facilities in a phased manner in Japan, the slowdown progresses in energy conservation since 1990 was because Japan have mostly completed implementing measures in large industry while energy consumptions in household and offices have been steadily increased (ECCJ 2000). For the energy efficiency, the energy input ratios in manufacturing remained the same level since 1990 while large enterprises has improved since 1990 (JSBRI 2010). Therefore, next target area has been shifted to small businesses and facilities as well as sectors in transportation, commercial and household. According to White Paper on Small and Medium Enterprises (JSBRI 2010), Japan emitted 1219 million tons of CO2 emissions deriving from energy consumption in fiscal 2007, and

SMEs account for 12.6% of the Japanese total. SMEs' share of CO<sub>2</sub> emissions from energy consumption in the commercial sector is 43% while that in the industrial sector is 11%.

The difficulty of promoting energy conservation in small and medium enterprises (SMEs) in Japan is the cost-effectiveness and awareness of the impact of energy efficiency. For example, the number of ESCO business is hard to be initiated in a facility with 1 million of annual utility costs. If the utility bills is 5 million yen and the utility cost can be reduced up to 10% by energy efficiency equipments, it can reduce only ¥ 500,000, and just a 2.5 million in five years (Kiryu, T et al 2009). The half of money is spent for the cost of interest and validation measurement. Therefore, the benefit can be realised by ESCO business is only for a facility that is operated for 24 hours in 367 days and which utility costs per year is more than tens of million yen. As the result, the business tends to prefer a project that has a large amount of energy consumptions without energy-saving renovations.

Conclusively, many components of policies are needed to be considered. The improvement of energy conservation in those countries are resulted from the suitable conditions of economic growth with favorable balance in industries, fossil fuel price increases, and appropriate fiscal policy.

- **Challenges to Promote Energy Efficiency Policy in Indonesia**

In Indonesia, energy subsidies can be widely accepted for the poor. Nevertheless, insufficiently planned energy grant program can lead to inefficiencies in the equity and distributions. Indonesia has implemented subsidy policies for energy supply required to fossil fuel, and domestic finance is affected by fluctuations of the price of fossil fuels. The government's subsidy policy is that energy subsidies in 2011 reached 6 % of GDP, which was greater than the proportion of capital expenditure. This implies a high risk that Indonesia may take in increasing financial tensions due to raise of international fossil fuel price.

Although Indonesia has been making efforts to reduce subsidies over the years, Indonesia has been given relatively large energy subsidies for in various energy sources as one of the energy-rich country. Therefore, the uncontrolled rising of oil prices in the world market (in 2005-2006) makes a huge burden of fuel subsidy in the state budget. About 30% of the expenditure of the national budget has been spent on subsidies for fuel and electricity. According to the World Bank, a subsidy from 2001 to 2008 amounted to 10-26% of the national budget (GSI2009) . Shown in Figure 9, in the last six years, the average of Indonesian energy subsidies absorbed budget subsidies around 80% of the total state budget. In the state budget 2011, the total fuel subsidy is around 129 trillion rupiahs, followed with the electricity subsidy reaching 65 trillion rupiahs. The fuel subsidy is penetrated around 10% of the total state budget. Whilst, Non energy subsidies is only 42 trillion rupiahs included food subsidy is 15 trillion rupiahs, agricultural subsidy (19 trillion rupiahs) and other subsidy (8 trillion rupiahs). From the trend above, it is obviously that the energy subsidy policy in Indonesia affecting the other sector of development budget subsidies. In order to face the challenge aforementioned, the government has set up a national development priority in efficiency energy framework i.e. energy diversification policy, energy conservation policy, restrictions policy on the use of subsidized energy, and gradually rationalizing energy prices.

This condition forces the government to setting up a subsidy mechanism to ensure that the subsidy will be utilized by the targeted needing group and also to prevent the overabundance of subsidies so that the targeted population who experiences difficulties in accessing fossil fuel energy do not suffer difficulties in purchasing these fuels in the future. When the Government of Indonesia raised fuel prices twice in 2005, the prices of food and commodities were also increased. Several measures have been carried out by the government. For instance, prior to the second of fuel price increases in 2005, in order to prevent opposition to the price increase and adverse economic and social impact the government launched three unconditional cash transfer programs, called cash transfer assistance (Bantuan Langsung Tunai: BLT), direct cash transfer program (Subsidi Langsung Tunai: SLT) and BBM compensation program (Beaton, C and L Lontoh 2010, Hastuti, et al 2006). However, although those cash transfer programs have given a certain impacts to the poor, there are the issues on the equity of distributions and the sustainability of the program in long-term.



**Figure 4. The Trend of Indonesian Subsidies**

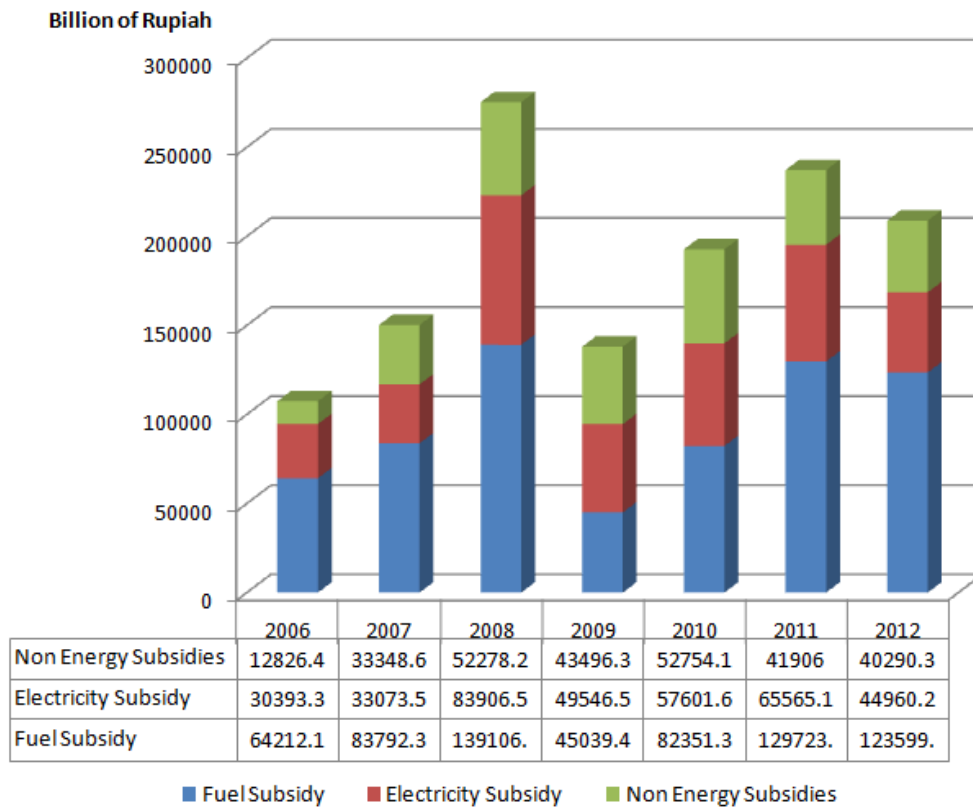

**Source: Fiscal Policy Office (MOF), 2012**

The financial expenditure by these energy subsidies can be improved with a reduction in the total energy consumption by improving energy efficiency program. If government can address clearly what benefits can be obtained economically by energy efficiency with energy efficiency efforts by company, the application of government policy and economic incentives, many industries can reduce their energy demand. Inexpensive energy prices in Indonesia may be one of the main reasons to prevent the energy efficiency programs.

As the conversion from Kerosene to LPG, Indonesia launched a program to reduce kerosene consumption by encouraging households and small businesses to consume LPG by distributing starter pack consisting of a stove and compact build gas cylinder to public to switch fuels and reducing subsidies in kerosene (MEMR 2007). The program to reduce the kerosene subsidy was effective with the result that the distribution of kerosene was dramatically limited in the targeted areas with the disappearance of low price kerosene in the market (Beaton, C and L Lontoh 2010). However, the issues of LPG as an alternative source still remain regarding on the capacity of supply and contributions to reduce of GHG emission.

## 5. CONCLUSION AND RECOMMENDATIONS

The national energy conservation strategies and national fiscal policy in these three countries are varying. Thailand and Japan have conducted various energy saving measures in responses to enhancing energy security after the oil crisis. The common strategies of Japan and Thailand were to establish a funding system to promote energy conservation to maintain energy security and to prevent the financial tension caused by external factors. As Table below shows, Thailand and Japan have actively introduced various financing instruments to promote energy efficiency. In addition, Thailand and Japan have, in common, been promoting energy conservation actions

through institutional arrangement of Energy Conservation Center in Thailand (ECCT) and DSM office in Thailand and Energy Conservation Center in Japan (ECCJ). These institutions have contributed to improve energy efficiency in equipment and machinery.

**Comparison of Financial Mechanism Policy in Thailand and Japan**

	Tax incentives	Subsidies	Loan Fund	ESCOs
Thailand	•		•	•
Japan	•	•	•	•

This case study demonstrates that in compared to Japan’s progresses, Thailand faced the difficulty to implement demand management system in terms of the financing and the enforcement. There are several differences in the strategies such as a framework of target setting and the operation to enhance national energy-savings between Thailand and Japan. Some of the differences are whether the program is operated in mandatory or voluntary manner, and the management and reporting system including the institutional arrangements of monitoring and auditing, and the enforcement. The strategies of the focus areas also differ in whether a county focuses on the improvement of management system or technology improvements or both.

In case of Japan, technology development in couple with improvement of the management system including operational improvement was introduced to enhance synergy of reinforcement of energy conservation effects. For instance, in the labeling system, while Thailand carried out the voluntary system, Japan introduced a mandatory scheme of labeling in combination with a method of a maximum standard value system. As the result, Japan was able to raise the overall improvement in energy saving. In Thailand, although there were energy efficiency improvements for some of equipments, the voluntary scheme did not give much incentive to label a project to a company who produce low level of energy efficiency products. Meanwhile a company who labels a product produces the one that achieves the highest level of quality (Singh, J and C Mulholland, 2000).

Furthermore, the difference in strategies between Japan and Thailand is the approach for energy technology innovation. In the focus areas, Thailand has focused on the management solution rather than technology development. In Thailand, under the ENCON fund, research & development (R&D) or technology improvements have been supported as one of the program providing about 50 million Bath to R&D on energy consumptions. Japan whose focus is in increasing energy security and decreasing energy consumptions, as Xiliang, Z (2000) stated, has conducted three strategies; regulations; economic incentives; and public R&D and technology improvements. One of the important elements in Japan was the public R&D in 1990s. R&D for improvement of the performance of equipment and reduction of the cost of energy technology innovations was supported by government with strong connection between the government and industry. The government was functioned to leverage private enterprises to fund the R&D with gradual diffusion of cost effective and energy efficiency technologies with appropriate policy instruments such as regulation and economic incentives. In current situation, efficiency technology R&D has been already matured, therefore, the needs for Thailand might be to reform and develop the current energy efficiency technology to fit in the spec and environment of the domestic facilities.

In case of institutional arrangement, the management strategies to reduce energy conservation depend on country strategies by choosing the methods and targeted areas and goals. In DSM office in Thailand, there were a certain financial constraints to promote DSM with considerable hurdles to bring electricity tariffs to cost recovery levels that make DSM surcharges unfeasible (Singh, J and C Mulholland 2000). Thailand like other countries has imposed DSM taxes within power tariff schemes. However, in such taxation scheme, a fund is required for low-income customers as a social program with the collaborations with other governments who support the programs. In Japan, the energy programs are funded through the special account which can keep a certain amount of funds.

As other elements for institutional arrangement, it is important to see the differences in whether promotion and regulation is operated by separated institutions. For instance, Japan has no separated system between a body that promotes nuclear and regulate it in order to make outcomes from effective energy saving policy. Thailand who learns from this experience needs to consider how it can carry out the monitoring and evaluation. Thailand environmental control was originally monitored and regulated by electricity authority without separation between promotion and

regulation of pollution control. Therefore, in terms of institutional arrangement, in order to properly perform monitoring, countries have become necessary to manage and monitor it by separated bodies and responsibilities.

Lastly, the differences are observed in the fiscal policies to stabilize fuel prices between Thailand and Indonesia. While Thailand took the price-based policies, Indonesia has provided a certain amount of money to stabilize the oil price with the subsidy system. There are two purposes for Thailand to have adopted a price basis policy: one is to reduce the volatility of oil prices and to keep the low prices; and by being separated from National budget, Thailand has laid the mechanism to avoid the effect of the Oil fund deficit for other welfare budget, and shifted from petroleum resources to natural gas that can be acquired in Thailand as net exporter of natural gas.

As discussed in this paper, Japan and Thailand had common goal to reduce the dependence on oil, but the actions and measures to alternative energy was different due to differences in geographical environment and resource availability. Japan has shifted from oil to coal and to nuclear power while Thailand was from oil to natural gas. At present, the three countries, Japan, Thailand and Indonesia, set up a plan to switch the power supply sources to move away from dependency of fossil fuels to reduce the consumption of primary energy sources and to enhance further energy efficiency. The lessons can be learned from the comparison from these countries, but which options to be implemented is dependent on the focused area and the goal to be achieved of the country.

## References

- Blumstein, C., B. Kreig, L. Schipper, and C. York 1980. "Overcoming Social and Institutional Barriers to Energy Efficiency."
- ICA 2010, Sustainable Electrical Energy, The Business Case for Electrical Energy Efficiency in Japan
- Jaffe, Adam., Newell, Richard. Stavins, Robert. 2004 "Economics of Energy Efficiency"
- Kirsch, I. 1993. Adult Literacy in America: A First Look at the Results of the National Adult Literacy Survey
- Lovins, A. 1976. "Energy Strategy: The Road Not Taken?"
- Robinson, J.B. 1991. "The Proof of the Pudding: Making Energy Efficiency Work." Energy Policy
- Sanstad, A.H. and R.B. Howarth 1994. "'Normal' Markets, Market Imperfections, and Energy Efficiency." Energy Policy
- Stern, P.C. 1986. "Blind Spots in Policy Analysis: What Economics Doesn't Say about Energy Use." Journal of Policy Analysis and Management
- Takahashi M and H Asano, 2011, An Assessment Study of Energy Efficiency Policy Measures for Japanese Commercial Sector, The Energy Journal, Special Issue. Strategies for Mitigating Climate Change Through Energy Efficiency: A Multi-Model Perspective
- William H. Golove and Joseph H. Eto 1996. "Market Barriers to Energy Efficiency: A Critical Reappraisal of the Rationale for Public Policies to Promote Energy Efficiency"
- Agency for Natural Resources and Energy (ANRE) 2012, Energy White Paper 2012,
- ANRE, 2011, Status of the enforcement of the Energy Conservation Act for factories and other sectors.16th Energy Efficiency Standards Subcommittee.
- A.K. van Harmelen and M.A. Uyterlinde, 1998, Integrated Evaluation of Energy Conservation Options and Instruments, A Country Comparison, The Netherlands Energy Research Foundation ECN
- Asia-Pacific Economic Cooperation (APEC) 2012, Peer Review on Low Carbon Energy Policies in Thailand Final Report, the APEC Energy Working Group
- APEC 2005, Thailand's Energy Efficiency Revolving Fund: A Case Study: Prepared for APEC Energy Working Group July 2005 DMG, Asia-Pacific Economic Cooperation
- Beaton, C and L Lontoh 2010, Lessons Learned from Indonesia's Attempts to Reform Fossil-Fuel Subsidies, International Institute for Sustainable Development (IISD)
- Bacon, R and M Kojima 2006, Coping with Higher Oil Prices, ESMAP Report 323/06. Washington, DC: World Bank.
- Bangkok Metropolitan Administration (BMA) 2009, Action Plan on Global Warming Mitigation 2007-2012, Bangkok Metropolitan Administration
- Clean Investment Fund (CIF) 2009, Clean Technology Fund, Investment Plan for Thailand, October 20, 2009
- ECCJ 2000, Introduction of Energy Conservation - Japan's energy conservation policies and the internal and external situation of energy-, Energy Conservation Center, Japan
- Energy Policy & Planning Office (EPPO) 2000, Energy Conservation Program and Guidelines, Criteria, Conditions and Expenditure Priorities of the Energy Conservation Promotion Fund During the Fiscal Period 2000-2004, Ministry of Energy,
- European External Action Service (EEAS) 2007, Thailand-European Community Strategy Paper for the period 2007 – 2013

- Grüning, C et al 2012, Case Study: The Thai Energy Efficiency Revolving Fund, National Climate Finance Institutions Support Programme, Frankfurt School of Finance & Management gGmbH
- Grüning, C 2012, Frankfurt School - UNEP Collaborating Centre for Climate & Sustainable Energy Finance (2012), Case Study: The Energy Efficiency Revolving Fund.
- Irawan et al. 2012, Case Study Report: Thailand Energy Conservation Fund, A UNDP working paper.
- International Energy Agency (IEA), 2010, Energy Efficiency Governance, OECD/IEA
- JSBRI 2012, 2010 White Paper on Small and Medium Enterprises in Japan, Small and Medium Enterprises Moving Forward through Adversity
- Jue, E at al, Case Study: Thailand's energy conservation (encon) fund, How Financial Mechanisms Catalyzed Energy Efficiency and Renewable Energy Investments, CENTER FOR CLEAN AIR POLICY
- Kiryu, T et al 2009, Financial development environment using the ESCO business, Bank of Japan, Press Release, ESCO.
- Kojima, M, 2009, Government Response to Oil Price Volatility, Extractive Industries for Development Series #10, the World Bank
- Leesombatpiboon, P and F L. Joutz 2010, Sectoral demand for petroleum in Thailand, Energy Economics 32 (2010) S15–S25
- Makinson S 2006, Public Finance Mechanisms to Increase Investment in Energy Efficiency, BASE - Basel Agency for Sustainable Energy for the UNEP Sustainable Energy Finance Initiative (SEFI),
- Ministry of Energy and Mineral Resources (MEMR), 2012. Policy Initiatives Regarding Green Economy Concept. Directorate of Energy Conservation. Directorate General of New, Renewable Energy and Energy Conservation.
- Ministry of Energy and Mineral Resources (MEMR) 2007, Accompanied by the Minister of Energy and Mineral Resources, the Vice President launches the conversion from Kerosene to LPG. Retrieved June 29, 2010, from Ministry of Energy and Mineral Resources for the Republic of Indonesia
- Ministry of Energy and Mineral Resources of GoI 2009, The GoI Regulation No. 70 Year 2009
- Ministry of Environment, Republic of Indonesia (MoEI) 2010, Indonesia Second National Communication, under the United Nation Framework Convention on Climate Change, Jakarta, November 2010
- MoF 2006a, Comprehensive Handbook of Japanese Taxes, the Tax Bureau of the Japanese Ministry of Finance, Research on the nature of desirable tax system.
- Patrick, H 1986, Japanese High Technology Industrial Policy in Comparative Context, Working Paper No. 1, Working Paper Series, Center on Japanese Economy and Business, Columbia University
- Santitarn S 2011, Thailand's oil price subsidy: How long can it last?, Credit Suisse, Economics Research
- Singh, J and C Mulholland, 2000, DSM in Thailand: A Case Study, October 2000, Joint UNDP/World Bank Energy Sector Management Assistance Programme (ESMAP)
- Small and Medium Enterprise Agency Ministry of Economy, Trade and Industry (JSBRI) 2010, 2010 White Paper on Small and Medium Enterprises in Japan, Pulling through the crisis
- Sulyma, I.M, et al, 2000, Taking the Pulse of Thailand's DSM Market Transformation Programs, American Council for an Energy-Efficient Economy

UNDP 2012, Case Study Report: Thailand Energy Conservation Fund, A case study providing inputs to discussions in Asia-Pacific region on the design and management of National Climate Funds, UNDP and the ENCON fund.

World Bank databank, <http://data.worldbank.org/topic/environment>

Wörten, C 2011, Meta-Evaluation of Climate Mitigation Evaluations, Case Study: Transforming Markets for Energy Efficient Products in Thailand, Climate Change Evaluation Community of Practice, c/o GEF Evaluation Office, Washington D.C.

Xiliang, Z 2000, Enabling the Transfer of Environmentally Sound Technologies in the Context of Climate Change: Some Lessons from Asia, Institute for Techno-Economics and Energy Systems Analysis, Tsinghua University, Beijing 100084, China

# THE DISASTER RISK MANAGEMENT FOR WOMEN HOME BASED WORKERS

**Daniel S. Stephanus**

Accounting Department, Business and Economics Faculty, Head of Community Service Office of Ma  
Chung University Malang  
[daniel.stephanus@machung.ac.id](mailto:daniel.stephanus@machung.ac.id)

## ABSTRACT

The women home based workers are workers in the weak economic position or in the poverty. The women home based workers should have education and training about the disaster risk management. From the experience work with and assistance the women home based workers in Indonesia, especially in the disaster area, the women home based workers are the stronger disaster victim than others workers group. The women home based workers in the disaster area are able to be an actor of the elements who reconstruct the economic condition after the emergency step done. Therefore, there is important to give the knowledge and educate the women home based workers about disaster risk management and make the women home based workers aware and empower when they must face the disaster in all circumstances. The women home based workers in the disaster area are not only reconstruct the economic element but act in the many aspects for the community. The can act as the economics reconstruct and as the example of mental healing model, the bigger role for the women home based workers in the family, community, and society.

**Keywords:** *women home based workers, climate change, disaster risk management.*

## INTRODUCTION

Now a day, the world faces the big problem because of the climate change. The poverty not handle yet but the new problem, the climate change, are threatening for human and make the poverty become worst and worst. The climate change makes several natural disasters. Flood, typhoon, and hurricane that make the farming area and even the residence area become vulnerable. Natural disaster will drive the economic disaster, the poverty become worst, and worst all around the world.

The poverty increase because of the disability in economic become distress because of the productivity decrease and natural disaster make the poverty increase because the loss of

house and the production places and facilities. The climate change makes the threat like natural disaster, and drives the economic disaster, than create the global humane disaster.

The women home based workers are in the weak economic position or in the poverty. The women home based workers will be more distress in the climate change condition. They are directly threatening by natural disaster because they work at home. This condition, push the women home based workers should have education and training about the disaster risk management, to manage their risk when they face the natural disaster. From the experience work with and assistance the

women home based workers in Indonesia, especially in the disaster area, the women home based workers are the stronger disaster victim than others workers group.

### **CLIMATE CHANGE AND DISASTER**

The climate change make the disaster, natural disaster, economic disaster and overall the humane disaster. The climate change makes the sea water level rise and the hard rain so the flood drowning so many areas in all around the world. The climate change makes the typhoon, storm, and hurricane that ruin and destroy so many building, facilities, and public facility. The climate change also makes the sea wave higher and savages. The climate change caused the natural disaster that not only threat so many live but damage the farming area and destroy the production facilities in so many places (www.wikipedia.org).

The natural disaster caused so many losses, so many people loss their assets, production tools, work place, and even life. The damage that happened is not threatening the local community but also threaten the existence of the global society. The damage of the production tools and facilities will destroyed the economic power of a community. The damage of the farming area is not destroyed the farmer life only but will affect the national food security and if happen in many countries will affect the global food security.

The damage of the farming area in many countries because of the climate change and

the natural disaster will affect the global food security. The climate change also affected the planting pattern and harvest season, so the planting and harvest fail. The failed of harvest will make threaten global food security worst. The climate change will make the natural disaster, drives the economic disaster, and finally makes the humane disaster.

### **The Indonesian Disaster Act (Undang Undang 24/2007 tentang Penanggulangan Bencana)**

To face the disaster and manage the disaster risk, especially the natural disaster, the government of Indonesia released **the Disaster Act – No. 24/2007**. The act are about the disaster risk management that involving the community and society actively. The stressing of the act are in emergency action and reconstruction effort, because a lot of money involve. Although the “big job” like emergency action and reconstruction in the government hand but the role of the community and society involving the disaster risk management increase.

The Disaster Act – No.24/2007 make the community and the society aware and prepare themselves facing the disaster problems, before (mitigation), when happen (emergency action), and after (rehabilitation and reconstruction). Unfortunately, the Indonesia government not seriously to empowering the citizen, because in the emergency action and reconstruction that involving a lot of money the government control very tight but in the critical moment like mitigation and



rehabilitation that involve a little bit money with a lot of job the government lose the control. The unserious obligation and just project (money) oriented.

There are definitions about disaster and the disaster management.

### **1. Disaster**

Disaster is the moment or events that threaten and disturb the community and society life and living by the natural phenomenon and/or unnatural phenomenon and caused the human life victims, the environmental damage, loss of assets, and psychological effect.

### **2. Danger Disaster Area**

Danger disaster area is the condition or characteristic of geologic, biologic, hydrologic, climatologic, geographic, social, culture, politic, economic, and technology in one area for the long term that reduce the ability to prevent, reduce, and decrease the ability to face the danger or bad situations.

### **3. Any Kind of Disaster**

#### **a. Natural Disaster**

The disaster because of the moment or events caused by nature like earthquake, tsunami, mount eruption, flood, dry, typhoon, earth slide that make human life victims, loss of assets, damage the facilities and infrastructure, environment, and public facilities.

#### **b. Unnatural Disaster**

The disaster because of the moment or events caused by unnatural like failed of technology, modernism, epidemic, and diseases.

### **c. Social Disaster**

The disaster because of the moment or events caused by the human like social conflict among the tribes or among the groups or among communities that terrorizing and suffering the society, disturb the social relationship, damage the function of social regulation, human life victims, and loss of assets.

### **d. Social Conflict**

The physical conflict by two or more group or side that make loss of group rights and assets, fearing the society, threatening the peaceful, security, and/or disturb the prestige and the balance of society social life.

## **4. Awareness and Preparation**

### **a. Disaster Risk Management**

The efforts like policy decision, developing with risk disaster, preventive activities, emergency, and rehabilitation.

### **b. The Awareness and Preparation**

The efforts to anticipate the disaster through organizing, the right and empower steps.

## **5. Disaster Risk Management**

### **a. Mitigation**

The efforts to reduce the disaster risk through physical development and increase the ability facing the disaster.

#### **b. Emergency Response**

The quickly activities when the disaster happen to handle the bad impact of disaster like help and evacuation the victims, assets, and fulfill the basic needs, protection, refugees management, recover the structures and infrastructures.

#### **c. Rehabilitation**

Rebuild and recover the public or society service aspects to the normal level or the government aspects and the society activities running well after the disaster gone.

#### **d. Reconstruction**

Build the structures and infrastructures, institution in the disaster area after the disaster gone in the government and society level with the purpose to recover the economic activities, social, and culture, law and order, civil society participation in every aspects of society in the disaster area.

### **WOMEN HOME BASED WORKERS**

Home based workers defined by International Labor Organization (ILO) through the ILO Conventions 177-1996 - Article 1. For the purposes of this convention:

- (a) the term “homework” means work carried out by a person, to be referred to as a home worker,
  - (i) in his or her home or in other premises of his or her own choice, other than the workplace of the employer;
  - (ii) for enumeration;
  - (iii) results in a product or service as specified by the employer, irrespective of who provides the equipment, materials or other inputs used.

Unless this person has the degree of autonomy and of economic independence necessary to be considered an independent worker under national laws, regulations or court decisions;

- (b) become home workers within the meaning of this Convention simply by occasionally performing their work as employee at home, rather than in their usual workplaces;
- (c) The term “employer” means a person, natural or legal, who, either directly or through an intermediary, whether or not intermediaries are provide for in national legislation, gives out homework in pursuance of his or her business activity.

### **Women Home Based Workers in the Disaster Area**

The women home based workers face the risk bigger than others because they work at home.

The women home workers living under economic pressure and work in the bad condition. Now a day, they must face another risk, natural disaster because of the climate change. Therefore, the women home based workers have no power in economic and they must preparing themselves to anticipate when the disaster come.

Based on the experience, the women home based workers in the disaster area in Indonesia, like Jogjakarta and Central Java Earthquake (2006) and Lapindo Mud Flow at Sidoarjo, East Java (2006-2007), we find that the women home based workers stronger than others to face the impact of the disaster in the shelter. The women home workers also more productive than others, because they can work with the limited condition. The women home based workers still work while they were in the shelter and make their work as the mental healing also as the economic healing. Therefore, when others can do anything and live in sadness, the women home based workers rise up quickly, mentally, and economically.

### **1. The Women Home Based Workers Role in The Emergency Phase**

The women home workers almost every day work in bad condition and limited facilities, the condition that make they can work at the refugee shelter when others can do anything. The women home based workers still work at the shelter. They make the work as the stress management and the mental healing, the first step to rise up the spirit of life. The stress

management by working, likes the women based home workers did, are not in the Disaster Management Organization program yet, also in the women home based workers organization. The important of the knowledge about stress management in the disaster management with work must be one of the programs of the women home based workers organization as their education program. One-step forward, for the women home based workers and for the disaster management.

When the women home based workers or all the refugee work at the shelter, they can release their stress because of the energy and thought can be manage, feel useful and not desperate. Work as the mental healing is the first step to rise up the spirit of life for the refugee. In addition, with work they can make income and make their economic life rise up again. The women home based workers can be a leader for the other refugee to rise up again. Therefore, the women home based workers not only become the pillar of the family economic but also become the pillar of the community economic, even in the disaster condition.

Stress management by work never in the Disaster Management program, so the women home based workers organization can make the program for upgrade the knowledge of the women home based workers, especially face the disaster form the climate change. Stress management by work makes the refugee have income, raise the human dignity, and avoid the beggar mindset.

## 2. The Women Home Workers Role in The Rehabilitation Phase

After pass the emergency phase, so the rehabilitation phase comes. In the rehabilitation phase, the women home based workers will be ready mentally and economically and can be stand alone as the human being. Work in the limited condition and facilities, when disaster comes they can work and rehabilitated themselves. So, they can avoid become beggar and only wait the donor. The women home based workers can live as the normal human being as soon as possible, they can rehabilitate their mental and economic quickly.

## 3. The Women Home Workers Role in The Reconstruction Phase

After pass the rehabilitation phase, so the reconstruction phase comes. The women home based workers in the reconstruction phases can do the advocacy. The advocacy for the economic, social, and culture rights as Indonesia citizen. The women home based workers must be demanding the economic structure and infrastructure, especially for the capital and production facilities.

Therefore, the women home based workers can be a leader and the locomotive for the economic rise up only in their family but for the community and society, rise up from the buried condition because of the natural disaster and the climate change. Therefore, the women home based workers can avoid the bad impact of the natural disaster become worst. The important role of the women home

based workers is to empower themselves, and be become leader for the community when they face the natural disaster because of the climate change.

## CONCLUSION

### THE WOMEN HOME BASED WORKERS PREPAREDNESS

#### 1. The Natural Victims and Looses Threat

The family member life; the important paper; production facilities; and assets

*“The biggest losses from the disaster are the family member”*

#### 2. Disaster Management by The Women Home Based Workers

##### a. Mitigation

- Prepare mentally and physically if the disaster come suddenly;
- involving in disaster evacuation training;
- Putting the important paper and the production facilities and make it easy to evacuate;
- Being productive and work to make the sustainable economic for the family.

##### b. Emergency Phase

- 1) Evacuation priority, in order: first the family member life, second the important

paper, third the production facilities, and the last one are assets.

- 2) When live in shelter actively help the public kitchen, health post, and other activities.
- 3) Light production activities to reduce the stress and make the income so can live stand-alone and not live in dependable anymore.

#### **c. Rehabilitation Phase**

After passed the disaster and back home the rehabilitation phase start with the trauma healing with work. Home working activities are the one of the way to heal the trauma and rehabilitate the economic.

The purposes of rehabilitation phase are:

- 1) Manage and reduce the stress with sublime the stresses to the productive activities like do home working.
- 2) Prepare and heal the economic condition, so the refugee can stand alone as soon as possible and not dependable to the donation.

*“Create the mechanism of trauma and economic healing by themselves and became the leader of community healing.”*

#### **d. Reconstruction Phase**

The reconstruction begins with the build activities, usually government and the donor organization start to build the infrastructure and public facilities. The women home workers do advocacy to access the capital and the production facilities. Advocacy the economic, social, and culture rights as the citizen.

*”Become the leader of the rehabilitation and reconstruction activities, especially to heal the trauma and rise up the economic condition in the disaster area.”*

#### **REFERENCES**

International Labor Organization Conventions (ILC) No. 177-1996 about Home Based Workers

Undang-Undang No. 24 tahun 2007 tentang Penanggulangan Bencana

[www.wikipedia.org](http://www.wikipedia.org)

# **CRIMINAL AND ADMINISTRATIVE LAW ENFORCEMENT FOR BUSINESS ACTORS AS AN EFFORT TO MINIMALIZE ENVIRONMENTAL POLLUTION**

**Hassanain Haykal and Vincent Leo Saputra**

Business and investment, Faculty of Law, Maranatha Christian University  
[hassanain.haykal@gmail.com](mailto:hassanain.haykal@gmail.com)

## **ABSTRACT**

In life, human relies heavily on the environment. Environment as a place to survive must be able to support all the activities and needs of the organs inside, where health is one of the requirements. Today, we have encountered the pollution of the environment in various regions of the earth. The cause of pollution comes from various fields, which one of them was waste that dumped by factories. In fact, the existence AMDAL documents and supervisory roles often unable to accommodate the prevention of environmental pollution. Many businesses have the document, in fact, many of waste disposed are not in accordance with the AMDAL analysis. We must realize that problematic environment will cause problems for other living beings too. Thus, it takes an effort from the government in order to minimize the environmental pollution by implementing normative sanctions for business actors who allegedly pollute the environment. The sanctions that going to be enforced in an effort to minimize the the pollution of the environment that criminal sanctions and administrative sanctions. However, is the existence of these penalties can be enforced in order to minimize the environmental pollution?

**Keywords:** *administrative sanctions, criminal sanctions, business actor, environmental pollution*

## **INTRODUCTION**

Environment is a place for man in implementing various activities in life. If an environment experience damage, for certain situation of mortal in it will also experience damage. In globalization era, environmental contamination problem become a thing that is often we met, where one of the contamination cause is because of man business activity like industry, transportation, and other.

To minimize the contamination of the environment, government had an obligation to protect its citizen. One of governmental effort for the agenda of minimalizes environmental contamination that is by forming regulation which in it arranges sanction stipulating. This meant that business perpetrator are made to obeying law order which has been specified, so that level of contamination can be minimized. Sanction is standing supporting facilities influences behavior of man. Applicable sanction in minimalizes

environmental contamination are criminal sanction and administrative sanction. This scientific paper will study straightening of criminal sanction and administrative sanction for perpetrator effort at corporation scope. With the existence of sanction applied, business perpetrators would expected to realize the long-range impact of damage of area as result of some business actions which they do.

## MATERIAL(S) AND METHOD(S)

### 1. Material

Material applied in writing of this scientific paper refers to secondary material, where secondary material consist of primary law material, secondary , and tertiary.

#### 1. Primary law material

Primary legal materials covers legislation related to environmental management.

#### 2. Secondary law material

Book material comprising information about primary material , consisted of explanation of related [code/law] to explanation of inviters , seminar materials that related to environment.

#### 3. Tertiary law material

Supporter law material that provide clues to primary law material and secondary law material, consisted of : legal dictionary Belanda-Indonesia, *Black's Law Dictionary*, and *Collin Dictionary*.

### 2. Method

The writing of this scientific paper applies method of law normative, that is by examining law area secondary data in the form of litelature data by using deductive<sup>1</sup> and coherent criterion of truth<sup>2</sup> method . Research character applied in this research done is a descriptive analysis which describes the matters relating to the implementation of the Mediation. While the approach that applied is conceptual research approach. In that case assessment and testing was conducted logically to the legal concepts (conceptual approach) regarding criminal penalties and alternative sanctions. The author will

---

<sup>1</sup> Deductive way of thinking is a way of thinking that the conclusion drawn from something of general nature which already proved right and the conclusion was addressed to something special, see further in Sedarmayanti dan Syarifudin Hidayat. *Metodologi Penelitian*. Bandung: Mandar Maju, 2002 hlm.23

<sup>2</sup> Coherent truth is a knowledge, theory, statement, proposition, or hypothesis considered true if aligned with knowledge, theory, statement, proposition or other hypothesis, that is if the proposition was confirmed and consistent with the previous proposition which is assumed true see further in A. Sonny Keraf & Mikhael Dua. *Ilmu Pengetahuan (Sebuah Tinjauan Filosofis)*. Yogyakarta: 2001, hlm.68.

conduct research with reference to the legal principles and doctrines that exist.

### **Factors of the Law Enforcement Legal System in Indonesia**

According to the Lawrence M. Freidman, the legal system has three main components that is legal structure, legal substance, and legal culture. These three components determine each other, as well influence each other, these components consist of:

1. Legal structure includes elements of structure that portray the legal institutions of law enforcement duties and law making.
2. The substance of law includes the rules, norms, and principles of law.
3. Cultural law covers public trust in law, values, ideas, and expectations of society.

Based on these opinions, in the amongst substance of the law, legal structure, and legal culture must be mutually sustainable in order to create a comprehensive law protection that can be realized.

Application component of legal substances in an effort to create a legal protection in regulatory policy in the field of the

environment is influenced by the principles of common law, environmental law principles, and the principles of civil law. First, the principle of common law include justice, expediency, and certainty. Second, the principle of economic law includes the principle of state intervention. And third, the principle of freedom of contract includes civil law, konsensualitas principle, the principle of good faith, the principle of confidentiality, the principle of law equality and the principle of balance. Application components in an effort to create a legal structure relating to the law protection of officials / law enforcement agencies in implementing the regulation in the field of economic policy which is influenced by the general principles of good governance which includes the principle of legal certainty, the orderly administration of the state, public interest, transparency, proporsionalistas, professionalism, accountability, efficiency principle and the principle of effectiveness. Application of law relating to the culture of component of business people in an effort to create a legal protection in the field of the environment is influenced by the principles of business ethics and good corporate governance principles, including transparency, accountability principle, the principle of responsibility, the principle of



independence, and the principle of fairness.

Application component of legal substances in an effort to create a legal protection in regulatory policy in the field of the environment is influenced by the principles of common law, and the principles of environmental laws. First, the principle of common law include justice, expediency, and certainty. Application of law relating to the culture of component of business people in an effort to create a legal protection in the field of the environment is influenced by the principles of business ethics and good corporate governance.

Application of sanctions is part which can not be removed from the embodiment of law enforcement in a law system. As noted by Talcott Parson, the main function of the law system is integrative, it means to reduce the elements of potential conflict in the society and to smooth the process of social interaction. With obeying the legal system, social interaction system will function properly, without the possibility of turning into overt or covert conflict that is chronic. Further stated, for the legal system to run integrative function

effectively, there are four issues that must be resolved first, namely<sup>3</sup>:

1. Legitimacy, that is the factors that will be the foundation for compliance with the rules.
2. Interpretation, that is issues concerning factors . determining the rights and obligations of the subject, through the process of setting certain rules.
3. Sanctions, factors that define whether a sanction will arise if there is compliance and any kind of sanction that would arise in case of denial of the rule, and as well affirm who shall apply the sanctions.
4. Jurisdiction, that is factors that define the lines of authority ruling confirms legal norms.

### **Criminal and Administrative Public Policy In Indonesian Law System Related to Environment**

One of the most important instrument in the enforcement of sanctions that is generated by the law itself. What is meant by a particular sanction is a result that arises or that may be caused by human behavior which can be applied to the perpetrator or actions that is concerned

---

<sup>3</sup> Talcott Parson. *The Social System*. Newyork : The Free Press, 1951

regarding the obligation to abide by the rules of behavior. Legal sanctions are directly related to the effectiveness of the law, namely the ability of legal norms influence human behavior in daily life which rooted in the will of human itself.

The way to entry into force of the rules of law that occur through the imposition of possible law consequences of certain so-called law sanction to a particular person as a result of certain actions. So the law sanction is a certain legal consequences that can be imposed on a person or group of persons regarding the actions abide by or not abide by the rule of law. In general, law enforcement can be interpreted can be interpreted as action to apply peripheral supporting facilities for law that meant to guarantee adhering of applicable law rule.<sup>4</sup>

The element that exists in law enforcement can be divided into two major parts, that is, elements that have a level of relevance which between distant and close one. The element law enforcement can be summarized into three elements: lawmaker, law enforcement and the public. In a simple concept (positivistic understanding), law enforcement already begun by the time the legal regulations made or created (as input). About it, just

---

<sup>4</sup> Asep Warlan Yusuf, *Penegakan Hukum Administrasi (Artikel)* : disampaikan pada September 2004

needs a bit explanation, and it can be concluded that the law enforcement is a process of realizing what is stated in the law to real life.<sup>5</sup>

Considering the imposition of sanctions may result deprivation of liberty (imprisonment), possessions (foreclosures), honor even one life (death penalty), hence in a state application of legal sanctions law was carried out according to the procedure (process) as outlined in the law criminal procedure. This is done so that the in a state exercised its right to enforce law obedient with regard to the rights of the accused as citizens and as human dignity. It is the embodiment of “Sila Prikemanusiaan” from Pancasila.<sup>6</sup>

In addition to the criminal penalties there are other sanctions are considered able to minimize deviation against norms stipulated in legislation, that is called the administrative sanctions. In the implementation of was rule contains commands, prohibitions, obligations. The rule law has meaning as if it can be imposed upon any person, in the form of action called with sanctions. Sanctions is very important in law, including in an

---

<sup>5</sup> William J Cambliss & Robert B. Seidman. *Law; Order and Power*. Addison-Wesley: Reading Mass , 1971, page 12-14

<sup>6</sup> Mochtar Kusumaatmadja dan B. Arief Sidharta. *Loc Cit.*

administrative law. The typical administrative law sanctions include:

1. Bestuurdwang (government coercion)
2. The recall decision (decree) favorable (permits, etc.)
3. Imposition of fines.
4. The Forcible imposition of money by the government (dwangsom).

Authority to implement administrative sanctions is basically a "discretionary power" or independent authority.

Therefore, the government was authorized to consider and evaluate whether to use or not of that authority. Government may not use the authority to impose sanctions (non-enforcement) with a variety of considerations, such as for some reason:

1. instrument of coercion is not sufficient;
2. no ability to cause the Forcible;
3. Other efforts which more effective and efficient for a deterrent effect for perpetrators, and;
4. Another reason that does not allow the application of administrative sanctions objectively rational.

However, position and action for "non-enforcement" nor position to apply sanction is not a position without

considering rational and objective measure. It mean, that "they" may specify sanction and may also don't apply sanction that is done subjectively and groundless (reason) strong, logical and responsible. Such attitude is a wrong attitude in applying the "discretionary power". The application of these powers should be done with extra caution and carefully, that in practice is often defined as a wise and prudent policy (discretion is the better part of valor), but without ignoring the function and purpose (enforcement) law itself.<sup>7</sup>

Administrative sanctions that can be shaped after the refusal to permits issued temporary licenses (preventive) or revoke permissions that have been granted (repressive), is much more effective to force people to comply with the provisions of law that govern business and industry and environmental protection than criminal sanctions.<sup>8</sup>

Sanctions are an important part in the law, which is to create consistency of law enforcement. Another aspect of the sanctions aimed at upholding the rule of law, adhered by everyone, so that law can be run in the manner intended, that is to create order, certainty and fairness. In the

<sup>7</sup> Asep warlan Yusuf. *Sanksi Administrasi (Artikel)*. : disampaikan pada Agustus 2004

<sup>8</sup> Mochtar Kusumaatmadja dan B. Arief Sidharta. *Op Cit*, hlm 47

implementation, the rule contains commands, prohibitions, obligations. The rule has the meaning as law when imposed upon any person, in the form of action that called by sanctions.

**Criminal and Administrative Penalties Enforcement In Order To Minimize Environmental Pollution Related to Act No. 32 Year 2009 on Environmental Management.**

According to the Act No. 32, criminal sanctions against business actors that conduct environmental pollution may be subject to criminal sanctions in the form of imprisonment and fines. Criminal sanctions is cumulative sanction, for example is the act contained in Article 97 to 120 Act No. 32 / 2009. Although the sanctions imprisonment and fines varies, it shows the government has the political will to enforce sanctions for business actors that pollute the environment.

Meanwhile, civil penalties stipulated in Law No. 32 of 2009 consists of: a written reprimand, government coercion, environmental license suspension, revocation of environmental permits. Administrative sanctions does not relieve management of the organization and activities of criminal responsibility and recovery. Imposition of administrative

sanctions in the form of suspension or revocation of environmental permits as referred to be done if the business is carrying out government coercion.

Government coercion as referred to in Article 76 paragraph (2) letter b of Law 32/2009 are:

1. temporary cessation of production activities;
2. transfer of production facilities;
3. sewerage or emissions closing;
4. demolition;
5. confiscation of goods or equipment that could potentially cause violations;
6. suspension of all activities, or
7. Other measures aimed at stopping violations and actions to restore environment function.

The imposition of government coercion can be imposed without prior reprimand when violation(s) pose

1. very serious threat to humans and the environment;
2. greater impact if not immediately stopped ; and
3. greater losses to the environment if not immediately stopped .

Keep in mind that the every person in charge of business and / or activities that do not implement the government coercion can be fined for any delays in the implementation of government-imposed sanctions.

## CONCLUSIONS AND SUGGESTIONS

It was concluded that the enforcement of criminal and administrative sanctions are important, especially in efforts to minimize environmental pollution by business actors and so that people abide by the rules set by the government trying to start protecting the environment. The government must be serious in the enforcement of criminal and administrative sanctions involving elements of the apparatus and the role of the people so that criminal and administrative sanctions can be fully enforced. The Government needs to act decisively against the efforts towards collusion and corruption that hinder enforcement sanctions.

## REFERENCES

A. Sonny Keraf & Mikhael Dua. *Ilmu Pengetahuan (Sebuah Tinjauan Filosofis)*, 2001 .Yogyakarta

Prof. Dr. jur. Andi Hamzah, 2005. *Penegakan Hukum Lingkungan* . Sinar Grafika, Jakarta

Jimly Asshiddiqie, *Mahkamah Konstitusi dan Cita Negara Hukum Indonesia: Refleksi Pelaksanaan kekuasaan kehakiman pasca amandemen UUD 1945*. MaPPI-FHUI

Mochtar Kusumaatmadja dan B. Arief Sidharta. *Pengantar Ilmu Hukum (Suatu Pengenalan Pertama Ruang Lingkup Berlakunya Ilmu Hukum.2000 Alumni, Bandung*

*Kitab Undang-Undang Hukum Pidana Indonesia*

Otto Soemarwoto 1988. *Analisis Mengenai Dampak Lingkungan*. Gadjah Mada University Press , Yogyakarta

Sedarmayanti dan Syarifudin Hidayat. *Metodologi Penelitian*, 2002 Mandar Maju , Bandung

Sukanda Husin, S.H., LL.M. 2009. *Penegakan Hukum Lingkungan Indonesia*. Sinar Grafika, Jakarta

Sunarjati Hartono, 1977 *.Apakah Rule of Law itu?*, Gramedia, Jakarta

Prof. Dr. Takdir Rahmadi, S.H., LL.M. , 2011. *Hukum Lingkungan di Indonesia*. RajaGrafindo Persada, Jakarta

Talcott Parson, 1951. *The Social System*. Newyork : The Free Press

UNDANG-UNDANG REPUBLIK INDONESIA. NO. 32 TAHUN 2009. *TENTANG. PERLINDUNGAN DAN PENGELOLAAN LINGKUNGAN HIDUP*

William J Cambliss & Robert B. Seidman, 1971 *Law; Order and Power*. Addison-Wesley: Reading Mass

Indonesian Act 2009 / No . 32 *Protection and Management of Environment ( Undang-Undang Perlindungan Dan Pengelolaan Lingkungan Hidup*

## ARTICLE

Asep warlan Yusuf, Agustus 2004 *Sanksi Administrasi (Artikel)*.

Asep Warlan Yusuf ,September 2004 *Penegakan Hukum Administrasi ( Artikel)*



# THE QUALITY CHANGES OF BLACK TIGER SHRIMP (*Penaeus monodon*) DURING HANDLING BY SEAFOOD SERVICE ESTABLISHMENTS

**Inneke Hantoro, Ita Sulistyawati, and Novia Natalie**

Department of Food Technology; Faculty of Agricultural Technology; Soegijapranata Catholic University, Semarang, Indonesia  
[inneke.hantoro@yahoo.com](mailto:inneke.hantoro@yahoo.com)

## ABSTRACT

Shrimp is very perishable and have a very limited shelf-life. Thus, appropriate handling during post-harvest is very crucial in order to extend the freshness and shelf-life of shrimp. Moreover, good handling also can prevent shrimp from pathogenic microorganism contamination, which may cause food poisoning. Shrimp is one of favorite seafood sold in various kinds of food service, starting from street vendors to restaurants. Each food service has different behaviors regarding seafood handling. The aim of this study was to evaluate the quality changes in black tiger shrimp during handling in different seafood service establishments in Semarang. Behavior of shrimp handling in food services was observed at three street vendors and two seafood restaurants. The shrimp sampling were done at different handling steps in those food services, including at the arrival, after washing, and after storage. The quality changes of the shrimp during handling were assessed using sensory, physicochemical and microbial analysis. This study showed that during handling in both type of food services the acceptance of the shrimp decreased gradually due to its appearance and texture changes. Quality of shrimp was influenced by its quality at procurement step and the storage condition. Proper handling resulted in a decrease of microbial counts. The recommendation for improvement of the shrimp handling will also be discussed. The challenge for implementation of the improvement of shrimp handling is not only related to food handlers in food services, but also to other food supply chain actors, such as fishermen, sellers, and distributors. Food safety literacy and appropriate behaviors of all actors involved in shrimp supply chain are required.

**Keywords:** *shrimp, food service, handling*

## INTRODUCTION

Black tiger shrimp (*Penaeus monodon*) is one of popular seafood in Semarang. Many seafood restaurants and seafood street vendors provide shrimp as main courses in their menu. Shrimp becomes favorite seafood for many people, since it has a good taste and high nutritional values. However, shrimp is categorized as a very perishable food, which can easily deteriorate during handling and storing. In order to maintain shrimp quality

and safety, appropriate handling must be applied by food handlers in food services.

The quality of shrimp can rapidly change during handling due to the activity of microorganisms and enzymatic reaction (Arvanitoyannis & Varzakas, 2009). These changes will effect not only on shrimp cooking quality but also on sensory and safety aspects.

Quality degradation in shrimp can be indicated based on some characteristics including, color,

flavor, odor, and texture. Muscle color is an important factor in consumer perception of meat quality. Consumers mostly associate color with freshness (Korel & Balaban, 2011). Improper handling may cause discolorations, which indicated by excessive yellowing or orange-reddish tints, as a result of thermal abuse and exposure. Prolonged handling may impart a bleached appearance (Jones, 2000). The appearance of blackspot (melanosis) also shows the poor quality of shrimp as a result of poor handling. Melanosis is the most common discoloration in shrimp, appearing as blackened strips between the shell segments (Jones, 2000; Adachi & Hirata, 2011).

Aroma is one of the most important determinants of seafood quality and can profoundly affect consumer acceptability. The fresh shrimp will has mild and pleasant shrimp smell. Spoiled shrimp begin to emit and ammonia smell (Jones, 2000).

Temperature abuse and poor hygiene during shrimp handling may lead to the growth both spoilage and pathogenic microorganisms. *E. coli*, *Salmonella*, *Staphylococci* and *Vibrio cholera* have been indentified in black tiger shrimp (Arvanitoyannis & Varzakas, 2009). These microorganisms can pose negative effects on human health.

Each food service establishment has different behaviors in handling. The behaviors may be influenced by knowledge background, sanitation facilities, and personal hygiene behaviors. Those factors will determine the

quality of food they cooked and served to consumers. Since shrimp is very sensitive to quality changes and one of the food poisoning sources, the observation on shrimp pre-cooked handling at different seafood services is required. The observation results may be used to get a better picture in what level the handling should be carefully done in order to get palatable and safe shrimp.

The aim of this study was to evaluate the quality changes in black tiger shrimp during handling by food service establishment in Semarang.

## **METHODOLOGY**

This research focused on the effects of black tiger shrimp handling at seafood street vendors and restaurants in Semarang on its quality.

### **Data Collection**

Visits to three street vendors namely SV1, SV2, SV3 and two restaurants namely R1 and R2 were undertaken by purposive random sampling method, during which shrimp handlers were interviewed to collect information. More data was collected through observation of services and facilities offered by the food services. The data collected was recorded on questionnaires with key questions of the food quality survey include among others source of the shrimp, quality criterion for shrimp selection, storage technique, procedure of handling (SNI 01—2728.3-2006), type of shrimp deterioration, and



duration of handling from procurement until before processing.

### **Shrimp Sampling**

Approximately 300 g sample was taken from each food service on the day of the procurement and was plastic packed and kept in the icebox prior to the analysis. The sample was taken at the arrival, after washing and after storage.

### **Microbiological Analysis**

*Sample preparation.* - Samples were further prepared aseptically for microbiological analysis by cutting out using sterile tools for approximately 100 g. As much as 25 g of the samples was put into sterile plastic, 225 mL of sterile aquadest was added and homogenized for 2 minutes.

*Total Plate Count (TPC).* - After homogenization, samples were serially plated using the pour-overlay method on Plate Count Agar (PCA), and aerobically incubated for 24 hours at  $35 \pm 1$  °C and counted as colony forming units (CFUs/g) according to SNI 01-2332.3-2006.

### **Organoleptics Test**

The organoleptics test was performed by six-trained panelist. Shrimp samples from five food services were served taken from three different steps of handling. The panelists then were asked to score the freshness of the shrimp range from one to nine according to

appearance, odor, and texture (SNI 01-2728.1-2006).

### **Physical Quality Measurement**

*Color measurement.* - This measurement was performed using Chromameter Minolta according to Silva *et al.* (2005). Prior to the measurement, the Chromameter was standardized using white reference tiles ( $Y=93,4$ ;  $x=0,3132$ ;  $y=0,3195$ ). The results were expressed in three color aspects:  $L^*a^*b^*$  and was done in triplicates.

*Texture analysis.* - Hardness and springiness of samples were measured with Texture Profile Analysis (TPA) method using LLOYD TA Plus. A ball probe with 500N capacity, test speed of 5 mm/s, trigger of 25 gf, normal length of 20 mm and 25% sample compression were applied in the measurement in triplicates.

### **Chemical Analysis**

*Moisture content.* - Moisture content was determined by drying samples in an oven at 105°C until constant weight was obtained (Apriyantono *et al.*, 1989).

*Total volatile basic nitrogen (TVB-N)/Trimethylamine (TMA) Analysis.* - The TVB-N and TMA were determined according to Apriyantono *et al.* (1989).

### **Data Analysis**

Data in numbers were calculated using Microsoft Excel and presented as Means  $\pm$  Standard Deviation; the data were

recapitulated in tables and figures. Significant differences of physicochemical characteristics of shrimp among the food services during handling were tested using the One-Way ANOVA F-test, continued with Post-hoc Duncan. Analyses were conducted using SPSS software package (version 13.0 for Windows).

## **RESULTS AND DISCUSSION**

### **Shrimp Handling Procedure**

The source of shrimp of the SVs mostly came from traditional markets, where they could not have choices for quality shrimp. Moreover, by stored it for two days could cause worse quality of shrimp since there was no standard for shrimp/ice ratio and non uniform of ice during storage. The soaking- in-water thawing performed by SV1 and SV3 would potentially reduce the quality. It could get worsen if the duration of cooling in the ice box during opening hours were too long or even some were restored again for tomorrow (Table 1).

### **The quality changes of shrimp during handling**

During handling the quality of shrimp seemed changed, which could be recognized by respondents through organoleptic test. This was described by the reduction of organoleptic score in terms of appearance, aroma, and texture (Table 2). However, the organoleptic score of all shrimp samples still above the minimal score required by SNI (minimal 7), except for samples taken from SV1. Since arrival, samples from SV1 showed discoloration of muscle and pinkish color in the head area. The color became more

prominent after washing and storage. Pinkish tint could be a sign that the shrimp was not fresh anymore. Jones (2000) stated temperature abuse during post-harvest handling may cause the appearance of reddish-orange tint in shrimp.

One of freshness indicators of raw shrimp is texture. During handling, shrimp texture insignificantly change ( $p < 0.05$ ), except in shrimp taken from SV2 and R1 (Table 4). The shrimp texture from SV2 became softer after storage, while shrimp texture from R1 became less firm. Fresh shrimp is relatively firm, and then becomes mushy and soft during iced storage (Nunak & Schleining, 2011). Erickson *et al.* (2007) have reported that during storage the texture became soft due to the protein degradation.

Seafood freshness and spoilage can be determined based on trimethylamine (TMA) and total volatile basic nitrogen (TVB-N) contents. The concentrations of TMA and TVB-N which indicate good quality of seafood are 15 mg/ 100g and 30 mg/ 100 g respectively (Ali *et al.*, 2010). Graph 1 demonstrated the chemical changes (TMA and TVB-N contents) of black tiger shrimp samples during handling. The graph depicted the differences of chemical quality of shrimp samples taken from arrival point from all food service establishments. This indicated the difference quality of shrimp received by food service establishments from suppliers. The lowest TMA and TVB-N concentration of initial shrimp samples (from arrival point)

were found in sample from SV2. Both TMA and TVB-N contents of samples taken from all food service establishments increased during handling.

The significant increase of TMA concentrations ( $p < 0.05$ ) during handling, especially after storage, was found in samples from SV1, SV2, and R1 (Graph 1a). The highest TMA concentration was observed in sample SV1 after storage, which was about 14.75 mg/ 100 g. However, the concentration of TMA in all samples still fulfilled the limit of good quality indicator of seafood (15 mg TMA/ 100g). TMA is produced by decomposition of trimethylamine oxide (TMAO), which is caused by bacterial activity and partly by intrinsic enzymes (Debevere and Boskou, 1996; Mitsubayashi *et al.*, 2004). TMA is the main compound in seafood which is responsible for an undesirable fishy odor (McGee, 2004).

TVB-N found in shrimp samples showed the presence of ammonia ( $\text{NH}_3$ ), which described spoilage phenomenon for seafood. Volatile bases are mainly caused by microbiological activity (Noseda *et al.*, 2010). Graph 1b showed that the concentration of TVB-N in shrimp samples observed from all food service establishments not significantly increased during handling. TVB-N found in all samples was below 30 mg/ 100g, the maximum limit of good quality indicator. The concentration of volatile nitrogen bases increases after death, the increase is influenced by storage duration and conditions (Belitz *et al.*, 2009). The result

of TVB-N assessment was in agreement microbial load changes during handling (Graph 2). The reduction of microbial density could influence the formation of TVB-N.

Washing and storing shrimp at cold condition definitely suppressed the growth of microorganisms (Graph 2). The exemption was found in samples taken after storage from R2. This might occurred due to the storage condition applied by R2. During storage, shrimp was stored in ice box. However the ratio of shrimp to ice was not considered well. It probably caused insufficient temperature (not enough ice) for inhibiting the growth of microorganism. The microbial density in all samples was below 5 log cfu/ g, which still fulfilled standard required by SNI. The maximum microbial density based on SNI 01-2728.1-2006 is 5.69 log cfu/g.

## CONCLUSION(S)

Different food service establishments showed different behaviors in shrimp handling, especially in washing, storing, and applying the amount of ice for preserving shrimp freshness. Washing and storage were very important for maintaining the quality of shrimp. Besides those two steps, the quality of shrimp was influence by the quality of shrimp origin. Thus, proper sorting method was required to get the good quality of shrimp before further handling steps.

## REFERENCES

- Adachi, K. & T. Hirata. (2011). *Blackening of crustaceans during storage: mechanism and prevention*. In: Alasalvar, C., F. Shahidi, K. Miyashita., & U. Wanasundara (Eds.). (2011). *Handbook of Seafood Quality, Safety and Health Applications*. Blackwell Publishing Ltd. Oxford.
- Ali, Y. M., M. I. Sharif, R. K. Adhikari, & O. Faruque. (2010). *Post mortem variation in total volatile base nitrogen and trimethylamine nitrogen between Galda (Macrobrychium rosenbergii) and Bagda (Penaeus monodon)*. *Rajshahi University Zoological Society*, 28: 7 – 10.
- Apriyantono, A., D. Fardiaz, N.L. Puspitasari, Sedarnawati and S. Budiyo. (1989). *Laboratory Manual of Food Analysis*. IPB Press. Bogor (in Indonesian)
- Arvanitoyannis, I. S. & T. H. Varzakas. (2009). *Seafood*. In: Arvanitoyannis, I. S. (Ed). 2009. *HACCP and ISO 22000: Application to Foods of Animal Origin*. Blackwell Publishing Ltd. Oxford.
- Belitz, H.-D., W. Grosch & P. Schieberle. (2009). *Food Chemistry 4th revised and extended edition*. Springer, Berlin.
- Debevere, J. & G. Boskou. (1996). *Effect of modified atmosphere packaging on the TVB/TMA-producing microflora of cod fillets*. *International Journal of Food Microbiology*, 31: 221 – 229.
- Erickson, M. C., M. A. Bulgarelli, A. V. A. . Resurrection, R. A. Vendetti & K. A. Gates. (2007). *Sensory differentiation of shrimp using a trained descriptive analysis panel*. *Lebensm. Wiss. U. Technol*, 40: 1774 – 1783.
- Jones, B. (2000). *Seafood Product Quality Code*. Southern Fisheries Association, Inc. Florida.
- Korel, F. & M. Ö. Balaban. (2011). *Quality assessment of aquatic foods by machine vision, electronic nose, and electronic tongue*. In: Alasalvar, C., F. Shahidi, K. Miyashita., & U. Wanasundara (Eds.). 2011. *Handbook of Seafood Quality, Safety and Health Applications*. Blackwell Publishing Ltd. Oxford.
- McGee, H. (2004). *On Food and Cooking: The science and lore of the kitchen*. Scribner. New York.
- Mitsubayashi, K., Y. Kubotera, K. Yano, Y. Hashimoto, T. Kon, & S. Nakakura. (2004). *Trimethylamine biosensor with flavin-containing monooxygenase type 3 (FMO3) for fish-freshness analysis*. *Sensors and Actuators B: Chemical*, 103: 463 – 467.
- Nosedá, B., J. Dewulf., J. Goethals., P. Ragaert., I. van Bree., D. Pauwels., H. Van Langenhove, & F. Devlieghere. (2010). *Effect of food matrix and pH on the volatilization of base (TVB) in packed north atlantic gray shrimp (Crangon crangon): volatile bases in MAP fishery products*. *Journal Agricultural Food Chemistry*, 58: 11864 – 11869.
- Nunak, N. & G. Schleining, G. 2011. *Instrumental textural changes in raw white shrimp during iced storage*. *Journal of Aquatic Food Product Technology*, 20: 350 – 360.
- SNI 01-2728.1-2006.(2006). *Specification of Fresh Shrimp*. National Bureau of Standardization. (in Indonesian)
- SNI 01-2728.3-2006.(2006). *Handling and Processing of Fresh Shrimp*. National Bureau of Standardization. (in Indonesian)
- SNI 01-2332.3-2006. (2006). *Microbiological Testing Methods-Part 3: Determination of Total Plate Count (TPC) in Seafood*. National Bureau of Standardization. (in Indonesian)



**Table 1** Fresh black tiger shrimp handling from procurement until before processing at five food services

Specification	Shrimp Handler				
	SV1	SV2	SV3	R1	R2
1. Source of shrimp	Peterongan Traditional Market	Kobong Traditional Market	Tambak Lorok Fish Market, Tanjung/Kobong Traditional Market	Supplier	Supplier
2. Procurement time and Frequency	09.00 am; every two days	06.00 am; every day or every two days	06.00 am; every two days	10.00 am; every two or three days	10.00 am; every three days
3. Selection criteria	Texture: hard and compact	Texture: elastic Appearance: wholesome	Texture: hard	Selection was done by the supplier	Texture: hard Odor: fresh Color: blackish green
4. Size uniformity of ice; shrimp & ice ratio	n.a.	Non uniformity; not available	Non uniformity; not available	Non uniformity; not available	n.a.
5. Shrimp handling*					
Arrival	Sorting according to the texture	Sorting according to the texture	Sorting according to the texture	Sorting according to the texture	Sorting according to the texture
First washing	Running clean water	Running clean water	n.a.	Running clean water three times	Soaking in a plastic container, was added with lemon juice
Sortation	Upon arrival	Upon arrival	Upon arrival	Upon arrival at the restaurant	Upon arrival at the restaurant
Washing II	After storage, soaking in water once	-	After storage, soaking in water one or two times	After storage, soaking in water once	-
Weighing	Based on size: large (13 pieces) and small (15 pieces); was done prior to cooking	Estimation	Estimation; was done prior to cooking	Weighing per portion (four pieces)	Weighing per portion (150 g)
Packing	Plastic container	Plastic container	Plastic container	Transparent plastic bag + Plastic container	Transparent plastic bag + Plastic container

Storage	In the freezer; moved to ice box with ice addition prior to opening hours	In the ice box with ice addition	In the ice container with ice addition; moved to plastic container with ice addition prior to opening hours	In the freezer	In the ice box with ice addition
6. Size uniformity of ice; shrimp & ice ratio	Non uniformity; 8 kg of crushed ice in one ice box	Non uniformity; 2 kg of shrimp; 4 kg crushed ice	Non uniformity; no certain ratio of shrimp and ice	No ice; in the freezer	Non uniformity; no certain ratio of shrimp and ice
7. Storage condition	Together with other seafood	Together with other seafood	Together with other seafood	Together with other seafood but with barrier	Together with other seafood
8. Duration of handling before storage	± 10 minutes	± 10 minutes	± 10 minutes	± 10 minutes	± 15 minutes

\* = Steps of handling process according to SNI 01-2728.3-2006

n.a. = Not available















**Table 2.** The changes of sensory characteristics of black tiger shrimp during handling at different food handlers

Shrimp handler	Sampling time	Sensory parameters		
		Appearance	Aroma	Texture
SV <sub>1</sub>	Arrival	6.92 ± 0.67	6.92 ± 0.67	6.92 ± 0.67
	After washing	6.75 ± 0.87	6.92 ± 0.67	6.92 ± 0.67
	After storage	6.67 ± 0.78	6.67 ± 0.78	6.50 ± 0.90
SV <sub>2</sub>	Arrival	8.00 ± 0.74	7.83 ± 0.72	7.83 ± 0.72
	After washing	7.92 ± 0.62	7.67 ± 0.49	7.75 ± 0.45
	After storage	7.67 ± 0.49	7.50 ± 0.58	7.58 ± 0.51
SV <sub>3</sub>	Arrival	7.17 ± 0.83	7.00 ± 0.74	7.08 ± 0.79
	After washing	7.08 ± 0.79	7.00 ± 0.74	7.08 ± 0.79
	After storage	7.00 ± 0.74	6.92 ± 0.67	7.00 ± 0.74
R <sub>1</sub>	Arrival	7.75 ± 0.62	7.70 ± 0.52	7.75 ± 0.75
	After washing	7.67 ± 0.78	7.33 ± 0.49	7.50 ± 0.67
	After storage	7.58 ± 0.67	7.33 ± 0.49	7.50 ± 0.52
R <sub>2</sub>	Arrival	7.33 ± 0.49	7.25 ± 0.45	7.17 ± 0.83
	After washing	7.33 ± 0.49	7.17 ± 0.39	7.08 ± 0.29
	After storage	7.25 ± 0.45	7.17 ± 0.39	7.25 ± 0.45

Note: Based on SNI 01-2728.1-2006 the requirement of organoleptic score for fresh shrimp is minimal 7, with 9 is the best score and 1 is the worst score



**Table 3.** The changes of black tiger shrimp appearance during handling at different food handlers

Shrimp handler	Sensory parameters		
	Arrival	After washing	After storage
SV <sub>1</sub>			
SV <sub>2</sub>			
SV <sub>3</sub>			
R <sub>1</sub>			
R <sub>2</sub>			

**Table 4.** The changes of black tiger shrimp texture during handling at different food handlers

Shrimp handler	Sampling time	Texture	
		Hardness (gf)	Springiness (mm)
SV <sub>1</sub>	Arrival	1980.58 ± 72.79 <sup>abcd</sup>	3.42 ± 0.37 <sup>bcd</sup>
	After washing	1974.35 ± 60.66 <sup>bcd</sup>	3.37 ± 0.43 <sup>cde</sup>
	After storage	1943.25 ± 39.14 <sup>d</sup>	3.17 ± 0.28 <sup>e</sup>
SV <sub>2</sub>	Arrival	2147.64 ± 112.42 <sup>a</sup>	3.94 ± 0.13 <sup>a</sup>
	After washing	2115.26 ± 66.91 <sup>abc</sup>	3.92 ± 0.12 <sup>ab</sup>
	After storage	2091.62 ± 83.86 <sup>bcd</sup>	3.75 ± 0.22 <sup>abcd</sup>
SV <sub>3</sub>	Arrival	2021.18 ± 113.61 <sup>abcd</sup>	3.62 ± 0.13 <sup>bcd</sup>
	After washing	2005.67 ± 146.42 <sup>abcd</sup>	3.58 ± 0.12 <sup>bcd</sup>
	After storage	1964.95 ± 102.98 <sup>cd</sup>	3.52 ± 0.27 <sup>de</sup>
R <sub>1</sub>	Arrival	2084.23 ± 109.27 <sup>ab</sup>	3.93 ± 0.27 <sup>a</sup>
	After washing	2066.21 ± 90.71 <sup>abcd</sup>	3.74 ± 0.36 <sup>abc</sup>
	After storage	2051.90 ± 74.76 <sup>abcd</sup>	3.48 ± 0.37 <sup>bcd</sup>
R <sub>2</sub>	Arrival	2044.96 ± 121.83 <sup>abcd</sup>	3.88 ± 0.17 <sup>bcd</sup>
	After washing	2043.27 ± 108.04 <sup>abcd</sup>	3.77 ± 0.33 <sup>bcd</sup>
	After storage	2030.07 ± 111.38 <sup>abcd</sup>	3.59 ± 0.18 <sup>cde</sup>

Note:

All data presented were means ± Standard Deviation.

The different superscripts in the same column indicate the significant differences ( $P < 0.05$ ).

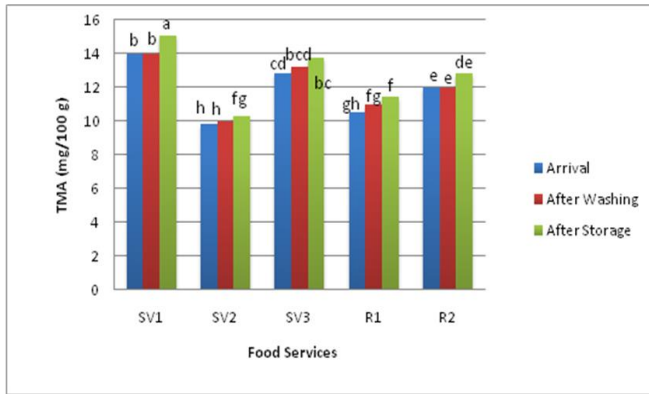

(a)

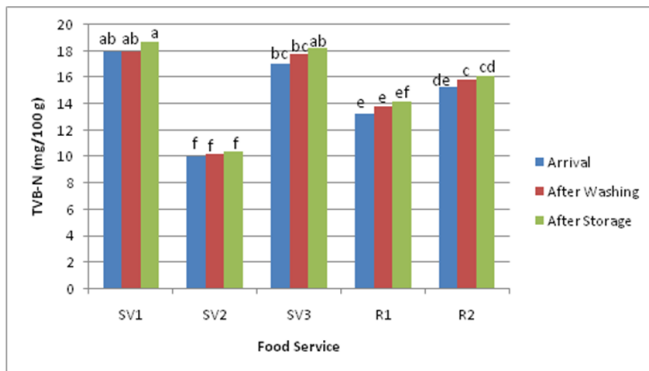

(b)

**Graph 1.** Chemical quality of black tiger shrimp at five food services: (a) TMA (mg N/100 g); (b) TVB-N (mg/100 g)

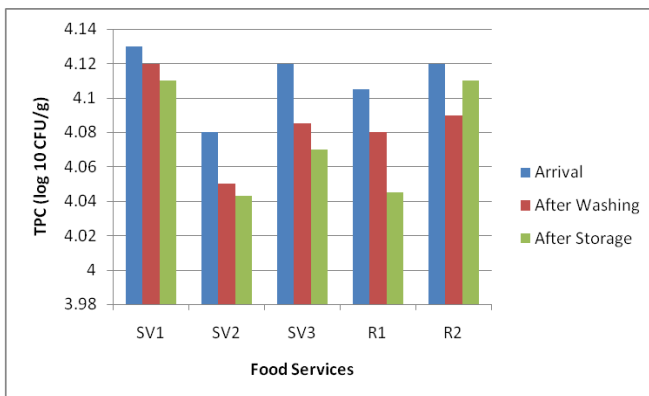

**Graph 2.** Microbiological quality of black tiger shrimp at five food services according to the Total Plate Count