

Matsuda, H.  
Osaka J. Math.  
40 (2003), 801–833

## ON THE ADDITIVITY OF THE CLASP NUMBER OF KNOTS

HIROSHI MATSUDA

(Received February 12, 2002)

### 1. Introduction

It is of great interest to know whether a knot invariant is additive under connected sum. The genus  $g(K)$  of a knot  $K$  is additive [13], that is,  $g(K_1\#K_2) = g(K_1) + g(K_2)$ , where  $K_1\#K_2$  denotes a connected sum of two knots  $K_1$  and  $K_2$ . For the braid index  $b(K)$  of a knot  $K$ , Birman and Menasco [1] showed that  $b(K) - 1$  is additive, that is,  $b(K_1\#K_2) - 1 = (b(K_1) - 1) + (b(K_2) - 1)$ . For the tunnel number  $t(K)$  of a knot  $K$ , it is known that  $t(K)$  is not additive under connected sum. See, for example, [8], [9], [5]. In this paper, we study the additivity of the clasp number of knots which is defined in the following.

Let  $K$  be a knot in  $S^3$ . We denote by  $f$  an immersion  $f: D \rightarrow S^3$  of a disc  $D$  into  $S^3$  such that  $f|_{\partial D}: \partial D \rightarrow K$  is a homeomorphism onto  $K$ . Let  $\tilde{\Sigma}$  denote the singular set  $\{x \in f(D) \mid |f^{-1}(x)| \geq 2\}$  of the immersion  $f$ , and let  $\Sigma$  denote  $f^{-1}(\tilde{\Sigma})$  on  $D$ . The following lemma is a special case of Lemma 1 in [14]. See also Lemma 1 in [15].

**Lemma 1.1.** *We may choose an immersion  $f$  so that each connected component of  $\Sigma$  is an embedded arc on  $D$  joining a point in  $\partial D$  and a point in  $\text{int } D$ .*

Note that this immersion  $f$  satisfies  $\{x \in f(D) \mid |f^{-1}(x)| \geq 3\} = \emptyset$ . An immersed disc  $B = f(D)$  with these properties is called a *clasp disc* of  $K$ . Fig. 1.1 illustrates a clasp disc of a trefoil knot. Let  $cp_B(K)$  denote the number of connected components of  $\tilde{\Sigma}$  in  $B$ . The minimal number of  $cp_B(K)$  among all clasp discs  $B$  of  $K$  is called the *clasp number* of  $K$ , denoted by  $cp(K)$ . Shibuya defined also the clasp number of a link in  $S^3$ . See Definition 3 in [14]. We refer to Appendix for the clasp number of prime knots of eight or fewer crossings except  $8_{18}$ . The following proposition is a special case of Theorem 1 in [14].

**Proposition 1.2.** *Let  $K$  be a knot in  $S^3$ . Then we have inequalities  $cp(K) \geq g(K)$  and  $cp(K) \geq u(K)$ , where  $u(K)$  denotes the unknotting number of  $K$ .*

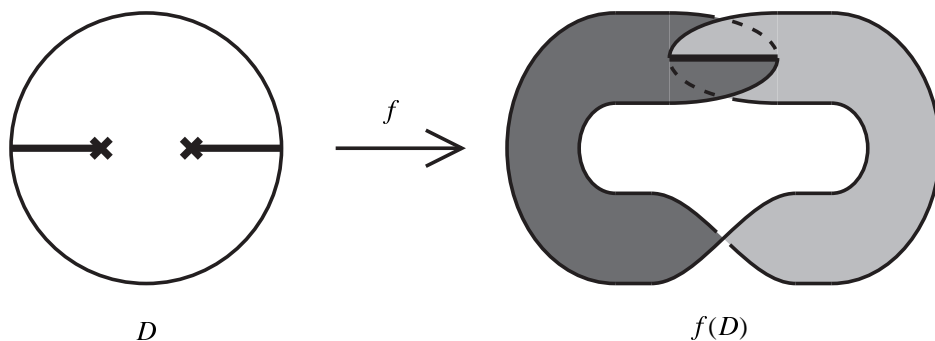

Fig. 1.1.

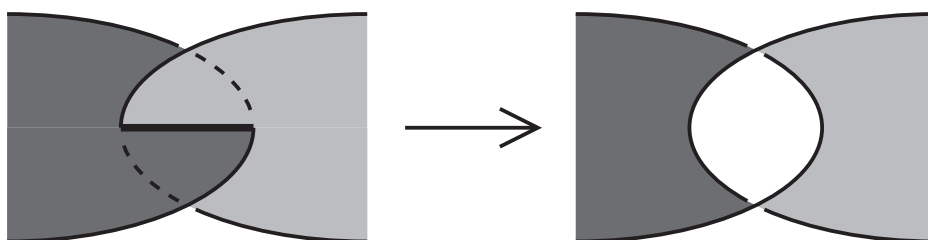

Fig. 1.2.

Fig. 1.2 illustrates a sketch of an operation to show the inequality  $cp(K) \geq g(K)$ . In [14], Shibuya called the operation, illustrated in Fig. 1.2, an orientation preserving cut along a clasp arc. This operation has been also called a smoothing.

Using Proposition 1.2, Morimoto [7] determined the clasp number of torus knots. Note that the genus of a torus knot of type  $(p, q)$  is  $(|p| - 1)(|q| - 1)/2$ . See, for example, Theorem 7.5.2 in [10]. Since the unknotting number of a torus knot of type  $(p, q)$  is equal to  $(|p| - 1)(|q| - 1)/2$  (see [3], [4]), we obtain the following theorem.

**Theorem 1.3.** *Let  $K$  be a torus knot of type  $(p, q)$ . Then the clasp number of  $K$  is  $(|p| - 1)(|q| - 1)/2$ , that is,  $cp(K) = g(K) = u(K)$ .*

Concerning the additivity of  $cp(K)$ , Morimoto made the following conjecture in [6].

**Conjecture 1.4.**  $cp(K_1 \# K_2) = cp(K_1) + cp(K_2)$ .

He obtained a partial solution to this conjecture in the same paper.

**Theorem 1.5** ([6]). *If  $cp(K_1 \# K_2) \leq 2$ , then  $cp(K_1 \# K_2) = cp(K_1) + cp(K_2)$ .*

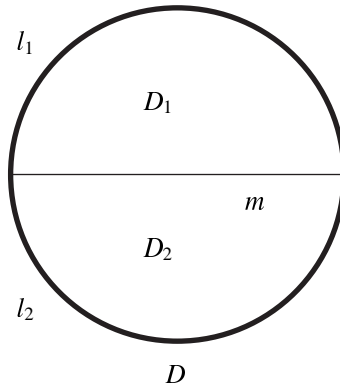

Fig. 2.1.

In this paper, we prove the following theorem.

**Theorem 1.6.** *Let  $K_1, K_2$  be non-trivial knots. If  $cp(K_1\#K_2) = 3$ , then  $cp(K_1) = 1$  and  $cp(K_2) = 2$ .*

Together with Theorem 1.5, we obtain the following corollary.

**Corollary 1.7.** *If  $cp(K_1\#K_2) \leq 3$ , then  $cp(K_1\#K_2) = cp(K_1) + cp(K_2)$ .*

**2. Preliminary lemmas**

Let  $B = f(D)$  be a clasp disc of  $K$  with  $cp_B(K) = cp(K)$ . Let  $K = K_1\#K_2$  denote a knot which is a connected sum of two non-trivial knots  $K_1$  and  $K_2$ . Then there exists a 2-sphere  $S$  which realizes a non-trivial decomposition of  $K = K_1\#K_2$ . We may isotope  $S$  so that  $S$  intersects  $B$  and  $\tilde{\Sigma}$  transversely. Let  $T$  denote the set  $f^{-1}(S \cap B)$  on  $D$ . Then  $T$  consists of a properly embedded arc  $m$  in  $D$  and some simple closed curves embedded in  $int D$ . Let  $D_1$  and  $D_2$  denote discs in  $D$  such that  $D_1 \cap D_2 = m$  and  $D_1 \cup D_2 = D$ , and let  $l_i$  ( $i = 1$  and  $2$ ) denote the arc  $D_i \cap \partial D$ . See Fig. 2.1. Let  $Q_i$  be the 3-ball which is bounded by  $S$  in  $S^3$  and which contains the arc  $f(l_i)$ . Let  $k$  be a simple arc on  $S$  which connects the two points of  $f(\partial D) \cap S = K \cap S$ . We may regard the knot  $K_i$  as the union of two arcs  $k$  and  $f(l_i)$ . In the following,  $Z_i$  ( $Z = D, K, l, \dots$ , etc.) denotes  $Z_1$  or  $Z_2$ .

Loop components of  $T$  separate  $D_i$  to many regions. Let  $\bar{D}_i$  denote the region in  $D_i$  separated by loop components of  $T$  such that  $l_i$  is a subarc of  $\partial \bar{D}_i$ . If there is no loop component of  $T$  in  $D_i$ , then  $\bar{D}_i$  is  $D_i$  itself. Let  $g$  be the restriction of  $f$  to  $\bar{D}_i$ . Let  $\tilde{\Sigma}_i$  denote the set  $\{x \in g(\bar{D}_i) \mid |g^{-1}(x)| \geq 2\}$ , and let  $\Sigma_i$  denote  $g^{-1}(\tilde{\Sigma}_i)$  on  $\bar{D}_i$ . By the definition of a clasp disc, a connected component of  $\Sigma_i$  on  $\bar{D}_i$  belongs to one of arcs of the following four types (see Fig. 2.2);

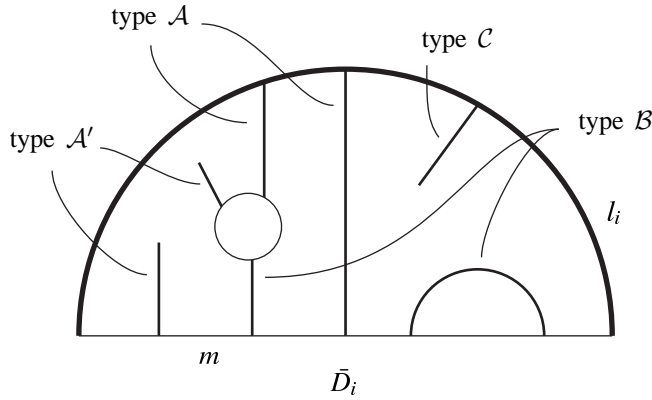

Fig. 2.2.

- type  $A$ : an arc which connects a point in  $l_i$  and a point in  $cl(\partial\bar{D}_i - l_i)$ ,
- type  $A'$ : an arc which connects a point in  $int \bar{D}_i$  and a point in  $cl(\partial\bar{D}_i - l_i)$ ,
- type  $B$ : an arc which connects two distinct points in  $cl(\partial\bar{D}_i - l_i)$ ,
- type  $C$ : an arc which connects a point in  $int \bar{D}_i$  and a point in  $l_i$ .

Note that an arc of type  $A$  is identified by  $g$  with an arc of type  $A'$ , that an arc of type  $B$  with another arc of type  $B$ , and that an arc of type  $C$  with another arc of type  $C$ . Let  $X_i$  denote the union of endpoints of arcs of types  $A'$  and  $C$  in  $int \bar{D}_i$ . The following lemma is essentially the same as Lemma 1 (2) in [6]. We refer to [6] for a proof.

**Lemma 2.1.** *Let  $\alpha$  be an arc of type  $A$  on  $\bar{D}_i$ . Suppose that  $\alpha$  and a subarc of  $m$  together with a subarc of  $l_i$  cobound a disc  $\delta$  with  $(int \delta) \cap \Sigma_i = \emptyset$  on  $\bar{D}_i$ . Then there are a surface  $D_i^*$  and an immersion  $g^*: D_i^* \rightarrow Q_i$  satisfying the following properties;*

- (i) *The surface  $D_i^*$  is homeomorphic to  $\bar{D}_i$ ,*
- (ii) *Every connected component of  $(g^*)^{-1}(\{x \in g^*(D_i^*) \mid |(g^*)^{-1}(x)| \geq 2\}) = \Sigma_i^*$  belongs to an arc of type  $A, A', B$  or  $C$ , where these arcs of four types are defined on  $D_i^*$  in the same way as they are on  $\bar{D}_i$ ,*
- (iii) *The numbers of arcs of types  $B$  and  $C$  in  $\Sigma_i^*$  are equal to those of types  $B$  and  $C$ , respectively, in  $\Sigma_i$ ,*
- (iv) *The numbers of arcs of types  $A$  and  $A'$  in  $\Sigma_i^*$  are strictly less than those of types  $A$  and  $A'$ , respectively, in  $\Sigma_i$ , and*
- (v) *There is a subarc  $l_i^*$  of  $\partial D_i^*$  such that  $g^*(l_i^*) = g(l_i)$  and that  $g^*(\partial D_i^* - l_i^*)$  is contained in  $S$ .*

**Lemma 2.2.** *Let  $\beta_1$  and  $\beta_2$  be arcs of type  $B$  on  $\bar{D}_i$  with  $g(\beta_1) = g(\beta_2)$ . Suppose that  $\beta_1$  and  $\beta_2$  together with two subarcs of  $\partial\bar{D}_i - l_i$  cobound a disc  $\delta$  in  $\bar{D}_i$ . Then there are a surface  $D_i^*$  and an immersion  $g^*: D_i^* \rightarrow Q_i$  satisfying the following*

properties;

- (i) The surface  $D_i^*$  is homeomorphic to  $\bar{D}_i$ ,
- (ii) Every connected component of  $(g^*)^{-1}(\{x \in g^*(D_i^*) \mid |(g^*)^{-1}(x)| \geq 2\}) = \Sigma_i^*$  belongs to an arc of type  $\mathcal{A}$ ,  $\mathcal{A}'$ ,  $\mathcal{B}$  or  $\mathcal{C}$ , where these arcs of four types are defined on  $D_i^*$  in the same way as they are on  $\bar{D}_i$ ,
- (iii) The numbers of arcs of types  $\mathcal{A}$ ,  $\mathcal{A}'$  and  $\mathcal{C}$  in  $\Sigma_i^*$  are equal to those of types  $\mathcal{A}$ ,  $\mathcal{A}'$  and  $\mathcal{C}$ , respectively, in  $\Sigma_i$ ,
- (iv) The number of arcs of type  $\mathcal{B}$  in  $\Sigma_i^*$  is strictly less than that of type  $\mathcal{B}$  in  $\Sigma_i$ , and
- (v) There is a subarc  $l_i^*$  of  $\partial D_i^*$  such that  $g^*(l_i^*) = g(l_i)$  and that  $g^*(\partial D_i^* - l_i^*)$  is contained in  $S$ .

Proof. Let  $V$  denote a regular neighborhood  $N(g(\beta_1); Q_i)$  of the arc  $g(\beta_1) = g(\beta_2)$  in  $Q_i$ . We may choose  $V$  so that  $g(\bar{D}_i) \cap V$  consists of two discs  $g(N(\beta_1; \bar{D}_i))$  and  $g(N(\beta_2; \bar{D}_i))$ . The disc  $g(N(\beta_1; \bar{D}_i))$  intersects  $g(N(\beta_2; \bar{D}_i))$  transversely along the arc  $g(\beta_1) = g(\beta_2)$ . We regard  $V$  as the set  $\{(x, y, z) \mid x^2 + y^2 \leq 1, 0 \leq z \leq 1\}$  so that two discs of  $V \cap S$  correspond to  $\{(x, y, 0) \mid x^2 + y^2 \leq 1\}$  and  $\{(x, y, 1) \mid x^2 + y^2 \leq 1\}$ . We may assume that  $g(N(\beta_1; \bar{D}_i))$  corresponds to  $\{(x, 0, z) \mid -1 \leq x \leq 1, 0 \leq z \leq 1\}$ , and that  $g(N(\beta_2; \bar{D}_i))$  corresponds to  $\{(0, y, z) \mid -1 \leq y \leq 1, 0 \leq z \leq 1\}$ . We may also assume that  $g(\delta) \cap V$  corresponds to the union of  $\{(x, 0, z) \mid 0 \leq x \leq 1, 0 \leq z \leq 1\}$  and  $\{(0, y, z) \mid 0 \leq y \leq 1, 0 \leq z \leq 1\}$ . Let  $\tilde{d}_1$  be the disc  $\{(x, y, z) \mid x^2 + y^2 = 1, x \geq 0, y \leq 0, 0 \leq z \leq 1\}$ , and  $\tilde{d}_2$  be the disc  $\{(x, y, z) \mid x^2 + y^2 = 1, x \leq 0, y \geq 0, 0 \leq z \leq 1\}$ .

Now we define an immersion  $g^*$  of a surface  $D_i^*$  into  $Q_i$ . Let  $g^*(D_i^*)$  be the immersed surface which is the union of  $g(\bar{D}_i - N(\beta_1 \cup \beta_2; \bar{D}_i))$ ,  $\tilde{d}_1$  and  $\tilde{d}_2$ . By this construction,  $g^*(D_i^*)$  satisfies the properties (ii)–(v).

The surface  $D_i^*$  is the union of  $\bar{D}_i - N(\beta_1 \cup \beta_2; \bar{D}_i)$ ,  $d_1$  and  $d_2$ , where  $d_j$  ( $j = 1$  and  $2$ ) is a disc corresponding to  $\tilde{d}_j$ . Since  $\tilde{d}_1$  may be regarded as a band which connects two arcs  $\{(1, 0, z) \mid 0 \leq z \leq 1\}$  and  $\{(0, -1, z) \mid 0 \leq z \leq 1\}$ , the disc  $d_1$  may be regarded as a band which connects the subarc  $c_{1,1}$  of  $\partial N(\beta_1; \bar{D}_i)$  and the subarc  $c_{1,2}$  of  $\partial N(\beta_2; \bar{D}_i)$ , where  $g(c_{1,1}) = \{(1, 0, z) \mid 0 \leq z \leq 1\}$  and  $g(c_{1,2}) = \{(0, -1, z) \mid 0 \leq z \leq 1\}$ . Similarly, the disc  $d_2$  may be regarded as a band which connects the subarc  $c_{2,1}$  of  $\partial N(\beta_1; \bar{D}_i)$  and the subarc  $c_{2,2}$  of  $\partial N(\beta_2; \bar{D}_i)$ , where  $g(c_{2,1}) = \{(-1, 0, z) \mid 0 \leq z \leq 1\}$  and  $g(c_{2,2}) = \{(0, 1, z) \mid 0 \leq z \leq 1\}$ . We notice that  $g(\delta)$  is either an immersed annulus or an immersed Möbius band in  $Q_i$ , because  $g(\beta_1) = g(\beta_2)$ . This construction of  $D_i^*$  shows that  $D_i^*$  is homeomorphic to  $\bar{D}_i$ .  $\square$

Fig. 2.3 (1) illustrates a sketch of the operation described in the proof of Lemma 2.2. Similar arguments as in the proof of Lemma 2.2 show the following two lemmas. See Fig. 2.3 (2) and (3) for sketches of operations to prove Lemmas 2.3 and 2.4, respectively.

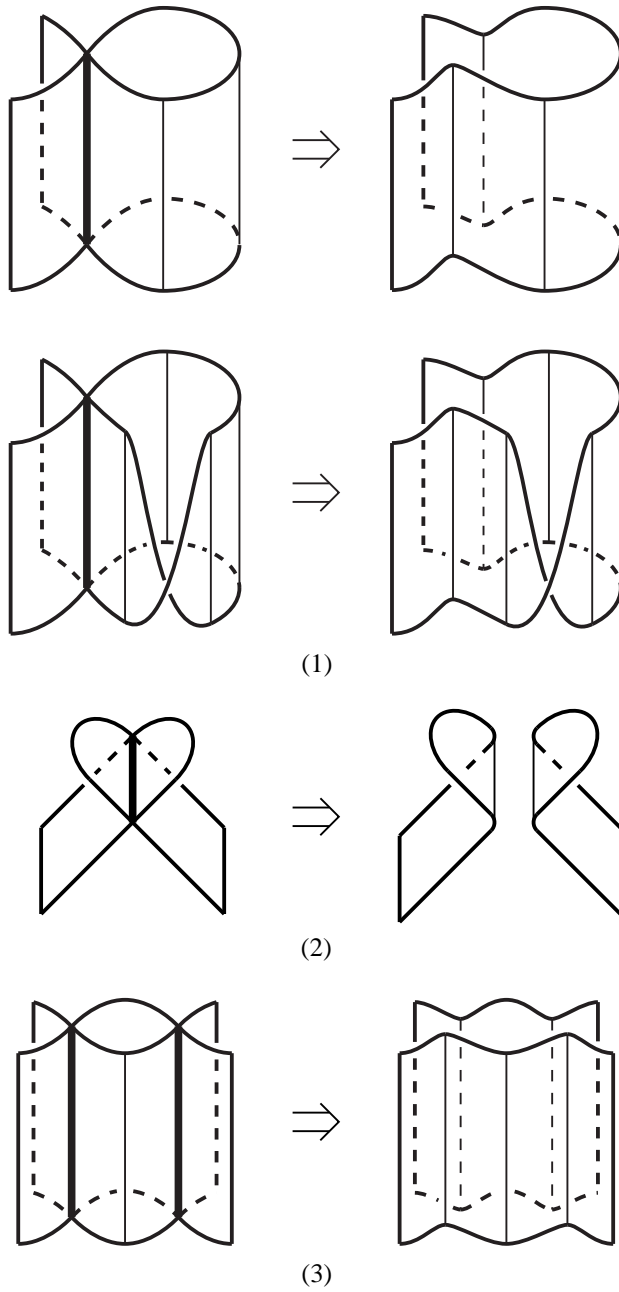

Fig. 2.3.

**Lemma 2.3.** *Let  $\beta_1$  and  $\beta_2$  be arcs of type  $\mathcal{B}$  on  $\bar{D}_i$  with  $g(\beta_1) = g(\beta_2)$ . Suppose that  $\beta_j$  ( $j = 1$  and  $2$ ) and a subarc of  $\partial\bar{D}_i$  cobound a disc  $\delta_j$  in  $\bar{D}_i$  such that  $\delta_1 \cap \delta_2 = \emptyset$ . Then there are a surface  $D_i^*$  and an immersion  $g^*: D_i^* \rightarrow Q_i$  satisfying the following properties;*

- (i) *The surface  $D_i^*$  is homeomorphic to  $\bar{D}_i$ ,*
- (ii) *Every connected component of  $(g^*)^{-1}(\{x \in g^*(D_i^*) \mid |(g^*)^{-1}(x)| \geq 2\}) = \Sigma_i^*$  belongs to an arc of type  $\mathcal{A}$ ,  $\mathcal{A}'$ ,  $\mathcal{B}$  or  $\mathcal{C}$ , where these arcs of four types are defined on  $D_i^*$  in the same way as they are on  $\bar{D}_i$ ,*
- (iii) *The numbers of arcs of types  $\mathcal{A}$ ,  $\mathcal{A}'$  and  $\mathcal{C}$  in  $\Sigma_i^*$  are equal to those of types  $\mathcal{A}$ ,  $\mathcal{A}'$  and  $\mathcal{C}$ , respectively, in  $\Sigma_i$ ,*
- (iv) *The number of arcs of type  $\mathcal{B}$  in  $\Sigma_i^*$  is strictly less than that of type  $\mathcal{B}$  in  $\Sigma_i$ , and*
- (v) *There is a subarc  $l_i^*$  of  $\partial D_i^*$  such that  $g^*(l_i^*) = g(l_i)$  and that  $g^*(\partial D_i^* - l_i^*)$  is contained in  $S$ .*

**Lemma 2.4.** *Let  $\beta_1, \beta_2, \gamma_1$  and  $\gamma_2$  be arcs of type  $\mathcal{B}$  on  $\bar{D}_i$  with  $g(\beta_j) = g(\gamma_j)$  for  $j = 1$  and  $2$ . Suppose that  $\beta_1, \beta_2$  and two subarcs of  $\partial\bar{D}_i$  cobound a disc  $d_\beta$  in  $\bar{D}_i$ , and that  $\gamma_1, \gamma_2$  and two subarcs of  $\partial\bar{D}_i - l_i$  cobound a disc  $d_\gamma$  in  $\bar{D}_i$  such that  $d_\beta \cap d_\gamma = \emptyset$ . Suppose also that  $g(d_\beta) \cup g(d_\gamma)$  forms an immersed annulus in  $Q_i$ . Then there are a surface  $D_i^*$  and an immersion  $g^*: D_i^* \rightarrow Q_i$  satisfying the following properties;*

- (i) *The surface  $D_i^*$  is homeomorphic to  $\bar{D}_i$ ,*
- (ii) *Every connected component of  $(g^*)^{-1}(\{x \in g^*(D_i^*) \mid |(g^*)^{-1}(x)| \geq 2\}) = \Sigma_i^*$  belongs to an arc of type  $\mathcal{A}$ ,  $\mathcal{A}'$ ,  $\mathcal{B}$  or  $\mathcal{C}$ , where these arcs of four types are defined on  $D_i^*$  in the same way as they are on  $\bar{D}_i$ ,*
- (iii) *The numbers of arcs of types  $\mathcal{A}$ ,  $\mathcal{A}'$  and  $\mathcal{C}$  in  $\Sigma_i^*$  are equal to those of types  $\mathcal{A}$ ,  $\mathcal{A}'$  and  $\mathcal{C}$ , respectively, in  $\Sigma_i$ ,*
- (iv) *The number of arcs of type  $\mathcal{B}$  in  $\Sigma_i^*$  is strictly less than that of type  $\mathcal{B}$  in  $\Sigma_i$ , and*
- (v) *There is a subarc  $l_i^*$  of  $\partial D_i^*$  such that  $g^*(l_i^*) = g(l_i)$  and that  $g^*(\partial D_i^* - l_i^*)$  is contained in  $S$ .*

For a positive integer  $p$  and an immersion  $g^p: \bar{D}_i^p \rightarrow Q_i$ ,  $l_i^p$  denotes, in the following, the subarc of  $\partial\bar{D}_i^p$  with  $g^p(l_i^p) = g(l_i)$ , and  $\Sigma_i^p$  denotes the set  $(g^p)^{-1}(\{x \in g^p(\bar{D}_i^p) \mid |(g^p)^{-1}(x)| \geq 2\})$  on  $\bar{D}_i^p$ .

### 3. Proof of Theorem 1.6

In this section, we give a proof of Theorem 1.6 assuming propositions we prove in §§4 and 5. Suppose  $cp(K) = 3$ , so that  $\Sigma$  consists of six arcs  $\sigma_1, \dots, \sigma_6$  on  $D$ . Let  $x_j$  ( $j = 1, \dots, 6$ ) be the point  $\partial\sigma_j \cap \text{int } D$ , and  $X$  be the union of the points  $\{x_1, \dots, x_6\}$ . The following proposition is the same as Lemma 1 (3) in [6]. We refer to [6] for a proof.

**Proposition 3.1.** *Let  $\alpha$  be a loop component of  $T$ , and  $\delta_\alpha$  be the disc bounded by  $\alpha$  in  $D$ . Then there exists a 2-sphere  $S$  such that  $S$  realizes a non-trivial decomposition of  $K = K_1 \# K_2$ , and that  $|\delta_\alpha \cap X| \geq 2$  for every loop component  $\alpha$  of  $T$ .*

The following four propositions are proved in §4.

**Proposition 4.1.** *Suppose that  $\bar{D}_i = D_i$  is a disc, and that the number of points of  $X_i$  on  $\bar{D}_i$  is at most one. Then  $K_i$  is the trivial knot.*

**Proposition 4.2.** *Suppose that  $\bar{D}_i = D_i$  is a disc, and that the number of points of  $X_i$  on  $\bar{D}_i$  is two. Then the clasp number of  $K_i$  is at most one.*

**Proposition 4.5.** *Suppose that  $\bar{D}_i = D_i$  is a disc, and that the number of points of  $X_i$  on  $\bar{D}_i$  is three. Then the clasp number of  $K_i$  is at most one.*

**Proposition 4.6.** *Suppose that  $\bar{D}_i = D_i$  is a disc, and that the number of points of  $X_i$  on  $\bar{D}_i$  is four. Then the clasp number of  $K_i$  is at most two.*

The following four propositions are proved in §5.

**Proposition 5.1.** *Suppose that  $\bar{D}_i$  is an annulus, and that the number of points of  $X_i$  on  $\bar{D}_i$  is 0. Then  $K_i$  is the trivial knot.*

**Proposition 5.3.** *Suppose that  $\bar{D}_i$  is an annulus, and that the number of points of  $X_i$  on  $\bar{D}_i$  is one. Then the clasp number of  $K_i$  is at most one.*

**Proposition 5.6.** *Suppose that  $\bar{D}_i$  is an annulus, and that the number of points of  $X_i$  on  $\bar{D}_i$  is two. Then the clasp number of  $K_i$  is at most one.*

**Proposition 5.14.** *Suppose that  $\bar{D}_i$  is a twice-punctured disc, and that the number of points of  $X_i$  on  $\bar{D}_i$  is 0. Then the clasp number of  $K_i$  is at most one.*

By Propositions 3.1 and 4.1, we may suppose that  $|D_1 \cap X| \geq 2$  and  $|D_2 \cap X| \geq 2$ . Without loss of generality, we may suppose that  $(|D_1 \cap X|, |D_2 \cap X|) = (2, 4)$  or  $(3, 3)$ .

First suppose  $|D_1 \cap X| = |D_2 \cap X| = 3$ . Propositions 3.1, 4.5, 5.1, and 5.3 show that the clasp numbers of  $K_1$  and  $K_2$  are at most one. By the definition of the clasp number, we see that  $cp(K_1 \# K_2) \leq cp(K_1) + cp(K_2)$ . Hence  $cp(K_1 \# K_2) \leq 2$ . This contradicts our supposition.

Next suppose  $|D_1 \cap X| = 2$  and  $|D_2 \cap X| = 4$ . Propositions 3.1, 4.2 and 5.1 show that the clasp number of  $K_1$  is at most one. Propositions 3.1, 4.6, 5.1, 5.3, 5.6 and 5.14 show that the clasp number of  $K_2$  is at most two. Therefore we have



$cp(K_1) = 1$  and  $cp(K_2) = 2$ .

This completes the proof of Theorem 1.6. □

**4. The case where  $D_i$  contains no loop component of  $T$**

In this section, we deal with an immersed surface  $g(\bar{D}_i)$  when there is no loop component of  $T$  in  $D_i$ . Therefore  $\bar{D}_i = D_i$  is a disc.

**Proposition 4.1.** *Suppose that the number of points of  $X_i$  on  $D_i$  is at most one. Then  $K_i$  is the trivial knot.*

Proposition 4.1 is essentially the same as Claim 1 in [6].

*Proof.* First suppose  $|X_i| = 0$ . Then  $\Sigma_i$  consists only of arcs of type  $\mathcal{B}$ . By Lemma 2.3, we obtain an embedding  $g^1$  of a disc  $D_i^1$  into  $Q_i$ . This embedded disc  $g^1(D_i^1)$  shows that  $K_i$  is the trivial knot.

Next suppose  $|X_i| = 1$ . Then  $\Sigma_i$  consists of one arc of type  $\mathcal{A}$ , one arc of type  $\mathcal{A}'$  and some arcs of type  $\mathcal{B}$ . By Lemma 2.3, we obtain an immersion  $g^1$  of a disc  $D_i^1$  into  $Q_i$  such that  $\Sigma_i^1$  consists of one arc of type  $\mathcal{A}$  and one arc of type  $\mathcal{A}'$ . Then we obtain, by Lemma 2.1, an embedding  $g^2$  of a disc  $D_i^2$  into  $Q_i$ . This embedded disc  $g^2(D_i^2)$  shows that  $K_i$  is the trivial knot. □

**Proposition 4.2.** *Suppose that the number of points of  $X_i$  on  $D_i$  is two. Then the clasp number of  $K_i$  is at most one.*

*Proof.* Since  $|X_i| = 2$ ,  $\Sigma_i$  consists of either (1) two arcs of type  $\mathcal{C}$  and some arcs of type  $\mathcal{B}$ , or (2) two arcs of type  $\mathcal{A}$ , two arcs of type  $\mathcal{A}'$  and some arcs of type  $\mathcal{B}$ . In both cases, we obtain, by Lemma 2.3, an immersion  $g^1$  of a disc  $D_i^1$  into  $Q_i$  such that there is no arc of type  $\mathcal{B}$  in  $\Sigma_i^1$ .

First suppose that  $\Sigma_i^1$  consists of two arcs of type  $\mathcal{C}$ . Then the immersed disc  $g^1(D_i^1)$  shows that the clasp number of  $K_i$  is at most one.

Next suppose that  $\Sigma_i^1$  consists of two arcs of type  $\mathcal{A}$  and two arcs of type  $\mathcal{A}'$ . Let  $\alpha_1, \alpha_2$  be arcs of type  $\mathcal{A}$ , and  $\alpha'_1, \alpha'_2$  be arcs of type  $\mathcal{A}'$  such that  $g^1(\alpha_j) = g^1(\alpha'_j)$  for  $j = 1$  and  $2$ . Let  $m^1$  be the arc  $cl(\partial D_i^1 - l_i^1)$ . When we proceed on  $m^1$  from one endpoint of  $m^1$ , we may assume, by Lemma 2.1 and Proposition 4.1, that the first point of  $\Sigma_i^1 \cap m^1$  we encounter is an endpoint of an arc of type  $\mathcal{A}'$ . Hence we may assume that the order of arcs of types  $\mathcal{A}$  and  $\mathcal{A}'$  whose endpoints we encounter, when we proceed on  $m^1$  from one endpoint of  $m^1$ , is either  $\alpha'_1, \alpha_1, \alpha_2, \alpha'_2$ , or  $\alpha'_1, \alpha_2, \alpha_1, \alpha'_2$  in this order. If the order is  $\alpha'_1, \alpha_1, \alpha_2, \alpha'_2$ , then a configuration of the singular arc  $g^1(m^1)$  on  $S$  is that of Fig. 4.1 (1) or (2), up to symmetry and isotopy on  $S$ . If the order is  $\alpha'_1, \alpha_2, \alpha_1, \alpha'_2$ , then a configuration of the singular arc  $g^1(m^1)$  on  $S$  is that of Fig. 4.1 (3), up to symmetry and isotopy on  $S$ .

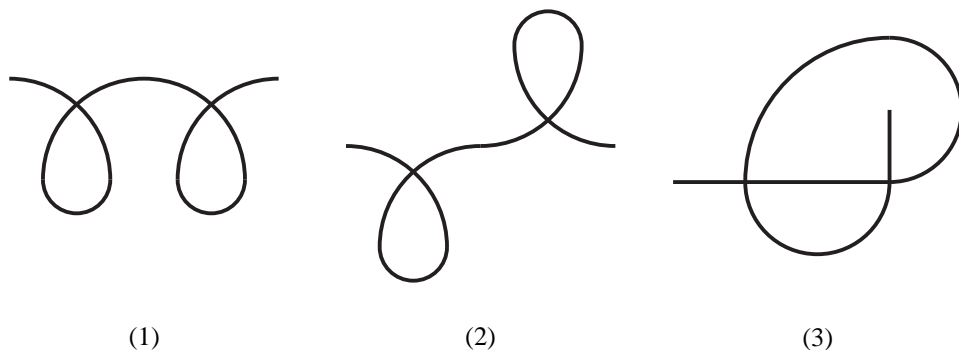

Fig. 4.1.

**Lemma 4.3.** *Suppose that a configuration of  $g^1(m^1)$  on  $S$  is that of Fig. 4.1 (1) or (2). Then  $K_i$  is the trivial knot.*

*Proof.* Suppose that the configuration is that of Fig. 4.1 (1). Let  $k$  be a simple arc on  $S$  such that  $k \cap g^1(m^1) = \partial k = g^1(\partial m^1)$ . The immersed disc  $g^1(D_i^1)$  implies that the singular arc  $g^1(m^1)$  is a projection of the arc  $g^1(l_i^1)$  to  $S$  fixing its boundary  $g^1(\partial l_i^1)$ . Therefore the union  $k \cup g^1(m^1)$  may be regarded as a projection of  $K_i$  to  $S$ . This shows that the crossing number of  $K_i$  is at most two, so  $K_i$  is the trivial knot.

Similar arguments as above prove the case in the configuration of Fig. 4.1 (2).  $\square$

**Lemma 4.4.** *Suppose that a configuration of  $g^1(m^1)$  on  $S$  is that of Fig. 4.1 (3). Then the clasp number of  $K_i$  is at most one.*

*Proof.* Let  $k$  be a simple arc on  $S$  which connects two points of  $g^1(\partial m^1)$  and which intersects  $g^1(int m^1)$  transversely in one point. The immersed disc  $g^1(D_i^1)$  implies that the union  $k \cup g^1(m^1)$  may be regarded as a projection of  $K_i$  to  $S$ . Therefore the crossing number of  $K_i$  is at most three, and the clasp number of  $K_i$  is at most one. See Appendix for the clasp number of prime knots of eight or fewer crossings except  $8_{18}$ .  $\square$

This completes the proof of Proposition 4.2.  $\square$

**Proposition 4.5.** *Suppose that the number of points of  $X_i$  on  $D_i$  is three. Then the clasp number of  $K_i$  is at most one.*

*Proof.* Since  $|X_i| = 3$ ,  $\Sigma_i$  consists of either (1) three arcs of type  $\mathcal{A}$ , three arcs of type  $\mathcal{A}'$  and some arcs of type  $\mathcal{B}$ , or (2) one arc of type  $\mathcal{A}$ , one arc of type  $\mathcal{A}'$ ,

two arcs of type  $\mathcal{C}$  and some arcs of type  $\mathcal{B}$ . In both cases, we obtain, by Lemma 2.3, an immersion  $g^1$  of a disc  $D_i^1$  into  $Q_i$  such that there is no arc of type  $\mathcal{B}$  in  $\Sigma_i^1$ .

First suppose that  $\Sigma_i^1$  consists of three arcs of type  $\mathcal{A}$  and three arcs of type  $\mathcal{A}'$ . Similar arguments as in the proof of Proposition 4.2 show that the crossing number of  $K_i$  is at most four, and the clasp number of  $K_i$  is at most one.

Next suppose that  $\Sigma_i^1$  consists of one arc of type  $\mathcal{A}$ , one arc of type  $\mathcal{A}'$  and two arcs of type  $\mathcal{C}$ . Let  $\alpha$  and  $\alpha'$  denote these arcs of types  $\mathcal{A}$  and  $\mathcal{A}'$ , respectively. Let  $V$  denote a regular neighborhood  $N(g^1(\alpha); Q_i)$  of the arc  $g^1(\alpha)$  in  $Q_i$ . We may choose  $V$  so that  $g^1(D_i^1) \cap V$  consists of two discs  $g^1(N(\alpha; D_i^1))$  and  $g^1(N(\alpha'; D_i^1))$ . The disc  $g^1(N(\alpha; D_i^1))$  intersects  $g^1(N(\alpha'; D_i^1))$  transversely along the arc  $g^1(\alpha) = g^1(\alpha')$ . We regard  $V$  as the set  $\{(x, y, z) \mid x^2 + y^2 \leq 1, 0 \leq z \leq 2\}$  so that the disc  $V \cap S$  corresponds to the set  $\{(x, y, 0) \mid x^2 + y^2 \leq 1\}$ . We suppose that  $g^1(N(\alpha; D_i^1))$  corresponds to the set  $\{(0, y, z) \mid -1 \leq y \leq 1, 0 \leq z \leq 1\}$ , and that  $g^1(N(\alpha'; D_i^1))$  corresponds to the set  $\{(x, 0, z) \mid -1 \leq x \leq 1, 0 \leq z \leq 2\}$ . See Fig. 4.2. We may suppose that an image of the outward-normal to  $D_i^1$  in  $N(\alpha; D_i^1)$  agrees with the direction of increasing  $x$ , and that an image of the outward-normal to  $D_i^1$  in  $N(\alpha'; D_i^1)$  agrees with the direction of increasing  $y$ . Let  $\tilde{d}_1$  be the disc  $\{(x, y, z) \mid x^2 + y^2 = 1, x \geq 0, y \geq 0, 0 \leq z \leq 1\}$ , and  $\tilde{d}_2$  be the disc  $\{(x, y, z) \mid x^2 + y^2 = 1, x \leq 0, y \leq 0, 0 \leq z \leq 1\}$  in  $V$ . Let  $\tilde{d}_3$  denote the disc embedded in  $V$  which is the union of discs  $\{(x, 0, z) \mid 2 - z \leq x \leq 1, 1 \leq z \leq 2\}$ ,  $\{(x, y, z) \mid x^2 + y^2 = (2 - z)^2, x \geq 0, y \geq 0, 1 \leq z \leq 2\}$ ,  $\{(0, y, z) \mid z - 2 \leq y \leq 2 - z, 1 \leq z \leq 2\}$ ,  $\{(x, y, z) \mid x^2 + y^2 = (2 - z)^2, x \leq 0, y \leq 0, 1 \leq z \leq 2\}$  and  $\{(x, 0, z) \mid -1 \leq x \leq z - 2, 1 \leq z \leq 2\}$ . We note here that the arc  $g^1(l_i^1) \cap V$  which corresponds to the set  $\{(0, y, 1) \mid -1 \leq y \leq 1\}$  is disjoint from  $\text{int } \tilde{d}_3$ , that  $\tilde{d}_3 \cap \partial V$  is an arc consisting of the three subarcs  $\tilde{d}_1 \cap \{(x, y, 1) \mid x^2 + y^2 = 1\}$ ,  $\tilde{d}_2 \cap \{(x, y, 1) \mid x^2 + y^2 = 1\}$  and  $g^1(\partial N(\alpha'; D_i^1)) \cap \{(x, y, z) \mid x^2 + y^2 \leq 1, 1 \leq z \leq 2\}$ , and that  $\partial \tilde{d}_3$  consists of the two arcs  $g^1(l_i^1) \cap V$  and  $\tilde{d}_3 \cap \partial V$ .

Now we define an immersion  $g^2$  of a surface  $D_i^2$  into  $Q_i$ . Let  $g^2(D_i^2)$  be the immersed surface which is the union of  $g^1(D_i^1 - (N(\alpha; D_i^1 - l_i^1) \cup N(\alpha'; D_i^1)))$ ,  $\tilde{d}_1$ ,  $\tilde{d}_2$  and  $\tilde{d}_3$ . We say that  $g^2(D_i^2)$  is obtained from  $g^1(D_i^1)$  by a *CP surgery* along  $g^1(\alpha)$ . A CP surgery may be regarded as a detailed explanation of a smoothing operation, illustrated in Fig. 1.2, in a regular neighborhood of an endpoint of the clasp arc. By this construction, we see that  $\Sigma_i^2$  consists of two arcs of type  $\mathcal{C}$ , and that there is a subarc  $l_i^2$  of  $\partial D_i^2$  with  $g^2(l_i^2) = g^1(l_i^1) = g(l_i)$ . Now we investigate the surface  $D_i^2$  in detail. The surface  $D_i^2$  is the union of  $D_i^1 - (N(\alpha; D_i^1 - l_i^1) \cup N(\alpha'; D_i^1))$ ,  $d_1$ ,  $d_2$  and  $d_3$ , where  $d_j$  ( $j = 1, 2$  and  $3$ ) is a disc corresponding to  $\tilde{d}_j$ . Let  $\tilde{c}_1$  be the arc  $\{(0, 1, z) \mid 0 \leq z \leq 1\}$  in  $V$ , and  $\tilde{c}_2$  be the arc  $\{(0, -1, z) \mid 0 \leq z \leq 1\}$  in  $V$ . Note that one endpoint of  $\tilde{c}_p$  ( $p = 1, 2$ ) is contained in  $S$ . Let  $c_p$  denote the arc on  $D_i^1$  with  $g^1(c_p) = \tilde{c}_p$ . Let  $\tilde{\gamma}_{1,1}$ ,  $\tilde{\gamma}_{1,2}$ ,  $\tilde{\gamma}_{2,1}$  and  $\tilde{\gamma}_{2,2}$  be the arcs  $\{(1, 0, z) \mid 0 \leq z \leq 1\}$ ,  $\{(1, 0, z) \mid 1 \leq z \leq 2\}$ ,  $\{(-1, 0, z) \mid 0 \leq z \leq 1\}$  and  $\{(-1, 0, z) \mid 1 \leq z \leq 2\}$  in  $V$ , respectively. Note that one endpoint of  $\tilde{\gamma}_{q,1}$  ( $q = 1, 2$ ) is contained in  $S$ . Let  $\gamma_{q,r}$  ( $q = 1, 2$ ;  $r = 1, 2$ ) denote the arc on  $D_i^1$  with  $g^1(\gamma_{q,r}) = \tilde{\gamma}_{q,r}$ . We may suppose, without loss

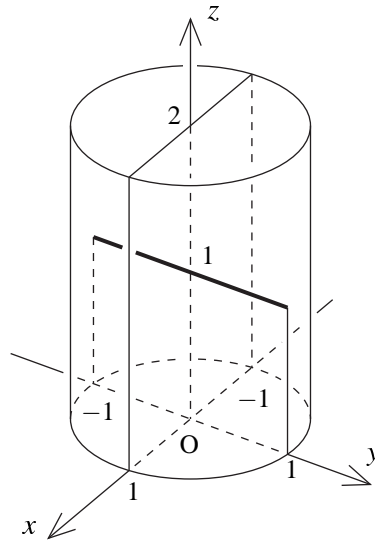

Fig. 4.2.

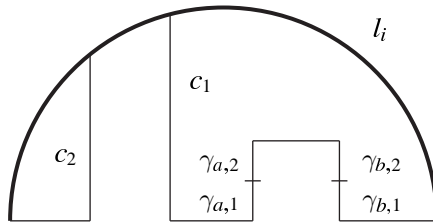

Fig. 4.3.

of generality, that Fig. 4.3 shows the location of the arcs  $c_1$  and  $c_2$  on  $\partial N(\alpha; D_i^1)$ , and the location of the arcs  $\gamma_{a,1}$ ,  $\gamma_{a,2}$ ,  $\gamma_{b,1}$  and  $\gamma_{b,2}$  on  $\partial N(\alpha'; D_i^1)$ , where  $(a, b) = (1, 2)$  or  $(2, 1)$ . Considering images of the outward-normal to  $D_i^1$  in  $N(\alpha; D_i^1)$  and  $N(\alpha'; D_i^1)$ , we see that  $(a, b) = (1, 2)$ . Since the disc  $\tilde{d}_j$  ( $j = 1, 2$ ) may be regarded as a band which connects  $\tilde{c}_j$  and  $\tilde{\gamma}_{j,1}$ , the disc  $d_j$  may be regarded as a band which connects  $c_j$  and  $\gamma_{j,1}$ . This construction of  $D_i^2$  shows that the surface  $D_i^2$  is homeomorphic to an annulus.

Let  $n^2$  denote the component of  $\partial D_i^2$  such that  $l_i^2$  is not contained in  $n^2$ . Let  $m^2$  be the arc  $cl(\partial D_i^2 - (n^2 \cup l_i^2))$ . The simple closed curve  $g^2(n^2)$  bounds a disc  $\delta$  on  $S$  such that  $g^2(m^2)$  is not contained in  $\delta$ . Isotope  $g^2(N(n^2; D_i^2)) \cup \delta$  slightly into  $int Q_i$ . Then we obtain an immersion  $g^3$  of a disc  $D_i^3$  into  $Q_i$  such that  $\Sigma_i^3$  consists of two arcs of type  $\mathcal{C}$ . This immersed disc  $g^3(D_i^3)$  shows that the clasp number of  $K_i$  is at most one. □

**Proposition 4.6.** *Suppose that the number of points of  $X_i$  on  $D_i$  is four. Then the clasp number of  $K_i$  is at most two.*

Proof. Since  $|X_i| = 4$ ,  $\Sigma_i$  consists of either (1) four arcs of type  $\mathcal{A}$ , four arcs of type  $\mathcal{A}'$  and some arcs of type  $\mathcal{B}$ , or (2) four arcs of type  $\mathcal{C}$  and some arcs of type  $\mathcal{B}$ , or (3) two arcs of type  $\mathcal{A}$ , two arcs of type  $\mathcal{A}'$ , two arcs of type  $\mathcal{C}$  and some arcs of type  $\mathcal{B}$ . In these three cases, we obtain, by Lemma 2.3, an immersion  $g^1$  of a disc  $D_i^1$  into  $Q_i$  such that there is no arc of type  $\mathcal{B}$  in  $\Sigma_i^1$ .

First suppose that  $\Sigma_i^1$  consists of four arcs of type  $\mathcal{A}$  and four arcs of type  $\mathcal{A}'$ . Similar arguments as in the proof of Proposition 4.2 show that the crossing number of  $K_i$  is at most six, and the clasp number of  $K_i$  is at most two.

Next suppose that  $\Sigma_i^1$  consists of four arcs of type  $\mathcal{C}$ . Then the immersed disc  $g^1(D_i^1)$  shows that the clasp number of  $K_i$  is at most two.

Finally suppose that  $\Sigma_i^1$  consists of two arcs of type  $\mathcal{A}$ , two arcs of type  $\mathcal{A}'$  and two arcs of type  $\mathcal{C}$ . Let  $\alpha_1, \alpha_2$  be arcs of type  $\mathcal{A}$ , and  $\alpha'_1, \alpha'_2$  be arcs of type  $\mathcal{A}'$  such that  $g^1(\alpha_j) = g^1(\alpha'_j)$  for  $j = 1$  and  $2$ . Let  $m^1$  denote the arc  $cl(\partial D_i^1 - l_i^1)$ .

Now we consider configurations of arcs of types  $\mathcal{A}$  and  $\mathcal{A}'$  on  $D_i^1$ . When we proceed on  $m^1$  from one endpoint of  $m^1$ , we may assume, without loss of generality, that the first point of  $\Sigma_i^1 \cap m^1$  we encounter is an endpoint of either  $\alpha_1$  or  $\alpha'_1$ . First suppose that the first point of  $\Sigma_i^1 \cap m^1$  is an endpoint of  $\alpha_1$ . If the second point of  $\Sigma_i^1 \cap m^1$  is an endpoint of  $\alpha'_1$ , then a configuration of arcs of types  $\mathcal{A}$  and  $\mathcal{A}'$  on  $D_i^1$  is that of Fig. 4.4 (1) or (2). In the configurations of Fig. 4.4, we omit arcs of type  $\mathcal{C}$ . If the second point of  $\Sigma_i^1 \cap m^1$  is an endpoint of  $\alpha_2$ , then the configuration is that of Fig. 4.4 (3) or (4). If the second point is an endpoint of  $\alpha'_2$ , then the configuration is that of Fig. 4.4 (5) or (6). Next suppose that the first point of  $\Sigma_i^1 \cap m^1$  is an endpoint of  $\alpha'_1$ . If the second point is an endpoint of  $\alpha_1$ , then the configuration is that of Fig. 4.4 (1) or (7), up to exchange of the suffix. If the second point is an endpoint of  $\alpha_2$ , then the configuration is that of Fig. 4.4 (6) or (8). If the second point is an endpoint of  $\alpha'_2$ , then the configuration is that of Fig. 4.4 (3) or (4), up to exchange of the suffix.

**Lemma 4.7.** *Suppose that a configuration of arcs of types  $\mathcal{A}$  and  $\mathcal{A}'$  on  $D_i^1$  is that of Fig. 4.4 (1), (2), (4), (6) or (7). Then the clasp number of  $K_i$  is at most one.*

Proof. Suppose that a configuration of arcs of types  $\mathcal{A}$  and  $\mathcal{A}'$  on  $D_i^1$  is that of Fig. 4.4 (1). Performing a CP surgery to  $g^1(D_i^1)$  along the arc  $g^1(\alpha_1) = g^1(\alpha'_1)$ , we obtain an immersion  $g^2$  of an annulus  $D_i^2$  into  $Q_i$  such that  $\Sigma_i^2$  consists of one arc of type  $\mathcal{A}$ , one arc of type  $\mathcal{A}'$  and two arcs of type  $\mathcal{C}$ . Let  $n^2$  denote the component of  $\partial D_i^2$  such that  $l_i^2$  is not contained in  $n^2$ . Let  $m^2$  be the arc  $cl(\partial D_i^2 - (n^2 \cup l_i^2))$ . The simple closed curve  $g^2(n^2)$  bounds a disc  $\delta$  on  $S$  such that  $g^2(m^2)$  is not contained in  $\delta$ . Isotope  $g^2(N(n^2; D_i^2)) \cup \delta$  slightly into  $int Q_i$ . Then we obtain an immersion  $g^3$  of a disc into  $Q_i$  such that  $\Sigma_i^3$  consists of one arc of type  $\mathcal{A}$ , one arc of type  $\mathcal{A}'$  and two

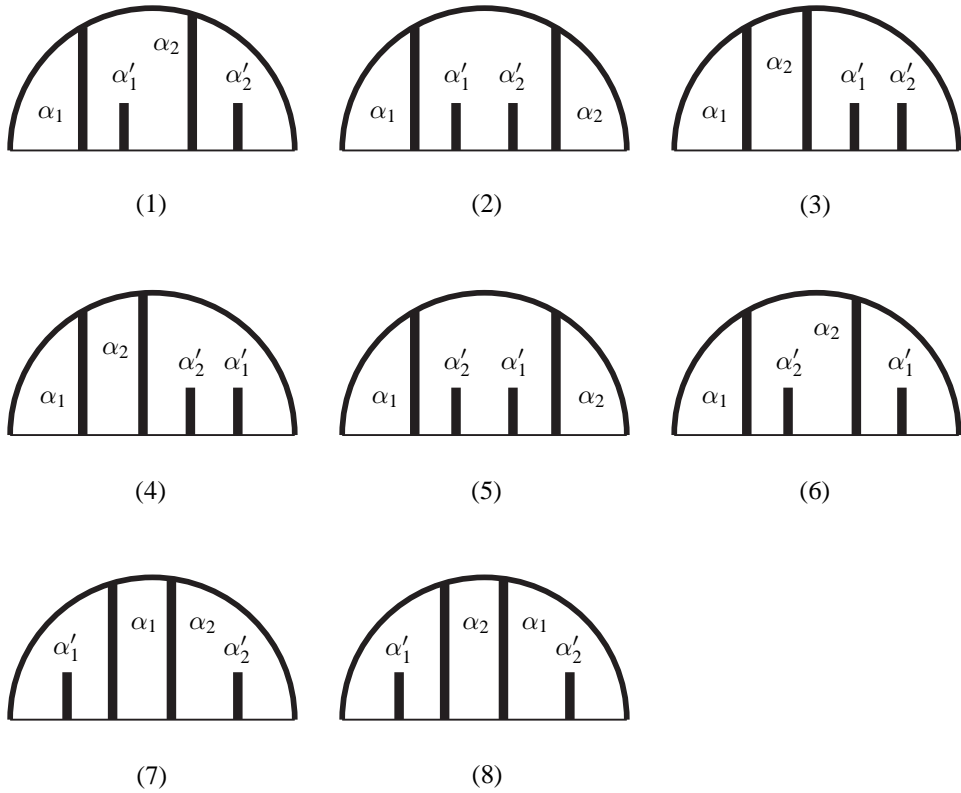

Fig. 4.4.

arcs of type  $\mathcal{C}$ . Proposition 4.5 shows that the clasp number of  $K_i$  is at most one.

Similar arguments as above prove the cases in the configurations of Fig. 4.4 (2), (4), (6) and (7).  $\square$

**Lemma 4.8.** *Suppose that a configuration of arcs of types  $\mathcal{A}$  and  $\mathcal{A}'$  on  $D_i^1$  is that of Fig. 4.4 (3) or (8). Then the clasp number of  $K_i$  is at most two.*

*Proof.* Suppose that a configuration of arcs of types  $\mathcal{A}$  and  $\mathcal{A}'$  on  $D_i^1$  is that of Fig. 4.4 (3). Performing a CP surgery to  $g^1(D_i^1)$  along the arc  $g^1(\alpha_1)$ , we obtain an immersion  $g^2$  of an annulus  $D_i^2$  into  $Q_i$  such that  $\Sigma_i^2$  consists of one arc of type  $\mathcal{A}$ , one arc of type  $\mathcal{A}'$  and two arcs of type  $\mathcal{C}$ . Let  $\alpha_2$  and  $\alpha'_2$  denote these arcs of types  $\mathcal{A}$  and  $\mathcal{A}'$  in  $\Sigma_i^2$ , respectively. Let  $n^2$  denote the component of  $\partial D_i^2$  such that  $l_i^2$  is not contained in  $n^2$ , and let  $m^2$  denote the arc  $cl(\partial D_i^2 - (n^2 \cup l_i^2))$ . The simple closed curve  $g^2(n^2)$  bounds a disc  $\delta$  on  $S$  which contains one endpoint of the simple arc  $g^2(m^2)$ . Isotope  $g^2(N(n^2; D_i^2)) \cup \delta$  slightly into  $int Q_i$ . Then we obtain an immersion  $g^3$

of a disc  $D_i^3$  into  $Q_i$ . This isotopy changes the union of the arcs  $g^2(\alpha_2) = g^2(\alpha'_2)$  and  $g^2(m^2) \cap \delta$  to a singular arc  $\gamma$  of  $g^3(D_i^3)$  such that  $(g^3)^{-1}(\gamma)$  consists of two arcs of type  $\mathcal{C}$  in  $D_i^3$ . Hence  $\Sigma_i^3$  consists of four arcs of type  $\mathcal{C}$ . This immersed disc  $g^3(D_i^3)$  shows that the clasp number of  $K_i$  is at most two.

Similar arguments as above prove the case in the configuration of Fig. 4.4 (8). □

**Lemma 4.9.** *Suppose that a configuration of arcs of types  $\mathcal{A}$  and  $\mathcal{A}'$  on  $D_i^1$  is that of Fig. 4.4 (5). Then the clasp number of  $K_i$  is at most two.*

Proof. Let  $\gamma_1$  be the subarc of  $m^1$  with  $\partial\gamma_1 = (\alpha_1 \cap m^1) \cup (\alpha'_2 \cap m^1)$ , and  $\gamma_2$  be the subarc of  $m^1$  with  $\partial\gamma_2 = (\alpha_2 \cap m^1) \cup (\alpha'_1 \cap m^1)$ . Note that the singular arc  $g^1(m^1)$  on  $S$  has the same configuration as that of Fig. 4.1 (3), up to symmetry and isotopy on  $S$ . The two arcs  $g^1(\gamma_1)$  and  $g^1(\gamma_2)$  cobound a disc  $\delta$  on  $S$  such that  $g^1(\partial m^1)$  is not contained in  $\delta$ . Isotope  $g^1(N(\gamma_1; D_i^1))$  along  $\delta$ . Then we obtain an immersion  $g^2$  of a disc  $D_i^2$  into  $Q_i$  such that  $g^2(m^2)$  is an embedded arc on  $S$ , where  $m^2 = cl(\partial D_i^2 - l_i^2)$ . This isotopy changes the union of the arcs  $g^1(\alpha_1) = g^1(\alpha'_1)$ ,  $g^1(\alpha_2) = g^1(\alpha'_2)$  and  $g^1(\gamma_2)$  to a singular arc  $\gamma$  of  $g^2(D_i^2)$  such that  $(g^2)^{-1}(\gamma)$  consists of two arcs of type  $\mathcal{C}$  in  $D_i^2$ . Therefore  $\Sigma_i^2$  consists of four arcs of type  $\mathcal{C}$ . This immersed disc  $g^2(D_i^2)$  shows that the clasp number of  $K_i$  is at most two. □

This completes the proof of Proposition 4.6 □

**5. The case where  $D_i$  contains loop components of  $T$**

In this section, we deal with an immersed surface  $g(\bar{D}_i)$  when there are loop components of  $T$  in  $D_i$ . Recall that  $\bar{D}_i$  is the region separated by loop components of  $T$  in  $D_i$  such that  $l_i$  is a subarc of  $\partial\bar{D}_i$ .

**Proposition 5.1.** *Suppose that  $\bar{D}_i$  is an annulus, and that the number of points of  $X_i$  on  $\bar{D}_i$  is 0. Then  $K_i$  is the trivial knot.*

Proof. Since  $X_i = \emptyset$ ,  $\Sigma_i$  consists only of arcs of type  $\mathcal{B}$ . Let  $n$  denote the component of  $\partial\bar{D}_i$  such that  $l_i$  is not contained in  $n$ .

First suppose  $\Sigma_i = \emptyset$ . Then the simple closed curve  $g(n)$  bounds a disc  $\delta$  on  $S$  such that  $g(m)$  is not contained in  $\delta$ . Isotope  $g(N(n; \bar{D}_i)) \cup \delta$  slightly into  $int Q_i$ . Then we obtain an embedding of a disc into  $Q_i$ . This embedded disc shows that  $K_i$  is the trivial knot.

Next suppose  $\Sigma_i \neq \emptyset$ . A properly embedded arc  $b$  on  $\bar{D}_i$  is said to be of type  $b_1$  if the two points of  $\partial b$  are contained in  $m$ , and if  $b$  and a subarc  $b'$  of  $\partial\bar{D}_i$  cobound a disc on  $\bar{D}_i$  such that  $l_i$  is contained in  $b'$ . See Fig. 5.1. A properly embedded arc  $b$  on  $\bar{D}_i$  is of type  $b_2$  if  $b$  together with a subarc of  $m$  cobounds a disc on  $\bar{D}_i$ . A

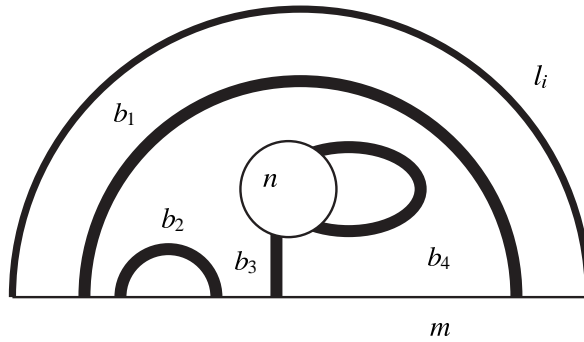

Fig. 5.1.

properly embedded arc  $b$  on  $\bar{D}_i$  is of type  $b_3$  if  $b$  connects a point on  $m$  and a point on  $n$ . A properly embedded arc  $b$  on  $\bar{D}_i$  is of type  $b_4$  if  $b$  together with a subarc of  $n$  cobounds a disc on  $\bar{D}_i$ . We note that an arc of type  $\mathcal{B}$  on  $\bar{D}_i$  is of type  $b_1, b_2, b_3$  or  $b_4$ .

Now we consider configurations of a pair of arcs of type  $\mathcal{B}$  on  $\bar{D}_i$  which are identified by  $g$ . If one of the arcs of type  $\mathcal{B}$  in the pair is of type  $b_1$ , then we may assume, by Lemmas 2.2 and 2.3, that a configuration of the pair is, up to symmetry of  $\bar{D}_i$ , that of Fig. 5.2 (1) or (2). If one of the arcs of type  $\mathcal{B}$  is of type  $b_2$ , then we may assume, by Lemmas 2.2 and 2.3, that a configuration of the pair is, up to symmetry of  $\bar{D}_i$ , that of Fig. 5.2 (1) or (3). If one of the arcs of type  $\mathcal{B}$  is of type  $b_3$ , then we may assume, by Lemma 2.2, that a configuration of the pair is, up to symmetry of  $\bar{D}_i$ , that of Fig. 5.2 (2), (3) or (4). If one of the arcs of type  $\mathcal{B}$  is of type  $b_4$ , then we may assume, by Lemmas 2.2 and 2.3, that a configuration of the pair is that of Fig. 5.2 (4).

**Lemma 5.2.** *Suppose that a configuration of the pair of arcs of type  $\mathcal{B}$  on  $\bar{D}_i$  which are identified by  $g$  is that of Fig. 5.2 (1), (2), (3) or (4). Then there exists an immersion  $g^2$  of an annulus  $\bar{D}_i^2$  into  $Q_i$  satisfying the following properties;*

- (i) *Every component of  $\Sigma_i^2$  is an arc of type  $\mathcal{B}$ ,*
- (ii) *The number of arcs of type  $\mathcal{B}$  in  $\Sigma_i^2$  is strictly less than that of type  $\mathcal{B}$  in  $\Sigma_i$ , and*
- (iii) *There is a subarc  $l_i^2$  of  $\partial\bar{D}_i^2$  such that  $g^2(l_i^2) = g(l_i)$ , and that  $g^2(\partial\bar{D}_i^2 - l_i^2)$  is contained in  $S$ .*

**Proof.** Suppose that a configuration of the pair of arcs of type  $\mathcal{B}$  on  $\bar{D}_i$  which are identified by  $g$  is that of Fig. 5.2 (1). Let  $\beta_1$  and  $\beta_2$  be the two arcs of type  $\mathcal{B}$ . Let  $V$  denote a regular neighborhood  $N(g(\beta_1); Q_i)$ . We may choose  $V$  so that  $g(\bar{D}_i) \cap V$  consists of two discs  $g(N(\beta_1; \bar{D}_i))$  and  $g(N(\beta_2; \bar{D}_i))$ . The disc  $g(N(\beta_1; \bar{D}_i))$  intersects  $g(N(\beta_2; \bar{D}_i))$  transversely along the arc  $g(\beta_1) = g(\beta_2)$ . We regard  $V$  as the set



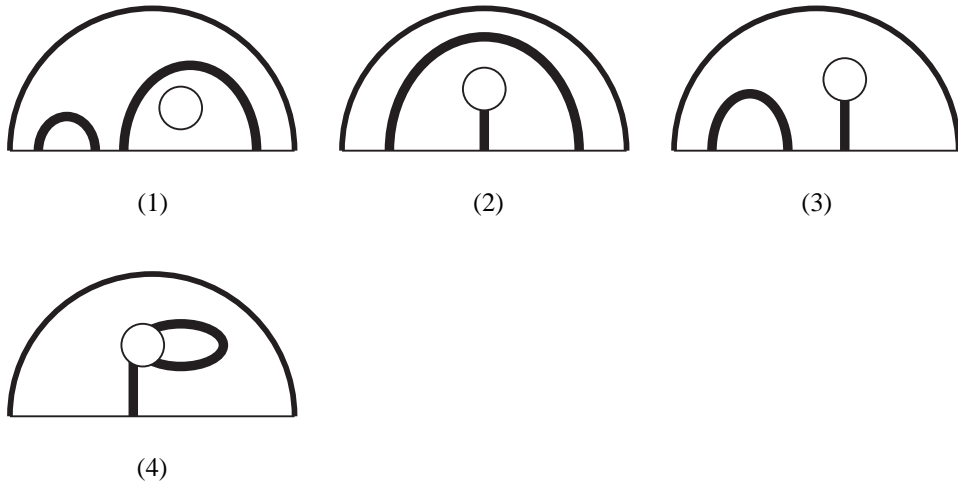

Fig. 5.2.

$\{(x, y, z) \mid x^2 + y^2 \leq 1, 0 \leq z \leq 1\}$  so that two discs of  $V \cap S$  correspond to the sets  $\{(x, y, 0) \mid x^2 + y^2 \leq 1\}$  and  $\{(x, y, 1) \mid x^2 + y^2 \leq 1\}$ . Without loss of generality, we may assume that  $g(N(\beta_1; \bar{D}_i))$  corresponds to  $\{(x, 0, z) \mid -1 \leq x \leq 1, 0 \leq z \leq 1\}$ , and that  $g(N(\beta_2; \bar{D}_i))$  corresponds to  $\{(0, y, z) \mid -1 \leq y \leq 1, 0 \leq z \leq 1\}$ . We may also assume that an image of the outward-normal to  $\bar{D}_i$  in  $N(\beta_1; \bar{D}_i)$  agrees with the direction of increasing  $y$ , and that an image of the outward-normal to  $\bar{D}_i$  in  $N(\beta_2; \bar{D}_i)$  agrees with the direction of increasing  $x$ . Let  $\tilde{d}_1$  be the disc  $\{(x, y, z) \mid x^2 + y^2 = 1, x \geq 0, y \geq 0, 0 \leq z \leq 1\}$ , and  $\tilde{d}_2$  be the disc  $\{(x, y, z) \mid x^2 + y^2 = 1, x \leq 0, y \leq 0, 0 \leq z \leq 1\}$ .

Now we define an immersion  $g^1$  of a surface  $\bar{D}_i^1$  into  $Q_i$ . Let  $g^1(\bar{D}_i^1)$  be the immersed surface which is the union of  $g(\bar{D}_i - N(\beta_1 \cup \beta_2; \bar{D}_i))$ ,  $\tilde{d}_1$  and  $\tilde{d}_2$ . We say that  $g^1(\bar{D}_i^1)$  is obtained from  $g(\bar{D}_i)$  by an *oriented double curve surgery* along the arc  $g(\beta_1) = g(\beta_2)$ . This operation was called an *orientation preserving cut* along the arc  $g(\beta_1) = g(\beta_2)$ . See, for example, [11, p. 4]. By this construction,  $g^1(\bar{D}_i^1)$  satisfies the properties (i)–(iii). The surface  $\bar{D}_i^1$  is the union of  $\bar{D}_i - N(\beta_1 \cup \beta_2; \bar{D}_i)$ ,  $d_1$  and  $d_2$ , where  $d_j$  ( $j = 1, 2$ ) is a disc corresponding to  $\tilde{d}_j$ . Similar arguments as in the proof of Lemma 2.2 show that  $\bar{D}_i^1$  is homeomorphic to either an annulus or two annuli.

Let  $\bar{D}_i^2$  denote the connected component of  $\bar{D}_i^1$  such that  $l_i^1$  is a subarc of  $\partial\bar{D}_i^2$ . Let  $g^2$  be the restriction of  $g^1$  to  $\bar{D}_i^2$ . Thus we obtain an immersion  $g^2$  of an annulus  $\bar{D}_i^2$  into  $Q_i$  satisfying the properties (i)–(iii).

Similar arguments as above prove the cases in the configurations of Fig. 5.2 (2), (3) and (4). □

By Lemma 5.2, we obtain an embedding  $g^3$  of an annulus  $\bar{D}_i^3$  into  $Q_i$  with

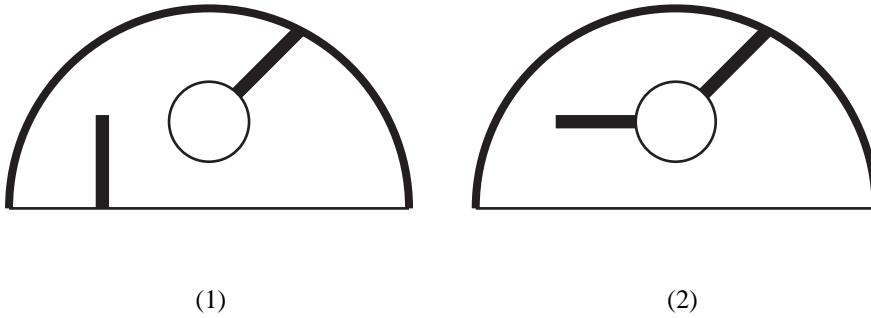

Fig. 5.3.

$g^3(l_i^3) = g(l_i)$ . Therefore we have  $\Sigma_i^3 = \emptyset$ , and  $K_i$  is the trivial knot. This completes the proof of Proposition 5.1.  $\square$

**Proposition 5.3.** *Suppose that  $\bar{D}_i$  is an annulus, and that the number of points of  $X_i$  on  $\bar{D}_i$  is one. Then the clasp number of  $K_i$  is at most one.*

*Proof.* Since  $|X_i| = 1$ ,  $\Sigma_i$  consists of one arc of type  $\mathcal{A}$ , one arc of type  $\mathcal{A}'$  and some arcs of type  $\mathcal{B}$ . By similar arguments as in the proof of Proposition 5.1, we obtain an immersion  $g^1$  of an annulus  $\bar{D}_i^1$  into  $Q_i$  such that there is no arc of type  $\mathcal{B}$  in  $\Sigma_i^1$ , and that there is a subarc  $l_i^1$  of  $\partial\bar{D}_i^1$  with  $g^1(l_i^1) = g(l_i)$ . If  $\Sigma_i^1 = \emptyset$ , then Proposition 5.1 shows that  $K_i$  is the trivial knot. So we may assume that  $\Sigma_i^1$  consists of one arc of type  $\mathcal{A}$  and one arc of type  $\mathcal{A}'$ . Let  $n^1$  denote the component of  $\partial\bar{D}_i^1$  such that  $l_i^1$  is not contained in  $n^1$ . Let  $m^1$  be the arc  $cl(\partial\bar{D}_i^1 - (n^1 \cup l_i^1))$ .

First suppose that there are no endpoints of arcs of types  $\mathcal{A}$  and  $\mathcal{A}'$  on  $n^1$ . Then the simple closed curve  $g^1(n^1)$  bounds a disc  $\delta$  on  $S$  such that  $g^1(m^1)$  is not contained in  $\delta$ . Isotope  $g^1(N(n^1; \bar{D}_i^1)) \cup \delta$  slightly into  $int Q_i$ . Then we obtain an immersion  $g^2$  of a disc  $\bar{D}_i^2$  into  $Q_i$  such that  $\Sigma_i^2$  consists of one arc of type  $\mathcal{A}$  and one arc of type  $\mathcal{A}'$ . Proposition 4.1 shows that  $K_i$  is the trivial knot.

Next suppose that there are endpoints of arcs of types  $\mathcal{A}$  and  $\mathcal{A}'$  on  $n^1$ . If there is an endpoint of only the arc of type  $\mathcal{A}$  on  $n^1$ , then a configuration of arcs of types  $\mathcal{A}$  and  $\mathcal{A}'$  on  $\bar{D}_i^1$  is that of Fig. 5.3 (1). If there is an endpoint of only the arc of type  $\mathcal{A}'$  on  $n^1$ , then the arc of type  $\mathcal{A}$  satisfies the supposition of Lemma 2.1, and we obtain an embedding of an annulus into  $Q_i$ . Proposition 5.1 shows that  $K_i$  is the trivial knot. If there are endpoints of the arcs of types  $\mathcal{A}$  and  $\mathcal{A}'$  on  $n^1$ , then a configuration of arcs of types  $\mathcal{A}$  and  $\mathcal{A}'$  on  $\bar{D}_i^1$  is that of Fig. 5.3 (2).

Similar arguments as in the proof of Lemma 4.8 prove the following lemma.

**Lemma 5.4.** *Suppose that a configuration of arcs of types  $\mathcal{A}$  and  $\mathcal{A}'$  on  $\bar{D}_i^1$  is that of Fig. 5.3 (1). Then the clasp number of  $K_i$  is at most one.*

**Lemma 5.5.** *Suppose that a configuration of arcs of types  $\mathcal{A}$  and  $\mathcal{A}'$  on  $\bar{D}_i^1$  is that of Fig. 5.3 (2). Then  $K_i$  is the trivial knot.*

Proof. Performing a CP surgery to  $g^1(\bar{D}_i^1)$  along the singular arc, we obtain an embedding  $g^2$  of a twice-punctured disc  $\bar{D}_i^2$  into  $Q_i$ . Let  $n_1^2$  and  $n_2^2$  denote the components of  $\partial\bar{D}_i^2$  such that  $l_i^2$  is not a subarc of  $n_1^2$  or  $n_2^2$ . Let  $m^2$  be the arc  $cl(\partial\bar{D}_i^2 - (n_1^2 \cup n_2^2 \cup l_i^2))$ . At least one of the simple closed curves  $g^2(n_1^2)$  and  $g^2(n_2^2)$ , say  $g^2(n_1^2)$ , bounds a disc  $\delta$  on  $S$  such that  $g^2(n_2^2)$  and  $g^2(m^2)$  are not contained in  $\delta$ . Isotope  $g^2(N(n_1^2; \bar{D}_i^2)) \cup \delta$  slightly into  $int Q_i$ . Then we obtain an embedding of an annulus into  $Q_i$ . Proposition 5.1 shows that  $K_i$  is the trivial knot.  $\square$

This completes the proof of Proposition 5.3.  $\square$

**Proposition 5.6.** *Suppose that  $\bar{D}_i$  is an annulus, and that the number of points of  $X_i$  on  $\bar{D}_i$  is two. Then the clasp number of  $K_i$  is at most one.*

Proof. Since  $|X_i| = 2$ ,  $\Sigma_i$  consists of either (1) two arcs of type  $\mathcal{A}$ , two arcs of type  $\mathcal{A}'$  and some arcs of type  $\mathcal{B}$ , or (2) two arcs of type  $\mathcal{C}$  and some arcs of type  $\mathcal{B}$ . In both cases, we obtain, by similar arguments as in the proof of Proposition 5.1, an immersion  $g^1$  of an annulus  $\bar{D}_i^1$  into  $Q_i$  such that there is no arc of type  $\mathcal{B}$  in  $\Sigma_i^1$ , and that there is a subarc  $l_i^1$  of  $\partial\bar{D}_i^1$  with  $g^1(l_i^1) = g(l_i)$ . We may assume, by Propositions 5.1 and 5.3, that  $\Sigma_i^1$  consists of two arcs of type  $\mathcal{A}$  and two arcs of type  $\mathcal{A}'$  in the case of (1), and that  $\Sigma_i^1$  consists of two arcs of type  $\mathcal{C}$  in the case of (2). Let  $n^1$  denote the component of  $\partial\bar{D}_i^1$  such that  $l_i^1$  is not contained in  $n^1$ . Let  $m^1$  be the arc  $cl(\partial\bar{D}_i^1 - (n^1 \cup l_i^1))$ .  $\square$

**Lemma 5.7.** *Suppose that  $\Sigma_i^1$  consists of two arcs of type  $\mathcal{C}$ . Then the clasp number of  $K_i$  is at most one.*

Proof. The simple closed curve  $g^1(n^1)$  bounds a disc  $\delta$  on  $S$  such that  $g^1(m^1)$  is not contained in  $\delta$ . Isotope  $g^1(N(n^1; \bar{D}_i^1)) \cup \delta$  slightly into  $int Q_i$ . Then we obtain an immersion  $g^2$  of a disc  $\bar{D}_i^2$  into  $Q_i$  such that  $\Sigma_i^2$  consists of two arcs of type  $\mathcal{C}$ . This immersed disc  $g^2(\bar{D}_i^2)$  shows that the clasp number of  $K_i$  is at most one.  $\square$

**Lemma 5.8.** *Suppose that  $\Sigma_i^1$  consists of two arcs of type  $\mathcal{A}$  and two arcs of type  $\mathcal{A}'$ . Then the clasp number of  $K_i$  is at most one.*

Proof. We consider configurations of arcs of types  $\mathcal{A}$  and  $\mathcal{A}'$  on  $\bar{D}_i^1$ .

CLAIM 5.9. If there are no endpoints of arcs of type  $\mathcal{A}$  or  $\mathcal{A}'$  on  $n^1$ , then the clasp number of  $K_i$  is at most one.

Proof. Suppose that there are no endpoints of arcs of type  $\mathcal{A}$  or  $\mathcal{A}'$  on  $n^1$ . Then the simple closed curve  $g^1(n^1)$  bounds a disc  $\delta$  on  $S$  such that  $g^1(m^1)$  is not contained in  $\delta$ . Isotope  $g^1(N(n^1; \bar{D}_i^1)) \cup \delta$  slightly into  $\text{int } Q_i$ . Then we obtain an immersion  $g^2$  of a disc into  $Q_i$  such that  $\Sigma_i^2$  consists of two arcs of type  $\mathcal{A}$  and two arcs of type  $\mathcal{A}'$ . Proposition 4.2 shows that the clasp number of  $K_i$  is at most one.  $\square$

We may assume, by Claim 5.9, that there is at least one endpoint of arcs of types  $\mathcal{A}$  and  $\mathcal{A}'$  on  $n^1$ . If there is an endpoint of only one arc of type  $\mathcal{A}$  on  $n^1$ , then we may assume, by Lemma 2.1 and Proposition 5.3, that a configuration of arcs of types  $\mathcal{A}$  and  $\mathcal{A}'$  on  $\bar{D}_i^1$  is, up to symmetry of  $\bar{D}_i^1$ , that of Fig. 5.4 (1) or (2). If there is an endpoint of only one arc of type  $\mathcal{A}'$  on  $n^1$ , then we may assume, by Lemma 2.1 and Proposition 5.3, that the configuration is, up to symmetry of  $\bar{D}_i^1$ , that of Fig. 5.4 (3). If there are endpoints of only one arc of type  $\mathcal{A}$  and one arc of type  $\mathcal{A}'$  on  $n^1$ , then we may assume, by Lemma 2.1 and Proposition 5.3, that the configuration is, up to symmetry of  $\bar{D}_i^1$ , that of Fig. 5.4 (4). If there are endpoints of only two arcs of type  $\mathcal{A}$  on  $n^1$ , then the configuration is that of Fig. 5.4 (5). If there are endpoints of only two arcs of type  $\mathcal{A}'$  on  $n^1$ , then at least one of the two arcs of type  $\mathcal{A}$  satisfies the supposition of Lemma 2.1, and we obtain an immersion  $g^2$  of an annulus into  $Q_i$  such that  $\Sigma_i^2$  consists of one arc of type  $\mathcal{A}$  and one arc of type  $\mathcal{A}'$ . Proposition 5.3 shows that the clasp number of  $K_i$  is at most one. If there are endpoints of only one arc of type  $\mathcal{A}$  and two arcs of type  $\mathcal{A}'$  on  $n^1$ , then the same arguments as above show that the clasp number of  $K_i$  is at most one. If there are endpoints of only two arcs of type  $\mathcal{A}$  and one arc of type  $\mathcal{A}'$  on  $n^1$ , then the configuration is that of Fig. 5.4 (6) or (7). If there are endpoints of two arcs of type  $\mathcal{A}$  and two arcs of type  $\mathcal{A}'$  on  $n^1$ , then the configuration is that of Fig. 5.4 (8), (9) or (10).

CLAIM 5.10. Suppose that a configuration of arcs of types  $\mathcal{A}$  and  $\mathcal{A}'$  on  $\bar{D}_i^1$  is that of Fig. 5.4 (1), (2), (3), (6) or (7). Then the clasp number of  $K_i$  is at most one.

Proof. Suppose that a configuration of arcs of types  $\mathcal{A}$  and  $\mathcal{A}'$  on  $\bar{D}_i^1$  is that of Fig. 5.4 (1). Let  $\alpha'_1, \alpha'_2$  denote arcs of type  $\mathcal{A}'$ , and  $\alpha_j$  ( $j = 1$  or  $2$ ) denote the arc of type  $\mathcal{A}$  as illustrated in the figure. We assume that  $g^1(\alpha_p) = g^1(\alpha'_p)$  for  $p = 1$  and  $2$ .

First suppose  $j = 2$ . The simple closed curve  $g^1(n^1)$  intersects the immersed arc  $g^1(m^1)$  transversely in one point on  $S$ . Since  $g^1(\alpha_1) = g^1(\alpha'_1)$ , we can construct a simple closed curve on  $S$  which intersects  $g^1(n^1)$  transversely in one point. This shows that  $g^1(n^1)$  is a non-separating simple closed curve on a 2-sphere, a contradiction.

Next suppose  $j = 1$ . Performing a CP surgery to  $g^1(D_i^1)$  along the arc  $g^1(\alpha_2) = g^1(\alpha'_2)$ , we obtain an immersion  $g^2$  of a twice-punctured disc  $\bar{D}_i^2$  into  $Q_i$  such that  $\Sigma_i^2$  consists of one arc of type  $\mathcal{A}$  and one arc of type  $\mathcal{A}'$ . Let  $n^2$  be the connected component of  $\partial\bar{D}_i^2$  such that there is no endpoint of the arc of type  $\mathcal{A}$  or  $\mathcal{A}'$  on  $n^2$ . Then the simple closed curve  $g^2(n^2)$  bounds a disc  $\delta$  on  $S$  such that  $g^2(\partial\bar{D}_i^2 - n^2) \cap S$

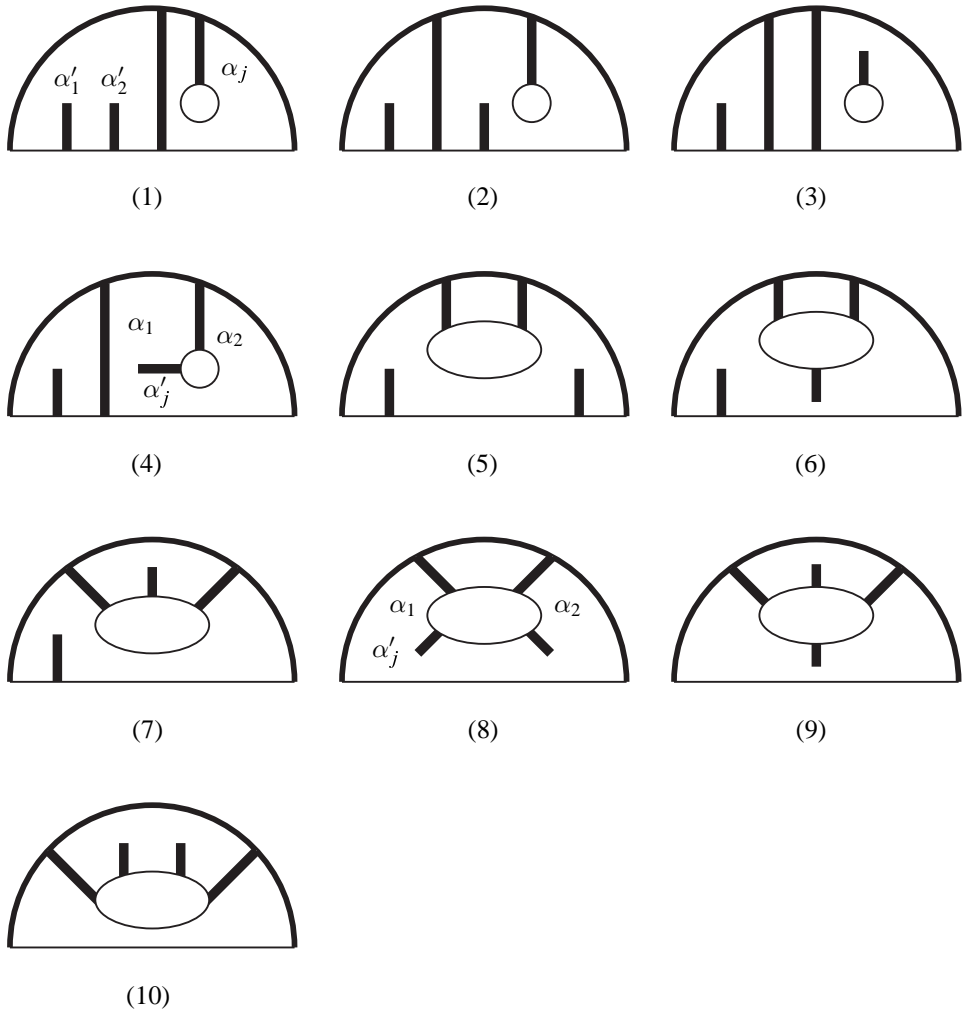

Fig. 5.4.

is not contained in  $\delta$ . Isotope  $g^2(N(n^2; \bar{D}_i^2)) \cup \delta$  slightly into  $\text{int } Q_i$ . Then we obtain an immersion  $g^3$  of an annulus into  $Q_i$  such that  $\Sigma_i^3$  consists of one arc of type  $\mathcal{A}$  and one arc of type  $\mathcal{A}'$ . Proposition 5.3 shows that the clasp number of  $K_i$  is at most one.

Similar arguments as above prove the cases in the configurations of Fig. 5.4 (2), (3), (6) and (7). □

CLAIM 5.11. Suppose that a configuration of arcs of types  $\mathcal{A}$  and  $\mathcal{A}'$  on  $\bar{D}_i^1$  is that of Fig. 5.4 (4). Then the clasp number of  $K_i$  is at most one.

Proof. Let  $\alpha_1, \alpha_2$  denote arcs of type  $\mathcal{A}$ , and  $\alpha'_j$  ( $j = 1$  or  $2$ ) denote the arc of type  $\mathcal{A}'$  as illustrated in the figure. We assume that  $g^1(\alpha_p) = g^1(\alpha'_p)$  for  $p = 1$  and  $2$ .

First suppose  $j = 1$ . Then the simple closed curve  $g^1(n^1)$  bounds a disc  $\delta$  on  $S$  which contains no endpoints of the simple arc  $g^1(m^1)$ . Isotope  $g^1(N(n^1; \bar{D}_i^1)) \cup \delta$  slightly into  $\text{int } Q_i$ . Then we obtain an immersion  $g^2$  of a disc  $\bar{D}_i^2$  into  $Q_i$ . This isotopy changes the union of the arcs  $g^1(\alpha_1) = g^1(\alpha'_1)$ ,  $g^1(\alpha_2) = g^1(\alpha'_2)$  and  $g^1(m^1) \cap \delta$  to a singular arc  $\gamma$  of  $g^2(\bar{D}_i^2)$  such that  $(g^2)^{-1}(\gamma)$  consists of two arcs of type  $\mathcal{C}$  in  $\bar{D}_i^2$ . Hence  $\Sigma_i^2$  consists of two arcs of type  $\mathcal{C}$ . This immersed disc  $g^2(\bar{D}_i^2)$  shows that the clasp number of  $K_i$  is at most one.

Next suppose  $j = 2$ . Perform a CP surgery to  $g^1(\bar{D}_i^1)$  along the arc  $g^1(\alpha_2) = g^1(\alpha'_2)$ . Then we obtain an immersion  $g^2$  of a twice-punctured disc into  $Q_i$ . By similar arguments as in the proof of Lemma 5.5, we obtain an immersion  $g^3$  of a disc into  $Q_i$  such that  $\Sigma_i^3$  consists of one arc of type  $\mathcal{A}$  and one arc of type  $\mathcal{A}'$ . Proposition 4.1 shows that  $K_i$  is the trivial knot. □

CLAIM 5.12. Suppose that a configuration of arcs of types  $\mathcal{A}$  and  $\mathcal{A}'$  on  $\bar{D}_i^1$  is that of Fig. 5.4 (5). Then  $K_i$  is the trivial knot.

Proof. Let  $\alpha_1$  and  $\alpha_2$  be arcs of type  $\mathcal{A}$  on  $\bar{D}_i^1$ . The simple closed curve  $g^1(n^1)$  bounds a disc  $\delta$  on  $S$  which contains no endpoints of the simple arc  $g^1(m^1)$ . Isotope  $g^1(N(n^1; \bar{D}_i^1)) \cup \delta$  slightly into  $\text{int } Q_i$ . Then we obtain an immersion  $g^2$  of a disc  $\bar{D}_i^2$  into  $Q_i$ . This isotopy changes the union of the arcs  $g^1(\alpha_1)$ ,  $g^1(\alpha_2)$  and  $g^1(m^1) \cap \delta$  to a singular arc  $\gamma$  of  $g^2(\bar{D}_i^2)$  such that  $(g^2)^{-1}(\gamma)$  consists of two arcs  $\gamma_1$  and  $\gamma_2$  embedded in  $\bar{D}_i^2$ , where  $\partial\gamma_1$  is contained in  $l_i^2$  and  $\gamma_2$  is contained in  $\text{int } \bar{D}_i^2$ . Note that  $\gamma_1 \cap \gamma_2 = \emptyset$  on  $\bar{D}_i^2$ , and that  $\gamma_1$  and a subarc of  $l_i^2$  cobound a disc  $d_\gamma$  in  $\bar{D}_i^2$  such that  $\gamma_2$  is not contained in  $d_\gamma$ . Isotope  $g^2(N(\gamma_2; \bar{D}_i^2))$  along  $g^2(d_\gamma)$ . Then we obtain an embedding  $g^3$  of a disc  $\bar{D}_i^3$  into  $Q_i$ . This embedded disc  $g^3(\bar{D}_i^3)$  shows that  $K_i$  is the trivial knot. □

CLAIM 5.13. Suppose that a configuration of arcs of types  $\mathcal{A}$  and  $\mathcal{A}'$  on  $\bar{D}_i^1$  is that of Fig. 5.4 (8), (9) or (10). Then  $K_i$  is the trivial knot.

Proof. Suppose that a configuration of arcs of types  $\mathcal{A}$  and  $\mathcal{A}'$  on  $\bar{D}_i^1$  is that of Fig. 5.4 (8). Let  $\alpha_1$  and  $\alpha_2$  denote arcs of type  $\mathcal{A}$ , and  $\alpha'_j$  ( $j = 1$  or  $2$ ) denote the arc of type  $\mathcal{A}'$  as illustrated in the figure. We assume that  $g^1(\alpha_p) = g^1(\alpha'_p)$  for  $p = 1$  and  $2$ .

First suppose  $j = 2$ . Then there is no configuration of an immersed closed curve  $g^1(n^1)$  on a 2-sphere.

Next suppose  $j = 1$ . Performing CP surgeries to  $g^1(\bar{D}_i^1)$  along the arcs  $g^1(\alpha_1)$  and  $g^1(\alpha_2)$ , we obtain an embedding  $g^2$  of a twice-punctured annulus  $\bar{D}_i^2$  into  $Q_i$ . Similar arguments as in the proof of Lemma 5.5 shows that  $K_i$  is the trivial knot.

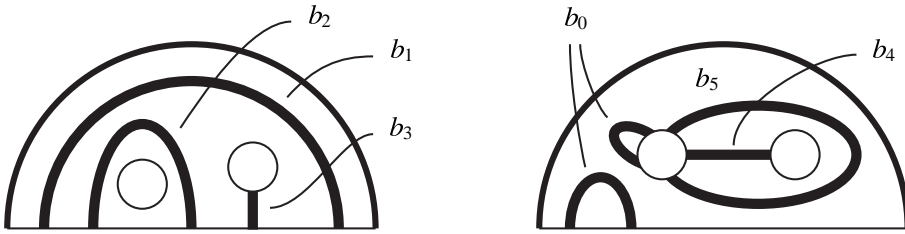

Fig. 5.5.

The same arguments as above prove the cases in the configurations of Fig. 5.4 (9) and (10). □

This completes the proofs of Lemma 5.8 and Proposition 5.6. □

**Proposition 5.14.** *Suppose that  $\bar{D}_i$  is a twice-punctured disc, and that the number of points of  $X_i$  on  $\bar{D}_i$  is 0. Then the clasp number of  $K_i$  is at most one.*

*Proof.* Since  $|X_i| = 0$ ,  $\Sigma_i$  consists only of arcs of type  $\mathcal{B}$ . Let  $n_1, n_2$  denote connected components of  $\partial\bar{D}_i - (m \cup l_i)$ .

A properly embedded arc  $b$  on  $\bar{D}_i$  is said to be of type  $b_0$  if  $b$  and a subarc of  $cl(\partial\bar{D}_i - l_i)$  cobound a disc on  $\bar{D}_i$ . See Fig. 5.5. A properly embedded arc  $b$  on  $\bar{D}_i$  is of type  $b_1$  if the two points of  $\partial b$  are contained in  $m$ , and if  $b$  together with a subarc  $b'$  of  $\partial\bar{D}_i$  cobounds a disc on  $\bar{D}_i$  such that  $l_i$  is contained in  $b'$ . A properly embedded arc  $b$  on  $\bar{D}_i$  is of type  $b_2$  if the two points of  $\partial b$  are contained in  $m$ , and if  $b$  separates  $\bar{D}_i$  to two annuli  $d_1$  and  $d_2$  so that  $n_j$  is a component of  $\partial d_j$  for  $j = 1$  and  $2$ . A properly embedded arc  $b$  on  $\bar{D}_i$  is of type  $b_3$  if  $b$  connects a point on  $m$  and a point on  $n_j$  for  $j = 1$  or  $2$ . A properly embedded arc  $b$  on  $\bar{D}_i$  is of type  $b_4$  if  $b$  connects a point on  $n_1$  and a point on  $n_2$ . A properly embedded arc  $b$  on  $\bar{D}_i$  is of type  $b_5$  if the two points of  $\partial b$  are contained in  $n_j$ , and if  $b$  and a subarc of  $n_k$  together with  $n_k$  cobound an annulus on  $\bar{D}_i$  for  $(j, k) = (1, 2)$  or  $(2, 1)$ . We note that an arc of type  $\mathcal{B}$  on  $\bar{D}_i$  is of type  $b_0, b_1, b_2, b_3, b_4$  or  $b_5$ .

The following lemma is essentially the same as Lemma 1 (1) in [6]. We refer to [6] for a proof.

**Lemma 5.15.** *Let  $\beta$  be an arc of type  $\mathcal{B}$  which is of type  $b_0$  on  $\bar{D}_i$ . Then there are an orientable surface  $\bar{D}_i^1$  and an immersion  $g^1: \bar{D}_i^1 \rightarrow Q_i$  satisfying the following properties;*

- (i) *The Euler characteristics of  $\bar{D}_i^1$  is equal to or greater than that of  $\bar{D}_i$ ,*
- (ii) *Every component of  $\Sigma_i^1$  is an arc of type  $\mathcal{B}$ ,*
- (iii) *The number of arcs of type  $\mathcal{B}$  in  $\Sigma_i^1$  is strictly less than that in  $\Sigma_i$ , and*
- (iv) *There is a subarc  $l_i^1$  of  $\partial\bar{D}_i^1$  such that  $g^1(l_i^1) = g(l_i)$ , and that  $g^1(\partial\bar{D}_i^1 - l_i^1)$  is*

contained in  $S$ .

We may assume, by Lemma 5.15 and Propositions 4.1 and 5.1, that there is no arc of type  $\mathcal{B}$  which is of type  $b_0$  on a twice-punctured disc  $\bar{D}_i$ .

Let  $\beta$  be an arc of type  $\mathcal{B}$  which is of type  $b_1$  on  $\bar{D}_i$ , and  $d_\beta$  be the disc on  $\bar{D}_i$  which is cobounded by  $\beta$  and a subarc of  $\partial\bar{D}_i$ . We may assume, by Lemma 2.2, that the restriction of  $g$  to  $d_\beta$  is an embedding. We can isotope the string  $g(l_i)$  of the 1-string tangle  $(Q_i, g(l_i))$  along the embedded disc  $g(d_\beta)$  in  $Q_i$  to the string  $g(\beta)$  of the 1-string tangle  $(Q_i, g(\beta))$ . It follows that it has no effect on the knot type of  $K_i$  to replace  $\bar{D}_i$  with  $cl(\bar{D}_i - N(d_\beta; \bar{D}_i))$ . So we suppose, in the following, that there is no arc of type  $\mathcal{B}$  which is of type  $b_1$  on  $\bar{D}_i$ .

Now we consider configurations of a pair of arcs of type  $\mathcal{B}$  on  $\bar{D}_i$  which are identified by  $g$ . If one of the arcs of type  $\mathcal{B}$  is of type  $b_2$ , then we may assume, by Lemma 2.2, that a configuration of the pair is, up to symmetry of  $\bar{D}_i$ , that of Fig. 5.6 (1), (2) or (3). If one of the arcs of type  $\mathcal{B}$  is of type  $b_3$ , then we may assume, by Lemma 2.2, that a configuration of the pair is, up to symmetry of  $\bar{D}_i$ , that of Fig. 5.6 (2)–(6) or (7). If one of the arcs of type  $\mathcal{B}$  is of type  $b_4$ , then we may assume, by Lemma 2.2, that a configuration of the pair is, up to symmetry of  $\bar{D}_i$ , that of Fig. 5.6 (6) or (8). If one of the arcs of type  $\mathcal{B}$  is of type  $b_5$ , then we may assume, by Lemma 2.2, that a configuration of the pair is, up to symmetry of  $\bar{D}_i$ , that of Fig. 5.6 (7) or (8).

**Lemma 5.16.** *Suppose that a configuration of a pair of arcs of type  $\mathcal{B}$  on  $\bar{D}_i$  which are identified by  $g$  is that of Fig. 5.6 (1), (2), (3), (5), (7) or (8). Then there is an immersion  $g^2: \bar{D}_i^2 \rightarrow Q_i$  with the following properties;*

- (i) *The surface  $\bar{D}_i^2$  is homeomorphic to either an annulus or a twice-punctured disc,*
- (ii) *Every component of  $\Sigma_i^2$  is an arc of type  $\mathcal{B}$ ,*
- (iii) *The number of arcs of type  $\mathcal{B}$  in  $\Sigma_i^2$  is strictly less than that in  $\Sigma_i$ , and*
- (iv) *There is a subarc  $l_i^2$  of  $\partial\bar{D}_i^2$  such that  $g^2(l_i^2) = g(l_i)$  and that  $g^2(\partial\bar{D}_i^2 - l_i^2)$  is contained in  $S$ .*

*Proof.* Suppose that a configuration of a pair of arcs of type  $\mathcal{B}$  on  $\bar{D}_i$  which are identified by  $g$  is that of Fig. 5.6 (1). Performing an oriented double curve surgery to  $g(\bar{D}_i)$  along the singular arc, we obtain an immersion  $g^1: \bar{D}_i^1 \rightarrow Q_i$  which satisfies the conditions (ii), (iii) and (iv). Similar arguments as in the proof of Lemma 2.2 show that the surface  $\bar{D}_i^1$  is homeomorphic to either a union of an annulus and a twice-punctured disc, or a twice-punctured disc. Let  $\bar{D}_i^2$  denote the connected component of  $\bar{D}_i^1$  such that  $l_i^1$  is a subarc of  $\partial\bar{D}_i^2$ . Let  $g^2$  be the restriction of  $g^1$  to  $\bar{D}_i^2$ . Then the immersion  $g^2: \bar{D}_i^2 \rightarrow Q_i$  satisfies the conditions (i)–(iv).

The same arguments as above prove the cases in the configurations of Fig. 5.6 (2), (3), (5), (7) and (8). □



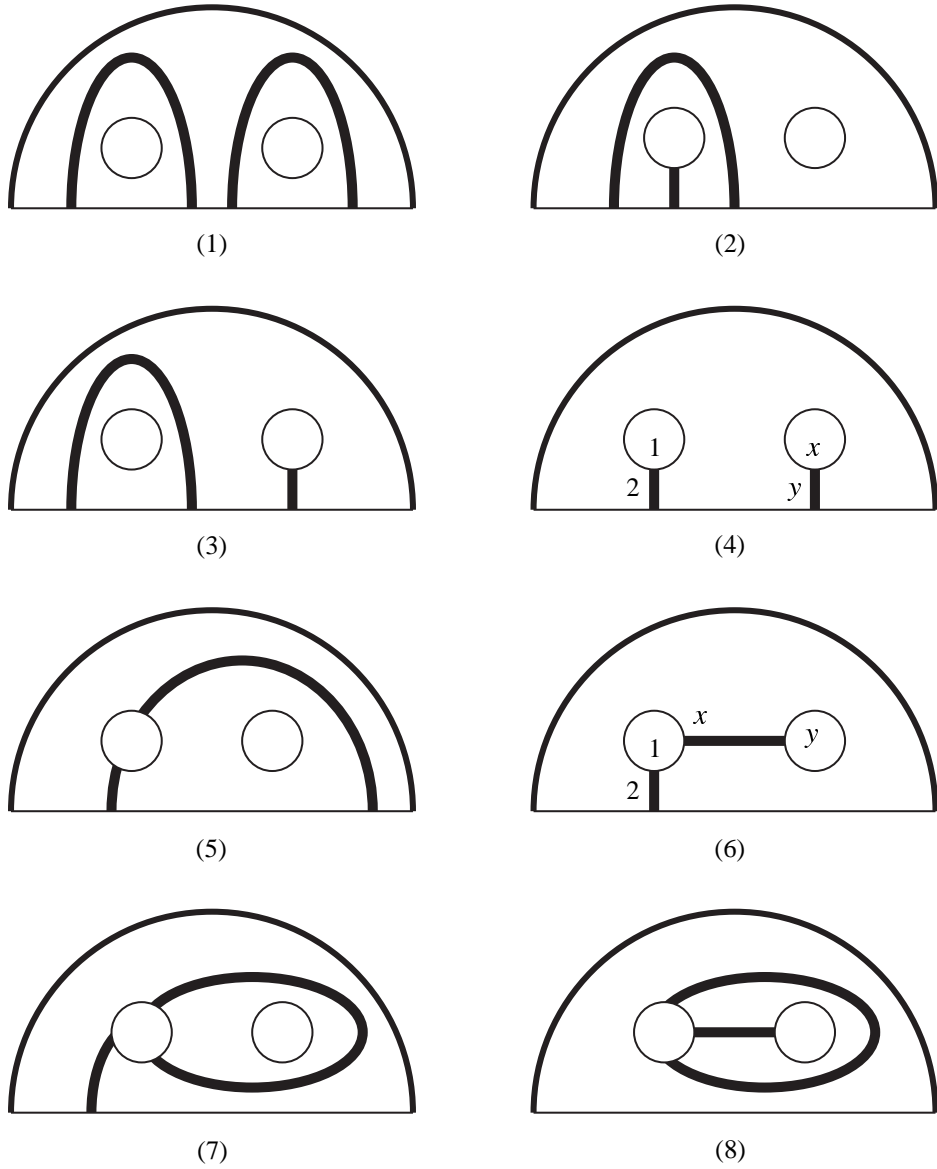

Fig. 5.6.

The same arguments as in the proof of Lemma 5.16 prove the following two lemmas.

**Lemma 5.17.** *Suppose that a configuration of a pair of arcs of type  $\mathcal{B}$  on  $\bar{D}_i$  which are identified by  $g$  is that of Fig. 5.6 (4). Let 1, 2,  $x$ ,  $y$  denote endpoints of arcs of type  $\mathcal{B}$  as illustrated in the figure. If  $g(1) = g(x)$  and  $g(2) = g(y)$ , then there is an immersion  $g^2$  of a twice-punctured disc  $\bar{D}_i^2$  into  $Q_i$  such that every component of  $\Sigma_i^2$  is an arc of type  $\mathcal{B}$ , that the number of arcs of type  $\mathcal{B}$  in  $\Sigma_i^2$  is strictly less than that in  $\Sigma_i$ , and that there is a subarc  $l_i^2$  of  $\partial\bar{D}_i^2$  with  $g^2(l_i^2) = g(l_i)$ .*

**Lemma 5.18.** *Suppose that a configuration of a pair of arcs of type  $\mathcal{B}$  on  $\bar{D}_i$  which are identified by  $g$  is that of Fig. 5.6 (6). Let 1, 2,  $x$ ,  $y$  denote endpoints of arcs of type  $\mathcal{B}$  as illustrated in the figure. If  $g(1) = g(x)$  and  $g(2) = g(y)$ , then there is an immersion  $g^2$  of a twice-punctured disc  $\bar{D}_i^2$  into  $Q_i$  such that every component of  $\Sigma_i^2$  is an arc of type  $\mathcal{B}$ , that the number of arcs of type  $\mathcal{B}$  in  $\Sigma_i^2$  is strictly less than that in  $\Sigma_i$ , and that there is a subarc  $l_i^2$  of  $\partial\bar{D}_i^2$  with  $g^2(l_i^2) = g(l_i)$ .*

By Lemmas 5.16, 5.17 and 5.18, we may suppose either that  $\bar{D}_i^2$  is an annulus such that  $\Sigma_i^2$  consists only of arcs of type  $\mathcal{B}$ , or that  $\bar{D}_i^2$  is a twice-punctured disc such that a configuration of every pair of arcs of type  $\mathcal{B}$  on  $\bar{D}_i^2$  which are identified by  $g^2$  is that of Fig. 5.6 (4) or (6) with  $g^2(1) = g^2(y)$  and  $g^2(2) = g^2(x)$ . If  $\bar{D}_i^2$  is an annulus, then Proposition 5.1 shows that  $K_i$  is the trivial knot.

In the rest of the proof of Proposition 5.14, we suppose that  $\bar{D}_i^2$  is a twice-punctured disc, and that every pair of arcs of type  $\mathcal{B}$  on  $\bar{D}_i^2$  which are identified by  $g^2$  is either the pair as in the configuration of Fig. 5.6 (4) with  $g^2(1) = g^2(y)$  and  $g^2(2) = g^2(x)$ , or the pair as in the configuration of Fig. 5.6 (6) with  $g^2(1) = g^2(y)$  and  $g^2(2) = g^2(x)$ .

We may assume, by Lemma 2.4, that  $\Sigma_i^2$  contains at most one pair of arcs of type  $\mathcal{B}$  as in the configuration of Fig. 5.6 (4), and at most two pairs of arcs of type  $\mathcal{B}$  as in the configuration of Fig. 5.6 (6). Now we consider configurations of arcs of type  $\mathcal{B}$  on  $\bar{D}_i^2$ . If  $\Sigma_i^2$  consists of only one pair of arcs of type  $\mathcal{B}$  as in the configuration of Fig. 5.6 (4), then a configuration of arcs of type  $\mathcal{B}$  on  $\bar{D}_i^2$  is that of Fig. 5.7 (1). In the configurations of Fig. 5.7, we suppose that endpoints of arcs of type  $\mathcal{B}$  which have the same labels are identified by  $g^2$ . If  $\Sigma_i^2$  consists of only one pair of arcs of type  $\mathcal{B}$  as in the configuration of Fig. 5.6 (6), then the configuration is that of Fig. 5.7 (2). If  $\Sigma_i^2$  consists of only one pair of arcs of type  $\mathcal{B}$  as in the configuration of Fig. 5.6 (4) and one pair of arcs of type  $\mathcal{B}$  as in the configuration of Fig. 5.6 (6), then the configuration is that of Fig. 5.7 (3), (4) or (5), up to symmetry of  $\bar{D}_i^2$ . If  $\Sigma_i^2$  consists of only two pairs of arcs of type  $\mathcal{B}$  as in the configuration of Fig. 5.6 (6), then the configuration is that of Fig. 5.7 (6), up to symmetry of  $\bar{D}_i^2$ . If  $\Sigma_i^2$  consists of one pair of arcs of type  $\mathcal{B}$  as in the configuration of Fig. 5.6 (4) and two pairs of arcs of type  $\mathcal{B}$  as

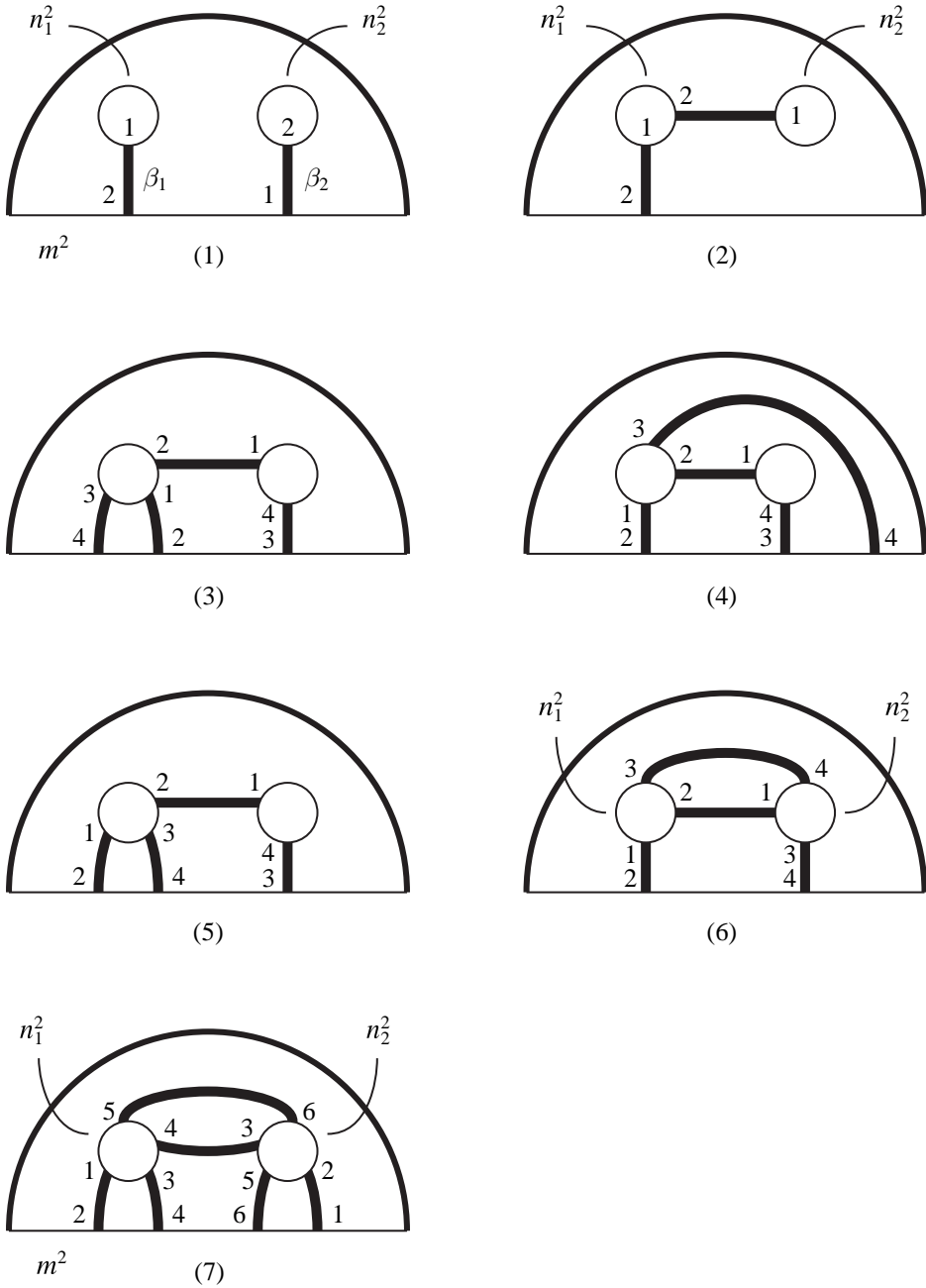
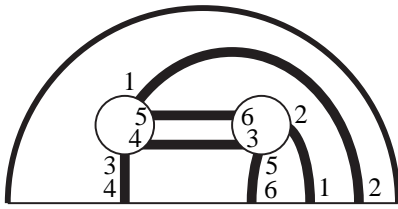
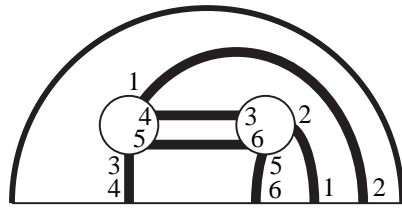

Fig. 5.7.



(8)



(9)

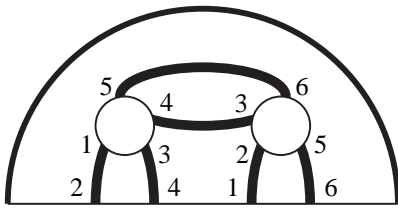

(10)

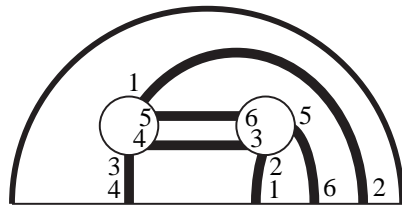

(11)

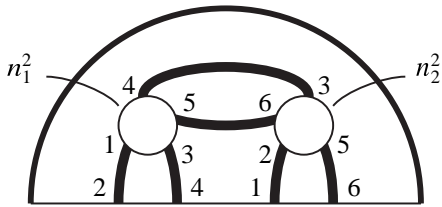

(12)

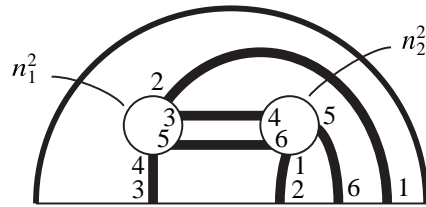

(13)

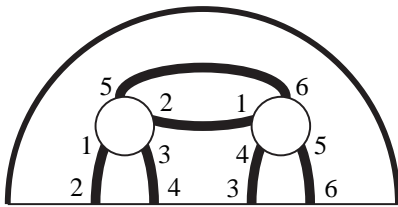

(14)

Fig. 5.7. (continued)

in the configuration of Fig. 5.6 (6), then the configuration is that of Fig. 5.7 (7)–(13) or (14), up to symmetry of  $\bar{D}_7^2$ .

**Lemma 5.19.** *A configuration of arcs of type  $\mathcal{B}$  on  $\bar{D}_i^2$  is not that of Fig. 5.7 (2)–(5), (7)–(11) or (14).*

*Proof.* First we deal with the configuration of Fig. 5.7 (2). Let  $n_1^2, n_2^2$  denote the components of  $\partial\bar{D}_i^2$  as illustrated in the figure. Note that both  $g^2(n_1^2)$  and  $g^2(n_2^2)$  are simple closed curves on  $S$ . The simple closed curve  $g^2(n_2^2)$  intersects  $g^2(n_1^2)$  transversely in one point at the image of the point labeled 1. This implies that each of  $g^2(n_1^2)$  and  $g^2(n_2^2)$  is a non-separating simple closed curve on a 2-sphere, a contradiction.

Similar arguments as above prove that a configuration of arcs of type  $\mathcal{B}$  on  $\bar{D}_i^2$  is not that of Fig. 5.7 (3), (4) or (5).

Next we deal with the configuration of Fig. 5.7 (7). Let  $n_1^2$  and  $n_2^2$  denote the components of  $\partial\bar{D}_i^2$ , and let  $m^2$  denote the arc  $cl(\partial\bar{D}_i^2 - (n_1^2 \cup n_2^2 \cup I_i^2))$  as illustrated in the figure. We denote by  $\gamma_m$  the subarc of  $m^2$  such that  $\partial\gamma_m$  consists of the two points labeled 2 and 6, and we denote by  $\gamma_n$  the subarc of  $n_2^2$  such that  $\partial\gamma_n$  consists of the two points labeled 2 and 6, and that  $int\ \gamma_n$  is disjoint from the points labeled 3 and 5. Then the union  $g^2(\gamma_m) \cup g^2(\gamma_n)$  forms a simple closed curve on  $S$ . The simple closed curve  $g^2(n_1^2)$  intersects  $g^2(\gamma_m) \cup g^2(\gamma_n)$  on  $S$  transversely in one point at the image of the point labeled 4. This implies that both  $g^2(n_1^2)$  and  $g^2(\gamma_m) \cup g^2(\gamma_n)$  are non-separating simple closed curves on a 2-sphere, a contradiction.

Similar arguments as above prove that a configuration of arcs of type  $\mathcal{B}$  on  $\bar{D}_i^2$  is not that of Fig. 5.7 (8)–(11) or (14). □

**Lemma 5.20.** *Suppose that a configuration of arcs of type  $\mathcal{B}$  on  $\bar{D}_i^2$  is that of Fig. 5.7 (1). Then the clasp number of  $K_i$  is at most one.*

*Proof.* Let  $n_1^2, n_2^2$  denote the components of  $\partial\bar{D}_i^2$ , and  $\beta_1, \beta_2$  denote arcs of type  $\mathcal{B}$  as illustrated in the figure. Let  $m^2$  be the arc  $cl(\partial\bar{D}_i^2 - (n_1^2 \cup n_2^2 \cup I_i^2))$ . The image  $g^2(n_1^2 \cup n_2^2 \cup m^2)$ , which is unique up to isotopy and symmetry on  $S$ , is illustrated in Fig. 5.8 (1). The simple closed curve  $g^2(n_1^2)$  bounds a disc  $\delta$  on  $S$  such that  $g^2(n_2^2)$  is not contained in  $\delta$ . Isotope  $g^2(N(n_1^2; \bar{D}_i^2)) \cup \delta$  slightly into  $int\ Q_i$ . Then we obtain an immersion  $g^3$  of an annulus  $\bar{D}_i^3$  into  $Q_i$ . This isotopy changes the union of the arcs  $g^2(\beta_1) = g^2(\beta_2)$  and  $g^2(m^2) \cap \delta$  to a singular arc  $\gamma$  of  $g^3(\bar{D}_i^3)$  such that  $(g^3)^{-1}(\gamma)$  consists of one arc of type  $\mathcal{A}$  and one arc of type  $\mathcal{A}'$  on  $\bar{D}_i^3$ . Hence  $\Sigma_i^3$  consists of one arc of type  $\mathcal{A}$  and one arc of type  $\mathcal{A}'$ . Proposition 5.3 shows that the clasp number of  $K_i$  is at most one. □

**Lemma 5.21.** *Suppose that a configuration of arcs of type  $\mathcal{B}$  on  $\bar{D}_i^2$  is that of Fig. 5.7 (6). Then the clasp number of  $K_i$  is at most one.*

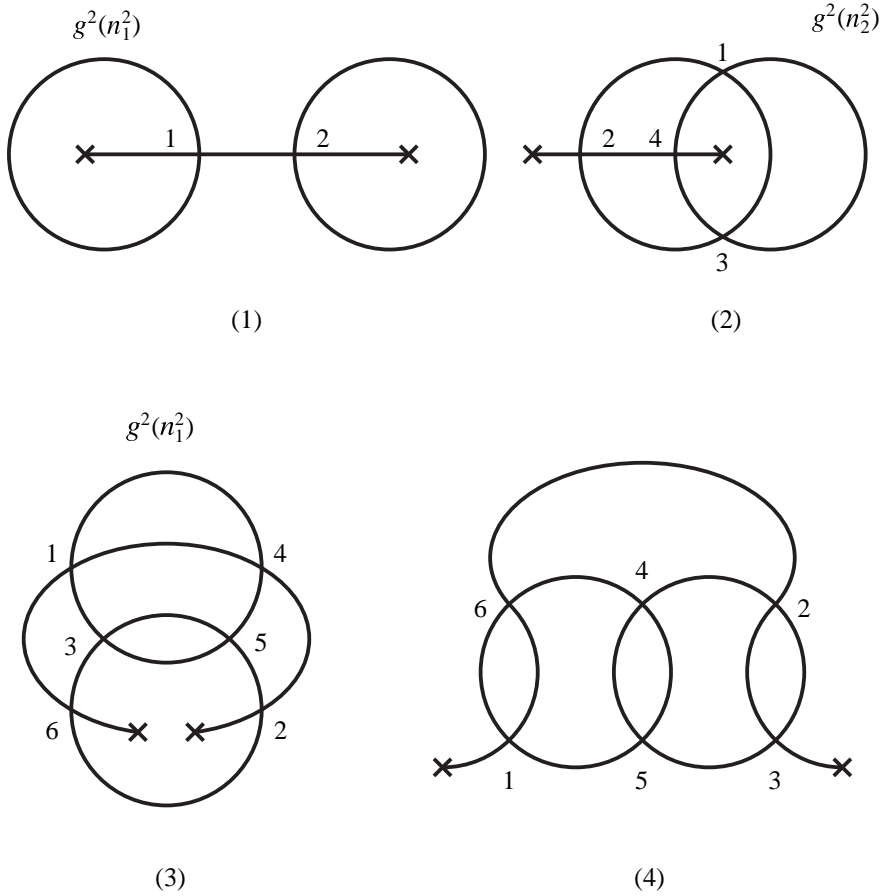

Fig. 5.8.

Proof. Let  $n_1^2, n_2^2$  denote the components of  $\partial\bar{D}_i^2$  as illustrated in the figure. Let  $m^2$  be the arc  $cl(\partial\bar{D}_i^2 - (n_1^2 \cup n_2^2 \cup l_i^2))$ . The image  $g^2(n_1^2 \cup n_2^2 \cup m^2)$ , which is unique up to isotopy and symmetry on  $S$ , is illustrated in Fig. 5.8 (2). The simple closed curve  $g^2(n_2^2)$  bounds a disc  $\delta$  on  $S$  such that the image of the point labeled 2 is not contained in  $\delta$ . Isotope  $g^2(N(n_2^2; \bar{D}_i^2)) \cup \delta$  slightly into  $int Q_i$ . Then we obtain an immersion  $g^3$  of an annulus into  $Q_i$ . Similar arguments as in the proof of Lemma 5.20 show that  $\Sigma_i^3$  consists of one arc of type  $\mathcal{A}$  and one arc of type  $\mathcal{A}'$ . Proposition 5.3 shows that the clasp number of  $K_i$  is at most one.  $\square$

**Lemma 5.22.** *Suppose that a configuration of arcs of type  $\mathcal{B}$  on  $\bar{D}_i^2$  is that of Fig. 5.7 (12). Then  $K_i$  is the trivial knot.*

Proof. Let  $n_1^2, n_2^2$  denote the components of  $\partial\bar{D}_i^2$  as illustrated in the figure. Let  $m^2$  denote the arc  $cl(\partial\bar{D}_i^2 - (n_1^2 \cup n_2^2 \cup l_i^2))$ . The image  $g^2(n_1^2 \cup n_2^2 \cup m^2)$ , which is unique up to isotopy and symmetry on  $S$ , is illustrated in Fig. 5.8 (3). The simple closed curve  $g^2(n_1^2)$  bounds a disc  $\delta$  on  $S$  which contains no endpoints of the simple arc  $g^2(m^2)$ . Isotope  $g^2(N(n_1^2; \bar{D}_i^2)) \cup \delta$  slightly into  $int Q_i$ . Then we obtain an immersion  $g^3$  of an annulus into  $Q_i$ . Similar arguments as in the proof of Lemma 5.20 show that  $\Sigma_i^3$  consists of two arcs of type  $\mathcal{B}$ . Proposition 5.1 shows that  $K_i$  is the trivial knot. □

**Lemma 5.23.** *Suppose that a configuration of arcs of type  $\mathcal{B}$  on  $\bar{D}_i^2$  is that of Fig. 5.7 (13). Then  $K_i$  is the trivial knot.*

Proof. Let  $n_1^2, n_2^2$  denote the components of  $\partial\bar{D}_i^2$  as illustrated in the figure. Let  $m^2$  denote the arc  $cl(\partial\bar{D}_i^2 - (n_1^2 \cup n_2^2 \cup l_i^2))$ . The image  $g^2(n_1^2 \cup n_2^2 \cup m^2)$ , which is unique up to isotopy and symmetry on  $S$ , is illustrated in Fig. 5.8 (4). The simple closed curve  $g^2(n_1^2)$  bounds a disc  $\delta$  on  $S$  which contains no endpoints of the simple arc  $g^2(m^2)$ . Isotope  $g^2(N(n_1^2; \bar{D}_i^2)) \cup \delta$  slightly into  $int Q_i$ . Then we obtain an immersion  $g^3$  of an annulus into  $Q_i$ . Similar arguments as in the proof of Lemma 5.20 show that  $\Sigma_i^3$  consists of two arcs of type  $\mathcal{B}$ . Proposition 5.1 shows that  $K_i$  is the trivial knot. □

By Lemmas 5.19–5.23, we may suppose that  $\bar{D}_i^2$  is a twice-punctured disc and  $\Sigma_i^2 = \emptyset$ . The same arguments as in the proof of Lemma 5.5 show that  $K_i$  is the trivial knot.

This completes the proof of Proposition 5.14. □

### Appendix

Kadokami obtained the following table in his Doctoral Dissertation [2]. This table gives us the clasp number of prime knots of eight or fewer crossings except  $8_{18}$ . We refer to Rolfsen’s table [12] for the nomenclature of knots. The clasp number of  $8_{18}$  is not known yet.

knot	$cp(K)$
$3_1$	1
$4_1$	1
$5_1$	2
$5_2$	1
$6_1$	1
$6_2$	2
$6_3$	2
$7_1$	3
$7_2$	1
$7_3$	2
$7_4$	2
$7_5$	2
$7_6$	2
$7_7$	2
$8_1$	1
$8_2$	3
$8_3$	2

knot	$cp(K)$
$8_4$	2
$8_5$	3
$8_6$	2
$8_7$	3
$8_8$	2
$8_9$	3
$8_{10}$	3
$8_{11}$	2
$8_{12}$	2
$8_{13}$	2
$8_{14}$	2
$8_{15}$	2
$8_{16}$	3
$8_{17}$	3
$8_{19}$	3
$8_{20}$	2
$8_{21}$	2

ACKNOWLEDGEMENTS. The author would like to express his sincere gratitude to Professor Kanji Morimoto, Professor Chuichiro Hayashi and Dr. Teruhisa Kadokami for thier helpful comments.

---

### References

- [1] J. Birman and W. Menasco: *Studying links via closed braids, IV: Split and composite links*, Invent. Math. **102** (1990), 115–139.
- [2] T. Kadokami: Doctoral Dissertation, Osaka City University (1998).
- [3] P. Kronheimer and T. Mrowka: *Gauge theory for embedded surfaces, I*, Topology **32** (1993), 773–826.
- [4] P. Kronheimer and T. Mrowka: *Gauge theory for embedded surfaces, II*, Topology **34** (1995), 37–97.
- [5] Y. Moriah and H. Rubinstein: *Heegaard structures of negatively curved 3-manifolds*, Comm. Anal. Geom. **5** (1997), 375–412.
- [6] K. Morimoto: *On the additivity of the clasp singularities*, Kobe J. Math. **3** (1986), 179–185.
- [7] K. Morimoto: *On the clasp number of torus knots*; original title: “*To-rasu musubime no kurasupu suu ni tsuite*” (in Japanese), The review of the Takushoku University **177** (1989), 319–323.
- [8] K. Morimoto: *Characterization of tunnel number two knots which have the property “ $2+1 = 2$ ”*, Topology Appl. **64** (1995), 165–176.
- [9] K. Morimoto, M. Sakuma and Y. Yokota: *Examples of tunnel number one knots which have the property “ $1 + 1 = 3$ ”*, Math. Proc. Cambridge Philos. Soc. **119** (1996), 113–118.
- [10] K. Murasugi: *Knot theory and its applications*, Birkhäuser Boston, Inc., Boston, MA (1996).
- [11] C.D. Papakyriakopoulos: *On Dehn’s lemma and the asphericity of knots*, Ann. of Math. **66** (1957), 1–26.
- [12] D. Rolfsen: *Knots and Links*, (Corrected reprint of the 1976 original.) Mathematics Lecture



- Series, 7, Publish or Perish Inc., Houston, TX, (1990).
- [13] H. Schubert: *Knoten und Vollringe*, Acta Math. **90** (1953), 131–286.
- [14] T. Shibuya: *Some relations among various numerical invariants for links*, Osaka J. Math. **11** (1974), 313–322.
- [15] S. Suzuki: *Local knots of 2-spheres in 4-manifolds*, Proc. Japan Acad. **45** (1969), 34–38.

Graduate School of Mathematical Sciences  
University of Tokyo  
Tokyo 153-8914  
Japan  
e-mail: matsuda@ms.u-tokyo.ac.jp

Current address:  
Department of Mathematics  
Graduate School of Science  
Hiroshima University  
Hiroshima 739-8526  
Japan  
e-mail: matsuda@math.sci.hiroshima-u.ac.jp