

# **Climate Change: Integrating Science, Economics, and Policy**

**Nakicenovic, N., Nordhaus, W.D., Richels, R.  
and Toth, F.L.**

**IIASA Collaborative Paper  
December 1996**



Nakicenovic, N., Nordhaus, W.D., Richels, R. and Toth, F.L. (1996) Climate Change: Integrating Science, Economics, and Policy. IIASA Collaborative Paper. Copyright © December 1996 by the author(s).  
<http://pure.iiasa.ac.at/5025/> All rights reserved. Permission to make digital or hard copies of all or part of this work for personal or classroom use is granted without fee provided that copies are not made or distributed for profit or commercial advantage. All copies must bear this notice and the full citation on the first page. For other purposes, to republish, to post on servers or to redistribute to lists, permission must be sought by contacting [repository@iiasa.ac.at](mailto:repository@iiasa.ac.at)

# Climate Change: Integrating Science, Economics, and Policy

*N. Nakićenović, W.D. Nordhaus, R. Richels, F.L. Toth*  
(Editors)

CP-96-1  
December 1996

Proceedings of a Workshop held on 19–20 March 1996  
at IIASA, Laxenburg, Austria



International Institute for Applied Systems Analysis □ A-2361 Laxenburg □ Austria

Telephone: +43 2236 715210 □ Telex: 079 137 iiasa a □ Telefax: +43 2236 71313

*Collaborative Papers* report work which has not been performed solely at IIASA and which has received only limited review. Views or opinions expressed herein do not necessarily represent those of the Institute, its National Member Organizations, or other organizations supporting the work.



## Introduction

The international workshop on “Climate Change: Integrating Science, Economics, and Policy” is the third in a series of interdisciplinary meetings organized at the International Institute for Applied Systems Analysis (IIASA) during the past four years. Currently, it is widely recognized in both the analytical and policy communities that the complex issues surrounding the prospect of climate change and response measures and policies cannot be adequately assessed from the perspective of any single discipline in either the natural or social sciences, and that these issues cannot be resolved in the policy domain alone. This is one of the reasons for the continued research activities in this important area at IIASA and for the decision to organize this, the third international workshop to address these issues.

The workshop originated because the organizers shared the view that small, focused meetings on specific aspects of the economics of international environmental problems would be a particularly effective way to expand the frontier of knowledge in this area. Such meetings would emphasize the interdisciplinary and international nature of both the issue and the underlying scientific effort. This vision has continued through all three of the workshops held to date.

The first workshop, which took place at IIASA from 28–30 September 1992, focused on the comparative assessment of mitigation of climate change and on its potential impacts and adaptation strategies. One of the key findings of this workshop was the need for integrated assessment. IIASA held the second workshop a year later from 13–15 October 1993. The second workshop focused on the review of the integrated assessment approaches and implications for climate change policies. The proceedings of both workshops have been published by IIASA.\*

This volume reports on the proceedings of the third international workshop, held 19–20 March 1996. This workshop focused on three related research areas in the economics of climate change: market and nonmarket impacts of climate change; costs and timing of greenhouse gas emissions abatement measures and strategies; and emissions reduction policies. Despite the considerable progress made during the past few years, these three

---

\* Kaya, Y., Nakićenović, N., Nordhaus, W.D., and Toth, F.L., eds., 1993, *Costs, Impacts, and Benefits of CO<sub>2</sub> Mitigation*, CP-93-2, IIASA, Laxenburg, Austria; and Nakićenović, N., Nordhaus, W.D., Richels, R., and Toth, F.L., eds., 1994, *Integrative Assessment of Mitigation, Impacts, and Adaptation to Climate Change*, CP-94-9, IIASA, Laxenburg, Austria.

research areas are still associated with significant methodological hurdles and scientific uncertainties. For example, on the impacts side, estimating nonmarket damages and the amenity effects has been very difficult, and on the mitigation side it has been very difficult to endogenize the role of technology in determining the costs and timing of emission abatement. The third research area, policy issues, is of great importance, because measures aimed at stabilizing atmospheric greenhouse gas concentrations at some negotiated level, in accordance with Article 2 of the United Nations Framework Convention on Climate Change, could require quite high, and in some cases costly, reductions of emissions. The proceedings have been divided into three parts to reflect these related research areas: the first part deals with the impacts of climate change, the second with greenhouse gas emissions abatement measures, and the third with emission reduction policies.

Participants in the workshop included some 62 scientists from more than 17 countries, representing a number of different disciplines. The two-day workshop was divided into seven sessions covering research areas such as the science of climate change, assessments of impacts of climate change, the role of technology, special topics in integrated assessment, and policy and implementation issues. Sessions generally started with the presentation of two invited papers and contributions by invited panel discussants, followed by general discussions. This volume includes the revised versions of papers presented at the workshop. The three parts of these proceedings reflect the written contributions and the discussions of the seven workshop sessions.

The workshop was jointly organized by the four editors of this volume, who share the responsibility for its scientific content. The editors are listed in alphabetical order, because of their joint contributions to the organization of the workshop. The workshop was financially supported by the Electric Power Research Institute (EPRI), the International Institute for Applied Systems Analysis (IIASA), the National Science Foundation (NSF), the Potsdam Institute for Climate Impact Research (PIK), and Yale University.

The workshop organizers would like to extend their thanks to the participants and contributors who provided the essential intellectual substance during the sessions and discussions, in particular to the authors of papers presented in this collaborative volume and to the institutions that provided financial support to bring such a distinguished group of scientists together for the third time on this important research topic.

The organizers are much indebted to Nadejda Makarova for research assistance and to Ewa Delpo, Ellen Bergschneider, Lilo Roggenland, Angela Dowds, and Patricia Wagner for their valuable help in the organization and preparation of this volume.

# Contents

<b>Introduction</b>	<b>iii</b>
<b>PART I: IMPACTS AND DAMAGES OF CLIMATE CHANGE</b>	<b>1</b>
<b>Climate Amenities and Global Warming</b> <i>William D. Nordhaus</i>	<b>3</b>
<b>Climate Change, Global Agriculture, and Regional Vulnerability</b> <i>John Reilly</i>	<b>47</b>
<b>The Impacts of Climate Change, Carbon Dioxide, and Sulfur Deposition on Agricultural Supply and Trade: An Integrated Impact Assessment</b> <i>Günther Fischer and Cynthia Rosenzweig</i>	<b>83</b>
<b>PAGE95: An Updated Valuation of the Impacts of Global Warming</b> <i>Erica L. Plambeck and Chris Hope</i>	<b>111</b>
<b>The Climate Change Footprint: Will We See It Before It Is upon Us?</b> <i>David L. Kelly and Charles D. Kolstad</i>	<b>135</b>
<b>The Economic Impacts of Climate Change in the USA</b> <i>Robert Mendelsohn</i>	<b>159</b>
<b>Equity and the Aggregation of the Damage Costs of Climate Change</b> <i>Richard S.J. Tol, Samuel Fankhauser, David W. Pearce</i>	<b>167</b>

<b>PART II: GREENHOUSE GAS EMISSIONS ABATEMENT MEASURES AND STRATEGIES</b>	<b>179</b>
<b>Future Projections and Structural Change</b>	
<i>Philip Bagnoli, Warwick J. McKibbin, Peter J. Wilcozen</i>	<b>181</b>
<b>Hedging Strategies for Global Carbon Dioxide Abatement: A Summary of Poll Results EMF 14 Subgroup – Analysis for Decisions under Uncertainty</b>	
<i>Alan S. Manne</i>	<b>207</b>
<b>The Berlin Mandate: The Design of Cost-Effective Mitigation Strategies</b>	
<i>Richard Richels, Jae Edmonds, Howard Gruenspecht, Tom Wigley</i>	<b>229</b>
<b>Technologies, Energy Systems, and the Timing of CO<sub>2</sub> Emissions Abatement: An Overview of Economic Issues</b>	
<i>Michael Grubb</i>	<b>249</b>
<b>Technological Change and Learning</b>	
<i>Nebojša Nakićenović</i>	<b>271</b>
<b>Technological Uncertainty</b>	
<i>Arnulf Grübler and Sabine Messner</i>	<b>295</b>
<b>The Carnol System for Methanol Production and CO<sub>2</sub> Mitigation from Coal-Fired Power Plants and the Transportation Sector</b>	
<i>Meyer Steinberg</i>	<b>315</b>
<b>PART III: EMISSION REDUCTION POLICIES AND INTEGRATED ASSESSMENTS</b>	<b>329</b>
<b>A Review of CO<sub>2</sub> Emission Reduction Policies in Japan and an Assessment of Policies of the Annex I Parties for Beyond the Year 2000</b>	
<i>Yuzuru Matsuoka, Yasuko Kawashima, Mikiko Kainuma, Tsuneyuki Morita</i>	<b>331</b>

<b>Optimization of CO<sub>2</sub> Emissions Using Coupled Integral Climate Response and Simplified Cost Models: A Sensitivity Study</b> <i>K. Hasselmann, S. Hasselmann, R. Giering, V. Ocana, H. von Storch</i>	<b>349</b>
<b>Learning from Integrated Assessment of Climate Change</b> <i>M. Granger Morgan and Hadi Dowlatabadi</i>	<b>399</b>
<b>International Institutions and Environmental Protection: Sources of Effectiveness and Ineffectiveness</b> <i>Robert O. Keohane</i>	<b>437</b>
<b>APPENDIX</b>	<b>449</b>
<b>Workshop Program</b>	<b>451</b>
<b>List of Participants</b>	<b>455</b>



**Part I**  
**Impacts and Damages of**  
**Climate Change**





# Climate Amenities and Global Warming\*

*William D. Nordhaus*

Yale University, New Haven, CT, USA

## Abstract

The most intractable issue in the economics of climate change has been to estimate the economic impacts. The present study addresses a specific major area of ignorance: the amenity effects of climate. We employ hedonic wage techniques to estimate the impact of an equilibrium carbon dioxide (CO<sub>2</sub>) doubling on climate amenities. Using data on 3105 US counties along with climate change estimates from general circulation climate models, we estimate that an equilibrium CO<sub>2</sub> doubling of 8°F (or 4.5°C) would be associated with a disamenity premium of about 0.17% of gross domestic product (GDP). Bootstrap techniques indicate that this estimate is quite fragile and subject to both sampling error and specification error. Considering all factors, we conclude that the most likely effect of an equilibrium CO<sub>2</sub> doubling for the USA would be a disamenity of 0.17% of output with an uncertainty of about 2.5% of output.

## 1. Summary and Conclusions

Because this study is long and complicated, I provide a summary for the harried scientist and policy maker.

1. The present study estimates the impact of greenhouse warming on climate amenities. The amenities associated with climate change include the effects on the value of directly “consumed” climate as well as the impacts on leisure and other nonmarket activities that are complementary with climate. Amenity effects may be significant because of the large economic value of leisure and because of the high climatic content of many leisure activities.

2. Valuation of climatic amenities poses deep difficulties because they are not directly bought and sold and do not provide the “price, quantity”

---

\*The author is grateful for the research assistance of Kathy Merola. Kris Reynolds assisted in preparation of the regional cost of living indexes. This study was supported by the National Science Foundation.

valuations that attach to most private goods and services. The measurement issue is addressed using hedonic wage theory. Under hedonic theory, wage differentials associated with different climates represent the amounts necessary to compensate people for the associated amenities: if the climate in a region is pleasant, then people will accept lower wages to work in that region.

3. The empirical estimates rely on a new county data set for the USA that provides comprehensive coverage of 3105 US counties. The major new data are nominal wages and cost of living indexes by county. The county climate data are drawn from an earlier study by Mendelsohn *et al.* (1994), and estimates of the impact of CO<sub>2</sub> doubling are drawn from projections of 16 general circulation models. We construct three “consensus climates” that are alternative averages of the different models. These models project an average warming of 8°F (4.5°C) and an increase of 4% in precipitation.

4. In the regression estimates, the dependent variable is real average hourly earnings, while the exogenous independent variables include climatic, demographic, and geophysical variables. The climatic variables are a cubic function of temperature, a quadratic function of precipitation, and interaction terms. The geographic variables include latitude, longitude, contiguous bodies of water (such as ocean, the Great Lakes, and navigable rivers), and interaction terms. The socioeconomic variables include the unemployment rate, the density of the population, education, and ethnic variables. Population density is taken to be an endogenous variable in the simultaneous-equation estimates, and we use as instrument for population the employment in “export industries.”

5. We estimate the model using different techniques and different specifications. The central estimates use a uniform climate change scenario. The preferred estimate (two-stage least squares with wage-weighting) indicates that a warming has a small disamenity premium for the USA. In the preferred equation, an equilibrium CO<sub>2</sub> doubling causes amenity losses of about 0.35% of aggregate US wages. This is the equivalent of about 0.17% of US gross domestic product (GDP). At 1995 levels of prices and incomes, this represents \$12 billion per year.

6. Bootstrap techniques indicate that this estimate is quite fragile and subject to both sampling error and specification error. Data bootstrap techniques indicate that the uncertainty of the hedonic impact is about 3.5% of total wages, while specification tests indicate a similar range uncertainty. Other wage series tend to indicate that climate change will lead to a positive amenity. Traditional weighting approaches also suggest that warming will lead to increased amenities.

7. Weighing all the different specifications and bootstraps, the most likely impact of an equilibrium CO<sub>2</sub> doubling for the USA is a disamenity of 0.35% of total wages (or 0.17% of total output) with an uncertainty or standard error on this estimate of 5% of wages (or 2.5% of output).

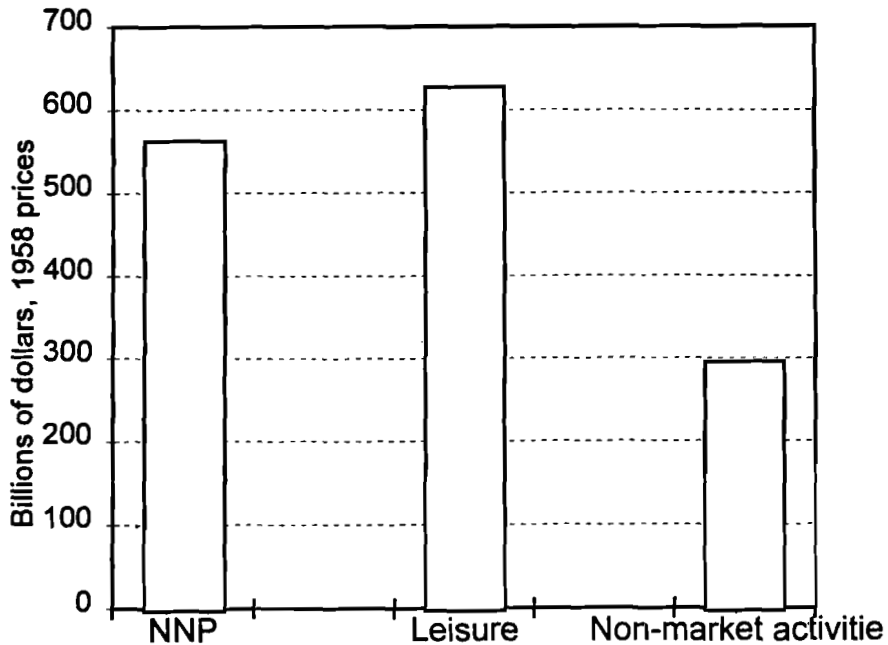
## 2. Background

Climate change involves complex and controversial issues of economics and politics, but perhaps the most intractable has been the issue of valuing climate change. This issue involves a wide variety of sectors and regions as well as the need to forecast impacts in the distant future. In a few areas, researchers are reasonably confident that they have identified the principal impacts. For agriculture and forestry, estimates of damage are in place for a number of countries, although the estimates differ widely depending on the technique and time horizon. However, in a number of sectors of great potential importance, there are no serious scientific estimates of the potential impacts. The areas of greatest uncertainty are nonmarket impacts on humans and impacts on natural ecosystems. For these, researchers have to date made essentially no progress.

The present study attempts to fill the knowledge gap in one particularly important area, *amenities*. More specifically, we estimate the value of climate on location-specific, nonmarketed goods and services. This mouthful of a phrase encompasses a wide array of goods and services. Perhaps the most important ones are the effects of climate change on the value of directly “consumed” climate as well as the effects on leisure and other nonmarket activities that are complementary with climate.

These effects may be quite significant for two reasons. First, the value of leisure and nonmarket time is a significant fraction of total economic income. Estimates of the value of leisure time indicate that it has approximately the same value as all marketed consumption goods and services (see Figure 1). A second factor is that climate has major interactions with the use of nonmarket time. While work time is often either climate-controlled or not significantly affected by climate, leisure time in activities such as skiing, swimming, sunning, gardening, hang gliding, and similar activities is highly dependent on the weather conditions. The importance of nonmarket time and the dependence of leisure activities on climate raises the potential for a major impact of climate change on the value of nonmarket activities.

The study of amenity values of climate change in the context of global warming is still in its infancy. Fankhauser, in his survey of the area, reports



**Figure 1.** Leisure, nonmarket activity, and measured output. Nonmarket activities such as leisure and household activities have economic value comparable with that of market output. Source: Nordhaus and Tobin, 1972.

that the “monetary value of a benign climate is still largely unknown ...” (Fankhauser, 1995, p. 43). In his study of climate change, Cline does not even hazard a guess on the amenity value (Cline, 1992, pp. 115–116). The only serious study of the subject dates back to an analysis by Hoch and Drake (1975) on the value of climate amenities associated with global cooling from ozone depletion.<sup>1</sup> Their study used relatively limited data on wages and climate. An application of their result would indicate that the greenhouse effect as applied to the USA would lead to modest increases in amenity values.

Local climate impacts actually encompass a broad array of factors in addition to climate amenities. For example, if the climate in a region is associated with unpleasant and dangerous pollution, then this would be included

<sup>1</sup>This was part of the CIAP study on the effect of a fleet of supersonic aircraft on various sectors (see Hoch and Drake, 1975).

in the climate valuation of that region. If the climate of the *Zauberberg* is beneficial to health, this also would enter into the valuation of the climate. More generally, we can distinguish the effect of climate on productivity of tradable goods, productivity of non-tradable goods, and consumption activities.

- To the extent that climate increases the productivity of tradable goods, there will be no effects on prices of goods across regions, but the rents of region-specific factors will rise to reflect the higher productivity.
- If climate affects the productivity of non-tradable goods, this will affect both the rents of region-specific factors and the prices of the non-tradable goods.
- If climate affects the consumption or utility in a region, then the rents of region-specific factors will change and the returns to labor will adjust.

The present study focuses primarily on the third factor – the effect of climate on utility and the complementarity of climate with consumption. In general, I will interpret this as the amenity effect of climate, including the delight in warm and sunny days or crisp powder snow. We should recognize, however, that estimated climate impacts include other climate-related public goods and non-traded goods such as pollution, health effects, transportation effects, and even energy costs to the extent that these are not included in real wages or price indexes.

The present study extends current research in this area in three ways. First, it extends the database to a comprehensive set of observations by constructing wages, climates, and other variables at the county level. Second, it identifies certain statistical issues in the estimation of hedonic wage regressions of environmental variables that have been largely ignored in the past and finds these to be important in the interpretation of the data. Finally, it presents a new set of estimates of climate amenities and their relationship to global warming.

### **3. The Theory of Implicit Valuation of the Environment**

Valuation of many climatic amenities poses deep difficulties, because they are not directly bought and sold and do not provide the “price, quantity” valuations that attach to most private goods and services. Economists therefore look for “implicit” values, or what is sometimes called the theory of “hedonic prices,” in attempting to infer the valuation of nonmarketed goods and

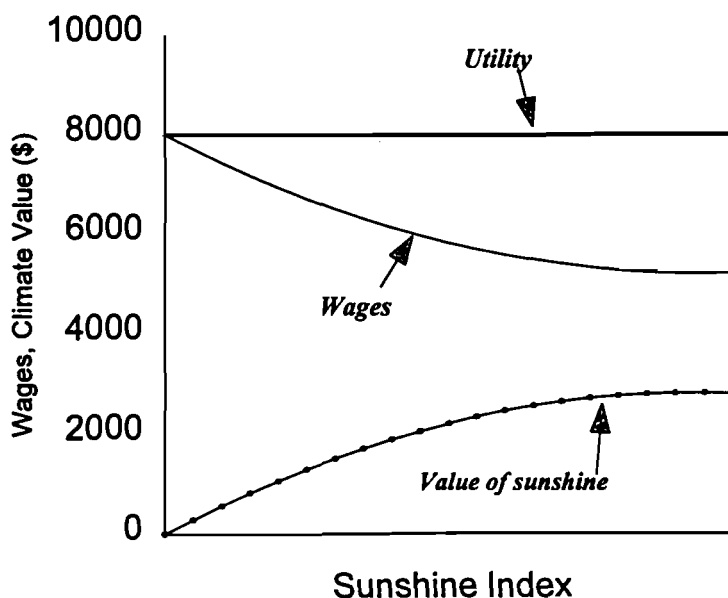
services. Hedonic valuation is used to infer the impact of climate on land productivity or agricultural yields; to infer the valuation of different recreational sites through examination of travel costs; and to understand the characteristics of jobs, such as the valuation of safety, through comparing wage rates.

This issue is particularly important for the issue of climate change, because of the extensive interaction between climate and nonmarket activities. Earlier studies have tended to find little impact of climate on *productive* activities in most high-income countries (at least outside of agriculture). The reason for the minimal influence on nonfarm output is the ability of most production processes to be separated from the vagaries of climate. On the other hand, climate interacts much more significantly with consumption both because climate is consumed directly (in terms of enjoyment of sunny days) and because climate is a complementary input in many consumption activities, particularly those involving leisure time (such as skiing, sitting on the beach, or gardening). Because of the strong influence of climate on leisure and consumption activities, it is possible that climate has a major impact on living standards even though its effect on measured national or individual income is negligible.

### 3.1. A simplified example

Even though we cannot directly measure the nonmarket impact of climate on economic welfare, we can attempt to deduce the value through the use of hedonic wage techniques. The basic reasoning in the simplest case is the following. Assume that a country is divided into different regions. Each region is identical except for its climate. All factors of production except climate and land are mobile, so labor, capital, and technology can move freely among the different regions. There is a single good (or composite good) that is produced in each region, and its price will be equal in all regions. Because factors are mobile, factor prices are in equilibrium equalized (net of any corrections for climate).

In this simplified example, we assume that climate affects the economy only through its effect on individual preferences and well-being. All individuals are identical, and, for simplicity, we suppose that all individuals have identical work and leisure hours. Suppose that the relevant climate variable is the percentage of the year that is sunny, called “sunshine.” We assume that individuals prefer sunnier locations to cloudy regions; that is, individual preferences include consumption of the composite good, leisure, and sunshine.



**Figure 2.** Wages and the hedonic value of climate. Value of sunshine rises with sunshine index. With mobile labor, utility must be equalized across climates. Therefore, in equilibrium, wages are lower in more pleasant locations. The sum of wages and hedonic value of sunshine equals the constant level of utility across regions.

What is the economic equilibrium? By construction, all individuals have the same hours of leisure, and a dismal climate *ceteris paribus* lowers individual well-being. To induce people to live in gloomy locations, wages must therefore adjust to allow people who work there to earn more and consume more of the market good. In other words, wages must provide *compensating differentials* to offset the desirability or lack of desirability of particular locations. If the climate in a region is so pleasant that it yields \$1000 of extra economic well-being, then in equilibrium wages must adjust so that workers can buy \$1000 less of marketed goods and services. The change in wages then just offsets the nonmarket amenity or disamenity of the environmental goods and services. Figure 2 shows the basic idea for the simplest model.

### 3.2. Realistic complications and the identification problem

The simplest example just presented is the usual approach in most analyses of the hedonic valuation of nonmarket goods. There are, however, potentially

significant statistical issues that must be addressed – the issue of statistical identification. This is in fact a deep and troubling issue which is usually ignored. In this section, I discuss the question and propose a solution. Consider the simplest set of equations for supply and demand for labor:

$$\omega = \alpha_1 L^s + \alpha_2 C + \alpha_3 Z \quad , \quad (1)$$

$$E^d = -\beta_1 \omega + \beta_2 C + \beta_3 Z \quad , \quad (2)$$

In these equations,  $\omega$  represents real wages in each county,  $L_s$  is labor supplied,  $E^d$  is the demand for labor,  $C$  is climate or a function of climate,  $Z$  is a set of exogenous variables such as demographics, latitude, and geographical conditions. The coefficients ( $\alpha_i$  and  $\beta_i$ ) are parameters. ( $C$  and  $Z$  may be vectors of variables.)

Equation (1) is usually interpreted as the equation for wage hedonics, in which the coefficients are the amenities or disamenities associated with particular variables. In the present study, we are interested in estimating the hedonic relationship between climate and wages, given by  $\alpha_2$ . For purposes of discussion, take the coefficients to be scalars, but the generalization to vectors is immediate. In equilibrium,  $L^s = E^d = L =$  actual employment, which yields

$$L = \{[\beta_2 - \beta_1 \alpha_2]C + [\beta_3 - \beta_1 \alpha_3]Z\} / (1 + \alpha_1 \beta_1) \quad , \quad (3)$$

$$\omega = [(\alpha_1 \beta_2 + \alpha_2)C + (\alpha_1 \beta_3 + \alpha_3)Z] / (1 + \alpha_1 \beta_1) \quad , \quad (4)$$

The total derivatives of employment and wages with respect to climate and the climate employment relationship are then

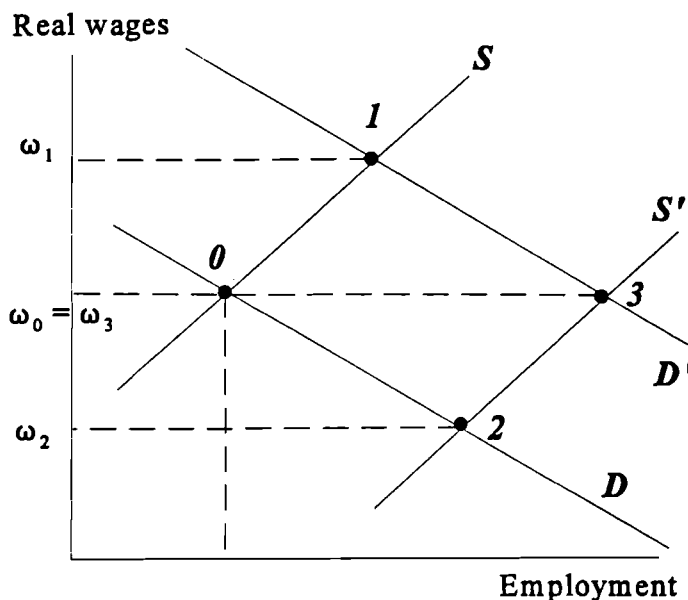
$$d\omega/dC = (\alpha_1 \beta_2 + \alpha_2) / (1 + \alpha_1 \beta_1) \quad , \quad (5)$$

$$dL/dC = (\beta_2 - \beta_1 \alpha_2) / (1 + \alpha_1 \beta_1) \quad , \quad (6)$$

$$d\omega/dL = (\alpha_1 \beta_2 + \alpha_2) / (\beta_2 - \beta_1 \alpha_2) \quad . \quad (7)$$

The point that emerges from this analysis is that the estimated coefficients in an ordinary least squares (OLS) hedonic wage regression will be





**Figure 3.** Potential statistical bias in hedonic estimates. County  $0$  is a cold-climate county, whereas the other counties are warm-climate counties. (a) If climate differences only affect supply and individuals prefer warmer climates, then a warmer climate shifts supply down to  $S'$ , leading to equilibrium at  $2$ . In this case, the negative association of temperature and wages indicates the true amenity value of climate. (b) Suppose individuals are indifferent among climates but climate affects production. By shifting demand from  $D$  to  $D'$ , with equilibrium at  $1$ , we see that the higher temperatures are associated with higher wages. This association gives the incorrect conclusion that individuals dislike higher temperatures. (c) If both (a) and (b) are at work, the resulting equilibrium at  $3$  gives a combination of supply and demand effects. The wage-temperature association cannot easily be interpreted.

a tangle of supply and demand coefficients. The implicit identifying assumption made in most studies of wage hedonics is that there is no relationship between utility and employment in the given area, or that  $\alpha_1 = 0$ . That is, individuals do not care whether they live in a high-employment or low-employment region. Under this assumption, it is clear from (5) that  $d\omega/dC = \alpha_2$ , which gives the correct estimate for the hedonic coefficient.

This is clearly subject to potential statistical bias. In the case where the coefficients on climate are positive (say higher temperatures are good for production but disliked by people) the coefficient may be biased if  $\alpha_1 = 0$

(that is, if people dislike densely populated areas). This is a real worry in the data because of the potential that warmer climates are good for production. Fortunately, there are well-developed statistical techniques for testing and correcting for simultaneous-equation bias. To correct for potential simultaneous-equation bias, we use two-stage least squares (TSLS). Under this approach, we use exogenous variables that affect demand but not supply as instruments for the right-hand-side endogenous variable in equation (1). With TSLS, the estimates of the parameters are consistent, although they may be inefficient relative to other estimators. OLS estimators, by contrast, will be biased if the right-hand-side endogenous variables are correlated with the disturbances.

Figure 3 illustrates how estimates of hedonic wage regressions can be biased if issues of simultaneous-equation bias are ignored. In this simple case, the wage-temperature relationship provides the correct hedonic estimate if production is unaffected by climate.

## 4. Sources of Data

### 4.1. General approach

To estimate the amenity value of climate, we have developed a new data set at the county level for the USA. Most studies to date have relied on larger aggregates, primarily data for cities or large metropolitan areas. The advantages of moving to the county level are twofold. First, the number of observations increases significantly, with the potential for using 3105 counties as opposed to approximately one-tenth that number of cities. Second, many of the important attributes of climate, particularly those relating to outdoor activities, are likely to be more important in nonurban locations than in urban locations. Simply put, the climate is likely to matter less in the Washington subway system or in the New York Squash and Racquet Club than on a beach in Southern California or a ski area in Colorado.

The disadvantages of using the county data are, first, the lack of observations on individuals and the consequent requirement of using county aggregates. This implies that less information on individual characteristics is available. A more important hurdle has been the need to construct a wide variety of data that do not exist at the county level. This study relies on an earlier set of estimates of county climates that were developed in Mendelsohn, Nordhaus, and Shaw (MNS; Mendelsohn *et al.*, 1994). To implement the present study, it was necessary to develop county wage rates, county cost of living estimates, and a set of county climate change estimates that

drew on a wide variety of climate models. The payoff from developing this data set is a comprehensive data set for the USA and a much more detailed resolution of the climate-amenity relationship.

## 4.2. Data

I begin with a description of the data used for the study. The most important are data on wage rates, initial climates, and projected climate change. The data generally pertain to the period 1979–1986, except for the climate data, which are climatic normals for the period 1951–1980. They are all the counties of the USA. There are 3105 counties, which include all counties, with some minor adjustments for economic reporting areas that do not conform with political boundaries.<sup>2</sup>

*Nominal wage rates.* There exists no widely used data set at the county level. It is not possible to use census data on individuals because of sparseness of the data for small counties. There are two largely independent data sets that can be used to construct county wage data. The first and least satisfactory are census estimates of total wages and hours of work in manufacturing by county. These data are the only ones that contain reliable estimates of hourly wages. Their shortcoming is that the coverage is but a small fraction of the work force, particularly so in many smaller rural counties.

The data set that forms the primary source for this study is derived from the Bureau of Economic Analysis (BEA) estimates of employment and wages by industry at the county level that is contained in the Regional Economic Information System (REIS; US Department of Commerce, 1995). We constructed a number of different indexes to test for robustness, but the preferred wage rate is an index of earnings in those industries which have primarily full-time workers (we call this Index # 4). To construct this index, we calculated average hourly earnings in each county for the 10 major full-time industries. These were calculated by taking average wages per employee in the county and dividing this by the national estimate of hours worked in that industry. The average hourly earnings were then combined in a fixed weighted index using national employment weights. To remove business cycles and temporary influences, we then took an average of the county wage rates for three years, 1979, 1982, and 1986.

---

<sup>2</sup>The major deviations are in the state of Virginia, for which we have created 25 “supercounties,” or reporting areas that are combinations of smaller counties. For these and other counties where the political and economic boundaries do not coincide, we either take average data for the counties or use the data for the largest county.

The major external validation of the wage series was a comparison for a series on manufacturing wages based on the BEA manufacturing earnings data with estimates on hourly earnings in manufacturing from the census. The correlation was 0.848. It is clear that there is potential for error in measurement of the wage rates given the lack of county-level hours data. On the other hand, there is little variation across states or years in the hours worked, and the errors are highly unlikely to be correlated with county climates, so the errors are likely to lead to imprecise estimates rather than biased ones.

*Regional cost of living indexes.* Hedonic estimates clearly should examine real wages (that is, wages corrected for regional cost of living) rather than nominal wages. This is potentially a serious issue because of the clear correlation of the cost of living with regions, with higher living costs in coastal areas, in cities, and in the Northeast and with lower costs of living in the South. There are no satisfactory cost of living indexes available today, so we devised an approach based on existing data. The basic data came from a Bureau of Labor Statistics (BLS) study of regional costs of living conducted in 1981–1983 (see BLS, 1982, 1967). This study contained observations for 25 cities and 4 regional nonmetropolitan areas. We have no further reliable data on general costs of living. However, this study indicated that the primary source of regional cost of living differentials is housing costs, and there are detailed surveys of housing costs in different regions prepared for government housing assistance programs. We therefore combined the BLS survey with Department of Housing and Urban Development data on rentals by county to compute a regional cost of living index. We then calculated real wages as the nominal wage rate divided by the regional (county) cost of living.

The regional cost of living calculations are probably the weakest link in the entire estimate of the wage hedonics (aside from missing variables). This is particularly worrisome because of the clear association of cost of living with climate. We have attempted to make various corrections for this potential bias, but the issue should be flagged.

*County climates.* Climatic data pose measurement issues because they are available by meteorological station rather than by county, so it was necessary to estimate county-average climates. As noted above, the data were constructed by Mendelsohn, Nordhaus, and Shaw (MNS). MNS started with climate data that were available from the National Climatic Data Center, which gathers information from more than 5000 meteorological stations

throughout the USA. These stations form a dense set of observations for most regions of the continental USA with the exception of some of the desert Southwest. The data include information on precipitation and temperature for each month from 1951 through 1980. Because the purpose of this study is to predict the impacts of climate change on amenities, it is appropriate to consider the long-run impacts on wages of precipitation and temperature, not of year-to-year variations in weather. We consequently examine the “normal” climatological variables – the 30-year average of each climatic variable for every station as well as seasonal averages. MNS then used the station data to create an estimated climate for each county. For this purpose, the county climate was located in the geographical center of the county.

For the present study, we conducted a number of validation exercises by comparing the county climates estimated in MNS with climate data on the cities in the counties. These comparisons indicated a close correspondence for most counties. For a dozen or so counties, mostly in the states of California and Washington, there were some significant deviations, generally because of unusual local topological conditions, but there were no obvious biases that seemed to arise from the discrepancies. Finally, we added data for the counties in Alaska and Hawaii so as to complete the coverage to the entire United States.

*Climate change estimates.* One of the principal issues addressed in this study is the estimated impact of climate change in the coming decades. To estimate this, we compare the difference between a hypothetical future climate and the current base climate. The base climate was just discussed. The future climate is generated by taking the current *level* of climate variables and adding to them the *estimated change* in climate.<sup>3</sup>

The changes are the estimated effects of doubling of CO<sub>2</sub> taken from runs of 16 different general circulation models (GCMs). The numerical estimates for the individual models were calculated by Robert Mendelsohn of Yale University and Larry Williams of Electric Power Research Institute (EPRI), which they provided for this study. These were interpolated from the GCM gridpoints by cubic splines. Alaska and Hawaii were included using data from runs on different GCMs.

We created three “consensus” climate change scenarios for this study. One is the simple average for each county across the different models

---

<sup>3</sup>That is, future climate is estimated as the base climate from the meteorological data plus the estimated change in climate from the climate models. This approach ensures that poor projections of current climate in the climate models will not influence the initial conditions.

(“average of models”). A second constructs a statistical optimum or portfolio in which the models were weighted by their success in predicting the initial climate (this is the “portfolio of models”). The final consensus climate is a uniform national average climate change. For this, we took the wage-weighted average climate change from the portfolio model (which is an 8.02°F or 4.5°C change in temperature, and a 4.04% change in precipitation) and applied this change equally in all counties (this is the “uniform national average”).

*Other data.* The regressions contain a number of other variables that are likely to affect labor markets either through supply or demand. These include variables on the supply side (including demographics such as ethnic origin and education) or demand side (such as the presence of bodies of water, ports, tonnage of ports, and rivers, as well as the presence of state capitals in the county). These variables were derived from a wide variety of sources including, notably, the US Commerce Department, County and City Data Book (US Department of Commerce, 1994). In addition, we included the influence of latitude and longitude, which determine seasonal sunshine, as well as interactions among the different geographical variables. We include certain labor market variables, such as the unemployment rate. Finally, other local public goods such as density are included. In addition, we have added state dummy variables to capture the impact of state tax structures and public goods.

*Regressions and the loss function.* A neglected issue in many studies is to link the statistical procedure to the underlying purpose of the analysis. Often, statistical analyses are undertaken to estimate or project an aggregate (such as consumption, the value of a stock portfolio, or total population). In such cases, it is generally inefficient to use ordinary least squares estimates. In this study, because the object of the analysis is to minimize the predicted error of the aggregate impact, this implies that the loss function that should be minimized is not the simple squared errors across counties. Rather, it is the squared error of the sum of the hedonic losses across counties. This loss function is equal to the error in each county multiplied by the amount of wages in each county, then summed across all counties. We therefore use a weighting function for our regressions, which has as weights the total wages in the county.<sup>4</sup>

---

<sup>4</sup>For a discussion of the use of weighted least squares, see Pindyck and Rubinfeld (1991). The author knows of no studies that address the issue of weighting when forecasting aggregates from microeconomic data.

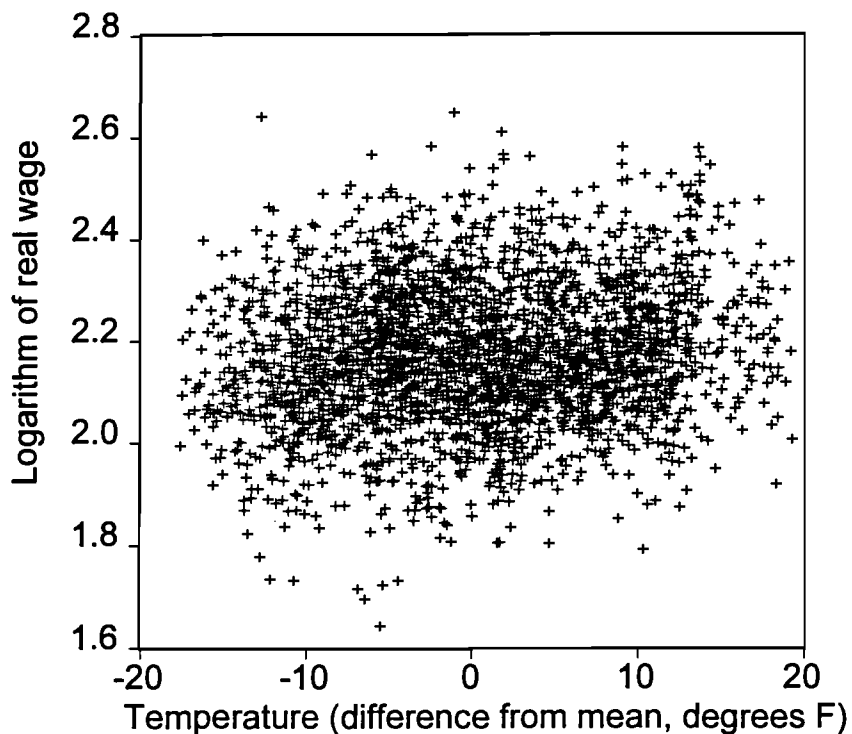


Figure 4. Raw data on real wages and temperature by county.

## 5. Empirical Results

### 5.1. Basic regression results

Figure 4 shows the raw association between annual mean temperature and real wages by county. The wide scatter in the figure indicates that there is more to life than climate. There is great variability of real wages by mean temperature. A visual scan indicates that little of the wide variation in wages across climatic zones is determined by the variation in average temperature.

The raw association of climate and wages proves little, of course, because other factors may lie behind the variability and may confound any underlying relationship. Figures 5(a)–5(i) show a number of simple bivariate scatter plots of real wages and other important variables. These show how wages vary by precipitation, summer temperature, winter temperature, unemployment, latitude, longitude, population density, port tonnage, and migration. There is no obvious relationship for most of the variables. The outlier with respect to high latitude is North Slope, Alaska. The summer temperature

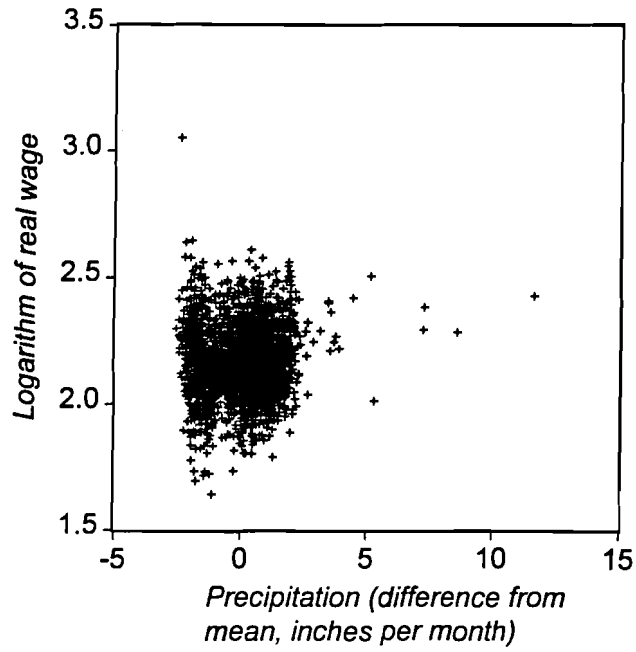


Figure 5(a). Real wage and precipitation.

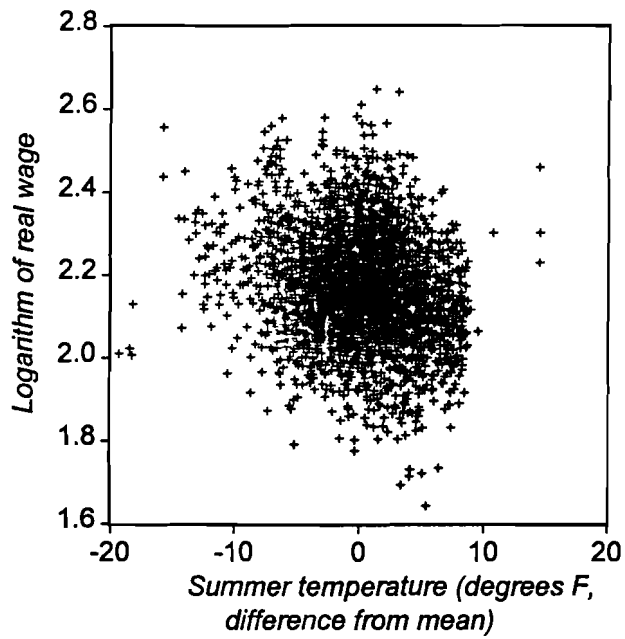


Figure 5(b). Real wage and summer temperature.



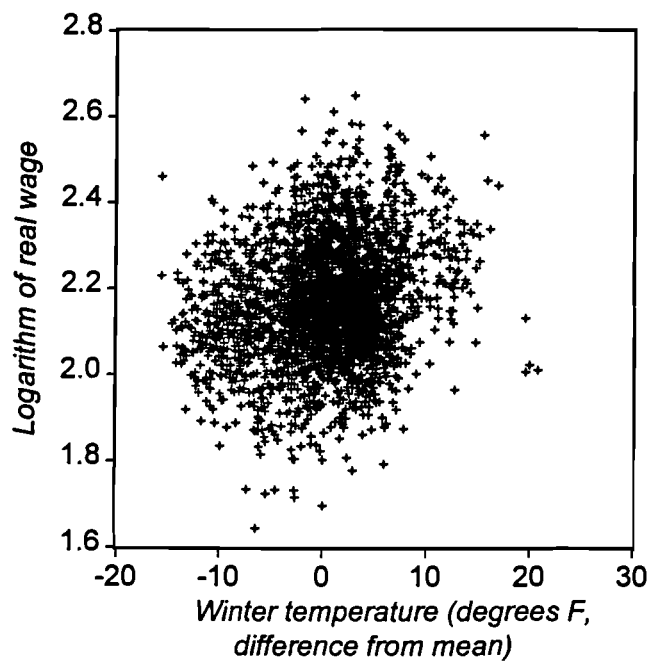


Figure 5(c). Real wage and winter temperature.

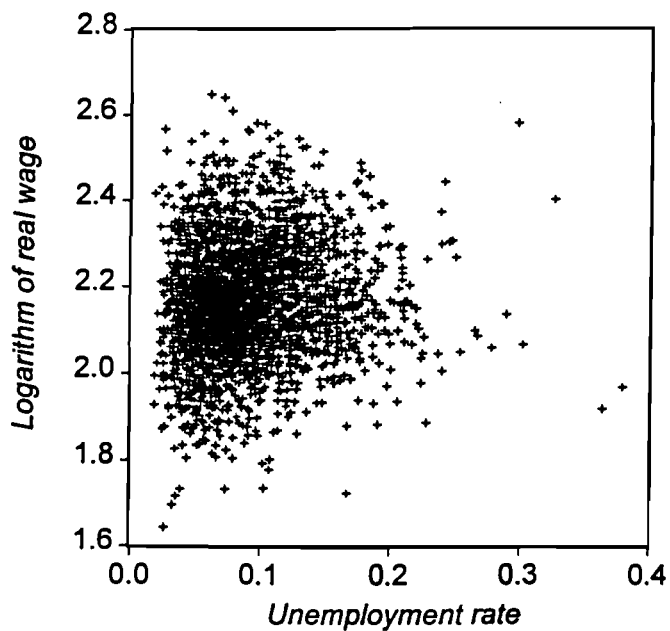


Figure 5(d). Real wage and unemployment.

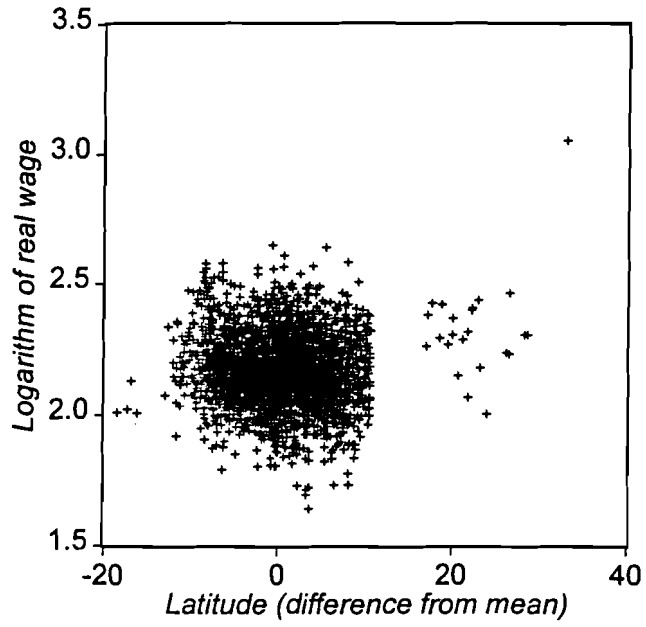


Figure 5(e). Real wage and latitude.

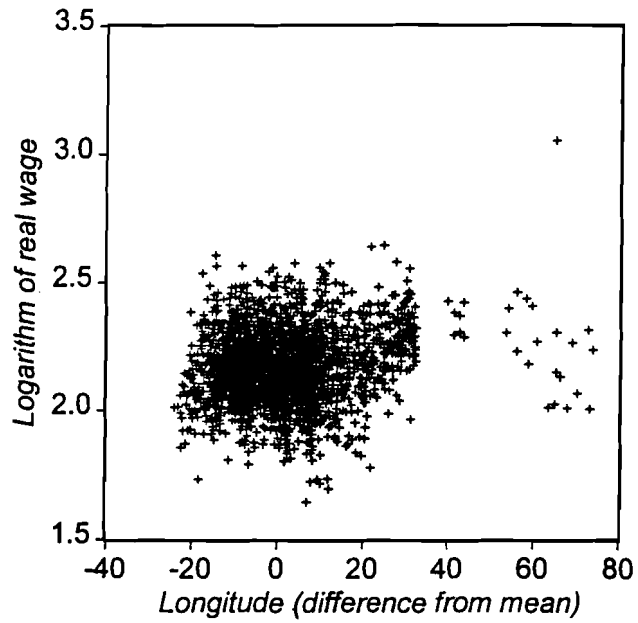


Figure 5(f). Real wage and longitude.

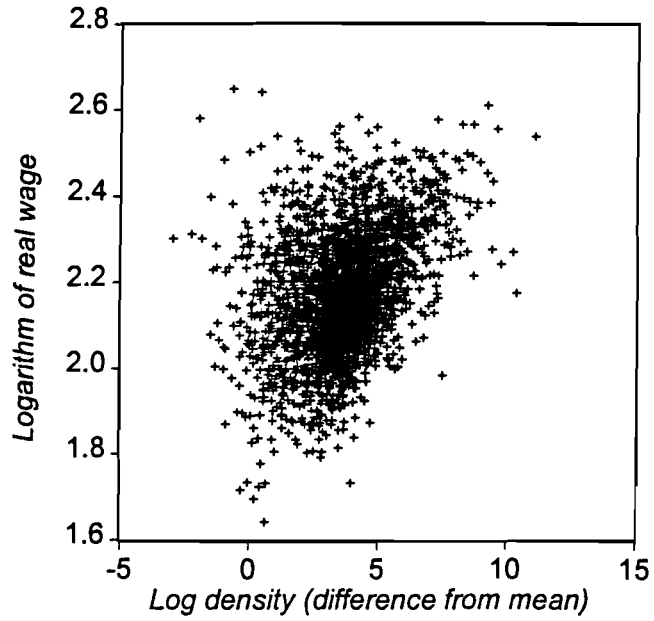


Figure 5(g). Real wage and density.

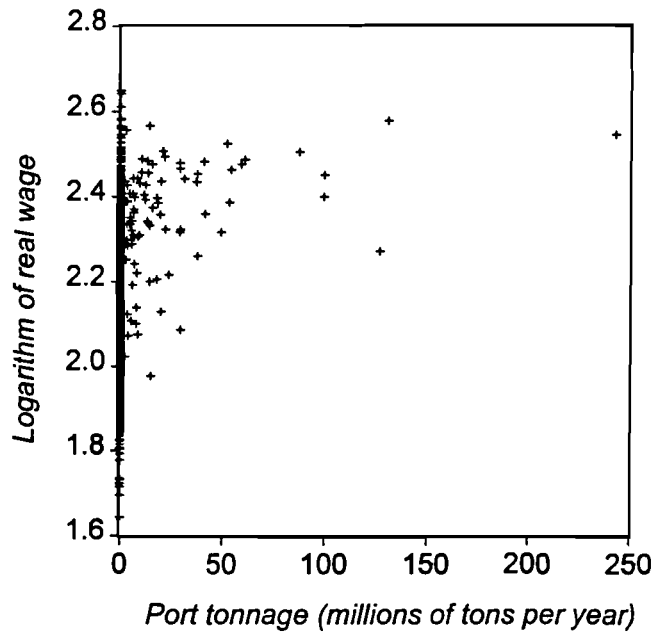


Figure 5(h). Real wage and port tonnage.

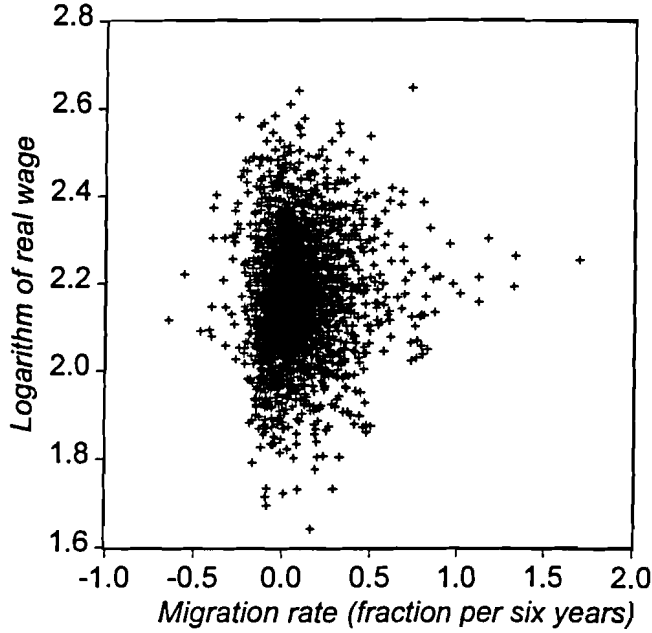


Figure 5(i). Real wage and migration.

graph indicates a slight negative relationship of wages with summer temperatures, suggesting a positive amenity. The only variable that comes through clearly is the clear association of wages with population density – a result that has been documented for many years.

The next step is to estimate the underlying hedonic wage function. The principal statistical results involve the OLS and TSLS estimates of the basic hedonic wage regression in (1) above. Rewriting this in its general form, we have

$$\omega_j = \alpha_1 L_j^s + \alpha_2 C_j + \alpha_3 Z_j^s + \epsilon_j^s \quad (1')$$

The bold letters indicate vectors, and the  $j$  subscripts indicate that the observations are over the 3105 counties. The  $Z_j^s$  are the exogenous variables affecting supply, while the  $\epsilon_j^s$  are the disturbances to the supply equation. In the OLS approach, we simply estimate (1'). In the TSLS approach, we treat the density variable,  $L_j^s$ , as endogenous and use omitted exogenous variables from the demand equation as instruments for the endogenous variable. It will be useful to present simple regressions. These are the log of real wages on temperature, temperature and log density, and these variables plus state

dummy variables. The first set is unweighted; the second group is wage-weighted.

Specification	Coefficient ( $\times 100$ )		
	On temp.	Std error	t-statistic
Variables: C, TEMP (unweighted)	0.1626	0.0290	5.60
Variables: C, TEMP, LDENS (unweighted)	0.0501	0.0278	1.80
Variables: C, TEMP, LDENS, STATE DUMMIES (unweighted)	-0.0456	0.0367	-1.24
Variables: C, TEMP (wage weighted)	-0.0368	0.0233	-1.58
Variables: C, TEMP, LDENS (wage weighted)	0.2417	0.0203	11.89
Variables: C, TEMP, LDENS, STATE DUMMIES (wage unweighted)	-0.3901	0.0301	-13.00

None of the temperature coefficients is large. Although three are statistically significant, the signs are inconsistent. The temperature coefficient is a semi-elasticity. The first coefficient indicates that a 1°F change in temperature is associated with a 0.16% increase in wages, or a 0.16% disamenity premium. The semi-elasticities range from minus 0.39% to plus 0.24%.

We now turn to the full regression analysis. Begin with the standard version of the hedonic equation (1'). This equation has the real wage rate on the left-hand side and a group of climatic, geographic, and socioeconomic variables on the right-hand side. The climatic variables are a cubic function of temperature, a quadratic function of precipitation, and interaction terms. The geographic variables include latitude, longitude, contiguous bodies of water (such as ocean, the Great Lakes, and navigable rivers), and interaction terms. The socioeconomic variables include the unemployment rate, the density of the population, education, and ethnic variables.<sup>5</sup>

To deal with simultaneous-equation bias, we treat wages and population density as endogenous and use TSLS. As an instrument for population

<sup>5</sup>We originally intended to include other demographic variables such as the crime rate, pollution, and data on other demographic groups. These were, however, not available on a comprehensive basis. Tests of the relationship with these variables for counties where the data were available did not indicate any economically significant difference in the outcome.

density, we used a variable we call *BROADX*, which is roughly equal to employment in exogenous or “exports” industries in a county per unit of area. *BROADX* begins with “broad export employment,” which includes employment in those industries in a county that we reckon to be relatively independent of the climate and other excluded labor-supply variables. Mining is a good example. The presence of mining output in a county is determined by geological considerations and is unlikely to be affected by variables affecting the supply of labor. (One of the largest observations for *BROADX* is the county containing North Slope, Alaska.) Other industries composing the broad instrument are manufacturing, fisheries, water transportation, and military. We then take total employment in these industries, divide it by the area, and define this to be *BROADX*, which is then assumed to be an instrument for population density.

Table 1 shows the definitions of the variables, and Table 2 shows the results of the basic OLS regression. It will be useful to focus on the coefficient of *TEMP*. Because we have removed the means from the variables, this coefficient gives the impact of a 1°F increase in temperature on the log of average wages at the mean of the sample. The semi-elasticity of 0.0075 indicates that at the mean of the sample, a 1°F increase in temperature (other things being equal) is associated with a 0.75% increase in wages. The hedonic interpretation of this coefficient is that higher temperatures are undesirable and require a compensating wage differential of slightly less than 1% per °F increase.

The TSLS regression in Table 3 shows that simultaneous-equation bias is a significant problem. The semi-elasticity on mean temperature is reduced by approximately half, as would be expected if the warm climates are associated with higher productivity. Other variables are relatively less affected.

In both the OLS and the TSLS equations, density is an extremely powerful variable. This relationship was interpreted long ago in Nordhaus and Tobin as an “urban disamenity premium” (Nordhaus and Tobin, 1973). This study shows that the premium is also apparent when extended to all US counties and when corrections are made for regional cost of living differences and for the simultaneous-equation bias. It is notable that the actual size of the urban disamenity premium is reduced by approximately half in the TSLS estimates.

Figure 6 shows a plot of “conditional wages” against mean county temperature. Conditional wages are calculated as wages after removing the predicted impact of the non-temperature variables on wages. This figure allows us to get a visual impression of the partial relationship between wages and

Table 1. Variable list in regression analysis.

TEMP = Temperature by county (degrees F, deviation from national average).  
 TEMP2 = TEMP<sup>2</sup> = temperature squared  
 TEMP3 = TEMP<sup>3</sup> = temperature cubed  
 PREC = Precipitation by county (inches per month, deviation from national average).  
 PREC2 = PREC<sup>2</sup> = precipitation squared  
 TEMPREC = TEMP × PREC = interaction of precipitation and temperature  
 XT1, XT4, XT7, XT10 = Temperature by county for January, April, July, October (degrees F, deviation from national average annual average).  
 XP1, XP4, XP7, XP10 = Precipitation by county for January, April, July, October (inches per month, deviation from national average annual average).  
 X(s,t)2 = X(s,t)<sup>2</sup>, where i = P and T, t = 1, 4, 7, 10  
 LDENS = log of density (persons per square mile)  
 LDENS<sup>2</sup> = square of LDENS  
 COLGRAD = Fraction of population with a college degree  
 HSGRAD = Fraction of population with a high-school degree  
 POPHISP = Fraction of population with Hispanic origin  
 LAT = Latitude (deviation from national average)  
 LONG = Longitude (deviation from national average)  
 LAT2 = LAT<sup>2</sup> = latitude squared  
 LONG2 = LONG<sup>2</sup> = longitude squared  
 LATLONG = LAT × LONG = interaction of latitude and longitude  
 OCEAN = 1 if county on ocean, 0 otherwise  
 OCEANLAT = OCEAN × LAT = interaction of ocean and latitude  
 OCEANLONG = OCEAN × LONG = interaction of ocean and longitude  
 OCEANLL = OCEAN × LONG × LAT = interaction of ocean, latitude, and longitude  
 TEMPOCEA = TEMP × OCEAN = interaction of temperature and ocean  
 PRECOCEA = PREC × OCEAN = interaction of precipitation and ocean  
 MISRIVER = 1 if on Mississippi River, 0 otherwise  
 TONPORT = Annual tonnage transshipped in port county  
 PORT = 1 if on a navigable waterway, 0 otherwise  
 GL = 1 if on Great Lakes, 0 otherwise  
 UR = Unemployment rate in county, 1982  
 LBROADX = Logarithm of instrumental variable for density. Instrument is equal to total employment in "exogenous" sectors per square mile as an instrument for density. Exogenous sectors are mining, manufacturing, water transportation, and military.  
 LBROADX2 = LBROADX<sup>2</sup> = squared instrument.

**Table 2.** Ordinary least squares estimates of hedonic regression.

LS // Dependent Variable is LAVI4		Date: 07/16/96 Time: 15:01		
Weighting series: WTWAG		Sample: 1 3105		
Included observations: 3105				
<i>Variable</i>	<i>Coefficient</i>	<i>Std. Error</i>	<i>t-Statistic</i>	<i>Prob.</i>
C	1.798495	0.026685	67.39679	0.0000
TEMP	0.007549	0.001092	6.912732	0.0000
TEMP2	-8.86E-06	4.81E-05	-0.184174	0.8539
TEMP3	-1.37E-05	1.51E-06	-9.097270	0.0000
PREC	-0.013303	0.003814	-3.487677	0.0005
PREC2	0.002717	0.001042	2.606923	0.0092
TEMPREC	0.001634	0.000285	5.737221	0.0000
XP1	-0.037747	0.003492	-10.80945	0.0000
XP7	-0.021746	0.003439	-6.323522	0.0000
XP12	0.001042	0.000889	1.172198	0.2412
XP72	0.004429	0.000741	5.974525	0.0000
XT1	-0.004795	0.002199	-2.179995	0.0293
XT7	0.004192	0.002489	1.684050	0.0923
XT12	0.000193	0.000112	1.731521	0.0835
XT72	-9.69E-05	0.000122	-0.792975	0.4279
LAT	-0.006051	0.002131	-2.839522	0.0045
LONG	0.003410	0.000394	8.648773	0.0000
LAT2	-0.000810	0.000104	-7.777373	0.0000
LONG2	-2.20E-05	1.14E-05	-1.939289	0.0526
LATLONG	0.000328	4.61E-05	7.132112	0.0000
LDENS	0.057761	0.005542	10.42297	0.0000
LDENS2	-0.001109	0.000379	-2.924014	0.0035
OCEAN	-0.032275	0.003129	-10.31390	0.0000
OCEANLAT	-0.007299	0.001922	-3.798457	0.0001
OCEANLON	0.002024	0.000204	9.921202	0.0000
OCEANLL	1.18E-05	3.41E-05	0.345934	0.7294
TEMPOCEA	-0.004292	0.001327	-3.234574	0.0012
PRECOCEA	0.010062	0.003924	2.564359	0.0104
COLGRAD	1.392918	0.051845	26.86723	0.0000
HSGRAD	-0.081877	0.046412	-1.764131	0.0778
POPHISP	-0.222265	0.017078	-13.01497	0.0000
UR	2.027405	0.077377	26.20161	0.0000
CAPITAL	0.038138	0.002640	14.44480	0.0000
GL	0.069676	0.003890	17.91220	0.0000
MISRIVER	-0.033337	0.005866	-5.683345	0.0000
TONPORT	0.000966	5.87E-05	16.44146	0.0000
PORT	0.013588	0.002809	4.837705	0.0000

[State dummy variables included but not listed here.]

*Weighted Statistics*

R-squared	0.999914	Mean dependent var	2.345064
Adjusted R-squared	0.999912	S.D. dependent var	11.38574
S.E. of regression	0.106667	Akaike info criterion	-4.456943
Sum squared resid	34.64586	Schwarz criterion	-4.340213
Log likelihood	2573.600	F-statistic	599363.9
Prob(F-statistic)	0.000000		



**Table 3.** Two-stage least squares estimates of hedonic regression.

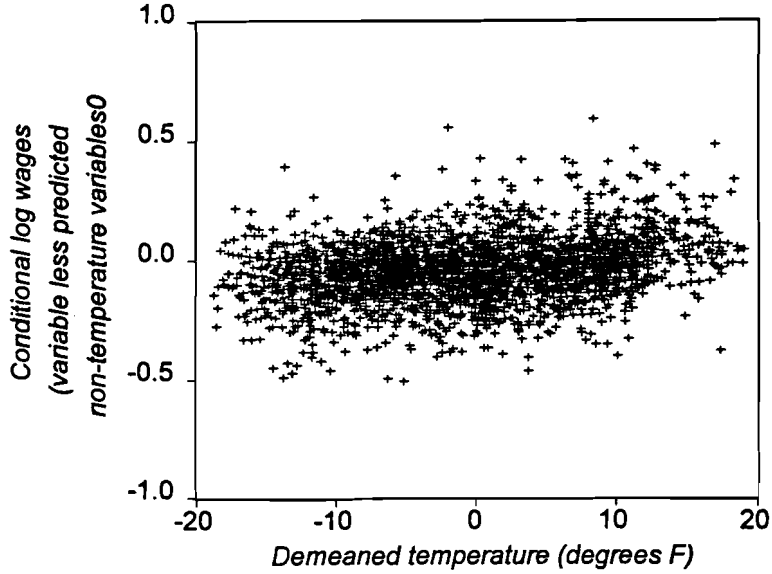
TLS // Dependent Variable is LAVI4                      Date: 07/16/96 Time: 15:06  
 Weighting series: WTWAG                                      Sample: 1 3105  
 Included observations: 3105  
 Instrument list: C TEMP TEMP2 TEMP3 PREC PREC2 TEMPREC XP1 XP7 XP12 XP72 XT1 XT7 XT12 XT72 LAT  
 LONG LAT2 LONG2 LATLONG LBROADX LBROAD2 OCEAN OCEANLAT OCEANLON OCEANLL TEMPOCEA  
 PRECOCEA COLGRAD HSGRAD POPHISP UR CAPITAL GL MISRIVER TONPORT PORT [plus state dummies]

Variable	Coefficient	Std. Error	t-Statistic	Prob.
C	1.871938	0.030094	62.20278	0.0000
TEMP	0.003824	0.001139	3.358667	0.0008
TEMP2	0.000128	5.03E-05	2.538596	0.0112
TEMP3	-1.06E-05	1.57E-06	-6.734890	0.0000
PREC	-0.013176	0.003927	-3.355173	0.0008
PREC2	0.005420	0.001082	5.011494	0.0000
TEMPREC	0.001152	0.000295	3.911870	0.0001
XP1	-0.044105	0.003621	-12.18047	0.0000
XP7	-0.023220	0.003553	-6.535569	0.0000
XP12	0.002219	0.000917	2.421004	0.0155
XP72	0.002588	0.000769	3.365319	0.0008
XT1	-0.014905	0.002395	-6.222615	0.0000
XT7	-0.009926	0.002776	-3.575968	0.0004
XT12	0.000144	0.000115	1.250632	0.2112
XT72	-0.000607	0.000131	-4.650234	0.0000
LAT	-0.009849	0.002201	-4.474471	0.0000
LONG	0.004215	0.000409	10.31163	0.0000
LAT2	-0.000883	0.000107	-8.229467	0.0000
LONG2	-1.16E-05	1.18E-05	-0.982138	0.3261
LATLONG	0.000432	4.77E-05	9.046894	0.0000
LDENS	0.033281	0.006729	4.945790	0.0000
LDENS2	0.001469	0.000469	3.134454	0.0017
OCEAN	-0.033070	0.003222	-10.26506	0.0000
OCEANLAT	-0.011037	0.002025	-5.451528	0.0000
OCEANLON	0.001970	0.000210	9.380862	0.0000
OCEANLL	-4.83E-05	3.52E-05	-1.369523	0.1709
TEMPOCEA	-0.006266	0.001392	-4.502148	0.0000
PRECOCEA	0.005198	0.004045	1.285010	0.1989
COLGRAD	1.138727	0.056539	20.14041	0.0000
HSGRAD	-0.000949	0.048609	-0.019533	0.9844
POPHISP	-0.258311	0.017672	-14.61693	0.0000
UR	1.684756	0.083587	20.15567	0.0000
CAPITAL	0.034771	0.002744	12.67172	0.0000
GL	0.065392	0.004043	16.17236	0.0000
MISRIVER	-0.030927	0.006084	-5.083507	0.0000
TONPORT	0.001164	6.27E-05	18.57184	0.0000
PORT	-0.004305	0.003043	-1.414570	0.1573

[State dummy variables included but not listed here.]

#### Weighted Statistics

R-squared	0.999909	Mean dependent var	2.345064
Adjusted R-squared	0.999907	S.D. dependent var	11.38574
S.E. of regression	0.109773	Akaike info criterion	-4.399540
Sum squared resid	36.69285	Schwarz criterion	-4.282810
F-statistic	565933.9	Durbin-Watson stat	2.047551
Prob(F-statistic)	0.000000		



**Figure 6.** Conditional wages and temperature by county. Conditional wages are wages less estimated impact of non-temperature variables on wages. That is, if  $w = f(T) + g(Z) + \epsilon$  is the estimated relationship, then stripped wages =  $w^* = w - g(Z) = f(T) + \epsilon$ . This shows graphically the conditional relationship between wages and mean temperature.

temperature after allowing for the estimated impact of density, unemployment, precipitation, and other variables. (The top and bottom 10 counties have been trimmed to fit the graph.) The overwhelming impression of this graph is the loud noise and weak temperature-on-wage signal.

We next show in Figures 7(a)–7(e) a number of conditional predictions of the hedonic value of climate. For each of these, we have taken the coefficients from the TSLS equation in Table 3 and changed the sign to reflect the hedonic interpretation that lower wages are interpreted as higher amenity values. These figures indicate that the preferred climate is slightly below the national mean [see Figure 7(a)]. The premium on warmer climates is strongly positive for colder regions. Note as well the strong value of warm winters and warm summers in Figures 7(c) and 7(d). The density disamenity premium is shown in Figure 7(e).

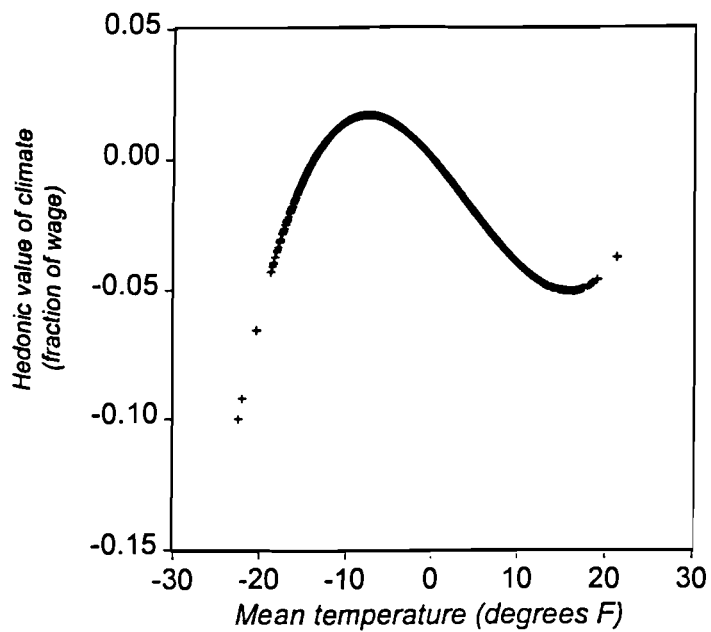


Figure 7(a). Estimated hedonic value of mean temperature.

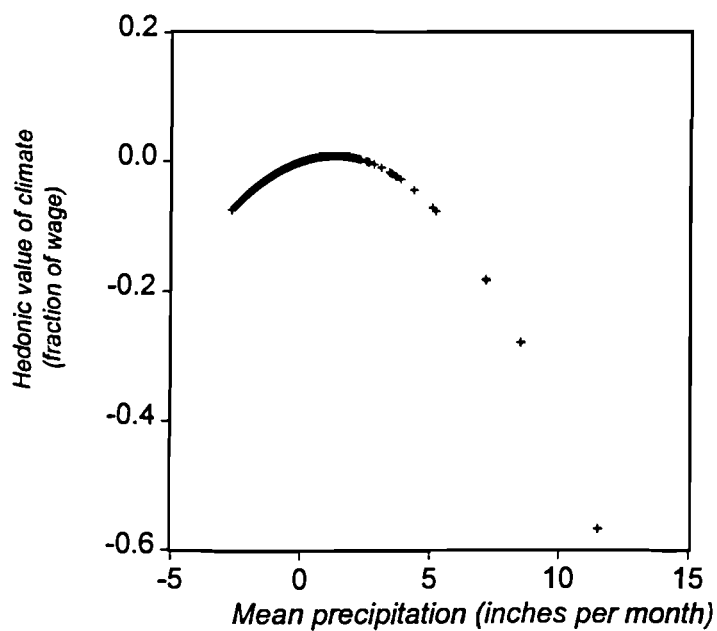


Figure 7(b). Estimated hedonic value of mean precipitation.

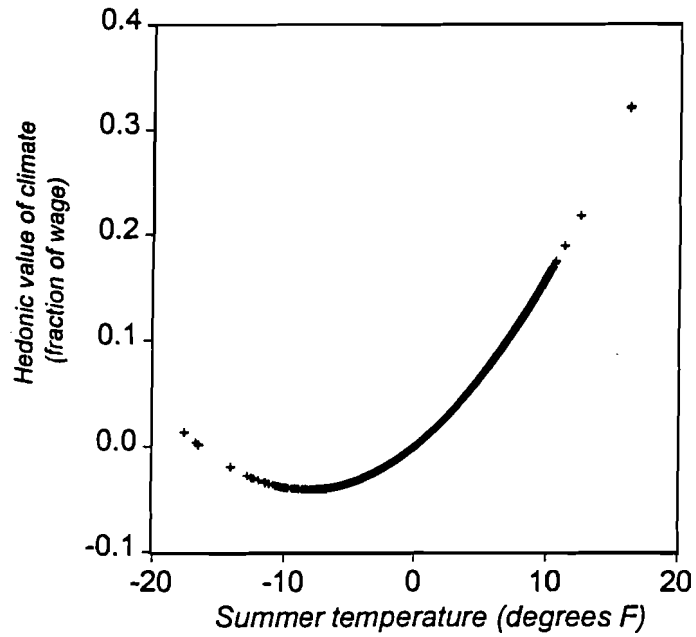


Figure 7(c). Estimated hedonic value of summer temperature.

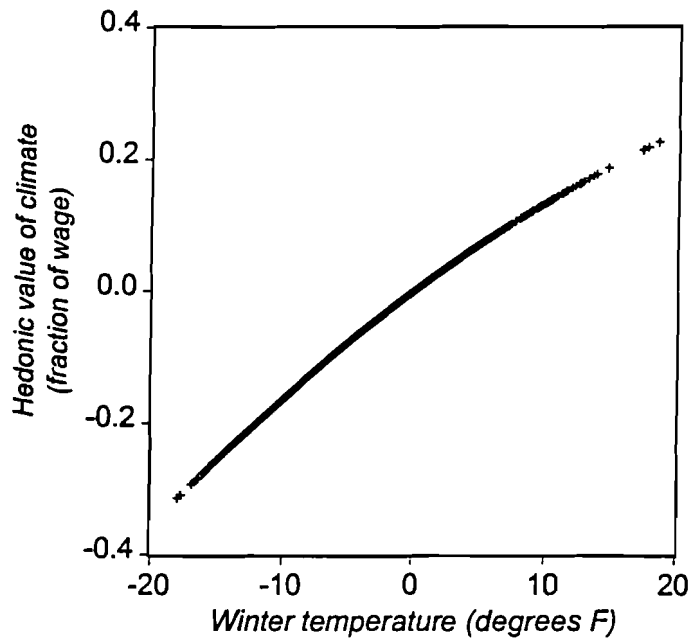


Figure 7(d). Estimated hedonic value of winter temperature.

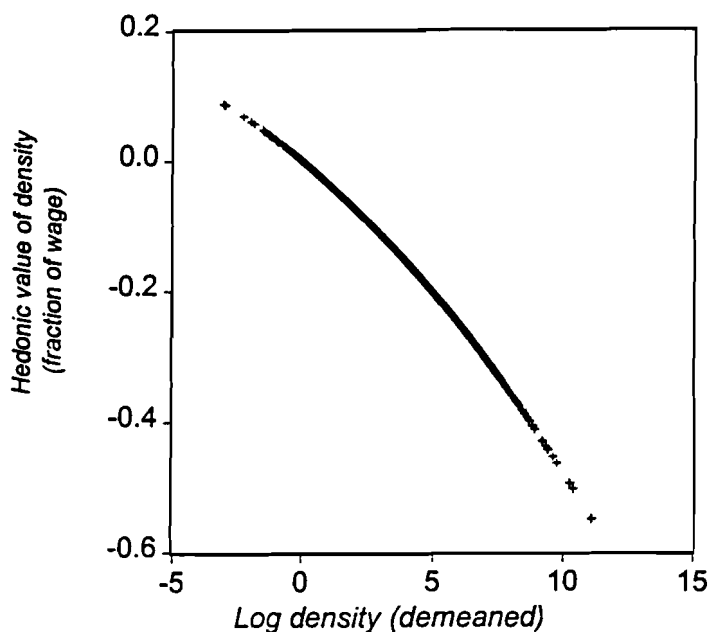


Figure 7(e). Estimated hedonic value of density.

## 5.2. Impacts of climate change

We next estimate the impact of climate change on climate amenities for the USA. The standard technique for making this calculation is the “snapshot” approach. *In the snapshot approach, we impose the estimated climate change over the next century or more on the existing economic and demographic structure assuming no future change in the distribution of income or population.*

The basic approach is straightforward. We begin with the hedonic estimates of the value of climate shown in Table 3. We then calculate the estimated amenity value of current climate and the estimated amenity value of the projected future climate. The estimated impact of climate change on amenities is simply the difference between the two estimates. The snapshot approach assumes that the distribution of the population is unchanged; that the hedonic prices of climate in the future will be the same as today; and that the other exogenous variables are unchanged. Obviously, these are major oversimplifications, but they are useful as a first step in the estimation.

We begin by showing in Table 4 the impact of climate change for a *standardized climate change scenario*. The standardized scenario is a 1°F increase in temperature and 0.5% increase in precipitation. Table 4 shows

**Table 4.** Impact of normalized 1°F climate change on climate amenities\* (equations are OLS unless noted).

<i>Specification</i>	<i>Hedonic Impact (percent of total wages)</i>	<i>Log likelihood</i>
<b>Weighted</b>		
STANDARD	-0.370	2573.6
STANDARD (TSLS)	-0.007	na
TEMP	0.036	-1608.8
TEMP PLUS STATE DUMMIES	0.039	-1603.8
TEMP, TEMP2	-0.080	-1557.5
TEMP, TEMP2, TEMP3	-0.034	-1555.8
TEMP, TEMP2, TEMP3, PREC	-0.160	-1474.9
TEMP, TEMP2, LDENS	-0.221	-976.0
TEMP, TEMP2, LDENS, PREC	-0.199	-975.1
TEMP, TEMP2, LDENS, PREC, UR	-0.151	-267.7
STANDARD WITHOUT UR	-0.250	2569.3
STANDARD WITH LA VI2 (TSLS)	0.088	na
STANDARD WITH LA VI3 (TSLS)	1.032	na
STANDARD WITH CENSUS WAGE (TSLS)	-0.059	na
<b>Unweighted</b>		
STANDARD	0.143	2993.7
STANDARD (TSLS)	0.521	na
TEMP	-0.162	1898.8
TEMP, TEMP2	-0.208	1910.5
TEMP, TEMP2, TEMP3	-0.183	1920.4
TEMP, TEMP2, LDENS	-0.133	2154.9
TEMP, TEMP2, LDENS, PREC	-0.180	2226.1
TEMP, TEMP2, LDENS, LPREC	-0.266	2308.7
TEMP, TEMP2, LDENS, PREC, UR	-0.133	2290.8

\*The results here correspond to a uniform 1 degree F warming along with a ½ percent increase in precipitation. A positive sign indicates a benefit of warming, while a negative sign indicates warming is penalized. Note that a log likelihood difference of 3.3 corresponds to a significant difference at a 1 percent level of confidence for normal variables with one variable excluded. With 50 variables excluded, a log likelihood difference of 32 is significant at the 1 percent confidence level.

**Table 5.** Estimates of impact of global warming on real income in the USA.\*

<u>Experiment</u>	<u>Impact on Average Real U.S. Income</u>	<u>Standard Deviation of County Income</u>
-------------------	---	--

**Impact of Doubling CO<sub>2</sub>  
Concentrations\*\***

As % of wages	-0.35	2.63
As % of GDP	-0.17	1.24

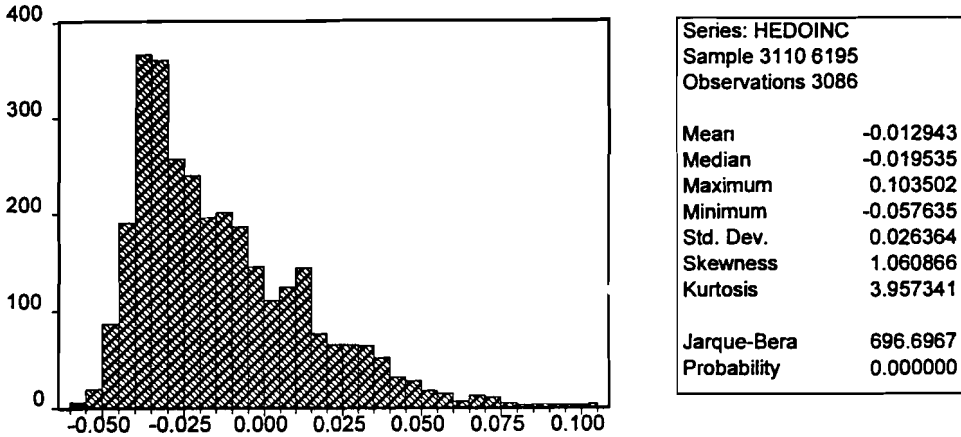
\* This estimate uses the two-stage least squares, with broad income per unit area as an instrument for density, with state dummy variables. The underlying equation is shown in Table 3.

\*\* CO<sub>2</sub> doubling is modeled as a uniform increase of 8.02 degrees F in temperature and a uniform increase of 4.04 percent in precipitation. This is the wage-weighted uniform climate change.

the impact as a percentage of wages in the first numerical column along with the log likelihood ratio of the regression equation in the last column. It is clear that the preferred specification shown in Tables 2 and 3 have much higher likelihood than the other specifications; on the other hand, alternative approaches give quite different estimates of the hedonic impact of climate change.

We next show the results of the preferred equation in Table 3 with the uniform national climate change scenario discussed above. This result is shown in Table 5. *For the preferred equation, the central estimate is that an equilibrium CO<sub>2</sub> doubling causes amenity losses of about 0.35% of aggregate US wages. This is the equivalent of about 0.17% of US GDP. At 1995 levels of prices and incomes, this represents US\$12 billion per year.*

Figure 8 and the last column of Table 5 shows the distribution of the hedonic estimate of climate change amenities by county. The distribution is centered about -1.3% of wages and is skewed to the right. The primary gainers from global warming in the USA are the very cold regions of Alaska



**Figure 8.** Distribution of impacts of CO<sub>2</sub> doubling on individual counties. (The underlying variable is the change in hedonic income in each county from a CO<sub>2</sub> doubling. The highest and lowest 10 have been excluded to increase the scale).

and the northern plains states. The unweighted mean of the counties in Figure 8 is less than the weighted mean shown in Table 5 because colder regions are relatively sparsely populated.

### 5.3. Results of alternative specifications

We have undertaken extensive sensitivity analysis to test for the robustness of the results. The principal results are shown in Tables 4 and 6. As will be shown formally below in the bootstrap estimates, the results are quite fragile. Climate is never very important as a determinant of wages, so there is a risk that climate will proxy for omitted variables. The central estimates indicate that global warming will on balance have a small amenity effect, but there is great variation around this central prediction depending on the exact specification.

The results for the different principal specifications are shown in Tables 4 and 6.

- The results are extremely sensitive to the choice of climate model, but the differences among the three consensus models is quite small.



Table 6(a). Hedonic impact using different wage series (ordinary least squares estimates).

Model Impact	States	No States	States	No States	States	No States	States	No States
Portfolio	-3.34	-5.98	-4.02	-2.66	7.00	0.74	-4.92	-1.77
Average of Models	-3.32	-4.85	-5.83	1.64	6.99	5.11	-6.60	-0.03
Uniform National Average	-2.64	-5.96	-3.03	-3.48	9.41	1.07	-3.59	-2.52
LAV14								
Model Impact	States	No States	States	No States	States	No States	States	No States
Portfolio	0.57	3.59	0.86	3.24	NA	NA	NA	NA
Average of Models	1.12	5.16	0.86	3.24	NA	NA	NA	NA
Uniform National Average	0.86	3.24	0.86	3.24	NA	NA	NA	NA
LAV13								
Model Impact	States	No States	States	No States	States	No States	States	No States
Portfolio	NA	NA	NA	NA	NA	NA	NA	NA
Average of Models	NA	NA	NA	NA	NA	NA	NA	NA
Uniform National Average	NA	NA	NA	NA	NA	NA	NA	NA
LAV14 Unweighted								

[Two-Stage Least Squares Estimates]

Model Impact	States	No States	States	No States	States	No States	States	No States
Portfolio	NA	NA	NA	NA	NA	NA	NA	NA
Average of Models	NA	NA	NA	NA	NA	NA	NA	NA
Uniform National Average	-0.36	-2.98	4.55	5.38	4.50	3.41	3.17	4.60
LAV14								
Model Impact	States	No States	States	No States	States	No States	States	No States
Portfolio	NA	NA	NA	NA	NA	NA	NA	NA
Average of Models	NA	NA	NA	NA	NA	NA	NA	NA
Uniform National Average	-0.36	-2.98	4.55	5.38	4.50	3.41	3.17	4.60
LAV13								
Model Impact	States	No States	States	No States	States	No States	States	No States
Portfolio	NA	NA	NA	NA	NA	NA	NA	NA
Average of Models	NA	NA	NA	NA	NA	NA	NA	NA
Uniform National Average	-0.36	-2.98	4.55	5.38	4.50	3.41	3.17	4.60
LAV14 Unweighted								

LAV14: Earnings in each of the 10 major full-time industries was divided by employment and the national average hours worked in that industry. The weighted average of these wage rates was taken, with the weights being national employment in that industry. The series was calculated for 1979, 1982, and 1986, and the average of the three years was taken.

LAVMREIS: REIS manufacturing earnings divided by manufacturing employment (the national average hours worked in manufacturing. The series was calculated for 1979, 1982, and 1986, and the average of the three years was taken.

LMFMRWR: Average weekly earnings of production workers in manufacturing divided by weekly hours worked, from the Census.

LAV13: Similar to LAV14, except that it includes only the 6 major full-time industries.

LAV14 Unweighted: Same as above, except that regression is not wage-weighted.

**Table 6(b).** Amenity effects for different consensus climate models. (Estimates use LAVI4, wage-weights, with and without state dummy variables.)

<b>Model Impacts</b>	<b>OLS</b>		<b>2SLS</b>	
	<b>With States</b>	<b>No States</b>	<b>With States</b>	<b>No States</b>
Portfolio	-3.34	-5.98	NA	NA
Average of Models	-3.32	-4.85	NA	NA
Uniform National Average	-2.64	-5.96	-0.36	-2.98

Table 6(c). Alternative estimates of climate amenities for different general circulation models. (Estimates use OLS, with wage-weighted regressions except for the last column, with state dummy variables. The average, median, and standard deviation are unweighted statistics on the 16 models.)

	LAVI4		LAVMREIS		LMWFMWR		LAVI3		LAVI4 unweighted	
	With States	No States	With States	No States	With States	No States	With States	No States	With States	No States
BMRC	-2.87	-9.31	3.37	-13.16	4.27	-12.61	2.17	-6.12	-1.16	-1.83
CSIR	-4.47	-10.26	-2.18	-5.97	12.97	1.41	-5.11	-4.75	1.01	4.47
CCC	-3.46	-6.58	-4.27	1.00	5.67	2.18	-4.99	-0.37	-0.33	3.28
GFDL	-3.55	-9.29	0.72	-11.46	8.95	-7.88	-0.56	-5.58	-0.63	0.07
GFQF	-3.20	-10.73	2.66	-10.76	8.23	-8.32	1.04	-6.07	-0.76	-0.38
GF30	-3.34	-5.30	-6.86	8.86	6.48	10.64	-7.77	2.32	0.88	6.48
GISS	-2.67	-6.34	-2.96	0.02	8.56	3.04	-3.54	-1.30	0.51	3.37
HEND	-3.34	-15.93	6.92	-12.16	2.88	-14.90	4.09	-7.97	-3.15	-3.10
OGL	-3.47	-5.11	-11.02	21.90	6.64	22.95	-12.25	6.43	1.53	10.69
OSU	-2.46	-3.55	-6.41	5.26	4.84	7.04	-6.59	1.36	0.59	4.81
UKMO	-4.30	-10.62	-4.00	-3.16	17.07	6.17	-6.53	-4.44	0.90	5.26
UIUC	-4.24	-9.98	-6.06	5.44	9.40	9.35	-8.56	-0.87	0.25	6.56
POLS	-1.06	2.09	-11.91	26.68	1.00	24.35	-10.76	10.30	1.16	8.93
POLD	-2.84	-5.10	-6.69	15.54	1.50	13.32	-7.64	4.65	0.22	6.51
WANG	-3.69	-8.64	-2.02	-1.05	8.54	1.95	-3.62	-2.12	0.46	3.52
WAS	-3.76	-6.14	-9.17	11.90	10.19	16.76	-10.75	2.39	1.96	9.25
<i>Median</i>	<i>-3.40</i>	<i>-7.61</i>	<i>-4.14</i>	<i>0.51</i>	<i>7.44</i>	<i>4.60</i>	<i>-5.82</i>	<i>-1.09</i>	<i>0.49</i>	<i>4.64</i>
<i>Average</i>	<i>-3.29</i>	<i>-7.55</i>	<i>-3.74</i>	<i>2.43</i>	<i>7.32</i>	<i>4.72</i>	<i>-5.09</i>	<i>-0.76</i>	<i>0.22</i>	<i>4.24</i>
<i>Std.Dev.</i>	<i>0.83</i>	<i>4.01</i>	<i>5.24</i>	<i>12.20</i>	<i>4.15</i>	<i>11.67</i>	<i>4.80</i>	<i>5.11</i>	<i>1.23</i>	<i>3.98</i>

Note: Estimates use OLS, with wage-weighted regressions except for the last column, with state dummy variables. The average, median, and standard deviation are unweighted statistics on the 16 models.

- The results are quite sensitive to the weighting. This is shown in Tables 4 and 6 by comparing the results with wage weighting and without weighting. Estimates that do not weight by the relative economic importance of different counties tend to show a gain from climate change.
- There is some inconsistency among the different wage indexes. Looking at the last row of Table 6(a), which contains the TSLS estimates, the preferred LAVI4 index suggests a small impact of global warming on climate amenities, while the three other wage indexes indicate a significant positive amenity from global warming. The difference between the wage series is maintained in the OLS estimates in the top half of Table 6(a). Although LAVI4 is conceptually superior to the other wage indexes, it is noteworthy that the other indexes all show higher estimates for the amenity impacts.

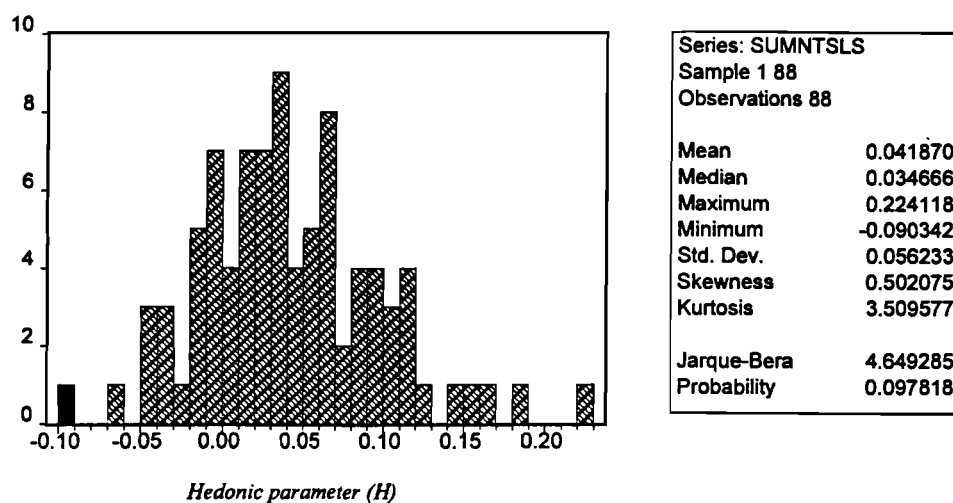
#### 5.4. Results of bootstrap simulations

For complicated models like the present one, it is useful to apply “bootstrap” techniques to indicate the statistical reliability of the results. Bootstrap procedures estimate reliability by replicating the estimates over a subsample of the original sample. Under ideal conditions (such as normality), a bootstrap estimate can provide an unbiased estimate of the distribution of parameters of interest.

In the case at hand, we are interested in estimating the robustness of our estimates of the hedonic impact of global warming. The amenity impact, call it  $H$ , is a function of the set of included variables ( $\zeta$ ) as well as the sample data ( $x$ ) for  $N$  observations; that is,  $H = h(\zeta, x, N)$ . We calculate a “data bootstrap” distribution of  $H$  by taking repeated subsamples of  $M \subset N$ . We also consider a “specification bootstrap,” which considers alternative specifications of the hedonic equation.

##### *Bootstrap Replications for the Data*

We first present a data bootstrap estimate of the hedonic impact of climate change,  $H = h(\zeta, x, N)$ , where we examine only the potential sampling error. For this estimate, we hold the specification ( $\zeta$ ) fixed and subsample from the 3105 counties. For this purpose, we use the basic weighted equations in Table 3 along with the uniform national climate change scenario. The exact procedure is to replicate the estimate with repeated subsamples of the



**Figure 9.** Distribution of impacts of CO<sub>2</sub> doubling using data bootstrap estimation. (The parameters are the estimated impact of a CO<sub>2</sub> doubling as a fraction of aggregate wages. These estimates correspond to the two-stage least squares specification in Table 3. The bootstrap sample is determined by drawing half of the counties at random with replacement.)

county data. For these, we conduct our subsampling by choosing half of the sample randomly and without replacement.<sup>6</sup>

Figure 9 shows the distribution of estimates of the hedonic impact of climate change. These replications give a mean *positive* 4.2% amenity impact, with a standard deviation of 5.6%. This distribution indicates that with the present data set we cannot judge whether the amenity impact is positive or negative. Indeed, about 80% of bootstrap samples have a positive hedonic value of climate change. Similar results are given by the bootstrap replications for the OLS estimates.

The unsettling result here is that the central tendency of the bootstrap estimate is markedly larger than that of the basic result shown in Table 5 (the mean of the bootstrap sample in Figure 9 is well determined). This shows the fragility of the relationship. In principle, the estimated central tendency of the bootstrap sample should be the same as the underlying regression, but non-normal errors can lead to differences in mean estimates.

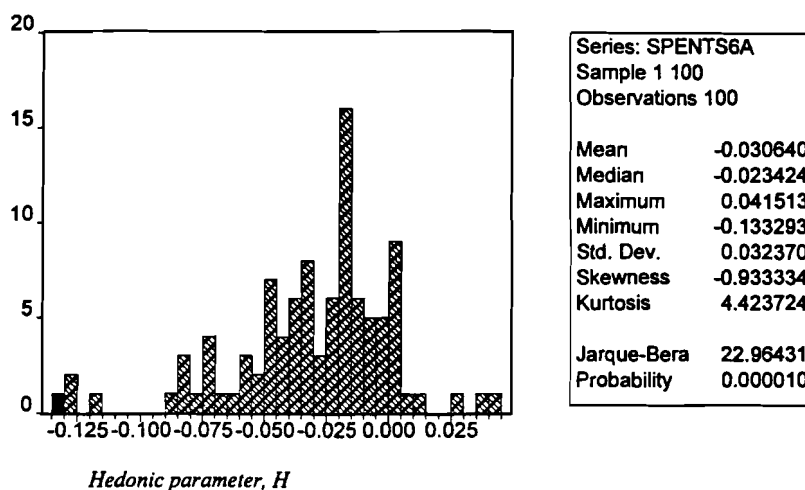
<sup>6</sup>This procedure was suggested by John Hartigan, who also made a number of helpful comments on the bootstrap procedure. The procedure employed is a “delete-half” jackknife, in which each observation has a probability of one-half of inclusion. For a discussion of bootstrap approaches, see Efron and Tibshirani (1993).

*Bootstrap Replications for the Specifications*

We have in addition developed a novel procedure that is called a specification bootstrap to test for the sensitivity of the results to different specifications. The idea here is as follows. As described in the last section, we are interested in estimating the hedonic impact of climate change,  $H = h(\zeta, x, N)$ . In addition to sampling issues, there are clearly uncertainties about the specification. Say that the hedonic function is estimated with variable set  $\zeta = (\zeta_1, \dots, \zeta_K)$ , where the vector  $\zeta$  represents the  $K$  possible included variables.

The standard approach to specification is to use maximum likelihood as a method of inclusion. This is useful but fails to give a measure of the sensitivity of the outcome to alternative specifications. Instead, we propose using a specification bootstrap. The simplest approach is to assume that we are unsure about which variables to include. We represent inclusion of the  $i$ th variable as  $\zeta_i = 1$  while exclusion is  $\zeta_i = 0$ . Assuming that we are uninformed about which variables belong in the relationship and which should be excluded, we take samples of  $M$  of the  $K$  possible variables. (There are obvious extensions for nonindependence and not-equally-likely cases, but those are not pursued here.) We then examine the distribution of  $H$  for a sample of the potential specifications.

For this purpose, we set  $M = 6$ ; that is, we assume that 6 of the non-central 56 included variables are the appropriate ones. The actual specification chosen is a two-stage least squares estimate with a constant, a linear temperature term, the two density variables and their instruments for the first stage, and 6 randomly chosen included variables from the other 56 variables included in the preferred equation shown in Table 3. We randomly sample 100 from the 32 million possible specifications. Figure 10 shows the estimates from the specification bootstrap simulation. The central tendency for the TSLS specification yields a negative hedonic relationship with an amenity impact of  $-3.5\%$  and a standard deviation of  $3.6\%$ . (The corresponding preferred estimate for the TSLS is  $-0.17$ .) The central tendency of the specification bootstrap is the mirror image of the data bootstrap, being less than the preferred estimate. The uncertainty in the specification bootstrap is somewhat less than that in the data bootstrap in part because three variables were included in all specifications.



**Figure 10.** Distribution of impacts of CO<sub>2</sub> doubling using specification bootstrap estimation. (The parameter is the estimated impact of a CO<sub>2</sub> doubling as a fraction of aggregate wages,  $H$ . These estimates correspond to the two-stage least squares specification in Table 3 and the central estimate of the hedonic parameter shown in Table 5. The specification bootstrap is generated by drawing 6 of 56 variables.)

#### *Conclusion on Uncertainty of Estimate*

Weighing the alternative specifications along with the bootstrap results, we conclude that it is not possible with the available evidence to determine the amenity impact of climate change for the USA. The preferred estimated impact of an equilibrium CO<sub>2</sub> doubling, using the TSLS regression and uniform climate change, is  $-0.37\%$  of total wages. For the simplest specifications shown above, the impact ranges between  $-1.9 (\pm 0.16)\%$  and  $+3.1 (\pm 0.24)\%$  of wages. The range of estimates in the specifications in Table 4 is from  $-3.0\%$  to  $+8.0\%$ . The range of estimates for different wage series shown in Table 6 is from  $-6.0\%$  to  $+4.6\%$ . The estimates for the different climate models range from  $-15.9\%$  to  $+26.7\%$  of wages. For the data bootstrap the estimated impact is  $+4.2 (\pm 5.6)\%$  while for the specification bootstrap the estimated impact is  $-3.5 (\pm 3.6)\%$  of total wages.

Taking all these estimates, the best judgment would seem to be that we are at this time unable to reliably determine the impact of global warming on

climate amenities. The most likely value of the amenity impact is  $-0.35\%$  of total wages (or  $-0.17\%$  of total output). I regard the estimated variation from the bootstrap replications as most reliable and estimate that the uncertainty of the estimate is about  $5\%$  of wages (or  $2.5\%$  of output).<sup>7</sup>

### 5.5. Results of alternative studies

It is useful to consider how this research compares with earlier research on the subject. The only comparable study is that of Hoch and Drake (1975). They used a technique quite similar to that shown in Table 2, estimating OLS regressions of wages on climate and other variables for three samples of workers, using wages for specific occupations, in 43 to 86 metropolitan areas. The climate data were relatively comprehensive, although in the end only precipitation, temperature, and their interactions were used.

Their statistical results are difficult to interpret because of the numerous unpooled samples and inconsistent inclusion of variables. In addition, they did not consider the potential for simultaneous-equation bias, nor did they allow for the possibility of a systematic North-South wage differential. The only robust result is the strong negative sign on summer temperature (in 33 of the 34 subsamples reported in the Appendix), with a smaller coefficient but inconsistent sign on winter temperatures. This result led Hoch and Drake to conclude that a  $1^\circ\text{F}$  warming would lead to a gain in living standards of approximately US\$1.6 billion in 1974. This represents a semi-elasticity of  $0.11\%$  for 1974 GDP. Scaling this to a baseline warming of  $8^\circ\text{F}$  (or  $4.5^\circ\text{C}$ ) for an equilibrium  $\text{CO}_2$  doubling used in this study yields a gain of  $0.88\%$  of US GDP. In the CIAP study, the effect on amenities through wages was the single largest impact. All other impacts totaled US\$0.67 billion, or about  $40\%$  of the effect on amenities.

The results of the present study are quite different from the earlier Hoch and Drake study. I interpret the inconsistent results as an indication of the fragility of the estimates to both data and specification differences. The larger sample size in the current study allowed us to control for other factors, such as the North-South wage differential, which explains much of OLS temperature-wage correlation. Other differences are that the present study has a much larger and more comprehensive sample – 3105 counties and comprehensive wage data – and that it has a correction for regional cost of living differentials.

---

<sup>7</sup>These figures are derived by combining the basic estimate in Table 5 with the bootstrap replications in Figures 9 and 10 along with the results of alternative specifications. Each of these four sets of estimates is equally weighted and assumed to be normally distributed.



## 6. Conclusions

The present study estimates the impact of greenhouse warming on climate amenities. The amenities associated with climate change include the effects on the value of directly “consumed” climate as well as those on leisure and other nonmarket activities that are complementary with climate. In the first case, climate may affect preferences directly, as in the cases of direct enjoyment of beautiful blue skies or cold, crisp nights in the mountains. The second case – which is more complex and probably more important – comes as climate interacts with other goods and services in the production of amenities; this would include the combination of warm weather, high surf, and surfboards in the production of surfing amenities or other consumption activities such as hiking, sledding, sunbathing, gardening, or powder-snow skiing. Additional cases of indirect effects would arise through the impact of climate on pollution and health.

Analytically, measuring the value of climate is difficult because climate is a public good rather than a private good bought and sold on markets. Because there are no market transactions for climate, we must infer its value indirectly from individual choices in other areas. The area studied here is individual locational choices as they interact with the labor market, using the technique of wage hedonics to estimate the impact of climate on economic well-being. The first step of the estimation is to determine the correlation between climate (as an exogenous variable) and wages (as an endogenous variable) for the USA. This estimation addresses the issue of simultaneous-equation bias, which has generally been overlooked up to now. Using data on 3105 counties, our preferred relationship indicates a small positive relationship of mean temperature and real wages. The interpretation of this result is that warming would be associated with an decrease in economic welfare.

The second step of the process is to combine estimates of the amenity value of climate with climate change projections. This is accomplished by using the results of simulations of a number of GCMs that calculate the impact of greenhouse warming on climate. The GCMs project an average increase of 8°F (4.5°C) along with an increase in precipitation of 4% from an equilibrium CO<sub>2</sub> doubling. Using the uniform climate change scenario, we estimate that an equilibrium CO<sub>2</sub> doubling would be associated with 0.35% higher wages averaged across US counties; this is the equivalent of about 0.17% of GDP.

Under hedonic theory, wage differentials associated with different climates represent the amounts necessary to compensate people for the associated amenities. Our preferred equation projects that an equilibrium CO<sub>2</sub>

doubling would produce disamenities amounting to 0.35% of wages or about 0.17% of GDP. However, alternative specifications give markedly different estimates. Weighing all the different specifications and bootstraps, the most likely impact is a disamenity of 0.35% of total wages (or 0.17% of total output) with an uncertainty or standard error on this estimate of 5% of wages (or 2.5% of output).

How do amenity impacts compare with other estimated economic impacts of climate change? Up to now, the only sectors with rigorous estimates of the impact of climate change are agriculture, energy, and sea-level rise. Although different studies have slightly different results, it is fair to say that the sum of the reliable estimates of the impact of global warming is very close to zero for the USA. This number consists of small losses from sea-level rise (less than 0.1% of GDP), a small gain in heating and cooling (less than 0.1% of GDP), and no net impact on agriculture. The present results suggest that inclusion of amenities does not change the overall picture dramatically, but the uncertainties surrounding amenity impacts swamp the impacts identified to date.

We must emphasize that the estimated relationship between climate change and amenity values is extremely fragile. The bootstrap estimates for data and for specification uncertainty indicate that it is difficult to determine whether the amenity value of climate change will be positive or negative.

Physicists have grown accustomed to the Heisenberg uncertainty principle, which concerns the limits to observability of physical systems. There may be a *behavioral uncertainty principle* operating in the social sciences. This principle holds that because of the complexity of human systems and the difficulty of establishing cause-effect relationships, it is sometimes impossible to accurately forecast the impact of exogenous or policy changes. In the case at hand, we are blessed with reliable and comprehensive data covering an enormous range of experience for the variables of interest of temperature, wages, and demographics. Yet the underlying complexity of labor markets is so great, and the wage-temperature relationship so noisy, that it appears that we cannot accurately project the impact of global warming on climate amenities over the coming decades.

## References

- BLS (Bureau of Labor Statistics), 1967, BLS Bulletin 1570-5, Bureau of Labor Statistics, Washington, DC, USA (Spring).
- BLS (Bureau of Labor Statistics), 1982, *Autumn 1981 Urban Family Budgets and Comparative Indexes for Selected Urban Areas*, Bureau of Labor Statistics, Washington, DC, USA (April).
- Cline, W., 1992, *The Economics of Global Warming*, Institute of International Economics, Washington, DC, USA.
- Efron, B., and Tibshirani, R.J., 1993, *An Introduction to the Bootstrap*, Chapman and Hall, New York, NY, USA.
- Fankhauser, S., 1995, *Valuing Climate Change*, Earthscan, London, UK.
- Hoch, I., and Drake, J., 1975, Estimate of Climatic Impact by Wage Relationship, Chapter 3.1 in *Economic and Social Measures of Biologic and Climate Change*, No. 6, pp. 3-3 to 3-75, Department of Transportation, Climatic Impact Assessment Program (CIAP).
- Mendelsohn, R., Nordhaus, W., and Shaw, D.G., 1994, The Impact of Global Warming on Agriculture: A Ricardian Approach, *American Economic Review* **84**(4):751-771.
- Nordhaus, W.D., and Tobin, J., 1972, Is Growth Obsolete? *Economic Growth*, N.B.E.R.; also published in *Income and Wealth*, Vol. 38, 1973, N.B.E.R., New York, NY, USA.
- Pindyck, R.S., and Rubinfeld, D.L., 1991, *Econometric Models and Economic Forecasts*, Third Edition, McGraw-Hill, New York, NY, USA.
- US Department of Commerce, 1994, *City and County Data Book 1994*, US Department of Commerce, Economics and Statistics Administration, Bureau of Census, Washington, DC, USA (CD-ROM).
- US Department of Commerce, 1995, *Regional Economic Information System*, US Department of Commerce, Economics and Statistics Administration, Bureau of Economic Analysis, Regional Measurement Division, Washington, DC, USA (CD-ROM).



# Climate Change, Global Agriculture, and Regional Vulnerability\*

*John Reilly*

Natural Resources and Environment Division,  
Economic Research Service, USDA, Washington, DC, USA

## 1. Introduction

The potential impacts of climate change on agriculture are highly uncertain. The large number of studies conducted over the past few years for many different sites across the world show few, if any, robust conclusions about either the magnitude or direction of impact for individual countries or regions. Where apparent consensus exists, it frequently appears to occur because only one or two studies have been conducted using a single climate scenario. Many such studies have focused on  $2\times\text{CO}_2$  general circulation model (GCM) equilibrium scenarios. These do not begin to describe the variety of climatic conditions any particular region is likely to experience as the actual climate changes over time.

Potential future climate changes are also made more uncertain because of the recently recognized role of sulfate aerosols, which may partly offset the warming expected from increased concentrations of carbon dioxide ( $\text{CO}_2$ ), methane, nitrous oxide, and other radiative trace gases. The significant spatial variation in sulfate aerosol concentrations means that the regional pattern of climate change may be quite different from that simulated on the basis of a  $\text{CO}_2$  increase alone. The short lifetime of aerosols in the atmosphere (a few days) means that if the use of high-sulfur coal in India or China increases or efforts to control sulfur emission in the USA or Europe are intensified the spatial pattern of climate change could change significantly within a relatively short period of time due to changes in the aerosol cooling effect.

Different impact methodologies also yield widely varying results concerning the direct impacts of climate change on crop yields and agricultural

---

\*An earlier version of this paper was originally prepared for the Food and Agriculture Organization. The views expressed in this paper are those of the author and do not necessarily reflect the views of the Department of Agriculture or the United States Government.

production, even when the same region and the same climate scenarios are examined. The socioeconomic environment, agricultural technology, and natural resource base will also necessarily undergo profound changes over the next 100 years whether agriculture meets the many challenges of feeding the world's growing population or fails to do so.

The robust conclusion that does emerge from impact studies is that climate change has the potential to significantly change the productivity of agriculture at most locations. Some currently highly productive areas may become much less productive. Some currently marginal areas may benefit substantially, while others may become unproductive. Crop yield studies show regional variations of +20%, 30%, or more in some areas and equal size losses in other areas. Most areas can expect change and will need to adapt, but the direction of change, particularly of precipitation, and required adaptations cannot now be predicted; moreover, it may never be possible to predict them with confidence. Current evidence suggests that regions near the poles where agriculture is limited by short growing seasons are more likely to gain while subtropical and tropical regions may be more likely to suffer drought and losses in productivity. However, these broad conclusions hardly provide the basis for mapping out a long-term strategy for agricultural adaptation. Thus, policy must retain flexibility to respond as conditions change.

A further issue is how climate change impacts on agricultural production fit within the other pressing challenges facing agriculture in different regions of the world. Is climate change a minor threat, likely to be undetected among the many changes that will reshape the agricultural sectors of the world's economies? Or is it another critical challenge to an agricultural sector straining to cope with growing population, resource degradation, tighter constraints on available resources, and exhaustion of technological capabilities to expand production using existing land and water resources?

It is useful to place some of the  $2\times\text{CO}_2$  agricultural projections in the context of other future projections. If we accept long-term demographic projections, the largest absolute addition to the world's population will occur during the decade of the 1990s, the growth rate having already slowed from that of the 1950s and 1960s. By the time  $2\times\text{CO}_2$  climate scenarios are expected to be realized (some time around 2100 or later), the world population will have stabilized according to these long-term projections and agricultural research will no longer face the challenge of improving productivity to keep up with a growing population.

The exercise of the previous paragraph – to think a bit about how very different the world may be by the time the scenarios of changed climate presented by standard GCM runs may be realized – emphasizes the need for more specific analysis about how climate will change over the next 10, 20, or 30 years rather than over the next 100 years. It also provides a caution not to consider our response to climate change apart from our response to the more immediate needs of agriculture: feeding a growing population where an estimated 740 million people still suffer from hunger and malnutrition while maintaining the productivity of basic agricultural resources and meeting the demands placed on agriculture to minimize off-site damages to the environment.

The strategy of this paper will be (1) to discuss briefly the primary methodologies used to estimate impacts of climate change, as different methods lead to substantially different climate change impacts; (2) to review the broad literature reporting results of crop yield studies of climate change conducted for many different areas – how much (or little) do we know?; (3) to review the set of estimates that have been made for global agricultural production and what it means for regional agricultural impacts; (4) to discuss the issue of vulnerability, adding a precise definition, while reviewing some of the vulnerability concepts that have been used in the literature; and (5) to review specific issues of adaptation – how can the world’s agricultural system, or more to the point, those populations highly dependent on agriculture make themselves less likely to suffer loss from climate change.

## **2. Impact Assessment Methodologies**

Climate change presents a challenge for researchers attempting to quantify its impact due to the global scale of likely impacts, the diversity of agriculture systems, and the decades-long time scale. Current climatic, soil, and socioeconomic conditions vary widely across the world. Each crop and crop variety has specific climatic tolerances and optima. It is not possible to model world agriculture in a way that captures the details of plant response in every location. The availability of data with the necessary geographic detail currently is the primary limitation, rather than computational capability or basic understanding of crop responses to climate. A specific problem has been how to incorporate the detailed knowledge of plant response into aggregate assessments of regional assessments. In general, compromises are necessary in developing quantitative analyses at regional scales.

There are two basic approaches to evaluating crop and farmer response to changing climate that have made different compromises. These are (1) structural modeling of the agronomic response of plants and the economic/management decisions of farmers based on theoretical specifications and controlled experimental evidence and (2) reliance on the observed response of crops and farmers to varying climate.

For the first approach, sufficient structure and detail are needed to represent specific crops and crop varieties whose responses to different conditions are known through detailed experiments. Similar detail on farm management allows direct modeling of the timing of field operations, crop choices, and how these decisions affect costs and revenues. These approaches typically model a representative crop plant or farm. Both in the case of economic models of farm decisions and in the case of crop response models, the original purpose of these models was to improve understanding of how the crop grows or how a farmer manages. In the case of models of a representative farm, one might hope to offer prescriptive advice for the farmer: where farm operations differ from the profit maximizing (or cost minimizing) model results, it provides guidance for how farmers might improve farm performance. In both cases, the idealized representation of the crop and farm operation tends to give results that differ markedly from the actual experience on farms operating under real world conditions. This may reflect the fact that farmers do not operate as profit maximizers (they could improve their performance) or that the models fail to consider some of the factors that the farmer takes into account, such as risk, lack of immediate employment alternatives, or other considerations. Because of the idealized nature of them models, many analysts consider them to provide evidence of the *potential production* or *potential profitability*. Imposing climate change on these models gives estimates of how potential production may change due to climate change. Using these results as indicative of how climate will actually affect agriculture thus rests on the assumption that the change in the potential represents the change likely to be actually experienced. Many approaches of this type have used detailed crop response models requiring daily weather records. For aggregate analyses inferences concerning large areas and diverse production systems must be made from a relatively few sites and crops because of the complexity of the models and the need for detailed data on weather over a decade or more. This is the basic approach of Fischer *et al.* (1994) reported elsewhere in this volume.

The work of Leemans and Solomon (1993) is in a similar vein, choosing much simpler representations of crop/climate interactions, but is still related to basic agronomic representation of crop growth in response to temperature



and precipitation. The advantage of their approach is that, because of the minimal amounts of climatic data (mean monthly data on temperature and precipitation), the data exist to apply the crop models at a resolution of  $0.5^\circ$  latitude  $\times$   $0.5^\circ$  longitude grids.

The second approach, relying on observed responses of crops and farmers, provided some of the earliest estimates of the potential effects. The simplest example of this approach is to observe the current climatic boundaries of crops and to redraw these boundaries for a predicted changed climate (e.g., Rosenzweig, 1985). In a similar vein, researchers have applied statistical analysis of data across geographic areas to separate climate from other factors (e.g., different soil quality, varying economic conditions) that explain regional production differences and have used these to estimate the potential agricultural impacts of climate change (e.g., Mendelsohn *et al.*, 1994). An advantage of using direct evidence from observed production is that the data reflect how farmers operating under commercial conditions and crops growing under such conditions actually respond to geographically varying climatic conditions. Here, the most recent work uses extremely reduced form models (e.g., Mendelsohn *et al.*, 1994) although estimation of more detailed structural models is possible. Darwin *et al.* (1995) use revealed evidence from geographic variation in climate in a global model, allocating production and input use to climatically determined land classes based on current production patterns. Climate change impacts are then simulated by altering the distribution of land classes and assuming that when an area's land class changes, its underlying production level changes to that of the new land class.<sup>1</sup> The advantage of these approaches is that the response of crops and farmers is based on actual response under current operating conditions rather than an idealized view of how crops and farmers respond. The basic caveat associated with this approach is that one must have faith that land currently producing one set of outputs can change to the new set of outputs once climate changes. Whether these types of approaches accurately

---

<sup>1</sup>The Darwin *et al.* (1995) approach links the basic agricultural productivity of land classes, described by a production function, with a computable general equilibrium model of the world economy. Thus, actual production in a region or land class depends on the final market clearing prices. The model also treats interactions with other sectors of the economy, most importantly sectors that compete for land and water. My interest in this section is in contrasting approaches used to estimate the initial impact of climate on agricultural production. As demonstrated by Fischer *et al.* (1994), Reilly *et al.* (1994), and Adams *et al.* (1988), given an initial climate shock on productivity there are a number of ways to introduce this shock into a variety of different types of economic models to generate estimates of the market impact and realized production under new equilibrium prices.

capture the productivity impact depends on how well they control for other factors (such as soil quality) and whether farmers can adjust their production as climate changes. This latter consideration leads to the interpretation that these approaches capture the long-run equilibrium response to climate change and may not capture adjustment costs associated with changing to new crops and production practices.

### **3. Crop Response Estimates for Different Regions of the World**

Table 1 summarizes the results of the large number of studies of the impact of climate change on potential crop production. Although the table does not provide the detail on the range of specific studies, methods, and climate scenarios evaluated, it provides an indication of the wide range of estimates. The general conclusion of global studies, that tropical areas may more likely suffer negative consequences, is somewhat supported by the results in the table. For example, Latin America and Africa show primarily negative impacts. However, very few studies have been conducted in these regions. For Europe, the USA and Canada, and for South Asia, China, and other Asia and the Pacific Rim, where many more studies have been conducted, the results generally range from severe negative effects ( $-60\%$ ,  $-70\%$ , or complete crop failure) to equally large potential yield increases.

The wide ranges of estimates are due to several, as yet unresolved, factors. Differences among climate scenarios are important and can generate wide ranges of impacts even when identical methods for the same regions are used. For example, a study of the potential impact on rice yields conducted for most of the countries of South and Southeast Asia and for China, Japan, and Korea using the same crop model found yield changes for India to range from  $-3\%$  to  $+28\%$ , for Malaysia from  $+2\%$  to  $+27\%$ , for the Philippines from  $-14\%$  to  $+14\%$ , and for mainland China from  $-18\%$  to  $-4\%$  (Matthews *et al.*, 1994a, 1994b) depending on whether the Goddard Institute for Space Studies (GISS), Geophysical Fluid Dynamics Laboratory (GFDL), or United Kingdom Meteorological Office (UKMO) climate scenario was used.

The impacts across sites can vary widely within a region. Thus, how many and which sites are chosen to represent a region and how the site-specific estimates are aggregated can have important effects on the results. Studies for the USA and Canada demonstrate the wide range of impacts across sites with total or near total crop failure projected every year for wheat and soybeans at one site in the USA (Rosenzweig *et al.*, 1994) but

**Table 1.** Regional crop yield for 2×CO<sub>2</sub> GCM equilibrium climates.

Region	Crop	Yield impact (%)	Countries studied/comments
Latin America	Maize	-61 to increase	Argentina, Brazil, Chile, Mexico. Range is across GCM scenarios, with and without the CO <sub>2</sub> effect.
	Wheat	-50 to -5	Argentina, Uruguay, Brazil. Range is across GCM scenarios, with and without the CO <sub>2</sub> effect.
	Soybeans	-10 to +40	Brazil. Range is across GCM scenarios, with CO <sub>2</sub> effect.
Former USSR	Wheat	-19 to +41	Range is across GCM scenarios and region, with CO <sub>2</sub> effect.
	Grain	-14 to +13	
Europe	Maize	-30 to increase	France, Spain, N. Europe. With adaptation, CO <sub>2</sub> effect. Longer growing season; irrigation efficiency loss; northward shift.
	Wheat	Increase or decrease	France, UK, N. Europe. With adaptation, CO <sub>2</sub> effect. Longer season: northward shift; greater pest damage; lower risk of crop failure.
	Vegetables	Increase	
North America	Maize	-55 to +62	USA and Canada. Range across GCM scenarios and sites, with and without CO <sub>2</sub> effect.
	Wheat	-100 to +234	
	Soybeans	-96 to +58	
Africa	Maize	-65 to +6	Egypt, Kenya, South Africa, Zimbabwe. With CO <sub>2</sub> effect, range across sites and climate scenarios.
	Millet	-79 to -63	Senegal. Carrying capacity fell 11–38%. South Africa; agricultural zone shifts.
	Biomass	Decrease	
South Asia	Rice	-22 to +28	Bangladesh, India, Philippines, Thailand, Indonesia, Malaysia, Myanmar. Range over GCM scenarios and sites; with CO <sub>2</sub> effect; some studies also consider adaptation.
	Maize	-65 to -10	
	Wheat	-61 to +67	
Mainland China and Taiwan	Rice	-78 to +28	Includes rain-fed and irrigated rice. Positive effects in NE and NW China, negative in most of the country. Genetic variation provides scope for adaptation.
Other Asia and Pacific Rim	Rice	-45 to +30	Japan and South Korea. Range is across GCM scenarios. Generally positive in northern Japan; negative in south.
	Pasture	-1 to +35	Australia and New Zealand. Regional variation.
	Wheat	-41 to +65	Australia and Japan. Wide variation, depending on cultivar.

Source: Summarized from Reilly *et al.*, 1996.

wheat yield increases of 180–230% for other sites in the USA and Canada (Rosenzweig *et al.*, 1994; Brklacich *et al.*, 1994; Brklacich and Smit, 1992).

Whether and how changes in a crop variety are specified in a study can have a large impact. Studies conducted of wheat response in Australia found impacts ranging from –34% to +65% for the same climate scenario and site depending on which known and currently grown wheat cultivar was specified in the crop model (Wang *et al.*, 1992). In a similar vein, Matthews *et al.* (1994a, 1994b) concluded that the severe yield losses in South, Southeast, and East Asia for rice in many scenarios was due to a threshold temperature effect that caused spikelet sterility but that genetic variation with regard to the threshold likely provided significant opportunity to switch varieties as temperatures rose. Thus, an impact analysis that narrowly specifies a crop variety is likely to generate an estimated impact that is much different than that of an analysis that specifies responses on the basis of the genetic variation across existing cultivars. Some studies have attempted to evaluate how future crop breeding may change the range of genetic variability available in future varieties (Easterling *et al.*, 1993).

Finally, the estimated amount of adaptation likely to be undertaken by farmers varies. Fundamental views about how the farm sector responds to changing conditions (of any kind) shape the choice of methodological approach, and these methodological approaches can give apparently widely different estimates of impact. Specification of the crop variety in a crop response model illustrates this difference. For some analysts, the prospect that farmers will not change the variety of crop grown over the next 100 years as climate, technology, prices, and other factors change is so remote that they choose to represent change among varieties as an essentially autonomous response of the farm sector. Other analysts choose more specific crop variety characteristics, viewing even crop variety change as neither automatic nor without cost. For example, different varieties of wheat produce flours with different characteristics and the cultural practices for growing spring and winter wheat differ. Similarly, studies of impacts on Japanese rice production estimate negative impacts for the southern parts of the country because of the climate tolerances of Japonica rice, which is preferred over Indica varieties in Japan (Seino, 1993).

The differences resulting from simply whether or not one assumes farmers will adopt the better adapted variety are large, but these differences are potentially greatly magnified because the series of potential adaptations are broad with some requiring more specific recognition, action, and investment by farmers. How do farmers choose a planting date – by planting at the same time each year regardless of weather conditions or by planting when

**Table 2.** Major cash crops percentage yield change at two US sites ( $1\times\text{CO}_2$  to  $2\times\text{CO}_2$ ).<sup>a</sup>

	Kaiser <i>et al.</i> , 1993			Rosenzweig <i>et al.</i> , 1994		
	Mount and Li, 1994 <sup>b</sup>					
	GISS	GFDL	UKMO	GISS	GFDL	UKMO
<i>Nebraska</i>						
Dryland maize	18	-22	19	-22	-17	-57
Dryland soybeans	24	19	14	-12	-18	-31
Dryland winter wheat	11	-3	-4	-18	-36	-33
<i>Iowa</i>						
Dryland maize	22	-24	3	-21	-27	-42
Dryland soybeans	15	17	-1	-7	-26	-76
Dryland winter wheat	0	-6	-5	-4	-12	-15

Abbreviations: GISS = Goddard Institute for Space Studies; GFDL = Geophysical Fluid Dynamics Laboratory; UKMO = United Kingdom Meteorological Office.

<sup>a</sup>Results without  $\text{CO}_2$  fertilization effect.

<sup>b</sup>To obtain results as comparable as possible to Rosenzweig *et al.* (1994), a special report was generated by Li that runs the same GCM results used by Rosenzweig *et al.* (1994) through the models used in Kaiser *et al.* (1993) and Mount and Li (1994). The results from this special report appear in this column. We are grateful to Li for generating the report and helping us to isolate the reasons for differences between the results of the studies.

Source: Schimmelpennig *et al.*, 1996.

soil temperatures are sufficient for crop growth, when the rainy season starts, or when the fields can be tilled? If the decision is partly keyed to weather conditions then the farm decision-making process will lead to some amount of autonomous adjustment to climate change. Similarly, will the changes in tillage and irrigation practices, crop rotation schemes, crops, and crop processing and harvesting that are likely to occur over the next 100 years due to many factors also reflect changes in climate that are occurring simultaneously, or will farmers be unable to detect climate change and therefore fail to adapt these systems, becoming and remaining ill-adapted to the climate conditions occurring locally? If they adapt to current conditions (but cannot confidently look ahead), how maladjusted will their long-lived investments be after 3, 5, 10, or 20 years of continuous changes in climate?

Table 2 provides estimates based on detailed structural models of the impact of climate change on agriculture. Estimates by both sets of authors are based on the same family of CERES crop response models and do not include the  $\text{CO}_2$  fertilization effect. The difference between these 2 sets of estimates are that Kaiser *et al.* (1993) link the crop response models to a structurally detailed farm-level model of economic decision making. Farmers

make economically optimal decisions about when to plant, till, and harvest crops and the amount of drying, fertilizer use, and other inputs used based on their expectations about the weather, which are assumed to be based on the past decade's climate average. Thus, farmers' expectations regularly lag behind the actual climate if climate is gradually changing. These are compared with the Rosenzweig *et al.* (1994) estimates without any adaptation.<sup>2</sup> The estimates reported under Kaiser *et al.* (1993) and Mount and Li (1994) are actually based on a response surface model (Mount and Li) estimated from multiple scenario runs of the detailed model of Kaiser *et al.* This facilitates comparison of the structurally detailed Kaiser *et al.* (1993) report beyond the specific sites where the detailed data necessary to run the model were available. The striking result in this comparison is that for most of the scenarios, the Kaiser *et al.* (1993) and Mount and Li (1994) analysis suggests significant increases in production potential compared with significant losses in production potential for the Rosenzweig *et al.* (1994) site results without adaptation. It has not been possible to conduct a broader regional or national analysis with the Kaiser *et al.* (1993) model, so it is not possible to compare this work with other national estimates for the USA. (For more discussion, see Schimmelpfennig *et al.*, 1996).

A variety of methods have now been applied to estimating the impacts for the USA. Table 3 provides the range of estimates for the USA that have been generated based on quite different methodologies and assumptions about the extent to which adaptation will occur. While the table covers only the USA, it is likely that applying this range of approaches in other regions would also generate a similar range of estimates. The Mendelsohn *et al.* (1994) estimates are based on an econometric model estimated on cross-sectional data and reflect, according to the authors, long-run, full adjustment of US agriculture to a climate change shock. The methodology does not allow consideration of how crop prices may change and thus may be most comparable to the initial crop yield shock used in other methodologies. Except for column 8, none of the reported estimates in Table 3 consider the direct effect of CO<sub>2</sub> on plant growth. Unfortunately, the wide ranging methodologies do not or have not generally reported results that are directly comparable, thus some interpretation is necessary.

The starkest difference in methodology is between Mendelsohn *et al.* (1994) and Rosenzweig and Parry (1994). Columns 1 and 2 reflect results

---

<sup>2</sup>In global simulations, Rosenzweig and Parry (1994) include farm-level adaptation, but the specific adaptation potential for individual sites has not been separately reported. Overall, for the USA, Rosenzweig and Parry (1994) scenarios, even with adaptation, generally do not show improvements.

**Table 3.** Estimates of the impact of climate change on USA agriculture (% change).

Climate scenario	Mendelsohn <i>et al.</i> , 1994; without CO <sub>2</sub> effect		Darwin <i>et al.</i> , 1995: without CO <sub>2</sub> effect				Rosenzweig and Parry, 1994; average yield effects across crops	
	Area wghts.	Rev. wghts.	Farm-level adaptation	Full adjustm.	No adjustm.	Full adjustm.	No adjustm.	Adjustm. and CO <sub>2</sub>
GISS	-1.8	+2.0	+4.1	-7.8	-24.4	-3.0	-14 to -21	0 to +17
GFDL	-1.2	+4.2	-16.1	+4.3	-38.0	-2.0	-23 to -29	+9 to -10
UKMO	-4.5	+1.1	-4.4	-5.4	-38.4	-5.0	-25 to -58	+1 to -20
OSU	-3.6	-0.7	-10.0	+5.8	-33.3	-5.2	-	-

Abbreviations: GISS = Goddard Institute for Space Studies; GFDL = Geophysical Fluid Dynamics Laboratory; UKMO = United Kingdom Meteorological Office; OSU = Oregon State University.

Notes: Mendelsohn *et al.* (1994) figures are annualized impact on land values as a percentage of total value of crop and livestock production. The values of crop and livestock production are for 1990 from Darwin *et al.* (1995). See Mendelsohn *et al.* (1994) for a description of the methodology used in that study. The simulations of the model for the GISS, GFDL, UKMO, and OSU scenarios reported above were provided by personal communication with Mendelsohn, March 29, 1995. Darwin *et al.* (1995) results are computed from simulations reported in Darwin *et al.* (1995). Rosenzweig and Parry summarize the range of crop yield impacts used in their 1994 study for the USA. The US average crop yield shocks used by estimated by them were reported in Reilly *et al.* (1993). Specific crop yield studies, which were, in part, the basis for these estimates, were reported in Rosenzweig *et al.* (1994).

from models estimated with different weights on the individual observations. Mendelsohn, *et al.* (1994) suggest the column 2 estimates based on revenue weights are more appropriate because they reflect the economic value of crops. They suggest that the more negative estimates based on area weights (column 1) reflect the type of bias that may be introduced by focusing on cereal crops, which generally have a lower value than many other crops such as fruits and vegetables. Contrasting the climate impact shock they estimate (column 2) with the types of yield shocks estimated by Rosenzweig and Parry (1994; column 7) provide a dramatically different picture of the impact of climate change on US agriculture. Rosenzweig and Parry (1994) include some adjustments but, unfortunately, the yield shocks for the USA comparable to the Mendelsohn *et al.* (1994) study (climate change and adaptation with no CO<sub>2</sub> effect) have not been reported. However, in their study adaptation they did not have a particularly powerful effect on mitigating losses as reported by Reilly and Hohmann (1993). The relatively benign impacts for the USA in the Rosenzweig and Parry yield estimates (column 8, with the CO<sub>2</sub> and adaptation) are, in a large part, less severe because of the CO<sub>2</sub> effect. Thus, different methodologies, including adaptation but not the CO<sub>2</sub> effect, apparently produce estimates of impact for four major climate scenarios on the order of -1% to +5% using a Mendelsohn *et al.* methodology but on the order of -10% to -25% using the Rosenzweig and Parry methodology. In deriving the -10% to -25% range, I assume that adaptation in their study may have reduced losses by 5-10%, whereas the CO<sub>2</sub> fertilization effect reduced losses by 75-100%, which is the relative importance of these two factors on a global basis as in their data as estimated by Reilly and Hohmann (1993).

The Darwin *et al.* (1995) study used an independently derived set of climate shocks, representing climate change as a change in land class where the productivity of each land class was estimated from current data. Their methodology for estimating the direct effect of climate was more akin to Mendelsohn *et al.* (1994), using the observed differences in production across geographically varying climate as the basis for the projections. Their results, columns 3-6 in Table 3, help explain and confirm some of the differences between the other two studies. The initial shock on US cereal production in the Darwin *et al.* (1995) study (column 5) is similar to and generally more severe than, the yield shocks estimated by Rosenzweig and Parry (1994; column 7). However, Darwin *et al.* (1995) estimate that by just considering the immediate farm-level adjustment (without price changes and without expansion of agricultural production into new areas), farmers could offset between 70-120% of the initial losses (i.e., comparing column 5 and column



3).<sup>3</sup> Columns 4 and 6 provide the estimates after full adjustment, including changes in world prices and trade, for cereal production and farm income. Note that the farm income effects with full adjustment (column 4) are sometimes worse than the farm income effects with only farm-level adaptation (column 3), because the Darwin *et al.* (1995) study considers worldwide effects with international trade. Thus, the impacts that occur in the rest of the world under the GISS and UKMO climate scenarios lead the USA to lose international comparative advantage once full adjustment of international markets is considered.

Together these three studies indicate the wide range of estimated impacts for the same region and same climate scenarios depending on the methodology used. Mendelsohn *et al.* (1994) and Darwin *et al.* (1995) use methodologies that they argue more completely consider adaptation, and they find impacts after adaptation to be generally less than Rosenzweig and Parry (1994). However, even between these two approaches there are significant differences in estimated impacts for some climate scenarios in comparable estimates (columns 2 and 3).

Table 4 provides reports the different types of economic impacts generated from these different supply and yield shocks. Adams *et al.* (1988) have used yield shocks generated by Rosenzweig *et al.* (1994). The broader economic implications of the different approaches follow fairly directly from the differential yield shocks. In particular, the Adams *et al.* (1988) scenarios without the CO<sub>2</sub> fertilization effect show much larger economic losses than the Darwin *et al.* (1995) and Mendelsohn *et al.* (1994) studies, which do not include CO<sub>2</sub> fertilization. A particular difference for the Mendelsohn *et al.* (1994) study, however, is the implicit assumption that commodity prices do not change and that all changes are reflected in changes in land rents. The distributional implications of this assumption is that all effects are felt by producers, whereas the structural market models often show that the producer effects are of opposite direction to the national effects.

The above discussion identified four separate factors that contribute to widely varying estimates of regional impacts of climate change apart from how or whether the CO<sub>2</sub> effect on crops is included in the simulation. These factors – varying climate scenarios, wide variation across sites within a region, how genetic variability across known crop varieties is addressed within

---

<sup>3</sup>Note that this comparison is between impacts on cereal production and impacts on farm income, which is comparable (given that the simulation in column 3 does not allow prices to change) except that farm income includes impacts to agriculture for livestock and non-grain production, as well.

**Table 4.** Estimated annual economic impacts of climate change on the US economy (in billion US dollars).

Climate scenario	Adams <i>et al.</i> , 1988 <sup>a</sup>			Darwin <i>et al.</i> , 1995 <sup>b</sup>		Mendelsohn <i>et al.</i> , 1994 <sup>c</sup>	
	With CO <sub>2</sub> and trade effects	No CO <sub>2</sub> or trade effects	CO <sub>2</sub> effects but no trade effects	Land use restricted	Land use unrestricted	Cropland weights	Crop revenue weights
<i>A. Aggregate US economic impacts</i>							
GISS	10.82	-11.33	10.21	5.9	5.8	-9.2	16.4
GFDL	4.37	-19.09	4.57	-11.1	-4.8	-35.6	33.1
UKMO	9.03	-67.01	-17.58	-1.2	1.1	-36.6	8.9
OSU	n.a.	n.a.	n.a.	-6.6	-3.9	-28.1	-5.8
<i>B. Impacts on US agricultural producers</i>							
GISS	12.56	10.79	12.74	2.8	-1.5	-9.2	16.4
GFDL	6.61	16.84	7.22	8.3	-1.5	-35.6	33.1
UKMO	44.44	114.97	41.52	8.2	-1.7	-36.6	8.9
OSU	n.a.	n.a.	n.a.	5.9	0.4	-28.1	-5.8

For abbreviations see Table 3.

<sup>a</sup>Part A reflects changes in total surplus. Part B reflects changes in producer surplus. In 1990 US dollars, the base scenario total (producer) surplus was US\$1,124 billion (US\$21 billion).

<sup>b</sup>Part A reflects changes in 1990 gross domestic product (GDP). Part B reflects changes in returns to agricultural land, capital, labor, and water resources.

<sup>c</sup>Reflects changes in the annual stream of returns to farmland due to climate change.

Note: For comparison purposes, base scenario (Darwin *et al.*, 1995) US GDP was US\$5,497 billion (in 1990 dollars) and the annualized 1982 implicit return to agricultural land in 1990 dollars was US\$31.1 billion.

Source: Schimmelpfennig *et al.*, 1996.

the crop-response modeling approach, and differences across impact methodologies, particularly in how different methods address the capability of farmers to adapt – appear to be of roughly equal magnitude in explaining the wide range of estimates.

#### **4. Global Studies and Their Implications for Regional Effects**

Accurate consideration of national and local food supply and economic effects depends on an appraisal of changes in global food supply and prices. International markets can moderate or reinforce local and national changes. In 1988, for example, drought presented a relatively severe threat because it occurred coincidentally in several of the primary grain-growing regions of the world. Reilly *et al.* (1994) demonstrate that considering country-level production impacts of climate change in the absence of consideration of the global impacts can generate highly misleading results. Agricultural exporting countries, whose productivity is reduced by climate change, may find themselves with a financial bonanza if world agricultural prices rise because of climate change. These same countries may suffer significant economic loss if climate change turns out to be generally beneficial to world agriculture, even if agricultural productivity in their country benefits. This feature of the agricultural economy is well-known and reflects what is, in aggregate, an inelastic demand for food. This point, which is a fundamental observation of agricultural economists, means that absolutely no implications for food availability, price, or farm financial success can be drawn from local and country-level estimates of production impacts of climate change unless one assumes that production changes around the world will generally balance to leave little impact on global production and prices. A country may attempt to carry out a set of policies that maintains a neutral effect on the country's agricultural sector vis-à-vis the rest of the world. However, maintaining such policies will generally entail significant economic cost through subsidization of domestic agricultural production and/or consumption, or through import or export controls. There are many different ways these costs may be borne (higher food prices, government expenditures, lost efficiency in the producing sector, lost export opportunities), depending on how the policies are structured.

There are now a number of different attempts to estimate the impacts of climate change on global agriculture, in part to consider the global impacts, but more importantly to more accurately consider what the regional

impacts could be, recognizing that what happens to global agriculture due to climate change will likely be more important for the viability and economic success of local agriculture than what happens to local production potential itself. Kane *et al.* (1992) and Tobey *et al.* (1992) examined the sensitivity of agriculture to potential yield losses in major temperate grain-growing regions based on very stylized climate change impacts. They loosely linked the potential for yield losses in temperate regions to climate projections that showed increasing aridity in the continental mid-latitude areas. They made alternative assumptions about how agriculture might be affected in higher latitudes and in the Tropics. They also developed scenarios that reflected the estimated yield impacts for different parts of the world that were summarized in the 1990 Intergovernmental Panel on Climate Change (IPCC) assessment (Parry *et al.*, 1990). The yield response estimates used by Rosenzweig and Parry (1994) also reported in Fischer *et al.* (1994) were also the basis of Reilly *et al.* (1994) and in greater detail Reilly *et al.* (1993). Many of the general conclusions are similar between the studies, indicating that given a set of yield shocks, economic modeling of international markets in itself is not a major source of difference in results even though there are major differences in the modeling approaches. Rather, these different economic modeling approaches focus in different aspects and degrees of detail of agricultural economic interactions among crops, livestock, land use, and the rest of the economy.

Among the issues that give rise to uncertainty in these studies are the following factors:

1. The timing of expected climate change. For example, Rosenzweig and Parry (1994) assume that the 4.0–5.2°C scenarios occur in 2060, but the most recent IPCC work suggests the mean estimate for 2060 is closer to 1.5°C and that the range of global temperature impacts by 2100 is likely to be between 1.0–5°C.
2. Aggregation from detailed sites. Detailed plant growth models, the basis for many studies, require daily temperature and precipitation records for a 10- to 30- year historical climate record and detailed soil data, limiting the number of sites for which data are readily available and that can be practicably assessed. An alternative approach (Leemans and Solomon, 1993; Carter *et al.* (1991) makes use of geographic information system databases that contain more extensive information on current climates across the world. These efforts have not been linked to an economic model. Results confirm the pattern of relative decreased crop potential

in the tropical areas and increased potential in the northern areas but are not aggregated to determine the net global effect.

3. Coverage of agricultural activities. Simulation of crop response models has been limited to a few major crops for a region, usually important grain crops, with yield effects extended to other crops. Left out are the indirect impacts of climate change through impacts on insect, disease, and weed pests; on soils; and on livestock production. Mendelsohn *et al.* (1994) argue that their statistical approach accounts for all agricultural activities, implicitly accounting for the full effects of climate.
4. Other resource changes and competition for resources from other sectors. Allocation of land and water resources is a conspicuous limitation in global studies. Water demand for other uses will grow, water use may have reached or passed sustainable levels of use in some areas, irrigation is responsible for salinization and land degradation, and water pricing and water system management are far from efficient under current conditions (e.g., Umali, 1993; Moore, 1991). Climate change also will affect demand for resources from other sectors.

The Darwin *et al.* (1995) study addresses many of these considerations in a global model including eight world regions. In a compatible general equilibrium model, land and climatic resource changes are based on a geographic information system; changing climate shifts the distribution of land across several agro-climatic land classes. Other resource-using sectors are included and are also affected by climate change. The model is a static model, imposing climate change on current economic and agricultural markets, and thus does not address the issue of timing directly.

The global results (Table 5) are comparable to those of Rosenzweig and Parry (1994) in terms of direct supply impacts for the world in the “no adaptation” case, but the study finds that adaptation is able to turn global losses into small global benefits (unrestricted case). Even when the model is constrained to continue to produce on existing amounts of land within each region and prices are not allowed to respond, adaptation mitigates a significant share of the losses. These results contrast with those of Rosenzweig and Parry (1994) in that they give generally smaller impacts and possible benefits even without the CO<sub>2</sub> effect and show adaptation to be quite important.

Again, the global results are important because they are the first step in considering whether a local economy’s consumers will be able to purchase food if it is unavailable domestically, how local producers may be affected by changes in demand for their crops, or how the cost of a country’s agricultural policies may change because of changing international market conditions.

**Table 5.** Percentage changes in the supply and production of cereals for the world by climate change scenario.

Climate scenarios	Supply		Production	
	No adaptation	Land use fixed	Land use fixed	No restrictions
GISS	-22.6	-2.4	0.2	0.9
GFDL	-23.5	-4.4	-0.6	0.3
UKMO	-29.3	-6.4	-0.2	1.2
OSU	-18.6	-3.9	-0.5	0.2

For abbreviations see Table 3.

Note: Changes in supply represent the additional quantities firms would be willing to sell at 1990 prices under the alternative climate. Changes in production represent changes in equilibrium quantities.

Source: Darwin *et al.*, 1995.

## 5. Regional Vulnerability

The previous sections documented the wide range of uncertainty in the potential direction and magnitude of climate change impact. While many new studies have been conducted, most have focused on specific climate scenarios associated with  $2\times\text{CO}_2$  GCM scenarios or arbitrary changes in climatic conditions to provide evidence of the general sensitivity of agriculture and crop production to climate change. The wide range of estimates limits the ability to extend, interpolate, or extrapolate from the specific climate scenarios used in these studies to “more” or “less” climate change or to draw implications for impacts beyond the sites where studies were conducted.

Given these uncertainties in both magnitude and direction of impact, a key issue is vulnerability to possible climate change. Vulnerability is used here to mean the potential for negative consequences that are difficult to ameliorate through adaptive measures given the range of possible climate changes that might reasonably occur. Thus, defining an area or population as vulnerable is not a prediction of negative consequences of climate change; it is an indication that across the range of possible climate changes there are some climatic outcomes that would lead to relatively more serious consequences for the region than for other regions.

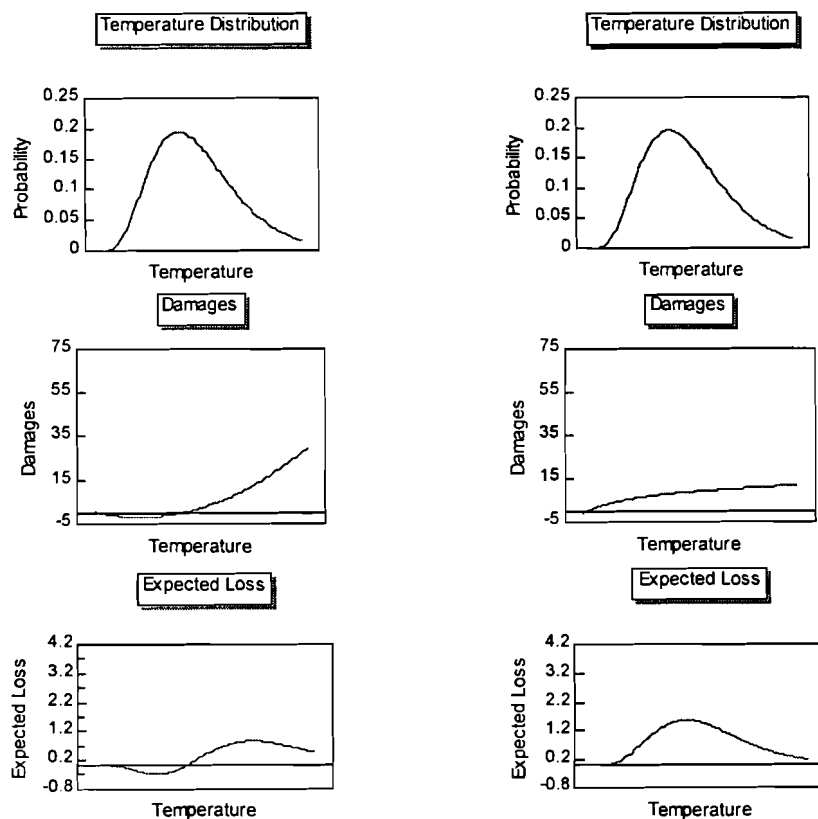
Vulnerability has been used rather loosely in many discussions. Before discussing some of the research that has examined potential vulnerability, I introduce a more formal definition. For the sake of simplicity, consider that climate can be described as a single variable,  $C$ . We are uncertain about what value  $C$  will take at some future point, but we can describe the probability,  $p$ , that  $C$  will take on a specific value by the probability

density function  $f(C)$ . Further, consider that we are able to describe the sensitivity of agriculture,  $A$ , to changes in climate by the function  $g(C)$ . We can then define the expected loss function,  $L(C)$  as  $f(C) \times g(C)$ . A population, region, or crop is relatively more vulnerable under this definition if the area under  $L(C)$  where damages occur is larger than for a comparison population, region, or crop. Thus, I use the term vulnerability to describe only that portion of  $L(C)$  where damages occur. For other purposes, it useful to consider expected (net) damage (or benefit), that is, the mean of the values of loss function which is a probability weighted mean of the damages.

Two, purely illustrative, numerical examples are plotted in Figure 1. For these examples I have chosen to represent  $f(C)$  as a gamma distribution. In Panel A damages are represented by a quadratic function; in panel B damages are represented by a logarithmic function. These choices illustrate just two of the ways that our expectations about the degree of future climate change and our understanding of the sensitivity of an agricultural system to climate change may interact. In these numerical illustrations, the system characterized by quadratic losses (Panel A) is more vulnerable to loss than the system described by logarithmic losses. Even though the quadratic sensitivity to climate leads to potentially larger losses at extreme temperature change, the system is less vulnerable because climate change is not likely to be that extreme in this example. In fact, the small region of beneficial warming (negative damages) in Panel A gives rise to a substantial possibility of beneficial effects of warming for the system described in this panel. In Panel B, in contrast, damages initially rise sharply but the rate of increase slows. This characterization of system sensitivity indicates damages across the entire range of expected temperature change.

Even though damages do not have the potential to become as severe as in Panel A, the system is more vulnerable to damage because climate is more likely to be in the relatively higher damage range of the sensitivity function.

In practice, multiple dimensions of climate affect any agricultural system. The simple characterization in Figure 1 is meant to make the definition of vulnerability mathematically precise even though it is not possible at this time to formally estimate the multidimensional, joint distribution of important climate variables. Nor do we precisely know the damage function that relates changes in these climate variables to agricultural impacts. The advantage is to make explicit that we must consider our expectations with regard to climate and damage sensitivity. To make the example concrete, a semi-arid area may be extremely sensitive to damage if it becomes more arid. However, if our expectation is that it is highly likely that the region



**Figure 1.** Defining vulnerability.

will become wetter, the region is not vulnerable. Another region in a humid agro-climatic zone may be vulnerable if substantial warming and drying are likely for the area.

Up to this point, I have not been explicit with regard to what I propose to measure as a damage. The existing literature suggests several different possible measures and therefore several different dimensions of vulnerability. Many studies focus on crop yields. Evidence suggests that yields of crops grown where temperature could easily exceed threshold values during critical crop growth periods are more vulnerable to warming (e.g., rice sterility: Matthews *et al.*, 1994a, 1994b).

*Farmer or farm sector vulnerability* may be measured in terms of impact on profitability or viability of the farming system. Farmers with limited



financial resources and farming systems with few adaptive technological opportunities available to limit or reverse adverse climate change may suffer significant disruption and financial loss for relatively small changes in crop yields and productivity, or these farms may be located in areas more likely to suffer yield losses. For example, Parry *et al.* (1988a, 1988b) focused on semi-arid and cool temperate and cold agricultural areas as those that might be more clearly affected by climate change and climate variability.

*Regional economic vulnerability* reflects the sensitivity of the regional or national economy to farm sector and climate change impacts. A regional economy that offers only limited employment alternatives for workers dislocated by the changing profitability of farming and other climatically sensitive sectors may be relatively more vulnerable than those that are economically diverse. For example, Rosenberg (1993) examined the Great Plains area of the USA because of its heavy dependence on agriculture. Increasing aridity is expected in this region under climate change, and thus it was considered to be potentially more economically vulnerable than other regions in the USA.

*Hunger vulnerability* has been used to mean the “aggregate measure of the factors that influence exposure to hunger and predisposition to its consequences” involving “interactions of climate change, resource constraints, population growth, and economic development” (Downing, 1992; Bohl *et al.*, 1994). Downing (1992) concluded that the semi-extensive farming zone, on the margin of more intensive land uses, appears to be particularly sensitive to small changes in climate. Socioeconomic groups in such areas, already vulnerable in terms of self-sufficiency and food security, could be further marginalized. In all likelihood we should not look only at agriculturally dependent people. We must consider the means people have within society and the family to obtain food and how their allocation will change if production potential changes. A poor urban household may suffer due to production losses elsewhere in the region while the rural farmer may continue to eat. Or, women and children of rural peasant farms may go hungry, while “excess” production from the region is sold. Assessing who has the means and rights to food during shortfalls is thus likely to be more critical in a climate vulnerability study than assessing how production may change. For hunger and famine in general, the relative importance of acquiring (versus producing ) food has been demonstrated by Sen (1981, 1993).

Given the diverse currently existing conditions, the geographical variation likely to exist in any climate change scenario, and the wide uncertainty

that must be associated with local prediction of future climates, some vulnerable agricultural areas and populations are likely in nearly every region, even if the expected value for the region is a net benefit. This makes vulnerability a relative concept – while there may be a few areas where even the most extreme climate change we can imagine would not generate losses, in general, the problem is to consider whether a particular region or population is relatively more vulnerable than others.

While perhaps most difficult to evaluate, vulnerability in terms of hunger and malnutrition ought to be the first concern. If so, we can almost certainly eliminate the richer countries of the world as vulnerable. For poorer regions, it is the poorest members of these areas or those that could be made poor by climate change that are most at risk. The wide uncertainty with regard to local and regional climate change means it is difficult to rule out negative possibilities for any area. Thus, without even considering specific climate scenarios we can assert that, of the world's populations, those who are currently poor, malnourished, and dependent on local production for food are the most vulnerable in terms of hunger and malnutrition to climate change. Similarly, severe economic vulnerability is most likely where a large share of the population depends on agriculture, leaving few alternative employment opportunities. Again, we need not assess climate scenarios or projected yield changes to establish where these vulnerable populations live. Given these considerations, Table 6 presents some of the critical dimensions of areas of the world that might be used to assess vulnerability. While the table is too aggregated to identify specifically vulnerable populations, it is indicative of where many of these people are likely to be. Because of the wide range of uncertainty in precipitation, the only climatic dimension likely to enter significantly in an assessment of vulnerability is temperature. Cool regions are more likely to be limited by low temperatures, and thus warming may prove beneficial – these areas may still suffer if precipitation changes are adverse. However, further warming is unlikely to benefit already warm regions. Thus, global warming appears somewhat stacked against the already warm areas. Coincidentally (or not), these regions tend to also be home to some of the world's poorest.

The focus on hunger and malnutrition as a first priority does not mean that other types of vulnerability are unimportant. Regional economic development, land degradation, or increased environmental stress resulting from agricultural production under a changed climate are important concerns as well.

**Table 6.** Basic regional agricultural indicators and vulnerability.

	Sub-Saharan Africa	Middle East/ North Africa	South Asia	Southeast Asia	East Asia	Oceania	Former USSR	Europe	Latin America	USA, Canada
Agric. land (%) <sup>a</sup>	41	27	55	36	51	57	27	47	36	27
Cropland (%)	7	7	44	13	11	6	10	29	7	13
Irrigated (%)	5	21	31	21	11	4	9	12	10	8
Land area (10 <sup>6</sup> ha)	2390	1167	478	615	993	845	2227	473	2052	1839
Climate <sup>b</sup>	(1)	(2)	(3)	(4)	(5)	(6)	(7)	(8)	(9)	(10)
Population (10 <sup>6</sup> )	566	287	1145	451	1333	27	289	510	447	277
Agric. pop. (%)	62	32	63	49	59	17	13	8	27	3
Pop./ha cropland	3.6	3.4	5.4	5.7	12.6	0.5	1.3	3.7	2.9	1.2
Agric. prod. (10 <sup>6</sup> t)										
Cereals	57	79	258	130	433	24	180	255	111	388
Roots and tubers	111	12.5	26	50	159	3	65	79	45	22
Pulses	5.7	4.1	14.4	2.5	6.3	2	6	7	5.8	2.2
Sugar cane and beet	60	39	297	181	103	32	62	144	494	56
Meat	6.7	5.5	5.7	6.4	39.6	4.5	17	42	20.5	33.5
1991 GNP/cap. <sup>c</sup>	350	1940	320	930	590	13780	2700	15300	2390	22100
Annual growth	-1.2	-2.4	3.1	3.9	7.1	1.5	N.A.	2.2	-0.3	1.7
Agric. (% of GDP) <sup>c</sup>	>30%	10-19%	>30%	20 to >30%	20-29%	<6%	10-29%	<6%	10-19%	<6%

<sup>a</sup>Agricultural land includes grazing land and cropland, reported as a percentage of total land area. Cropland is reported as a percentage of agricultural land. Irrigated area is reported as a percentage of cropland.

<sup>b</sup>Climate: (1) tropical; arid, humid. (2) subtropical, tropical; arid. (3) tropical, subtropical; humid, arid. (4) tropical; humid. (5) subtropical, temperate oceanic, continental; humid. (6) tropical, temperate, oceanic subtropical; arid, humid. (7) polar, continental, temperate oceanic; humid, arid. (8) temperate oceanic, some subtropical; humid, arid. (9) tropical, subtropical; mostly humid (10) continental, subtropical, polar, temp. oceanic; humid, arid.

<sup>c</sup>Gross national product (GNP) is in 1991 US dollars; annual growth (percent per annum) is for the period 1980-1991.

Note: East Asia GNP excludes Japan. Also, regional GNP data generally include only those countries for which data are given in Table 1 in World Development Indicators. Countries with a population of more than 4 million for which GNP data are not available include Vietnam, Democratic People's Republic of Korea, Afghanistan, Cuba, Iraq, Myanmar, Cambodia, Zaire, Somalia, Libya, and Angola; land areas are in hectares, production is in tonnes.

Sources: Computed from FAO Statistics Division, 1992; GNP per capita, GNP growth rates, and agriculture as a share of the economy are from World Bank; World Development Indicators 1993 and temperature and climate classes from Rötter *et al.*, 1995.

## 6. Adaptation Potential and Policies

The hierarchy of damage considerations as above – hunger, regional economic, farmer/farm sector, and yield vulnerability – helps to focus on adaptive strategies that reduce vulnerability. How can we avoid yield failures? If yields fail, what other crops can be grown? If farming becomes uneconomic, what other opportunities for employment exist? If the people of the region can no longer produce food, what other sources of food are available and how will they earn the income necessary to purchase food, or what other means does the society in which they live have to provide food assistance?

Historically, farming systems have adapted to changing economic conditions, technology, and resource availabilities, and have kept pace with a growing population (Rosenberg, 1992; CAST, 1992). Evidence exists that agricultural innovation responds to economic incentives such as factor prices and can relocate geographically (Hayami and Ruttan, 1985; CAST, 1992). A number of studies indicate that adaptation and adjustment will be important to limit losses or to take advantage of improving climatic conditions (e.g., US NAS, 1991; Rosenberg, 1992; Rosenberg and Crosson, 1991; CAST, 1992; Mendelsohn *et al.*, 1994).

Despite the successful historical record, issues of future adaptation to climate change arise with regard to whether the rate of climate change and required adaptation would add significantly to the disruption likely due to future changes in economic conditions, technology, and resource availability (Gommes, 1993; Harvey, 1993; Kane and Reilly, 1993; Smit, 1993; Norse, 1994; Pittock, 1994; Reilly, 1994). If climate change is gradual, it may be a small factor that goes unnoticed by most farmers as they adjust to other more profound changes in agriculture stemming from new technology, increasing demand for food, and other environmental concerns such as pesticide use, water quality, and land preservation. However, some researchers see climate change as a significant addition to future stresses, where adapting to yet another stress such as climate change may be beyond the capability of the system. Part of the divergence in views may be due to different interpretations of adaptation, which include the prevention of loss, tolerating loss, or relocating to avoid loss (Smit, 1993). Moreover, while the technological potential to adapt may exist, the socioeconomic capability to adapt likely differs for different types of agricultural systems (Reilly and Hohmann, 1993).

## 6.1. The technological potential to adapt

Nearly all agricultural impact studies conducted over the past five years have considered some technological options for adapting to climate change. Among those that offer promise are

- *Seasonal changes and sowing dates.* For frost-limited growing areas (i.e., temperate and cold areas), warming could extend the season, allowing planting of longer maturity annual varieties that achieve higher yields (e.g., Le Houerou, 1990; Rowntree, 1990a, 1990b). For short-season crops such as wheat, rice, barley, oats, and many vegetable crops, extension of the growing season may allow more crops per year, fall planting, or, where warming leads to regular summer highs above critical thresholds, a split season with a short summer fallow. For subtropical and tropical areas where growing season is limited by precipitation or where the cropping already occurs throughout the year, the ability to extend the growing season may be more limited depending on how precipitation patterns change. A study for Thailand found that yield losses in the warmer season were partially offset by gains in the cooler season (Parry *et al.*, 1992).
- *Different crop variety or species.* For most major crops, varieties exist with a wide range of maturities and climatic tolerances. For example, Matthews *et al.* (1994a, 1994b) identified wide genetic variability among rice varieties as a reasonably easy response to spikelet sterility in rice that occurred in simulations for South and Southeast Asia. Studies in Australia showed that responses to climate change are strongly cultivar dependent (Wang *et al.*, 1992). Longer-season cultivars were shown to provide a steadier yield under more variable conditions (Connor and Wang, 1993). In general, such changes may lead to higher yields or may only partly offset losses in yields or profitability. Crop diversification in Canada (Cohen *et al.*, 1992) and in China (Hulme *et al.*, 1992) has been identified as an adaptive response.
- *New crop varieties.* The genetic base is broad for most crops but limited for some (e.g., kiwi fruit). A study by Easterling *et al.* (1993) explored how hypothetical new varieties would respond to climate change (also reported in McKenney *et al.*, 1992). Heat, drought, and pest resistance; salt tolerance; and general improvements in crop yield and quality would be beneficial (Smit, 1993). Genetic engineering and gene mapping offer the potential for introducing a wider range of traits. Difficulty in assuring traits are efficaciously expressed in the full plant, consumer

concerns, profitability, and regulatory hurdles have slowed the introduction of genetically engineered varieties compared with early estimates (Reilly, 1989; Caswell *et al.*, 1994).

- *Water supply and irrigation systems.* Across studies, irrigated agriculture is, in general, less negatively affected than dryland agriculture, but adding irrigation is costly and subject to the availability of water supplies. Climate change will also affect future water supplies. There is wide scope for enhancing irrigation efficiency through adoption of drip irrigation systems and other water-conserving technologies (FAO, 1989; 1991) but successful adoption will require substantial changes in how irrigation systems are managed and how water resources are priced. Because inadequate water systems are responsible for current problems of land degradation, and because competition for water is likely to increase, there likely will be a need for changes in the management and pricing of water regardless of whether and how climate changes (Vaux, 1990, 1991; World Bank, 1994). Tillage method and incorporation of crop residues are other means of increasing the useful water supply for cropping.
- *Other inputs and management adjustments.* Added nitrogen and other fertilizers would likely be necessary to take full advantage of the CO<sub>2</sub> effect. Where high levels of nitrogen are applied, nitrogen not used by the crop may leach into the groundwater, run off into surface water, or be released from the soil as nitrous oxide. Additional nitrogen in groundwater and surface water has been linked to health effects in humans and affects aquatic ecosystems. Studies have also considered a wider range of adjustments in tillage, grain drying, and other field operations (Kaiser *et al.*, 1993; Smit, 1993).
- *Tillage.* Minimum and reduced tillage technologies in combination with planting of cover crops and green manure crops offer substantial possibilities for reversing existing soil organic matter, soil erosion, and nutrient loss and combating potential further losses due to climate change (Rasmussen and Collins, 1991; Logan, 1991; Edwards *et al.*, 1992; Langdale *et al.*, 1992; Peterson *et al.*, 1993; Brinkman and Sombroek, 1996). Reduced and minimum tillage techniques have spread widely in some countries but are more limited in other regions. There is considerable current interest in transferring these techniques to other regions (Cameron and Oram, 1994).
- *Improved short-term climate prediction.* Linking agricultural management to seasonal climate predictions (currently largely based on ENSO), where such predictions can be made with reliability, can allow management to adapt incrementally to climate change. Management/climate

**Table 7.** Speed of adoption for some major adaptation measures.

Adaptation	Adjustment time (yrs)	References
Variety adoption	3–14	Dalrymple, 1986; Griliches, 1957; Plucknett <i>et al.</i> , 1987; CIMMYT, 1991.
Dams and irrigation	50–100	James and Lee, 1971; Howe, 1971.
Variety development	8–15	Plucknett <i>et al.</i> , 1987; Knudson, 1988.
Tillage systems	10–12	Hill <i>et al.</i> , 1994; Dickey <i>et al.</i> , 1987; Schertz, 1988.
New crop adoption: Soybeans	15–30	FAO, Agrostat, various years.
Opening new lands	3–10	Medvedev, 1987; Plusquellec, 1990.
Irrigation equipment	20–25	Turner and Anderson, 1980.
Transportation system	3–5	A. Talvitie, World Bank, personal communication, 1994.
Fertilizer adoption	10	Pieri, 1992; Thompson and Wan, 1992.

predictor links are an important and growing part of agricultural extension in both developed and developing countries (McKeon *et al.*, 1990, 1993; Nichols and Wong, 1990).

## 6.2. The socioeconomic capability to adapt

While identifying many specific technological adaptation options, Smit (1993) concluded that necessary research on their cost and ease of adoption had not yet been conducted.

One measure of the potential for adaptation is to consider the historical record on past speeds of adoption of new technologies (Table 7). Adoption of new or different technologies depends on many factors: economic incentives, varying resource and climatic conditions, the existence of other technologies (transportation systems and markets), the availability of information, and the remaining economic life of equipment and structures (e.g., dams and water supply systems).

Specific technologies can only provide a successful adaptive response if they are adopted in appropriate situations. A variety of issues have been considered, including land-use planning, watershed management, disaster vulnerability assessment, consideration of port and rail adequacy, trade policy, and the various programs countries use to encourage or control production, limit food prices, and manage resource inputs to agriculture (CAST, 1992; US OTA, 1993; Smit, 1993; Reilly *et al.*, 1994; Singh, 1994). For example, studies suggest that current agricultural institutions and policies in the USA may discourage farm management adaptation strategies such as

altering crop mix by supporting prices of crops not well-suited to a changing climate, providing disaster payments when crops fail, or prohibiting imports through import quotas (Lewandrowski and Brazee, 1993).

Existing gaps between best yields and the average farm yields remain unexplained, but many are due in part to socioeconomic considerations (Oram and Hojjati, 1995; Bumb, 1995); this adds considerable uncertainty to estimates of the potential for adaptation, particularly in developing countries. For example, Baethgen (1994) found that a better selection of wheat variety combined with improved fertilizer regime could double yields achieved at a site in Uruguay to 6 T/ha under the current climate with current management practices. Under the UKMO climate scenario, yields fell to 5 T/ha, still well above 2.5–3.0 T/ha currently achieved by farmers in the area. On the other hand, Singh (1994) concluded that the normal need to plan for storms and extreme weather events in Pacific island nations creates significant resiliency. Whether technologies meet the self-described needs of peasant farmers is critical in their adaptation (Cáceres, 1993). Other studies document how individuals cope with environmental disasters, identifying how strongly political, economic, and ethnic factors interact to facilitate or prevent coping in cases ranging from the dust bowl disaster in the USA to floods in Bangladesh to famines in the Sudan, Ethiopia, and Mozambique (McGregor, 1994). These considerations indicate the need for local capability to develop and evaluate potential adaptations that fit changing conditions (COSEPUP, 1992). Important strategies for improving the ability of agriculture to respond to diverse demands and pressures, drawn from past efforts to transfer technology and provide assistance for agricultural development, include

- Improved training and general education of populations dependent on agriculture, particularly in countries where education of rural workers is currently limited. Agronomic experts can provide guidance on possible strategies and technologies that may be effective. Farmers must evaluate and compare these options to find those appropriate for their needs and the circumstances of their farm.
- Identification of the present vulnerabilities of agricultural systems, causes of resource degradation, and existing systems that are resilient and sustainable. Strategies that are effective in dealing with current climate variability and resource degradation are also likely to increase resilience and adaptability in the face of future climate change.
- Agricultural research centers and experiment stations can examine the “robustness” of present farming systems (i.e., their resilience to extremes



- of heat, cold, frost, water shortage, pest damage, and other factors) and also test the robustness of new farming strategies as they are developed to meet changes in climate, technology, prices, costs, and other factors.
- Interactive communication that brings research results to farmers and farmers' problems, perspectives, and successes to researchers is an essential part of the agricultural research system.
  - Agricultural research provides a foundation for adaptation. Genetic variability for most major crops is wide relative to projected climate change. Preservation and effective use of this genetic material would provide the basis for new variety development. Continually changing climate is likely to increase the value of networks of experiment stations that can share genetic material and research results.
  - Food programs and other social security programs would provide insurance against local supply changes. International famine and hunger programs need to be considered with respect to their adequacy.
  - Transportation, distribution, and market integration provide the infrastructure to supply food during crop shortfalls that might be induced in some regions because of climate variability or worsening of agricultural conditions.
  - Existing policies may limit efficient response to climate change. Changes in policies such as crop subsidy schemes, land tenure systems, water pricing and allocation, and international trade barriers could increase the adaptive capability of agriculture.

Many of the above strategies will be beneficial regardless of how or whether climate changes. Goals and objectives among countries and farmers vary considerably. Current climate conditions and likely future climates also vary. Building the capability to detect change and evaluate possible responses is fundamental to successful adaptation. Thus, even without having clear predictions of climate change, is it possible to identify some strategies that reduce potential vulnerability.

## References

- Adams, R.M., McCarl, D.B.A., Dudek, J., and Glycer, J.D., 1988, Implications of Global Climate Change for Western Agriculture, *Western Journal of Agricultural Economics* 13:348–356.
- Baethgen, W.E., 1994, Impact of Climate Change on Barley in Uruguay: Yield Changes and Analysis of Nitrogen Management Systems, in C. Rosenzweig and A. Iglesias (eds.), *Implications of Climate Change for International Agriculture: Crop Modeling Study*, US Environmental Protection Agency, Uruguay, Washington, DC, USA.

- Bohl, H.G., Downing, T.E., and Watts, M.J., 1994, Climate Change and Social Vulnerability: Toward a Sociology and Geography of Food Insecurity, *Global Environmental Change* 4(1):37-48.
- Brinkman, R., and Sombroek, W.G., 1996, The Effects of Global Change on Soil Conditions in Relation to Plant Growth and Food Production.
- Brklacich, M., and Smit, B., 1992, Implications of Changes in Climatic Averages and Variability on Food Production Opportunities in Ontario, Canada, *Climatic Change* 20:1-21.
- Brklacich, M., Stewart, R., Kirkwood, V., and Muma, R., 1994, Effects of Global Climate Change on Wheat Yields in the Canadian Prairie, in C. Rosenzweig and A. Iglesias (eds.), *Implications of Climate Change for International Agriculture: Crop Modeling Study*, US Environmental Protection Agency, Canada Washington, DC, USA.
- Bumb, B., 1995, Growth Potential of Existing Technology is Insufficiently Tapped, in N. Islam (ed.), *Population and Food in the Early 21st Century: Meeting Future Food Demand of an Increasing World Population*, Occasional Paper, International Food Policy Research Institute (IFPRI), Washington, DC, USA.
- Cáceres, D.M., 1993, *Peasant Strategies and Models of Technological Change: A Case Study from Central Argentina*, Masters Phil. thesis, Manchester, University of Manchester, UK.
- Cameron, D., and Oram, P., 1994, *Minimum and Reduced Tillage: Its Use in North America and Western Europe and its Potential Application in Eastern Europe, Russia, and Central Asia*, International Food Policy Research Institute, Washington, DC, USA.
- Carter, T.R., Porter, J.R., and Parry, M.L., 1991, Climatic Warming and Crop Potential in Europe: Prospects and Uncertainties, *Global Environmental Change* 1(September):291-312.
- CAST (Council for Agricultural Science and Technology), 1992, *Preparing U.S. Agriculture for Global Climate Change*, Task Force Report No. 119, CAST, Ames, Iowa, USA.
- Caswell, M.F., Fuglie, K.O., and Klotz, C.A., 1994, *Agricultural Biotechnology: An Economic Perspective*, AER No. 687, US Department of Agriculture, Washington, DC, USA.
- CIMMYT (Centro Internacional de Mejoramiento de Maiz y Trigo), 1991, *Annual Report: Improving the Productivity of Maize and Wheat in Developing Countries: An Assessment of Impact*, CIMMYT, Mexico City, Mexico.
- Cohen, S., Wheaton, E., and Masterton, J., 1992, *Impacts of Climatic Change Scenarios in the Prairie Provinces: A Case Study from Canada*, SRC Publication No. E-2900-4-D-92, Saskatchewan Research Council, Saskatoon, Canada.
- Connor, D.J., and Wang, Y.P., 1993, Climatic Change and the Australian Wheat Crop, in S. Geng (ed.), *Proceedings of the Third Symposium on the Impact of Climatic Change on Agricultural Production in the Pacific Rim*, Centre Weather Bureau, Ministry of Transport and Communications, Republic of China.

- COSEPUP (Committee on Science, Engineering and Public Policy), 1992, *Policy Implications of Global Warming*, National Academy Press, Washington, DC, USA.
- Dalrymple, D.G., 1986, Development and Spread of High-Yielding Rice Varieties in Developing Countries, 7th edition, U.S. AID, Washington, DC, USA.
- Darwin, R., Tsigas, M., Lewandrowski, J., and Ranases, A., 1995, *World Agriculture and Climate Change: Economic Adaptation*, Report No. AER-709, Economic Research Service, Washington, DC, USA.
- Dickey, E.C., Jasa, P.J., Dolesh, B.J., Brown, L.A., and Rockwell, S.K., 1987, Conservation Tillage: Perceived and Actual Use, *Journal of Soil Water Conservation* (Nov.-Dec.):431-434.
- Downing, T.E., 1992, Climate Change and Vulnerable Places: *Global Food Security and Country Studies in Zimbabwe, Kenya, Senegal, and Chile*, Research Report No. 1, Environmental Change Unit, University of Oxford, Oxford, UK.
- Easterling, W.E., III, Crosson, P.R., Rosenberg, N.J., McKenney, M., Katz, L.A., and Lemon, K., 1993, Agricultural Impacts of and Responses to Climate Change in the Missouri-Iowa-Nebraska-Kansas (MINK) Region, *Climatic Change* **24**:23-61.
- Edwards, J.H., Wood, C.W., Thurow, D.L., and Ruff, M.E., 1992, Tillage and Crop Rotation Effects on Fertility Status of a Hapludult Soil, *Soil Science Society of America Journal* **56**:1577-1582.
- FAO (Food and Agriculture Organization Statistics Division), 1989, *Guidelines for Designing and Evaluating Surface Irrigation Systems*, Irrigation and Drainage Papers 45, FAO, Rome, Italy.
- FAO (Food and Agriculture Organization Statistics Division), 1991, *Water Harvesting*, AGL Miscellaneous Papers 17, FAO, Rome, Italy.
- FAO (Food and Agriculture Organization Statistics Division), 1992, *AGROSTAT Digital Data*, FAO, Rome, Italy.
- Fischer, G., Frohberg, K., Rosenzweig, C., and Parry, M., 1994, Climate Change and Global Agriculture: Who Benefits, Who Loses? *Global Environmental Change* **4**(March):1-24.
- Gommes, R., 1993, Current Climate and Population Constraints on World Agriculture, in H.M. Kaiser and T.E. Drennen (eds.), *Agricultural Dimensions of Global Climate Change*, St. Lucie Press, Delray Beach, FL, USA.
- Griliches, Z., 1957, Hybrid Corn: An Exploration in the Economics of Technological Change, *Econometrica* **25**(October):501-522.
- Harvey, L.D.D., 1993, Comments on "An Empirical Study of the Economic Effects of Climate Change on World Agriculture," *Climatic Change* **21**:273-275.
- Hayami, Y., and Ruttan, V.W., 1985, Disequilibrium in World Agriculture, in *Agricultural Development: An International Perspective*, Johns Hopkins University Press, Baltimore, MD, USA.
- Hill, P.R., Griffith, D.R., Steinhardt, G.C., and Parsons, S.D., 1994, *The Evolution and History of No-Till Farming in the Midwest*, Purdue University, West Lafayette, IN, USA.

- Howe, C., 1971, *Benefit Cost Analysis for Water System Planning: Water Resources Monograph 2*, American Geophysical Union, Washington, DC, USA.
- Hulme, M., Wigley, T., Jiang, T., Zhao, Z., Wang, F., Ding, Y., Leemans, R., and Markham, A., 1992, *Climate Change Due to the Greenhouse Effect and Its Implications for China*, World Wide Fund for Nature, CRU/WWF/SMA, Gland, Switzerland,
- James, L.D., and Lee, R.R., 1971, *Economics of Water Resources Planning*, McGraw Hill, New York, NY, USA.
- Kaiser, H.M., et al., 1993, *Agricultural Dimensions of Global Climate Change*, St. Lucia Press, Delray Beach, FL, USA.
- Kaiser, H.M., 1994, An Annotative Bibliography of Research on the Economic 1994, *Effects of Climate Change on Agriculture*, Publ. No. P94-10, University of Minnesota, St. Paul, MN, USA.
- Kane, S., and Reilly, J., 1993, Reply to Comment by L.D. Danny Harvey on "An Empirical Study of the Economic Effects of Climate Change on World Agriculture," *Climatic Change* 21:277-279.
- Kane, S., Reilly, J., and Tobey, J., 1992, An Empirical Study of the Economic Effects of Climate Change on World Agriculture, *Climate Change* 21(May):17-35.
- Knudson, M., 1988, *The Research and Development of Competing Biological Innovations: The Case of Semi- and Hybrid Wheats*, Ph.D. dissertation, University of Minnesota, St. Paul, MN, USA.
- Langdale, G.W., West, L.T., and Bruce, R.R., 1992, Restoration of Eroded Soil with Conservation Tillage, *Soil Technology* 5:81-90.
- Leemans, R., and Solomon, A.M., 1993, Modelling the Potential in Yield and Distribution of the Earth's Crops Under a Warmed Climate, *Climate Research* 3(30 August):79-96.
- Le Houerou, H.N., 1990, Global Change: Vegetation, Ecosystems and Land Use in the Mediterranean Basin by the Twenty-First Century, *Israel Journal of Botany* 39:481-508.
- Lewandowski, J.K., and Brazee, R.J., 1993, Farm Programs and Climate Change, *Climatic Change* 23:1-20.
- Logan, T.J., 1991, Tillage Systems and Soil Properties in North America, *Tillage Research* 20:241-270.
- Matthews, R.B., Kropff, M.J., Bachelet, D., 1994a, Climate Change and Rice Production in Asia, *Entwicklung und Ländlicher Raum* 1:16-19.
- Matthews, R.B., Kropff, M.J., Bachelet, D., and van Laar, H.H., 1994b, *The Impact of Global Climate Change on Rice Production in Asia: A Simulation Study*, Report No. ERL-COR-821, US Environmental Protection Agency, Environmental Research Laboratory, Corvallis, USA.
- McGregor, J., 1994, Climate Change and Involuntary Migration, *Food Policy* 19(2):121-132.
- McKenney, M.S., Easterling, W.E., and Rosenberg, N.J., 1992, Simulation of Crop Productivity and Responses to Climate Change in the Year 2030: The Role of Future Technologies, Adjustments and Adaptations, *Agricultural and Forest Meteorology* 5:103-127.

- McKeon, G.M., Day, K.A., Howden, S.M., Mott, J.J., Orr, D.M., Scattini, W.J., and Weston, E.J., 1990, Management for Pastoral Production in Northern Australian Savannas, *Journal of Biogeography* **17**:355-372.
- McKeon, G.M., Howden, S.M., Abel, N.O.J., and King, J.M., 1993, Climate Change: Adapting Tropical and Subtropical Grasslands, in *Proceedings of the XVII International Grassland Congress*, pp. 1181-1190.
- Medvedev, Z.A., 1987, *Soviet Agriculture*, W.W. Norton and Co., New York, NY, USA.
- Mendelsohn, R., Nordhaus, W., and Shaw, D., 1994, The Impact of Climate on Agriculture: A Ricardian Approach, *American Economic Review* **84**(September):753-771.
- Moore, M.R., 1991, The Bureau of Reclamation's New Mandate for Irrigation Water Conservation: Purposes and Policy Alternatives, *Water Resources Research* **27**(February):145-155.
- Nichols, N., and Wong, K.K., 1990, Dependence of Rainfall Variability on Mean Rainfall, Latitude and the Southern Oscillation, *Journal of Climatology* **3**:163-170.
- Norse, D., 1994, Multiple Threats to Regional Food Production: Environment, Economy, Population? *Food Policy* **19**(2):133-148.
- Oram, P.A., and Hojjati, B., 1995, The Growth Potential of Existing Agricultural Technology, in N. Islam (ed.), *Population and Food in the Early 21st Century: Meeting Future Food Demand of an Increasing World Population*, Occasional Paper, International Food Policy Research Institute (IFPRI), Washington, DC, USA.
- Parry, M.L., Carter, T.R., and Konijn, N.T. (eds.), 1988a, *The Impact of Climate Variations on Agriculture, Volume 1: Assessments in Cool Temperate and Cold Regions*, Kluwer Academic Publishers, Dordrecht, The Netherlands.
- Parry, M., Carter, T.R., and Konijn, N.T. (eds.), 1988b, *The Impact of Climatic Variations on Agriculture, Volume 2: Assessment in Semi-arid Regions*, Kluwer Academic Press, Dordrecht, The Netherlands.
- Parry, M.L., Duinker, P.N., Morison, J.I.L., Porter, J.H., Reilly, J., and Wright, L.J., 1990, Agriculture and Forestry, in W.J.McG. Tegart, G.W. Sheldon, D.C. Griffiths (eds.), *Climate Change: The IPCC Impacts Assessment*, Australian Government Printing Office, Canberra, Australia.
- Parry, M.L., Blantran de Rozari, M., Chong, A.L., and Panich, S. (eds.), 1992, *The Potential Socio-Economic Effects of Climate Change in South-East Asia*, United Nations Environment Programme, Nairobi, Kenya.
- Peterson, G.A., Westfall, D.G., and Cole, C.V., 1993, Agroecosystem Approach to Soil and Crop Management Research, *Soil Science Society of America Journal* **57**:1354-1360.
- Pieri, C., 1992, *Fertility of Soils: The Future for Farmers in the West African Savannah*, Springer Verlag, Berlin, Germany.
- Pittock, A.B., 1994, Climate and Food Supply, *Nature*(371):25.
- Plucknett, D.L., Smith, N.J.H., Williams, J.T., and Anishetty, N.M., 1987, *Gene Banks and the World's Food*, Princeton University Press, Princeton, NJ, USA.

- Plusquellec, H., 1990, *The Gezira Irrigation Scheme in Sudan: Objectives, Design, and Performance*, Technical Paper No. 120, The World Bank, Washington, DC, USA.
- Rasmussen, P.E., and Collins, H.P., 1991, Long-term Impacts of Tillage, Fertiliser and Crop Residue on Soil Organic Matter in Temperate Semiarid Regions, *Advances in Agronomy* **45**:93–134.
- Reilly, J., 1989, *Consumer Effects of Biotechnology*, AIB No. 581, US Department of Agriculture, Washington, DC, USA.
- Reilly, J., 1994, Crops and Climate Change, *Nature* **367**:118–119.
- Reilly, J., and Hohmann, N., 1993, Climate Change and Agriculture: The Role of International Trade, *American Economic Review* **83**(May):306–312.
- Reilly, J., Hohmann, N., and Kane, S., 1993, *Climate Change and Agriculture: Global and Regional Effects Using an Economic Model of International Trade*, MIT-CEEPR 93-012WP, Massachusetts Institute for Technology, Center for Energy and Environmental Policy, Boston, MA, USA.
- Reilly, J., Hohmann, N., and Kane, S., 1994, Climate Change and Agricultural Trade: Who Benefits, Who Loses? *Global Environmental Change* **4**(March):24–36.
- Reilly, J., Baethgen, W., Chege, F.E., van de Geijn, S.C., Erda, L., Iglesias, A., Kenny, G., Patterson, D., Rogasik, J., Rötter, R., Rosenzweig, C., Sombroek, W., and Westbrook, J., 1996, Agriculture in a Changing Climate: Impacts and Adaptation, in R.T. Watson, M.C. Zinyowera, and R.H. Moss (eds.), *Climate Change 1995: Impacts, Adaptations, and Mitigation of Climate Change: Scientific and Technical Analyses*, Cambridge University Press, Cambridge, UK.
- Rosenberg, N.J., 1992, Adaptation of Agriculture to Climate Change, *Climatic Change* **21**:385–405.
- Rosenberg, N.J., 1993, *Towards an Integrated Assessment of Climate Change: The MINK Study*, Kluwer Academic Publishers, Boston, MA, USA.
- Rosenberg, N.J., and Crosson, P.R., 1991, *Processes for Identifying Regional Influences of and Responses to Increasing Atmospheric CO<sub>2</sub> and Climate Change: The MINK Project, An Overview*, DOE/RL/01830T-H5, Resources for the Future and US Department of Energy, Washington, DC, USA.
- Rosenzweig, C., 1985, Potential CO<sub>2</sub>-induced Climate Effects on North American Wheat-producing Regions, *Climatic Change* **7**:367–389.
- Rosenzweig, C., and Parry, M.L., 1994, Potential Impacts of Climate Change on World Food Supply, *Nature* **367**(13 January):133–138.
- Rosenzweig, C., Curry, B., Richie, J.T., Jones, J.W., Chou, T.Y., Goldberg, R., and Iglesias, A., 1994, The Effects of Potential Climate Change on Simulated Grain Crops in the United States, in C. Rosenzweig and A. Iglesias (eds.), *Implications of Climate Change for International Agriculture: Crop Modeling Study*, US Environmental Protection Agency, Washington, DC, USA.
- Rötter, R., Stol, W., van de Geijn, S.C., and van Keulen, H., 1995, *World Agroclimates: 1. Current Temperature Zones and Drylands*, AB-DLO, Research Institute for Agrobiolgy and Soil Fertility, Wageningen, The Netherlands.

- Rowntree, P.R., 1990a, Predicted Climate Changes Under "Greenhouse-Gas" Warming, in M. Jackson, B.V. Ford-Lloyd, and M.L. Parry (eds.), *Climatic Change and Plant Genetic Resources*, Belhaven Press, London, UK.
- Rowntree, P.R., 1990b, Estimates of Future Climatic Change over Britain, Part 2: Results, *Weather* **45**:79-89.
- Schertz, D.L., 1988, Conservation Tillage: An Analysis of Acreage Projections in the United States, *Journal of Soil Water Conservation* (May-June):35-42.
- Schimmelpfennig, D., Lewandowski, J., Reilly, J., Tsigas, M., and Parry, I., 1996, Agricultural Adaptation to Climate Change: Issues of Long Run Sustainability, Agricultural Economics Report, Economic Research Service, USDA, forthcoming.
- Seino, H., 1993, Impacts of Climatic Warming on Japanese Agriculture, in N. Shuzo, H. Hideo, H. Hirokazu, O. Toshiichi, and M. Tsuneyuki (eds.), *The Potential Effects of Climate Change in Japan*, Environment Agency of Japan, Tokyo, Japan.
- Sen, A., 1981, *Poverty and Famines: An Essay on Entitlement and Deprivation*, Oxford University Press, London, UK.
- Sen, A., 1993, The Economics of Life And Death, *Scientific American*:40-47.
- Singh, U., 1994, *Potential Climate Change Impacts on the Agricultural Systems of the Small Island Nations of the Pacific*, Draft, IFDC-IRRI, Los Banos, Philippines.
- Smit, B. (ed.), 1993, *Adaptation to Climatic Variability and Change*, Occasional Paper No. 19, University of Guelph, Guelph, Canada.
- Thompson, T.P., and Wan, X., 1992, *The Socioeconomic Dimensions of Agricultural Production in Albania: A National Survey*, PN-ABQ-691, International Fertilizer Development Center, US AID, Washington, DC, USA.
- Tobey, J., Reilly, J., and Kane, S., 1992, Economic Implications of Global Climate Change for World Agriculture, *Journal of Agricultural and Resource Economics* **17**(1):195-204.
- Turner, H.A., Anderson, C.L., 1980, *Planning for an Irrigation System*, American Association for Vocational Instructional Materials, Athens, GA, USA.
- Umali, D.L., 1993, *Irrigation-Induced Salinity: A Growing Problem for Development and the Environment*, World Bank Technical Paper No. 215, The World Bank, Washington, DC, USA.
- US NAS (US National Academy of Sciences), 1991, *Report on Adaptation to Climate Change*, Committee on Science, Engineering, and Public Policy, National Academy Press, Washington, DC, USA.
- US OTA (US Congress, Office of Technology Assessment, 1993, *Preparing for an Uncertain Climate*, Volume 1., OTA-O-567, US Government Printing Office, Washington, DC, USA.
- Vaux, H.J., 1990, The Changing Economics of Agricultural Water Use: Visions of the Future, *Proceedings of the 3rd National Irrigation Symposium*, American Society of of Agricultural Engineers, St. Joseph, MI, USA.

- Vaux, H.J., 1991, Global Climate Change and California's Water Resources, in J.B. Knox and A.F. Scheuring (eds.), *Global Climate Change and California*, University of California Press, Berkeley, CA, USA.
- Wang, Y.P., Handoko, J., and Rimmington, G.M., 1992, Sensitivity of Wheat Growth to Increased Air Temperature for Different Scenarios of Ambient CO<sub>2</sub> Concentration and Rainfall in Victoria, Australia – A Simulation Study, *Climatic Research* 2:131–149.
- Woodward, F.I., 1993, Leaf Responses to the Environment and Extrapolation to Larger Scales, in A. Solomon and H. Shugart (eds.), *Vegetation Dynamics and Global Change*, International Institute for Applied Systems Analysis, Laxenburg, Austria, Chapman and Hall, New York, NY, USA.
- World Bank, 1994, *A Review of World Bank Experience in Irrigation*, Operations Department, Report 13676, The World Bank, Washington, DC, USA.



# The Impacts of Climate Change, Carbon Dioxide, and Sulfur Deposition on Agricultural Supply and Trade: An Integrated Impact Assessment

*Günther Fischer and Cynthia Rosenzweig*  
IIASA, Laxenburg, Austria

## Abstract

This paper examines the impacts of climate change and altered atmospheric concentrations of carbon dioxide (CO<sub>2</sub>) and sulfur dioxide (SO<sub>2</sub>) on crop yields, food supply, and trade. The analysis is part of an integrated assessment study undertaken at the International Institute for Applied Systems Analysis (IIASA). For the agricultural study, results from the 11R and MESSAGE III energy models of IIASA's Environmentally Compatible Energy Strategies Project and from the regional air pollution model RAINS developed by IIASA's Transboundary Air Pollution Project were compiled to define economic and environmental conditions for simulation experiments with the Basic Linked System (BLS) world food trade model. Three different CO<sub>2</sub> and SO<sub>2</sub> emission scenarios were tested, representing a range of possible energy policy pathways.

Results from the BLS world food trade model show that the three emission scenarios have only limited impact on global agricultural output, due to moderate climate sensitivity to CO<sub>2</sub> and negative radiative forcing by sulfate aerosols. However, the effects of SO<sub>2</sub> on agricultural productivity associated with the different scenarios are considerable at the regional scale. Regional impacts on agriculture of a coal-intensive high CO<sub>2</sub> and SO<sub>2</sub> emissions scenario are substantial, especially in regions where agricultural production is located near industrial areas, as in China and India. Thus, with regard to agriculture, the choice of CO<sub>2</sub> abatement strategy may be more of a regional issue than a global one.

## 1. Introduction

Changes in climate and the atmosphere will alter potential and actual agricultural production in various regions of the world. Rising levels of

atmospheric carbon dioxide (CO<sub>2</sub>) will likely contribute to increased agricultural productivity and enhanced crop water-use efficiency. Global warming will tend to expand the agro-ecological potential poleward and into higher altitudes. These positive effects, however, may be constrained by altered temperature, precipitation, and evaporation regimes. In addition, other anthropogenic changes in the chemical composition of the atmosphere and lithosphere could further alter and possibly reduce regional agricultural productivity. For instance, the air pollutants sulfur dioxide (SO<sub>2</sub>), nitrogen oxides (NO<sub>x</sub>), and ozone (O<sub>3</sub>) cause damage to agricultural crops.

Our earlier work focused on the combined effects of higher levels of atmospheric CO<sub>2</sub> and climate change on world food supplies and trade (Rosenzweig and Parry, 1994; Fischer *et al.*, 1994). Here we add another anthropogenic factor to our analysis, examining the impacts of altered atmospheric concentrations of CO<sub>2</sub>, climate change, and one air pollutant, SO<sub>2</sub>, on global and regional crop production, agricultural sector gross domestic product (GDP), and food prices. The work is part of an integrated assessment of the consequences of possible energy emission and climate change scenarios carried out at the International Institute for Applied Systems Analysis (IIASA). Three different CO<sub>2</sub> and SO<sub>2</sub> emission scenarios derived from this integrated assessment are tested, representing a range of energy policy pathways.

## 2. Effects of Increased Atmospheric SO<sub>2</sub> Concentration

Sulfur dioxide is a prime cause of acid pollution and results primarily from the burning of fossil fuels (Fitter and Hay, 1987; Conway and Pretty, 1991; and Ashmore and Wilson, 1993). This pollutant is prevalent in industrialized countries, particularly in parts of Europe and northeastern USA. Such emissions are currently declining in developed regions due to regulatory activities; the highest rates of increase of SO<sub>2</sub> emissions and other pollutants in recent years have occurred in countries that are rapidly industrializing, notably in China (Chameides *et al.*, 1994).

The nature and amount of damage caused to plants by air pollutants depends on three factors: the inherent toxicity of the pollutant gas, the proportion that is taken up by the plants, and their physiological reaction. These factors, in turn, are affected by the environment in which the crop is growing, including the presence of other pollutants. From the air, SO<sub>2</sub> can be deposited onto farmers' fields directly as dry deposition or dissolved in

water in the form of rain or snow as wet deposition, or it can be taken up by plants from fog or clouds as occult deposition. Indirect effects of sulfur deposition on crops involve changes in the chemical dynamics of the soil and surface-water acidification. Apart from these interactions, SO<sub>2</sub> aerosols may also affect the radiation and temperature environment in which crops grow by scattering incoming solar radiation.

## 2.1. Dry deposition

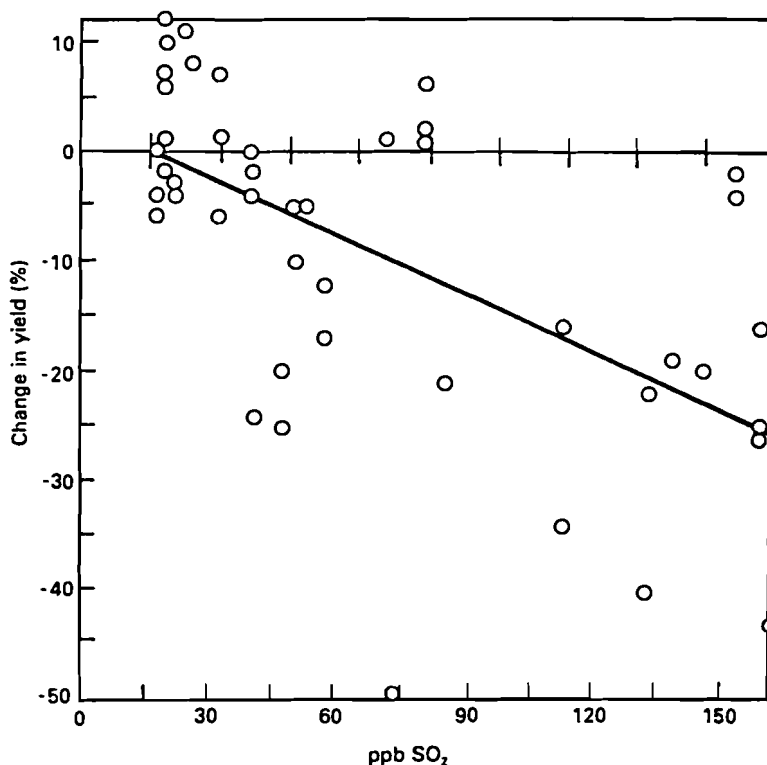
Early research on SO<sub>2</sub> damage was mainly concerned with acute injury of plants. Conditions under which visible damage of plant foliage occurs have been studied for almost 100 years. Such visible injury is closely correlated with yield losses and can occur when SO<sub>2</sub> levels exceed 500 ppbv<sup>1</sup> for a few hours. However, with the adoption of efficient dispersion mechanisms (i.e., tall smokestacks for heavy polluters) such conditions are now rare and acute injury of agricultural crops from dry deposition is unlikely.

In recent decades, the research focus has shifted toward the effects of sustained low to moderate concentrations of pollutants on arable crops and grasses (Figure 1). Experiments and field studies have shown that most reductions in yield occur without signs of visible injury. Impacts at doses comparable to levels typically observed in rural areas in Europe and the USA have been found to be highly variable and results have sometimes been conflicting. Nevertheless, a few general conclusions have been formulated (see, e.g., Ashmore and Wilson, 1993). SO<sub>2</sub>-induced chronic injury is enhanced in situations where plants grow slowly, such as in higher altitudes or during winter months. Low light intensity, short days, and low temperature produce slow growth, which makes plants more vulnerable to SO<sub>2</sub>.

Evidence from filtration and low-concentration fumigation experiments indicates that critical levels for SO<sub>2</sub> might be lower in the presence of nitrous oxide or ozone. On the other hand, a reduction in stomatal conductance due to enhanced atmospheric CO<sub>2</sub> could potentially reduce the negative effects of SO<sub>2</sub> and ozone (Allen, 1990). However, the experimental results are complicated and sometimes conflicting, making it difficult to predict what type of interaction will occur when a crop is subjected to a given combination of pollutants. Mixtures of toxic gases are most harmful to plants

---

<sup>1</sup>Concentrations of gaseous pollutants are usually expressed either on a volume-to-volume basis, such as parts per billion volume (ppbv), or on a mass-to-volume basis, such as micrograms per cubic meter ( $\mu\text{gm}^{-3}$ ). Conversion between measures depends on pressure, temperature, and molecular weight of the gas. At a temperature of 20°C and a pressure of 1 atmosphere, the respective conversion factor for SO<sub>2</sub> is 1 ppbv  $\approx$  2.67  $\mu\text{gm}^{-3}$ .



**Figure 1.** Effects of long-term exposure (20–200 days) to SO<sub>2</sub> on the grass *Lolium perenne*. Source: Roberts, 1984.

under stress and may reduce their ability to withstand such environmental stress, for instance, their ability to tolerate freezing. Plants with the C<sub>3</sub> photosynthetic pathway<sup>2</sup> tend to be more susceptible to air pollution than C<sub>4</sub> plants. There is some evidence to suggest that soil type does not have a major influence on the response of crops to pollutants when crops are grown in adequately fertilized soils (Sanders, 1993).

<sup>2</sup>In the process of photosynthesis, CO<sub>2</sub> and water are combined in plant leaves using sunlight to produce carbohydrates and oxygen. Plants differ in the intermediate steps and compounds produced in the photosynthetic process. One major group of plants are referred to as C<sub>3</sub> plants, because one of the first intermediate compounds has three carbon atoms (phosphoglyceric acid). Most agricultural crops, notably, wheat, rice, barley, soybeans, and potatoes, belong to the C<sub>3</sub> group. Similarly, a second group of plants, termed C<sub>4</sub> plants, produce a compound with four carbon atoms (oxaloacetic acid). C<sub>4</sub> plants of economic importance include maize, sorghum, millet, and sugarcane.

In studies of critical loads of pollutants in Europe (see Bell, 1993), it has been noted that in the case of agricultural and horticultural crops adverse effects are not observed for annual mean SO<sub>2</sub> concentration levels below 30  $\mu\text{gm}^{-3}$ . The overall dose or average concentration of pollutant gases, rather than intermittent peaks in exposure levels, appears to be the primary factor controlling these effects.

## 2.2. Wet deposition

Most investigations into the effects of wet deposition, commonly termed acid rain, have focused on damage to forests and water bodies. Studies on annual crops indicate that the usual ambient concentrations of acids in rainfall are insufficient to produce acute injury, except in the immediate vicinity of sources of intense emissions. Plant damage has been reported for pH values below 3.5, a concentration of acids in rainfall that is rarely achieved, even in highly polluted areas. Some general findings are that broadleaf plants are more susceptible than grasses, and root and leafy vegetables are more susceptible than forage, grain, and fruit crops. Overall, the effects of wet deposition of pollutants on plants are even less understood than those of gaseous pollutants (Fitter and Hay, 1987).

Much attention has also been given to studying the indirect effects of sulfur deposition, for instance, on the chemical dynamics of soil and surface-water acidification. A reduction in pH below a level of 4.2 eventually leads to an increase in toxic aluminum concentration in the soil, enhancing the potential for damage to vegetation and reduction in soil fertility. This possibility has been a major concern with regard to less intensively managed ecosystems such as forests, but seems of less importance for agro-ecosystems where mitigating management practices (e.g., liming of agricultural land) can neutralize even high rates of acidic deposition, albeit at increased costs of agricultural production.

## 3. Study Methods

This integrated assessment study involves several models developed by different IIASA projects. To achieve consistency among the various research groups, the assessment models have been harmonized through an approach that we term soft-linking. The first step in this process is linking the economic growth rate and regional investment results of the macroeconomic energy model 11R (Manne and Richels, 1992) and IIASA's model of the world

food and agriculture system, the Basic Linked System of National Agricultural Policy Models (BLS) (Fischer *et al.*, 1988). Second, the climate change yield component of the BLS is parameterized according to CO<sub>2</sub> emissions projected by the energy model MESSAGE III (Messner and Strubegger, 1995) and global temperature changes derived from MAGICC (a Model for the Assessment of Greenhouse-gas Impacts and Climate Change; Hulme *et al.*, 1995; Wigley and Raper, 1992). Third, results from RAINS (Regional Acidification INformation and Simulation model; Amann, 1993; Amann *et al.*, 1995; Cofala and Dörfner, 1995) are used to derive regional yield damage functions in the BLS to account for the effects of increasing SO<sub>2</sub> emissions and deposition in the high CO<sub>2</sub> and SO<sub>2</sub> emission energy scenario used in this study.

### 3.1. The world agriculture model system

The BLS is a global general equilibrium model system developed by the Food and Agriculture Project at IIASA. It consists of some 35 national and regional models: 18 national models, 2 models of regions with close economic cooperation (EC-9 and Eastern Europe and former Soviet Union<sup>3</sup>), 14 aggregate models of country groupings, and a small component that accounts for statistical discrepancies and imbalances during the historical period (see Appendix). The individual models are linked by means of a world market module. A detailed description of the entire system is provided in Fischer *et al.* (1988). Earlier results obtained with the system are discussed in Parikh *et al.* (1988) and in Fischer *et al.* (1991, 1994, 1996).

The country models are linked through trade, world market prices, and financial flows. The system is solved in annual increments simultaneously for all countries in a recursive dynamic simulation. Although the BLS contains different types of models, all adhere to some common specifications. The models contain two main sectors: agriculture and nonagriculture. Agriculture produces nine aggregated commodities; all nonagricultural activities are combined into a single aggregate sector. Agricultural production is dependent on the availability of the modeled primary production factors, that is, land, labor, and capital.

For agricultural commodities, yield is determined separately from acreage or numbers of animals, and is represented as a function of fertilizer

---

<sup>3</sup>The political changes and changes in national boundaries of the recent past are not captured in the BLS, although the model formulation has been adjusted away from centrally planned economies toward more market-oriented behavior.

application (crops) or feeding intensity (livestock). Technological development is assumed to be largely determined by exogenous factors. Technical progress is included in the models as biological technical progress in the yield functions of both crops and livestock. Rates of technical progress are estimated from historical data and, in general, show a decline over time. Mechanical technical progress is part of the function determining the level of harvested crop area and livestock husbandry.

Several factors in the BLS cause consumers and producers to adjust their behavior over time to political changes and altered economic and technological conditions. For consumers, responses are altered by the formation of taste and habit, and by changing prices and incomes. Producers are most affected by their past investment decisions, by technological innovations, or – as in this study – by changes in productivity due to climate change, increased atmospheric concentrations of CO<sub>2</sub>, and sulfur deposition.

Information generated in BLS simulations contains a variety of variables. At the world market level these include prices, net exports, global production, and consumption. At the country level the information generated varies in the different models, but generally includes the following variables: producer and retail prices; level of production; use of primary production factors (land, labor, and capital); intermediate input use (feed, fertilizer, and other chemicals); level of human consumption; stocks and net trade; GDP and investment by sector, population number, and labor force; welfare measures such as equivalent income; and the level of policy measures as determined by the government (e.g., taxes, tariffs). Here we focus on cereal production and demand, agricultural GDP, and world food commodity prices.

### **3.2. Linking BLS with 11R and MESSAGE III**

11R is an 11-region adaptation of the Global 2100 model (Manne and Richels, 1992). This model, in several variants, has been widely used for economic studies of the global implications of CO<sub>2</sub> reductions. 11R is a dynamic non-linear macroeconomic optimization model. Its objective function is the total discounted utility of a single representative producer-consumer. The maximization of this utility function determines trajectories of optimal savings, investment, and consumption decisions. Savings and investment drive the accumulation of capital stocks. Available labor (dependent on demographic change) and energy inputs determine the total output of the economy according to a nested constant elasticity of substitution (CES) production function. 11R generates internally consistent projections of global and regional GDP,

as well as trajectories of regional investment, labor, and primary energy consumption. A high degree of correspondence with the BLS in key variables for modeling the economy makes it feasible to harmonize the scenario analyses undertaken with the 11R and BLS models. One possible approach would have been to directly impose projections of GDP, labor, investment, and technological progress as exogenous inputs to the BLS. This alternative was dropped, however, as it would have constrained the BLS in an extremely rigid manner, in effect bypassing its representation of the interdependencies between the agriculture and nonagriculture sectors.

To keep these interdependencies intact, the approach chosen for linking the models was to harmonize the rates of economic growth generated in the BLS with those projected by 11R by adjusting production factors and assumed technical progress. Growth rates in the national models of the BLS are endogenously determined based on three elements: capital accumulation through investment and depreciation, related to a savings function that depends on lagged GDP levels as well as balance of trade and financial aid flows; dynamics of the labor force as a result of demographic changes; and (exogenous) technical progress. The 34 model components of the BLS were aggregated into 11 world regions matching the regionalization of 11R as closely as possible. The harmonization of production factors and GDP for the period 1990 to 2050 was then carried out on a region-by-region basis. Regional GDP and investment generated by 11R for the high CO<sub>2</sub> and SO<sub>2</sub> emissions scenario (HER) are shown in Table 1. Economic growth is highest (over 4%) in the developing regions. Developed regions grow by a little less than 2%. This model calibration resulted in a BLS reference scenario (BLS/REF3) specifically designed to derive projections of the world food system that are consistent with the basic economic assumptions used in 11R. As a benchmark run for comparing alternative energy policy scenarios, reference scenario BLS/REF3 assumes current climate and current levels of atmospheric CO<sub>2</sub> and SO<sub>2</sub> concentrations.

Another cornerstone of the integrated assessment exercise is MESSAGE III, a dynamic systems engineering optimization model used for medium- to long-term energy system planning and energy policy analysis. MESSAGE III uses a bottom-up approach to describe the full range of technological aspects of energy use, from resource extraction, conversion, transport, and distribution to the provision of energy end-use services. The model keeps a detailed account of pollutant emissions of CO<sub>2</sub> and SO<sub>2</sub>.

The emission projections arrived at by iteration over the 11R and MESSAGE III scenario runs are input to MAGICC (Hulme *et al.*, 1995), which



**Table 1.** Economic growth and investment in the 11R high CO<sub>2</sub> and SO<sub>2</sub> emissions energy scenario (HER).

	GDP			Growth rate (% p.a.)		Investment			Growth rate (% p.a.)	
	(billion 1990 US\$)			-2030	-2050	(billion 1990 US\$)			-2030	-2050
	1990	2030	2050			1990	2030	2050		
World	20,870	59,346	97,532	2.65	2.60	4,020	11,570	18,810	2.68	2.61
Developed	18,390	41,121	58,210	2.03	1.94	3,230	7,360	10,550	2.08	1.99
Developing	3,420	19,848	41,451	4.49	4.25	800	4,220	8,260	4.25	3.97

has been widely used for assessments reported by the Intergovernmental Panel on Climate Change (IPCC) (see IPCC, 1990, 1992, 1996). MAGICC accounts for the climate feedback due to CO<sub>2</sub> fertilization and for negative radiative forcing due to sulfate aerosols and stratospheric ozone depletion. Emissions are converted to atmospheric concentrations by gas models, and the concentrations are converted to radiative forcing potentials for each gas. The net radiative forcing is then computed and input into a simple upwelling-diffusion energy-balance climate model. This produces estimates of mean annual temperature for the Northern and Southern Hemispheres useful for impact studies (see Carter *et al.*, 1994). This study compares the results of a high CO<sub>2</sub> and SO<sub>2</sub> emissions scenario (HER) with the outputs from two alternative CO<sub>2</sub> and SO<sub>2</sub> emission abatement scenarios. These are the MIS (Mitigation Including Single-purpose options) and the MOM (Mitigation Only with Multi-purpose strategies) abatement scenarios. The global climate and emission characteristics of the three scenarios used in this study are shown in Table 2.

The HER scenario is purposely high in both CO<sub>2</sub> and sulfur emissions. The goal was to better understand possible interactions among strategies dealing with various aspects of energy development, and the HER scenario makes interactions between CO<sub>2</sub> abatement strategies and sulfur abatement strategies more visible than they might be in a low-emission scenario.

The two low-emission scenarios take advantage of MESSAGE III's ability to optimize the energy structure in response to sulfur emission limits. The first abatement scenario, MIS, uses all opportunities to reduce sulfur, from the addition of specific mitigation technologies to the redesigning of some parts of the energy system. The second abatement scenario, MOM, relies exclusively on emission reductions from the redesigning of the energy system. Technologies whose single purpose is sulfur abatement are not used.

**Table 2.** Climate and emission characteristics of three energy scenarios.

Scenario	1990	2010	2030	2050	2100
<b>HER</b>					
Temperature change (°C)					
North	0	0.23	0.48	0.83	1.87
South	0	0.34	0.75	1.24	2.60
Global	0	0.30	0.65	1.07	2.34
CO <sub>2</sub> concentration (ppmv)	355	398	458	538	810
SO <sub>2</sub> emissions (Mty <sup>-1</sup> )	142	198	272	348	498
<b>MOM</b>					
Temperature change (°C)					
North	0	0.54	1.00	1.50	2.71
South	0	0.41	0.82	1.28	2.47
Global	0	0.43	0.85	1.30	2.50
CO <sub>2</sub> concentration (ppmv)	355	391	425	474	622
SO <sub>2</sub> emissions (Mty <sup>-1</sup> )	142	100	80	72	76
<b>MIS</b>					
Temperature change (°C)					
North	0	0.59	1.11	1.60	2.88
South	0	0.44	0.89	1.37	2.64
Global	0	0.47	0.93	1.39	2.67
CO <sub>2</sub> concentration (ppmv)	355	395	434	488	656
SO <sub>2</sub> emissions (Mty <sup>-1</sup> )	142	92	68	72	76

### 3.3. Temperature and CO<sub>2</sub> effects on crop yields

A projection of global temperature change only, as calculated by MAGICC, provides insufficient information to assess the impact of climate change on agriculture. Therefore, we employed geographically detailed information generated within earlier climate impact studies to estimate regional crop yield changes for the three scenarios (see Rosenzweig and Parry, 1994; Rosenzweig and Iglesias, 1994; Fischer *et al.*, 1994, 1996; Rosenzweig *et al.*, 1995; Strzepek and Smith, 1995; IBSNAT, 1989).

The original yield change estimates referred to well-defined conditions of climate and CO<sub>2</sub> concentrations according to the results of doubled-CO<sub>2</sub> simulations of three general circulation models (GCMs) (Table 3): GISS, Goddard Institute for Space Studies (Hansen *et al.*, 1983); GFDL, Geophysical Fluid Dynamics Laboratory (Manabe and Wetherald, 1987); and UKMO, United Kingdom Meteorological Office (Wilson and Mitchell, 1987).

The simulated temperature changes of these GCM scenarios (+4°C to +5.2°C) are at or above the upper end of the range (+1.5°C to +4.5°C)

**Table 3.** GCM climate change scenarios.

GCM	Year <sup>a</sup>	Resolution (lat.×long.)	CO <sub>2</sub> level (ppmv)	Change in average global temp.(°C)    precip.(%)	
GISS	1982	7.83°×10°	630	4.2	11
GFDL	1988	4.4°×7.5°	600	4.0	8
UKMO	1986	5.0°×7.5°	640	5.2	15

<sup>a</sup>Year GCM result was calculated.

projected for doubled-CO<sub>2</sub> warming by the IPCC<sup>4</sup> (IPCC, 1996). Due to the lack of negative radiative forcing by sulfate aerosols, the temperature changes generated in the GCM experiments are well above the temperature changes projected by MAGICC using the emission scenarios of the current study. For the crop modeling part of the original study (Rosenzweig and Parry, 1994), climate changes from doubled-CO<sub>2</sub> GCM simulations are utilized with an associated level of 555 ppmv CO<sub>2</sub>, slightly higher than the CO<sub>2</sub> levels occurring in the HER energy scenario (i.e., 538 ppmv in year 2050).

For the regional specification of crop yield impacts for the three energy scenarios, we scale our previous results calculated for the different GCM climate scenarios in the following manner. Let  $\Delta T_{GCM}$  denote the temperature change associated with any particular GCM experiment. The levels of atmospheric CO<sub>2</sub> for the control run (i.e., approximately the current levels) and for an effective doubling of greenhouse gases are indicated by  $C_{GCM}^0$  and  $C_{GCM}^{\Delta T}$ , respectively. Furthermore, let  $\Delta y_{GCM}^{t,j}$  denote the yield changes in region  $j$  of the BLS, and  $\Delta y_{GCM}^{c,j}$  be a vector of respective yield changes from CO<sub>2</sub> fertilization at CO<sub>2</sub> level  $C_{GCM}^{\Delta T}$ . These vectors of yield impacts can be derived from the agronomic results produced in the previous crop modeling study (Rosenzweig and Iglesias, 1994): (i) the vectors  $\Delta y_{GCM}^{t,j}$  of climate-change-induced yield effects are captured in the *climate change only* experiments, and (ii) vectors  $\Delta y_{GCM}^{c,j}$  can be calculated as the difference between *climate impacts with physiological effects of elevated CO<sub>2</sub>* and *climate change only* scenarios. For global climate conditions resulting from any particular energy scenario  $s$ , that is, a combination of projected temperature change and increase of CO<sub>2</sub> concentration ( $\Delta t_s, \Delta c_s$ ), the effective yield impact is calculated by linear interpolation:

<sup>4</sup>Taking into account the range in the estimate of climate sensitivity (1.5–4.5°C) and the full set of IS92 emission scenarios, the climate models used in the IPCC assessment project an increase in global mean temperature of between 0.9°C and 3.5°C by 2100.

$$\Delta y_{GCM}^j(\Delta t_s, \Delta c_s) = \Delta y_{GCM}^{t,j} \cdot \frac{\Delta t_s}{\Delta T_{GCM}} + \Delta y_{GCM}^{c,j} \cdot \frac{\Delta c_s}{c_{CGM}^T - c_{GCM}^0} . \quad (1)$$

The respective changes in global temperature and the level of CO<sub>2</sub> concentrations for the high CO<sub>2</sub> and SO<sub>2</sub> emissions scenario (HER) and the two alternative abatement scenarios (MOM and MIS) are taken from Table 2. Temperature changes were applied separately for the Northern and Southern Hemispheres as calculated in MAGICC. This approach, which mixes equilibrium climate and transient CO<sub>2</sub> projections, is the best available given the lack of GCM transient climate change simulations consistent with the assumed emission scenarios.

### 3.4. Effects of SO<sub>2</sub> on crop yields

Quantification of the effects of SO<sub>2</sub> on crop yields requires the estimation of regional SO<sub>2</sub> deposition and crop damage. RAINS is a modular simulation system originally designed for integrated assessment of alternative strategies to reduce acid deposition in Europe (Alcamo *et al.*, 1990). The model quantifies sulfur emissions from given activity levels in the energy sector, both production and end uses; traces the fate of these emissions using atmospheric transport and chemical transformation models; calculates the amount of sulfur deposition; and estimates the impacts of the emissions on soils and ecosystems. RAINS generates results in a geographically explicit manner on a grid of 1° latitude × 1° longitude. To parameterize the crop yield damage caused by dry deposition of SO<sub>2</sub>, the gridded estimates of sulfur deposition and SO<sub>2</sub> concentrations for South and Southeast Asia projected by RAINS-Asia<sup>5</sup> were evaluated using a linear damage function:

$$\Delta y_s^j(x) = - \max \left( 0, \frac{e(x) - 30}{2.67} 0.01 \right) , \quad (2)$$

where  $x$  is the geographic location (i.e., pixel of 1° latitude × 1° longitude);  $e(x)$  is the mean annual SO<sub>2</sub> concentration in  $\mu\text{gm}^{-3}$  at location  $x$ ; and  $\Delta y_s^j(x)$  is the yield change caused by SO<sub>2</sub> at mean annual concentration of  $e(x)$ .

From Section 2 we know that quantifying SO<sub>2</sub> impacts on crops is difficult and controversial. Nevertheless, it was decided to attempt to quantify

---

<sup>5</sup>Results of RAINS are available for Europe and for South and Southeast Asia. Spatially disaggregated estimates of sulfur deposition were not available for other regions.

possible crop damage from dry deposition in the BLS runs, because omitting these effects would have created an unacceptable bias in the assessment. However, there is great uncertainty as to the magnitude of the possible SO<sub>2</sub> damage to crops.

We use an SO<sub>2</sub> concentration threshold of 30 μgm<sup>-3</sup>, as established for Europe (see Ashmore and Wilson, 1993). In accordance with experiments cited in Fitter and Hay (1987) and Conway and Pretty (1991), we have adopted the assumption that crop yield damage increases linearly when SO<sub>2</sub> concentration levels exceed the threshold such that yield is reduced by 10% for each 10 ppbv (i.e., each 10 ppbv ≅ 26.7 μgm<sup>-3</sup>) increase of mean annual SO<sub>2</sub> concentrations beyond the critical level.

The estimates of crop damage by grid-cell were then aggregated for the main agricultural areas of major countries in the study region of RAINS-Asia (e.g., China, India, Pakistan, etc.). In addition to South and Southeast Asia (CPA, PAS, and SAS regions<sup>6</sup>), estimates of crop damage from SO<sub>2</sub> deposition were also included for the former Soviet Union (FSU) and North America (NAM) using the regional trajectories of sulfur emissions calculated by MESSAGE III in the HER energy scenario. Consequently, the yield impact equation (1) discussed above was amended to include a term accounting for SO<sub>2</sub> damage:

$$\begin{aligned} \Delta y_{GCM}^j(\Delta t_s, \Delta c_s, e_s) = & \Delta y_{GCM}^{t,j} \cdot \frac{\Delta t_s}{\Delta T_{GCM}} + \Delta y_{GCM}^{c,j} \cdot \frac{\Delta c_s}{c_{GCM}^T - c_{GCM}^0} \\ & + \Delta y_s^{s,j}(e_s) . \end{aligned} \quad (3)$$

### 3.5. Scenario analysis with the BLS

The evaluation of the potential impacts of alternative future CO<sub>2</sub> and SO<sub>2</sub> emissions on production and trade of agricultural commodities is carried out by comparing the results of corresponding climate change scenarios with a reference projection, scenario BLS/REF3. The reference scenario represents a future with current climate and atmospheric conditions and the continuation of current economic, population, and technology growth rates. The basic assumptions of the reference and three CO<sub>2</sub> emission abatement scenarios are described in Table 4.

Data on crop yield changes were estimated for different scenarios of climate change and increases of atmospheric CO<sub>2</sub> and SO<sub>2</sub> concentrations,

---

<sup>6</sup>The mapping from BLS components to aggregate world regions is given in the Appendix.

**Table 4.** BLS scenarios analyzed in the study.

Scenario	Scenario characteristics
BLS/REF3	Reference scenario: UN 1992 medium-growth population scenario; economic growth by region calibrated through adjustment of production factor dynamics to approximately match growth characteristics of 11R results in high-emission energy scenario; agricultural protection is reduced by 50% between 1990 and 2020; climate and levels of CO <sub>2</sub> and SO <sub>2</sub> concentrations remain at base-year level.
HER	High-emission scenario: same basic assumptions as in BLS/REF3; yield changes parameterized according to temperature changes and increases in CO <sub>2</sub> and SO <sub>2</sub> levels (see Table 10) derived from emissions in high-emission energy scenario using MAGICC and RAINS-Asia and scaling yield impacts calculated in EPA climate impact study; spatial pattern of climate change derived from doubled-CO <sub>2</sub> GCM experiments using results published for GISS, GFDL, and UKMO general circulation models.
MOM	Abatement variant 1: same basic assumptions as in BLS/REF3; yield changes parameterized according to temperature changes and increases in CO <sub>2</sub> levels (see Table 10) derived from emissions in an energy scenario that implements mitigation through abatement measures according to multipurpose strategies using MAGICC and scaling yield impacts calculated in EPA climate impact study; spatial pattern of climate change derived from doubled-CO <sub>2</sub> GCM experiments using results published for GISS, GFDL, and UKMO general circulation models.
MIS	Abatement variant 2: same basic assumptions as in BLS/REF3; yield changes parameterized according to temperature changes and increases in CO <sub>2</sub> levels (see Table 10) derived from emissions in an energy scenario that implements mitigation through abatement measures according to single-purpose (i.e., SO <sub>2</sub> mitigation) options using MAGICC and scaling yield impacts calculated in EPA climate impact study; spatial pattern of climate change derived from doubled-CO <sub>2</sub> GCM experiments using results published for GISS, GFDL, and UKMO general circulation models.

based on the emissions resulting from three alternative emission scenarios. Data were compiled for each of the 34 regional or national components representing the world in the BLS. Yield variations caused by climate change, CO<sub>2</sub> fertilization, and sulfur deposition were introduced into the yield response functions of the BLS country models by means of a multiplicative factor [see equation (3)] impacting on the relevant parameters in the mathematical representation. This approach implies that both average and marginal fertilizer productivity are affected by the imposed yield changes. Therefore, changes in yield obtained in simulations with the BLS that include economic adaptation will deviate somewhat from productivity changes derived from crop modeling results, because input levels adjust accordingly.

It is uncertain to what extent the positive physiological effects of CO<sub>2</sub> observed in crop experiments will materialize in farmers' fields (e.g., see FAO, 1994), and to what extent negative impacts from climate change can be mitigated by farmers' adaptation to changing conditions. Thus, we tested two variants of our BLS scenarios in order to examine the robustness of our results given our optimistic specification of CO<sub>2</sub> fertilization effects based on agronomic experiments (Rosenzweig and Iglesias, 1994) and the potential for farmer adaptation to yield changes. In scenario variant V1, we assume that the effect on farmers' fields will be only two-thirds of the beneficial impacts of increased CO<sub>2</sub> levels derived from crop experiments. Scenario variant V2 assumes that only two-thirds of both climate and CO<sub>2</sub> effects materialize under open field conditions, assuming that farmers act to minimize yield damage.

Finally, we include the cost of abatement's potential to affect capital accumulation for agricultural and other sectoral investment (scenarios V1b and V2b). Additional investment required for emission abatement is determined by MESSAGE III. The results, calculated by world region, were input to the BLS as percentages of GDP used for additional energy investment (and thus not available for other purposes). The underlying idea is that additional investment requirements for CO<sub>2</sub> and SO<sub>2</sub> emissions abatement will also affect capital accumulation in other sectors, including agriculture. Averaged over decades, the global investment required in scenarios MOM and MIS is about 0.5% of GDP. The investment requirements differ significantly between developed and developing regions. The following investment coefficients, that is, the percentages of GDP required for investing in abatement, were used in the V1b and V2b BLS simulation runs: 0.1% North America (NAM), 0.05% Western Europe and other developed countries (WEU&ODE), 0.10% Pacific OECD countries (PAO), 1.2% Africa (AFR), 0.6% Latin America (LAM),

**Table 5.** Global agriculture production in BLS/REF3 reference scenario.<sup>a</sup>

	Production level			Growth (% p.a.)	
	1990	2030	2050	1990	1990
				-2030	-2050
Wheat	560	897	1037	1.2	1.0
Rice, milled	345	605	706	1.4	1.2
Coarse grains	912	1476	1685	1.2	1.0
Agriculture	377	659	784	1.4	1.2

<sup>a</sup>Units of measurement: wheat, rice (milled equivalent), coarse grains in million tons; agriculture production in billion 1970 US dollars. In addition, the BLS also includes the following commodity groups: bovine and ovine meat, dairy products, other animal products, protein feed, other food products, and nonfood products.

0.6% Western Asia (WAS), 0.8% South Asia (SAS), 1.0% centrally planned Asia (CPA), and 0.85% Pacific Asia, developing countries (PAS).

#### 4. The Agriculture Sector in the BLS/REF3 Reference Scenario

The reference scenario BLS/REF3 is a long-term projection of agricultural supply, demand, and trade that serves as a neutral point of departure for studying potential impacts of alternative emissions scenarios on productivity changes in agriculture. The reference scenario adopts the economic growth patterns calculated by the energy model 11R according to the assumptions in the high-emissions (unabated) energy scenario (HER). We discuss here the characteristics of the reference scenario BLS/REF3 for comparison with the impacts of the CO<sub>2</sub> and SO<sub>2</sub> emissions abatement scenarios. BLS/REF3 represents a future in which current climate conditions prevail.

Effective demand for food grows substantially, because of higher incomes and larger populations. This increase in demand is met at somewhat decreasing world market prices for agricultural products, consistent with historical trends. Table 5 shows global production of agricultural commodities in the BLS/REF3 scenario. Average annual growth rates of production during the period 1990 to 2050 (and hence effective demand) for agricultural commodities range between 1.0% and 1.2% per annum, implying a 1.8- to 2.2-fold increase compared with 1990 levels. Gross agricultural production<sup>7</sup> increases on average 1.2% per annum, that is, by the year 2050 it reaches about 2.1

<sup>7</sup>Gross agricultural production, labeled *Agriculture* in Table 5, is calculated at constant 1970 world market prices.



**Table 6.** Population in BLS/REF3 reference scenario.

	Population (bln. people)			Growth rate (% p.a.)	
	1990	2030	2050	1990-2030	1990-2050
World	5.2	8.7	9.9	1.3	1.0
Developed	1.3	1.5	1.5	0.4	0.2
Developing	3.9	7.2	8.4	1.5	1.1

**Table 7.** Cereal production in BLS/REF3 reference scenario.

	Total production (mln. tons)			Production per capita (kg)		
	1990	2030	2050	1990	2030	2050
World	1,818	2,977	3,428	350	344	348
Developed <sup>a</sup>	962	1,327	1,448	759	899	984
Developing	855	1,650	1,979	218	230	236

<sup>a</sup>Because the *Rest of the world* region (containing both developed and developing countries) is included here with the developed region the figures for cereal production and demand are somewhat higher than shown in the statistics and values for the developing region are somewhat lower (see Appendix). Rice is included in milled equivalent, that is, a conversion factor of 0.667 is applied to paddy rice.

times the 1990 level. This compares favorably with the projected average population increase of about 1.0% annually during the 60-year period from 1990 to 2050 (Table 6).

Global cereal production in 1989–1991 is estimated in the BLS to amount to 1.8 billion tons (note that rice is included in milled form). Production is projected to increase to about 3.0 billion tons by the year 2030 and to some 3.4 billion tons by the year 2050, implying an average annual increase of 1.1% over a period of 60 years (Table 7). This increase slightly exceeds the projected population growth. The share of developed countries (plus “Rest of the world”) in global production of cereals is projected to decline steadily between 1990 and 2050, from 53% to 42% by the end of the simulation period. Over the same period the share of developed countries in the global demand of cereals declines from 49% in 1990 to 33% in 2050, resulting in an increased net flow of cereals into developing countries (Table 8).

## 5. Static Yield Impacts

The individual yield impact components of climate, CO<sub>2</sub> fertilization, and SO<sub>2</sub> damage, and the resulting net impact for each energy scenario at global and broad regional levels are listed in Table 9. The net yield change is a measure of distortion known as the static yield impact, because it describes

**Table 8.** Cereal demand in BLS/REF3 reference scenario.

	Total demand (mln. tons)			Demand per capita (kg)		
	1990	2030	2050	1990	2030	2050
World	1,818	2,977	3,428	350	344	348
Developed	866	1079	1129	683	731	767
Developing	952	1899	2296	242	264	274

**Table 9.** Static impact on crop productivity in 2050 under GISS climate assumptions (% change).

	Impact of	Cereals		
		World	Developed	Developing
HER	Climate	-5.8	-3.0	-7.9
	CO <sub>2</sub>	13.8	13.3	14.2
	SO <sub>2</sub>	-6.7	-7.2	-6.4
	Net total	1.3	3.2	-0.1
MOM	Climate	-7.4	-5.2	-9.1
	CO <sub>2</sub>	9.0	8.7	9.2
	SO <sub>2</sub>	0.0	0.0	0.0
	Net total	1.6	3.5	0.1
MIS	Climate	-7.9	-5.5	-9.7
	CO <sub>2</sub>	10.0	9.7	10.3
	SO <sub>2</sub>	0.0	0.0	0.0
	Net total	2.1	4.2	0.6

a hypothetical effect of climate change without taking into account adjustments of the economic system. To obtain an estimate of the static climate change yield impact for any particular year  $\tau$ , say,  $\Lambda_s(\tau)$  for scenario  $s$ , we apply the estimated crop-wise yield changes,  $\lambda^j(s, \tau) = \Delta y_{GCM}^j[\Delta t_s(\tau), c_s(\tau)]$ , to the yield and production levels as observed in a BLS reference projection in year  $\tau$ . For cereals these impacts can be added up without weighting. To arrive at static impact estimates for other groups of crops and the entire sector, world market prices for year  $\tau$  as simulated in the respective reference projection are used. In mathematical notation,

$$\Lambda_s^R(\tau) = \left\{ \sum_{j \in R} \sum_{i \in C} P_{i\tau}^W \cdot Q_{i\tau}^j \cdot \lambda_i^j(s, \tau) \right\} / \left\{ \sum_{j \in R} \sum_{i \in C} P_{i\tau}^W \cdot Q_{i\tau}^j \right\}, \quad (4)$$

where  $\Lambda_s^R(\tau)$  is the static climate change yield impact of scenario  $s$  on region  $R$  in year  $\tau$ ;  $\lambda_i^j(s, \tau)$  is the climate change yield impact of scenario  $s$  for crop

**Table 10.** Dynamic impact on cereal production under alternative GCM variants in 2050 (% change).

	GISS			GFDL		
	HER	MOM	MIS	HER	MOM	MIS
World	0.8	0.9	1.2	0.3	0.3	0.5
Developed	5.2	4.9	5.5	3.5	2.5	2.9
Developing	-2.3	-2.0	-2.0	-2.0	-1.4	-1.3
	UKMO			AVERAGE		
	HER	MOM	MIS	HER	MOM	MIS
World	1.2	1.5	1.7	0.8	0.9	1.1
Developed	4.9	4.8	5.4	4.5	4.1	4.6
Developing	-1.5	-1.0	-1.0	-1.9	-1.5	-1.4

$i$  in country  $j$  in year  $\tau$ ;  $P_{i\tau}^W$  is the world market price of commodity  $i$  in year  $\tau$  of BLS/REF3 projection; and  $Q_{i\tau}^j$  is the production of commodity  $i$  in country  $j$  in year  $\tau$  of BLS/REF3 projection.

Climate effects on crop yields are uniformly negative, whereas CO<sub>2</sub> fertilization effects are positive. SO<sub>2</sub> effects are negative in the high-emissions scenario, but are mitigated in the abatement scenarios. Net static impacts of the emissions scenarios on world cereal yields are small, less than 3%, but tend to be more positive in developed countries.

## 6. Scenario Results

The dynamic impacts of the three emission scenarios on cereal production under alternative GCM regional distributions of temperature are shown in Table 10. The results take into account economic adjustments triggered by the changes in crop productivity. Although the CO<sub>2</sub> concentration is highest in the HER scenario, the projected temperature increase is less than in the abatement runs, MOM and MIS, because of lower radiative forcing caused by the high amount of aerosols. This combination of factors causes the smallest impacts on world cereal production. Because increased temperature, at least at an aggregate regional level, leads to negative yield impacts, and increased CO<sub>2</sub> leads to sizable positive yield impacts, the HER scenario would clearly be the best option for agriculture if one were to ignore possible damage from SO<sub>2</sub>. Even when taking SO<sub>2</sub> damage to crops into account, estimates of aggregate global crop productivity in the HER scenario are comparable with the estimates for the abatement cases. Overall, the global results are

**Table 11.** Regional impacts on agriculture sector GDP and cereal production in 2050 (% change relative to BLS/REF3) under GISS climate assumption.<sup>a</sup>

	Agricultural GDP			Cereals		
	HER	MOM	MIS	HER	MOM	MIS
World	1.9	1.3	1.6	0.8	0.9	1.2
Developed	4.6	5.3	5.8	5.2	4.9	5.5
Developing	1.0	0.0	0.2	-2.3	-2.0	-2.0
NAM	-3.7	-0.8	-1.1	-2.1	-0.1	-0.2
WEU+ODE	7.5	3.7	4.1	9.3	3.5	3.8
EEU+FSU	11.0	13.8	15.4	13.2	13.9	15.9
PAO	1.8	0.8	0.7	12.7	5.0	4.4
AFR	4.3	0.1	0.4	-1.4	-5.5	-5.8
LAM	0.1	-3.6	-3.9	-8.2	-11.7	-12.7
WAS	5.4	-0.1	0.1	6.5	-1.5	-1.3
SAS	1.8	1.0	1.3	0.2	-0.8	-0.6
CPA	-2.5	1.8	2.1	-4.6	1.9	2.4
PAS	-1.8	-1.9	-1.8	0.4	-1.4	-1.4

<sup>a</sup>See Table 4 for an explanation of acronyms and scenario variants.

similar across the climate impacts derived from GISS, GFDL, and UKMO doubled-CO<sub>2</sub> GCM runs.<sup>8</sup>

However, although world impacts are small, abatement to avoid damage from SO<sub>2</sub> pollution clearly matters to regional agricultural production and GDP (Table 11). Outcomes are more beneficial for developed regions than for developing countries. For both groups, however, the magnitude of the impacts falls into a fairly broad range, with the most positive results for the regions including the former Soviet Union (EEU&FSU), Pacific OECD countries (PAO), and Western Europe (WEU&ODE). The highest cereal production losses occur in Latin America (LAM) and Africa (AFR). Compared with the abatement scenarios, the HER scenario with high coal output has the potential for a downturn in the agricultural sectors of North America, the former Soviet Union, and China and other nations in Far East Asia.

The impact on world prices, on the other hand, is fairly moderate (Table 12). As a consequence of a modest increase in crop productivity relative to the reference scenario BLS/REF3, mainly due to the physiological effects of

<sup>8</sup>Although regional results according to different doubled-CO<sub>2</sub> GCM scenarios are in most cases compatible with regard to direction of change, there are some striking differences in the magnitude of the changes.

**Table 12.** Dynamic impact on world market prices in 2050 (% change compared with BLS/REF3).

	Price change		
	HER	MOM	MIS
Cereals	-15	-10	-12
Other crops	-24	-15	-17
All crops	-21	-13	-15
Agriculture	-15	-9	-11

**Table 13.** Regional impact on cereal production under GISS climate assumptions in runs V1 (lower CO<sub>2</sub> fertilization) and V2 (lower CO<sub>2</sub> fertilization and farmer adaptation) in 2050 (% change).

	V1			V2		
	HER	MOM	MIS	HER	MOM	MIS
World	-0.9	-0.2	-0.1	-0.3	0.6	0.7
Developed	3.1	3.6	4.0	2.5	3.3	3.7
Developing	-3.9	-3.0	-3.2	-2.3	-1.4	-1.4
NAM	-0.8	0.6	0.7	-1.7	0.0	0.0
WEU+ODE	7.9	2.6	2.8	7.6	2.5	2.6
EEU+FSU	4.2	8.3	9.4	4.5	9.1	10.4
PAO	18.2	8.5	8.8	14.6	3.5	3.2
AFR	-1.7	-5.7	-6.3	0.2	-3.9	-4.1
LAM	-4.1	-8.9	-9.8	-2.4	-8.0	-8.9
WAS	3.7	-3.8	-3.9	5.8	-0.9	-0.8
SAS	-2.3	-2.4	-2.5	-0.2	-0.6	-0.4
CPA	-7.8	-0.1	0.1	-7.0	1.3	1.6
PAS	-1.1	-2.2	-2.3	0.7	-0.9	-0.9

CO<sub>2</sub> on plants, prices of agricultural commodities are generally lower when considering changes in climate and the atmosphere. When assuming that the beneficial physiological effects of CO<sub>2</sub> in the open fields will on average be only two-thirds of the magnitude determined in crop experiments, the abatement scenarios become superior for agriculture (scenario variant V1; Table 13). In this variant, the global impact on cereal production is slightly negative, between -1% and 0%, and the regional impacts still vary widely, between -10% and +18%. These conclusions are further strengthened in scenario variant V2, where we assume that the climate effect will also be limited to two-thirds of the level determined in the crop experiments (a rough estimate of adaptation measures by farmers). In this case, the global

**Table 14.** Regional impact on cereal production under GISS climate assumptions in runs V1b and V2b, including the costs of CO<sub>2</sub> and SO<sub>2</sub> abatement in 2050 (% change).

	V1b			V2b		
	HER	MOM	MIS	HER	MOM	MIS
World	-0.9	-0.5	-0.4	-0.3	0.3	0.4
Developed	3.1	3.3	3.8	2.5	3.1	3.4
Developing	-3.9	-3.3	-3.5	-2.3	-1.7	-1.7
NAM	-0.8	0.5	0.7	-1.7	0.0	-0.1
WEU+ODE	7.9	2.6	2.8	7.6	2.4	2.6
EEU+FSU	4.2	7.6	8.7	4.5	8.4	9.7
PAO	18.2	8.4	8.7	14.6	3.5	3.0
AFR	-1.7	-6.5	-7.3	0.2	-4.7	-4.8
LAM	-4.1	-9.2	-10.1	-2.4	-8.3	-9.2
WAS	3.7	-4.2	-4.1	5.8	-1.2	-1.1
SAS	-2.3	-2.9	-2.9	-0.2	-1.0	-0.9
CPA	-7.8	-0.2	0.0	-7.0	1.2	1.5
PAS	-1.1	-2.5	-2.5	0.7	-1.1	-1.2

results tend to be positive, producing a net benefit in the order of less than +1% (see Table 13).

Finally, the dynamic impacts on crops taking the cost of abatement measures into account are shown in Table 14, referring to scenario variants V1b and V2b. There is, of course, no difference in results for the coal-intensive energy scenario HER between Table 13 and Table 14, as no additional investment is required. Earmarking additional energy investment requirements for abatement causes a small reduction of crop output and GDP of agriculture of about 0.3–0.4%.

## 7. Summary

The simulation experiments with the BLS, computed to analyze the impacts of alternative energy futures on agriculture, suggest a few general conclusions:

- The overall effects are limited due to moderate climate sensitivity and negative radiation forcing by sulfate aerosols.
- Productivity in agriculture at the aggregate global level increases in simulations for all three energy scenarios compared with present climate and

CO<sub>2</sub> concentration levels, mainly because of the positive physiological effects of increased CO<sub>2</sub> levels on crop performance.

- The aggregate impact for the group of developed countries is clearly positive in all simulated cases. The aggregate impact on developing countries is likely to be negative.
- Although there is relatively little difference between outcomes at the global level, regional results vary greatly between scenarios.
- In particular, regional impacts on agriculture of a coal-intensive high CO<sub>2</sub> and SO<sub>2</sub> emissions scenario could be substantial, especially in regions where agricultural production is located near industrial areas, as in China and India.

## 8. Discussion and Conclusions

World population is expected to almost double between 1990 and 2050 from 5 to about 10 billion people, which in turn will necessitate major increases in the level of economic activities, in energy consumption, and in food production. The analysis presented starts from economic projections that stipulate a more than 10-fold increase of GDP in developing regions between 1990 and the middle of the next century. Undoubtedly, such dramatic demographic and economic changes will put heavy demands on resources and will require the application of more efficient and environmentally benign technologies.

The costs of such environmentally benign technologies, however, are considerable. The projected differences in energy investments between abatement scenarios (both MOM and MIS) and the coal-intensive HER scenario amount to about 0.5% of global GDP (US\$ value), and more than 1% of GDP in East Asia (CPA region). It is justified, therefore, to carefully analyze the regional and global consequences of a failure to implement emission abatement in the energy sector.

When looking *only* at the projected climate and CO<sub>2</sub> effects of the three alternative energy and emission scenarios, conditions in the high-emissions scenario are more beneficial to agriculture than those in the abatement scenarios. This perhaps counterintuitive finding derives from the projected conditions, namely, that the high-emissions scenario produces the highest CO<sub>2</sub> level (a positive effect) and causes the least warming (a negative impact) of the three cases analyzed. Thus, global impacts on agriculture *alone*, and on the basis of the single pollutant taken into account here (i.e., SO<sub>2</sub>), do not seem to provide sufficient economic justification for abatement.

However, unlike the debate on climate change impacts where the regions mainly responsible for the increase in atmospheric CO<sub>2</sub> concentration may be different from those most affected by it, the damage caused by air pollution stays more closely within the region of origin, at least when analyzing the effects in terms of broader world regions. Hence, from a regional perspective, abatement appears to be foremost in the interest of the polluters themselves. Thus, emission abatement in terms of agricultural impacts is a regional issue much more than a global one. Furthermore, high levels of SO<sub>2</sub> emissions pose a number of environmental risks not included in this analysis. The detrimental impacts of airborne chemicals include human health effects, acidification of soils and water bodies, forest dieback, and damage to buildings and infrastructure. Whereas the cost of abatement measures is determined by rather well-specified investment requirements, the damage caused by SO<sub>2</sub> and related pollutants is complex, of multiple forms, and widespread.



**Appendix.** Aggregation of BLS country modules into world regions.

Economic group	Region	BLS component <sup>a</sup>
Developed	NAM	Canada, USA
	WEU+ODE	Austria, EC-9, Rest of the world <sup>b</sup>
	EEU+FSU	Eastern Europe & USSR
	PAO	Australia, Japan, New Zealand
Developing	AFR	Kenya, Nigeria, Africa Oil Exporters, Africa medium income/calorie exporters, Africa medium income/calorie importers, Africa low income/calorie exporters, Africa low income/calorie importers
	LAM	Argentina, Brazil, Mexico, Latin America high income/calorie exporters, Latin America high income/calorie importers, Latin America medium income
	WAS	Egypt, Turkey, Near East Asia oil exporters, Near East Asia medium-low income
	SAS	India, Pakistan, Asia low income
	CPA	China, Far East Asia high-medium income/calorie importers
	PAS	Indonesia, Thailand, Far East Asia high-medium income/calorie exporters

<sup>a</sup>For details of country grouping in the BLS, see Fischer *et al.* (1988).

<sup>b</sup>The main characteristics of the *Rest of the world* region derive from developed countries mainly in Europe; the region also includes some developed and developing countries in other parts of the world.

## References

- Alcamo, J., Shaw, R., and Hordijk, L. (eds.), 1990, *The RAINS Model of Acidification: Science and Strategies in Europe*, Kluwer, Dordrecht, Netherlands.
- Allen, L.H., Jr., 1990, Plant Responses to Rising Carbon Dioxide and Potential Interactions with Air Pollutants, *Journal of Environmental Quality* **19**:15–34.
- Amann, M., 1993, Transboundary Air Pollution: The RAINS Model, *Options*, Winter, International Institute for Applied Systems Analysis, Laxenburg, Austria.
- Amann, M., Cofala, J., Dörfner, P., Gyarmas, F., and Schöpp, W., 1995, Impacts of Energy Scenarios on Regional Acidification, in *Local and Regional Energy-Related Environmental Issues: Case Studies*, World Energy Council (WEC), London, UK.
- Ashmore, M.R., and Wilson, R.B. (eds.), 1993, *Critical Levels of Air Pollutants for Europe*, Creative Press, Reading, UK.
- Bell, J.N.B., 1993, A Reassessment of Critical Levels for SO<sub>2</sub>, in M.R. Ashmore and R.B. Wilson (eds.), *Critical Levels of Air Pollutants for Europe*, Creative Press, Reading, UK.
- Carter, T.R., Parry, M.L., Harasawa, H., and Nishioka, S., 1994, IPCC Technical Guidelines for Assessing Climate Change Impacts and Adaptations, Department of Geography, University College London, UK, and Center for Global Environmental Research, National Institute for Environmental Studies, Tsukuba, Japan.
- Chameides, W.L., Kasibhatla, P.S., Yienger, J., and Levy II, H., 1994, Growth of Continental-Scale Metro-Agro-Plexes, Regional Ozone Pollution, and World Food Production, *Science* **264**(5155):74–77.
- Cofala, J., and Dörfner, P., 1995, Constructing Regional Energy Scenarios from Global Energy Models, WP-95-112, International Institute for Applied Systems Analysis, Laxenburg, Austria.
- Conway, G.R., and Pretty, J.N., 1991, *Unwelcome Harvest: Agriculture and Pollution*, Earthscan, London, UK.
- FAO (Food and Agriculture Organization of the United Nations), 1994, *Global Climate Change and Agricultural Production: Highlights from an Expert Consultation*, FAO, Rome, Italy.
- Fischer, G., Frohberg, K., Keyzer, M.A., and Parikh, K.S., 1988, *Linked National Models: A Tool for International Policy Analysis*, Kluwer Academic Publishers, Netherlands.
- Fischer, G., Frohberg, K., Keyzer, M.A., Parikh, K.S., and Tims, W., 1991, *Hunger – Beyond the Reach of the Invisible Hand*, RR-91-15, International Institute for Applied Systems Analysis, Laxenburg, Austria.
- Fischer, G., Frohberg, K., Parry, M.L., and Rosenzweig, C., 1994, Climate Change and World Food Supply, Demand and Trade: Who Benefits, Who Loses? *Global Environmental Change* **1994** **4**(1):7–23.

- Fischer, G., Frohberg, K., Parry, M.L., and Rosenzweig, C., 1996, Impacts of Potential Climate Change on Global and Regional Food Production and Vulnerability, in E.T. Downing (ed.), *Climate Change and World Food Security*, Springer-Verlag, Berlin, Germany.
- Fitter, A.H., and Hay, R.K.M., 1987, *Environmental Physiology of Plants*, Academic Press, London, UK.
- Hansen, J., Russell, G., Rind, D., Stone, P., Lacis, A., Lebedeff, S., Ruedy, R., and Travis, L., 1983, Efficient Three-Dimensional Global Models for Climate Studies: Models I and II, *Monthly Weather Review* **111**(4):609–662.
- Hulme, M., Raper, S., and Wigley, T.M.L., 1995, An Integrated Framework to Address Climate Change (ESCAPE) and Further Development of the Global and Regional Climate Modules (MAGICC), *Energy Policy* **23**(4/5):347–356.
- International Benchmark Sites Network for Agrotechnology Transfer (IBSNAT) Project, 1989, Decision Support System for Agrotechnology Transfer Version 2.1 (DSSAT V2.1), Department of Agronomy and Soil Science, College of Tropical Agriculture and Human Resources, University of Hawaii, Honolulu, HI, USA.
- IPCC (Intergovernmental Panel on Climate Change), 1990, *Climate Change: The IPCC Scientific Assessment*, J.T. Houghton, G.J. Jenkins, and J.J. Ephraums (eds.), IPCC, Cambridge University Press, Cambridge, UK.
- IPCC (Intergovernmental Panel on Climate Change), 1992, *Climate Change 1992: The Supplementary Report to the IPCC Scientific Assessment*, J.T. Houghton, B.A. Callander, and S.K. Varney (eds.), Cambridge University Press, Cambridge, UK.
- IPCC (Intergovernmental Panel on Climate Change), 1996, *Climate Change 1995: The Science of Climate Change*, J.T. Houghton, L.G. Meira Filho, B.A. Callander, N. Harris, A. Kattenberg, K. Maskell (eds.), Contribution of Working Group I to the Second Assessment Report of the Intergovernmental Panel on Climate Change, Cambridge University Press, Cambridge, UK.
- Manabe, S., and Wetherald, R.T., 1987, Large-scale Changes in Soil Wetness Induced by an Increase in CO<sub>2</sub>, *Journal of Atmospheric Sciences* **44**:1211–1235.
- Manne, A., and Richels, R., 1992, *Buying Greenhouse Insurance: The Economic Costs of CO<sub>2</sub> Emission Limits*, MIT Press, Cambridge, MA, USA.
- Messner, S., and Strubegger, M., 1995, User's guide for MESSAGE III, WP-95-69, International Institute for Applied Systems Analysis, Laxenburg, Austria.
- Parikh, K.S., Fischer, G., Frohberg, K., and Gulbrandsen, O., 1988, *Toward Free Trade in Agriculture*, Martinus Nijhoff, The Hague, Netherlands.
- Roberts, T.M., 1984, Long-term Effects of Sulphur Dioxide on Crops: An Analysis of Dose-Response Relations, *Phil. Trans. R. Soc. Lond.* **B 305**:299–316.
- Rosenzweig, C., and Parry, M.L., 1994, Potential Impacts of Climate Change on World Food Supply, *Nature* **367**:133–138.
- Rosenzweig, C., and Iglesias, A., (eds.), 1994, *Implications of Climate Change for International Agriculture: Crop Modeling Study*, United States Environmental Protection Agency, Office of Policy, Planning and Evaluation, Washington, DC, USA.

- Rosenzweig, C., Allen, L.H., Jr., Harper, L.A., Hollinger, S.E., and Jones, J.W. (eds.), 1995, *Climate Change and Agriculture: Analysis of Potential International Impacts*, *ASA Special Publication Number 59*, American Society of Agronomy, Madison, WI, USA.
- Sanders, G.E., 1993, Critical Levels for Agricultural Crops, in M.R. Ashmore, and R.B. Wilson (eds.), *Critical Levels of Air Pollutants for Europe*, Creative Press, Reading, UK.
- Strzepek, K.M., and Smith, J.B., (eds.), 1995, *As Climate Changes: International Impacts and Implications*, Cambridge University Press, Cambridge, UK.
- Wigley, T.M.L., and Raper, S.C.B., 1992, Implications for Climate and Sea Level of Revised IPCC Emissions Scenarios, *Nature* **357**(6376):293–300.
- Wilson, C.A., and Mitchell, J.F.B., 1987, A Doubled CO<sub>2</sub> Climate Sensitivity Experiment with a Global Climate Model Including a Simple Ocean, *Journal of Geophysical Research* **92**(13):315–343.

# PAGE95: An Updated Valuation of the Impacts of Global Warming

*Erica L. Plambeck and Chris Hope*  
Judge Institute of Management Studies  
University of Cambridge, UK

## Abstract

A vital measure for global warming policy is the marginal impact of a tonne of carbon emitted to the atmosphere. In economic terms, this value corresponds to the carbon tax level needed to internalize the externalities associated with climate change. This study re-evaluates the marginal impact of carbon dioxide (CO<sub>2</sub>) emissions in light of new scientific and economic understanding of the cooling effects of sulfate aerosols and ozone depletion, the regional distribution of global warming damage, nonlinearity in damage as a function of temperature rise, and the appropriate discount rate.

## 1. Introduction

Global warming policy must balance the cost of reducing greenhouse gas emissions now against potential damage from future climatic change. A vital and ongoing debate involves valuing the impacts of carbon dioxide (CO<sub>2</sub>) emissions to the atmosphere (Nordhaus, 1991; Cline, 1992; Fankhauser, 1993; Fankhauser, 1994b; Azar, 1994). One common measure is the marginal impact of a tonne of carbon emitted to the atmosphere. In economic terms, this value corresponds to the carbon tax level needed to internalize the externalities associated with climate change. However, the complexity of the global warming phenomenon and difficulties in representing the impacts of climatic change using a single monetary value make the marginal impact per tonne carbon (tC) a highly uncertain value. The range of estimates is large; most values lie between US\$5–25/tC (Fankhauser and Pearce, 1993).

Hope and Maul (1996) demonstrated that much of this disparity is explained by different assumptions about the effectiveness of adaptation to climate change, the background level of CO<sub>2</sub> emissions, economic growth rates, and the discount rate. Another key factor is the treatment of uncertainty.

One of the two models used by Hope and Maul, the Policy Analysis for the Greenhouse Effect (PAGE) model, was developed for use by European Union (EU) decision makers in 1991. Since then, scientific knowledge of the global warming problem and methods for impact valuation have developed greatly. For example, the sulfate aerosols produced by the burning of fossil fuel have been found to have a significant cooling effect. Chlorofluorocarbons (CFCs), once thought to be the most potent greenhouse gases, are now believed to have only a slight effect because they destroy ozone, itself a strong greenhouse gas. Case studies in various regions of the world have improved our ability to measure damage from global warming, and suggest that damage is likely to be a nonlinear function of temperature. The PAGE model was recently updated to reflect this information (Plambeck *et al.*, 1995). In this paper we use the updated PAGE model, PAGE95, to examine the effect of new scientific and economic knowledge on the predicted marginal impact per tonne of carbon, and take another look at the role of assumptions about the discount rate, economic growth rate, and the effectiveness of adaptation to climate change.

## 2. The PAGE95 Model

The PAGE integrated assessment model was developed in 1991 for use by EU decision makers (Hope *et al.*, 1993). An updated model version, PAGE95, accounts for recent developments in the science and economics of global warming (Plambeck *et al.*, 1995). Global warming policy decision variables are the level of greenhouse gas emissions over time and the degree of adaptation to climate change. For a specified global warming policy, PAGE95 estimates the cost of enacting that policy as well as the resulting climate change impacts, the focus of this paper.

PAGE95 contains equations that model

- Emissions of the primary greenhouse gases, CO<sub>2</sub> and methane. Chlorofluorocarbons (CFCs) and hydrochlorofluorocarbons (HCFCs), decision variables in the original PAGE model, have a reduced role in PAGE95. Although future emissions are limited by international agreements to protect the ozone layer, existing atmospheric concentrations are not expected to decline significantly in the next century. Therefore, PAGE95 models (H)CFCs as a small addition to background radiative forcing (small due to the cooling effect of ozone depletion).
- The greenhouse effect. Anthropogenic emissions of greenhouse gases exceed the rate of removal by chemical and biological processes and

accumulate in the atmosphere. The greenhouse gases trap heat in the atmosphere so that less of the incoming solar radiation is re-radiated to space. This increases radiative forcing, the net flux of energy to the earth. The earth's temperature rises very slowly as excess heat is transferred from the atmosphere to land and ocean.

- Cooling from sulfate aerosols. Sulfate aerosols result from fossil fuel combustion and are commonly known as the cause of acid rain. They also backscatter incoming solar radiation and interfere with cloud formation, producing a reduction in radiative forcing. This counteracts the greenhouse effect.
- Regional temperature effects. Unlike greenhouse gases, which remain in the atmosphere for decades and are globally mixed, sulfate aerosols have a very short atmospheric lifetime (about six days) and so tend to remain in the source region. Therefore, sulfate aerosol cooling is a regional phenomenon. For the eight world regions in PAGE95,<sup>1</sup> temperature rise is computed from the difference between global warming and regional sulfate aerosol cooling. Sulfate cooling is greatest in the more industrialized regions, and tends to decrease over time due to sulfur controls to prevent acid rain and negative health effects.
- Nonlinearity in the damage caused by global warming. Climatic change impacts are a polynomial function of regional temperature increase above some tolerable level of temperature change,  $(T - T_{tol})^n$ , where  $n$  is an uncertain input parameter.
- Regional economic growth. Impacts are evaluated in terms of an annual percentage loss of gross domestic product (GDP) in each region, for a maximum of two sectors – in this application defined as economic impacts and noneconomic (environmental and social) impacts.
- Adaptation to climate change. Investment in adaptive measures (e.g., the building of sea walls; development of drought-resistant crops) can increase the tolerable level of temperature change ( $T_{tol}$ ) before economic losses occur and also reduce the intensity of both noneconomic and economic impacts.

All aspects of the global warming problem are subject to profound uncertainty. To express the model results in terms of a single “best guess” could be dangerously misleading. Instead, policy should be informed by a range of possible outcomes. Therefore, PAGE95 represents more than 70 key

---

<sup>1</sup>The eight regions are China and Centrally Planned Asia, India and Southeast Asia, Latin America, Africa and the Middle East, Eastern Europe and the former Soviet Union, USA, EU, and Other OECD Nations.

input parameters by probability distributions. Random sampling is used to build up an approximate probability distribution for the model results. The comprehensive scope and probabilistic formulation of the model necessitate the simplest credible equations. These equations and the probability distributions for key input parameters are described in Plambeck *et al.* (1995) and Plambeck and Hope (1995).

### 3. Calculating Marginal Impacts

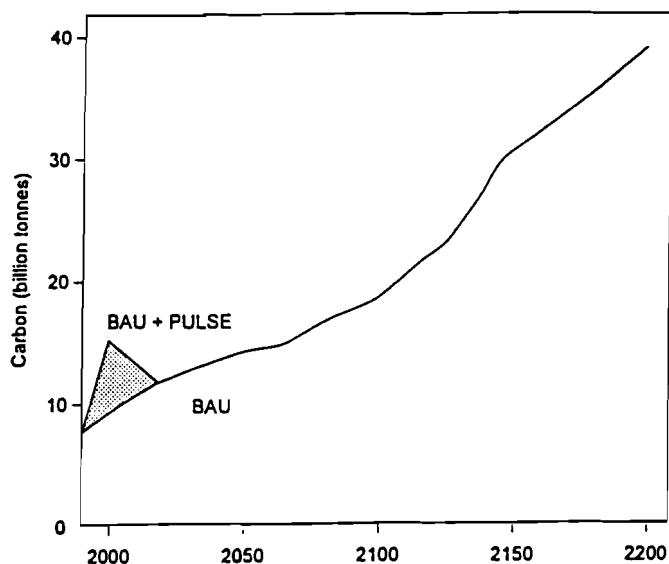
The marginal impact of a tonne of carbon emitted as CO<sub>2</sub> is computed by comparing the impacts of two policies that differ only by a “pulse” of carbon emissions. The impact of one tonne of carbon is too small to be detected. Human emissions of CO<sub>2</sub> are small compared with natural cycles, so the pulse must be large in human terms to produce a measurable effect. Even 1 billion tonnes (1 GtC, about 15% of annual world emissions), cannot be detected, and 10 GtC is at the limit of resolution of the PAGE95 model. For this study the policies are made to differ by a pulse of 100 GtC. The incremental impact of this pulse is then divided by 10<sup>11</sup> to give the valuation of impacts per tC. This procedure is taken from Hope and Maul (1996).

The structure of the PAGE95 model, designed to look at long-term policies, does not allow for an instantaneous pulse. Therefore the 100 Gt C pulse is emitted over the 30-year period from 1990–2020, peaking in 2000. Hope and Maul (1996) observe that, for a positive discount rate, this will produce a smaller impact valuation than an instantaneous pulse in the year 2000. For example, given an effective discount rate of 2%, the approximate levelizing factor is 0.77. However, the results in this paper are *not* modified by any levelizing factor. Spreading the pulse is reasonable given the long time scale required for policy to affect CO<sub>2</sub> emissions (e.g., a carbon tax leading to the replacement of inefficient fuel-burning equipment).

Hope and Maul (1996) used the original PAGE model to estimate the marginal impact per tonne of carbon emissions at US\$5, with a 90% range from US\$2–7/tC, based on the following assumptions:

- A horizon of 2200 for calculating impacts to allow for the long time lags in the natural systems. The impacts were aggregated and discounted back to the base year, 1990, at 5% per year; this rate reflects the opportunity cost of capital.
- Business-as-usual (BAU) emissions of CO<sub>2</sub>, methane, CFCs, and HCFCs based on Intergovernmental Panel on Climate Change (IPCC) Scenario





**Figure 1.** Carbon emissions by policy and year.

IS92a up to 2100. The second policy (BAU+PULSE) added the pulse of 100 GtC of CO<sub>2</sub> emissions to these BAU emissions, as shown in Figure 1.

- Economic impacts were taken to be in the range of 0.25–1.6% of GDP per °C per year, with a most likely value of 0.6% for all world regions. Noneconomic impacts were taken to be slightly lower than economic impacts to conform with the results found by Nordhaus in a poll of experts (Nordhaus, 1994). Both economic and noneconomic impacts grew as a linear function of temperature.
- Large amounts of adaptation in the developed world, such as the building of sea walls and the prevention of development in vulnerable areas, that eliminated economic impacts altogether for the first 2°C temperature rise, and reduced the remaining impacts by 90% after 50 years; in the developing world, adaptation reduced impacts by 50% after 50 years (CRU/ERL, 1992). In all regions, adaptation was less effective at reducing noneconomic impacts, bringing only a 25% reduction.
- A worldwide economic growth rate of 2% per year, implying that both the economic and noneconomic impacts of a 1°C temperature rise also grew at 2% per year before adaptation.

In a series of experiments in this paper, we examine the effect of successive updates to the PAGE model on the estimated marginal impact per

tonne of carbon emissions. This process culminates in the PAGE95 current best assessment of marginal impact. Subsequent experiments with PAGE95 explore the sensitivity of that result to assumptions about the discount rate and the degree of adaptation to climatic change.

### 3.1. The PAGE95 updated climate model

#### *Ozone Depletion*

The first experiment, CLIMATE, involves the PAGE95 updated climate model with cooling from ozone depletion and sulfate aerosols. All other aspects of the PAGE model remain as in Hope and Maul (1996). For more than 15 years it was thought that CFCs were the most potent greenhouse gases (Ramanathan, 1975). However, recent studies show that the radiative forcing effect of CFCs is counterbalanced by their destruction of stratospheric ozone, itself a greenhouse gas. For this reason CFCs have only a small net warming effect (Wigley and Raper, 1992). In PAGE95 net radiative forcing from all halocarbons, including CFCs, is taken to be  $0.2 \text{ W/m}^2$  for the period 1990–2080 and zero thereafter based on the latest scientific data (Daniel *et al.*, 1995). This change reduces the predicted level of global warming by as much as 10% by the year 2200.

#### *Sulfate Aerosols*

The more dramatic update is regional cooling from sulfate aerosols. Current research indicates that anthropogenic aerosols in the troposphere, notably, sulfate, have a significant cooling effect (Wigley, 1994; Charlson *et al.*, 1992; Taylor and Penner, 1994). Aerosols are produced primarily by metal smelting and the combustion of biomass and fossil fuels. These activities produce gases containing sulfur, carbon, and nitrogen, which are converted into aerosols (small, solid particles from  $10^{-3}$  to  $10^2 \mu\text{m}$  in radius) by chemical reactions in the atmosphere. The primary actor is sulfur dioxide ( $\text{SO}_2$ ) gas, which is oxidized to produce sulfate ( $\text{SO}_4^{++}$ ) aerosol, commonly known as a contributor to acid rain. Aerosols have been found to have a direct effect on climate by reflecting incoming sunlight, and an indirect effect involving cloud formation.

Aerosols absorb and backscatter solar radiation. This is commonly referred to as the direct cooling effect. In the absence of clouds, radiative forcing decreases as a linear function of tropospheric aerosol concentration. In this paper, we take the magnitude of the direct cooling effect to be in the range from  $-0.3$  to  $-0.9 \text{ W/m}^2$  in annual global mean forcing for present

concentrations, based on Jones *et al.* (1994), Charlson *et al.* (1992), Kiehl and Briegleb (1993), and Taylor and Penner (1994). This is not insignificant compared with the radiative forcing effect of anthropogenic greenhouse gases, estimated at 2 to 2.5 W/m<sup>2</sup> (IPCC, 1990).

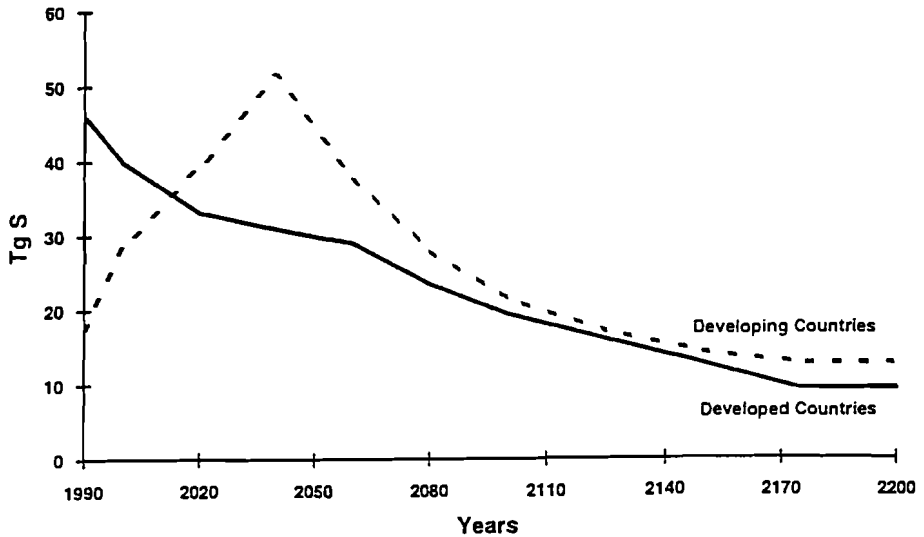
Aerosols also impact climate indirectly through cloud formation. Aerosols act as cloud condensing nuclei (CCN), increasing the overall volume of clouds. Clouds augment the albedo (reflectivity) of the atmosphere so that more incoming sunlight is reflected back into space (Langner and Rohde, 1991). Second, by increasing the concentration of CCN, aerosols reduce mean cloud droplet size. This interferes with rainfall and changes the distribution of clouds and water vapor. As water vapor is the primary greenhouse gas, this phenomenon will play a major role in climate change. The indirect effect of aerosols on radiative forcing is more difficult to quantify than the direct effect, because the complex interactions between aerosols, CCN, and cloud properties are poorly understood. The indirect effect might even constitute a net increase in radiative forcing (Charlson *et al.*, 1992). Using a version of the Hadley Centre GCM, Jones *et al.* (1994) estimate that the global annual mean of indirect radiative forcing is -1.3 W/m<sup>2</sup> for present concentrations. Based on these results, we take the indirect effect to be in the range from +0.2 to -2.4 W/m<sup>2</sup> of annual global mean forcing for present concentrations

Climate modelers are moving quickly to incorporate aerosols, “the missing forcing factor,” so that model results will reflect observed temperatures over the past century (Matthews, 1994). Aerosols can explain past overestimates of heating by GCMs (Hadley, 1995). Aerosols can also account for the previously inexplicable decrease of temperature in the Northern Hemisphere (in which more than 90% of industrial SO<sub>2</sub> is emitted) that has not occurred in the Southern Hemisphere (Wigley, 1989).

Unlike greenhouse gases such as CO<sub>2</sub>, which remains in the atmosphere for centuries, aerosols are rapidly removed from the atmosphere through precipitation or dry deposition. The average lifetime is only six days (Charlson *et al.*, 1992). As a result, the cooling effect of sulfate aerosols is concentrated in the source region. Greenhouse gases, which are uniformly mixed throughout the atmosphere, can be modeled as a simple additive component in mean global forcing, whereas modeling the effect of aerosols requires regional specificity. Therefore, PAGE95 computes regional temperature rise based on the change in radiative forcing from regional sulfur emissions.<sup>2</sup> Figure 2 shows

---

<sup>2</sup>The direct cooling effect is modeled as a linear reduction in radiative forcing as a function of anthropogenic sulfur flux for each region. The indirect effect on radiative



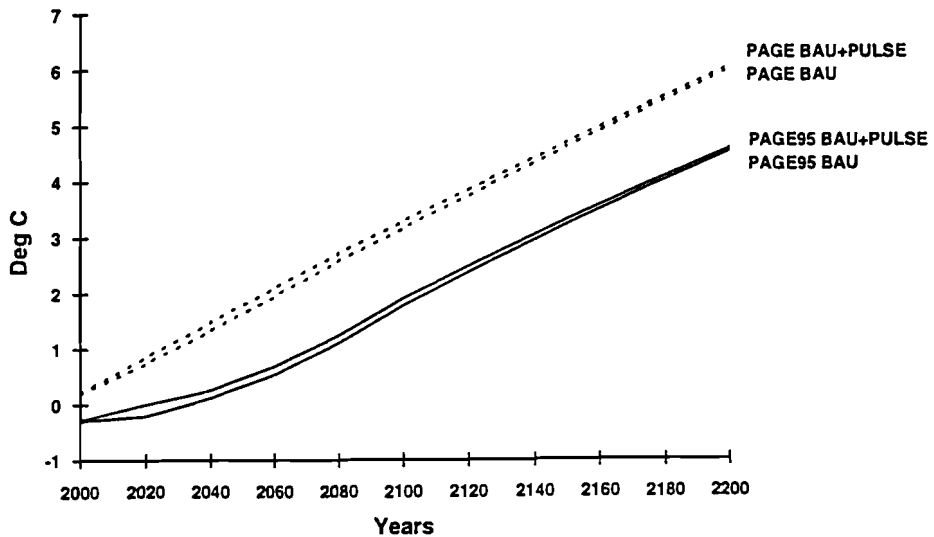
**Figure 2.** Annual emissions of sulfur for developing and developed countries, 1990–2200, in Tg of sulfur. Developed countries include the following PAGE95 regions: European Union, USA, other OECD Countries, Eastern Europe and the former Soviet Union. Developing countries include the following PAGE95 regions: China and Centrally Planned Asia, India and Southeast Asia, Africa and the Middle East, and Latin America. Sources: Spiro *et al.*, 1992; WEC, 1992; Ball and Dowlatabadi, 1994.

the projected sulfur emissions over time used in this paper. These are derived from Spiro *et al.* (1992); WEC (1992); Ball and Dowlatabadi (1994).

Figure 3 contrasts the temperature rise predicted by PAGE95 with the results from PAGE (Hope and Maul, 1996): for both policy scenarios the mean temperature rise predicted by PAGE95 is significantly lower than in PAGE. The difference is most important in the early years, when the sulfate cooling effect is greatest in proportion to greenhouse warming. Due to their short atmospheric lifetime, sulfate aerosols do not accumulate in the atmosphere over time as does CO<sub>2</sub>; sulfate aerosol cooling is roughly proportional to the *rate* of emission. Therefore the greenhouse effect will dominate in the long term unless sulfate aerosol emissions increase dramatically relative to the greenhouse gases, which is very unlikely. Fossil fuel combustion is the

---

forcing is modeled as a logarithmic function of the ratio of anthropogenic sulfur to the natural sulfur flux. Regional temperature rise is calculated from the difference between positive radiative forcing from the greenhouse effect and negative radiative forcing from aerosols, allowing for thermal lag.



**Figure 3.** Mean temperature rise ( $^{\circ}\text{C}$ ) in the CLIMATE experiment, by policy and year, 2000–2200. Pulse of 100 GtC emitted from 1990–2020. Source: Hope and Maul, 1996; and PAGE95 runs.

primary source of both sulfate aerosols and  $\text{CO}_2$  emissions, so the two are closely linked. However, unlike  $\text{CO}_2$ , sulfates can be removed from the exhaust stream. Particularly in wealthy countries, concerns about acid rain and health effects have prompted investment in sulfur control technologies. Decision makers are very unlikely to choose to increase sulfate emissions in order to combat global warming. As Figure 2 shows, we assume that aggregate world sulfate aerosol emissions decrease after 2040, causing the level of net radiative forcing in the two models to converge. However, as a result of the earth's thermal lag, temperatures in PAGE95 are still significantly lower through the year 2200.

The CLIMATE experiment computes the marginal impact per tonne of carbon emissions using the PAGE95 updated climate model with cooling from ozone depletion and sulfate aerosols. All other aspects of the PAGE model remain as in Hope and Maul (1996). Marginal impact results for the CLIMATE experiment appear in Table 1. Net present value of impacts refers to the sum of economic and noneconomic impacts through the year 2200, discounted and aggregated back to 1990. The columns “min” and “max” refer to the 5% and 95% points on the probability distribution of results. Recall that Hope and Maul (1996) estimated the marginal impact per tonne

**Table 1.** Total and marginal impacts in the CLIMATE experiment, 1990–2200.

	Min <sup>a</sup>	Mean	Max <sup>b</sup>
Net present value of impacts			
BAU + 100GtC emissions (US\$ trillion)	0.9	2.5	5.5
BAU emissions (US\$ trillion)	0.8	2.2	4.6
Marginal impacts (US\$/tC)	1.0	3.0	6.0

<sup>a</sup>Min = 5% point on distribution of results.

<sup>b</sup>Max = 95% point on distribution of results.

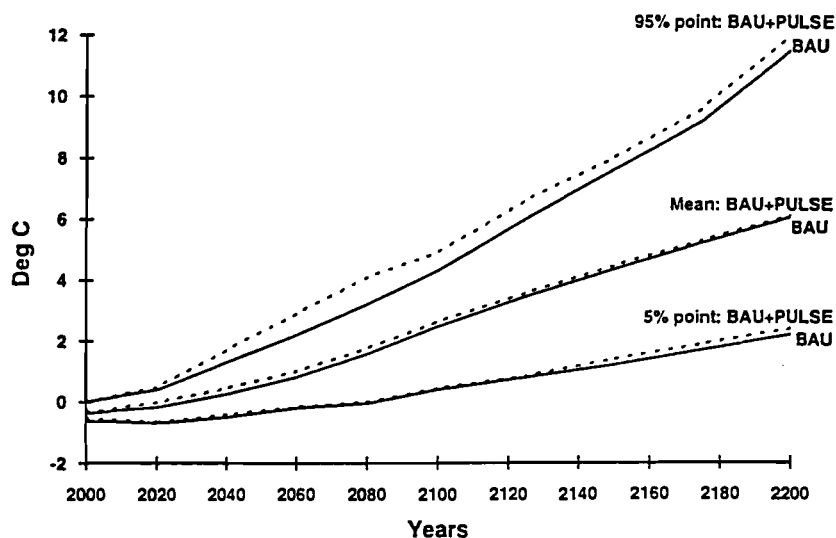
Source: PAGE95 runs.

of carbon emissions at US\$5, with a 90% range from US\$2–7/tC. The CLIMATE experiment suggests that the cooling effects of ozone depletion and sulfate aerosols decrease the estimated marginal impact per tonne of carbon by US\$1–2. This result is unsurprising. Natural and economic systems are thought to be robust; that is, impacts will not occur for sufficiently small or gradual increases in temperature. By depressing temperature, ozone depletion and sulfate aerosols are expected to reduce and delay the onset of impacts from the CO<sub>2</sub> pulse.

#### *Climate Sensitivity to Carbon Dioxide Concentration*

Nevertheless, the true implications of the scientific findings on aerosol cooling may be counterintuitive. Climate sensitivity to increased atmospheric CO<sub>2</sub> concentration is usually estimated from global circulation models (GCMs) calibrated to reproduce observed temperature trends over the past century. However, by leaving out a substantial cooling factor (sulfate aerosols) GCMs have probably underestimated climate sensitivity to CO<sub>2</sub>. Therefore, greenhouse warming is likely to be greater than was previously expected. As discussed previously, sulfate aerosol cooling will not significantly counteract greenhouse warming in the long term. Hence recent scientific findings on cooling from sulfate aerosols may actually increase the estimate of marginal impact per tonne carbon emissions.

The second experiment, CLIMATE2, investigates this possibility by also varying a key input parameter in PAGE: the equilibrium warming caused by a doubling of atmospheric CO<sub>2</sub> concentration ( $\Delta T_{2CO_2}$ ). Previous experiments in Hope and Maul (1996) and CLIMATE used the IPCC 1992 estimate of  $\Delta T_{2CO_2}$  in the range 1.5–4.0°C, with most likely value being 2.5°C. This figure was derived from GCMs without sulfate aerosol cooling; an increased value is appropriate for use in the PAGE95 climate model with



**Figure 4.** The 90% range and mean temperature rise ( $^{\circ}\text{C}$ ) above the 1990 level in the EU in the CLIMATE2 experiment, by policy and year, 2000–2200. Pulse of 100 GtC emitted from 1990–2020. Source: PAGE95 runs.

sulfate aerosols. In the CLIMATE2 experiment,  $\Delta T_{2CO_2}$  ranges between 1.5 and 6.0 $^{\circ}\text{C}$ , with most likely value being 3.0 $^{\circ}\text{C}$ . This increase in  $\Delta T_{2CO_2}$  is conservative. From the estimates of aerosol cooling in the forthcoming IPCC report, Raper *et al.* (1995) conclude that the value of  $\Delta T_{2CO_2}$  must be at least 4.5 $^{\circ}\text{C}$  to explain the observed temperature rise of 0.5 $^{\circ}\text{C}$  over the past century. West *et al.* (1995) recommend a range of 2.0–5.5 $^{\circ}\text{C}$ , with a best estimate of 3.5 $^{\circ}\text{C}$  for  $\Delta T_{2CO_2}$ . Figure 4 shows the 90% range and mean temperature rise predicted by PAGE95 with increased climate sensitivity for each policy. Note that the level of temperature increase is highly uncertain, and that the range of possible values is large compared with the difference between policies.

The marginal impact results for the CLIMATE2 experiment appear in Table 2. Increased climate sensitivity to atmospheric  $\text{CO}_2$  yields an estimated marginal impact of US\$5/tC, in agreement with Hope and Maul (1996) and 25% higher than in the previous experiment, CLIMATE. We observe that cooling from ozone depletion and sulfate aerosols reduces the estimated marginal impact per tonne carbon, but only if the temperature sensitivity to atmospheric  $\text{CO}_2$  is not adjusted. Clearly, the marginal impact valuation per tonne carbon may rise if, as suggested by Raper *et al.* (1995), climate sensitivity is even greater than assumed in CLIMATE2.

**Table 2.** Total and marginal impacts in the CLIMATE2 experiment, 1990–2200.

	Min <sup>a</sup>	Mean	Max <sup>b</sup>
Net present value of impacts			
BAU + 100GtC emissions (US\$ trillion)	1.1	3.7	8.4
BAU emissions (US\$ trillion)	0.9	3.2	7.2
Marginal impacts (US\$/tC)	2.0	5.0	12.0

<sup>a</sup>Min = 5% point on distribution of results.

<sup>b</sup>Max = 95% point on distribution of results.

Source: PAGE95 runs.

Expansion of the 90% range for the marginal impact per tonne carbon, from US\$2–7/tC in Hope and Maul (1996) to US\$2–12/tC, illustrates a very important point about recent scientific findings on aerosol cooling. The climate system is even more complex than was previously thought. Modelers must assess the strength of two competing phenomena, greenhouse warming and aerosol cooling, from the historical temperature record. Therefore, although the mean results have not changed, we can be far less certain of our calculations. The marginal impacts caused by a tonne of carbon emissions may be significantly larger than previous predictions.

### *Regional Differences in the Impacts of Climate Change*

In the third experiment, IMPACTS, PAGE95 is run as in CLIMATE2 with the addition of an updated valuation of the regional impacts of global warming. Much of the research on valuing the impacts of climate change has focused on the USA and other Organisation for Economic Co-operation and Development (OECD) countries (e.g., EPA, 1989; CRU/ERL, 1992). However, the level of damage from global warming is expected to vary widely among geographical regions. Different areas may be more or less vulnerable to climatic change. For example, heat stress and drought are expected to be most extreme in the interior of continents, while island nations and low lying coastal areas such as Bangladesh will suffer most from sea level rise. Impacts are expected to be relatively large in the less developed countries due to the relative importance of climate-dependent sectors such as agriculture. Furthermore, loss of life is likely to be proportionally greater in developing countries because of poor nutrition and health infrastructure. With limited financial reserves, developing countries have less capacity for adaptation. According to Fankhauser (1994c), damage to developing countries will be 50% higher than the OECD average. However, not all agree.



**Table 3.** Regional impact factors (compared with the EU) for the IMPACTS experiment.

Region	Regional impact factors		
	Minimum	Most likely	Maximum
USA	0.75	1.20	1.40
OECD except USA and EU	0.75	2.20	2.60
Former USSR and Eastern Europe	-0.30	0.00	0.30
China and Centrally Planned Asia	1.00	4.00	4.80
India and Southeast Asia	1.00	6.60	7.90
Africa and the Middle East	1.00	4.50	5.40
Latin America	1.00	3.30	4.00

Sources: Tol, 1995; Fankhauser, 1994b; CRU/ERL, 1992,

Manne *et al.* (1995) observe that willingness to pay to avoid noneconomic (ecological and social) damages from global warming increases with income. Therefore the valuation of noneconomic damages should be higher in the developed countries.

Most attempts to quantify damage have focused on the benchmark of a doubling of atmospheric CO<sub>2</sub> concentration and the associated temperature rise of 2.5°C (IPCC, 1990). PAGE95 has two uncertain input parameters representing the percentage of GDP loss per 2.5°C in the economic and noneconomic sectors. These values are estimated for the focus region, the EU. In terms of the percentage of GDP lost per 2.5°C, noneconomic impacts will range between 0.3 and 3.5, with the most likely value being 0.7; economic impacts will range between 0.3 and 1.5, with the most likely value being 0.6. Economic and noneconomic impacts in the other regions are computed as a multiple of the EU values. For example, percentage of GDP lost per 2.5°C in India and Southeast Asia is between 1 and 7.9 times the value for the EU, with the most likely value being 6.6. In some cases, benefits are expected to occur as a result of warming (e.g., agriculture in the former Soviet Union). This is represented by a negative value for GDP loss (see Table 3). This valuation of impacts derives from Tol (1995), Fankhauser (1994b), and CRU/ERL (1992).

The results of the IMPACTS experiment appear in Table 4. Updating the regional damage estimates yields a slight reduction in the estimated range of marginal impacts. However, the mean marginal impact increases to US\$8/tC in IMPACTS, compared with US\$5/tC in the CLIMATE2 experiment, primarily due to significant damage in the less developed countries.

**Table 4.** Total and marginal impacts in the IMPACTS experiment, 1990–2200.

	Min <sup>a</sup>	Mean	Max <sup>b</sup>
Net present value of impacts			
BAU + 100GtC emissions (US\$ trillion)	2.8	6.8	14.2
BAU emissions (US\$ trillion)	2.5	6.0	13.0
Marginal impacts (US\$/tC)	3.0	8.0	12.0

<sup>a</sup>Min = 5% point on distribution of results.

<sup>b</sup>Max = 95% point on distribution of results.

Source: PAGE95 runs.

**Table 5.** Total and marginal impacts in the NONLINEAR experiment, 1990–2200.

	Min <sup>a</sup>	Mean	Max <sup>b</sup>
Net present value of impacts			
BAU + 100GtC emissions (US\$ trillion)	1.8	6.7	16.7
BAU emissions (US\$ trillion)	1.2	5.9	14.9
Marginal impacts (US\$/tC)	6.0	8.0	18.0

<sup>a</sup>Min = 5% point on distribution of results.

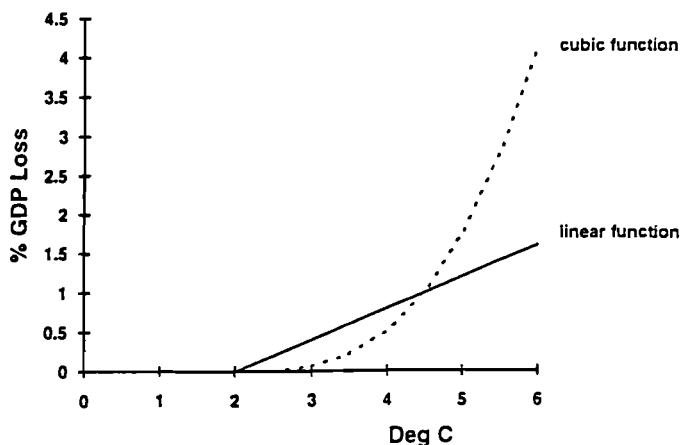
<sup>b</sup>Max = 95% point on distribution of results.

Source: PAGE95 runs.

### *Nonlinearity in Climatic Impacts*

We observed previously that most attempts to quantify the impacts of climate change focus on a benchmark warming of 2.5°C, yet this benchmark is likely to be surpassed within the next century. A current issue in policy analysis is how to extrapolate in order to predict damage before and after the benchmark of 2.5°C. Impacts are usually assumed to be a polynomial function of temperature rise with power between 1 and 3 (Nordhaus, 1993a, 1993b; Peck and Teisberg, 1993a, 1993b). A poll of experts suggests a power of 1.3 as the most likely value (Fankhauser, 1994b). In the fourth experiment, NONLINEAR, both economic and noneconomic impacts grow nonlinearly with temperature rise (recall that a linear model was used in the previous experiments). The impact function is a polynomial function of temperature rise above the tolerable level,  $(T - T_{tol})^n$ , where  $n$  is an uncertain input parameter with minimum of 1, maximum of 3, and most likely value of 1.3. The impact function is calibrated to give the same results as a linear function for a 2.5°C temperature rise.

The results for the NONLINEAR experiment appear in Table 5. For the range of emissions we examine, nonlinearity in the impact function does



**Figure 5.** Impacts by temperature rise and form of damage function (warming above the preindustrial level). Tolerable temperature rise before impacts occur is 2°C.

not change the estimated mean marginal impact of a tonne of carbon emissions. As shown in Figure 5, for a temperature rise above the tolerable level that is smaller than 2.5°C, the nonlinear damage function falls below the linear function. However, for a large temperature rise the nonlinear damage function dominates. In short, nonlinearity in the damage function decreases damage in the early years, but increases damage later. In the NONLINEAR experiment the net effect is slight. However, the introduction of an additional uncertain parameter to represent the curvature of the damage function yields an increase in the range of estimated marginal impacts.

#### *Regional Economic Growth and Time-Variable Discounting*

Previous experiments assumed a uniform, worldwide economic growth rate of 2% per year and a discount rate of 5%. The fifth experiment, REGIONAL, is distinguished from NONLINEAR by the use of time- and region-specific values for the economic growth rate taken from the Energy Modelling Forum (EMF, 1994). These values appear in Table 6. Furthermore, the discount rate is time variable and linked to economic growth (see Table 7).

In economic growth theory the discount rate,  $r(t)$ , is given by Ramsey's rule:

$$r(t) = y \cdot g(t) + p \quad ,$$

**Table 6.** Regional annual economic growth rates (in percent).

Years	EU, USA	Other OECD	Former USSR, Eastern Europe	China, Centrally Planned Asia	India, Southeast Asia, Africa
1990–2000	2.5	2.7	–1.5	4.0	3.8
1990–2020	2.3	2.3	4.3	3.5	4.2
1990–2040	1.5	1.5	3.6	3.3	3.6
1990–2060	1.7	1.7	2.7	3.1	3.1
1990–2080	1.2	1.2	2.0	3.0	2.8
1990–2100	1.1	1.1	2.0	3.0	2.8
1990–2125	1.1	1.1	1.0	2.0	2.0
1990–2150	0.8	0.8	1.0	2.0	2.0
1990–2200	0.8	0.8	0.8	1.0	1.0

Source: EMF, 1994.

**Table 7.** Time-variable discount rate,  $r(t)$ .

Years	1990–2000	2000–2020	2020–2040	2040–2060	2060–2080	2080–2150	2150–2200
$r(t)$	3.93	4.59	4.56	4.58	4.70	4.94	3.90

Source: World per capita economic growth rate + 3% time preference (EMF, 1994).

where  $y$  is the negative of the elasticity of marginal utility of consumption,  $p$  is the pure rate of time preference, and  $g(t)$  is the per capita relative growth rate of consumption. The term  $y \cdot g(t)$  is positive under the standard conditions that the economy grows, and that marginal utility is positive, but its derivative is negative (Azar, 1994, p. 1256). The value  $y$  is usually set to one, corresponding to a logarithmic utility function. The per capita relative growth rate of consumption may be computed as

$$g(t) = \frac{d(C/P)}{dt} / (C/P) ,$$

where  $C(t)$  is the global consumption, and  $P(t)$  the world population at time  $t$ . For experimental purposes in this study,  $g(t)$  is assumed to be equivalent to the worldwide per capita economic growth rate (i.e., consumption accounts for a fixed percentage of total production).

A time-variable discount rate should be used in climate change analysis because economic and population growth rates, and hence the value  $g(t)$ , are highly variable in the long term. In particular, economic growth rates will be affected by abatement policies and warming impacts. Nevertheless, to date most global warming analyses have used a fixed discount rate, the level

**Table 8.** Total and marginal impacts in the REGIONAL experiment, 1990–2200.

	Min <sup>a</sup>	Mean	Max <sup>b</sup>
Net present value of impacts			
BAU + 100GtC emissions (US\$ trillion)	5.0	19.8	45.5
BAU emissions (US\$ trillion)	4.0	17.7	40.7
Marginal impacts (US\$/tC)	10.0	21.0	48.0

<sup>a</sup>Min = 5% point on distribution of results.

<sup>b</sup>Max = 95% point on distribution of results.

Source: PAGE95 runs.

**Table 9.** Total and marginal impacts in the PTP2 experiment, 1990–2200.

	Min <sup>a</sup>	Mean	Max <sup>b</sup>
Net present value of impacts			
BAU + 100GtC emissions (US\$ trillion)	19.0	58.1	103.5
BAU emissions (US\$ trillion)	17.0	53.5	94.1
Marginal impacts (US\$/tC)	20.0	46.0	94.0

<sup>a</sup>Min = 5% point on distribution of results.

<sup>b</sup>Max = 95% point on distribution of results.

Source: PAGE95 runs.

of which strongly conditions the results (see Haraden, 1993; Fankhauser, 1994a)

The use of variable discounting based on economic and population growth rates still requires a difficult decision on the pure rate of time preference,  $p$ . The appropriate pure time preference for the study of global warming is hotly disputed. According to Azar (1994) and Cline (1992) the use of a positive pure time preference,  $p$ , is unethical because it implies that the utility of the current generation is worth more than that of future generations. However, only a positive rate is consistent with savings and interest rate data (Fankhauser, 1994b). Many global warming optimization models (Nordhaus, 1991, 1993a, 1993b; Peck and Teisberg, 1992, 1993a, 1993b; Manne *et al.*, 1993) use a 3% rate of pure time preference, and that value is also assumed in the REGIONAL experiment.

The results of the REGIONAL experiment appear in Table 8. These figures represent the PAGE95 current best estimate for marginal impacts. The extremely large increase in the valuation of marginal impacts, from a mean value of US\$8/tC in NONLINEAR to a mean value of US\$21/tC in REGIONAL, occurs because both economic growth and damage tend to be concentrated in the developing countries.

**Table 10.** Total and marginal impacts in the PTP0 experiment, 1990–2200.

	Min <sup>a</sup>	Mean	Max <sup>b</sup>
Net present value of impacts			
BAU + 100GtC emissions (US\$ trillion)	237.0	965.0	2156.0
BAU emissions (US\$ trillion)	198.0	921.0	2058.0
Marginal impacts (US\$/tC)	390.0	440.0	980.0

<sup>a</sup>Min = 5% point on distribution of results.

<sup>b</sup>Max = 95% point on distribution of results.

Source: PAGE95 runs.

**Table 11.** Total and marginal impacts in the NO-ADAPT experiment, 1990–2200.

	Min <sup>a</sup>	Mean	Max <sup>b</sup>
Net present value of impacts			
BAU + 100GtC emissions (US\$ trillion)	10.0	31.1	69.6
BAU emissions (US\$ trillion)	7.8	27.9	64.0
Marginal impacts (US\$/tC)	22.0	32.0	56.0

<sup>a</sup>Min = 5% point on distribution of results.

<sup>b</sup>Max = 95% point on distribution of results.

Source: PAGE95 runs.

The next two experiments, PTP2 and PTP0, are equivalent to REGIONAL except for the use of a pure rate of time preference  $p=2\%$  and  $p=0\%$ , respectively. The results of the experiments PTP2 and PTP0 appear in Tables 9 and 10. The mean value of impacts rises to US\$46 and US\$440, respectively. Clearly, the marginal impact per tonne of carbon emissions is highly sensitive to the choice of a pure rate of time preference. This is due to the long-term nature of the global warming problem. A pulse of CO<sub>2</sub> emissions affects the climate for many decades, if not centuries.

#### *Adaptation to Climatic Change*

The final experiment, NO-ADAPT, is the same as REGIONAL except that no adaptation is used to reduce the impacts of climate change. Results for the NO-ADAPT experiment appear in Table 11. Without adaptation the estimated marginal impact per tonne of carbon is US\$32/tC, an increase of US\$11/tC compared with the REGIONAL experiment, which assumed aggressive adaptation. In the literature, impact valuations are frequently made without stating assumptions on the degree of adaptation to climate change. The NO-ADAPT experiment demonstrates the need to clarify assumptions about adaptation in future work. Note that marginal impact estimates in

this study do not consider the cost of adaptive measures. This is justified because aggressive adaptation has been shown to be optimal for both policy scenarios considered in the study (Hope *et al.*, 1993). The cost of adaptation is slight compared with potential impacts from climate change. Furthermore, different policy levers are needed to influence adaptation and greenhouse gas abatement, so the incremental costs of adaptation and greenhouse gas emissions should be considered separately.

#### 4. Discussion and Conclusions

Our current best estimate of marginal impacts from PAGE95 is US\$21/tC, with a 90% uncertainty range of US\$10–48/tC. To put this measure into context, \$21/tC corresponds roughly to a petroleum tax of US\$2 per barrel, or a petrol tax of 1.2 cents per liter. Our estimate of the marginal impact of a tonne of carbon is based on the following key assumptions and inputs:

- An updated climate model with cooling from sulfate aerosols and ozone depletion, and increased climate sensitivity to atmospheric CO<sub>2</sub> concentration. Impacts grow as a nonlinear function of temperature.
- Noneconomic impacts are slightly greater than economic impacts and are also more uncertain. Expressed as a percentage GDP loss, both economic and noneconomic damages are largest in the developing countries. Economic growth is region and time specific. Since both climatic change impacts and economic growth tend to be concentrated in the developing countries, this increases the estimated marginal impact per tC.
- Large amounts of adaptation to climate change, such as the building of sea walls and the prevention of development in vulnerable areas, particularly in the developed world.
- A time-variable discount rate computed as the sum of world per capita economic growth and a pure rate of time preference of 3%.

This “best” marginal impact estimate is most sensitive to assumptions about adaptation, nonlinearity, and the discount rate. In the case of zero adaptation to climate change, marginal impacts rise by 50% to US\$32/tC. An important interaction effect was observed between the degree of adaptation and nonlinearity in damages as a function of temperature rise above some tolerable level. Recall that the net effect of nonlinearity in the damage function is slight under aggressive adaptation, because the decrease in predicted damage early in the time horizon is balanced by the increase in predicted damage later on. This trade-off is highly sensitive to the tolerable

level of temperature increase before damage occurs, which in turn depends on the degree of adaptation. For example, in the absence of adaptation, the tolerable level of temperature increase is assumed to be zero, as compared with 2°C for the developing countries under aggressive adaptation. Nonlinearity in the damage function makes a substantial contribution to the difference in marginal impacts under aggressive and zero adaptation. In a similar manner, nonlinearity in the damage function increases the importance of the discount rate.

The most influential assumption examined in this study is the discount rate. Reducing the pure rate of time preference component of the discount rate from 3% to 2% doubles the mean marginal impact to US\$46/tC. If a zero rate of pure time preference is chosen to satisfy intergenerational equity, then the mean marginal impact increases by an order of magnitude to \$440/tC.

In addition to the issue of intergenerational equity, the existence of *secondary benefits to CO<sub>2</sub> abatement* suggests that our best marginal impact estimate of US\$21/tC may be conservative, even though it is at the upper end of the range of estimates in the literature (US\$5–25/tC; Fankhauser and Pearce, 1993). Fossil fuels are the primary source, not only of CO<sub>2</sub>, but of other air pollutants – CO, SO<sub>x</sub>, NO<sub>x</sub>, particulates, and volatile organic compounds. Therefore, a carbon tax to reduce fossil fuel use will incur secondary benefits in improved air quality and reduced acid rain. Furthermore, recycling the carbon tax revenues to reduce other distortional taxes such as value-added taxes (VAT) or payroll taxes will stimulate employment and generally increase the social welfare (Barker *et al.*, 1993).

Finally, the 90% range for the marginal impact per tonne of carbon emissions found in this study, US\$10–48/tC, is very large in comparison to the uncertain range of US\$2–7 estimated in Hope and Maul (1996) or the accepted range of values in the literature, US\$5–25/tC. New scientific and economic knowledge, in particular about sulfate aerosols and nonlinearity in damage as a function of temperature rise, suggests that climate-human interactions are even more complex and difficult to predict than was previously thought. This increase in uncertainty is reflected in the results of our study.

In conclusion, in reading any study on the valuation of global warming impacts, policy makers are advised to carefully consider the treatment of uncertainty as well as assumptions about adaptation to climate change, nonlinearity in damage as a function of temperature rise, secondary benefits to CO<sub>2</sub> abatement, and the discount rate. We have shown that these assumptions, often hidden in the small print or not reported at all, have a profound effect upon the marginal impact calculations.



## References

- Azar, C., 1994, The Marginal Cost of CO<sub>2</sub> Emissions, *Energy* **19**(12):1255–1261.
- Ball, M., and Dowlatabadi, H., 1994, The Role of Aerosols in Climate Change: Results from an Integrated Assessment Model (ICAM-2.0), Working Paper, Department of Engineering and Public Policy, Carnegie Mellon University, Pittsburgh, PA, USA.
- Barker, T.S., Baylis, S., and Madsen, P., 1993, A UK Carbon/Energy Tax: The Macroeconomic Effects, *Energy Policy* **21**(3):296–308.
- Charlson, R.J., Schwartz, S.E., Hales, J.M., Cess, R.D., Coakley, J.A., Hansen, J.E., and Hoffman, D.J., 1992, Climate Forcing by Anthropogenic Aerosols, *Science* **255**:423–430.
- Cline, W.R., 1992, *The Economics of Global Warming*, Institute for International Economics, Washington, DC, USA.
- CRU/ERL, 1992, *Economic Evaluation of Impacts and Adaptive Measures in the European Community*, Commission of the European Communities, DG XI, Brussels, Belgium.
- Daniel, J.S., Solomon, S., and Albritton, D.L., 1995, On the Evaluation of Halocarbon Radiative Forcing and Global Warming Potentials, *Journal of Geophysical Research—Atmospheres* **100**:1271–1285.
- EMF (Energy Modelling Forum), 1994, *Final First Round Study Design for EMF 14: Integrated Assessment of Climate Change*, EMF, Terman Engineering Center, Stanford University, Stanford, CA, USA.
- EPA (Environmental Protection Agency), 1989, *The Potential Effects of Global Climate Change on the United States*, United States Environmental Protection Agency Report, J.V. Smith and D. Tirpak (eds.), Washington, DC, USA.
- Fankhauser, S., 1993, Greenhouse Economics and the Costs of Global Warming, PhD dissertation, University College, London, UK.
- Fankhauser, S., 1994a, The Social Costs of Greenhouse Gas Emissions: An Expected Value Approach, *The Energy Journal* **15**(2):157–184.
- Fankhauser, S., 1994b, *Valuing Climate Change: The Economics of the Greenhouse Effect*, Earthscan, London, UK.
- Fankhauser, S., 1994c, The Economic Costs of Global Warming Damage: A Survey, *Global Environmental Change* **4**(4):301–309.
- Fankhauser, S., and Pearce, D.W., 1993, The Social Costs of Greenhouse Gas Emissions, Paper to the OECD/IEA International Conference on the Economics of Climate Change, OECD/GD (93) 74, Organisation for Economic Co-operation and Development, Paris, France.
- Hadley Center, 1995, *Modelling Climate Change: 1860–2050*, Report from the Hadley Center, Bracknell, UK.
- Haraden, J., 1993, The Economic Cost of Global Warming, *Energy—The International Journal* **18**:303.
- Hope, C.W., and Maul, P., 1996, Valuing the Impact of Carbon Dioxide Emissions, *Energy Policy* **24**(3):211–219.

- Hope, C.W., Anderson, J.P., and Wenman, P., 1993, Policy Analysis of the Greenhouse Effect, *Energy Policy* **21**(3):327–338.
- Intergovernmental Panel on Climate Change (IPCC), 1990, *Climate Change: The IPCC Scientific Assessment*, Houghton, J.T., Jenkins, G.J., and Ephraums, J.J., (eds.), Cambridge University Press, Cambridge, UK.
- Jones, A., Roberts, D.L., and Slingo, A., 1994, A Climate Model Study of Indirect Radiative Forcing by Anthropogenic Sulphate Aerosols, *Nature* **370**:450–453.
- Kiehl, J.T., and Briegleb, B.P., 1993, The Relative Roles of Sulphate Aerosols and Greenhouse Gases in Climate Forcing, *Science* **260**:311–314.
- Langner, J., and Rohde, H., 1991, A Global Three-Dimensional Model of the Tropospheric Sulphur Cycle, *Journal of Atmospheric Chemistry* **13**:225–263.
- Manne, A.S., Mendelsohn, R., and Richels, R.G., 1993, MERGE: A Model for Evaluating Regional and Global Effects of Greenhouse Gas Reduction Policies, Electric Power Research Institute, Palo Alto, CA, USA.
- Manne, A.S., Mendelsohn, R., and Richels, R.G., 1995, MERGE: A Model for Evaluating Regional and Global Effects of Greenhouse Gas Reduction Policies, *Energy Policy*.
- Matthews, R., 1994, The Rise and Rise of Global Warming, *New Scientist* **144**(1953):6.
- Nordhaus, W.D., 1991, To Slow or Not to Slow: The Economics of the Greenhouse Effect, *The Economic Journal* **101**:920–937.
- Nordhaus, W.D., 1993a, Optimal Greenhouse Gas Reductions and Tax Policy in the “DICE” Model, *American Economic Review, Papers and Proceedings* **83**:313–317.
- Nordhaus, W.D., 1993b, Rolling the “DICE”: An Optimal Transition Path for Controlling Greenhouse Gases, *Resources and Energy Economics* **15**:27–50.
- Nordhaus, W.D., 1994, Expert Opinion on Climate Change, *American Scientist* **82**(1):45–51.
- Peck, S.C., and Teisberg, T.J., 1992, CETA: A Model for Carbon Emissions Trajectory Assessment, *The Energy Journal* **13**(1):55–77.
- Peck, S.C., and Teisberg, T.J., 1993a, CO<sub>2</sub> Emissions Control: Comparing Policy Instruments, *Energy Policy* **21**:222–230.
- Peck, S.C., and Teisberg, T.J., 1993b, Global Warming Uncertainties and the Value of Information: An Analysis using CETA, *Resource and Energy Economics* **15**:71–97.
- Plambeck, E.L., Hope, C.W., and Anderson, J.P., 1995, Updating PAGE: Policy Analysis for the Greenhouse Effect, *Research Papers in Management Studies 1994-95/14*, University of Cambridge, Cambridge, UK.
- Plambeck, E.L., and Hope, C.W., 1995, Validation and Initial Results for the Updated PAGE Model: Policy Analysis for the Greenhouse Effect, *Research Papers in Management Studies 1994-95/15*, University of Cambridge, Cambridge, UK.
- Ramanathan, V., 1975, Greenhouse Effect Due to Chlorofluorocarbons: Climatic Implications, *Science* **190**:50–52.

- Raper, S.C.B., Wigley, T.M.L., and Warrick, R.A., 1995, Global Sea Level Rise: Past and Future, in J.D. Milliman (ed.), *Rising Sea Level and Subsiding Coastal Areas*, Kluwer Academic Publishers, Dordrecht, Netherlands.
- Spiro, P.A., Jacob, D.J., and Logan, J.A., 1992, Global Inventory of Sulphur Emissions with a  $1 \times 1^\circ$  resolution, *Journal of Geophysical Research* **97**(D5):6023–6036.
- Taylor, K., and Penner, J.E., 1994, Response of the Climate System to Atmospheric Aerosols and Greenhouse Gases, *Nature* **369**:734–737.
- Tol, R.S.J., 1995, The Damage Costs of Climate Change: Toward More Comprehensive Calculations, *Environmental and Resource Economics* **5**:353–374.
- WEC (World Energy Council), 1992, *Energy for Tomorrow's World: The Realities, the Real Options, and the Agenda for Achievement*, World Energy Council 15th Congress, Madrid, Spain.
- West, J.J., Hope, C., and Lane, S.N., 1995, Climate Change Through Energy Policy: Isolating the Impacts and Implications of Aerosols, submitted to *Energy Policy*.
- Wigley, T.M.L., 1989, Possible Climate Change due to SO<sub>2</sub>-derived Cloud Condensation Nuclei, *Nature* **339**:365.
- Wigley, T.M.L., 1994, Outlook Becoming hazier, *Nature* **369**:709–710.
- Wigley, T.M.L., and Raper, S.C.B., 1992, Implications for Climate and Sea Level of Revised IPCC Emissions Scenarios, *Nature* **330**:127–131.



# The Climate Change Footprint: Will We See It Before It Is upon Us?\*

*David L. Kelly and Charles D. Kolstad*  
Department of Economics, University of California  
Santa Barbara, CA, USA

## Abstract

This paper considers the case of Bayesian learning about the relationship between the greenhouse-gas level and temperature rise. Learning takes time because of a stochastic shock to the realized global mean temperature. The paper illustrates the difficulty of quickly learning about the underlying relationship in the presence of a shock. The paper then goes on to present an integrated assessment model with endogenous learning. The model is a stochastic growth model with learning. It is solved as a dynamic program and then simulated for particular realizations of the shock.

## 1. Introduction

One of the dominant issues in the economics of climate change is the role of uncertainty. Manne and Richels (1992), in their important book on controlling precursors of climate change, focus almost entirely on hedging against uncertainty. Nordhaus (1994), in his important book on the economics of climate change, devotes considerable space to the uncertainty in forming control policies.<sup>1</sup> The policy debate worldwide is dominated by the question, “Do we know enough to control the problem now, or should we wait until more is known about climate change?” Although uncertainty is always present in problems of environmental policy, the uncertainty is much greater in the case of climate change if for no other reason than that the problem and its solution span decades or even centuries.

---

\*Research supported by US Department of Energy grant numbers DE-FG03-94ER61944 and DE-FC03-90ER61010, the latter through the Midwestern Regional Center of the National Institute for Global Environmental Change. Research assistance from Aran Ratcliffe is gratefully acknowledged. Also appreciated are comments from Michael Schlesinger, Steve Salant, John Laitner, and seminar participants at the University of Michigan.

<sup>1</sup>Other papers that have considered these issues include Peck *et al.* (1989), Hammitt *et al.* (1992), and Kolstad (1993).

There are two dimensions to the uncertainty problem, as it is normally perceived: parametric uncertainty and stochasticity. There are clearly aspects of climate change that are not well understood, although presumably over time the problem will be better understood. Simply stated, we are uncertain about particular parameters of the problem, but we expect that uncertainty to diminish with time or effort [e.g., research and development (R&D)]. This is what we term parametric uncertainty. A close relative of parametric uncertainty is stochasticity. Climate change is subject to stochastic shocks that affect climate, technology, and costs, but the future value of these shocks will always remain uncertain. No amount of information acquisition will allow us to predict whether a coin toss will come up heads or tails. These two elements – parametric uncertainty and stochasticity – generate significant uncertainty in trying to formulate policy for controlling greenhouse gases.

To make things more complex, there is a third aspect of uncertainty – learning. Over time, parametric uncertainty can be reduced. By investing in R&D or observing climate behavior, we can learn about uncertain parameters. However, *ex ante*, we do not know how this uncertainty will be resolved or what the results of learning will be.

Learning has many dimensions. Learning can take place at various levels of a policy problem, ranging from agents in the economy who are learning in order to adapt to changes in their environment to policy makers who are trying to formulate the best policy in an uncertain and changing world. When agents within the economy react to changed circumstances, it is usually termed adaptation. If these agents perceive uncertainty but learn over time, then adaptation may also take time. While learning is taking place, suboptimal decisions (relative to perfect information) are made with resulting welfare losses. To offer an overly simplistic example, suppose the climate has changed in the midwestern USA, resulting in a higher frequency of flooding and more rainfall. It may take decades before farmers realize the change is permanent and change their crops to take advantage of this (perhaps by planting flood-resistant strains). In the meantime, significant crop losses occur. Even though farmers can adapt perfectly to the changed climate, the delay in realizing a change has occurred results in significant losses.

Policy makers also base their decisions on some body of knowledge. When that knowledge base evolves over time, regulatory decisions may evolve over time. More subtly, current regulatory decisions must take into account the fact that more will be known tomorrow. This process takes time and the decisions made in the interim influence the rate at which information is acquired.

In addition to who learns, learning can be characterized by how it occurs.<sup>2</sup> Active learning involves the agent's having some influence over the rate at which information arrives. For instance, investment in R&D yields information. If a monopolist is uncertain about her demand curve, she can experiment by varying price and observing sales, learning over time about demand (Balvers and Cosimano, 1990). Greenhouse gas emissions may be varied in a grand experiment to determine how emissions influence climate.

Passive learning involves the exogenous arrival of information. This may occur all at once, as in Manne and Richels (1992), or more gradually as a function of time, as in Kolstad (1993). Obviously, there has to be some process whereby information is generated and arrives; however, with passive learning, that process is exogenous to the system being examined.

R&D is an obvious way in which information is acquired and a clear example of active learning. It is also a major factor in learning about climate change. However, learning from experience is also very important in climate change. In the example of the farmer's learning from realizations of the climate, learning occurs without R&D, simply by observation. Furthermore, much effort has been expended by the research community in trying to detect a climate change footprint/fingerprint in the temperature record of the last century. The implication is that if a footprint is clearly evident, a much stronger case can be made for controlling the problem.

The purpose of this paper is to understand the interplay between learning about the climate change problem and decisions to control the problem. Although there are many characterizations of learning, we are considering the case of endogenous learning, where agents learn from observing the climate record and base their actions on their state of knowledge at the point where action is taken. Using the farmer example again, after 10 years of drought, a farmer will view the probability of being in a drier climate as higher than it was prior to the drought and will make planting decisions accordingly (reducing the potential damage from drought).

From the policy maker's point of view, even if the climate has changed, she may not realize it. But she may know that in 50 years parametric uncertainty will be resolved. In contrast to the agent within the economy, the policy maker can adjust emissions. At least conceptually, emissions can be varied in order to coax more information from the resulting climate realizations. What emission control decisions will the policy maker undertake?

---

<sup>2</sup>See Cunha-e-sa (1994) and Kolstad (1996) for further discussion of different types of learning.

How are those decisions influenced by the fact that parametric uncertainty will be resolved at some point in the future?

In the next section of the paper, we consider this problem of learning about the climate, using a simple statistical model of temperature change. In particular, we show how hard it is to quickly detect a climate change footprint when there are stochastic shocks to the climate system. Was this year's frigid winter in the USA just a stochastic event or evidence of climate change?

In the subsequent section we expand this analysis to a simple integrated assessment model with endogenous learning embedded in the model. We are interested in the difference between levels of greenhouse gas emission control with perfect knowledge versus the case of slow learning based on climate realizations.

## 2. Learning About a Stochastic Process

Most climatic processes are stochastic. In particular, the average annual global temperature is well recognized to be stochastic, with some deterministic elements, such as radiative forcing from increased levels of greenhouse gases. Consider the simplest representation of this process:

$$T_{t+1} = \beta \ln M_t + u_t \quad , \quad (1a)$$

where  $T_t$  and  $M_t$  are temperature and greenhouse gas concentrations (relative to some base) at time  $t$ ;  $\beta$  is a constant; and  $u_t$  is a random shock, assumed to have a zero mean but perhaps exhibiting serial correlation.

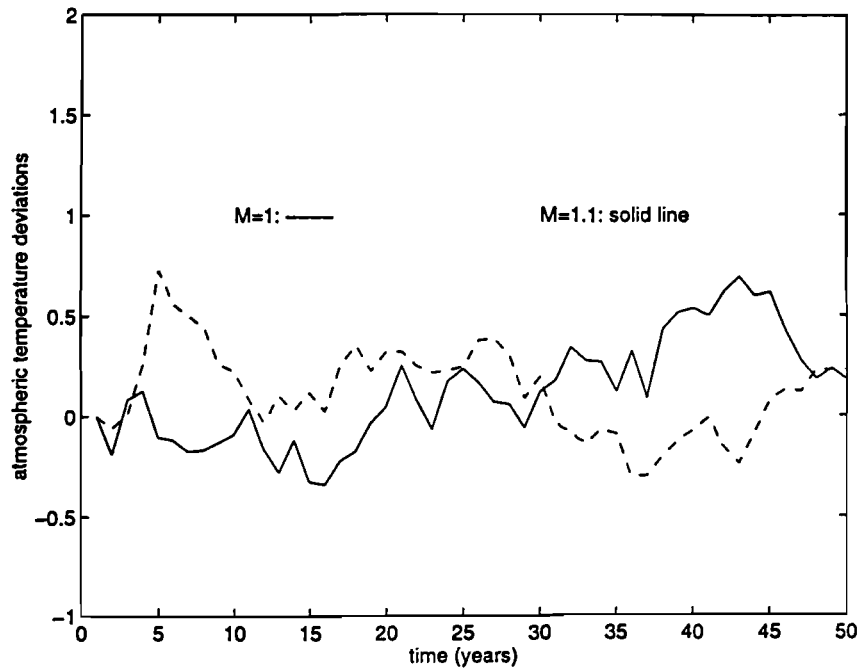
How might such a process evolve over time? Schlesinger and Ramanakutty (1995) and Bassett (1992) have estimated several different stochastic processes for temperature of the form of equation (1a), though without the dependence on greenhouse gases. All of these authors consider the case of first-order autocorrelation. In such a case, equation (1a) can be rewritten as

$$T_{t+1} = \alpha T_t + \beta(\ln M_t - \alpha \ln M_{t-1}) + \varepsilon_t \quad , \quad (1b)$$

where  $\alpha$  is a constant and  $\varepsilon_t$  exhibits no serial correlation.

Bassett (1992) estimates values of  $\alpha = 0.808$  and  $\text{Var}(\varepsilon) = 0.0185$ , where temperature is in deviations from the sample (1880-1991) average, in degrees Celsius. Figure 1 shows a 50-year simulation of temperatures for this model





**Figure 1.** Atmospheric temperature deviations, with and without  $\text{CO}_2$  effect.

(broken line), assuming  $\varepsilon$  is normally distributed and starting with  $T_0 = 0$  and  $M_t \equiv 1, \forall t$  so there is no climate effect. Note that these temperatures can exhibit medium-term temperature trends (“transitory shocks”), even though the long-term steady state level of temperature should be zero.

Now suppose we introduce some radiative forcing due to an increase in carbon dioxide ( $\text{CO}_2$ ). Assume for the time being that a doubling of greenhouse gases leads to a  $2.5^\circ\text{C}$  increase in the steady-state temperature. This is the Intergovernmental Panel on Climate Change’s (IPCC) best estimate (Lempert *et al.*, 1996). This implies a value for  $\beta$  of 3.6. The solid line in Figure 1 shows a simulation of an instantaneous 10% increase in greenhouse gas levels ( $T_0 = 0, M_t \equiv 1.1, \forall t$ ), though not necessarily with exactly the same realizations of the random shocks as in the case of no greenhouse gas effect. Note two things. First, as with the broken line, there are medium-term trends that do not necessarily persist. Second, it is not at all obvious from casual inspection of the two lines which figure involves a climate effect. This illustrates the problem of depending on a noisy signal for deducing whether climate change is a “real” phenomenon.

Let us now consider a Bayesian approach to the problem. We will make this as simple as possible. Suppose we are uncertain about the true value of  $\beta$ , but know it must be one of two values:  $\beta \in \{\beta_L, \beta_H\} \equiv \{2.16, 6.48\}$ . These two values of  $\beta$  correspond to the IPCC low and high values (greenhouse gas doubling leads to 1.5°C or 4.5°C temperature change, respectively) reported in Lempert *et al.* (1996). Let  $\pi$  be the probability that  $\beta$  takes on the high value,  $\beta_H$ . Thus, *a priori*,  $\pi = 0.33$ , so that the expected value of  $\beta$  is 3.6, corresponding to climate sensitivity of 2.5°C from a greenhouse gas doubling. As we move through time, we observe realizations at temperature  $T$ , which gives us information about  $\beta$ , and thus  $\pi$  evolves. Let  $\pi_t$  be the value of  $\pi$  at time  $t$ . At time  $t$ , our prior is  $\pi_t$ ; we observe a temperature realization,  $T_{t+1}$ , and update  $\pi$  to obtain a posterior,  $\pi_{t+1}$ . This updating follows Bayes rule:

$$\pi_{t+1} = \text{Prob} \{ \beta_H | T_{t+1} \} = \frac{f\{T_{t+1} | \beta_H\} \text{Prob}\{\beta_H\}}{\sum_{i=L,H} f\{T_{t+1} | \beta_i\} \text{Prob}\{\beta_i\}} , \quad (2)$$

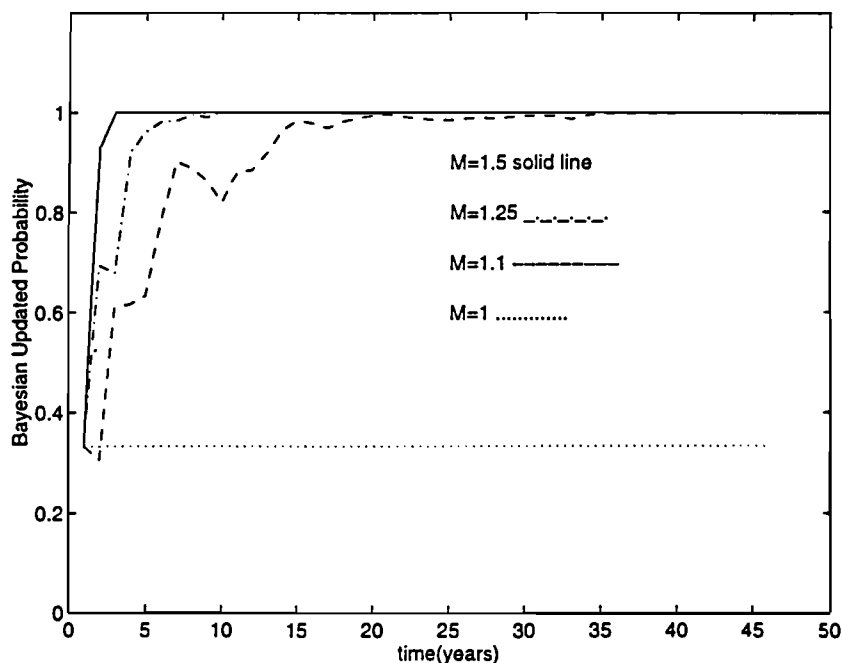
where  $f$  is the conditional density on the continuous random variable  $T_{t+1}$ . Focus on the right-hand side of equation (2). In the numerator, the first term can be obtained directly from equation (1), provided we know the distribution of  $\varepsilon$ . Assuming  $\varepsilon \sim \eta(0, \sigma_\varepsilon^2)$ , then for  $\beta = \beta_i$ , where  $i = L$  or  $H$ ,

$$T_{t+1} | \beta_i \sim \eta(\alpha T_t + \beta_i(1 - \alpha) \ln M_t, \sigma_\varepsilon^2) . \quad (3)$$

The second term in the numerator of equation (2) is simply the prior on  $\beta$ ,  $\pi_t$ . The second term in the denominator is similarly either  $\pi_t$  or  $(1 - \pi_t)$ .

Figure 2 shows how a prior of 0.33 might evolve over time, assuming the true value of  $\beta$  is at its high value ( $\beta_H$ ). This figure shows how equation (2) evolves when temperature in equation (1) is simulated for a 0%, 10%, 25% and 50% increase in greenhouse gases with  $\beta = \beta_H$ . Remember, uncertainty is resolved only when the probability reaches one (or zero if the true  $\beta$  is  $\beta_L$ ). The figure shows the evolution of the probability as a function of  $M$ . For small  $M$ , learning occurs slowly, because the stochastic shocks overwhelm differences between  $\beta_L$  and  $\beta_H$  and make learning difficult. For larger values of  $M$ , the noise is relatively smaller and it is thus easier to distinguish the true value of  $\beta$ .

Figure 2 illustrates how learning is endogenously affected by decision making. For example, more restrictive policy scenarios such as limiting greenhouse gas emissions to 1990 levels or limiting total CO<sub>2</sub> concentrations



**Figure 2.** Evolution of learning over time for a prior of 0.33.

to a low level slows learning. Conversely, the absence of controls results in faster learning, though of course more rapid increases in greenhouse gases.

### 3. Controlling Greenhouse Gases with Learning

We now turn our attention to the problem of incorporating learning within a model of the costs and benefits of controlling greenhouse gases. The model we present here is similar to that found in Kolstad (1994) and is in the spirit of the Ramsey growth models applied to climate change, particularly the DICE model of Nordhaus (1994).

#### 3.1. A stochastic, learning integrated climate economy model

We now turn to a specific description of our model of climate change. We maximize the net present value of utility subject to a capital accumulation constraint as well as an embedded model of climate change:

$$\max_{\mu_t, I_t} \quad \varepsilon \left\{ \sum_{t=0}^{\infty} \rho^t \log[C_t/L(t)] \right\} , \quad (4)$$

$$\text{s.t.} \quad C_t = \frac{[1-b_t\mu_t^{b_2}]}{[1+\theta_t T_t^{\theta_2}]} A(t) K_t^\gamma L(t)^{1-\gamma} - I_t \geq 0 , \quad (5a)$$

$$\text{Capital} \quad K_{t+1} = (1 - \delta_K) K_t + I_t , \quad (5b)$$

$$\begin{aligned} \text{GHG} \quad M_{t+1} &= (1 - \mu_t) \underbrace{\sigma(t) A(t) K_t^\gamma L(t)^{1-\gamma}}_{\substack{\text{Emissions} \\ \text{Uncontrolled}}} \\ &+ (1 - \delta_M)(M_t - 590) + 590 , \end{aligned} \quad (5c)$$

$$\text{Atmospheric temp.} \quad T_{t+1} = \alpha T_t + \beta \ln \left[ \frac{M_t}{590} \right] + \phi O_t + \varepsilon_t , \quad (5d)$$

$$\text{Ocean temp.} \quad O_{t+1} = O_t + \omega [T_t - O_t] , \quad (5e)$$

where the variables  $\mu_t, I_t, T_t, O_t, K_t,$  and  $M_t$  are, respectively, the emission control rate ( $\in[0,1]$ ), the investment level ( $\geq 0$ ), the atmospheric temperature, the deep-ocean temperature, capital, and the concentration of greenhouse gases. The parameters  $\rho, b_1, b_2, \theta_1, \theta_2, \gamma, \delta_K, \delta_M, \alpha, \phi,$  and  $\omega$  are constants.  $A(t), L(t),$  and  $\sigma(t)$  are time-varying exogenous parameters.  $A(t)$  and  $L(t)$  gradually rise over time;  $\sigma(t)$  gradually falls (Nordhaus, 1994). All three of these variables cease to change much after a few centuries.

Equation (5a) is simply a consumption identity, with the two bracketed terms representing the reduction in gross domestic product (GDP) [ $A(t)K_t^\gamma L(t)^{1-\gamma}$ ] associated with the cost of emission control (numerator) and pollution damage (denominator). Equation (5b) is the capital accumulation equation; equation (5c) is the greenhouse gas accumulation equation; equation (5d) is the equation of evolution of the atmospheric temperature; and equation (5e) is the evolution of the deep-ocean temperature. The last term ( $\varepsilon_t$ ) in equation (5d) is the stochastic shock, assumed distributed as  $\eta(0, \sigma_\varepsilon^2)$ . Uncertainty is embodied in uncertainty in the parameter  $\beta$ .

The model presented in equations (4) and (5), without the uncertainty or stochasticity, is very similar to Nordhaus' DICE model, though the parameter values may differ somewhat from the current version of DICE. A relatively modest difference between this model and DICE is that we have an infinite horizon, whereas DICE and nearly all other similar models deal with a finite horizon. Another difference is that our objective involves the utility

of a representative consumer. In DICE, per capita utility is multiplied by the size of the labor force,  $L(t)$ . All else being equal, our model places less weight on the future, compared with DICE.

The primary difference between our model and DICE is that here the parameter  $\beta$  is not known with certainty. The expectation operator in the objective function [equation (4)] is over the possible values of  $\beta$  as well as the possible values of  $\varepsilon_t$  [the stochastic shock in equation (5d)]. Uncertainty in  $\beta$  at any given point in time is represented as a prior distribution at that point in time. A decision is made on the optimal values of  $\mu$  and  $I$ , the economy evolves, is observed, the prior on  $\beta$  is updated and a posterior is formed, which becomes the prior for the next time period.

In earlier work on learning in the context of climate change (Kolstad, 1993, 1994), knowledge of the distribution on an uncertain parameter was assumed to evolve in an exogenous fashion, following a “star-shaped spreading of beliefs.” That approach has the advantage of involving a parametric and well-defined movement from less knowledge to more knowledge, and eventually certainty. That approach has the disadvantage of saying nothing about the process underlying information acquisition. Information just arrives like manna from heaven. The approach presented here is much more explicit about how information is acquired. The entire process of information acquisition is endogenous to the model.

Assume the prior that  $\beta$  is distributed  $\eta(r, V)$ ; i.e., normally with a (finite) mean of  $r$  and variance of  $V$ . With this prior, all we actually observe are  $T$  and  $O$ , not the realizations of  $\varepsilon$ . From this, the distribution on  $\beta$  must be updated. Rewrite equation (5d) as

$$H_t \equiv T_{t+1} - \alpha T_t - \phi O_t = \beta \ln \left[ \frac{M_t}{590} \right] + \varepsilon_t \equiv \beta X_t + \varepsilon_t . \quad (6)$$

All that is observed are  $T_{t+1}$ ,  $T_t$ ,  $O_t$ , and  $M_t$ , or, equivalently,  $H_t$  and  $X_t$ . We must infer the value of  $\beta$ , or rather update our prior on  $\beta$ , based on these observations. Let  $p_\varepsilon$  be the precision of  $\varepsilon$ ; i.e.,  $p_\varepsilon = 1/\text{Var}(\varepsilon)$ . After some mathematical wrangling with Bayes rule, we find the well-known result (e.g., Cyert and Degroot, 1974) that the posterior distribution on  $\beta$  is also normal with

$$r_{t+1} = \frac{r_t + V_t p_\varepsilon X_t H_{t+1}}{1 + V_t p_\varepsilon X_t^2} , \quad (7a)$$

$$V_{t+1} = \left[ \frac{1}{V_t} + p_\varepsilon X_t^2 \right]^{-1} . \quad (7b)$$

Note from equation (7b) that the variance estimate on  $\beta$  is monotonically nonincreasing with time. Thus, except for trivial examples, no matter what the realization of the shock, the variance shrinks. Recall that perfect information is associated with a variance of zero.

It is straightforward to interpret the updating rules in equation (7). First, the current estimate of the mean of  $\beta$  is a sufficient statistic for all information up to period  $t$ . Hence the new estimate of the mean will be a weighted average of the old estimate and the new information,  $H_{t+1}/X_t$ :

$$r_{t+1} = \left[ \frac{1}{1+V_t p_\epsilon X_t^2} \right] r_t + \left[ \frac{V_t p_\epsilon X_t^2}{1+V_t p_\epsilon X_t^2} \right] \frac{H_{t+1}}{X_t} . \quad (8)$$

A high prior variance ( $V_t$ ) causes the updating process to put more weight on the new information; similarly, a low prior variance results in very little weight being placed on new information.

The model is now complete. It consists of equations (4, 5, and 7). The net present value of utility is maximized, using as controls  $\mu$  (the emission control rate) and  $I$  (investment). The system is characterized by state variables that evolve over time:  $t$  (time),  $T$  (atmospheric temperature),  $O$  (ocean temperature),  $K$  (capital stock),  $M$  (greenhouse gas stock),  $r$  (estimated mean of  $\beta$ ), and  $V$  (estimated variance of  $\beta$ ). The reason  $t$  (time) is considered a state variable is that some of the parameters ( $A, L, \sigma$ ) depend on time. Parameter values are presented in Table 1. In our implementation, a time period is a decade. The time-dependent parameters ( $A, L, \sigma$ ) take on exactly the same values as in Nordhaus (1994).

### 3.2. Solution approach

Nearly all models of climate and the economy involve optimization over a finite horizon as a solution technique. This has the advantage of being computationally efficient. However, direct optimization is very difficult to use when there is a stochastic element. All variables depend on the possible realizations of the shock ( $\epsilon$ ). A more elegant, though not easy to implement, approach involves rewriting the model using the Bellman equation and then solving that system numerically (see Stokey and Lucas, 1989).

To describe the approach concisely, without getting bogged down in notation, suppose we have a vector of controls ( $C_t$ ) – variables that are adjusted to maximize the objective – and a vector of state variables ( $S_t$ ), which evolve over time, based on what controls are chosen. Assume there is

**Table 1.** Parameter values.

Parameter	Value
$\rho$	0.7441 <sup>a</sup>
$b_1$	0.0686
$b_2$	2.887
$\theta_1$	0.01478
$\theta_2$	2
$\gamma$	0.25
$\delta_K$	0.6513
$\delta_M$	0.083
$\alpha$	0.5819
$\phi$	0.0944
$\omega$	0.02
$\text{Var}(\varepsilon)$	0.11

<sup>a</sup>Equivalent to 3% annually.

Note: One unit of time = 10 years.

some stochastic shock every period,  $\varepsilon$ , and a parameter that is imperfectly known,  $\beta$ . We can write this problem as

$$\max_{C_t} \varepsilon \sum_{t=0}^{\infty} \rho^t f(S_t, C_t) \quad (9a)$$

$$\text{s.t. } S_{t+1} = g(S_t, C_t, \varepsilon, \beta) \quad (9b)$$

The Bellman principle of optimality states that the net present value of the objective [equation (9a)] must obey a dynamic consistency condition, known as the Bellman equation. Let  $F(S)$  be the value of the objective in equation (9), starting at any state  $S$ . The Bellman equation in this case is

$$F(S) = \max_C \{f(S, C) + \rho \varepsilon_{\beta, \varepsilon} F[g(S, C, \varepsilon, \beta)]\} \quad (10)$$

The Bellman equation [equation (10)] states that the maximum attainable net present value of the objective starting at  $S$  must be equal to today's one-period objective ( $f$ ) plus tomorrow's maximum attainable net present value of the objective, assuming the optimal control is chosen today. Because  $\beta$  and  $\varepsilon$  are random variables *ex ante*, one must take the expectation of  $F$  on the right-hand side with respect to the distributions of  $\beta$  and  $\varepsilon$ . In our case, the distribution of  $\beta$  is defined by two state variables (the prior mean and variance).

Note that if one knows  $F$ , then it is easy to calculate the optimal action to take at any point in time; simply solve the right-hand side of equation (10) for  $C^*$ . However, the real problem is finding an  $F()$  that satisfies equation (10). Equation (10) is really a functional equation with, as an unknown, the function  $F$ .

So the problem is how to find an  $F()$  that satisfies equation (10). This is a problem of some concern in macroeconomics and a number of numerical techniques have been developed.<sup>3</sup> The basic idea is to define a family of functions of which  $F$  is a member. The family must be parameterized by some parameter vector,  $\chi$ . Thus the family is defined by the function  $\Phi(S; \chi)$  where the solution to equation (10),  $F(S)$ , corresponds to some particular value of the parameter,  $\chi^*$ . We can rewrite equation (10) as

$$\Theta(S; \chi) \equiv \max_C \{f(S, C) + \rho \varepsilon_{\beta, \varepsilon} \Phi[g(S, C, \varepsilon, \beta); \chi]\} \quad , \quad (11a)$$

$$\Phi(S; \hat{\chi}) = \Theta(S; \chi) + \eta(S; \chi, \hat{\chi}) \quad . \quad (11b)$$

We may not be able to have equation (10) hold exactly because we are using a restricted set of value functions, parameterized by  $\chi$ , instead of the universe of real-valued functions. That is the reason for the error term,  $\eta$ , appended to equation (11b). The task is to find the  $\chi^*$  for which  $\eta$  in equation (11b) is as close to zero as possible over relevant values of the state variable,  $S$ . An obvious norm is least squares; i.e., find the  $\chi$  that minimizes the sum of squared  $\eta$  over a finite set of values of  $S$ , which span that portion of the state space that is of interest. This defines a recursive algorithm for finding  $\chi$ 's given some  $\chi_j$ , evaluate equation (11a). Then find  $\chi_{j+1}$  that solves equation (11b), minimizes some norm of  $\eta$  over  $S$ .

There are a number of alternative parametric families that can be used to define the appropriate set of value functions for consideration.<sup>4</sup> The primary requirements are that any real-valued function can be approximated to any degree of precision and that the parameterization be computational

---

<sup>3</sup>The January 1990 issue of the *Journal of Business and Economic Statistics* was devoted to such techniques. In particular, see the review article by Taylor and Uhlig (1990) in that issue.

<sup>4</sup>Judd and Guu (1993) describe the familiar Taylor approximation (a series of polynomials) and the Padé approximation (quotient of polynomials). Judd (1991) argues for the use of a series of Chebyshev polynomials as more computationally efficient. Hornik *et al.* (1989) show that neural networks, approximations involving transcendental functions, can approximate any Borel measurable mapping arbitrarily well.



efficient.<sup>5</sup> We choose to use neural network approximations to the value function. As we have implemented this, it is a close relative of the Fourier network. Our approximation is

$$\Phi(S; \chi) = \sum_{\ell} [\chi_{1\ell} \tanh(\chi'_{2\ell} S + \chi_{3\ell})] + \chi_4 \quad , \quad (12)$$

where  $\chi_{2\ell}$  is a vector and other  $\chi$ s are scalar components of the parameter vector  $\chi$ , and  $S$  is the state vector.

The next step is to define a compact region of the state space where equation (11) will be required to hold. For instance, if the capital stock is one of the state variables, a lower limit would be zero and an upper limit would be any stock for which it is optimal for investment to be less than depreciation, thus causing the stock to shrink over time. Having defined the relevant compact region of the state space, choose a finite set of points in that region,  $S_i, i = 1, \dots, I$ . The finer the mesh covering the region of interest, the more accurate the approximation, although the computations will also be more intensive. We then recursively generate a sequence of  $\chi_j, \{\chi_0, \chi_1, \dots, \chi_J\}$ , starting from some initial guess  $\chi_0$ . If one knows  $\chi_j$ , then  $\chi_{j+1}$  is the error-minimizing solution to equation (11b) where the rhs in equation (11b) is evaluated at  $\chi_j$ :

$$\chi_{j+1} = \arg \min_{\chi} \sum_i [\Phi(S_i; \chi) - \theta(S_i; \chi_j)]^2 \quad . \quad (13)$$

These  $\chi_j$  converge to an  $\chi^*$ , which defines the approximate solution,  $\Phi(S; \chi^*)$ , to the Bellman equation (10). Convergence criteria are discussed in the next section.

This approach is essentially the same as the contraction mapping constructive proofs of existence of solution to dynamic program (see, for example, Stokey and Lucas, 1989). These proofs define an operator ( $T$ ) from the space of continuous functions to the space of continuous functions. Choosing an arbitrary continuous function ( $v$ ) on the value function on the right-hand side of equation (10), the left-hand sets of the equation define  $T(v)$ . If  $T$  is

---

<sup>5</sup>In other words, for  $\chi$  of sufficiently large dimension,  $\Phi$  spans the space of continuous functions. To be more precise, define  $\Phi(S, \chi) : \mathcal{R}^n \times \mathcal{R}^m \rightarrow \mathcal{R}$  where  $n$  is the dimension of the state space and  $m$  is the dimension of the parameter vector  $\chi$ . For any  $C^1$  function  $G: A \rightarrow \mathcal{R}$  where  $A$  is a compact subset of  $\mathcal{R}^n$  and any  $\lambda > 0, \exists m, \chi \in \mathcal{R}^m, \exists \|G(S) - \Phi(S, \chi)\|_s < \lambda$ .

**Table 2.** Region of interest in state space and 1985 values of state variables.

State	Units	Number of grid points	Grid values	1985 value
$K$	( $10^9$ 1987 US\$)	5	10,40,100,190,310	51.26
$M$	( $10^9$ tonnes)	4	600,1000,1400,1800	730
$T$	(°C from 1950)	4	0.2,1.7,3.2,4.7	0.45
$O$	(°C from 1950)	3	0.1,0.75,2	0.11
$r$	3.07 w/m <sup>2</sup>	3	0.72,1.1,1.4	0.81 <sup>a</sup>
$V$	–	3	0.1,0.5,1	0.75
$t$	(Decades from 1905)	6	1,3,7,12,20,50	3

<sup>a</sup>Equivalent to 2.5°C temperature rise from doubling of greenhouse gas stock.

a contraction mapping, then multiple applications of  $T$  to  $v$  eventually converge to a fixed point, a solution to equation (10). In our case, we are dealing with a restricted set of functions,  $\Phi(S, \chi)$ . Iteration on  $\chi$  as described above is essentially the same as multiple applications of  $T$ .

This defines the solution to model (9). While this is much more computationally intensive than solving a deterministic finite horizon version of equation (9) using standard optimization software, two clear advantages of this approach are: a) stochasticity is represented; and b) once solved, the solution (optimal actions) for all values of the state vector is also known – no further computations are necessary for other values of the state vector. This is a very important advantage of dynamic programming. It allows straightforward comparative statics analysis as well as great flexibility in policy analysis.

### 3.3. The solution

We now turn to the specific solution of the model defined in equations (4) and (5). Recall that there are seven state variables:  $t$  (time),  $T$  (atmospheric temperature),  $O$  (ocean temperature),  $K$  (capital stock),  $M$  (greenhouse gas stock),  $r$  (estimated mean of  $\beta$ ), and  $V$  (estimated variance of  $\beta$ ). The range of interesting values for these states is shown in Table 2, along with the discrete values of each state that are used to make up the points that span the state space for approximation purposes. The state variable  $t$  (time) was truncated at the point where exogenous labor and technical change virtually stop changing.

Finding a good grid over the state space requires considerable trial and error. The idea is to put grid points in the regions where the value function

has significant curvature, to improve the fit. Also, the grid must have the stationary state in the interior. The grid we used contained 12,960 points.

The neural network approximation [equation (12)] is assumed to have 16 terms in the summation, resulting in 129 elements in  $\chi$ .<sup>6</sup> The maximization in equation (11a) is solved using sequential quadratic programming.<sup>7</sup> The expectations in equation (11a) are evaluated using numerical integration based on 12-24 point Gaussian quadrature (Tauchen, 1990).

Equation (13) is solved using a quasi-Newton method with analytic first derivatives of  $\eta$  with respect to  $\chi$ . The nonlinear least squares is assumed to converge when the objective is less than  $10^{-7}$ . As indicated in the previous section, we iterate on  $\chi$  until convergence of  $\chi$  appears to be obtained.<sup>8</sup> Our convergence criterion is that the difference in value function approximations [equation (11b)], between one iteration and the next is less than or equal to  $10^{-4}$  at all grid points.

The problem was implemented using Matlab on a Sun Sparc 20 (75 mHz). Solution time was about 72 hours.<sup>9</sup>

## 4. Results

The solution of the dynamic program is a value function  $F(t, T, O, K, M, r, V)$ , and the corresponding policy functions giving optimal pollution control and investment as functions of the state variables:  $\mu^*(t, T, O, K, M, r, V)$  and  $I^*(t, T, O, K, M, r, V)$ . Today's values of the state variables are sufficient to

---

<sup>6</sup>An important issue in the statistics literature is the optimal choice for the number of parameters in the neural net ( $m$ ). When observations are subject to iid noise, one often gets the result to set  $m$  such that the number of parameters equals the square root of the number of observations. So given 13,000 observations, we might set  $m = \sqrt{13,000} \approx 114$ . This results in the number of terms [the  $l$ s in equation (12)] being approximately 13. Given that the actual value function is deterministic, we can use a few more terms to increase the fit without concern that the data are noisy. We let  $m = 16$  in the derivation of the value function.

<sup>7</sup>The maximand in equation (11a) is not guaranteed to be globally concave. It is easy to show that the set of feasible solutions to the maximization is convex. Provided the climate shock is not too great ( $|\varepsilon|$  less than  $\sim 5^\circ$ ), we can show concavity of the objective function over the region of the state space shown in Table 2.

<sup>8</sup>Provided utility is bounded, given our assumptions, a solution to equation (10) exists (Stokey and Lucas, 1989). Given the range of values for states given in Table 2, and that controls are chosen so that  $K$  is bounded away from zero and  $T$  remains below some upper bound, utility will be bounded.

<sup>9</sup>Solution time can presumably be significantly reduced by compiling some of the computationally intensive parts of the process rather than using the Matlab interpreter exclusively.

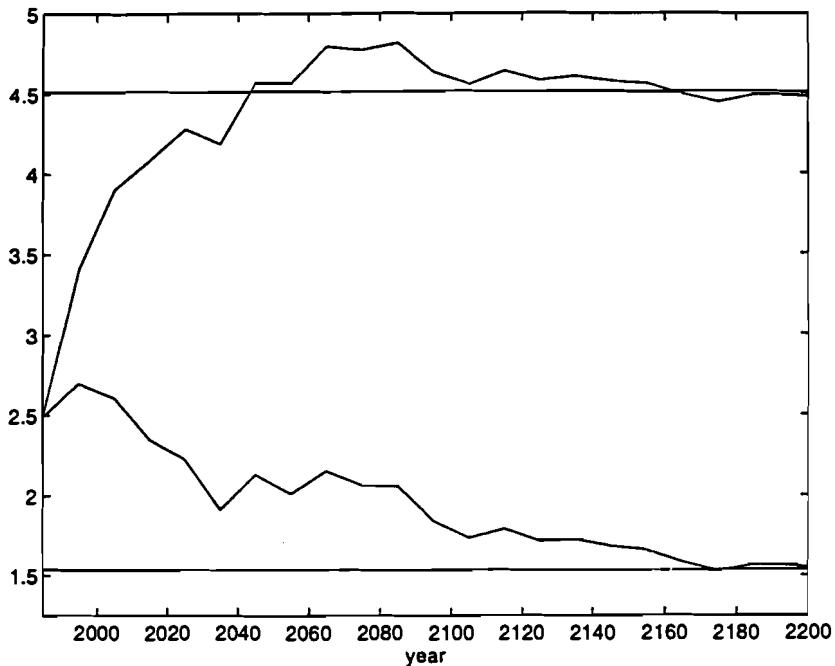
determine today's optimal action. In order to simulate the path of investment, pollution control, or any of the states over time, one must simulate the transition equations (5) and optimal control functions, using particular realizations of the random shock,  $\varepsilon$ . It is important to realize that, while in the model there is uncertainty over the climate response parameter,  $\beta$ , the dynamic system requires a specific value of  $\beta$  in order to evolve. Thus, when we simulate the model, we must simulate it for a specific  $\beta$ , even though learning is occurring about beliefs on  $\beta$ . Starting in 1985 from initial values of the state variables given in Table 2 and assuming the shock is distributed  $\eta(0,0.11)$ ,<sup>10</sup> we examine the evolution of the system for two different values of  $\beta$ , a high value and a low value. These high and low values correspond respectively to the IPCC high and low climate sensitivities of a 4.5°C and 1.5°C temperature change from greenhouse gas doubling (Lempert *et al.*, 1995).

Figure 3 shows how the estimate of the mean of the distribution on the true  $\beta$  evolves over time for each of the two actual values of  $\beta$ . (Actually, for clarity, climate sensitivity is shown, equal to  $3.07\beta$ .) The curves are jagged because they involve the realization of the random shock. A different set of realizations could very well have resulted in somewhat different paths. Although the variance is not shown, it is virtually identical for the two values of  $\beta$ . This is because the updating formula for the variance [equation (7b)] only involves  $M_t$ , the stock of greenhouse gases – a variable that changes very slowly and is very insensitive to a temporary lack of knowledge about  $\beta$ . Note that it takes 50–100 years for the mean of the distribution of  $\beta$  to “converge” to the true value (and the variance to be reduced to a small number).

We can be a little more precise about how long it takes to converge. The prior distribution on  $\beta$  is that it is normal with a mean of 0.86. Over time the distribution changes. At any point in time the agent can test the hypothesis that  $\beta = 0.86$ . We have run several hundred Monte Carlo simulations (the realization of the shock varies from one simulation to another) and for each determined the time period where we first reject that null hypothesis. Table 3 shows the mean time to rejection of the null under different assumptions about the true  $\beta$  and different levels of confidence. Note that rejection at the 95% level takes less than 100 years if the true  $\beta$  is high, but over 160

---

<sup>10</sup>The variance of the shock is computed from an analysis of the global annual temperature data. We found the standard error to be approximately 0.105, equivalent to a variance of 0.011. Bassett (1992) and Nordhaus (1994) report standard errors for the interannual variation in the range of 0.1 to 0.15. Although it is not strictly statistically correct to do so, we multiply our 0.111 variance by 10 to yield a decadal variance of 0.11.



**Figure 3.** Evolution of the estimate of the mean of the distribution on the true  $\beta$  over time for two actual values of  $\beta$ .

**Table 3.** Decades to reach confidence levels on  $\beta$ .

True beta	Confidence level	
	95%	99%
$H$	9.3	12.5
$L$	16.3	22.9

Note: Figures shown are in decades. Represents mean over Monte Carlo simulations of time to reach indicated confidence level for rejecting the null hypothesis that  $\beta = 0.86$ .

years if it is low. This is somewhat surprising since most analyses of learning hypothesize that uncertainty is resolved in 20–60 years. Also note that the learning time is not symmetric.

The implication of this slow learning can be seen in the level of pollution control. Figure 4 shows the pollution control rate ( $\mu$ ) as a function of time for both the low value of  $\beta$  and the high value (solid lines). Also shown are the values of  $\mu$  that would be obtained if  $\beta$  were perfectly known (broken lines). For low  $\beta$ , where greenhouse gases have a smaller effect on temperature, pollution control starts low and *rises* as uncertainty is reduced. This is a

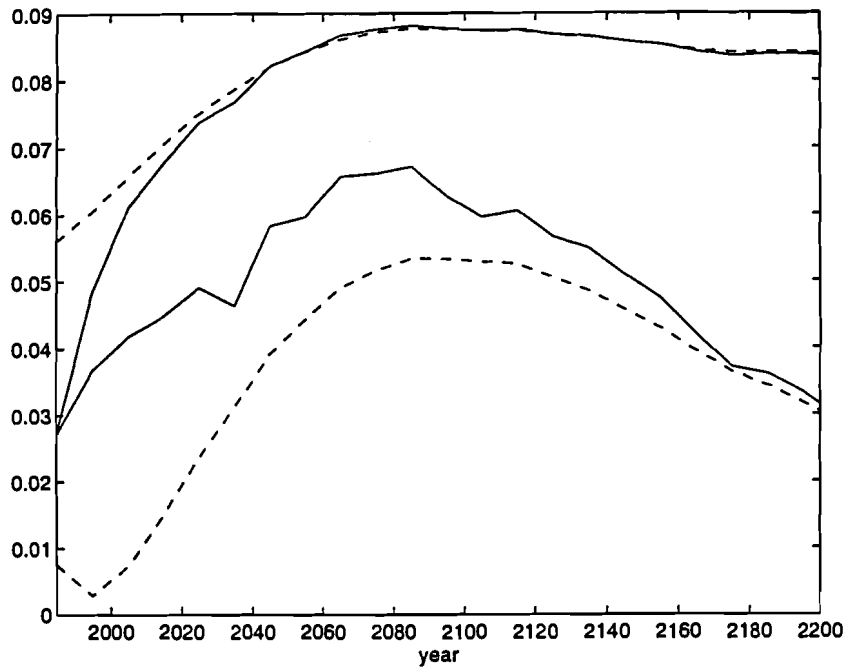


Figure 4. Pollution control rate as a function of time for both the low and the high values of  $\beta$ .

somewhat unusual result. Growth in control implicit in the underlying model dominates learning which would tend to reduce control to the no-uncertainty case. Another explanation is that learning causes the deferment of control until some of that uncertainty is eliminated. This is not as obvious when the true value of  $\beta$  is high. Pollution control still starts low but gradually builds to 8–9% as the true value of  $\beta$  is learned.

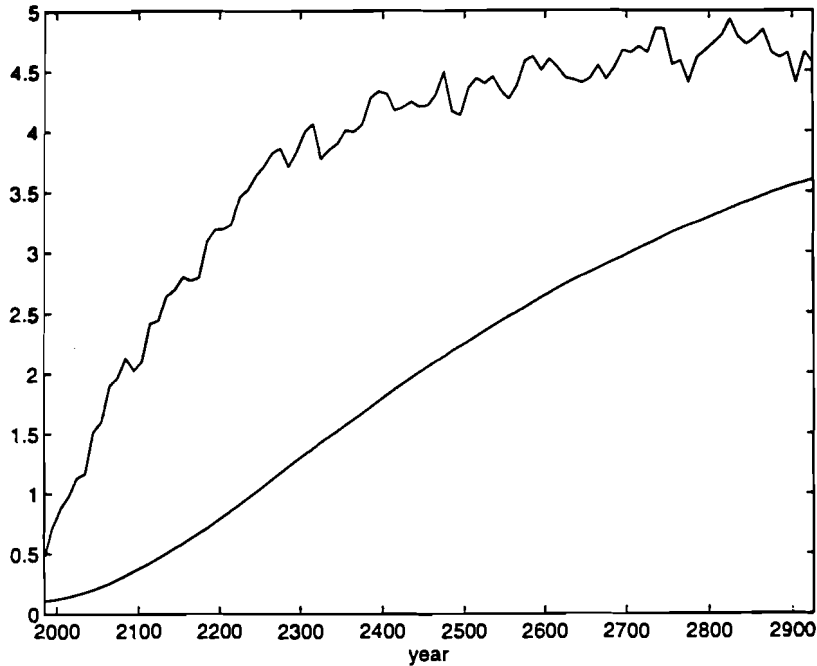
We can provide additional insight as to why control rises to its peak around 2100 and then falls (when the true  $\beta$  is low).<sup>11</sup> Much is changing over the next century; what is most important in driving emission control? Assuming the true value of  $\beta$  is low, the control rate increases by 148% ( $[\mu_{2095} - \mu_{1985}]/\mu_{1985} = 1.48$ ). We know the values of each state variable in 1985 and 2095. We can set all state variables at their 1985 value except one, which we set at its 2095 value and see how much pollution control changes. Let that value be  $\mu_i$ , where  $S_i$  is the state that has been changed to its

<sup>11</sup>We are unable to offer an unambiguous explanation for why control levels drop after 2100.

**Table 4.** Proportion of change in control due to each state variable.

Variable	$K$	$M$	$T$	$O$	$r$	$V$	$t$
Proportion	26%	70%	6%	1%	-40%	-21%	57%

Note: Shown is  $\frac{\mu_i - \mu_{1985}}{\mu_{2095} - \mu_{1985}}$ , assuming the true  $\beta$  is low.  $\mu_i$  is the control level when all states take their 1985 value except state  $i$ , which takes its 2095 value.

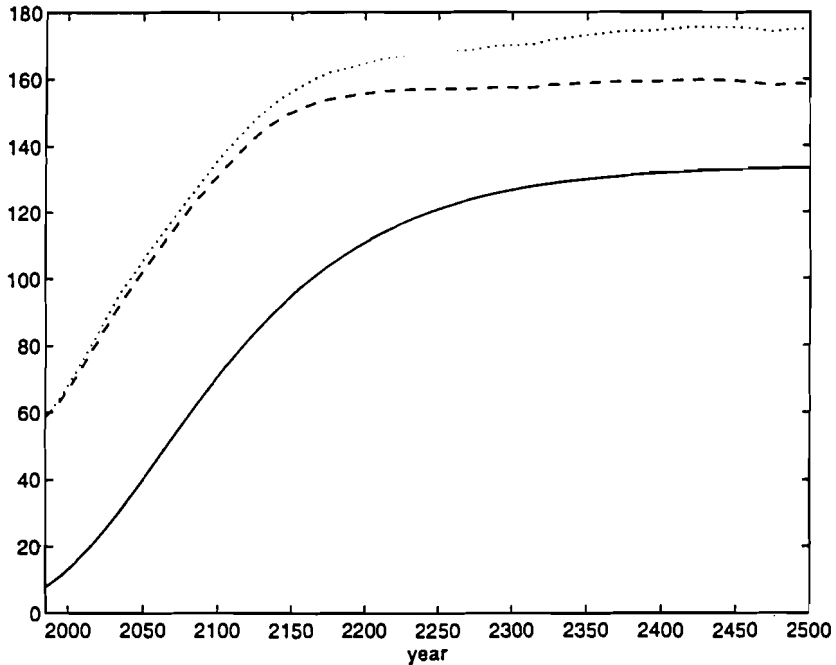


**Figure 5.** Evolution of atmospheric and deep ocean temperatures over the very long run for the high value of  $\beta$ .

2095 value. Table 4 shows the ratio of  $\mu_i - \mu_{1985}$  to  $\mu_{2095} - \mu_{1985}$ . Roughly speaking, these figures should sum to 100%, though because of nonlinearities and other factors, they will not do so precisely.

Note in the table that  $K$ ,  $M$ , and  $t$  have the biggest positive impact on  $\mu$ , whereas learning has the opposite effect. The change in  $r$  and  $V$ , which is due to learning, tends to work in the opposite direction. On net, learning is dominated by the other variables and the control rates rise.

Figure 5 shows the evolution of atmospheric and deep ocean temperature over the very long run for the high value of  $\beta$ . Note the very long lags built into the temperature response of the deep ocean. It is clear that while the deep ocean temperature is not significant now, it will be eventually.



**Figure 6.** Decadal emissions for the high value of  $\beta$  and a scaled plot of the product of three variables: technology, labor force, and emissions per unit GDP.

It should be pointed out that much of the growth in emissions and greenhouse gas stock levels is due to growth in the labor force and growth in output-enhancing technology. Figure 6 shows a plot of decadal emissions (for the high value of  $\beta$  – a similar result holds for the low value) and a scaled plot of the product of three variables: technology ( $A_t$ ), labor force ( $L_t$ ), and emissions per unit of GDP ( $\sigma_t$ ). Higher  $A$ 's and  $L$ 's yield higher GDP;  $\sigma$  is the greenhouse gas emissions–GDP ratio. Thus the product of these three variables is proportional to uncontrolled greenhouse gas emissions. The relationship between this product and emissions is striking. Since there is very little control (<10%), emissions and this triple product track each other well. Why is this significant? It is significant because the  $A$ ,  $L$ , and  $\sigma$  variables are all exogenous. An interpretation of Figure 6 is that exogenous variables determine how much is emitted and thus how serious the warming problem is. This is explored further in Kelly and Kolstad (1996).

This leads to the obvious question of how the optimal policy is affected by the various state variables. The optimal policy function is nonlinear,



**Table 5.** Sensitivity of emission control to 1% increase in value of states.

$K$	$M$	$T$	$O$	$r$	$V$	$t$
0.4	3.8	0.1	0.02	1.7	0.2	1.2

Note: States evaluated at 1985 values; shown is percent change in  $\mu$ .

which makes generalization difficult. However, we can ask specific questions. Suppose we start with the value of the state variable in 1985 (see Table 2). We can then investigate how a 1% increase in each of the states would affect the optimal CO<sub>2</sub> control rate, assuming the true value of  $\beta$  is at its high value. Table 5 shows the change in  $\mu$  from its base value of just under 3% control of greenhouse gases.

We see that the most significant states are  $M$ ,  $r$ , and  $t$ . The optimal policy puts little weight on  $T$ , because  $T$  is subject to stochastic shocks and is not a very good predictor of future temperature. However,  $M$  and  $r$  are excellent predictors of future  $T$  values, and  $M$  has much less stochastic fluctuation than  $T$ . Also important are the levels of the exogenous variables, represented by  $t$  (as mentioned earlier). So we see that learning is an important component of the optimal policy, although most analyses focus on  $M$  or  $T$ .

## 5. Conclusions

This paper is one of the first papers to deal explicitly with learning about the climate within an integrated-assessment framework. We have explored learning about the exact relationship between elevated greenhouse gas levels and temperature rise. We have shown that it can take a very long time to resolve that uncertainty, time during which significant suboptimal control can take place (relative to perfect information).

It should be noted that in this model, learning is from the point of view of the policy maker. We have assumed the agents within the model are perfectly informed. If agents also were learning then adaptation would be slower and the effect of learning more pronounced.

There are several drawbacks to our approach, not the least of which is the computational complexity. A related problem is that other parameters are also uncertain but the problem becomes too complex if learning about more parameters is included in the model. Finally, Bayesian leaning is not the only kind of learning that takes place. Clearly research and development also generates information; that process is not represented here.

## References

- Balvers, R., and Cosimano, T., 1990, Actively Learning About Demand and the Dynamics of Price Adjustment, *The Economic Journal* **100**:882–898.
- Bassett, G.W., Jr., 1992, Breaking Recent Global Temperature Records, *Climatic Change* **21**:303–315.
- Cunha-e-sa, M.A., 1994, Essays in Environmental Economics, Ph.D. dissertation, Department of Economics, University of Illinois, Urbana, IL, USA.
- Cyert, R., and Degroot, M., 1974, Rational Expectations and Bayesian Equilibrium, *Journal of Political Economy* **82**:521–535.
- Edmonds, J., and Reilly, J., 1983, Global Energy and CO<sub>2</sub> to the Year 2050, *Energy Journal* **4**(3):21–47.
- Hammitt, J.K., Lempert, R.J., and Schlesinger, M.E., 1992, A Sequential-Decision Strategy for Abating Climate Change, *Nature* **357**:315–318.
- Hornik, K., Stinchcombe, M., and White, H., 1989, Multilayer Feedforward Networks are Universal Approximators, *Neural Networks* **2**:359–366.
- Judd, K.L., 1991, Minimum Weighted Residual Methods for Solving Dynamic Economic Models, unpublished manuscript, Hoover Institution, Stanford University, Stanford, CA, USA.
- Judd, K.L., and Guu, Sy-Ming, 1993, Perturbation Solution Methods for Economic Growth Models, in H.R. Varian (ed.), *Economic and Financial Modeling with Mathematica*, Springer-Verlag/TELOS, Santa Clara, CA, USA.
- Kelly, D.L., and Kolstad, C.D., 1996, A Note on the Importance of Population-Technology Growth in Integrated Assessment Models, mimeo, Economics Department, University of Santa Barbara, Santa Barbara, CA, USA, February.
- Kolstad, C.D., 1993, Looking vs. Leaping: The Timing of CO<sub>2</sub> Control in the Face of Uncertainty and Learning, pp. 63–82 in Y. Kaya, N. Nakićenović, W.D. Nordhaus and F.L. Toth (eds.), *Costs, Impacts and Benefits of CO<sub>2</sub> Mitigation*, International Institute for Applied Systems Analysis, Laxenburg, Austria.
- Kolstad, C.D., 1994, The Timing of CO<sub>2</sub> Control in the Face of Uncertainty and Learning, in E. van Ireland (ed.), *International Environmental Economics*, Elsevier, Amsterdam, Netherlands.
- Lempert, R.J., Schlesinger, M.E., and Banks, S.C., 1996, When We Don't Know the Costs or Benefits: Adaptive Strategies for Abating Climate Change, *Climatic Change* (in press).
- Lempert, R.J., Schlesinger, M.E., and Hammitt, J.K., 1994, The Impact of Potential Abrupt Climate Changes on Near-Term Policy Choices, *Climatic Change* **26**:351–376.
- Manne, A.S., and Richels, R.G., 1992, *Buying Greenhouse Insurance: The Economic Costs of CO<sub>2</sub> Emission Limits*, MIT Press, Cambridge, MA, USA.
- Nordhaus, W.D., 1994, *Managing the Global Commons: The Economics of Climate Change*, MIT Press, Cambridge, MA, USA.
- Peck, S.C., Chao, H-P, and Teisberg, T.J., 1989, Optimal Control and Learning Strategies When Environmental Costs are Cumulative, Proceedings of the

- IFAC/IFORS/IAEE International Symposium on Energy Systems, Management and Economics, held 25–27 October 1989 at Tokyo, Japan.
- Ramsey, F., 1928, A Mathematical Theory of Saving, *Economic Journal*.
- Schlesinger, M.E., and Ramankutty, N., 1995, Is the Recently Reported 65- to 70-year Surface-temperature Oscillation the Result of Climatic Noise?, *J. Geophysical Research* **100**(07):13767–13774.
- Stokey, N.L., and Lucas, R.E., Jr., 1989, *Recursive Methods in Economic Dynamics*, Harvard University, Cambridge, MA, USA.
- Tauchen, G., 1990, Solving the Stochastic Growth Model by Using Quadrature Methods and Value-Function Iterations, *Journal of Business and Economics Statistics* **8**:49–51.
- Taylor, J.B., and Uhlig, H., 1990, Solving Nonlinear Stochastic Growth Models: A Comparison of Alternative Solution Methods, *J. Business and Economics Statistics* **8**:1–17.



# The Economic Impacts of Climate Change in the USA

*Robert Mendelsohn*

Yale School of Forestry and Environmental Studies  
360 Prospect Street, New Haven, CT, USA

## Abstract

This paper discusses a new systematic set of studies measuring the economic impacts of climate change on the USA. These studies develop new methodologies that emphasize adaptation. With fast-moving sectors that adapt quickly, the methods focus on cross-sectional natural experiments to measure climate sensitivity. With capital-intensive sectors that adapt slowly, the methods focus on dynamic adjustments which take decades to complete. The set of studies also emphasizes comprehensive analyses of entire sectors. Many components of sectors that were previously ignored are now included. The result of including these new elements is that climate impacts on the market economy of the USA are likely to be beneficial. Several nonmarket impacts have yet to be measured.

Although a great deal is now understood about the science of climate change, very little has yet been learned about the impacts of changing climate. As scientists become more convinced that anthropogenic emissions of greenhouse gases are disturbing the planet's climate, it is increasingly important to understand what the consequences of this change may be. All the existing comprehensive estimates of aggregate economic impacts are expert judgements (Nordhaus, 1991; Cline, 1992; Fankhauser, 1995; Tol, 1995). These in turn are based largely on a single set of empirical studies for the USA (Smith and Tirpak, 1989), which did not estimate aggregate welfare effects.

This article reviews a new set of impact studies and empirical results for the USA. These new studies (Adams *et al.*, 1996; Hurd *et al.*, 1996; Mendelsohn and Markowski, 1996; Mendelsohn *et al.*, 1996; Morrison and Mendelsohn, 1996; Segerson and Dixon, 1996; Sohngen and Mendelsohn, 1996; Yohe *et al.*, 1996) were coordinated to develop improved comprehensive measures of the impacts of global warming. For example, the studies examine the same climate scenarios (except timber) with the identical economic assumptions. Consistent assumptions were made about joint resources

such as land, water, capital, and labor. The studies were also designed to cover all impacted sectors and provide a more thorough analysis of each sector. Two types of nonmarket effects are also examined, outdoor recreation and nonmarket water impacts.

## 1. Methodology

The economic approaches employed in these parallel sector studies reflect several improvements in measuring climate sensitivity. All of these studies carefully capture adaptation. Each of the sector studies assesses the extent to which economic actors could adapt to climate change given current technology. Farmers adjust crops in response to changes in yields. Forest owners harvest vulnerable timber early and plant more in anticipation of new opportunities. The owners of coastal structures make economically rational decisions about whether to protect coastal structures from rising sea levels or gradually abandon them over time. Homeowners and stores adjust energy needs for space conditioning as climate changes outside.

Several of the studies rely on natural climate experiments. Nature contains many examples where actors adapt to different climates over the landscape. By comparing behavior in one location with one climate to that in another location with a different climate, we can see how people would adapt to climate change in the long run. For example, by comparing the farming net revenue of town A (which experiences 25°C temperatures) with the net revenue of town B (which experiences 30°C temperatures), one can see how a 5°C temperature increase may affect farming in town A. These are long-run comparisons that presume that people have adapted to the local climate they experience. The models do not assume infinite foresight on the part of actors, but merely that they adapt to what they experience. The models do not assume new technology will save everyone. The models assume that people will use existing technology, but perhaps not techniques currently employed locally. For sectors that are known to adapt quickly, this long-run approach can provide accurate impact estimates.

Some sectors, notably coastal structures and timber, are characterized by large capital stocks that are difficult to adjust over time. These sectors cannot immediately adjust from one equilibrium to another, because it can take decades to change the capital stock. Because the period of adjustment can last for decades or, in the case of climate change, for centuries, it is important to model these sectors dynamically. Comparing the equilibrium outcome today versus several centuries away provides little insight into what

will happen during the period of adjustment. Because the period of adjustment is everything in these sectors, it is crucial to capture it carefully. The dynamic model must explicitly treat how quickly climate changes and how quickly the sector can respond. The dynamic forestry and coastal models find that these sectors are sensitive to the rate of climate change, confirming the importance of using a dynamic approach.

The new studies are more comprehensive than earlier research. For example, the agriculture study extends previous analyses of grains to include effects on livestock, fruits, and vegetables. Not only does this capture a larger fraction of the agricultural sector, but it explicitly includes farming activities that predominate in warmer environments. The energy analysis extends earlier research in electricity to include all fuels. Because electricity is used primarily for cooling, extending the analysis to all fuels provides a more balanced treatment of both heating and cooling. The recreation study extends earlier work on skiing to include summer outdoor recreation activities. Although warming should shorten the winter season, it should also tend to lengthen the summer season, when most outdoor recreation occurs. These changes alter the results. Whereas earlier research focused on measuring phenomena that were damaged by warming, the parts of these sectors that they omitted often benefit from warming.

The set of new studies was carefully designed to be consistent across sectors so that the results could be aggregated into a single index. For example, each study explored the same temperature and precipitation scenarios. Effects across studies could then be aggregated for each scenario. Care was taken to make consistent assumptions across shared resources. For example, as temperature rises, agriculture turns to more irrigation and so requires a bigger share of water consumption. The projected increase in irrigation in the agricultural sector model was included in the water sector model. As forests become more productive, the forestry model projects that forest land will increase slightly in some marginal agricultural areas. Care was taken to protect highly valued agricultural lands, which were needed in the farming sector. Similar economic assumptions were also used across scenarios, where possible. For example, each study assumed that US gross national product would grow to \$20.8 trillion by 2060 and the US population would grow to 294 million (Houghton *et al.*, 1990).

The scenarios examined a broad range of climatological projections. Climate scenarios were chosen across the range of plausible values suggested by the Intergovernmental Panel on Climate Change (IPCC; Houghton *et al.*, 1990). Temperature increases of 1.5, 2.5, and 5.0°C were included, whereas

previous studies focused more closely in the neighborhood of 4.5°C temperature increases. As forecasts of future climate change have been moderated in recent years, these other impact studies have become obsolete. However, by providing a range of responses, these new studies can adapt to many different forecasts. For each temperature increase, precipitation was assumed to increase by 0%, 7%, and 15%, for a total of nine climate scenarios. For most of the studies, temperature and precipitation changes were assumed to be uniform across the continental USA and across seasons. With the timber study, the climate predictions come from global circulation models (GCMs) that predict regional and seasonal patterns of change.

Many climate scientists do not believe that a uniform temperature increase is likely. Consequently, they argue for using GCM predictions instead. However, recent analyses of multiple GCM runs indicated that the expected impact from using a large set of GCMs was identical to using a uniform climate change model for the USA (Williams *et al.*, 1996). The study also indicated that a large set of GCMs produce a wide variance in predicted impacts. Consequently, we explored using GCMs for the agriculture, energy, and recreation studies. Both of the dynamic studies (timber and sea level rise) also specified a path of climate change from current to future conditions. Carbon dioxide was assumed to increase to 530 ppm [710 ppm in the timber study, which was determined by assumptions in the ecological modeling (VEMAP Members, 1996)], which is consistent with a doubling of all greenhouse gases from preindustrial times. The coastal study tested the impacts from rising sea levels of 0.33, 0.66, and 1.0 meter by 2100.

## 2. Results

Table 1 summarizes the impacts predicted for an economy in 2060 with a climate scenario of a 2.5°C temperature increase, a 7% precipitation increase, a carbon dioxide level of 530 ppmv, and a 33-cm sea level rise. This scenario reflects the IPCC's central estimates of temperature, precipitation, and atmospheric carbon dioxide increases (Houghton *et al.*, 1990). There are two important policy conclusions to be drawn from the results in Table 1: (1) the effects that will occur will be small relative to the size of the economy, and (2) the new models and methods predict that warming will result in a net benefit to the economy, rather than the net loss suggested by previous research.

There are several explanations for the more optimistic results of the current study in comparison with previous work. The new, more comprehensive



**Table 1.** The economic impacts of climate change in 2060<sup>a</sup> (in billion US dollars).

	Impact
Market sectors	
Farming	41.4
Timber <sup>b</sup>	3.4
Coastal structures <sup>c</sup>	-0.1
Residential energy	
Commercial energy	-4.1
Water	-3.7
Total market	36.9
% of GNP	0.2
Nonmarket sectors	
Recreation	3.5
Water	-5.7

<sup>a</sup>Positive numbers represent benefits and negative numbers represent damage. Estimates based on 530 ppmv of CO<sub>2</sub> and uniform expected climate change.

<sup>b</sup>Timber uses GCM, not uniform climate scenarios, and 710 ppmv of CO<sub>2</sub>.

<sup>c</sup>Sea level scenario assumes 33 cm rise by 2100.

measures of these sectors generally benefit from warming (e.g., citrus and vegetable crops in agriculture, heating in energy, summer activities in recreation). The new studies do a more complete job of including adaptation. Adaptation increases benefits and reduces damage. The sectors dependent on the ecosystem benefitted from carbon fertilization and were not seriously damaged by warming. Agronomic studies suggest that carbon fertilization is likely to offset some, if not all, of the damage from warming. Forest ecology models suggest that the northern expansion of productive southern pines more than offsets reductions in productivity per hectare (VEMAP Members, 1996). Dynamic micro-analyses of the coastal and timber sectors predict damage would be smaller than earlier static analyses. Finally, estimates of climate change have moderated over the past decade. Whereas earlier impact studies examined the implications of climate changes of a 4.5°C or more temperature increase with sea levels rising one meter, doubling projections now center on a 2.5°C temperature increase with sea levels rising 33 cm (Houghton *et al.*, 1990).

It is worth noting that this study focuses on impacts in 2060 instead of 1990. Earlier studies used the 1990 economy as a point of comparison, because it is an easy benchmark to agree on. Warming, if it is to occur,

however, will take many decades. The 1990 economy will have transformed to the 2060 economy (or a later economy) by the time a 2.5°C temperature change materializes. Because some sectors grow and others do not, the impacts in 2060 could be quite different than those in 1990. Furthermore, the plausibility that the economy will have adjusted in 2060 to a small climate change is far more credible than if the change were to occur spontaneously.

The warming scenario benefits the US market economy by about \$37 billion. The farming, timber, and commercial energy sectors all benefit from warming. In contrast, the coastal structures, residential energy, and water sectors are all damaged. The largest effect by far occurs with respect to farming, which enjoys a vast increase in supply from carbon fertilization. Overall, however, the effect is small compared with the projected US economy in 2060. The total benefit from warming to the economy is only 0.2% of the economy.

Warming has different effects on the two studied nonmarket sectors: water quality and outdoor recreation. Water quality is harmed by warming because of predicted reductions in mean runoff. Recreation largely benefits from warming because of the relatively large increases in fishing and boating benefits associated with prolonged summer seasons. These two sectors largely offset each other. Little can be concluded about the effect of warming on quality of life from these water and recreation analyses, because several other important nonmarket impacts (health, species loss, and human amenities) have yet to be quantified.

The results reported in Table 1 are conditional on the selected climate and economic scenario tested. Alternative climate scenarios and economic projections lead to a wide range of impacts. With more severe climate scenarios, damage increases and benefits shrink. The slower the economic growth, the smaller the impact. All the climate sensitivity estimates are empirical and thus uncertain. Policy responses by the government can inhibit efficient responses, which would increase damage. New technologies may be better able to adapt to changing conditions, which would decrease damage and increase benefits. The impact of climate change on other countries may be different from the effects on the USA. Foreign impact can affect US welfare through trade. If other countries increase their productivity, prices could fall, resulting in gains for domestic consumers and losses for domestic producers. If other countries have lower productivity because of warming, prices would rise, which would hurt domestic consumers and help domestic producers.

The improvements described above in the economic modeling of climate change impacts suggest that modest warming would result in small but beneficial impacts to the American economy. These results are more optimistic than previous analyses and should be incorporated into ongoing efforts to determine the optimal policy response to greenhouse warming. The results strongly suggest that aggregate market impacts in the USA are not a motivating factor for near-term action to reduce emissions of greenhouse gases.

These market studies, however, do not address all potential impacts from climate change, including some potentially large impacts from human health, species loss, and aesthetic changes. The optimal response to greenhouse warming will depend on the magnitude of these effects, as well. The study also does not address the climate sensitivity of the economies of other countries, especially developing countries. Given the worldwide consequences of greenhouse gases, it is important to measure impacts beyond US boundaries. Many of the methods demonstrated in this US study, particularly the less data-intensive “natural experiments,” could be applied directly in other developed countries and, with careful adjustment, to developing countries.

### Acknowledgments

This research was funded by the Electric Power Research Institute and the US Department of Energy. We thank Jim Neumann, Tom Wilson, A. Myrick Freeman III, John Houghton, William Nordhaus, Roger Sedjo, Joel Smith, and Robert Unsworth for their comments.

### References

- Adams, R., McCarl, B., Segerson, K., Rosenzweig, C., Bryant, K., Dixon, B., Connor, R., Evenson, R., and Ojima, D., 1996, *The Economic Effect of Climate Change on US Agriculture*, Report to the Electric Power Research Institute, Palo Alto, CA, USA.
- Cline, W., 1992, *The Economics of Global Warming*, Institute of International Economics, Washington, DC, USA.
- Fankhauser, S., 1995, *Valuing Climate Change: The Economics of the Greenhouse*, Earthscan, London, UK.
- Houghton, J.T., Jenkins, G.J., and Ephraums, J.J. (eds.), 1990, *Climate Change: The IPCC Scientific Assessment*, Cambridge University Press, Cambridge, UK.
- Hurd, B., Callaway, M., and Smith, J., 1996, *Economic Effect of Climate Change on Water Resources*, Report to the Electric Power Research Institute, Palo Alto, CA, USA.

- Mendelsohn, R., and Markowski, M., 1996, *The Economic Effect of Climate Change on Outdoor Leisure*, Report to the Electric Power Research Institute, Palo Alto, CA, USA.
- Mendelsohn, R., Nordhaus, W., and Shaw, D., 1996, *The Economic Effect of Climate Variation on US Agriculture*, Report to the Electric Power Research Institute, Palo Alto, CA, USA.
- Morrison, W., and Mendelsohn, R., 1996, *The Economic Effect of Climate Change on US Energy Expenditures*, Report to the US Department of Energy, Washington, DC, USA.
- Nordhaus, W., 1991, To Slow or Not to Slow: The Economics of the Greenhouse Effect, *The Economic Journal* **101**:920–937.
- Segerson, K., and Dixon, B., 1996, *Climate Change and US Agriculture: The Role of Farmer Adaptation*, Report to the Electric Power Research Institute, Palo Alto, CA, USA.
- Smith, J., and Tirpak, D., 1989, *The Potential Effects of Global Climate Change on the USA: Report to Congress*, US Environmental Protection Agency, Washington, DC, USA.
- Sohngen, B., and Mendelsohn, R., 1996, *The Economic Effect of Climate Change on US Timber Markets*, Report to the Electric Power Research Institute, Palo Alto, CA, USA.
- Tol, R., 1995, The Damage Costs of Climate Change: Toward More Comprehensive Calculations, *Environmental Resource Economics* **5**:353–374.
- VEMAP Members, *Global Biogeochemical Cycles* **9**:407–437.
- Williams, L., Shaw, D., and Mendelsohn, R., 1996, *Evaluating GCM Output with Impact Models*, Report to the Electric Power Research Institute, Palo Alto, CA, USA.
- Yohe, G., Neumann, J., Marshall, P., and Ameden, H., 1996, *Climatic Change* **32**:387–410.

# Equity and the Aggregation of the Damage Costs of Climate Change\*

*Richard S.J. Tol*

Institute for Environmental Studies, Vrije Universiteit, Amsterdam

*Samuel Fankhauser*

Global Environment Facility Secretariat, Washington, DC

*David W. Pearce*

Centre for Social and Economic Research on the Global Environment,  
University College London and University of East Anglia

## 1. Introduction

Economic assessment of the impacts of climate change has advanced considerably, but many improvements are conceivable. Experience gained during the preparation of the chapter on social cost in the Second Assessment Report (SAR) of the Intergovernmental Panel on Climate Change (IPCC), Working Group III (Pearce *et al.*, 1996), suggests that equity aspects of impact valuation, comparison, and aggregation should be high on the list of research priorities. This paper focuses on aggregation, showing one way damage estimates can be corrected for inequalities in income distribution. In the proposed model, regional damage estimates are weighted with an equity factor derived from the social welfare functions of world regions and the entire world. Equity weighting can significantly increase global damage figures, although some specifications of weighting functions also imply reduced estimates. The use of equity weights requires value judgements by decision makers or analysts. It is also shown that equal valuation – despite empirical evidence – implies a global welfare function, possibly with undesirable properties.

Section 2 of this paper contains a brief account of the state of the art as reflected in the SAR of the IPCC, correcting a somewhat unfortunate way of expressing damage in poorer countries. In Section 3, various ways

---

\*Most of the work for this paper was done during Sam Fankhauser's association with the Centre for Social and Economic Research on the Global Environment (CSERGE). The opinions put forward here are those the authors and cannot be attributed to the Global Environment Facility (GEF) or its associated agencies.

of aggregating estimates over countries with different levels of economic development are discussed. The implications of equal valuation are treated in Section 4, and some conclusions are presented in Section 5.

## 2. Background

Scientific research on global warming impacts has focused predominantly on the (arbitrarily chosen)  $2\times\text{CO}_2$  scenario, in other words, the impacts of an atmospheric carbon dioxide ( $\text{CO}_2$ ) concentration that is twice the preindustrial level. In addition, most research focuses on the impact climate change would have on the present situation. Although counterfactual (the long-term vulnerability profile could change as a consequence of economic development and population growth), the advantages of this approach are that only one variable (climate) is altered and that projections of future worlds are avoided.

Climate change impacts can be classified as being either market related (affecting tradable goods and services) or nonmarket related (affecting “intangibles” such as ecosystems or human health). Table 1 categorizes the expected impacts of global warming. Climate change will affect a broad range of economic sectors and activities, as well as natural systems. Impacts on coastal zones, human health, water supply, and agricultural production are likely to be among the most serious effects. Table 1 also assesses how carefully these impacts have been estimated in the literature so far. It is clear that, despite a growing body of literature, much remains to be done. It should be noted that estimates include both adaptation costs and residual damage. The former include the costs of coastal protection and migration, and the change in energy demand due to alterations in space heating and cooling requirements. The underlying adaptation assumptions, however, are not explicitly stated for most impact categories.

Monetary estimates of both market and nonmarket damage are ideally expressed in the form of willingness to pay to obtain a good or service (WTP), or willingness to accept compensation to forego a good or service (WTA). WTP measures the amount of income a person is willing to forego in exchange for improvements in the state of the world; WTA is an estimate of the compensation required to accept a deterioration in the state of the world. With regard to climate change, WTP values improvements over business-as-usual scenarios, whereas WTA values deterioration of present conditions. Both measures are used in welfare economics as a way to determine individuals' preferences in monetary terms. They are often used interchangeably,

**Table 1.** Overview of climate change impacts.

Damage	Market impacts			Nonmarket impacts			
	Primary economic sector damage	Other economic sector damage	Property loss	Damage from extreme events	Ecosystem damage	Human impacts	Damage from extreme events
Fully estimated based on willingness to pay	Agriculture		Dryland loss, coastal protection		Wetland loss		
Fully estimated using approximations	Forestry	Water supply		Hurricane damage	Forest loss		Hurricane damage
Partially estimated	Fisheries <sup>a</sup>	Energy demand, leisure activity	Urban infrastructure	Damage from droughts <sup>b</sup>	Species loss	Human life, air pollution, water pollution, migration	Damage from droughts <sup>b</sup>
Not estimated		Insurance costs, construction, transport, energy supply		Nontropical storms, river floods, hot/cold spells, other catastrophes	Other ecosystems loss	Morbidity, physical comfort, political stability, human hardship	Nontropical storms, river floods, hot/cold spells, other catastrophes

<sup>a</sup>Often included in wetland loss.

<sup>b</sup>Primarily agricultural damage.

Source: Pearce *et al.*, 1996.

**Table 2.** Aggregate monetary damage for  $2\times\text{CO}_2$  levels (annual damage).

Region	Damage	
	Percent of GDP	Percent of real GDP <sup>a</sup>
Developed countries (OECD)	1.0 to 3.0	1.0 to 4.0
Developing countries and countries with economies in transition	-0.5 to 9.0	-0.5 to 7.0
World	1.5 to 2.0	1.0 to 2.0

<sup>a</sup>GDP corrected for differences in purchasing power parity.

Source: Fankhauser and Tol, 1995.

although WTA estimates are generally (and sometimes substantially) higher than WTP estimates. Studies on climate change damage costs predominantly focus on WTP, although WTA has also been used for some damage categories. There has been discussion about which concept is appropriate for the enhanced greenhouse effect. This discussion relates to issues of responsibility and equity and is not elaborated here (for more information, see Fankhauser *et al.*, 1996b). Unfortunately, WTP and WTA estimates are not available for all global warming impacts. Reductions in revenues, the return on input factors (such as capital or land), and other indicators are frequently used to approximate the welfare impacts of climate change (see Table 1). Often, WTP and WTA estimates are based on study results transferred from issues other than climate change, or from one region to another.

Available estimates on the costs of climate change are therefore neither accurate nor complete, and there is a considerable range of error. Figures on developing countries, in particular, are usually based on approximations and extrapolations, and are clearly less reliable than those for developed regions. Nevertheless, the available estimates can serve as an indication of the relative vulnerability of different regions.

Table 2, which is based on the extensive literature survey of IPCC Working Group III, shows the aggregate damage often associated with  $2\times\text{CO}_2$  levels. Figures range between -0.5% and 9.0% of gross domestic product (GDP), with damage in developing countries typically accounting for a greater percentage of GDP than that in Organisation for Economic Co-operation and Development (OECD) countries. The damage estimates reported by the IPCC, while in most cases corrected for differences in purchasing power parity (PPP), are expressed as a percentage of uncorrected GDP. In addition to the IPCC figures, Table 2 also shows calculations that express damage as a percentage of real (PPP-corrected) GDP, with PPP corrections



**Table 3.** Damage resulting from  $2\times\text{CO}_2$  levels in monetary terms, by world regions.

Region	Fankhauser		Tol	
	Bln.US\$	% of GDP <sup>a</sup>	Bln.US\$	% of GDP <sup>a</sup>
European Union	63.6	1.4	–	–
USA	61.0	1.3	–	–
Other OECD	55.9	1.2	–	–
OECD America	–	–	74.5	1.5
OECD Europe	–	–	57.4	1.6
OECD Pacific	–	–	60.7	3.8
<i>Total OECD</i>	180.5	1.3	192.7	1.9
E. Europe/Former USSR	29.8 <sup>b</sup>	0.4 <sup>b</sup>	–14.8	–0.4
Centrally Planned Asia	50.7 <sup>c</sup>	2.9 <sup>c</sup>	–4.0	–0.1
South and Southeast Asia	–	–	92.2	5.3
Africa	–	–	46.4	6.9
Latin America	–	–	40.3	3.1
Middle East	–	–	11.5	5.5
<i>Total Non-OECD</i>	141.6	0.9	171.7	1.7
<i>World</i>	322.0	1.1	364.4	1.8

<sup>a</sup>GDP corrected for differences in purchasing power parity; GDP base may differ between the studies.

<sup>b</sup>Former USSR only.

<sup>c</sup>China only.

Source: Fankhauser and Tol, 1995. The figures in this table differ from those in Pearce *et al.*, 1996; these figures are fully corrected for purchasing power parity.

where this had not been done initially. The differences between the two sets of estimates are small compared with the likely range of error.

The figures in Table 2 are *best guess* estimates. They do not reflect uncertainties and they neglect the possibility of impact surprises and low-probability/high-impact events (such as a drastic change in ocean currents).

Considerable regional differences are likely, with the potential for relatively high impacts for some individual countries, such as small island states. Table 3 shows some of the estimates that underlie the figures in Table 2, highlighting the substantial differences between regions. The estimates are again corrected for differences in PPP. For the former USSR, for example, damage could be as low as 0.4% of real (PPP-corrected) GDP, or might even be negative (climate change is potentially beneficial). Asia and Africa, on the other hand, could face extremely high levels of damage, mainly due to

the severe life/morbidity impacts. Mortality estimates are extremely volatile and controversial, however, and should be interpreted with caution. Developing countries generally tend to be more vulnerable to climate change than developed countries, because of the greater importance of agriculture, the lower health standards, and the stricter financial, institutional, and knowledge constraints on adaptation.

The wide range of results shows that, although a rough picture of regional vulnerability to climate change is starting to emerge, much additional research is still necessary to improve the currently limited understanding of the issue.

### 3. Aggregation

The damage estimate for the world listed in Tables 2 and 3 results from simply totaling the regional damage estimates. The implicit assumption is that the current income distribution is fair, or that distributional impacts are of secondary importance. This assumption can be criticized. Alternatively, worldwide damage can be expressed as

$$D^{world} = \left\{ \frac{W_1 \cdot u_Y^1}{W_M} \right\} D^1 + \dots + \left\{ \frac{W_n \cdot u_Y^n}{W_M} \right\} D^n \quad , \quad (1)$$

where the terms in brackets denote “equity weights.”  $D$  denotes climate change damage;  $i=1,2, \dots, n$  denotes the region;  $W_i$  denotes the first-order derivative of global welfare with respect to  $u^i$ ;  $u_Y^i$  denotes the marginal welfare of income of region  $i$ ; and  $W_M$  denotes marginal value of income, that is, the maximum global welfare increase that can be achieved with an additional unit of income. Equity weights are thus built up from three elements: the change in regional welfare due to climate change damage, the change in global welfare due to the change in regional welfare, and the optimal way to change global welfare. Note that if the income distribution is considered just, equity weights all equal one. [For a detailed derivation of equation (1), see Fankhauser *et al.* (1996a).] Equation (1) rests on four crucial assumptions: that meaningful welfare functions exist; that valuable goods and services are approximately substitutable; that climate change damage is small in each region – equation (1) is a linear approximation; and that climate change does not change the relative welfare of regions.

A number of additional assumptions are needed before equation (1) can be used. We employ a conventional CRRA (constant relative rate of risk

**Table 4.** Global 2×CO<sub>2</sub> damage, corrected for income inequality (bln.US\$/year).

	Fankhauser, 1995	Tol, 1995
Uncorrected damage	322.0	364.4
Utilitarian welfare function		
$e = 0.5$	315.6	411.4
$e = 1.0$	405.2	614.3
$e = 1.5$	621.9	1,057.6
Bernoulli-Nash welfare function <sup>a</sup>	405.2	614.3
Maximin welfare function		
$e = 0.5$	95.8	89.4
$e = 1.0$	181.0	172.2
$e = 1.5$	342.7	331.8

<sup>a</sup>Bernoulli-Nash weights are independent of  $e$ , and correspond to the case  $e=1$  of the utilitarian welfare function.

Source: Fankhauser *et al.*, 1996a.

aversion) utility function that depends solely on income (superscripts are suppressed for simplicity) for regional welfare:

$$u = \frac{a}{(1-e)} \cdot Y^{(1-e)} \quad (2)$$

Different values for parameter  $e$  (the income elasticity of marginal welfare) will be used below. Values between 1.0 and 1.5 are commonly used in the literature (see, for example, the discussion in Cline, 1992), although Pearce and Ulph (1994) note that household behavior models support lower values of about 0.8. Each region is assumed to have the same welfare function.

A useful specification for the global welfare function that encompasses a number of concepts is

$$W = \frac{\sum_{i=1}^n u^i(\cdot)^{(1-\gamma)}}{(1-\gamma)} \quad (3)$$

where  $\gamma$  is a parameter of inequality aversion: the larger  $\gamma$  is, the greater the concern about equality. For  $\gamma=0$ , equation (3) reduces to a utilitarian welfare function. Letting  $\gamma$  approach 1 leads to a Bernoulli-Nash function, while  $\gamma \rightarrow \infty$  represents the maximin (Rawlsian) paradigm (see Boadway and Bruce, 1984).

Table 4 presents the global aggregate damage for different values of  $e$  and  $\gamma$ . For  $\gamma=0$  (i.e., utilitarian welfare), Tol's equity-weighted global damage is considerably higher than non-equity-weighted damage and increases as inequality aversion  $e$  increases. Fankhauser's equity-weighted damage is lower than non-weighted damage for  $e=0.5$ , but increases rapidly for higher values of the inequality aversion parameter. The explanation for this result is that, in general, Fankhauser estimates the poorer regions to be slightly less vulnerable than the richer regions to climate change (hence an initial drop in damage), but the weight assigned to China – which is highly vulnerable – increases rapidly with  $e$ . Note that for  $e=0$  (a linear regional welfare function), weighted and unweighted damages coincide. With a linear regional welfare function, marginal welfare is identical across individuals and income levels. Because the same is true for marginal global welfare, changes in income have a constant effect on global welfare, independent of where the changes occur. If  $\gamma$  approaches unity (i.e., Bernoulli-Nash welfare), equity weights become independent of risk aversion. The resulting weights equal the case  $\gamma=0$  and  $e=1$ . For  $\gamma \rightarrow \infty$  (i.e., maximin welfare), Fankhauser's equity-weighted figures are much lower than the simple aggregate for low values of  $e$ , but exceed the non-equity-weighted aggregate for higher values. Tol's figures are somewhat lower: the region with the lowest per capita income (PPP-corrected) is Africa. Obviously, damage increases as parameter  $e$  increases.

#### 4. The Implicit Assumption behind Uniform Values

Some papers on estimating climate change damage have advocated the use of uniform unit values for damage (e.g., Ayres and Walter, 1991; Hohmeyer and Gärtner, 1992; Ekins, 1995; Meyer and Cooper, 1995). Note the difference between a global assessment without regional distinctions and a global assessment with regional distinctions. In the former case, the common way to proceed is to value everything at a global average, in the same way that Fankhauser and Tol (1995) valued at regional averages. It is the latter case that we are interested in, where regions are distinguished and damage is regionally assessed and subsequently compared and aggregated. It is important to note that the case in favor of uniform damage valuation in all these papers is made on the basis of *ad hoc* decisions, not welfare theoretic reasoning. This section analyzes these value judgements in the framework

of the model of Section 3, and calculates the type of global welfare function implicitly assumed when using uniform unit damage values.

For the sake of simplicity, individuals are divided into only two groups, inhabitants of OECD countries (denoted by superscript  $r$ ) and inhabitants of non-OECD countries (including middle-income countries such as those with economies in transition; denoted by superscript  $p$ ). We are interested in the ratio of per unit damage values (e.g., the relative WTP per km<sup>2</sup> of wetlands). Suppose the ratio actually observed, based on the current income distribution, is  $V^r/V^p$ . The goal then is to choose the parameters of the regional and global welfare functions such that the ratio of equity-weighted per unit values is unity. Using equation (1), this requirement can be written as

$$\left\{ \frac{W_r \cdot u_Y^r}{W_p \cdot u_Y^p} \right\} \cdot \frac{V^r}{V^p} = 1 \quad . \quad (4)$$

Using equation (3) for global welfare and equation (2) to specify regional welfare, after some manipulation equation (4) becomes

$$e \cdot \gamma - \gamma - e = \Omega \quad , \quad (5)$$

with  $\Omega = [\ln(V^p) - \ln(V^r)] / [\ln(Y^r) - \ln(Y^p)]$ . Recall that  $\gamma$  is the parameter for inequality aversion in the global welfare function, and  $e$  is the income elasticity of the marginal regional welfare. That is, for any given values for  $\Omega$  and  $e$  (which are both determined empirically), the presumption that climate change impacts are to be valued equally implies a certain value for  $\gamma$ , and thus a certain degree of inequality aversion.<sup>1</sup>

Table 5 presents  $\gamma$  as a function of  $e$  and  $V^r/V^p$ . As before, we assume values for  $e$  between 0 and 2, with values of 0.8–1.5 being the most likely specification according to empirical evidence (see Cline, 1992; Pearce and Ulph, 1994). The ratio  $V^r/V^p$  is more difficult to determine, because empirical evidence is scarce. An often used starting point is to assume an income elasticity of WTP of one (Pearce, 1980). In this case, WTPs as proportions of income are identical for all individuals. That is,  $V^r/Y^r = V^p/Y^p$ , which in turn implies a value of  $V^r/V^p = Y^r/Y^p$ , or a ratio of about four (recall that  $Y$  is purchasing-power-corrected per capita income and that the group of poorer countries includes middle-income as well as low-income countries). The estimates quoted in Pearce *et al.* (1996) took the same starting point; however, rounding and extrapolation inaccuracies, as well as deviations from

<sup>1</sup>Note that we only require equal values between regions, not equal values at a particular level. The latter would imply an additional restriction on (5).

**Table 5.** Implied inequality aversion ( $\gamma$ ) as a function of risk aversion ( $e$ ) and empirical value ratio ( $V^r/V^p$ ).

$V^r/V^p$	1.36	2	4 <sup>a</sup>	8	10
Elasticity of WTP	0.35	0.66	1.00	1.16	1.20
$\gamma$ , for					
$e = 0.0$	0.22	0.50	1.00	1.49	1.65
$e = 0.5$	-0.56	-0.01	1.00	1.98	2.31
$e = 1.0$	$\pm\infty^b$	$\pm\infty^b$	1.00	$\pm\infty^c$	$\pm\infty^c$
$e = 1.5$	2.56	2.01	1.00	0.02	-0.31
$e = 2.0$	1.78	1.50	1.00	0.51	0.35

<sup>a</sup>Corresponds to the case  $V^r/V^p = Y^r/Y^p$ .

<sup>b</sup> $\gamma \uparrow \infty$  for  $e \downarrow 1$ , and  $\gamma \downarrow -\infty$  for  $e \uparrow 1$ .

<sup>c</sup> $\gamma \downarrow -\infty$  for  $e \uparrow 1$ , and  $\gamma \uparrow \infty$  for  $e \downarrow 1$ .

Source: Fankhauser *et al.*, 1996a.

this rule for some damage categories, led to a slightly higher average income elasticity of WTP, in the order of 1.15–1.20. This result implies a  $V^r/V^p$  ratio of about 8–10.<sup>2</sup> Flores and Carson (1995) and Kriström and Riera (1996) argue that elasticities generally tend to be less than one, and Krupnick *et al.* (1995), for example, have assumed a value of 0.35–1.0 for statistical life estimates in Eastern Europe. This second set of studies would imply a much lower  $V^r/V^p$  ratio, perhaps in the order of 1.3–4.0. Table 5 presents estimates of  $\gamma$  for both sets of assumptions.

As Table 5 shows, the postulate of uniform per unit values is compatible with many sets of “reasonable” parameter assumptions, but by no means with all of them. For several parameter specifications, common values imply degrees of inequality aversion in the utilitarian ( $\gamma=0$ ) or Bernoulli-Nash range ( $\gamma=1$ ).<sup>3</sup> In the case of a unitary income elasticity of WTP, for example, uniform per unit values imply a Bernoulli-Nash welfare function. Other parameter sets imply higher degrees of inequality aversion, and in the case of a logarithmic regional welfare function ( $e=1$ ), equal values are only compatible with a maximin welfare concept ( $\gamma = \infty$ ).

There are also cases where the notion of common per unit values would seem untenable. As Table 5 shows, there are parameter combinations for which common per unit values imply negative values for  $\gamma$ , that is, “inequality attraction,” which could in the limit go to a maximax (Nietzschean)

<sup>2</sup>This figure is an average value between middle-income and low-income country ratios, which are all subsumed in the “poor” group. The middle-income country ratio assumed by Fankhauser (1995) is about 4:1, and the low-income country ratio is in the order of 10:1 to 15:1.

<sup>3</sup>Although  $\gamma=1$  is only approached for  $e \uparrow \infty$  and  $e \downarrow \infty$ .

welfare concept ( $\gamma = -\infty$ ). With certain parameter combinations, weighted per unit damage estimates for the “poor” region can be higher than those for the “rich” region. The restriction of equal values then favors the rich. Clearly, this would be an indefensible welfare concept, and it would therefore be hard to make a case for common per unit values should these particular parameter values prevail. As noted, the question of the appropriate regional welfare and WTP parameters is an empirical one, about which precious little is known to date.

## 5. Conclusions

It is arguable that climate change is such a large and pervasive issue that it is right for equity arguments to be integrated into a benefit-cost comparison, even though equity weighting is no longer common in benefit-cost analysis. This paper shows one approach to equity weighting in the aggregation of damage estimates for world regions into a global damage estimate.

In our approach, equity weights depend on regional and global welfare functions, notably, the degrees of risk aversion and inequality aversion. Equity-weighted global damage estimates can be substantially higher than the damage estimates presented by the IPCC SAR (Pearce *et al.*, 1996), although reduced damage cannot be excluded. The simple aggregation underlying the figures reported in the IPCC SAR implies unacceptable welfare functions.

The degree of inequality aversion required for per unit damage values to be the same in rich and in poor countries – a notion frequently called for in the debate on the chapter on social costs of the IPCC SAR – is compatible with a wide range of “reasonable” welfare functions, but can also be incongruous with defensible welfare concepts.

## References

- Ayres, R., and Walter, J., 1991, The Greenhouse Effect: Damages, Costs and Abatement, *Environmental and Resource Economics* 1:237–270.
- Boadway, R., and Bruce, N., 1984, *Welfare Economics*, Basil Blackwell, Cambridge, MA, USA.
- Cline, W.R., 1992, *The Economics of Global Warming*, Institute for International Economics, Washington, DC, USA.
- Ekins, P., 1995, Rethinking the Costs Related to Global Warming: A Survey of the Issues, *Environmental and Resource Economics* 5:1–47.
- Fankhauser, S., 1995, *Valuing Climate Change: The Economics of the Greenhouse*, Earthscan, London, UK.

- Fankhauser, S., and Tol, R.S.J., 1995, The Social Costs of Climate Change: The IPCC Second Assessment Report and Beyond, Working Paper W-95-34, Institute for Environmental Studies, Vrije Universiteit, Amsterdam, Netherlands.
- Fankhauser, S., Tol, R.S.J., and Pearce, D.W., 1996a, The Aggregation of Climate Change Damages: A Welfare Theoretic Approach, *Environmental and Resource Economics* (submitted).
- Fankhauser, S., Pearce, D.W., Tol, R.S.J., and Vellinga, P., 1996b, *Extensions and Alternatives to Climate Change Damage Valuation: On the Critique on IPCC Working Group III* (in preparation).
- Flores, N.E., and Carson, R.T., 1995, *The Relationship between the Income Elasticities of Demand and Willingness to Pay*, Department of Economics, University of California, San Diego, CA, USA.
- Hohmeyer, O., and Gärtner, M., 1992, The Costs of Climate Change, Report to the Commission of the European Communities, Fraunhofer Institut für Systemtechnik und Innovationsforschung, Karlsruhe, Germany.
- Kriström, B., and Riera, P., 1996, Is the Income Elasticity of Environmental Improvements Less Than One? *Environmental and Resource Economics* 7:45-55.
- Krupnick, A., Harrison, K., Nickell, E., and Toman, M., 1995, The Value of Health Benefits from Ambient Air Quality Improvements in Central and Eastern Europe: An Exercise in Benefit Transfer, Discussion Paper ENR 93-19-REV, Resources for the Future, Washington, DC, USA (revised version, May).
- Meyer, A., and Cooper, T., 1995, A Recalculation of the Social Costs of Climate Change, *The Ecologist - Occasional Paper Series*.
- Pearce, D.W., 1980, The Social Incidence of Environmental Costs and Benefits, in T. O'Riordan and R.K. Turner (eds.), *Progress in Resource Management and Environmental Planning*, Vol. 2, Wiley, Chichester, UK.
- Pearce, D.W., and Ulph, D., 1994, *Discounting and the Early Deep Disposal of Radioactive Waste*, A Report to United Kingdom NIREX Ltd, Centre for Social and Economic Research on the Global Environment, University College London and University of East Anglia, Norwich, UK.
- Pearce, D.W., Cline, W.R., Achanta, A.N., Fankhauser, S., Pachauri, R.K., Tol, R.S.J., and Vellinga, P., 1996, The Social Costs of Climate Change, in J.P. Bruce, H. Lee, and E.F. Haites (eds.), *Climate Change 1995: Economic and Social Dimensions of Climate Change - Contribution of Working Group III to the Second Assessment Report of the Intergovernmental Panel on Climate Change*, Cambridge University Press, Cambridge, UK.
- Tol, R.S.J., 1995, The Damage Costs of Climate Change - Toward More Comprehensive Calculations, *Environmental and Resource Economics* 5:353-374



**Part II**  
**Greenhouse Gas Emissions**  
**Abatement Measures and**  
**Strategies**



# Future Projections and Structural Change\*

*Philip Bagnoli*

The Brookings Institution, Washington, DC, USA

*Warwick J. McKibbin*

Australian National University, ACT 0200, Australia

*Peter J. Wilcoxon*

The University of Texas at Austin, Austin, TX, USA

## Abstract

This paper argues that using simple extrapolations of aggregate gross domestic product (GDP) growth as a basis for projecting energy use and carbon emissions in the medium term is potentially misleading. In fact, we argue that simple extrapolations derived by projecting GDP and assuming all variables grow in proportion would do a particularly poor job of explaining the historical record (and there is no reason to expect this approach to do better in the future). In this paper we present medium-term projections for the world economy, starting with projections of future population growth and industry-level technical change based on a wide range of empirical studies. We use these projections in an empirically based multisector general equilibrium model of the world economy to calculate aggregate GDP and the sectoral composition of GDP endogenously. We then explore the sensitivity of the aggregate outcomes across economies to the assumptions about sectoral productivity growth. In particular, we use as a metric the emissions of carbon dioxide from fossil fuel use in the global economy. Under each set of assumptions we calculate the size of a carbon tax sufficient to stabilize emissions in 2010 at 1990 levels. We show that this tax varies significantly depending on the assumptions made about productivity growth at the sectoral level.

---

\*Alan Wong provided helpful assistance with data. This project has received financial support from the US Environmental Protection Agency through Cooperative Agreement CR818579-01-0, from the National Science Foundation through grant SBR-9321010, and from The Brookings Institution. The views expressed are those of the authors and should not be interpreted as reflecting the views of the trustees, officers, or other staff of the Brookings Institution, The University of Texas, the Environmental Protection Agency, or the National Science Foundation.

## 1. Introduction

Projecting the course of the world economy over the next few decades is a daunting task. To see precisely how difficult it is, one need only look at the history of the last half century. How accurately, for example, would we have been able to predict the 1995 world economy in 1965? Would anyone have imagined the sharp decline of the US steel industry, the rapid increase in market share by Japanese automobile manufacturers, the rapid growth of Japan, the rapid growth in world trade, the explosion of the computer industry, the decline in manufacturing employment and the expansion in services, the sharp decrease in energy use per capita and per unit of gross domestic product (GDP) brought about by the oil price shocks, and the transition of the US from international creditor to net debtor?

History holds at least three lessons that are important to remember. The most obvious is simply that today's projections are unlikely to be correct. Projections of the world economy should be used more to discover which variables are important than to develop point estimates of future GDP or other variables. The second lesson is that the most interesting and important events are likely to lie in the details of individual industries and countries. The third lesson, demonstrated vividly by the oil shocks of the 1970s, is that people respond to changes in prices. Together these lessons mean that projecting aggregate GDP is unlikely to be useful: it will almost certainly be wrong, and it will fail to capture the most important events. To put this another way, the 1995 world economy is clearly not a simple scaling of the 1965 economy.[1]

This paper draws on some results presented in Bagnoli *et al.* (1996) to argue that simple extrapolation of future GDP as a basis for projecting energy use and carbon emissions without taking into account the changing future structure of economies is problematic.

The third lesson is clearly illustrated in the effect of the 1973 and 1979 oil price shocks on the economies of the USA and Japan. Figure 1 shows GDP, energy use, and carbon dioxide (CO<sub>2</sub>) emissions for the USA from 1965 to 1990 (each series has been normalized to one in 1965).[2] Figure 2 shows the same series for Japan.[3] Before the 1973 increase, oil prices were low and energy use per unit of GDP was relatively constant. When prices rose, however, energy use per unit of GDP began to fall significantly. During that period, in other words, energy use was growing much more slowly than GDP. In economic terminology, American and Japanese energy users substituted away from energy when oil prices were high; in ordinary language, they

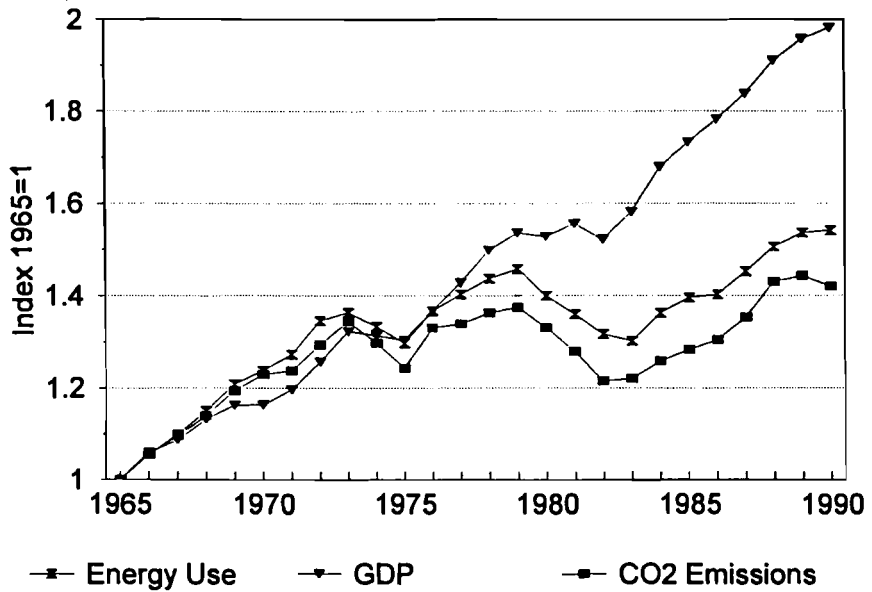


Figure 1. GDP, energy use, and CO<sub>2</sub> emissions in the USA.

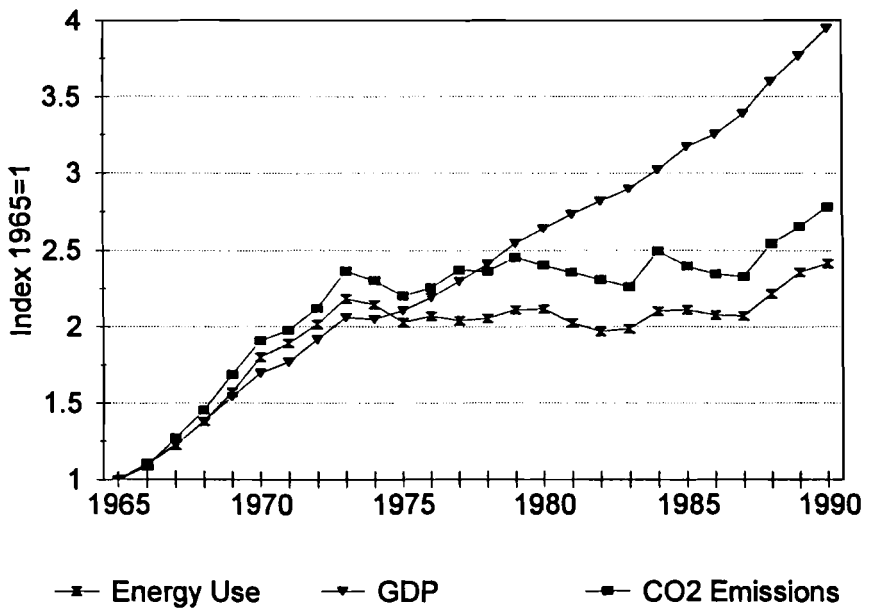


Figure 2. GDP, energy use, and CO<sub>2</sub> emissions in Japan.

conserved energy. From this example it is clear that economies can be highly responsive to changes in relative prices, even over fairly short periods of time.

The evidence in these graphs has been analyzed more formally in a number of papers using econometric techniques to quantify the responsiveness of energy demand to changes in relative prices. For example, using a model with moderate disaggregation, Ban (1991) estimates that the responsiveness of the Japanese economy to changes in energy prices has been high and much of the change in the energy–gross national product (GNP) ratio from the early 1970s to the late 1980s has been due to the response of households and firms to changes in relative prices of energy. A recent Organisation for Economic Co-operation and Development (OECD) study covering a range of countries also comes to the same conclusion. Hoeller and Coppel (1992) estimate price and income elasticities for carbon emissions using a cross section of 20 OECD countries. After accounting for energy taxes in each economy, the authors found that for 1988 the income elasticity of carbon emissions was 0.95 and the price elasticity was  $-0.75$ . In other words, these results imply that a 10% rise in the price of carbon emissions would potentially reduce carbon emissions by 7.5%. (Because this figure is based on a cross-sectional study, it should be considered a long-run result.) Both the income elasticity and the price elasticity are somewhat larger than would be consistent with the results we present below. Comparing this with the historical record suggests that a 1960 projection of current carbon emissions based on output growth alone would miss nearly half of the actual movements in carbon emissions for OECD countries!

Thus, future projections for carbon emissions depend, not just on GDP growth projections, but also importantly on changes in relative energy prices, as well as a range of other economic factors. This suggests that an exercise of this kind requires the use of a global general equilibrium model that embodies the empirical relationships we have observed during the recent decades.

In this paper we use a multisector, multiregion world economic growth model called G-Cubed to explore the roles of population growth and differential rates of productivity growth across countries and sectors in determining the future course of the world economy. G-Cubed is a neoclassical growth model in the spirit of Cass-Koopmans and Ramsey. The behavior of households and firms in the model is based on econometric evidence from the postwar period. As a result, G-Cubed will be able to capture the demonstrated ability of economies to respond to changes in relative prices. In addition, the model also accounts for physical capital accumulation, perhaps the single most important determinant of economic growth. We base our forecasts of future population on projections produced by the World Bank;

our productivity figures are taken from various papers in the productivity literature.

In addition to presenting projections of the world economy through the year 2020, we also consider how the composition of GDP growth contributes to industrial emissions of CO<sub>2</sub>, an important greenhouse gas that has received the attention of policy makers concerned about global warming.[4] In particular, we calculate how large a carbon tax would have to be to hold year 2010 emissions to 1990 levels.[5]

In the following section we present a general discussion of the sources of economic growth, drawing on the approach in Bagnoli *et al.* (1996). We then give a brief overview of the G-Cubed model in Section 3. Two projections are presented in Section 4 under the assumption of equal sectoral productivity growth and under the assumption of differential productivity growth that is more consistent with the recent historical record.

## 2. The Sources of Economic Growth

At an abstract level there are four sources of growth within an individual economy: (1) increases in the supply of labor, capital, and other inputs; (2) increases in the quality of these inputs; (3) improvements in the way inputs are used (technical change); and (4) improvements in the way that inputs are allocated across industries. For the world economy as a whole, a fifth source of growth is reallocation of inputs among countries. The first three effects can be illustrated with a simple model. Suppose an industry can be represented by the following Cobb-Douglas production function:

$$Y_t = A_t(F_t K_t)^\beta (G_t L_t)^\gamma (H_t M_t)^{(l-\beta-\gamma)} ,$$

where  $Y_t$  is output at time  $t$ ;  $K_t$ ,  $L_t$ , and  $M_t$  are inputs of capital, labor and materials, respectively;  $\beta$  and  $\gamma$  are parameters;  $A_t$  is a coefficient reflecting the overall level of productivity; and  $F_t$ ,  $G_t$ , and  $H_t$  are coefficients capturing the quality of each input.[6] This expression can be transformed into a relationship between growth rates by differentiating with respect to time and dividing through by  $Y_t$ . The result is shown below, where lower-case variables represent the rates of growth of the corresponding upper-case variables:

$$y = a + \beta(f + k) + \gamma(g + l) + (l - \beta - \gamma)(h + m) .$$

Output growth will thus be a weighted sum of overall productivity growth ( $a$ ), increases in the quantity of factors ( $k$ ,  $l$ , and  $m$ ), and increases in factor

quality ( $f$ ,  $g$ , and  $h$ ). The weights in the sum are parameters of the production function.[7] A more general expression can be obtained by relaxing the assumption that the production function is Cobb-Douglas. Suppose the production process may be represented by a constant-returns-to-scale function,  $Q$ , that depends on the level of technology,  $A$ , and quality-adjusted inputs of capital, labor, and materials:

$$Y_t = Q(A_t, F_t K_t, G_t L_t, H_t M_t) .$$

If firms minimize costs taking prices as given, it is straightforward to show that the rate of output growth will be given by

$$y = \left( \frac{1}{Q} \frac{\partial Q}{\partial A} \right) a + S_K(f + k) + S_L(g + l) + S_M(h + m) ,$$

where the first term on the right-hand side is called the rate of total factor productivity (TFP) growth, and  $S_K$ ,  $S_L$ , and  $S_M$  are respectively the shares of capital, labor, and materials in total costs. This expression is similar to the Cobb-Douglas case, except that the weights in the sum are now cost shares instead of production function parameters. In fact, the Cobb-Douglas function is a special case in which the cost share of each input can be shown to be equal to the corresponding parameter. The main difference between the two expressions is that the general case is nonparametric: decomposition of the growth rate does not depend on estimates of production function parameters. Moreover, observations of the rates of growth of inputs and outputs cannot be used to estimate parameters of the production function as no parameters are identified. For the purposes of analyzing growth, however, this is not a liability.[8]

As an empirical matter, decomposing output growth into its constituent pieces is a difficult task. For many industries measuring the rate of output growth  $y$  is fairly straightforward: the quantity produced in one year is compared with the quantity produced the previous year. However, determining the source of the growth requires very careful accounting to measure the quality-adjusted rates of growth of factor inputs. Any errors in measuring inputs will cause the rate of total factor productivity growth to be misstated.

It is worth emphasizing the last point: studies of the sources of growth use the equation above to determine TFP growth ( $tfp$ ) as a residual after accounting for other factors:

$$tfp = \left( \frac{1}{Q} \frac{\partial Q}{\partial A} \right) a = y - S_K(f + k) - S_L(g + l) - S_M(h + m) .$$



Any error in the measurement of input growth rates will cause *tfp* to be measured incorrectly. Denison (1962), Christensen and Jorgenson (1969), and others have emphasized that careful accounting for quality-adjusted growth of inputs leaves little residual growth to be attributed to improvements in TFP.

Jorgenson (1988) has shown that for the economy as a whole there is also another potential source of growth: reallocation of resources between industries. To see this, consider an economy with two sectors, *X* and *Y*. If the overall productivity of labor in sector *X* is higher than it is in sector *Y* (say because of prior technical change), a shift in final demand from *Y* to *X* shifts primary factors from *Y* to *X* and will result in growth of total output. This occurs even if there is no concurrent productivity growth in the individual sectors. The effect is even more pronounced if the composition of demand shifts toward sectors that have productivity growth rates that are higher than average.

Thus, in order to project the world economy over the next few decades we would need underlying projections of each country's labor force, capital stock, materials inputs, changes in factor quality, and changes in product demand patterns. Many of these will lead to changes in relative prices and thus change the structure of each region's economy. Moreover, the evolution of each country's capital stock will be an endogenous result of domestic and foreign investment decisions. In order to combine all of these projections, capture the effects of relative price changes, and project the future path of the capital stock we have developed a disaggregated intertemporal general equilibrium model called G-Cubed. In the next section we describe the key features of G-Cubed.

### 3. An Overview of The G-Cubed Model

We now present a brief overview of the features of our model, G-Cubed, that are important for this study. A more complete description is contained in McKibbin and Wilcoxon (1995) or McKibbin and Wilcoxon (1994).

G-Cubed has several features that together distinguish it from other models in the literature. It uses econometric estimates of parameters describing preferences and production technology; it integrates macroeconomic adjustment with the sectoral adjustment to changes in exogenous variables; it captures the link between flows of goods and flows of assets between

**Table 1.** List of regions.

---

USA
Japan
Australia
Other OECD (ROECD)
China
LDCs
Eastern Europe and the Former USSR (EEB)
Oil Exporting Developing Countries (OPEC)

---

**Table 2.** Industries in each region.

---

1 Electric utilities
2 Gas utilities
3 Petroleum refining
4 Coal mining
5 Crude oil and gas extraction
6 Other mining
7 Agriculture, fishing, and hunting
8 Forestry and wood products
9 Durable manufacturing
10 Nondurable manufacturing
11 Transportation
12 Services

---

economies; and it endogenously determines financial prices such as interest rates and exchange rates which play a crucial role in the adjustment of the global economy to alternative projections and policies.

G-Cubed disaggregates the world economy into the eight economic regions listed in Table 1. Each region is further decomposed into a household sector, a government sector, a financial sector, the 12 industries shown in Table 2, and a capital-goods-producing sector. This disaggregation enables us to capture regional and sectoral differences in the impact of alternative environmental policies.

We model the behavior of firms, households and governments. Each producing sector is represented by a single firm that chooses its inputs and its level of investment in order to maximize its stock market value subject to a multiple-input production function (using capital, labor, energy, and materials) and a cost of adjustment model for the capital stock (see Lucas, 1967; Treadway, 1967) and a vector of prices it takes to be exogenous. The parameters of the production technology are estimated using a time series of input-output tables and price series for the USA [see McKibbin and Wilcoxon (1995) for more details].

To parameterize the other regions, we impose the restriction that substitution elasticities are equal throughout the world. In other words, we assume that each industry has the same energy, materials, and substitution elasticities no matter where it is located. This is consistent with the econometric evidence of Kim and Lau in a number of papers (see, for example, Kim and Lau, 1994). However, the share parameters for other regions corresponding to individual countries (Japan, Australia, China, and approximately the Eastern Europe and former Soviet Union region) are derived from input-output data for those regions and are not set equal to their US counterparts. The share parameters for the remaining regions, which are aggregates of individual countries, are calculated by adjusting US share parameters to account for actual final demand components from the aggregate national accounts data for each of the regions. In effect, we are assuming that all regions share production methods that differ in first-order properties but have identical second-order characteristics. This is intermediate between the extremes of assuming that the regions share common technologies and allowing the technologies to differ across regions in arbitrary ways. Finally, the regions also differ in their endowments of primary factors and patterns of final demands. The main limitation of this approach is that there are very few benchmark input-output tables, so our data set contains few observations. The problem is severe outside OECD countries.

In addition to the 12 industries discussed above, the model also includes a special sector that produces capital goods. This sector supplies the new investment goods demanded by other industries. Like other industries, the investment sector demands labor and capital services as well as intermediate inputs. We represent its behavior using a nested CES production function with the same structure as that used for the other sectors. However, we estimate the parameters of this function from price and quantity data for the final demand column for investment.

Households consume goods and services in every period and also demand labor and capital services. Household capital services consist of the service flows of consumer durables plus residential housing. Households receive income by providing labor services to firms and the government, and from holding financial assets. In addition, they also may receive transfers from their region's government. Within each region we assume household behavior can be modeled by a representative agent maximizing an intertemporal utility function of consumption over time subject to an intertemporal budget constraint that the present value of future consumption is constrained by the present value of future income.

We take each region's real government spending on goods and services to be exogenous and assume that it is allocated among final goods, services, and labor in fixed proportions, which we set to 1987 values. Total government spending includes purchases of goods and services plus interest payments on government debt, investment tax credits, and transfers to households. Government revenue comes from sales taxes, corporate taxes, personal income taxes, and from issuing government debt. In addition, there can be taxes on externalities such as CO<sub>2</sub> emissions.

We assume that agents will not hold government bonds unless they expect the bonds to be serviced, and accordingly impose a transversality condition on the accumulation of public debt that has the effect of causing the stock of debt at each point in time to be equal to the present value of all future budget surpluses from that time forward. This condition alone, however, is insufficient to determine the time path of future surpluses: the government could pay off the debt by briefly raising taxes a lot; it could permanently raise taxes a small amount; or it could use some other policy. We assume that the government levies a lump sum tax equal to the value of interest payments on the outstanding debt. In effect, therefore, any increase in government debt is financed by consols and future taxes are raised enough to accommodate the increased interest costs. Thus, any increase in the debt will be matched by an equal present value increase in future budget surpluses.

The eight regions in the model are linked by flows of goods and assets. Flows of goods are determined by the bilateral import demands of households, firms, and governments. These demands are summarized in a set of bilateral trade matrices which give the flows of each good between exporting and importing countries. There is one  $8 \times 8$  trade matrix for each of the 12 sectors for each country.

Trade imbalances are financed by flows of assets between countries. We assume asset markets are perfectly integrated across the OECD regions. With free mobility of capital, expected returns on loans denominated in the currencies of the various regions must be equalized period to period according to a set of interest arbitrage relations. In generating the baseline of the model, we allow for risk premia on the assets of alternative currencies, although during simulations we assume these risk premia are constant and unaffected by the shocks under study. For the non-OECD countries we also make the assumption that exchange rates are free to float at an annual frequency. We also assume that capital is freely mobile within the regions and between the regions and the rest of the world. This may seem simplistic since many developing countries have restrictions on short-term flows of financial

capital. Many of these countries nonetheless have significant flows of direct foreign investment responding to changes in expected rates of return. In the model, capital flows capture both of these effects because they include foreign direct investment as well as short-term financial capital. Future work will focus more on modeling financial markets in the developing regions of the model. Finally, we assume that the Organization of the Petroleum Exporting Countries (OPEC) chooses its foreign lending in order to maintain a desired ratio of income to wealth subject to a fixed exchange rate with the US dollar.

We assume that labor is perfectly mobile among sectors within each region but is immobile between regions. Thus, within each region wages will be equal across sectors. The nominal wage is assumed to adjust slowly according to an overlapping contracts model where nominal wages are set based on current and expected inflation and on labor demand relative to labor supply. In the long run labor supply is given by the exogenous rate of population growth, but in the short run the hours worked can fluctuate depending on the demand for labor. For a given nominal wage, the demand for labor will determine short-run unemployment.

Finally, we assume that money enters the model via a constraint on transactions. We use a money demand function in which the demand for real money balances is a function of gross output and short-term nominal interest rates. The supply of money is determined by the balance sheet of the central bank and is exogenous.

## **4. Projecting Labor Supply and Productivity Growth**

The first step in using G-Cubed to project the future path of the world economy is to obtain appropriate estimates of the rates of labor force growth, total factor productivity growth, and factor augmentation for each country and industry in the model. For each of these we relied on the extensive literature of empirical studies of the postwar historical record. More details on these studies can be found in Bagnoli *et al.* (1996).

### **4.1. Labor supply**

To compute long-run labor supply growth, we began by assuming that labor force participation rates remain constant. As a result, labor force growth will be exactly equal to population growth. To project population, we used figures from the World Bank.

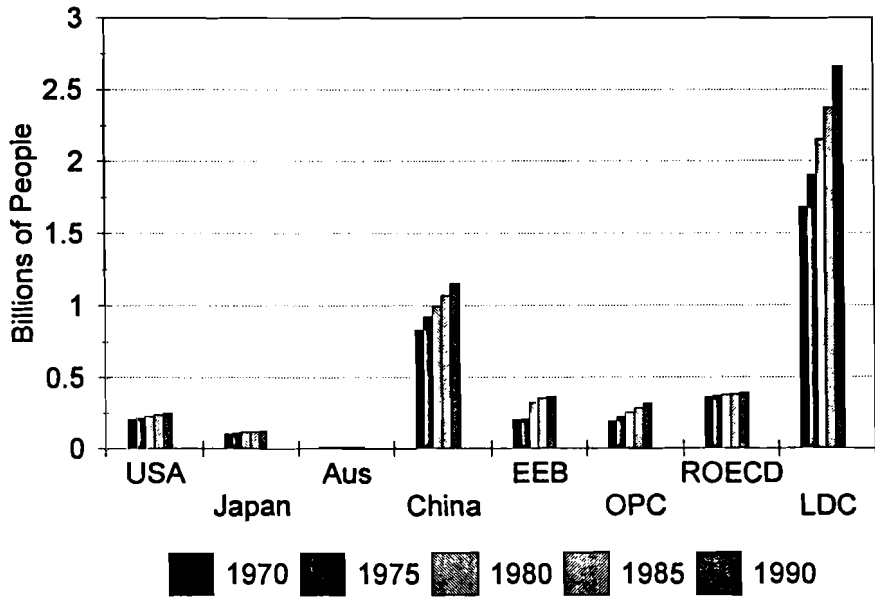


Figure 3. G-cubed regional population, historical data 1970-1990.

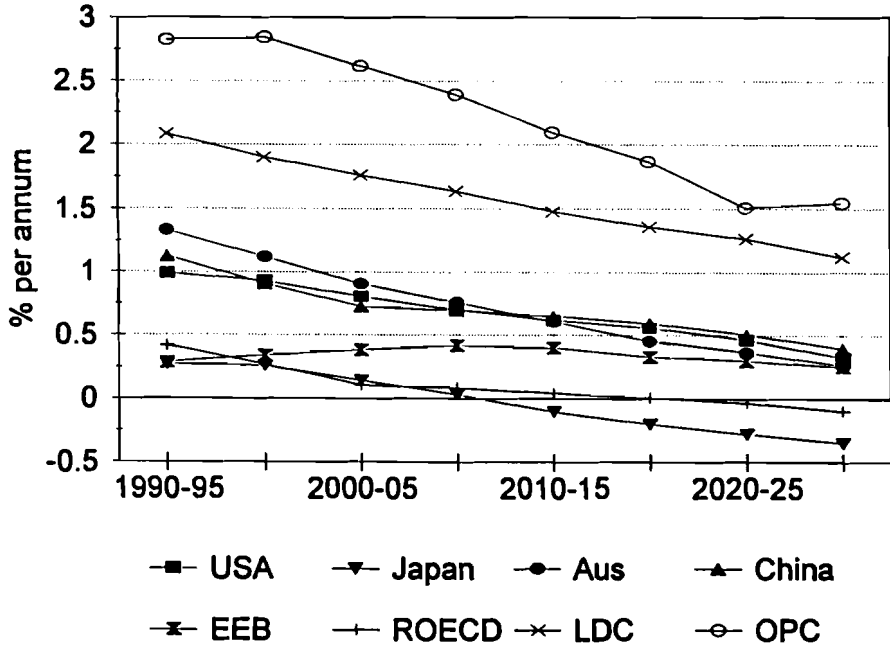


Figure 4. G-cubed population projections.

Figure 3 shows population levels for G-Cubed regions for five periods beginning in 1970. As one would expect, the largest increases have been in China and the LDC region. Figure 3 provides an uncomfortable reminder of the scale of the population problem – excluding China, the LDC region added more than a quarter of a billion people between 1985 and 1990. Figure 4 shows the World Bank’s population projections under its “standard fertility decline” scenario. This figure shows population growth rates are projected to decline. If population growth continues to slow, global population will eventually stabilize, albeit at a level considerably higher than today’s.

#### 4.2. Productivity growth

The empirical literature on productivity growth is enormous. However, many of the studies reach contradictory conclusions and none has been done with exactly the right specification for use with G-Cubed. An extensive survey of the literature on estimating productivity growth by sector can be found in Bagnoli *et al.* (1996). A key result from the empirical studies is that productivity growth not only varies considerably across sectors but also that for most sectors improvements in the use of intermediate goods have been a significant source of growth.

### 5. The Importance of Structural Change in Future Scenarios

In this section we describe the results of using the model to project a range of variables from 1990 to 2020. Because agents in the model have foresight, in order to predict future endogenous variables such as industry output and GDP we must first project the model’s exogenous variables far into the future. The most important of these variables are shown in Table 3. To create these projections we begin with the World Bank population projections discussed above.

We then use two alternative sets of projections for changes in labor quality. These two alternatives are referred to as Scenario 1 and Scenario 2. In Scenario 1 we project aggregate technical change based on the studies of aggregate productivity growth discussed above and then apply the aggregate projection equally to each sector within an economy. Thus, for example referring to Table 4, we assume the aggregate growth in labor quality in the United States is 1.4% per year and this aggregate growth is applied equally to all sectors within the US economy.

**Table 3.** Share of each region in global carbon emissions, Scenario 1.

	1990	2000	2010	2020
USA	23.0	20.2	17.5	15.3
Japan	5.4	5.1	4.7	4.4
Australia	1.3	1.3	1.2	1.2
Other OECD	17.6	16.4	15.2	14.5
China	10.5	14.3	14.9	15.0
LDCs	17.5	25.7	28.8	30.3
Eastern Europe and former USSR (EEB)	17.4	11.8	13.8	16.6

**Table 4.** Regional assumptions used in generating Scenario 1.

	USA	Japan	Aust	ROECD	China	LDCs	EEB
Population growth <sup>a</sup>							
Non-energy labor							
productivity growth (%)	1.4	2.5	1.8	2.0	5.0	5.0	3.0
Energy sector labor							
productivity growth (%)	1.4	2.5	1.8	2.0	5.0	5.0	3.0
Energy efficiency growth (%)	0	0	0	0	0	0	0
Tax rates <sup>b</sup>							
Fiscal spending <sup>c</sup>							
Monetary policy (%)							
(fixed money growth rate)	2.9	1.25	1.64	3.98	12.84	6.48	23.81

<sup>a</sup>See Figure 4.

<sup>b</sup>1990 levels.

<sup>c</sup>1990 shares.

**Table 5.** Annual labor productivity growth used in generating Scenario 2.

1 Electric utilities	0.0
2 Gas utilities	0.0
3 Petroleum refining	0.0
4 Coal mining	0.0
5 Crude oil and gas extraction	0.0
6 Other mining	0.0
7 Agriculture, fishing, and hunting	3.9
8 Forestry and wood products	0.0
9 Durable manufacturing	0.0
10 Nondurable manufacturing	5.3
11 Transportation	0.7
12 Services	0.6



Scenario 2 is based on projections of differential labor quality change by sector within each economy. The purpose of Scenario 2 is not to necessarily make the most likely projection of labor quality change, but to show how sensitive future projections of energy use, carbon emissions, and aggregate GDP are to assumptions of differential labor quality changes (or labor-augmenting technical change) across sectors of an economy. The growth rates of each sector are based on the studies of sectoral growth outlined above. The projections of labor quality change or labor-augmenting technical change are contained in Table 5. We assume that there is no labor quality change in the energy sectors and several of the non-energy sectors. Positive labor quality change is projected in agriculture, nondurable manufacturing, transportation, and services. For comparability with Scenario 1, we scale up the sectoral productivity numbers in Table 5 for each country individually so that aggregate labor quality change, calculated as the output-weighted shares of labor quality change in each sector (using 1990 weights), is equal to aggregate labor quality change for each country from Scenario 1. By normalizing to the same aggregate labor quality change in each country, we have a clear comparison of the importance of differential productivity growth across sectors for the projections.

The other main assumptions for Scenario 1 are also shown in Table 4. These include assumptions about energy efficiency improvements, tax rates, fiscal spending, monetary policy assumptions, and the real price of oil. The real price of oil is assumed to be determined by the OPEC region in the model. This last assumption is fairly important: Jorgenson and Wilcoxon (1992) have argued, and we have illustrated above, that the oil price shocks of the 1970s reduced US energy demand enough to hold CO<sub>2</sub> emissions essentially constant from 1972 through 1985. Several comments should also be made about the assumptions above in relation to other studies. Biases in technical change have been a significant source of controversy in the literature. Engineering studies sometimes suggest that there have been substantial improvements in energy efficiency over the last few decades beyond what would arise from price-induced substitution. Manne and Richels (1990) included this effect in their model "Global 2100" and referred to it as the rate of "autonomous energy efficiency improvements" or AEEI. Their value for AEEI ranges from 0–1% annually and varies over time and across regions. An AEEI of 1 implies that annual energy requirements per unit of output drop by 1% per year. The true value for AEEI is still a subject of debate. Econometric analysis by Hogan and Jorgenson (1991) suggests that the biases of technical change vary across industries and that for many industries technical change is actually energy-using, which would imply that

AEEI should really be negative. In any case, AEEI plays a very important role: Manne and Richels (1990) have shown that high values of AEEI lead to very slow growth of baseline carbon emissions, and hence to low carbon taxes for any given target, while low values of AEEI lead to rapid growth in baseline emissions and high carbon taxes. By the year 2100, according to Manne and Richels, the level of baseline emissions under a pessimistic view of AEEI is several hundred percent higher than under a more optimistic view. In our study we assume a zero value for AEEI and let the model determine endogenously the relationship between GDP and energy use.

Given these assumptions, we solve for the model's perfect-foresight equilibrium growth path over the period 1990–2050 using software developed by McKibbin (1994) for solving large models with rational expectations on a personal computer.

### **5.1. Scenario 1: Sectoral productivity growth the same across sectors**

For the purposes of this paper, the most important results for Scenario 1 are the future paths of GDP (shown in Figure 5), the energy intensity of each economy (Figure 6), and future paths of CO<sub>2</sub> emissions (shown in Figure 7). Figure 5 illustrates that the different population growth rates and labor productivity growth rate as well as different rates of private capital accumulation lead to different paths for real GDP in each economy. Figure 6 shows an index of the energy use per unit of GDP. A fall in this index indicates that energy use is falling per unit of GDP produced. For China and other developing countries, the energy intensity rises initially before gradually falling over time. For industrial economies the index falls over time, although after 2000 there is some gradual rise in the energy intensity because falling energy intensity in developing economies reduces the relative price of energy for industrial economies. Energy intensity in the Eastern Europe and former Soviet Union region moves around far more, reflecting the large structural changes taking place in these economies. Frankly, however, this part of the model is largely based on speculation. Few reliable data exist.

Figure 7 shows the emission of carbon in million tonnes from 1990 to 2020 by country or region. In Scenario 1, global emissions rise from 5,388 million tonnes of carbon in 1990 to 15,378 million tonnes in 2020. The changes in carbon emissions in individual countries and regions between 1990 and 2020 (in million tonnes) are USA, 1,339 to 2,251; Japan, 316 to 680; Australia, 76 to 176; Rest of the OECD, 1,025 to 2,228; China, 608 to 2,310; other non-oil

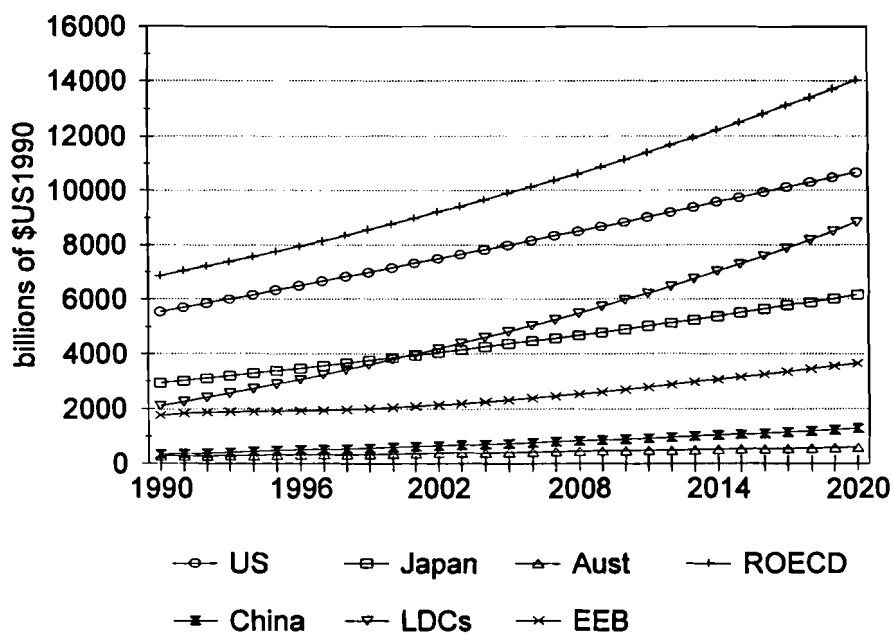


Figure 5. Real GDP in US\$1990, Scenario 1.

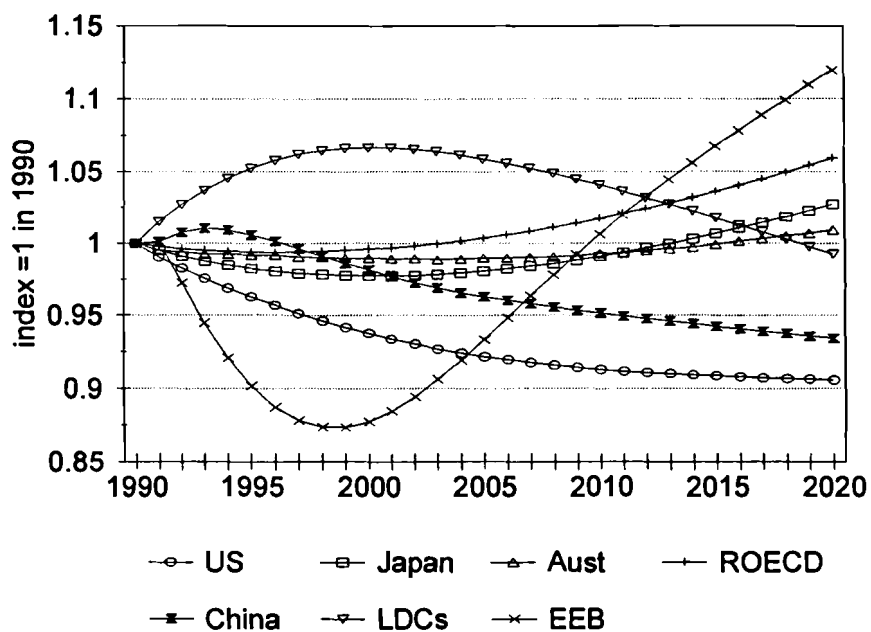


Figure 6. Energy use per unit of GDP, Scenario 1.

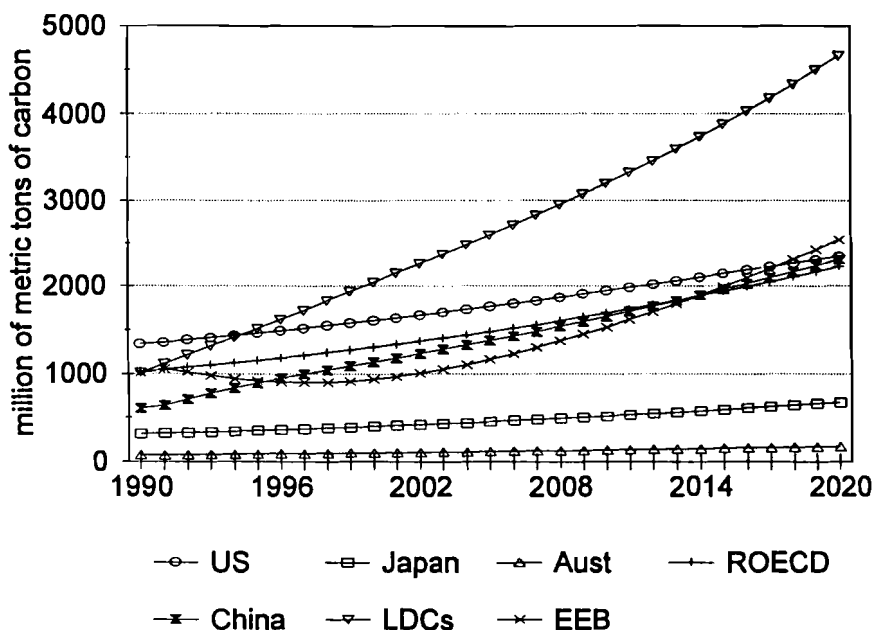


Figure 7. Carbon emissions, Scenario 1.

developing countries, 1,015 to 4,663; and Eastern Europe and former Soviet Union, 1,010 to 2,544. Emissions growth in China and the other developing country region is particularly high because economic growth is projected to be highest in those regions.

Regional shares in total emissions and their projected evolution are shown in Table 5. The share of emissions from China and other developing countries rises over the next 30 years. At the same time, the share of carbon emissions from currently industrialized economies in the OECD falls (although in absolute terms emissions continue to increase). This clearly illustrates the policy dilemma with greenhouse gas emission reduction: a large part of future emissions are likely to be produced by developing economies who can least afford to bear the burden of future emissions reductions.

## 5.2. Scenario 2: Differential sectoral productivity growth

The same calculations as for Scenario 1 are undertaken for Scenario 2 with differential rates of sectoral productivity growth. The path of GDP for each country is shown in Figure 8. These results are similar to those for Figure 5, except the growth rates are lower. Given that average labor productivity and population growth are the same, the difference in trends is due to differential

capital accumulation across sectors in the two scenarios. Strong growth in the non-energy sectors leads to a rise in the demand for energy. This raises the relative price of energy, which draws resources into the energy sectors and leads to substitution away from energy inputs, in production. With this reallocation of inputs, the aggregate GDP growth path is reduced.

Energy intensity in each region is shown in Figure 9. Here we see a difference in the results compared with Figure 6. Differential productivity growth across sectors has led to large changes in energy intensity despite similar paths for overall GDP in each economy. If one were to look only at GDP and energy use, this would appear to be “autonomous energy efficiency improvement,” because energy intensity is declining even though prices are constant. These results show that even if energy efficiency appears to improve at the aggregate level it should not be interpreted, as it commonly is, as resulting from technical change in energy production. In this case, differential productivity growth across sectors changes relative prices and thus the pattern of energy demand. The results look more like the historical experience than Scenario 1, because we have imposed differential sectoral growth more similar to historical experience than the assumptions behind Scenario 1.

The path of carbon emissions are shown in Figure 10. It is clear comparing this with Figure 7 that the emission paths for carbon are quite different, as one might expect given the different energy intensities under the two scenarios. Even over a 30-year period, we see a significant difference between the two scenarios despite similar aggregate assumptions. In Scenario 2, global emissions rise from 5,388 million tonnes of carbon in 1990 to 9,818 million tonnes in 2020. That is almost 5,500 million tonnes less than under Scenario 1! The change in carbon emissions in individual countries and regions between 1990 and 2020 (in million tonnes) are USA, 1,339 to 1,738; Japan, 316 to 488; Australia, 76 to 146; Rest of the OECD, 1,025 to 1,648; China, 608 to 1,020; other non-oil developing countries, 1,015 to 2,523; and Eastern Europe and former Soviet Union, 1,010 to 1,831.

The shares of each region in global carbon emissions are shown in Table 6. A broadly similar story to Scenario 1 holds for the pattern of emission shares over the next 30 years for Scenario 2. The share of emissions from developing countries is expected to rise, and the share for industrialized economies is expected to decline. However, the size of the shift is quite different under the two scenarios. In Scenario 2 the rise in emissions is projected to be much less, and therefore the change in shares is less dramatic. This is clearly seen in Figure 10. The faster rise in emissions when overall productivity growth is the same is not surprising. In Scenario 2 the relative

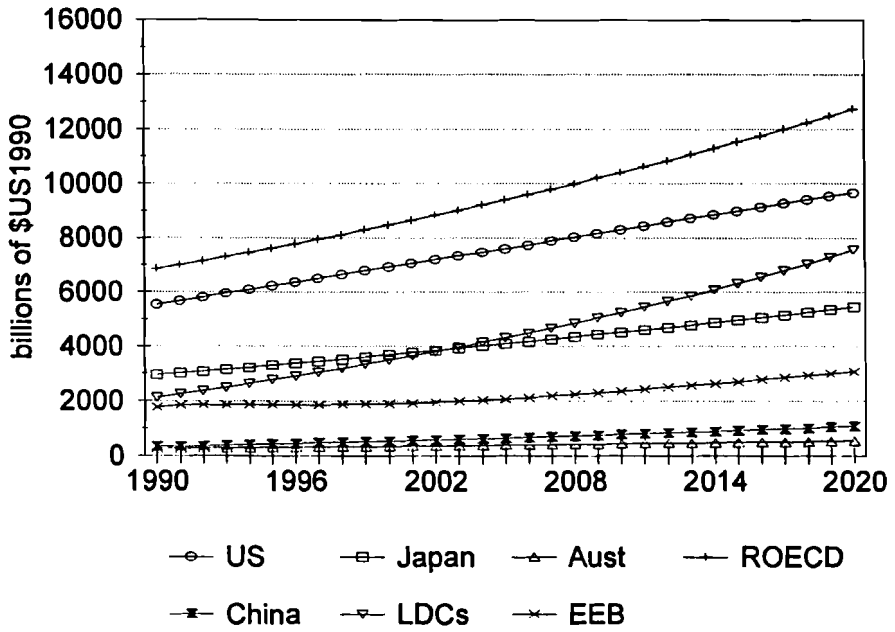


Figure 8. Real GDP in US\$1990, Scenario 2.

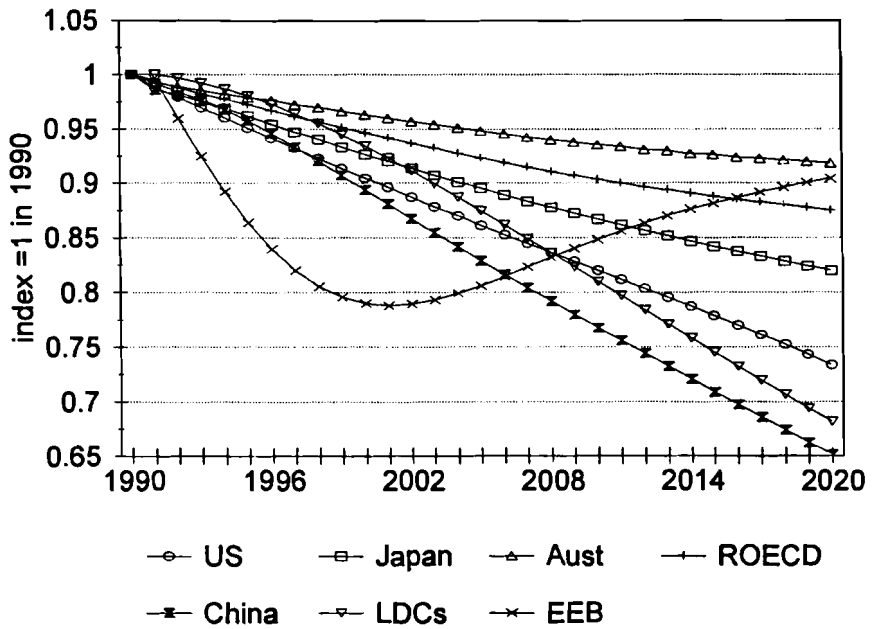


Figure 9. Energy use per unit of GDP, Scenario 2.

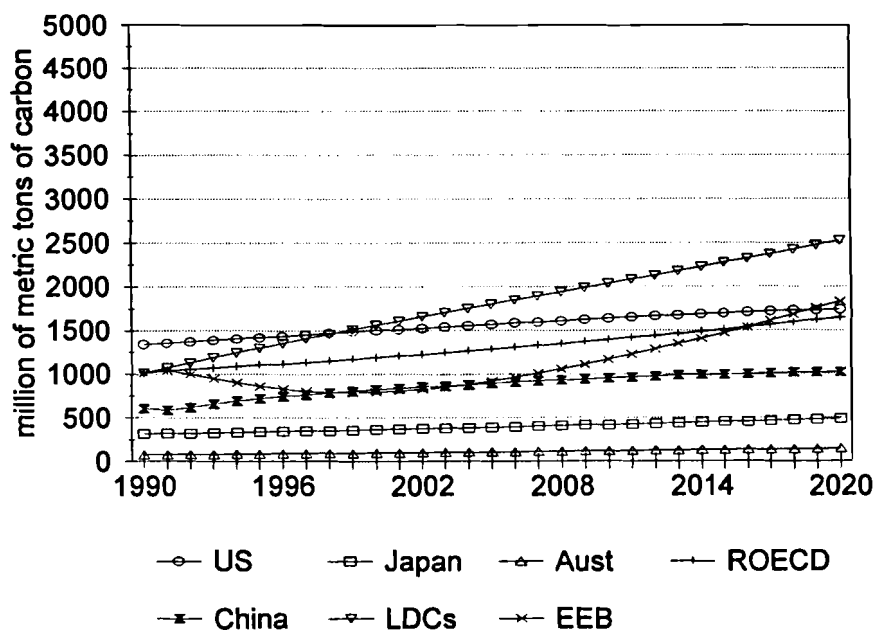


Figure 10. Carbon emissions, Scenario 2.

Table 6. Share of each region in global carbon emissions, Scenario 2.

	1990	2000	2010	2020
USA	23.0	22.4	20.1	17.7
Japan	5.4	5.4	5.2	5.0
Australia	1.3	1.4	1.5	1.5
Other OECD	17.6	17.6	17.1	16.8
China	10.5	12.2	11.7	10.4
LDCs	17.5	23.1	25.0	25.7
Eastern Europe and former USSR (EEB)	17.4	11.7	14.3	18.7

prices of non-energy goods fall faster than the prices of energy goods. This raises the relative price of energy, causing consumers and firms to substitute away from it. (Another way to think of this is that, without rising labor productivity in the energy sectors, energy becomes relatively scarce, which reduces the growth of downstream industries.) The growth in energy supply in Scenario 1 is dominated by the assumed growth in productivity, whereas in Scenario 2 the growth in energy supply is dominated by capital accumulation in the energy sectors in response to market forces changing relative prices. Hence emissions of CO<sub>2</sub> rise with growth in GDP, but at a slower rate in Scenario 2 than in Scenario 1.

### 5.3. The implications for emission stabilization

The UN Framework Convention on Climate Change requires countries to take action to limit rising emissions of CO<sub>2</sub>. To show the effect on this policy of assumptions about baseline conditions, we calculate the carbon taxes needed to stabilize emissions in each region by the year 2010 at the level of 1990, given that the revenue is used to reduce fiscal deficits in each country by the amount of revenue raised by that country. We have shown elsewhere (McKibbin and Wilcoxon, 1994) that the assumption about how the revenue is recycled has important macroeconomic and sectoral impacts on the results. Here we will stay with a deficit reduction assumption for both scenarios.

Several important assumptions make the results we report here different from those of other studies of this issue, and from our own previous work using G-Cubed. First, we begin the simulation in 1990, but since 1990 has actually passed, we phase the carbon tax in gradually starting in 1995. In other words, the simulations are conducted as though the tax were announced in 1990 to start in 1995. (As a result, asset prices adjust somewhat before 1995.) The tax is set so that emissions gradually fall to the 1990 target by the year 2010 rather than stabilizing emission in every year up to 2010. This is done to minimize the output loss over the adjustment path since, in this model, announcing credible tax changes in advance leads to changes in capital accumulation in advance of the policy. Investment is channeled away from sectors hurt by the shock (in this case the coal industry in each country) and toward other sectors of production. The results would be quantitatively different had we stabilized each year at 1990 levels.

With the tax in place in both Scenario 1 and Scenario 2, emissions are gradually reduced to 1990 levels by the year 2010 (in all regions) but begin rising after that because the tax is held constant. This is an important aspect of the problem of taxing carbon emissions. Because the future path of emissions is projected to rise continually in both scenarios, targeting emissions at 1990 levels after the year 2010 will require a continually rising tax. In the experiments reported here, we assume that the tax is held constant after the year 2010 so emissions continue to rise after 2010 but from a lower level.

The taxes required to stabilize emissions are shown in Table 7. For clarity, three representative years are shown, although the model is actually solved on an annual basis. By 2010 the stabilizing tax in the USA is \$44.80 (1990 US\$) per tonne of carbon in Scenario 1 and \$22.40 per tonne of carbon under Scenario 2. It is clear from this table that the different assumptions



**Table 7.** Emission stabilization taxes by the year 2010 (US\$1990 per tonne of carbon).

	1995	2000	2010
USA			
Scenario 1	2.80	16.80	44.80
Scenario 2	1.40	8.40	22.40
Japan			
Scenario 1	10.50	63.00	168.00
Scenario 2	5.50	33.00	88.00
Australia			
Scenario 1	3.80	22.80	60.80
Scenario 2	2.60	15.60	41.60
Other OECD			
Scenario 1	6.80	40.80	108.80
Scenario 2	3.70	22.20	59.20
China			
Scenario 1	1.15	6.90	18.40
Scenario 2	0.24	1.44	3.84
Developing countries			
Scenario 1	2.60	15.60	41.60
Scenario 2	1.15	6.90	18.40
Eastern Europe and former USSR			
Scenario 1	1.15	6.90	18.40
Scenario 2	0.35	2.10	5.60

about the sectoral composition of growth have a dramatic effect on the size of the taxes necessary to stabilize carbon emissions in each region. This is not surprising, because we saw above that the path of carbon emissions is quite different under the two scenarios given the change in energy intensity caused by changes in relative prices in the global economy.

## 6. Conclusion

In this paper we have focused on the importance of the sectoral composition of economic growth for calculating future paths of the world economy. The common practice of using aggregate projections of trend GDP growth in different countries to derive projections of energy use, carbon emissions, and other variables can be misleading. Using a global economic model that accounts for (1) general equilibrium interactions and (2) expectations of future events, and (3) that is based on historically estimated substitution

possibilities, we have illustrated that the composition of future growth is crucial for the relationship between a range of variables of importance.

We found that the energy composition of GDP can change significantly over a 30-year period, because of changes in the composition of output as well as a changes in the use of inputs in production. These changes occur through changes in relative prices reflecting substitution decisions by households and firms. These have been observed historically and the model suggests that under plausible assumptions they may be important in the future.

## Notes

- [1] In spite of this, simple projections of GDP growth have been widely used. For example, such projections form the basis of much of the material used in the scenarios prepared for the Intergovernmental Panel on Climate Change (IPCC). Moreover, almost all studies of global warming have very simple stories about GDP growth and the relationship between growth and a range of variables.
- [2] This point has been emphasized by Jorgenson and Wilcoxon (1991), who point out that over the period 1973-85, US energy consumption and carbon emissions remained essentially constant.
- [3] Similar graphs for Japan can be found in Ban (1991) and Yamazawa *et al.* (1995).
- [4] Gases that contribute to the greenhouse effect include carbon dioxide, methane, nitrous oxide, chlorofluorocarbons, and others. For an overview of the economics of global warming see Cline (1992), Nordhaus (1991a), or Schelling (1992). See Hoeller *et al.* (1990), Nordhaus (1991b), or Energy Modeling Forum (1992) for surveys of estimates of the cost of reducing greenhouse gas emissions.
- [5] A carbon tax would be applied to fossil fuels in proportion to the CO<sub>2</sub> they produce when burned. Nordhaus (1979) proposed this as a means of taxing the externality (global warming) produced by users of fossil fuels.
- [6] Coefficients  $F$ ,  $G$ , and  $H$  could also be interpreted as biases in the pattern of technical change. A more general specification would allow for both improvements in factor quality and biases in technical change. Empirically, it would be difficult to distinguish the two effects. One approach would be to form a panel data set from time series data for a large number of industries and then estimate productivity growth rates imposing the restriction that biases be industry specific and improvements in factor quality be the same across industries.
- [7] This is a generalization of Solow (1957). For a survey of recent papers that use less restrictive production or cost functions, see Diewert (1992). Maddison (1987) presents a broad survey of the productivity literature.
- [8] This approach is due to the pioneering work of Denison and is sometimes called "growth accounting." See Denison (1974, 1979, 1985) for much more refined examples of this style of analysis.

## References

- Bagnoli, P., McKibbin, W., and Wilcoxon, P., 1996, Global Economic Prospects: Medium Term Projections and Structural Change, Brookings Discussion Paper in International Economics # 121, The Brookings Institution, Washington, DC, USA, also United Nations University Center for Advanced Studies Working Paper #1.
- Ban, K., 1991, Energy Conservation and Economic Performance in Japan: An Econometric Approach to CO<sub>2</sub> Emissions, Discussion Paper 112, Faculty of Economics, Osaka University, Toyonaka, Japan.
- Christensen, L.R., and Jorgenson, D.W., 1969, The Measurement of US Real Capital Input, 1929–1967, *Review of Income and Wealth* 15(4):293–320.
- Cline, W.R., 1992, *The Economics of Global Warming*, Institute for International Economics, Washington, DC, US, DC, USA.
- Denison, E.F., 1962, The Measurement of Productivity, *Bulletin of Economic Research* 44(3):163–198.
- Denison, E.F., 1974, *Accounting for United States Economic Growth 1929–1969*, The Brookings Institution, Washington, DC, USA.
- Denison, E.F., 1979, *Accounting for Slower Economic Growth: The United States in the 1970s*, The Brookings Institution, Washington, DC, USA.
- Denison, E.F., 1985, *Trends in American Economic Growth, 1929–1982*, The Brookings Institution, Washington, DC, USA.
- Diewert, W.E., 1992, The Measurement of Productivity, *Bulletin of Economic Research* 44(3):163–198.
- Energy Modeling Forum, 1992, *Global Climate Change: Impacts of Greenhouse Gas Control Strategies*, Energy Modeling Forum Report 12, Stanford University, Stanford, CA, USA (forthcoming).
- Hoeller, P., and Coppel, J., 1992, Energy Taxation and Price Distortions in Fossil Fuel Markets: Some Implications for Climate Change Policy, OECD Economics Department Working Paper #110, OECD, Paris, France.
- Hoeller, P., Dean, A., and Nicolaisen, J., 1991, Macroeconomic Implications of Reducing Greenhouse Gas Emissions: A Survey of Empirical Studies, *OECD Economic Studies*, 16:45–78.
- Hogan, W.W., and Jorgenson, D.W., 1991, Productivity Trends and the Cost of Reducing CO<sub>2</sub> Emissions, *Energy Journal* 12(1):67–86.
- Jorgenson, D.W., 1988, Productivity and Postwar US Economic Growth, *Journal of Economic Perspectives* 2(4):23–42.
- Jorgenson, D.W., and Wilcoxon, P.J., 1991, Global Change, Energy Prices and US Economic Growth, *Structural Change and Economic Dynamics* 3(1):135–154.
- Jorgenson, D.W., Slesnick, D.T., and Wilcoxon, P.J., 1992, *Carbon Taxes and Economic Welfare*, Brookings Papers on Economic Activity, Microeconomics Issue, pp. 393–431.
- Kim, J., and Lau, L., 1994, *The Role of Human Capital in the Economic Growth of the East Asian Newly Industrialized Countries*, paper presented at the Asia-Pacific Economic Modelling Conference held in August at Sydney, Australia.

- Lucas, R.E., 1967, Optimal Investment Policy and the Flexible Accelerator, *International Economic Review* 8(1):78-85.
- Maddison, A., 1987, Growth and Slowdown in Advanced Capitalist Economics: Techniques of Quantitative Assessment, *Journal of Economic Literature* 25(June):649-698.
- Manne, A.S., and Richels, R.G., 1990, CO<sub>2</sub> Emission Limits: An Economic Analysis for the USA, *The Energy Journal* 11(2):51-74.
- McKibbin, W.J., 1994, *The MSG Multicountry Model version 39: User Manual*, McKibbin Software Group Inc., Arlington, VA, USA.
- McKibbin, W.J., and Wilcoxon, P.J., 1994, *The Global Costs of Policies to Reduce Greenhouse Gas Emissions III*, Final Report on US Environmental Protection Agency Cooperative Agreement CR818579-01-0, The Brookings Institution, Washington, DC, USA.
- McKibbin, W., and Wilcoxon, P., 1995, *The Theoretical and Empirical Structure of the G-Cubed Model*, Brookings Discussion Paper in International Economics #118, The Brookings Institution, Washington, DC, USA.
- Nordhaus, W.D., 1979, *The Efficient Use of Energy Resources*, Yale University Press, New Haven, CT, USA.
- Nordhaus, W.D., 1991a, To Slow or Not to Slow: The Economics of the Greenhouse Effect, *Economic Journal* 101:920-937.
- Nordhaus, W.D., 1991b, The Cost of Slowing Climate Change: A Survey, *Energy Journal* 12(1):37-65.
- Schelling, T.C., 1992, Some Economics of Global Warming, *American Economic Review* 82(1):1-14.
- Solow, R.M., 1957, Technical Change and the Aggregate Production Function, *Review of Economics and Statistics* 39(3):312-320.
- Treadway, A., 1969, On Rational Entrepreneurial Behavior and the Demand for Investment, *Review of Economic Studies* 3(2):227-239.
- Yamazawa, I., Nakayama, S., and Kitamura, H., 1995, *Asia-Pacific Cooperation in Energy and Environment*, paper presented at the PAFTAD conference on "Environment and Development in the Pacific" held 7-9 September 1995 at Ottawa, Canada.

# Hedging Strategies for Global Carbon Dioxide Abatement: A Summary of Poll Results EMF 14 Subgroup – Analysis for Decisions under Uncertainty\*

*Alan S. Manne*

Stanford University, Stanford, CA, USA

## Abstract

This report describes the concept of hedging strategies for global carbon emissions and climate change. It compares the application of these ideas within seven of the models participating in Energy Modeling Forum Study 14.

## 1. Introduction: Hedging Strategies

The global warming problem resembles the dilemma faced by a driver on a foggy road. It is desirable to move rapidly toward one's destination, but one's speed must be governed by the distance that one can see ahead and by the ability to make rapid changes. Reasonable people will differ in their estimates of these factors. A driver does not automatically determine his speed on the basis of worst-case scenarios such as brake failure. A prudent decision maker allows for the possible costs of rapid mid-course corrections, and hedges his bets against both upside and downside risks. Any of the current projections can be wrong. The extremely pessimistic outcomes grab headlines, but they are not a sure thing. Their probabilities need to be considered in the design of global emissions strategies.

This report compares the application of these ideas within seven of the models participating in Energy Modeling Forum Study 14, Integrated Assessment of Climate Change (EMF, 1995). The acronyms of these models

---

\*This report summarizes a collective effort. William Nordhaus was the principal architect of the guidelines for scenarios. Other active participants included Minh Ha Duong, James Hammitt, Charles Kolstad, Stephen Peck, Thomas Teisberg, and Gary Yohe. Helpful comments were received from John Rowse, Richard Richels, and John Weyant. The author is much indebted to Felmi Ashaboglu and Joel Singer for research assistance. Financial support was provided by the Center for Economic Policy Research of Stanford University.

**Table 1.** References to the seven participating models.

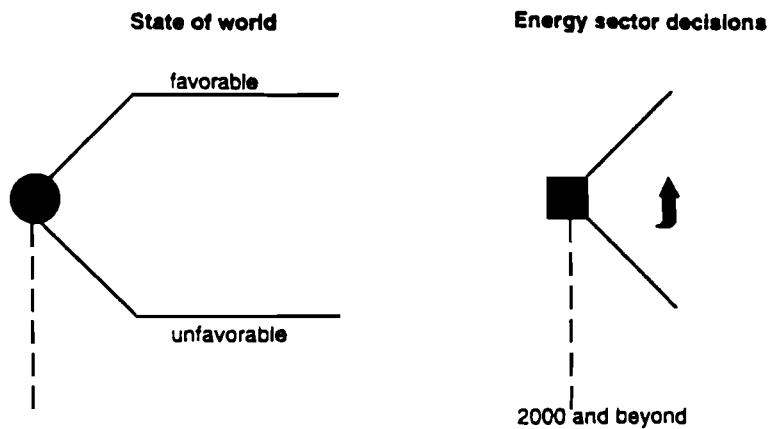
CETA	Peck and Teisberg (1992)
DIAM	Chapuis <i>et al.</i> (1995)
DICE	Nordhaus (1994a)
HCRS	Hammitt (1996)
MERGE	Manne and Richels (1995)
SLICE	Kolstad (1994)
YOHE	Yohe (1995)

and the most recent documentation for each are shown in Table 1. The models differ in terms of the degree to which they include details concerning regions, energy supply and conservation technologies, the carbon cycle, and climate impacts. They all, however, share a common approach: the belief that policy-relevant results can be obtained by comparing the abatement strategies associated with a favorable versus an unfavorable (low probability, high consequence) scenario.

Figure 1 presents a general overview of hedging strategies. This contrasts two alternative ways of thinking about the greenhouse issue when there are just two possible outcomes: a favorable and an unfavorable one. One is an upside possibility, the other is a downside risk. The topmost panel describes a scenario in which all uncertainties are resolved prior to decision making. In a “scenario” approach such as this one, we have the opportunity to learn whether the state of the world is favorable or unfavorable *before* taking action. The panel shows the decision tree for this “learn then act” (LTA) viewpoint. A circle denotes a chance node, a point at which the uncertainties are resolved; a square denotes a decision node, a point at which actions are required.

The bottom panel shows an alternative way of looking at things. This viewpoint is characterized by the phrase “act then learn” (ATL). For illustrative purposes, it is assumed that global carbon dioxide (CO<sub>2</sub>) uncertainties are resolved sometime shortly after 2020. Prior to 2020, the energy sector’s supply and conservation investment decisions must be made under uncertainty about the importance of limiting carbon emissions. Thereafter, the uncertainties are resolved. The ATL approach is a pragmatic one. It is *not* designed for producing accurate long-range forecasts. Rather, it emphasizes the importance of near-term decisions, how they are affected by long-term uncertainties, and how much one should be willing to pay for the timely resolution of those uncertainties.

**Alternative Characterizations of Decision Problem  
Learn-Then-Act (LTA)**



**Alternative Characterizations of Decision Problem  
Act-Then-Learn (ATL)**

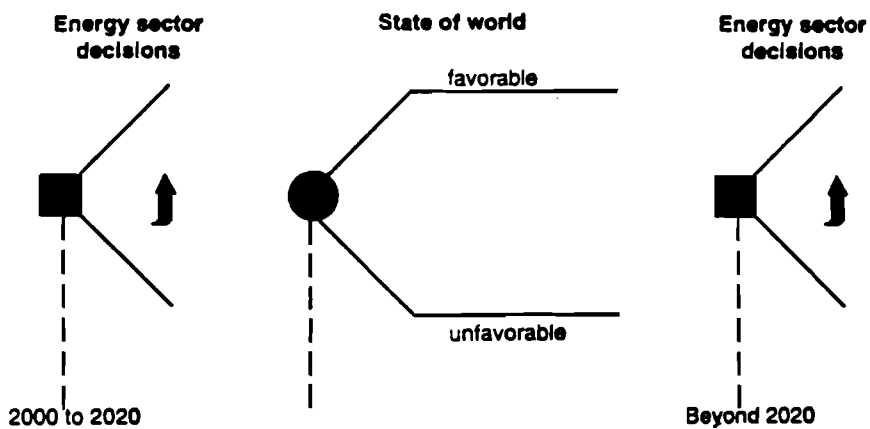


Figure 1. Alternative characterizations of decision problem.

## 2. Guidelines for Scenarios

By focusing on hedging strategies for low probability, high consequence scenarios, this model comparison study adopts a deliberately parsimonious design. We contrast just two out of many possibilities. One is described as a base (or reference) case; the other is a low probability, highly unfavorable case. At some point, it would be instructive to do a systematic analysis of more than two scenarios.

In designing the two alternatives, we took advantage of preliminary work that had been undertaken by several of the participants in the EMF 14 study. These enabled us to screen out several plausible sources of uncertainty and to focus on those that were likely to have a major impact on near-term decisions. For example, differences in gross domestic product (GDP) growth rates during the mid to late 21st century could have major impacts on carbon emissions during that period, but not prior to 2020.

The meaning of the underlying probabilities must be carefully defined. They refer to “judgmental” and “subjective” distributions, and are not derived from empirical observations of relative frequencies. For a readable overview of these issues, see Raiffa (1968).

For reasons of practicality, we had to define uncertainties in a way that could be incorporated in as many of the participating models as possible, and to reduce the computational burden on them. The uncertainties had to be chosen in a way that would allow unambiguous interpretation, would be easily understandable by policy makers, and would have significant impacts on near-term decisions. In addition, it was desirable to employ variables that had been the subject of surveys of expert opinion. In this way, we hoped to reduce the arbitrariness of the probability judgments that are central to this type of decision analysis.

After reviewing the earlier work, it appeared that there were only two parameters that seemed to meet all of these criteria: the mean temperature sensitivity factor and the cost of the damage associated with global warming. More precisely, *climate sensitivity* is the equilibrium temperature change that would occur if atmospheric CO<sub>2</sub> concentrations were to double from their preindustrial level of around 275 ppmv (parts per million, by volume). *Warming damage* is defined as the economic losses that would occur if CO<sub>2</sub> doubling in the late 21st century were to produce, say, a 3°C warming from the preindustrial level. These losses include both market damage and the willingness-to-pay for avoiding nonmarket damage. Inherently, there is a good deal of uncertainty if we are to allow for all the potential surprises and



adaptive measures that might be taken in response to this rate of global warming.

The next question to be decided was the numerical values of the two parameters being investigated. The group discussed alternative values and eventually concluded that it would be useful to define the unfavorable cases as the top 5% of each of these two distributions. The values of the unfavorable variants are therefore the conditional means of each variable in the top 5% of the subjective distribution. For example, if the distribution is uniform over the range [0,1], then the unfavorable top 5% would be represented by 0.975, the mean of the distribution between 0.95 and 1.0.

In choosing the distributions of the two variables, we relied on two surveys of expert opinion. These are by no means fully satisfactory. They do, however, have the advantage of having been undertaken systematically, and they were subject to peer review prior to publication. For the opinion survey on climate sensitivity, see Morgan and Keith (1995). For warming damage, see Nordhaus (1994b).

For further details on the design of this model comparison, see Nordhaus (1995). The following is a summary of these guidelines:

1. To implement the uncertainty scenarios, the models are to employ both a “base” and an “unfavorable” case for the climate sensitivity and for the warming damage parameters.
2. The unfavorable value of the climate sensitivity factor is 2.3°C above the base value employed by the individual model. The unfavorable value of warming damage is 7.8 times its base value.
3. For identification purposes, the following abbreviations are convenient:
  - U0: base value of both parameters
  - U1: unfavorable value of both parameters
  - U2: unfavorable value of climate sensitivity; base value of warming damage
  - U3: unfavorable value of warming damage; base value of climate sensitivity
4. The probability of the unfavorable outcome is 5% when either U2 or U3 is being compared with U0. The probability of the unfavorable outcome is 0.25% when U1 is being compared with U0. That is, the standard assumption is statistical independence of the two parameters. Modelers are encouraged to explore probabilities other than these standard values, and to report the results.

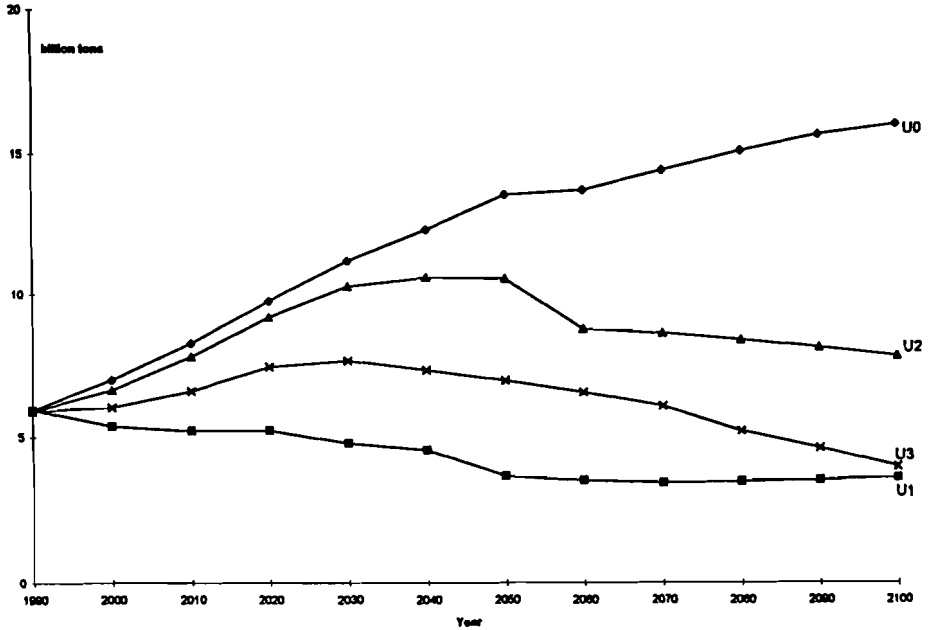


Figure 2. Carbon emissions (average of all models, LTA).

### 3. Four LTA Scenarios: Average Model Results

In order to perform a controlled comparison between the base case and the three unfavorable scenarios, we begin with the LTA (learn, then act) approach. Figure 2 is a conventional sensitivity analysis. It shows how an economically efficient carbon emissions trajectory might be affected by the climate and damage parameters, and it reports the average carbon emissions projected by the seven participating models.

Under U0 (the base case), emissions rise steadily throughout the 21st century. According to the other cases, climate sensitivity has a smaller impact than the warming damage parameter. Even under U2 (high climate sensitivity), emissions rise during the next 50 years. It is only when we incorporate a high value for the warming damage parameter (cases U1 and U3) that it becomes desirable to stabilize or reduce global emissions during the next few decades. As might be expected, the greatest difference in emissions occurs when we compare the base scenario U0 with the low probability, high consequence unfavorable scenario U1. For this reason, we will concentrate on these two alternatives when we turn to the ATL (act, then learn) view of the world.

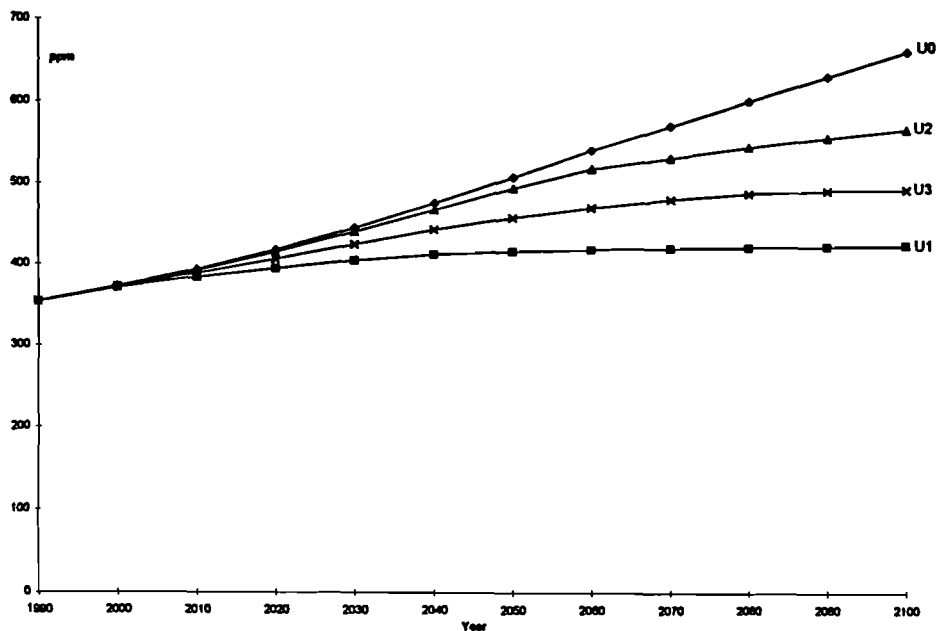


Figure 3. Carbon concentrations (average of all models, LTA).

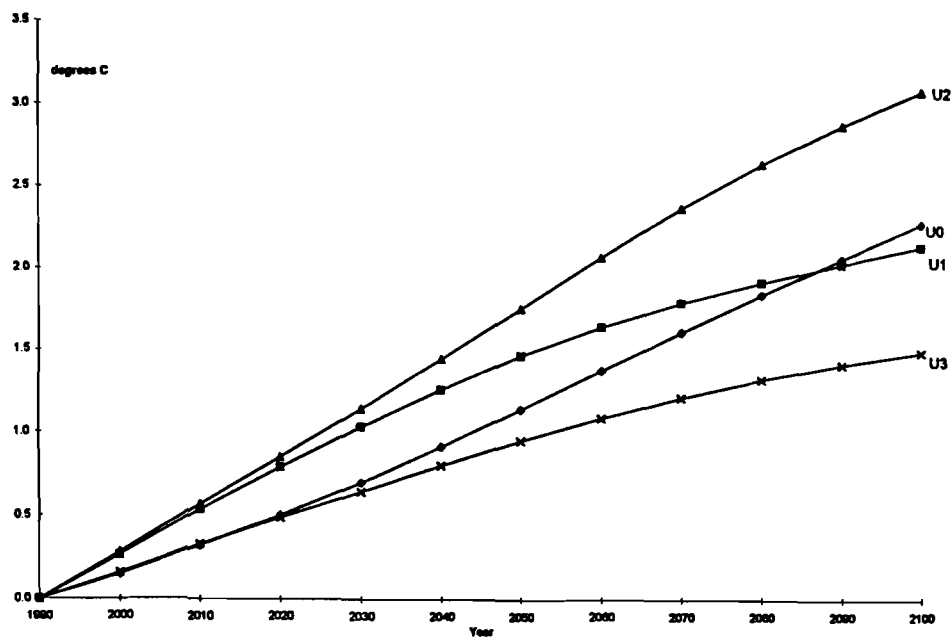


Figure 4. Temperature change (average of all models, LTA).

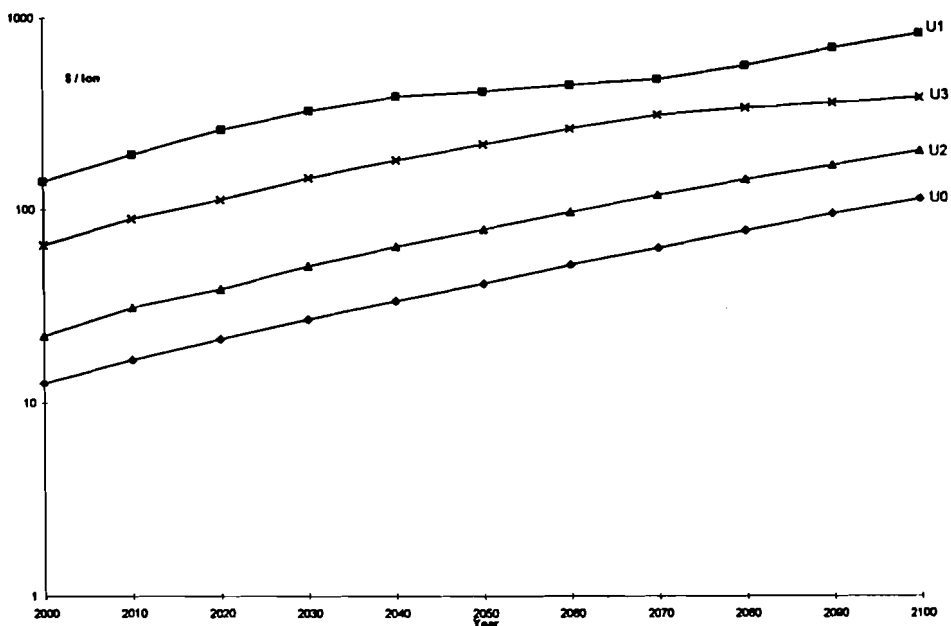


Figure 5. Value of carbon emission rights (average of all models, LTA).

Figures 3 to 5 show the average model projections of concentrations, temperature change, and the value of emission rights. Except for carbon emissions, not all of these values were reported by all seven models. For details on the coverage and for the actual values reported by each model, see Appendix.

Carbon inflows are a small fraction of atmospheric stocks, and there is a long time lag before concentrations are translated into equilibrium temperature changes. This is why changes in emissions (Figure 2) make their way only slowly into changes in concentrations (Figure 3) and even more slowly into temperature changes (Figure 4).

The value of carbon emission rights (alternately termed “carbon taxes”) are indicators that could be useful for the decentralized implementation of globally efficient abatement scenarios. These values suggest how the payoffs might vary from different research and development strategies. According to Figure 5, they represent the most volatile series reported by the participants in this study. Each model has a somewhat different approach for determining the optimal mix between the costs and the benefits of abatement. The inter-scenario differences are so great that the only satisfactory way to compare cases is through a semilogarithmic scale.

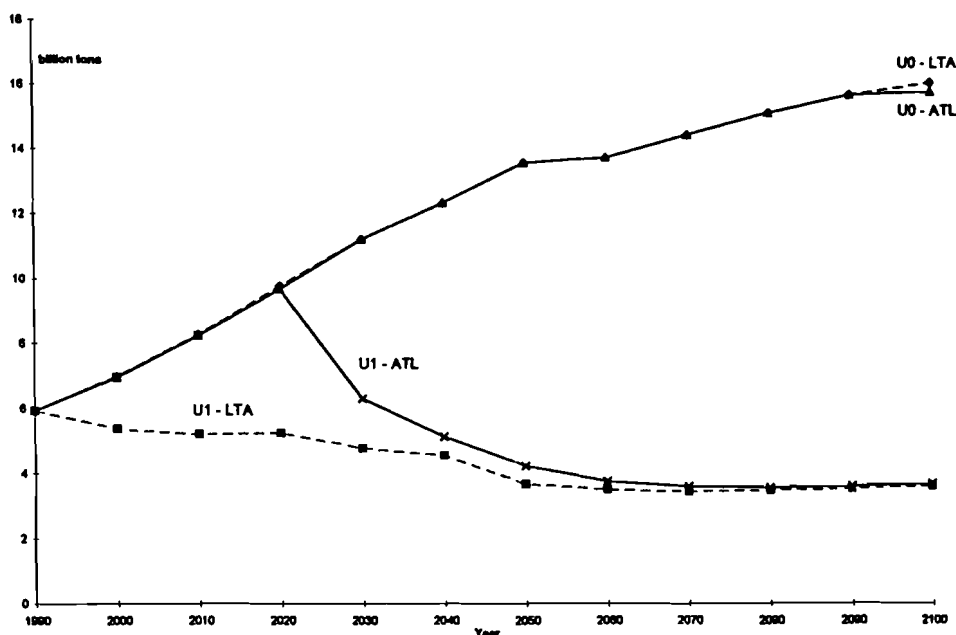


Figure 6. Carbon emissions (average of all models).

For the year 2000, the typical model indicates that the carbon price might be only US\$10 per ton in U0 (the base case), but could be worth ten times that amount in U1 (the low probability, high damage case). In all scenarios, there is a rising value over time – somewhat along the lines suggested by the Hotelling rule for the price of exhaustible resources. When one adopts a long-term benefit-cost perspective, the abatement problem becomes one of determining the optimal cumulative volume of emissions, not the quantity in any one year. The year-by-year carbon prices are then linked by what one assumes with respect to the rate of return on capital in alternative forms of investment.

#### 4. ATL Scenarios: U0 vs. U1 Comparisons

Figures 6 to 10 report on ATL scenarios in which U0 and U1 are the only alternatives considered and the uncertainties are resolved just after 2020. According to the guidelines, the probability is only 0.25% for the unfavorable outcome.

Figure 6 provides an average of the carbon emission results reported by all seven models. It compares two possible futures: the base case U0 and

the unfavorable outcome U1. The dashed lines show what happens when we are endowed with perfect foresight and can make today's decisions with full knowledge of which of these outcomes will occur. The upper dashed line shows the path corresponding to the base case. The lower dashed line shows the path when we are told today that the unfavorable scenario will definitely occur; that is, both climate sensitivity and warming damage are high. These perfect foresight projections are repeated directly from the LTA scenarios shown in Figure 2. The lower of the two dashed lines is the scenario that would be followed if we were to ignore the numerical value of the probabilities and govern our near-term decisions solely by worst-case considerations.

The solid lines indicate the average results for an economically efficient hedging strategy. Note that there is a fork at 2020, the date of resolution of uncertainties. The best hedging strategy consists of adopting an emissions path that lies somewhere between the two cases shown along the dashed lines. Somewhat surprisingly, this optimal hedging strategy lies quite close to the LTA reference (U0) scenario throughout the 21st century. Taking account of both the costs and benefits of abatement, it is desirable to wait until 2020 and at that point begin to reduce emissions rapidly – but only in the unlikely event of the unfavorable scenario. The world would then have to change course abruptly and move to rapid decarbonization.

There is a range of ATL estimates obtained from the individual models. Figures 7 and 8 report on carbon emissions for the U0 and U1 scenarios, respectively. During the decades through 2020, *none* of the models indicates that it is economically efficient to aim for global emissions stabilization. The increases are modest in the case of DIAM, but substantial in the case of DICE. These two models are distinguished by dashed lines.

Beyond 2020, there is no simple way to characterize the differences between models. Under the favorable U0 scenario (Figure 7), all of them indicate that emissions will continue to rise after 2020. Two models, MERGE and SLICE, indicate that it will eventually become optimal for emissions to stabilize or to decline in order to avoid the negative consequences of global climate change.

Figure 8 shows how the models react to the unfavorable U1 scenario. The only valid generalization is that in 2020 (upon the resolution of uncertainties), there is an abrupt change in the trend of carbon emissions. DICE, SLICE, and YOHE report that it is optimal to stabilize emissions from the middle of the century onward, but the other four models show a decline to virtually zero by the end of the century. Opinions will differ on whether

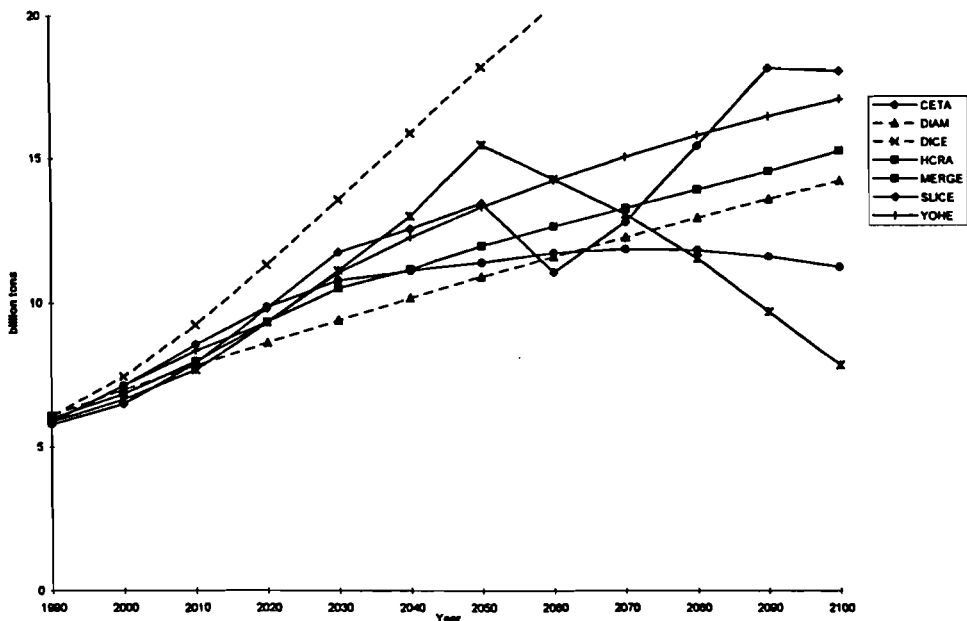


Figure 7. Carbon emissions (all models, U0-ATL).

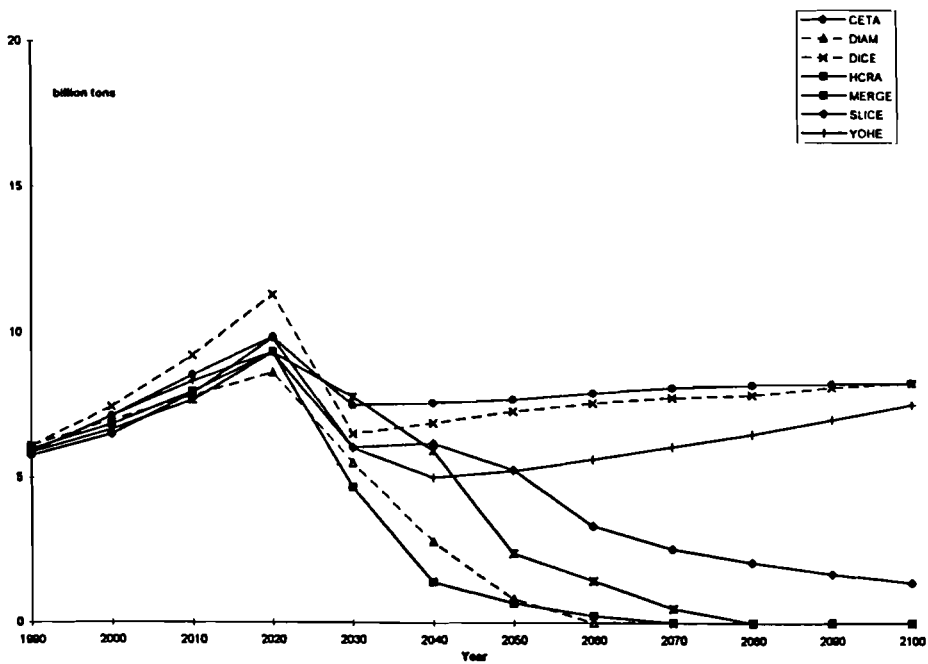


Figure 8. Carbon emissions (all models, U1-ATL).

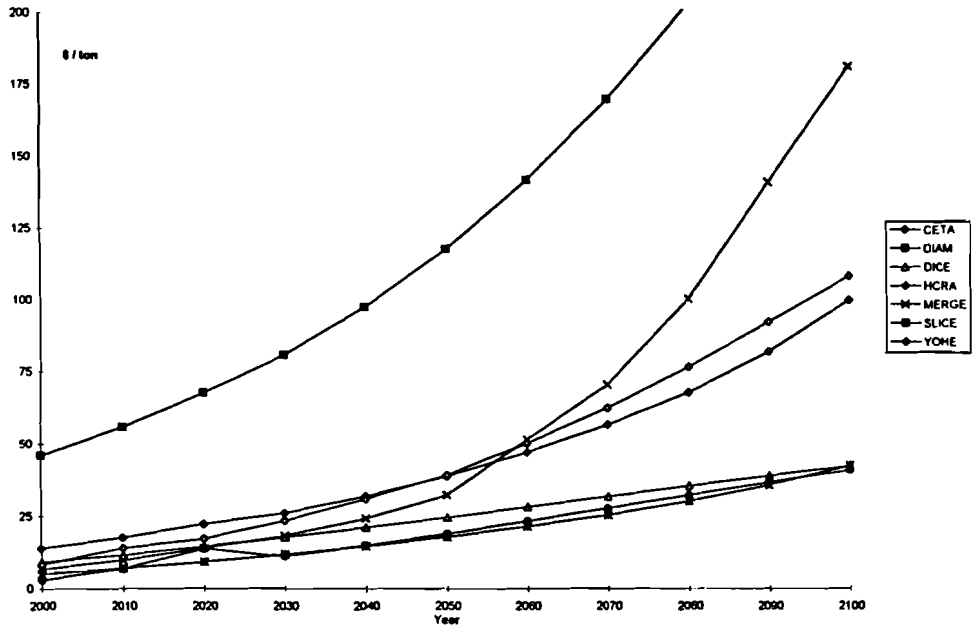


Figure 9. Value of carbon emission rights (all models, U0-ATL).

these are reasonable estimates of decarbonization rates. The answer will depend on what one assumes with respect to the system's inertia and the costs of abrupt changes in direction. In terms of the foggy road analogy, these models provide alternative estimates of how rapidly a driver might attempt to apply the brakes under unfavorable circumstances.

Figures 9 and 10 report the value of carbon emission rights under the two scenarios. For the year 2000, most of the models indicate a modest but positive carbon tax (US\$5–10 per ton). There is a general tendency for these values to increase over time. By definition, the value of carbon emission rights is identical for scenarios U0 and U1 between 2000 and 2020. Immediately thereafter, there is a bifurcation – a decline in the favorable scenario U0 and a sharp jump in the unfavorable scenario U1 (see Figure 10.) Carbon values then exceed US\$100 per ton, and in some cases exceed US\$1000. CETA is the only model in which carbon values are limited by a backstop assumption (US\$465 per ton).



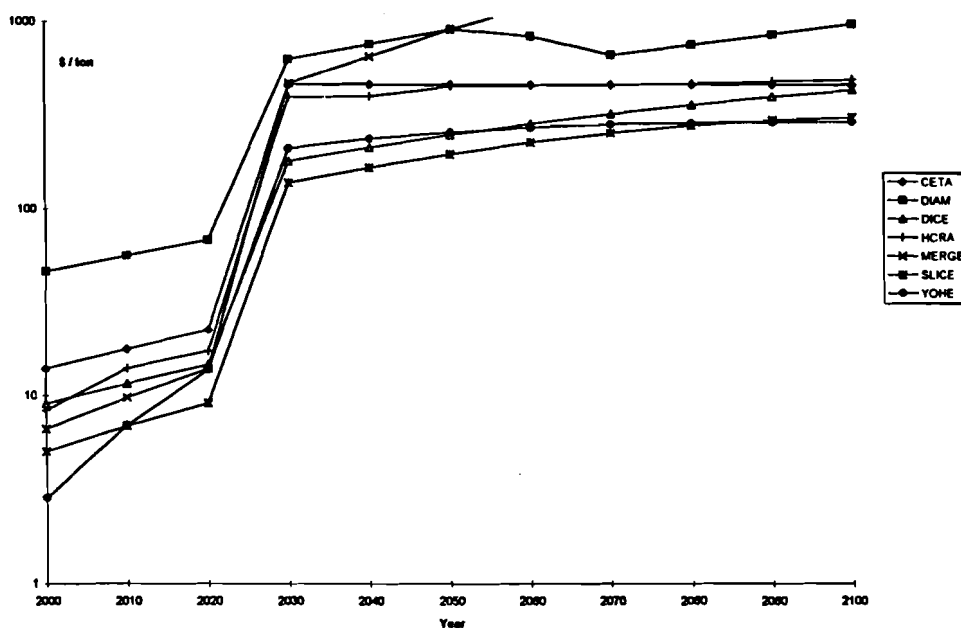


Figure 10. Value of carbon emission rights (all models, U1-ATL).

## 5. Concluding Comments

This paper has emphasized the concept of hedging strategies for dealing with uncertainty. It is misleading to interpret such strategies as an argument for a do-nothing policy. Delay should not be confused with inaction. There is widespread agreement that we need to maintain a broad portfolio of options for dealing with global climate change. According to most of the participating models, it would be desirable to institute a modest carbon tax in the near future (US\$5–10 per ton in the year 2000), and to have that tax increase over time.

During the next few decades, we will learn how far we can get with “no-regrets” energy conservation policies. It is important to continue intensive scientific research to reduce climate and impact uncertainties. Our energy research and development efforts must be directed toward cost-effective conservation and low-carbon supply technologies. Immediate reduction of emissions is only one among several competing possibilities. The issue is not one of either-or, but of finding the right mix of policies.

## **Appendix: Model Results**

**EMF-14 Uncertainty Subgroup**

**Analysis for Decisions Under Uncertainty – Data Tables**

**Organized by Model, Variable, then LTA U0..U3, ATL U0,U1**

<b>EMF-14: Analysis for Decisions Under Uncertainty -- Data tables</b>												
<b>Organized by model, variable, then LTA U0..U3, ATL U0,U1</b>												
<b>CETA:</b>												
	<b>CO2 Emissions</b>											
	1990	2000	2010	2020	2030	2040	2050	2060	2070	2080	2090	2100
LTA U0	5.760	6.510	7.930	9.850	11.770	12.570	13.450	11.060	12.810	15.470	18.200	18.150
LTA U1	5.760	3.840	4.420	4.740	3.570	2.470	2.020	1.650	1.350	1.100	0.900	0.740
LTA U2	5.760	6.250	7.540	9.260	10.880	11.240	10.440	4.550	3.900	3.380	2.940	2.590
LTA U3	5.760	5.520	6.220	7.030	6.980	6.170	5.230	4.460	3.830	2.300	1.880	1.530
ATL U0	5.760	6.500	7.920	9.830	11.770	12.570	13.440	11.060	12.810	15.460	18.190	18.090
ATL U1	5.760	6.500	7.920	9.830	6.050	6.190	5.300	3.350	2.560	2.090	1.710	1.390
ATL U2	5.760	6.490	7.910	9.820	10.860	11.310	10.860	6.010	5.100	4.350	3.740	3.240
ATL U3	5.760	6.450	7.840	9.690	7.940	7.390	5.250	4.130	3.560	2.080	1.700	1.380
ATL U0-50	5.760	6.490	7.910	9.820	11.710	12.470	13.180	11.030	12.800	15.460	18.180	18.010
ATL U1-50	5.760	6.490	7.910	9.820	11.710	12.470	13.180	4.760	3.890	3.180	2.600	2.120
ATL U2-50	5.760	6.490	7.910	9.820	11.710	12.480	13.230	8.050	6.760	5.710	4.850	4.150
ATL U3-50	5.760	6.450	7.850	9.720	11.570	12.260	12.780	5.700	4.840	4.140	2.550	2.090
	<b>Carbon Concentrations</b>											
	1990	2000	2010	2020	2030	2040	2050	2060	2070	2080	2090	2100
LTA U0	359.390	378.500	397.620	421.930	452.240	487.930	523.350	559.640	581.590	612.050	652.460	701.510
LTA U1	359.390	378.500	385.120	395.670	406.700	411.470	411.780	411.180	409.800	407.870	405.600	403.140
LTA U2	359.390	378.500	396.420	419.150	447.200	479.570	510.090	534.320	529.870	527.290	524.420	521.310
LTA U3	359.390	378.500	393.000	410.290	429.490	446.640	458.880	468.650	471.380	473.980	470.300	466.620
	<b>Temperature Change</b>											
	1990	2000	2010	2020	2030	2040	2050	2060	2070	2080	2090	2100
LTA U0	0.000	0.170	0.410	0.630	0.850	1.080	1.330	1.600	1.870	2.130	2.380	2.640
LTA U1	0.000	0.320	0.710	1.040	1.350	1.630	1.880	2.090	2.260	2.400	2.510	2.600
LTA U2	0.000	0.320	0.710	1.080	1.460	1.860	2.280	2.720	3.140	3.480	3.750	3.970
LTA U3	0.000	0.170	0.410	0.620	0.820	1.020	1.210	1.390	1.560	1.710	1.830	1.940

Value of Carbon Emission Rights												
	1990	2000	2010	2020	2030	2040	2050	2060	2070	2080	2090	2100
LTA U0	10.100	12.980	16.560	20.940	26.150	32.000	38.870	47.200	56.690	67.940	82.000	100.030
LTA U1	219.360	281.790	358.050	447.340	465.000	465.000	465.000	465.000	465.000	465.000	465.000	465.000
LTA U2	27.270	35.520	45.800	58.470	73.610	90.930	111.020	136.290	165.810	201.170	245.140	299.930
LTA U3	80.530	103.410	131.860	166.890	208.690	257.260	311.330	378.460	456.330	465.000	465.000	465.000
ATL U0	10.710	13.790	17.610	22.290	26.150	32.000	38.860	47.200	56.700	67.950	82.020	100.050
ATL U1	10.710	13.790	17.610	22.290	465.000	465.000	465.000	465.000	465.000	465.000	465.000	465.000
DIAM:												
CO2 Emissions												
	1990	2000	2010	2020	2030	2040	2050	2060	2070	2080	2090	2100
LTA U0	6.097	6.994	7.844	8.655	9.433	10.181	10.903	11.602	12.281	12.946	13.600	14.244
LTA U1	6.097	5.297	4.084	2.589	1.119	0.100	0.000	0.000	0.000	0.000	0.000	0.000
ATL U0	6.097	6.990	7.834	8.639	9.420	10.171	10.895	11.596	12.277	12.942	13.597	14.242
ATL U1	6.097	6.990	7.834	8.639	5.517	2.810	0.815	0.000	0.000	0.000	0.000	0.000
Carbon Concentrations												
	1990	2000	2010	2020	2030	2040	2050	2060	2070	2080	2090	2100
LTA U0	354.000	372.933	393.665	415.889	439.349	463.825	489.128	515.099	541.604	568.535	595.809	623.361
LTA U1	354.000	369.707	380.329	384.952	383.571	377.573	369.930	362.711	356.071	349.964	344.348	339.182
Value of Carbon Emission Rights												
	1990	2000	2010	2020	2030	2040	2050	2060	2070	2080	2090	2100
LTA U0	0.000	45.431	55.105	66.772	80.809	97.649	117.782	141.748	170.118	203.469	242.323	287.054
LTA U1	0.000	238.930	337.851	479.925	630.309	761.663	862.432	934.768	988.966	1028.943	1060.926	1083.602
ATL U0	0.000	45.915	55.812	67.805	80.809	97.649	117.782	141.748	170.118	203.469	242.323	287.054
ATL U1	0.000	45.915	55.812	67.805	630.309	761.664	818.703	842.200	868.966	895.943	920.936	943.602

<b>DICE:</b>												
<b>CO2 Emissions</b>												
	1990	2000	2010	2020	2030	2040	2050	2060	2070	2080	2090	2100
LTA U0	6.088	7.458	9.256	11.335	13.583	15.904	18.205	20.391	22.366	24.035	25.318	28.158
LTA U1	6.088	4.750	5.336	5.904	6.410	8.840	7.197	7.490	7.732	7.934	8.113	8.280
ATL U0	6.088	7.448	9.239	11.311	13.583	15.904	18.205	20.392	22.369	24.032	25.308	26.162
ATL U1	6.088	7.448	9.239	11.311	6.523	6.887	7.305	7.595	7.768	7.863	8.154	8.316
<b>Carbon Concentrations</b>												
	1990	2000	2010	2020	2030	2040	2050	2060	2070	2080	2090	2100
LTA U0(N)	736.400	775.709	820.510	873.082	934.584	1005.354	1085.082	1172.893	1267.380	1366.633	1468.302	1569.713
LTA U1(N)	736.400	775.709	803.179	832.114	862.273	893.156	924.221	954.983	985.057	1014.170	1042.156	1068.952
LTA U0	353.000	371.843	393.319	418.520	448.001	481.926	520.144	562.237	607.530	655.108	703.844	752.456
LTA U1	353.000	371.843	385.011	398.881	413.338	428.142	443.034	457.780	472.196	486.152	499.567	512.412
<b>Temperature Change</b>												
	1990	2000	2010	2020	2030	2040	2050	2060	2070	2080	2090	2100
LTA U0(N)	0.430	0.522	0.665	0.844	1.051	1.283	1.537	1.809	2.092	2.384	2.677	2.967
LTA U1(N)	0.430	0.583	0.783	0.994	1.214	1.442	1.675	1.911	2.148	2.383	2.615	2.842
LTA U0	0.000	0.092	0.235	0.414	0.621	0.853	1.107	1.379	1.662	1.954	2.247	2.537
LTA U1	0.000	0.153	0.353	0.564	0.784	1.012	1.245	1.481	1.718	1.953	2.185	2.412
<b>Value of Carbon Emission Rights</b>												
	1990	2000	2010	2020	2030	2040	2050	2060	2070	2080	2090	2100
LTA U0	0.000	8.810	11.300	14.250	17.540	21.020	24.630	28.280	31.920	35.510	39.010	42.430
LTA U1	0.000	93.380	118.530	148.540	182.210	218.560	256.770	296.190	332.800	375.550	414.140	451.070
ATL U0	0.000	9.020	11.570	14.580	17.540	21.020	24.630	28.280	31.920	35.510	39.010	42.430
ATL U1	0.000	9.020	11.570	14.580	179.330	212.800	248.640	285.950	323.900	361.860	399.420	435.520

HCRA:												
CO2 Emissions												
	1990	2000	2010	2020	2030	2040	2050	2060	2070	2080	2090	2100
LTA U0	6.000	6.850	8.000	9.370	10.520	11.170	11.970	12.630	13.280	13.920	14.570	15.290
LTA U1	6.000	5.010	4.490	4.660	3.950	2.930	1.900	0.690	0.000	0.000	0.000	0.000
LTA U2	6.000	6.600	7.520	8.720	9.540	9.870	10.290	10.460	10.510	10.390	10.250	10.050
LTA U3	6.000	6.070	6.480	7.240	7.340	6.980	6.640	5.900	4.940	3.760	2.480	0.980
ATL U0	6.000	6.840	7.990	9.350	10.520	11.170	11.960	12.630	13.280	13.920	14.570	15.290
ATL U1	6.000	6.840	7.990	9.350	4.680	1.410	0.660	0.240	0.000	0.000	0.000	0.000
CO2 Concentrations												
	1990	2000	2010	2020	2030	2040	2050	2060	2070	2080	2090	2100
LTA U0	353.000	370.660	390.520	413.510	439.140	465.690	492.830	520.570	548.810	577.500	606.720	636.680
LTA U1	353.000	366.600	375.420	384.260	391.420	394.750	394.620	390.840	383.980	378.120	373.300	369.210
LTA U2	353.000	370.110	388.460	409.490	432.410	455.300	477.840	499.820	520.800	540.250	558.210	574.720
LTA U3	353.000	368.950	384.100	400.740	417.490	432.210	444.750	454.510	460.790	463.110	461.380	455.360
ATL U0	353.000	370.650	390.470	413.400	439.010	465.600	492.740	520.490	548.740	577.430	606.650	636.610
ATL U1	353.000	370.650	390.470	413.400	426.050	420.290	412.580	404.830	397.320	391.050	385.790	381.260
Temperature Change												
	1990	2000	2010	2020	2030	2040	2050	2060	2070	2080	2090	2100
LTA U0	0.000	0.190	0.350	0.510	0.680	0.850	1.020	1.190	1.350	1.510	1.660	1.810
LTA U1	0.000	0.350	0.600	0.780	0.930	1.030	1.100	1.120	1.110	1.060	1.010	0.970
LTA U2	0.000	0.360	0.660	0.930	1.200	1.460	1.710	1.950	2.170	2.380	2.580	2.750
LTA U3	0.000	0.180	0.320	0.450	0.570	0.690	0.790	0.870	0.930	0.970	0.990	0.980
ATL U0	0.000	0.190	0.350	0.510	0.680	0.850	1.020	1.190	1.350	1.510	1.660	1.810
ATL U1	0.000	0.370	0.670	0.950	1.210	1.340	1.370	1.350	1.310	1.250	1.190	1.130
Value of Carbon Emission Rights												
	1990	2000	2010	2020	2030	2040	2050	2060	2070	2080	2090	2100
LTA U0	0.000	7.980	13.370	16.520	23.370	31.110	39.260	50.270	62.630	76.780	92.330	108.440
LTA U1	0.000	142.030	193.350	225.860	301.030	352.510	419.760	473.030	459.710	469.310	483.150	497.460
LTA U2	0.000	22.230	35.610	42.410	59.330	77.150	96.070	120.180	148.370	180.330	212.970	247.800
LTA U3	0.000	55.910	86.990	105.580	148.350	187.230	230.650	282.440	335.240	393.100	449.650	513.020
ATL U0	0.000	8.300	13.950	17.240	23.410	30.980	39.350	50.260	62.810	76.820	92.340	108.450
ATL U1	0.000	8.300	13.950	17.240	397.750	402.090	455.070	460.640	459.710	469.310	483.150	497.460

1/29/96

EMF-14 Uncertainty Subgroup

Model Results

MERGE:	1990	2000	2010	2020	2030	2040	2050	2060	2070	2080	2090	2100
<b>CO2 Emissions</b>												
LTA U0	5.864	6.664	7.692	9.342	11.137	12.999	15.487	14.274	13.061	11.534	9.693	7.853
LTA U1	5.864	5.830	5.730	5.723	4.962	4.043	0.770	0.462	0.154	0.000	0.000	0.000
ATL U0	5.864	6.663	7.686	9.332	11.136	13.005	15.493	14.281	13.071	11.544	9.702	7.861
ATL U1	5.864	6.663	7.686	9.332	7.805	5.949	2.404	1.442	0.481	0.000	0.000	0.000
<b>CO2 Concentrations</b>												
LTA U0	353.000	372.171	393.257	417.934	447.442	481.757	521.911	561.110	592.365	616.448	633.040	642.373
LTA U1	353.000	370.466	386.095	400.379	412.219	420.124	419.489	412.693	406.341	400.282	394.907	390.301
ATL U0	353.000	372.164	393.243	417.902	447.412	481.770	521.980	561.231	592.534	616.664	633.286	642.636
ATL U1	353.000	372.164	393.243	417.902	440.609	454.751	457.575	452.382	445.181	436.751	428.907	422.289
<b>Temperature Change</b>												
LTA U0	0.000	0.167	0.351	0.551	0.773	1.017	1.284	1.567	1.848	2.112	2.351	2.561
LTA U1	0.000	0.330	0.678	1.028	1.373	1.701	1.986	2.206	2.364	2.480	2.567	2.635
ATL U0	0.000	0.167	0.351	0.551	0.772	1.017	1.284	1.567	1.849	2.113	2.353	2.563
ATL U1	0.000	0.167	0.351	0.551	0.947	1.500	1.975	2.351	2.631	2.836	2.983	3.090
<b>Value of Carbon Emission Rights</b>												
LTA U0	0.000	6.351	9.288	13.183	18.239	24.276	32.462	51.601	70.741	100.617	141.228	181.84
LTA U1	0.000	134.564	206.766	303.922	430.889	582.026	790.314	874.188	958.062	1387.115	2161.346	2935.577
ATL U0	0.000	6.616	9.726	13.904	18.221	24.248	32.426	51.548	70.670	100.529	141.125	181.720
ATL U1	0.000	6.616	9.726	13.904	471.340	653.286	918.924	1202.618	1486.312	1858.730	2319.873	2781.015

SLICE:												
	<b>Carbon Emissions</b>											
	1990	2000	2010	2020	2030	2040	2050	2060	2070	2080	2090	2100
LTA U0	5.864	7.146	8.571	9.905	10.798	11.112	11.389	11.726	11.868	11.821	11.602	11.237
LTA U1	5.864	6.150	6.293	7.063	7.520	7.619	7.750	7.980	8.143	8.251	8.315	8.351
LTA U2	5.864	7.027	8.299	9.562	10.398	10.678	10.928	11.241	11.371	11.327	11.127	10.796
LTA U3	5.864	6.475	7.072	8.028	8.627	8.795	8.975	9.243	9.406	9.472	9.458	9.381
ATL U0	5.864	7.141	8.559	9.859	10.798	11.112	11.389	11.726	11.868	11.821	11.602	11.237
ATL U1	5.864	7.141	8.559	9.859	7.505	7.584	7.710	7.937	8.101	8.209	8.274	8.310
	<b>Carbon Concentrations</b>											
	1990	2000	2010	2020	2030	2040	2050	2060	2070	2080	2090	2100
LTA U0	351.162	368.488	389.439	414.276	442.319	471.559	499.602	526.403	552.307	576.614	598.708	618.098
LTA U1	351.162	368.488	385.499	401.662	419.520	437.698	454.752	470.904	486.620	501.672	515.895	529.190
LTA U2	351.162	368.484	388.960	412.757	439.563	467.441	494.106	519.536	544.085	567.104	588.031	606.426
LTA U3	351.162	368.336	386.480	405.458	426.607	448.350	468.938	488.518	507.523	525.582	542.398	557.758
	<b>Temperature Change</b>											
	1990	2000	2010	2020	2030	2040	2050	2060	2070	2080	2090	2100
LTA U0	0.000	0.115	0.247	0.398	0.570	0.759	0.956	1.151	1.336	1.511	1.674	1.822
LTA U1	0.000	0.156	0.334	0.524	0.716	0.915	1.118	1.317	1.510	1.696	1.875	2.044
LTA U2	0.000	0.156	0.334	0.535	0.761	1.009	1.273	1.540	1.802	2.057	2.300	2.528
LTA U3	0.000	0.115	0.246	0.388	0.536	0.691	0.849	1.004	1.150	1.289	1.420	1.541
	<b>Value of Carbon Emission Rights</b>											
	1990	2000	2010	2020	2030	2040	2050	2060	2070	2080	2090	2100
LTA U0	0.000	5.025	6.874	9.104	11.706	14.598	17.812	21.430	25.509	30.198	35.748	42.514
LTA U1	0.000	61.270	82.251	106.754	134.395	163.467	193.316	223.295	251.616	276.428	295.558	306.390
LTA U2	0.000	8.590	11.710	15.475	19.864	24.712	30.057	35.997	42.532	49.757	57.844	67.025
LTA U3	0.000	36.704	49.563	64.584	81.565	99.571	118.225	137.161	155.407	171.984	185.735	195.223
ATL U0	0.000	5.024	6.873	9.103	11.705	14.596	17.810	21.428	25.508	30.197	35.744	42.512
ATL U1	0.000	5.024	6.873	9.103	137.407	166.524	196.441	226.432	254.711	279.468	298.583	309.482



YOHE:												
	<b>CO2 Emissions</b>											
	1990	2000	2010	2020	2030	2040	2050	2060	2070	2080	2090	2100
LTA U0	5.864	7.251	8.519	9.833	11.065	12.195	13.243	14.175	15.024	15.774	16.459	17.074
LTA U1	5.864	6.609	6.027	5.866	5.796	5.771	5.917	6.164	6.513	6.897	7.312	7.718
ATL U0	5.864	7.141	8.345	9.343	11.058	12.269	13.305	14.239	15.074	15.823	16.495	17.108
ATL U1	5.864	7.141	8.345	9.343	6.027	5.027	5.258	5.649	6.069	6.504	7.034	7.551
	<b>Value of Carbon Emission Rights</b>											
	1990	2000	2010	2020	2030	2040	2050	2060	2070	2080	2090	2100
LTA U0	0.000	1.740	4.180	8.070	11.460	15.070	19.210	23.460	28.010	32.430	36.840	40.920
LTA U1	0.000	24.500	58.960	120.730	163.200	198.130	226.810	247.240	263.570	275.660	286.400	295.840
ATL U0	0.000	2.860	6.920	13.710	11.080	14.840	18.920	23.300	27.800	32.360	36.760	40.950
ATL U1	0.000	2.860	6.920	13.710	210.490	238.440	256.980	272.090	284.500	287.580	290.800	293.470

## References

- Chapuis, T., Ha Duong, M., and Grubb, M., 1995, DIAM: a Model for Studying the *Dynamics of Inertia and Adaptability in the Climate Change Issue*, working paper, modified by A. Manne for "Analyzing Decisions Under Uncertainty".
- EMF (Energy Modeling Forum), 1995, Second Round Study Design for EMF 14: Integrated Assessment of Climate Change, Working Paper, Stanford University, Stanford, CA, USA.
- Hammitt, J., 1996, *Atmospheric Stabilization, Benefit-Cost Analysis, and Near-Term Reductions in CO<sub>2</sub> Emissions*, Center For Risk Analysis, Harvard School of Public Health, February.
- Kolstad, C., 1994, George Bush vs. Al Gore: Irreversibilities in Greenhouse Gas Accumulation and Emission Control Investment, *Energy Policy* **22**:771-778.
- Manne, A., and Richels, R., 1995, The Greenhouse Debate - Economic Efficiency, Burden Sharing and Hedging Strategies, *The Energy Journal* **16**(4):1-37.
- Morgan, M.G., and Keith, D.W., 1995, Subjective Judgment by Climate Experts, *Environmental Science and Technology* (forthcoming).
- Nordhaus, W., 1994a, *Managing the Global Commons: The Economics of Climate Change*, MIT Press, Cambridge, MA, USA.
- Nordhaus, W., 1994b, Expert Opinion on Climate Change, *American Scientist* **82**(1):45-51.
- Nordhaus, W., 1995, Notes on Scenarios for Uncertainty Group, Working Paper, Yale University, New Haven, CT, USA, June.
- Peck, S., and Teisberg, T., 1992, CETA: A Model for Carbon Emissions Trajectory Assessment, *The Energy Journal* **13**:(1).
- Raiffa, H., 1968, *Decision Analysis: Introductory Lectures on Choices under Uncertainty*, Random House, New York, NY, USA.
- Yohe, G., 1995, Exercises in Hedging against Extreme Consequences of Global Change and the Expected Value of Information, forthcoming in *Global Environmental Change*.

# The Berlin Mandate: The Design of Cost-Effective Mitigation Strategies\*

*Richard Richels*

Electric Power Research-Institute, Palo Alto, CA, USA

*Jae Edmonds*

Pacific Northwest Laboratory, Washington, DC, USA

*Howard Gruenspecht*

US Department of Energy, Washington, DC, USA

*Tom Wigley*

University Corporation for Atmospheric Research

## Abstract

The Berlin Mandate calls for strengthening developed countries' commitments to limiting greenhouse gas emissions. This paper addresses a key issue in the current analysis and assessment phase – the costs of proposals to limit carbon dioxide (CO<sub>2</sub>) emissions. Employing four widely used energy-economy models, we explore the direct and indirect effects of alternative proposals on the global economy. We also examine the implications for atmospheric CO<sub>2</sub> concentrations.

We begin by examining a proposal, like that of the Alliance of Small Island States (AOSIS), in which Organisation for Economic Co-operation and Development (OECD) countries agree to reduce CO<sub>2</sub> emissions to 80% of 1990 levels by a specified date. We find that implementing such a proposal could be quite costly. Not surprisingly, OECD countries would be the hardest hit. Their costs could be as high as several percent of gross domestic product (GDP). The analysis also shows that, because of trade effects, non-OECD countries would likely incur costs even when reductions are confined to the OECD. An economic slowdown in the OECD would affect the full range

---

\*This paper reports initial results of the Subgroup on the Regional Distribution of the Costs and Benefits of Climate Change Policy Proposals, Energy Modeling Forum 14, Stanford University, with contributions from Henry Jacoby (Massachusetts Institute of Technology), Alan Manne (Stanford University), Stephen Peck (Electric Power Research Institute), Tom Teisberg (Teisberg and Associates), Marshal Wise (Pacific Northwest Laboratory), and Zili Yang (Massachusetts Institute of Technology). Helpful comments were received from Sally Kane and John Weyant. The authors are much indebted to Amy Craft for research assistance. The views presented here are solely those of the authors.

of exports of developing countries, and hence their economic growth. This would likely be the case for both oil-importing and oil-exporting developing countries.

We then explore alternatives that are apt to be quite similar in terms of environmental benefits, but allow for flexibility in where and when emission reductions are made. We find that costs could be substantially reduced through international cooperation and the optimal timing of emission reductions. Indeed, such flexibility can reduce costs by more than 80%, potentially saving the international community *trillions* of dollars in mitigation costs. We find that reliance on more flexible alternatives reduces costs more effectively than adopting weaker, but still inflexible, commitments.

## 1. Introduction

The Berlin Mandate calls on the Parties to the United Nations Framework Convention on Climate Change to strengthen developed countries' commitments to reducing greenhouse gas emissions.<sup>1</sup> A number of proposals have been put forward. These range from slowing the current growth in emissions to sharp reductions below present levels. The choice is a difficult one. Acting too slowly risks irreversible environmental damage. Acting too aggressively risks imposing large, and perhaps unnecessary, costs on the global economy. As noted by the Intergovernmental Panel on Climate Change (IPCC), the challenge is to develop a prudent hedging strategy in the face of climate-related uncertainties (see IPCC, 1996).

The Framework Convention is the mechanism established by the international community for implementing precautionary measures. It recognizes that a sensible hedging strategy should be flexible, with ample opportunities for learning and midcourse corrections. Periodic reviews are required "in light of the best available scientific information on climate change and its impacts, as well as relevant technical, social and economic information." Based on these reviews, appropriate measures are to be taken, including the adoption of new commitments.

Upon entering into force in 1994, the Convention established an initial (but nonbinding) aim for developed countries to return emissions to their 1990 levels by 2000. At the first meeting of the Conference of the Parties

---

<sup>1</sup>For the text of the Berlin Mandate, see UN (1995). For the text of the Framework Convention, see Intergovernmental Negotiating Committee for a Framework Convention on Climate Change (1992).

(COP-1) in Berlin in April of 1995, it was determined that existing commitments under the Convention were inadequate. Further commitments for developed countries are to be negotiated, and prepared for approval at COP-3 in 1997.

Although calling for new commitments, the Berlin Mandate does not specify what these commitments should be. Rather, it seeks further analysis and assessment to guide and inform the decision-making process. This paper addresses a key issue in the analysis and assessment phase – the costs of proposals to limit carbon dioxide (CO<sub>2</sub>) emissions. Rather than rely on a single model, the analysis is based on independent runs of four widely used energy-economy models.<sup>2</sup> In each instance, we explore both the direct and indirect effects on the global economy.

We also examine the impact of alternative proposals on atmospheric concentrations. The ultimate objective of the Framework Convention is “the stabilization of greenhouse gas concentrations in the atmosphere at a level that would prevent dangerous anthropogenic interference with the climate system” (see Intergovernmental Negotiating Committee for A Framework Convention on Climate Change, 1992). Although the issue of what constitutes an appropriate limit has yet to be resolved, it is instructive to explore the implications that alternative emission pathways have for future concentrations.

We pay particular attention to the design of cost-effective mitigation strategies. The Framework Convention states that “policies and measures to deal with climate change should be cost-effective so as to ensure global benefits at the lowest possible costs.” Adopting least-cost mitigation strategies will free up valuable resources for further addressing the threat of climate change or for meeting other societal needs. We explore two ways of promoting this objective. In the first, emission reductions take place *where* it is cheapest to do so. In the second, they take place *when* it is cheapest to do so.

A number of studies have suggested that the cost of emission reductions can be substantially reduced through international cooperation (see IPCC, 1996). From a global perspective, it would be economically wasteful to incur high marginal abatement costs in one country when low-cost alternatives are available elsewhere in the world. We discuss ways to ensure that emission

---

<sup>2</sup>The four models make up the Subgroup on the Regional Distribution of Costs and Benefits of Climate Change Policy Proposals. The Subgroup is open to models participating in Stanford University’s Energy Modeling Forum Study on “Integrated Assessment of Climate Change” (EMF, 1995).

reductions are made where it is cheapest to do so, and explore the potential gains.

The timing of emission reductions can also influence costs. What is important in meeting a concentration target is cumulative, not year-by-year, emissions (see IPCC, 1994; Wigley *et al.*, 1996). A particular concentration target can be met through a variety of emission time paths. Several studies have suggested that emission time paths that provide flexibility in making the transition away from fossil fuels will be less costly (see IPCC, 1996). We examine the implications for the design of cost-effective mitigation strategies under the Berlin Mandate.

Mitigation costs are, of course, only part of the story. The more difficult question is the appropriate level of emissions abatement. This requires consideration of both costs *and* benefits. The present analysis is confined to the cost side of the ledger. That is, we focus on the costs of emissions reduction. Policy makers will also want to know what they are buying in terms of reducing the undesirable consequences of global climate change. Such an analysis is beyond the scope of the present effort.

## 2. The Models

The analysis employs four energy-economy models: CETA (Peck and Teisberg, 1995), EPPA (Yang *et al.*, 1996), MERGE (Manne and Richels, 1995), and MiniCAM (Edmonds *et al.*, 1996). These models reflect the recent trend toward hybrid modeling tools that incorporate features from both bottom-up and top-down approaches to energy modeling. On the supply side, each model employs a bottom-up representation of the energy system. Energy technologies are described in process model detail (e.g., availability dates, heat rates, carbon emission coefficients, etc.). The technology vector includes both existing sources and new options that are likely to become available. Cost and performance constraints are adjusted for regional differences. A more top-down perspective is taken toward the balance of the economy. This is done using macroeconomic production functions that provide for substitution between capital, labor, and energy inputs.

The models provide a consistent way to examine alternative strategies for limiting CO<sub>2</sub> emissions and to examine the impacts of higher energy prices on economic output. They can be used, for example, to estimate the increase in fossil fuel prices required to induce consumers to reduce emissions. They also can be used to analyze the possibility of significant regional differences

in marginal abatement costs that would lead to opportunities for cost savings through international cooperation.

The models employ a general equilibrium formulation of the global energy and economic system. This allows us to examine the impacts of actions taken in one region on the economies of another. This is particularly important in the case of the Berlin Mandate. Constraints imposed on developed countries may have unexpected consequences for developing countries. For example, the international price of oil will be affected by the imposition of carbon constraints on oil-importing countries.

While general equilibrium models are useful in tracing the long-term implications of a carbon constraint, they may ignore important short-term effects. This is because they assume full employment of the economy and instantaneous adjustment to policy shocks. The lack of attention to adjustment costs means that these models may *understate* the short-run cost of economic shocks, particularly if these are large and unexpected.

On the other hand, some have argued that the exogenous specification of technology change tends to *overstate* the cost of a carbon constraint. This is an important issue in the energy policy debate – one that is deserving of considerably more attention than it has received to date. It should be noted, however, that the direction of any bias is still unclear. An acceleration of energy-related technical progress may be accompanied by a slowdown in labor and capital productivity improvements throughout the economy. To receive proper consideration, the issue of endogenous change must be examined on an economy-wide basis (see Hogan and Jorgenson, 1991).

Although similar in many respects, the models differ in important ways. For example, EPPA is a recursive rather than an intertemporal optimization model. EPPA and MERGE employ a “putty-clay” rather than a “putty-putty” approach to the vintaging of capital stocks (i.e., they explicitly recognize that one type of capital cannot be “transformed” into another once it is put into place). Moreover, all models differ in regional disaggregation: CETA contains 2 regions, EPPA 12 regions, MERGE 5 regions, and Mini-CAM 9 regions.<sup>3</sup>

The models also differ with respect to key inputs, for example, population, per capita productivity trends, the fossil fuel resource base, and the cost and availability of long-term supply options. Rather than try to impose a common set of driving assumptions, the choice of inputs was left to the discretion of the modeling teams. It was felt that we would be better able to assess the robustness of our results with a diverse set of energy futures.

---

<sup>3</sup>For a detailed model comparison, see EMF-14 (EMF, 1995).

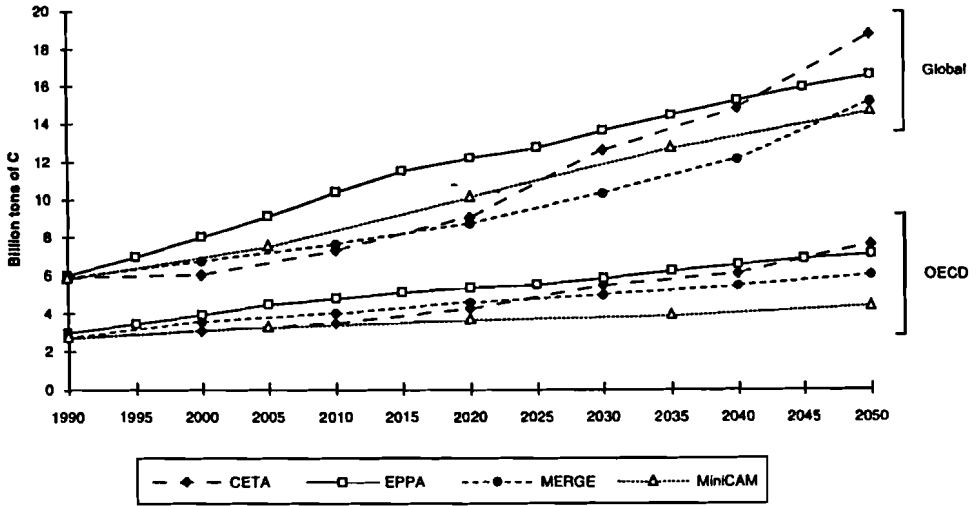


Figure 1. Carbon emissions under business as usual.

### 3. Future Emissions

We begin with an examination of how fossil fuel emissions are projected to grow in the absence of policy intervention. The costs of a carbon constraint are quite sensitive to the emissions baseline. The baseline describes how emissions will grow under existing policies. The higher the emissions baseline, the more carbon must be removed from the energy system to meet a particular target and the higher the costs become.

Figure 1 compares baseline projections for our four models.<sup>4</sup> Note that in each instance emissions are projected to grow in the absence of policy intervention. This is the case for the Organisation for Economic Co-operation and Development (OECD) countries and for the world as a whole. This is consistent with the overwhelming majority of analyses recently reviewed by the IPCC (1994). Of the dozens of studies surveyed, all but a few showed a rising emissions baseline.

In reviewing these emission projections, several points are worth noting. First, although the annual growth rates are substantial – between 1.5% and 2% – they represent a marked slowing in the historical trend. Indeed, global

<sup>4</sup>These projections are intended as examples of how emissions might evolve under existing policies. They should not be interpreted as each analysis team's "best guess" of future emissions.



emissions grew at an annual rate of approximately 3.5% between 1950 and 1990. In part, the slowdown is due to a projected decline in global economic growth. Since 1950, gross world product grew at an average annual rate of 2.9%. The projected growth rate for the next half century or so is closer to 2.5%. Also at work is the gradual decoupling of energy and gross domestic product (GDP) growth and a decoupling of CO<sub>2</sub> emissions and energy use.

The differences in emissions baselines should come as no surprise given the uncertainty over the period studied and thus the freedom the modelers had in the choice of input assumptions. Although it would be impractical to sort out all of the reasons for the differences, several factors have been identified as being particularly important when modeling future emissions (see Manne and Richels, 1994). High up on the list is economic growth. Those models with higher gross domestic product (GDP) growth rates tend to project higher emissions. The more optimistic one is about the prospects for reducing energy intensity or the availability of low-cost carbon-free substitutes, the lower the CO<sub>2</sub> growth rate.

Although the models differ on the cost and availability of supply- and demand-side alternatives, it should be noted that each includes some “no-regrets” emission reduction options. These are alternatives that would be worth adopting apart from climate considerations. A growing emissions baseline does not imply the absence of economically competitive alternatives to fossil fuels. It only means that the supplies of such options are insufficient to arrest the growth in carbon emissions.

The focus of the Berlin Mandate is on emissions from developed countries. Negotiators will be interested in how a particular proposal changes the emissions baseline. We start by examining a case in which OECD countries return emissions to 1990 levels by the year 2000, reduce them by an additional 20% by 2010, and hold them at that level thereafter. This is similar in many respects to the proposal put forward by the Alliance of Small Island States (AOSIS).<sup>5</sup> For the present analysis, we place no constraints on non-OECD emissions.

Figure 2 shows the implications for global emissions. An AOSIS-like proposal may slow the growth in global emissions, but it is unlikely to stabilize them at anywhere near present levels. This is because non-OECD countries currently account for over half of the global total, and their share is expected to grow. The implications for climate policy are clear: stabilization of global emissions will eventually require the participation of developing countries.

---

<sup>5</sup>The AOSIS proposal calls for Annex 1 countries to reduce emissions by 20% by 2005.

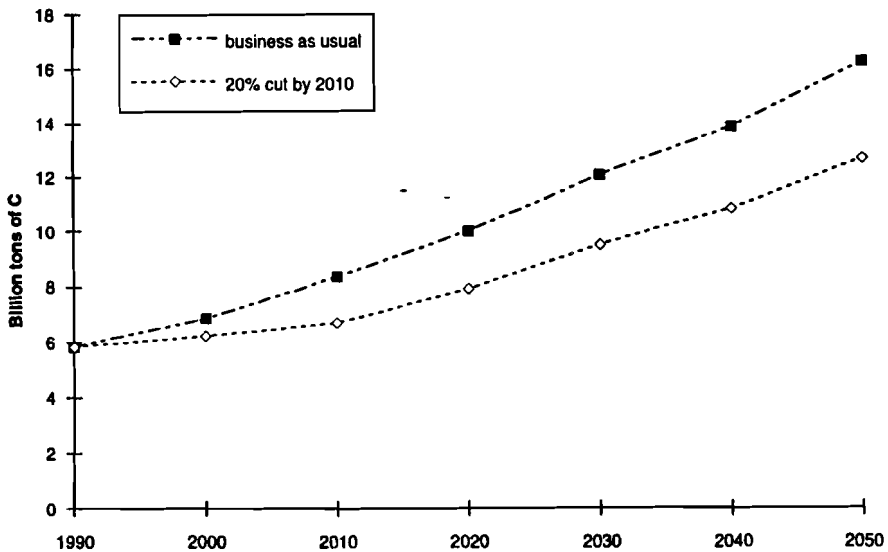


Figure 2. Global emissions under business as usual and with a 20% cut in OECD emissions (based on average of model results).

#### 4. The Costs of Alternative Commitments

We next turn to the issue of costs. In recent years, a number of studies have highlighted the potential role of international cooperation and flexible timing in reducing the costs of a carbon constraint (see IPCC, 1994, 1996; Wigley *et al.*, 1996). To explore the implications for the Berlin Mandate, we first estimate the costs of adopting the AOSIS-like proposal described above. We then examine three variants. Each results in the same cumulative emissions, but there are significant differences in the geographical location and timing of the emission reductions.

Before proceeding, one caveat is in order. We use trade in emission rights to examine the potential gains from international cooperation. By allowing such trade we ensure that, at a given point in time, emission reductions are made where it is cheapest to do so. It should be noted that this is but one of a number of mechanisms that could be used to facilitate international cooperation. For example, various forms of bilateral joint implementation could accomplish the same objective. Hence, trade in emission rights is intended only as a proxy for any of a number of cooperative mechanisms.

With the above caveat in mind, we now describe our four cases:

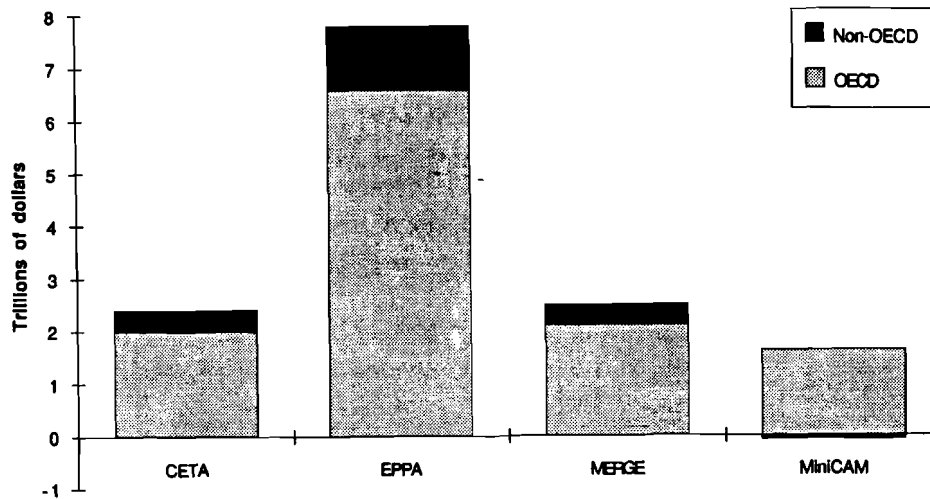
- Case 1 (no interregional or intertemporal efficiency): Each OECD region is required to meet its annual emissions constraint independently. There is no trade in emission rights between the OECD and other regions.<sup>6</sup>
- Case 1a (interregional efficiency): The constraint is still on year-by-year emissions, but trade in emission rights is now permitted between the OECD and other regions. Non-OECD countries are allowed to emit in each period up to the level of their emissions in Case 1. If they reduce their emissions below this level, they may benefit from the sale of the emission rights generated.
- Case 1b (intertemporal efficiency): Rather than a set of year-by-year emission limits, the constraint on emissions from each OECD region is expressed as an upper limit on its cumulative emissions. This allows for higher emissions in years where the cost of emissions abatement is highest. “Payback” must occur by 2050. There is no trade in emission rights between the OECD and non-OECD regions.
- Case 1c (interregional and intertemporal efficiency): The constraint is now on cumulative emissions at the global level. Both interregional and intertemporal trading is permitted. Emission rights are based on Case 1. As a result, reductions take place both *where* and *when* it is cheapest to do so.

Figure 3 shows costs for Case 1 discounted to 1990 at 5% per year. The constraint on carbon-emitting activities leads to a reallocation of resources away from the pattern that is preferred in the absence of this limit and toward potentially costly conservation activities and fuel substitution. Relative prices change as well. These forced adjustments lead to a reduction in economic performance, as measured by GDP or some other indicator, depending on the model. The tighter the constraint, the greater the effect.

Note that, because of trade effects, many non-OECD countries will incur costs even when reductions are confined to the OECD. Restrictions on carbon emissions lead to lower OECD demand for oil, which results in lower revenue for the oil-exporting countries. In addition, an economic slowdown in the OECD countries affects the full range of exports of developing countries, and thus their growth. For many oil-importing developing countries these broader trade effects outweigh the gain from lower world oil prices. Three of the four models shown account for at least some of these effects (MiniCAM is the exception) and show a spillover of OECD losses onto non-OECD countries.

---

<sup>6</sup>There is some trade in emission rights within the OECD, however. This is the consequence of aggregating single countries into larger regions.



**Figure 3.** Costs of a 20% cut in OECD emissions by 2010: Case 1 (costs through 2050 discounted to 1990 at 5%).

Not surprisingly, the models differ as to the magnitude of the economic impacts. This is to be expected given the large differences in emission baselines. EPPA, with the highest baseline, shows the highest costs. MiniCAM, with the lowest baseline, shows the lowest costs.

A second factor contributing to the large spread among models is the speed with which the capital stock is allowed to adjust to higher energy prices. As noted earlier, two of the models, EPPA and MERGE, employ a so-called putty-clay formulation. They attempt to track the economic lifetime of existing plant and equipment. As a result, these models show less responsiveness of energy demand to price changes in the short run than over the long run. Alternatively, models that assume greater malleability of capital (CETA and MiniCAM) produce lower cost estimates.

The models are in more agreement on the relative costs of the various alternatives (Figure 4). Note that the potential benefits from economic efficiency are substantial. In Case 1, each OECD region is required to act independently to reduce its emissions. There is no opportunity to take advantage of low-cost emission reduction options elsewhere in the world. From the perspective of global economic efficiency, this makes little sense. Clearly, it is inefficient to incur high marginal domestic abatement costs when low-cost alternatives exist in other countries. In Case 1a, we allow OECD countries to take advantage of the lower-cost alternatives. We do this by permitting

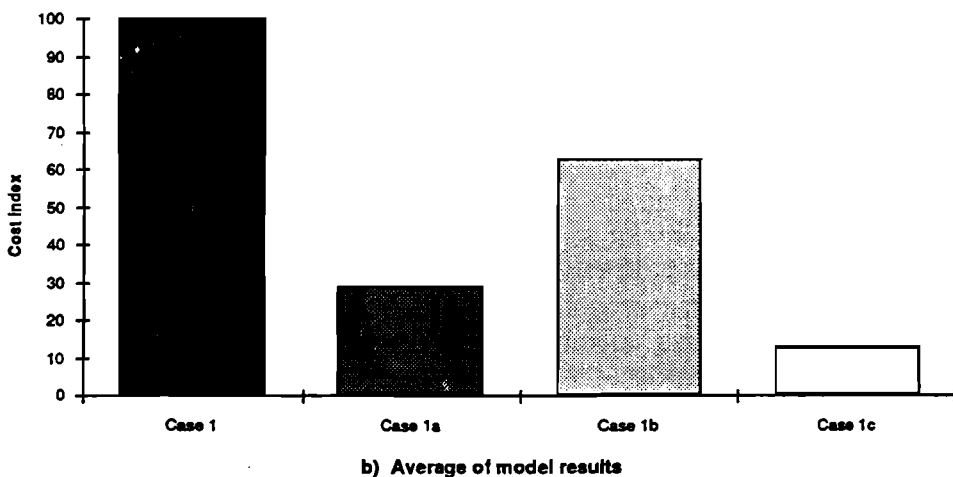
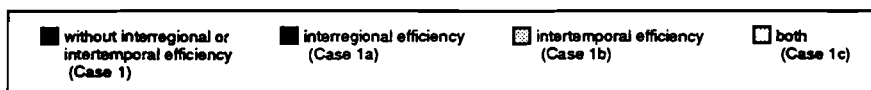
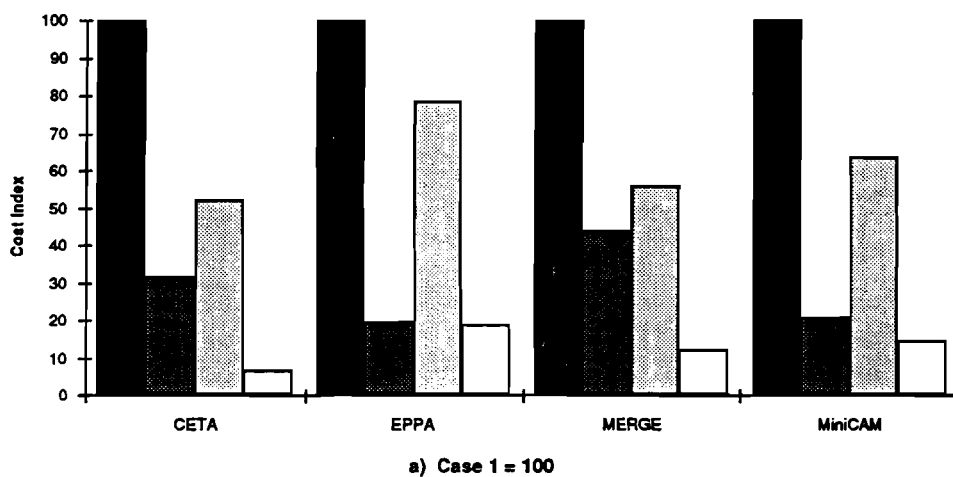
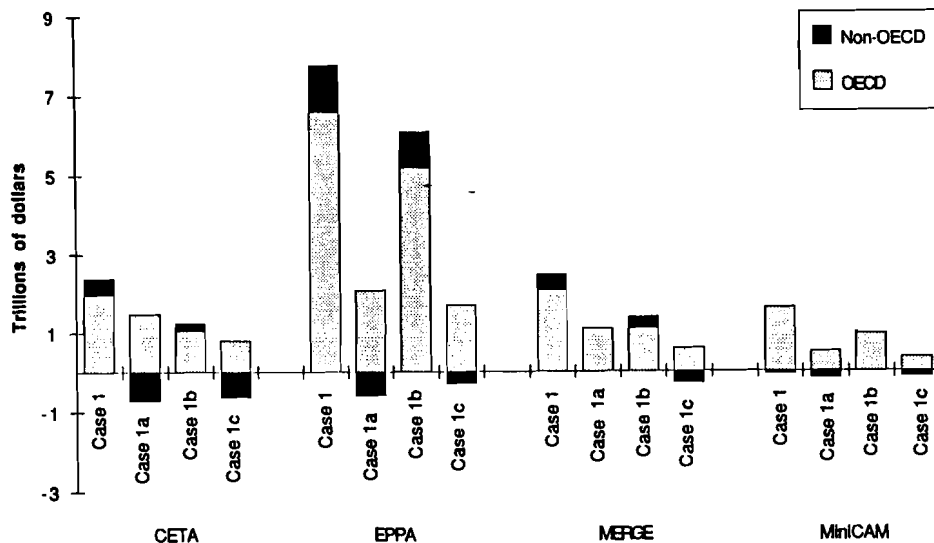


Figure 4. Global costs under four alternative cases.



**Figure 5.** Regional costs under four alternative cases (costs through 2050 discounted to 1990 at 5%).

trade in carbon emission rights. Note that cooperation of this type can cut the costs of a carbon constraint by well over one-half.

Figure 5 shows the impact on non-OECD countries. International cooperation not only reduces costs within the OECD, it may also result in substantial wealth transfers. Indeed, for three of our models, the revenue received from the sale of emission rights more than offsets the trade-related losses to non-OECD countries. Alternatively, one could devise a burden sharing scheme that imposes zero net costs on non-OECD countries.<sup>7</sup> Such a scheme would compensate non-OECD countries for losses accruing through international trade but would result in no additional wealth transfers. In this instance, costs to the OECD would be equivalent to global costs.

We next turn to the issue of timing (Case 1b). When given the choice, each model shifts some emission reductions into the future. That is, it chooses to emit more in the early years with payback coming later on (see Figure 6a). This behavior can best be understood in terms of an optimal allocation problem. A constraint on cumulative emissions defines a carbon budget. That is, it specifies a total amount of carbon to be emitted over

<sup>7</sup>With an international market in carbon emission rights, global abatement costs are independent of the burden sharing scheme. This allows us to separate the difficult issues of efficiency and equity. For the theoretical considerations underlying this proposition, see Manne (1996).

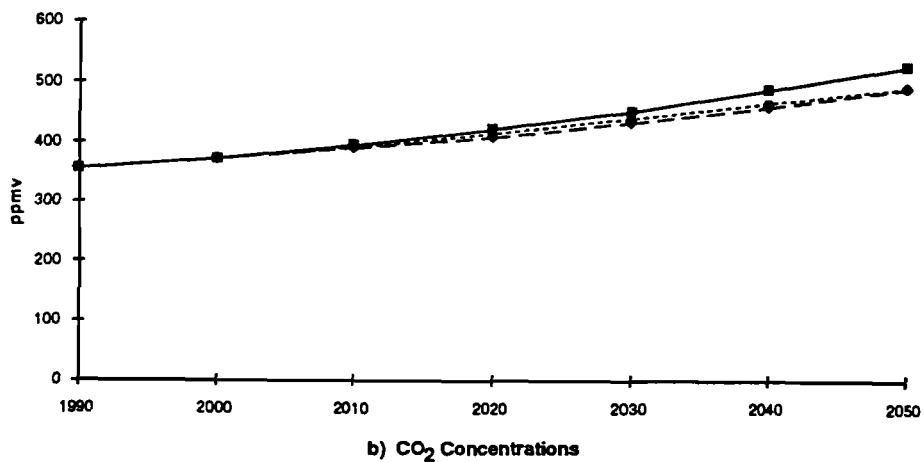
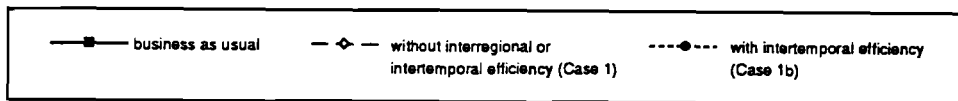
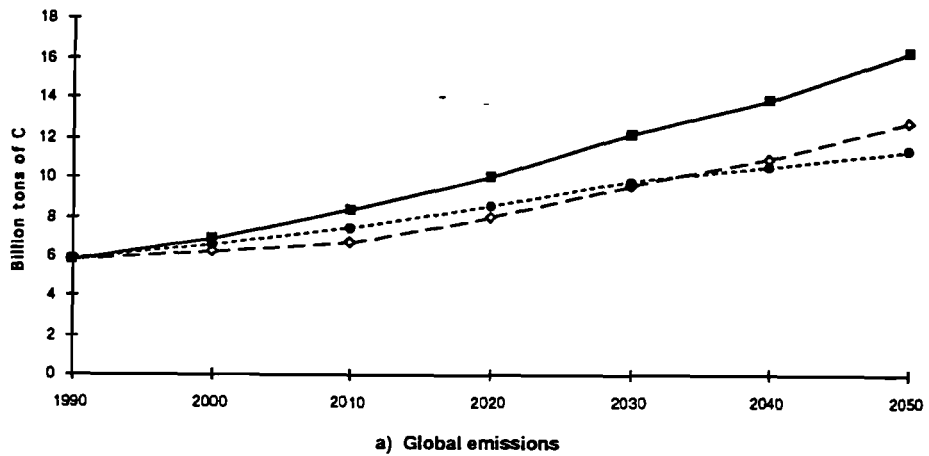


Figure 6. Global emissions and CO<sub>2</sub> concentrations with and without intertemporal efficiency (based on average of model results).

a fixed period of time. For Case 1b, each OECD region's carbon budget is defined as the sum of its permissible emissions between 2000 and 2050 (as specified in Case 1). The issue is how best to allocate the carbon budget over this period.

There are several factors that argue for using more of the available budget in the early years.<sup>8</sup> Deferring emission reductions provides valuable time to reoptimize the capital stock. Energy-producing and energy-using investments are typically long-lived (e.g., power plants, houses, transport). They were put into place with a particular set of expectations about the future. Abrupt changes are apt to be expensive. This is particularly the case when it comes to premature retirement of existing plants and equipment. Time is needed for the capital stock to adapt.

The optimal timing of emission reductions is also influenced by the prospects for new supply and conservation technologies. There has been substantial progress in lowering the costs of carbon-free substitutes (e.g., solar, biomass, energy efficiency) in the past. With a sustained commitment to research and development, there should be further cost reductions in the coming decades. It would make sense to draw more heavily on the carbon budget in the early years, when the marginal costs of emissions abatement are highest. With cheaper alternatives in the future, there will be less need for reliance on carbon-intensive fossil fuels.

Finally, with the economy yielding a positive return on capital, future reductions can be made with a smaller commitment of today's resources. For example, suppose that the net real return on capital is 5% per year and it costs US\$100 to remove a ton of carbon – regardless of the year in which the reduction is made. If we were to remove a ton today, it would cost US\$100. Alternatively, we could invest US\$31 today to have the resources to remove a ton in 2020.

Before leaving the timing issue, several additional caveats are in order. First, it should be noted that the two emission paths of Figure 6 result in different levels of atmospheric concentrations (prior to 2050). They may therefore differ in terms of environmental impacts. Given that the concentration paths lie so close together, however, the differential impacts on temperature and sea level are likely to be negligible.<sup>9</sup>

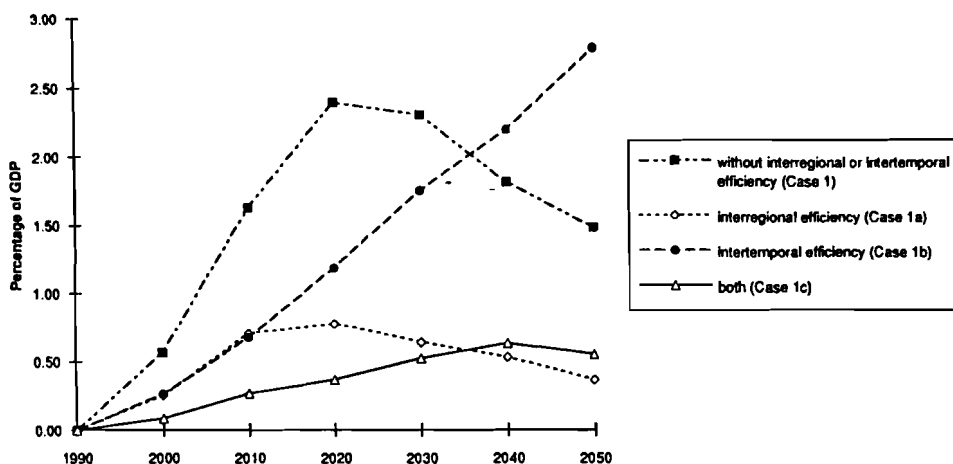
Second, the above considerations (capital stock turnover, research and development, and discounting) argue for shifting some emission reductions into the future. They cannot, however, be used as an excuse for deferring

---

<sup>8</sup>For a more detailed discussion of the timing issue, see Wigley *et al.* (1996).

<sup>9</sup>For the analysis, we use the carbon cycle model of Wigley (1993).





**Figure 7.** OECD GDP losses under alternative assumptions about economic efficiency (based on average of model results).

these reductions indefinitely. The carbon budget is finite. There is an upper limit on the amount to be emitted between now and 2050, which continued deferment would soon exceed. The issue is one of optimal timing.

Finally, note that the amount of deferment depends on the size of the carbon budget. In this instance, there is insufficient flexibility to defer emission reductions altogether in the early years. The optimal emissions path lies between Case 1 and business as usual.

Returning to Figure 4, we see that the most efficient strategy is one that combines international cooperation with flexible timing (Case 1c).<sup>10</sup> In this instance, costs are reduced by more than 80%. Figure 7 provides some insight into why the savings are so large. It shows OECD GDP losses averaged across the four models. In Case 1, GDP losses grow to 2.4% over the next quarter century – roughly US\$400 billion in today's economy. In Case 1b, GDP losses grow more slowly. Although annual losses exceed those of Case 1 toward the end of the time horizon, they are considerably lower early on. As a result, cumulative losses are smaller. If OECD countries are able to take advantage of low-cost emission reduction options elsewhere in the world, losses can be held to under 1% of GDP.

<sup>10</sup>EPPA is a recursive rather than an intertemporal optimization model. Several alternative emission paths were explored for Cases 1b and 1c. The results reported here are for the lowest-cost of the paths tested, and the results are not strictly comparable with those from the other models.

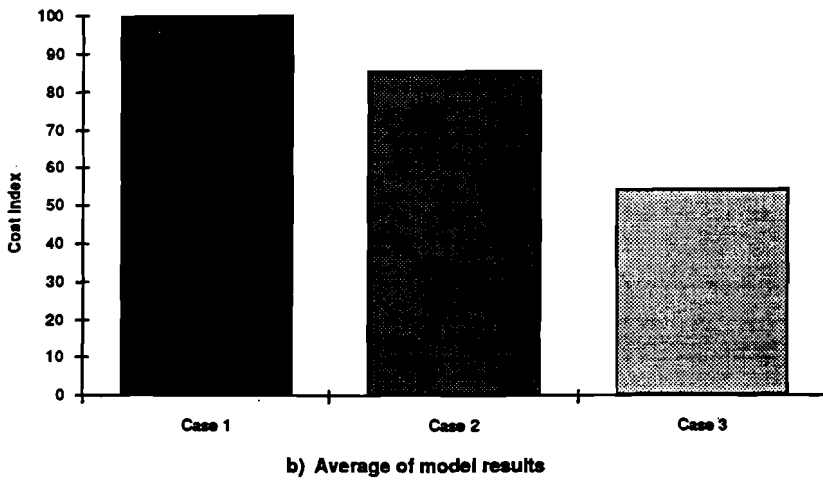
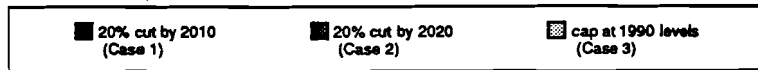
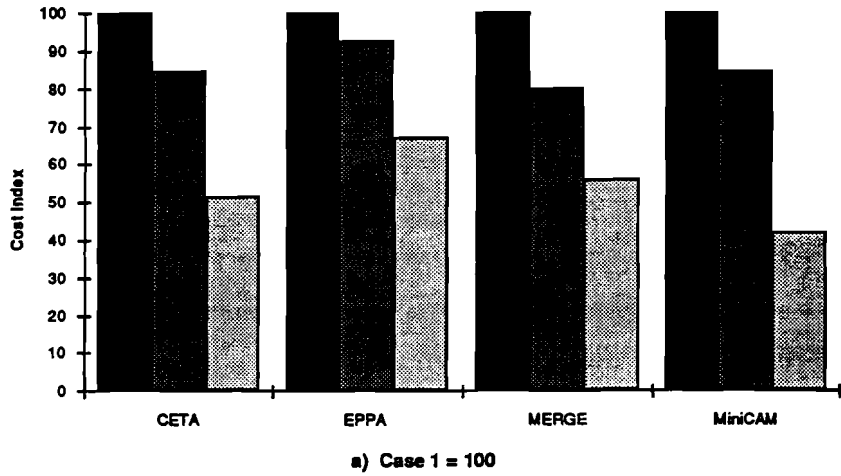
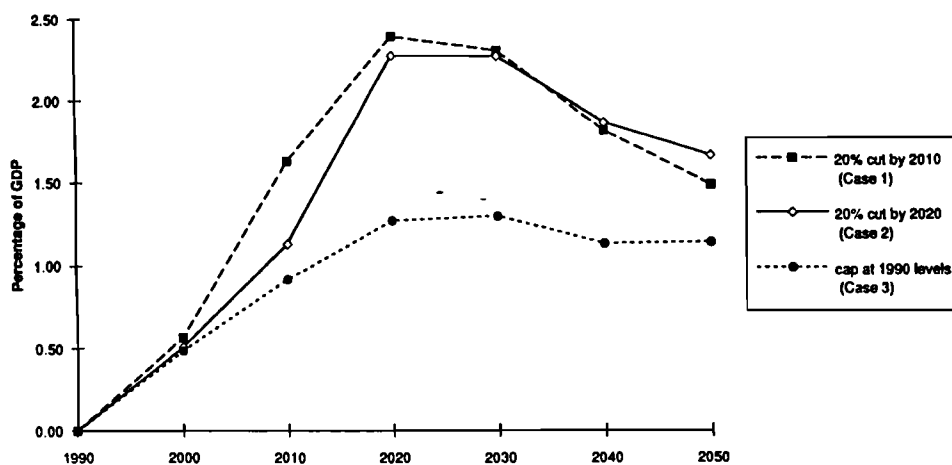


Figure 8. Costs of alternative sets of targets and timetables.



**Figure 9.** OECD GDP losses under alternative targets and timetables (based on average of model results).

One way to reduce costs would be to design more cost-effective strategies. A second way would be to make the constraints less stringent. We now consider two additional variants of Case 1. In Case 2, we delay the date by which OECD countries must achieve the 20% reduction by 10 years. In Case 3, we put off the 20% reduction altogether: that is, OECD countries continue to hold emissions at 1990 levels.

From Figure 8, note that a substantial fraction of the costs of a 20% reduction would be incurred simply by extending the existing target. That is, much of the costs result from reducing emissions from the business-as-usual path to 1990 levels. Between 40% and 70% of the costs are associated with the decision to stabilize emissions at 1990 levels.

Figure 9 compares OECD GDP losses for the three cases. In Case 1, annual losses rise to 2.4% of GDP by 2020. Postponing the 20% cut by 10 years results in lower GDP losses during the initial two decades of the next century, but losses are similar thereafter. For Case 3, GDP losses are lower for the entire period. On average, lowering the target cuts GDP losses by nearly one-half.

## 5. Some Final Comments

Estimating mitigation costs is a daunting task. It is difficult enough to envisage the evolution of the energy-economic system over the next decade.

Projections involving a half century or more must be treated with considerable caution. Nevertheless, we believe that exercises like the present one contain useful information. The value, however, lies not in the specific numbers, but in the insights for policy making. With this in mind, we attempt to summarize what we have learned:

- Implementing an AOSIS-type proposal may require substantial CO<sub>2</sub> reductions for OECD countries. With a growing emissions baseline, more and more carbon must be removed from the energy system to maintain an absolute target. Such reductions could be quite costly – perhaps, as much as several percent of GDP for OECD countries.
- Because of trade effects, the non-OECD countries will likely incur costs even when emissions reductions are confined to the OECD. Restrictions on carbon emissions lead to lower demand for oil, which results in lower revenue for oil-exporting countries. In addition, an economic slowdown in the OECD countries affects the full range of exports of developing countries, and thus their growth. For many oil-importing developing countries, these broader trade effects outweigh the gain from lower world oil prices.
- One way to reduce mitigation costs would be to design cost-effective constraints. Indeed, the present analysis suggests that the potential gains from international cooperation (interregional efficiency) and flexible timing (intertemporal efficiency) are huge. Taken together, they can reduce costs by more than 80%. The key is to allow emission reductions to take place both *where* and *when* it is cheapest to do so.
- A second way to reduce mitigation costs would be to adopt less stringent constraints. For example, rather than a 20% cutback, the OECD could agree to hold emissions at 1990 levels. The analysis suggests that the reduction in overall mitigation costs would be between 30% and 60%. The savings, however, must be weighed against the impacts of the incremental emissions through larger changes in climate.
- The following steps could substantially reduce the costs of implementing a carbon constraint under the Berlin Mandate: (1) allow developed countries to purchase low-cost abatement options in developing countries; (2) allow time for the economic turnover of existing plants and equipment; (3) invest in the development of economically attractive substitutes for carbon-intensive fuels; and (4) ensure that cost-effective options are adopted to the greatest extent possible.

- Our results are consistent with other studies which suggest that carbon emissions will continue to grow in the absence of policy intervention. Proposals that focus exclusively on developed countries may slow the growth in global emissions, but they will not stabilize them at anywhere near present levels. Nor will they stabilize atmospheric concentrations, the ultimate goal of the Framework Convention. To do so, would eventually require the participation of developing countries.

The present paper identifies enormous savings from international cooperation and flexible timing. Realizing this potential, however, may be another matter. For example, how do we divide up the savings from international cooperation? Or, how do we ensure that parties maintain a credible path toward fulfilling commitments? Considerable ingenuity will be required, but given the stakes, even partial success is likely to be well worth the effort.

Fortunately, some of the necessary concepts are already being tested. For example, efforts to incorporate international cooperation can build on the experience gained from national and international joint implementation initiatives. With regard to flexible timing, a limit might be placed on a country's cumulative emissions. Subject to this constraint, the country could lay out its own projected emissions time path and prepare a formal plan that builds on existing experience with National Action Plans under the Framework Convention. Periodic reviews could then track adherence to the commitment. Technology development efforts, with suitable performance milestones, also could be an integral part of both the path definition and review processes.

Negotiators must consider myriad competing ideas and interests inherent in shaping a global policy. One of their greatest challenges will be to meet the injunction of Article 3 of the Framework Convention: "policies and measures to deal with climate change should be cost-effective so as to ensure global benefits at the lowest possible costs." Our success in confronting the challenge of climate change may depend directly on their success in doing so.

The larger question, of course, is what constitutes an appropriate set of emission constraints. This requires consideration of both benefits and costs. The present analysis has been confined to the cost side of the ledger. That is, we examine the costs of reducing CO<sub>2</sub> emissions. Policy makers will also want to know what they are buying in terms of reducing the undesirable consequences of global warming. Such an analysis is beyond the scope of the present effort.

## References

- Edmonds, J., Wise, M., Pitcher, H., Richels, R., Wigley, T., and MacCracken, C., 1996, An Integrated Assessment of Climate Change and the Accelerated Introduction of Advanced Energy Technologies: An Application of MiniCAM 1.0., *Environment Modelling & Assessment* (forthcoming).
- EMF (Energy Modeling Forum), 1995, Second Round Study Design for EMF-14: Integrated Assessment of Climate Change, Stanford University, Stanford, CA, USA.
- Hogan, W., and Jorgenson, D., 1991, Productivity Trends and the Costs of Reducing CO<sub>2</sub> Emissions, *The Energy Journal* **12**(1):67-86.
- Intergovernmental Negotiating Committee for a Framework Convention on Climate Change, 1992, Fifth Session, Second Part, 30 April-9 May, New York, NY, USA.
- Intergovernmental Panel on Climate Change (IPCC), 1994, *Climate Change 1994*, Cambridge University Press, Cambridge, UK.
- Intergovernmental Panel on Climate Change (IPCC), 1996, Report of Working Group III, Chapters 1, 9, and 10, forthcoming, Cambridge University Press, Cambridge, UK.
- Manne, A., 1996, Greenhouse Gas Abatement - Toward Pareto Optimality in Integrated Assessments, in K.J. Arrow, R.W. Cottle, B.C. Eaves, and I. Olkin (eds.), *Education in a Research University*, Stanford University Press, Stanford, CA, USA.
- Manne, A., and Richels, R., 1994, The Costs of Stabilizing Greenhouse Gas Emissions: A Probabilistic Analysis Based on Expert Judgments, *The Energy Journal* **15**(1).
- Manne, A., and Richels, R., 1995, The Berlin Mandate: The Costs of Meeting Post-2000 Targets and Timetables, *Energy Policy* (forthcoming).
- Peck, S., and Teisberg, T., 1995, International CO<sub>2</sub> Emissions Targets and Timetables: Analysis Using CETA-M, Working Paper, Electric Power Research Institute, Palo Alto, CA, USA.
- UN, 1995, *United Nations Climate Change Bulletin*, Issue 7, 2nd Quarter, Interim Secretariat for the UN Climate Change Convention, Geneva, Switzerland.
- Wigley, T.M., 1993, Balancing the Carbon Budget: The Implications for Projections of Future Carbon Dioxide Concentration Changes, *Tellus* **45B**.
- Wigley, T., Richels, R., and Edmonds, J., 1996, Economic and Environmental Choices in the Stabilization of Atmospheric CO<sub>2</sub> Concentrations, *Nature* **379**(6562):240-243.
- Yang, Z. *et al.*, 1996, The MIT Emissions Projection and Policy Assessment (EPPA) Model, draft report, MIT Joint Program on the Science and Policy of Global Change, February.

# Technologies, Energy Systems, and the Timing of CO<sub>2</sub> Emissions Abatement: An Overview of Economic Issues

*Michael Grubb*

Energy and Environmental Programme  
Royal Institute of International Affairs, London, UK

## Abstract

This paper provides an overview of economic issues involved in the timing of limitations on carbon dioxide (CO<sub>2</sub>) from energy systems, with particular reference to issues of technology availability, development, and diffusion, but also considering briefly other aspects of the problem.

It is stimulated by the debate in the USA about optimal abatement paths, in particular, recent claims that it would be economically preferable to defer such abatement action in favor of measures that support technology development but do not affect emission trends for many years.

This paper categorizes the various economic issues involved and concludes that for each economic argument that has been advanced to justify deferring emission constraints, there are countervailing economic arguments that could be used in support of rapid near-term emissions abatement.

Rational policy lies between these extremes. A policy of deferring all emissions abatement exposes economic systems and industries, as well as the environment, to significantly greater costs and risks than those arising from a more balanced approach.

Furthermore, the modeling studies that have been used to justify deferring emissions abatement do so because they embody the economic factors favorable to delay and largely neglect the countervailing issues, to the point where they cannot be considered as relevant to a balanced assessment of the issues relating to economically optimal abatement timing.

## 1. Introduction

The debate in the USA on the optimal timing of greenhouse gas emissions abatement has been greatly stimulated by recent modeling studies that

examine trajectories of carbon dioxide (CO<sub>2</sub>) emissions aimed at a predetermined stabilization level in the atmosphere. The paper by Wigley, Richels, and Edmonds (1996, hereafter the WRE paper) applied a carbon cycle model to explore alternate emission pathways, and suggested that pathways in which abatement is deferred would be economically preferable (Wigley *et al.*, 1996). This was justified in part by reference to economic modeling studies that used resource allocation/equilibrium models (Manne and Richels, 1995).

These studies stated that four main reasons justify the belief that deferring abatement of greenhouse gas emissions may be economically preferable: technical progress; capital stock considerations; positive marginal product of capital (discounting); and greater absorption of CO<sub>2</sub> emissions emitted earlier.

This paper explores these arguments and their relationship to the overall economic problem of how best to time limits on greenhouse gas emissions.

The paper focuses primarily on issues concerning the development of technologies and energy systems, and related investment patterns (Sections 2 and 3). This is divided into two main sections: issues of *technical change and systems evolution*, and *issues of capital stock and systems inertia*.

The paper also examines the broader context of economic issues surrounding the timing of greenhouse gas emissions abatement. Specifically, Sections 4 and 5 consider how studies of preset stabilization constraints relate to the real policy problem, namely, that of timing policies under the expectation of aggregate damage of highly uncertain magnitude arising from climate change.

Section 6 briefly sketches relevant strengths and weaknesses of some of the different modeling approaches that have been applied to the question of timing emissions abatement.

Finally, a concluding section brings together the main insights of the analysis.

## 2. Technical Change

Technical change has been advanced as a reason for delaying emissions abatement, on the grounds that cost reductions in technologies will make abatement cheaper in the future. Three issues need to be clarified in this context.



## 2.1. The continuum of abatement options

The first of these issues is that there are a wide range of options and technologies for limiting emissions, at varying cost levels and with different prospects for cost reductions. Even when we have exhausted “no-regrets” options that can be implemented at no costs, there are a wide range of options still available, including many cheap ones such as incremental improvements in building insulation, car and appliance efficiency, etc.<sup>1</sup>

An economic representation of this is illustrated in Figure 1(a), which shows an estimate of the “abatement cost curve” for CO<sub>2</sub> reductions derived in Nordhaus (1991) from a number of (mostly top-down) studies. Clearly, even after all “negative cost” options have been utilized, some additional reductions can be achieved at very modest costs, as one would expect; with a fixed cost curve, the cost then rises steadily as greater reductions are sought.

Over time, technology development can be expected to lower technology costs, and thus move the curve to the right. The argument that technology development will reduce abatement costs in the future appears to have been interpreted as an argument for deferring emissions abatement in general, i.e., waiting at the origin while governments pursue sufficient new research and development (R&D), and then moving rapidly to exploit a wide range of technologies once there has been “enough” (in some unspecified sense) development. It may be characterized as a “do R&D, then sprint” approach.

Alternatively (and in addition), one could move steadily along the curve but remain in the region of fairly low (but non-zero) abatement costs. As technology development shifts the curve to the right, more options will become available at modest cost (if we find that we are starting to climb too far up the cost curve, so that it is getting expensive, then it should always be possible to ease off while development continues). This could be termed a “steady walk” approach, and it is not obvious that it involves much higher costs than waiting – depending on how ambitiously one moves up the curve.

---

<sup>1</sup>The extent of negative-cost and low-cost options is actually a very important question in the context of the WRE paper, since its conclusions are claimed to be policy relevant and are stated in terms of near-term emission levels. There are plenty of studies around claiming that most Organisation for Economic Co-operation and Development (OECD) countries could at least stabilize emissions in the near term by implementing such low-cost measures; the Working Group II report of the Intergovernmental Panel on Climate Change (IPCC) lists a plethora of such options. The IPCC’s WG-II report details a huge range of such options.

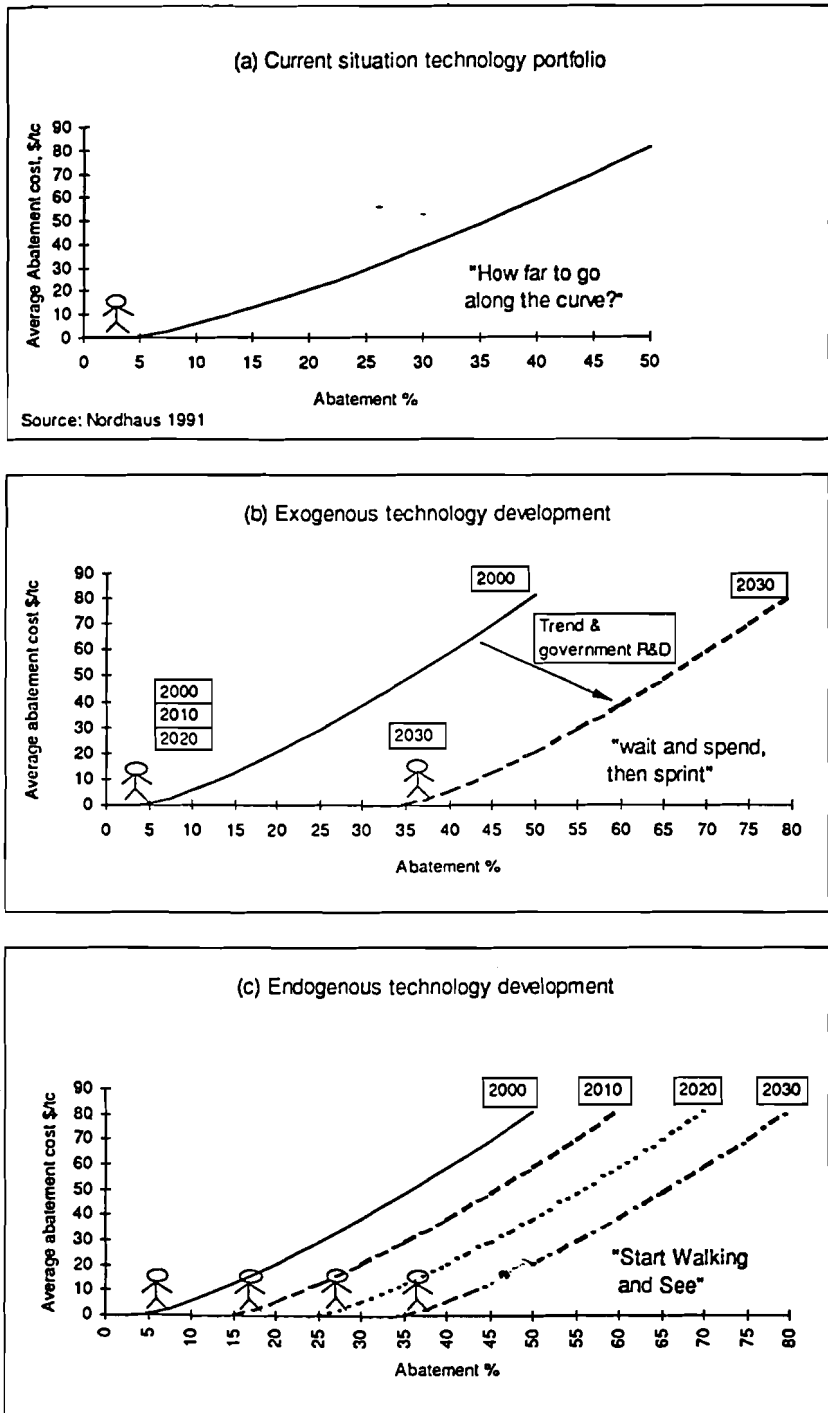


Figure 1. Technology menus and development.

## 2.2. Endogenous technology development

The above discussion assumes that all technological development occurs independently of emission abatement efforts. This reflects an idea of technology development as an “exogenous” process – the idea that technology development occurs independently-of market conditions. This would apply, for example, to the extent that technology development represents an automatic accumulation of knowledge, or is fostered primarily by government R&D.

In fact, the idea that new technologies develop autonomously, or arise primarily because governments pay to develop them, is an idea that economists who work on technology issues abandoned decades ago. More than 30 years ago, Arrow (1962) noted that much knowledge is acquired through learning-by-doing and explored the economic consequences of this (see also some of the reviews in Dasgupta and Stoneman, 1987). Government R&D can help, but most effective technology development and dissemination is done by the private sector in the pursuit of markets. In other words, much technology development is *induced* by market circumstances – market experience leads to cost reductions and expectations about future market opportunities determine how industries deploy their R&D efforts.

This is not surprising, since in fact corporate R&D swamps government R&D in most countries. The energy sector in the 1980s provided powerful examples of the fact that technology development depends powerfully on market conditions. The cost of offshore oil platforms fell greatly as companies sought to keep operations economical in the face of declining oil prices. The costs of wind energy fell threefold over the 1980s as an artificial market was created in California and then steadily tightened, and they have continued to do so as supports have shifted to European markets. Even gas turbine/combined-cycle stations started their major developments as natural gas and electricity system conditions emerged to make a market available.<sup>2</sup>

In these circumstances, it is in steering the markets that governments can have the biggest impact on technology development (though government R&D can also play an important role for technologies still in an early stage of development). This can also be illustrated with reference to Figure 1(c). Induced technology development implies that it is the act of moving steadily along the curve that pushes the curve to the right, i.e., abatement efforts generate market opportunities, cash flows, and expectations that enable industries to orient their efforts and learning in the direction of lower-carbon

---

<sup>2</sup>For a detailed account of some of these developments see Grubb and Walker (1992).

technologies. Hence, in this model, action itself generates cheaper technological options arising out of accumulating experience.<sup>3</sup> In this case, deferring emission reductions simply delays the generation of options that can address the problem at low cost.

Therefore, conclusions about how technology development affects optimal timing hinge critically on the assumptions made about *how* technology develops. The evidence suggests that an important role needs to be accorded to the potential for inducing technology development through actions that affect energy markets. Notably, policies that act to constrain CO<sub>2</sub> emissions will tend to create appropriate incentives in energy markets to turn the bulk of corporate energy R&D away from improving fossil fuel technologies toward developing and deploying lower-carbon technologies.

### 2.3. Technology clustering and “lock-in”

A third important issue in technology development is that of clustering, and related effects of “lock-in,” and “lock-out.” Studies of the economics of technology development have demonstrated that technological development tends to be strongly biased toward existing modes (e.g., Nakićenović and Grübler, 1991). Industries that have a large market share in any particular technology can spend large amounts on R&D and expend other resources trying to make incremental improvements to those technologies to protect their existing position, and try in various ways to discourage the emergence of new options with which small competitors might threaten their preeminence.

Furthermore, no industry exists in isolation; rather, each is part of a very extensive network, dependent on infrastructure, supplier relationships, and consumer outlets, as well as interrelated technologies. Consequently, technological trends have an evolutionary character, with interrelated lines of development and deployment. On the grand scale, “Kondratiev waves” of interrelated technological developments (such as the internal combustion engine combined with petroleum extraction and refining technologies and distributional infrastructure) have been proposed. On a smaller scale, a

---

<sup>3</sup>Note that one objection that has been raised to this is the fact that stimulating innovation in one sector (e.g., energy) may reduce innovation in another sector, so that there is no “free lunch.” In fact, the evidence for this is rather slim; it is not all obvious that challenges in one sector do in general cause them to draw “innovation resources” from elsewhere, though the possibility deserves further empirical study. However, the broader argument about the implications of adaptability (Section 2.4) does not hinge on this issue; it simply asserts that the ability to innovate and develop alternate systems gives us some freedom in how to orient developments in our economic systems with respect to environmental impacts.

---

## **Induced technology development, technology clustering, and systemic adaptability**

### **Induced/endogenous technology development**

“Learning-by-doing” (Arrow, 1962)

Corporate R&D

Examples from the energy sector during the 1980s:

Offshore oil platforms

Wind energy

Gas turbines

### **Technology clustering**

Technology waves (Kondratiev),

e.g., Petroleum refining/internal combustion engine/  
road technology and infrastructure

Technology morphological/evolution (Grübler and Foray, 1990)

e.g., Ferrous casting

“Lock-in” example: steam turbine

“Lock-out” example: 1930s hydrocarbon refrigeration

### **Systemic adaptability**

Combination of induced innovation, clustering,  
infrastructure, and behavioral adjustments

Examples: Japanese response to the oil shocks

Other international comparisons

Implies very different emission profiles and much higher cost of delay.

---

whole disciplinary approach of morphological analysis has been developed to explore the interrelated evolution of particular technological strands (e.g., with detailed studies of ferrous metal technologies).<sup>4</sup>

Such factors give rise to the phenomena of technological “lock-in” and “lock-out.” For example, as the steam turbine began to dominate electricity

---

<sup>4</sup>See, for example, studies in Nakićenović and Grübler (1991).

supply, R&D expenditure became focused on making marginal improvements in its performance. Conversely, the technology of refrigeration using hydrocarbons that developed in Central Europe in the 1930s withered as chlorofluorocarbon (CFC) refrigeration developed, and has only very recently been revived, with little intervening development, under the pressure of the CFC phaseout.

Because of such phenomena, it can be very difficult for new technologies to be adequately developed and brought into the market quickly. Thus, establishing market share takes time and appears to be a very important prerequisite for adequate technological development, because such development depends on cumulative corporate R&D and the parallel evolution of a series of interrelated industries.

On all three counts therefore – technology availability, technology development processes, and technology clustering – understanding the economics of technology evolution is extremely important to climate change policy. A rounded understanding strongly suggests that developing markets for low-carbon options, for example, by emission reduction programs, is a very important part of fostering the developments required to achieve low-cost, long-term reductions.

#### **2.4. Adaptability in energy systems**

Put together, these various features of induced technology development, technology clustering, etc., form a basis for expecting that energy systems are to an important degree adaptable – over time, they can develop to accommodate various constraints. This is hardly surprising given the issues set out above, and this evidence is complemented by analyses of responses to the oil shocks (e.g., in Japan) and by international comparisons that show just how different energy systems can be, as summarized in Grubb *et al.* (1996).

In Grubb *et al.* (1996), the authors show that if appropriate technology and systems development is indeed induced by emission constraints, it stands the argument about waiting for cost reductions on its head: rather, it becomes optimal to act earlier with steady pressure, so as to stimulate the necessary technological and systemic developments. This is hardly surprising; it is all an indication that complex technological systems evolve, but that they may need significant pressures to evolve in different directions, for example, in the direction of minimizing particular external environmental impacts that previously have not affected corporate investment and R&D decisions.

Similar insights are developed in an analysis by Hourcade, who discusses the “flexibility” of the French energy economy in terms of different development paths (Hourcade, 1993). His study explicitly models the role of policy in accelerating paper technology diffusion and develops scenarios that differ widely in CO<sub>2</sub> emissions but not long-run costs.

The World Energy Council also offers insight on such issues and their implications; one of the recommendations of the Tokyo World Energy Congress Statement urges “governments, business decision-makers and energy consumers” to “start taking action now to adapt to the needs of our long term future . . . the next two or three decades represent the key period of opportunity for a transition to a more sustainable path of development for the long term. Research done and action taken now will begin the shift of direction required of ‘minimum-regrets’ action” (WEC, 1995).

To explore the implications further, however, we first need to consider another aspect of energy systems, namely, investment cycles and inertia.

### **3. Capital Stock Turnover and Inertia**

#### **3.1. Capital stock turnover**

The fact that “time is needed to re-optimize the capital stock” has been advanced as a second reason for deferring abatement. Certainly, a major change takes time if it is to be done without high cost. But capital stock is continually being restructured as existing stock is refurbished or retired and new stock is created to replace old stock or to meet demand growth or changes in demand structure.<sup>5</sup> New capital investment is thus continually occurring.

A key to economically efficient abatement is thus to seek to make new capital stock less carbon intensive than it otherwise would be. This obviously involves a steady departure of emissions from the “business as usual” trajectory, starting as soon as climate change is recognized to be a potentially serious problem [a point that may reasonably be identified with the publication of the Intergovernmental Panel on Climate Change’s First Assessment Report in 1990 (IPCC, 1990)].

---

<sup>5</sup>Frequently, the oldest capital stock is also the least efficient, with rising maintenance costs. The net costs of retiring such stock rather than refurbishing it for a longer (polluting) life may be small and may indeed result in net gain when other factors are considered. When the costs are finely balanced, the economic issues are similar to those involved in new investment to meet demand growth.

The economic importance of getting this right is itself apparent from the scenarios in the WRE paper. For their central stabilization case (550 ppm stabilization), their “deferred abatement” case shows the new pathway as involving emissions rising over the next 40 years from the current level of just under 7GtC/yr to a peak about 4GtC/yr higher, before dropping by about 2GtC/yr over the subsequent 40 years (and even faster thereafter). Thus the delay scenario involves constructing an *additional* 4GtC/yr of capital stock over and above that required for replacement. In total, WRE’s central deferred scenario thus means investing in at least as much new CO<sub>2</sub>-based capital stock over the next few decades as is embodied in all of the world’s energy systems today. Then, to meet their target, the additional stock must be replaced by carbon-free sources over the subsequent decades.

Especially when coupled with uncertainties about the actual objective (see below), this has powerful industrial implications. Inappropriate delay in constraining emissions is not in the interests of industry. It increases the exposure of industry to the risk that new, carbon-intensive investments will have to be prematurely retired, at large cost and dislocation compared with the costs of avoiding such investments in the first place (e.g., coal power plants or mines left “stranded,” or frontier oil exploration and development left without sufficient high-price markets when they mature).

The World Energy Council, in the conclusions to the Tokyo World Energy Congress (WEC, 1995), recognized this in stating that “action postponed will be opportunity lost, guaranteeing that when action can no longer be avoided the ensuing costs will be higher; dislocations more severe; and the effects much less predictable, than if appropriate actions are taken today.”

### 3.2. Inertia

Because scenarios that defer action to limit greenhouse gas emissions generally imply more rapid subsequent abatement (if the same ultimate goal is to be achieved), adequate understanding of inertia in energy systems is essential to analyzing timing issues.

The existing structure of capital stock in energy-producing sectors, discussed above, is one source of inertia. However, such “first order” capital stock issues (the structure of power generation facilities, petroleum refineries, etc.) represent only a component of the issue. Considering only these first-order components appears to suggest that most of the stock has a lifetime of 30–40 years, suggesting possibilities for almost complete transitions over such a period at low cost.

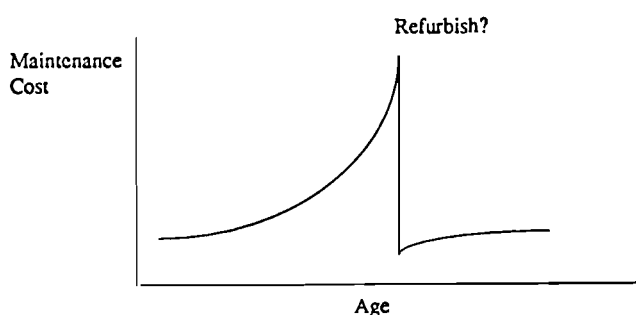


---

### 1. Capital stock is continually being created and replaced

- New investments may be an opportunity for efficient abatement
- New carbon-intensive investments are risk-exposed
- Encouraging move toward lower carbon investments implies steady departure from BAU

### 2. Aging capital stock is similarly a continuum offering lower cost opportunities for abatement



### 3. Rapid changes are costly, in both GDP and welfare impacts

- Reduces opportunity for low-cost utilization of natural stock turnover
  - Industrial dislocation, stranded investments
  - Breaking out of “lock-in” may be expensive
  - Amplifies disequilibrium and reduces optimality of resource allocation
    - Capital market imperfections
    - Labor force resistance and inappropriate training
    - Other macroeconomic dislocations
  - Human “pain of change” from enforced unemployment, etc.
- 

In fact the situation is far more complex. Some causes of CO<sub>2</sub> emissions lie in even more fixed structures such as poor building construction, urban sprawl, etc. Thus town planning today, for example, could have implications for abatement potential and costs at the end of the next century.

The discussion of Section 2 points to deeper sources of inertia. Further emissions growth involves expansion of a huge complex of interdependent infrastructure and industries dependent ultimately on emitting CO<sub>2</sub>. Certain transport and urban developments – infrastructure that may substantively last throughout the next century – carry with them a whole structure of personal and business location consequences, upon which the infrastructure in turn comes to depend. Coal-fired power stations carry with them a complex network of delivery systems, usually stretching back through rail and/or port facilities right back to the decisions and investment surrounding coal mines for the next century. The costs of escaping from such interdependent systems rapidly is likely to be far higher than more gradual, steady transitions, and avoiding such construction in the first place (to the extent that adequate alternatives are available) is likely to be cheaper still.

This obviously relates to the phenomena of technology clustering, “lock-in,” and “lock-out,” discussed above. Established industries invest to protect their comparative advantage and draw on clusters of technologies surrounding them. New entrants and even fundamental shifts are of course possible, but they take a long time to evolve and be deployed on a large scale. Hourcade’s study develops the concept more explicitly with reference to European transport in terms of “bifurcations,” different paths that, once followed, are costly to escape (Hourcade, 1993).

The issue is thus far deeper than one of just understanding capital stock replacement. It involves basic questions about the inertia in socioeconomic and political systems. Scenarios that involve a period of substantial emissions growth followed by rapid changes in trajectory toward reductions could involve economic dislocation far beyond issues of capital stock. Labor forces trained for carbon-intensive operations would have to be made redundant or retrained, the network of industries based around growing fossil fuel consumption and carbon-based infrastructure would have to be thrown into reverse, reformed, and remodeled, etc. Each new investment in carbon-intensive stock may make the transition toward a low-carbon system that little bit more difficult and slower.

Quite apart from the economic and social costs of waiting and then forcing a rapid transition, in reality it is doubtful whether governments, after putting off action for another couple of decades, could or would impose such drastic changes of direction. This in turn is a reflection of the high welfare costs associated with rapid contractions in any given industry, probably much greater than measured in GDP terms. The political feasibility of such scenarios is thus also very doubtful; starting off on such a trajectory in reality would probably not deliver the objective claimed.

To consider the policy implications of such issues more fully, however, we need first to consider more carefully the broader nature of the policy challenge.

#### 4. The Impact of Uncertain Stabilization Objectives

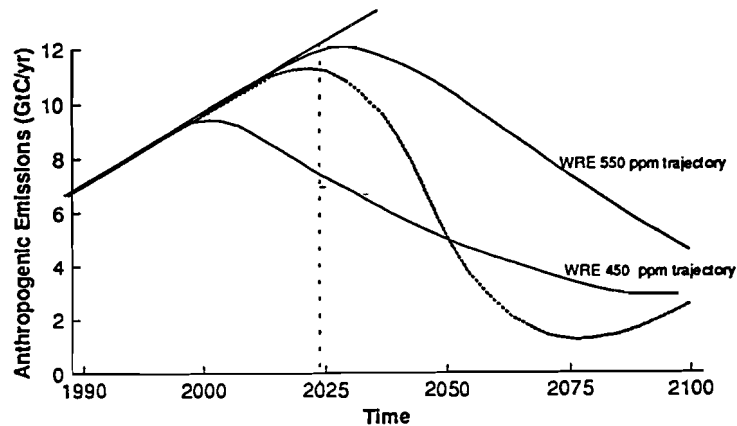
Recent studies (Wigley *et al.*, 1996; Manne and Richels, 1995) have analyzed the long-term objective of stabilizing atmospheric concentrations at a prespecified level and discussed paths toward this objective as a fixed constraint. This may be an interesting exercise, but it is one that is only weakly related to the problem we face.

The real problem we face is characterized by concern about potential impacts of a highly uncertain nature and magnitude. The Climate Change Convention establishes an aim of ultimately stabilizing the atmosphere, but we do not know at what level it needs to be stabilized, or how the interim impacts on climate change and consequent human impacts may be related to the rate at which the atmosphere changes (the Convention Objective also refers to rates of change). I consider the economic implications of stabilization uncertainties and physical impacts in turn.

A common misconception in economic analysis is that by analyzing a number of different scenarios, we have analyzed uncertainty. This is not the case at all. We are not in a position to choose an appropriate stabilization objective; indeed, it would be highly irrational to choose a single objective and stick with it for the next 100 years without reference to what we learn. It would also be contrary to the Convention, which emphasizes the need to adjust policy in light of the accumulating knowledge. We have to develop policy in the full recognition of uncertainties and the expectation of learning more.

This brings the question of inertia to the fore even more. If we delay action in the belief that we are aiming at a 500 ppm target, for example, then after a couple of decades it may simply be too late to be able to stabilize at 400 ppm, however urgent the problem then turns out to be; and even stabilization at 450 ppm might by then involve radical changes of direction that could prove economically very disruptive.

Figure 2 sketches the changes that would be required if we were to follow until 2020 the “deferred abatement” trajectory set out in the WRE paper for a 550 ppm limit, but then find that we have to stay within a 450 ppm



**Figure 2.** Potential impact of uncertain stabilization constraints.

limit.<sup>6</sup> Within the space of 30 years, we would then have to dismantle or transform more than two-thirds of the world's carbon-based infrastructure – more carbon-intensive stock than exists in the whole of the world's energy systems today. It would furthermore require not only faster, but much deeper action – car-free cities, for example, rather than the low-emission, high-efficiency vehicles that might be consistent with a smoother abatement trajectory.

Conversely, if we act on the assumption of aiming at a lower level, but after a while conclude that we can safely go to higher levels, we may have incurred more costs than needed. But the costs of excessive caution against excessive optimism may be highly asymmetric (within limits). Steady sustained pressure to limit emissions cannot expose us either economically or environmentally to the scale of risks that may be incurred by a long delay, if there is a real possibility that a low stabilization level may prove necessary. The risk of overreacting – excessive abatement – seems comparable only if

<sup>6</sup>The 450 ppm and 550 ppm trajectories are estimated from the graphs in Wigley *et al.* (1996), and the transition is estimated on the basis of equilibrating the areas of excess emissions against the later deficit, with some allowance for the greater absorption of the earlier emissions. The IMAGE model, which contains a full carbon cycle model, has been applied to consider different trajectories of stabilization at 450 ppm. Results indicate that delaying abatement until 2025 would then require rather more drastic subsequent abatement than is depicted in Figure 2; the concentration unavoidably overshoots 450 ppm and emissions in their projections go below zero in the period 2075–2100 in order to try and bring concentrations back toward 450 ppm (Alcamo, 1996). Thus, Figure 2 may understate the degree of reduction required after such a delay to stay within such a limit.

we embark on drastic and very costly abatement programs that later prove unnecessary.

The best initial path is a complex balance of such risks, but an appropriate balance clearly does not involve following “business as usual” emissions while waiting for evidence to accumulate. Governments acknowledged this clearly in a number of references in the IPCC WG-III Policymakers Summary (IPCC, 1995).

## 5. Impact Costs: Time Preferences and the Rate of Atmospheric Change

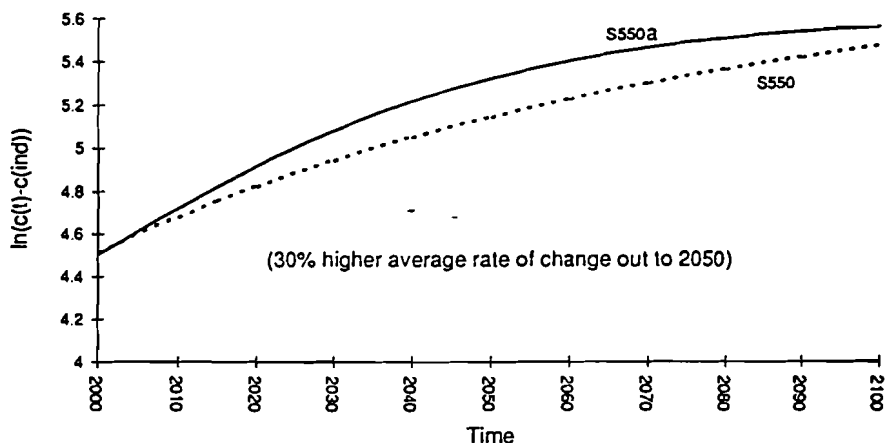
Finally, a reasonable appraisal of the economic issues involved in timing emissions abatement needs to consider the actual impacts of climate change. These are of course fraught with uncertainty. However, several qualitative considerations indicate that considering impact costs leads to different time profiles than optimization under a fixed (or perhaps even a stochastic) stabilization constraint, quite apart from the fact that a positive benefit (in terms of reduced impacts) is now associated with achieving lower stabilization levels.

First, consideration of the damage expected from climate change, whether large or small, brings a new element into consideration of time discounting. For the argument that marginal productivity makes it cheaper to defer the costs of abatement applies similarly to impacts: avoiding damage earlier also has a greater present economic value. Deferring emissions abatement defers abatement costs, but it brings impact costs nearer. So, even neglecting all other considerations, the implications of time discounting for the overall policy problem are not as clear-cut as is implied in studies that consider only the question of stabilization without reference to damage (so that discounting applies only to abatement costs).

In physical terms the time paths of impacts may be expected to differ according to the time path of emissions (as the WRE paper is careful to note; it presents calculations of how global average temperature and sea-level change vary between scenarios). One particular feature of this is, however, worth highlighting. An important index of climate change impacts may be the rate at which radiative forcing in the atmosphere (and hence average temperature) changes.<sup>7</sup> The question of rates of change may be particularly important given the tendency of some complex systems to become more

---

<sup>7</sup>Note that the rate of radiative change has no direct impact in itself, but represents a driving force that emerges as subsequent temperature and other changes.



**Figure 3.** Impact of deferred abatement on radiative change. Source: Derived from data in Wigley, 1996.

unstable when subject to high rates of change and given the inertia of human societies. Thus, more rapid radiative and temperature change seems likely to bring more rapid, and perhaps more volatile, climatic change, and human societies are likely to have greater difficulty in adapting to such changes than if they were to occur more slowly and smoothly.

Because the radiative impact of CO<sub>2</sub> is approximately logarithmic with concentration, the rate of radiative change in most scenarios is greatest at present and in the near future. Figure 3 shows how deferring abatement until 2010 and following the WRE 550a trajectory, greatly extends the period of high rates of radiative change.<sup>8</sup> Averaged over the period 2000-2050, the average rate of change is about 30% higher than in the IPCC trajectory for the same ultimate stabilization limit.

Figure 3 compares the radiative forcing associated with CO<sub>2</sub> emissions (as indexed by the log of CO<sub>2</sub> concentration relative to preindustrial conditions) in the IPCC 550 ppm stabilization profile against the profile arising from the WRE scenario with abatement delayed until 2010 (550a). Although they converge on the same concentration, the average rate of change in the

<sup>8</sup>If emissions are assumed to have been growing steadily and to continue to do so, then the rate of radiative change would already be declining from its peak. Given a more realistic representation of CO<sub>2</sub> emissions over the past 20 years (i.e., the very slow growth in global emissions following the oil shocks, followed by large reductions in the countries with economies in transition), but with resumed global growth from the mid 1990s, the rate of radiative change may approach its maximum in the coming years and delaying abatement would increase the maximum rate of change as well as extending it.

first 50 years of the next century is about 30% higher for the case with delayed abatement.

This is reflected in projections of temperature change. The WRE paper shows that deferring emissions abatement implies a more rapid temperature change through the middle of the next century, and then a rather abrupt transition as the stabilization ceiling is approached. For their central case, averaged over the next 50 years, the rate of temperature change appears to be more than 20% higher than is the case without deferment of emissions abatement.

Results from the IMAGE model reinforce the importance of such considerations. Compared with the IPCC 450 ppm scenario, a 450 ppm scenario in which abatement is delayed until 2025 (followed by rapid reductions) leads to a 40% higher rate of global average temperature change over the first half of the next century, and a higher overall peak temperature later in the century. We do not know the extent to which the physical and human impacts of climate change depend on the rate of radiative and temperature change, but it is clearly something that needs to be factored into consideration of emission paths, and deserves further analysis urgently.<sup>9</sup>

## 6. A Brief Note on Economic Modeling

The discussion so far has not addressed specific economic modeling results. Although the WRE paper likewise does not contain any economic modeling, it does justify some of its economic statements and choice of delay scenarios with reference to the results of some economic models. The models referred to are all of the equilibrium, resource-allocation type; notably, the MERGE model, which has been applied directly to questions of emissions abatement timing (Manne and Richels, 1995) and the Edmonds-Reilly model (the Australian MEGABARE model, which has also been applied extensively to examine the near-term costs of different abatement strategies but not explicitly to questions of abatement timing, is also of this type).

Such a modeling framework is very weak in both the dimensions of inertia and technology development discussed above – the key dimensions required for analysis of technological and systems aspects of the timing issue. Most such models do reflect capital stock turnover, but only first-order issues of

---

<sup>9</sup>The IMAGE model has been used to look in more detail at the implications of delay for rates of change under a 450 ppm ceiling. Other indicators that are substantially affected throughout the next century by delayed action include maize yields and natural vegetation change (Alcamo, 1996).

energy production stock. Because they assume that the economy is in a state of full equilibrium resource allocation and do not model the inertia associated with interdependence among different economic sectors, they only capture a small fraction of the full costs associated with imposing rapid changes. Such models simply do not provide realistic insight into the full economic and welfare costs of making more rapid changes of direction and steeper abatement after a period of delay.

In addition, these models all assume that technology development is exogenous, i.e., the costs of different options and the rate of cost reductions are external to the market conditions assumed in the model. None of the models cited embodies mechanisms by which emission constraints can stimulate corporate R&D, learning-by-doing, or other behavior that may reduce the costs of lower-carbon technology; nor do they capture issues of technology clustering or wider adaptive responses.

Consequently, the economic modeling studies that have been widely referred to in the context of justifying delays in emissions abatement cannot be considered to give reliable insight into the timing issue. And, as noted above, most of these studies focus on the question of time paths to a fixed, preset stabilization constraint, which for the reasons discussed above is only weakly related to the actual policy problem.

Other studies using different approaches indicate just how much results can differ. Nordhaus (1991, 1995) and Cline (1992) have adopted highly aggregated cost-benefit frameworks. Despite great differences in their assumptions regarding climatic damage, their studies both indicate that some significant abatement action would be optimal now and that the appropriate level of control is increased when uncertainty is taken into account. This conclusion emerges from the cost-benefit nature of the analysis rather than their analysis of energy systems. Grubb *et al.* (1996) extend such frameworks and show that if the energy system has high inertia but is in the long run highly adaptive, then the costs of delaying abatement may be many times higher than when these factors are ignored or assumed to be negligible.<sup>10</sup>

## 7. Conclusions

The discussion in this paper highlights many issues that need to be considered in addressing the optimal timing of CO<sub>2</sub> emission limitations.

---

<sup>10</sup>A more extensive numeric model, which yields similar results concerning the costs of delay, is presented in Ha Duong *et al.* (1996).



The analysis of energy technology and systems issues illustrates their complexity. The fact that energy technology development may make large emission reductions cheaper in the future needs to be assessed against other factors: the diversity of options currently available; the fact that such technology development may actually be induced by abatement action; and the interacting nature of technology and systems development. To the extent that energy systems have a broader capacity to adapt given time, all this implies that countervailing economic benefits may flow from earlier action.

Furthermore, energy systems are characterized by continuous slow stock turnover combined with tremendous inertia to rapid change. Incremental changes toward greater efficiency and lower-carbon options in the course of stock replacement and expansion may consequently be much cheaper than continuing to construct new carbon-intensive capital stock, since that stock may be exposed to the risk of requiring more rapid reductions later on.

This assumes particular importance when the high uncertainties about the damage from climate change are recognized. The fact that we cannot know at present the concentration at which the atmosphere should be stabilized makes the question of inertia extremely important, because of the potentially very high industrial and economic costs if the initial response proves to be much too relaxed. Consideration of impacts, and particularly rates of change in the first half of the next century, highlights the need to consider the benefits that may come from earlier action, in terms of reducing rates of change, alongside considerations of aiming at a fixed stabilization ceiling.

These various economic issues are summarized in Table 1. Some favor deferment, some rapid action. Clearly, focusing only on the economic factors that favor deferment leads one to the conclusion that this will be cheaper. Conversely, focusing only on the economic and other reasons for early action, without reference to the factors that could make rapid action now more expensive, leads one to conclude that we should take rapid and perhaps drastic abatement action.

Economics is about making tradeoffs. Neither of the above extremes represents a balanced approach, or a balanced conclusion. The problem requires serious analysis of many complex dimensions, but I would suggest that it should be possible for most analysts to agree on the following minimal conclusions.

1. Economic issues surrounding the optimal timing of greenhouse gas emissions abatement are complex, with some factors favoring deferment and others favoring strong early reductions in emissions.

**Table 1.** Balancing the economic issues.

Issue	Favoring deferment	Favoring early abatement
Technology development	<ul style="list-style-type: none"> <li>• Exogenous technical change implies that it is cheaper to focus on R&amp;D expenditure and wait for improvements</li> </ul>	<ul style="list-style-type: none"> <li>• Low-cost measures may have substantial impact on trajectories</li> <li>• Endogenous (market-induced) change will accelerate development of low-cost solutions</li> <li>• Clustering effects highlight importance of getting on lower emission trajectories</li> </ul>
Capital stock and inertia	<ul style="list-style-type: none"> <li>• Deferment avoids action now that could (if rapid enough) force premature retirement/misutilization of current stock</li> </ul>	<ul style="list-style-type: none"> <li>• Exploit natural stock turnover by influencing new investments</li> <li>• Reduces max. rate of reduction and associated transitional scrapping and disequilibrium</li> <li>• Reduces risks from uncertainties in stabilization constraint and hence risk of being forced into very rapid changes</li> </ul>
Discounting	<ul style="list-style-type: none"> <li>• Reduces the present value of abatement costs (<i>ceteris paribus</i>)</li> </ul>	<ul style="list-style-type: none"> <li>• Reduces impacts and (<i>ceteris paribus</i>) reduces their present value</li> </ul>
Carbon cycle and radiative change	<ul style="list-style-type: none"> <li>• More early emissions absorbed, thus enabling higher total carbon emissions under a given stabilization constraint</li> </ul>	<ul style="list-style-type: none"> <li>• Reduces high rates of radiative and temperature change over coming decades (<i>except for sources with high aerosol emissions</i>)</li> <li>• Enables lower stabilization levels to be achieved</li> </ul>

2. Questions of technology and systems availability and development are very important and must recognize the wide spectrum of technologies both currently and potentially available, as well as the spectrum of processes by which such technologies may be developed and incorporated in energy systems.
3. In an equilibrium framework, considering only exogenous technology development and first-order capital stock turnover under a preset stabilization constraint (as cited in the WRE paper) favors deferring emission reductions.<sup>11</sup> Focusing only on an opposite mix of issues favors rapid

<sup>11</sup>It should be noted that Tom Wigley, the lead author of the WRE paper, objected to this representation of the WRE paper on the grounds that it is primarily a scientific paper and contains no economic modeling. I refer to it in this context only because the central economic assertions in the paper have received considerable policy and political

and drastic abatement. Neither represents a balanced assessment of the policy problem.

4. A balanced assessment would recommend avoiding large-scale deployment of technologies that are immature and costly, but would favor steady abatement efforts to exploit at least low-cost measures, to deter new carbon-intensive investments (including major refurbishments), and to stimulate development and diffusion of lower-carbon technologies, practices, and infrastructure through market incentives as well as government R&D.

Thus, given acceptance of the basic climate problem, from any credible economic perspective some abatement action is justified now.<sup>12</sup> The question of just how much will doubtless be a topic of modeling wars for many years to come. For to go much beyond the general conclusions set out here, much more research and model application of technology and systems development and deployment processes, in a context of high uncertainty, among other things, is required.

## References

- Alcamo, J., 1996, Safe Emission Corridors, Paper presented at 3rd International Workshop on the IMAGE 2 Model, Delft, The Netherlands, 15–16 February 1996.
- Arrow, K.J., 1962, The Economic Implications of Learning-by-Doing, *Review of Economic Studies* 29:155–173.
- Cline, W.R., 1992, *The Economics of Global Warming*, Institute for International Economics, Washington, DC, USA.
- Dasgupta, P., and Stoneman, P., 1987, *Economic Policy and Technological Performance*, CUP.
- Grubb, M., Chapuis, T., Ha Duong, M., 1996, The Economics of Changing Course, *Energy Policy* 23(4):1–14.
- Grubb, M., and Walker, J., 1992, *Emerging Energy Technologies: Impacts and Policy Implications*, Royal Institute of International Affairs, London, UK.
- Grübler, A., and Foray, D., 1990, Morphological Analysis, Diffusion and Lock Out of Technologies: Ferrous Casting in France and FRG, *Research Policy* 19(6):535–550.

---

attention, and these do unfortunately neglect most of the issues listed in the final column of Table 1 (as do the modeling studies to which the WRE paper refers in its brief economic discussion). Some of the countervailing issues are indeed noted later in the WRE paper as caveats requiring further consideration, which this paper has sought to provide.

<sup>12</sup>Strictly, the only condition that appears to be required is the assumption that higher rates and degrees of atmospheric change increase the risk of adverse impacts.

- Ha Duong, M., Chapuis, T., and Grubb, M., 1996, DIAM: A Model for Studying Dynamics and Inertia in Optimal Abatement Policies, submitted to *The Energy Journal*.
- Hourcade, J.C., 1993, Modelling Long-run Scenarios: Methodology Lessons from a Prospective Study on a Low CO<sub>2</sub> Intensive Country, *Energy Policy* **21**(3):309.
- IPCC (Intergovernmental Panel on Climate Change), 1990, J.T. Houghton, G.J. Jenkins, and J.J. Ephraums (eds.), *The IPCC Scientific Assessment*, Cambridge, University Press, Cambridge, UK.
- IPCC (Intergovernmental Panel on Climate Change) Working Group III, 1995, Summary for Policymakers, Cambridge, University Press, Cambridge, UK.
- Manne, A., and Richels, R., 1995, The Greenhouse Debate: Economic Efficiency, Burden-Sharing and Hedging Strategies, *The Energy Journal* **16**(4).
- Nakićenović, N., and Grübler, A., (eds.), 1991, *Diffusion of Technologies and Social Behavior*, Springer-Verlag, Berlin/Heidelberg.
- Nordhaus, W.D., 1991, To Slow or Not to Slow: The Economics of the Greenhouse Effect, *Economic Journal* **101**:920–937.
- Nordhaus, W.D., 1995, *Managing the Global Commons: The Economics of Climate Change*, MIT Press, Cambridge, MA, USA.
- WEC (World Energy Council), 1995, *Energy for our Common World: What Will the Future Ask of Us?* Conclusions and Recommendations of the 16th WEC Congress, Tokyo 1995; WEC, London, UK.
- Wigley, T., 1996, Stabilisation of CO<sub>2</sub> Concentration Levels, in T. Wigley and D. Schimel (eds.), *The Global Carbon Cycle*, Cambridge University Press, Cambridge, UK.
- Wigley, T., and Schimel, D. (eds.), 1996, *The Global Carbon Cycle*, Cambridge University Press, Cambridge, UK.
- Wigley, T., Richels, R., and Edmonds, J., 1996, Economic and Environmental Choices in the Stabilization of Atmospheric CO<sub>2</sub> Concentrations, *Nature* **379**:240–243.

# Technological Change and Learning\*

*Nebojša Nakićenović*

IIASA, Laxenburg, Austria

## 1. Introduction

Energy and carbon intensities of economic activities have been declining since the onset of industrialization two centuries ago. Technologies that are more energy efficient have replaced less efficient ones, and technologies that are less carbon intensive have replaced those that are more carbon intensive. Technological change has made a major contribution to these long-term improvements in the productivity of energy. In particular, the decarbonization of energy – namely, the reduction of the specific carbon content of energy – can be interpreted as a long-term learning process that can be represented by a learning curve. In this paper it is argued that the dynamics of technological change is a cumulative process of learning by doing. Technological change is not an “autonomous” process, although it is often represented as such in energy and economic models.

A number of implications will be considered with reference to the mitigation of carbon dioxide (CO<sub>2</sub>) emissions. Various mitigation strategies for countering the possibility of climate change have been proposed. Recently, research has begun to focus on the formulation of global CO<sub>2</sub> emissions profiles that would lead to the stabilization of atmospheric concentrations at some negotiated level in accordance with Article 2 of the Framework Convention on Climate Change (UN/FCCC, 1992). For example, all of the CO<sub>2</sub> emissions profiles that lead to concentrations stabilization that were analyzed by the Intergovernmental Panel on Climate Change (IPCC, 1996) require the eventual reduction of global carbon emissions from well below to less than half the current levels during the next two centuries. In view of the increasing needs for energy services in the world, especially in developing countries, such emission reductions will require a substantial increase in the decarbonization rate. This, in turn, implies a larger future role for new

---

\*This paper reports initial results of introducing technological learning into the model MESSAGE based on the analysis presented in greater detail by Messner (1996). The author is grateful for the permission to use these results. Helpful comments and suggestions were received from Jae Edmonds, Dominique Foray, Bill Nordhaus, and Rich Richels. The views presented are solely those of the author.

technologies with lower CO<sub>2</sub> emissions. Thus, there is an increasing recognition in the literature that abatement of CO<sub>2</sub> emissions requires a sustained commitment to research, development, and demonstration (RD&D) today (see, for example, Wigley *et al.*, 1996).

It will be shown that in conjunction with RD&D timely investment in new technologies with lower CO<sub>2</sub> emissions might be a more cost-effective strategy for reducing global emissions than postponing investment decisions in the hope that mitigation technologies might somehow become more attractive through RD&D, “autonomous” improvements, and cost reductions in step with natural turnover of capital. It has recently been argued that the latter strategy is superior to a more timely introduction of lower-emission technologies, because at present these technologies are generally costlier than the alternatives (see, for example, Wigley *et al.*, 1996, and the paper by Richels *et al.* in this volume). Although this is true, postponement in itself will bring few additional benefits. While the costs and performance of technologies are generally modeled as if they were exogenous, they are not. Costs of new technologies have been shown to decline and performance to increase with accumulated experience and improvements. Unless there is dedicated, timely, and pronounced investment in these technologies, they are unlikely to be developed and thus become commercially viable and competitive in the market place. Learning by doing is a prerequisite for performance improvements, cost reductions, and eventual diffusion. Postponing investment decisions will not bring about the technological change required to reduce CO<sub>2</sub> emissions in a cost-effective way. Even worse, under unfavorable conditions it might bring about further “lock-in” of energy systems and economic activities along fossil-intensive development paths.

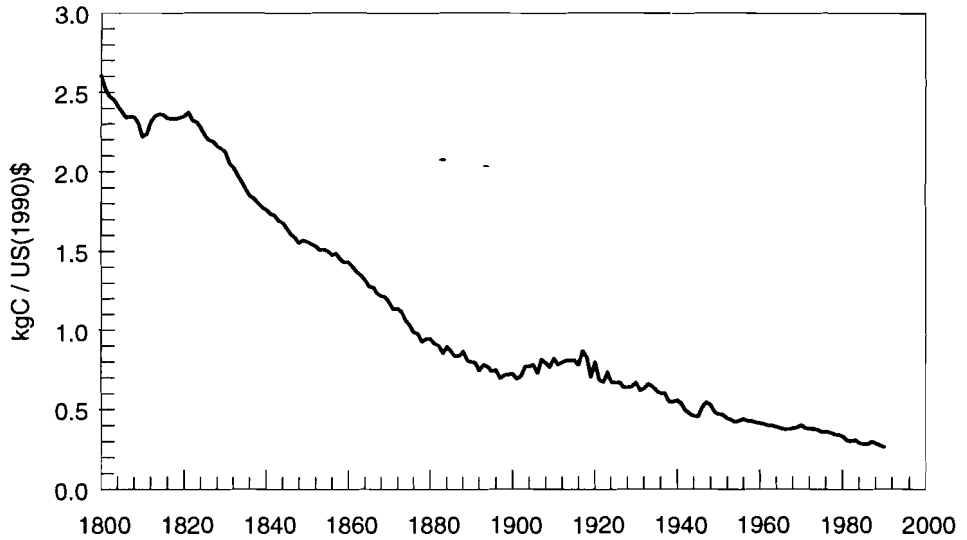
The implication is that there may be great leverage in policies and measures that accelerate the accumulation of experience in new technologies with lower environmental impacts, for example, through early adoption and development of special niche markets. This leverage can be important, particularly if these policies can minimize the “deadweight” loss to society associated with the foregone exploitation of cheaper fossil fuels and possible reductions of RD&D in other parts of the economy. That is, an acceleration of energy-related technical progress may be accompanied by a slowdown in labor and capital productivity. These are some of the problems and issues that must be resolved before technological change can become a truly endogenous component in standard modeling approaches. In the meantime, an increasing number of models are being adapted to explore alternative ways of incorporating endogenous technical change. In this paper we will

explore the nature of the relationship between technological learning, costs and performance of new technologies, and resulting emissions profiles from the global electricity generation system with the MESSAGE model.

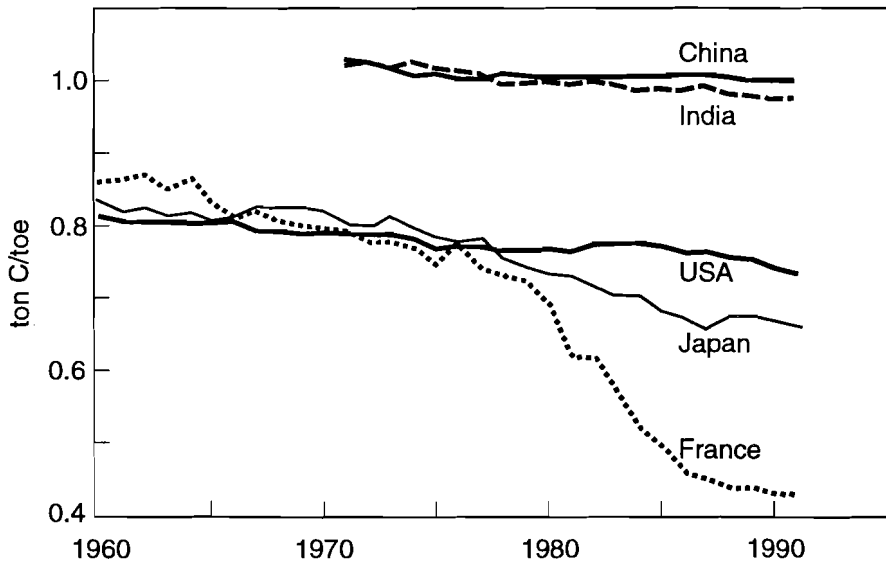
## 2. Decarbonization

Through decarbonization, energy services can be provided with lower carbon emissions. The process can be expressed as a product of two factors: decarbonization of energy and reduction of the energy intensity of economic activities, for example, as measured by gross domestic product (GDP). Figure 1 shows the decarbonization of GDP; Figures 2 and 3 show the decarbonization of energy and the reduction of energy intensity of GDP, respectively. The example for the USA is shown in the three figures primarily because the data are of relatively good quality; however, available data allow the assessment of decarbonization trends with reasonable confidence for other major energy-consuming regions and countries, such as France and the UK, and for the world as a whole (see, for example, Nakićenović, 1996; Grübler and Nakićenović, 1996). Over shorter time periods similar decarbonization trends can be obtained for many developed and industrializing countries, such as India and China. In Figure 1, the decarbonization rate is expressed in kilograms of carbon (kgC) per unit of GDP in US dollars measured at 1990 prices. The average annual rate of decline is about 1.3%, meaning that every year about 1.3% less carbon is emitted to generate one dollar of value added.

Today, about a quarter of a kilogram of carbon is emitted per dollar value added in the USA, and about half that amount is emitted per dollar value added in Europe and Japan. However, the amount of carbon emitted per dollar value added is significantly greater in most developing and many re-forming countries. Thus, it is evident there are different paths of economic development that lead to similar levels of affluence at quite different levels of CO<sub>2</sub> emissions. The prime objective of possible mitigation strategies is to reduce these emission levels by increasing the rate of decarbonization throughout the world. At an average decarbonization rate of 1.3% per year, global CO<sub>2</sub> emissions will increase about 1.7% annually, assuming the economic growth rate remains at about 3% per year. This increase will lead to a doubling of emission levels in about 40 years. Thus, to stabilize global emissions at some (higher) level in the future, the decarbonization rate would have to at least double to offset the current rate of economic growth. The second

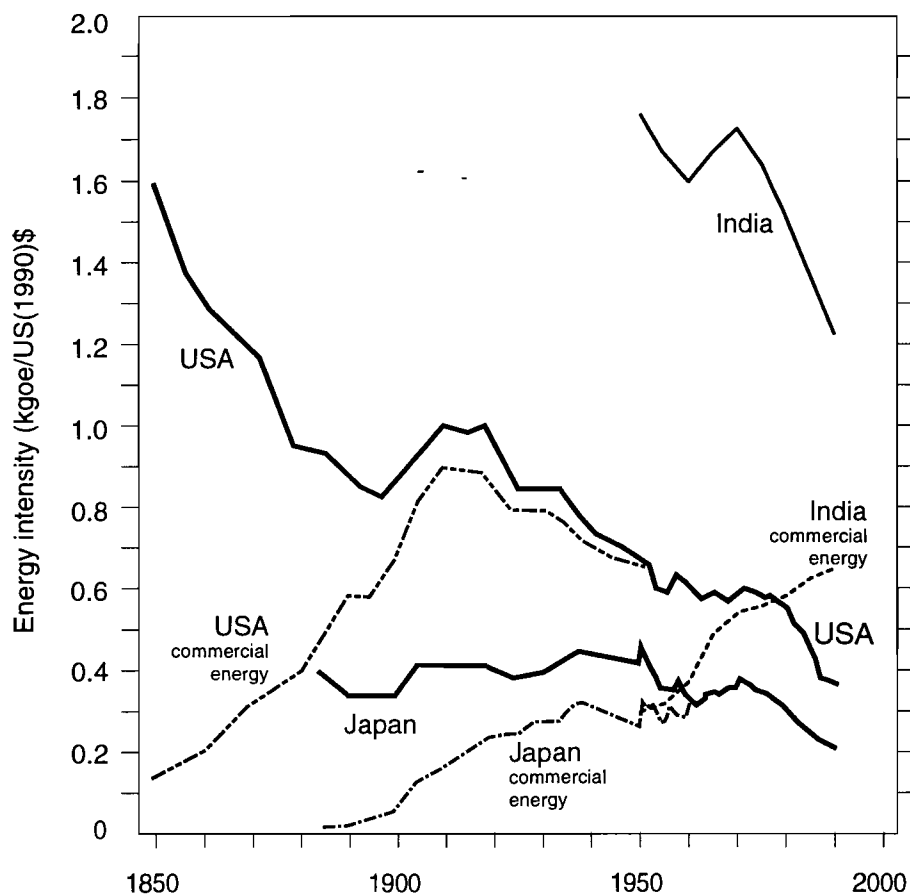


**Figure 1.** Decarbonization of economic activities in the USA, expressed in kilograms of carbon per unit of GDP at constant 1990 prices [kgC/US(1990)\$].



**Figure 2.** Decarbonization of primary energy in the USA and selected countries, expressed in kilograms of carbon per kilogram oil equivalent (kgC/kgoe).

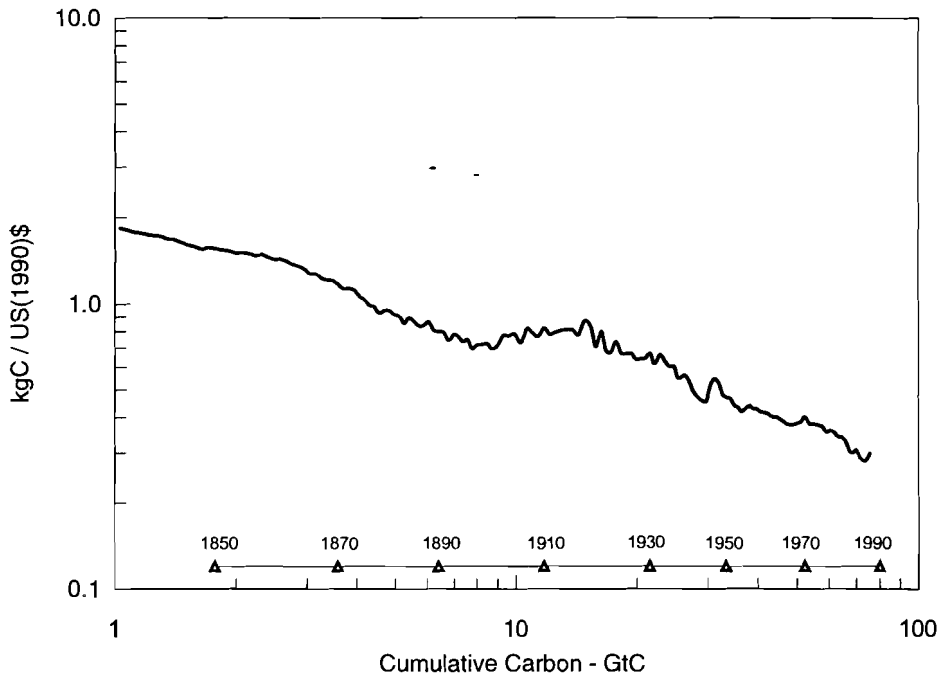




**Figure 3.** Primary energy intensity of economic activities in the USA and selected countries, expressed in kilograms of oil equivalent per unit GDP at constant 1990 prices [kgoe/US(1990)\$].

alternative, maintaining lower rates of economic growth, is clearly undesirable in light of the existing widespread poverty and deprivation throughout the world.

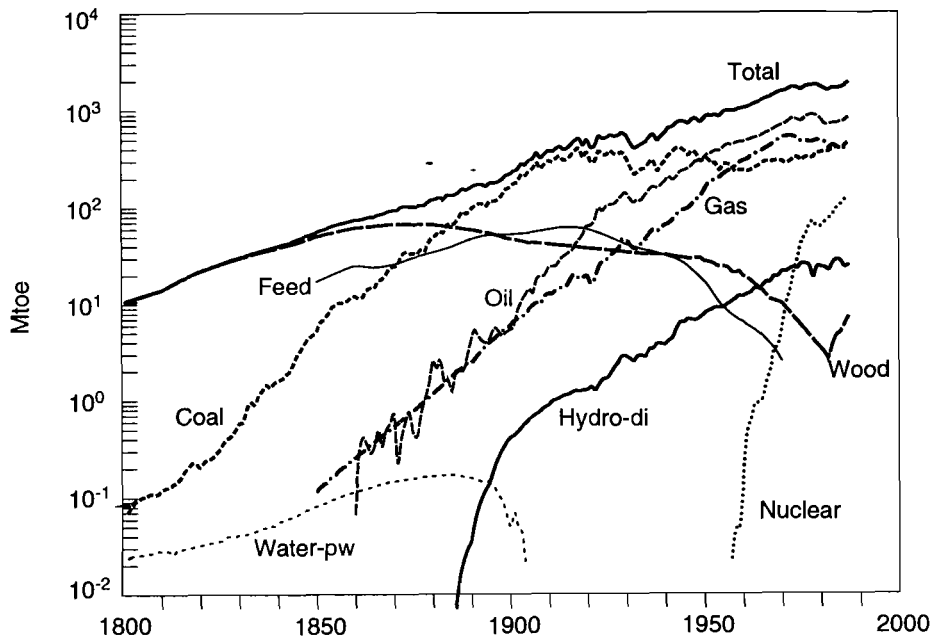
Figure 4 portrays another image of the dynamics of decarbonization. The data from Figure 1 are now shown as a learning or experience curve. The ratio of carbon emissions to GDP is shown versus the cumulative emissions in a double logarithmic diagram. There is an exponential decline (linear on double logarithmic scales) in specific carbon emissions per doubling of cumulative emissions. Apparently, the more we emit, the more we learn



**Figure 4.** Decarbonization of economic activities in the USA as a learning process where accumulated experience is represented by cumulative CO<sub>2</sub> emissions, expressed in kilograms of carbon per unit of GDP at constant 1990 prices [kgC/US(1990)\$] versus cumulative CO<sub>2</sub> emissions in gigatons of carbon (GtC) on double logarithmic axes.

about how to emit less per unit value. This is a typical process of learning with cumulative experience. The progress ratio is actually quite high at about 76% (representing a 24% cost reduction in specific emissions) per doubling of cumulative emissions. This figure compares with progress ratios in the range of 70–90% across a number of energy technology learning curves reported in the literature (e.g., see Christiansson, 1995).

As a kind of thought experiment, assume a hypothetical case where this rate of learning continues for another century. In this case, one could expect the specific carbon emissions to continue to decline. To date, the USA has emitted about 100 gigatons of carbon (GtC, or billion tons of carbon), slightly less than half the cumulative global emissions, estimated at about 250 GtC. If the rate of learning were to remain the same, another 100 GtC would be emitted before the specific emissions could be reduced



**Figure 5.** Primary energy consumption by major energy sources in the USA, expressed in million tons of oil equivalent (Mtoe).

another 24%. This rate is clearly too slow for a transition to the post-fossil era within a century or two. Thus, for a more drastic increase of decarbonization, substantially higher rates of technological learning would be required.

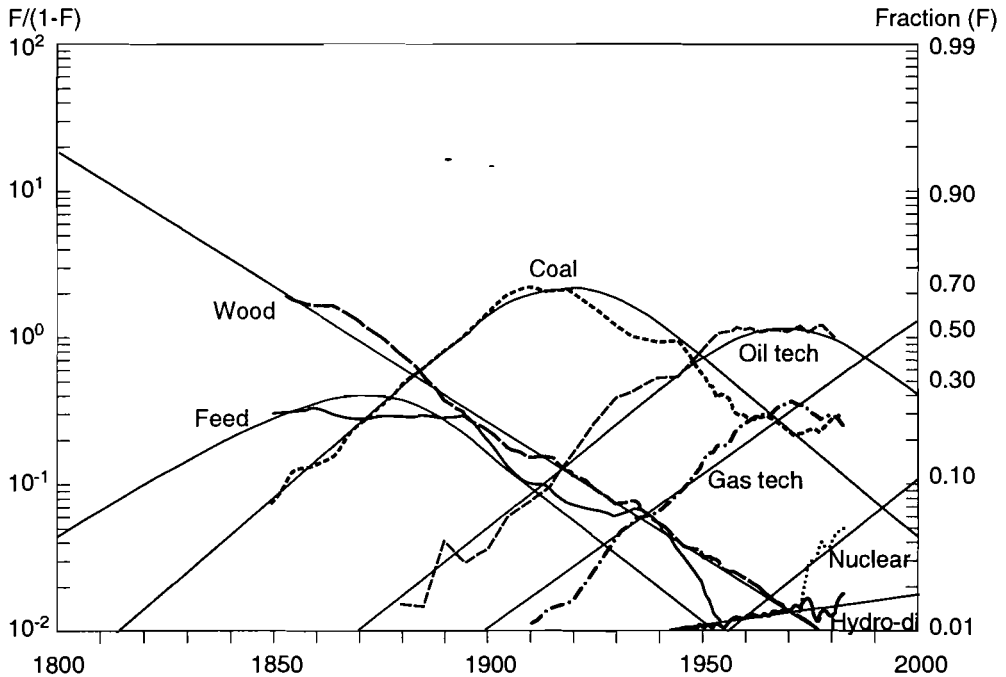
Before discussing the process of endogenizing technological learning, let us first consider the technology dynamics behind the historical rates of decarbonization and the implications decarbonization carries for the possible diffusion of less-carbon-intensive energy technologies in the future. Figure 5 shows the hierarchy of replacements of old energy sources with new ones in the USA. This dynamic process of technological substitution is the driving force behind the historical rates of decarbonization.

Traditional energy forms such as animal feed and wood have a high carbon content, both per unit of energy and per unit of economic activity, because of the relatively low efficiency with which they deliver demanded energy services. Draft animals and open fire have very low energy conversion efficiencies compared with contemporary prime movers and furnaces. It is true that some of the released carbon can be reabsorbed by new plant growth

and new trees, and by the replanting of animal feed, but quite often the land is not used in a sustainable fashion. For example, because many of these activities are associated with deforestation and land degradation, they often lead to net carbon flux to the atmosphere. The carbon intensity of fuelwood and animal feed is substantially higher than that of coal. Moreover, coal can be used with generally higher efficiencies. For these reasons, coal eventually supplanted traditional energy forms. This progress toward energy sources with lower carbon contents and higher conversion efficiencies has continued, with shifts from coal to oil to natural gas, and more recently to nuclear energy and new renewable sources of energy, both of which have minimal carbon emissions. Natural gas in itself brings enormous reductions in carbon emissions (with half the carbon emissions of coal) as well as higher efficiencies.

Using the available data, the historical replacement of coal with oil and later with natural gas can be illustrated for most countries and major energy-consuming regions, as well as for the world as a whole (Marchetti and Nakićenović, 1979; Nakićenović, 1979). If all energy sources are considered the replacement process is very intricate and complex, as can be seen from Figure 5. Similar dynamics of technological substitution have been studied for other systems, such as transport and steel making (Grübler and Nakićenović, 1988; Nakićenović, 1990). It is a process with long transition periods from older to newer technologies, especially in the areas of energy systems and infrastructure. The competitive struggle between the five main sources of primary energy – wood, feed, coal, oil, gas, and nuclear materials – has proved to be a process with regular dynamics that can be described by relatively simple rules. This process is shown in Figure 6 for the USA, based on the data from Figure 5.

A glance reveals the dominance of coal as the principal energy source between the 1880s and the 1950s, after a long period during which fuelwood, animal feed, and other traditional energy sources were predominant. The mature coal economy meshed with the massive expansion of railroads and steamship lines, the growth of steel making, and the electrification of factories. During the 1960s, oil assumed a dominant role in conjunction with the development of automotive transport, the petrochemical industry, and markets for home heating oil. If this substitution continues to progress at similar rates in the future, natural gas (methane) will be the dominant source of energy during the first decades of the next century, although oil is likely to maintain the second largest share until the 2020s. Such an exploratory look into the future requires additional assumptions to describe the subsequent competition of potential new energy sources such as nuclear, solar, and other

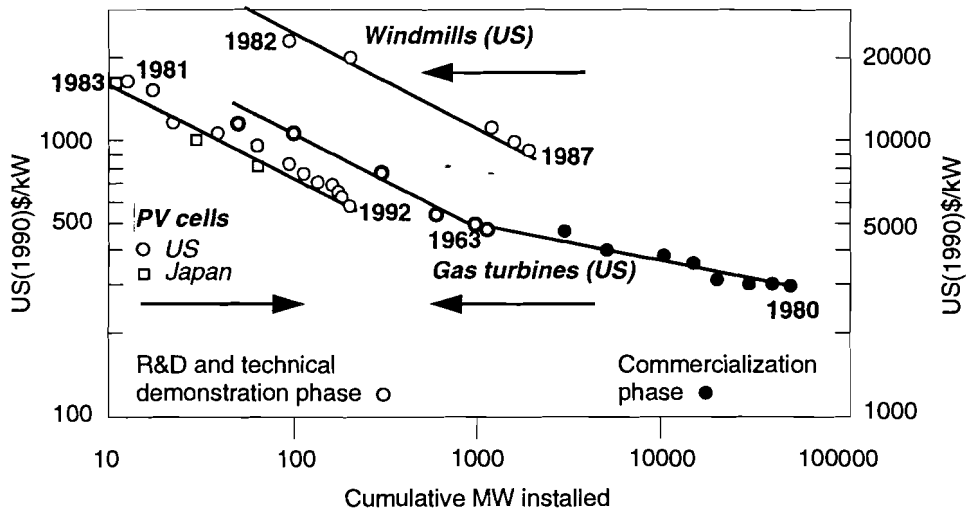


**Figure 6.** Primary energy substitution in the USA, historical data and model projections for the future, expressed in fractional market shares ( $F$ ) and transformed as  $F/(1-F)$  on logarithmic axes.

renewables, which have not yet captured sufficient market shares to allow an estimation of their penetration rates and market potentials. Because all of these alternative energy sources have only minimal  $\text{CO}_2$  emissions and natural gas has the lowest emissions of all fossil fuels, the unfolding of primary energy substitution implies a gradual continuation of energy decarbonization throughout the world.

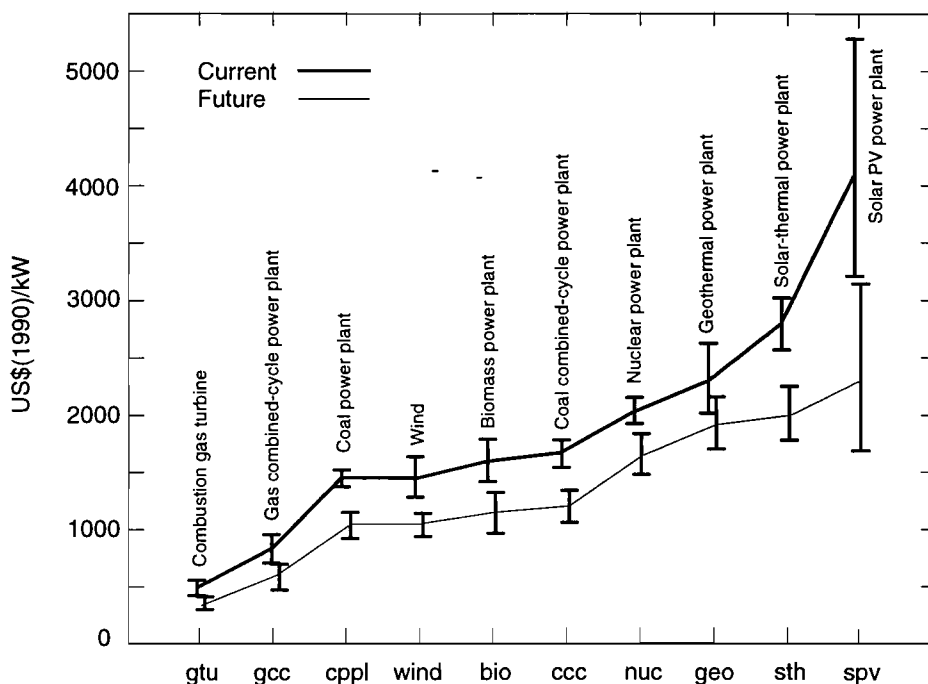
### 3. Technological Learning

The replacement of old technologies with new ones occurs gradually. The performance of new technologies improves and their costs decrease with increases in production and use. Accumulated experience and learning can be assumed to increase with increases in the market shares of a new technology. As technologies mature, their improvement potentials decrease. A somewhat stylized difference between new and old technologies is that the



**Figure 7.** Reductions of investment costs for three representative new and advanced technologies as a learning process, expressed in US dollars at constant 1990 prices per unit installed capacity [US(1990)\$ / kW] versus cumulative installed capacity (MW) on double logarithmic axes.

former are costlier at the time of their introduction, but their costs can be assumed to decrease with increases in their market share so that at some point the cost curves might cross, making them a more attractive choice than the old technology. Learning curves capture this process. Figure 7 presents a number of illustrative examples (IIASA-WEC, 1995; Grübler *et al.*, 1996; Nakićenović and Rogner, 1996). It shows rapid declines in investment costs with every doubling of cumulative installed capacity of gas combustion turbines and wind and photovoltaic (PV) systems. This pattern of performance improvement and cost reductions with accumulated experience and learning is common to most technologies, although its specific shape depends on the technology. Typical progress ratios listed in the literature range between 65% and 95% for all technologies and between 70% and 90% for energy technologies (Christiansson, 1995). There are significant cost improvements during the RD&D. For example, in Figure 7 (with a progress ratio of 88%) an 18% reduction in investment costs per doubling of cumulative production is shown for the case of gas combustion turbines. These improvements during the RD&D phase are followed by more modest improvements after commercialization, 7% per production doubling for combustion turbines, for example. If such cost reductions were to continue in the future for the PV



**Figure 8.** Mean and standard deviation of investment costs for 10 representative conversion technologies, current and future (about 2020), based on data in the IIASA technology inventory CO2DB. Source: Strubegger and Reitgruber, 1995.

systems, these systems could become commercially viable in a few decades, with cost reductions of about a factor of five to one order of magnitude compared with today's costs (from between US\$10,000/kW and US\$5,000/kW to as little as US\$1000/kW; see IIASA-WEC, 1995; Ishitani *et al.*, 1996; Nakićenović *et al.*, 1996).

Technological learning is reflected in most energy and emission scenarios and their underlying assumptions. New and emerging technologies are assumed to have better performance and lower costs in the future compared with current levels. Figure 8 reflects a range of such assumptions for some new and emerging energy conversion technologies. It is based on the International Institute for Applied Systems Analysis (IIASA) inventory of mitigation technologies, CO2DB (Messner and Strubegger, 1991; Messner and Nakićenović, 1992; Schäfer *et al.*, 1992). This database currently includes characterization of about 1600 energy technologies, from energy extraction

and conversion to energy end use. The database includes current and future technologies based on information from the literature for a number of countries and representative world regions. A large share of technology descriptions come from various energy modeling efforts. Most of the information is available for energy conversion technologies. In many cases, there are a sufficient number of data points for a given type of technology, such as for gas combustion turbines or PV systems, so that sample mean and standard deviation can be meaningfully derived. Figure 8 shows such statistics for 10 representative conversion technologies and gives the mean and standard deviation for current and future (about 2020) investment costs (Strubegger and Reitgruber, 1995). A glance reveals a clear pattern: current costs are higher than the assumed future costs. The less mature a technology is today (such as the PV systems), the higher the future cost reductions and the higher the uncertainty, as evidenced by wider distribution of cost estimates. This is indeed consistent with the phenomenon of cost reductions associated with learning, assuming that the installed capacities of these technologies will increase in the future, making them more competitive compared with current alternatives.

Equivalent assumptions are made in most modeling efforts and scenarios about future energy and emissions. Over time, new technologies become more attractive as their costs decrease and their performance improves. Sometimes such new technologies are called “backstops.” Originally, Nordhaus (1973) formulated the concept of a backstop to mean a technology that has a virtually infinite resource base (for example, photovoltaic systems). Generally it is assumed that backstop technologies require RD&D and that they are too costly to be competitive at the present time. Alternatively, if the costs of other technologies increase, the backstops may become competitive at some point in the future. There is, of course, a fundamental difference between the two approaches. In the first approach, it is assumed that new technologies will become cheaper and have better performance through RD&D and “autonomous” technological change, without however explicitly accounting for RD&D and appropriability issues. In the second approach, backstops become more attractive as supply limitations of currently competitive technologies lead to increases in their costs compared with those of the alternatives. In either case, technological change is either assumed to occur implicitly through specified market increases or takes the form of an exogenous parameter. This is a standard view of technological change in most economic modeling approaches. In some manner technologies are “ready” before entering the economic world and the entrepreneurs



can choose among them according to their costs and relative performance so that they do have incentives to postpone investment in new technologies. For example, Richels *et al.* argue in this volume that “exogenous specification of technology change tends to *overstate* the costs of carbon” emissions reductions.

In general, the problem is that new technologies appear as “manna from heaven” in the standard approaches of modeling technological change: as time passes, new technologies become the best choices without any explicit RD&D effort or investment and without any of the risks that entrepreneurs usually face. This is why these models are said to have an “autonomous” rate of technological change.

Models that employ autonomous technological change portray exogenous improvement of technologies over time. Because these models employ market allocation algorithms, the technologies gradually penetrate the market. This kind of simulation can emulate the introduction of new technologies and their diffusion. The employment of autonomous technological change assumptions can lead to either too much or too little technological change relative to an endogenous model, unless the nature of the autonomous path of technological change is known *a priori* as a scenario assumption.

The exogenous specification of costs of new technologies and their decrease over time implies that later adoption would be cheaper than early adoption. Thus, it is evident that in a model where a given autonomous rate of technological change is assumed, is a cost-effective strategy to postpone investment in low-carbon technologies until they become cheaper and until the current vintages become obsolete. In reality, such results are misleading. If such mitigation strategies were to be adopted, there would be no investment in new technologies: all agents would wait for them to become more attractive, and no one would risk an early investment. Consequently, the technologies would not enter the market place and there would be no backstops in the future to reduce emissions. Instead, an emissions-intensive development path would be adopted that might prove difficult if not impossible to change midcourse. Even worse, there is some evidence that technological “forgetting by not doing” can occur (Rosegger, 1991). Figure 6 illustrates how important inertia is in the energy systems: it takes decades to achieve a transition from old to new technologies through active innovation and diffusion of new technologies, and for each of the successes there are many failures. It is in this light that the policy-relevant assessments of cost-optimal time paths of emissions reductions should be considered.

## 4. Endogenizing Technological Change

The lack of technological realism and dynamics in most energy modeling work obviously must be rectified. This has been recognized for a long time. For example, Nordhaus and van der Heyden (1977) attempted to endogenize technological change in an energy model of the USA two decades ago. They included RD&D and learning by doing in the form of cost reductions as a function of cumulative output of a technology. In the meantime, mathematical programming and computing techniques have improved so that it is now possible to capture RD&D and learning processes in greater detail, although computations requirements are still quite challenging.

A new research effort currently under way at IIASA aims at endogenizing technological change into the energy systems mathematical programming model MESSAGE (Messner, 1995) and introducing uncertainty into the characteristics of new and emerging technologies (Messner *et al.*, 1996). The article by Grübler and Messner in this volume summarizes some of this work in the area of technological uncertainty analysis. This paper reports on some of the research findings based on introducing technological learning into the model MESSAGE, including some results that are relevant for future rates of decarbonization of electricity generation. This analysis is presented in greater detail by Messner (1996).

Messner (1996) introduced technological learning into MESSAGE in terms of investment-cost reductions as a function of cumulative installations for six new and emerging electricity generation technologies: advanced coal, natural gas combined-cycle, advanced nuclear, wind, solar thermal, and PV systems. The learning process starts at present costs and can reach much lower and more competitive costs by accumulating experience. For example, for PV systems the assumed learning curve can lead to cost reductions of a factor of five between the base year (1990) and 2050 (from US\$5,100 to US\$1,000 per kW installed); the reduction potential for gas combined-cycle systems is approximately 45% (from US\$730 to US\$400 per kW installed). The technological learning assumptions for all six conversion technologies are shown in Table 1, reproduced from Messner (1996). In the model, RD&D activities and investments must be made in expensive new technologies if the technologies are to become cheaper through accumulated experience, represented by cumulative increase in installed capacity.

The representation of endogenous RD&D and technological learning in the energy systems model MESSAGE requires so-called mixed integer programming techniques, because the constraint set is nonconvex. Computationally, this approach is very demanding so that only six new technologies

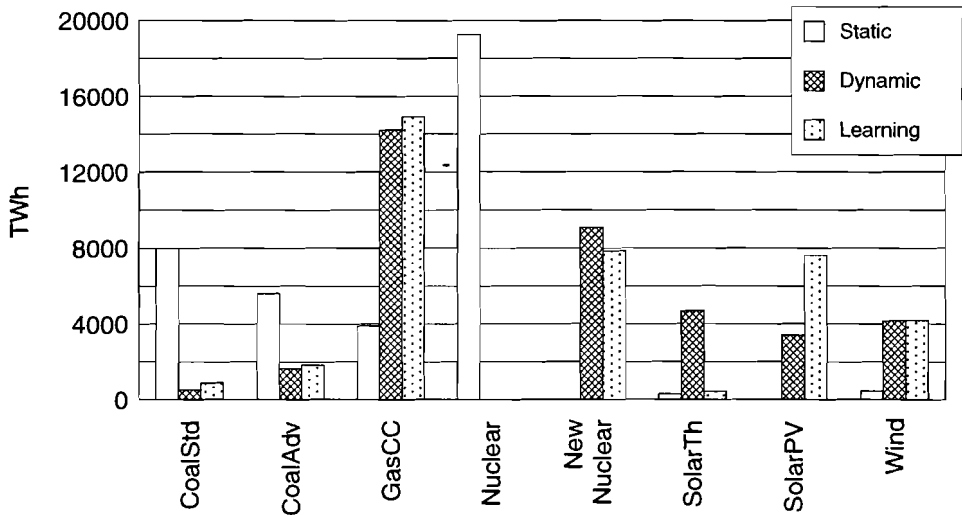
**Table 1.** Reductions of investment costs as a learning process for electricity generation by six new and advanced technologies, expressed in US dollars at constant 1990 prices per unit installed capacity [US(1990)\$ /kW].

Technology	1990	2050	Progress ratio
Advanced coal	1,650	1,350	0.93
Gas combined cycle	730	400	0.85
New nuclear	2,600	1,800	0.93
Wind	1,400	600	0.85
Solar thermal	2,900	1,200	0.85
Solar PV	5,100	1,000	0.72

are explicitly modeled as a single-region world model of the electricity sector. The next research tasks will include the extension of the approach to the whole energy system and inclusion of other down-stream technologies in addition to electricity generation. Among the shortcomings of the approach are that the shape of the learning curves is specified exogenously (including RD&D) and that the uncertainty of technological change is not yet captured in this particular model. The article by Grübler and Messner in this volume presents a version of the MESSAGE model that captures technological uncertainty analysis.

In order to compare the technological learning case with alternative ways of modeling technological change, Messner (1996) developed two additional cases. The first variant, the “static” case, is the least realistic of the three cases. In this variant, it is assumed that the investment costs of the new technologies remain at their 1990 levels over the entire time horizon. The “dynamic” variant assumes the same degree of cost reductions given in Table 1, but they are exogenous (“autonomous”), occurring at continuous rates between the base year (1990) and 2050. The dynamic case emulates the most common approach to modeling technological change in energy systems. In fact, it corresponds to Case A presented in the joint IIASA and WEC study, *Global Energy Perspectives to 2050 and Beyond* (IIASA-WEC, 1995).

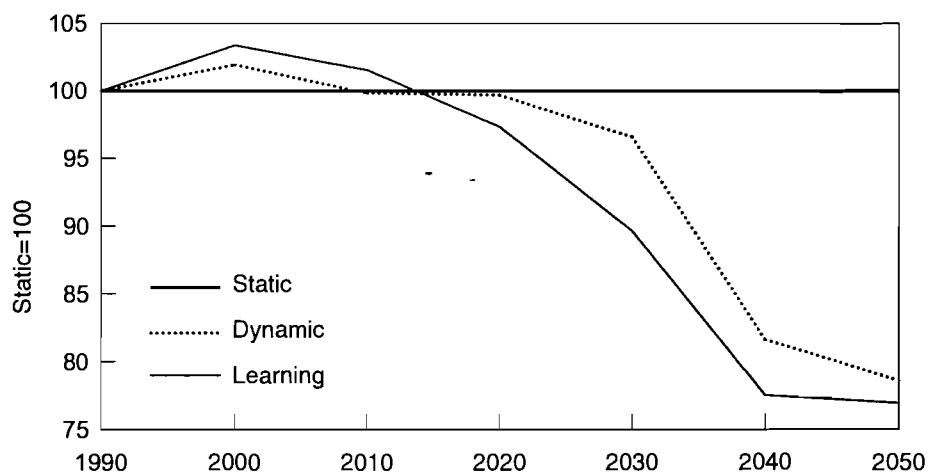
Figure 9 shows the mix of global electricity generation in 2050 from eight different conversion technologies, including the six selected new and emerging technologies. The static variant relies primarily on established technologies such as standard coal and nuclear power plants, and to a more limited degree on less costlier advanced coal and natural gas combined-cycle technologies. With the exception of some coal, the new and advanced technologies are hardly used, because of the relatively high investment costs. In comparison, the dynamic cost profile does indeed lead to greater investment



**Figure 9.** World electricity generation (TWh) in 2050 by eight generation technologies for three alternative cases: the “static” case, with constant investment costs, the “dynamic” case, with exogenously declining costs; and the “technology-learning” case, with endogenously declining costs.

in new and advanced technologies. The roles of coal and standard nuclear technologies diminish compared with the static case; they are replaced by natural gas combined-cycle, new nuclear, solar, and wind technologies. Because in the dynamic case these technology improvements are exogenous, the shift in investments from traditional to new and advanced technologies changes in step with the cost reductions. In contrast to the dynamic case, with technological learning investments in new technologies must be made up front, when these technologies are much costlier than the conventional alternatives, if they are to become cheaper with cumulative experience as installed capacity increases. With technological learning, the structure of electricity production in 2050 is not all that different from the dynamic alternative, with the exception of a slight shift from advanced nuclear to PV systems.

Messner (1996) has analyzed the different dynamics of investment paths in new and advanced technologies in the two alternative cases – the dynamic case with exogenous cost reductions and the technology learning case with endogenous cost reductions. Figure 10 presents her findings for global annual investments in electricity generation in the technological learning and dynamic cases compared with the static case. The most striking difference



**Figure 10.** Annual investment requirements for electricity generation in the world for three alternative cases: the “dynamic” case, with exogenously declining costs, and the “technology-learning” case, with endogenously declining costs, compared with the “static” case, with constant costs (index=100), expressed as an index.

is that the case with endogenous learning shows higher up-front investment costs but has lower discounted systems costs than the dynamic case with exogenous cost reductions. Both cases lead to roughly the same investment costs in 2050, because there is sufficient cumulative investment in new and advanced technologies to reduce the costs along the learning curve to the level of exogenous reductions in the dynamic case. Over the entire time period (1990–2050), cumulative discounted investments are 6.6% lower in the dynamic case with exogenous learning and 9.7% lower in the case with endogenous learning than in the static case (Messner, 1996). The difference in the investments is particularly large between 2020 and 2050. The discounted investment costs in the case with technological learning are 50% below the discounted investment costs of the dynamic case.

This single example illustrates some of the generic differences between the two approaches in modeling future technology costs and performance. In the dynamic case it pays to postpone some investment in new technologies until the costs are reduced (exogenously). In the case of technological learning there is no time to waste. Higher levels of costly investments are made immediately in order to accrue sufficient experience to be able to reap the benefits of cost reductions at some point further along the learning curve.

If these costly investments are not made, the technology stays expensive. Nonetheless, despite high initial investments, the overall discounted costs are lower in this example than in the other cases. This result means that early RD&D expenditures and development of niche markets for new technologies may be able to reduce the overall discounted costs of long-term mitigation strategies, even if similar rates of “autonomous” technology improvement are assumed in the case without learning. In reality, however, the exogenous cost reductions are unlikely to occur unless someone else invests instead. At the global level this is of course a contradiction, because even in the dynamic case such investments must be included in the calculations if cost reductions are to occur.

## 5. Conclusion

Incorporating the concept of technological learning into the energy model MESSAGE led to lower CO<sub>2</sub> mitigation costs compared with an alternative model employing a fixed rate of autonomous technological change, as is usually done in studies of future energy and emissions perspectives. The costs were also lower although exactly the same rates of performance improvements and cost reductions were assumed to occur over the study time horizon in both approaches. Compared with the case of endogenized learning, the “autonomous” case leads to the postponement of investment decisions until lower-emission technologies “become” cheaper. This means that initially the investments are somewhat lower. In the case with endogenous technological learning initial investments are higher, but this higher investment is offset later through the possibilities of reducing emissions at substantially lower costs when installed capacities and emission levels are higher. Even with discounting at 5% per year, the endogenous learning case leads to lower total costs in the global electricity sector. Of course, these results are sector specific, and do not reflect any of the deadweight loss or intersectoral trade-offs stipulated by Goulder (1996). That is, the analysis does not consider the potential loss of welfare associated with the costly initial market penetration of the new technologies or the transfer of resources away from other technology development toward the development of new technologies. The results, however, do shed light on the process by which new technologies enter and penetrate the market, which has important implications for both the cost and timing of policy interventions designed to achieve emission mitigation.

Endogenization of technological change through technology learning captures some of the positive externalities generated by RD&D and early

investment in new technologies. This means that not only will a given technology be improved through RD&D and learning, but other technologies of the same “family” will improve, as well. Knowledge spillover is often assumed to be determined by the combination of processes by which knowledge diffuses and by which it becomes obsolete. It has a positive impact on the social return of the technology learning development strategies.

The introduction of technological learning into the model does not solve all the problems associated with understanding technological change or the future costs of alternative energy technology strategies. Some basic problems also encountered in the autonomous technological change approach are still unsolved. Technical performance and cost profiles of learning-by-doing must be specified *a priori*. In the real world the performance improvement rates of new technologies are not known *a priori*, which is reflected in the risks that entrepreneurs usually face when they make new technology adoption decisions. It should be acknowledged that technical change is only one of several factors that determine technology costs and performance and thus ultimately also emissions paths.

Including this “stylized” treatment of technological change in the model captures some of the dynamic patterns common to the cost reductions and improvement in performance of almost all technologies that are successful at the market place. Initially, costs are high due to batch-production methods that require highly skilled labor. Performance optimization and cost minimization are rarely important; the overriding objective is the demonstration of technical feasibility. When the technology seeks entry into a market niche, costs begin to matter, although usually what is of central importance is the technology’s ability to perform a task that cannot be accomplished by any other technology. Examples are fuel cells in space applications, PV systems for remote and unattended electricity generation, gas turbines for military aircraft propulsion, and drill-bit steering technology in oil and gas exploration. Including in the model the more costly new and advanced technologies with the promise of lower costs and better performance through accumulated learning captures these effects of early and pre-commercial technology development and entry into specialized market niches.

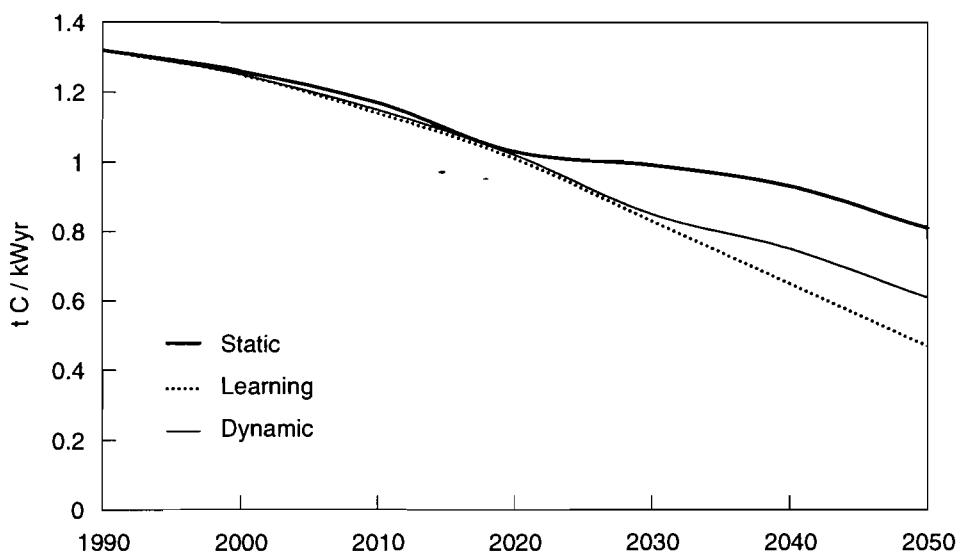
A technology’s success in a niche market, however, does not ensure its successful commercialization. Improvements must be made in reliability, durability, and efficiency, and, even more important, costs must be reduced. Any RD&D devoted to these objectives creates a supply push. This supply push must be complemented by a demand pull, by which initial markets are expanded sufficiently to further reduce costs through economies of scale. The demand pull may be policy driven. Technically feasible technologies that are

not yet economically competitive might benefit from environmental or energy security policies that increase their competitors' costs. For example, other electricity generation options benefit from requirements for flue gas desulfurization in coal-fired plants, or from bans on electricity generation from natural gas that restrict combined-cycle gas technology. New technologies may also benefit from economies of scale and market dominance already achieved by older technologies. The existing transmission infrastructure, for example, can be readily used by new electricity generating technologies (IIASA-WEC, 1995). Including such effects in the model by initially introducing new and advanced technologies only in some "niche" markets and later in more widespread applications as their costs decrease, captures some of these complex phenomena associated with innovation diffusion and technological change.

Thus, the rate of technological change depends on the diffusion of innovations and the dynamics of their adoption. The replacement of carbon-intensive technologies with zero- or low-carbon alternatives can be expressed as the process of energy decarbonization. Scenarios with high shares of coal actually lead to a reversal of the historical trends toward decarbonization. Other scenarios that envisage that the transition to the post-fossil era will occur during the next century portray decarbonization rates similar to, or sometimes even higher than, historical rates. Decarbonization must continue if CO<sub>2</sub> emissions are to stabilize in the future. Quite high rates would be required to actually reduce global CO<sub>2</sub> emissions, as would be required to achieve stabilization of atmospheric concentrations at some negotiated level in accordance with Article 2 of the Framework Convention on Climate Change (UN/FCCC, 1992). Figure 11 captures the differences in the decarbonization of global electricity generation with and without technological learning presented in this paper.

Without improvements in technological performance or cost reductions compared with the present situation, the static case actually leads to a reversal of historical trends toward decarbonization after the 2020s as the global electricity generation is "locked-in" on the carbon-intensive generation technologies. Decarbonization occurs in the dynamic case, indicating a high degree of structural change in electricity generating capacity. However, the rate slows down after the 2030s compared with the technological learning case. The more dynamic interplay among different technologies in electricity generation leads to the highest degree of decarbonization, and yet here the total discounted costs are the lowest of all three alternatives. That the costs are lower than in the static case is not at all surprising as the static case does not include any reduction in costs, and thus older and cheaper technologies





**Figure 11.** Decarbonization of electricity in the world for three alternative cases: the “static” case, with constant investment costs; the “dynamic” case, with exogenously declining costs; and the “technology learning” case, with endogenously declining costs [expressed in kilograms of carbon per watt-year of electricity (kgC/Wyr)].

are generally chosen, leading to relatively high emissions and high costs. An interesting result of this analysis is that technological learning leads to lower emissions and costs compared with the dynamic case, even though costs and emission-reduction potentials are the same as the exogenously assumed improvement rates in the dynamic case by the end of the time horizon. The additional degree of freedom of initially introducing promising technologies in the niche markets although they are still too costly leads to overall cost reductions, because cumulative learning allows for significant cost reductions later on, when installed capacities and emissions levels are high. In contrast, the dynamic case does not lead to early market entry of new and advanced technologies. These technologies diffuse as they become more attractive, but by that time the system’s inertia and the still-high shares of older technologies in the vintage structure do not allow a more dynamic transition toward lower emissions.

The “stylized” treatment of RD&D and technological learning in the model requires further improvement. Endogenous technological change is captured only for six new technologies in the presented example. This is

seriously deficient and clearly needs to be extended to other technologies in the energy system and other sectors of the economy. High computational requirements are a serious barrier to such extensions, so that new research is required. There are serious methodological shortcomings to the approach, as it captures RD&D and learning only for low carbon-emitting technologies. According to Goulder (1996), knowledge-generating resources are generally scarce, so that expansion of technological progress in one industry often implies a reduction in the rate of technological progress in others, even if the policy in question does not intend to discourage any industry's rate of technological progress. Another critical issues is that endogenization of technological change through learning by doing means that the energy system will be "locked in" a few technologies that have high progress ratios. But variety has a value in itself. This means that a number of speculative projects should be funded in any case, with the idea that his will enlarge the stock of future possibilities.

This first result of endogenizing technological change indicates that the postponement of investments in new and advanced technologies in itself will bring few additional benefits to future CO<sub>2</sub> mitigation strategies. In other cases there might be benefits from delay. Costs of some technologies might decrease due to "exogenous" improvement of other technologies. For example, improvements in information technologies might benefit energy technologies so that postponement might be attractive. the main result of the analysis, however, is robust: unless there is dedicated, timely, and pronounced investment in CO<sub>2</sub> mitigation technologies, they are less likely to be developed and thus become commercially viable and competitive in the market place. Learning by doing is a prerequisite for performance improvements, cost reductions, and eventual diffusion. Postponement of investment decisions will not bring about the technological change required to reduce CO<sub>2</sub> emissions in a cost-effective way. Even worse, it might bring about further "lock-in" of energy systems and economic activities along fossil-intensive development paths.

## References

- Christiansson, L., 1995, Diffusion and Learning Curves of Renewable Energy Technologies, WP-95-126, International Institute for Applied Systems Analysis, Laxenburg, Austria.
- Goulder, L.H., 1996, Notes on the Implications of Induced Technological Change for the Attractiveness and Timing of Carbon Abatement, Paper presented at the Workshop on Timing and Abatement of Greenhouse-Gas Emissions, 17-18 June 1996, Paris, France.

- Grübler, A., and Nakićenović, N., 1988, The Dynamic Evolution of Methane Technologies, in T.H. Lee, H.R. Lindin, D.A. Dreyfus, and T. Vasko (eds.), *The Methane Age*, Kluwer Academic Publishers, Dordrecht, Netherlands.
- Grübler, A., and Nakićenović, N., 1996, Decarbonizing the Global Energy System, *Technological Forecasting and Social Change* **53**(1):97-110.
- Grübler, A., Jefferson, M., and Nakićenović, N., 1996, Global Energy Perspectives: A Summary of the Joint Study by the International Institute for Applied Systems Analysis and World Energy Council, *Technological Forecasting and Social Change* **51**(3):237-264.
- IIASA-WEC (International Institute for Applied Systems Analysis-World Energy Council), 1995, Grübler, A., Jefferson, M., McDonald, A., Messner, S., Nakićenović, N., Rogner, H.-H., Schrattenholzer, L., Lead Authors, *Global Energy Perspectives to 2050 and Beyond*, IIASA-WEC, Laxenburg, Austria, and London, UK.
- Intergovernmental Panel on Climate Change (IPCC), 1996, *Second Assessment Synthesis of Scientific-Technical Information Relevant to Interpreting Article 2 of the UN Framework Convention on Climate Change, Climate Change 1995*, IPCC, Geneva, Switzerland.
- Ishitani, H., Johansson, T.B., Convening Lead Authors; Al-Khouli, S., Audus, H., Bertel, E., Bravo, E., Edmonds, J.A., Frandsen, S., Hall, D., Heinloth, K., Jefferson, M., de Laquil III, P., Moreira, J.R., Nakićenović, N., Ogawa, Y., Pachauri, R., Riedacker, A., Rogner, H.-H., Saviharju, K., Sørensen, B., Stevens, G., Turkenburg, W.C., Williams, R.H., Fengqi, Z., Principal Lead Authors, 1996, Energy Supply Mitigation Options, in R.T. Watson, M.C. Zinyowera, and R.H. Moss (eds.), *Climate Change 1995: Impacts, Adaptations and Mitigation of Climate Change: Scientific-Technical Analyses. Contribution of Working Group II to the Second Assessment Report of the Intergovernmental Panel on Climate Change*, Cambridge University Press, Cambridge, UK.
- Marchetti, C., and Nakićenović, N., 1979, *The Dynamics of Energy Systems and the Logistic Substitution Model*, RR-79-13, International Institute for Applied Systems Analysis, Laxenburg, Austria.
- Messner, S., 1995, Endogenized Technological Learning in an Energy Systems Model, WP-95-114, International Institute for Applied Systems Analysis, Laxenburg, Austria.
- Messner, S., 1996, Endogenized Technological Learning in an Energy Systems Model, *Journal of Evolutionary Economics* (forthcoming).
- Messner, S., and Nakićenović, N., 1992, A Comparative Assessment of Different Options to Reduce CO<sub>2</sub> Emissions, *Energy Conversion and Management* **33**(5-8):763-771.
- Messner, S., and Strubegger, M., 1991, User's Guide to CO<sub>2</sub>DB: The IIASA CO<sub>2</sub> Technology Data Bank, Version 1.0, WP-91-31a, International Institute for Applied Systems Analysis, Laxenburg, Austria.
- Messner, S., Golodnikov, A., and Gritsevskii, A., 1996, A Stochastic Version of the Dynamic Linear Programming Model MESSAGE III, *Energy* **21**(9):775-784.

- Nakićenović, N., 1979, *Software Package for the Logistic Substitution Model*, RR-79-12, International Institute for Applied Systems Analysis, Laxenburg, Austria.
- Nakićenović, N., 1990, Dynamics of Change and Long Waves, in T. Vasko, R. Ayres, and L. Fontvielle (eds.), *Life Cycles and Long Waves*, Springer-Verlag, Berlin, Germany.
- Nakićenović, N., 1996, Freeing Energy from Carbon, *Dædalus* **125**(3):95–112.
- Nakićenović, N., and Rogner, H.-H., 1996, Financing Global Energy Perspectives to 2050, *OPEC Review* **XX**(1):1–24.
- Nakićenović, N., Convening Lead Author; Grübler, A., Ishitani, H., Johansson, T., Marland, G., Moreira, J.-R., Rogner, H.-H., Principal Lead Authors, 1996, Energy Primer, in R.T. Watson, M.C. Zinyowera, and R.H. Moss (eds.), *Climate Change 1995: Impacts, Adaptations and Mitigation of Climate Change: Scientific-Technical Analyses. Contribution of Working Group II to the Second Assessment Report of the Intergovernmental Panel on Climate Change*, Cambridge University Press, Cambridge, UK.
- Nordhaus, W.D., 1973, The Allocation of Energy Resources, *Brookings Papers on Economics Activity*, Brookings Institution, Washington, DC, USA, Vol. 3:529–576.
- Nordhaus, W.D., and van der Heyden, L., 1997, Modeling Technological Change: Use of Mathematical Programming Models in the Energy Sector, Cowles Foundation Discussion Paper No. 457, New Haven, CT, USA.
- Rosegger, G., 1991, Diffusion Through Interfirm Cooperation: A Case Study, in N. Nakićenović and A. Grübler (eds.), *Diffusion of Technologies and Social Behavior*, Springer-Verlag, Berlin, Germany.
- Schäfer, A., Schrattenholzer, L., and Messner, S., 1992, Inventory of Greenhouse-Gas Mitigation Measures: Examples from IIASA Technology Data Bank, WP-92-85, International Institute for Applied Systems Analysis, Laxenburg, Austria.
- Strubegger, M., and Reitgruber, I., 1995, Statistical Analysis of Investment Costs for Power Generation Technologies, WP-95-109, International Institute for Applied Systems Analysis, Laxenburg, Austria.
- UN/FCCC (United Nations Framework Convention on Climate Change), 1992, *Convention Text*, IUCC, Geneva, Switzerland.
- Wigley, T.M.L., Richels, R., and Edmonds, J.A., 1996, Economic and Environmental Choices in the Stabilization of Atmospheric CO<sub>2</sub> Concentrations, *Nature* **379**:240–243.

# Technological Uncertainty

*Arnulf Grübler and Sabine Messner*  
Environmentally Compatible Energy Strategies Project  
IIASA, Laxenburg, Austria

## Abstract

Technological uncertainties are endogenized into the bottom-up, systems engineering, linear programming (LP) model MESSAGE III using stochastic optimization. Technological uncertainty as reflected in investment costs of electricity generation technologies is first analyzed statistically using data from the CO2DB technology database. Empirical technology cost distributions are incorporated into the LP model and sampled simultaneously. A penalty term in the objective function integrates (weighted by probabilities) stochastically drawn data samples into the final solution. The stochastic programming approach ensures short computation time and full endogenization of uncertainty in the model solution. Model simulations illustrate that compared with traditional deterministic model representations that assume perfect foresight, endogenization of technological uncertainty yields different, more diversified future energy systems structures. Diversification becomes the optimal hedging strategy for responding to technological uncertainty. However, technologies that currently have very high cost and uncertainty ranges (e.g., photovoltaics) do not make it to the market in the stochastic model simulations. They become part of the diversification portfolio, however, once research and development, technology dynamics, and learning are introduced as the most important endogenous mechanisms for reduction of technological uncertainties.

## 1. Introduction

Life is uncertain, and technology is no exception. A first source of technological uncertainty is related to obtaining correct and relevant information about the characteristics of a technology. This process can be more difficult than it sounds due to asymmetry of information between suppliers and buyers and the considerable technical knowledge required for evaluating complex technological information. Nevertheless, these informational barriers can be

overcome, and the market provides the ultimate final solution for resolution of uncertainty about the characteristics of a technology: investment.

A second source of uncertainty about technology derives directly from its dynamic nature as a result of innovative activities. Through innovation, both incremental and radical, technologies and their characteristics change continuously. Technologies also change during application or technology diffusion (Grübler 1991, 1992), a phenomenon known in economics as “learning by doing” (Arrow, 1962). Of course, both the rate and direction of change are uncertain, as are the eventual impacts of technological change on costs, competitiveness, structure of an industry, etc. Only one thing is certain: just as the technology of today is different from that of yesterday, the technology of tomorrow will be different from that of today.

It is important to emphasize that innovative activities and the technological variety and uncertainty they create are not exogenous. Technological innovations through research, development, and demonstration (RD&D) are part of the economic activities of firms, either in-house, in the research and development (R&D) laboratory of a large firm, or through economic transactions (i.e., buying technologies from specialized suppliers). Close supplier-user relations are important (Metcalf, 1981) for testing and improving design and performance characteristics of new technologies. Therefore, even when new technology is supplied from the “outside,” the transactions involved are far more complex than simply buying off the shelf in the technology “supermarket.”

When dealing with the energy sector and its environmental impacts, technological change and uncertainty enter the picture at each step, from the provision of energy services for the final consumer, to transport and distribution, energy conversion, and finally primary resource extraction. Characteristics of (future) technologies in terms of availability, performance, and costs are key factors that determine productivity (energy needs per unit of service delivered), resource availability (e.g., success rates of resource exploration and recovery rates), costs, and environmental impacts (emissions).

The importance of technological uncertainty in determining the structure and impacts of future energy systems has been recognized and explored since the earliest days of energy studies and modeling efforts (e.g., Nordhaus, 1973; Starr and Rudman, 1973). Different approaches have been followed for analyzing the impacts of technological uncertainty through

- Formulation of alternative scenarios (e.g., IIASA-WEC, 1995);
- Model sensitivity analysis (e.g., Nordhaus, 1973, 1979); and

- Sensitivity analysis based on expert polls or Delphi-type methods (e.g., Manne and Richels, 1994).

In each of these types of analysis the subjective choice of the technological uncertainty range investigated is made either by the modelers themselves in the sensitivity analysis, or by the experts polled. Also, whereas scenarios or sensitivity analyses yield insights into the variations in model outcomes that result from changes in technology input assumptions, (technological) uncertainty is not endogenized into the decision rules (usually based on some optimization criterion) employed in the model. In other words, although we know of different future outcomes depending on when, how, and in what direction uncertainty is resolved, we remain ignorant about robust (or even “optimal”) strategies in the face of uncertainty.

Our treatment of technological uncertainty differs from the other approaches that have been used. First, we replace the subjective nature of defining the technological uncertainty range with a more “objective” approach based on statistical analysis of data obtained from engineering studies about costs of new energy technologies. Second, we attempt to endogenize uncertainty into the decision-making process: we maintain an optimization framework, but the deterministic point estimates of technology parameters and the perfect foresight under which the model operates are replaced by random (stochastic) variation.

### 1.1. Plan of paper

In Section 2 we briefly review the sources of technological data used in the statistical analysis to derive uncertainty distributions used as input for the modeling exercise. Section 3 then briefly presents the energy model MESSAGE III, which was adapted for a novel approach of stochastic data sampling to reflect technological uncertainty. The results of this stochastic programming exercise are presented in Section 4 for an illustrative global energy scenario extending to the year 2050. Sections 3 and 4 draw heavily on the investigations published in Messner *et al.* (1996). Finally, Section 5 presents a discussion of the results obtained and the modeling and policy conclusions.

## 2. Sources of Technological Data

The limited availability of technology-specific data was a serious problem for the first energy modeling and scenario studies of the 1970s. The situation has since improved substantially, because of the combined efforts of energy

modelers (e.g., Fishbone *et al.*, 1983; Kram, 1993) and the first attempts to assemble generic technology (or process-specific) databases (Grenon and Lapillonne, 1976; Gault *et al.*, 1985). In recent years, technology inventories have been developed for national (e.g., EPRI, 1989; Katscher, 1993) and international energy planning (IEA, 1991, 1992; IAEA, 1995), and for greenhouse gas mitigation studies (e.g., IPCC, 1996).

For the analysis reported here, we use a computerized database of energy technologies and greenhouse gas mitigation options, CO2DB, developed over the past few years at the International Institute for Applied Systems Analysis (IIASA; Messner and Strubegger, 1991; Schäfer *et al.*, 1992). CO2DB is a fully interactive, personal-computer-based technology database for the storage and retrieval of technological data that also permits the combination of individual technologies into product- or service-specific technology chains for full fuel cycle analysis. Another distinguishing characteristic of CO2DB (one that makes it particularly suited for the purposes here) is that it retains the original data and references of the engineering studies used as input to CO2DB. Hence no additional subjective data evaluation/validation bias is introduced by the database developers. Currently, CO2DB contains over 1600 technologies that cover the most salient energy production (coal mines, oil wells), conversion (refineries, power plants), transport and distribution (pipelines, electricity networks), and end-use technologies (automobiles, light bulbs, etc.) in existence today or estimated to become available in the future. Technology data are included for the industrialized countries of the Organisation for Economic Co-operation and Development (OECD), the transitional economies of Central and Eastern Europe, and developing countries, which, according to our information, makes the database the largest of its kind available at the international level.

Altogether, eight representative classes of electricity generation technologies were chosen. Their range and (arithmetic) mean values are given in Table 1. Typically, cost ranges vary by a factor of 1.5–2.5 for established technologies and by a factor of 5–6 for new technologies such as advanced biomass or solar photovoltaic (PV) systems, where the scope for future cost improvements and resulting commercialization prospects are much more uncertain.

Performance characteristics are well-known for technologies that are mature, widely available commercially, and dominant on the market. In contrast, uncertainties are considerable for new technologies, largely because they have not been extensively used or experimented with as they hold low current market shares. At the same time, new technologies hold promise for



**Table 1.** Investment cost range and (arithmetic) mean for eight classes of electricity generating technologies (in 1990 US\$/kW). Source: Messner *et al.*, 1996.

Technology	Mean	Minimum	Maximum	Range	Range (max/min)
Conventional coal	1,350	650	2,450	1,800	2.77
Advanced coal	1,695	1,195	2,905	1,710	1.43
Conventional gas	570	330	1,050	720	2.18
Gas CC	815	514	1,702	1,188	2.31
Biomass	1,580	500	3,020	2,520	5.04
Nuclear	2,145	1,070	3,600	2,530	2.36
Solar thermal	3,010	1,790	4,490	2,700	1.51
Solar PV	6,120	1,740	12,540	10,800	6.21

Abbreviations: CC = Combined cycle; PV = Photovoltaics.

substantial improvements through applied research, experimentation, and technological learning.

The uncertainty of investment cost estimates analyzed by Messner *et al.* (1996) is considerable. For coal power plants, cost estimates vary by US\$1,700–1,800 per kW, both for conventional and advanced systems. For conventional coal-fired electricity systems, this translates into a 177% investment cost variation. Conversely, for capital-intensive advanced systems, such as integrated gasification combined cycles (IGCC) or pressurized fluidized bed combustion (PFBC), the variation is only 43%, although it is about the same in absolute amounts as for conventional systems. For solar thermal systems, the uncertainty range is also 50%, but the absolute difference between minimum and maximum investment cost estimates amounts to US\$2,700/kW. Here the investment cost uncertainty is about the same as the maximum cost estimate for advanced coal power plants. Gas-based systems have comparatively low capital costs. As a result, absolute cost uncertainties are comparatively low, although in relative terms the cost uncertainty is about a factor of two, which is similar to that of nuclear power plants. For solar thermal systems, estimated investment cost ranges are comparable to those of nuclear power plants (US\$2,500/kW). Finally, solar PVs are the most uncertain with respect to their eventual economic feasibility, because of their current high costs and the enormous range in estimated future costs, which exceeds US\$10,000/kW. It is interesting to observe that for all estimates the arithmetic mean of the estimated investment costs lies below the middle of the range covered in the data sample.

### 3. Modeling Technological Uncertainty

#### 3.1. The basic model

The basic model used for the analysis reported here is the dynamic linear programming (LP) model MESSAGE III, which was developed at IIASA for the analysis of energy supply and end-use systems alternatives and their general environmental impacts (Messner and Strubegger, 1995). The model assists the analysis of future energy strategies under the influence and constraints of available technologies, resources, energy service demands, and environmental impacts. The model is dynamic over time, integrating the optimization for the whole time horizon into one objective function. The model also links the different (variable) time steps (periods) using various dynamic constraints representing the market penetration, or diffusion, of new technology vintages.

Technology-specific information about numerous technologies is incorporated into MESSAGE, including information on costs, efficiency, technical plant life, and pollutant emissions. It is therefore representative of the systems engineering or "bottom-up" class of energy models. The objective function in most applications concerns minimizing the sum of total discounted costs, including investment and operation and maintenance costs of technologies. As a rule, fuel costs are determined endogenously in the model through various resource categories with (rising) extraction costs (resulting from depletion of cheaper deposits) and associated processing, transport, and distribution costs. As with the technologies of the energy sector "downstream" (for example, electricity generation as it is discussed here), extraction technologies are also subject to uncertainty and technology dynamics. These technologies are not, however, analyzed separately here (for a discussion of scenario sensitivity, see IIASA-WEC, 1995).

Costs or profits from international energy trade or from energy or emission taxes can also be included in the objective function. Technical, social, political, or environmental constraints for technology choice and utilization, such as biomass land availability, specific temporal patterns of energy demand (load curves), capital availability, etc., are usually represented by a number of constraints in various model applications. Such constraints serve an additional important purpose: they combat the drawback inherent to LP models of always exploiting the cheapest technologies to the maximum degree possible. As a consequence of this model characteristic, minute changes in cost assumptions can lead to qualitatively very different results. Such

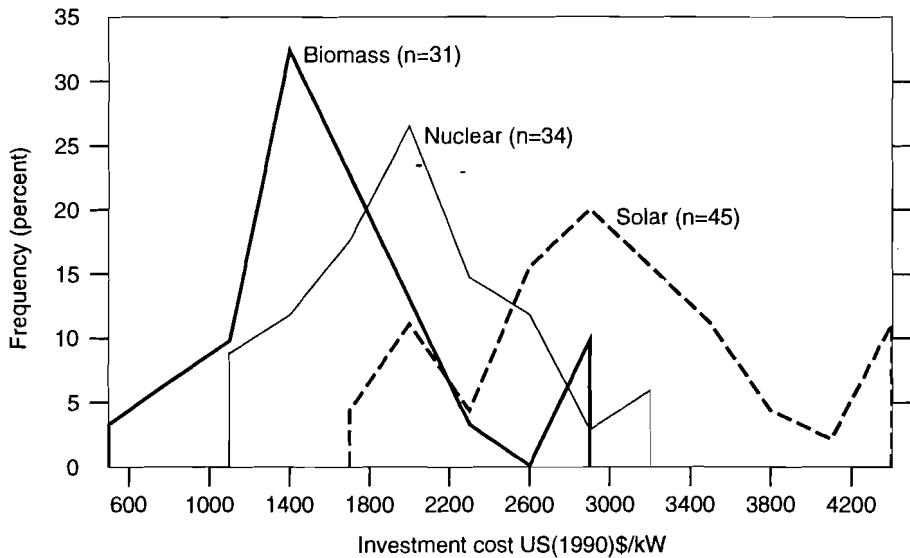
“flip-flop” behavior is usually counteracted by introducing various smoothening constraints: limiting changes over time (diffusion or market-penetration constraints), limiting new installations of a technology (capacity build-up constraints), or linking technologies to each other (representing technological interdependence in the model).

The MESSAGE model has been applied in a wide range of energy-related analyses, such as regional and urban energy planning (Messner and Strubegger, 1996) and the analysis of different energy options (Messner and Strubegger, 1986). The most recent application of the model was in the joint IIASA-WEC (World Energy Council) study on long-term energy perspectives (IIASA-WEC, 1995), where three families of global energy scenarios for the next century were explored.

The model used here is based on the global energy model developed for the joint IIASA-WEC study. In that study, the model consisted of 11 regional models covering the world energy system. Energy flows are described through all relevant energy carriers and conversion technologies, from coal mining and oil drilling and refining via various electricity generation technologies up to final energy consumption (for example, in residential heating and in automotive transport). For the analysis reported here, a compressed version of the IIASA-WEC (1995) study's global energy model was used. This compressed model aggregates the original 11-region model into a 1-region model, but includes all the technological detail concerning electricity generation of the original model. Energy demands are based on the intermediate “Middle Course” scenario of the IIASA-WEC (1995) study. In that scenario, between 1990 and 2050 global economic output increases nearly fourfold to some US\$75 trillion ( $10^{12}$ ); primary energy needs double to some 20 Gtoe ( $10^9$  tons oil equivalent); and electricity consumption increases almost threefold to some 3.8 TW/yr (Terawatts per year). The time frame for the model simulations (1990 to 2050) allows us to consider in the model calculations about two complete capital turnover cycles of energy generation facilities, which typically have a lifetime of about 30 years.

### **3.2. A Conventional Sensitivity Analysis**

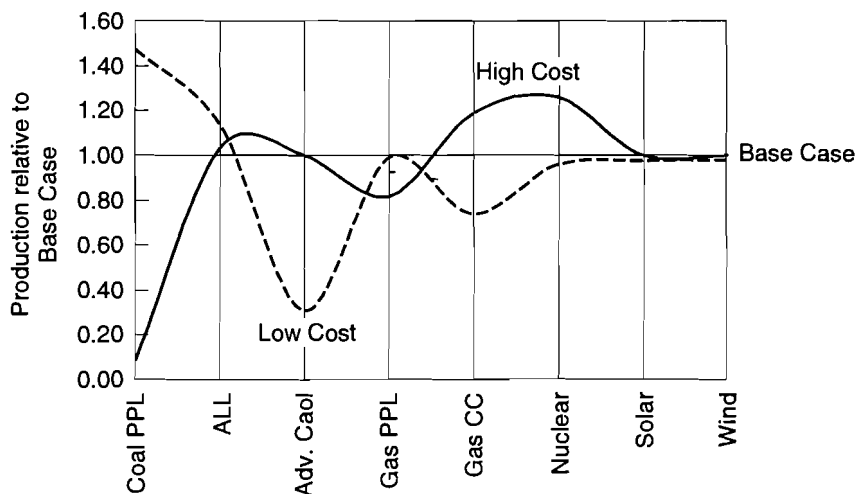
Uncertainties concerning investment costs of energy conversion technologies (electricity generation) were reviewed using a statistical analysis of data contained in CO2DB (for a more detailed analysis, see Strubegger and Reitgruber, 1995). Figure 1 illustrates representative distributions of investment costs for biomass-, nuclear-, and solar-thermal-based electricity generation.



**Figure 1.** Range of investment cost distributions from CO2DB technology inventory for biomass, nuclear, and solar electricity generation used as input to assess the costs of current and future energy systems. Source: IIASA-WEC, 1995.

As a first step of the modeling exercise, all technology costs are set to the mean value obtained from the observations in CO2DB (cf., Table 1). Investment costs are then varied within the data uncertainty range given above. Operating costs are not varied in this analysis, and the mean value from the CO2DB is retained. As mentioned above, fuel costs are determined endogenously in the model as a function of resource grades and related extraction, processing, transport, and distribution costs.

Figure 2 shows the results of this conventional sensitivity analysis. The changing relative contribution of electricity generated from conventional coal-fired power plants to variations in its own investment costs, as well as to variations in the investment costs of the other eight technologies, is shown for the year 2050. The straight line at 100% represents an initial model run using the (arithmetic) mean investment costs for all technologies (Base Case). Two types of sensitivity runs were performed: the Low Cost cases reduce investment costs of one specific technology or all new technologies (labeled ALL) to the minimum estimates from Table 1; the High Cost cases follow the same procedure using the maximum estimates.



**Figure 2.** Relative production of (conventional) coal-fired power plants as a function of varying cost assumptions compared with the arithmetic mean (Base Case), in the year 2050.

As the results for the conventional coal power plant indicate, the sensitivity is rather high, particularly to the own cost estimates of the conventional coal technology (for a similar analysis of gas combined-cycle power plants, see Messner *et al.*, 1996). When high cost estimates are adopted, the share of conventional coal power plants drops to a mere 10% of the Base Case scenario, based on mean investment cost estimates. Conversely, adopting low cost estimates increases the contribution of conventional coal plants by some 50% compared with the Base Case calculation. In the Low Cost case the sensitivity of the contribution of conventional coal power plant technology to variations in the cost of alternative technologies is highest for advanced coal technologies (a decrease of approximately 70% for conventional coal) and gas combined cycle (a decrease of approximately 30% for conventional coal). Conversely, conventional coal technology is a winner (showing a gain of approximately 20%) if combined-cycle and/or nuclear technologies follow a high cost trajectory.

For all other cases, variations for conventional coal are relatively minor. Interestingly, this is also the case if all investment costs are changed at once (i.e., taking either all low or all high ends of the range for all technologies simultaneously). In such a case, none of the other technological alternatives to conventional coal becomes either decisively cheaper or more

expensive. Thus, the relative structure of electricity supply remains basically unchanged from the Base Case, although of course the total energy systems costs are substantially higher or lower in the High Cost and Low Cost scenarios, respectively.

This high sensitivity of model results to (admittedly rather high) variations of cost assumptions highlights two major weaknesses of any deterministic cost-minimization approach. First, it illustrates how sensitive the model outcomes are to the cost assumptions employed, which – in a caricature of the actual decision-making problem at stake – are assumed to be known *ex ante* with perfect foresight. Second, on a more practical level, a multitude of model runs would be required to identify resilient investment strategies in the wake of this uncertainty, including an exact analysis of the investment cost points at which the model starts to flip into another stratum of the energy system. Such an analysis is obviously time consuming, which explains why it is rarely performed.

The approach suggested in Golodnikov *et al.* (1995) and Messner *et al.* (1996), and summarized in the next section, enables the performance of such analyses in a closed form by incorporating uncertainties and risks concerning future investment costs of technologies directly into the mathematical formulation of the model, which thus gains a more realistic representation of the typical real-life investment decision-making process.

### 3.3. Stochastic programming

MESSAGE III has three major types of variables and a variety of equation types (constraints). Variables include technology activity, annual new installations of technologies, and annual resource extraction. Constraints in MESSAGE can be grouped as follows: (a) demand constraints that ensure that an exogenously specified demand is satisfied by appropriate (i.e., least-cost) technologies; (b) balancing constraints for energy vectors (e.g., electricity) that ensure that consumption does not exceed production; (c) capacity constraints that constrain the production of a technology to the overall capacity existing in the period; (d) dynamic (expansion or contraction) constraints that relate the activity in one period to the activity level in the previous period; and, finally, (e) two types of resource constraints that limit resource consumption to the overall quantities available and annual extraction to a fraction of the remaining resources in any period. All variables and most constraints are attributable to (any) one specific time period. Only dynamic constraints link two time periods.

The simplified formulation of MESSAGE III can be written as follows (based on Golodnikov *et al.*, 1995; and Messner *et al.*, 1996; see these publications for a more detailed description than that presented here):

$$\min \sum_{t=0}^T \langle C^t, x^t \rangle, \quad (1)$$

$$B_t x^t \geq d^t, t = 0, 1, \dots, T, \quad (2)$$

$$\sum_{t=0}^T A_t x^t \leq r, \quad (3)$$

$$\sum_{t=0}^T P_t x^t \leq e^t, t = 0, 1, \dots, T, \quad (4)$$

$$0 \leq x^t \leq \bar{x}^t, t = 0, 1, \dots, T, \quad (5)$$

where  $C^t$  is the cost vector at time  $t = 0, 1, \dots, T$ ;  $r$  is the vector of available resources;  $d^t$  is the energy-demand vector at time  $t$  or zero for the energy balances;  $e^t$  is the vector of other exogenous right-hand sides, for example, representing capacities already installed in the base year;  $A_t$  is an identity to sum all consumption of one resource over time;  $B_t$  is a matrix of input/output coefficients for the technologies represented in the model; and  $P_t$  is a matrix that provides relations between periods, e.g., in the form of capacity constraints.

In the stochastic application suggested in Messner *et al.* (1996) the technology cost vectors,  $C^t$ , are treated as random. They are defined as  $C^t(w)$ , where  $w$  is an element from a probability space indicating the dependence of the "real" (i.e., the actual future) cost vector  $C^t(w)$  on a random event that is characterized by a probability  $dP(w)$ . In contrast to other studies, we do not rely on subjectively defined probability measures. Instead, we derive the probabilities directly from the distribution functions of observations from the CO2DB technology database, which are entered directly into the model formulation in the form of histograms. These define the initial distributions at  $t = 0$ . If the cost vector,  $C^t$ , is stochastic, then the real cost,  $\sum_{t=0}^T \langle C^t(w), x^t \rangle$ , of a given strategy  $x$  can be derived directly from (1).

The underestimation of the expected cost incurred by using the deterministic model can be calculated as follows. For a given strategy,  $x^t$ , and an observed "realization,"  $w$ , of the cost-path,  $C^t(w)$ , the positive deviation

of the “real” (observed) total cost,  $\sum_{t=0}^T \langle C^t(w), x^t \rangle$ , from the calculated cost,  $\sum_{t=0}^T \langle C^t, x^t \rangle$ , is defined as

$$R(x, w) = \sum_{t=0}^T \max[0, \langle C^t(w) - C^t, x^t \rangle] .$$

This deviation is an expression of the underestimation of the real costs for strategy  $x$  using a deterministic cost function. The expected cost of underestimating investment costs,  $R(x) = \mathbf{E}R(x, w)$ , can be used as an indicator of the economic risk associated with strategy  $x$ . The risk function,  $R(x)$ , enters the objective function as an additional “penalty” term (it also could be modeled as an additional nonlinear constraint added to the original deterministic model). Ermoliev and Wets (1988) provide an extensive discussion of motivation, formulation, and solution procedures for the optimization of functions, expressed in terms of expectations similar to  $R(x)$ .

The stochastic model that explicitly incorporates the risk of underestimating future investment costs can be formulated as minimizing the performance function

$$\sum_{t=0}^T \langle C^t, x^t \rangle + \rho R(x) \quad (6)$$

subject to the original constraints (2) to (4).  $\rho$  describes the weight that the risk of underestimating costs has in the objective function. When  $\rho = 1$ , the first term of the performance function corresponds to the expected cost associated with energy developments and the second corresponds to the expected underestimation of real costs. Applying a risk factor  $\rho > 1$  corresponds to risk aversion, while  $\rho < 1$  reflects a neutral attitude toward risk.

The resulting stochastic optimization problem is solved on the basis of successive approximation of  $R(x)$  by  $N$  sample functions using independent draws  $w^s$  of possible cost paths  $C^t(w^s)$ , based on the frequencies of cost distributions entered into the stochastic model calculation. The performance function (6) is approximated by including the sequence of random functions

$$\sum_{t=0}^T \langle C^t, x^t \rangle + \rho \frac{1}{N} \sum_{s=1}^N R(x, w^s) .$$

A simple sequential optimization procedure is designed to follow the solution path of the optimal strategies  $x^N$  with  $N \rightarrow \infty$ , which are derived from the optimization of the functions  $F^N(x)$  for  $N \rightarrow \infty$ .



Thus, the stochastic optimization model discussed in Messner *et al.* (1996) and summarized above endogenizes technological uncertainties into the bottom-up, systems engineering, LP model MESSAGE III. Empirically derived cost distribution functions reflect probability distributions of future technology costs that are sampled simultaneously in the model runs. A penalty term in the objective function that reflects the economic costs associated with making a “wrong bet” on future technology costs integrates (weighted by probabilities) stochastically drawn data samples into the final solution. The advantage of the algorithm is that the stochastic sampling is directly integrated into the model, ensuring a short computation time and full endogenization of uncertainty in the model solution.

#### 4. Simulation Results

Three illustrative simulations for electricity generating technologies have been performed to analyze the performance of the stochastic version of MESSAGE. The results summarized here are reported in more detail in Messner *et al.* (1996). The three simulations include

- A deterministic unbound (“Det Unbd”) case in which technology costs are set to their mean values from the CO2DB. The decision algorithm assumes perfect foresight of these future costs and the (unrealistic) model results correspond to a least-cost pathway for satisfying the exogenously specified energy demand scenario under the assumed technology investment costs. (Operating costs are not varied in this analysis; as mentioned above, they are set at their respective mean values from the CO2DB. Fuel costs are determined endogenously through successive depletion of low-cost resource grades.)
- A deterministic bound (“Det Bd”) case, which makes the same technology assumptions as the deterministic case described above but introduces additional market-penetration and technology-diversification constraints to avoid erratic “flip-flop” model solutions and to produce a more “realistic” and robust model outcome.
- A stochastic (“Stochastic”) case that incorporates full technological uncertainty and endogenizes this uncertainty into the decision rule of the model, which consequently no longer operates under conditions of perfect foresight of future characteristics of technologies. The stochastic case draws on the (unconstrained) model structure of the deterministic bound case.

Figures 3 and 4 show respectively the development of gas- and coal-based electricity generation up to 2050 for the three cases analyzed in Messner *et al.* (1996).

The overall trend for all simulations is rather similar: coal use declines and gas use expands over time. Gas is used most extensively in the deterministic unbound case, with a strong oscillation and trend reversal starting around 2030, a (rather implausible) pattern that is somewhat reduced in the deterministic bound case. In that simulation, more coal and less gas is used for electricity generation in the nearer future than in the other cases. As such, the scenario reflects “conventional wisdom” (and the fact that the regulatory restrictions for gas use in electricity generation were lifted only recently), which considers gas to be a “premium” fuel, too “precious” for use in electric power plants. In the unbound cases this constraint is relaxed and leads to an immediate substitution of natural gas for coal.

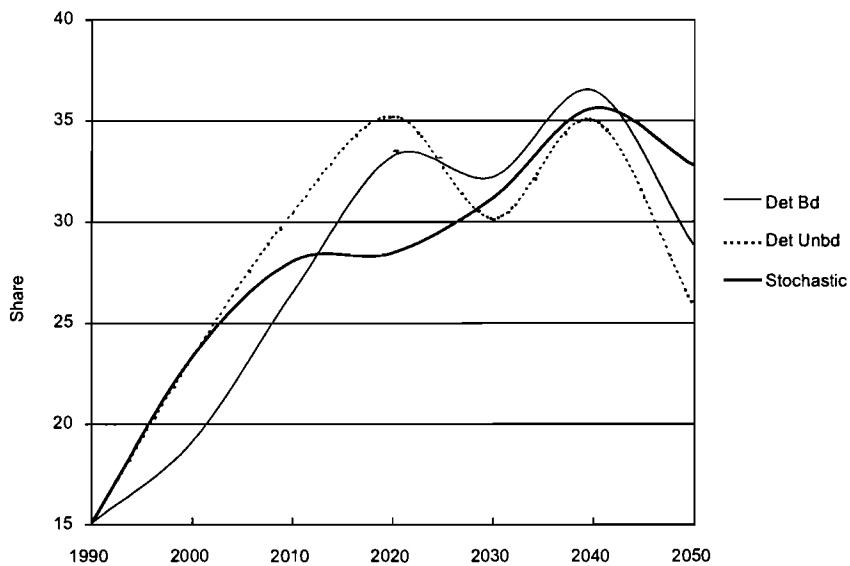
A diversification of electricity generation similar to that in the deterministic bound case occurs in the stochastic case. This adjustment generally leads to reduced gas use toward the end of the simulation horizon and, in the deterministic unbound case, to a resurgence of coal-based power generation. This resurgence can be avoided in the deterministic bound and the stochastic cases.

Figure 5 compares the structure of electricity generation by technology. Scenario results are shown for the year 2050.

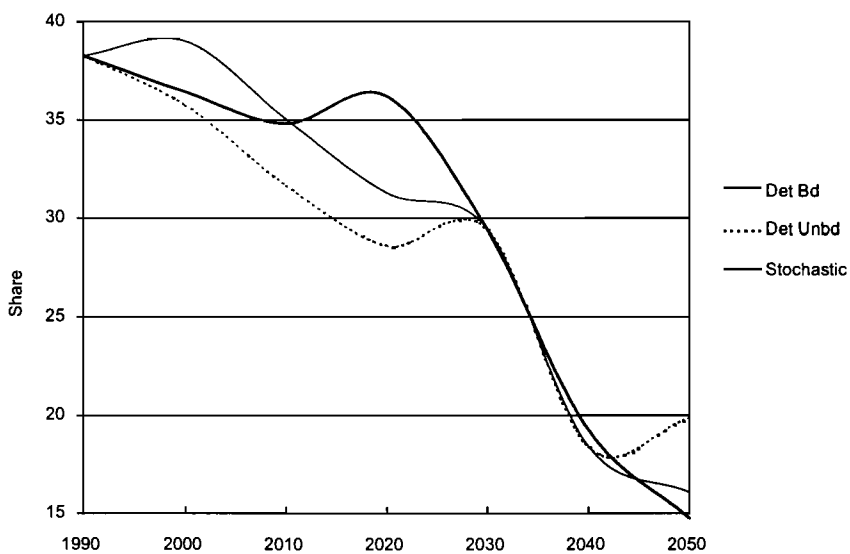
According to the results of Messner *et al.* (1996), in the deterministic cases the use of conventional coal power plants and, to a lesser degree, nuclear power plants is reduced in the bound case compared with the unbound case. In contrast, gas-fired combined-cycle power plants are deployed less in the unbound model. The stochastic model formulation yields an interesting result: the tendencies emerging in the bound (versus unbound) deterministic case tend to become reinforced. Gas combined cycles are used to an even greater extent than in the deterministic unbound case, and coal-based power generation and deployment of nuclear reactors are even reduced further.

Messner *et al.* (1996) interpret this result in the following way: the modeler, through his or her expert judgement, anticipates uncertainties of important model parameters and introduces model bounds to minimize extreme, unidirectional technology selections in the deterministic bound case simulations. The “expert” choices turn out to be confirmed (in fact, to a certain extent even amplified) in the stochastic unbound case simulations that operate under completely endogenized technological uncertainty.

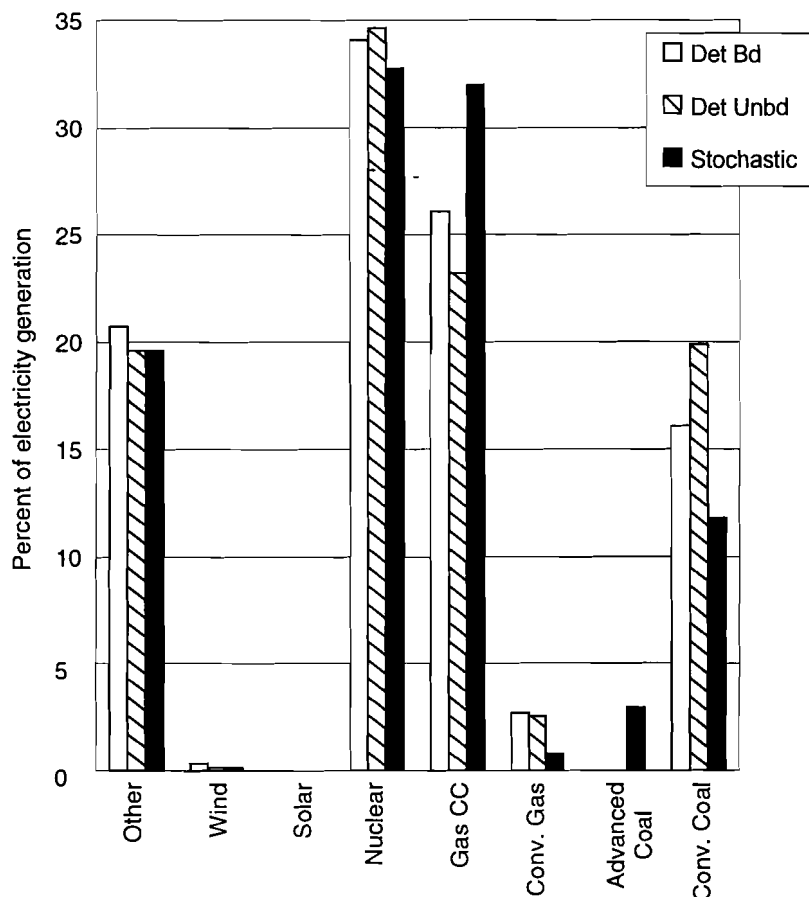
Even more important is the look at the finer technological structure emerging from the model runs, in particular the distribution between



**Figure 3.** Share of gas in electricity generation for the three cases. Source: Messner *et al.*, 1996.



**Figure 4.** Share of coal in electricity generation for the three cases. Source: Messner *et al.*, 1996.



**Figure 5.** Electricity generation by technology in the three cases in 2050. Source: Adapted from Golodnikov *et al.*, 1995.

conventional and advanced coal- and gas-fired electricity generation. For the coal-based systems, conventional power plants are generally cheaper (based on mean cost estimates from the CO<sub>2</sub>DB), but they are also less energy efficient and have higher emissions. Therefore, in the Base Case simulations with deterministic costs, conventional coal-based systems are the preferred technology option. If uncertainties become incorporated into the analysis, however, technological diversification takes place, with some 20% of coal-generating capacity being based on advanced coal systems.

According to Messner *et al.* (1996), there is a different effect for gas-based electricity generating technologies. Advanced technology as represented by

combined cycles is already the preferred technology option in the deterministic case. Introducing uncertainty into the stochastic case simulations amplifies this technology preference: the use of advanced gas systems (combined cycles) expands even more and the use of conventional (steam-cycle-based) gas systems declines sharply. These trends result from the attractive cost structure of combined-cycle technology, which is unaffected by future cost uncertainties. The attractiveness of the cost structure can be easily understood when looking at the investment cost distribution: 30% of the engineering studies' cost estimates for combined cycles in the CO2DB are at the lower end of the cost range (around US\$500/kW), confirming their economic competitiveness.

Technologies whose current costs and uncertainty ranges are very high, such as solar PV or wind electricity, are practically not deployed at all in any of the model simulations.

As a last observation, let us touch on the costs of technology diversification as it emerges in the model runs. In the stochastic formulation such diversification occurs "naturally." In technical terms, this means that diversification is achieved without relying on additional "hard" exogenous constraints. For the stochastic model formulation this results in increased model flexibility technically and in lower overall systems costs economically. This result can be easily understood considering that in the stochastic case, as in the deterministic bound case, exogenous constraints always entail the danger of eliminating potentially advantageous technological solutions, even if they do not appear advantageous from today's (or the modeler's) perspective. Conversely, incorporating additional information into the objective function, as in the stochastic model formulation discussed above, leaves more degrees of freedom for choosing optimal solutions and thus yields lower overall energy systems costs compared with those in the deterministic bound case.

## 5. Discussion

Among the main results from the model simulations presented here are the following:

1. Considering technological uncertainty yields future energy systems structures and emission levels that are different from those arising from a deterministic case with perfect foresight.
2. The structure approaches the deterministic case with additional market penetration and diversification constraints introduced by the modeler.

Introducing stochastic uncertainty thus yields more robust and “realistic” energy systems structures than those in the deterministic unbound case.

3. The stochastic model also responds to a frequent criticism of LP or other types of optimization models: the inappropriate assumption of a single decision-making agent that operates under perfect foresight. Through endogenization of uncertainty, decision making no longer operates under perfect foresight. The model behavior also approximates real-life decision-making situations in which different economic agents with different “technological expectations” (Rosenberg, 1982) and attitudes toward risk display persistent differences in strategies and investment behavior that result in technological diversification. (Although, of course, technically speaking the model still presumes the existence of a single decision agent.)
4. Technology diversification becomes the optimal hedging strategy for responding to uncertainty. The calculations reported here, however, show only suboptimal hedging, as they exclude R&D and technological learning, which are the most important endogenous mechanisms for the reduction of technological uncertainties. Even more important, the model results reveal a pro-innovation bias and no risk aversion in investments into new technologies.
5. Cost differences between the stochastic and deterministic unbound cases (i.e., hedging costs) are small; in most simulations the stochastic case also yields lower total systems costs than the deterministic bound case.
6. Technological uncertainty leads to diversification strategies along incremental innovation pathways, or to technology changes within a “technological neighborhood” (Foray and Grübler, 1990). For instance, investments are shifted away from conventional coal- and gas-based electricity generation toward advanced coal and gas systems (that incidentally are also more benign environmentally).
7. Technologies that currently have very high cost and uncertainty ranges (e.g., PVs) do not make it to the market in the model simulations. However, they become part of the diversification portfolio once technology dynamics and learning are endogenized into the model (see the contribution by Nakićenović in this volume).

## Acknowledgments

The research reported here would not have been possible without the contributions of our IIASA colleagues Yuri Ermoliev and Andrei Gritsevskii,

and those of Alexander Golodnikov from the V.M. Glushkov Institute of Cybernetics in Kiev, Ukraine. Remaining errors and misinterpretations are entirely ours.

## References

- Arrow, K., 1962, The Economic Implications of Learning by Doing, *Review of Economic Studies* **29**:155–173.
- EPRI (Electric Power Research Institute), 1989, *Technical Assessment Guide (TAG), Revision 6*, Electric Power Research Institute, Palo Alto, CA, USA.
- Ermoliev, Y., and Wets, R. (eds.), 1988, *Numerical Techniques for Stochastic Optimization*, Computational Mathematics, Springer Verlag, Berlin, Germany.
- Fishbone, L.G., Giesen, G.A., Goldstein, H.A., and Hymen, H.A., 1983, *User's Guide for MARKAL (BNL/KFA Version 2.0)*, BNL-46319, Brookhaven National Laboratory, Upton, NY, USA.
- Foray, D., and Grübler, A., 1990, Morphological Analysis, Diffusion and Lock-out of Technologies: Ferrous Casting in France and Germany, *Research Policy* **19**(6):535–550.
- Gault, F.D., Hoffman, R.B., and McInnis, B.C., 1985, The Path to Process Data, *Futures* **17**(5):509–527.
- Golodnikov, A., Gritsevskii, A., and Messner, S., 1995, A Stochastic Version of the Dynamic Linear Programming Model MESSAGE III, WP-95-94, International Institute for Applied Systems Analysis, Laxenburg, Austria.
- Grenon, M., and Lapillonne, B., 1976, *The WELMM Approach to Energy Strategies and Options*, RR-76-19, International Institute for Applied Systems Analysis, Laxenburg, Austria.
- Grübler, A., 1991, Diffusion: Long-term Patterns and Discontinuities, *Technological Forecasting & Social Change* **39**(1-2):159–180.
- Grübler, A., 1992, Introduction to Diffusion Theory, in R.U. Ayres, W. Haywood, and I. Tchijov (eds.), *Computer Integrated Manufacturing, Vol. II*, Chapman & Hall, London, UK.
- IAEA (International Atomic Energy Agency), 1995, *Computer Tools for Comparative Assessment of Electricity Generation Options and Strategies*, International Atomic Energy Agency, Vienna, Austria.
- IEA (International Energy Agency), 1991, *CADDET Brochure*, Centre for the Analysis and Dissemination of Demonstrated Energy Technologies, Organisation for Economic Co-operation and Development (OECD), Paris, France.
- IEA (International Energy Agency), 1992, *IEA/ETSAP News*, Energy Technology Systems Analysis Programme Annex IV: Greenhouse Gases and National Energy Options, Netherlands Energy Research Foundation (ECN), Petten, Netherlands.
- IIASA-WEC (International Institute for Applied Systems Analysis and World Energy Council), 1995, *Global Energy Perspectives to 2050 and Beyond*, World Energy Council, London, UK.

- IPCC (Intergovernmental Panel on Climate Change), 1996, Inventory of Technologies, Methods, and Practices, in *Climate Change 1995: Impacts, Adaptations and Mitigation of Climate Change: Scientific-Technical Analysis*, Cambridge University Press, Cambridge, UK.
- Katscher, W., 1993, *IKARUS: Instruments for Greenhouse Gas Reduction Strategies*, Forschungszentrum Jülich GmbH, Jülich, Germany.
- Kram, T., 1993, *National Energy Options for Reducing CO<sub>2</sub> Emissions*, Report of the Energy Technology Systems Analysis Programme (ETSAP), Annex IV (1990–1993), ECN-C-93-101, Netherlands Energy Research Foundation, Petten, Netherlands.
- Manne, A.S. and Richels, R.G., 1994, The Cost of Stabilizing Global CO<sub>2</sub> Emissions: A Probabilistic Analysis Based on Expert Judgement, *The Energy Journal* **15**(1):31–56.
- Messner, S. and Strubegger, M., 1986, First-Order Effects of a Nuclear Moratorium in Central Europe, WP-86-80, International Institute for Applied Systems Analysis, Laxenburg, Austria.
- Messner, S. and Strubegger, M., 1991, User's Guide to CO<sub>2</sub>DB: The IIASA CO<sub>2</sub> Technology Data Bank, Version 1.0, WP-91-31a, International Institute for Applied Systems Analysis, Laxenburg, Austria.
- Messner, S. and Strubegger, M., 1995, User's Guide for MESSAGE III, WP-95-69, International Institute for Applied Systems Analysis, Laxenburg, Austria.
- Messner, S. and Strubegger, M., 1996, Energy Policy Evaluation for Cities, in Z. Chen, T.N. Veziroglu, and D.A. Reay (eds.), *Energy and Environment: Proceedings of the International Conference on Energy and Environment*, Shanghai, China, May 1995, Begrell House, New York, NY, USA.
- Messner, S., Golodnikov, A., and Gritsevskii, A., 1996, A Stochastic Version of the Dynamic Linear Programming Model MESSAGE III, *Energy*, **21**(9):775–784.
- Metcalf, J.S., 1981, Impulse and Diffusion in the Study of Technical Change, *Futures* **13**(5):347–359.
- Nordhaus, W.D., 1973, The Allocation of Energy Resources, *Brookings Papers on Economic Activity* **3**:529–576.
- Nordhaus, W.D., 1979, *The Efficient Use of Energy Resources*, Cowles Foundation Monograph 26, Yale University Press, New Haven, CT, USA.
- Rosenberg, N., 1982, *Inside the Black Box: Technology and Economics*, Cambridge University Press, Cambridge, UK.
- Schäfer, A., Schrattenholzer, L. and Messner, S., 1992, Inventory of Greenhouse-Gas Mitigation Measures: Examples from the IIASA Technology Data Bank, WP-92-85, International Institute for Applied Systems Analysis, Laxenburg, Austria.
- Starr, C., and Rudman, R., 1973, Parameters of Technological Growth, *Science*, **182**(26 October):358–364.
- Strubegger, M., and Reitgruber, I., 1995, Statistical Analysis of Investment Costs for Power Generation Technologies, WP-95-109, International Institute for Applied Systems Analysis, Laxenburg, Austria.



# The Carnol System for Methanol Production and CO<sub>2</sub> Mitigation from Coal-Fired Power Plants and the Transportation Sector\*

*Meyer Steinberg*

Brookhaven National Laboratory, Upton, NY, USA

## Abstract

The Carnol system consists of methanol production from carbon dioxide (CO<sub>2</sub>) recovered from coal-fired power plants and natural gas, and the use of the methanol as an alternative automotive fuel. In the Carnol process, hydrogen is produced through the thermal decomposition of natural gas; the hydrogen is then reacted with CO<sub>2</sub> recovered from the power plant. The carbon produced can be stored or used. A design and economic evaluation of the process is presented and compared with gasoline as an automotive fuel. An evaluation of the CO<sub>2</sub> emission reductions of the process and system is made and compared with other conventional methanol production processes, including the use of biomass feedstock and methanol fuel cell vehicles. The CO<sub>2</sub> emissions for the entire Carnol system using methanol in automotive internal combustion engines can be reduced by 56% compared with the conventional system of coal plants and gasoline engines, and by as much as 77% when methanol is used in fuel cells in automotive engines. The Carnol system is shown to be an environmentally attractive and economically viable system connecting the power generation sector with the transportation sector that warrants further development.

## 1. Introduction

Coal and natural gas are abundant fuels. Because of their physical and chemical properties, coal and natural gas are difficult to handle and utilize in mobile as well as stationary engines. The infrastructure is mainly geared to handle clean liquid fuels. In order to convert coal to liquid fuel, it is generally necessary to increase its hydrogen-to-carbon ratio, either by

---

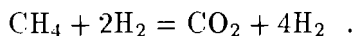
\*This work was performed under the auspices of the US Department of Energy.

increasing its hydrogen content or by decreasing its carbon content. Conversely, to convert natural gas to liquid fuels it is necessary to decrease its hydrogen content. Thus, by coprocessing the hydrogen-rich natural gas with hydrogen-deficient coal, it should be possible to produce liquid fuels in an economically attractive manner. For environmental purposes of decreasing carbon dioxide (CO<sub>2</sub>) greenhouse gas emissions, several approaches can be taken. The CO<sub>2</sub> emissions from central power stations can be removed, recovered, and disposed of in the deep ocean (Cheng and Steinberg, 1984). Alternatively, carbon can be extracted from coal and natural gas and the remaining hydrogen-rich fractions from both of these fuels can be utilized to reduce CO<sub>2</sub> emissions while storing the carbon (Steinberg, 1989). Because of its physical properties, it is much easier to dispose of carbon, either by storage or through use as a materials commodity, than it is to sequester CO<sub>2</sub> (Cheng and Steinberg, 1984). A third CO<sub>2</sub> mitigation method is to use the stack gas CO<sub>2</sub> from coal-burning plants along with hydrogen obtained from natural gas to produce methanol, which is a well-known liquid automotive fuel. In this paper, we describe and evaluate the Carnol process (Steinberg, 1993), which connects the power generation sector with the transportation sector, resulting in an overall CO<sub>2</sub> mitigation system.

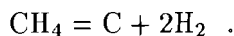
## 2. The Carnol Process

The Carnol process is composed of three unit operations:

1. CO<sub>2</sub> is extracted from the stack gases of coal-fired power plants using monoethanolamine (MEA) solvent in an absorption-stripping operation. The technology for this operation is well known in the chemical industry for CO<sub>2</sub> recovery and has recently been significantly improved for use in extracting CO<sub>2</sub> from power plant stack gases (Suda *et al.*, 1994; and Mimura, 1995). The power required to recover 90% of the CO<sub>2</sub> from the flue gas of an integrated coal-fired power plant can be reduced to about 10% of the capacity of the power plant. However, this energy requirement can be reduced to less than 1% when the CO<sub>2</sub> recovery operation is integrated with a methanol synthesis step, described in step 3 below.
2. The hydrogen required to react with CO<sub>2</sub> for producing methanol can be obtained from either of two methods involving natural gas. In the conventional method for producing hydrogen, natural gas is reformed with steam:



This process produces  $\text{CO}_2$  and, thus,  $\text{CO}_2$  emissions are increased. Hydrogen can, however, be produced without  $\text{CO}_2$  emissions, using the nonconventional method of thermally decomposing methane to carbon and hydrogen:



The energy requirement for this process is less than that required for the conventional process. A fluidized bed reactor has been used to thermally decompose methane, and more recently we have been attempting to improve reactor design by using a molten metal bath reactor (Steinberg, 1996). The carbon is separated and either is stored or sold on the market as a materials commodity, such as in strengthening rubber for tires. This operation requires temperatures of  $800^\circ\text{C}$  or above and pressures of less than 10 atm, preferably about 1 atm.

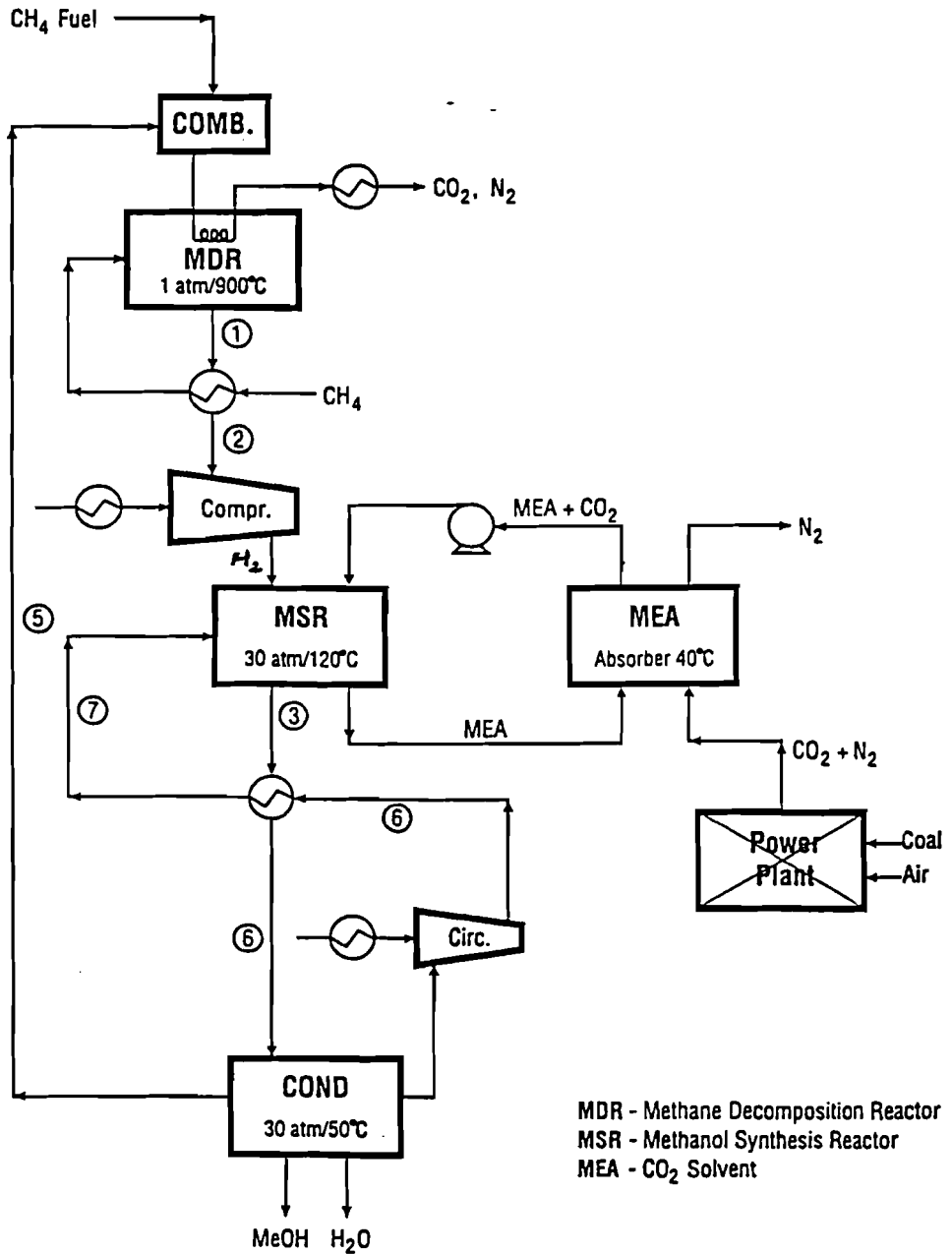
3. The third step in the process consists of reacting the hydrogen from step 2 with the  $\text{CO}_2$  from step 1 in a conventional gas phase catalytic methanol synthesis reactor:



Because this is an exothermic reaction, the heat produced in this operation can be used to recover the  $\text{CO}_2$  from the absorption-stripping operation described in step 1, thus reducing the energy required to recover the  $\text{CO}_2$  from the power plant to less than 1% of the power plant capacity. This is an advantage compared with the energy costs in terms of derating the power plant when  $\text{CO}_2$  is disposed of in the ocean, in which case more than 20% of the power plant's capacity is consumed. The gas phase methanol synthesis usually takes place at temperatures of  $260^\circ\text{C}$  and pressures of 50 atm using a copper catalyst. The synthesis can also be conducted in the liquid phase by using a slurry zinc catalyst at a lower temperature ( $120^\circ\text{C}$ ) and at 30 atm of hydrogen pressure.

### 3. Carnol Process Design

A computer process simulation equilibrium model has been developed for the Carnol process based on the flow sheet shown in Figure 1. A material



**Figure 1.** Carnol VI process: Methanol production from power plant CO<sub>2</sub> and natural gas (process simulation).

**Table 1.** Carnol process VI design process simulation: Mass and energy balances.

UNIT (See Fig. 1)	CARNOL VI MDR and Liquid Phase MSR
<b>MDR</b>	
Pressure, atm	1
Temp. °C	900
CH <sub>4</sub> Feedstock, Kg	100
Preheat Temp. °C	837
CH <sub>4</sub> Fuel for MDR, Kg	6.6
CH <sub>4</sub> Conversion, %	96.3
Carbon Produced, Kg	72.1
Heat Load, Kcal	65,006
Purge Gas from Fuel, Kmol	2.1
<b>MSR - Liquid Phase</b>	
Pressure, atm	50
Temp. °C	120
Recycle Ratio	0.5
CO <sub>2</sub> Feedstock, Kg	171.1
CO <sub>2</sub> Conversion, %	90.3
Methanol Prod., Kg	112.1
Water Cond., Kg	63.2
<b>Energy for Gas Compression to MSR</b>	
Primary, Kcal	53,306
Secondary for Recycle, Kcal	694
<b>Performance</b>	
Ratio MeOH/CH <sub>4</sub> , Kg/Kg	1.12
Carbon Efficiency, MeOH, %	56.0
Thermal Eff., MeOH, %	42.9
Thermal Eff., C+MeOH, %	85.7
CO <sub>2</sub> Emission Lbs/MMBTU	25.8
CO <sub>2</sub> Emission Kg/GJ	11.1

and energy balance is shown in Table 1, selected from a number of computer runs. This run shows that 112.1 kg of methanol can be produced from 100 kg of natural gas (CH<sub>4</sub>) and 171.1 kg CO<sub>2</sub> with a net emission of only 25.8 lbs CO<sub>2</sub>/million British thermal units (MMBTU) of methanol energy including combustion of the methanol. This is an 85.7% reduction in CO<sub>2</sub> emissions compared with conventional emissions from a steam reforming methanol plant that emits 182 lbs CO<sub>2</sub>/MMBTU, including the CO<sub>2</sub> from combustion

of the methanol. At the same time, the power plant has a 90% reduction in CO<sub>2</sub> emissions, because only 10% of the CO<sub>2</sub> from the MEA solvent absorption plant remains unrecovered and is emitted to the atmosphere.

### 3.1. Methanol as an automotive fuel

The Carnol process can be considered a viable coal CO<sub>2</sub> mitigation technology, because the resulting large production capacity of liquid methanol can be used in the large-capacity automotive fuel market. Most processes that utilize CO<sub>2</sub> produce chemical products that tend to swamp the market and thus cannot be used. Methanol as an alternative automotive fuel has been used in internal combustion (IC) engines as a specialty racing car fuel for a long time. More recently, the Environmental Protection Agency (EPA) has shown that methanol can be used in IC engines with reduced CO and HC emissions and at efficiencies exceeding those of gasoline fuels by 30% (MVEL, 1989). Methanol can also be used either directly or indirectly in fuel cells at efficiency levels several times higher than those for automotive use. A great advantage of methanol is that as a liquid it fits in well with the infrastructure of storage and distribution compared with compressed natural gas and gaseous or liquid hydrogen which are being considered as alternative transportation fuels. Compared with gasoline, CO<sub>2</sub> emissions from methanol in IC engines are 40% lower.

It should also be pointed out that removal and ocean disposal of CO<sub>2</sub> is only possible for large central power stations. For the dispersed domestic power and transportation (industry and automobiles) sectors, the Carnol process provides the capability of CO<sub>2</sub> reduction by supplying liquid methanol fuel to these smaller, diverse CO<sub>2</sub>-emitting sources.

### 3.2. Economics of the Carnol process

A preliminary economic analysis of the Carnol process has been made based on the following assumptions:

- 90% recovery of CO<sub>2</sub> from a 900 MW(e) coal-fired power plant.
- Capital investment based on an equivalent three-step conventional steam reforming plant amounting to US\$100,000/ton MeOH/day (Korchnak, 1994).
- Production costs that include 19% financing, 1% labor, 3% maintenance, and 2% process catalyst and miscellaneous, adding up to a fixed charge of 25% of the capital investment (IC) on an annual basis.

- Natural gas prices vary between US\$2 and US\$3/million standard cubic feet (MSCF).
- Carbon storage is charged at US\$10/ton. Market value for carbon black is as high as US\$1000/ton.
- Methanol market price is US\$0.45/gallon, although historically it has varied from US\$0.45/gallon to US\$1.30/gallon in the past few years.

At US\$18/barrel of oil, with 90% recovery as gasoline and US\$10/barrel for refining costs, gasoline costs US\$0.78/gallon. Methanol, being 30% more efficient than gasoline, competes with gasoline at US\$0.57/gallon.

Table 2 summarizes the economics of production cost factors and income factors for a range of cost conditions. In terms of reducing CO<sub>2</sub> costs from power plants, with US\$2/MSCF for natural gas, and a US\$0.55/gallon methanol income, the CO<sub>2</sub> reduction cost is zero. At US\$3/MSCF for natural gas and US\$0.45/gallon income from methanol, the CO<sub>2</sub> disposal cost is \$47.70/ton CO<sub>2</sub>, which is less than the maximum estimated for ocean disposal (IEA, 1993). More interesting, without any credit for CO<sub>2</sub> disposal from the power plant, methanol at US\$0.55/gallon can compete with gasoline at US\$0.76/gallon (-\$18/barrel of oil) when natural gas is at US\$2/MSCF. Any income from carbon makes the economics look even better.

### 3.3. CO<sub>2</sub> emission evaluation of entire Carnol system

Although we can show at least a 90% CO<sub>2</sub> emission reduction for the coal-fired power plant, the other two parts of the system, methanol production and automotive emissions, show less CO<sub>2</sub> emission reduction than conventional systems. Therefore, the entire Carnol system must be evaluated as shown in Figure 2.

Alternative methanol production processes are evaluated in Table 3. The yield of methanol per unit of methane feedstock is shown for 1) the conventional process in two parts, A) using steam reforming of natural gas process, and B) using a CO<sub>2</sub> addition in the conventional steam reforming process; 2) the Carnol process, in two parts, A) using methane combustion to decompose methane for hydrogen in a methane decomposition reactor (MDR), and B) using hydrogen combustion to decompose the methane in MDR; and 3) a steam gasification of biomass process. The Carnol process with H<sub>2</sub> and the biomass process (solar energy) reduce CO<sub>2</sub> emissions to zero compared with the conventional process, but with a loss of 35% and 47% methanol yield, respectively. When using methane combustion in the decomposer, the Carnol process reduces CO<sub>2</sub> emissions by 43% while the

**Table 2.** Advanced Carnol VI preliminary process economics.

Plant Size - To Process 90% Recovery of CO<sub>2</sub> from 900 MW(e) Nominal Coal Fired Power Plant  
 90% Plant Factor, CO<sub>2</sub> Rate = 611 T/Hr. = 4.82 x 10<sup>6</sup> Tons CO<sub>2</sub>/Yr.  
 Feedstock: Natural Gas Rate = 2.82 x 10<sup>6</sup> T/Yr. = 407,000 MSCF/D  
 Carbon Production = 2.03 x 10<sup>6</sup> T/Yr.  
 Methanol Production = 3.16 x 10<sup>6</sup> T/Yr. = 69,300 Bbl/D  
 Plant Capital Investment (IC) = 9607 T/D x \$10<sup>3</sup> = \$961 x 10<sup>6</sup>

Production Cost Factors							Income Factors						
0.25 IC	Natural Gas		C Storage		CO <sub>2</sub> Cost		C Income		MeOH Income		Cost for Reducing CO <sub>2</sub>		
\$10 <sup>3</sup> /Yr	\$10 <sup>3</sup> /Yr	(\$/MSCF)	\$10 <sup>3</sup> /Yr	(\$/Ton)	\$10 <sup>3</sup> /Yr	(\$/Ton)	\$10 <sup>3</sup> /Yr	(\$/Ton)	\$10 <sup>3</sup> /Yr	(\$/Gal)	\$10 <sup>3</sup> /Yr	(\$/Ton)	
2.40	2.67	(2)	0.20	(10)	0	(0)	0	(0)	5.27	(0.55)	0	(0)	
2.40	4.00	(3)	0.20	(10)	0	(0)	0	(0)	5.27	(0.55)	-1.34	(-27.60)	
2.40	2.67	(2)	0.20	(10)	0	(0)	0	(0)	5.27	(0.55)	0	(0)	
2.40	4.00	(3)	0	(0)	0	(0)	1.13	(55.60)	5.27	(0.55)	0	(0)	
2.40	2.67	(2)	0.20	(10)	0	(0)	0	(0)	4.30	(0.45)	-0.97	(-20.00)	
2.40	2.67	(2)	0	(0)	0	(0)	0.77	(37.90)	4.30	(0.45)	0	(0)	
2.40	4.00	(3)	0.20	(10)	0	(0)	0	(0)	4.30	(0.45)	-2.30	(-47.70)	
2.40	4.00	(3)	0	(0)	0	(0)	2.10	(103.00)	4.30	(0.45)	(0)	(0)	



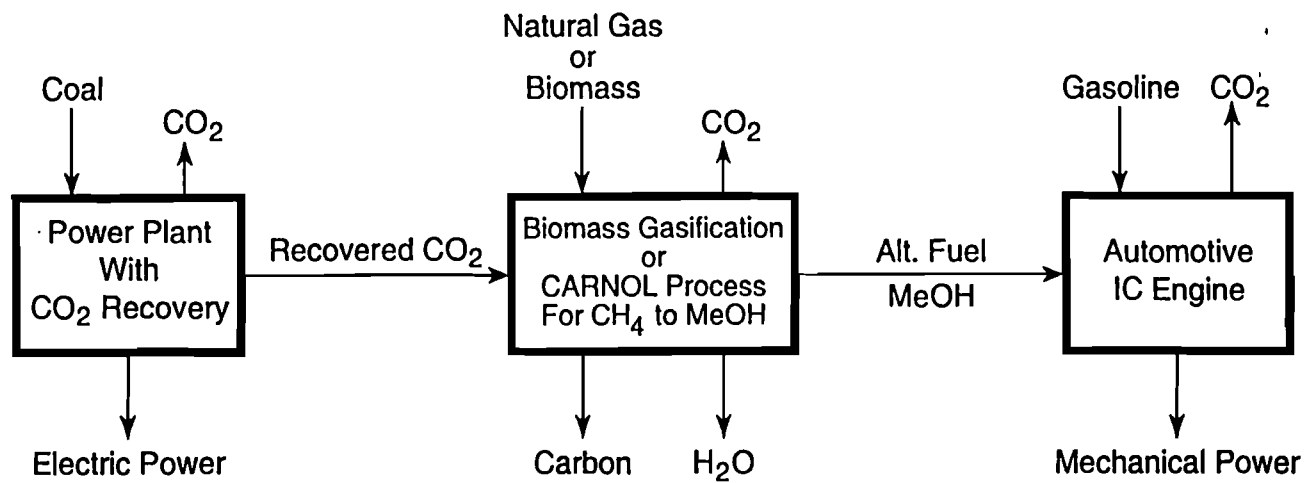


Figure 2. Carnol system configuration for CO<sub>2</sub> emission mitigation.

**Table 3.** Methanol production and CO<sub>2</sub> emission process comparison.

PROCESS	PRODUCTION YIELD		CO <sub>2</sub> EMISSION <sup>4</sup>	
	Moles MeOH Mole Feedstock	% Reduction from Conventional	Lbs CO <sub>2</sub> MMBTU (MeOH)	% Reduction from Conventional
1A Conventional Process Steam Reforming of CH <sub>4</sub>	0.76 <sup>(1)</sup>	0%	44	0%
1B Conventional Process with CO <sub>2</sub> Addition	1.00	(32%) <sup>(2)</sup>	34	23%
2A Carnol Process Heating MDR with CH <sub>4</sub>	0.56	26%	25	43%
2B Carnol Process Heating MDR with H <sub>2</sub>	0.50	35%	0	100%
3 Steam Gasification of Biomass	0.40 <sup>(3)</sup>	47%	43	100%

(1) Based on thermal efficiency of 64% (Wyman *et al.*, 1993).

(2) This represents a 32% increase in yield vs conventional.

(3) Based on BCL process (Larson and Katofsky, 1992).

(4) CO<sub>2</sub> emission only from fuel production plant.

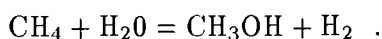
production yield is only reduced by 26% compared with the conventional process. The conventional process with a CO<sub>2</sub> addition (1B) is interesting because there is an increase of 32% in production although the CO<sub>2</sub> emissions are only reduced by 23%.

For purposes of comparison and clarification, the overall stoichiometry for the Carnol process is shown below, together with the conventional processes, and with a CO<sub>2</sub> addition.

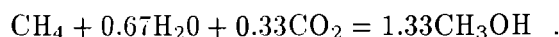
*Carnol Process*



*Conventional Steam Reforming of Methane*



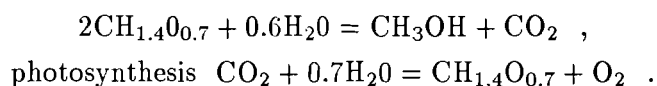
*Conventional Steam Reforming of Methane with CO<sub>2</sub> Addition*



It is noted that in the Carnol process a maximum amount of CO<sub>2</sub> is used and an excess of carbon is produced. In the conventional process, no CO<sub>2</sub> is used and an excess of hydrogen is produced. With a CO<sub>2</sub> addition to the conventional process, no excess carbon or hydrogen is formed and methanol per unit of natural gas is maximized.

Methanol can also be produced using biomass, and as the net CO<sub>2</sub> emissions are zero with CO<sub>2</sub> being converted to biomass by solar photosynthesis, the biomass process must also be included in the evaluation.

*Biomass Steam Gasification Process for Methanol Synthesis*



The entire Carnol system is evaluated in Table 4 in terms of CO<sub>2</sub> emissions and compared with the alternative methanol processes and the baseline case of conventional coal-fired power plants and gasoline-driven automotive IC engines. Methanol in fuel cell engines is also evaluated. All the cases are normalized to emissions from 1.0 MMBTU from a coal-fired power plant that produces CO<sub>2</sub> for a Carnol methanol plant equivalent to 1.27 MMBTU for use in an automotive IC engine. The assumptions made are listed at the bottom of Table 4. The conclusions drawn from Table 4 are as follows:

**Table 4.** CO<sub>2</sub> emission comparison for systems consisting of coal-fired power plant, fuel process plant, and automotive power plant.

Basis: 1 MMBTU for coal fired 900 MW(e) power plant  
 1.27 MMBTU of liquid fuel for IC engine - other fuel efficiencies proportions energy up and down  
 CO<sub>2</sub> Emission units in Lbs CO<sub>2</sub>/MMBTU (multiply by 0.43 for KG/GJ)

System Unit	Coal Fired Power Plant	Fuel Process Plant	IC Automotive Power Plant	Total System Emission	CO <sub>2</sub> Emission Reduction
<b>Baseline Case:</b> Coal Fired Power Plant and Gasoline Driven IC Engine	215	15	285	515	0%
<b>Case 1A</b> Coal Fired Power Plant With Conventional Steam Reformed Methanol Plant	215	56	175 <sup>(2)</sup>	448	13%
<b>Case 1B</b> Coal Fired Power Plant With CO <sub>2</sub> Addition to Conventional Methanol Plant	161 <sup>(4)</sup>	54	175	390	24%
<b>Case 2</b> Coal Fired Power Plant with CARNOL Process Methanol Plant	21 <sup>(1)</sup>	32	175	228	56%
<b>Case 3</b> Coal Fired Power Plant with Biomass for Methanol Plant	0	43	175	219	57%
<b>Case 4</b> Coal Fired Power Plant with CARNOL Methanol and Fuel Cell Automotive Power	11 <sup>(5)</sup>	17	Fuel Cell 89 <sup>(3)</sup>	117	77%

1) 90% recovery of CO<sub>2</sub> from coal fired plant,

3) Fuel cell as 2.5 times more efficient than conventional gasoline IC engine.

5) Only 52% emissions of coal plant CO<sub>2</sub> is assigned to Carnol for fuel cells

2) Methanol is 30% more efficient than gasoline in IC engines,

4) Only 25% recovery of CO<sub>2</sub> from coal plant is necessary for supply CO<sub>2</sub> to conventional methanol plant.

1. The use of conventional methanol reduces CO<sub>2</sub> emissions by 13% compared with the gasoline base case, mainly due to the 30% improved efficiency of the use of methanol in IC engines.
2. By adding CO<sub>2</sub> recovered from the coal-fired power plant to the conventional methanol process, the CO<sub>2</sub> emissions from the power plant are reduced by about 25% (161 lbs/MMBTU compared with 215 lbs CO<sub>2</sub>/MMBTU) and the CO<sub>2</sub> emissions for the entire system are reduced by 24%. It should be pointed out that the CO<sub>2</sub> can also be obtained from the flue gas of the reformer furnace of the methanol plant and does not need to be obtained from the coal-fired plant.
3. The Carnol process reduced coal-fired power plant CO<sub>2</sub> emissions by 90%, and the overall system emissions are reduced by 56%.
4. Biomass is a CO<sub>2</sub>-neutral feedstock; there are no emissions from the power plants, because the production of biomass feedstock comes from an equivalent amount of CO<sub>2</sub> in the atmosphere, which has been generated from the coal-fired power plant. Thus, the only net emissions come from burning methanol in the automotive IC engine, and the CO<sub>2</sub> emissions for the entire system are reduced by 57%, only slightly more than the Carnol system. However, the main point is that at present the cost of supplying biomass feedstock is higher than that of providing natural gas feedstock.
5. Another future system involves the use of fuel cells in automotive vehicles. The efficiency of fuel cells is expected to be 2.5 times greater than that of gasoline-driven engines (World Car Conference, 1996). Applying the Carnol process to produce methanol for fuel cell engines reduces CO<sub>2</sub> emissions for the entire system by a maximum of 77%. Furthermore, because of the huge increase in efficiency, the capacity for driving fuel cell engines can be increased by 92% over that for the Carnol process, using the same 90% of the CO<sub>2</sub> emissions from the coal-burning power plant.

#### 4. Conclusions

The Carnol process can reduce CO<sub>2</sub> emissions from coal-fired power plants while producing methanol for automotive IC engines with virtually no de-rating of the power plant. With natural gas at US\$2/MSCF, the cost of methanol appears to be competitive with that of gasoline for IC engines at US\$18/barrel of oil. The CO<sub>2</sub> emissions for the entire Carnol system are reduced by 56%. Compared with the conventional system, steam reformed natural gas with a CO<sub>2</sub> addition from the power plant reduces CO<sub>2</sub> emissions

by only 13%, but can have a higher production capacity per unit natural gas than the Carnol process. Biomass as a methanol feedstock can reduce CO<sub>2</sub> emissions by 57%. The development of methanol fuel cell engines can reduce CO<sub>2</sub> emissions by 77% for the entire system with a large increase in production capacity. The use of methanol as an automotive fuel produced from coal-fired power plant CO<sub>2</sub> emissions and natural gas appears to be an environmentally attractive and economically viable system connecting the power generation sector with the transportation sector and, therefore, warrants further development effort.

## References

- Cheng, H., and Steinberg, M., 1984, A System Study for the Removal, Recovery and Disposal of Carbon Dioxide from Fossil Fuel Power Plants in the US, DOE/CH-0016-2 TR016, US Department of Energy, Washington, DC, USA.
- IEA (International Energy Agency), 1993, IEA Greenhouse Gas R and D Programs, *Greenhouse Issues*, No. 7, Cheltenham, UK.
- Korchnak, J., 1994, John Brown Engineers Co., Houston, Texas, Personal communication.
- Larson, E.D., and Katofsky, R.E., 1992, *Production of Hydrogen and Methanol via Biomass Gasification, in Advance in Thermochemical Biomass Conversion*, Elsevier Applied Science, London, UK.
- Mimura, T., 1995, Kansai Electric Power Co., Osaka, Japan, Personal communication.
- MVEL (Motor Vehicle Emissions Laboratory), 1989, *An Analysis of the Economic and Environmental Effects of Methanol as an Automotive Fuel*, EPA Report No. 0730, Ann Arbor, MI, USA.
- Steinberg, M., 1989, *Coal to Methanol to Gasoline by the Hydrocarb Process*, BNL 43555, Brookhaven National Laboratory, Upton, NY, USA.
- Steinberg, M., 1993, *The Carnol Process for Methanol Production and Utilization with Reduced CO<sub>2</sub> Emissions*, BNL 60575, Brookhaven National Laboratory, Upton, NY, USA.
- Steinberg, M., 1996, *The Carnol Process for CO<sub>2</sub> Mitigation from Power Plants and the Transportation Sector*, to be published as EPA report NMRL-RTP-015, USEPA, Research Triangle Park, NC, USA.
- Suda, O. *et al.*, 1994, Development of Fuel Gas Carbon Dioxide Recovery Technology, pp. 222-235 in *Carbon Dioxide Chemistry Environment Issues*, T. Paul and C.M. Pradies (eds.), The Royal Society of Chemistry, Hemovan, Sweden.
- World Car Conference, 1996, *World Car Conference '96*, 21-24 January 1996, Bourns College of Engineering, Center for Environmental Research and Technology, University of California, Riverside, CA, USA.
- Wyman, C.E., *et al.*, 1993, Ethanol and Methanol from Cellulosic Biomass, pp. 866-923, in T.B. Johansson *et al.* (eds.), *Renewable Energy*, Island Press, Washington, DC, USA.

**Part III**  
**Emissions Reduction**  
**Policies and Integrated**  
**Assessments**





# A Review of CO<sub>2</sub> Emission Reduction Policies in Japan and an Assessment of Policies of the Annex I Parties for Beyond the Year 2000

*Yuzuru Matsuoka*

Nagoya University, Chikusa-ku, Nagoya, Japan

*Yasuko Kawashima, Mikiko Kainuma, Tsuneyuki Morita*

National Institute for Environmental Studies, Tsukuba, Japan

## Abstract

This paper investigates the effects of international agreements on policies and measures to reduce carbon dioxide (CO<sub>2</sub>) emissions from Organisation for Economic Co-operation and Development (OECD) countries by analyzing the past and possible future effects of policies and measures instituted by Japan between 1970 and 1993. Environmental policies played a crucial role in Japan's successful decoupling of economic growth from CO<sub>2</sub> emissions during the period from 1970 to 1993. The world oil crises in 1973 and 1979, key turning points for most industrialized countries, served to increase Japan's awareness of the need for energy conservation. However, increases in oil prices were not the only reason Japan's performance exceeded that of other countries. The latter part of this paper introduces the Asian-Pacific Integrated Model (AIM) used to simulate the effects of regulatory and economic measures. The results of the simulation show that regulatory and common economic measures would be the most cost-effective for CO<sub>2</sub> emission abatement. The analyses presented here indicate that a policy that combines two approaches, one focusing on achievements through energy efficiency standards and the other focusing on behavioral changes brought about by economic incentives, would be effective for CO<sub>2</sub> emission reductions.

## 1. Introduction

Various policies and measures to mitigate climate change have been proposed. Some have already been implemented in numerous countries, and many have yet to be introduced but are likely to be effective. Policies and measures can be categorized into four major types: regulatory measures, economic instruments, voluntary agreements, and information and education

(UN, 1994). Of these types of action, regulations and economic measures are commonly implemented by Annex I countries.

There is a growing need to assess the effectiveness of these various measures. Without such knowledge, setting reasonable and achievable objectives for Annex I countries is difficult. However, the effectiveness of policies and measures differs among countries according to their national circumstances, and thus it is difficult to make quantitative and universally applicable assessments of the effectiveness of specific actions.

This study assesses the policies and measures instituted by Japan between 1970 and 1993 by determining the factors that helped increase or decrease total carbon dioxide (CO<sub>2</sub>) emissions. The effects of possible policies and measures in the future, simulated using the Asian-Pacific Integrated Model (AIM), are also discussed.

## 2. Japan's Experience, 1970–1993

### 2.1. Factors contributing to CO<sub>2</sub> emission changes

During the past 50 years Japan has experienced rapid economic growth. In many cases energy consumption and CO<sub>2</sub> emissions have grown almost in proportion to economic growth; Japan, however, has successfully decoupled increases in CO<sub>2</sub> emissions from economic growth. A similar trend can be seen in most industrialized countries since the world oil crises of the 1970s, but Japan's performance has been one of the best in terms of limiting the growth of CO<sub>2</sub> emissions while maintaining a high GDP growth rate. This section deals with factors that have contributed to Japan's success in this regard.

The factor analysis in this paper is based on the Kaya identity:

$$\begin{aligned} \Delta\text{CO}_2 &= \Delta(\text{CO}_2/\text{energy consumption}) + \Delta(\text{energy}/\text{GDP}) \\ &+ \Delta(\text{GDP}/\text{population}) + \Delta\text{population} \end{aligned}$$

where  $\Delta(x)$  denotes the percent change of  $x$ .

To focus on the effects of environmental and energy policies on CO<sub>2</sub> emissions, we further elaborated the first two into energy efficiency improvements induced by energy efficiency standards, energy efficiency due to increases in oil prices, fuel shift for energy security and environmental reasons, and changes within the Japanese industrial sector. All of these factors have been influential in stabilizing CO<sub>2</sub> emissions.

*Energy Conservation and Environmental Factors*

The following measures were related to energy conservation and other environmental concerns.

- Energy efficiency improvements due to the introduction of standards: After the world oil crises in the 1970s, standards for energy efficiency improvement were set for many goods used in the residential sector. Air conditioners, refrigerators, televisions, insulation for buildings, and cars are examples of products whose energy efficiencies have improved due to such standards. It was estimated that altogether 20.3 MtC of CO<sub>2</sub> emissions were reduced by setting standards for those goods.
- Energy efficiency improvements due to increases in oil prices: Increases in oil prices led to short-term decreases in energy demand. However, in the longer term they have become key incentives for industry to accelerate development of technologies with higher energy efficiencies. Assuming a case in which energy consumption per unit of value added in the industrial sector remained the same as in 1973, this price effect reduced CO<sub>2</sub> emissions by 136.7 MtC.
- Fuel shift: The proportion of electricity generated by nuclear power increased from 1.3% in 1970 to 24.0% in 1991, because Japan's energy policy has given particular weight to energy security issues. This increase has contributed to a decline in the CO<sub>2</sub> emissions per unit of electricity produced (the CO<sub>2</sub> emissions coefficient) by Japan over the past two decades. The CO<sub>2</sub> emissions coefficient of electricity declined from 1.75 ktC/10<sup>10</sup>kcal in 1970 to 1.37 ktC/10<sup>10</sup>kcal in 1980, to 1.12 ktC/10<sup>10</sup>kcal in 1993. Had nuclear power's share of electricity generation remained the same as it was in 1973, an additional 36.6 MtC of CO<sub>2</sub> emission could be expected today.
- From the pollution abatement point of view, Japan has implemented severe sulfur oxide (SO<sub>x</sub>) abatement measures by setting SO<sub>x</sub> emission standards at low levels (i.e., the standards are quite strict). As a result, oil consumption shifted from inexpensive, heavy, high-sulfur oil (heavy oil C) to better quality, low-sulfur oil (heavy oil A). This shift also helped limit CO<sub>2</sub> emission increases (Table 1), contributing to a 0.4 MtC CO<sub>2</sub> reduction.
- The rate of consumption of natural gas in the industrial and residential sectors has increased, especially since the oil crises. This trend has caused a shift away from the consumption of petroleum, with concomitant declines in CO<sub>2</sub> emissions. There has, however, been a small

**Table 1.** Share of different types of oil in total heavy oil consumption (in percent).

	1970	1980	1990
Heavy oil A	16.0	36.1	68.0
Heavy oil B	18.6	9.2	0.4
Heavy oil C	65.4	54.7	31.6
Total	100.0	100.0	100.0

increase in the use of coal, which has contributed to increased CO<sub>2</sub> emissions. This fuel shift toward natural gas has led to a 10.2 MtC reduction in CO<sub>2</sub> emissions.

#### *Other Factors Limiting CO<sub>2</sub> Emissions*

The following factors helped limit the rise in CO<sub>2</sub> emissions, but had little to do with the government's specific policies and measures.

- Growth in gross domestic product (GDP): The GDP growth rate has declined since the oil crises; for example, the GDP growth rate was 10.52% in 1971 and 2.71% in 1974. Levels of CO<sub>2</sub> emissions would have been higher if growth rates like those of the 1970s had continued to the present. It is estimated that, had the GDP growth rate between 1973 and 1985 been 5% per year instead of the actual growth rates (-1.76% to 4.75% per year), CO<sub>2</sub> emissions today would be 94.2 MtC higher.
- Structural changes within the industrial sector: The shares of GDP generated by the industrial and services/commercial sectors have not changed much. However, within the industrial sector the proportion of energy-intensive industries has decreased and less-energy-intensive industries have grown more rapidly (Table 2). Assuming that the share of each industry in the industrial sector has not changed since 1973, we estimated that this effect led to a 38.5 MtC reduction of CO<sub>2</sub>.

#### *Factors Contributing to CO<sub>2</sub> Emissions*

With respect to the above-mentioned factors, Japan could have reduced CO<sub>2</sub> emissions more than it actually did. However, there were some factors that contributed to increasing CO<sub>2</sub> emissions during those two decades. We noticed that life-style changes in Japan, in particular, have increased CO<sub>2</sub> emissions.

**Table 2.** Share of industries in GDP (in percent).

	1970	1980	1990
Energy transformation	4.9	4.3	3.6
Agriculture, fisheries	6.1	3.6	2.3
Mining	0.7	0.5	0.3
Construction	12.6	10.2	9.1
Manufacturing	25.7	26.6	31.2
Food	4.6	4.0	2.8
Textiles	1.4	1.1	0.8
Pulp, paper	0.8	0.7	0.8
Chemicals	0.9	1.6	3.2
Ceramics	1.6	1.0	1.0
Primary metals	3.0	3.2	1.9
Machines	7.8	10.4	16.7
Other	5.6	4.5	4.2
Service	50.0	54.8	53.6
Total	100.0	100.0	100.0

**Table 3.** Shares of the means of transportation in total transportation (in percent).

	1970	1980	1990
Passenger			
Motor vehicles	39	46	57
Taxis	3	2	1
Buses	15	12	8
Railroads	41	35	30
Ships	1	1	0
Air	1	3	4
Total	100	100	100
Freight			
Motor vehicles	39	41	52
Railroads	18	8	5
Ships	43	50	44
Air	0	0	0
Total	100	100	100

- Changes in the means of transportation: In the 1970s, mass transit (buses and trains) was the primary means of transportation; by the 1990s, however, motor vehicles had taken over this position (Table 3). This change has led to a 10.6 MtC increase in CO<sub>2</sub> emissions since 1973.

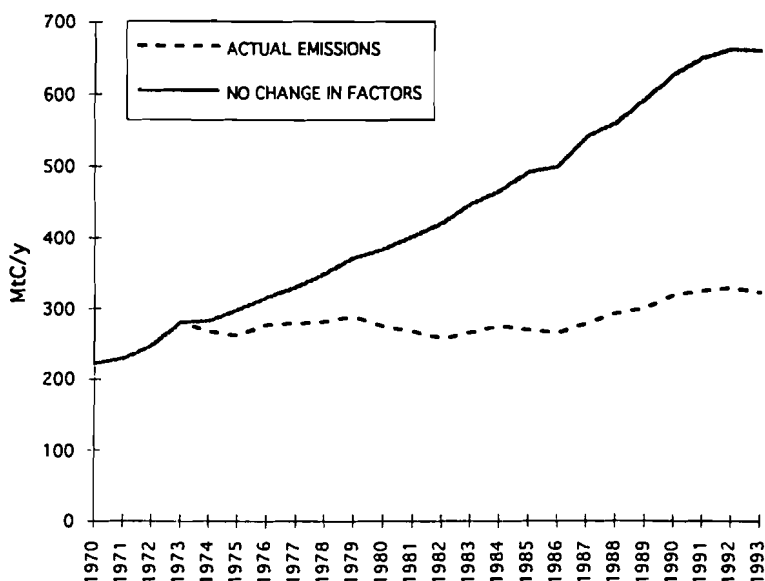
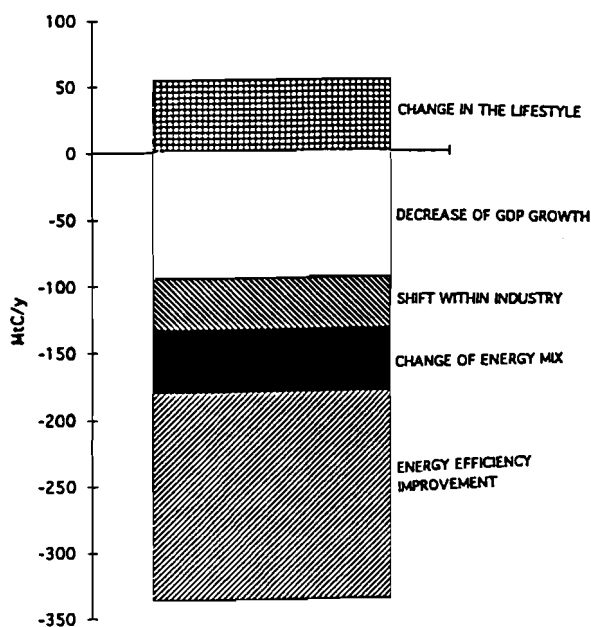


Figure 1. CO<sub>2</sub> emissions in Japan during 1970–1993.

- The shift to more energy-intensive goods at home: Higher demand for computers in offices and goods such as air conditioners, microwave ovens, laundry dryers, electric rugs, mattresses, and second and third television sets in homes, as well as a preference for larger, luxury cars have elevated energy consumption. Without these new goods, CO<sub>2</sub> emissions would have been 44.5 MtC lower than current levels.

## 2.2. Effects of factors

The previous section discussed nine factors that have contributed to the changes in CO<sub>2</sub> emissions in Japan. If those factors had not changed since the 1970s, what would Japan's current CO<sub>2</sub> emissions be? If the factors had not changed since 1973, the year just before the oil crisis, the calculations indicate that CO<sub>2</sub> emissions would be more than double their current levels (Figure 1). The share of the factors' contributions to limiting CO<sub>2</sub> growth can be estimated by multivariate analysis (Figure 2). Of all the factors, energy efficiency improvements resulting from increases in oil prices contributed the most to the observed decreases in CO<sub>2</sub> emissions; 40.6% of the limitation of CO<sub>2</sub> emissions was due to such improvements. If energy efficiency due to standards is included, the ratio increases to 46.7%. Altogether, policies for fuel shift contributed 14.1% of the limitation. These



**Figure 2.** Contribution of factors to the CO<sub>2</sub> emission limitations, 1970–1993.

results confirm that energy efficiency improvements played an important role in limiting CO<sub>2</sub> emissions.

### 3. The AIM Model and Its Assumptions

#### 3.1. Outline of the Asian-Pacific Integrated Model (AIM)

In this analysis, we conducted simulations with the Asian-Pacific Integrated Model (AIM) (Morita *et al.*, 1993). This model was developed primarily to examine global warming response measures in the Asian-Pacific region, but it also has world modules that enable it to produce global estimates.

AIM comprises three linked models, an emission model that estimates greenhouse gas emissions, a climate model that determines atmospheric greenhouse gas concentrations and climatic change, and an impact model that evaluates environmental and social impacts of climatic change.

The emission model integrates country/regional models, which produce detailed estimates of technological, social, and economic situations in each country/region (Figure 3), with a top-down world economic model. This structure ensures international interactions and consistency throughout the

**Table 4.** Population assumptions (in thousands of people).

	1950	1985	2000	2025	2050	2075	2100
USA	152271	239000	269000	301000	297000	295496	294000
EU+Canada	300245	450000	457000	473000	459000	454982	451000
Pacific OECD	96307	144000	159000	165000	160000	158997	158000
CIS Eastern Europe	286136	416000	453000	496000	518000	515494	513000
Centr. Planned Asia	590509	1140000	1430000	1721000	1858000	1890712	1924000
Middle East	39048	111000	175000	327000	470000	532363	603000
Africa	222039	570000	870000	1587000	2275000	2595871	292000
Latin America	165764	402000	529000	708000	816000	842083	869000
Southeast Asia	652760	1417000	1890000	2636000	3178000	3359172	3538000

**Table 5.** Assumptions of GDP growth rate (in percent per year).

	Before	2025	2050	2075	2100
USA	2.5	2.3	1.5	1.1	1.1
EU+Canada	2.5	2.3	1.5	1.1	1.1
Pacific OECD	2.7	2.3	1.5	1.1	1.1
CIS, Eastern Europe	-1.5	4.3	3.5	2.0	2.0
Centr. Planned Asia	4.0	3.5	3.5	3.0	3.0
Middle East	3.75	4.2	3.4	2.8	2.8
Africa	3.75	4.2	3.4	2.8	2.8
Latin America	3.75	4.2	3.4	2.8	2.8
Southeast Asia	3.75	4.2	3.4	2.8	2.8

world market and enables us to evaluate the combined effects of a policy mix, such as a mixture of economic instruments and regulatory measures.

In this paper, AIM is used to assess the effects of policy mixes that combine three options: technological policies for efficiency improvement, a carbon tax, and joint implementation of carbon reductions within Organisation for Economic Co-operation and Development (OECD) countries. The effect of energy efficiency policies is simulated by applying additional improvement rates to the base-case model.

In order to estimate technological policy effects, AIM's country/regional modules were used to calculate changes in the future energy demand of each country/region caused by technological efficiency improvements. OECD countries were categorized into three regions, the USA, EU+Canada, and the Pacific OECD nations, because this model was originally intended to focus on the Asian-Pacific region. The assumptions of population and economic growth used in the model are from EMF 14 (EMF, 1994) and are



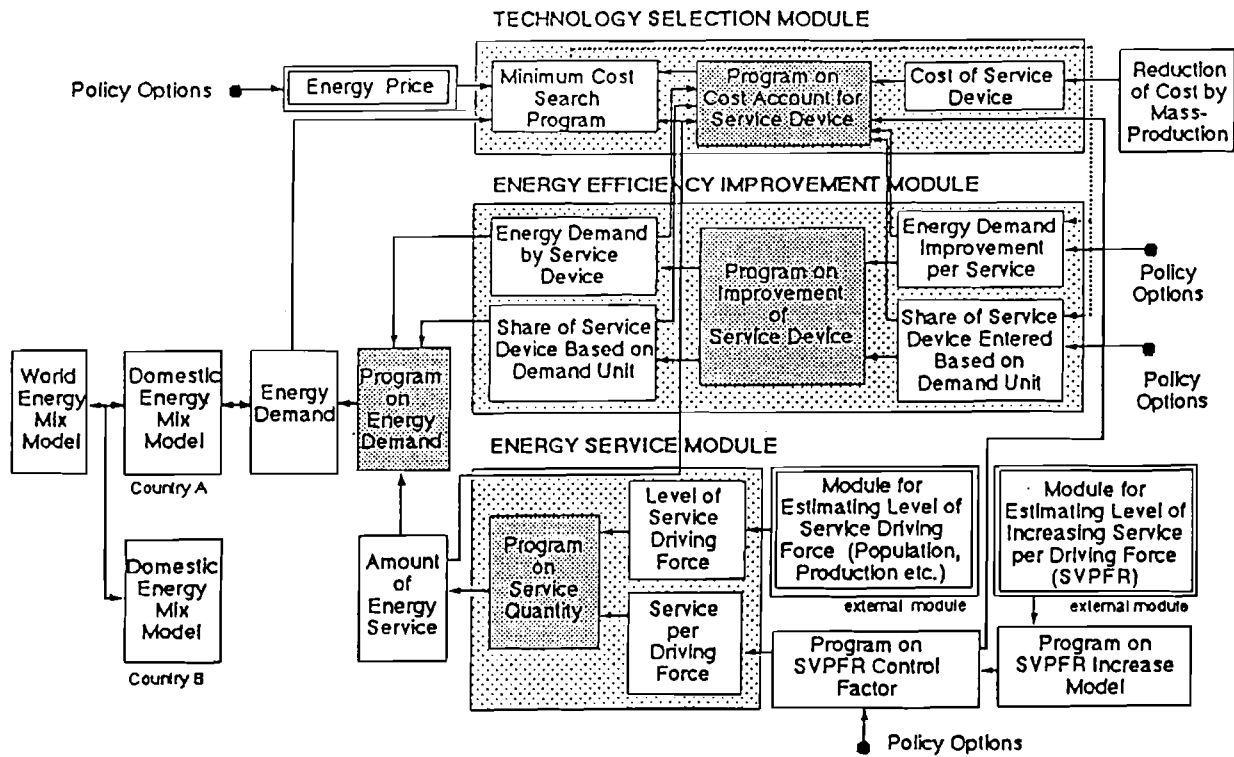


Figure 3. Structure of end-use energy demand model.

**Table 6.** Energy intensity of subsectors in residential and industrial sectors in 1985.

	Pacific OECD	USA	EU+Canada
<i>Residential sector (GJ/cap)</i>			
Space heating	7.2	43.3	29.6
Water heating	8.2	13.4	4.0
Cooling	1.0	2.1	0.8
Other	8.2	14.4	5.6
Total	24.7	73.2	40.0
<i>Industrial sector (GJ/GDP, US\$)</i>			
Iron and steel	0.83 (47.2) <sup>a</sup>	0.88 (173.3) <sup>b</sup>	0.69 (45.1)
Nonferrous metals	0.16 (28.6)		0.12 (16.7)
Stone and clay	0.23 (16.1)	0.22 (34.2)	0.38 (22.3)
Paper and pulp	0.10 (4.4)	0.57 (22.0)	0.24 (8.6)
Chemicals	0.23 (5.2)	0.62 (20.7)	0.57 (11.0)
Other	1.01 (4.9)	2.07 (13.7)	0.99 (14.1)
Total	2.60 (8.2)	4.40 (19.8)	3.00 (10.0)

<sup>a</sup>Figures in parentheses denote subsectoral consumed energy divided by subsectoral GDP in 1985.

<sup>b</sup>Figure given is for iron and steel, and nonferrous metals.

**Table 7.** Additional AEEIs in each sector.

	Energy intensity		Improvement rate (R <sup>c</sup> )	Δ AEEIs (%/year)	
	In 1985	Relative to Pacific OECD <sup>a</sup>			In 2020 <sup>b</sup>
<i>Residential/Commercial (GJ/cap)</i>					
USA	73.2	2.96	1.67	1.77	1.60
EU+Canada	40.0	1.62	1.14	1.41	0.98
Pacific OECD	24.7	1.00	1.00	1.00	0.00
<i>Industrial (GJ/US\$1000)</i>					
USA	4.4	1.69	1.25	1.35	0.85
EU+Canada	3.0	1.15	1.13	1.02	0.07
Pacific OECD	2.6	1.00	1.00	1.00	0.00
<i>Transportation (GJ/cap)</i>					
USA	93.7	3.51	2.83	1.24	0.61
EU+Canada	31.2	1.17	0.94	1.24	0.61
Pacific OECD	26.7	1.00	1.00	1.00	0.00

<sup>a</sup>Energy intensity in 1985 normalized to Pacific OECD levels.

<sup>b</sup>Energy efficiency in 2020 (normalized to Pacific OECD levels) after technological improvements in energy efficiencies in the USA and EU countries. This is the level of energy intensity under the standard reference scenario.

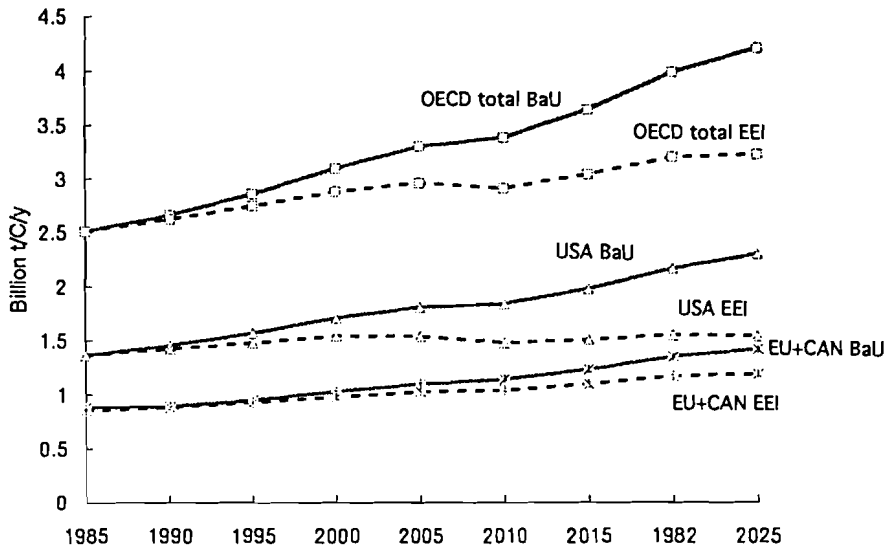
<sup>c</sup>(Relative to Pacific OECD)/(Energy intensity in 2020).

**Table 8.** AEEI input to the AIM model from EMF 14 (1994).

	1985	2000	2025	2050	2075	2100
USA	0.0070	0.0070	0.0063	0.0052	0.0037	0.0036
EU+Canada	0.0070	0.0070	0.0067	0.0051	0.0037	0.0036
Pacific OECD	0.0072	0.0072	0.0067	0.0051	0.0036	0.0036
CIS, Eastern Europe	-0.0066	-0.0066	0.0125	0.0107	0.0060	0.0062
Centr. Planned Asia	0.0087	0.0087	0.0085	0.0094	0.0092	0.0091
Middle East	0.0046	0.0046	0.0081	0.0077	0.0076	0.0083
Africa	0.0046	0.0046	0.0081	0.0077	0.0076	0.0083
Latin America	0.0046	0.0046	0.0081	0.0077	0.0076	0.0083
Southeast Asia	0.0046	0.0046	0.0081	0.0077	0.0076	0.0083

given in Tables 4 and 5. The country/regional model is a bottom-up estimation model that divides the residential/commercial, industrial, and transport sectors into eight, six, and three subsectors, respectively. Energy demand for each country/region in the year 2020 was estimated based on individual energy efficiency factors evaluated for each sector (see Table 6), as well as on population and economic growth assumptions.

Our top-down model expresses the rates of energy efficiency improvements with parameters (autonomous energy efficiency improvements; AEEIs), which are given by the bottom-up model. In this paper, however, we focus on energy intensity gaps among three regions in the OECD (Table 7) and consider an AEEI scenario in which the gaps fade out by 2020. As a result, the energy efficiency in the three regions will be leveled to that of the most efficient region, that is, Pacific OECD. In order to do this, we assumed extra efficiency improvements in addition to the standard AEEIs, by which we estimate the effectiveness of regulatory measures such as energy efficiency standards. Table 7 shows the calculations made to arrive at these extra AEEIs. The left-hand column shows that the energy efficiency in the Pacific OECD countries was the lowest in all sectors in 1985. Column two shows that in the residential/commercial sector, for example, per capita energy consumption in the USA was 2.96 times that in the Pacific OECD. Column three shows that, according to AIM estimates, the residential/commercial sector of the USA would consume 1.67 times as much energy per capita as that of the Pacific OECD countries in 2020 under the standard reference scenario given by EMF 14 (1994). The year 2020 was chosen because it takes approximately 30–40 years to rebuild large facilities such as electrical power plants. To determine the improvement rates (column four) necessary to achieve the energy intensities given in column three by the selected year (2020), the figures in the second column were divided



**Figure 4.** CO<sub>2</sub> emissions under BAU and regulatory scenarios.

by figures in the third column. The right-hand column shows the additional improvement rate needed annually, given by the following function:

$$\Delta AEEI = R^{(1/T)} - 1 .$$

The total AEEIs for the world model were then estimated by totaling the changes in AEEIs and the base-case AEEIs (Table 8; EMF 14, 1994).

### 3.2. Results of simulations

#### *Effect of Energy Efficiency Improvements*

The first scenario evaluated assumed that regulatory measures mandating energy efficiency improvements (EEIs) were implemented in two regions, the USA and EU+Canada. The effects of these EEIs can be assessed by comparing the results for this scenario (AEEIs with additional AEEIs) with those for the business-as-usual (BAU) scenario (base case, AEEIs only). As can be seen from Figure 4, the total OECD CO<sub>2</sub> emissions in the additional AEEI case (OECD total EEI case) are reduced by 10.3% in 2005, 13.9% in 2010, and 16.5% in 2015 relative to the BAU case. This result suggests the possibility of a similar CO<sub>2</sub> reduction if the same regulatory measures mandating energy efficiency standards already in force in the Pacific OECD countries are introduced in the USA and EU+Canada by the year 2020.

### *Achieving Targets*

In this section, we consider three scenarios in which different carbon taxes are introduced into the scenario described in the previous section. Here, we stipulated a 20% reduction from 1990 levels of OECD emissions by the year 2010 as a case study. A comparison was made of the three scenarios:

- *Scenario 1:* A carbon tax with different rates is introduced in each OECD region so that the reduction target is achieved individually. Only base-case AEEIs are expected.
- *Scenario 2:* EEIs and a carbon tax with different rates are introduced in each OECD region so that the reduction target is achieved individually.
- *Scenario 3:* EEIs and a common tax rate are introduced so that the total emissions from all OECD countries achieve the reduction target as a whole.

Although Japan is not currently ready to commit itself to a carbon tax, these scenarios are used to reflect the effect of energy prices in the economic model.

The simulations were evaluated for the year 2015, because full introduction of efficiency standards is assumed to be completed in 2020 and the target year is 2010. The rate of the carbon tax introduced in each scenario is shown in Figure 5. With individual taxes alone, the carbon tax would become US\$222–233/tC in 2015. With the combination of EEIs and a carbon tax, the tax would be reduced to US\$108–229. The Pacific OECD countries would not benefit if other OECD countries were to initiate EEI policies, because Pacific OECD countries would have less of a shift from coal to other fuels under Scenario 2. Implemented along with EEIs, a common tax rate of only US\$142 would achieve the 20% reduction in OECD CO<sub>2</sub> emissions. Only in the USA would the rate of carbon tax under Scenario 3 be higher than the tax rate under Scenario 2, because in this model the marginal cost of CO<sub>2</sub> reduction is lower in the USA than in other OECD countries. However, it is clear that for the total OECD, the amount of carbon tax necessary would be reduced with the policy mix of EEIs and a common carbon tax.

It is also important to identify the GDP losses of the three regions under the different scenarios (Figure 6). If the target were to be achieved through a carbon tax alone, the world GDP loss would be 1.66–1.92% in each region. However, if the EEIs were to be introduced at the same time, then the loss would decrease to 0.72–1.91%. There is only a small difference between the first two scenarios in the Pacific OECD countries, because it is assumed that EEIs are implemented only in the other two regions. The amount of GDP

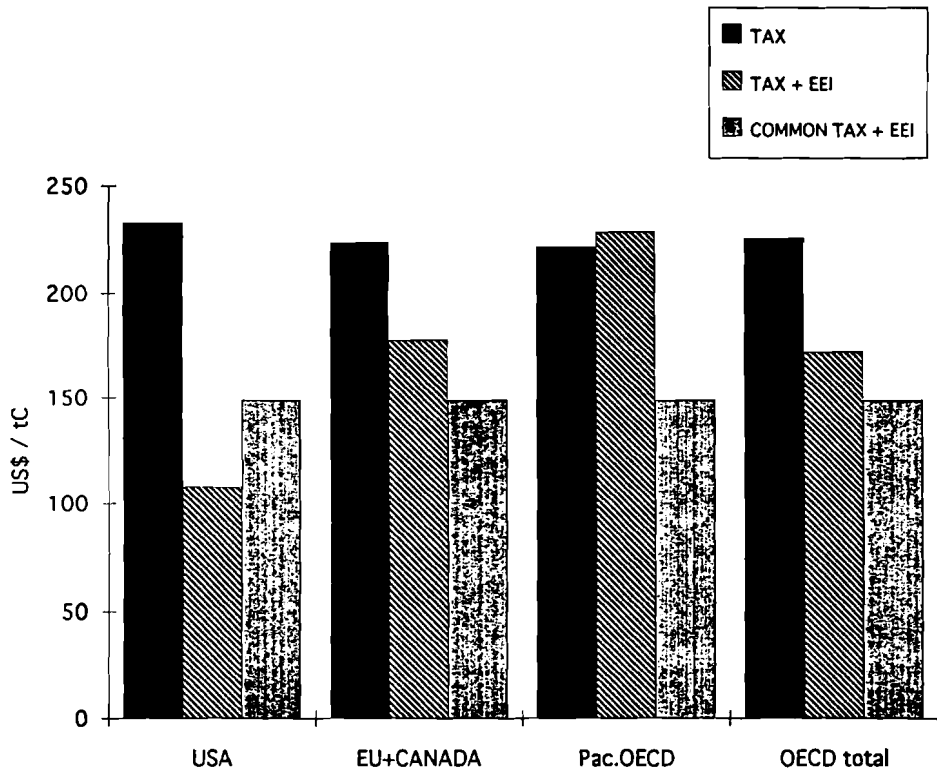


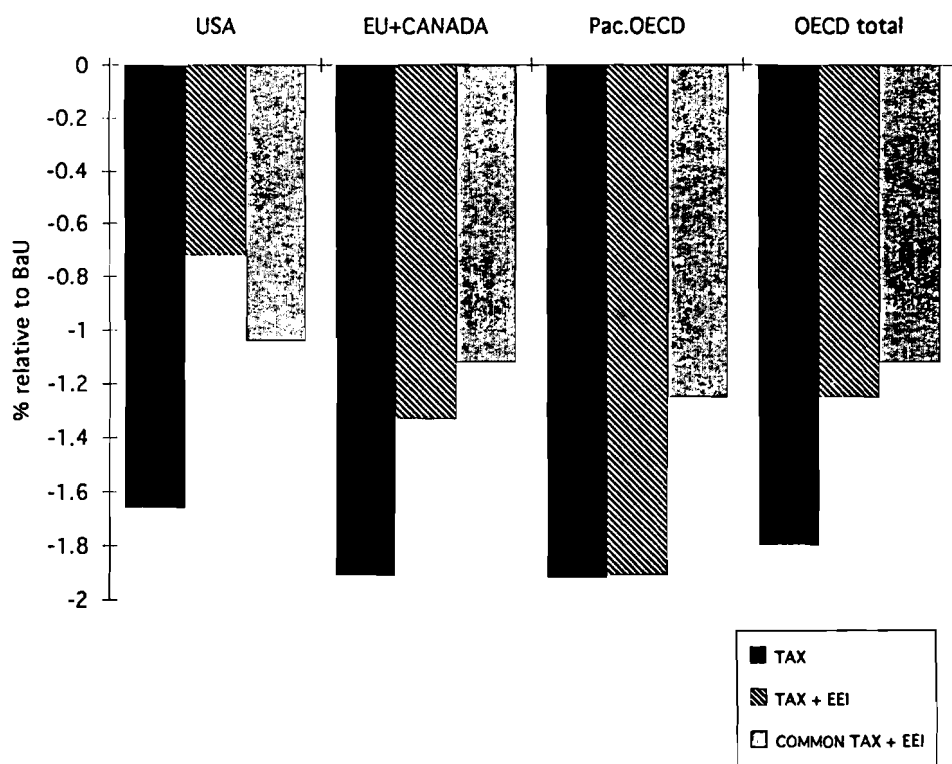
Figure 5. Carbon tax rate in 2015 under three scenarios.

loss decreases further with a common tax, to 1.04–1.25%. The GDP loss for the OECD as a whole would be the smallest if EEIs and a common carbon tax were to be introduced.

#### 4. Discussion

The main findings of this study are as follows:

- Japan's successful decoupling of economic activities from CO<sub>2</sub> emission growth was the result of several major factors. Energy efficiency improvements resulting from energy efficiency standards and the increase in oil prices contributed 46.7% of the factors' total effects. Fuel shift, change in the composition of industry from energy-intensive industry to service/commercial sectors, and a decrease in the economic growth rate were other major factors that helped maintain low growth rates of CO<sub>2</sub> emissions in Japan.



**Figure 6.** GDP losses of the three regions in 2015 relative to the BAU scenario.

- Without the factors mentioned above, CO<sub>2</sub> emissions in Japan would have been more than twice the amount of the actual emissions in 1993. If there had been no changes in the Japanese life-style, today's emissions would have been even lower.
- If the energy efficiency level of Pacific OECD countries were to be achieved by all the OECD countries by the year 2025, total CO<sub>2</sub> emissions from OECD countries could be reduced 10.3% in 2005, 13.9% in 2010, and 16.5% in 2015 relative to the BAU scenario.
- In order to achieve a 20% reduction of the 1990 CO<sub>2</sub> emission levels by the year 2010 using a carbon tax introduced in each region, the tax rate would have to be in the range of US\$222–233/tC. If the tax were implemented together with regulatory measures such as energy efficiency improvement standards, the rate would be \$108–229/tC. The rate would be further reduced to \$142/tC if a common tax rate were implemented in all OECD countries together with regulatory measures.

- GDP loss would also be reduced if the carbon tax were implemented together with regulatory measures. With an individual carbon tax alone, GDP losses in the OECD countries would be 1.66–1.92%. With regulatory measures, however, the loss would be decreased to 0.72–1.91%, and it would be 1.04–1.25% if a common carbon tax were implemented together with regulatory measures.

The Berlin Mandate calls for detailed policies and measures to be discussed at an early stage. However, it is difficult to evaluate the effectiveness of such policies and measures, because those that exist differ widely among countries. The intention of this paper is not to elaborate on the possible policies and measures as they are implemented in each country, but rather to evaluate the overall effectiveness of policies when regulatory measures and economic measures are mixed.

The main conclusion from this paper is that a mixture of policies, such as those that set certain standards of achievement and those that work as economic incentives, would be effective for CO<sub>2</sub> emission reductions. It is therefore important to maintain a wide variety of policy options and measures that can effectively achieve a given target.

CO<sub>2</sub> emissions can be reduced significantly with the implementation of common energy efficiency standards, as has already been achieved in some OECD countries. The Second Assessment Report of the IPCC (1995) states, “there is agreement that energy efficiency gains of perhaps 10 to 30% compared with baseline trends over the next two to three decades can be realized at negative to zero net cost.” We see from this statement, as well as from our own analyses, that reducing emissions without substantially harming economic activity is possible. We should be aware, however, that both the IPCC report and our study assume that the full introduction of the most efficient technology in all sectors requires time, on the order of 20 to 30 years; therefore, it is important not to delay the implementation of effective policies and measures.

## Acknowledgments

We are grateful to Mr. Hikaru Kobayashi of the Environment Agency and Mr. Go Hibino of Fuji Research Institute for their support and comments.



## References

- EMF (Energy Modeling Forum), 1994, *Final First Round Study Design for EMF 14: Integrated Assessment of Climate Change*, EMF, Terman Engineering Center, Stanford University, Stanford, CA, USA.
- IPCC Working Group III, 1995, *Summary for Policymakers: Chapter 9*, IPCC.
- Matsuoka, Y., Kainuma, M., and Morita, T., 1995, Scenario Analysis of Global Warming Using the Asian-Pacific Integrated Model (AIM), *Energy Policy* **23**(4/5):357-371.
- Morita, T., Matsuoka, Y. *et al.*, 1993, AIM – Asian-Pacific Integrated Model for Evaluating Policy Options to Reduce GHG Emissions and Global Warming Impacts, in: *Global Warming Issue in Asia*, Asian Institute of Technology, pp. 254-273.
- United Nations, 1994, Document FCCC A/AC.237/81.



# Optimization of CO<sub>2</sub> Emissions Using Coupled Integral Climate Response and Simplified Cost Models: A Sensitivity Study

*K. Hasselmann, S. Hasselmann, R. Giering, V. Ocana*  
Max Planck Institute of Meteorology, Hamburg, Germany  
*H. von Storch*  
GKSS-Forschungszentrum Geesthacht GmbH  
Geesthacht, Germany

## Abstract

A cost-benefit analysis for greenhouse warming based on a structurally simplified, globally integrated coupled climate-economic costs model, SIAM (structural integrated assessment model), is used to compute optimal paths of global carbon dioxide (CO<sub>2</sub>) emissions that minimize the net sum of climate-damage and mitigation costs. The climate model is represented by a linearized impulse-response model calibrated using a coupled ocean-atmosphere general circulation climate model and a three-dimensional global carbon cycle model. The cost terms are represented by greatly simplified expressions designed for studying the sensitivity of the computed optimal emission paths with respect to critical input assumptions. These include the discount rates assumed for mitigation and damage costs, the inertia of the socioeconomic system, and the dependence of climate damage on the change in temperature and the rate of temperature change. Differences in assumptions regarding these parameters are believed to be the origin of the marked divergences of existing cost-benefit analyses based on more sophisticated economic models.

The long memory of the climate system implies that time horizons of several hundred years are needed to optimize CO<sub>2</sub> emissions on time scales relevant for creating a policy of sustainable development. Cost-benefit analyses over time scales of only a century or two can lead to dangerous underestimations of the long-term climatic impact of increasing greenhouse gas emissions. However, the drawdown of CO<sub>2</sub> emissions to very low levels needed to avert major long-term global warming need not be implemented in the short term, but can be realized as a gradual transition over many decades or even centuries. Nevertheless, the sooner the necessary mitigation policies

are initiated the less costly the transition will be; the long time horizon then still leaves room for later adjustments. Short-term energy conservation alone is insufficient and can be viewed only as a useful measure in support of the necessary long-term transition to carbon-free energy technologies.

Optimal emission paths limiting long-term global warming to sustainable development levels are achieved only if climate-damage costs are not significantly discounted. Discounting of climate-damage costs at normal economic rates yields emission paths that are only slightly reduced compared with business-as-usual scenarios, producing unacceptably high global warming levels in the long run. Although these solutions are logically consistent with the assumption that global warming damage in the distant future is indeed of negligible concern today, a commitment to sustainable development may be regarded as a willingness-to-pay-today value assessment that to the first order does not depend on the time horizon of climate change and, therefore, should not be discounted.

To translate our general conclusions into quantitative cost estimates required by decision makers, the present exploratory study must be extended using more detailed disaggregated climate-damage and mitigation cost estimates and more realistic socioeconomic models that include multi-actor interactions, inherent variability, the role of uncertainty, and adaptive control strategies.

## 1. Introduction

The creation and implementation of an effective international climate protection policy is one of the central issues facing decision makers today. Among the basic difficulties in arriving at a common policy are the global nature of the problem and the fact that any individual nation makes only a relatively small contribution to the global anthropogenic climate forcing. This combination invites a free-rider approach, a tendency that is reinforced by divergent national interests.

This basic game-theoretical difficulty is compounded by insufficient scientific information on the impact of climate change on the economy, ecology, and societal conditions. The uncertainty provides individual actors with a wide range of possible scenarios from which they can select and promote those that further their particular interests. Therefore, to establish a level game-theoretical playing field, it is important to reduce the present uncertainties regarding the impact of climate change. To provide a rational basis

for decision making, the costs of adapting to climate change must be assessed further in relation to the abatement costs of reducing greenhouse gas emission levels.

The scientific basis for such integrated assessment studies is still far from complete and varies greatly for the different components of the integrated climate-socioeconomic system. The Scientific Assessment of Working Group I of the Intergovernmental Panel on Climate Change (IPCC) has provided valuable summaries of our current ability to predict anthropogenic climate change (IPCC, 1990a, 1992, 1994). These reports provided an important background for the negotiations at the United Nations Conference on Environment and Development, held in Rio de Janeiro, 1992, and the first Conference of the Parties (COP), held in Berlin, 1995. A parallel assessment of the socioeconomic impact of anthropogenic climate change, together with analyses of the mechanisms for the transmission of scientific information to the political arena, the decision-making processes, and the implementation of policy decisions through appropriate market or regulatory instruments, would be similarly beneficial. However, our understanding in this field has not yet advanced to the point where general scientific consensus statements can be presented (see summaries in IPCC, 1990b). To minimize the current divergences of existing analyses, extensive interdisciplinary research using climate, ecological, and economic models, with support from researchers in the social sciences, is needed.

In the present paper we attempt to contribute to this interaction by investigating the origin of some of the marked divergences found in previous cost-benefit analyses. Our approach is to combine a climate response model calibrated using sophisticated state-of-the-art climate models with a relatively simple, structurally transparent climate-damage and abatement costs model designed to illuminate the impact of the various assumptions that we believe lie at the core of the divergent results. By means of this structural integrated assessment model (SIAM) we are then able to distinguish between the relatively robust conclusions that are only weakly dependent on such assumptions and more sensitive results, whose dependence on the critical input parameters can then be systematically explored.

We purposely chose much simpler abatement cost expressions than have been used in most previous greenhouse cost analyses (see Reilly *et al.*, 1987; Nordhaus, 1991, 1993; Nordhaus and Yang, 1995; Manne and Richels, 1991, 1995; Peck and Teisberg, 1992; Michaelis, 1994; Tahvonen *et al.*, 1994, 1995; Beltratti, 1995; Richels and Edmonds, 1995; and the more complete list of references and discussion in Cline, 1992, and Fankenhau, 1995). In our

view, the wide divergences in the conclusions of previous cost-benefit analyses using more sophisticated multisectoral economic models do not arise from differences in the internal details of the models. Rather, they can be attributed at a much more elementary level to different basic input assumptions, such as the dependence of climate-damage costs on climate change and the rate of climate change, the discount rates for climate-damage and mitigation costs, the inherent inertia of the economic system, the indigenous rate of technical development, or the adaptability of energy technology in response to imposed mitigation measures. An expert poll conducted by Nordhaus (1994) revealed a wide range of opinions on the magnitudes and impacts of these processes among economists, social scientists, and climate researchers. Therefore, before embarking on a detailed description of interactions between different sectors of the economy, it appears appropriate to investigate the impact of these basic assumptions on the computed optimal carbon dioxide ( $\text{CO}_2$ ) emission paths in a general framework, independent of model details. We believe this investigation is best achieved using structurally highly simplified cost function expressions designed to illuminate the fundamental cause-and-effect relations.

A fundamental property of both climate and the socioeconomic system is the wide range of time scales involved. The principal climate subsystems relevant for anthropogenic climate change – the atmosphere, ocean, and biosphere – change over time scales varying from weeks to millennia (excluding short weather time scales). Ice sheets and geological processes involve still longer time scales. Similarly, economic and societal adjustment processes cover time scales varying in length from weeks to several decades or even centuries. This implies that realistic integrated global environment and society (GES) models used for cost-benefit analyses must be conceived from the outset as dynamic models. Moreover, the impact of climate change in response to human activities must be considered over time horizons compatible with the natural time constants of the coupled GES systems, that is, over several hundred years. These time horizons far exceed the usual economic planning horizons, but this is an unavoidable consequence of the dynamics of the GES system if the challenge of sustainable development is to be faced.

A novel feature of our approach is the introduction of a simple linearized integral impulse-response climate model, which clarifies the impact of the long climatic time scales on the optimal emissions solution. The model is calibrated using the outputs of a state-of-the-art climate model consisting of a coupled ocean-atmosphere general circulation model and a three-dimensional global carbon cycle model. The impulse-response climate

model is then coupled with a structurally highly simplified economic model of climate-damage and abatement costs.

The analysis is restricted to an idealized single-world system whose evolution is governed by a single decision maker representing the collective decisions of the world community. Multi-actor models constructed with the same basic building blocks as presented in this paper, but allowing for different climate-damage and abatement costs as well as the divergent political goals and strategies of different economic regions, are considered in Hasselmann and Hasselmann (1996).

Following the standard cost-benefit approach, the optimal climate protection strategy is defined as the time-dependent path for the control variables of the integrated climate-socioeconomic system that minimizes total costs related to climate change, consisting of the sum of the time-integrated global mitigation and climate-damage costs. The only control variable we will consider are the CO<sub>2</sub> emissions, but we will also briefly discuss the impact of other greenhouse gases.

An alternative approach that is sometimes pursued is to define *a priori* a permissible climate change “corridor” within which the climate-state trajectory is constrained. The optimal emissions path is then defined as the path that minimizes the economic abatement costs under this constraint, ignoring the climate-damage costs within the corridor. One can take this approach a step further by prescribing a ceiling on the atmospheric CO<sub>2</sub> concentration instead of a climate change limit (see Richels and Edmonds, 1995; Wigley *et al.*, 1996; and the discussion in Manne and Richels, 1995). The usual motivation for prescribing *a priori* limits for the climate change or CO<sub>2</sub> concentration is the notorious difficulty of assessing climate-damage costs, including intangible values such as the protection of species or the “quality of the environment.” However, the corridor approach hides rather than avoids the issue of quantifying climate-damage costs. Formally, the corridor approach is equivalent to minimizing the sum of climate-damage and emission-abatement costs under the assumption that the damage costs are zero within the allowed climate change or CO<sub>2</sub> corridor and immediately become very large – in excess of any conceivable mitigation costs – as soon as one leaves the corridor. We prefer a more continuous representation of the climate-damage costs inside and outside the corridor. Independent of the details of the climate-damage cost function, however, rational determination of the acceptable size of the corridor inevitably leads to the problem of assessing climate impacts in relation to mitigation costs: the trade-off between climate change impacts and mitigation efforts – independent of the value units in which these are measured – is the central issue of the climate

protection problem and cannot be circumvented by the ad hoc introduction of arbitrary climate change or CO<sub>2</sub> concentration ceilings.

For the political implementation of abatement measures, it may nevertheless be expedient to define CO<sub>2</sub> concentration targets and devise market control or other regulatory mechanisms for meeting these targets – in accordance, for example, with the approach adopted in the Framework Convention on Climate Change. However, the definition of the concentration targets should be based on prior cost-benefit analyses that considered all the components of the cost budget.

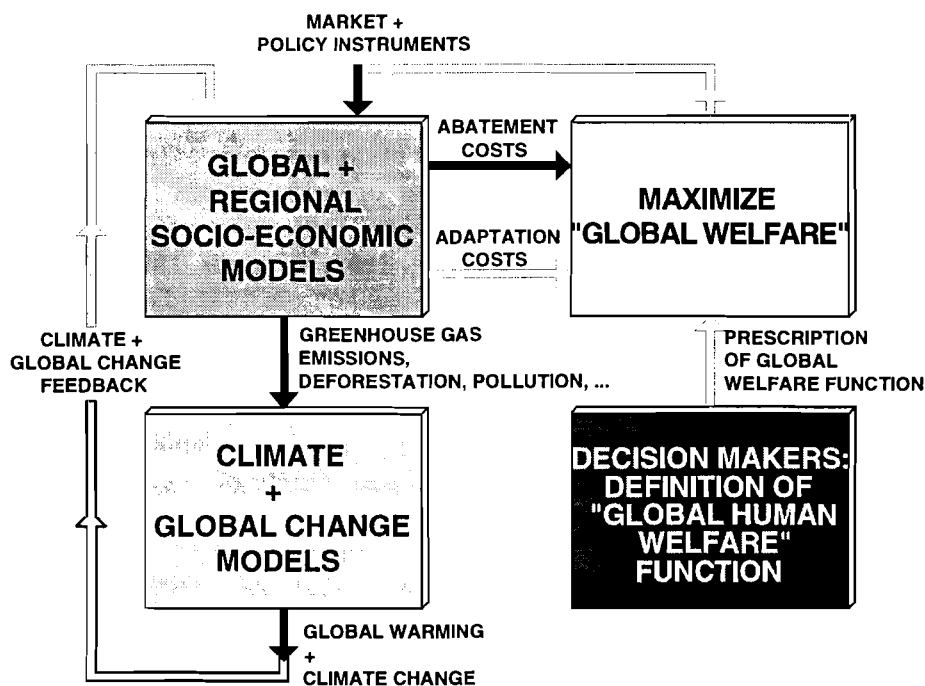
The paper is organized as follows: after a discussion of the general structure of GES models in Section 2, the construction of simple linearized integral impulse-response climate models from the simulation results of complex nonlinear climate models is described in Section 3. The coupling of the impulse-response climate model to an idealized climate-damage and mitigation costs model, and the application of this elementary GES model to the single-actor greenhouse gas optimization problem are presented in Section 4. A series of sensitivity experiments with the model is described in Section 5. The results are summarized in Section 6 and placed in the perspective of more complete GES models in Section 7.

## 2. Structure of GES models

Figure 1 shows the basic elements and interactions within a GES model. In this simplified scheme it is assumed that negotiations lead to a cooperative definition of the global welfare function, which assigns appropriate weights to the welfare values and interests of individual nations and distributes the burdens of an optimized global climate protection policy in accordance with accepted rules. Once the cooperative global welfare function and burden sharing have been agreed on, the optimization task is essentially reduced to a single-actor dynamic optimization problem in which available market and policy instruments are applied to minimize the time-integrated, appropriately discounted net climate-damage and mitigation costs.

A more detailed representation of the same set of interactions, consisting again of a single global climate system and a single international negotiation box, but with the socioeconomic system disaggregated into separate units representing different economic regions, is discussed in the context of the more general multi-actor greenhouse gas optimization problem in Hasselmann and Hasselmann (1996).





**Figure 1.** Interactions and subsystems of an integrated global environment and society (GES) model (from Hasselmann, 1991).

In either case – cooperative agreement on a global welfare function or the more general game-theoretical situation – the dynamic system will generally be too complex for analytical investigations and will need to be studied using numerical simulation techniques. Unfortunately, no suitable set of subsystem models is currently available that could be combined in a reasonably realistic GES model for such dynamic optimization studies. There exist a number of sophisticated climate models based on coupled general circulation models (CGCMs) of the atmosphere and ocean, which have been shown to represent the present climate quite accurately (see IPCC, 1992; Cubasch *et al.*, 1992), as well as similarly sophisticated and realistic three-dimensional ocean-atmosphere carbon cycle models (Maier-Reimer and Hasselmann, 1987; Maier-Reimer, 1993; Sarmiento *et al.*, 1992). However, these are far too costly in computer time to be applied in dynamic optimization studies, which normally require a large number of integrations using an iterative optimization algorithm. Similarly, realistic economic models, although

less demanding of computer resources and still highly simplified with respect to the societal components and the interactions between the climate and economic systems, are generally too cumbersome for applications in iterative optimization studies.

It is therefore not surprising that most of the dynamic optimization studies carried out to date have been single-actor investigations based on simplified box-type climate models and strongly aggregated economic models (Nordhaus, 1991, 1993; Peck and Teisberg, 1992; Michaelis, 1994; Tahvonen *et al.*, 1994, 1995; and Beltratti, 1995). Greenhouse cost studies using more sophisticated disaggregated economic models have usually been carried out in the scenario mode, rather than as optimization computations (see references quoted above, as well as Cline, 1992, and Fankhauser, 1995). We limit ourselves here to optimization studies using single-actor models, but with the goal, as outlined above, of clarifying the sensitivity of the computed optimal emission paths with respect to critical input assumptions, rather than providing quantitative cost estimates of particular emission paths.

In the following section we describe a general technique for projecting the simulation results of sophisticated CGCM climate models onto simpler but nonetheless geographically and dynamically realistic climate models. The models are formulated as linear integral response models and are sufficiently economical with respect to computer time to be applicable for iterative optimization integrations. The technique presented is a basic building block that can also be used for the development of more realistic GES models.

### **3. Projection of CGCM Climate Models onto Linear Integral-Response Climate Models**

#### **3.1. General approach**

Although the climate system and its detailed representation in terms of CGCMs are inherently strongly nonlinear, the response of the climate system to a small external forcing, as that of any differentiable nonlinear system, is linear to the first order. In this paper we consider the annual anthropogenic emissions,  $e(t)$ , of CO<sub>2</sub> as the external forcing. Because CO<sub>2</sub> is well mixed in the atmosphere,  $e(t)$  can be represented as a single scalar function of time. Although CO<sub>2</sub> contributes only about 60% of the anthropogenic radiative forcing of all greenhouse gases, we restrict the discussion here to CO<sub>2</sub> because models of non-CO<sub>2</sub> greenhouse gases are generally less well developed. Also, the sources and sinks of these gases often are not well known, so that the

mechanisms for controlling their atmospheric concentrations are not well defined. It must therefore be kept in mind that the following projections of future climate change represent systematic underestimates of the real climate change. However, we will attempt to provide first-order estimates of the impact of non-CO<sub>2</sub> greenhouse gases later.

In the linear approximation, the response of the perturbed climate state,  $\mathbf{x}(t)$  (which in a discrete model representation consists of the perturbation vector of all climate variables at all model gridpoints), to an arbitrary, sufficiently small emission function,  $e(t)$ , can be represented in the general integral form

$$\mathbf{x}(t) = \int_{t_0}^t \mathbf{R}(t-t')e(t')dt', \quad (1)$$

where the climate impulse-response function,  $\mathbf{R}(t-t')$ , represents the climate response at time  $t$  to a unit  $\delta$ -function emission at time  $t'$ . It is assumed that the forcing and climate perturbation are zero up to the initial time  $t_0$ :  $e(t) = \mathbf{x}(t) = 0$  for  $t \leq t_0$ .

The first-order linear response approximation can be generalized to nonlinear response relations in which the linear kernel  $\mathbf{R}(t) \equiv \mathbf{R}_1(t_1)$  is replaced by a series expansion in terms of higher-order nonlinear kernels  $\mathbf{R}_2(t_1, t_2)$ ,  $\mathbf{R}_3(t_1, t_2, t_3)$ , ... occurring in quadratic, cubic, ... integrals over the emission. However, noting that a doubling of the CO<sub>2</sub> concentration corresponds to an increase in radiative forcing of about 4 W/m<sup>2</sup>, or little more than 1% of the mean incident solar radiation of 340 W/m<sup>2</sup>, the linear form will be adequate for many applications. We discuss the limitations of the linearization approximation in more detail below.

The dimension of  $\mathbf{R}(t)$  in equation (1) is the same as that of  $\mathbf{x}(t)$ . Thus, the linear response can be represented with the same geographical resolution and with respect to the same set of variables (temperature, humidity, precipitation, ocean currents, etc.) as a fully coupled ocean-atmosphere general circulation climate model. The response function can be determined empirically from numerical climate response experiments with realistic three-dimensional carbon cycle models or CGCMs (Maier-Reimer and Hasselmann, 1987; Cubasch *et al.*, 1992; Hasselmann *et al.*, 1993). In practice, it will normally be convenient to reduce the number of degrees of freedom of  $\mathbf{R}(t)$  by expanding the response function with respect to some set of base functions, such as the empirical orthogonal functions (EOFs) of the CGCM climate response simulations. However, it is important to recognize that the linearized form [(equation (1))] implies no loss of information in the representation of the climate state relative to the complete nonlinear system, but

represents simply a reduction of the full nonlinear dynamics to the first-order linearized response, which is always permissible for a small external forcing.

The present approach appears preferable to the usual construction of simplified climate models in the form of empirical box models with a small number of degrees of freedom. These lose the detailed information on the climate state and therefore cannot be readily constrained to conform to the detailed linearized dynamics of a more realistic CGCM climate model.

The formulation of the climate response in terms of a response integral rather than in the traditional form of a differential equation for a box model has further advantages: it is not limited to simple low-order differential equations, but applies generally for differential equations of arbitrary order; it is easy to fit to the data; and it enables a direct determination of the gradient of the cost function (see Section 3.2 and Appendix), without solving a Hamiltonian problem in terms of the adjoint model. The last advantage does not come to bear, however, if an automatic adjoint model and functional derivative compiler are used, as in our applications below. This model-compiler combination can be applied equally well to differential or integral representations of the system dynamics (Giering and Kaminski, 1996).

### 3.2. A simple climate model

In the applications of this paper we use a strongly aggregated climate model in which the climate state vector,  $\mathbf{x}$ , is reduced to a single climate variable,  $T$ , representing the global mean (surface) temperature. The model consists of two subsystems, a carbon cycle model and a global temperature response model.

#### *The Carbon Cycle Model*

This model describes the evolution of the atmospheric  $\text{CO}_2$  concentration,  $w$ , in response to  $\text{CO}_2$  emissions,  $e(t)$ :

$$w(t) = \int_{t_0}^t R_w(t-t')e(t')dt' \quad , \quad (2)$$

where  $R_w(t-t')$  is the impulse response of the concentration at time  $t$  for a unit  $\delta$ -function emission pulse at time  $t'$  and it is assumed, as in equation (1), that  $e(t) = w(t) = 0$  for  $t \leq t_0$ . Later, we shall choose  $t = t_0$  as the preindustrial date 1800 (the exact date is immaterial, as  $e(t)$  is assumed to be zero in the preindustrial epoch).

In this paper the unit for time is years. To retain the same carbon units (GtC, gigatons of carbon) for  $w$  and the emissions  $e$  (in GtC/yr), in all equations  $w$  represents the total carbon in the atmosphere. However, in later figures we will present results for  $w$  in the usual units of parts per million (ppm). The conversion factor is  $w$  [GtC] = 2.13  $w$  [ppm]. The present atmospheric CO<sub>2</sub> concentration is 358 ppm, corresponding to an atmospheric carbon content of 760 GtC; the preindustrial concentration was  $w_0 = 280$  ppm = 594 GtC.

Initially, all emissions enter the atmosphere, so that

$$R_w(t_0) = 1. \quad (3)$$

$R_w(\infty)$  defines the fraction of the emissions that is retained in the atmosphere in the asymptotic equilibrium state. If the ocean sink alone is considered, this is approximately 14%; if the uptake of CO<sub>2</sub> by dissolution in the upper layers of the ocean sediments is also included, the long-term atmospheric retention factor may fall to about 7% (Maier-Reimer, 1993). The increased storage of CO<sub>2</sub> in the terrestrial biosphere through CO<sub>2</sub> fertilization and the significantly slower loss of CO<sub>2</sub> through sedimentation in the ocean are not included in these estimates.

Invoking equation (3), the time derivative of equation (2) (which will be needed to couple the CO<sub>2</sub> model with the following temperature response model) is given by

$$\frac{dw}{dt} \equiv \dot{w}(t) = \int_{t_0}^t \dot{R}_w(t-t')\epsilon(t')dt' + \epsilon(t) . \quad (4)$$

In an analysis of the response of a nonlinear three-dimensional global ocean carbon cycle model to various CO<sub>2</sub> emission levels, Maier-Reimer and Hasselmann (1987) found that the model response could be fitted to a linear relation of the form (1) quite well for an increase in the CO<sub>2</sub> level up to a factor of two. For a stronger emission level producing a fourfold increase in the CO<sub>2</sub> concentration, the linear response underestimated the atmospheric concentration predicted by the full model by about 30%. This discrepancy was due primarily to the nonlinear decrease of the solubility of CO<sub>2</sub> in seawater with increasing CO<sub>2</sub> concentration. A relatively simple nonlinear extension of the linear response form to allow for the nonlinearities (and temperature dependence) associated with the solution of CO<sub>2</sub> in seawater has recently been proposed by Joos *et al.*, (1995).

*The Global Temperature Response Model*

The general linear response of the change,  $T(t)$ , of the global mean temperature induced by a change,  $w$ , in the CO<sub>2</sub> concentration is given by

$$T(t) = \int_{t_0}^t \hat{R}_T(t-t')w(t')dt', \quad (5)$$

where the temperature impulse-response function,  $\hat{R}_T(t-t')$ , represents the change in the global mean temperature produced at time  $t$  by a unit  $\delta$ -function change in the atmospheric CO<sub>2</sub> concentration at time  $t'$ .

It is more convenient to rewrite equation (5) in terms of the rate of change of the CO<sub>2</sub> concentration,  $\dot{w}$ , instead of  $w$ . This is because a  $\delta$ -function input in the emissions generates a step-function response in the concentration [see equation (2)], that is, a  $\delta$ -function response in the derivative of the concentration, rather than in the concentration itself. Integrating equation (5) in parts, we obtain

$$T(t) = \int_{t_0}^t R_T(t-t')\dot{w}(t')dt', \quad (6)$$

where the response function

$$R_T(t-t') = \int_{t'}^t \hat{R}_T(t-t'')dt'' \quad (7)$$

represents the change in the global mean temperature produced at time  $t$  by a unit step-function increase in the atmospheric CO<sub>2</sub> concentration at time  $t'$ .

Because of the inertia of the climate system, the instantaneous response to a step-function change in CO<sub>2</sub> concentration is zero [see equation (7)],

$$R_T(0) = 0 \quad . \quad (8)$$

In the opposite limit,  $R_T(\infty)$  represents the asymptotic equilibrium response of the (thermodynamic) climate system to a unit increase in the CO<sub>2</sub> concentration.

The generalization of this simple one-parameter climate model to more complex climate-state models, including, for example, regional temperature distributions represented by the first few EOFs of CGCM climate response experiments, or additional information such as regional changes in sea level or precipitation patterns as well as temperature patterns, is basically straightforward. Such models could be readily constructed, in accordance

with the general form (1), from existing data generated by CGCM climate response simulations. However, for illustrative purposes we restrict the model here to a single climate variable representing the global mean temperature. In fact, the critical elements of our optimization analysis concern not so much the detailed description of the predicted climate change as the estimation of the resulting climate-damage costs. As long as these are not better assessed, there is little point in being too specific about the details of the climate change.

In the applications discussed in Hasselmann and Hasselmann (1996) involving simultaneous multi-actor greenhouse gas emission optimization strategies, it would be more appropriate to consider different climate impact functions for different actors. This can be achieved within the framework of the present model by simply assigning different regional impact factors to the single global climate variable  $T$ . To the extent that the climate impact for a given region can be characterized by the average temperature change over the region, this approach can be justified by the results of numerical global warming simulations with coupled CGCMs (Cubasch *et al.*, 1992). The response of the global temperature distribution is dominated in these simulations by the first EOF, implying that the average temperature response for any region can indeed be related to the global mean temperature by a time-independent scaling factor.

The linear response relation between the temperature change and the change of the  $\text{CO}_2$  concentration can be modified in accordance with the more accurate logarithmic dependence between the radiative greenhouse forcing and the  $\text{CO}_2$  concentration by replacing  $\dot{w}$  with  $d(\ln w)/dt$  in equation (5). This substitution introduces no significant complications in the numerical examples considered in the following section. However, the difference between the linear and logarithmic formulation is small for a small forcing (which we assume), and for the present illustrative purposes the linear relation (5) has the advantage of yielding a net linear climate response to the emissions in accordance with the form (1).

Linear-response-fitting exercises for coupled ocean-atmosphere CGCM global warming simulations (Hasselmann *et al.*, 1993) suggest that, as in the case of the linearized carbon cycle model, the linearized temperature response relation is applicable for climate changes associated with  $\text{CO}_2$  concentration increases up to about double the preindustrial level, that is, for a temperature rise up to about  $3^\circ\text{C}$ . The linear response relations should also not be used beyond this range because the temperature feedback on the  $\text{CO}_2$  model (increasing temperature decreases the  $\text{CO}_2$  solubility of seawater and thus increases the atmospheric retention factor) has not been included

in the CO<sub>2</sub> response relation (2) (however, this effect is incorporated in the general nonlinear impulse-response relation of Joos *et al.*, 1995).

Combining the carbon cycle and global temperature response models, the net response of the “climate”  $T$  to the emissions  $\epsilon(t)$  can now be written

$$T(t) = \int_{t_0}^t dt' R_T(t-t') \left\{ \epsilon(t') + \int_{t_0}^{t'} dt'' \dot{R}_w(t'-t'')\epsilon(t'') \right\} . \quad (9)$$

Noting that

$$\int_{t_0}^t dt' \int_{t_0}^{t'} dt'' = \int_{t_0}^t dt'' \int_{t''}^t dt' , \quad (10)$$

this may be expressed as

$$T(t) = \int_{t_0}^t R(t-t')\epsilon(t')dt' , \quad (11)$$

in accordance with the form (1), where

$$R(t) = R_T(t) + \int_0^t R_T(t-t')\dot{R}_w(t')dt' . \quad (12)$$

At  $t = t_0$  we have

$$T(t_0) = \dot{T}(t_0) = R(t_0) = 0 . \quad (13)$$

The net temperature impulse-response function,  $R(t)$ , or *global warming response* [to be distinguished from the global warming “potential” or “commitment,” defined by IPCC (1990a) as integrated radiative warming quantities], represents the temperature increase at time  $t$  due to a unit  $\delta$ -function CO<sub>2</sub> input into the atmosphere at time  $t = 0$ , allowing for both the thermal inertia of the ocean-atmosphere climate system and the slow decay of the atmospheric CO<sub>2</sub> concentration through the transfer of CO<sub>2</sub> from the atmosphere to other components of the carbon cycle.

### 3.3. Numerical values

The response functions  $R_w$  and  $R_T$  have been determined empirically from numerical response experiments using realistic three-dimensional models of the global carbon cycle (Maier-Reimer and Hasselmann, 1987; Maier-Reimer, 1993) and the coupled ocean-atmosphere climate system (Hasselmann *et al.*,



1993). It was found that the response curves could be closely fitted by sums of exponentials in the form

$$R_w = A_0^w + \sum_j A_j^w \exp(-t/t_j^w) , \quad (14)$$

$$\begin{aligned} R_T &= w_0^{-1} \sum_j A_j^T [1 - \exp(-t/t_j^T)] , \\ &= w_0^{-1} R'_T , \end{aligned} \quad (15)$$

where  $R'_T$  represents the temperature response to a step-function doubling of the CO<sub>2</sub> concentration at time  $t = 0$  relative to the preindustrial value.

The empirically fitted amplitude factors,  $A_j^w$  and  $A_j^T$ , and time constants,  $t_j^w$  and  $t_j^T$ , for various response models are listed in Table 1.

The CO<sub>2</sub> response model RW1 was fitted to the response of the original inorganic three-dimensional ocean carbon cycle model of Maier-Reimer and Hasselmann (1987) and yields an asymptotic atmospheric retention factor of 14%. The modified form RW0, which we will take as our baseline model, was derived from a fit (Maier-Reimer, personal communication) to the response of a more recent three-dimensional organic carbon cycle model (Maier-Reimer, 1993), including an additional sediment pool whose CO<sub>2</sub> uptake reduces the asymptotic atmospheric retention factor to 7%. Other impulse-response functions for different CO<sub>2</sub> models are presented in the background report of Enting *et al.* (1994) for IPCC Working Group I.

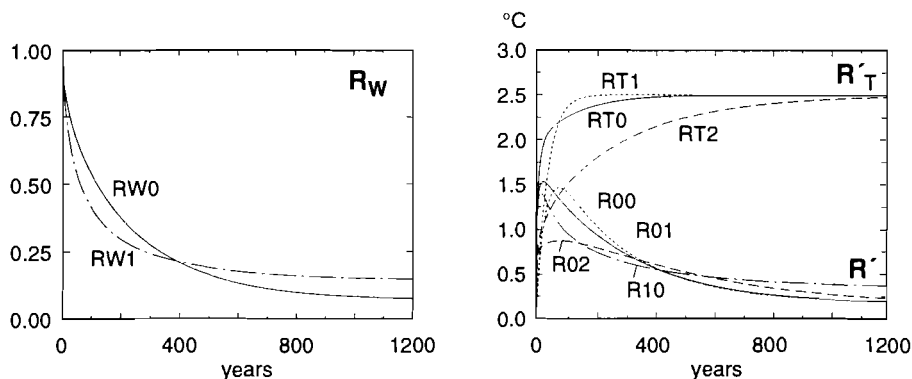
Various temperature response functions were considered by Hasselmann *et al.* (1993) in their analysis and correction of cold-start errors in CGCM global warming simulations. These errors are incurred when, to save computing costs, the climate is initialized as an equilibrium state at some relatively recent starting time, ignoring the delayed impact (global warming response) of the CO<sub>2</sub> that had already been emitted prior to the start of the model integration. The authors found that the global mean temperature response computed directly from an experiment in which the CO<sub>2</sub> level was suddenly increased by a factor of two was initially larger but asymptotically smaller than the equilibrium response inferred from transient response experiments in which the CO<sub>2</sub> level was increased gradually. They attributed this result to nonlinearities in the response of the ocean mixed layer to a sudden CO<sub>2</sub> step-function doubling: the rapid initial warming tends to stabilize the upper mixed layer of the ocean, inhibiting the subsequent penetration of heat into the deep ocean.

**Table 1.** Top part: amplitudes,  $A_j^w$ , and time constants,  $t_j^w$ , for the CO<sub>2</sub> response models RW0 (Maier-Reimer, 1993) and RW1 (Maier-Reimer and Hasselmann, 1987). Bottom part: amplitudes,  $A_j^T$ , and time constants,  $t_j^T$ , for the temperature response function,  $R'_T$ , for the models RT0 (baseline case), RT1 (single time constant model of Hasselmann *et al.*, 1993), and RT2 (modification of RT0 with long time constant term).

Model	$A_0^w$	$A_1^w$	$t_1^w$	$A_2^w$	$t_2^w$	$A_3^w$	$t_3^w$	$A_4^w$	$t_4^w$
RW0	0.07	0.648	258.5	0.101	71.9	0.097	17.6	0.084	1.6
RW1	0.142	0.241	313.8	0.323	79.8	0.206	18.8	0.088	1.7
Model	$A_1^T$	$t_1^T$	$A_2^T$	$t_2^T$	$A_3^T$	$t_3^T$			
RT0	1.21	2.1	0.759	12.0	0.531	138.6			
RT1	2.5	36.8	–	–	–	–			
RT2	0.8	2.9	0.3	40.0	1.4	300			

To investigate the impact of different time-delay characteristics of the temperature response function we considered three models, listed in Table 1. All models were normalized to yield the same asymptotic equilibrium temperature 2.5°C for a CO<sub>2</sub> doubling. The baseline model, RT0, represents a fit to the 800-year transient response computed with the Hamburg large-scale global (LSG) ocean circulation model, which was coupled to an atmospheric energy balance model, for a very small step-function increment in the CO<sub>2</sub> concentration (Mikolajewicz and Maier-Reimer, personal communication). The model RT1 corresponds to the single time-constant fit of Hasselmann *et al.* (1993) to the global warming simulation of Cubasch *et al.* (1992) for IPCC Scenario A. Model RT2 was obtained by fitting the temperature impulse-response model to a 100-year CGCM simulation for a sudden CO<sub>2</sub> doubling (Cubasch *et al.*, 1992). It reproduces the principal short-term response characteristics of model RT0, but with smaller amplitude, and is augmented by an additional term with a long time constant representing heat storage in the deep ocean. This term is probably exaggerated for typical slowly increasing transient global warming simulations, which are better represented by the models RT0 and RT1. However, it is reasonable for a sudden CO<sub>2</sub> doubling because of the inhibition of heat transfer into the deep ocean by the nonlinear response of the mixed layer. The model has been included to investigate the sensitivity of cost-benefit analyses with respect to the details of the climate model.

Figure 2 shows the various carbon cycle and temperature response functions,  $R_w$  and  $R'_T = w_0 R_T$  (left and right panels, respectively), together



**Figure 2.** Left panel: Response functions,  $R_W$ , representing the atmospheric retention factor for a unit  $\delta$ -function emission of  $\text{CO}_2$  at time  $t = 0$ , as given by the  $\text{CO}_2$ -response models RW0 (solid line) and RW1 (dotted line). Right panel: Temperature response functions,  $R'_T = w_0 R_T$  and  $R' = w_0 R$  for a step-function doubling of the  $\text{CO}_2$  concentration at time  $t = 0$  for the  $R'_T$  models RT0 (solid line), RT1 (dotted line), and RT2 (dashed line), and the resultant  $R'$  models R00 (solid line), R10 (dotted line), R01 (dashed line), and R02 (dashed-dotted line).

with the net temperature response function,  $R' = w_0 R$  (right panel), for the model combinations R00 (RW0+RT0), R10 (RW1+RT0), R01 (RW0+RT1) and R02 (RW0+RT2). The temperature response functions  $R'_T$  and  $R'$  represent the response to a step-function doubling of the atmospheric  $\text{CO}_2$  concentration at time  $t = 0$ , which is then either retained at a constant level (in the case of  $R'_T$ ), or (in the case of  $R'$ ) is allowed to relax back to an asymptotic value representing 7% (model R00) or 14% (model R10) of the initial level, in accordance with the carbon cycle response (14).

The response curves illustrate (as indicated by the analytical expressions) that the net climate response to  $\text{CO}_2$  emissions cannot be characterized by a single time constant. In all models, after a rapid temperature rise in the first few years as the upper mixed layer of the ocean warms, the net response function for the global mean temperature increases more slowly as the warming penetrates into the main ocean thermocline, reaching its maximum value of about 1–1.5°C after about a decade or two (compared with the asymptotic temperature response of 2.5°C for a  $\text{CO}_2$  doubling without subsequent  $\text{CO}_2$  losses from the atmosphere), after which the temperature gradually returns, over a period of several hundred years, to its asymptotic

equilibrium value of  $2.5 \times 0.07 = 0.175^\circ\text{C}$  for models R00, R01, and R02, or  $2.5 \times 0.14 = 0.35^\circ\text{C}$  for model R10. The initial fast response is governed by the temperature response of the ocean-atmosphere system, while the later relaxation stages are determined by slow response terms in both the carbon cycle and the climate system.

Although there clearly are differences in detail between the different carbon cycle and temperature response models, all model combinations shown in Figure 2 exhibit rather similar qualitative features. It was found that the computed optimal emission paths presented below did not depend on the choice of model combination shown in Figure 2, and that our general conclusions applied for all climate models considered: the climate model is not a critical element in integrated assessment studies (ignoring possible instabilities of the climate system, which are excluded in the models considered). Accordingly, we will later present results only for the baseline model R00.

For the optimization of greenhouse gas emission paths, the climate response characteristics for both the near and far time must be considered. In particular, if the mandate of sustainable development is taken seriously, the socioeconomic impact of the long-term climate response over several hundred years should not be ignored or severely attenuated through the application of exponential discount factors designed to model economics or intertemporal societal preferences over the short term. Furthermore, in keeping with the multiple time scales of the climate system, the dynamic properties of the ecological and economic responses to climate change should also be modeled in terms of several different time constants reflecting different dynamic processes in the coupled ecological-socioeconomic system. We will attempt to follow this principle later in the formulation of simplified expressions for the climate-damage and mitigation costs in our sensitivity studies.

The need to consider climate impact over time horizons of several hundred years has been stressed by several authors, in particular Cline (1992). He points out that limiting the time span to only one hundred years, as in the IPCC reports (IPCC 1990a, 1992), can lead to a dangerous underestimation of the long-term greenhouse warming impact. However, in considering longer-term climate impacts, it is also important to apply realistic climate response models. It is often assumed that the asymptotic atmospheric retention factor for  $\text{CO}_2$  emissions is about 50%, in accordance with the observed retention factor in recent decades. This leads to an incorrect overestimation of the long-term global warming response. The recent atmospheric retention values of the order of 50% are the result of a continual exponential increase in  $\text{CO}_2$  emissions in recent decades. This increase has been too rapid for the large but very slow deep-ocean  $\text{CO}_2$  sink to become

effective. For a CO<sub>2</sub> pulse corresponding to, say, an initial CO<sub>2</sub> doubling, the incorrect assumption that half the emissions are retained asymptotically in the atmosphere yields a long-term global warming response that is half as large as the equilibrium warming for a doubled CO<sub>2</sub> concentration, or  $2.5/2 = 1.25^\circ\text{C}$ . However, for a finite CO<sub>2</sub> pulse (or for constant rather than exponentially growing emissions) the asymptotic atmospheric retention factor is of the order of only 7–14% [equation (14); Table 1]. Thus the global warming response for a  $\delta$ -function emission pulse corresponding to an initial CO<sub>2</sub> doubling is not constant, but, as indicated in Figure 2, attains a maximum after a few decades and decreases continually thereafter, approaching a relatively low asymptotic equilibrium value of  $0.07 \times 2.5 = 0.175^\circ\text{C}$  (for model R00) or  $0.14 \times 2.5 = 0.35^\circ\text{C}$  (for model R10).

In conclusion, we note that the existence of a small but non-zero asymptotic CO<sub>2</sub> response level,  $R_w(\infty)$ , implies that for a finite asymptotic temperature rise, the total emissions must remain finite; that is, the asymptotic emission level must approach zero. This is indeed the case in the optimal solutions derived below (with the exception of simulation S2, in which only the rate of temperature change, not the temperature change itself, enters into the climate-damage cost expression). In practice, of course, finite total emissions are ensured by the finite resources of fossil fuels.

#### 4. The Optimization Problem

We now combine our global climate model with a simple globally integrated economic climate-damage and abatement costs model to form a coupled climate-economic model. We adopt the same level of global aggregation as used in similar studies by Nordhaus (1991, 1993), Tahvonen *et al.* (1994, 1995), and Beltratti (1995). There are two main differences, however, in our approach relative to previous studies: the use of a general integral impulse-response climate model, which illustrates more clearly the memory properties of the climate system and enables a direct calibration of the model in terms of CGCM global warming simulations, and the introduction of a structurally highly simplified abatement costs model.

The resulting GES model involves two levels of aggregation of basically different quality. The first level is the climate model, for which our input information for the aggregate climate state (the global mean temperature) is relatively reliable, and where we have merely introduced a linear approximation, valid for small perturbations, of the basically well-defined nonlinear system to arrive at a numerically readily tractable system. The second level

of aggregation is the economic climate-damage and greenhouse gas abatement costs. Because the climate impact relations are not well known, we have assumed simplified expressions for the climate-damage costs, and, for the reasons stated earlier, have also considered only structurally highly idealized expressions for the mitigation costs. These are introduced in order to focus on the differences in the basic assumptions that have led to the marked divergences in the conclusions of earlier cost-benefit analyses based on more sophisticated economic models. As a basis for the application of more detailed economic models, it appears necessary to clarify the origin of the present divergences. Despite these simplifications, the important effects of inertia have been included in the expressions for both climate-damage and mitigation costs.

We repeat that the purpose of our exercise is not to generate quantitative cost calculations, but to study the sensitivity of the coupled GES system and the computed optimal emission paths with respect to different input assumptions and parameters. Our goals are to distinguish between relatively robust and more sensitive conclusions of the optimization analysis and to clarify the role of the characteristic climatic and economic time scales in governing the short- and long-term properties of the optimal emission paths. The same basic model, but disaggregated into several interacting subsystems, is also applied in Hasselmann and Hasselmann (1996) in the discussion of the multi-actor greenhouse gas emission problem.

The global economy is represented as a two-parameter system dependent on total CO<sub>2</sub> emissions and the climate state. It is assumed that there exists a global welfare function,  $W$ , that has been agreed on by all actors involved and that depends solely on  $\epsilon(t)$  (including its first and second derivatives, to represent the effects of economic inertia) and  $T(t)$  (including its first derivative to model climate impacts, for example in the ecology, governed by the rate of climate change). The common goal of all actors, represented by a single actor in this idealized cooperative scenario, is to maximize  $W$ .

If climate damages are ignored, the optimal solution, yielding a welfare value  $W_A$ , will be some "business as usual" (BAU) path,  $e_A(t)$ , corresponding to, say, IPCC Scenario A (IPCC, 1990a). How this optimal reference path excluding climate-damage costs is attained is irrelevant for the analysis that follows. If climate-damage costs,  $C_d$ , are included, the optimal solution will be a diminished emission path that reduces the climate-damage costs but incurs some abatement costs,  $C_a$ . The optimal emission path is then the path that maximizes the net welfare

$$W = W_A - C \quad , \quad (16)$$

or minimizes the additional costs

$$C' = C'_a + C'_d \quad (17)$$

relative to the BAU path. We use the term “cost” here as a synonym for loss of welfare. The distinction between costs and welfare loss is immaterial for the present optimization problem, provided welfare depends solely on costs. In general, this cannot be assumed if the concept of welfare includes nonmonetary quality-of-life factors. However, for the present idealized single-actor problem, there is no need to be more specific in distinguishing between costs and negative welfare.

We assume that both cost contributions can be expressed as integrals over the *specific* costs,  $c_a(t)$  and  $c_d(t)$ , in the form

$$C'_a = \int_{t_0}^{t_h} c_a[c(t), \dot{c}(t), \ddot{c}(t), t] dt \quad , \quad (18)$$

$$C'_d = \int_{t_0}^{t_h} c_d[T(t), \dot{T}(t), t] dt \quad . \quad (19)$$

We can choose a finite time horizon,  $t_h$ , for the total cost definition or consider the case  $t_h \rightarrow \infty$ . The integrals converge for  $t_h \rightarrow \infty$  if exponential discount factors are introduced. Time has been included explicitly as a separate variable in the specific cost functions,  $c_a$  and  $c_d$ , to allow for such discount factors; different factors may be chosen for the abatement and damage costs.

Costs and discount factors are assumed to be adjusted for inflation. We are concerned only with the ratios of abatement and climate-damage costs, defined as additional costs relative to an unspecified BAU welfare value,  $W_A$ . Thus, all costs are defined only to an arbitrary constant scaling factor. We make no attempt to introduce an absolute scaling with respect to, say, gross domestic product (GDP). Our interest lies in establishing the forms of the optimal emission paths for various input assumptions regarding the relative magnitudes and forms of the cost functions. For this analysis the absolute cost values are irrelevant. However, we note that most quantitative cost estimates suggest that the mitigation and damage costs for optimal emission paths are generally of the same order and lie in the range from one to a few percent (this does not apply for estimates of the climate-damage costs for the uncontrolled BAU emission path, however, which vary more widely).

We ignore cross-coupling of the climate and emission variables in the cost expressions. A change in emissions, producing a change in the structure of

the socioeconomic system, may be expected to affect the vulnerability of the system to climate change. Similarly, a change in climate will presumably have some impact on the abatement costs. For example, the costs of switching from fossil fuels to solar energy will be increased if the cloud cover is increased. However, these effects are regarded as being of a higher order and are neglected.

In addition to  $e$ , first and second time derivatives  $\dot{e}$  and  $\ddot{e}$  are included in the specific abatement cost function in order to penalize rapid changes in emissions, thereby ensuring a smooth transition from the reference BAU emission path,  $e_A(t)$ , to alternative reduced-emission paths without discontinuities in emissions and their time derivative. In a more sophisticated economic model, these inertia effects would, of course, be achieved by introducing capital investments. However, to demonstrate the sensitivity of the computed optimal emission paths with respect to the effects of economic inertia, we prefer to represent the dependence of the abatement costs on the first and second derivatives of the emissions in the simplest possible manner, without the camouflaging details of a more complex economic model.

With the same philosophy, we assume a particularly simple dependence of the mitigation costs on the deviation of emissions from the prescribed optimal climate-insensitive BAU path. As the simplest mathematical expression that captures the principal properties of the abatement costs that may be anticipated from a more detailed economic model, we set

$$c_a = \left\{ \left( \frac{1}{r} - r \right)^2 + \tau_1^2 \dot{r}^2 + \tau_2^4 \ddot{r}^2 \right\} D_a(t) \quad , \quad (20)$$

where  $r = e/\epsilon_A$ ,  $\tau_1$  and  $\tau_2$  are time constants, and

$$D_a(t) = \exp(-t/\tau_a) \quad (21)$$

is the abatement cost discount factor, characterized by an abatement cost discount time constant,  $\tau_a$  (inverse annual discount factor).

The first term in the expression (20) has the property that any positive or negative departure from the reference BAU emission path,  $e_A$ , incurs costs that are quadratic in the deviations  $\delta r = r - 1$  for small  $\delta r$ ,  $(\frac{1}{r} - r)^2 \approx 4(\delta r)^2$ , and approach infinity for both  $r \rightarrow 0$  and  $r \rightarrow \infty$ . The quadratic dependence on the first and second derivatives of  $e(t)$  is the simplest way of parameterizing economic inertia in the model. We have not included a “no-regrets” feature to model market imperfections, which would yield an initial decrease in the costs for an initial decrease in emissions.



The use of a prescribed BAU emission path as a reference in the abatement costs expression follows Nordhaus (1991, 1993) and Tahvonen *et al.* (1994, 1995). It can be argued that this approach is unrealistic. The introduction of abatement measures will necessarily induce changes in technology, which will result in continually changing (presumably continually lower) reference BAU emission curves if these curves are continually updated. Thus, ideally the BAU curves should be defined with respect to a running reference time, allowing for technological changes already induced by mitigation measures in the past. However, the optimization problem becomes more complex if these changes are taken into account, and few data exist to define such a dynamic set of BAU emission curves. In the interest of transparency, we shall therefore use a fixed BAU reference curve. In practice, this simplification is probably not too serious, as the impacts of uncertainties in the future mitigation costs are exponentially discounted (see discussion below).

For the specific climate-damage costs, we take the simple form

$$c_d = \left\{ \left( \frac{T}{T_c} \right)^2 + \left( \frac{\dot{T}}{\dot{T}_c} \right)^2 \right\} D_d(t) \quad , \quad (22)$$

where

$$D_d(t) = \exp(-t/\tau_d) \quad (23)$$

is the climate-damage cost discount factor, with discount time constant  $\tau_d$ , and  $T_c$  and  $\dot{T}_c$  are scaling constants. Thus, we assume that climate damage is incurred not only through a change in the temperature itself but also through the rate at which the temperature changes: the adjustment of the ecology and human activities to climate change is more difficult the faster the change. The incurred climate damage is assumed to be independent of the sign of the temperature change, although we will be concerned only with positive changes. The quadratic dependencies also reflect the general view that climate-damage costs increase nonlinearly with climate change.

We have made use of the freedom to choose an arbitrary common normalization constant in the definition of the cost functions by setting the coefficient of the first term of the abatement cost function (20) equal to unity. This establishes the significance of the constants  $T_c$  and  $\dot{T}_c$  in the damage cost function in relation to the abatement costs:  $T_c$  and  $\dot{T}_c$  represent critical values of the temperature change and rate of temperature change, respectively, for which the climate-damage costs become comparable with the abatement costs when emissions are reduced by approximately

50% ( $r=0.5$ ) relative to the BAU case. Thus, the parameters  $T_c$  and  $\hat{T}_c$  may be regarded as defining a critical (soft-shouldered) elliptical window or corridor in the climate phase space  $T_c, \hat{T}_c$  within which the climate-damage costs are less than or of the same order as the mitigation costs at an abatement level of order  $r = O(0.5)$ . Outside the corridor the climate-damage costs are greater than the mitigation costs at this abatement level.

The minimal-cost solution can be found numerically by a method of steepest descent (e.g., a conjugate gradient technique; see Press *et al.*, 1986). This method requires computing the gradient of the cost with respect to the control function, that is, the emissions  $e(t)$ . For a climate model expressed in integral response form, the gradient can be computed explicitly (see the Appendix). However, in the numerical results presented below, the gradient was computed automatically using a general numerical functional derivative compiler (Giering and Kaminski, 1996), which had the advantage of immediately providing the gradient whenever the climate model was modified.

## 5. Sensitivity experiments

In all computations we have taken a simple functional form as our reference climate-independent BAU emission scenario  $e_A(t)$  for the computation of the abatement costs: a linear increase for the first 205 years, from 1995 until 2200, growing from 6.3 GtC/yr in 1995 at an initial growth rate of 2.5 %/year to 38 GtC/yr in 2200. This increase is consistent with the upper and lower bounds of emission projections from different energy models (Nordhaus and Yohe, 1983; Reilly *et al.*, 1987; Manne and Richels, 1991; see Table 2.1 in Cline, 1992) and also with the range of IPCC (1992) projections. After 205 years, the emissions are simply frozen at the 38 GtC/yr level. The decision to freeze them at this level is based in part on the tentative longer-term projections of the energy models, which assume a continual decrease of the emission growth rate beginning in the next century (although they do not consider projections significantly longer than 200 years), but is basically arbitrary. A constant long-term emissions level will clearly not be attainable indefinitely because of limits to fossil fuel resources. Nevertheless, we have not used a decreasing long-term projection for our reference level in computing the abatement costs, because the relevant information would be speculative and, more important, our optimal emission scenarios are found to be insensitive to the form of scenario  $e_A(t)$  beyond a few hundred years, provided a modest discount factor, with a time constant of the order of 50 or

100 years, is applied to the abatement costs. (This assumes, however, that a smaller discount rate is applied to the climate-damage costs in order to obtain optimal emission paths that are consistent with limited global warming; see discussion below.)

The simulations were repeated with a BAU scenario in which the linear increase of  $e_A$  was extended to 800 years. Despite the significant (and clearly unrealistic) increase in the BAU reference emissions level and the corresponding CO<sub>2</sub> concentration over the longer term, the differences in the computed optimal emission paths were minimal, because the changes in the BAU path became effective only after the abatement costs had already been strongly discounted. Nevertheless, to place the BAU scenario in a more general perspective, we compare the BAU climate projections (run SA) with a modified BAU scenario (run SB) in which the emissions decline linearly after 200 years, and two frozen-emission scenarios (runs SF and SG).

Prior to the linear BAU curve beginning in 1995, we have introduced an exponential spin-up stage, starting from the preindustrial state at time  $t_0 = 1800$ ,

$$e_A(t) = 6.3 \exp[(t - t_0 - 195)/t_s] \quad \text{for } t_0 \leq t < 1995 \quad , \quad (24)$$

where  $195 = t(\text{today}) - t_0 = 1995 - 1800$  corresponds to the length of the spin-up period. The emissions spin-up time constant was determined as  $t_s = 35$  years from the condition that the carbon cycle model (14) must reproduce the 1995 CO<sub>2</sub> concentration  $w(1995) = 358$  ppm for the given preindustrial concentration  $w_0 = w(1800) = 280$  ppm. Coincidentally, the condition for a continuous derivative in the transition from exponential to linear growth in 1995, which would require  $t_s = 40$  years, is thereby also almost satisfied.

All computations have been carried out with a discretization time step of  $\Delta t = 5$  years from the year 1800 over a period of 1200 years, up to the year 3000. However, the emissions were allowed to adjust freely only over 805 years, from 1995 to 2800, and were then frozen at the level  $e(2800)$  for the last 200 years. The time span is clearly unrealistically long for economic predictions, but, as is apparent from Figure 2 and the results shown in the following figures, is nevertheless appropriate for assessing long-term climate impacts relevant for a sustainable development policy. The set of computations for different parameter combinations is listed in Table 2. The results are shown in Figures 3 to 7.

**Table 2.** Emission scenarios.

Scenario	Figure	Parameter settings
SA	3	Business as usual (BAU)
SB	3	Modified BAU
SF	3	Frozen emissions at 1990 level after 2000
SG	3	Reduced emissions frozen at 80% of 1990 level after 2000
S0	4	Baseline reduced-emissions run: baseline climate model R00, cost-function parameters: $T_c = 1^\circ C$ , $\dot{T}_c = 0.02^\circ C/yr$ $\tau_1 = \tau_2 = 100$ yrs $\tau_a = 50$ yrs, $\tau_d = \infty$ yrs
S1a, S1b	4	Same as S0, but with reduced abatement cost inertial terms (run S1a, $\tau_1 = \tau_2 = 50$ yrs) or zero inertial terms (run S1b, $\tau_1 = \tau_2 = 0$ )
S2	4	Same as S0, but with temperature rate-of- change term $\dot{T}_c$ only in climate-damage costs
S3a, S3b	5	Same as S0, but with abatement cost discount time constant changed from $\tau_a = 50$ yrs to $\tau_a = 25$ yrs (S3a) and $\tau_a = 100$ yrs (S3b)
S4a, S4b, S4c, S4d	6	Same as S0, but with finite climate-damage cost discount time constants $\tau_d = 100$ yrs (S4a), 50 yrs (S4b), 35 yrs (S4c), and 25 yrs (S4d)
S5	7	Same as S0, but with damage costs enhanced by various factors $\gamma$

### 5.1. The BAU scenario

The CO<sub>2</sub> emissions and resultant concentrations and global warming for the reference BAU scenario (run SA, solid curves) are shown in Figure 3, together with other scenarios in which the emissions are prescribed. The evolution is depicted both for the full 1000-year horizon (with an additional initial 200-year spin-up period) and for a 200-year horizon to illustrate the dangers of designing sustainable development strategies only over short time scales. The BAU scenario can be interpreted quantitatively only for the first 100–150 years. Thereafter, the CO<sub>2</sub> concentrations and temperatures exceed the limits of our linear response model. However, the order-of-magnitude prediction that the CO<sub>2</sub> concentrations will grow to some 10 times the present value over the course of several hundred years may be expected to remain valid. In fact, this figure is presumably an underestimate, as it ignores the positive feedbacks of the decreasing solubility of CO<sub>2</sub> in the ocean with increasing temperature and increasing CO<sub>2</sub> concentrations (these effects are

included in the above-mentioned nonlinear response model of Joos *et al.*, 1995).

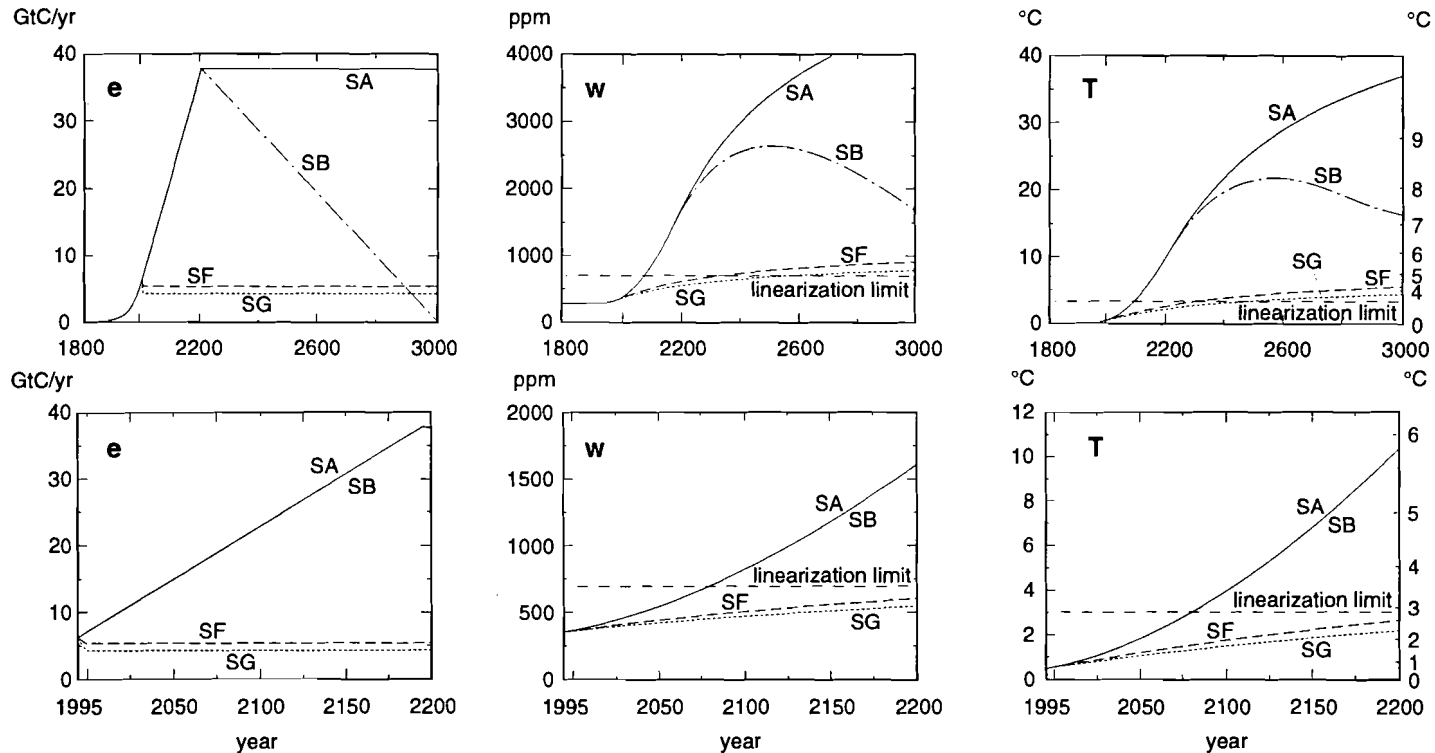
The linearized temperature response, on the other hand, is strongly exaggerated for higher temperature increases. If the usual logarithmic dependence of the radiative forcing on changes in the CO<sub>2</sub> concentration is assumed instead of our linear relation, the temperature response for a 10-fold increase in the CO<sub>2</sub> level is estimated to be of the order of 8°C (see the logarithmic temperature scale on the right-hand side of the top-right panel of Figure 3; the scale is normalized by setting the equilibrium temperature response to a CO<sub>2</sub> doubling at 2.5°C for both the linear and the logarithmic case). However, at these temperatures other nonlinearities besides the dependence of radiative forcing on the CO<sub>2</sub> concentration will become important, including possible instabilities, for example through a breakdown of the North Atlantic circulation. Reliable predictions cannot be made for these extreme climate changes even with complex nonlinear three-dimensional carbon cycle and coupled atmosphere-ocean general circulation models, as one then enters a climate regime for which there exist no previous experience or data.

The full severity of the BAU climate change impact becomes apparent only in the long-term perspective over several hundred years. However, the constant increase in the second half of the next millennium depends on the presumably unrealistic assumption of a constant emission level of 38 GtC/yr after 200 years. Accordingly, in Figure 3 we have also shown a modified BAU scenario (SB) that is more consistent with the estimated fossil fuel reserves; this scenario assumes a linear decrease of the emissions level, from a maximum value of 38 GtC in the year 2200 down to zero in the year 3000. The climate change is also dramatic for this scenario.

Although it is useful to recall the drastic climatic impact of a laissez-faire climate policy, the BAU climate prediction, and thus the limitations of the present linearized climate response model, as well as our questionable long-term emissions assumption are, in fact, irrelevant to the present study. We need to refer to the BAU emission curve only to compute the abatement costs for the determination of optimal reduced-emission scenarios, all of which – assuming a rational climate protection strategy consistent with a policy of sustainable development – yield significantly smaller climate changes lying more or less within the linear climate response range.

## 5.2. The frozen-emissions scenarios

The UN Conference on Environment and Development, held in Rio de Janeiro, 1992, recommended the freezing of CO<sub>2</sub> emissions at 1990 levels



**Figure 3.** From left to right: CO<sub>2</sub> emissions, computed CO<sub>2</sub> concentrations, and global warming for the time periods 1800–3000 (top) and 1995–2200 (bottom) for the BAU scenario (SA, solid lines), modified BAU scenario (SB, dashed-dotted lines), frozen emissions at 1990 levels after the year 2000 (SF, dashed lines), and 20% reduced emissions relative to the 1990 level after 2000 (SG, dotted lines). The linear model is not applicable above the indicated linearization limits. The logarithmic *T* scale on the right ordinate axis of the top-right panel indicates the order-of-magnitude temperature response allowing for the logarithmic dependency of the radiative forcing on the CO<sub>2</sub> concentration.

by the year 2000 as a first target toward a long-term climate stabilization policy. The evolution of CO<sub>2</sub> concentrations and the global mean temperature for this scenario, SF, assuming that 1990 emission levels are maintained after 2000, is shown in Figure 3. Also shown is an alternative scenario, SG, in which the emissions are frozen at a slightly lower level of 80% of the 1990 levels, as has been proposed by some countries. Although in the medium term global warming is significantly reduced in the frozen-emission scenarios, the long-term temperature rise is still considerable. Thus, these scenarios can be regarded only as effective in gaining time for the implementation of longer-term abatement measures, which, as shown below, require a greater reduction of CO<sub>2</sub> emission levels and a transition to carbon-free energy technologies.

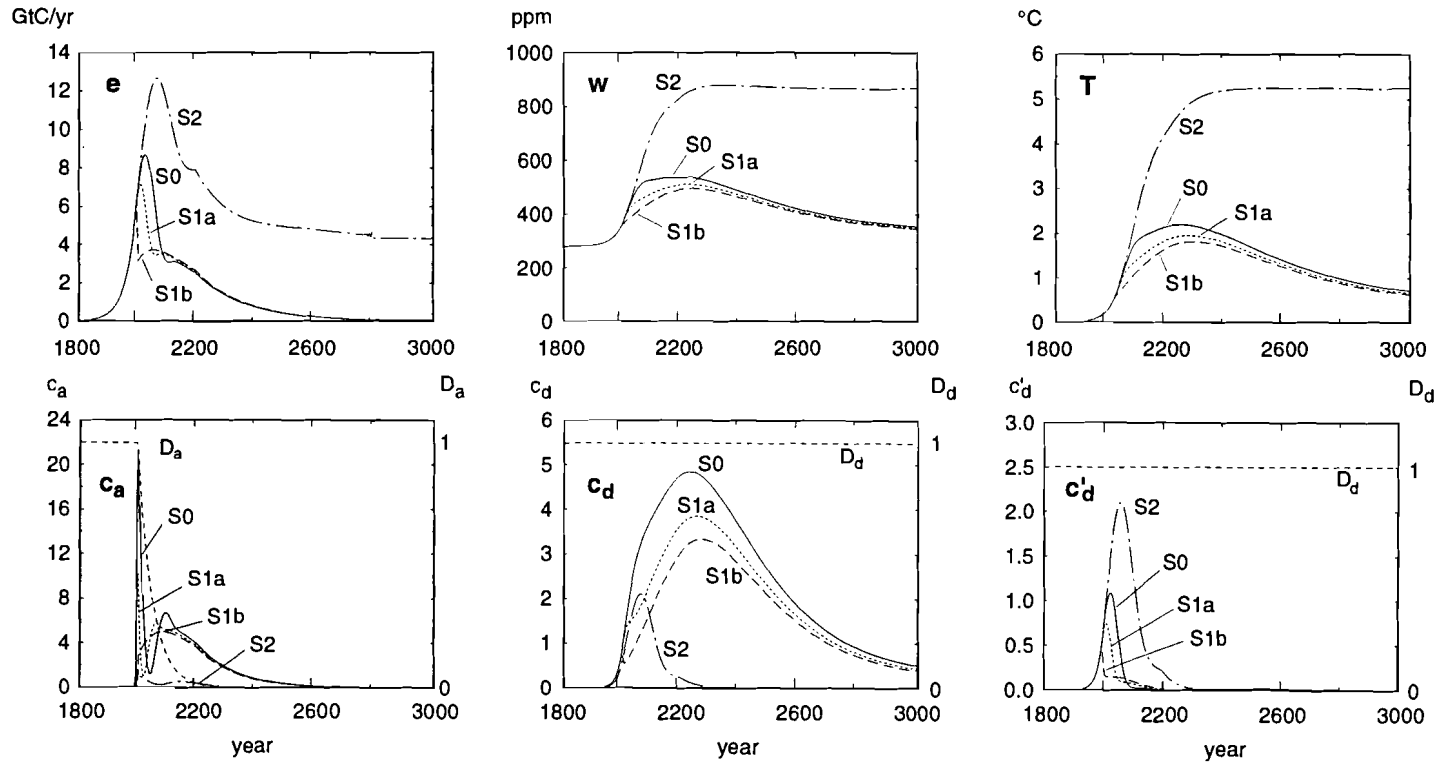
### 5.3. The baseline scenario S0

A baseline reduced-emissions computation S0 (Figure 4) was carried out for the cost-function parameter values  $T_c = 1^\circ\text{C}$ ,  $\dot{T}_c = 0.02^\circ\text{C}/\text{yr}$ , and  $\tau_1 = \tau_2 = 100$  years, with discount time constants  $\tau_a = 50$  years and  $\tau_d = \infty$ . The impact of different parameter settings and different discount factors is explored in runs S1 to S5 (Figures 4 to 7).

The critical temperature,  $T_c = 1^\circ\text{C}$ , and rate of temperature change,  $\dot{T}_c = 0.02^\circ\text{C}/\text{yr}$  ( $1^\circ\text{C}$  increase in 50 years), for the climate-damage cost function of the standard scenario, S0, are representative of typical values quoted in the literature. For scenario S0, they lead to a maximum temperature increase of  $T_{max} = 2.2^\circ\text{C}$  (see Figure 4). The decrease in temperature beyond the year 2200 results from discounting the abatement costs while applying no discounting factor to the climate-damage costs: this asymmetry makes it economical in the long term to continually reduce emissions in order to reduce damage costs (discount factors are discussed in more detail below).

### 5.4. Economic inertia

The choice of the economic inertia coefficients,  $\tau_1$  and  $\tau_2$ , was found to be relatively uncritical. These coefficients act mainly in the initial stages, ensuring that the emission reduction is not discontinuous at the start time of the control path ( $t = 1995$ ). Thus, initially the emissions follow the BAU path (see also the more detailed discussion in Wigley *et al.*, 1996). However, the long-term impact of economic inertia remains minimal, as demonstrated in Figure 4, which shows a comparison of the baseline scenario S0 with runs in which the inertial terms were reduced (S1a) or set equal to zero (S1b).



**Figure 4.** Evolution paths over the period 1800–3000. Top, left to right: CO<sub>2</sub> emissions, CO<sub>2</sub> concentrations, global mean temperature. Bottom, left to right: specific abatement costs ( $c_a$ ), specific damage costs ( $c_d$ ), and the contribution to the specific damage cost ( $c'_d$ ) from the rate of change of temperature. Cases shown are (see Table 2) the baseline reduced-emissions scenario S0 (solid lines), the same run with reduced or zero inertial terms in the abatement cost function (run S1a, dotted lines, and run S1b, dashed lines, respectively), and a modified baseline run in which the climate-damage costs are assumed to depend only on  $T$  (run S2, dashed-dotted lines). Also indicated in the lower panels are the exponential abatement and damage cost discount factors,  $D_a$  and  $D_d$ .



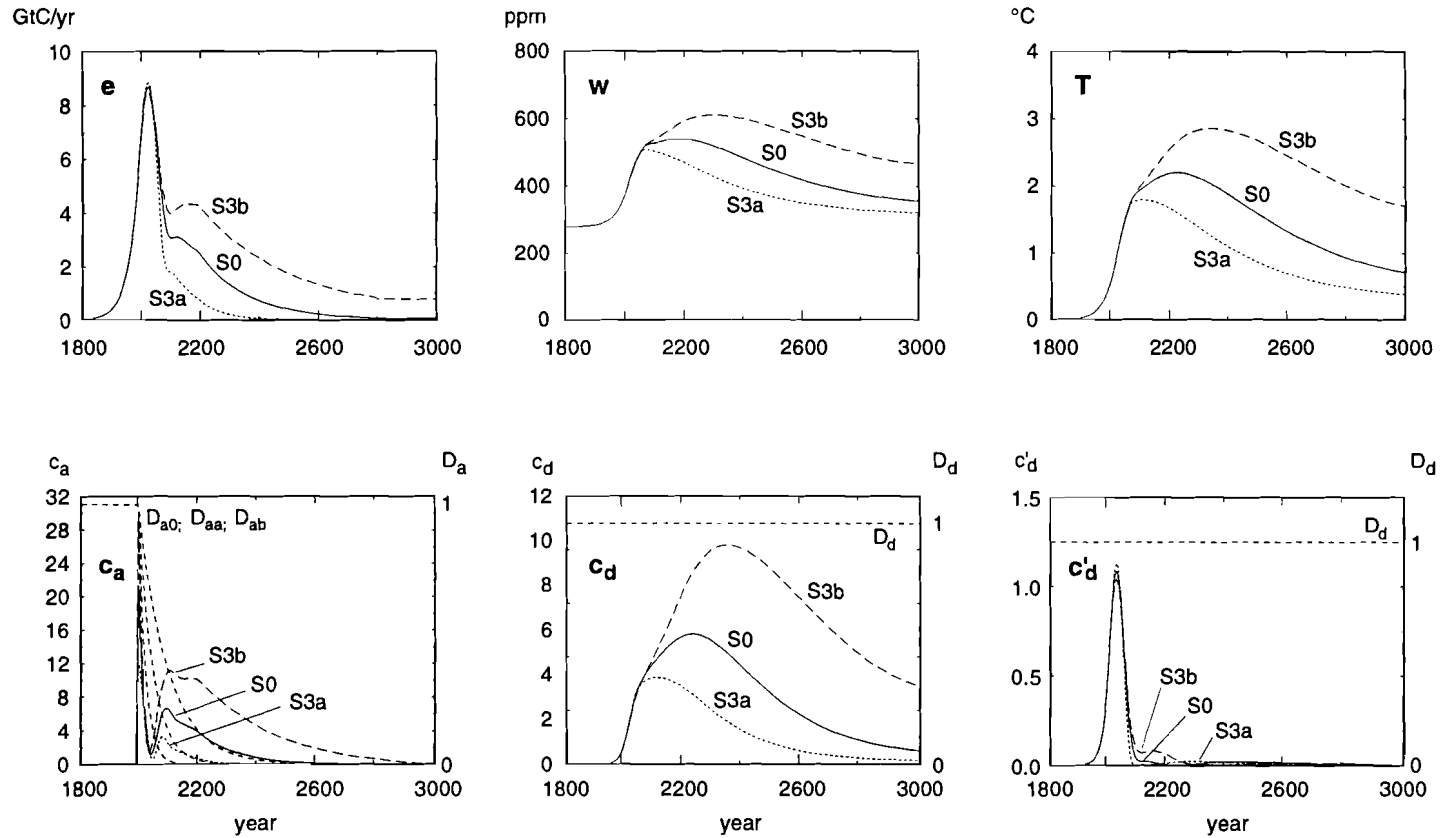
### 5.5. Impact of temperature change and rate of temperature change

The principal contribution to climate-damage costs was found to stem from the temperature change itself, rather than the rate of temperature change (see net climate-damage costs,  $c_d$ , and the contribution,  $c'_d$ , incurred by the rate of temperature change depicted in Figure 4). This result is also demonstrated by the optimal emissions scenario S2 (see Figure 4), in which the climate-damage costs were represented only by a single term depending on the rate of temperature change. The maximal temperature increases 6°C within 300 years and then remains at this level. The results of Tahvonen *et al.* (1994, 1995), who considered only this  $\dot{T}$ -dependent term in their climate-damage costs, should therefore be regarded as only illustrative (as was pointed out by the authors). Adopting the usually quoted critical values  $T_c$  and  $\dot{T}_c$  of our baseline scenario S0, our model indicates that for the typical time constants of climate change the climate-damage costs will be dominated by the temperature change itself rather than the rate of temperature change. However, for quantitative projections this point needs closer scrutiny with respect to the different types of climate damage.

### 5.6. Discount rates for mitigation costs

The most critical and also most controversial terms in the cost functions are the discount factors. It has been argued that the discount rates for mitigation and climate-damage costs should be treated differently. Accordingly, we study their impacts separately first and return to the question of their interrelation later.

Because our simple abatement costs model does not distinguish between the separate effects of growth in wealth, return on capital, endogenous technological development, and other processes normally included in a more detailed economic model, our discount factor for the mitigation costs represents the net impact of all of these processes combined. Our choice of the abatement cost discount time constant  $\tau_a = 50$  years (2% per year) for the baseline scenario is at the lower range of (inflation-adjusted) discount factors proposed in greenhouse gas abatement studies (see Nordhaus, 1991, 1993). Figure 5 shows the impact of decreasing the time constant,  $\tau_a$ , to 25 years (scenario S3a), and the effect of doubling  $\tau_a$  to 100 years (scenario S3b). A shorter discount time scale implies that one can afford to apply mitigation measures earlier, thus reducing global warming; for a larger time constant it is more economical to delay abatement measures, with a resultant increase



**Figure 5.** Impact of changed abatement cost discount time constants  $\tau_a = 25$  years (S3a, dotted lines) and  $\tau_a = 100$  years (S3b, dashed lines) compared with baseline case  $\tau_a = 50$  years (scenario S0, solid lines; see Table 2 and caption to Figure 4 for information on layout of figure.)

in global warming. The value of  $\tau_a$  is seen to have a strong influence on the computed optimal emission paths. However, this conclusion is based on a fixed discount rate for the climate-damage costs, which we have set to zero in our baseline scenario S0 and in scenarios S3a and S3b. Because we are concerned only with the ratio of climate-damage costs to mitigation costs, parallel changes in the discount rates for both types of costs tend to offset one another. This point is discussed further below.

### 5.7. Discount rates for climate-damage costs

More controversial than the discount rate for mitigation costs has been the proper intertemporal treatment of climate-damage costs. According to the traditional economic view, climate-damage costs are economic costs just like any other costs and therefore should be discounted at the same rate as mitigation costs. This view is based on the idea that climate damages can be countered by appropriate engineering measures, such as building higher dikes in response to rising sea levels, or other economic adjustments. Thus, in principle, there is no difference between the economic efforts required to respond to or limit climate change.

An alternative view is that the deterioration of future living conditions through an irreversible change in climate represents a loss in welfare that to first order is independent of the period in the future when the climate change actually takes place. Future sustainable development is perceived as a commitment that does not degrade over time, and to which a time-independent welfare value should therefore be assigned. In this view, climate damage represents a quality-of-life or welfare loss that is fundamentally different from abatement costs. The preservation of a habitable planet for future generations is accepted as a legacy that must be honored today, regardless of the time horizon over which our present actions will affect future living conditions.

Following this second line of reasoning, we have not introduced discounting of damage costs in our baseline reduced-emissions run, S0. The underlying value judgements are, of course, debatable. The application of the same or comparable discount factors to both mitigation and climate-damage costs (e.g., Nordhaus, 1991, 1993; Beltratti, 1995) yields basically different conclusions, as is discussed below.

For political decision making, however, it is irrelevant which of these theoretical assessments of the future impact of climate change is “correct.” What is relevant for the computation of an optimal emission path – at least in a functioning democratic society – is the public and politically transmitted

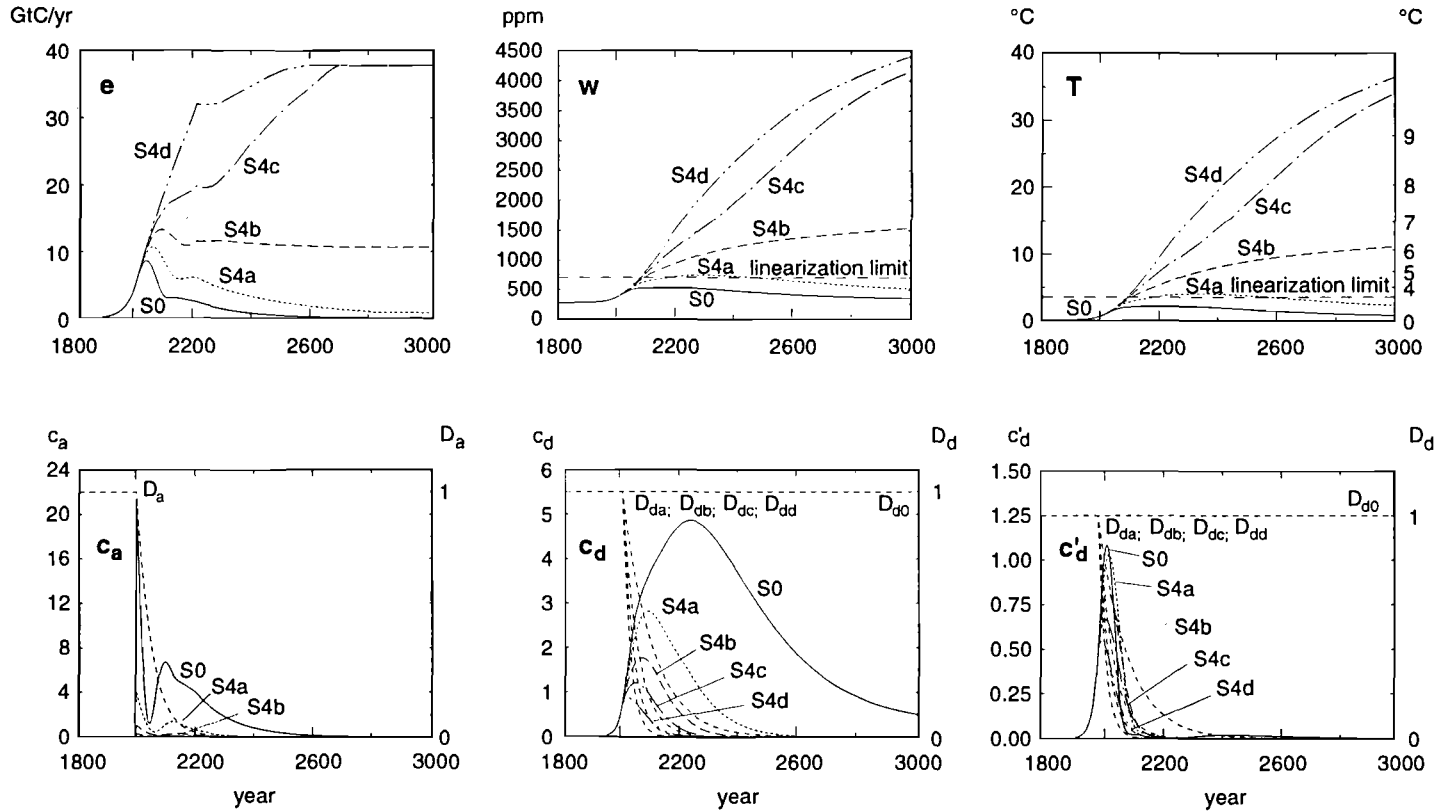
perception of the value of a stable future climate. It would be an instructive sociological exercise to ascertain whether a significant irreversible climate change resulting from the present activities of humankind that is predicted to create major existential problems for generations far in the future, well beyond the normal economic discounting time horizon, is regarded by the public and politicians as a serious problem requiring remedial action today. Investigations by Kempton *et al.* (1995) suggest that this is probably the case, although this assessment is not always supported by current politics.

Different assumptions regarding the rate of damage cost discounting can be readily explored with our model. Scenarios S4a, S4b, S4c, and S4d (Figure 6) show the effect of introducing finite damage-cost discount time constants of 100, 50, 35, and 25 years, respectively. The maximal CO<sub>2</sub> concentrations and temperatures increase markedly, particularly for the last two cases. The climate changes implied by these temperature increases – noting that regional temperature changes, for example over continents, can be significantly higher than the global mean temperature rise – imply a dramatic change in the living conditions on our planet. However, this occurs only after several hundred years, when the climate-damage costs have been discounted by one or two orders of magnitude.

### 5.8. Ratio of climate-damage and abatement cost discount rates

The character of the solutions depends critically on the ratio of the climate-damage and abatement cost discount factors. With the exception of scenarios S4b, S4c, and S4d (Figure 6), in all cases considered the discount time constant was higher for the climate-damage costs than for the abatement costs, and the long-term temperature increase for the optimal emissions path remained limited. If this inequality holds, the discounted specific abatement costs become exponentially small compared with the discounted specific climate-damage costs for  $t \rightarrow \infty$ , and the most cost-effective path is one in which the emissions approach zero asymptotically (except for scenario S2, in which the damage costs depended only on  $\dot{T}$ ).

The form of the solution changes completely if the opposite inequality,  $\tau_d < \tau_a$ , holds (scenarios S4c and S4d). In this case, the climate-damage costs are discounted more rapidly than the mitigation costs, and it becomes more cost-effective to revert to the BAU scenario asymptotically. Although the nondiscounted specific climate damage grows with the square of the temperature, this is more than offset by the more effective exponential discount factor for the damage costs, and  $e(t) \rightarrow e_A(t)$  as  $t \rightarrow \infty$ . Accordingly, the



**Figure 6.** Comparison of the baseline case S0 without climate-damage cost discounting (solid lines) with scenarios assuming finite discount time constants  $\tau_d = 100$  years (simulation S4a, dotted lines),  $\tau_d = 50$  years (S4b, dashed lines),  $\tau_d = 35$  years (S4c, dashed-dotted lines), and  $\tau_d = 25$  years (S4d, dashed-double-dotted lines). See Table 2 and caption for Figure 4 for information on layout of figure.

asymptotic CO<sub>2</sub> concentrations and temperatures of scenarios S4c and S4d are the same as for the BAU scenario (Figure 3).

If  $\tau_d = \tau_a$  (scenario S4b, Figure 6), neither cost term is discounted more rapidly than the other. (However, the discounted climate-damage costs are reduced by a more or less constant factor relative to the discounted abatement costs because of the time lag of climate change relative to the emissions.) In this case, the optimal emissions path remains at a relatively high level between the BAU path and zero emissions.

The global warming levels of the optimal path solutions of Figure 6 – even for case S4a with  $\tau_d = 100$  years  $>$   $\tau_a = 50$  years – are considerably higher than the solutions obtained assuming zero discount rates for the climate-damage costs. The temperature increases exceed most estimates of the limits of global warming acceptable for sustainable development. Thus, if one subscribes to the ethical commitment of preserving a habitable planet for future generations, these solutions cannot be accepted. It follows that to the extent that there exists a public commitment to this principle, the societal intertemporal preference relations describing the present and future costs of adapting to or mitigating climate change cannot be expressed in terms of standard economic discount factors appropriate for, say, the short-term return on capital investment or intertemporal expenditure preferences for consumer goods. Rather, the willingness to pay for the well-being of future generations is analogous to the willingness to contribute to public education, development aid, or other societal actions that do not directly benefit the individual. Thus, it appears more appropriate to determine the intertemporal values attached by society to the mitigation of future climate change empirically by assessing public willingness to pay for such measures.

We conclude from these examples that the computed optimal emission paths are highly sensitive to the relative values of the discount rates for climate-damage and mitigation costs, and that solutions qualitatively consistent with the requirement of sustainable development are obtained only if the climate-damage discount time constants are greater than the discount time constants for abatement costs.

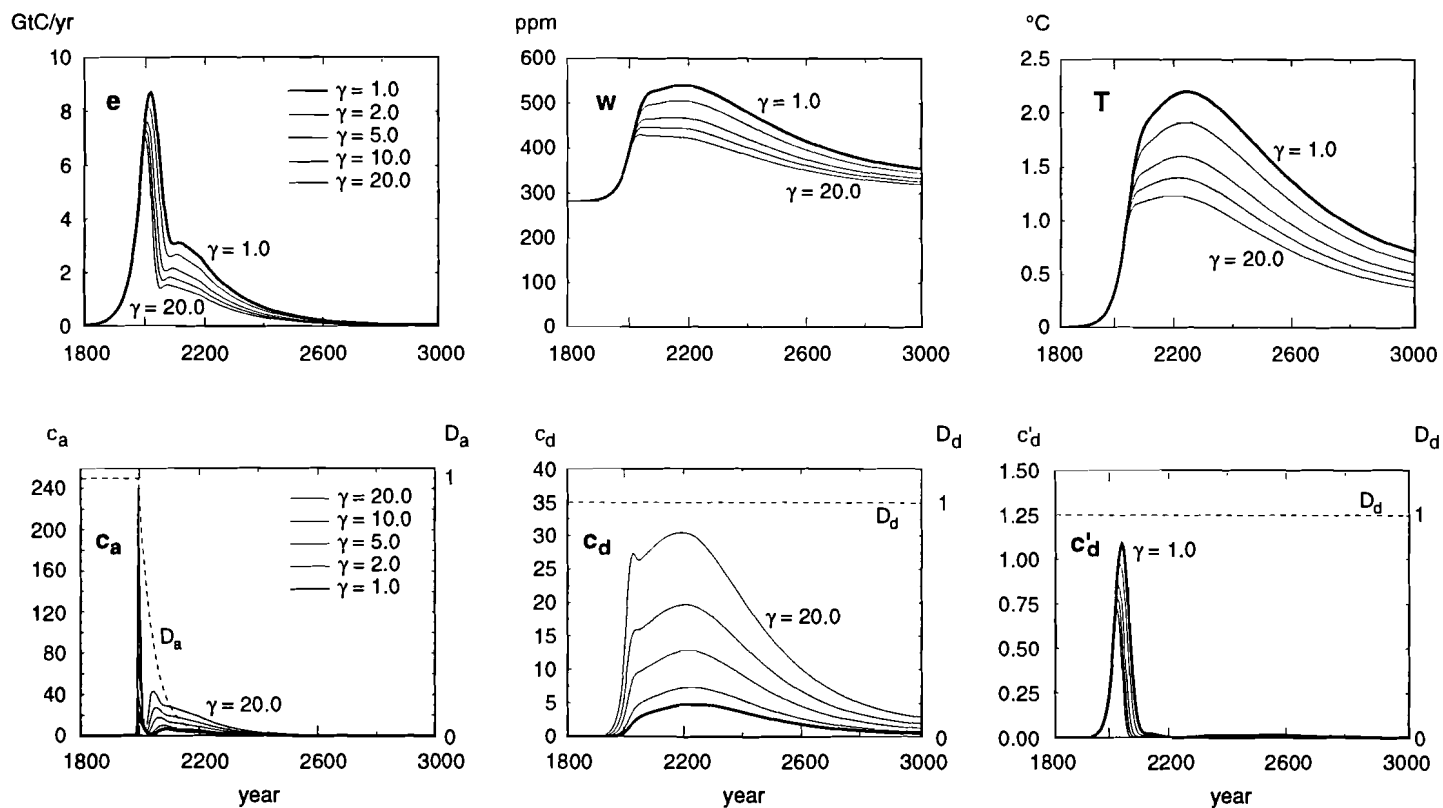
### **5.9. Impact of other greenhouse gases or modified mitigation/damage cost ratios**

Our greenhouse warming simulations have been carried out only for CO<sub>2</sub> emissions and are thus overly optimistic. To allow for the comparable climatic impact of other greenhouse gases such as methane and

chlorofluorocarbons (CFCs), our computed optimal CO<sub>2</sub> emission paths must be reduced. To gain a qualitative estimate of the influence of non-CO<sub>2</sub> greenhouse gases, we assume that they can be reduced in parallel with, and at the same relative costs as, the CO<sub>2</sub> concentrations. The computed CO<sub>2</sub> concentrations may then be regarded to the first order simply as a proxy for the equivalent greenhouse CO<sub>2</sub> concentration, representing the net effect of all greenhouse gas concentrations (see IPCC, 1990a). Assuming a fixed ratio,  $\gamma$ , between the equivalent and true CO<sub>2</sub> concentrations, the effect of the non-CO<sub>2</sub> greenhouse gases can then be represented by simply replacing the temperature computed for the true CO<sub>2</sub> emissions path,  $T$ , with the temperature  $T_{equiv} = \gamma T$ . Because the damage cost function depends quadratically on the temperature [see equation (22)], this corresponds to an increase of the damage cost function by a factor of  $\gamma^2$ . The mitigation costs, on the other hand, increase by a factor of only  $\gamma$ . Thus, the ratio of climate-damage costs to mitigation costs is increased by a net factor of  $\gamma$ .

The impact is shown in Figure 7. The curves can also be interpreted as showing the general effect of a change  $\gamma$  in the ratio of climate-damage costs to mitigation costs. The impacts are smaller than may have been anticipated intuitively. This can be explained by two effects. First, a relative increase in climate-damage costs by a factor of  $\gamma$  implies a decrease in the critical climate temperature,  $T_c$  (and the critical rate of change of temperature  $\dot{T}_c$ ), by a factor of only  $\gamma^{-1/2}$ . Thus, to reduce the climate-damage costs to the same level as in the CO<sub>2</sub>-only case, the emissions must be decreased by a factor of only  $\gamma^{-1/2}$ . Second, while for these emission values the climate-damage costs are at the same level as in the CO<sub>2</sub>-only case, because of the lower emission levels, the abatement costs are higher. For the optimal-emissions solution, in which a balance is attained between the mitigation and damage costs, the abatement costs will therefore be lower and the emission levels higher than these values. Hence the reduction in emission levels for the solution including both CO<sub>2</sub> and non-CO<sub>2</sub> greenhouse gases will be still smaller than the factor  $\gamma^{-1/2}$ .

However, if we adopt the alternative assumption that the non-CO<sub>2</sub> greenhouse gases cannot be readily reduced, the reduction in CO<sub>2</sub> emission levels needed to counteract the effect of increasing concentrations of other greenhouse gases can be considerably larger than computed for the CO<sub>2</sub>-only case. This situation is discussed in the context of noncooperative actors in the  $n$ -actor climate mitigation problem in Hasselmann and Hasselmann (1996).



**Figure 7.** Impact of a change in the ratio of climate-damage costs to mitigation costs by a factor of  $\gamma$ . Non- $\text{CO}_2$  greenhouse gases can be modeled qualitatively by values of  $\gamma > 1$  (e.g.,  $\gamma = 2$  if they contribute the same radiative forcing as  $\text{CO}_2$ ). Results for the baseline scenario S0 ( $\gamma = 1$ ) are shown as thick solid lines. See Table 2 and caption for Figure 4 for information on layout of figure.



## 6. Conclusions

The purpose of this study was not to provide quantitative monetary estimates of costs and benefits of optimal CO<sub>2</sub> emission strategies to assist decision makers in determining, say, the proper level of carbon taxes. Rather, the goal was to clarify the basic input assumptions and cause-and-effect relations that are presumably responsible for the pronounced divergences in existing cost-benefit analyses. Our approach has enabled us to discriminate between conclusions that represent relatively robust consequences of the dynamics of the climate system and predictions that depend on controversial input assumptions.

To this end we introduced a simple impulse-response climate model, calibrated using state-of-the-art CGCM climate and three-dimensional global carbon cycle models, as well as highly idealized but structurally transparent expressions for the climate-damage and mitigation costs. For the determination of optimal emission paths, only the relative levels of climate-damage and mitigation costs, not the absolute cost values, are relevant.

The principal conclusions from our investigation can be summarized as follows:

- Because global warming response for CO<sub>2</sub> emissions extends over several hundred years (Figure 2), the costs associated with the climate impact of present and future CO<sub>2</sub> emissions must be optimized over horizons far beyond normal economic discounting time scales.
- If, as in many studies, climate-damage costs are discounted at standard economic discount rates, the optimal CO<sub>2</sub> emission paths are only weakly reduced relative to the BAU scenario. The resultant long-term climate warming remains very large and sustainable development is not attained. This result is logical: by discounting climate-damage costs, it is assumed that the maintenance of a habitable climate far in the future is of negligible present value. It is questionable, however, whether this scenario corresponds to the value assigned by society to sustainable development: an “optimal” emissions path that leads to major global warming is probably not acceptable to the general public. Although we subscribe to the principle that the optimal climate protection strategy should be determined through a cost-benefit analysis in which an attempt is made to attach a monetary value to all costs, we suggest that the monetary value of the asset “a habitable planet for future generations” should be ascertained on the basis of willingness-to-pay criteria. This approach would presumably reveal intertemporal value assignments

for the principle of sustainable development that are different from the normal discount relations used to model societal time preference relations associated with, say, the deferred purchase of consumer goods.

- If global warming is to remain below an acceptable bound the discount rate for mitigation costs must be greater than the discount rate for climate-damage costs. In practice, optimal CO<sub>2</sub> emission paths yielding acceptable global warming are obtained only if the discount rate of climate damage is very small or zero. Accordingly, our baseline scenario assumes a zero discount rate for climate-damage costs. In all solutions yielding limited global warming, CO<sub>2</sub> emissions must be drawn down significantly by a factor of at least a half over a few centuries, with a continual decrease thereafter. The rate of reduction for the optimal path depends on the assumed discount rate for the mitigation costs.
- Because economic inertia is included in the mitigation cost function, CO<sub>2</sub> emissions are not immediately reduced in our baseline optimal emissions path, but rise for a few decades before declining. However, even when the inertial terms are omitted, allowing emissions to adjust immediately to a new level at no economic rate-of-change cost penalty, the optimal emission paths exhibit no immediate drastic drawdown. Moreover, the long-term climate response does not differ significantly for the cases with and without economic inertia. We conclude that an effective climate mitigation strategy must focus on the long-term transition to energy technologies with zero or very low CO<sub>2</sub> emissions. Short-term reductions through energy savings, although high on the present political agenda, are insufficient on their own and should be viewed only as a useful auxiliary measure in support of the necessary long-term technological transition process.
- The technological restructuring can be carried out without dramatic dislocations over the course of many decades or a century. This should not be interpreted as implying that there is no urgency in the implementation of policies initiating the necessary gradual transition to lower CO<sub>2</sub>-emission levels: any delay permitting a nonregulated continuation along the BAU path incurs the need for larger, more costly adjustments later. Moreover, in initiating the transition, the inertia not only of the economy but also of the political process must be taken into account. The computed delay in the drawdown of CO<sub>2</sub> emissions for our baseline scenario was based on a simple parameterization of the transition costs associated with economic inertia only – assuming an optimal reduction policy can be immediately implemented politically. Our results are thus overly optimistic regarding the time pressures of adjusting the complete

socioeconomic system and should not be interpreted as implying the existence of a time cushion for delaying implementation decisions.

- Another simplification resulting in emission scenarios that are too optimistic is the limitation to CO<sub>2</sub> emissions, ignoring the comparable global warming contributions of non-CO<sub>2</sub> greenhouse gases. To the extent that the abatement of non-CO<sub>2</sub> greenhouse gases can be achieved at a relative cost similar to that of CO<sub>2</sub> emissions, the impact of non-CO<sub>2</sub> greenhouse gases can be accounted for to the first order by simply increasing the climate-damage costs by an appropriate factor. This approach leads to somewhat lower but not drastically reduced optimal CO<sub>2</sub> emission paths. As the ratio of climate-damage costs to abatement costs is an arbitrary free parameter in our analysis anyway, our general conclusions are not affected by this modification. However, the problem is more severe if non-CO<sub>2</sub> greenhouse gases cannot be effectively abated (see discussion of the analogous single mitigator, multi-actor problem in Hasselmann and Hasselmann, 1996).
- For the time scales of climate change corresponding to the optimal CO<sub>2</sub> emission paths, climate damage due to the rate of change of temperature is an order of magnitude smaller than damage due to the change in temperature itself. However, these estimates are based on global critical climate-damage thresholds of  $T_c = 1^\circ\text{C}$  for temperature and  $\dot{T}_c = 0.2^\circ\text{C}/\text{decade}$  for the rate of temperature change, which need to be differentiated more carefully with regard to the type of climate damage.

A number of general implications can be drawn from these conclusions. Although our sensitivity analysis was based on structurally highly simplified cost models and must be quantified in monetary units using more realistic economic models, most of the practical policy implications of our structural analysis are independent of the details of such models. In practice, more realistic economic models necessarily involve assumptions, for example regarding future technological development, whose uncertainties largely mask the quantitative predictive potential of the models.

The central dilemma for decision makers highlighted by our analysis is the time scale mismatch between the multicentury climate response to present and future CO<sub>2</sub> emissions, on the one hand, and typical economic and policy planning horizons of a few years to a decade, on the other hand. It is obviously unrealistic to plan CO<sub>2</sub> emissions centuries into the future. Our computed optimal emission paths are meaningful only in the sense that they identify the time scales and orders of magnitude of the emission reductions required to stabilize the climate. The optimal paths will depend in detail on

evolving energy technology and other factors that cannot be predicted over long time horizons. Short- and medium-term policy decisions can establish only the necessary framework favoring a gradual transition to a path of continually decreasing emissions. Long-term policies will necessarily be limited to establishing effective monitoring mechanisms and periodically adjusting regulatory mechanisms in accordance with continually updated projections.

Much of the discussion on the reduction of CO<sub>2</sub> emissions has revolved around instruments for internalizing climate-damage costs, for example, through carbon taxes or tradable emission permits. However, our computations indicate that, taken alone, the encouragement of energy efficiency through these measures will be insufficient to attain the goal of climate stability. To achieve the necessary transition to carbon-free energy technologies, a push-pull approach will presumably be needed, including both penalties for CO<sub>2</sub> emissions and rewards for the development of alternative energy technologies.

Realistic climate protection measures are necessarily limited in their immediate impact on CO<sub>2</sub> emissions to time scales that are short relative to the natural time span of the global warming problem. Thus their immediate influence on long-term climate evolution is small. Nonetheless, a far-sighted policy can induce a negative curvature in the emissions curve which, if upheld in the future, would have a significant long-term impact. From this viewpoint, the principal role of more realistic economic models should be to study the impact of the available instruments for controlling climate emissions in the politically viable short and medium time scales on the trend and change in trend (that is, on the first and second time derivatives) of the CO<sub>2</sub> emissions curve. From these studies one could then derive realistic (moving) targets for the first two time derivatives, defined from the perspective of the major long-term reduction of CO<sub>2</sub> emissions mandated by climate model predictions. The performance of the economy in response to the applied regulatory instruments would need to be continually monitored and the targets and control mechanisms periodically updated.

## 7. Outlook

The implementation of a long-term monitoring policy and a continually re-tuned regulatory policy requires more realistic modeling tools than are currently available. The realization of an effective climate protection policy within an international framework, for example, raises a number of complex

issues regarding decision making involving several actors with different values and goals, which cannot be adequately addressed with the single-actor economic models considered here. However, we suggest that before embarking on complex multi-actor game-theoretical analyses using sophisticated multiregional, multisectoral economic models, it would be useful, in keeping with the philosophy of the present approach, to carry out a general systems analysis study using a structurally highly simplified multi-actor model (see Hasselmann and Hasselmann, 1996).

In addition to the restriction to a single actor and the simplification of the economics, there are a number of other basic limitations to the present model that need to be addressed. For example, a realistic model would also need to simulate the inherent internal variability of the system, which is an essential dynamic feature of both climate and socioeconomic systems. It has been shown (Hasselmann, 1976) that long-term fluctuations in the climate system can be generated by the stochastic forcing exerted by short-term random weather fluctuations acting on the slow components of the system (the oceans, the biosphere, and the cryosphere), analogous to the Brownian motion of heavy molecules excited by random collisions with lighter molecules. Stochastic forcing may also be expected to produce slow fluctuations in the socioeconomic system, which similarly contains both slow elements (for example, in the form of energy technology or the cultural values of a society) and more rapidly fluctuating components (such as business cycles, societal fashions, and other short-term adjustment processes). A realistic representation of the interactions between the different spectral frequency bands of the natural variability spectrum is an important test of our understanding of the dynamics of the GES system and our ability to correctly represent the response of the system to external anthropogenic forcing.

Another reason for the consideration of natural variability is that the impact of anthropogenic global climate change must be weighed against the impacts of the inherent internal variability of the GES system. The skepticism that is occasionally expressed with regard to the need for a climate protection strategy can probably be attributed in good part to the intuitive feeling that the effects of the (unpredictable) inherent variability of the socioeconomic system will always outweigh the impact of the predicted climate change. The rational analysis of such assessments requires GES models that are able to simulate both the response to external anthropogenic forcing and the internal variability of the system.

A more realistic GES model will also need to include societal components, particularly with regard to the establishment of the mitigation and climate-damage cost functions and the representation of the decision-making

module in Figure 1. For the political decision-making process, the “true costs” are less relevant than the “perceived costs” (Stehr and von Storch, 1995). Transmitting scientific predictions of future climate change, as well as rational assessments of the ensuing climate-damage or mitigation costs, to the political arena involves the creation of a “social construct” of climate change and its impact. This product of the media, interest groups, and public awareness and education need not be closely correlated with scientific perceptions. A significant portion of the population in the USA, for example, perceives as dangers attributable to global warming the unrelated problem of the pollution of the atmosphere by health-threatening gases or the (entirely negligible) depletion of oxygen in the atmosphere (Kempton *et al.*, 1995). In a similar poll conducted in Germany, 80% of those interviewed believed that global warming and the ozone hole were directly related.

In this context, the concept of a predefined cost function dependent only on the state of the economy and the climate may also be questioned. Social values change over time, as evidenced by the recent increase in public concern over threats to the environment (see also Turner, 1995). Our understanding of climate change also evolves with time. The non-stationarity of the “social construct” of climate change on longer time scales of several hundred years is well illustrated by the medieval example related by Stehr and von Storch (1995), in which a severe climate degradation in fourteenth-century England was successfully reversed (in the perception of the time) by a “mitigation” policy of public penitence initiated by the archbishop of Canterbury.

Thus, both our scientific assessment of climate change and its impact, and the transmission of this understanding into a “climate construct” serving as the basis of policy decisions, should be viewed as evolving entities. Our present assessment and the resultant policy decisions may well be regarded as inadequate and inappropriate by future generations. A further aspect that should be included in more detailed integrated assessment studies is therefore the problem of decision making under uncertainty. This aspect would need to include the probabilistic assessment of risk and the impact of an anticipated future reduction of uncertainty on the timing of decisions.

The time scale and uncertainty dilemma notwithstanding, we have no choice but to accept our present understanding as the basis for defining and implementing policies that, although subject to continual later revision, must nevertheless be designed to shape the future far beyond the societal horizon that we can confidently perceive or anticipate today.

Despite the limitations of the present study and the nonmonetary, illustrative nature of our simulations, we believe that several general features of the optimal emission path solutions we have presented will survive later

improved insights and more quantitative treatments. These concern, in particular, the long time scales of the climate response, the general time history and order of magnitude of the reduction in CO<sub>2</sub> emissions required to avert a major global warming, and the need to express the commitment to long-term sustainable development independent of standard discounting rates in terms of “willingness to pay” present values in order to obtain meaningful optimal emission solutions from cost-benefit analyses that do indeed satisfy the requirement of sustainable development.

### **Acknowledgments**

We are grateful to Renate Brokopf for assistance in carrying out the computations and to Norbert Noreiks for producing the graphics. Our investigations were stimulated in part by a contribution in collaboration with Hans-Joachim Schellnhuber for a report of the Wissenschaftlicher Beirat Globale Umweltveränderungen (German Advisory Council on Global Change).

## Appendix: Computation of the Cost Gradient

We derive the gradient of the cost,  $g(t)$ , in the following using continuous functional-derivative notation. In practice, however, the cost  $C$ , equation (17), is computed as a discrete sum rather than the integrals (18) and (19), and the functional derivative  $\delta C/\delta e = g(t)$  becomes a normal gradient vector whose components are indicated by a discrete time index.

Applying definitions (18) and (19), the variation of  $C$  yields

$$\delta C = \int_{t_0}^{t_h} \left[ \frac{\partial c_a(e, \dot{e}, t)}{\partial e} \delta e + \frac{\partial c_a(e, \dot{e}, t)}{\partial \dot{e}} \delta \dot{e} + \frac{\partial c_a(e, \ddot{e}, t)}{\partial \ddot{e}} \delta \ddot{e} + \frac{\partial c_d(T, \dot{T}, t)}{\partial T} \delta T + \frac{\partial c_d(T, \dot{T}, t)}{\partial \dot{T}} \delta \dot{T} \right] dt \quad (\text{A1})$$

or, substituting the variational relations

$$\delta T(t) = \int_{t_0}^t R(t-t') \delta e(t') dt' \quad , \text{ and} \quad (\text{A2})$$

$$\delta \dot{T}(t) = \int_{t_0}^t \dot{R}(t-t') \delta e(t') dt' + R(0) \delta e(t) \quad (\text{A3})$$

for the model equation (1), and removing the time derivatives on  $\delta e$  by partial differentiation,

$$\begin{aligned} \delta C &= \int_{t_0}^{t_h} \left( \frac{\partial c_a}{\partial e} - \frac{d}{dt} \frac{\partial c_a}{\partial \dot{e}} + \frac{d^2}{dt^2} \frac{\partial c_a}{\partial \ddot{e}} \right) \delta e(t) dt \\ &+ \left[ \frac{\partial c_a}{\partial \dot{e}} \delta e(t) - \frac{d}{dt} \frac{\partial c_a}{\partial \ddot{e}} \delta e(t) \right]_0^{t_h} + \left[ \frac{\partial c_a}{\partial \ddot{e}} \delta \dot{e}(t) \right]_0^{t_h} \\ &+ \int_{t_0}^{t_h} dt \frac{\partial c_d}{\partial T} \int_{t_0}^t dt' R(t-t') \delta e(t') \\ &+ \int_{t_0}^{t_h} dt \frac{\partial c_d}{\partial \dot{T}} R(0) \delta e(t) + \int_{t_0}^{t_h} dt \frac{\partial c_d}{\partial \dot{T}} \int_{t_0}^t dt' \dot{R}(t-t') \delta e(t') \quad . (\text{A4}) \end{aligned}$$

Applying relation (10) to the double integrals and invoking equation (13), we obtain for the gradient  $g(t) = \delta C/\delta e(t)$

$$\begin{aligned} g(t) &= \left( \frac{\partial c_a}{\partial e} - \frac{d}{dt} \frac{\partial c_a}{\partial \dot{e}} + \frac{d^2}{dt^2} \frac{\partial c_a}{\partial \ddot{e}} \right) + \int_t^{t_h} \left\{ \frac{\partial c_d}{\partial T}(t') R(t'-t) \right. \\ &+ \left. \frac{\partial c_d}{\partial \dot{T}}(t') \dot{R}(t'-t) dt' \right\} \quad . \quad (\text{A5}) \end{aligned}$$



In equation (A5) we have dropped the terms resulting from the perturbations in equation (A4) at the endpoints of the interval. These yield  $\delta$ -function expressions that in effect impose the boundary conditions

$$e(t) = 0 \quad \text{at } t = 0, t_h \quad (\text{if } c^a \text{ depends on } \dot{e}) \quad , \quad (\text{A6})$$

$$\dot{e}(t) = 0 \quad \text{at } t = 0, t_h \quad (\text{if } c^a \text{ depends on } \ddot{e}) \quad . \quad (\text{A7})$$

If these boundary conditions are not satisfied, the contributions to the abatement cost,  $c_a$ , at the endpoints of the interval will become infinite if the dependence on  $\dot{e}$  or  $\ddot{e}$  is quadratic, as we have assumed. However, in the discretized practical implementation there is no need to impose boundary conditions (A6) and (A7) explicitly; they are satisfied automatically by the minimal-cost solution in the limit of a very small discretization increment.

## References

- Beltratti, A., 1995, Sustainable Growth: Models and Implications, pp. 296-311, in G. Boero and A.Z. Silverstone (eds.), *Environmental Economics*, St. Martin's Press, New York, NY, USA.
- Bryan, K., Komro, F.G., Manabe, S., and Spelman, M.J., 1982, Transient Climate Response to Increasing Atmospheric Carbon Dioxide, *Science* **215**:56-58.
- Cline, W.R., 1992, *The Economics of Global Warming*, Institute for International Economics, Washington, DC, USA.
- Cubasch, U., Hasselmann, K., Höck, H., Maier-Reimer, E., Mikolajewicz, U., Santer, B.D., and Sausen, R., 1992, Time-Dependent Greenhouse Warming Computations with a Coupled Ocean-Atmosphere Model, *Climate Dynamics* **8**: 55-69.
- Enting, I.G., Wigley, T.M.L., and Heimann, M., 1994, Future Emissions and Concentrations of Carbon Dioxide: Key Ocean/Atmosphere/Land Analyses, CSIRO Technical Paper **31**.
- Fankhauser, S., 1995, *Valuing Climate Change*, Earthscan, London, UK.
- Giering, R., and Kaminski, T., 1996. Recipes for Adjoint Code Construction, submitted to *ACM Transactions on Mathematical Software*.
- Hasselmann, K., 1976, Stochastic Climate Models. Part 1: Theory, *Tellus* **28**:473-485.
- Hasselmann, K., 1991, How Well Can We Predict the Climate Crisis? Conference on Environmental Scarcity: The International Dimension, 5-6 July at Kiel, Germany (ed. H. Siebert). *Symposien- und Konferenzbände des Instituts für Weltwirtschaft an der Universität Kiel*, J.C.B. Mohr (Paul Siebeck), Tübingen, Germany, pp. 165-183.
- Hasselmann, K., Sausen, R., Maier-Reimer, E., and Voss, R., 1993, On the Cold Start Problem in Transient Simulations with Coupled Atmosphere-Ocean Models, *Climate Dynamics* **9**:53-61.
- Hasselmann, K., and Hasselmann, S., 1996. Multi-actor Optimization of Greenhouse Gas Emission Paths Using Coupled Integral Climate Response and Economic Models, *Proceedings of Potsdam Symposium on Earth System Analysis: Integrating Science for Sustainability*, 1994.
- IPCC (Intergovernmental Panel on Climate Change), 1990a, *Climate Change. The IPCC Scientific Assessment* (J.T. Houghton, G.J. Jenkins, J.J. Ephraums, eds.), Cambridge University Press, Cambridge, UK.
- IPCC (Intergovernmental Panel on Climate Change), 1990b, *Climate Change. The IPCC Impact Assessment*, Report from Working Group II, Australian Government Publishing Service, Canberra, Australia.
- IPCC (Intergovernmental Panel on Climate Change), 1992, *Climate Change 1992. The Supplementary Report to the IPCC Assessment* (J.T. Houghton, B.A. Callander, and S.K. Varney, eds.), Cambridge University Press, Cambridge, UK.
- IPCC (Intergovernmental Panel on Climate Change), 1994, *Climate Change 1994. Radiative Forcing of Climate Change and an Evaluation of the IPCC IS92*

- Emission Scenarios* (J.T. Houghton, L.G. Meira Filho, J. Bruce, Hoesung Lee, B.A. Callander, E. Haites, N. Harris, and K. Maskell, eds.), Cambridge University Press, Cambridge, UK.
- Joos, F., Bruno, M., Fink, R., Siegenthaler, U., Stocker, T.F., Le Quéré, C., and Sarmiento, J.L., 1995, An Efficient and Accurate Representation of Complex Oceanic and Biospheric Models of Anthropogenic Carbon Uptake (submitted to *Tellus*).
- Kempton, W., Boster, J.S., and Hartley, J.A., 1995, *Environmental Values in American Culture*, MIT Press, Cambridge, MA, USA, and London, UK.
- Maier-Reimer, E., and Hasselmann, K., 1987, Transport and Storage of CO<sub>2</sub> in the Ocean: An Inorganic Ocean-Circulation Carbon Cycle Model, *Climate Dynamics* **2**:63–90.
- Maier-Reimer, E., 1993, The Biological Pump in the Greenhouse, *Global and Planetary Climate Change* **8**:13–15.
- Manne, A.S., and Richels, R.G., 1991, Global CO<sub>2</sub> Emission Reductions: The Impacts of Rising Energy Costs, *The Energy Journal* **12**:88–107.
- Manne, A.S., and Richels, R.G., 1995, The Greenhouse Debate: Economic Efficiency, Burden Sharing and Hedging Strategies, *The Energy Journal* **16**:4.
- Michaelis, P., 1994, The Cost of Stabilising the Atmospheric Concentration of Greenhouse Gases, paper prepared for the EU Workshop on Designing Economic Policy for Management and of Natural Resources and the Environment, 7–9 September 1994, Rethymon, Crete, Greece.
- Mikolajewicz, U., Santer, B., and Maier-Reimer, E., 1990, Ocean Response to Greenhouse Warming, *Nature* **345**:589–593.
- Nordhaus, W.D., 1991, To Slow or Not to Slow: The Economics of the Greenhouse Effect, *Economic Journal* **101**:920–937.
- Nordhaus, W.D., 1994, Expert Opinion on Climate Change, *American Scientist* **82**:45–51.
- Nordhaus, W.D., 1993, Rolling the 'DICE': An Optimal Transition Path for Controlling Greenhouse Gases, *Resource and Energy Economics* **15**:27–50.
- Nordhaus, W.D., and Yohe, G.W., 1983, Future Carbon Dioxide Emissions from Fossil Fuels, in *Changing Climate*, pp. 87–153, National Research Council, National Academy Press, Washington, DC, USA.
- Nordhaus, W.D., and Yang, Z., 1995, *A Regional Dynamic General Equilibrium Model of Optimal Climate-Change Policy*, draft report, Yale University, New Haven, CT, USA.
- Peck, S.C., and Teisberg, C.J., 1992, CETA: A Model for Carbon Emissions Trajectory Assessment, *Energy Journal* **13**:55–77.
- Press, W.H., Flannery, B.P., Teukolsky, S.A., and Vetterling, W.T., 1986, *Numerical Recipes*, Cambridge University Press, Cambridge, UK.
- Reilly, J.M., Edmonds, J.A., Gardner, R.H., and Brenkert, A.L., 1987, Uncertainty Analysis of the IEA/ORAU CO<sub>2</sub> Emissions Model, *The Energy Journal* **8**:1–29.
- Richels, R.G., and Edmonds, J., 1995, The Economics of Stabilizing CO<sub>2</sub> Emissions, *Energy Policy* **23**:4–5.

- Rotmans, J., de Boois, H., and Swart, R., 1990, An Integrated Model for the Assessment of the Greenhouse Effect: The Dutch Approach, *Climate Change* **16**:331-335.
- Sarmiento, J.L., Orr, J.C., and Siegenthaler, U., 1992, A Perturbation Simulation of CO<sub>2</sub> Uptake in an Ocean General Circulation Model, *Journal of Geophysical Research* **97**:3621-3624.
- Stehr, N., and von Storch, H., 1995, The Social Construct of Climate and Climate Change, *Climate Research* **5**:99-110.
- Tahvonen, O., von Storch, H., and von Storch, J., 1994, Economic Efficiency of CO<sub>2</sub> Reduction Programs, *Climate Research* **4**:127-141.
- Tahvonen, O., von Storch, H., and von Storch, J., 1995, Atmospheric CO<sub>2</sub> Accumulation and Problems in Dynamically Efficient Emission Abatement, pp. 234-265 in G. Boero and Z.A. Silverstone (eds.), *Environmental Economics*, St. Martin's Press, New York, NY, USA.
- Turner, R.K., 1995, An Ecological Economics Approach to Coastal Zone Management, Proceedings Conference on Changing Estuarine and Coastal Environments, GKSS Research Centre, Geesthacht, Germany, 8-12 October 1995, pp. 122-141.
- Wigley, T.M.L., Richels, R., and Edmonds, J.A., 1996, Economic and Environmental Choices in the Stabilization of Atmospheric CO<sub>2</sub> Emissions, *Nature* **379**:240-243.

# Learning from Integrated Assessment of Climate Change

*M. Granger Morgan and Hadi Dowlatabadi*  
Carnegie Mellon University, Pittsburgh, PA, USA

## 1. Introduction

The idea of doing integrated assessment of climate change has recently become popular in the USA (Corell, 1993; Gibbons, 1993). It is argued that, by putting current knowledge together into a single, coordinated analysis framework, it should be possible to draw better insights about policy options and to do a better job of setting future research priorities. Such activities began more than a decade ago, both as coordinated discussion pieces (Schneider and Chen, 1980; Schneider, 1989; National Research Council, 1992) and also as formal models (Nordhaus, 1977; Rotmans, 1990; Manne and Richels, 1992; Peck and Teisberg, 1992). Today, more than 20 efforts are under way around the world (Dowlatabadi, 1995a; Weyant *et al.*, 1996). Not all of these efforts share the same goals. For example, some address a particular nation's problems, some are international in focus, and others examine specific economic sectors in great detail. However, we believe a few basic principles, summarized in Table 1, should guide all integrated assessments (Dowlatabadi and Morgan, 1993a).

Integrated assessment is neither an end in itself, nor a one-shot proposition. The most useful results from doing integrated assessment will typically not be "answers" to specific policy questions. Rather they will be insights about the nature and structure of the climate problem, about what matters, and about what we still need to learn. At Carnegie Mellon, we have had a group of about 12 faculty and 15 graduate students working on integrated assessment for the past six years. We began our work in 1990 by building a list of key policy questions and constructing a set of influence diagrams that spanned the problem and acted as a graphical checklist for subsequent analysis (Morgan and Dowlatabadi, 1994). Then we performed a systematic scenario analysis (ICAM-0) to examine the relative importance of uncertainty in the science versus value judgments about costs and benefits (Lave and Dowlatabadi, 1993). Given current and likely future uncertainties, we found that the value judgments dominate. Next, we constructed a stochastic simulation model called the Integrated Climate Assessment Model, or

**Table 1.** Hallmarks of a good integrated assessment of climate change.

- 
1. The characterization and analysis of uncertainty should be a central focus of all assessments.
  2. The approach should be iterative. The focus of attention should be permitted to shift over time depending on what has been learned and which parts of the problem are found to be critical to answer the questions being asked.
  3. Parts of the problem about which we have little knowledge must not be ignored. Order-of-magnitude analysis, bounding analysis, and carefully elicited expert judgment should be used when formal models are not possible.
  4. Treatment of values should be explicit and, when possible, parametric so that many different actors can make use of results from the same assessment.
  5. To provide proper perspective, climate impacts should be placed in the context of other natural and human background stochastic variation and secular trends. Where possible, relevant historical data should be used.
  6. A successful assessment is likely to consist of a set of coordinated analyses that span the problem, not a single model. Different parts of this set will probably need to adopt different analytical strategies.
  7. There should be multiple assessments:
    - Different actors and problems will require different formulations; and,
    - No one project will get everything right; nor are results from any one project likely to be persuasive on their own.
- 

ICAM-1 (Dowlatabadi and Morgan, 1993b). In parallel, we began a number of detailed studies, building on the lessons we were learning, to lay the ground work for our next iteration. We have recently completed a second-generation stochastic simulation model called ICAM-2 (Dowlatabadi and Kandlikar, 1995). In the ICAM model, most parameters are described as probability distributions and uncertainties are propagated through the model and analyzed using standard methods in the DEMOS software environment (Henrion and Morgan, 1985; Morgan and Henrion, 1990). ICAM 2.1 involves specification of over 2000 uncertain quantities. Probability distributions are constructed from primary literature, expert elicitations (Morgan and Keith, 1995), and, in some cases, our own subjective judgments. In parallel with simulation of demographic, economic, and environmental changes and their response to various policy implementations, ICAM includes estimates of market and nonmarket impacts of climate change. The latter have been chosen to reflect plausible ability and willingness to pay in different regions of the world. The ICAM family of models is in the public domain (through the authors), and

they should be regarded as frameworks for coherent probabilistic exploration of climate change issues.

While we have produced over 40 papers and conference reports on various facets of the climate change problem (Global Change Integrated Assessment Program, 1995), in this article we step back from all the specifics to reflect on the broader insights that we can draw from our work to date.

Most discussions of climate change begin with the natural science, then discuss physical, biological, and social impacts, and finally move to policy. Indeed, that is a reasonable reflection of the structure of the US Global Change Research Program, which until recently has devoted almost all its attention to the natural sciences. However, because the motivation for our work on integrated assessment is to try to gain policy-relevant insight, a somewhat different structure is appropriate for this article. We will begin by asking who are the decision makers? Then we will identify the issues that concern them. From there we will go on to ask where are the serious impacts likely to occur? Although policy issues will be discussed throughout the paper, we will close with some specific evaluations of several policy options, followed by a very brief discussion of some of the problems we see for future work. Throughout the discussion, our focus will be on the insights we have gained relevant to how decision makers and research administrators frame and think about the climate problem.

## **2. Who Are the Climate Decision Makers?**

Some assessment efforts implicitly assume that the world's policy decisions about climate will be made just once, by a single decision maker: a "unitary rational actor" who might also be termed a "global commoner." Of course, the people who build and use these models know this is not true. However, they would argue, such models can at least give a valuable first impression.

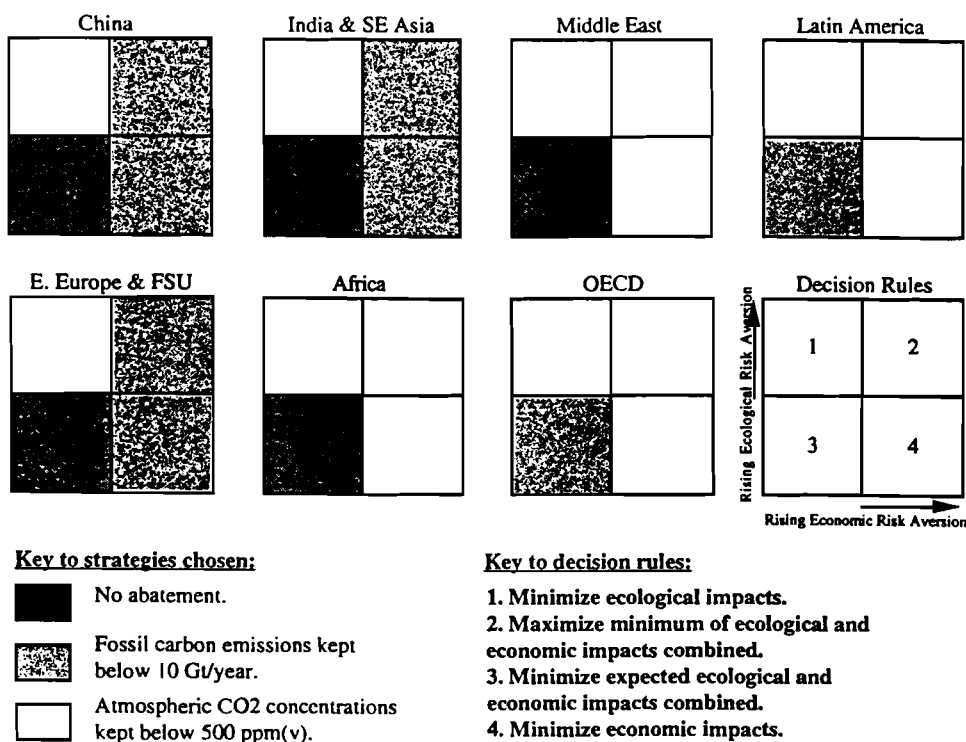
Our work has led us to believe that the first impressions gained from a "global commoner" model may confuse more than they clarify. At the international level, at least a dozen different nations will make choices that could have significant climate implications. Many of those choices will not be made by single national decision-making authorities, but rather through the individual choices of millions of organizations and individual citizens, and they will be driven by local interests and conditions. This distributed decision making is one of the most fundamental characteristics of the climate problem. A second, equally fundamental characteristic of the problem is

that these many separate decision makers are principally motivated by non-climate considerations (micromotives) and will each make a long sequence of choices with climate implications (macrobehaviors) (Schelling, 1978). As time goes by, many of these choices will be designed to adapt as new social and climate circumstances and understanding emerge. This pattern of sequential and adaptive decision making is an equally fundamental characteristic of the climate problem.

The first stochastic simulation integrated assessment model we built (ICAM-1) divided the world into two geopolitical regions: high-latitude industrial economies and low-latitude less industrial economies. Even with this very simple model, we found that the choices national decision makers are likely to prefer are very different for these two regions. This difference springs from differential vulnerability to climate change, diverse economic and demographic conditions, and differences in the range of possible response options.

Of course, one reason so many of today's climate assessments assume a single national or international decision maker is that the analyses get complicated very quickly if an attempt is made to include multiple decision makers. For example, will the different actors cooperate or play strategic games? Clearly it is impossible to include all the different perspectives and views of different decision makers in a single analysis. What one can do is include *representative* views so as to begin to explore the implications of the diversity. In the scenario analysis we did in our ICAM-0 model (Lave and Dowlatabadi, 1993), we considered a number of typical groups on the American political scene (environmentalists, industrialists, etc.) and were able to show that groups that held middle-of-the-road views were likely to favor moderate abatement of carbon dioxide (CO<sub>2</sub>), but the more extreme groups on both ends were unlikely to be able to reach any consensus, even if the current scientific uncertainty was reduced considerably. Those favoring no action might favor research as a tactical matter, as a way to stall, but we found it unlikely that modest improvements in scientific understanding would change their policy prescriptions. Similarly, we found it unlikely that those favoring drastic action would moderate their policy prescriptions in the face of modest improvements in scientific understanding. These results suggest that, in a fundamental way, the climate problem is a *political* problem, and that we should work to avoid exaggerated expectations about how much modest improvements in scientific understanding over the next decade or two can improve the situation.





**Figure 1.** The optimal climate policy is dependent on the decision rule and regional factors affecting outcomes. Here, the results for each of the seven regions in ICAM-2 are presented as shaded squares. Each quadrant of these squares represents a different decision rule. Along the horizontal axis, the decision rules reflect neutral and high aversion to economic risk. Along the vertical axis the decision rules reflect neutral and high aversion to ecological risk. The shading in each box indicates the strategy chosen by that regional decision maker when adopting each of the four decision rules. Only when all regions adopt the first decision rule, minimize ecological impact, is there a concordance in strategy. In all other cases, different regions find that different strategies best suit their goals.

We have begun to explore these issues further with results from the ICAM-2 stochastic simulations. Figure 1 illustrates how four different “decision rules” would affect policy choice by different “regional commoners” if they were to make a single one-time policy choice today under the assumptions of our current ICAM-2 assessment model. Clearly, real decision makers will not make a single choice and then stick with it as the world and their

knowledge about it changes. In order to explore the implications of this fact, we have begun to build sequential decision-making models of climate policy evolution. Adaptive behavior and policy revisions occur as a response to learning about the changing global environment. Once a policy instrument has been chosen, the design of implementation requires consideration of how the policy may be introduced and how it may be revised through time as an adaptation to a changing environment. Different implementation designs can be explored and their performance and evolution under different future conditions can be evaluated. The best of these adaptive policy strategies dominate one-time decision-making approaches under a wide range of possible future outcomes (Dowlatabadi, 1995b). A major departure from traditional analysis, this approach to exploring climate change policies shows that setting the policy into motion can provide information about the behavior of the climate and socioeconomic system that can be useful in subsequent decision making. Our simulations suggest that a well-designed “policy experiment” can yield information about the system’s behavior with high net payoff in the long run.

Just as there are questions about which decision rules to adopt in analyzing the problem, there are questions about what structural assumptions to make in constructing the assessment model. Both the behavioral assumptions that are made and the physical and economic processes that are included in the model can have a large impact on the conclusions that one reaches. We illustrate the importance of structural assumptions by using ICAM-2 to calculate the probability that a specific carbon tax will have a positive net present value when compared with business as usual. The results for the world as a whole and the seven regions modeled are presented in Table 2. The important finding is the change in values from case to case, not the absolute value of the probability for any particular case. Column 1 reports the results from the probabilistic ICAM-2 model for structural assumptions that are typical of most deterministic integrated assessment models. As we add plausible elaborations, note the enormous changes that result. For the world as a whole the probability that this particular tax policy will yield a net positive benefit ranges from 15–95%, depending on the structural assumptions that are made!

Note that some modifications tend to increase the odds across all regions, while others tend to move them down. However, whatever structural assumptions are made, one result remains robust: the variation in results across the different regions, which face different geographical and socioeconomic conditions, remain very large. For example, the difference in the

**Table 2.** Probability, as a function of different model structures, that a US\$4.00/ton carbon tax that begins in the year 2000 and increases by US\$4.00/ton every five years through the year 2100 will have a positive net present value.

Model alternatives	Six alternative model structures					
	1	2	3	4	5	6
Model:						
Discounting:	□	•	•	•	•	•
□ – applied at the same level globally;						
• – based on regional growth per cap.						
Technological change:	□	□	•	•	•	•
□ – occurs autonomously;						
• – induced by carbon tax.						
Aerosols:	□	□	□	•	•	•
□ – radiative effects excluded;						
• – radiative effects included.						
Adaptation to climate impacts:	□	□	□	□	•	•
□ – impacts are permanent;						
• – adaptation occurs after detection.						
Oil & gas:	□	□	□	□	□	•
□ – reserves exhausted by 2050;						
• – new reserves will be discovered.						
Region	Probability that the carbon tax policy will have a positive net present value					
China	0.05	0.10	0.10	0.05	0.05	0.00
E. Europe & FSU	0.20	0.65	0.70	0.40	0.15	0.05
India & SE Asia	0.40	0.40	0.55	0.30	0.25	0.15
Africa	0.40	0.50	0.60	0.30	0.25	0.20
Middle East	0.45	0.50	0.55	0.40	0.20	0.15
OECD	0.50	0.85	1.00	0.60	0.60	0.30
Latin America	0.60	0.70	0.95	0.70	0.70	0.25
World	0.25	0.70	0.95	0.55	0.45	0.15

odds between the Organisation for Economic Co-operation and Development (OECD) and China never falls below 30%, and can be as high as 90%.

The ICAM-2 model allows us to describe changes in a number of separate climate, environmental, and socioeconomic attributes such as regional mean annual temperature and precipitation change, local sea level rise, gross domestic product (GDP), fuel use, abatement and adaptation costs, ecosystem characteristics, and so on. Akihiro Tokai and colleagues (1995) have

**Table 3.** Impact of climate and other disturbances on managed and unmanaged ecosystems for the year 2050 with  $2\times\text{CO}_2$  and a global population of 10 billion.

Category of disturbance	Low estimate ( $10^6 \text{ km}^2$ )	High estimate ( $10^6 \text{ km}^2$ )
Ecosystem stressed by climate change <sup>a</sup>	4.2	7.9
Land lost to sea level rise <sup>b</sup>	0.08	0.26
Unmanaged ecosystems lost to agriculture <sup>c</sup>	5.3	12.4
Land lost to urbanization <sup>d</sup>	2.1	6

<sup>a</sup>The low estimate is the 5th percentile projection from the ecosystem dynamics model using a logistic loss function. The high estimate is the 95th percentile projection from the ecosystem dynamics model using an exponential loss function.

<sup>b</sup>The low estimate is the 5th percentile projection from the sea level rise impacts module of ICAM-2. The high estimate is the 95th percentile projection from the same model.

<sup>c</sup>The low estimate is from US Department of Agriculture (Langer *et al.*, 1992). The high estimate is from Kreileman and Bouwman (US Environmental Protection Agency, 1992) under an assumption of no forest regrowth on the land freed from agriculture in North and Latin America, Europe, Commonwealth of Independent States (CIS), and Oceania.

<sup>d</sup>The low estimate is from Waggoner (1994). The high estimate is based on the value of current urban area from Dixon *et al.* (1993) and a trend suggested by Waggoner for the future urban area increase.

performed a preliminary analysis to show how one might construct separate “multi-attribute utility functions” for different hypothetical national actors such as environmentalists and industrialists. Such analysis not only demonstrates the different policy prescriptions preferred by each group but can be used to explore opportunities for “deals” (if the actors are prepared to trade performance on one attribute for another). We are now working to elaborate this work, but find that, because different actors are likely to value social and ecological impacts differently depending on where they occur in space and time, new methods must be developed to support the elicitation of multi-attribute utility functions from representative actors.

In addition to differences caused by basic values and judgments about the future, different policy makers are likely to favor different actions because climate change and its impacts will be only one issue among many requiring their attention and action. Table 3, which estimates the relative magnitude of impacts on ecosystems projected for climate change, sea level rise, agriculture, and urbanization, suggests that this is true even if we restrict ourselves to issues involving global change. If we were concerned only with a single “global commoner,” or even with a number of “national commoners,” whose sole concern is economic efficiency, these results suggest that climate change would not figure as the first priority of very many actors on the world stage.

In a later section, we argue that on average economic impacts of climate change will be modest, at least in the developed world. In some parts of the developing world this may not be true, but even in these places there are probably many investments that could yield greater benefits than climate change abatement. Ecological impacts will be primarily focused on coastal margins and zones of transition from one major biome to another. However, if we abandon the formulation in terms of a global or national commoner, and make the more realistic assumption of multiple actors and political process, the importance of climate change in national and international agendas can increase dramatically. Governments, particularly democracies, tend to focus on “squeaky wheels.” Wealthy coastal communities that are losing valuable real estate and infrastructure to storms as a consequence of sea level rise, and nature lovers who are watching favorite ecological regions become stressed and undergo major change, can exert considerable political leverage. Through processes of interest group politics and “social amplification” (Kasperson *et al.*, 1988) their concerns may drive regional, national, and even international decision processes in ways that are entirely different from the “economically optimal” national or international strategies.

So, who are the climate decision makers? The insight is that, to a greater extent than for any previous environmental problem, they are a diffuse and often divergent group spread all over the globe, many of whom, over a period of many decades, will make a series of climate-relevant decisions that are primarily driven by local, non-climate, considerations. Costs and benefits are both *distributed* and *valued* differently among these decision makers. As a consequence, the mind-set and the social and policy tools we will need in order to frame and deal with the climate problem will often be quite different from those associated with the conventional single-actor single-decision models that have dominated most public policy thinking.

### 3. What Is the Climate Problem?

Most scientists and other well-informed people would describe the climate problem in roughly the following terms. Human activities result in the release into the atmosphere of radiatively important trace substances such as greenhouse gases and aerosols. A portion of these substances remain in the atmosphere and affect the balance of outgoing and incoming solar radiation. This balance is further affected by human changes to the surface of the land. The net effect can be an appreciable change in the average temperature of the planet as well as in the dynamics of the ocean-atmosphere system. These

changes can in turn lead to a variety of changes in local and regional climatic patterns. As they have in the past, such changes in climate will affect both natural ecosystems and the pattern and nature of human activities. Both can be expected to feed back to cause further change in the climate system.

Humans can respond to climate change and its impacts in any or all of four ways. *Abatement* involves reducing emissions in order to slow, stop, or reverse the accumulation of radiatively important trace substances. *Adaptation* involves adjusting to live with the changed climate by changing technology (build aqueducts and dikes) and by shifting behaviors (change farming practices). *Geoengineering* involves modifying the earth system to reestablish the desired radiative balance (e.g., by adding more reflective aerosols to the stratosphere when too much energy is trapped in the atmosphere) or by removing greenhouse gases from the atmosphere (e.g., by planting trees, which sequester CO<sub>2</sub> as they grow). *Research* produces knowledge that can place us in a better position to understand climate and to make more informed choices about abatement, adaptation, and geoengineering. To many, research means extensions to known climate science (Morgan and Keith, 1995), but in fact, some of the most important research is likely to involve impacts, adaptation strategies, abatement technologies, and social experiments that provide information on the relative cost and difficulty of various policies.

So that's "the problem." But is it? In a democracy like the USA, "the problem" is whatever voters and their elected representatives think it is. Thus, one of the first things we did was to try to understand what the American public knows and thinks about the issues of climate change and global warming. To do this we used methods developed in previous work on risk communications (Bostrom *et al.*, 1992; Morgan *et al.*, 1992). We began by conducting a set of carefully structured interviews to develop a preliminary description of what the public knows and thinks about climate change. This description is termed a "mental model." We then went on to verify our findings with a larger set of survey studies.

The people we interviewed regarded global warming as undesirable and highly likely (Bostrom *et al.*, 1994). Many believe that substantial warming has already occurred. They tend to confuse stratospheric ozone depletion with the greenhouse effect and weather with climate. Automobile use, industrial process heat and emissions, pollution in general, and aerosol spray cans are perceived as the main causes of global warming. Additionally, the "greenhouse effect" is often interpreted literally to mean a hot and steamy climate. Respondents described global climate change effects that included

increased incidence of skin cancer and changes in agricultural yields. Mitigation and control strategies proposed by interviewees ranged from alternative fuels for cars to the creation of a synthetic ozone layer. Many of the strategies proposed focused on general pollution control and regulation, with an emphasis on automobile and industrial emissions. Specific links to CO<sub>2</sub> and energy use were relatively infrequent. Respondents appeared to be relatively unfamiliar with recent regulatory developments regarding the environment, such as the ban on chlorofluorocarbons (CFCs) for nonessential uses, such as spray cans.

Drawing on the results of these open-ended interview studies, we developed a questionnaire that was designed to examine laypeople's knowledge about the possible causes and effects of global warming, as well as the likely efficacy of possible interventions. This questionnaire was administered to two groups of well-educated people in Pittsburgh, USA. Our results (Read *et al.*, 1994), which have been supported by similar findings by Kempton and his colleagues (1995), suggest that laypeople have a very nonspecific mental model of climate change. Many appear to believe that all pollutants cause climate change and good green practice will prevent it. Our respondents showed a poor appreciation of two key facts: (1) if significant global warming occurs it will be primarily the result of an increase in the concentration of CO<sub>2</sub> in the earth's atmosphere; and (2) the single most important source of CO<sub>2</sub> additions to the atmosphere is the combustion of fossil fuels, most notably coal and oil. Our respondents' understanding of the climate issue was encumbered by a large number of secondary, irrelevant, and incorrect beliefs. Of these, the two most critical are confusion with the problems of stratospheric and tropospheric ozone, and difficulty in differentiating between causes and actions specific to climate and more general good environmental practice.

When the world is being asked to spend hundreds of billions of dollars on solutions to the problem of climate change, people need a more specific understanding than they now have if they are going to make informed private decisions and be informed participants in public debate about the issue of climate change. The clarifications needed to produce adequate public understanding are fairly simple and well within the capabilities of modern risk communication.

As one step toward improving the situation, we developed a public information booklet on climate change (Morgan and Smuts, 1994). The booklet has two novel features. It is designed to address the misconceptions identified earlier among the general public and it is hierarchically organized so

that readers can choose the level of detail they wish in discussions about climate change, its impacts, and the options we face.

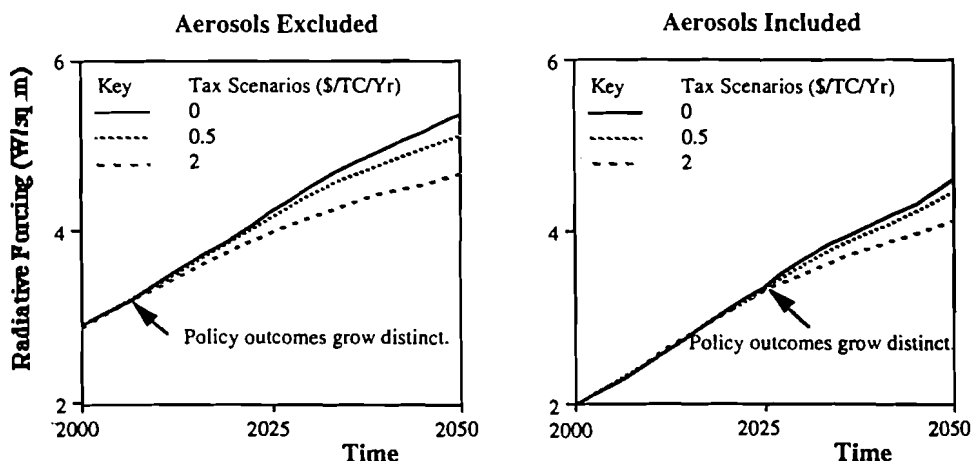
Defining the climate problem involves several other issues beyond the differences between lay and expert characterizations. Different regional actors emphasize different issues; analysis conventions have placed greater emphasis on some processes than on others; and institutional needs have shaped the way in which the problem has been summarized. We illustrate with two examples, the first involving the role and treatment of aerosols, the second involving the choices of summary measures to allow easy comparisons between the greenhouse gas emissions of different nations.

Most policy assessments have framed the climate problem as a CO<sub>2</sub> problem. A few have also considered other radiatively important gases such as methane and nitrous oxide. Although climate scientists have known for many decades that aerosols can also play an important role, until very recently aerosols have not received much attention in policy studies. The short residence time of aerosols leads to geographically specific regions of radiative cooling, with possibly complex effects on global circulation patterns.

Historically, regional air pollution has evolved from the control of particulate matter to the dispersal of sulfur dioxide (SO<sub>2</sub>) emissions, and most recently, the control of sulfur and nitrogen oxides. The USA and many other OECD countries have reduced particulate emissions by more than 95%, have experimented with tall stacks, and are now engaged in reducing their SO<sub>2</sub> emissions by roughly 50% from levels in the mid-1980s. Few countries in the rest of the world yet have embarked on particulate matter controls, let alone SO<sub>2</sub> controls. Economic prosperity and trends in industrial countries determine the timetable for control. The global discussions about climate change, if managed appropriately, could lead to enhanced local and regional air pollution control. But the large differences in initial conditions for the OECD and other regions can lead to very different regional outcomes associated with proposed climate mitigation policies.

Many climate policy studies have been defined as a greenhouse gas problem. However, at the regional level, soot, smoke, and sulfate aerosols play a significant role in the radiative balance of the atmosphere. These aerosols serve to change the albedo of the atmosphere, clouds, and underlying ground. Scientists have not yet agreed on the net radiative impact of sulfate aerosols (Charlson *et al.*, 1991; Kiehl and Briegleb, 1993; Pandis *et al.*, 1994; Pilinis *et al.*, 1995). In interviews, 16 of the country's leading climate scientists estimated the radiative forcing due to aerosol averaged over the Northern Hemisphere to be between -1 and -2 watts/m<sup>2</sup> (Morgan and Keith, 1995). The impact of aerosols on climate dynamics is uncertain (Charlson and Wigley,





**Figure 2.** Globally averaged mean radiative forcing projections are presented without aerosol effects (left), and with aerosol effects (right). Two features are evident: i) in this model inclusion of aerosols reduces total forcing in the year 2000 by  $1 \text{ Wm}^{-2}$ , and ii) the point at which the impact of carbon taxes can be felt as a reduction in radiative forcing (indicated with the arrow) is delayed by 20 years.

1994; Mitchell *et al.*, 1995) and may have significant regional implications, such as a reduction in monsoon precipitation (Lal *et al.*, 1995).

Inclusion of both greenhouse gases and aerosols in ICAM-2 has led us to four interesting findings. First, barring unforeseen dynamical responses, inclusion of aerosols lowers the amount of climate change and its adverse impacts in the business-as-usual policy. Second, proposed  $\text{CO}_2$  abatement programs impose a hitherto unquantified cost associated with accelerated climate change if  $\text{CO}_2$  controls lead to an associated reduction in  $\text{SO}_2$  emissions. Third, on the time-scale of a century or more, the radiative forcings estimated with and without the inclusion of sulfate aerosols converge as local pollution controls grow more stringent. Fourth, initial regional atmospheric aerosol loadings play a significant role in the determination of the eventual climate impacts. In the Southern Hemisphere, low aerosol loadings lead to minimal adverse impacts from  $\text{CO}_2$  abatement. In China, where aerosol loadings are high and expected to rise in the next quarter century, the adverse impacts of  $\text{CO}_2$  abatement are very large. The globally averaged results are shown in Figure 2. Although these insights do not surprise aerosol physicists, their policy implications have proven surprising to decision makers.

In problems that involve long-term consequences, policy choices can depend critically on whether and how costs are compared over time. For most decisions, both individuals and societies adopt discounting, which means that future costs weigh less heavily than present ones. While it is clear from Figure 2 that stringent abatement will produce the smallest impact on climate change *in the long run*, even with a modest discount rate, the enormous up-front costs of abatement combined with the costs of the accelerated short-term warming from removing sulfates, overwhelm the long-term benefits. Edmonds *et al.* (1994) have found similar results when considering benefits of renewable energy sources. This difficulty can be avoided if SO<sub>2</sub> emissions are maintained while CO<sub>2</sub> emissions are controlled, but such a policy is likely to meet strong opposition from people concerned about regional acid deposition. It should also be noted that the alternative of releasing sulfates in the stratosphere (albeit in much smaller quantities) is likely to have deleterious impacts on the stratospheric ozone and a different impact on global circulation patterns. We will return to this issue in the discussion of geoengineering.

We turn now to a second illustration. Most diplomats frame the climate problem as one of negotiating international accords that specify how countries will manage their emissions over time. To simplify the problem of specifying what nations should do and have done, they have sought a single metric that can be used to compare emissions across nations and over time. The most widely discussed metric is the Global Warming Potential or GWP (Lashof and Ahuja, 1990), which compares the net radiative forcing of a unit of any other trace gas (such as methane) over its lifetime as gas with that of a unit of CO<sub>2</sub>. Different human activities produce different mixes of greenhouse gases. For example, electricity generation mainly produces CO<sub>2</sub>. In contrast, rice farming mainly produces methane, which has an instantaneous radiative forcing an order of magnitude larger than CO<sub>2</sub>, but has an atmospheric residence time that is an order of magnitude shorter.

GWPs capture the instantaneous physics of the problem. By integrating for some arbitrary period (the length of which is, of course, a value judgment and thus subject to controversy), they can also reflect some aspects of the temporal dynamics. However, they do not recognize the economic reality of discounting, which can work to reduce the effective importance of future changes in radiative forcing (Eckaus, 1992). Further, Milind Kandlikar has argued that, because most decision makers are principally concerned about impacts, not gas concentrations, any reliable equivalence scheme also needs to incorporate climate change and impact dynamics.

**Table 4.** Comparison of GWP values with several alternative scenario based indices for trace gases. All values shown compare other trace gases with carbon dioxide. Thus, an index value of 100 means a unit mass of the trace gas contributes 100 times as much as a unit mass of carbon dioxide.

Trace gas	GWP <sup>a</sup>	SBI index when damage assumed to be linearly proportional to temperature <sup>b</sup>		SBI index when damage assumed proportional to square of temperature		SBI index when damage assumed proportional to cube of temperature	
		IPPC-A	IPCC-D	IPPC-A	IPCC-D	IPPC-A	IPCC-D
<b>Methane</b>							
2% discount	11	19	12	12.9	8.5	10	
6% discount	11	38.4	27.5	28.1	19.9	21.5	
<b>Nitrous oxide</b>							
2% discount	290	269	282	280	289	286	
6% discount	290	258	271	269	278	275	
<b>HCFC-22</b>							
2% discount	1500	2445	1706	1811	1284	1466	
6% discount	1500	3178	2217	2354	1700	1879	

<sup>a</sup>GWP computed in this example with a time horizon of 100 years.

<sup>b</sup>If damage is linear in temperature, details of the emissions scenario do not affect the relative weights for the trace gases.

Kandlikar has proposed that the problem can be addressed by devising indices that compare the eventual economic impacts of unit emissions of different greenhouse gases (Kandlikar *et al.*, 1993). If greenhouse damage is a function of global mean temperature change, then the indices will depend on the future emissions of trace gases. Future emissions of trace gases are intrinsically linked to economic growth and abatement policies, which in turn are governed by expectations of greenhouse damage. Trace gas indices can thus be calculated either on the basis of emissions scenarios such as those devised by the Intergovernmental Panel on Climate Change (IPCC), or using optimal control techniques where the trade-off between damage and abatement costs is made explicit, and the trace gas index values are a by-product of computing an optimal emissions trajectory.

Damage and abatement costs are poorly known quantities. However, by using a range of plausible values for these quantities, it is possible to provide values for a scenario-based index, or SBI, and draw some conclusions about their dependence on uncertain variables. Results are shown in Table 4. Although for long-lived nitrous oxide the difference between GWP and the SBI is 10% or less, the difference can be much greater for species with

atmospheric lifetimes significantly shorter than CO<sub>2</sub>. The differences exceed a factor of three for methane and a factor of two for HCFC-22. Such differences can have *enormous* economic consequences in the abatement costs that a country, especially one with a large agricultural sector, may face.

Kandlikar has found SBIs to be far more sensitive to the nonlinearity in climate change damage than to costs of abatement and the future energy mix. The index calculations are reasonably robust over a wide range of possible outcomes of energy supply futures. Trace gas indices depend critically on the choice of the discount rate. A higher discount rate reduces the impact of future damage from trace gases with longer lifetimes and leads to an increase in the value of the index for species that are short-lived relative to CO<sub>2</sub>. Conversely, for a species that is long-lived relative to CO<sub>2</sub>, higher discount rates lead to a decrease in its trace gas index. Thus, the debate over an appropriate time horizon of integration for GWPs, is translated into the choice of an appropriate discount rate for the greenhouse warming problem. Finally, it is found that economic uncertainties from the nonlinearity of the damage function and from the choice of the discount rate both influence the SBI more than uncertainties in atmospheric lifetime of greenhouse gases.

#### **4. Where Are the Serious Impacts?**

Opponents of climate change mitigation policies expect serious economic impacts due to implementation of any abatement policy. Proponents expect significant impacts of climate change in coastal areas, in agriculture, in unmanaged ecosystems, and for human health. There is a fundamental difference in the distributional features of climate policy and climate change impacts. By *design*, most climate mitigation policies impose a small burden on most of the population. By *nature*, many climate change impacts fall on specific subsets of the population. We shall return to this issue in a discussion of equity versus efficiency in the section on policy insights.

Unfortunately, the mechanism of impacts due to climate change and valuation of such impacts are both poorly understood. Furthermore, climate policy evaluations often ignore direct policy interventions targeted at the impacts rather than at control of anthropogenic emissions. To illustrate these issues we discuss selected results from our research.

##### **4.1. Coastal areas and adaptation**

Impact mechanisms in coastal areas are relatively well understood. Climate change has been linked to sea level rise, which can result in losses to coastal

ecosystems and property. Early sea level rise impact assessments involved a coloring book approach where the area of shorefront inundated by rising sea level was multiplied by its price and the total was used as an estimate of economic impacts (Schneider and Chen, 1980; Barth and Titus, 1984; Titus, 1986). Greater sophistication of impact assessment has brought with it a realization of the role of hard (seawalls) and soft (zoning regulations) coastal protection measures (Yohe, 1990). These realizations have reduced impacts of sea level rise assessed for industrial countries (Patwardhan and Small, 1994).

More recently, the role of adaptation to sea level rise has been emphasized. It has been argued that, because the secular trend in sea level rise is predictable, adaptation is likely. With known trends in future sea level, it is possible to plan a retreat or calculate the value of a defense (Rijkswaterstaat, 1990; Titus *et al.*, 1991). Armed with this knowledge, it is argued, the finite life of coastal properties can be determined, and they can be discounted through their remaining life. Furthermore, the lost value of the vulnerable properties will be transferred inland. The next row of houses will appreciate in value with the recognition that they will soon be on the beach front. Thus, while the physical losses occur on the coast, it is argued that adaptation leads to economic losses that are equivalent to greenfield property at the inland boundary of developments. This formulation of adaptation has lowered estimated damage of sea level rise by almost an order of magnitude.

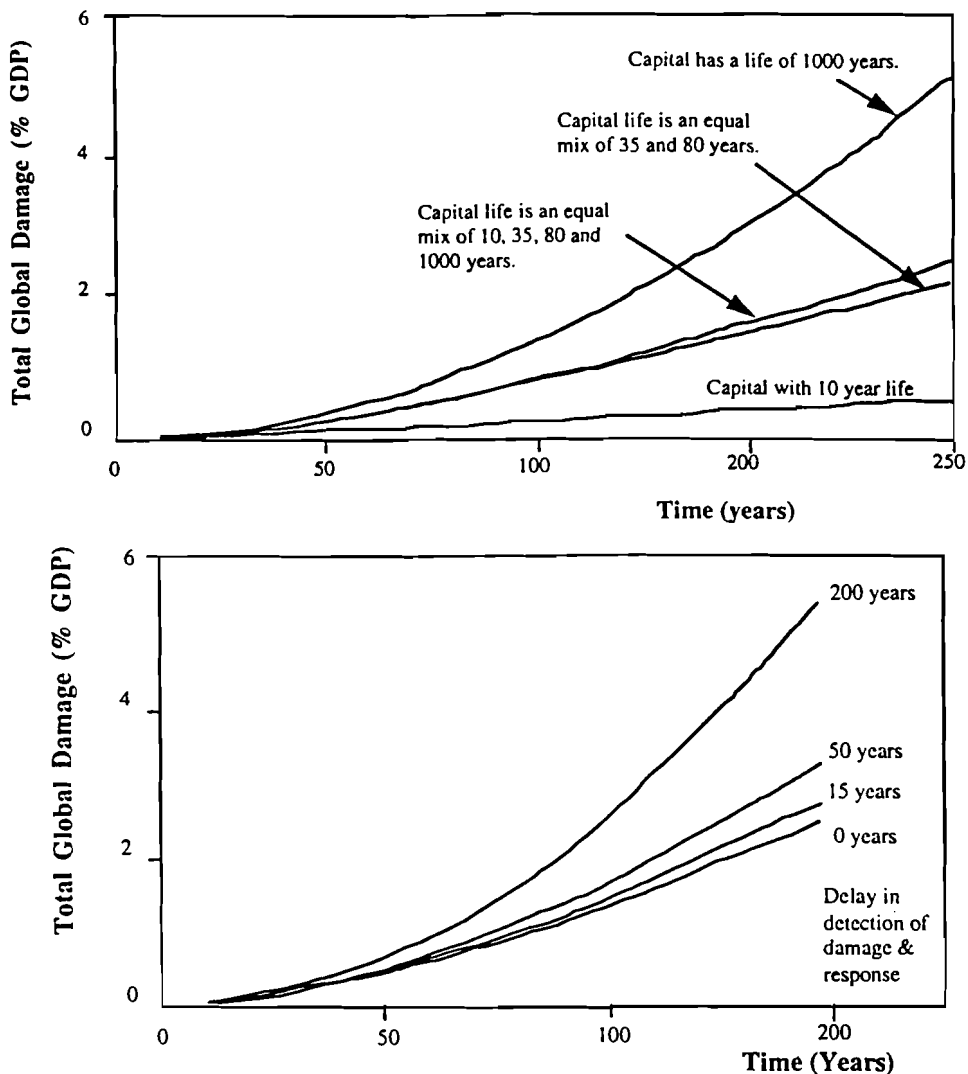
However, the above is too simple a characterization of the impact mechanism. Sea level rise and storm surge together lead to inundation. We have modeled these processes and decision making for a coastal town (West, 1994) and find that, when stochastic storm events are introduced into the problem, well-timed adaptation is very difficult and full depreciation of structures is unlikely. The principal problem decision makers face is attribution of impacts to changes in sea level and to extreme events. There is always the chance that a freak storm will lead to premature abandonment of structures or that a calm period (while sea level is rising) will lead to inappropriate investment in vulnerable coastal properties. Thus, because of the stochastic nature of weather, adaptation to climate change impacts in coastal areas or in agriculture is extremely difficult and unlikely to be executed with finesse. The pendulum of impact estimates, which has been swinging toward lower values, is now on a return swing to higher impact valuations as we learn more about the limited potential for managed adaptation to many climate change impacts.

The notion of a climate or policy impact on welfare hinges on the presumption that the status quo is optimal, or at least superior to the status after climate change. In other words, on the coast, the docks, piers, hotels, and homes are ideally located and matched to present patterns of activity and climate. Then, it is argued, altered future climate conditions will necessarily lead to an inferior outcome if present practice is continued. This is a strong assumption that is unlikely to be true when one considers marginal climate change and the stochastic nature of weather. After an extreme event wipes out existing capital, opportunities may arise actually to improve productivity and welfare. By *assuming* optimal allocation of resources, economists implicitly ignore these scenarios. Here, impacts leading to replacement of obsolete structures and capital can have long-run benefits. This is especially the case in industrialized nations where insurance is available. In less industrialized countries, incomes are more closely tied to nature, citizens live closer to a subsistence level, and institutionalized safety nets are a rarity. Thus, the impacts of climate change on individuals and the fabric of society are likely to be more severe (Lave, 1988; Lave and Vickland, 1989), and opportunities to upgrade to more efficient new capital, more limited.

In conclusion, people's ability to adapt to the economic impacts of climate change depends on three factors: (i) how often they turn over the capital stock that shapes their patterns of production and consumption; (ii) whether they learn to anticipate climate change through time; and (iii) whether they have already detected climate change and/or its impact(s). These three factors were used in the simple model that yielded the results reported above and in Figure 3. This figure illustrates the difference in realized climate change impacts when assuming that people will be dumb and not adjust and when making plausible assumptions about future adjustment activity. Perfect adjustment (unlikely when facing stochastic impacts) yields the lowest curves. When no adaptation is possible, the impacts follow a path similar to having very long-lived capital, or long-delayed detection of climate change and can be an order of magnitude higher. When stochastic impacts are considered, impacts are somewhere in between these two extremes.

## 4.2. Terrestrial biosphere and valuation

At present, ecologists are unable to build good predictive models of how ecosystems will change in the presence of climate change. There are a number of fundamental reasons for this impasse. First, few undisturbed ecosystems have been observed and, in general, few landscapes are in equilibrium. Second, although much of the concern has been about climate change, there



**Figure 3.** In the upper figure, the level of damage follows the familiar path if there is no opportunity for adaptation to climate change. This is replicated in the case with long-lived capital. For capital with shorter lifetimes, the damage is significantly lower. In the lower figure, as the lag in detection of climate impacts and availability of suitable new technologies increases, so does the damage level. Here the damage for an even mix of capital stock (10-, 35-, 80-, and 1000-year lifetimes) is depicted with various lag times in detection and adaptation. In both cases, the assumed rate of average temperature change is  $0.7^{\circ}\text{C}/\text{decade}$  and the damage function follows Nordhaus' familiar figure of 0.25% of GDP for a temperature change of  $3^{\circ}\text{C}$ .

are also significant perturbations in the carbon, nitrogen, and water cycles. These play as important a role as climate in the function of biota.

Biomes are communities of living organisms, each of which may be affected by climate change and other disturbances down to the subcellular level. Thus, the relative fitness of each organism may change, affecting its survival as part of the newly emerging community and the overall function of the new biome. Ideally, impacts of climate change need to be considered from the subcellular level through to regional and continental land cover. This is a challenge akin to socioeconomic modeling of each individual in the society and their interactions and functions under different climate and policy conditions.

In order to make the problem tractable, ecological modelers have tended to focus on potential land cover rather than actual land cover and have explored shifts in the location of ecotones under equilibrium conditions for present and hypothesized future climates. In this work, two major challenges have been sidestepped: (i) the role of factors of disturbance other than climate, soil, and elevation in determining land cover; and (ii) the dynamics of ecological response to perturbations such as climate change and its influence on the structure and composition of future biomes.

Physiological effects are fundamental to our understanding of global change impacts. Nonetheless, due to computational, model, and data limitations, most of the climate impact assessments have used continental "transfer models" for regional- and planetary-scale climate change impact assessments. Most transfer models use a climate database and an ecosystem classification scheme defined deterministically by climate (and at times soil) conditions (Emanuel *et al.*, 1985; Prentice *et al.*, 1992; Smith *et al.*, 1992). Malanson (1993) notes that, ideally, impacts should be assessed at every scale, but neither the knowledge nor the computational power needed to perform such calculations are at hand. The second-best compromise of transfer models involves further inadequacies, because these have not been able to simulate dynamic features such as inertia and competition. Within our integrated assessment effort we have developed a new approach to modeling continental scale land-cover change. This zeroth-order model, developed by Shevliakova and Dowlatabadi (1994), is based on the observation that land cover is diverse even when the climate, soil, and disturbance regimes are similar. Armed with this observation, a probabilistic description of land cover has been developed. This new model permits the potential coexistence of different vegetation types. Dynamics are simulated as changing probabilities of occurrence for different vegetation types and hence transition from one dominant form to another. By replacing the deterministic framework with



a probabilistic model, we have also succeeded in simulating some measure of inertia and competition in land cover response to climate change and other disturbances.

To date, four important insights have resulted from this work. First, proximity to human settlement is as powerful a determinant of land cover as are various indicators of climate, elevation, and soil. Second, with plausible assumptions about dieback, migration, and establishment rates new quasi-equilibria are established after very long lag times ( $\geq 250$  years). Third, uncertainties in key time constants (for dieback, migration, and re-establishment) lead to uncertainty in both sign and magnitude of net annual CO<sub>2</sub> fluxes from the terrestrial biosphere. Furthermore, the perturbations to the net terrestrial carbon cycle are of the same order of magnitude as emissions due to combustion of fossil fuels. Finally, in terms of land cover, climate change impacts are estimated to be of the same magnitude as several other modes of disturbance (see Table 3).

Estimating a value for impacts on land cover is antithetical to those who assign rights to nature. However, quantification of nonmarket values, which economists such as Mitchell and Carson (1989) have approached with equal measures of ingenuity and controversy, is only half the challenge. The dynamic evolution of these values through time is also in question (Loewenstein, 1987; Loewenstein and Mather, 1988; Fischhoff, 1991). We have proposed that, for the majority of the public, two healthy stands of trees will be indistinguishable (Dowlatabadi *et al.*, 1994). Thus, while the constituents of land cover may change in response to climate change, for the majority of the public, the loss of species may not be experienced, or if experienced will be forgotten through time. We have coined the term "value erosion" to describe this process. This is also described in the cognitive psychology literature as a process of psychological adaptation that influences the longevity and severity with which losses are perceived. While losses loom large at the outset, over time an erosion in valuation often occurs as people re-calibrate their thinking to the changed circumstances (Kahneman and Tversky, 1979). Consider the loss, due to disease, of the great ornamental elm trees that just a few decades ago graced the northeastern USA, or even earlier, the loss of the wonderful "spreading Chestnut tree(s)," which most of us now know about only through Longfellow's poem about the village blacksmith. At the time of these tragedies, many people mourned the dramatic population collapses, and would have been willing to, and indeed did, spend large amounts of money to try to prevent the loss. But now that these losses have occurred, and time has gone by, both we and nature have readjusted. While we remain sad today that there are not very many elms and chestnuts, most of

us don't continue to carry that loss at the same level in our "mental balance sheets." As another example, consider one of the greatest environmental disruptions of all time . . . the settlement of North America by Europeans. Today, few Americans think of this as an enormous environmental loss, let alone continue to grieve and carry a large debit on their "mental balance sheets."

Of course, valuations do not just erode, through various social process they also can be amplified. Who in 1950 would have predicted the change in attitude that Americans have undergone with respect to the quality of the environment and the need for its protection? Similarly, as late as 1980, who would have predicted the dramatic shift in American attitudes toward smoking in public places? The possibility of such rapid social shifts or "tipping" (Schelling, 1978) places serious limitations on our ability to predict how future societies will value things such as the impacts of climate change. Indeed, just as many Americans seem to feel that their local environment is in continued decline, despite the fact that many environmental indicators have shown marked improvements in recent decades, the debate on climate change policy and its potential ecological impacts may itself lead to increased perceived losses, whether abatement action is taken or not! This observation suggests an assessment based on exploration of different model specification and parameter values is likely to be more promising than one that attempts prediction.

We believe that value erosion is subject to manipulation. Nature programs on television and environmental activists at the door serve to heighten awareness about the environment. These can lead to value amplification and further complicate the question of how values may change through time. Our exploration of labile values placed on nonmarket impacts of climate change leads to outcomes that vary over an order of magnitude.

### **4.3. Human health and policy context**

Climate change could have both direct temperature-related impacts on health and indirect impacts through changes in the prevalence and virulence of diseases and their vectors. Here, as in the case of ecosystem impacts, a major challenge in developing a predictive model of climate impacts is the attribution of historic effects to climate versus other environmental factors. Lifestyles, modes of activity, demographics, environmental pollution, and public health policy all play critical roles in life expectancy.

Kalkstein and others (1987; 1994) have explored the direct impacts of climate on human health. Their application of epidemiological methods in

analysis of climate and mortality data for a number of US cities has led to interesting findings. According to these models, different cities exhibit great diversity of impacts. This confirms the important role of other local environmental, vulnerability, and exposure factors. Jacksonville, FL (the warmest city studied in the USA) shows no increased deaths in response to heat stress. However, cities such as New York exhibit a strong correlation between deaths and heat waves. It is estimated that on average 40% of these heat-stress-induced deaths are due to harvesting (Scheraga and Sussman, 1994). Extremes of cold in winter also lead to mortalities. Mortalities due to extreme heat and cold are found to be of similar magnitude in the USA. Outside of extreme weather conditions, weather has a benign effect on health (Cifuentes, 1995).

A major challenge in assessing the direct health effects of climate change is the collinearity of climate conditions and air-pollution episodes. Cifuentes and Lave (1996) have explored this issue by examining daily pollution, weather, and mortality data for Philadelphia and Birmingham. They find air pollution to be far more important than weather as a driver of the observed patterns of mortality. This suggests that the interplay between climate change and local air pollution deserves more attention, and that public health policies first be targeted toward reduction of local air pollution, especially respirable particulates.

Vector-borne impacts of climate change are also considered to be a significant source of risk to the human population. Malaria has been the focus of a number of studies (Martens *et al.*, 1994; Nichols, 1994; Rogers and Packer, 1994). Here too, projections are plagued with uncertainties in the relative impact of climate compared with human development and movement as determinants of disease prevalence. In the 19th century, malaria was prevalent in Canada. Today, public health and urbanization have essentially eradicated the problem. The absence of malaria there today is neither caused by, nor indicative of, a regional climate change. Alternatively, consider dengue fever, which was essentially eradicated in Texas by the middle of the 20th century. Its resurgence today is not due to climate change, but due to the loss of a potent pesticide (DDT), trade in used tires with Mexico, and increased urban detritus.

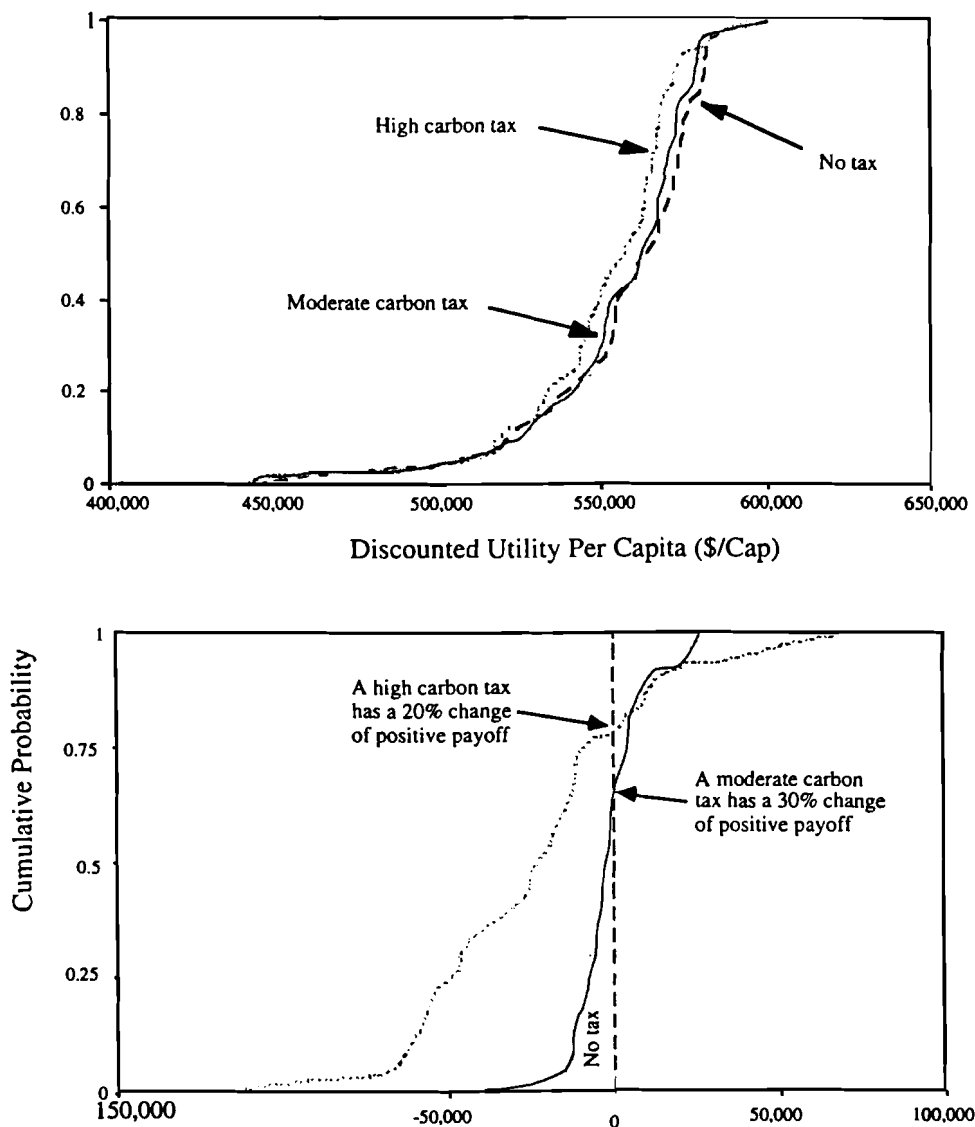
Health impacts have grown more prominent in discussions of climate change policy. This is in part due to the public salience of human health and results from an attempt to focus increased attention on the climate issue. Furthermore, human health is an impact of climate change where valuation of lives lost (in economic terms) has strong opponents. Consequently, this framing tends to push the public toward considering the (economic) costs

of abatement of emissions to be trivial in light of the (incalculable value of) averted premature deaths. This is an incomplete and possibly incorrect perspective on the issue. Should abatement expenditures lead to generally lower levels of welfare, public health could suffer and far more premature deaths ensue than if a business-as-usual or proactive public health policy were to be pursued. In general, the weak interaction between climate and mortality suggests that air pollution control and targeted public health policies are likely to be far more effective in averting premature deaths than would any climate policy.

## 5. Insights About Policy Options

The uncertainties are large and, when propagated through the model, often lead to an inability to differentiate between the outcome of a “no abatement strategy” and all but the most stringent abatement policies. A specific example of this is shown in Figure 4, in which no policy is stochastically dominant. We have found very similar results repeatedly in our various assessment activities, across a variety of model formulations. By using expected values, we showed in Figure 1 that regional outcomes vary by policy and strategy. However, with the exception of China, for which the strategy of “no abatement” often stochastically dominates other strategies, it is typically also difficult at the regional scale to obtain results that persuasively differentiate between modest abatement and no abatement. Furthermore, the resources available for transfer between regions are rarely sufficient to allow incentives for concerted global action. Results from our interviews with climate scientists suggest that it is unlikely that improvements in understanding will change this situation appreciably over the next several decades (Morgan and Keith, 1995).

In the face of these uncertainties, three normative policy perspectives are common in discussions of climate policy: (1) Even small abatements are good practice and, if they can be obtained for free or at low cost, should be pursued. Proponents of this view favor the “no-regrets option” and argue that there is a largely untapped potential for energy conservation. (2) We are morally wrong to incur the risks of changing climate and should engage in “significant abatement.” This group favors “carbon taxes” and restructuring of macroeconomic incentives for energy use and greenhouse gas release. (3) We must think in terms of “disaster relief” because the world will be incapable of concerted mitigation action before catastrophic change. This group is resigned to adaptation and “geoengineering,” which has the potential of



**Figure 4.** The upper figure shows cumulative distribution functions (CDFs) from ICAM 2.1 for estimates of the per capita net present value of three alternative abatement policies in the OECD. The moderate and high carbon taxes start at US\$0.5 and 2.0 per ton of carbon in the year 2000, respectively, and grow by those same amounts in each subsequent year. The lower figure displays the net difference between the case of no tax and the two tax policies. The points at which the CDFs cross the origin are the values reported for model 6 in the lower part of Table 3.

giving us time to implement mitigation after the fact or to modify climate to favor our needs. We have studied aspects of these perspectives and offer selected insights below.

### **5.1. No-regrets options: Energy conservation**

Some have argued that so much energy efficiency is being overlooked that 40% of US CO<sub>2</sub> emissions may be abated at a net economic benefit (National Research Council, 1992). A leading contender is management of the demand for electricity, called “demand-side management” or DSM. For 20 years there have been scattered DSM programs, some of which appear to have been quite successful. Could a rapid increase in investment in such programs significantly reduce electricity consumption and associated CO<sub>2</sub> emissions? To answer this question Sonnenblick has reviewed neoclassical economic studies of consumer investment decisions, engineering studies of the technical potential of DSM, and DSM field evaluation studies.

Only by admitting market failure do neoclassical economic studies allow the possibility of major savings. These studies tend to ascribe people’s failure to invest more in DSM to poor or unreliable performance by DSM equipment, large transaction costs, or hidden costs associated with installation and operation. Thus, they argue, DSM programs may be pushing equipment or behavior that consumers have already deemed prohibitively expensive, unreliable, or too technically immature to be adopted today. Our analysis of selected DSM programs suggests that transaction costs may exist for consumers, but that well-designed DSM programs can reduce these costs and improve the flow of information to customers (Sonnenblick, 1995).

In contrast to economic studies, engineering assessments of DSM suggest large savings – as much as 75% of the nation’s electric demand (Lovins and Lovins, 1991). Most of these studies focus on laboratory-based savings and retail cost of the DSM technologies. This approach ignores the uncertainties of a highly decentralized resource and fails to account for the full costs of implementing a nationwide retrofit through utilities, as DSM is practiced today.

Field evaluation programs of varying quality have been conducted for a handful of DSM programs. Their performance lies between the two extremes above, usually resulting in energy savings of a few percent. For example, some commercial lighting programs have been relatively successful at reducing participants’ energy needs by around 5% at a cost of 3–5 cents/kWh. Programs aimed at the residential sector have generally been

costlier. Savings of 5% in these programs have typically cost between 8 and 15 cents/kWh.

Sonnenblick concludes that well-implemented DSM can lead to modest energy savings, but that, to date, no large field study has come close to the significant savings suggested by engineering studies. The large discrepancy between studies of technical potential and real-world experience is an intriguing and complex issue. One factor may be that allowing returns on DSM investments to utilities is relatively new to most states' regulations. Another may be that the DSM measures are being selected and installed by contractors who are not as expert in these matters as the engineers who perform the laboratory evaluations. Utilities are also finding that the skill and wisdom required to implement an effective program are hard-won. Finally, the administrative burden of even relatively small programs is formidable.

Today's DSM programs probably amount to between 1% and 2% of peak electric demand. An aggressive national program might be able to achieve a 5% savings at a cost of the order of 10 cents/kWh. Above such a level it is unclear how rapidly diminishing returns might set in for larger investments. It appears, however, at least with the current generation of technologies and implementation methods, that one should not be too optimistic.

## 5.2. Significant abatement: Taxes

Economists have touted fuel price adjustments as the most efficient lever with which to control energy use and hence emissions of CO<sub>2</sub>. Taxes on the carbon content of fuels are their preferred method for mitigating carbon emissions. Faced with higher prices, consumers conserve energy and switch away from fuels with high carbon content (e.g., coal to natural gas or renewables). Using a detailed model of energy supply to consumers in the USA (electricity, oil, gas, gasoline) and a detailed model of consumer energy demands statistically estimated from historic data developed by Jorgenson and colleagues (1982, 1987, 1988, 1990a, 1990b, 1992), Dowlatabadi *et al.* (1995) explored the consequence of energy and carbon taxes for US households.

Our detailed model of electricity production revealed conditions under which the imposition of carbon taxes could actually raise emissions of CO<sub>2</sub> (Dowlatabadi *et al.*, 1993). This is due to the high capital costs embodied in electricity prices, permitting situations where the relative price rise in electricity generated using coal is smaller than price rises experienced in consumption of natural gas. A long-term shift away from coal-generated electricity requires high carbon taxes (US\$100 per ton under historic fuel price and technological price-performance assumptions) or continuation of

the significant technical (e.g., aero-derived gas turbines) and institutional changes (e.g., reform of utility generation monopolies) experienced in the recent past.

Dowlatabadi *et al.* (1995) have also explored the distributional burden of carbon taxes and the “BTU tax” proposed by the Administration. These instruments were found to be equally efficient in carbon abatement. In addition, the distribution of the burden of energy price manipulations was found to be evenly distributed (geographically) across the nation. Furthermore, for a given revenue target, the burden of carbon and “BTU taxes” imposed on average households were found to be very similar.

Finally, on the positive side, we have identified a strong link between gains in efficiency of energy technologies and price and regulatory signals (Oravetz and Dowlatabadi, 1995; Tschang and Dowlatabadi, 1995). In combination with the carbon abatement possible from modification of consumer behavior, these led to very significant abatement being possible through imposition of gradually increasing energy or carbon taxes.

### 5.3. Disaster relief: Geoengineering

Actions undertaken with the primary goal of changing the climate, usually by manipulating climate forcing, are geoengineering. Specific strategies can include something as uncontroversial as planting trees, but may also include mass fertilization of the tropical oceans to enhance CO<sub>2</sub> uptake by phytoplankton, or lofting reflective materials to the stratosphere or into earth orbit. Unlike emission abatement strategies, some geoengineering strategies could produce effects quite rapidly, and can be adopted unilaterally by one or a few countries.

Strategies that will reduce the emissions of greenhouse gases below 40% of 1990 emissions, the amount needed to prevent climate change in the long run (Houghton *et al.*, 1990), will require extensive international cooperation and sustained effort for many decades. If these are not successful, or if they are only partly successful and climate change turns out to be more serious than anticipated, adaptation will be inevitable and widespread, but in some cases will be difficult and costly. Consequently, geoengineering is an option that at least some major participants are likely to want to pursue.

Arrhenius (1896) suggested that burning fossil fuels might help prevent the coming ice age – a geoengineering solution! More recent looks at the technical possibilities for geoengineering have been undertaken by Dyson and Marland (1979) and the National Research Council (1992). Keith and Dowlatabadi (1992) have performed a more complete evaluation. Although



they have not been able to exhaustively explore all possible secondary effects, their work suggests that there are a number of strategies, with relatively low direct costs. Policies such as lofting fine particles into the stratosphere, may appear attractive to decision makers if climate change becomes serious, but the risks of unintended consequences are unknown and possibly large.

Many observers believe the idea of geoengineering, or even its study, is morally repugnant. We believe such study is needed for two reasons. We need to understand the implications if some nation were to take unilateral action. Second, the existence of a plausible fallback strategy might be an important element of achieving an international compromise on moderate abatement options, since it would provide a hedge against catastrophe if climate change proves more serious than anticipated.

#### **5.4. Beyond an efficiency-based framing**

There are externalities associated both with taking action and with adopting a policy of no abatement. For example, a program of modest abatement might result in technical development and social learning, which could prove very useful if climate change becomes more serious and more stringent responses are needed quickly. Even in the absence of significant climate change, proponents of the precautionary principle might argue that much of the new technical and social know-how accumulated through moderate abatement would prove useful in other contexts. On the negative side, those with a strong belief in the ability of markets to allocate resources efficiently would argue that the resources would produce much greater physical and social well-being and greater technical capability if they were not diverted to support early abatement. Thus, given that our estimates of expected value produce no definitive policy choice, deciding the question on the basis of economic efficiency may depend on determining the difference between two highly uncertain terms – the negative and positive externalities. This is inherently difficult because the answer depends on social and economic processes that are not well understood and upon their interactions with other uncertain phenomena. Most integrated assessments have ignored both of these externalities. In Models 5 and 6 of Table 2, we attempted to incorporate both, but we have little confidence in the stability of the results in the face of a variety of alternative plausible formulations. We believe that it is unlikely that we, or others, will ever be able to definitively resolve these difficulties.

Some may mistake our findings of a lack of clear stochastic dominance by an identifiable policy as an argument for doing nothing. This is not the

correct interpretation of our results. If, when viewed in terms of economic efficiency, there is no discernible difference between the expected value of “no abatement” and of various strategies of moderate abatement, factors other than expected value should determine policy choice.

Two obvious candidates for determining policy choice are equity and ecological stewardship. While we cannot discern a dominant strategy on efficiency grounds, we can clearly see that the costs and benefits associated with any strategy will be very unequally distributed. Earlier we reported that the burden of carbon and energy taxes are broadly distributed (Dowlatabadi *et al.*, 1995). We have also noted that the impacts of climate change will fall on a few vulnerable populations (Lave, 1988; Dowlatabadi and Lave, 1993; Patwardhan and Small, 1994). Democratic governments at all levels are typically more concerned with equity issues than with efficiency. Although our analysis suggests that the policies of inaction and moderate abatement are indistinguishable on efficiency grounds, if climate changes, moderate abatement has significant equity benefits.

It is much more difficult to study equity than it is to study efficiency. There is no widely accepted metric and there are fewer analytical methods on which to draw. However, as we argued in Table 1, the fact that there is limited knowledge and analytical capability does not justify analysts’ ignoring the problem. More explicit consideration of equity issues would make future integrated assessments more valuable to government decision makers.

Turning now to ecological stewardship, there have long been arguments in the climate debate that costs are irrelevant: mankind has no business disturbing the climate. Framed in such absolutist terms, the choice of how to proceed becomes a choice between value systems, and thus a very difficult topic for analysis.

We believe, however, that the most useful framing is not so absolutist. At least in the industrialized world, formulations in terms of willingness and ability to pay are now widely accepted as an analytic procedure for studying changes at the *margin*. However, in many regions the ecological impacts of climate change could be far from marginal. We have begun to conclude that the most useful way to think about the problem of valuing ecological impacts is in terms of a mixed strategy that uses a utility-based formulation for modest changes, but imposes a rights-based constraint on the magnitude of the change that people are willing to accept without violating some basic responsibility of stewardship toward the natural environment.

Again, most integrated assessment activities, our own included, have tended not to systematically explore the stewardship implications of alternative policy options. In our next round of analysis we plan to do so.

## 6. Next Steps

The second guideline in Table 1 argues that good integrated assessment should be iterative. We have now worked our way through the problem four times and, based on many of the lessons outlined here as well as a number of others, are embarking on our fifth iteration. Much of our work will continue to focus on the obvious substantive issues: How should we incorporate the relationship between technological change and policy? How might we better represent the dynamic process of research investment, gathering of knowledge, and sequential decision making? How do we improve our estimates of ecological impacts? The list goes on and on.

Yet the more we work on integrated assessment of climate change, the more we realize that the biggest challenges are philosophical and methodological. For example, from the outset we have placed great emphasis on including uncertainty in our analysis (Dowlatabadi and Morgan, 1993a). However, it is only recently that we have come to understand just how extensive the uncertainties are. New methodological challenges appear when some parts of the problem involve manageable uncertainty while other parts involve extreme uncertainty. We are facing similar challenges in the area of values. In most cases, analysts are used to thinking of values, or utilities, as given. On occasion, we and others have performed analyses designed to help decision makers explore and refine their values. But we have never worked on a problem in which the labile and adaptive nature of values, or the number of different actors with different values, is as central as it is in climate policy. Finally, we have been doing analysis for the entire world, using basic ideas of causation, probability, and rational expectation: ideas that are probably not shared by 80% of the world's peoples. The available tools of policy analysis are simply not up to the challenges we face, so we are busy inventing new tools. The problem may wear us down before we succeed, but there is no risk of running out of interesting and fundamental questions!

### Acknowledgments

We thank: Ann Bostrom, Luis Cifuentes, Cliff Davidson, Paul Fischbeck, Baruch Fischhoff, Robert Hahn (at the American Enterprise Institute), Milind Kandlikar, David Keith, Ray Kopp (at Resources for the Future), Lester Lave, Charles Linville, Matt Oravetz, Spyros Pandis, Anand Patwardhan, Daniel Read, James Risbey, Ed Rubin, Tom Smuts, F. (Ted) Tschang,

Mitch Small, Elena Shevliakova, Richard Sonnenblick, Jason West, and three anonymous referees for contributions to this paper.

This work has been supported by grants from the Electric Power Research Institute (RP-3441-14), the National Science Foundation (SES-9209783, BCS-9218045), the Department of Energy (DE-FG02-93ER61712, DE-FG02-93ER61711, DE-FG02-94ER61916), the National Oceanographic and Atmospheric Agency, the Scaife Family Fund, and a gift of equipment from Apple Computers.

## References

- Arrhenius, S., 1896, On The Influence of Carbonic Acid in the Air Upon the Temperature on the Ground, *Philosophical Magazine* **41**:237-275.
- Barth, M.C., and Titus, J.G. (eds.), 1984, *Greenhouse Effect and Sea Level Rise: A Challenge for this Generation*, Van Nostrand, New York, NY, USA.
- Bostrom, A., Fischhoff, B., *et al.*, 1992, Characterizing Mental Models of Hazardous Processes: A Methodology and an Application to Radon, *Journal of Social Issues* **48**(4):85-100.
- Bostrom, A., Morgan, M.G. *et al.*, 1994, What Do People Know About Global Climate Change? 1: Mental Models, *Risk Analysis* **14**(6):959-970.
- Charlson, R.J., and Wigley, T.M.L., 1994, Sulfate Aerosol and Climate Change, *Scientific American* **270**(2):28-35.
- Charlson, R.J., Langer, J. *et al.*, 1991, Perturbation of the Northern Hemisphere Radiative Balance by Backscattering from Anthropogenic Sulfate Aerosols,
- Charlson, R.J., and Wigley, T.M.L., 1994, Sulfate Aerosol and Climate Change, *Scientific American* **270**(2):28-35. *Tellus* **43AB**:152-163.
- Cifuentes, L.A., 1995, Social Cost of Air Pollution Related Mortality, PhD dissertation, Carnegie Mellon University, Pittsburgh, PA, USA.
- Cifuentes, L.A., and Lave, L.B., 1996, Association of Daily Mortality and Air Pollution in Philadelphia, 1983-1988, *Journal of the Air and Waste Management Association* (in press).
- Corell, R.W., 1993, Statement of Robert W. Corell, Chairman, CEES Subcommittee on Global Change Research and Assistant Director for Geosciences National Science Foundation, before the Committee on Science, Space and Technology, Subcommittee on Space, US House of Representatives.
- Dixon, R.K., Brown, S. *et al.*, 1993, Carbon Pools and Flux of Global Forest Ecosystems, *Science* **263**:185-190.
- Dowlatabadi, H., 1995a, Integrated Assessment Models of Climate Change: An Incomplete Overview, *Energy Policy* **23**(4/5):289-296.
- Dowlatabadi, H., 1995b, Groping For Control: A Study in Sequential Climate Policy Decision-making, Society for Risk Analysis, Waikiki, HI, USA.
- Dowlatabadi, H., and Kandlikar, M., 1995, Key Uncertainties in Climate Change Policy: Results from ICAM-2, The 6th Global Warming Conference, San Francisco, CA, USA.

- Dowlatabadi, H., Kopp, R.J. *et al.*, 1995, Distributional and Environmental Consequences of Taxes on Energy: A Partial Equilibrium Model of U.S. Household Energy Demand, Sustainable Economic Growth, pp. 203–235, JAI Press, Greenwich, CT, USA.
- Dowlatabadi, H., and Lave, L.B., 1993, Pondering Greenhouse Policy (Letter), *Science* **259**:1381.
- Dowlatabadi, H., and Morgan, M.G., 1993a, Integrated Assessment of Climate Change, *Science* **259**(5103):1813.
- Dowlatabadi, H., Hahn, R. *et al.*, 1993, How Reliably Can Climate Change Impacts on Electric Utilities Be Assessed? *Utility Policy* **3**(July):261–268.
- Dowlatabadi, H., and Morgan, M.G., 1993b, A Model Framework for Integrated Studies of the Climate Problem, *Energy Policy* **21**(3):209–221.
- Dowlatabadi, H., Shevliakova, E. *et al.*, 1994, Issues in Evaluation of Ecosystem Change in Response to Global Change, Western Economic Association, Vancouver, BC, Canada.
- Dyson, F.J., and Marland, G., 1979, Technical Fixes for the Climate Effects of CO<sub>2</sub>, Workshop on the Global Effects of Carbon Dioxide from Fossil Fuels, US Department of Energy, Washington, DC, USA.
- Eckaus, R.S., 1992, Comparing the Effects of Greenhouse Gas Emissions on Global Warming, *The Energy Journal* **13**(1):25–35.
- Edmonds, J.A., Wise, M. *et al.*, 1994, Advanced Energy Technologies and Climate Change: An Analysis Using the Global Change Assessment Model (GCAM), Pacific Northwest Laboratory, Richland, WA, USA.
- Emanuel, W.R., Shugart, H.H. *et al.*, 1985, Climatic Change and the Broad-Scale Distribution of Terrestrial Ecosystem Complexes, *Climatic Change* **7**:29–43.
- Fischhoff, B., 1991, Value Elicitation: Is There Anything in There? *American Psychologist* **46**:835–847.
- Gibbons, J.H., 1993, Statement of the Honorable John H. Gibbons, Director Office of Science and Technology Policy before the Committee on Energy and Natural Resources, United States Senate.
- Global Change Integrated Assessment Program, 1995, Degrees of Change, Department of Engineering & Public Policy, Carnegie Mellon University, Pittsburgh, PA, USA.
- Henrion, M., and Morgan, M.G., 1985, A Computer Aid for Risk and Other Policy Analysis, *Risk Analysis* **5**:195–208.
- Houghton, J.T., Jenkins, G.J., *et al.* (ed.), 1990, Climate Change: The IPCC Scientific Assessment, Cambridge University Press, Cambridge, UK.
- Jorgenson, D.W., and Slesnick, D.T., 1987, Aggregate Consumer and Household Equivalence Scales, *Journal of Business and Economic Statistics* **5**(2):219–232.
- Jorgenson, D.W., and Wilcoxon, P.J., 1990a, Intertemporal General Equilibrium Modeling of US Environmental Regulations, *Journal of Policy Modeling*.
- Jorgenson, D.W., and Wilcoxon, P.K., 1990b, Environmental Regulation and US Economic Growth, *Rand Journal of Economics* **21**(2):314–340.

- Jorgenson, D.W., Lau, L.J., *et al.*, 1982, The Transcendental Logarithmic Model of Aggregate Consumer Behavior, pp. 97–238 in R.L. Basmann, G.F. Rhodes (eds.), *Advances in Econometrics*, JAI Press, Greenwich, CT, USA.
- Jorgenson, D.W., Slesnick, D.T. *et al.*, 1988, Two-Stage Budgeting and Exact Aggregation, *Journal of Business and Economic Statistics* **6**(3):313–326.
- Jorgenson, D.W., Slesnick, D.T. *et al.*, 1992, Carbon Taxes and Economic Welfare, Harvard University, Cambridge, MA, USA.
- Kahneman, D., and Tversky, A., 1979, Prospect Theory: An Analysis of Decision Under Risk, *Econometrica* **47**(2):363–391.
- Kalkstein, L., 1994, Direct Impacts on Cities, pp. 26–28 in *Health and Climate Change*, The Lancet Ltd., London, UK.
- Kalkstein, L.S., and Valimont, K.M., 1987, The Effect on Human Health, pp. 122–152 in *Potential Effects of Future Climate Changes on Forest and Vegetation, Agriculture, Water Resources, and Human Health*, US Environmental Protection Agency, Washington, DC, USA.
- Kandlikar, M., and Patwardhan, A., *et al.*, 1993, Trace Gas Indices Using an Optimal Control Framework, Hanford Regional Conference on Regional Climate Change, Richland, WA, USA.
- Kasperson, R.E., Renn, O., *et al.*, 1988, The Social Amplification of Risk: A Conceptual Framework, *Risk Analysis* **8**(2):177–87.
- Keith, D.W., and Dowlatabadi, H., 1992, A Serious Look at Geoengineering, *EOS* **73**(27):289, 292–293.
- Kempton, W., Boster, J.S., *et al.*, 1995, *Environmental Values in American Culture*, MIT Press, Cambridge, MA, USA.
- Kiehl, J.T., and Briegleb, B.P., 1993, The Relative Role of Sulfate Aerosols and Greenhouse Gases in Climate Forcing, *Science* **260**:311–314.
- Lal, M., Cubasch, U., *et al.*, 1995, Effect of Transient Increase of Greenhouse Gases and Sulphate Aerosols on Monsoon Climate, *Current Science* **69**(9):752–763.
- Langer, J., Rodhe, H., *et al.*, 1992, Anthropogenic Influence on the Distribution of Tropospheric Sulphate Aerosol, *Nature* **359**:712–716.
- Lashof, D., and Ahuja, D., 1990, Relative Contributions of Greenhouse Gas Emissions to Global Warming, *Nature* **344**:529–531.
- Lave, L.B., 1988, The Greenhouse Effect: What Government Actions are Needed, *Journal of Policy Analysis and Management* (3):460–470.
- Lave, L.B., and Dowlatabadi, H., 1993, Climate Change Policy: The Effects of Personal Beliefs and Scientific Uncertainty, *Environmental Science and Technology* **27**(10):1962–1972.
- Lave, L.B., and Vickland, K.H., 1989, Adjusting to Greenhouse Effects: The Demise of Traditional Cultures and the Cost to the USA, *Risk Analysis* **9**(3):283–291.
- Loewenstein, G., 1987, Frames of Mind in Intertemporal Choice, *Management Science* **34**:200–214.
- Loewenstein, G., and Mather, J., 1988, Dynamic Processes in Risk Perception, Department of Social and Decision Sciences, Carnegie Mellon University, Pittsburgh, PA, USA.

- Lovins, A.B., and Lovins, L.H., 1991, Least Cost Climate Stabilization, pp. 433-531 in J.M. Hollander, R.H. Socolow, D. Sternlight (eds.), *Annual Review of Energy and the Environment*, Volume 16, Annual Reviews Inc., Palo Alto, CA, USA.
- Malanson, G.P., 1993, Comment on Modeling Ecological Response to Climatic Change, *Climatic Change* **23**:95-109.
- Manne, A.S., and Richels, R.G., 1992, *Buying Greenhouse Insurance: The Economic Costs of CO<sub>2</sub> Emission Limits*, MIT Press, Cambridge, MA, USA.
- Martens, W.J.M., Rotmans, J., *et al.*, 1994, Climate Change and Malaria Risk, RIVM.
- Mitchell, J.F.B., Johns, T.C. *et al.*, 1995, Climate Response to Increasing Levels of Greenhouse Gases and Sulfate Aerosols, *Nature* **376**:501-504.
- Mitchell, R.C., and Carson, R.T., 1989, Using Surveys to Measure Public Goods: The Contingent Valuation Method, Resources for the Future, Washington, DC, USA.
- Morgan, M.G., and Dowlatabadi, H., 1994, Integrated Assessment of Climate Change: A Status Report on the Carnegie Mellon Program, Electric Power Research Institute, Integrated Systems Division.
- Morgan, M.G., and Henrion, M., 1990, Uncertainty: A Guide to Dealing With Uncertainty in Quantitative Risk and Policy Analysis, Cambridge University Press, New York, NY, USA.
- Morgan, M.G., and Keith, D., 1995, Subjective Judgments by Climate Experts, *Environmental Science & Technology* **29**(10):468A-476A.
- Morgan, M.G., and Smuts, T., 1994, Global Warming and Climate Change, Department of Engineering & Public Policy, Carnegie Mellon University, Pittsburgh, PA, USA.
- Morgan, M.G., Fischhoff, B., *et al.*, 1992, Communicating Risk to the Public: First Learn What People Know, *Environmental Science and Technology* **26**(11):2048-2056.
- National Research Council, 1992, Policy Implications of Greenhouse Warming: Mitigation, Adaptation, and the Science Base, National Academy Press, Washington, DC, USA.
- Nichols, N., 1994, El Niño-Southern Oscillation and Vector-borne Diseases, pp. 21-22 in *Health and Climate Change*, The Lancet Ltd., London, UK.
- Nordhaus, W.D., 1977, Economic Growth and Climate: The Carbon Dioxide Problem, *American Economic Review* **67**(1):341-346.
- Oravetz, M., and Dowlatabadi, H., 1995, Is There Autonomous Energy Efficiency Improvement? Department of Engineering & Public Policy, Carnegie Mellon University, Pittsburgh, PA, USA.
- Pandis, S.N., Russell, L.M. *et al.*, 1994, The Relationship Between DMS Flux and CCN Concentration in Remote Marine Regions.
- Patwardhan, A.P., and Small, M.J., 1994, Decision-making for Coastal Protection with Uncertain Future Sea Level and Storm Damage, *Water Resources Research* (under review).
- Peck, S.C., and Teisberg, T.J., 1992, CETA: A Model for Carbon Emissions Trajectory Assessment, *The Energy Journal* **13**(1):55-77.

- Pilinis, C., Pandis, S.N., *et al.*, 1995, Sensitivity of Direct Climate Forcing by Atmospheric Aerosols to Aerosol Size and Composition, *Journal of Geophysical Research* **100**(D9):18739–18754.
- Prentice, C., Cramer, W., *et al.*, 1992, A Global Biome Model Based on Plant Physiology and Dominance, Soil Properties and Climate, *Journal of Biogeography* **19**:117–134.
- Read, D., Bostrom, A., *et al.*, 1994, What Do People Know About Global Climate Change? 2: Survey Studies of Educated Lay People, *Risk Analysis* **14**(6):971–982.
- Rijkswaterstaat, 1990, Sea Level Rise: A World-wide Cost Estimate of Basic Control Defense Measures, Delft Hydraulic Laboratory, Rijkswaterstaat.
- Rogers, D.J., and Packer, M.J., 1994, Vector-borne Diseases, Models, and Global Change, pp. 19–21 in *Heath and Climate Change*, The Lancet Ltd., London, UK.
- Rotmans, J., 1990, IMAGE: An Integrated Model to Assess the Greenhouse Effect, Kluwer Academic Publishers, Dordrecht, The Netherlands.
- Schelling, T.C., 1978, *Micromotives and Macrobehavior*, Norton, New York, NY, USA.
- Scheraga, J.S., and Sussman, F., 1994, Preliminary Assessment of the Benefits to the US of Avoiding, or Adapting to Climate Change, US Environmental Protection Agency, Washington, DC, USA.
- Schneider, S.H., 1989, The Greenhouse Effect: Science and Policy, *Science* **243**(4894):771–781.
- Schneider, S.H., and Chen, R.S., 1980, Carbon Dioxide Warming and Coastline Flooding: Physical Factors and Climate Impact, *Annual Review of Energy* **5**:107–140.
- Shevliakova, E., and Dowlatabadi, H., 1994, Probabilistic Modeling of Ecosystem Changes Due to Climate Change, Proceedings of the Air and Waste Management Association International Specialty Conference: Global Climate Change Science, Policy, and Mitigation Strategies, 5–8 April held at Phoenix, AZ, USA.
- Smith, T.M., Leemans, R., *et al.*, 1992, CO<sub>2</sub>-induced Climate Change: Comparison of Four Scenarios Based on General Circulation Models, *Climatic Change* **21**:367–384.
- Sonnenblick, R., 1995, A Framework for Improving the Cost-Effectiveness of Demand-Side Management Program Evaluations, PhD dissertation, Carnegie Mellon University, Pittsburgh, PA, USA.
- Titus, J.G. (ed.), 1986, Effects of Changes in Stratospheric Ozone and Global Climate, Vol 4: Sea Level Rise, Environmental Protection Agency, Washington, DC, USA.
- Titus, J.G., Park, R.A. *et al.*, 1991, Greenhouse Effect and Sea Level Rise: The Cost of Holding Back the Sea, *Coastal Management* **19**(2):172–204.
- Tokai, A., Yuasa, A., *et al.*, 1995, Climate Change Scenario Analysis: Assessment of Alternatives Using Multi-Attribute Utility Measures, Society for Risk Analysis, Waikiki, HI, USA.



- Tschang, F.T., and Dowlatabadi, H., 1995. A Bayesian Technique for Refining the Uncertainty in Global Energy Model Forecasts, *International Journal of Forecasting* **11**:43–61.
- US Environmental Protection Agency, 1992, Agricultural Futures Project: Overview and Summary, US Environmental Protection Agency, Washington, DC, USA.
- Waggoner, P.E., 1994, How Much Land Can Ten Billion People Spare for Nature? Council for Agricultural Science and Technology.
- West, J., 1994, Evaluation of Non-structural Coastal Management Under Uncertain Physical Conditions: A Case Study at Duck, NC, M.S., Carnegie Mellon University, Pittsburgh, PA, USA.
- Weyant, J., Davidson, O., *et al.*, 1996, Integrated Assessment of Climate Change: An Overview and Comparisons of Approaches and Results, IPCC Working Group III.
- Yohe, G., 1990, The Cost of Not Holding Back the Sea: Toward a National Sample of Economic Vulnerability, *Coastal Management* **18**:403–432.



# International Institutions and Environmental Protection: Sources of Effectiveness and Ineffectiveness\*

*Robert O. Keohane*

Duke University, Durham, NC, USA

## Abstract

International cooperation on environmental issues, involving mutual adjustment of policy, typically takes place through international institutions. Institutions are the typical vehicle for international environmental protection, not because they supersede state authority, but because they facilitate joint action on transboundary issues that are within the jurisdiction of no single country. Key functions that international institutions perform for states include facilitating the negotiation of agreements; providing information; structuring reciprocity; and providing governance arrangements for the transfer of funds from rich countries to poorer countries to cope with environmental problems having transboundary effects. The general point to emphasize is that international institutions operate, not through coercion or mere persuasion, but by changing the incentives facing states. By coordinating state actions, well-functioning institutions reduce the costs of cooperation.

The effectiveness of international institutions varies from one environmental issue to another. Furthermore, sources of effectiveness or ineffectiveness may appear at any of three stages in the process: problem definition, policy negotiation, and policy implementation. Environmental institutions will only be effective if they create incentives for cooperation, whether among regulators, between regulators and the regulated, or between those who contribute to funds and those who receive aid from them. Otherwise, they will merely become sites for repetitive and costly political struggle. Such incentives depend on what earlier work has dubbed the “three Cs”: effective environmental aid is likely to follow a path that increases concern for environmental protection, provides solutions to contracting problems, or increases capacity for designing and implementing specific measures.

---

\*Parts of this paper draw on joint work with Barbara Connolly.

If the international environment is to be protected through international action, the institutions that accomplish this task will not be patterned on modern states. They will not use hierarchies to enforce rules. Instead, effective institutions will promote negotiation, provide information, and facilitate the operation of reciprocity. They will help to generate concern, reduce contractual difficulties, and enhance capacity within countries. Collective management of resources will have to be carried out by institutions that foster cooperation through reciprocity, monitoring, and persuasion. These institutions, to be legitimate, will have to be multilateral in form, involve many states, and operate according to nondiscriminatory rules based on general principles. They will also have to “get the incentives right.”

## 1. Introduction

When governments convene to negotiate on international environmental issues, they typically establish new international institutions, assign tasks to existing institutions, or modify existing institutions. Institutions – sets of formal and informal rules and procedures, usually linked to bureaucratic organizations – are centrally involved in international environmental policy. Examples of institutions created especially for environmental purposes include the UN Environment Programme (UNEP), the 1973 Convention on International Trade in Endangered Species (CITES); the 1973 Convention on Prevention of Pollution by Ships (MARPOL); the 1979 Convention on Long-Range Transboundary Air Pollution (LRTAP); the Montreal Protocol for protection of the ozone layer (1987) and the Montreal Protocol Fund (1990); and the Global Environment Facility (1990). Almost all such institutions have their origins in postwar treaties, most dating from after the Stockholm Conference of 1972.<sup>1</sup> Examples of established institutions assigned environmental tasks or modified to achieve environmental purposes include the World Bank, the UN Development Programme (UNDP), and the European Union.

## 2. Cooperation, Sovereignty, Institutions

International cooperation on such issues can be thought of as mutual adjustment of policy through a set of political bargains. It should not be confused with harmony; on the contrary, international cooperation (like

---

<sup>1</sup>Caldwell (1990) lists over 40 “significant” environmental treaties concluded between 1946 and 1989.

labor-management cooperation) entails significant conflict, including threats of noncooperation unless the terms are right. So, for instance, China and India eventually signed the Montreal Protocol, but only after developing countries were compensated with a Fund and given extended deadlines for a chlorofluorocarbon (CFC) phaseout to help them adjust to the new rules. Since no state can deal effectively with transboundary issues on its own, on the whole they can achieve their objectives better by sacrificing some of their legal freedom of action in return for restrictions on the freedom of action of others – but only if the price is right. Governments do not become altruistic when they enter international negotiations.

States agreeing to international institutions do not give up their constitutional sovereignty – their consent is still needed and they can refuse even to implement their legal obligations if they so choose. However, in return for compensation they are often willing to relinquish some of what could be called their “operational sovereignty” – their legal freedom of action. Operational sovereignty is subject to bargaining and exchange, and becomes more a bargaining chip than a symbol for insistence on unilateralism.

Institutions are the typical vehicle for international environmental protection, not because they supersede state authority, but because they facilitate joint action on transboundary issues that are within the jurisdiction of no single country. Key functions that international institutions perform for states can be summarized in four phrases: 1) facilitating the negotiation of agreements; 2) providing information; 3) structuring reciprocity; and 4) providing governance arrangements for the transfer of funds from rich countries to poorer countries to cope with environmental problems having transboundary effects.

*Ex ante*, many possible agreements might be superior to the status quo for all essential participants, that is, those states (and possibly other actors such as international organizations or industrial firms) with sufficient resources to render institutions ineffective if they choose not to cooperate. These participants could prefer different arrangements, leading to protracted negotiations. Institutional rules help to define “focal points” and to narrow the range of disagreement subject to bargaining. Furthermore, institutions contain procedural rules for making decisions – for instance, by majority vote, consensus, or supermajority voting – that enable valid rules to be recognized (since they have been adopted through these legitimate procedures).

Once in operation, international institutions largely operate by providing information to members about each others’ preferences and performance. Institutions provide information publicizing the consequences of damaging environmental policies. Institutions also establish standards of behavior

against which actual performance can be compared and monitor the performance of states and industry. A study of a variety of international environmental institutions revealed that each of them monitored aspects of environmental quality, either alone or in conjunction with independent scientific laboratories (Haas *et al.*, 1993, p. 402). Monitoring, however, is often done badly, particularly when it relies exclusively on national reporting, which is spotty in character (Mitchell, 1994).

Third, international institutions structure reciprocity. They do not, in general, have the capacity to enforce rules directly through vertical sanctions. On the contrary, national governments retain the ultimate capacity to sanction one another. However, institutions link similar issues together, so that the nonfulfillment of obligations by one state is more likely to lead others to retaliate. Some institutions, such as the Montreal Protocol, provide for trade sanctions against those who violate the rules.

Finally, international institutions can legitimize the provision of aid to solve environmental problems by structuring the arrangements governing its provision. As shown by their frustrated demands for new financial commitments at the 1992 Earth Summit and by their positions in global negotiations regarding the climate change and ozone regimes, developing countries increasingly view enlarged resource transfers as a prerequisite for their participation in global environmental protection efforts. For such aid to be provided, it is necessary to establish financial transfer institutions for the environment: sets of rules, typically linked to one or more international organizations, established to govern a flow of funds from richer to poorer countries to achieve specific environmental purposes.

The general point to emphasize is that international institutions operate, not through coercion or mere persuasion, but by changing the incentives facing states. By coordinating state actions, well-functioning institutions reduce the costs of cooperation. By subjecting laggards to public and private criticisms in focused ways institutions may increase the costs of nonfulfillment. These effects are exerted at the margin – institutions cannot overcome adverse interests – but are frequently significant (Keohane, 1984).

### **3. Variation in Institutional Effectiveness**

“Effectiveness” is a slippery concept with many meanings. Ultimately, students of this subject aim to discover how international institutions change the behavior of actors and the policies and performance of institutions in ways that contribute to or impede the solution of significant environmental

problems. That is, without the institution, would environmental quality, and the policies designed to improve such quality in the future, be worse? Institutional effectiveness depends on choosing a significant problem, defining its scope in a manageable way, proposing solutions, devising institutional arrangements to implement the solutions, and actually implementing the solutions agreed upon.

Regardless of one's specific definition of institutional effectiveness, it clearly varies from one environmental issue to another. The Montreal Protocol on the ozone layer has led to significant policy change that has been quite thoroughly implemented. LRTAP has helped to reduce transboundary pollution in Europe associated with acid rain, especially in countries that were neither leaders in pollution reduction nor adamantly opposed to costly action. Consistent with the functions mentioned above, its success was due to its provision of information about the problem (the domestic consequences of acid rain) and about the implementation of pollution-reducing measures, and to its ability to link issues to one another (Levy, 1993, p. 119). On the other hand, institutions designed to prevent overfishing in international waters and to protect tropical forests have been notoriously ineffective in achieving these purposes (Peterson, 1993; Ross, 1996). It may be helpful to describe typical stages of institutional policy making and to identify potential causal factors that may account for variations in effectiveness.

Three broad stages of policy making can be identified: problem definition, policy negotiation, and policy implementation. Sources of effectiveness or ineffectiveness may appear at any of these stages in the process. Consider problem definition. The Montreal Protocol process may be a model of sensible problem definition, involving a combination of scientific analysis and policy, but it is hardly typical. After 1989 Western governments and international agencies began to assess how to deal with dangerous East European nuclear power plants. However, all the solutions they came up with were "essentially pronuclear," involving continued reliance on nuclear power. Demand management was not emphasized. As Barbara Connolly and Martin List comment, "The pronuclear orientation is not surprising, given domination by professional nuclear organizations" (Connolly and List, 1996, p. 269). The other side of this coin is that "coalitions of the green and the greedy" have more political impact than environmental movements alone. When such coalitions are mobilized behind an adequate definition of the problem, as happened with respect to ozone and CFC production, policy change and implementation can occur with remarkable rapidity (Oye and Maxwell, 1995).

Policy negotiation can also be smooth or contorted. At this stage of the process, we also observe variation in effectiveness. Compare, for instance, the Montreal Protocol Fund with the Global Environment Facility (GEF). Both funds had similar purposes: to transfer resources from rich to poor countries to help solve environmental problems with transboundary implications. The GEF was established in 1990 with a World Bank-led administrative structure and with clear dominance of an “informal” governance structure by donor countries and the Bank. It therefore lacked legitimacy with governments of poor countries. Since it was an open-ended pilot program with ambiguous rules, both poor and rich countries worried about setting adverse precedents that would affect major future allocations of resources. As a result, in its initial years the GEF became thoroughly politicized. Each specific negotiation became part of a North-South struggle over control of financial transfers for environmental purposes. In its first few years, the GEF probably made it harder, rather than easier, for governments to cooperate on environmental aid. Furthermore, conflicts among the implementing agencies – especially between the World Bank, on the one hand, and the UNDP and the UNEP, on the other – worsened the situation.

In contrast, negotiations in the Montreal Protocol Fund, also established in 1990, have been businesslike and productive. Before the developing countries were brought into negotiations, developed countries had already taken steps, individually and collectively, to reduce production of ozone-depleting substances. Hence they were keen to ensure that developing countries would not undermine their efforts by sharply increasing their own production of these substances. The combination of high demand for agreement on the part of developed countries and strong bargaining power for developing countries led to a formal decision-making structure with equal representation, on an executive committee, of developed and developing countries. Decisions are normally made by consensus and in any case require a two-thirds vote of all members and a majority of both developed and developing countries. The Fund has a strong independent secretariat, and serious attention is paid to scientific criteria in evaluating project proposals.

The third stage in the process involves implementation, where the most serious problems of ineffectiveness arise. Each set of institutions has its “laggards” – countries that either refuse to sign commitments or fail to live up to them. With respect to ozone, China and India are particularly problematic (Desombre and Kaufman, 1996). In the LRTAP regime, the laggards were largely from Eastern and Southern Europe, but also included Great Britain (Levy, 1993, p. 119). Indeed, as became evident after 1989, the



socialist countries of Eastern Europe were laggards in most areas of environmental policy. Organization of the Petroleum Exporting Countries (OPEC) countries and independent tanker firms were most reluctant to conform to MARPOL standards during the 1970s (Mitchell, 1994, pp. 233, 246). Many producers, including Brazil, Indonesia, and Malaysia, have failed to effectively regulate logging of tropical forests (Ross, 1996). For international institutions to have effects on the quality of implementation, they must get resources into the right hands. Bribes do not produce environmental improvement. When recipients of aid do not share the priorities of donors, or when they lack the capacity to act effectively, resources are wasted.

The contrast between World Bank forestry programs in Indonesia and the Philippines (Ross, 1996) makes this point well. In Indonesia, efforts to make aid conditional on more sustainable logging policies foundered: when the logging industry is part of the government coalition, as in Indonesia, those who contribute to the funds cannot persuade governments to implement genuine reform. In the Philippines in the late 1980s, however, conditionality led to a remarkably far-reaching series of reforms, because the World Bank was able to work with activists in the new Aquino government, who sought conditionality in order to increase their leverage vis-à-vis the logging industry. Effective international financial transfers to protect tropical forests depend on active forces for reform within the countries concerned. "Buying" reform through conditional aid does not work.

#### **4. Explaining Variation in Effectiveness: The "Three Cs"**

Environmental institutions will only be effective if they create incentives for cooperation, whether among regulators, between regulators and the regulated, or between those who contribute to funds and those who receive aid from them. Otherwise, they will merely become sites for repetitive and costly political struggle. Such incentives depend on what earlier work has dubbed the "three Cs": effective environmental aid is likely to follow a path that increases concern for environmental protection, provides solutions to contracting problems, or increases capacity for designing and implementing specific measures (Haas *et al.*, 1993).

Concern refers to the interest in preserving the environment expressed by potential participants in an international environmental institution. Governmental concern must be sufficiently high to prompt states to devote scarce resources to solving the problem. Such concern requires political mobilization

within societies, putting pressure on government for action; it also requires sympathetic or at least responsive individuals within governments. Where financial aid is concerned, the level of concern of the recipient must be sufficient to make action feasible, but not so high as to induce it to go ahead on its own, since if it did the latter, no financial transfers would be necessary. Potential contributors, however, must be sufficiently concerned to be willing to spend funds on selected environmental problems abroad, rather than at home. Hence, when financial transfers occur, concern is typically higher among potential contributors than in the home state. Such asymmetrical levels of concern create persistent political tensions between contributors and recipients, but they also provide opportunities: financial transfers can increase support for environmental protection in recipient countries by augmenting the political or financial resources available to sympathetic groups, altering attitudes of key actors, or building political coalitions behind reform packages.

Also important for institution building are contracting problems: how to draw up international agreements in which the parties can have confidence, despite the absence of world courts and police to enforce them, and how to avoid the kinds of negotiating foul-ups experienced by the GEF. Where environmental aid is concerned, the differing priorities of donors and recipients give rise to many potential contracting problems. In some cases, recipients face the danger that, after implementing costly policy changes, contributors will renege on their financial commitments. Developing countries expressed these concerns in negotiations about the GEF. More typically, however, contributors worry more than recipients about contracting problems, as evidenced by the histories of the Montreal Protocol Fund, debt-for-nature swaps, and nuclear aid in Eastern Europe. In all three cases, contributors made large contributions in return for promises of future performance by recipients – promises that are difficult to enforce. Having received funds, recipients have incentives to revert to actions oriented toward their own priorities, rather than those of the contributors: to continue producing ozone-depleting chemicals after an extended deadline has passed; to let loggers and poachers invade nature preserves; or to extend the lives of retrofitted nuclear plants rather than closing them down. Institutions for environmental aid are always designed with such contracting problems more or less explicitly in mind.

Finally, a dearth of political and administrative capacity to formulate and implement policies to protect the natural environment and assure sustainability is often the greatest difficulty for international environmental

institutions. I use “capacity” broadly here – referring not just to the ability of governments to enforce laws and regulations, but to the capacity of individuals in civil society to play an effective role in policy making. Issues of capacity are particularly important with respect to environmental aid. Rich countries typically initiate these arrangements out of concern that poorer countries are not adequately protecting the global or regional environment. These perceived policy failures always reflect, in part, lack of human, organizational, and financial resources in the poor countries, although they may also result from a lack of local concern about environmental problems. Therefore, almost by definition, recipient capacity is deficient on issues that financial transfer mechanisms target. Developing countries typically have environmental ministries, but many of them lack the technical competence, financial resources, or political clout to make much difference. Potential contributors may also lack appropriate analytic capability, local knowledge, or long-term ties to recipient counterpart agencies to support relatively new environmental goals. Also important is the capacity of the donor institutions. As the example of environmental aid to Eastern Europe shows, when established donor institutions such as the World Bank, the European Bank for Reconstruction and Development, the European Union’s Assistance for Economic Restructuring in the Countries of Central and Eastern Europe (PHARE) program, and bilateral aid agencies confront new environmental issues, they often seek out problems and solutions that fit their ready-made organizational tool kits instead of tailoring interventions to the specific characteristics of environmental problems. Each of the “three Cs” provides an analytical lens through which to view features of the environment in which financial transfers operate. Yet the “Cs” are not separate phenomena in the real world; they interact. Perhaps most obviously, capacity to some extent reflects concern. Decisions on where to allocate scarce resources, whether for aid programs by the governments of wealthy countries or for autonomous initiatives by developing countries, depend on domestic priorities. Conversely, development of capacity among strategic actors can affect subsequent concern: for example, strengthened nongovernmental organizations may enjoy greater success in promoting public environmental awareness as well as in pressuring governments to take action. Clearly, concern affects the contractual environment, since differing priorities among contributors and recipients create incentives for renegeing on commitments. Hence, although it is analytically convenient to distinguish among concern, contracting, and capacity, they may be hard to disentangle in practice.

## 5. Understanding Nonhierarchical Governance

The domestic analogy and discussions of the “tragedy of the commons” may have led some people to believe that international environmental protection should be fostered through the reinvention of Hobbes’s *Leviathan*. In this model, international environmental law would be legislated, then enforced. However, reflection on the nature of international relations and the experiences of international environmental institutions suggests that such an organizational design would fail. World politics is inherently decentralized; any enforcement of rules that takes place is not managed from above, but occurs through the operation of reciprocity among states, often with the active involvement of intergovernmental and nongovernmental organizations. If the international environment is to be protected through international action, the institutions that accomplish this task will not be patterned on modern states. They will not use hierarchies to enforce rules. Instead, effective institutions will promote negotiation, provide information, and facilitate the operation of reciprocity. They will help to generate concern, reduce contractual difficulties, and enhance capacity within countries. They will define problems competently – in ways that are both consistent with science and with underlying configurations of power and interests in the world system. Collective management of resources will have to be carried out by institutions that foster cooperation through reciprocity, monitoring, and persuasion. These institutions, to be legitimate, will have to be multilateral in form, involve many states, and operate according to nondiscriminatory rules based on general principles (Ruggie, 1992). They will also have to “get the incentives right.”

For institutions to work well, political pressure for environmental protection must continue to be mobilized at the domestic level, and both nongovernmental and governmental institutions need the capacity to analyze and implement protective policies. That is, both concern and capacity need to be high. Without robust institutions at both domestic and international levels linked closely to one another, diffuse public pressure for “green” policies could lead to merely symbolic efforts, rather than to effective measures to assure improvement of the quality of the natural and human environment.

## References

- Caldwell, L.K., 1990, *International Environmental Policy: Emergence and Dimensions*, Duke University Press, Durham, NC, USA.
- Connolly, B., and List, M., 1996, Nuclear Safety in Eastern Europe and the Former Soviet Union, in R.O. Keohane and M.A. Levy (eds.), *Institutions for Environmental Aid*, MIT Press, Cambridge, MA, USA.
- Desombre, B., and Kaufman, J., 1996, The Montreal Protocol Multilateral Fund: Partial Success Story, in R.O. Keohane and M.A. Levy (eds.), *Institutions for Environmental Aid*, MIT Press, Cambridge, MA, USA.
- Haas, P.M., Keohane, R.O., and Levy, M.A. (eds.), 1993, *Institutions for the Earth: Sources of Effective International Environmental Protection*, MIT Press, Cambridge, MA, USA.
- Keohane, R.O., 1984, *After Hegemony: Cooperation and Discord in the World Political Economy*, Princeton University Press, Princeton, NJ, USA.
- Levy, M.A., 1993, European Acid Rain: The Power of Tote-Board Diplomacy, in P.M. Haas *et al.* (eds.), *Institutions for the Earth: Sources of Effective International Environmental Protection*, MIT Press, Cambridge, MA, USA.
- Mitchell, R.B., 1994, *Intentional Oil Pollution at Sea: Environmental Policy and Treaty Compliance*, MIT Press, Cambridge, MA, USA.
- Oye, K.A., and Maxwell, J.H., 1995, Self-Interest and Environmental Management, in R.O. Keohane and E. Ostrom (eds.), *Local Commons and Global Interdependence*, Sage Publications, London, UK.
- Peterson, M.J., 1993, International Fisheries Management, in P.M. Haas *et al.* (eds.), *Institutions for the Earth: Sources of Effective International Environmental Protection*, MIT Press, Cambridge, MA, USA.
- Ross, M., 1996, Conditionality and Logging Reform in the Tropics, in R.O. Keohane and M.A. Levy (eds.), *Institutions for Environmental Aid*, MIT Press, Cambridge, MA, USA.
- Ruggie, J.G., 1992, Multilateralism: The Anatomy of an Institution, *International Organization* Vol. 46, No. 3 (Summer):561-598.



# Appendix





**INTERNATIONAL WORKSHOP ON  
CLIMATE CHANGE: INTEGRATING SCIENCE,  
ECONOMICS, AND POLICY  
19–20 March 1996  
IIASA, Laxenburg, Austria  
P R O G R A M**

**Tuesday, 19 March 1996**

8:45–9:00 Welcome: *Peter E. de Jánosi*

**Session I: Climate**

Chairperson: *William Nierenberg*

9:00–10:00 Speakers:

*Klaus Hasselmann*: Sensitivity Studies of Greenhouse Warming: Cost-Benefit Analyses Using a Simplified Integrated Assessment Model (SIAM)

*Tom Wigley*: New Insights from the IPCC Scientific Assessment  
Discussants:

*Michael Schlesinger*: The Standard Error of Observationally Based Estimates of Climate Sensitivity and Sulfate Forcing

*Hadi Dowlatabadi*: Detection and Implications of Century Scale Climate Oscillations

10:00–10:30 **General Discussion**

**Session II: Impacts I: Non-Market and Public Goods**

Chairperson: *Hans-Joachim Schellnhuber*

11:00–12:00 Speakers:

*William Nordhaus*: The Valuation of Climatic Amenities and the Prospect of Global Warming

*Colin Prentice*: Global Impacts of Climate Change and Atmospheric CO<sub>2</sub> on the Structure and Primary Production of Ecosystems

Discussants:

*Richard Tol*: The Damage Costs of Climate Change: The IPCC Second Assessment Report and Beyond

*Yuzuru Matsuoka*: Climate Change Impacts in Asia

12:00–12:30 **General Discussion**

**Session III: Impacts II: Market Sectors**Chairperson: *Stephen Peck*

14:00–15:00 Speakers:

*Robert Mendelsohn*: Market Impacts of Climate Change Other than Agriculture*John Reilly*: Market Impacts of Climate Change on Agriculture

Discussants:

*Günther Fischer and Cynthia Rosenzweig*: The Impacts of Climate Change, CO<sub>2</sub>, and SO<sub>2</sub> on Agricultural Supply and Trade15:00–15:30 **General Discussion****Session IV: Special Topics in Integrated Assessment I**Chairperson: *John Weyant*

Introduction to EMF-14

16:00–17:00 I: The Design of Cost-Effective Mitigation Strategies

Speaker: *Richard Richels*

II: Hedging Strategies for Global Carbon Dioxide Abatement:

A Summary of Poll Results. EMF-14 Subgroup:

Analysis for Decisions under Uncertainty

Speaker: *Alan Manne*

III: Learning

Speaker: *Charles Kolstad*17:00–17:30 **General Discussion****Wednesday, 20 March 1996****Session V: Technology**Chairperson: *Bruno Fritsch*

9:00–10:00 Speakers:

*Meyer Steinberg*: CO<sub>2</sub> Mitigation Technologies*Nebojša Nakićenović*: Technological Change and Learning

Discussants:

*James Edmonds*: The Value of Advanced Energy Technologies in Stabilizing the Atmosphere*Arnulf Grübler*: Technological Uncertainty10:00–10:30 **General Discussion**

**Session VI: Policy and Implementation**Chairperson: *Henry Jacoby*

11:00–12:00 Speakers:

*Robert Keohane*: International Institutions and Environmental Protection: Sources of Effectiveness and Ineffectiveness*Thomas Schelling*: Policy Issues of Climate Change

Discussants:

*Michael Grubb*: Technologies, Energy Systems, and the Timing of CO<sub>2</sub> Emissions Abatement: An Overview of Economic Issues*David Victor*: Integrated Assessment and Policy Implementation12:00–12:30 **General Discussion****Session VII: Special Topics in Integrated Assessment II**Chairperson: *Pantelis Capros*

14:00–15:00 I: New Results from the PAGE95 Model

Speaker: *Chris Hope*

II: Economics for Integrated Assessment

Speaker: *Warwick McKibbin*

III: Ecological Damage Functions

Speaker: *Ferenc Toth*

IV: Discounting and the Structure of Economic Evaluation in Integrated Assessment Models

Speaker: *Robert Lind*15:00–15:30 **General Discussion****Overview of the Workshop and Conclusions**Chairperson: *William Nordhaus*16:00–17:00 **General Discussion**17:00–18:00 Panelists: *Thomas Schelling, William Nierenberg, Robert Keohane, Hans-Joachim Schellnhuber, Bruno Fritsch*



**INTERNATIONAL WORKSHOP ON  
CLIMATE CHANGE: INTEGRATING SCIENCE,  
ECONOMICS, AND POLICY  
19-20 March 1996  
IIASA, Laxenburg, Austria  
Final List of Participants**

Mr. Nobuo Akutsu  
Research Scholar  
Environmentally Compatible Energy  
Strategies (ECS) Project  
International Institute for  
Applied Systems Analysis (IIASA)  
Schlossplatz 1  
A-2361 Laxenburg  
Austria

Dr. Joseph Alcamo  
Professor  
Scientific Center for  
Environmental Systems Research  
University of Kassel  
Kurt-Wolters-Strasse 3  
D-34109 Kassel  
Germany

Dr. Markus Amann  
Project Leader  
Transboundary Air Pollution (TAP)  
Project, International Institute  
for Applied Systems Analysis (IIASA)  
Schlossplatz 1  
A-2361 Laxenburg  
Austria

Dr. Natasha Andronova  
Assistant Professor, Research Specialist  
Department of Atmospheric Sciences  
University of Illinois at  
Urbana-Champaign  
105 S. Gregory Avenue  
Urbana, IL 61801-3819  
USA

Dr. Normand Beaudoin  
Senior Economic Advisor  
Environment Analysis Branch  
Environment Protection Service of  
Environment Canada  
Global Air Issues Branch  
351 St. Joseph Boulevard  
Place Vincent-Massey, 10th floor  
Hull, Quebec K1A 0H3  
Canada

Prof. Pantelis Capros  
Department of Electrical and  
Computer Engineering  
National Technical University of Athens  
Institute of Computers and  
Communications & Electric Power Div.  
42 Patission Str.  
106 82 Athens  
Greece

Dr. Peter E. de Jánosi  
Director, International Institute  
for Applied Systems Analysis (IIASA)  
Schlossplatz 1  
A-2361 Laxenburg  
Austria

Prof. Hadi Dowlatabadi  
Coordinator, Global Climate Change  
Integrated Assessment Program  
Carnegie Mellon University  
Dept. Engineering and Public Policy  
Schlenley Park, P.O. Box 100  
5000 Forbes Avenue  
Pittsburgh, PA 15213  
USA

Dr. James A. Edmonds  
 Technical Leader, Economics Program  
 Battelle Pacific Northwest Laboratories  
 901 D Street, SW, Suite 900  
 Washington, DC 20024-2115  
 USA

Prof. Yuri Ermoliev  
 Project Co-Leader  
 Risk, Policy and Complexity (RPC) Project  
 International Institute for  
 Applied Systems Analysis (IIASA)  
 Schlossplatz 1  
 A-2361 Laxenburg  
 Austria

Dr. Günther Fischer  
 Project Leader  
 Modeling Land-Use and Land-Cover  
 Changes in Europe and Northern Asia  
 (LUC) Project, International Institute  
 for Applied Systems Analysis (IIASA)  
 Schlossplatz 1  
 A-2361 Laxenburg  
 Austria

Prof. Bruno Fritsch  
 Professor Emeritus  
 Swiss Federal Inst. of Technology  
 via del Sole 47  
 CH-6600 Locarno-Muralto  
 Switzerland

Dr. Yasumasa Fujii  
 Research Scholar  
 Environmentally Compatible Energy  
 Strategies (ECS) Project, IIASA  
 (until 1 May 1996)  
 and Lecturer, Yokohama National  
 University  
 International Institute for  
 Applied Systems Analysis (IIASA)  
 Schlossplatz 1  
 A-2361 Laxenburg  
 Austria

Mr. Laurent Gilotte  
 Research Assistant  
 Environmentally Compatible Energy  
 Strategies (ECS) Project  
 International Institute for  
 Applied Systems Analysis (IIASA)  
 Schlossplatz 1  
 A-2361 Laxenburg  
 Austria

Dr. Andrei Gritsevskii  
 Research Scholar  
 Environmentally Compatible Energy  
 Strategies (ECS) Project  
 International Institute for  
 Applied Systems Analysis (IIASA)  
 Schlossplatz 1  
 A-2361 Laxenburg  
 Austria

Dr. Michael Grubb  
 Energy and Environment Programme  
 The Royal Institute of International Affairs  
 Chatham House  
 10 St. James's Square  
 London SW1Y 4LE  
 United Kingdom

Dr. Arnulf Grübler  
 Research Scholar  
 Environmentally Compatible Energy  
 Strategies (ECS) Project  
 International Institute for  
 Applied Systems Analysis (IIASA)  
 Schlossplatz 1  
 A-2361 Laxenburg  
 Austria

Dr. Sujata Gupta  
 Tata Energy Research Institute  
 Darbari Seth Block, India Habitat Centre  
 Lodi Road  
 New Delhi 110003  
 India

Dr. Erik Haites  
 Head, Technical Support Unit  
 Working Group III  
 Intergovernmental Panel on  
 Climate Change (IPCC)  
 145 King Street West, Suite 1000  
 Toronto, Ontario M5H 3X6  
 Canada

Dr. Sally Kane  
 Senior Economist  
 Office of Global Programs  
 United States Department of Commerce  
 National Oceanic and Atmospheric  
 Administration (NOAA)  
 1100 Wayne Avenue - Suite 1210  
 Silver Spring, MD 20910-5603  
 USA

Prof. Klaus Hasselmann  
 Director, Max-Planck-Institute  
 for Meteorology  
 Bundesstrasse 55  
 D-20146 Hamburg  
 Germany

Prof. Robert Keohane  
 Stanfield Professor of International Peace  
 National Humanities Center  
 7 Alexander Drive, P.O. Box 12256  
 Research Triangle Park, NC 27709  
 USA

Dr. Chris W. Hope  
 University Lecturer  
 Judge Inst. of Management Studies  
 University of Cambridge  
 Trumpinton St.  
 Cambridge CB2 1AG  
 United Kingdom

Prof. Charles Kolstad  
 Professor of Economics  
 Department of Economics  
 University of California  
 Santa Barbara, CA 93106-9210  
 USA

Prof. Henry Jacoby  
 Professor of Management  
 MIT Sloan School of Management  
 Co-Director, MIT Joint Program on the  
 Science and Policy of Global Change  
 Massachusetts Institute of Technology  
 1 Amherst Street, Bldg. E40-271  
 Cambridge, MA 02139-4307  
 USA

Prof. Yuri D. Kononov  
 Head of Energy-Problems Laboratory  
 Siberian Energy Institute  
 Siberian Branch of the Russian  
 Academy of Sciences  
 Lermontov Street 130  
 664033 Irkutsk  
 Russia

Dr. Jill Jäger  
 Deputy Director  
 International Institute for Applied  
 Systems Analysis (IIASA)  
 Schlossplatz 1  
 A-2361 Laxenburg  
 Austria

Dr. Julia M. Kundermann  
 Assistant Manager for Global Change  
 and Climate Impact Research  
 Federal Ministry of Education, Science,  
 Research and Technology  
 Heinemannstrasse 2  
 D-53175 Bonn  
 Germany

Dipl. Ing. Rainer Kurz  
 Research Assistant  
 Environmentally Compatible Energy  
 Strategies (ECS) Project  
 International Institute for  
 Applied Systems Analysis (IIASA)  
 Schlossplatz 1  
 A-2361 Laxenburg  
 Austria

Prof. Robert C. Lind  
 Professor of Economics, Management  
 and Public Policy  
 Cornell University  
 Johnson Graduate School of Management  
 562 Malott Hall  
 Ithaca, NY 14853-4201  
 USA

Dr. Nadejda Makarova  
 Research Assistant  
 Environmentally Compatible Energy  
 Strategies (ECS) Project  
 International Institute for  
 Applied Systems Analysis (IIASA)  
 Schlossplatz 1  
 A-2361 Laxenburg  
 Austria

Prof. Alan S. Manne  
 Professor Emeritus of Operations Research  
 Stanford University  
 834 Esplanada Way  
 Stanford, CA 94305-4022  
 USA

Prof. Yuzuru Matsuoka  
 Professor, Department of  
 Geotechnology and Environment  
 Nagoya University  
 Furocho, Chikusa,  
 Nagoya  
 Japan

Prof. Warwick J. McKibbin  
 Professor of Economics  
 Economics Division  
 Australian National University  
 Research School of Pacific Studies  
 Canberra ACT 0200  
 Australia

Prof. Robert Mendelsohn  
 School of Forestry and  
 Environmental Studies  
 Yale University - FES  
 Marsh Hall  
 360 Prospect Street  
 New Haven, CT 06511  
 USA

Dipl. Ing. Sabine Messner  
 Research Scholar  
 Environmentally Compatible Energy  
 Strategies (ECS) Project  
 International Institute for  
 Applied Systems Analysis (IIASA)  
 Schlossplatz 1  
 A-2361 Laxenburg  
 Austria

Dr. Tsuneyuki Morita  
 Head of Global Warming Response Team  
 National Institute for Environmental  
 Studies  
 (Japan Environment Agency/Prime  
 Minister's Office)  
 16-2 Onogawa, Tsukuba  
 Ibaraki 305  
 Japan

Dr. Nebojša Nakićenović  
 Project Leader  
 Environmentally Compatible Energy  
 Strategies (ECS) Project  
 International Institute for  
 Applied Systems Analysis (IIASA)  
 Schlossplatz 1  
 A-2361 Laxenburg  
 Austria



Prof. William Nierenberg  
 Director Emeritus  
 Scripps Institution of Oceanography  
 Mail Code 0221  
 University of California, San Diego  
 La Jolla, CA 92093-0221  
 USA

Prof. William D. Nordhaus  
 Economics Department  
 Yale University  
 Box 1972, Yale Station  
 28 Hillhouse Avenue  
 New Haven, CT 06511  
 USA

Dr. Stephen C. Peck  
 Vice President, Environment Group  
 Electric Power Research Institute (EPRI)  
 3412 Hillview Avenue  
 P.O. Box 10421  
 Palo Alto, CA 94303  
 USA

Dr. Gerhard Petschel-Held  
 Potsdam Institute for  
 Climate Impact Research  
 Postfach 60 12 03  
 D-14412 Potsdam  
 Germany

Dr. Colin Prentice  
 Skåne Association for Global  
 Environmental Studies (SAGES)  
 Department of Ecology  
 Ecology Building  
 Sölvegatan 37  
 S-22362 Lund  
 Sweden

Dr. John M. Reilly  
 Deputy Director for Technology  
 U.S. Department of Agriculture (USDA)  
 Economic Research Service  
 1301 New York Ave, N.W. - Room 524  
 Washington, D.C. 20005  
 USA

Dr. Richard Richels  
 Director  
 Energy Analysis and Planning Dept.  
 Electric Power Research Institute (EPRI)  
 3412 Hillview Avenue  
 Palo Alto, CA 94303  
 USA

Dr. Cynthia Rosenzweig  
 Research Scholar  
 Modeling Land-Use and Land-Cover  
 Changes in Europe and Northern Asia  
 (LUC) Project, International Institute  
 for Applied Systems Analysis (IIASA)  
 Schlossplatz 1  
 A-2361 Laxenburg  
 Austria

Prof. Thomas Schelling  
 School of Public Affairs  
 University of Maryland  
 College Park, MD 20742  
 USA

Prof. Dr. Hans-Joachim Schellnhuber  
 Director, Potsdam Institute for  
 Climate Impact Research  
 Postfach 60 12 03  
 D-14412 Potsdam  
 Germany

Prof. Michael E. Schlesinger  
 Professor  
 Department of Atmospheric Sciences  
 University of Illinois at  
 Urbana-Champaign  
 105 South Gregory Avenue  
 Urbana, IL 61801  
 USA

Dr. Leo Schrattenholzer  
 Research Scholar  
 Environmentally Compatible Energy  
 Strategies (ECS) Project  
 International Institute for  
 Applied Systems Analysis (IIASA)  
 Schlossplatz 1  
 A-2361 Laxenburg  
 Austria

Dr. Meyer Steinberg  
Senior Chemical Engineer  
Process Sciences  
Department of Applied Technology  
Brookhaven National Laboratory  
Associated Universities, Inc.  
Upton, Long Island  
New York, NY 11973  
USA

Mr. Taishi Sugiyama  
Research Scholar  
Environmentally Compatible Energy  
Strategies (ECS) Project  
International Institute for  
Applied Systems Analysis (IIASA)  
Schlossplatz 1  
A-2361 Laxenburg  
Austria

Dr. Kazuliko Takemoto  
Research Scholar  
Methodology of Decision Analysis (MDA)  
Project, International Institute  
for Applied Systems Analysis (IIASA)  
Schlossplatz 1  
A-2361 Laxenburg  
Austria

Dr. Richard S.J. Tol  
Research Associate  
Institute for Environmental Studies  
Free University of Amsterdam  
De Boelelaan 1115  
NL-1081 HV Amsterdam  
Netherlands

Dr. Ferenc Toth  
Potsdam Institute for  
Climate Impact Research  
Postfach 60 12 03  
D-14412 Potsdam  
Germany

Dr. Phillip Tseng  
Senior Analyst  
U.S. Department of Energy  
1000 Independence Avenue, SW  
Washington, DC 20585  
USA

Dr. Jelle van Minnen  
Research Scholar  
Modeling Land-Use and Land-Cover  
Changes in Europe and Northern Asia  
(LUC) Project, International Institute  
for Applied Systems Analysis (IIASA)  
Schlossplatz 1  
A-2361 Laxenburg  
Austria

Mr. David Victor  
Co-Leader, Implementation and Effective-  
ness of International Environmental  
Commitments (IEC) Project  
International Institute for  
Applied Systems Analysis (IIASA)  
Schlossplatz 1  
A-2361 Laxenburg  
Austria

Prof. John P. Weyant  
Director, Energy Modeling Forum  
Stanford University  
406 Terman Building  
Stanford, CA 94305-4022  
USA

Dr. Tom M.L. Wigley  
Senior Scientist  
National Center for Atmospheric Research  
1850 Table Mesa Drive, Suite 259  
Boulder, CO 80307-3000  
USA

Dr. Larry Williams  
Manager, Integrated Assessment  
Global Climate Change Research  
Electric Power Research Institute (EPRI)  
3412 Hillview Avenue  
Palo Alto, CA 94303-1395  
USA

Prof. Gary W. Yohe  
Director, John E. Andrus  
Center for Public Affairs  
Professor of Economics  
Wesleyan University  
238 Church Street  
Middletown, CT 06459-0007  
USA