



The University of  
**Nottingham**

UNITED KINGDOM • CHINA • MALAYSIA

## Bedford, Simon Bernard (1993) Synthesis of oxygen heterocycles. PhD thesis, University of Nottingham.

### Access from the University of Nottingham repository:

<http://eprints.nottingham.ac.uk/13159/1/336045.pdf>

### Copyright and reuse:

The Nottingham ePrints service makes this work by researchers of the University of Nottingham available open access under the following conditions.

- Copyright and all moral rights to the version of the paper presented here belong to the individual author(s) and/or other copyright owners.
- To the extent reasonable and practicable the material made available in Nottingham ePrints has been checked for eligibility before being made available.
- Copies of full items can be used for personal research or study, educational, or not-for-profit purposes without prior permission or charge provided that the authors, title and full bibliographic details are credited, a hyperlink and/or URL is given for the original metadata page and the content is not changed in any way.
- Quotations or similar reproductions must be sufficiently acknowledged.

Please see our full end user licence at:

[http://eprints.nottingham.ac.uk/end\\_user\\_agreement.pdf](http://eprints.nottingham.ac.uk/end_user_agreement.pdf)

### A note on versions:

The version presented here may differ from the published version or from the version of record. If you wish to cite this item you are advised to consult the publisher's version. Please see the repository url above for details on accessing the published version and note that access may require a subscription.

For more information, please contact [eprints@nottingham.ac.uk](mailto:eprints@nottingham.ac.uk)



# **Synthesis of Oxygen Heterocycles**

**by**

**Simon Bernard Bedford**

**Thesis submitted to the University of Nottingham  
for the degree of Doctor of Philosophy  
May 1993**

## **Acknowledgements**

---

I wish to take this opportunity to acknowledge a number of people who have assisted me in the production and preparation of this thesis.

First of all, I am indebted to David Knight, for his supervision, advice and encouragement most particularly during the writing up phase of this work. I would also like to thank Philip Cornwall and Frank Bennett for initiating this project.

I owe a great deal to some past and present members of the Chemistry Department, especially the technical staff and fellow Postgraduates, who have aided me in various aspects of my work.

I am most grateful to the Science and Engineering Research Council for financing me and making it possible to produce this thesis.

---

---

## **Declaration**

---

I hereby declare that the substance of this thesis has not been submitted, nor is being concurrently presented, for any other degree.

I also declare that the work embodied in this thesis is the result of my own investigations and where the work of other researchers has been used, this has been fully acknowledged in the text.

-----  
S. B. Bedford

DIRECTOR OF STUDY

-----  
D. W. Knight

---

---

## Abstract

---

In chapter one, the various methods of generating benzenoid *ortho*-quinodimethanes are discussed and approaches to their heterocyclic analogues are also reviewed. The utility of *ortho*-quinodimethanes in organic synthesis is highlighted by examples of both inter- and intramolecular Diels-Alder cycloadditions as the key steps in the total synthesis of naturally occurring polycyclic systems.

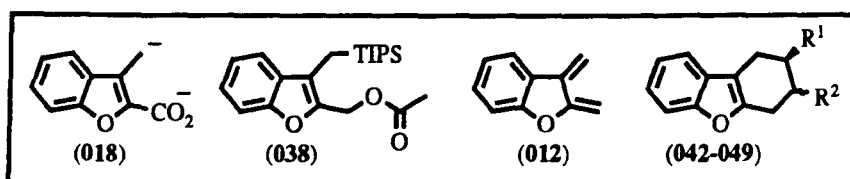

In chapter two, work aimed at the development of a rapid synthetic entry to heterocyclic quinodimethanes starting from *ortho*-methyl heterocyclic carboxylic acids is presented. To this end, the dianion of 3-methylbenzofuran-2-carboxylic acid (**018**) was used to facilitate the construction of a “benzylsilane type” precursor (**038**) which in turn when treated with fluoride base, resulted in the generation of benzofuran-2,3-quinodimethane (**012**). We were then successful in trapping this intermediate with reactive dienophiles to form a series of the corresponding tetrahydrodibenzofurans (**042 to 049**). We have been able, for the first time, to determine the regioselectivity in this reaction by performing an X-ray crystallographic analysis on the major isomer (**046**) arising from cyclization with methylvinylketone. Preliminary work on an intramolecular variant as well as other heterocyclic acids is also presented.

Chapter three, deals with the extensive modern approaches to tetrahydrofurans, but concentrates on examples that exhibit 2,5-disubstitution. It is sub-divided into the methods which involve an electrophile induced cyclization and the numerous alternative ones which do not. Their relevance in Natural Product assembly, especially the polyether antibiotics, is appraised.

Chapter four continues with studies which have already established that *Z*-3-silyloxy-5-alkenoic acids undergo efficient and highly stereoselective iodolactonizations leading to the Mevinic analogues and related valerolactones. We have now established that the iodolactonizations of *Z*- and *E*-3-silyloxy-5-alkenoic acids (**174** and **131**) both lead to *trans*-disubstituted valerolactones, which differ only in the stereochemistry of the iodine substituent (**175** and **178**).

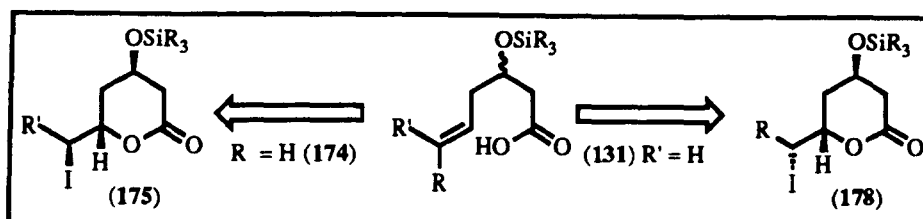

The possibilities of effecting etherifications of the related *Z*-3-hydroxy-5-alkenoates (**106**) are then examined. By simply blocking the carboxylate end of the hydroxy-5-alkenoic acids involved in the above reactions it was found that under iodolactonization conditions a novel iodoetherification-hydroxylation process ensues which leads to 3-hydroxy-2,5-disubstituted tetrahydrofurans of which (**182**) is an example. These products were essentially single diastereoisomers according to all their spectroscopic data indicating that a well defined transition state must be involved in these cyclizations.

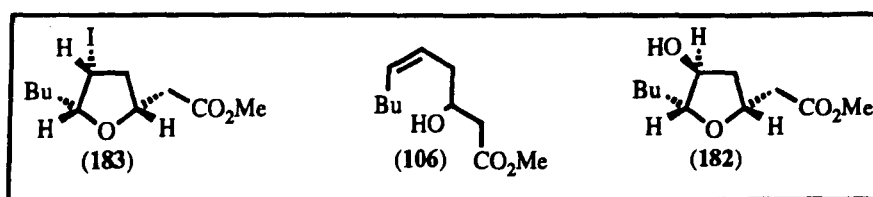

Extensive work was then conducted in probing the mechanism of this reaction which required developing several complementary routes to various homoallylic alcohol precursors. Indeed, results thus generated suggest that the more expected iodotetrahydrofuran (**183**) is not an intermediate and neither is the plausible epoxide (**201**). A strong link with hydroxytetrahydrofuran formation and the amount of water present in the reaction was established. That the ester

group plays a key role in the cyclization was evident from the observation that its repositioning (135) or removal (137) gave only iodo-diols (204-5 and 221-2) which failed to cyclize further.

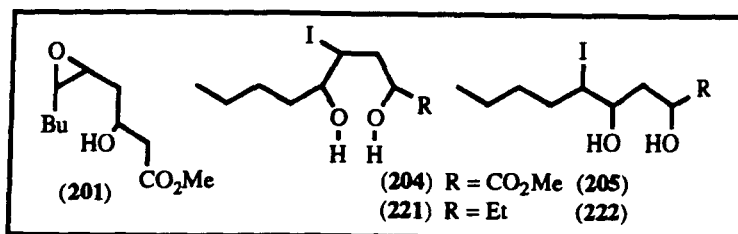

Similar cyclizations of the corresponding *E*-isomers gave iodotetrahydrofurans (199) in excellent yield. In each case, the cyclization was reasonably stereoselective with a modest improvement in yields being obtained in anhydrous solvents. However, under a variety of conditions, these did not lead to hydroxytetrahydrofurans.

Iodoetherification of simpler *Z*- and *E*-3-hydroxy-5-alkenes proceeded efficiently with high levels of stereoselection by a 5-*endo*-trig process and gave iodotetrahydrofurans, but only when anhydrous acetonitrile was used as solvent. The *E*-alk-5-en-ols gave a stereoselective reaction and the *Z*-isomers showed poorer selectivity. In semi-aqueous conditions iodo-diols and not hydroxytetrahydrofurans were obtained.

Displacements on the iodotetrahydrofurans with azide (240) and hydroxide (243) equivalents have also been demonstrated in which the inverted products are obtained in good yield as single isomers.

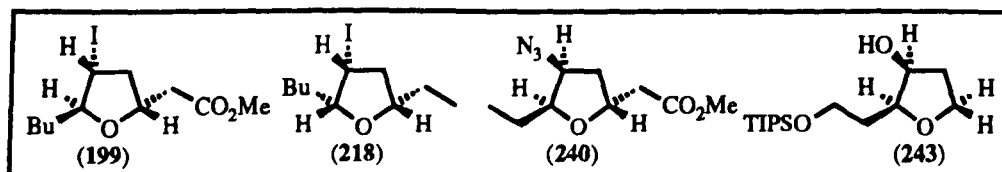

The relevance of all these tetrahydrofurans in Natural Product assembly is then emphasized by a few specific examples.

## Contents

---

<b>Chapter 1</b>	<i>ortho</i> -Quinodimethanes and their heterocyclic analogues in organic synthesis	<b>(1)</b>
<b>Chapter 2</b>	<i>ortho</i> -Methyl heterocyclic carboxylic acids: Intermediaries to heterocyclic quinodimethanes	<b>(38)</b>
<b>Chapter 3</b>	Modern strategies toward tetrahydrofurans	<b>(65)</b>
<b>Chapter 4</b>	Iodoetherification of homoallylic alcohols: A stereoselective approach to tetrahydrofurans	<b>(104)</b>
<b>Chapter 5</b>	Experimental section	<b>(166)</b>
<b>Chapter 6</b>	Spectral data	<b>(241)</b>
<b>Chapter 7</b>	References	<b>(253)</b>



# ***ortho*-Quinodimethanes and their heterocyclic analogues in organic synthesis**

## **I *ortho*-Quinodimethanes**

- a) General history
- b) Methods of generation
- c) Hetero-atom analogues
- d) Use in natural product synthesis
- e) Recent developments

## **II Heterocyclic analogues**

- a) General history
- b) Methods of generation

## ( I ) ortho-Quinodimethanes

### a) General history

The generation of reactive dienes (*ortho*-quinodimethanes or *ortho*-xylylenes) from aromatic systems and their subsequent Diels-Alder trapping reactions, both intermolecular but especially intramolecular, has been shown to be a powerful method for the rapid assembly of a variety of polycyclic systems.<sup>1</sup> The first published example of an *ortho*-quinodimethane was Finkelstein's quinonoid dibromide, generated from a tetrabromoxylene.<sup>2</sup> The "parent" *ortho*-quinodimethane was created by Cava and Deana by extrusion of sulphur dioxide from a variety of sulphones.<sup>3</sup> This could then be trapped with reactive dienes such as *N*-phenylmaleimide (Scheme 1).

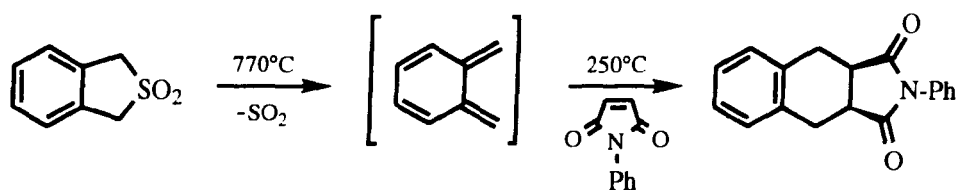

(Scheme 1)

Synthetic applications for these new *ortho*-quinodimethanes were slow to appear until Oppolzer<sup>4-6</sup> published a number of intramolecular cycloadditions of *ortho*-quinodimethane intermediates, generated from benzocyclobutene carboxylic acid<sup>4</sup> and benzocyclobutenylamine<sup>5</sup> derivatives. He went on to demonstrate their synthetic possibilities by using them to synthesize the (±)-chelidonine alkaloid.<sup>6</sup> Oppolzer's new discoveries were to initiate greater interest in the synthetic use of *ortho*-quinodimethanes for the production of many challenging targets.

Subsequent work has led to a wide variety of methods for the generation of *ortho*-quinodimethanes, a brief outline of the main ones is now discussed.

## b) Methods of *ortho*-quinodimethane generation

### *Thermal generation of ortho-quinodimethanes*

Generation of *ortho*-quinodimethanes by thermal methods is centred around those which involve benzocyclobutenes. Work in this field first began with Quinkert *et al*<sup>7</sup> who successfully generated *ortho*-quinodimethanes from *cis* and *trans*-diphenylbenzocyclobutenes (*Scheme 2*). This symmetry allowed, conrotatory ring opening reaction<sup>8</sup> uses relief of ring strain to drive the reaction and, as in the case of butadiene, is a reversible process.

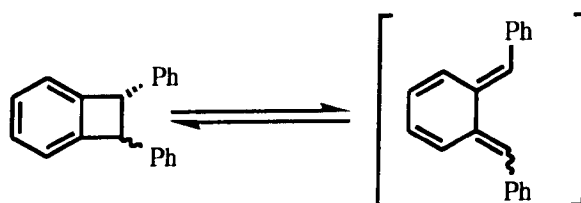

(*Scheme 2*)

Benzocyclobutene derivatives have shown a high degree of tolerance when put through a wide range of chemical processes.<sup>9</sup> Furthermore, with their ability to ring open at moderate temperatures, they have become the most widely used precursors to *ortho*-quinodimethanes.<sup>10</sup> Their main drawback however is the limited number of routes by which they can be made. Bunnett<sup>11</sup> published one of the most versatile of these (*Scheme 3*) in which *ortho* or *meta*-halo-3-phenylpropionitrile undergoes intramolecular cyclization, on treatment with a strong base, leading to a 1-cyanobenzocyclobutene *via* a benzyne intermediate.

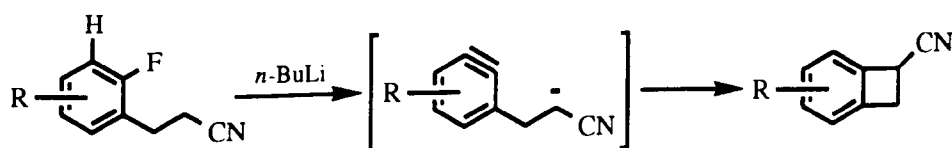

(*Scheme 3*)

A number of derivatives can be made by manipulation of the cyanide group. While this method is convenient for access to simple *ortho*-quinodimethanes, more complex analogues needed for natural product assembly require multiple step processes often involving insurmountable synthetic problems.

Other routes to benzocyclobutenes have similar drawbacks when called upon to make the more intricate precursors required, although one worth noting is that of Vollhardt.<sup>12-15</sup>

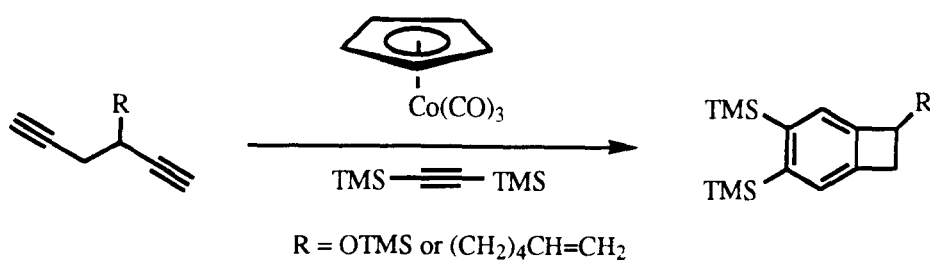

(Scheme 4)

His acyclic starting blocks can be converted to benzocyclobutenes *via* a cobalt-catalysed co-oligomerisation reaction of a 1, 5-diyne with *bis*-(trimethylsilyl)acetylene (Scheme 4). This method has been used to synthesize many annulated systems.<sup>16-18</sup>

#### *ortho*-Quinodimethanes by extrusion methods

One of the earliest methods developed for *ortho*-quinodimethane generation was that of sulphur dioxide extrusion from a sulphone.<sup>3</sup> It was left again to Oppolzer<sup>19-21</sup> to exploit this method, and along with Nicolaou,<sup>22, 23</sup> he found that these sulphones could be deprotonated and then mono-alkylated with a number of alkenyl or acyl side chains (Scheme 5).<sup>20</sup> These precursors could then be reacted to form a wide variety of new polycycles. Introduction of other substituents into the aromatic ring of the sulphone precursor could be accomplished by electrophilic substitution at the five position using the known methods of iodination, nitration and chlorosulphonation.<sup>21</sup> This allowed the

construction of a range of ring substituted, annulated aryl systems.

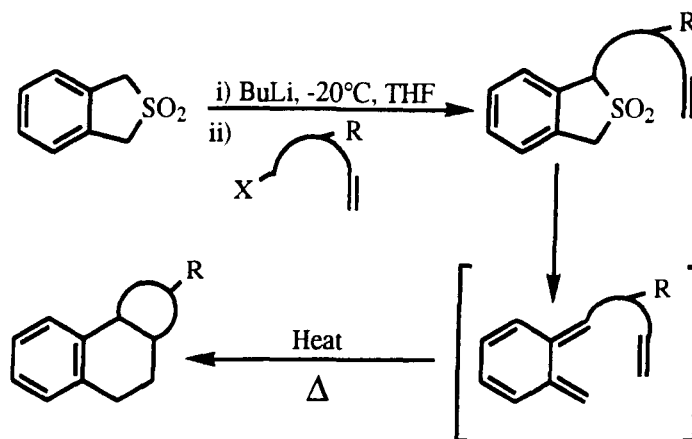

Another related reaction was that of sulphur dioxide extrusion from a sultine. Durst and co-workers<sup>24</sup> reported that this system underwent a retro Diels-Alder elimination of sulphur dioxide on gentle (80°C) heating. Unfortunately, construction of the sultine precursors was often difficult and required many steps. It was not until the discovery by Durst and Charlton<sup>25, 26</sup> that sultines could be obtained in high yield by the reduction of hydroxylated sulphone systems with sodium borohydride that these intermediates started to be widely used as a means of *ortho*-quinodimethane generation (Scheme 6).

A further improvement in this method has recently been developed by Dittmer<sup>27</sup> who constructs his sultine by reaction of rongalite (sodium hydroxymethanesulphinate), a catalytic amount of sodium iodide and either  $\alpha$ ,  $\alpha'$ -dibromo- or  $\alpha$ ,  $\alpha'$ -dichloro-*o*-xylene in DMF. The reaction proceeds at room temperature, thus avoiding polymerization due to quinodimethane formation.

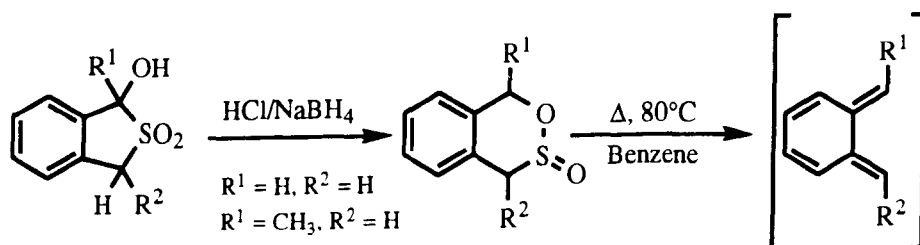

Sulphur dioxide is not the only gas that can be extruded to yield *ortho*-quinodimethanes. Indeed, loss of nitrogen from a 1,4-dihydro-2,3-diazanaphthalene has been accomplished thermally<sup>28-30</sup> as well as photochemically.<sup>31</sup> Carbon dioxide removal from the 3-isochromanone system is more noteworthy. This was first reported by Spangler *et al*<sup>32, 33</sup> when they prepared a benzocyclobutene by thermolysis of 3-isochromanone under flash vacuum pyrolysis [f. v. p.] conditions. Oppolzer<sup>1, 19, 34</sup> further investigated the potential of this process with varying degrees of success. The overall reaction sequence is shown in *scheme 7*. However this method has not caught on as a general preparative source of *ortho*-quinodimethane due to the harsh conditions required in the elimination step.

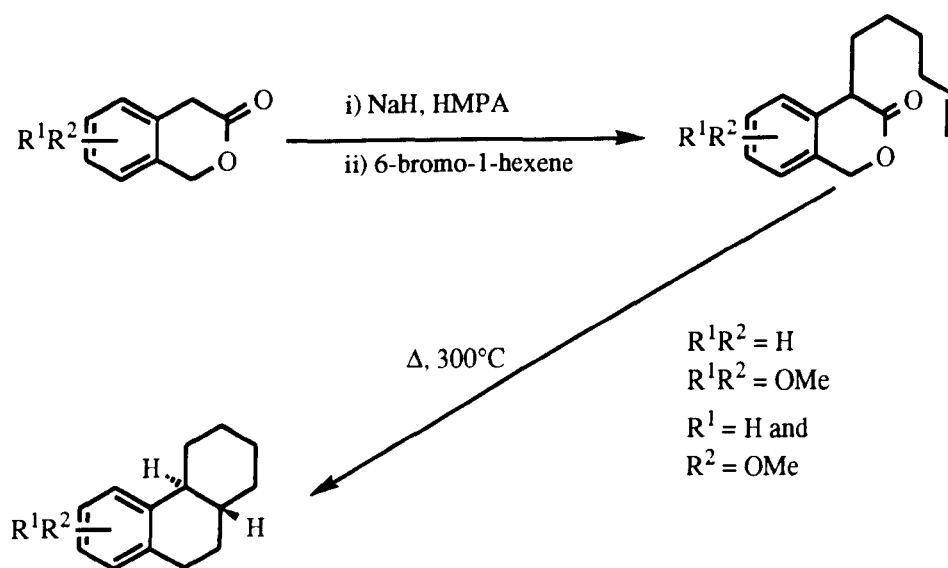

(Scheme 7)

### Photochemical generation of *ortho*-quinodimethanes

One of the most widely studied process for the generation of *ortho*-quinodimethanes by photochemical means is that of photoenolisation.<sup>35</sup> Yand and Rivers<sup>36</sup> showed that a hydroxy-substituted *ortho*-quinodimethane could be formed by photolysis of either methyl or benzylbenzophenone and then trapped with simple dienophiles such as dimethyl acetylenedicarboxylate. The

photoenolisation process yields exclusively the *E*-hydroxy-*ortho*-quinodimethane since the *Z*-isomer returns rapidly to starting material by a [1.5] sigmatropic shift. Proof of this came when 2-methylbenzophenone was irradiated in the presence of maleic anhydride as a single adduct with the shown stereochemistry was formed (*Scheme 8*).<sup>37</sup>

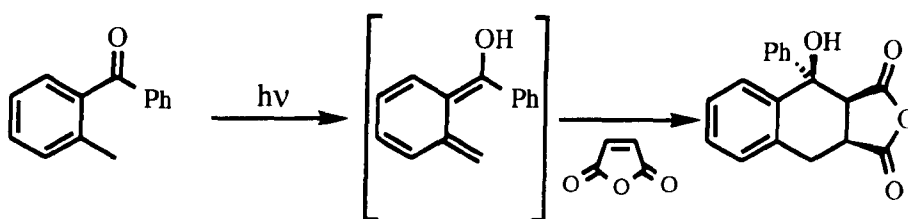

(*Scheme 8*)

The exclusive formation of this adduct is due to *endo*-addition of the dienophile to the *E*-isomer. The main advantage of this method is that the precursors are in the main easy to synthesize and the reaction itself only requires low temperatures. This allows thermally sensitive dienophiles to be used. Although photochemical side reactions are a problem, it has been shown that photosensitive dienophiles can be successfully trapped.<sup>38</sup> On the other hand, formation of *ortho*-quinodimethanes from 2, 6-disubstituted-1-carbonyl arenes is not possible because of steric constraints.<sup>39, 40</sup> In spite of this, generally the method is a sound one for synthetic purposes in appropriate examples.

Morrison and Scully<sup>41</sup> and Pratt<sup>42</sup> were to explore the photolysis of *ortho*-alkylstyrenes, a reaction related to that of enolization. A full study of the synthetic utility came from Hornbeck *et al*<sup>43, 44</sup> who were able to trap the *ortho*-quinodimethane with a very poor dienophile, cyclohexene. Unfortunately, the adducts were stereochemical mixtures. It is only when reactive dienophiles such as maleic anhydride are used, which prevent *ortho*-quinodimethane isomerisation, that stereoselectivity is improved (*Scheme 9*). The application of this method has the unique ability to provide 1', 1'-dialkylated intermediates that are resistant to [1.5]-hydrogen shifts and can therefore provide an approach to *gem*-dialkylated polycycles.

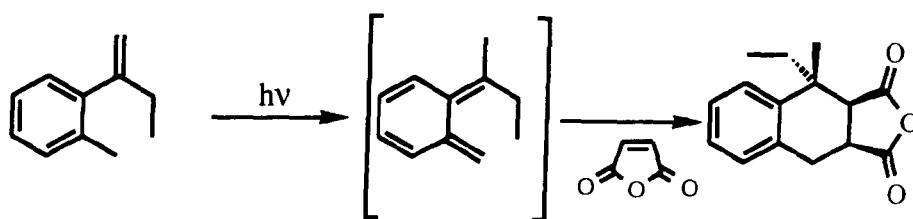

(Scheme 9)

### *ortho*-Quinodimethanes via 1,4-elimination

In general terms, this reaction can be summarised as an elimination of some kind from a 1, 2-dialkylbenzene precursor (Scheme 10). There are three main classes into which this type of reaction can be subdivided.

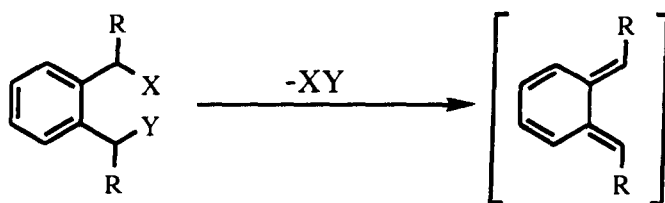

(Scheme 10)

Dehalogenation of a 1, 2-dihalogen species has been extensively studied and can be brought about by a variety of means; sodium iodide in dimethylformamide [DMF]<sup>45, 46</sup> and zinc dust are two well known methods. The former is restricted to activated precursors and the latter tends to be unreliable. Attempts to improve upon the elimination step have been somewhat disappointing, but the one which involves zinc and ultrasound stands out.<sup>47</sup> Treatment of a dibromide and zinc dust in dioxan solvent, under ultrasound bombardment, gave the *ortho*-quinodimethane which could then be trapped, in high yield, with a number of dienophiles (Scheme 11).



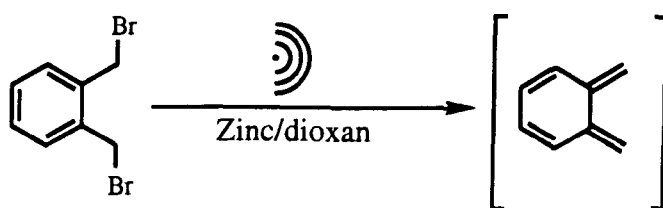

(Scheme 11)

The second class of reaction is a fluoride induced fragmentation. Saegusa<sup>48</sup> invented and then developed the idea of adding fluoride to a number of alkylated benzylsilane ammonium salts. This addition leads to a smooth generation of an *E-ortho*-quinodimethane which has been successfully trapped in good yield with dienophiles such as fumarate, acrylate, and acrylonitrile (Scheme 12).

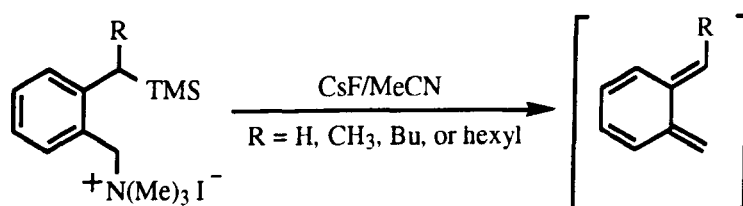

(Scheme 12)

The reaction relies on the affinity of silicon for fluoride whose attack brings about a [1.4] fragmentation. The method is quite versatile and has been extended to polycyclic synthesis *via* intramolecular means.<sup>49</sup> Thus a hexenyl derivative has been converted to a predominantly *trans*-octahydrophenanthrene (Scheme 13).

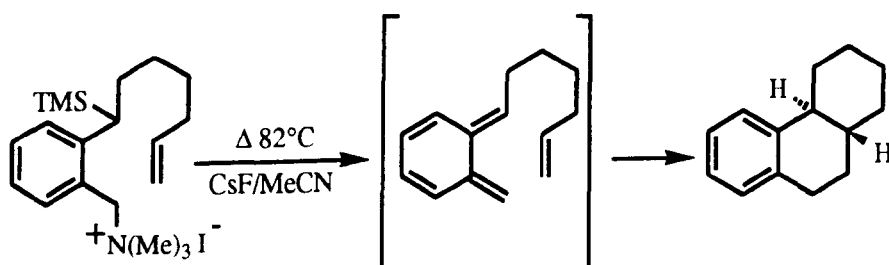

(Scheme 13)

The main drawback to this method is the difficulty in producing the benzylsilane ammonium salts which tends to involve multi-step, relatively low yielding pathways. The problems escalate when methoxy substituents are required on the aromatic ring.<sup>48, 49</sup> A variety of leaving groups other than the trimethylammonium function have been used. Halide,<sup>49</sup> epoxide,<sup>50</sup> methoxide<sup>51</sup> and acetate<sup>52</sup> are the common alternatives. Fluoride sources tend to be either caesium fluoride or a solution of tetra-*n*-butylammonium fluoride [TBAF] with acetonitrile as the universal solvent.

A recent development in this area has been due to Sano and Migita<sup>53</sup> who have exchanged silicon for tin (*Scheme 14*). They then generate the quinodimethane *via* a proton-induced [1, 4] elimination. The reaction conditions are relatively mild and yields excellent. A simple intramolecular model has also been achieved.

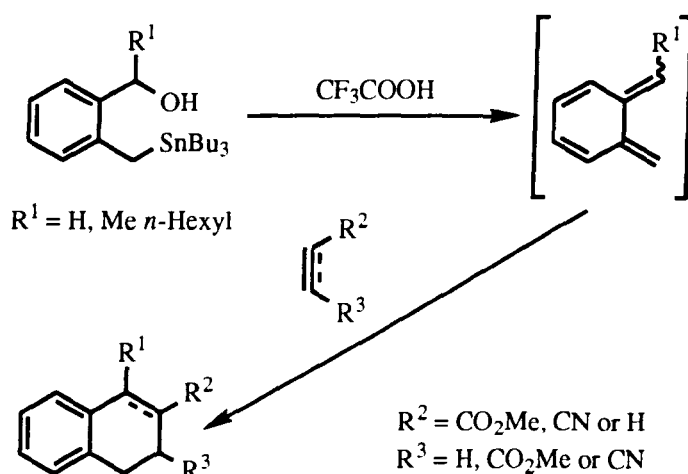

(Scheme 14)

The final class of [1, 4] elimination deals with removal of methanol from methyl *ortho*-methylbenzyl ethers. Rickborn *et al*<sup>64</sup> have reported that attack of lithium tetramethylpiperidide on this type of ether results in a facile generation of *ortho*-quinodimethane (*Scheme 15*). Successful trapping with unactivated dienophiles was accomplished. An intramolecular variant<sup>54</sup> was then developed which led to a number of interesting polycycles. However, limitations are the

exclusion of dienophiles that can interact with lithium dialkylamide bases and any benzyl ether precursor that contains groups which promote ring metallation.

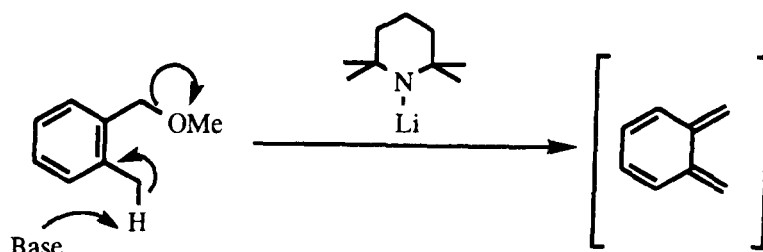

(Scheme 15)

### c) Heteroatom analogues of *ortho*-quinodimethanes

By employing *ortho*-quinodimethanes containing heteroatoms, it is possible to access a wide range of functionalized heteropolycyclic systems (Scheme 16).<sup>55</sup>

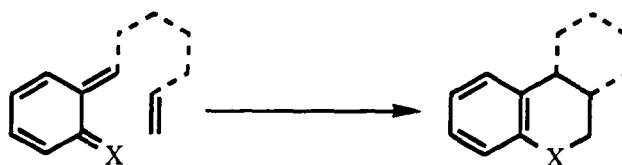

(Scheme 16)

But despite their obvious potential, little work has been published in this field compared to their non heteroatom-partners. This is primarily due to the fact that many of the foregoing methods cannot be extended to the generation of such systems. This area can be neatly divided into three main divisions according to the heteroatom present.

#### *The azaxylylenes: nitrogen ortho-quinodimethanes*

The majority of methods used to form *ortho*-quinodimethane fail to be anywhere near as feasible when applied to their nitrogen counterparts. The

benzazetidines, the nitrogen analogues of benzocyclobutenes, are an elusive, little known group of compounds.<sup>56</sup> Pyrolytic and [1. 4] elimination methods to azaxylylenes have not been reported for intermolecular reactions, although Storr and co-workers<sup>57</sup> had some success with a pyrolytic intramolecular cycloaddition. Their use of alkenylated benzoxazinones, the nitrogen equivalents of 3-isochromanones, allowed formation, in low yield, of some nitrogen polycycles. The low yields were due mainly to [1. 5] hydrogen shifts leading to *ortho*-toluidine by-products.

Saegusa and Ito<sup>58, 59</sup> were to invent the most useful route to the azaxylylenes. Applying their fluoride-induced fragmentation strategy to *N*-silylalkenylamines (Scheme 17) allowed nitrogen polycycles to be easily synthesized. Intermolecular cycloadditions involving *N*-alkylated azaxylylenes and maleate or fumarate esters were also reported to proceed in high yield.<sup>59</sup>

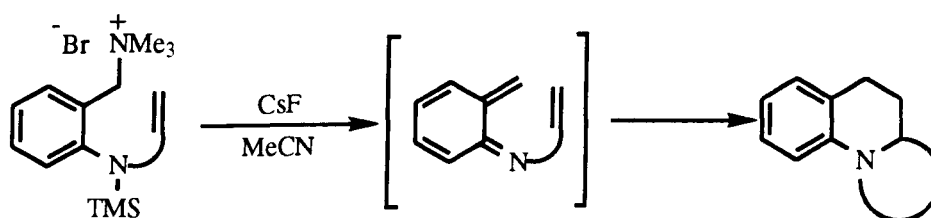

(Scheme 17)

#### *ortho*-Thioquinonemethides: sulphur containing analogues

*ortho*-Thioquinonemethide is the only well reported example of a sulphur containing quinodimethane. This was formed by Kanakarajan and Meier<sup>60</sup> from benzothiete, an easily accessible, but unstable precursor. Reactions with electron deficient dienophiles by intermolecular cyclization were reported (Scheme 18). Dimerisation of the diene was its major limitation, which increased when less reactive dienophiles were used.

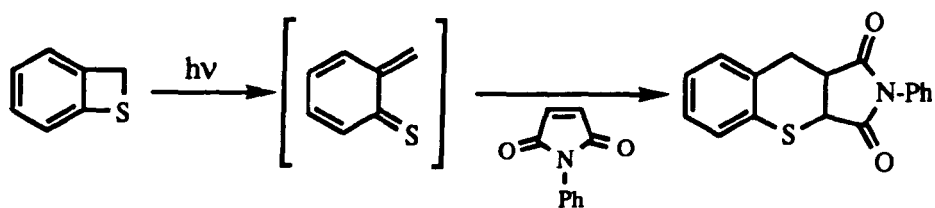

(Scheme 18)

*ortho*-Quinonemethides: oxygen containing quinodimethanes

These, unlike their nitrogen and sulphur counterparts, are a well established class of compounds.<sup>61</sup> *ortho*-Quinonemethides are unusual as they behave as inverse electron demand dienes and react efficiently with electron rich dienophiles. Marino and Dax<sup>62</sup> adapted Saegusa and Ito's fragmentation method to produce an oxygen *ortho*-quinodimethane and then cyclized it intramolecularly to access an enantiomerically pure cannabinoid (Scheme 19). Demethylation of the methyl ether gave the natural product (-)-hexahydrocannabinol.

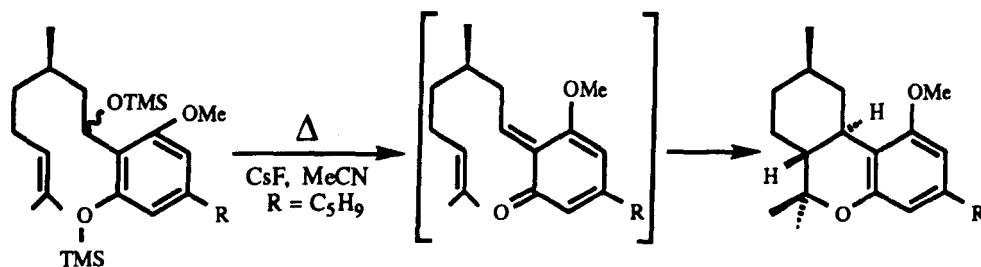

(Scheme 19)

The use of *ortho*-quinodimethanes in the important steps to natural products covers a large area of Chemistry, a short synopsis of which is now given.

## d) ortho-Quinodimethanes in Natural Product synthesis

Since Oppolzer<sup>6</sup> first described an alkaloid synthesis using an *ortho*-quinodimethane cyclization, this methodology has been applied to a whole host of other naturally occurring systems. As it is not possible to assemble them all into this brief review, a limited number has been selected to highlight the enormous potential and flexibility that this methodology gives in the production of complex polycyclic systems.

### *Naturally occurring steroidal systems*

The pharmacological importance of the steroidal system has led to the development of many preparative methods to them.<sup>24</sup> Due to their inherent complexity the *ortho*-quinodimethane cyclization methodology has found some of its most important applications in this area. Kametani and co-workers<sup>63</sup> first described a steroid synthesis using an *ortho*-quinodimethane intermediate (Scheme 20).

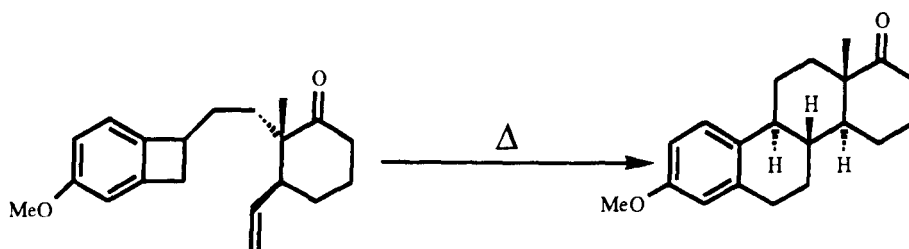

(Scheme 20)

A highly functionalized benzocyclobutene was converted stereoselectively into the immediate precursor of *D*-homoestrone. This strategy based on a functionalized benzocyclobutene precursor has limitations because of the low overall yields and problems in construction. Oppolzer<sup>62</sup> has however improved on this procedure and went on to form an enantiomerically pure 11-oxo steroid. Along with Roberts,<sup>21</sup> he was also able to construct (+)-estradiol (Scheme 21) by applying the sulphone method of generation. A cyano-substituted sulphone was regioselectively alkylated with an optically active iodide and the resulting

olefinic sulphone transformed into the silylated steroid in 80% yield. The natural product was formed by using standard procedures.

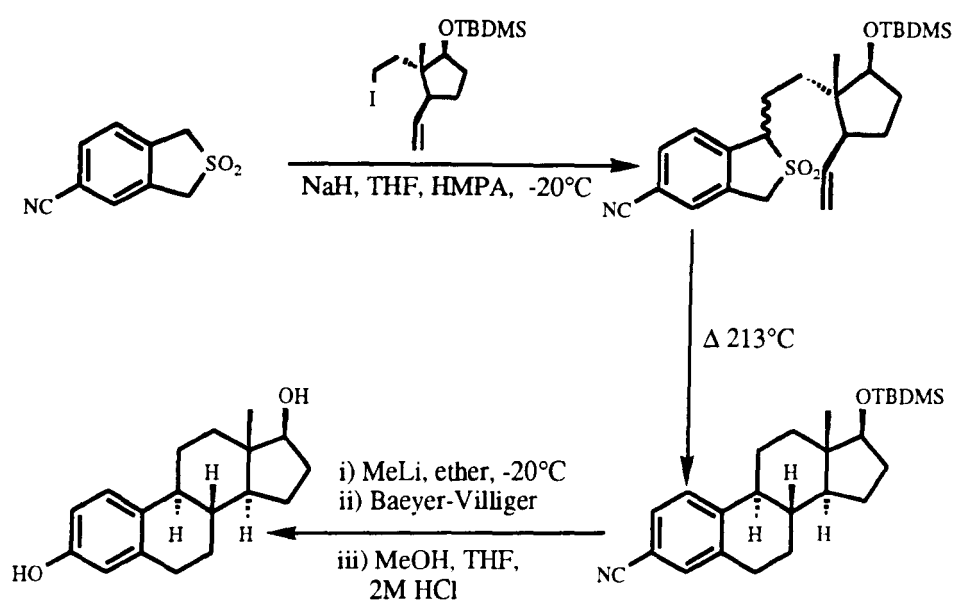

(Scheme 21)

Photochemically generated *ortho*-quinodimethane intermediates have also been used.<sup>24</sup> Photoenolisation of a substituted phenylketone gave rise to the *Z*-hydroxy *ortho*-quinodimethane which then underwent intramolecular *exo*-cycloaddition (Scheme 22).

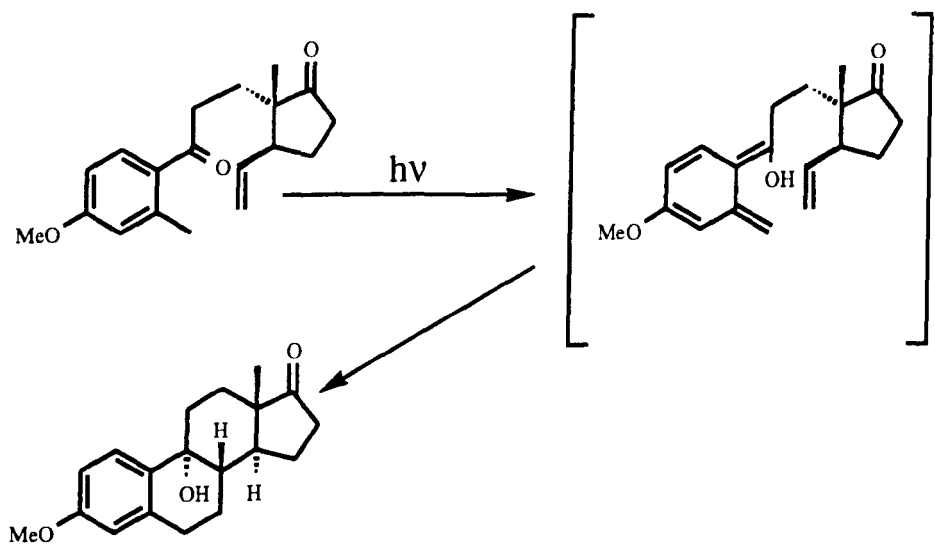

(Scheme 22)

The resulting 9 $\alpha$ -hydroxyestrone methyl ether<sup>65</sup> was later reported by the Quinkert group<sup>66</sup> to have been taken onto (+)-estrone.

The Saegusa and Ito fragmentation method when applied to steroid synthesis can best be exemplified by the Magnus synthesis<sup>50</sup> of 11 $\alpha$ -hydroxyestrone methylether (*Scheme 23*). A 70% yield of the natural product was reported when the epoxide was subjected to fluoride attack at 20°C. *ortho*-Quinodimethane methodology is not just confined to A-ring synthesis. Kametani *et al*<sup>67</sup> have published several stereoselective syntheses of D-ring steroids. These D-ring systems can enable synthetic entry into the important pregnanal class of steroids.

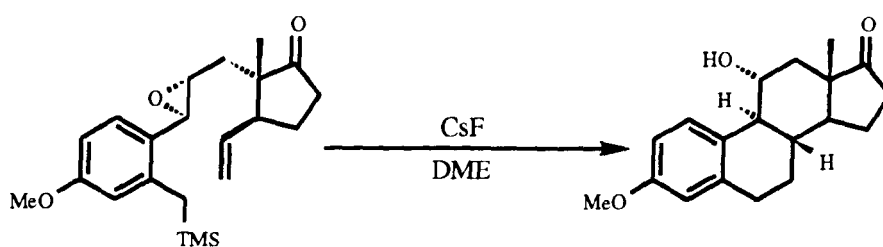

(*Scheme 23*)

#### *ortho*-Quinodimethanes in lignan construction

Some initial exploration work into lignan construction was performed by Sammes *et al.*<sup>68</sup> The lignans justicidin E, taiwaanin E and C were successfully synthesized by the photoenolisation method. A more recent report by Charlton and Alauddin<sup>69</sup> showed how the dimethyl ether lignan, isolariciresinol could be made (*Scheme 24*). Thermolysis of a *cis*-sulphone and trapping the generated *ortho*-quinodimethane with dimethyl fumarate led to diastereoselective formation of an intermediate adduct, which was then converted into the natural product by hydrogenolysis and reduction.



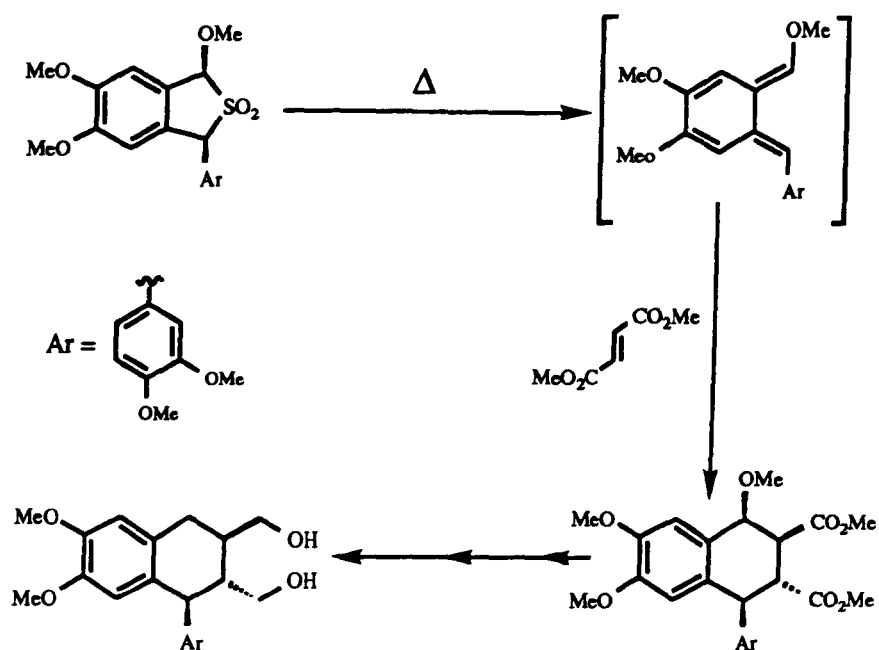

(Scheme 24)

In 1985, a Japanese group<sup>70</sup> reported an *ortho*-quinodimethane mediated synthesis of the anti-tumour lignan, deoxypodophyllotoxin (Scheme 25).<sup>71</sup> A benzyl silane was heated with excess maleic anhydride in toluene thus allowing the stereoselective formation of the intermediate polycycle. The synthesis was completed by conversion of this adduct into the natural product. This report is particularly notable because of the unusual step wise mechanism postulated by the authors for the generation of the quinodimethane intermediate.

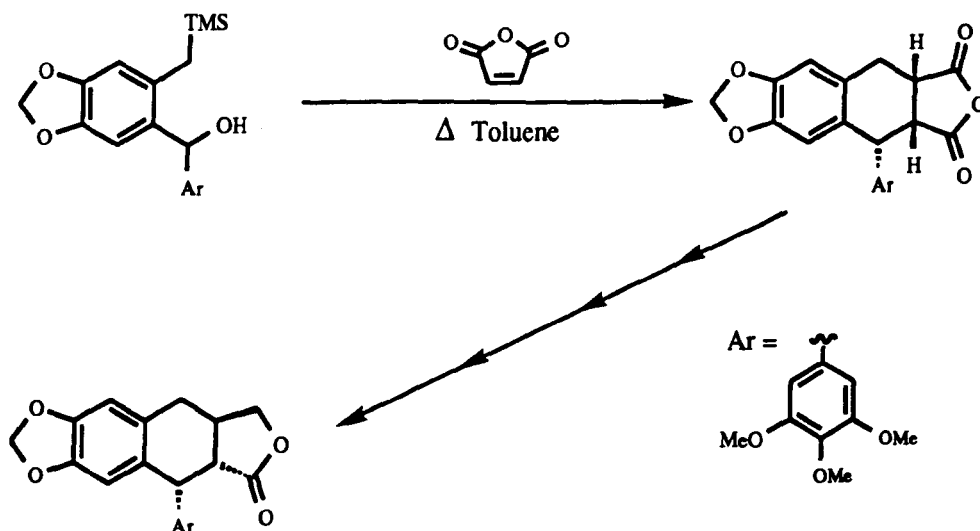

(Scheme 25)

## Naturally occurring alkaloids

The preparation of the (+)-Chelidonine alkaloid by Oppolzer and Keller<sup>6</sup> was the pioneering example of alkaloid synthesis using quinodimethane intermediates. The Kametani group<sup>72, 73</sup> has been actively engaged in alkaloid synthesis. An illustrative example is their synthesis of norcoryaldine which is shown in *scheme 26*.

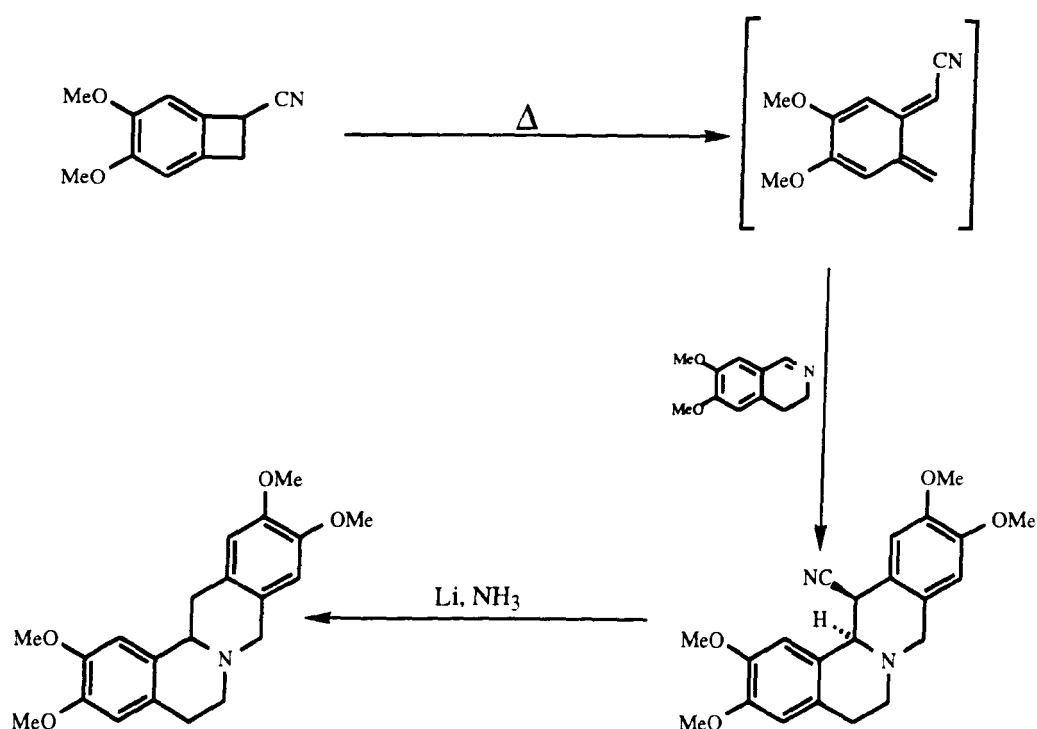

The quinodimethane generated from heating the cyano-substituted benzocyclobutene, was regioselectively cyclized with a bicyclic imine to yield a tetracyclic adduct. The alkaloid was formed after this adduct was subjected to reductive decyanation.

An interesting example involving an azaxylylene or nitrogen based quinodimethane is Ito's gephyrotoxin synthesis.<sup>74</sup> An *N*-silylammonium bromide was reacted under standard Saegusa conditions and the azaxylylene formed underwent intramolecular cyclization to give a mixture of diastereoisomers. Rhodium catalysed hydrogenation of this mixture gave

predominantly an enaminoketone which had previously been converted to the alkaloid gephyrotoxin (*Scheme 27*).<sup>75</sup>

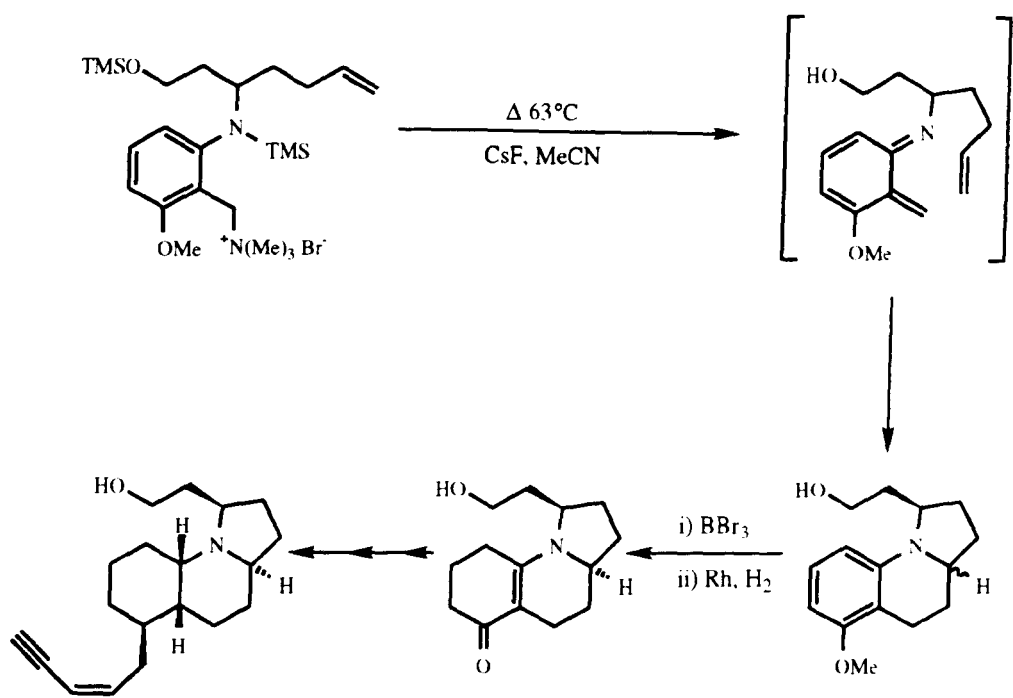

(*Scheme 27*)

### *The anthracyclinone natural product system*

Cava<sup>34</sup> was the first to see the potential of quinodimethane intermediates in the synthesis of these potent anti-tumour compounds. His synthesis of 4-demethoxydaunomycin provides a good illustration of the strategy employed.<sup>76</sup> A [1, 4] elimination from the dibromide derivative, using zinc dust, generated a symmetrical quinodimethane which was trapped with methyl vinyl ketone. Subsequent demethylation of the quinol and introduction of two hydroxy functions into the D-ring completed the synthesis (*Scheme 28*). Later on, due to the unreliable zinc generation process, the iodide-induced fragmentation procedure was adopted.<sup>34</sup> Other research groups<sup>77</sup> have also reported similar approaches and successful syntheses.

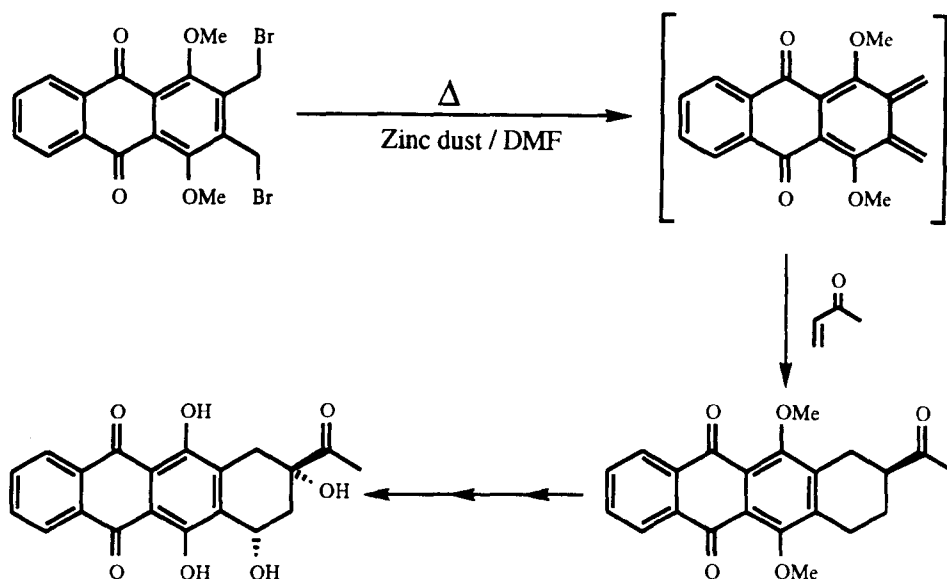

## e) Recent developments

### *Ortho-quinodimethanes in asymmetric synthesis*

There is intense interest at the moment in developing methodology that brings about an asymmetric induction in the quinodimethane cycloaddition.<sup>78</sup> The ways in which this can be accomplished include the incorporation of a chiral auxiliary in the diene or dienophile. This is used to block or hinder one face of the diene or dienophile causing the reaction to occur on the other side. Equally important is the use of a chiral catalyst that binds in a reversible way to one of the reacting components and again obscures one face.

Ito *et al*<sup>79</sup> published encouraging work using the first method of inducing asymmetry, the chiral auxiliary. They described a procedure in which several chiral oxazolidine derivatives were fragmented to chirally substituted quinodimethanes. These were successfully trapped with methyl acrylate to yield a 2:1 mixture of diastereoisomers (Scheme 29).

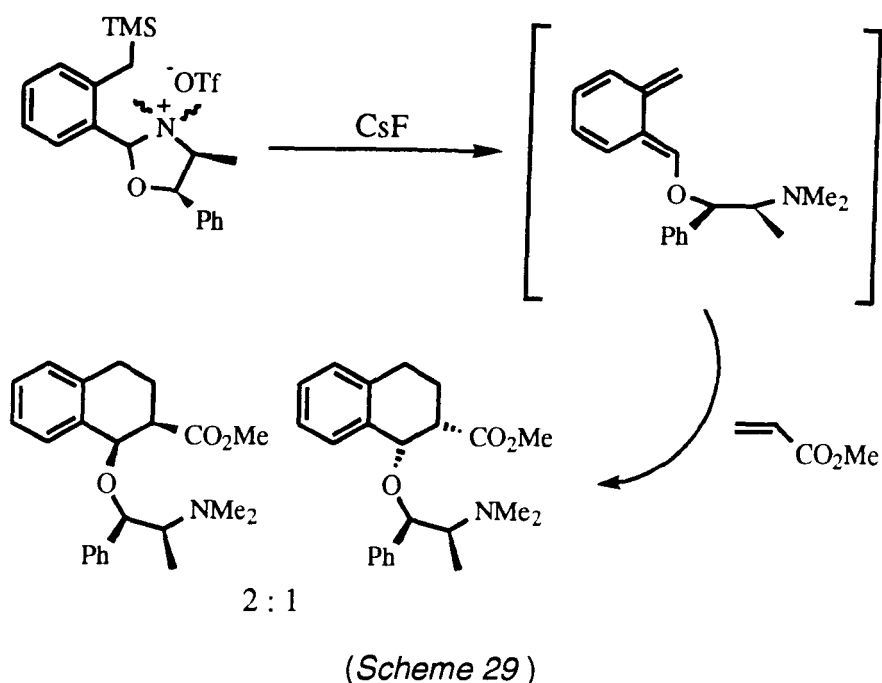

To account for the observed asymmetric induction shown, Ito used the  $\pi$ -stacking theory developed by Trost.<sup>80</sup> It was proposed that the phenyl group of the chiral auxiliary took up a parallel disposition to that of the cyclohexadiene ring thus shielding one face of the quinodimethane (Scheme 30).

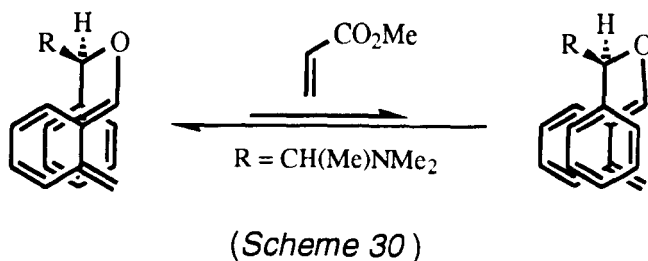

This proposal was later strongly disputed by Charlton<sup>81, 82</sup> who argued that this intermediate was too sterically compressed and unstable. He proposed that the phenyl group hinders the bottom face of the quinodimethane from approach of the dienophile. Charlton<sup>69</sup> went on to report his own synthesis of a key tetralin intermediate of the lignan, (+)-isolariciresinol dimethyl ether (Scheme 31). Quinodimethane generation was brought about by extrusion of sulphur dioxide from a substituted sulphone.

The reaction then proceeded *via* a face selective addition of dimethyl fumarate to the chiral quinodimethane.

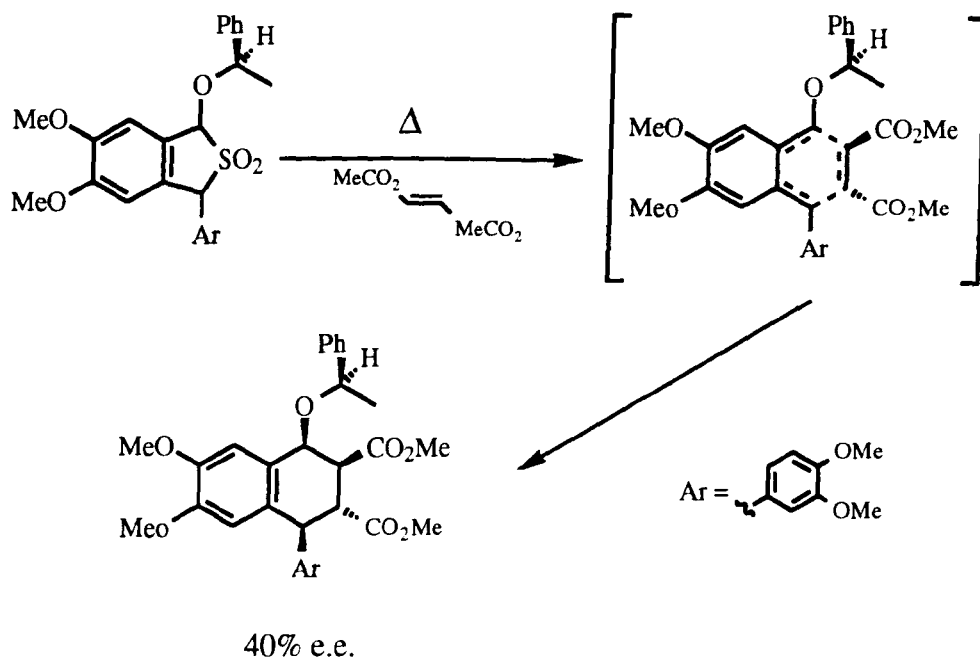

(Scheme 31)

The reaction of a dienophile carrying a chiral auxiliary has also been investigated.<sup>83</sup> An intermolecular example is illustrated in *scheme 32* where the benzocyclobutenol derivative generates the quinodimethane which is trapped by an acrylate dienophile substituted with a chiral sugar.

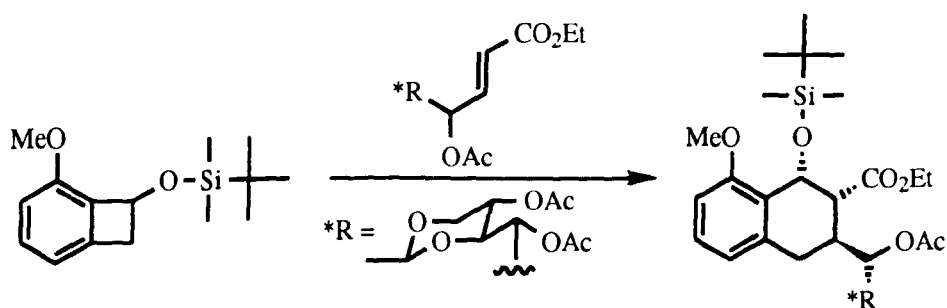

(Scheme 32)

This gave selective formation of the adduct having an enantiomeric excess of 60%. The intramolecular cycloadditions to chiral dienophiles are well explored and have been most notably exploited in the field of steroid synthesis.

## Benzocyclobutenones

Kang and co-workers<sup>84</sup> have recently published a useful synthetic route to benzocyclobutenones (Scheme 33) from readily prepared acylsilane precursors.

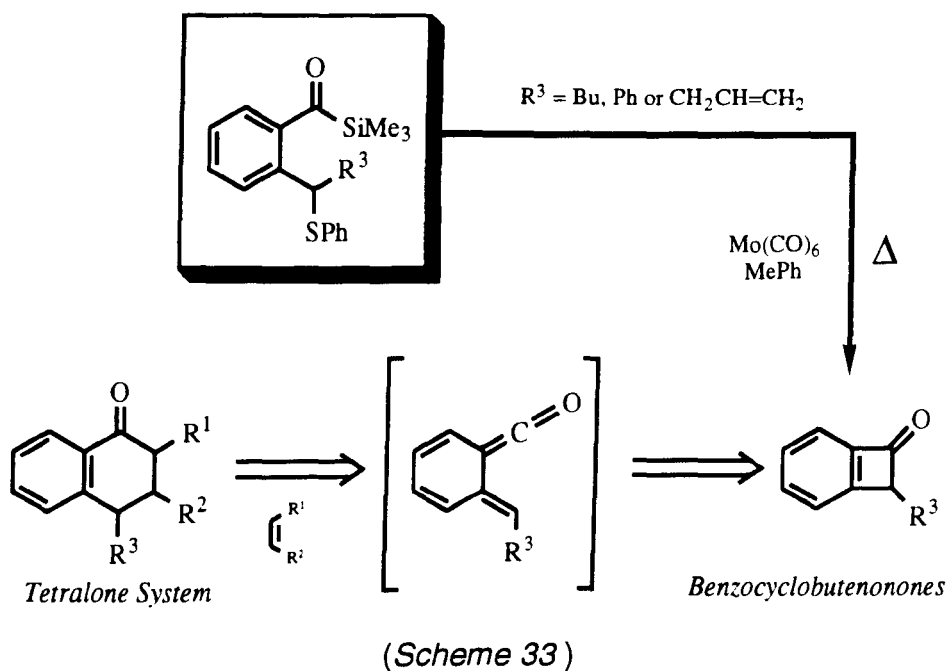

These could provide a means of generating a methylene ketene species, trapping of which would allow preparation of numerous tetralones.

## ( II ) Heterocyclic analogues

### a) General history

The success of *ortho*-quinodimethanes has stimulated interest in their heterocyclic counterparts. Again intermediates containing, sulphur, oxygen and nitrogen have been made, the cycloadditions of which have proven to be of important preparative value in the construction of annulated heteroaromatic compounds (Scheme 34).

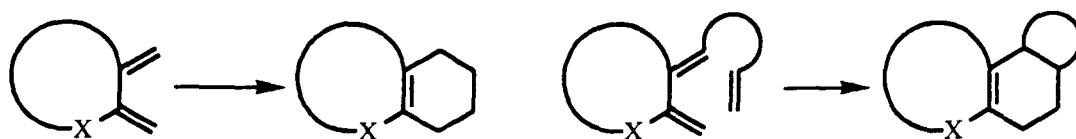

(Scheme 34)

As already stated, there are a wide range of methods available for the generation of benzenoid quinodimethanes. Unfortunately, many of these have been unsuccessful when applied to heterocyclic cases. Again it seems that the synthesis and elaboration of the precursors is to blame. What follows is a summary of the more useful routes to these important heterocyclic intermediates.

### b) Methods of quinodimethane generation

#### *Thermally from cyclobutane-fused heteroaromatics*

The only generally useful method to date of generating *ortho*-quinodimethanes thermally is the cyclobutene method of Kaneko and Naito.<sup>85</sup> Up to then a few annulated pyridines,<sup>86-88</sup> benzothiophene<sup>89</sup> and furan<sup>90</sup> examples had been prepared by low yielding flash vacuum pyrolysis routes<sup>24</sup> (Scheme 35). However none of the *ortho*-quinodimethanes thus formed were



trapped with dienophiles. Kaneko and Naito's<sup>85</sup> methodology also has its limitations being confined to six-membered heteroaromatics which contain a  $\beta$ -alkoxyenone function as part of the ring structure.



(Scheme 35)

All the reported cycloadditions proceed with poor or non-existent stereoselectivity. Their initial study<sup>91</sup> had shown that when 4-methoxy-2-quinolone was irradiated in the presence of an excess of an electron-deficient olefin, the [2 + 2] photoadduct was formed in good yield (Scheme 36).

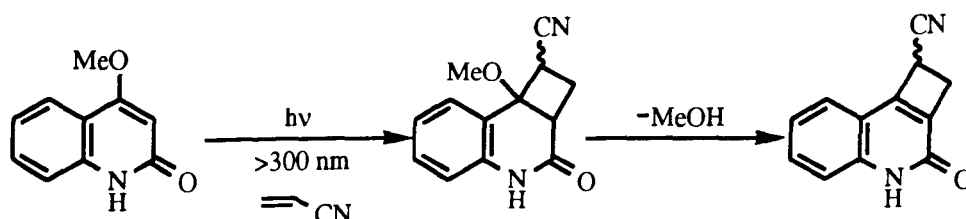

(Scheme 36)

Removal of methanol under basic or acidic conditions gave the desired cyclobutene. This method was successfully used in the synthesis of several cyclobutene-fused heterocycles.<sup>92-96</sup> Further work<sup>97</sup> showed (Scheme 37) that the cyano-cyclobutenequinolone derivative, when heated in the presence of a thirty fold excess of methyl acrylate, gave good yields of the cycloaddition product regioselectively.

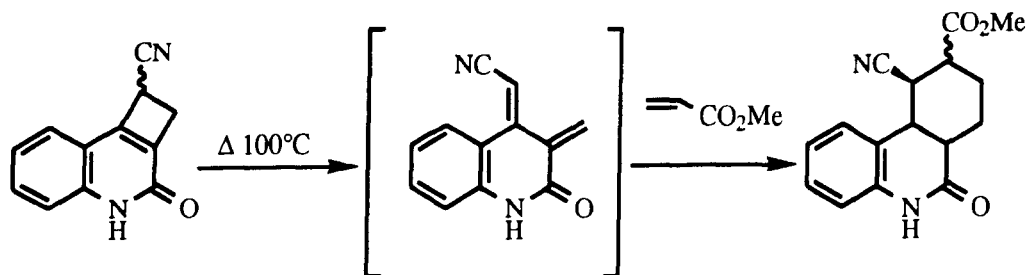

(Scheme 37)

Other successful trappings were achieved with dimethyl fumarate, methyl methacrylate, but no electron-rich olefins could be trapped. This accomplishment paved the way for more heterocyclic cyclobutenes to be constructed and tested in such cycloaddition reactions.

Important monocyclic hetero-quinodimethanes<sup>95</sup> have been generated from annulated pyridones<sup>98, 99</sup> which could have either a cyano or ethoxy substituent on the cyclobutene ring (*Scheme 38*). What became interesting was that the cyano-quinodimethane when generated, reacted preferentially with electron-rich methyl vinyl ether as opposed to the more electron-deficient methyl acrylate. Stranger still, the ethoxy-quinodimethane showed the reverse behaviour and favoured electron poor acrylate.

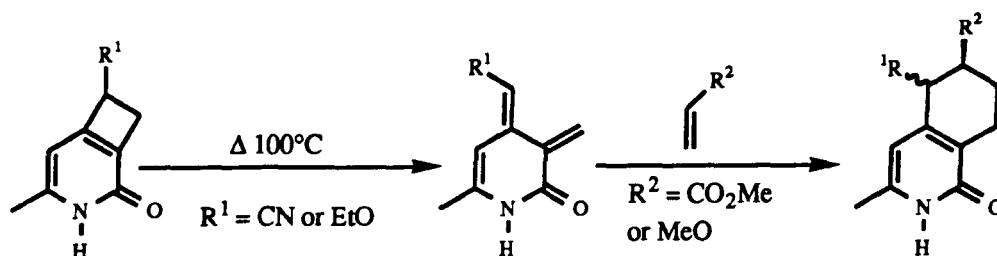

(*Scheme 38*)

The intramolecular version requiring a 1-alkenyl cyclobutane was published by Kaneko, Ito and Naito.<sup>97</sup> The cyclobutene precursor was formed by reacting the required alkoxy-quinolone, the diene and sodium methoxide under photolysis conditions (*Scheme 39*). When this cyclobutene was heated in refluxing dichlorobenzene, the resulting quinodimethane cyclized to the tetracycle system. Yields from these reactions were good to excellent.

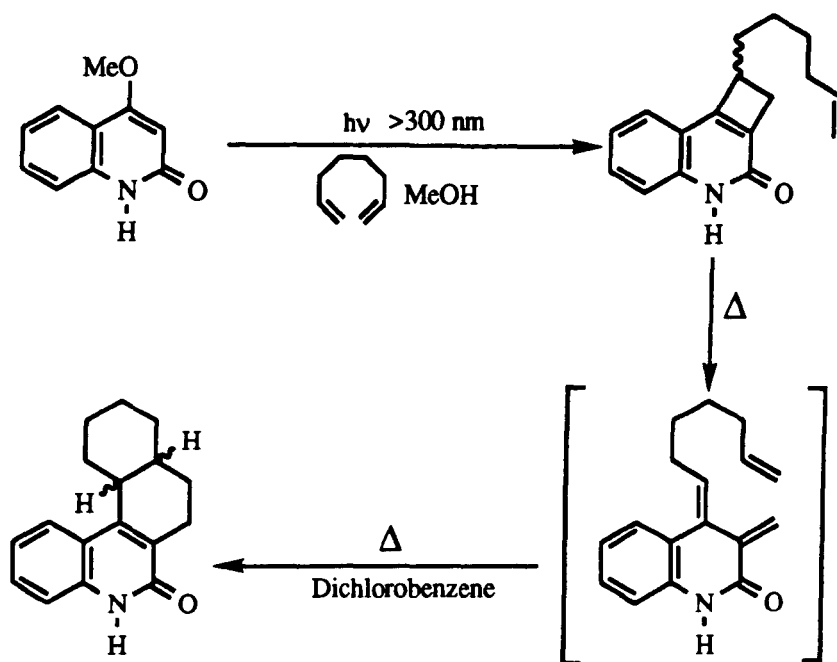

(Scheme 39)

*Extrusion of sulphur dioxide from heterocyclic analogues of dihydrobenzothiophenedioxide*

Storr<sup>100</sup> was to successfully construct the thiophene sulphone needed to generate thiophene quinodimethane. This was accomplished by sequential *bis*-chloromethylation of methyl thiophene-2-carboxylate, treatment with sodium sulphide and oxidation to the dioxide (Scheme 40).

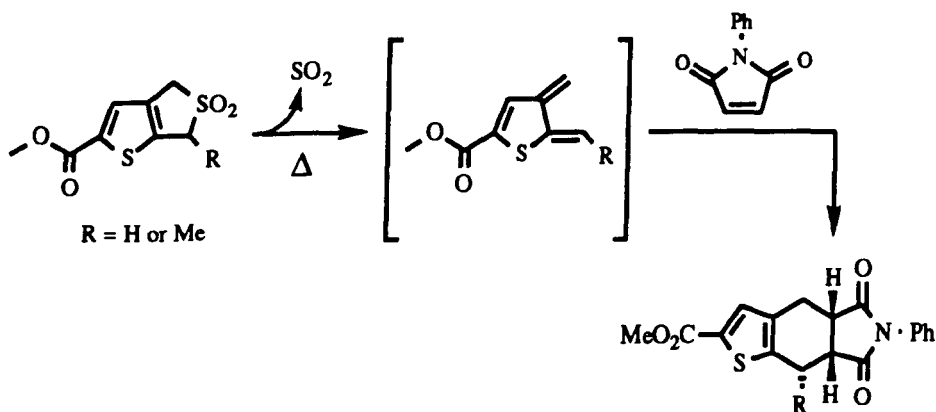

(Scheme 40)

Heating of this in sulpholane at 200°C in the presence of a range of dienophiles gave the thiophene quinodimethane Diels-Alder adducts, in good yield. Further functionalization was carried out by treatment of this cyclic sulphone with LDA and quenching with methyl iodide. The single methyl analogue thus formed gave, under similar thermal conditions in the presence of *N*-phenylmaleimide, the *endo*-adduct. This is consistent with the formation of the less hindered *Z*-quinodimethane.

Until recently, two pyridone derivatives<sup>101</sup> were the only nitrogen based sulphone examples known, but the generation of quinodimethanes from these has not yet been published (*Scheme 41*). Very recently some eloquent work has been reported by Chou and Chang<sup>102</sup> concerning pyrrolo-3-sulpholenes.

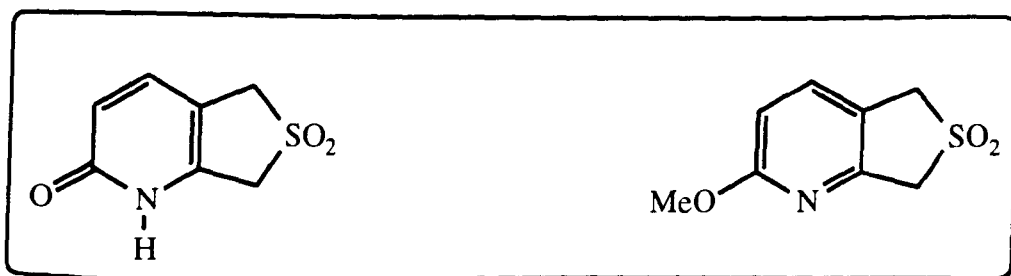

(*Scheme 41*)

These have been used to generate the corresponding 2, 3-dimethylene pyrroles, a so far unknown quinodimethane (*Scheme 42*). Reaction of the *N*-phenylsulphonyl pyrrolo-3-sulpholene, in refluxing toluene, with *N*-phenyl maleimide or dimethyl fumarate gave the corresponding [4 + 2] cycloadducts. The desulphonylation was then accomplished with sodium/mercury amalgam. Further functionality could be introduced by a highly regioselective alkylation of the 3-sulpholene with base and treatment with either iodomethane or 5-iodopent-1-ene.

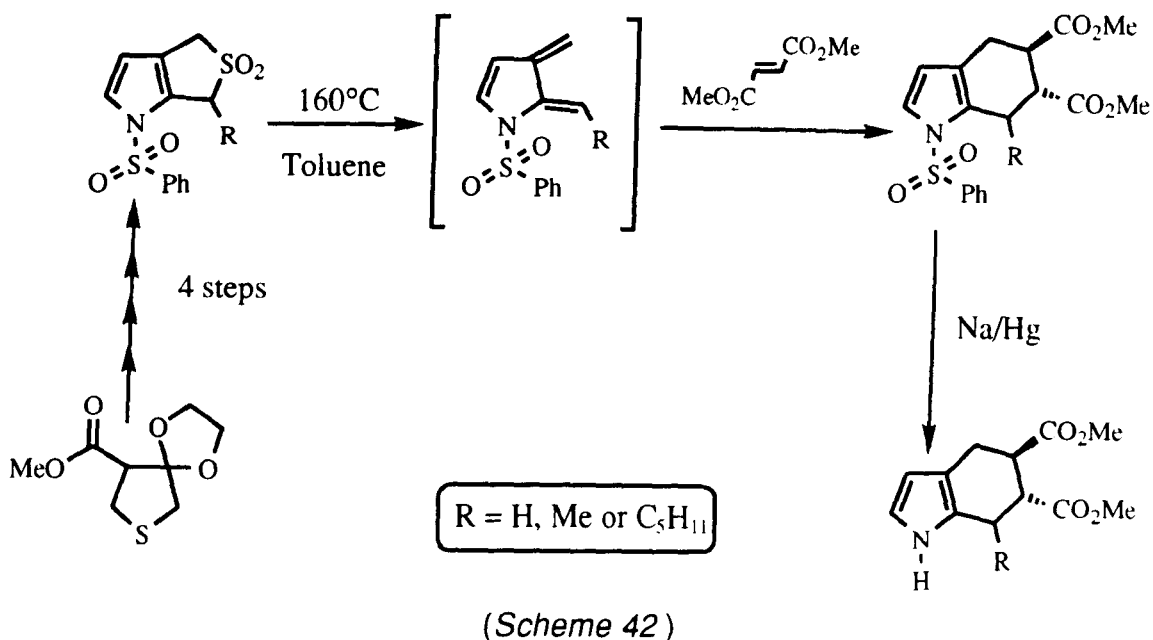

Examples of the hetero-sultine or isochromanone systems are not abundant. Tamura<sup>103</sup> has accomplished some useful work in the latter field. He was able to construct heterohomophthalic anhydrides of the indole, benzofuran and thiophene systems (Scheme 43).

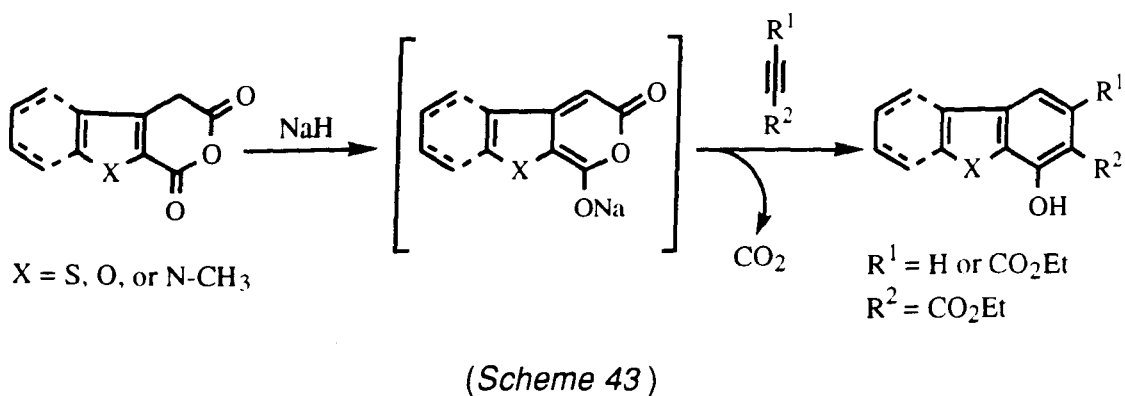

Loss of carbon dioxide was accomplished by treatment with a strong base; by using acetylenes as trapping agents, a useful route to polycyclic *peri*-hydroxy heteroaromatic compounds was achieved.

Moody<sup>104</sup> used pyranothiophenes, prepared from thiophene-3-acetic acid, as precursors to thiophene-2, 3-quinodimethane equivalents. On refluxing in bromobenzene with alkynes, these readily underwent Diels-Alder reaction to

give, after loss of carbon dioxide, benzothiophenes. Reaction with dimethyl acetylenedicarboxylate (DMAD) gave the benzothiophene 5, 6-diester, whereas the unsymmetrical alkyne ethyl propiolate gave mixtures of the 5- and 6-esters, with the 6-isomer predominating (*Scheme 44*). The regioselectivity of these reactions was similar to that of thiophene-2, 3-quinodimethane prepared by Van Leusen and Van den Berg<sup>105</sup> using the Saegusa fluoride induced elimination method. A simple intramolecular version using either a 2- or 4-acylthienopyranone was also reported. Moody<sup>106</sup> went on to use his method to prepare an equivalent benzothiophene-2, 3-quinodimethane from the easily prepared 1-methylbenzothieno[2,3-c]pyran-3-one, (*see discussion 39*).

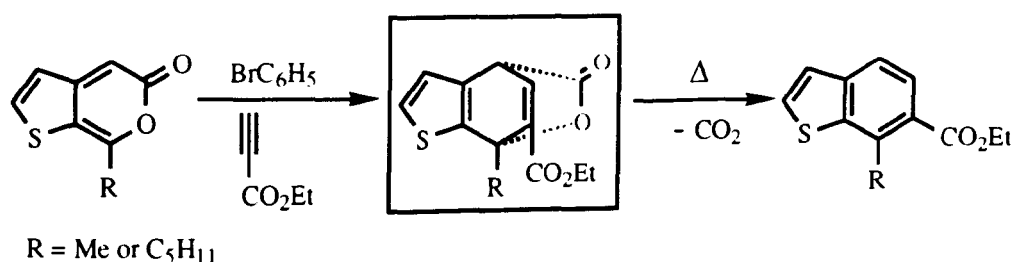

(*Scheme 44*)

#### *Heterocyclic quinodimethanes via [1. 4] elimination routes*

There are three main classes into which this type of reaction can be subdivided.

The classical Cava and Finkelstein 1, 2-dihalogenation method requires iodide to bring about the elimination. Few examples containing heteroatoms are known despite the ready availability<sup>107</sup> of haloalkyl substituted heteroaromatics. The first example, reported in early 1984, involved the reaction of a dibromoindole compound which generated the quinodimethane at 50°C in DMF using sodium iodide (*Scheme 45*).<sup>108</sup> This was then successfully trapped with benzoquinone, dimethyl fumarate and *N*-phenylmaleimide in good yields.

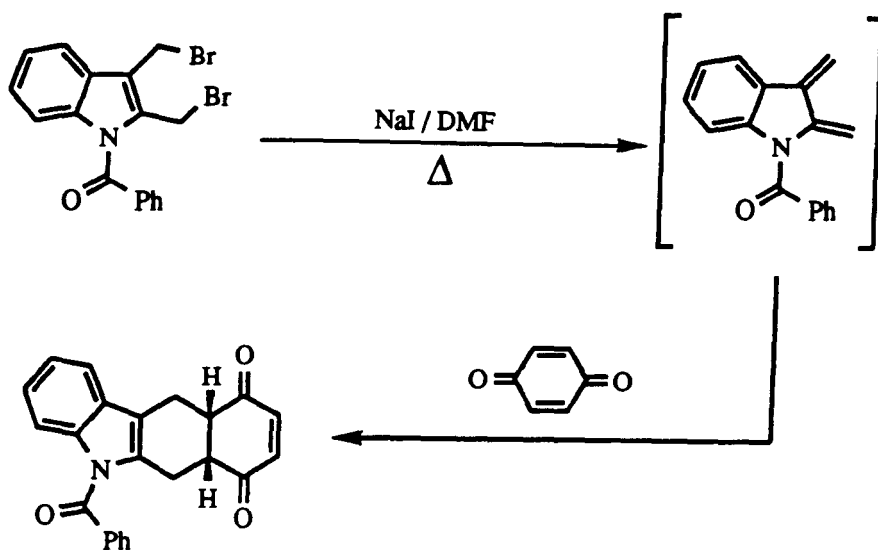

(Scheme 45)

Shepherd<sup>109</sup> was also to report the generation of a wide range of nitrogen containing, six membered  $\alpha,\alpha'$ -dibromo quinodimethanes from *ortho*-bis-(dibromomethyl) heteroaromatics. The tetrabromo derivatives were obtained in good yield from the *ortho*-dimethyl compounds *via* an NBS bromination procedure. Again, debromination using sodium iodide in DMF at reflux gave the  $\alpha,\alpha'$ -dibromo quinodimethanes which were trapped with *N*-phenylmaleimide in high yield (Scheme 46).

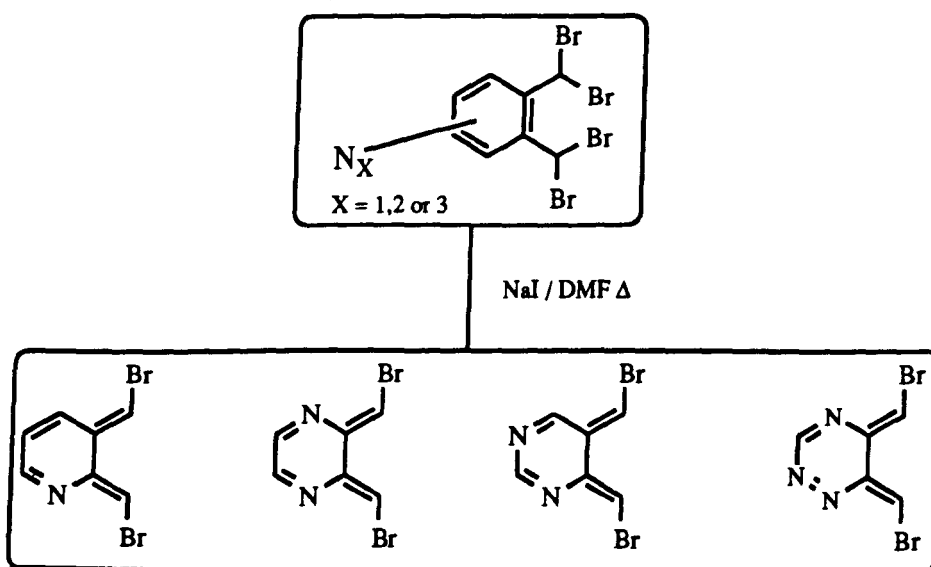

(Scheme 46)

The dibromoquinodimethanes generated with a pyrimidine, pyrazine and 1, 2, 4-triazine ring substituent are worthy of note since they are the first polyheteroatomic examples to be reported.

The most up to date example of an iodide induced elimination is that of Chadwick and Plant.<sup>110</sup> They were able to generate a thiophene quinodimethane using a dibromomethyl thiophene precursor (*Scheme 47*). Moderate yields of adducts were obtained when this quinodimethane was trapped with methyl vinyl ketone, acrylonitrile and *N*-phenylmaleimide.

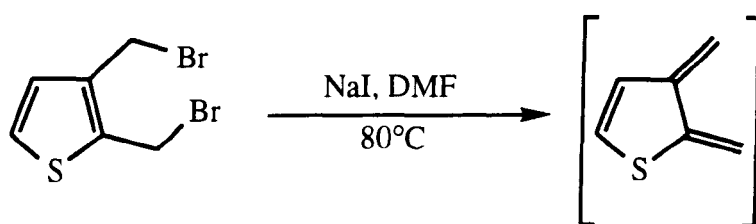

(*Scheme 47*)

The second class of [1. 4] elimination is the Saegusa and Ito type which is brought about by a fluoride induced fragmentation as has already been mentioned in the production of benzenoid quinodimethanes. This method of generation was also applied to the heterocyclic counterparts by the same workers.<sup>49</sup> First, an intermolecular approach was tried where a 3-chloromethyl-2-methylpyridine hydrochloride was converted into the trimethylsilylpyridine ammonium bromide, the quinodimethane precursor (*Scheme 48*).

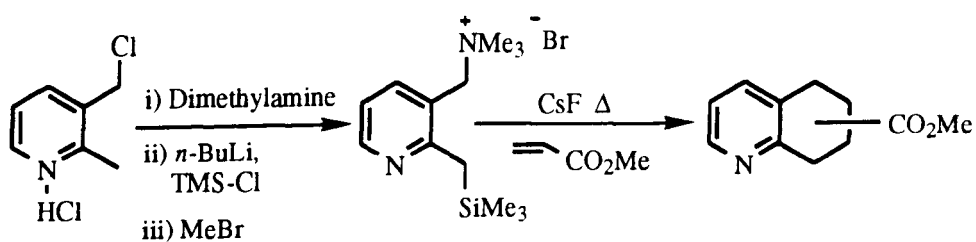

(*Scheme 48*)

Heating this compound in acetonitrile containing five equivalents of methyl acrylate and caesium fluoride as fragmentation agent led to the cyclic adduct in



good yield. Unfortunately no regioselectivity was observed and a 1:1 mixture was obtained. The intramolecular path was soon to follow. This involved a similar pyridine ammonium salt, but one substituted with a hexenyl side chain (*Scheme 49*). Again, when this was exposed to caesium fluoride under suitable conditions, a very good yield of the tricyclic pyridine was formed, alas as a 1:1 diastereoisomeric mixture.

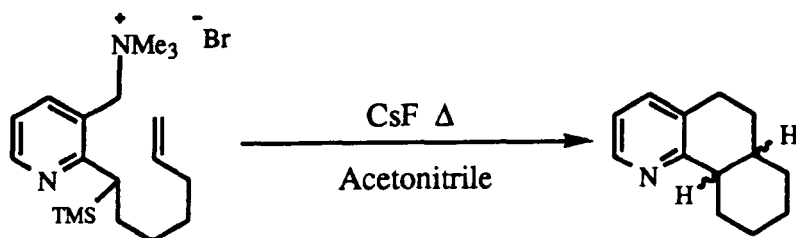

(*Scheme 49*)

Important inroads have recently been made by Van den Berg and Van Leusen<sup>111, 105</sup> into the preparation of a thiophene quinodimethane. They successfully prepared 2-(trimethylsilylmethyl)thiophene-3-trimethylammonium iodide, which when treated with fluoride, gave the quinodimethane at room temperature (*Scheme 50*).

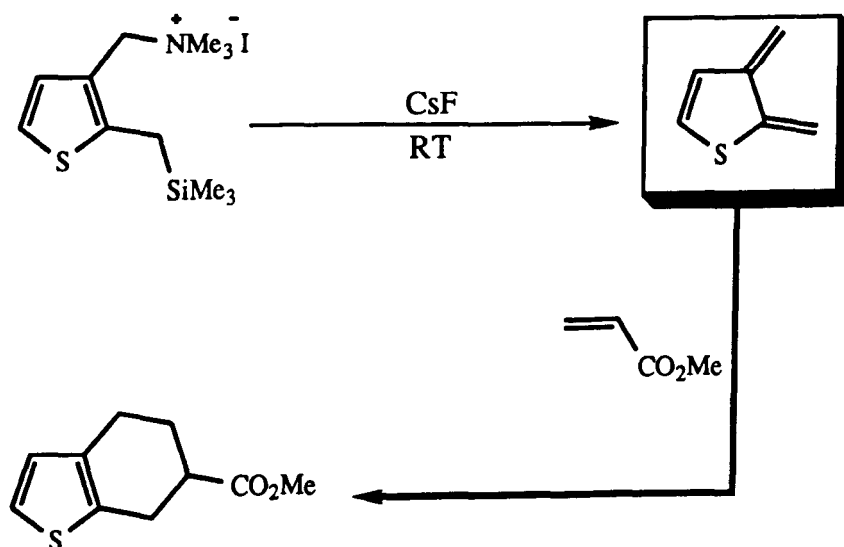

(*Scheme 50*)

Successful capture of this was accomplished with a wide variety of dienophiles including methyl acrylate, acrylonitrile, dimethyl fumarate and diethyl azodicarboxylate. Yields were generally high, with unsymmetrical dienophiles giving 2:1 regioisomer mixtures of which the major isomer is shown.

The third and final class of quinodimethane generation *via* [1.4] elimination is that which involves pyrolytic techniques. In late 1984, a furan-2, 3-quinodimethane was generated by Trahanovsky and co-workers<sup>112</sup> using a furyl benzoate precursor (*Scheme 51*). This was vaporised by heating to 70°C at 0.001 mm Hg of pressure and then passed through a furnace heated to 600°C. The eliminated benzoic acid was collected in a condenser cooled to -20°C and the diene deposited in a liquid nitrogen trap (< -90°C). Dimerisation would then occur if the temperature was allowed to rise to -40°C but trapping could be accomplished by addition of a dienophile at -60°C and allowing the temperature to rise.

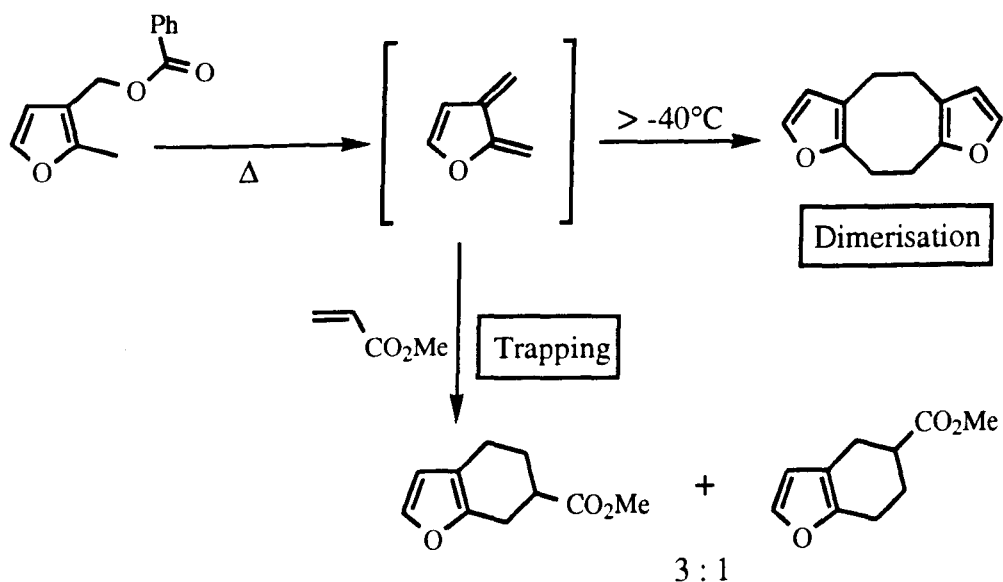

Successful trapping with methyl acrylate using 80 molar equivalents gave good yields of the Diels-Alder adducts. Importantly there was some regioselectivity shown with a 3 : 1 preference for the "meta"-adduct.

In stark contrast, the sulphur analogue of this, namely thiophene-2, 3-quinodimethane proved far more difficult to generate and trap by pyrolytic techniques. Storr *et al*<sup>113</sup> developed a path to this by heating a chloromethylthiophene up to 750°C (0.01 mm Hg) followed by attempted trapping at lower temperatures. Unfortunately no adducts were obtained, even though a wide range of dienophiles were tried, including MVK, DMAD, acrylate and methyl vinyl ether. However proof that the quinodimethane was being generated was the formation of a head to tail dimerisation product along with greater amounts of polymerisation material (*Scheme 52*).

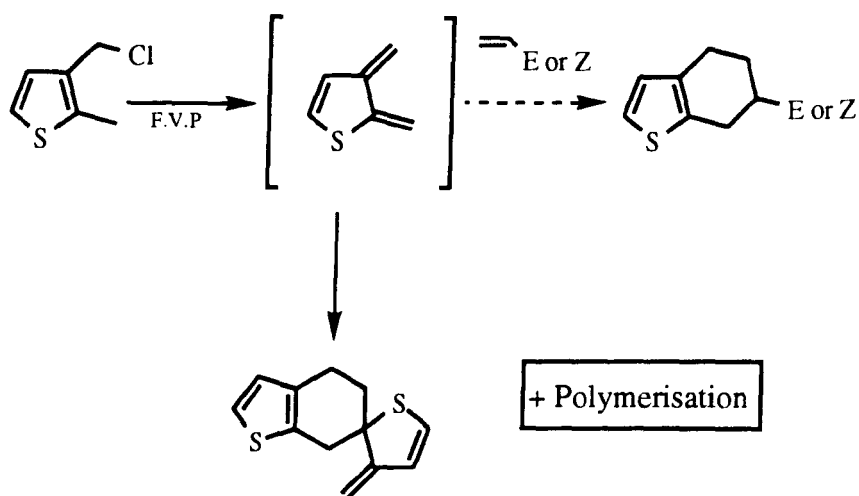

(*Scheme 52*)

This result indicates that the thiophene quinodimethane is decidedly less reactive towards dienophiles than its furan counterpart. Storr<sup>113</sup> suggested that the thiophene quinodimethane was a diradical, retaining its aromaticity, whereas the furan species, due to its lower aromatic stabilization, was more diene-like in character. Therefore, the thiophene species behaved as a reactive diradical by rapidly polymerising, but the furan, being less reactive was resistant to extensive polymerisation and could therefore be trapped by dienophiles.

In a similar vein Storr<sup>114</sup> has managed to make oxazole, thiazole and imidazole heteroquinodimethanes pyrolytically (700°C/10<sup>-2</sup> Torr) from their corresponding *p*-chlorobenzoate esters (*Scheme 53*).

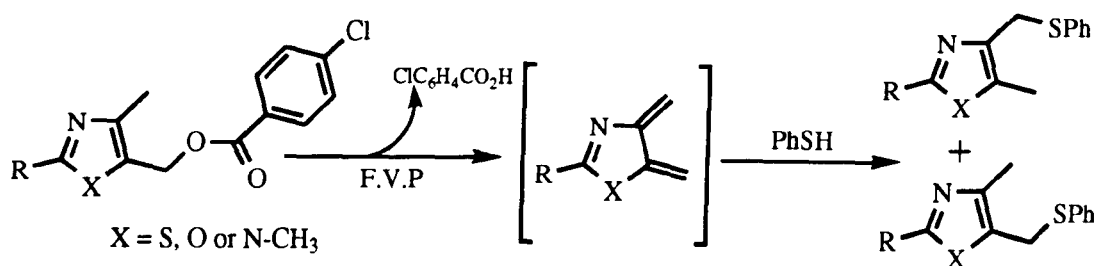

(Scheme 53)

All gave poor yields and a regioisomeric mixture of adducts when trapped with thiophenol or sulphur dioxide. Interestingly the oxazole quinodimethane only gave a Diels-Alder adduct, when co-condensed with methyl acrylate. All attempts to intercept the imidazole or thiazole quinodimethane with dienophiles failed.

*From a 1,5-rearrangement of alkyvinyl indoles*

The alkaloid, ellipticine was prepared in 1970 by Bergman and Carlsson<sup>115</sup> when they heated a 3-vinylindole derivative to 350°C (Scheme 54). Later<sup>116</sup> they proposed that the intermediate quinodimethane was formed by a [1,5] hydride shift; this subsequently cyclized to the alkaloid precursor. Similar work has been published by Kano.<sup>117</sup>

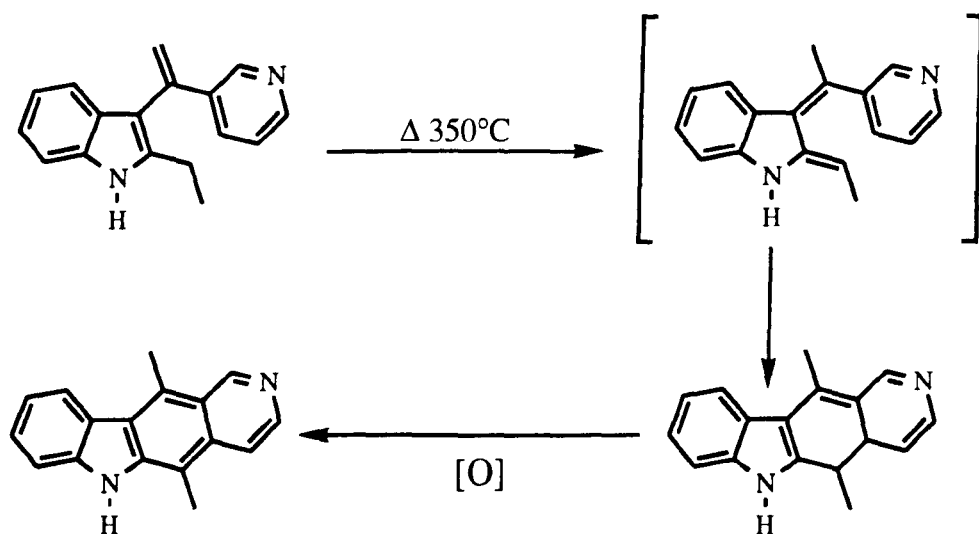

(Scheme 54)

Important work, also involving indol-2, 3-quinodimethanes, came from Gallagher and Magnus.<sup>118</sup> They developed a method which was based on the thermolysis of indolimines and showed that these could be converted into an all-*cis* annulated indole (*Scheme 55*). The stereochemical outcome is due to the formation of the *E*-indole-2, 3-quinodimethane arising from the favoured *exo*-conformation.

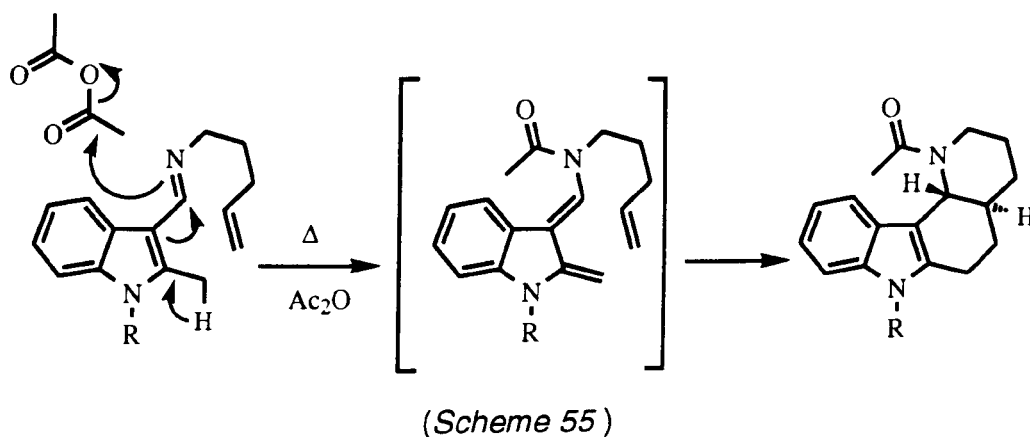

This important result laid the foundation for the utilisation of indole quinodimethanes as key intermediates in indole alkaloid synthesis. This strategy was used to construct the alkaloid, (+)-aspidospermine<sup>119, 120</sup> and later to the synthesis of members of the kopsane group of alkaloids.<sup>121</sup> Both (+)-10,22-dioxokopsane and (+)-kopsanone were prepared *via* suitable imine precursors. The preparation of these alkaloids is worthy of note since it is the first synthetic entry into this highly condensed class of heptacyclic indoles (*Scheme 56*).

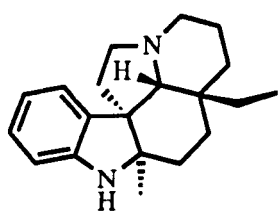

(+)-Aspidospermine

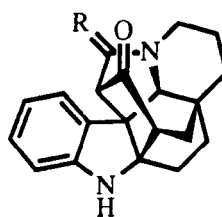

(+)-10, 22-Dioxokopsane, R = O  
 (+)-Kopsanone, R = H<sub>2</sub>

(*Scheme 56*)

Construction of the 3-alkylindoles was also attempted, now having the imine attached onto the 2 position.<sup>121</sup> This was successful in generating quinodimethane intermediates which Magnus and Sear<sup>122</sup> demonstrated could be put to good use in the construction of fused *bis*-indoles. This example was later taken on to become the *N*-carbomethoxy derivative of Staurosporinone (Scheme 57). Later successes were the syntheses of Aspidospermidine<sup>124</sup> and Vinca<sup>125</sup> indole alkaloids.

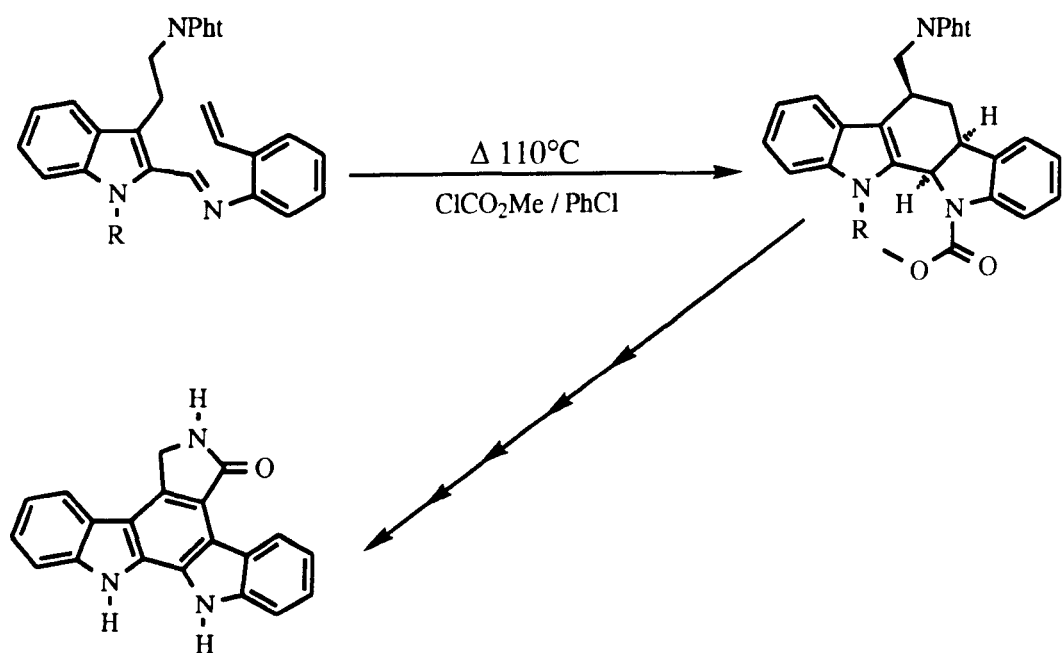

(Scheme 57)

Despite the outstanding success of this method of quinodimethane generation, there have been no reported attempts to apply this methodology to other heterocyclic systems. Indeed, of all the heterocyclic quinodimethanes which have been characterised, only the intramolecular cycloadditions of the indole species have found application in the synthesis of structurally complex targets and natural products.

.....O.....

### ***ortho*-Methyl heterocyclic carboxylic acids: Intermediaries to heterocyclic quinodimethanes**

- a) Introduction to heteroquinodimethanes
- b) *ortho*-Methyl heterocyclic carboxylic acids
- c) Reactions of 2,4-dimethylfuran-3-carboxylic acid
- d) Reactions of 3-methylbenzofuran-2-carboxylic acid
- e) Intramolecular reactions of benzofuran-2,3-quinodimethane
- f) Reactions of 2,4-dimethyloxazole-5-carboxylic acid  
and 2,4-dimethylthiazole-5-carboxylic acid

## a) Introduction to heteroquinodimethanes

The indole-2, 3-quinodimethane species (**004**) has been one of the most extensively studied of all heteroquinodimethanes. An immense amount of material has been published on its generation by a variety of different methods and its trapping by inter- and intra-molecular means has been well reported. Research in this field was initiated by Gallagher and Magnus who investigated ways in which indole-2, 3-quinodimethane species could be generated. Although unsuccessful with an earlier silane fragmentation approach,<sup>118</sup> their thermolysis route proved it could be used to access the key intermediates required for indole alkaloid synthesis (see introduction page 36).<sup>120</sup> Other work in this field has been undertaken by Marinelli<sup>126</sup> who was able to prepare silylated ammonium salts (**003**) from 1,2-dimethyl (**001**) and 2-methylindole (**002**) (Scheme 1).

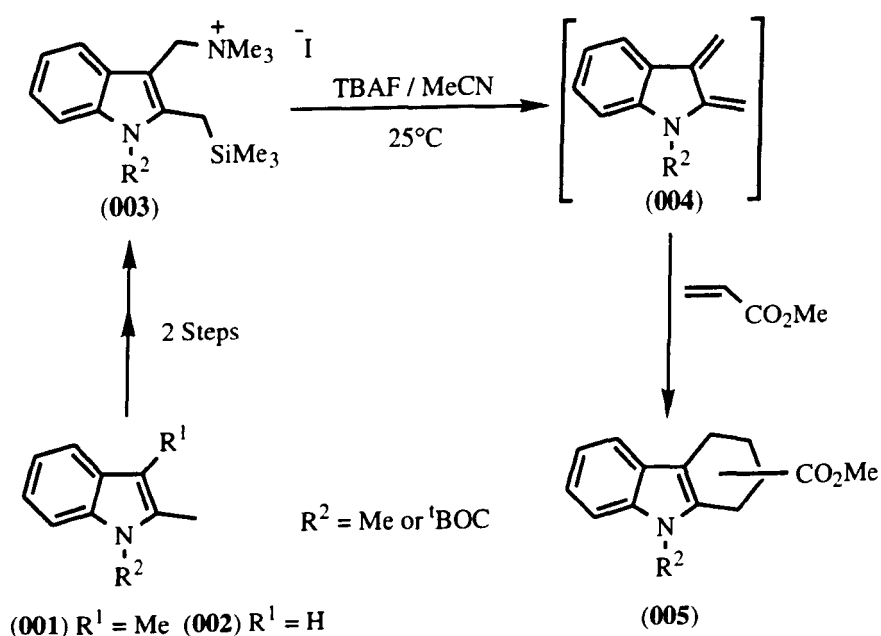

(Scheme 1)

Subsequent treatment of these salts with TBAF in acetonitrile furnished the required quinodimethane (**004**) at room temperature. Trapping with methyl acrylate gave a regioisomeric mixture of adducts (**005**).



Pindur<sup>127</sup> published in 1989 a comprehensive review of indolo-2,3-quinodimethanes and their stable cyclic analogues and the utility of these in regio- and stereo-controlled syntheses of [b]-annelated indoles and the reader is asked to draw upon this review for a fuller account on this work.

In contrast to the above indole examples, very little work to date has been published on the related benzofuran and benzothiophene class of compounds. Some introductory work on the latter by Storr<sup>113</sup> gave rise to the benzothiophene-2,3-quinodimethanes *via* a flash vacuum pyrolysis route, but the best preparative method so far to an equivalent of this quinodimethane (**008**) is due to Moody.<sup>106</sup> He prepared a benzothienopyrone (**007**) by reaction of benzothiophene-3-acetic acid (**006**) with acetic anhydride (*Scheme 2*).

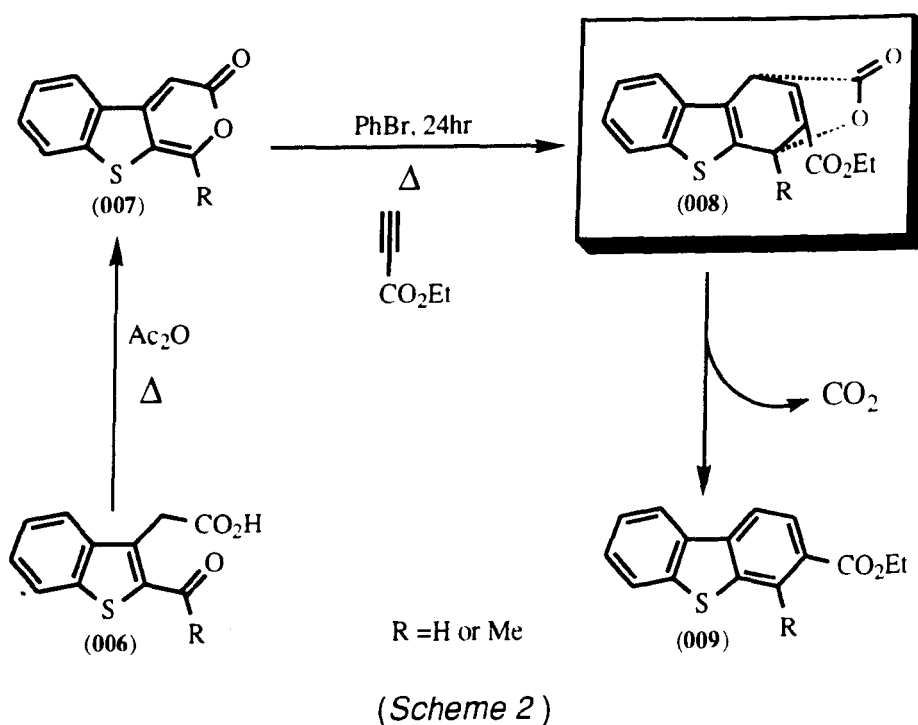

Heating this benzothienopyrone (**007**) with DMAD in boiling bromobenzene for 8 hr gave the dibenzothiophene diester in an excellent 93% yield. The unsymmetrical alkyne ethyl propiolate gave a mixture (1.5:1) of the dibenzothiophene 2- and 3-esters in a 78% yield, with the 2-ester (**009**) as the major product.

Benzofuran 2,3-quinodimethanes (**012**) are even rarer examples in the literature than their sulphur counterparts. The sole example is Trahanovsky and Chou's vapour-phase synthesis using benzoate precursors.<sup>128</sup> These benzoate esters (**011**) were prepared by metallation of 3-benzofuran-carboxylic acid (**010**) and quenching this anion with methyl iodide to give methyl-3-benzofurancarboxylic acid. This was then reduced with lithium aluminium hydride to give the corresponding alcohol which was esterified with benzoyl chloride. Formation of the quinodimethane (**012**) was accomplished by heating this ester to 650°C at 10<sup>-4</sup> torr. Interestingly, quantitative <sup>1</sup>H NMR showed there was only a 35% conversion of the benzoate to the corresponding quinodimethane (*Scheme 3*). They also found that this diene was stable in carbon disulphide at -60°C but that it dimerized at ambient temperatures to more than one dimer. They went on to show that these dimers were the [4+4] (**013**) and [4+2] (**014**) adducts, the latter predominating in a ratio of 4:1.

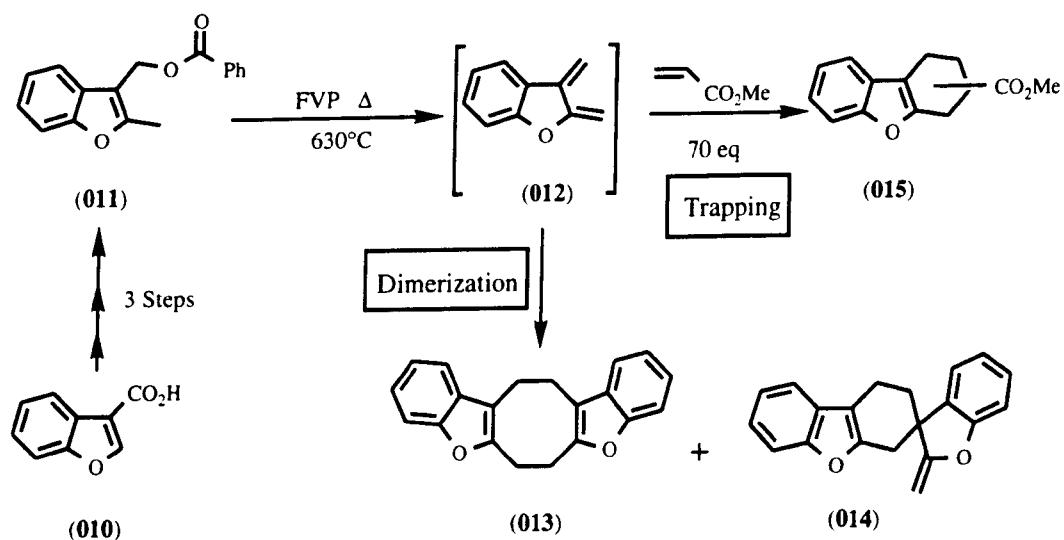

(*Scheme 3*)

They were successful in forming one Diels-Alder adduct using methyl acrylate in a 70 equivalent excess. This afforded a regioisomeric mixture of adducts (**015**) in a yield of only 30% relative to starting benzoate (**011**).

## b) ortho-Methyl heterocyclic carboxylic acids: Precursors of heterocyclic quinodimethanes

A recurring interest in our group at Nottingham has involved the synthesis and characterisation of a wide variety of heterocycles. One particular project has entailed the preparation of *ortho*-methyl heterocyclic carboxylic acids (**016a**). Their subsequent metallation leads to a dianionic intermediate (**016b**) whose reaction with a broad range of electrophiles has been studied.<sup>129-132</sup> We therefore wanted to make further use of such dianions and proposed a strategy which could allow access to new hetero polycycles based on the Saegusa and Ito type of *ortho*-quinodimethane generation (*Scheme 4*).<sup>133</sup>

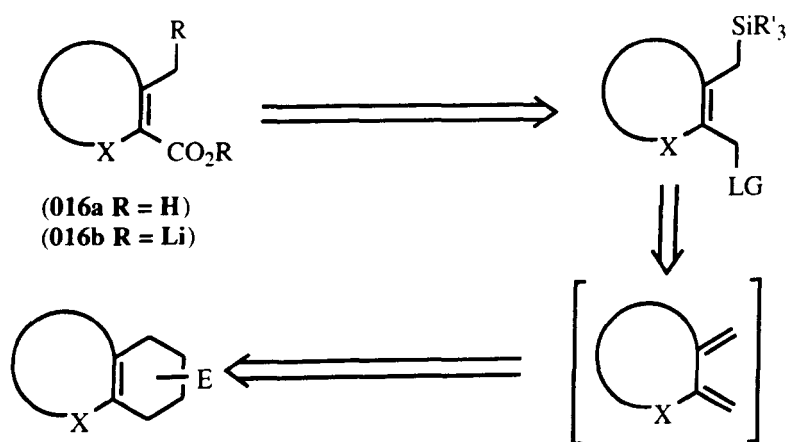

(Scheme 4)

It was anticipated that treatment of the intermediate dianion (**016b**) with excess chlorotrialkylsilane followed by reduction of the resulting silyl ester with hydride would furnish the required silyl alcohol. Subsequent conversion of the alcohol function into a suitable leaving group would give the quinodimethane precursor, which would have the necessary 1,4-relationship between the silyl substituent and the leaving group. The conversion of this precursor to the corresponding quinodimethane using existing fluoride-induced elimination methods and trapping with suitable dienophiles could then be investigated. If successful, this approach would allow easy access to the quinodimethane precursor, something

many other routes are not able to provide.<sup>133</sup> There were four main heterocyclics that we thought were suitable for this approach, 2,4-dimethylfuran-3-carboxylic acid (**017**), 3-methylbenzofuran-2-carboxylic acid (**018**), 2,4-dimethyloxazole-5-carboxylic acid (**019**) and 2,4-dimethylthiazole-5-carboxylic acid (**020**), all of which could be synthesized by existing methodology (*Scheme 5*).

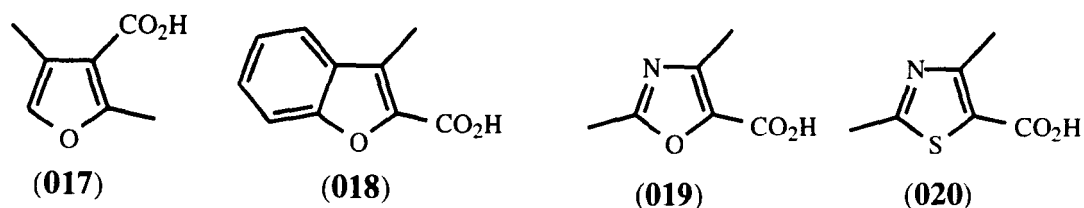

(*Scheme 5*)

We were curious therefore to see if we could use these heterocycles to produce quinodimethanes since these had received sparse attention to date.

### c) Reactions of 2,4-dimethylfuran-3-carboxylic acid (**017**)

A feasibility study was initiated by Cornwall.<sup>134</sup> He reacted 2,4-dimethylfuran-3-carboxylic acid (**017**)<sup>135</sup> with lithium diisopropylamide in tetrahydrofuran at  $-78^{\circ}\text{C}$  to generate the required dianion (*Scheme 6*).<sup>136</sup> Quenching with trimethylsilyl chloride and subsequent reduction with lithium aluminium hydride in ether at  $0^{\circ}\text{C}$  furnished the required alcohol (**021**) in a 70% yield. This was then successfully taken onto the silyl acetate (**022**) by reaction with acetyl chloride and 4-dimethylaminopyridine in dichloromethane, with a 90% yield. Generation of the required quinodimethane (**023**) was then attempted using TBAF as fluoride source and dimethyl fumarate as dienophile, in refluxing acetonitrile. Unfortunately this afforded, after column chromatography, only a 31% yield of the head to head dimerisation product (**024**) identical to that which was obtained by Trahanovsky, Cassidy and Woods<sup>112</sup> by their pyrolysis route. Although none of the anticipated diester

product (025) was procured, the successful generation of the quinodimethane intermediate had probably been accomplished.

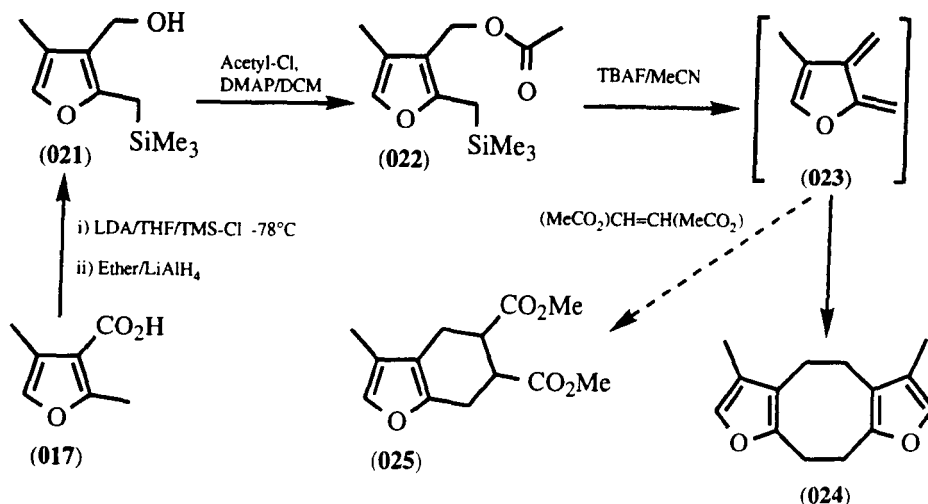

(Scheme 6)

#### d) Reactions of 3-methylbenzofuran-2-carboxylic acid (018)

The viability of the route having thus been indicated, we now had the task of developing it further and consolidating its potential as a general means of quinodimethane generation. We chose 3-methylbenzofuran-2-carboxylic acid as the next example since it could provide benzofuran 2,3-quinodimethane (012), a so far under-exploited species.

In 1963 W. R. Boehme<sup>137a</sup> published a route to 3-methylbenzofuran-2-carboxylic acid (018) in which he acquired the acid in three steps (Scheme 7). It was this preparative method that we chose to obtain our required starting acid. However, we did make certain alterations to this procedure in order to improve upon the yields. The reaction of commercially available ethyl 2-chloroacetoacetate with sodium phenolate (obtained by reaction of phenol and sodium hydroxide) gives high yields of the required ethyl 2-phenoxy-3-oxobutanoate (026). Cyclization of this keto-ester *via* dehydration with concentrated sulphuric acid gave after distillation ethyl 3-methylbenzofuran-2-carboxylate (027) in a poor 34-42% yield, mp 50-51°C [lit.<sup>137a</sup> mp 49-51°C]. Our

attempts to improve upon this cyclization step revolved around modifications in the work up procedure and were successful in improving the yield to 60-65%.

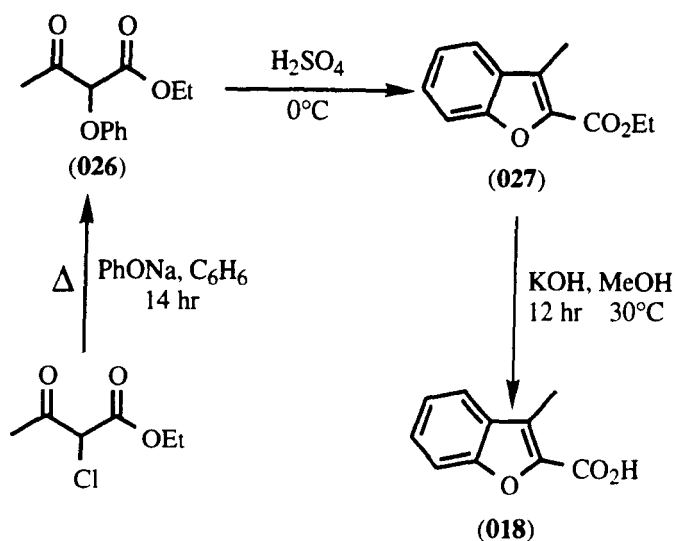

(Scheme 7)

Moreover, we believed that substantial amounts of the product were also being lost due to decomposition of the benzofuran ring by the concentrated acid. We wanted to bring about the ring cyclization using less harsh conditions and looked for suitable replacements. A French publication<sup>138</sup> had shown that a similar cyclization could be accomplished with phosphorous oxychloride (Scheme 8).

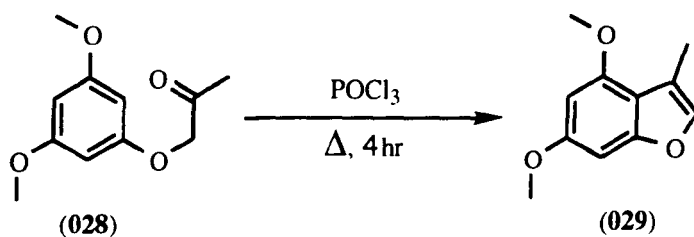

(Scheme 8)

Heating of the substrate (028) on a steam bath for 15 min, with twice the weight of phosphorous oxychloride gave the benzofuran (029) in a respectable 85% yield. We anticipated that our reaction might take longer since it had an ester

function present. Unfortunately, no benzofuran product was ever isolated in our reactions, despite trying several temperatures and reaction times. A possible explanation for this could be the lack of activation of the phenyl group in substrate (**026**). The published example had two methoxy groups present making the phenyl ring relatively electron rich.

A possible alternative route has been reported by Wasson<sup>139</sup> who was able to construct the required methylbenzofuran acid (**018**) directly in one step from readily available ethyl 2-(2-acetylphenoxy)acetate (**030**) by a base induced cyclization reaction (*Scheme 9*).

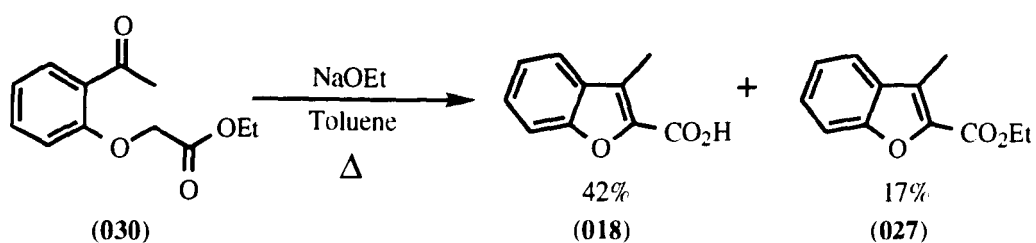

(*Scheme 9*)

The secondary product from the reaction was the ethyl ester (**027**) which can easily be saponified into the required acid (**018**), mp 191-193°C [lit.<sup>137b</sup> mp 192-193°C]. In our hands, this proved a more viable route to the starting acid (**018**). The next stage was to be metallation of this acid and quenching with a suitable silicon electrophile. The dianion (**031**) was formed from the parent acid by treatment with two equivalents of lithium diisopropylamide [LDA] in tetrahydrofuran at -78°C. This procedure had been previously developed in our research group by Buttery.<sup>131</sup> The dianion was quenched with two equivalents of trimethylsilyl chloride. Although spectroscopic analysis of the crude products from these reactions indicated essentially complete silylation of the dianion, attempted isolation led to significant loss of the silane functions, to return the starting acid (**018**). A possible explanation could be delocalization of dianion (**031**). O-silylation would give a "disilyl acetal" (**032**) like species, which upon work up would give back the original acid (*Scheme 10*). To overcome this, we attempted to use the bulkier *t*-butyldimethylsilyl function [TBDMS].

Nevertheless, all attempts to silylate with TBDMS chloride by the aforementioned procedure met with similar problems.

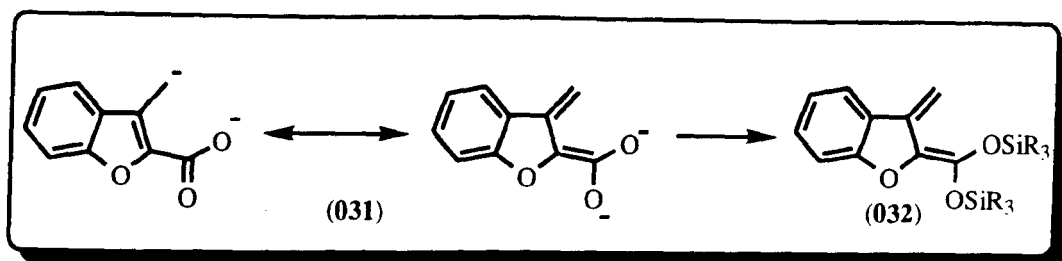

(Scheme 10)

It was only when we turned to the very bulky triisopropylsilyl group [TIPS] that the reaction became viable. Thus, treatment of the claret-coloured dianion with 2.4 equivalents of TIPS chloride at  $-78^{\circ}\text{C}$  led to a 69% isolated yield of the silyl ester (033) (Scheme 11).

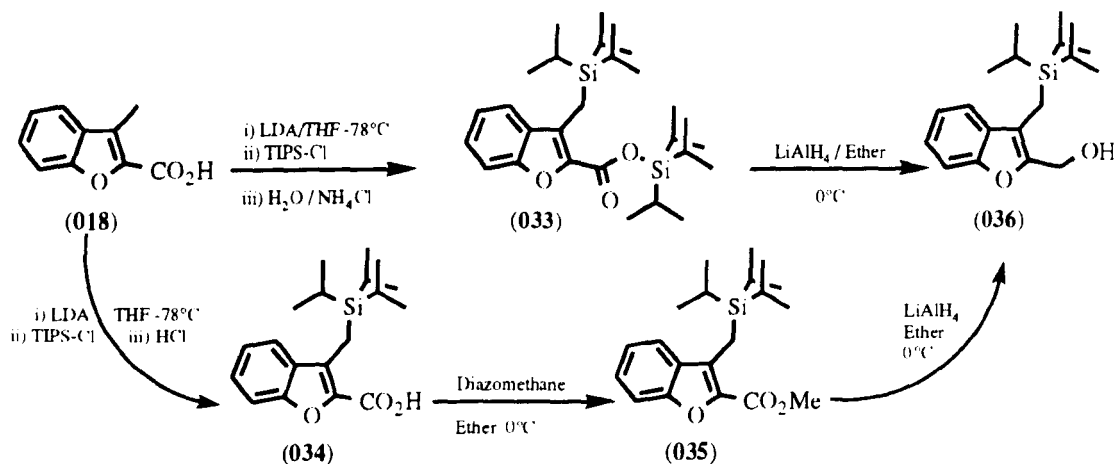

(Scheme 11)

During the optimization of this reaction step, it was found that the main by-product was the silyl benzofuran acid (034) and not as before the starting acid (018) formed by hydrolytic desilylation. The silyl acid (034) was independently synthesized by a similar procedure to that of above but with the alteration that the reaction was quenched with dilute hydrochloric acid instead of the normal



ammonium chloride solution, the acid (**034**) being isolated, after recrystallisation, in a 53% yield. Clearly, in this compound at least, the bulky TIPS group was now virtually immune to any hydrolytic desilylation. The silyl acid (**034**) was esterified with diazomethane<sup>302</sup> to give the methyl ester (**035**). This and the silyl ester (**033**) were then reduced with lithium aluminium hydride in ether to give the same silyl alcohol (**036**). Purification by column chromatography on this product to remove various silylated debris resulted in a 71% recovered yield. Typically 10-15% of the desired alcohol (**036**) is converted into the methyl alcohol (**037**) due to a desilylation reaction on the column (*Scheme 12*).

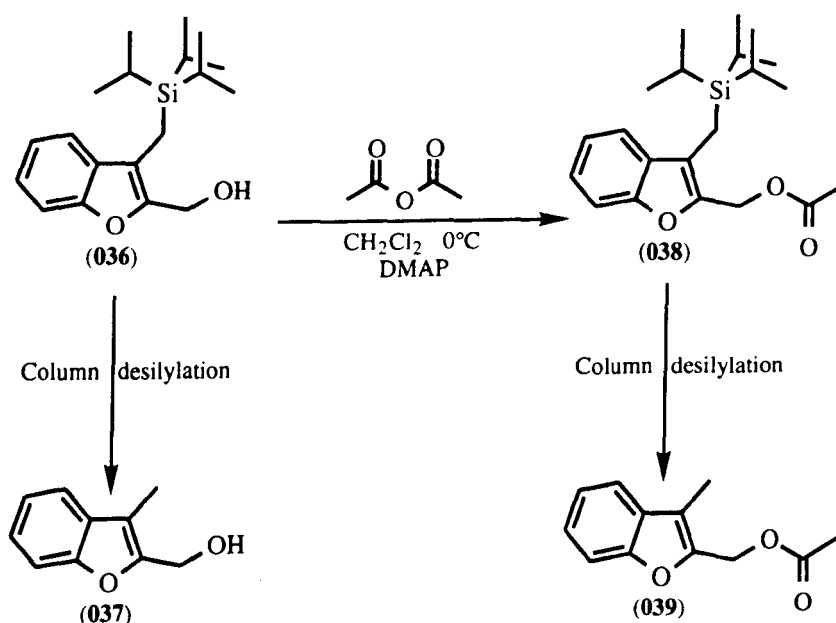

(*Scheme 12*)

Finally, acetylation under mild conditions<sup>140</sup> using acetic anhydride and 4-dimethylaminopyridine [DMAP] in dry, acid free dichloromethane, gave the silyl acetate (**038**), in 86% yield. This acetate was found to be unstable when subjected to column chromatography during which it rapidly degraded to the methyl acetate analogue (**039**).

Slightly improved yields for the first two steps were obtained when the silyl ester (**033**) was reduced without prior isolation. After quenching the dianion with TIPS-chloride, the reaction mixture was allowed to reach ambient temperature

and then lithium aluminium hydride was added, the resultant suspension stirred for 10 min and worked up in the same manner as usual, after reduction.

With our key precursor now in place, the next stage was to attempt the generation of benzofuran 2,3-quinodimethane with the aim of trapping it by means of an Diels-Alder reaction. We chose the standard Saegusa and Ito<sup>49</sup> conditions of refluxing our precursor in acetonitrile solvent with caesium fluoride to produce fragmentation. As dienophile we used diethyl fumarate in a two fold excess. The reaction produced after 5 hr, a complex mixture of products on which electron impact MS showed the correct molecular ion ( $M^+ = 136$ ) for the adduct.

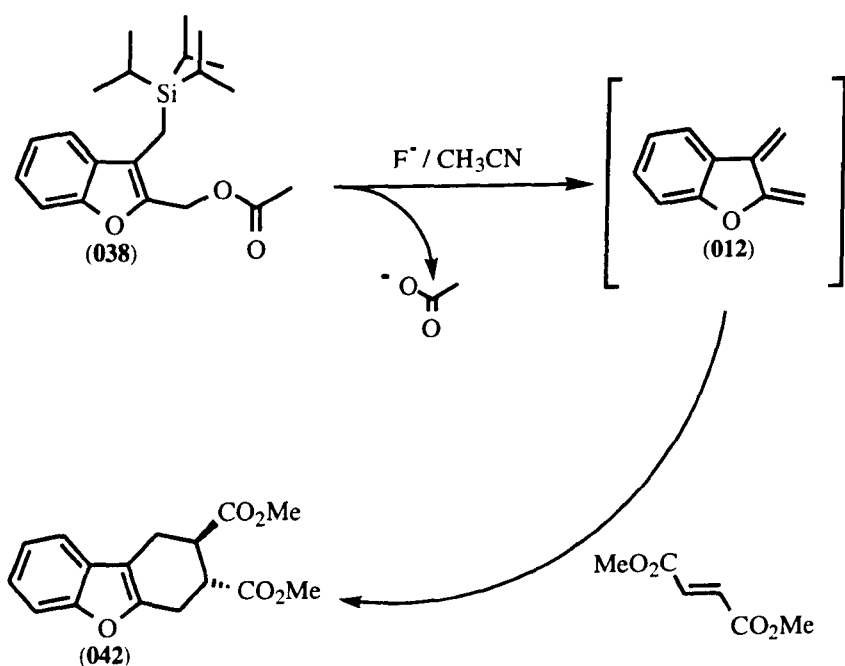

(Scheme 13)

However, isolation of this in the pure form could not be accomplished. We switched over to dimethyl fumarate as electrophile to aid NMR interpretation and changed our fragmentation agent to tetrabutylammonium fluoride [TBAF] (Scheme 13). The reaction required several more additions of dienophile/TBAF before the removal of the acetate was complete during 4 hr. Three major products and some polymeric material were isolated, the latter possibly arising from an initial Michael reaction between fluoride and dienophile.

The first two components were the [4+4] and [4+2] dimerisation products (**013** and **014**) recovered in a combined 29% yield. Both these adducts were obtained as single isomers and although no definite structural assignments could be made, the structures indicated would appear to be the most likely ones by analogy with the previously reported dimerisations of furan<sup>112</sup> and indole<sup>126</sup> quinodimethanes. The work of Trahanovsky and Chou<sup>128</sup> has indeed shown that the dimeric structures given are the correct ones and all spectral data that we obtained were consistent with those reported [vide infra]. We found the ratio of [4+2] to [4+4] to be 4:1 identical to their own vapour-phase method. This contradicts the results reported for the furan case where the [4+4] dimer is exclusively favoured over the [4+2]. The [4+4] dimer is forbidden on symmetry grounds<sup>8</sup> and was believed to come from an [1, 3]-rearrangement of the [4+2] adduct and so benefits from greater aromatic stabilization energy (*Scheme 14*).

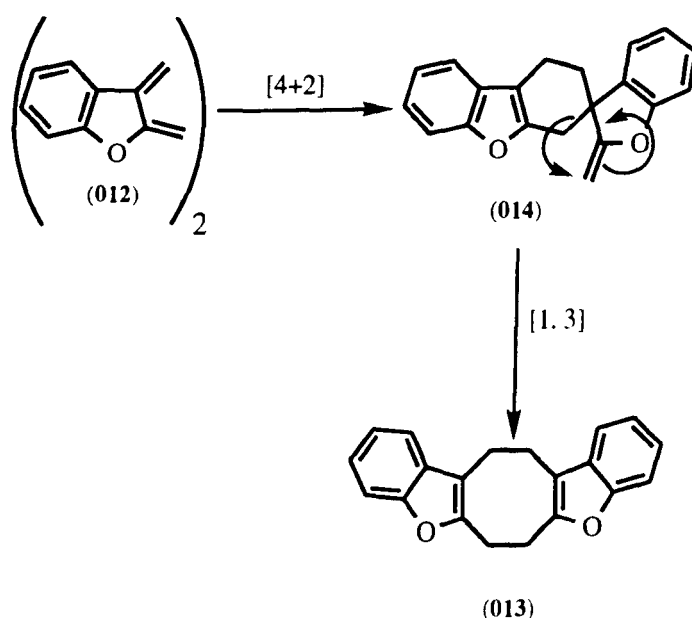

(*Scheme 14*)

Studies by Boekelheide<sup>141</sup> concerning the synthesis of cyclophane systems by quinodimethane dimerisations, have pointed toward a dimerisation pathway that does not involve a spiro-type intermediate. This is best illustrated by considering the preparation of "superphane" (**041**) from the precursor<sup>142</sup> (**039**). The

conformation of the intermediate *bis*-quinodimethane (**040**) is rigidly locked and it is therefore, extremely unlikely that it could achieve the required geometry for the formation of a spirotriene intermediate (*Scheme 15*). For this reason Boekelheide<sup>141</sup> proposed a stepwise radical dimerisation to account for this transformation.

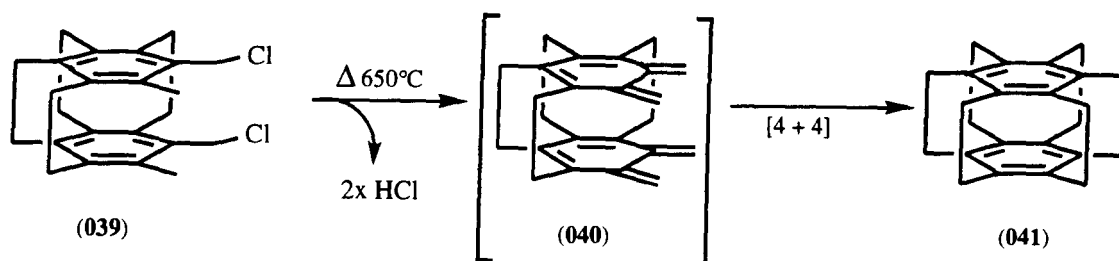

(*Scheme 15*)

The Diels-Alder adduct was the third and major product from our reaction and was obtained as a single isomer in a respectable 63% yield. All spectral data were consistent with the structure being that of *trans*-dimethyl 1,2,3,4-tetrahydrodibenzofuran-2,3-dicarboxylate<sup>143</sup> (**042**) (*Scheme 16*). We then tried to optimize the reaction by firstly changing the solvent to tetrahydrofuran which effectively reduced the refluxing temperature by some 15°C. This had only a marginal effect on reaction time but the (**042**) adduct yield was significantly increased by some 10%. Taking this still further, we carried out the reaction at a temperature of -4°C and found it possessed significant advantages over the reflux method. Firstly, there was now almost no polymer formation during reaction. This meant that we could cut down on the amount of dienophile and TBAF we were adding during the course of the reaction. We now found that two equivalents of dienophile were sufficient and typically 2-4 equivalents of TBAF. We suspected the extra TBAF was needed when the acetate precursor was not of the highest purity and contained silicon-based debris which of course removed some of the fluoride. Secondly, the reaction yields were now very good. For example, the reaction with dimethyl fumarate was giving the required

adduct in some 75-80% yield with the amounts of dimerisation products kept below 10%. The reaction was now taking some 48hr to run to completion but the gain in yield and efficient use of reactants were certainly a worthwhile compensation for this.

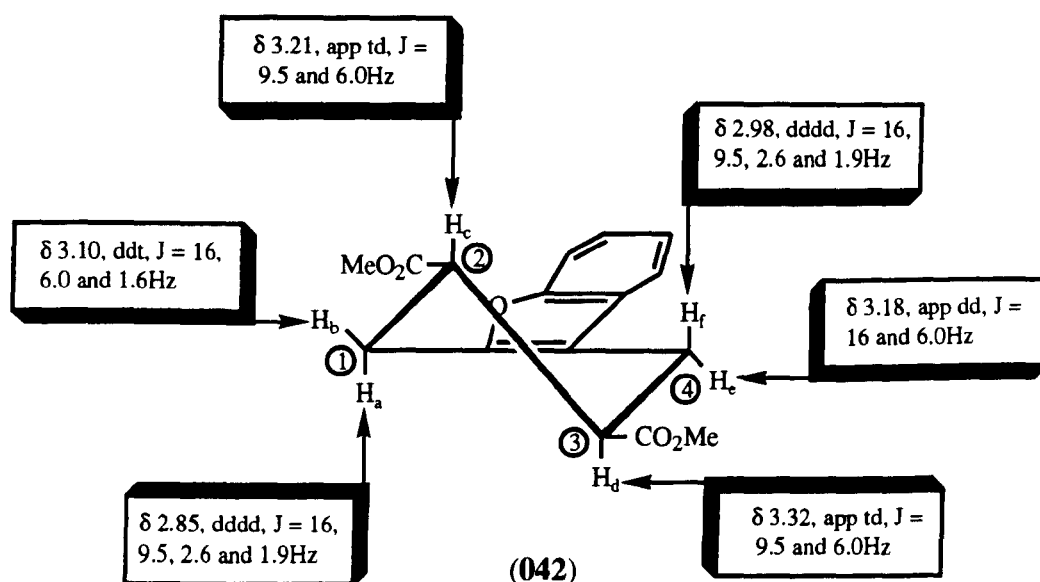

(Scheme 16)

Having now fine tuned our experiment to an efficient level, we carried out the reaction with a range of different, electron poor dienophiles, specifically dimethyl maleate, methyl vinyl ketone, methyl acrylate and acrylonitrile, the outcome of which is shown in *scheme 17*. The reactions with cyclohexene, acetone and benzaldehyde were also investigated. The reaction with dimethyl maleate gave a combined yield of the *cis* (043) and *trans* (042) adducts of 69% with a surprising 2:1 preference for the *trans* isomer. The ratio of (042) and (043) was determined by comparison of the six signals,  $\delta$  173.4, 173.1, 52.4, 52.3, 40.98, 40.67, 24.4 and 21.5 from (043) to the corresponding ones from (042). It was assumed that the relaxation rates of the corresponding carbons in (042) and (043) are the same. This interconversion was reasoned to have occurred due to a simple base catalysed epimerization by the fluoride present. A separate experiment was therefore carried out in which a pure

sample of adduct (**043**) was stirred in the presence of fluoride base. There was at the end of 24 hr sufficient evidence of *cis-trans* isomerisation to account for the observed stereoselectivity in the Diels-Alder reaction.

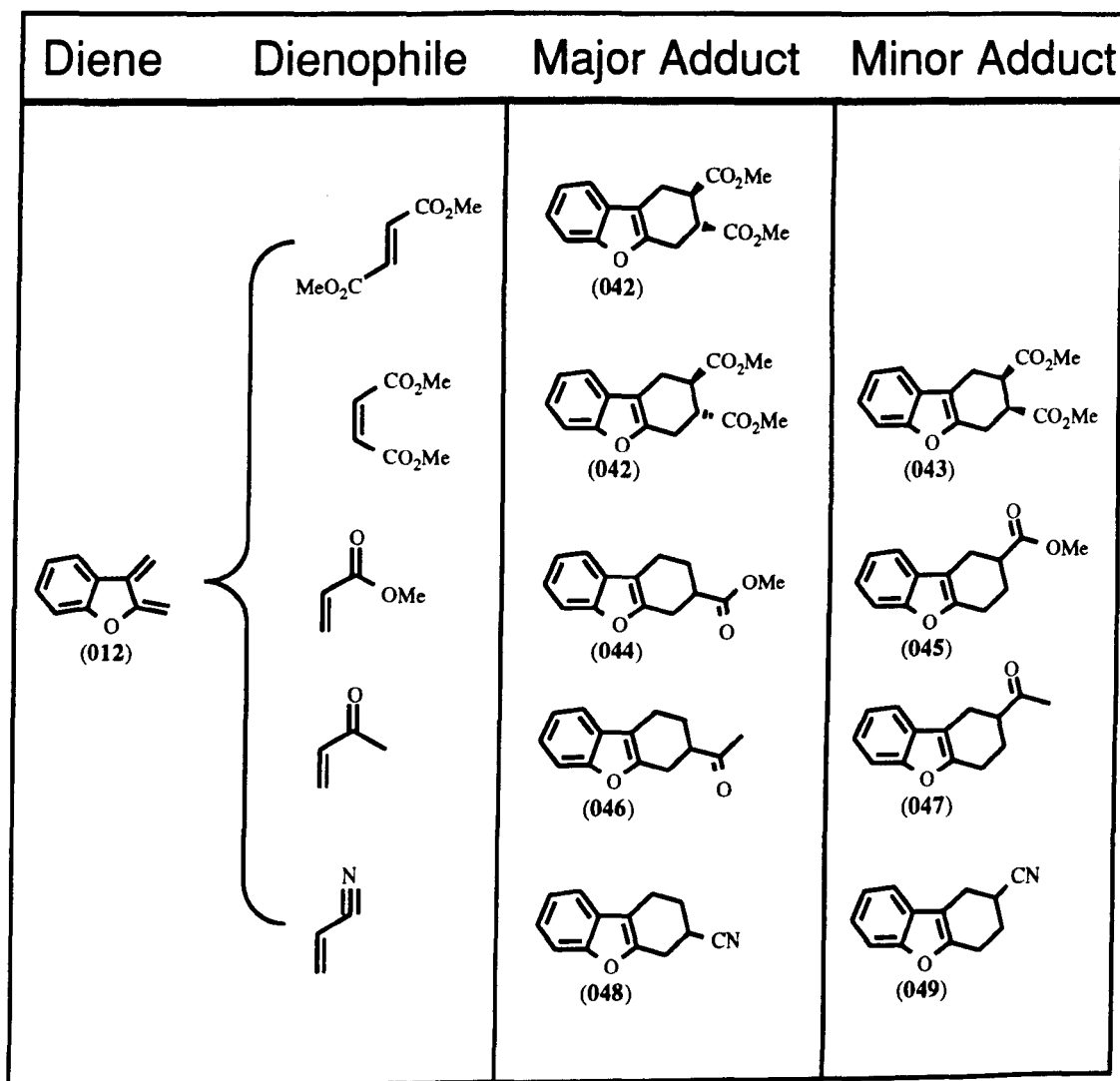

(Scheme 17)

Trapping of the quinodimethane (**012**) with methyl acrylate gave one of the best adduct yields. The reaction work up only required removing the excess dienophile by reduced pressure evaporation and an elementary flash column to remove any other components. The recovered yield was typically 85-90%. The adducts (**044** and **045**) were obtained in a ratio of 2:1 as a low melting point solid, which compares well to the 3:1 ratio obtained by Trahanovsky and Chou<sup>128</sup> for the same product. It was then important to establish the

regiochemical outcome of the reaction by attempting an X-ray structural analysis on this material. Unfortunately numerous recrystallisation failed to give an acceptable crystal to submit for analysis. We then switched to methyl vinyl ketone and attempted trapping with this reactive dienophile. This was regrettably very prone to Michael addition by fluoride even under our mild conditions of below 0°C. However, by using some 8 equivalents of ketone and 4 equivalents of fluoride base during the span of the reaction we were able to obtain a very respectable yield of the adducts (**046** and **047**) in a regioisomeric ratio of 4:1. This time we were able to obtain an acceptable, single crystal which we submitted for X-ray analysis. The analysis showed that the major regioisomer was substituted at the 2-position (**046**) (*Scheme 18*).

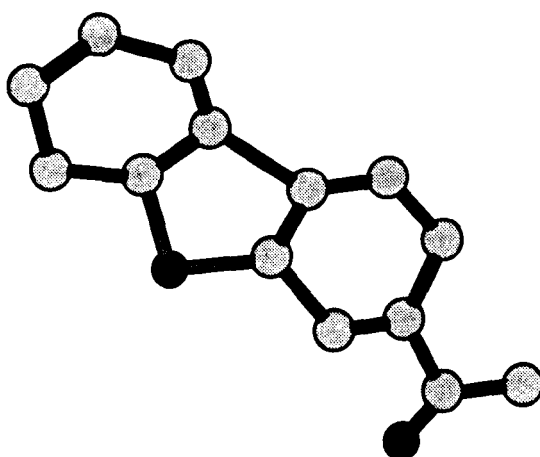

(*Scheme 18*)

Compound (**046**) was crystallized from ethyl acetate/hexane (1:1) in the monoclinic system, space group  $P2_1/c$  with unit cell dimensions  $a = 12.018$  (4),  $b = 11.303$  (3),  $c = 8.574$  (2) Å and  $\beta = 100.19$  (2)°. Intensity data were collected on an Enraf Nonius CAD 4 diffractometer; the structure was solved by direct methods using the MULTAN programme and refined to a final R value of 5.32% over the 1102 observed reflections.<sup>144</sup> This was the first time that the regioselectivity of this type of reaction had been determined and gave us the ability to make regioisomeric assignments to the other adducts formed from

monosubstituted alkenes by using comparative  $^{13}\text{C}$  NMR spectroscopy.

Further evidence for the regiochemical outcome of the reactions can be found by making a comparison of their  $^{13}\text{C}$  NMR spectral data with the known Diels-Alder adducts (**049** and **050**) formed between 4-methyl-2,3-dimethylene-2,3-dihydrofuran<sup>112</sup> and methyl acrylate. For example, the data for the methyl acrylate adducts (**044**) and (**045**) are shown in *scheme 19*. One can clearly see this relationship between the two ring  $\text{CH}_2$  pairs, typically the major 2-position ester has a higher field shift to that of the other ester. This allows the chemical shifts and structures of (**044**) and (**045**) to be assigned. The remaining  $^{13}\text{C}$  NMR data from all the other adducts can therefore be treated in a similar way to allocate all regiochemical outcomes and proper chemical shift positions.

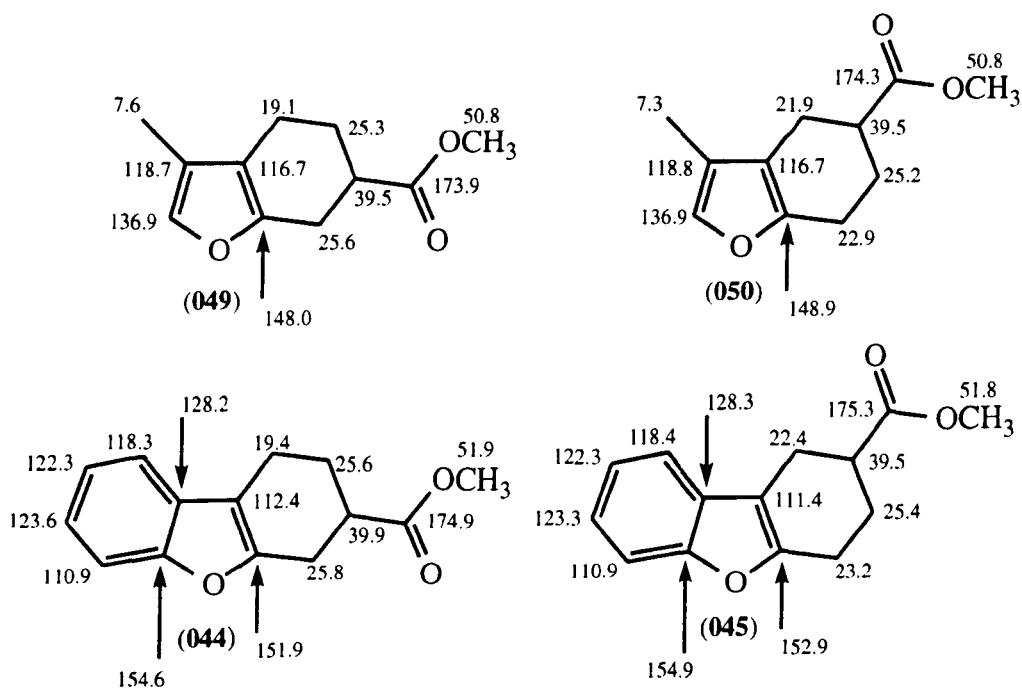

(Scheme 19)

The regioselectivity of these reactions could be predicted by applying simple Frontier Molecular Orbital [FMO] considerations.<sup>145</sup> Thus, one could assume that the Highest Occupied Molecular Orbital [HOMO] of the benzofuran 2,3-quinodimethane (**012**) is similar to that of butadiene. But, the oxygen substituent on the 2-position can be thought of as affecting the  $\pi$ -bond to which it is attached more than it influences the other  $\pi$ -bond. Then the HOMO of the



quinodimethane is made by mixing components from both butadiene and an allyl anion. The polarity and size of the FMO for the quinodimethane are therefore represented by **(051)**. Similarly, the Lowest Unoccupied Molecular Orbital [LUMO] for the dienophile, methyl vinyl ketone for example, can be represented by mixing coefficients of the LUMO of butadiene and the allyl cation **(052)**. The major FMO interaction is most likely to be the one between the diene's HOMO and the LUMO of the dienophile because this usually represents the smallest energy gap (*Scheme 20*).

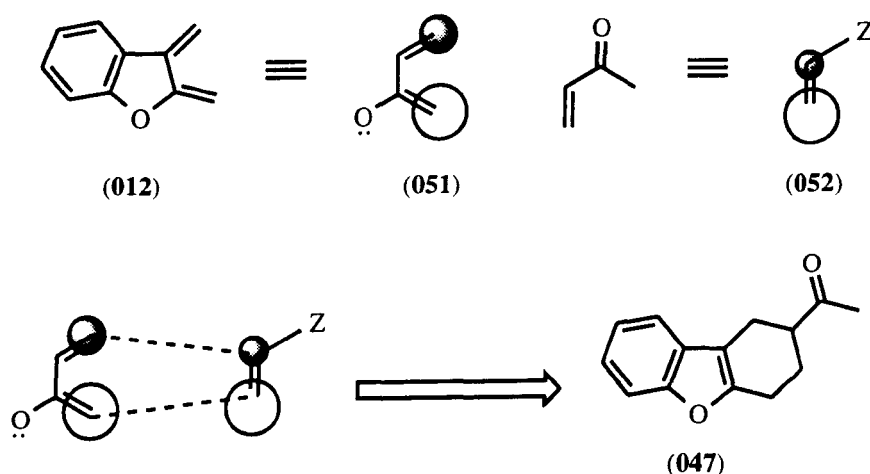

(*Scheme 20*)

To match and pair up the two we must remember that the relative *size* of the lobe, that is overlapping with another lobe, is the important factor in determining the energy change, hence the regioselectivity. Thus, pairing up *large-large* and *small-small* lobes, this gives the 3-substituted isomer **(047)** and not the observed major, 2-position isomer **(046)**. The problem is caused by not taking into account the effect of the phenyl group on the diene's  $\pi$ -system in our calculation of **(051)**. The ability of the oxygen substituent to affect both  $\pi$ -bonds, one directly and the other *via* the aromatic system, makes the relative sizes of the lobes on our diene model **(051)** difficult to estimate. The observed regiochemistry may also be caused by a reverse electron demand Diels-Alder reaction. Here the LUMO of the diene has the coefficients reversed to that shown on **(051)** and hence would give rise to the opposite regiochemistry.

It has been suggested that the species such as diene (**012**) could have considerable diradical character.<sup>128</sup> Indeed, as mentioned beforehand, such a formulation is indicated by the isolation of the [4+4] dimer. Trahanovsky *et al.*<sup>112, 128</sup> have put forward a convincing argument for the involvement of a diradical mechanism in the dimerisation of furan-2,3-quinodimethanes, which explains the complete regioselectivity of this reaction. These workers proposed that initial dimerisation of the quinodimethane could give three possible diradical intermediates (**053**, **054** and **055**) (*Scheme 21*).

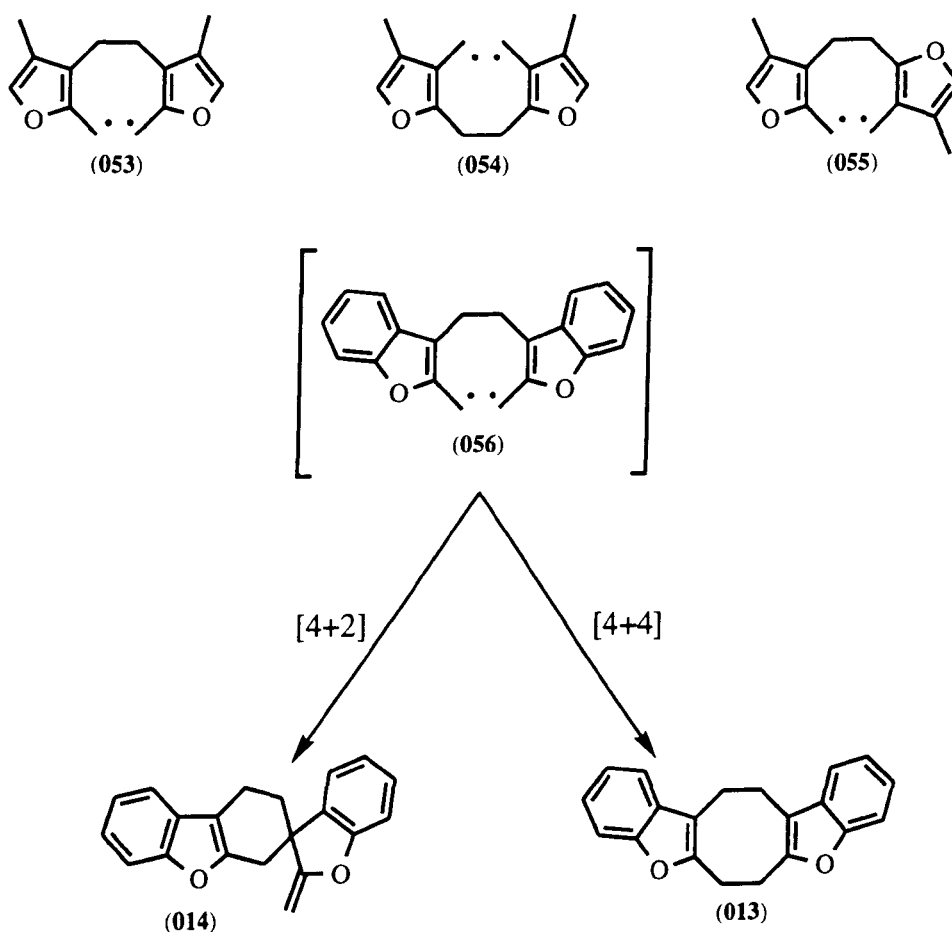

(*Scheme 21*)

Evidently, recombination of (**053**) or (**054**) would give the observed "head to head" dimer, whereas intermediate (**055**) would lead to a 'head to tail' dimer. The (**053**) diradical would be more resonance stabilised than the diradicals (**054** and **055**) since more canonical forms are available to it. A recent kinetic

study<sup>146</sup> has confirmed that this dimerisation occurs *via* a two step process. The dimerisation of benzofuran-2,3-quinodimethane is more difficult to explain in terms of diradical intermediates. Using the above reasoning, Trahanovsky and Chou<sup>106</sup> proposed that structure (056) would be the most stable diradical. Recombination of the above intermediate then occurs in two ways which results in the formation of both [4+4] and the [4+2] dimeric compounds. This is in contrast to the furan case where only the [4+4] adduct is formed. A satisfactory explanation has yet to be found to explain the divergence in these dimerisation pathways. Recent studies using flow NMR techniques<sup>147</sup> are consistent with earlier theoretical calculations in suggesting that intermediates such as (012) do exist, at least predominantly, in singlet ground states with the structure indicated, at least in the case of *ortho*-quinodimethanes derived from benzene and naphthalenes.

However, an alternative mechanism could be operative in this present method of generating the intermediate. It may be that the initial attack by fluoride results in Michael addition of the now nucleophilic 3-methylene carbon to the "dienophile" ; the cyclization would then be completed by intramolecular nucleophilic displacement of the acetate group. Partial participation by this mechanism could account for the existence of the other regioisomers.

Reaction of the quinodimethane with acrylonitrile gave the most selective regiochemical outcome of all the dienophiles used. The major 2-isomer (048) was formed in a 7:1 preference over the 3-position (049), based on <sup>13</sup>C spectral data. Again the ease at which excess diene could be removed led to an extremely good 93% yield of the adducts.

Attempts were then made to trap with the poor dienophile cyclohexene because benzenoid quinodimethanes have been reported<sup>32-3,54</sup> to participate in cycloadditions when generated in cyclic olefinic solvents.<sup>148-9</sup> These failed at all temperatures from -4°C to 80°C, even when the diene was present as a co-solvent in the reaction. The same result arose when the hetero dienophiles, benzaldehyde and acetone were used. All these reactions generated good yields of the dimers (013 and 014) in similar ratios to those previously indicated.

It was then decided that the reaction time could be improved upon by amending the leaving group. The most versatile leaving group is that of a tetra-alkyl ammonium salt and due to its polar nature, it is more likely to be compatible with the rest of the reaction components. The first two steps of our planned route to this adapted quinodimethane precursor are shown in *scheme 22*. The reaction of methylbenzofuran acid (**018**), oxalyl chloride in benzene and dimethyl formamide [DMF] as catalytic agent, readily led to the required acid chloride.<sup>150</sup> Displacement with dimethylamine subsequently gave the required amide (**057**) in an 87% yield. We then attempted what we thought was the simple metallation of this amide and quenching with TIPS-chloride. However, our endeavours to do this using LDA at -78°C under the previous conditions failed.

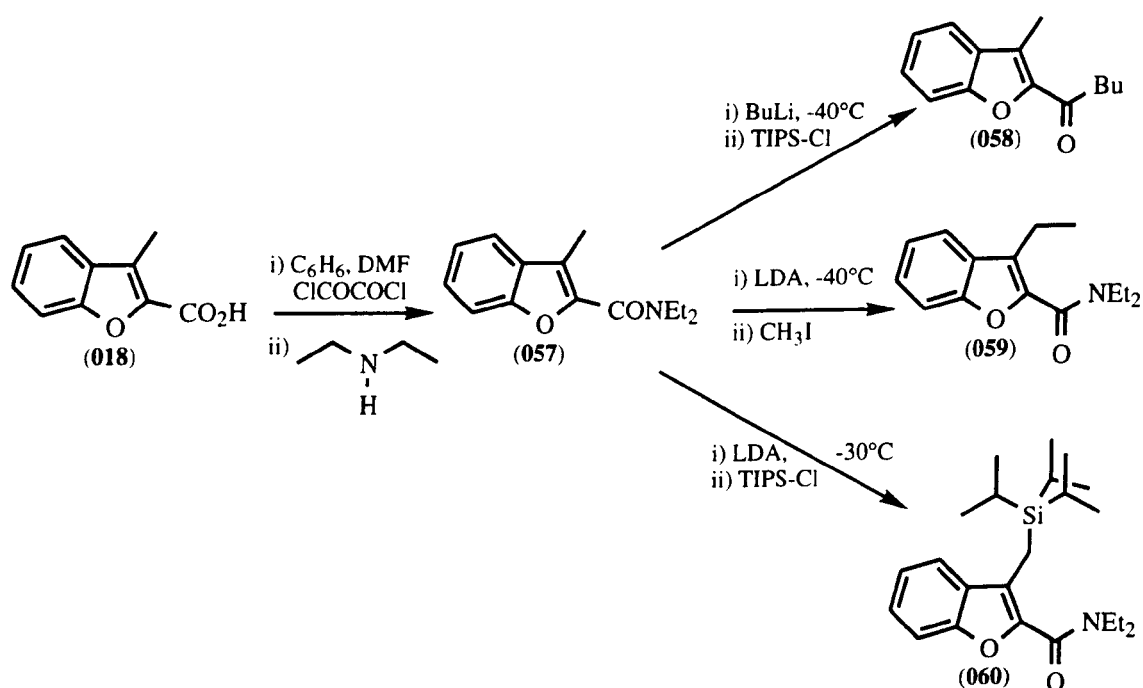

(Scheme 22)

We knew from prior work<sup>131</sup> that the acid dianion (**016b**) could be generated using *n*-butyl lithium, so we attempted metallation of the amide with this base at all temperatures from  $-78^\circ\text{C}$  to  $30^\circ\text{C}$ . This provided a complex clutter of products at the lower temperatures and the product (**058**) at higher ones,

presumably formed by a simple nucleophilic displacement reaction between the amide group and the butyl anion ( $M^+ = 216$ ). We returned to the more hindered LDA base and tried trapping at a similar range of temperatures, this time using methyl iodide as electrophile. The correct addition product (**059**) was then obtained, but only when the amide in a tetrahydrofuran solution was added to the LDA and not *vice versa*, at a temperature of around  $-30^\circ\text{C}$ . What became apparent from the  $^1\text{H}$  400 MHz NMR of this adduct (**059**) was that the ethyl functions were unresolved, presumably due to hindered rotation around the amide linkage. However, raising the temperature of the spectrometer's probe resolved these signals into the characteristic quartet and triplet signals ( $J = 7.6\text{Hz}$ ). This problem was to plague the rest of this work making interpretation of NMR data confusing. Having established the correct conditions by which to obtain successful coupling, we then attempted trapping with TIPS-chloride. Thus, 1.2 equivalents of LDA at  $-30^\circ\text{C}$  was treated with a tetrahydrofuran solution of the amide.

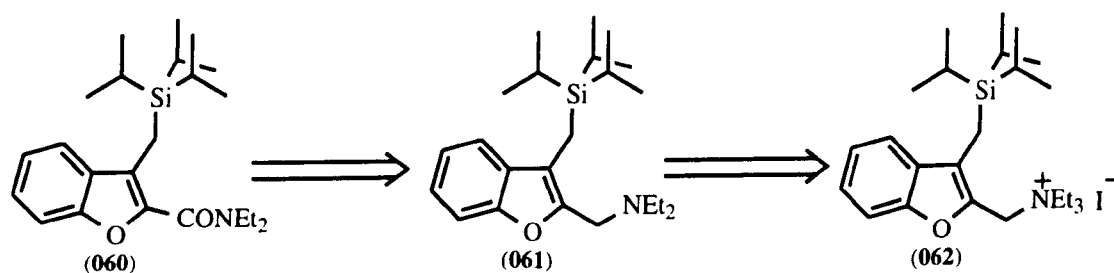

(Scheme 23)

This generated an exquisite, emerald green anion. Quenching with TIPS-chloride and stirring at this temperature for 8-10 hr gave the silylated amide (**060**) in an unoptimized 53% yield. The next stage was to be reduction to the corresponding amine<sup>151</sup> (**061**) and assembly of the ammonium salt (**062**) (Scheme 23). Unfortunately, several preliminary reactions using lithium aluminium hydride in refluxing tetrahydrofuran failed to produce the amine although it should be possible to accomplish this step with either borane<sup>152</sup> or

the novel trichlorosilane method.<sup>153</sup> This route was therefore relinquished so as to concentrate on the intramolecular version of this work.

### e) Intramolecular reactions of benzofuran-2,3-quinodimethane

We then focused our attention to the intramolecular cyclization which is more entropically favoured than the intermolecular equivalent. Using a substituted benzofuran ring as the model, it seemed possible that an intramolecular cyclization based on the already successful intermolecular variant could be performed by utilising an *in situ* generated quinodimethane moiety (Scheme 24).

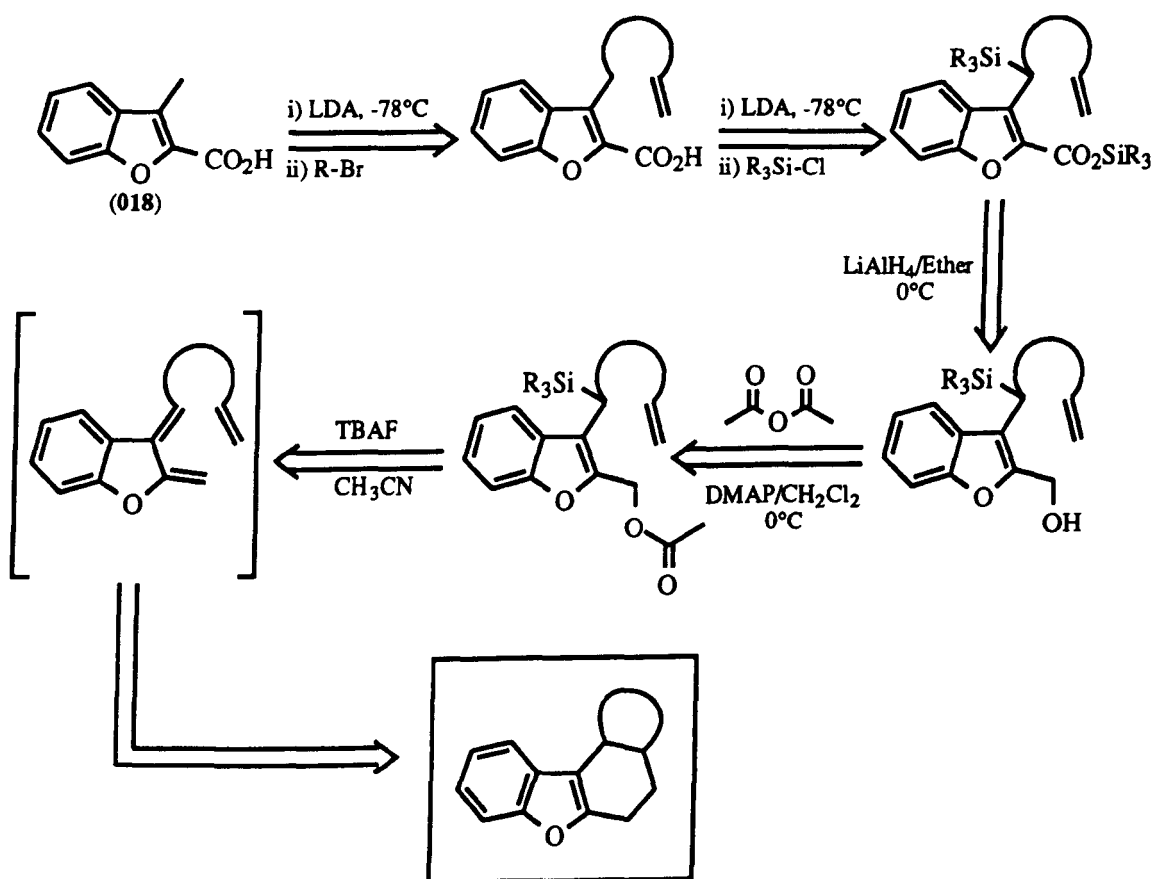

(Scheme 24)

Alkylation of the dianion from acid (018) with allyl bromide routinely provided the butenyl-substituted acid (063).<sup>131</sup> Treatment of this acid with LDA at -78°C gave

a reddish-orange solution, indicative of the formation of the dianion (**064**). However, subsequent addition of TIPS-chloride followed by treatment with lithium aluminium hydride gave a complex mixture which resisted chromatographic separation (*Scheme 25*).

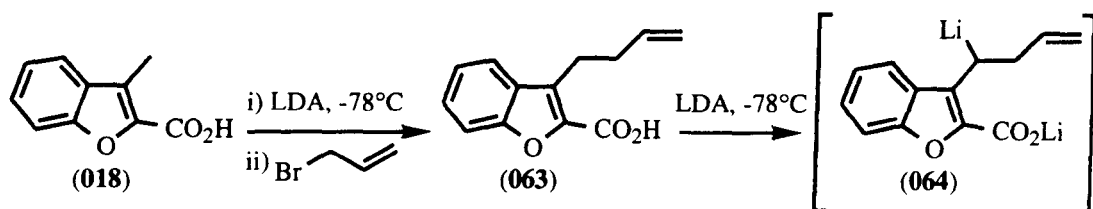

(*Scheme 25*)

No evidence was found to indicate that the desired silyl alcohol, or even the desilylated reduction product, had been formed in this reaction. This route had previously come under scrutiny by Cornwall<sup>134</sup> who had used chlorotrimethylsilane as silylating vehicle and lithium aluminium hydride as reducing agent (*Scheme 26*).

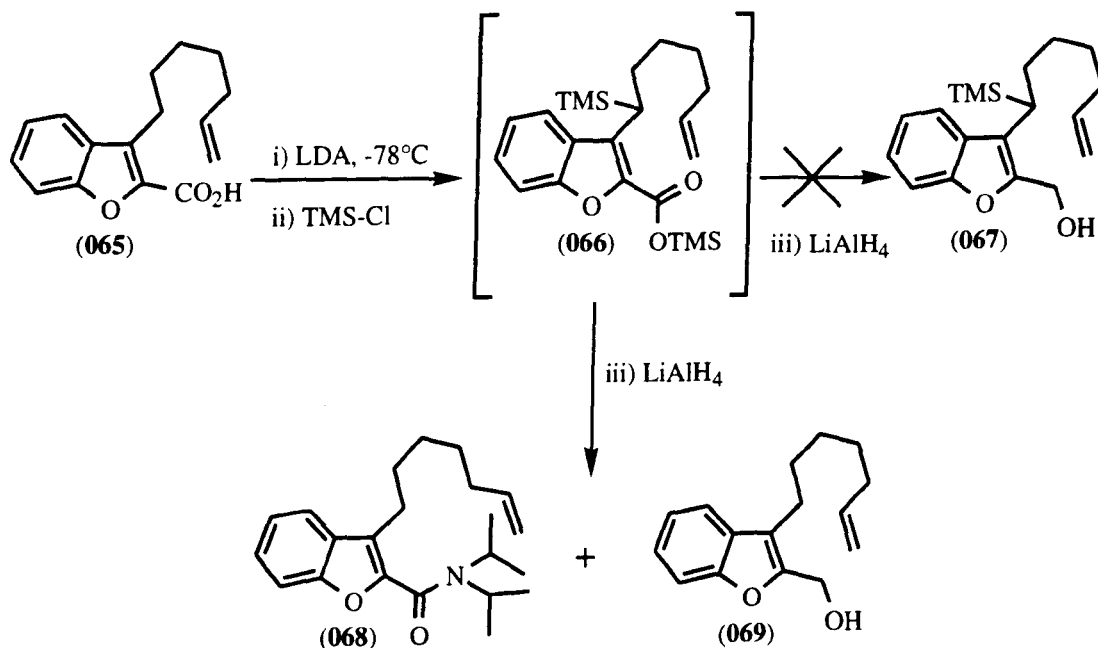

(*Scheme 26*)

He had come across a similar outcome when using the hexenyl substituted acid (**065**),<sup>154</sup> but was able to separate some compounds. Although there was no

sign of the silyl alcohol (**067**), chromatography of the crude mixture resulted in the isolation of the benzofuran amide (**068**) along with the desilylated alcohol (**069**). The unexpected amide could conceivably be formed from the intermediate silyl ester (**066**) by amide ester exchange with residual diisopropylamine, followed by desilylation. As this amidation has not been observed under similar conditions in the case of the unsubstituted benzofuran (**033**) and furan silyl esters (**021**), he believed that a different mechanism was in operation. The cleavage of the silyl ester (**066**) by a [1.4]-elimination process would lead to an  $\alpha$ -oxoquinodimethane (**070**).

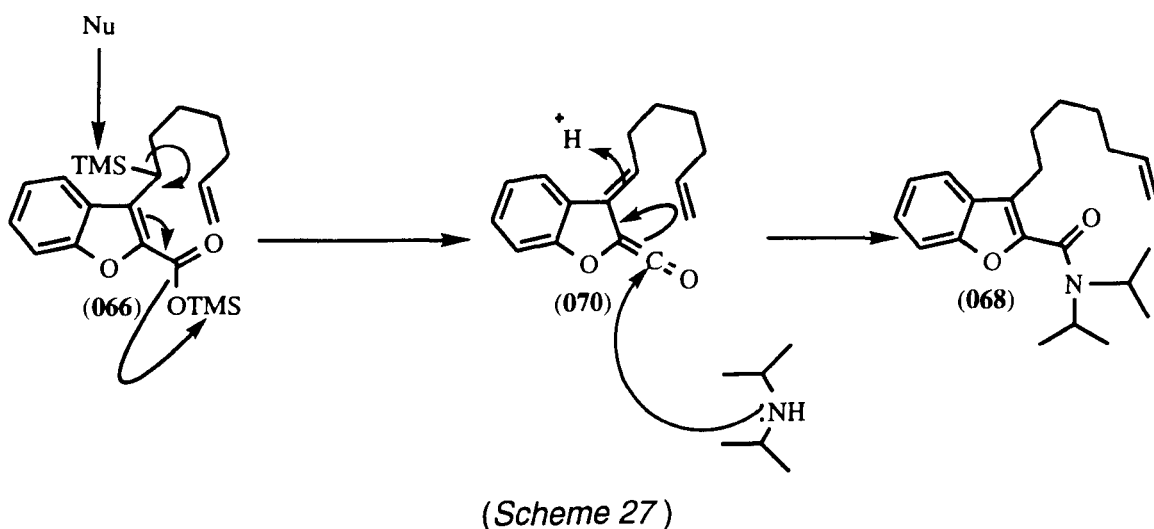

Regioselective addition of diisopropylamine to the intermediate completes the conversion to the amide (Scheme 27).<sup>134</sup>

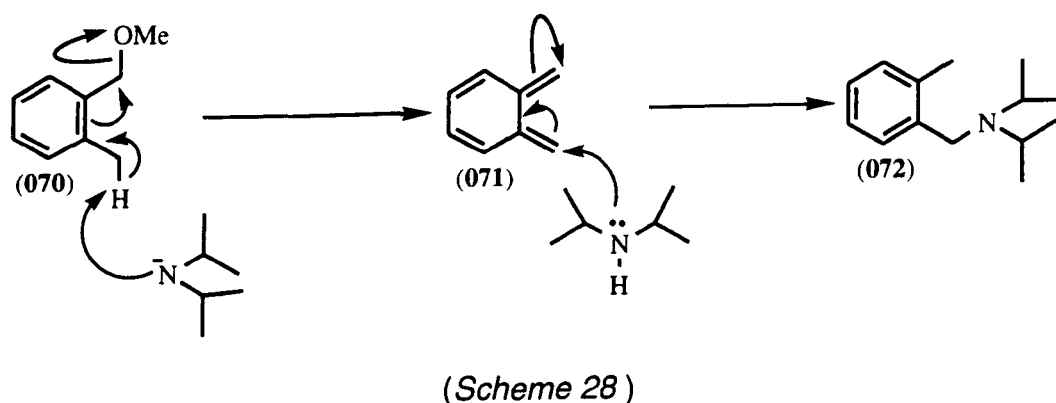

A similar mechanism has been proposed by Rickborn *et al.*<sup>54</sup> to explain the



conversion of the *ortho*-methylbenzyl ether (**070**) to the *ortho*-methylbenzylamine derivative (**072**) (*Scheme 28*).

Further work on this substituted benzofuran consisted of trying to condense the dianion with the reactive electrophile methyl iodide. Failure to achieve this elementary step spelled the end for this particular route.

### f) Reactions of 2, 4-dimethyloxazole-5-carboxylic acid and 2, 4-dimethylthiazole-5-carboxylic acid (019 and 020)

Because of our interest in the preparation of annelated azole systems we required the generation of the novel anionic species (**075**), derived from the corresponding *ortho*-methyloxazole carboxylic acid or the analogous thiazole acid by a metallation procedure.

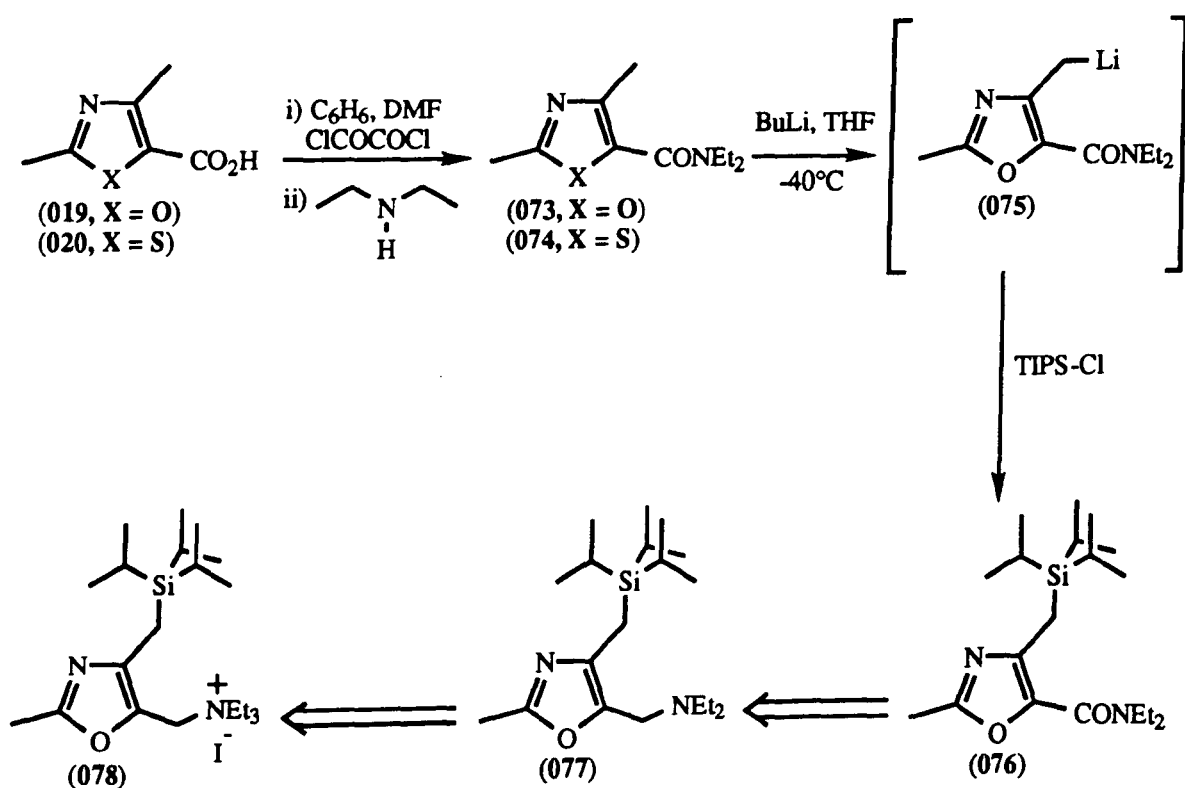

(*Scheme 30*)

Previous research<sup>134</sup> had shown that conversion of the acid functional group to a tertiary amide (**073** and **074**) promoted alkylation only on the 4-position methyl

group. Therefore, by applying a similar strategy as was used for 3-methylbenzofuran carboxylic acid, we could form the required precursors (**079 and 080**) and thus generate the quinodimethanes (**081 and 082**). These quinodimethanes have only recently been reported by Storr<sup>114</sup> who prepared them pyrolytically from their corresponding *para*-chlorobenzoate esters. Intermolecular cycloaddition of this quinodimethane with a suitable dienophile would provide an entry to linearly fused [5.6.n.] annelated azole systems, whilst intramolecular cycloaddition would access angularly fused [5.6.n.] annelated heteroaromatics.

Unfortunately, there was only a limited amount of time devoted to this particular route but the successful construction of the silyl amide (**076**) was achieved. However, conversion of this to the corresponding amine (**077**) using refluxing lithium aluminium hydride in tetrahydrofuran, as in the benzofuran amide (**060**) case, failed to occur.

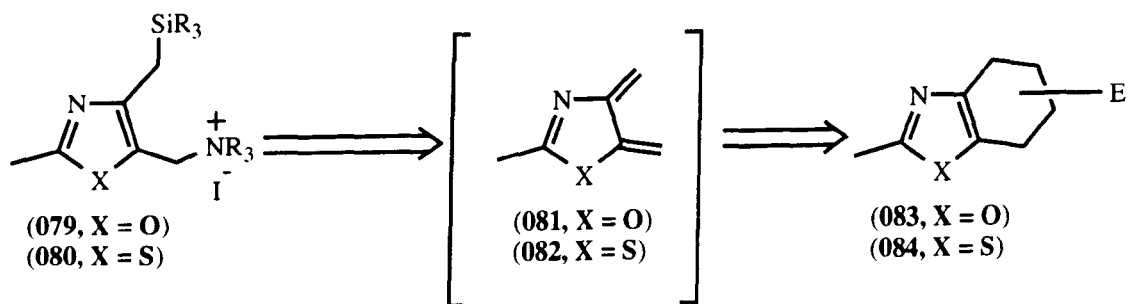

(Scheme 31)

Nevertheless, future perseverance with this work may well lead to a reliable route to these important heteroquinodimethanes and beyond.

.....O.....

# Modern strategies toward substituted tetrahydrofurans

- a) Natural Product history
- b) Electrophile induced cyclizations  
to substituted tetrahydrofurans
- c) Other routes to tetrahydrofurans

## Tetrahydrofurans

### a) Natural Product history

The monocarboxylic acid ionophores, such as those shown in *scheme 1*, are a large group of natural products commonly known as polyether antibiotics. They have attracted considerable attention<sup>155</sup> because of their ability to transport metal ions across lipid bilayers,<sup>155-6</sup> a property that is implicated in the biological action of the compounds.<sup>157</sup>

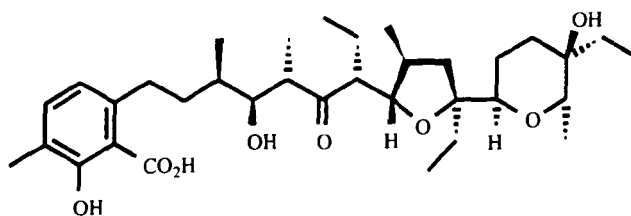
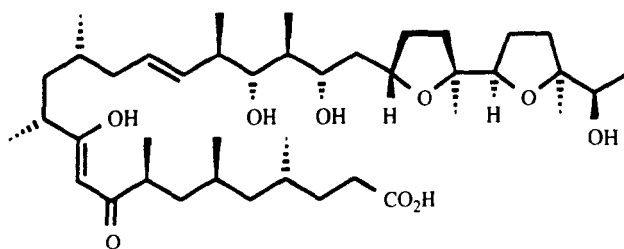
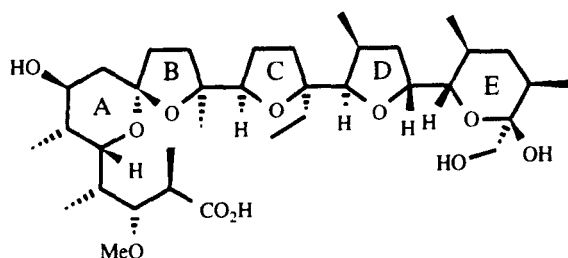

**Lasalocid A**

(*Scheme 1*)

They are antimicrobial agents,<sup>158</sup> they cause growth promotion in ruminants<sup>158</sup> and some are known to produce cardiovascular responses.<sup>159</sup> Several of the

polyether antibiotics are commercially important<sup>155</sup> and their value, as well as their elaborate structure, have stimulated the interest of organic chemists. The extreme complexity of the polyethers, however, presents a very formidable challenge for synthesis and only a few total syntheses<sup>160-166</sup> have been reported. These clearly represent significant advances in the development of organic chemistry. Construction of a polyether antibiotic is, to a large extent, an exercise in the preparation of substituted oxygen heterocycles. The framework of the molecules is dominated by the presence of 2,5-disubstituted tetrahydrofurans, substituted tetrahydropyrans and spiroketal systems.

As well as the polyether antibiotics, 2,5-disubstituted tetrahydrofurans are important structural sub-units found in a wide range of other natural products,

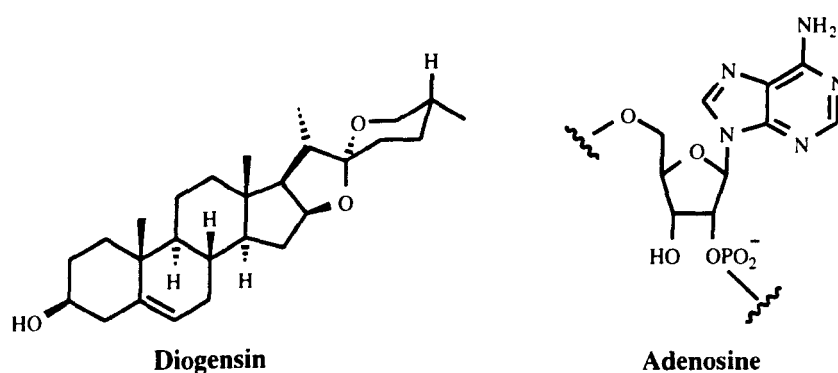

(Scheme 2)

including B<sub>12</sub> vitamins, steroids and ribo- and deoxyribonucleic acids<sup>167</sup> (Scheme 2). Therefore, the past decade has seen a great deal of effort injected into the development of efficient and stereocontrolled routes toward these key structural fragments, using the wide range of synthetic methods available.<sup>168-171</sup>

For our purposes the following review deals with the extensive modern approaches to tetrahydrofurans but will concentrate on examples that exhibit *cis* and *trans* 2,5-disubstitution. It is divided into two main sections, those methods which involve an electrophile induced cyclization, and the many other ones which do not.

## b) Electrophile induced cyclizations to substituted tetrahydrofurans

The functionalization of a double bond promoted by an electrophile is one of the most used reactions in organic synthesis. The term "cyclofunctionalization" was introduced by Clive<sup>172</sup> in 1977 to indicate a process where the addition of an electrophile to an alkene containing an internal nucleophile promotes a cyclization where a carbon of the double bond involved in the ring formation becomes attached to a group specifically chosen to allow further modifications. This approach has received growing interest, testified by the number of reports and excellent reviews<sup>168</sup> written on the subject.<sup>173, 174</sup> Significant applications to the chemistry of functionalized reduced furans and other heterocycles have been reported and the factors that affect the cyclization regiochemistry and diastereofacial selectivity towards an electrophile have been investigated.

Baldwin<sup>175</sup> has reported some rules on an empirical basis to predict the relative facility of ring-forming reactions. These rules are based on the trajectory of the reagent that attacks the tetrahedral, trigonal or digonal carbon atom leading to the ring closure reaction. Several factors appear to direct the regioselectivity toward 5-*exo* or 6-*endo* closures, but both tetrahedral and trigonal ring closures seem to proceed preferentially through the *exo*-modes under kinetic control. The kinetic or thermodynamic conditions utilized in the reaction are very important to determine the regiochemistry.<sup>169</sup> The structure of the starting material, e.g. the *E* or *Z* configuration of the double bond,<sup>176, 7</sup> or the configuration of the stereogenic centre in an  $\alpha$ - or  $\beta$ -position to the double bond,<sup>178</sup> strongly influence both the stereo- and regiochemistry. A number of electrophilic agents have been employed in order to effect ring closure and the nature of the electrophile seems to play an important role.<sup>179-182</sup> These cyclizations will now be discussed individually according to the electrophile present.

## Haloetherification

### 2,5-Tetrahydrofurans

This interesting route to tetrahydrofurans involves the cyclization between a hydroxy or an alkoxy group and an appropriately placed double bond, mediated by a halo-electrophile, more often than not iodine or bromine. Secondary  $\gamma,\delta$ -unsaturated alcohols that afford 2,5-disubstituted tetrahydrofurans preferentially give the *cis*-2,5- relationship under kinetic conditions ( $I_2/NaHCO_3$ ) and the *trans*-2,5-relationship under thermodynamic conditions ( $I_2/MeCN$ ) (Scheme 3).

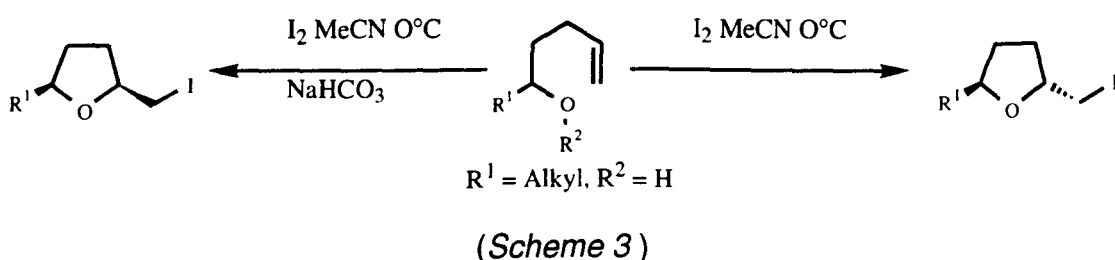

Opposite results occur when unsaturated ethers are cyclized; in fact under thermodynamic conditions the major product is the *cis*-2,5-disubstituted furan.

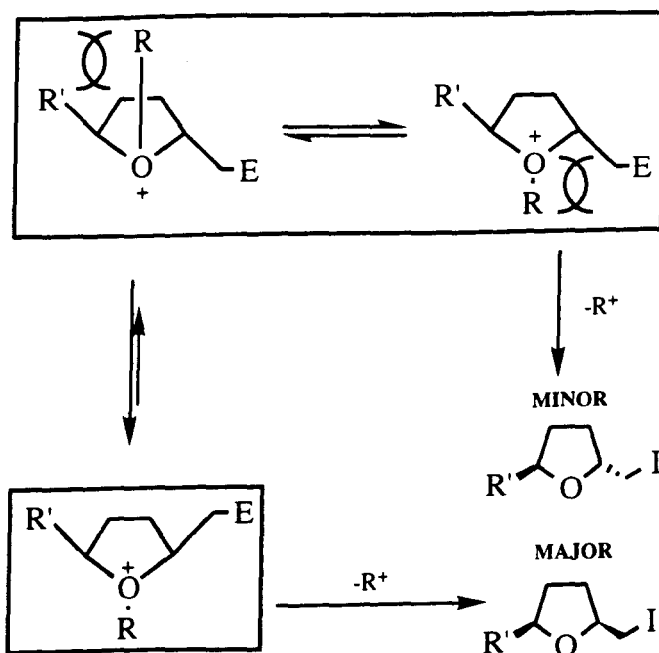

(Scheme 4)

This field of study has been developed by Bartlett<sup>183</sup> and rationalised in terms of 1,2- and 1,5-strain, due to the hindrance of the ethereal group (*Scheme 4*). In this context, the nature of the alkyl group plays an important role and the most suitable derivatives are the benzyl ones, due to their electrofugal capacities. The cleavage of the C-O bond takes place on a reasonable time scale so that the equilibration of the reaction mixture can be obtained.

### 2.3-Tetrahydrofurans

The pronounced stereochemical 2,3-*cis* preference in cyclizations directed by an allylic OH group in the synthesis of 5-membered rings under kinetic conditions is in agreement with the proposed reactivity model shown in *scheme 5*. In fact, the electrophilic attack is preferred on the OH-in-plane conformer from the face of the  $\pi$  bond *syn* to allylic hydrogen, when  $R' = H$ . If  $R' \neq H$ , a reversed facial stereo-selectivity is observed.<sup>184</sup>

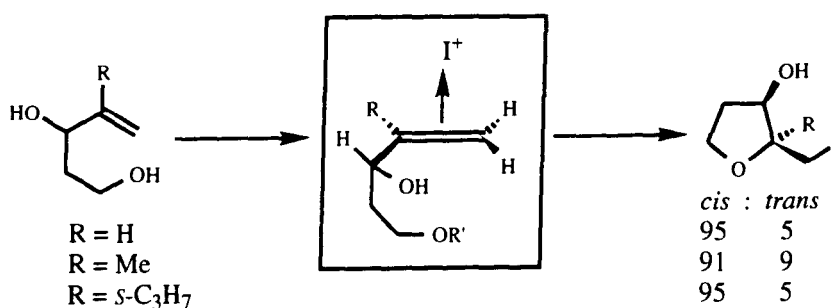

(*Scheme 5*)

A systematic investigation into the iodoetherification of 4-pentene-1,3-diol and its mono-substituted derivatives has been reported by Yoshida *et al.*<sup>185</sup> Thus, intramolecular iodoetherification of 4-pentene-1,3-diol under kinetic control proceeds with a diastereoselectivity of 95% providing *cis*-2-iodomethyl-3-hydroxytetrahydrofuran. Stereoselectivity in the formation of *cis*-2,3-disubstituted tetrahydrofurans is high under all the conditions employed and this method constitutes a general route to *cis*-3-hydroxy-2-iodomethyltetrahydrofurans. The interest in this approach depends on the possibility of introducing a 2,3-*cis*-relationship as this is frequently observed in naturally occurring polyether antibiotics.



### 2.3.5-Tetrahydrofurans

Yoshida and his colleagues then extended this iodoetherification reaction to include 1,2 and 4-monosubstituted derivatives to produce the corresponding 2,3,5-tetrahydrofurans, generating similar diastereoselectivity. For example, the *syn* 1-substituted-1,3-diols shown in *scheme 6* were treated under the conditions described above to produce tetrahydrofurans in good yield. Complete conversion to the respective tetrahydrofuran was achieved within 18 hr; however, the corresponding *anti*-isomers were completely unreactive under these same conditions. Nevertheless, they did react when the temperature was increased by some 25°C.

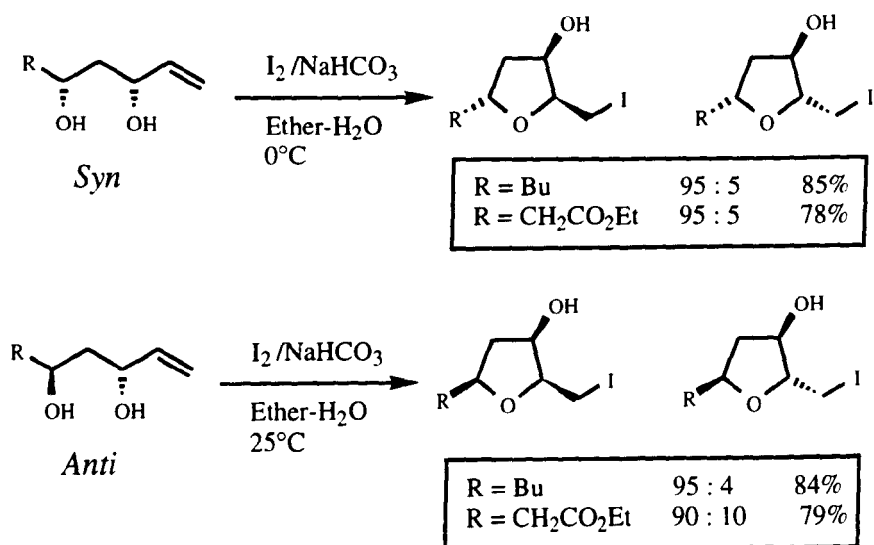

(Scheme 6)

Using this phenomenon, the Japanese workers<sup>178</sup> were able to separately conduct the reaction of each diastereoisomer using a mixture of diols ( *Scheme 7*). Thus, when a mixture of *syn* and *anti* diols [50:50] was reacted with iodine at 0°C for 12 hr, the shown 2-iodomethyl-3-hydroxy-5-phenyltetrahydrofuran was obtained as the sole product.

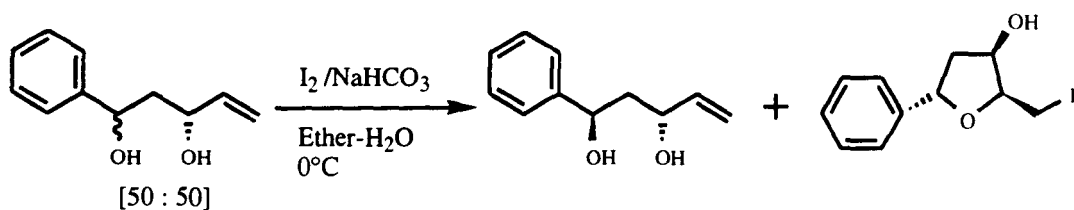

(Scheme 7)

The *anti* diol was recovered quantitatively and independently treated under similar reaction conditions at the elevated temperature of 25°C to give largely the all *cis* tetrahydrofuran.

The diastereoselectivity and the dramatic difference in reactivity shown with the *syn*- and *anti*-diols was explained in terms of a bicyclic transition state, stabilised by intramolecular hydrogen bonding. Analysis of the proposed intermediate immediately reveals that the *anti*-substituents suffer relatively more non-bonded interactions than the corresponding *syn*-substituents (Scheme 8).

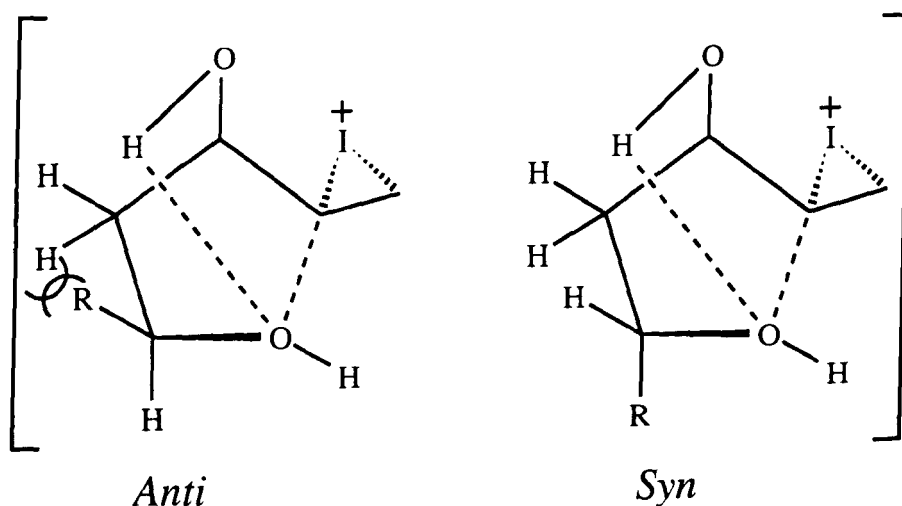

(Scheme 8)

The transition state involving the *anti*-diols are therefore energetically less favourable and hence, show the lower reactivity of the two isomers.

The configuration of the double bond also dramatically alters the stereoselectivity in this reaction. In fact, starting from the *Z*-*syn*-diol, the *trans*-2,3-tetrahydrofuran becomes the main product (Scheme 9).

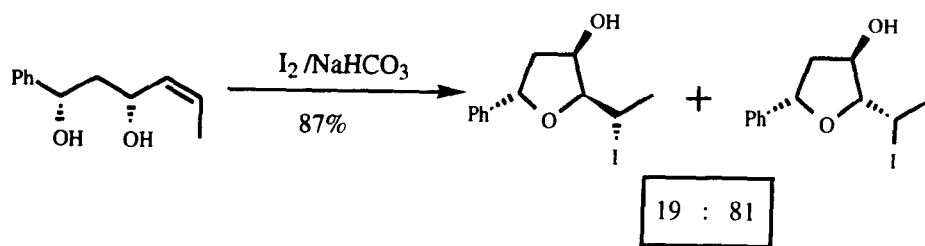

(Scheme 9)

This reversed stereochemistry has been rationalized on the basis of the fact that the *cis*-substituent destabilizes the OH-in-plane conformer, making the conformer with the hydrogen in plane energetically more accessible. It is worth mentioning that the *Z*- and *E*-anti-diol configuration favours a 6-*endo* closure (Scheme 10).<sup>185-187</sup>

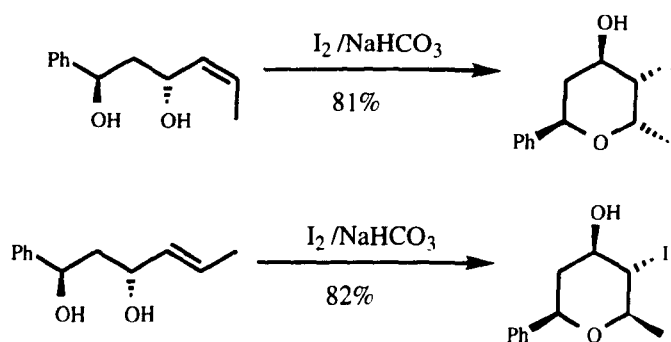

(Scheme 10)

### Phenylselenoetherification

Cyclizations involving the phenylselenenyl cation are considered one of the most versatile, due to the diverse functionalization possibilities of this group.<sup>188</sup> Perhaps the most important and useful characteristic of the phenylselenoetherification reaction is its unique and rather complementary nature to the iodoetherification reaction in the synthesis of saturated and unsaturated cyclic ethers by reductive and oxidative means.<sup>189</sup> In comparing these two methodologies, two points should be emphasized. First, the

introduction of the double bond proceeds under much milder conditions in the case of the selenium procedure and second the *syn*-elimination of the selenoxide occurs selectively away from the oxygen as opposed to the usual toward-oxygen, base-induced elimination of hydrogen iodide from the iodoethers. Thus the methodology represents an excellent and selective procedure for the synthesis of allylic ethers.<sup>189</sup> The usual procedure involves oxidation with O<sub>3</sub>, NaIO<sub>4</sub> and peroxides.<sup>190</sup> Oxyselenylation of olefins may also be performed by electrochemical oxidation of these substrates in the presence of diphenyl diselenide and halides as mediators in water-acetonitrile medium.<sup>191-194</sup> Mihailovic<sup>195</sup> reported a transformation of olefinic alcohols to the corresponding cyclic phenylselenoethers by electrochemical oxidation. When alkenols, such as 4-penten-1-ol and its various substituted derivatives, were electrolysed in the presence of diphenyl diselenide, in cold methylene chloride solution, phenylselenoethers were obtained in good to excellent yields (*Scheme 11*). In the case of alkenols with a terminally monosubstituted olefinic double bond of the *Z*-type, such as *Z*-4-hexen-1-ol, only the five-membered cyclic phenylselenoether were obtained, whereas the *E*-isomer gave exclusively the six-membered cyclic ether.

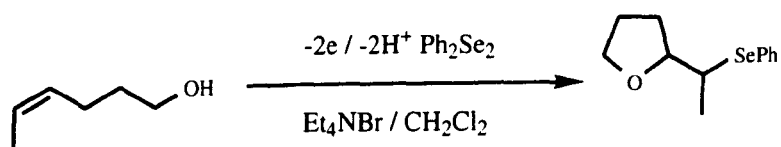

(*Scheme 11*)

The stereochemistry of these products was not investigated by the workers. Mild conditions, simple equipment and inexpensive reagents are the major advantages of this reaction.

### 2.3.5-Tetrahydrofurans

In 1991, Kang<sup>196</sup> reported a useful stereocontrolled synthesis of *cis*-2,5-disubstituted tetrahydrofurans. Triethylsilyl ethers of *trans*-4-phenyl-3-buten-1-ol were cyclized using phenylselenenyl chloride in the presence of potassium carbonate in acetonitrile. *Cis* to *trans* isomer ratios were greater than 100 : 1 and yields as high as 95%. The triethylsilyl group [TES] was found to be the most suitable oxygen-protecting group since, according to Bartlett,<sup>183</sup> leaving ability and bulkiness giving rise to *cis* stereoselectivity (Scheme 12).

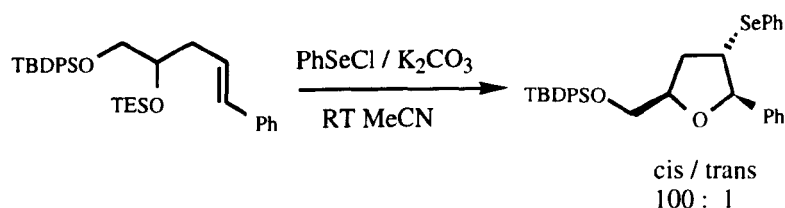

(Scheme 12)

These workers<sup>197</sup> also reported a stereoselective synthesis of *trans*-2,5-disubstituted tetrahydrofurans from *trans*-4-phenyl-3-buten-1-ol derivatives. This time cyclization was accomplished using phenylselenenyl chloride with zinc bromide in DME at -55°C (Scheme 13). Use of phenylselenenyl chloride alone, without the Lewis acid catalyst, gave poor chemical conversion.

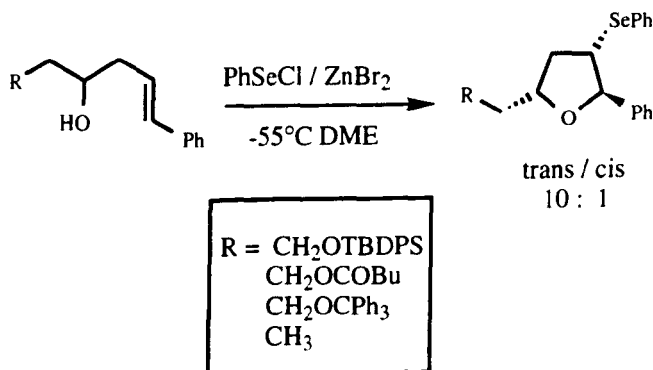

(Scheme 13)

Typically the stereochemical outcomes were >10 to 1 in favour of the *trans* isomer, with yields reaching beyond 90%.

Despite extensive research efforts directed toward the stereocontrolled production of substituted tetrahydrofurans from olefinic precursors,<sup>198</sup> few studies have addressed the feasibility of directed ring closures of homoallylic alcohols.<sup>199</sup> This is largely because *endo*-cyclization modes are generally considered to be energetically unfavourable.<sup>175</sup> But, recently Mihelich<sup>200</sup> has reported the stereoselective synthesis of tri- and tetra-substituted tetrahydrofurans based on such homoallylic alcohols (*Scheme 14*). Ring opening of epoxy alcohols<sup>201, 202</sup> with sodium phenyl selenide<sup>202</sup> afforded the corresponding selenyl diols, which, on treatment with perchloric acid in tetrahydrofuran, produced tetrahydrofurans in good yield.

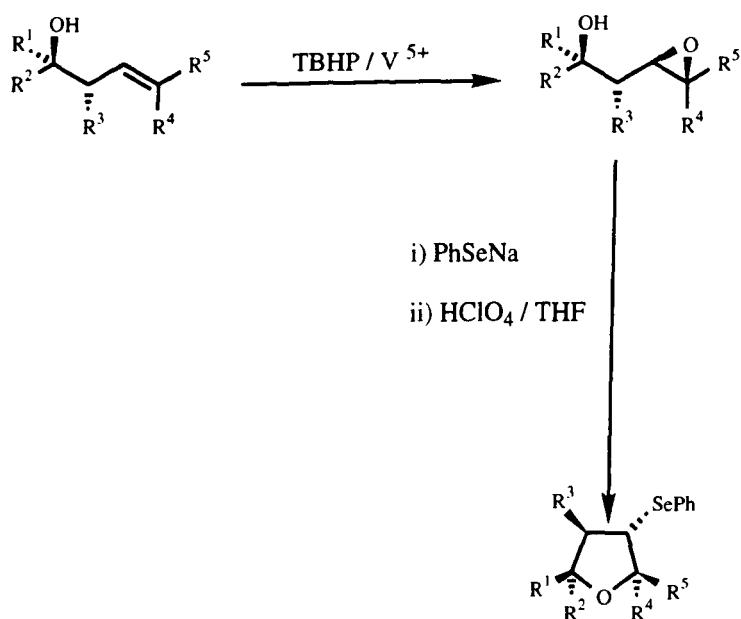

(*Scheme 14*)

As well as tri-substituted rings, an additional substituent at R<sup>3</sup> allowed access to tetra-substituted tetrahydrofurans; these were obtained as essentially single isomers, again in excellent yield, *scheme 15*. This constitutes the first report of the stereoselective formation and ring closure of acyclic selenyl diols to highly substituted tetrahydrofurans.

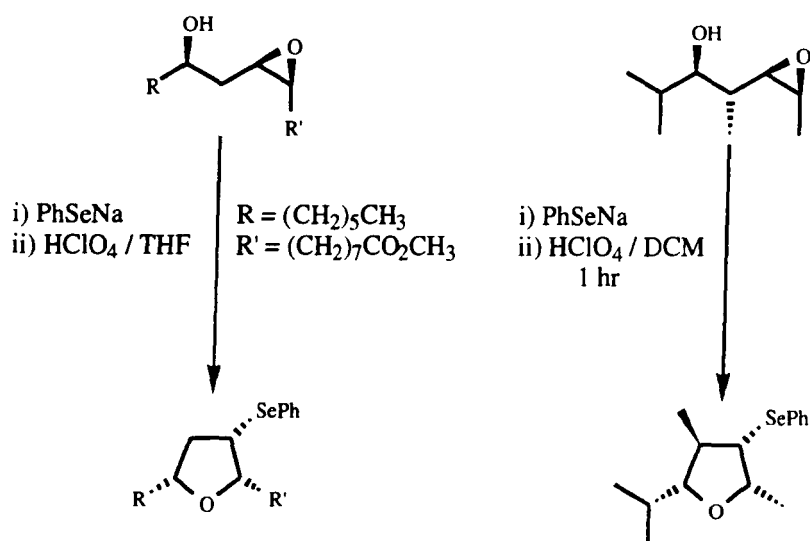

(Scheme 15)

Murata<sup>203</sup> has been able to achieve the stereoselective formation of several substituted tetrahydrofurans by employing the electrophile, benzeneselenenyl triflate; this work demonstrates the potential of this useful reagent. This so called 'super' electrophile<sup>204</sup> has some important advantages over the more typically employed benzeneselenenyl chloride: better reactivity, improved selectivity and the possible addition of the counter ion is avoided. These workers reacted this reagent with a range of substituted 5-hydroxyalkenes in dichloromethane at -78°, to give the *exo*-cyclized tetrahydrofurans displayed in *scheme 16*.

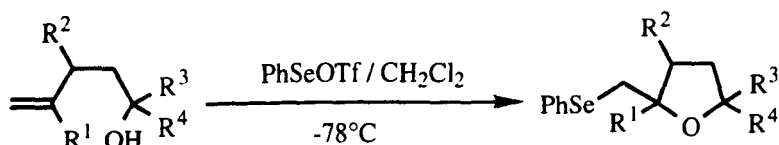

R <sup>1</sup>	R <sup>2</sup>	R <sup>3</sup>	R <sup>4</sup>	Yield	Trans/Cis
H	Me	H	H	79	4:1
H	H	Me	H	80	1:1
Me	H	Me	H	63	1:1
Me	H	Me	Me	87	1:1

(Scheme 16)

Further work<sup>205</sup> using *cis* and *trans*-2-allylcyclohexanols gave the corresponding fused tetrahydrofurans which are key components to many marine natural polyethers (Scheme 17). Although in the case of the *trans* substrate 6-*endo*-cyclization under thermodynamic control predominated, so the addition of pyridine was needed to quench the equilibrium and form the kinetic furan product.

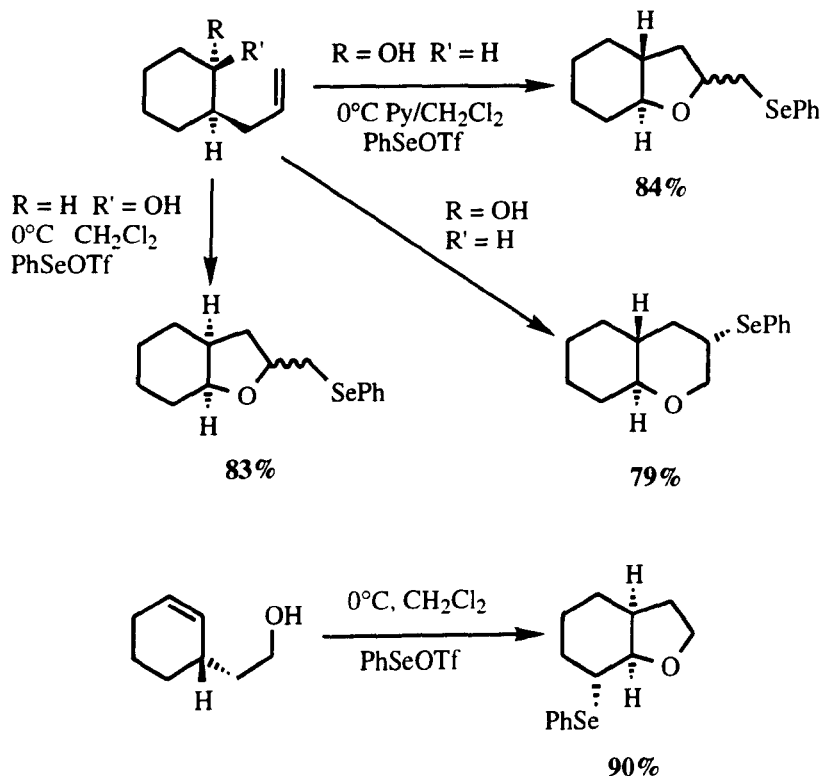

(Scheme 17)

Also, reaction of 2-cyclohexen-3-yl-ethanol with benzeneselenyl triflate gave *cis*-5-phenylseleno-7-oxabicyclo[4.3.0]nonane in greater than 90% yield.

#### Hydroxyl capture of an episulphonium ion

The stereospecific synthesis of cyclic ethers by hydroxyl capture of an episulphonium ion, during acid-catalysed cyclization of phenylthio alcohols constitutes a successful route to a variety of substituted tetrahydrofurans.<sup>206-211</sup>



Tuladhar<sup>212</sup> reported a simple tetrahydrofuran synthesis in which the alcohol, shown in *scheme 18*, was treated with a solution of benzenesulphenyl chloride in acetonitrile at 21°C followed by *N, N*-diisopropylethylamine. The initial formation of an episulphonium ion intermediate is followed by displacement by the internal oxygen nucleophile.

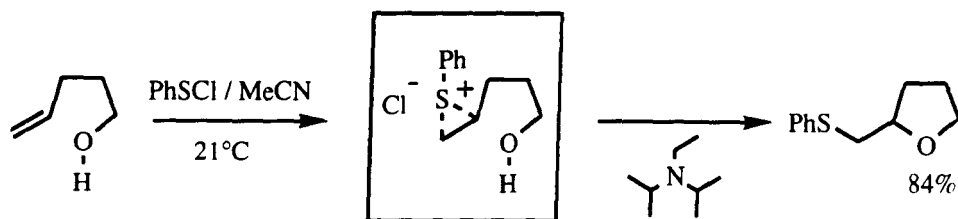

(Scheme 18)

The products arise *via* a preferred 5-*exo-tet* cyclization with the alternative 6-*endo-tet* mode of ring closure to the corresponding pyran not being observed.

Later Williams<sup>211</sup> reported a remarkably facile transformation of acyclic  $\beta$ -hydroxysulphide precursors to tetra-substituted tetrahydrofurans with complete stereospecificity. Thus, when the sulphide shown in *scheme 19* was treated with excess dimethylsulphate in dichloromethane at 0°C, a dehydration occurred, producing the single tetrahydrofuran isomer in 85% yield. The stereochemical outcome of the cyclization was found to occur with complete retention of configuration at each of the four asymmetric carbon centres.

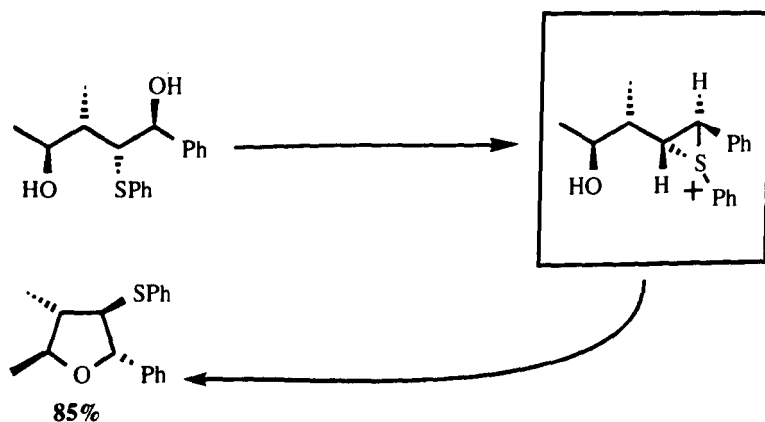

(Scheme 19)

The workers were able to assemble a wide series of tetrahydrofurans displaying a variety of different stereochemistries.<sup>211</sup>

Warren *et al*<sup>213</sup> has recently reported on the stereoelectronic factors which govern such episulphonium mediated cyclizations. These workers found that the hydroxyl group prefers to attack the more substituted end of the episulphonium ion *via* a loose  $S_N2$  transition state and that the ring size preference is  $5 > 6 > 4$ . Also, in accordance with the Thorpe-Ingold effect,<sup>214</sup> these reactions prefer to form the most highly substituted ring and, following Baldwin's rules,<sup>175, 215</sup> go through *6-endo* or *5-exo-tet* cyclization modes (*Scheme 20*).

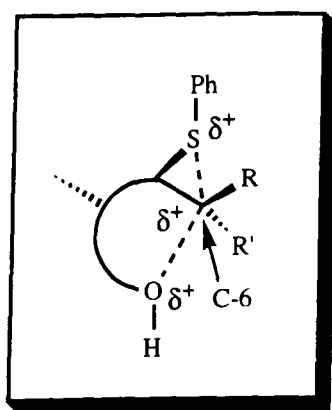

(*Scheme 20*)

Addition of two extra substituents at C-6 make a looser  $S_N2$  transition state possible and allows a partial positive charge to be supported at C-6.

### *Epoxidation-Cyclization*

Epoxidation methodology used in the synthesis of tetrahydrofurans has proved extremely valuable for several reasons. This approach has been utilised to complement the stereochemistry induced in iodo- and phenylseleno-etherification reactions.<sup>199</sup> For example, direct ring closure of a diol by iodoetherification affords a single diastereoisomeric product (*Scheme 21*). A

product displaying the inverted C-2 stereochemistry can be prepared by a two step procedure. Vanadium catalysed epoxidation<sup>216</sup> of an alkene proceeds with high diastereoselectivity to yield the corresponding oxide. A ratio of more than 20 to 1 in favour of the  $\beta$ -epoxide over the  $\alpha$ -isomer has been reported using this reagent. This was then cyclized to the desired 2,3,4-Syn substituted tetrahydrofuran, with boron trifluoride etherate.

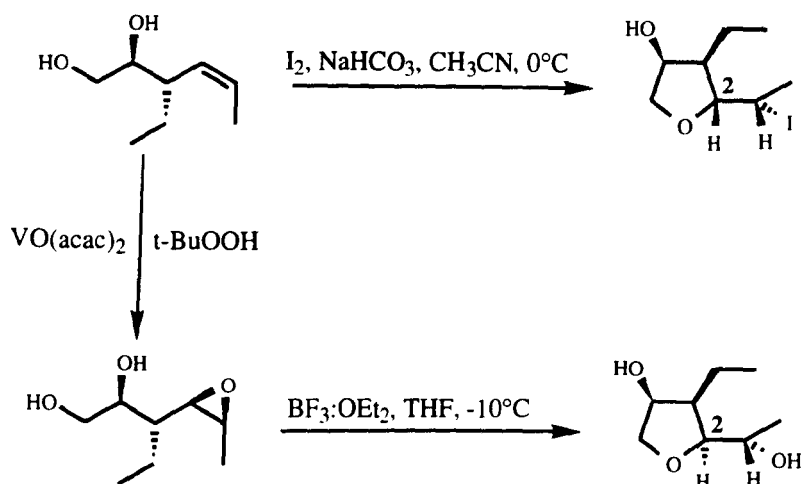

(Scheme 21)

Kishi<sup>161</sup> utilized these results in the first total synthesis of lasalocid A. An optically pure alcohol was converted into the epoxide by the above reagents. On treatment with acetic acid, the tetrahydrofuran was obtained in a 75% yield as an 8:1 mixture of stereoisomers with the expected major product being shown.<sup>217</sup> A second epoxidation again proceeded in the anticipated fashion<sup>217</sup> but the epoxide stereochemistry was the opposite to that required for lasalocid A synthesis. The desired epoxide had to be generated by a sequence of four additional steps, although later a more concise method was developed.<sup>218</sup> The new epoxide then afforded the *bis*-tetrahydrofuran unit in 45% yield. This compound represents the tetrahydrofuran ring (C-15 to C-18) and the precursor to the tetrahydrofuran ring (C-19 to C-22) of Lasalocid A with correct relative and absolute stereochemistry. Kishi<sup>161</sup> and co-workers subsequently transformed this fragment into the natural product (Scheme 22).

The asymmetric Sharpless epoxidation procedure<sup>219</sup> has been utilised in a similar fashion. This method, of course, has the added advantage of introducing chirality into the system, demonstrated in the synthesis of a fragment which corresponds to the right hand portion of ionomycin<sup>220</sup> (Scheme 23).

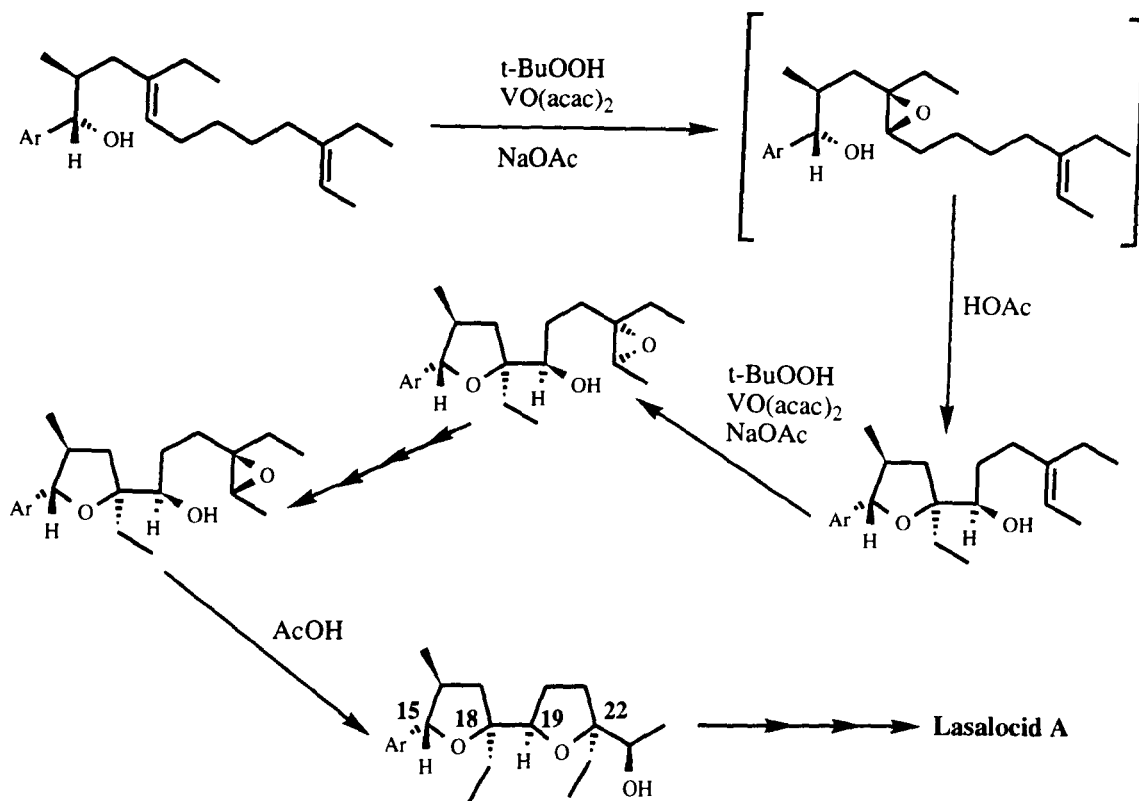

Asymmetric epoxidation<sup>219</sup> of the starting alkene gave predominantly the required phenylurethane, which was converted into the cyclic carbonate when treated with perchloric acid. Hydroxyl protection, base-catalysed hydrolysis of the acetate, and deprotection set the stage for a second asymmetric epoxidation. The intermediate epoxide was not isolated since Lewis acid-catalysed cyclization involving the free hydroxyl occurred spontaneously and the desired tetrahydrofuran was formed. Conventional methods were then used to convert this into the ionomycin fragment.

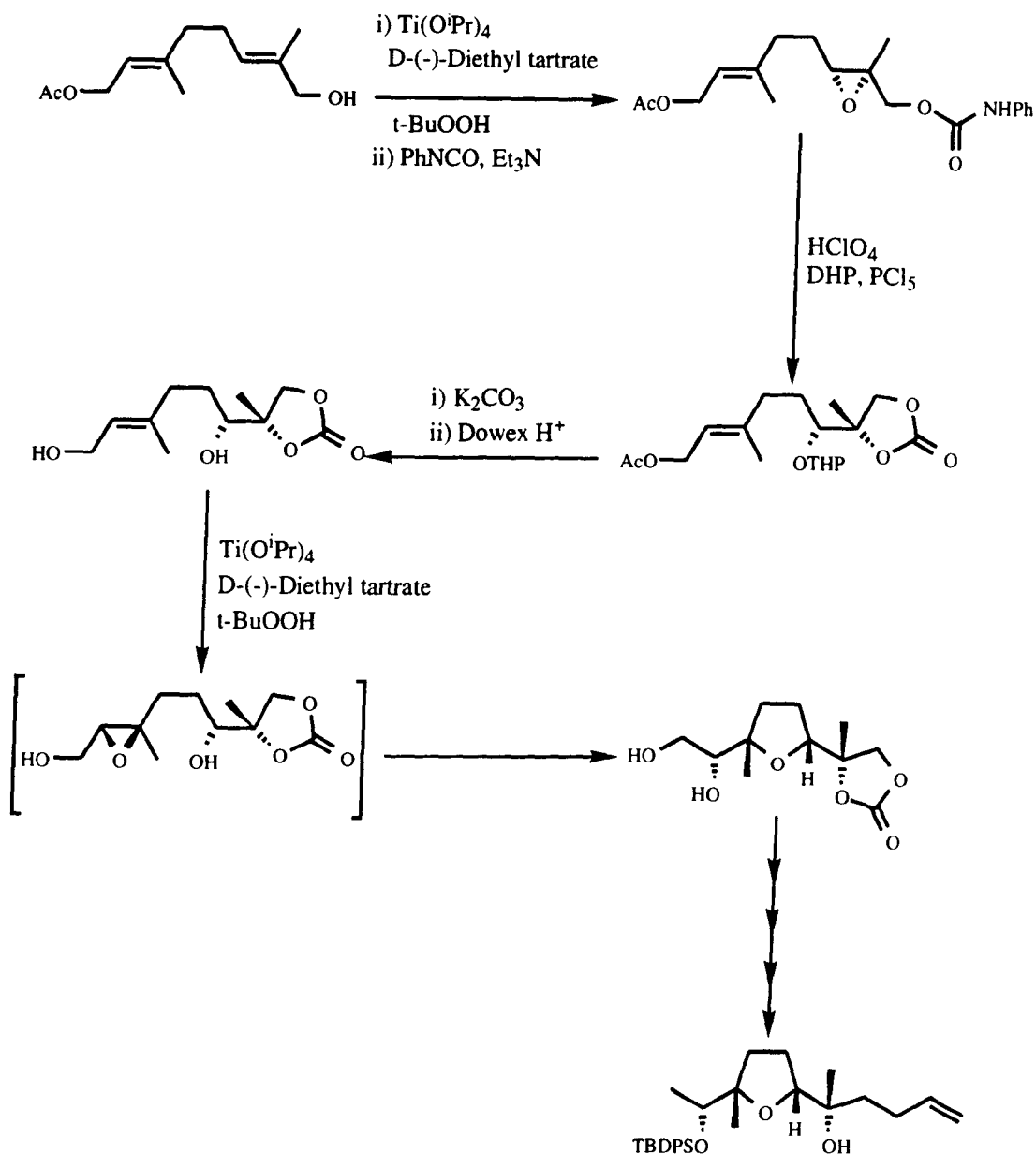

(Scheme 23)

### Mercuricyclization

In general, metal induced cyclizations offer poor selectivity. Examples that do exhibit high selectivity produce the thermodynamically favoured *trans*-2,5-tetrahydrofurans.<sup>221</sup> The mercuricyclization of unsaturated alcohols is an example that has been successfully used to generate, mainly *trans*, 2,5-disubstituted tetrahydrofuranyl systems selectively.

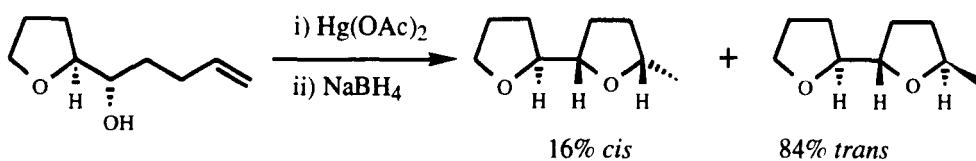

(Scheme 24)

In the last step of the process, the mercury group is removed by borohydride reduction. In principle, this reaction could be used for chain extension by free radical methods; however, this possibility has not been examined.<sup>222</sup> This mercuricyclization route has been used to make *bis*-tetrahydrofurans required for the ionophore antibiotics (Scheme 24).<sup>223</sup>

One notable exception<sup>224</sup> to the *trans*-selectivity rule is shown in scheme 25. When this alcohol was exposed to mercuric chloride, the *cis*-2,5-disubstituted tetrahydrofuran was produced with only 7% of the more usually favoured *trans*-isomer.

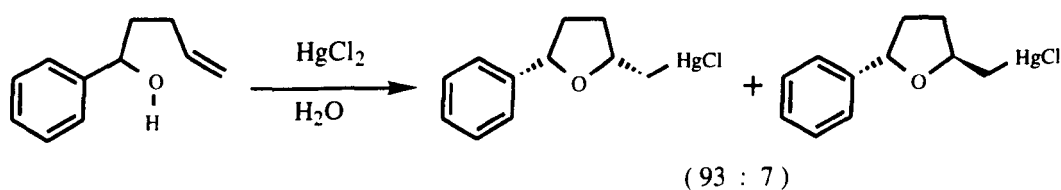

(Scheme 25)

One of the most common metal promoted cyclizations used for cyclic ether construction, after mercury, is that in which palladium is involved. Trost<sup>225</sup> constructed simple tetrahydrofurans from vicinal diol allyl acetates *via* a cyclic stannylene diether, outlined in scheme 26. Conversion to this diether was accomplished by subjecting the chosen alcohol to a refluxing solution of dibutyltin oxide in benzene. Exposure of this stannylene diether to a palladium (0) complex gave the 2,4-substituted tetrahydrofuran in 95% yield, the isomeric ratio being 9:1 in favour of the *trans* isomer with stereocontrol being template rather than substrate led. No cyclization products derived from the secondary alcohol serving as nucleophile were detected.

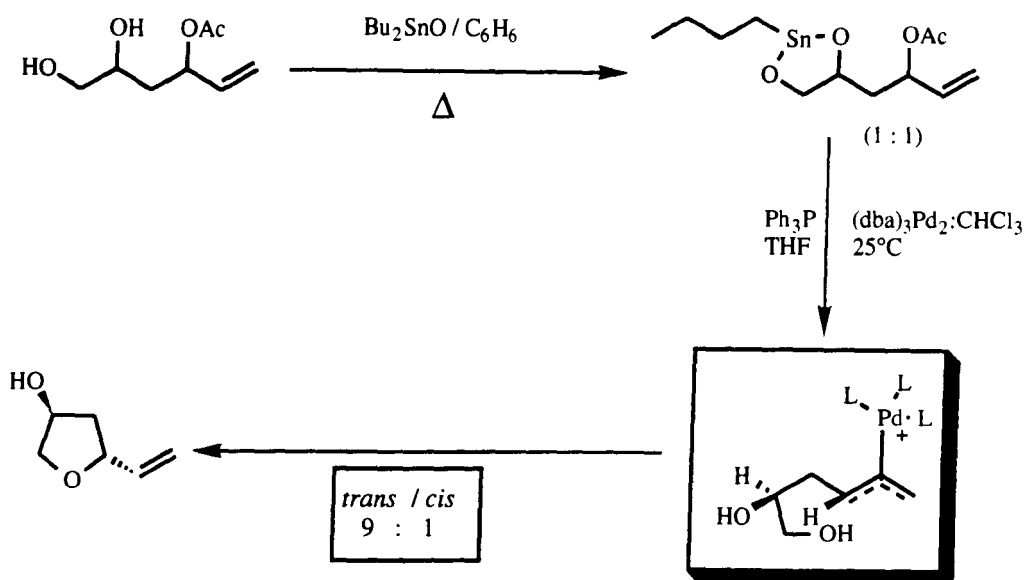

Further work in this field came from Semmelhack<sup>226</sup> who attempted a palladium-catalysed cyclization and concomitant chain extension with carbon monoxide. Starting from 5-hydroxy-1-pentenes, a palladium-catalysed intramolecular “alkoxycarbonylation” gave 2,5-disubstituted tetrahydrofurans in good yield. In simple cases, mixtures of *cis*- and *trans*-2,5-substitution were obtained. Placing a methyl group at C-4 gave 1:1 or 2:1 mixtures, depending on the relative configuration of the methyl group (Scheme 27). With a methyl or phenyl group placed at C-3, the selectivity was much higher, producing either *cis*-2,5- or *trans*-2,5-disubstituted furans in >9:1 selectivity. In the best case, with a 3-phenyl derivative, the selectivity was > 99%.

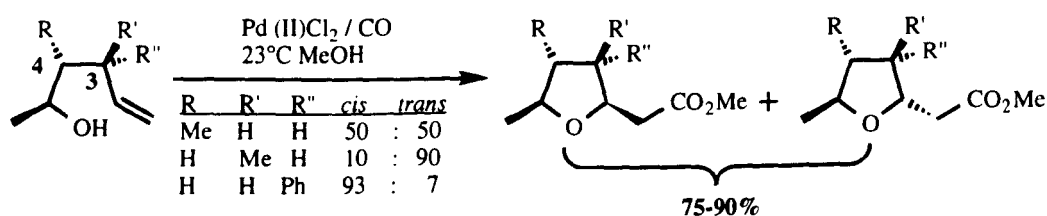

The formation of either the *cis* or *trans* isomer depended on the configuration at C-3 in a predictable way.

## b) Other routes to substituted tetrahydrofurans by non-electrophile induced methods

Electrophile promoted cyclizations are a very important method of tetrahydrofuran construction but they constitute only a part of the vast work that has been carried out to synthesize these molecules. What now follows is a brief summary of the many other routes to these important heterocycles.

### *Oxidative cyclization of 1,5-dienes and 5,6-dihydroxyolefins*

In 1965, Klein and Rojahn<sup>227</sup> reported that 1,5-dienes are converted into tetrahydrofurans when treated with potassium permanganate under mildly alkaline conditions. The course of this oxidative cyclization was established as being that which leads specifically to *cis*-2,5-disubstituted heterocycles. Thus, neryl acetate and geranyl acetate reacted as shown in *scheme 28*

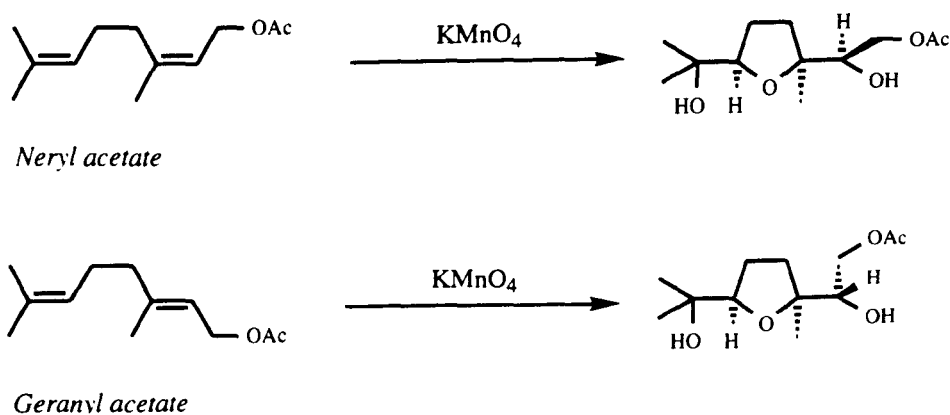

(Scheme 28)

Many years later, when interest in polyether antibiotics had developed, the synthetic possibilities of this pioneering work was re-examined and extended<sup>228, 229</sup>: the reaction is general, *cis*-2,5-bis(hydroxymethyl)-tetrahydrofurans can be generated from appropriate dienes with complete stereospecificity. Moreover, *four* new chiral centres are produced in a single reaction.



In the course of their study of oxidative cyclization, Walba's group<sup>228</sup> examined the three isomeric 1,5-dienes shown in *scheme 29*, each of which underwent cyclization in the manner shown with a very high level of stereospecificity (>90%).

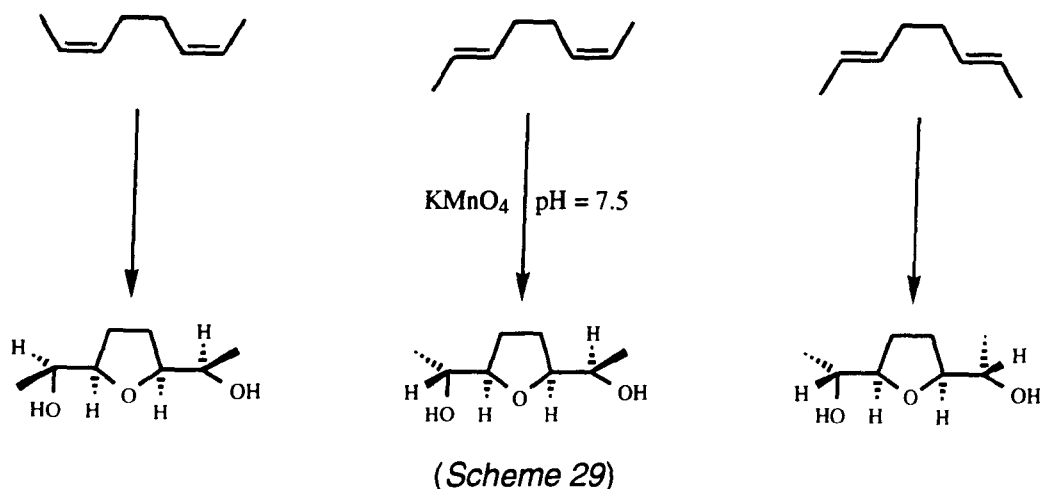

Baldwin's group<sup>229</sup> probed the stereochemical course of oxidative cyclization by employing deuterated dienes, as summarised in *scheme 30*, using NMR techniques to assign relative configurations at each of the stereocentres. Again, the evidence pointed to complete stereospecificity in the cyclization reaction.

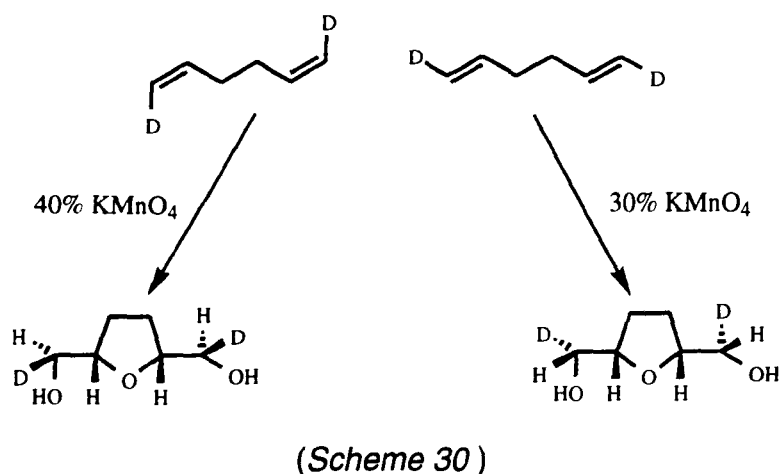

Both groups have proposed mechanisms to explain the high level of stereospecificity in this reaction. Walba *et al.*<sup>228</sup> basing their pathway on

proposals made by Sharpless<sup>230</sup> concerning the mechanism of oxidation of the olefins by oxo transition metal species, suggest initial formation of a *bis-π*-complex between the diene and  $\text{MnO}_4^-$ , *scheme 31*. This is followed by two cycloadditions in a [2+2] manner which yield an octahedral Mn(VII) intermediate. Alkyl migration with retention then occurs and finally reductive elimination, also with retention, yields the Mn(III) diester. Oxidation of this diester followed by hydrolysis produces the observed diol and  $\text{MnO}_2$ .

The mechanism suggested by Baldwin *et al*<sup>229</sup> involves initial [3+2] cycloaddition of  $\text{MnO}_4^-$  to one of the diene double bonds and the resulting Mn(V) ester, is considered to be rapidly oxidized by another molecule of permanganate to a Mn(VI) diester. This undergoes intramolecular cycloaddition to the remaining double bond to yield an intermediate which, on

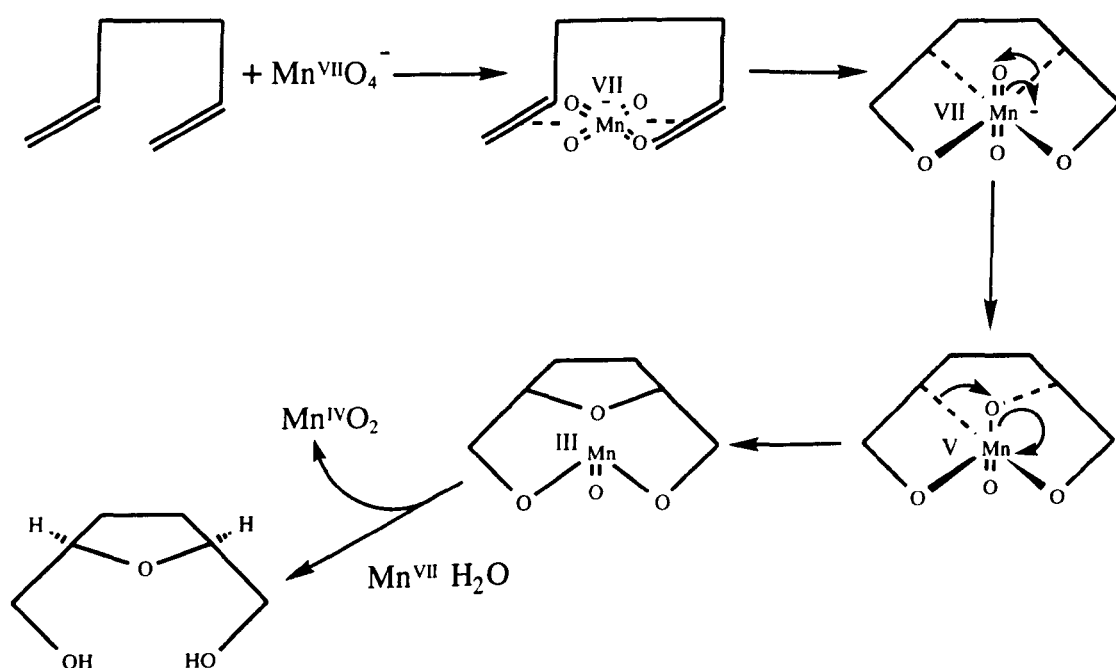

(Scheme 31)

hydrolysis, produces the observed *cis* product. Support for this pathway lies in the fact that there is evidence for the intermediacy of a cyclic Mn(V) ester in reactions of alkenes with permanganate. Additional support is apparent in more recent studies by Wolfe<sup>230</sup> involving  $^{18}\text{O}$ -labelling experiments. Oxidative

cyclization of 1,5-dienes has been used in a racemic synthesis of the B-C ring system of monensin (*Scheme 32*).

Walba and Stroud<sup>232</sup> have extended the scope of oxidative cyclization to include substrates other than 1,5-dienes. Elaborating on much earlier work,<sup>233</sup> they found that 5,6-dihydroxy alkenes could be transformed directly into *cis*-2,5-disubstituted tetrahydrofurans by treatment with a Cr (VI) oxo species.

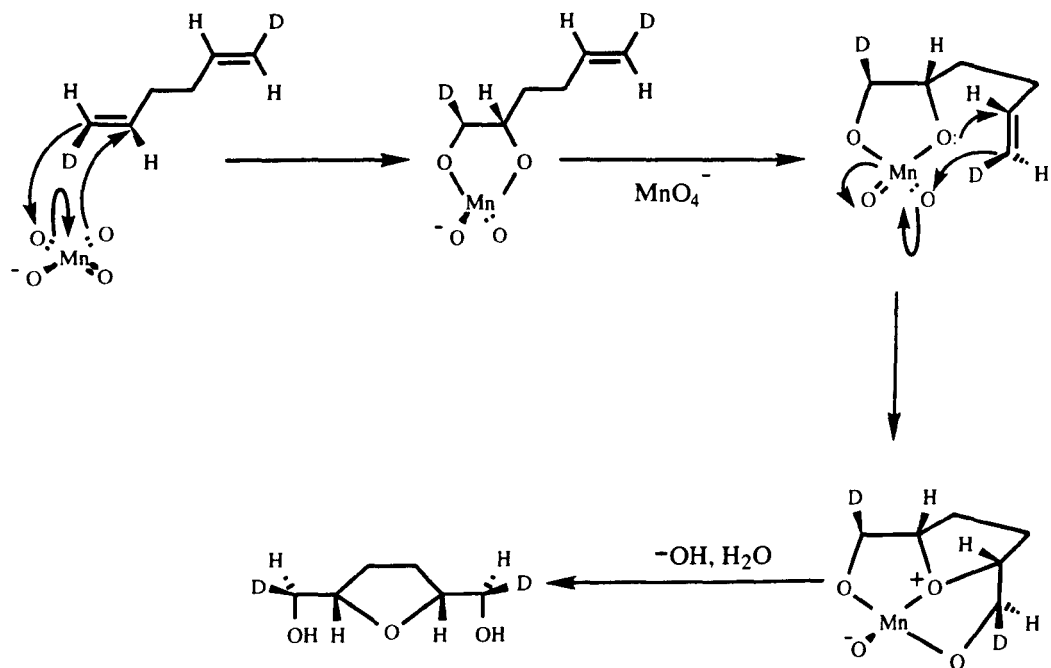

(*Scheme 32*)

Thus, a series of diols were treated with Collins' reagent,<sup>234</sup> the corresponding heterocycles were produced in a process that was judged to be at least 99.5% stereospecific (*Scheme 33*).

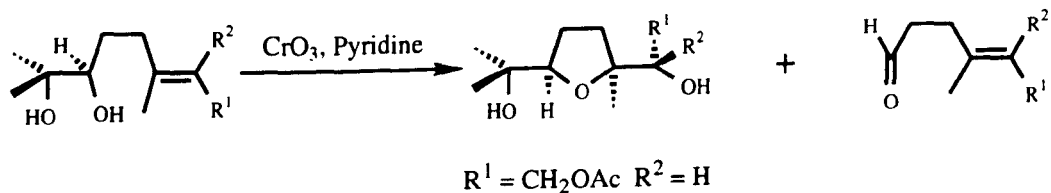

(*Scheme 33*)

Pyridinium chlorochromate<sup>235</sup> oxidation gave similar results but bipyridinium

chlorochromate was unsuitable.<sup>236</sup> Two pathways were suggested for the reaction and are both related to the mechanisms proposed for cyclization of dienes by permanganate.<sup>228, 229</sup>

### *Ester enolate Claisen rearrangement*

The Ireland<sup>237</sup> ester enolate rearrangement constitutes an important route to tetrahydrofurans. In 1976, Ireland *et al* reported that stereochemical control was possible through stereoselective enolate formation. They showed that [3.3]-sigmatropic rearrangement of a number of allylic esters as either the enolate ions or, better, the corresponding silylketene acetals produces  $\gamma$ ,  $\delta$ -unsaturated acids (Scheme 34). It was demonstrated that kinetic enolization with lithium diisopropylamide gives selective formation of the enolates in which the geometry is solvent dependent.

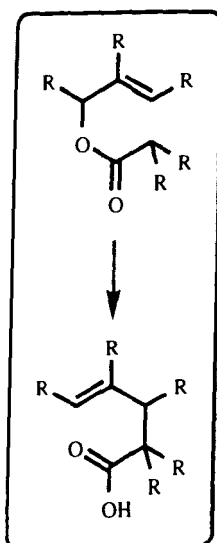

(Scheme 34)

Use of THF favours formation of a *Z*-enolate (corresponding to *E*-silylketene acetal) while use of THF/HMPA (3:1) gives mainly the isomeric *E*-enolate (and *Z*-silylketene acetal). The stereochemical outcome of the enolization is probably the result of kinetic (THF) and thermodynamic (THF/HMPA) control.

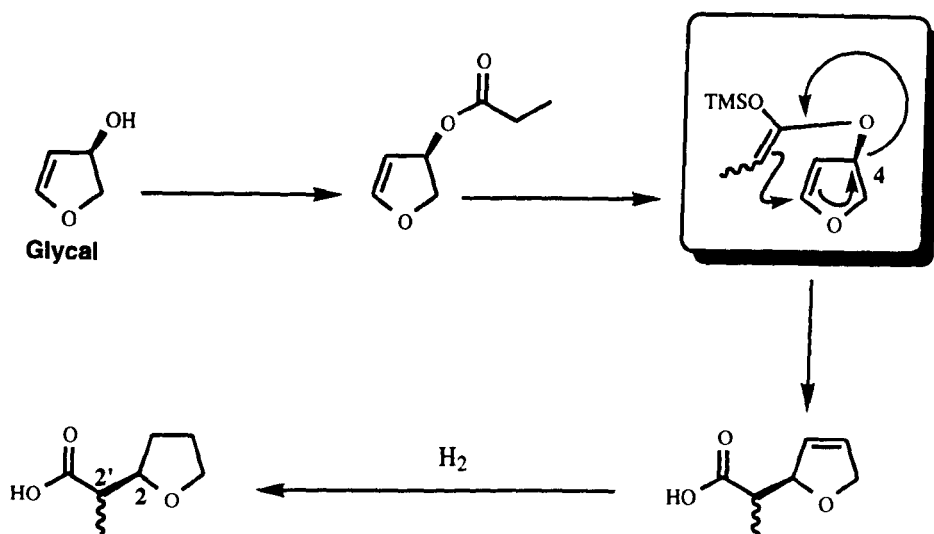

(Scheme 35)

*Scheme 35* illustrates the basis of the method, which involves first preparation of a glycal<sup>238</sup> (an efficient method for the preparation of these was developed by Ireland<sup>238, 239</sup>), then, esterification with the appropriate acid chloride and generation of the corresponding enolate. Upon warming, [3.3]-sigmatropic rearrangement of the enolate occurs to afford a substituted dihydrofuran, with predictable side-chain stereochemistry at the C-2 and C-2' centres.<sup>240</sup> Hydrogenation then gives the corresponding substituted tetrahydrofuran. The stereochemistry at C-2 is a direct result of the asymmetry at C-4 of the enolate, since the entire ester fragment is transferred suprafacially. Similarly, the stereochemistry at C-2' is controlled by the geometry of the enolate, the observed relative stereochemistry being rationalised in terms of a boat-like transition state.

The ester enolate rearrangement has been used frequently in the preparation of polyether antibiotic synthesis. For example, Ireland<sup>161</sup> has employed the methodology in his total synthesis of Lasalocid A, as well as its enantiomer,<sup>162</sup> and in the preparation of the constituent fragments of monensin.<sup>241</sup> Application to the C-D ring fragment of monensin<sup>241</sup> illustrates the power of the method. The retrosynthetic analysis is shown in *scheme 36*. Ireland intended to esterify the glycal corresponding to the monensin D-ring, using a second glycal, which would serve as a precursor to the C-ring. Ester

enolate Claisen rearrangement would then give the desired C-D fragment, with the requisite stereochemistry at C-16 and C-17.

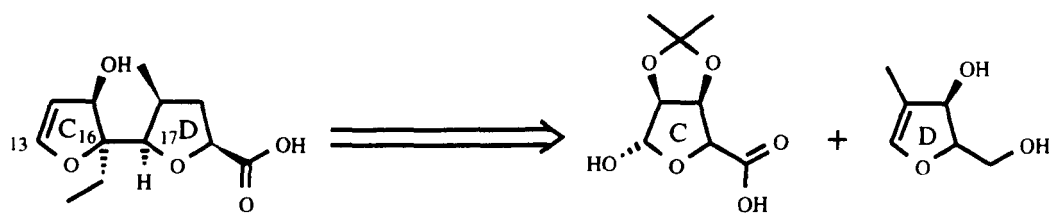

(Scheme 36)

The C-13 ring terminus of the resultant fragment would be used in extending the polyether chain to the left, while the D-ring would act as the acyl partner to extend the chain in the opposite direction.

Implementation of this idea is shown in *scheme 37*. The glycal was constructed from *D*-xylose and esterified with the C-ring precursor, prepared from *D*-mannose. This ester was added to a pre-mixed solution of lithium diisopropylamide and trimethylsilyl chloride in THF/HMPA (9:1) at  $-110^{\circ}\text{C}$ . Desilylation and treatment with diazomethane after thermal re-arrangement at room temperature afforded a mixture of esters. The ester functionality was reduced, and under Swern conditions, a mixture of aldehydes (1:1.5) was obtained. The minor isomer was taken on to synthesize the C-D ring unit.

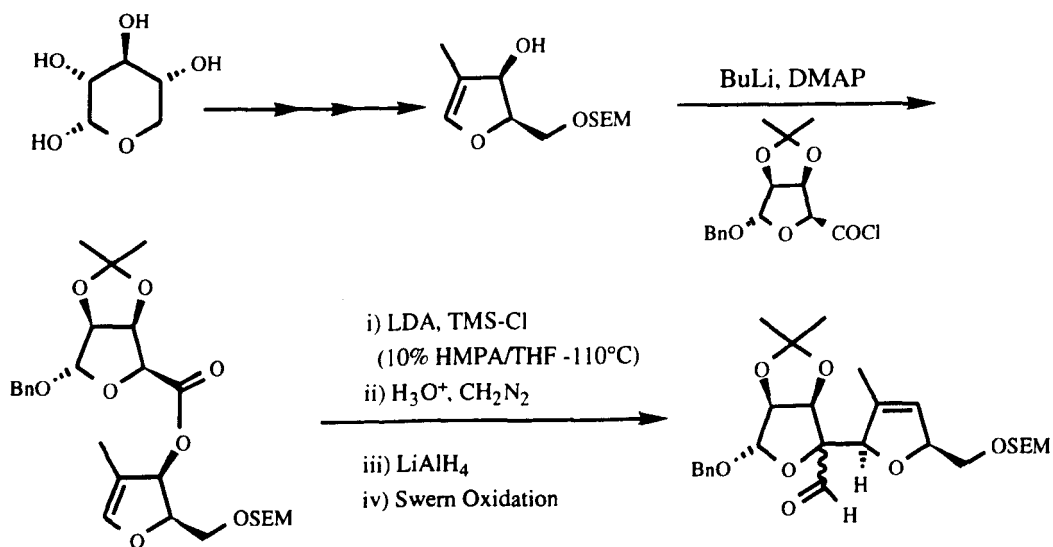

(Scheme 37)

## Ring contraction of tetrahydropyrans

The production of *trans*-2,5-disubstituted tetrahydrofurans by ring contraction of appropriately substituted tetrahydropyrans has been investigated by Bartlett.<sup>242</sup> The approach is based on the fact that relative 1,3-asymmetric induction is more easily attained in a 6- rather than in a 5-membered ring. Advantage was taken of this and, in the event, a high degree of stereocontrol was realized as shown in *scheme 38*. A  $\gamma$ ,  $\delta$ -unsaturated alcohol was treated with 2,4,4,6-tetra-bromo-2,5-cyclohexadienone [TBCO] to generate the desired bromotetrahydropyran as the major cyclic ether. This tetrahydropyran was then separated from residual furan by products and, upon ring contraction induced by silver tetrafluoroborate in acetone, a good yield (78%) of the *trans*-2,5-disubstituted tetrahydrofuran was isolated. Presumably, ring contraction takes place *via* intermediate formation of a bridged oxonium ion. Nucleophilic capture of this incipient carbocation by solvent yields the observed product. Side chain stereocontrol in this type of process was also examined.<sup>242</sup>

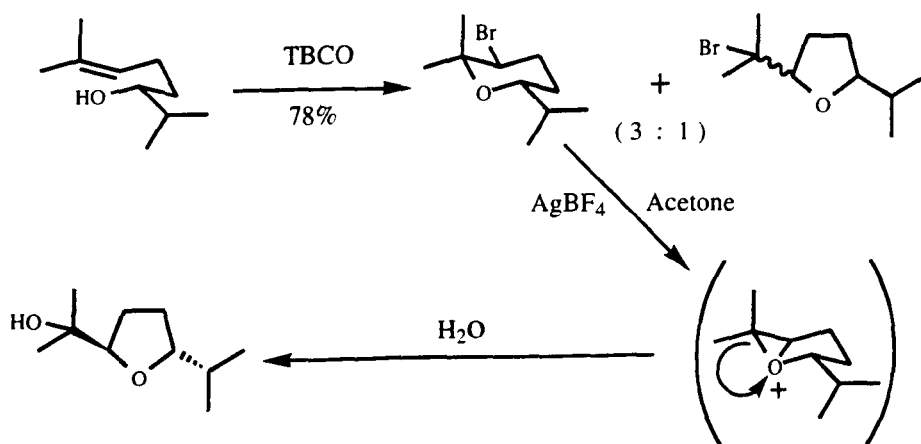

(Scheme 38)

Modification of the above sequence provides an ingenious route to *bis*-tetrahydrofurans<sup>243</sup> (Scheme 39). Cyclization of a  $\gamma$ ,  $\delta$ -unsaturated alcohol with TBCO, followed by silver ion induced ring contraction in the presence of

hydrogen peroxide, leads directly, as shown, to the stereocontrolled generation of five new asymmetric centres in the *bis*-tetrahydrofuran.

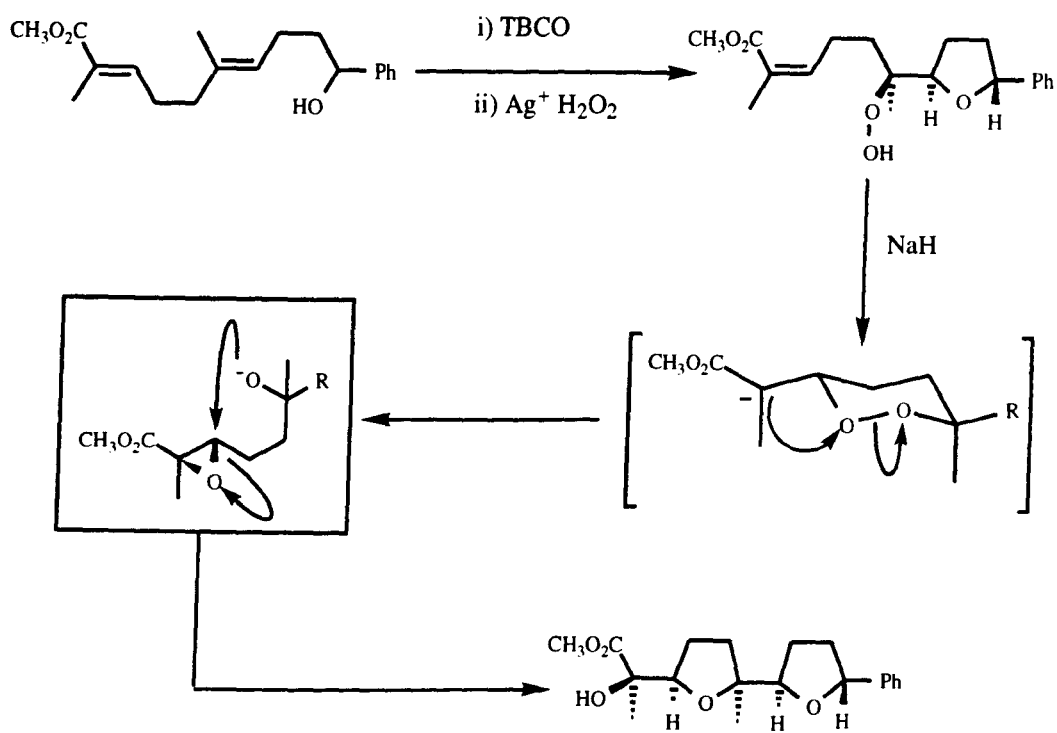

(Scheme 39)

It is possible to improve the ring contraction methodology by using thallium (III) ions as electrophiles instead of positive bromine and a detailed study on the alcohol shown in *scheme 40* was made by Bartlett.<sup>244</sup> Treatment with a series of different thallium (III) electrophiles, under a variety of mild conditions, served to convert the alcohol into substituted tetrahydrofurans in a single operational step. The lifetime of the thallated intermediate appeared to be extremely short. Presumably, this is due to the fact that in the tetrahydropyranyl intermediate the ring oxygen is suitably placed to aid in departure of the electrophile.



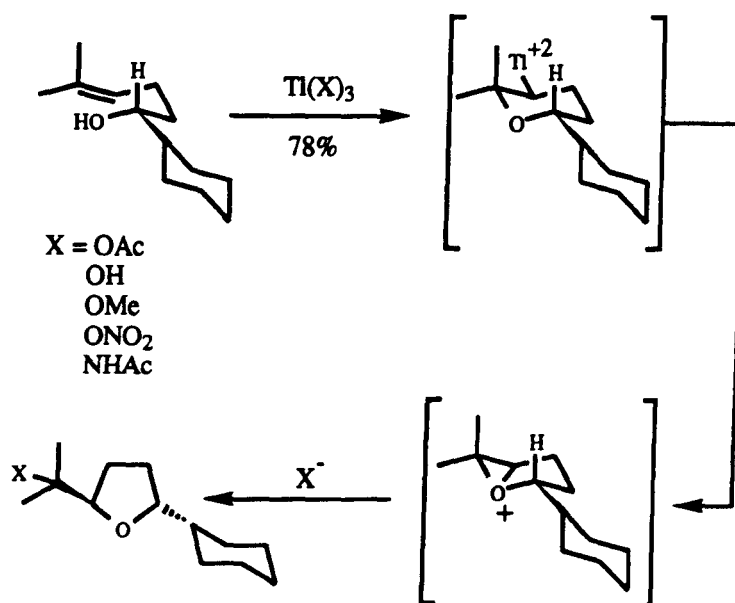

(Scheme 40)

In a related study, Frauenrath<sup>245</sup> used a stereocontrolled rearrangement of 4,5-dihydro-1,3-dioxepins to access 2,3,5-trisubstituted tetrahydrofurans in high yield. This Lewis acid catalysed ring contraction gave *trans*-2,5-tetrahydrofurans with a preference for the isomer with a 2,3-*cis* relationship in the ring. Formation of the corresponding 2,5-*cis* tetrahydrofurans was also possible but proved more difficult due to a strong steric demand in the transition state of the rearrangement. Again these showed a bias toward a 2,3-*cis* relationship in the ring, but to a lesser extent (Scheme 41).

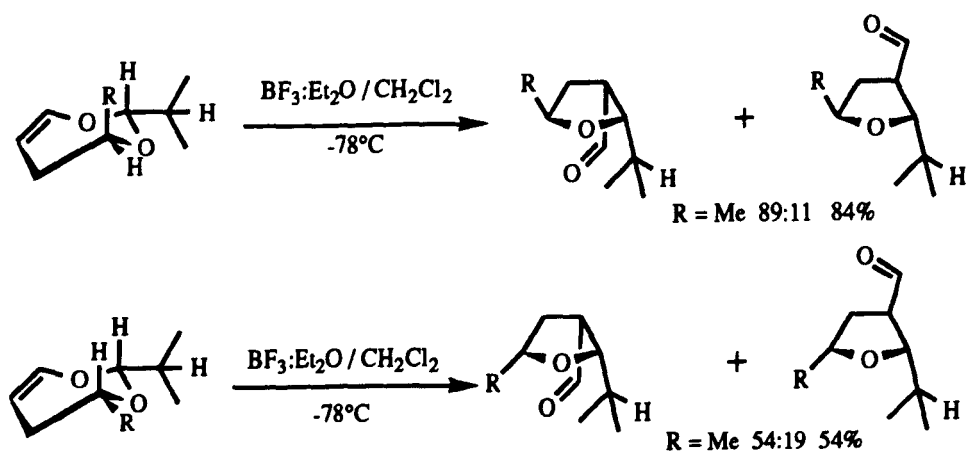

(Scheme 41)

### Ring expansion of an epoxide

Expansion of a three membered ring, typically an epoxide<sup>246</sup> or, more unusually, a cyclopropane ring,<sup>247</sup> is a useful method of tetrahydrofuran synthesis.

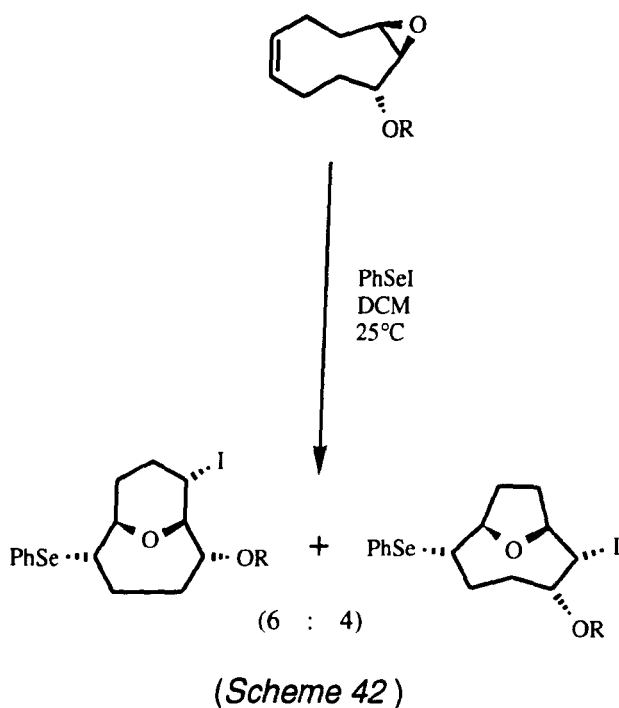

Martin<sup>248</sup> described an electrophile promoted transannular ring expansion of cyclo 1,5- and 1,6-epoxyalkenes and cyclo *trans*-1,5-*bis*-epoxides in late 1988. Reaction of a cyclic 1,2-epoxy-5-ene with benzeneselenenyl iodide at room temperature in dichloromethane proceeded to give after hydrolysis, a 4:6 mixture of cyclic furan and pyran respectively, in 92% yield (Scheme 42). The reaction seemed to proceed *via* transannular nucleophilic attack of the epoxide oxygen toward an “olefin-phenylselenenyl cation” complex, which then led to the *exo*-cyclized benzeneselenenyl ether. Interestingly when the *trans*-1,5-*bis*-epoxide shown in *scheme 43* was treated with a suitable Lewis acid at -78°C, there was an efficient conversion only to the expanded tetrahydrofuran. The regiochemistry of this addition seemed to be determined by the selectivity of

attack on the shown tricyclic oxonium intermediate to give *exo*-cyclized ethers. These intermediates predict that in these electrophile-mediated cyclizations, the regioselectivity of the reaction does not depend on which electrophile is used, although they alone cannot explain the intercepting nucleophile regioselectivity.

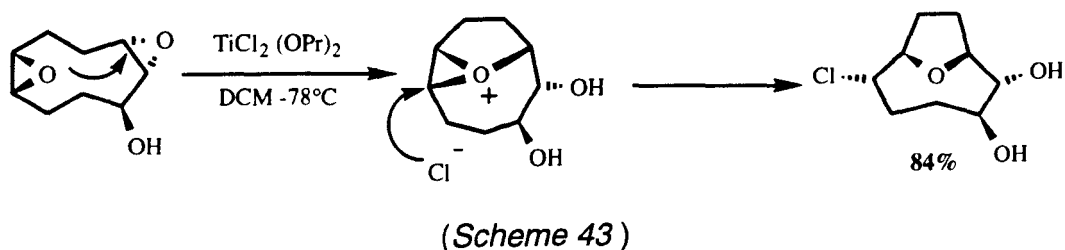

### Cyclization of 1,4-diols

The cyclization of a 1,4-diol system was used by Still *et al*<sup>163a</sup> in the course of their synthesis of monensin to make the C-13 to C-16 tetrahydrofuran ring in 67% yield (Scheme 44). Thus the 1,4-diol was converted into a monomesylate and then by stereospecific ring closure, into the C-ring of monensin. [See also Ponpipom's<sup>163b</sup> cyclization of chiral 1,4-diols].

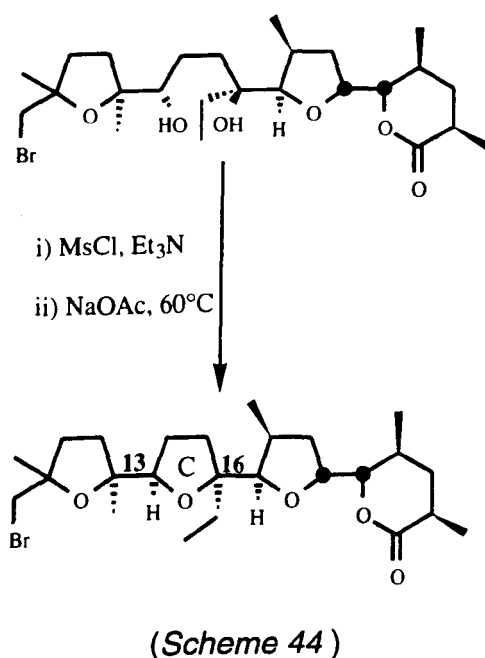

## Radical mediated cyclizations

Moriya<sup>249</sup> reported a synthetic route to tetrahydrofurans from active methylene compounds *via* radical addition onto a vinyl ether moiety. This presents a straightforward example of radical cyclization when vinylic oxygen is contained in the chain (*Scheme 45*). The radical cyclization of these vinyl ethers, containing two electron withdrawing groups such as CN or COR at the  $\beta$ -position, with tri-*n*-butyltin hydride and AIBN afforded the tetrahydrofurans in moderate yields.

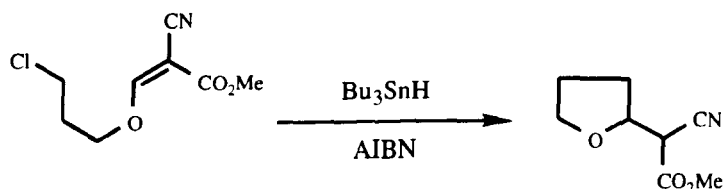

(*Scheme 45*)

There was a similar approach by Watanabe,<sup>250</sup> who reported a stereoselective synthesis of tetrahydrofuran derivatives *via* a dichloromethyl radical. An allyl 2,2,2-trichloroethyl ether afforded a 2,4-disubstituted-3,3-dichlorotetrahydrofuran in an excellent yield after treatment with equimolar tri-*n*-butyltin hydride (*Scheme 46*). Predominantly *cis*-diastereomers were obtained with high degrees of regioselectivity.

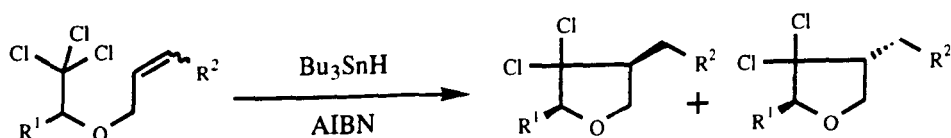

R1	R2	Cis / Trans
Ph	Ph	92 : 8
CH <sub>2</sub> COMe	H	87 : 13
C <sub>3</sub> H <sub>7</sub>	H	86 : 14

(*Scheme 46*)

Classical strategies,<sup>251</sup> as outlined above, have been advanced to give high levels of stereochemical control in tetrahydrofuran ring cyclizations, but more recently, [3 atom + 2 atom] bond construction approaches have come into prominence.<sup>252, 253</sup> These methods can generally be divided into two main categories: dipolar or diyl addition of a three carbon unit to a suitably functionalized aldehyde<sup>252</sup> or, carbonyl ylid/alkene cycloadditions.<sup>253</sup> The utility of the former strategy for the stereoselective preparation of 2,5-disubstituted tetrahydrofurans, crucial for application to many natural product systems, has not been demonstrated. Using the latter strategy, Feldman<sup>254</sup> has been able to prepare tri- and tetra-substituted tetrahydrofuran rings by this novel, free radical, [3 atom + 2 atom] addition (*Scheme 47*). Treatment of a vinyl oxirane and excess alkene with a phenylthio-radical source leads to formation of 2,5-*cis*-tetrahydrofuran products as a mixture of epimers at C-4. Use of pure *cis* or *trans* oxiranes gave identical yields and isomer distributions.

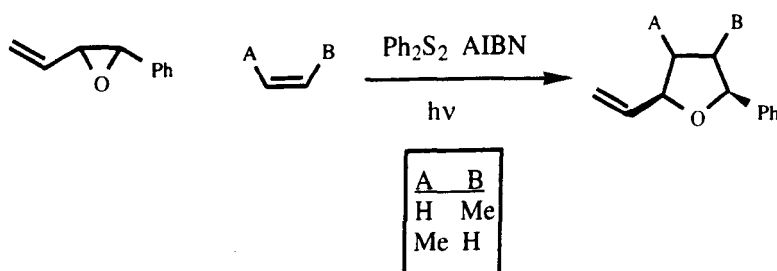

(*Scheme 47*)

### *Carbanion induced cyclization to tetrahydrofurans*

The cyclization reactions of 5-hexenyl radicals have formed the basis for a wide variety of synthetic methods introduced during recent years.<sup>255</sup> It has been known for sometime that 5-hexenyl carbanions can undergo a similar regioselective closure to afford cyclopentyl rings.<sup>256</sup> Broka<sup>257</sup> found that  $\alpha$ -alkoxy lithium reagents, generated from tri-*n*-butylstannylmethyl ethers of several homoallylic alcohols, undergo facile and highly stereoselective

cyclization to afford substituted tetrahydrofurans. Treatment of the stannanes shown in *scheme 48* with a three-fold excess of *n*-butyl lithium in THF at -78°C was required to suppress the formation of stannane by-products and gave rise to  $\alpha$ -alkoxy lithiums. Upon warming to 0°C, these anions underwent cyclization to produce, after aqueous workup, the corresponding tetrahydrofurans.

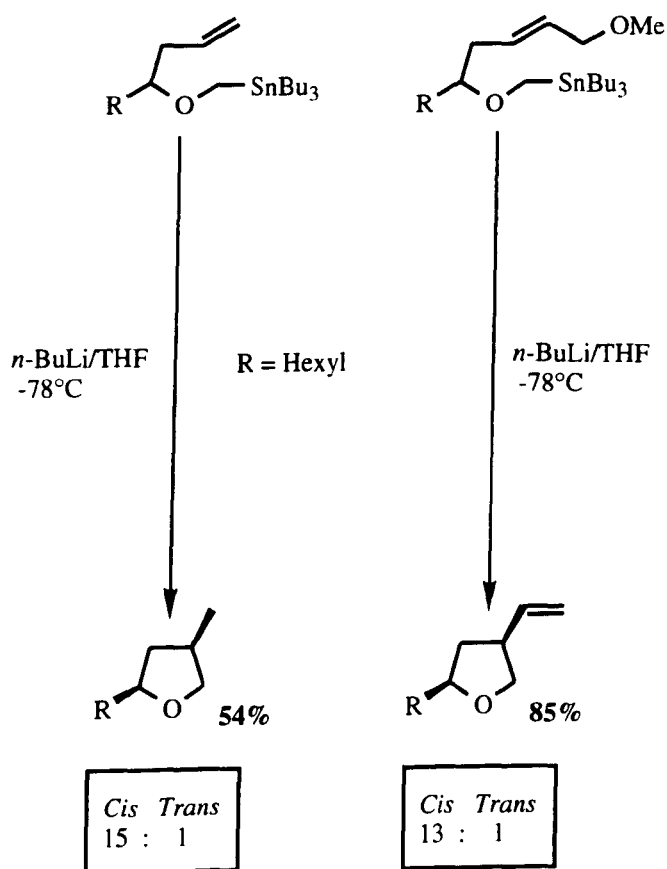

(Scheme 48)

The reaction gives a high degree of stereoselectivity with *cis* to *trans* ratios being greater than fifteen to one. These stereochemical outcomes are similar to those expected from the corresponding radical-mediated processes. As with the radical reactions, this stereoselectivity is due to a chair-like transition state, although the situation is rendered more complex by the possibility that the

reacting species is not monomeric but, instead, an aggregate. Employing the same conditions these workers were able to achieve successful cyclization using  $\alpha$ -alkoxy lithiums in which the double bond bears a methoxy substituent. The vinyl tetrahydrofurans thus formed, in excellent yield, are suitable for further manipulation. It was only necessary to use a slight excess of base this time, since formation of by-products was precluded by rapid elimination of methoxide.

The opening of an epoxide ring with functionalized carbon nucleophiles is a process of great synthetic importance,<sup>258</sup> especially since there is now a wide range of methods for the preparation of substituted epoxides in optically active form.<sup>216</sup>

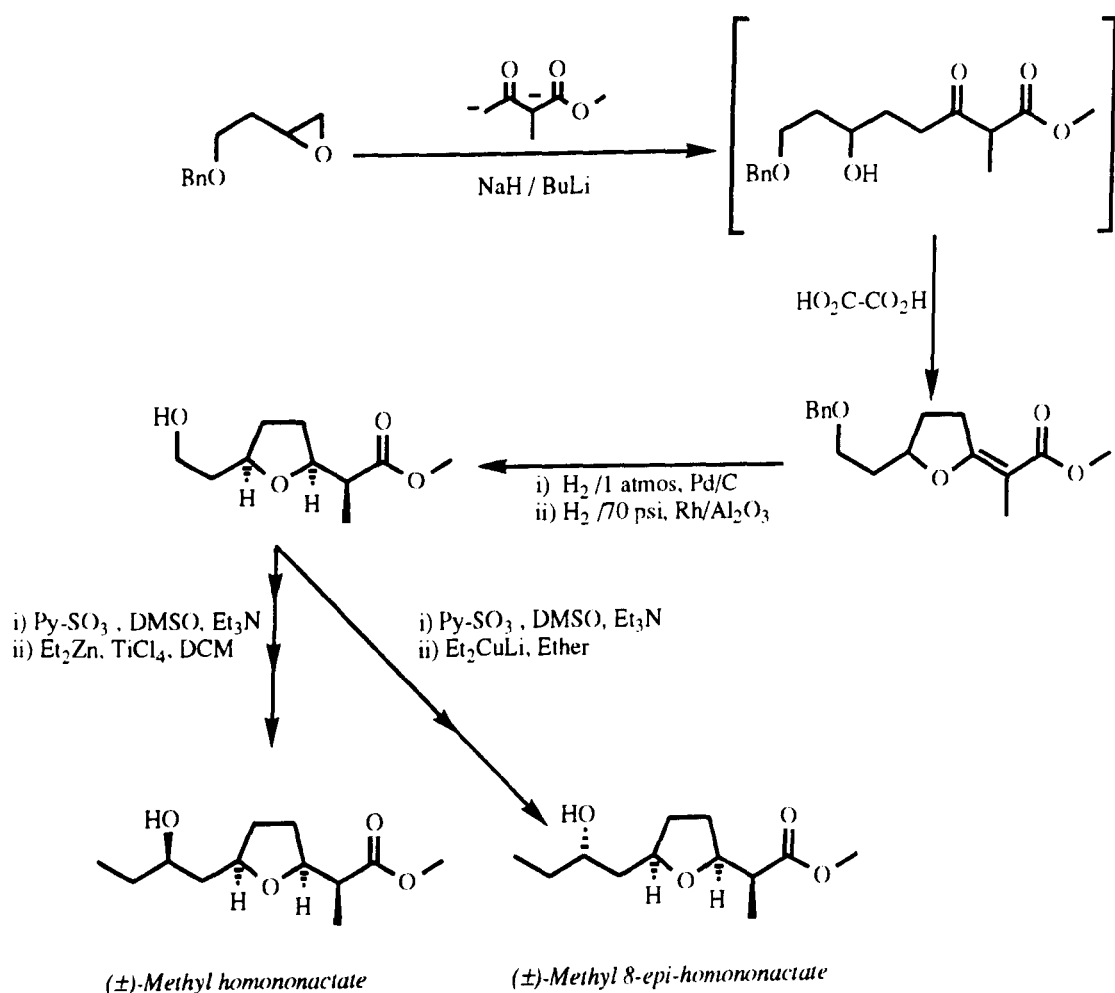

(Scheme 49)

One such reaction,<sup>259</sup> namely that between a dianion derived from a  $\beta$ -keto ester and an epoxide, leads, on subsequent treatment with acid, to substituted tetrahydrofurans, (Scheme 49). A range of alkyl substituents in the epoxide moiety could be tolerated, although Lewis acid activation of the epoxide was necessary in more hindered cases. These cyclizations give the thermodynamically favoured *E*-olefin isomer with high selectivity.<sup>259, 260</sup> Lygo<sup>261, 262</sup> used such a strategy employing either substituted  $\alpha$ - or  $\beta$ -epoxides to synthesize ( $\pm$ )-methyl homonactate and ( $\pm$ )-methyl 8-*epi*-homononactate, precursors to the antibiotic tetranactin. The required dianion was readily generated from methyl 2-methyl-3-oxobutanoate by sequential treatment with sodium hydride and *n*-butyl lithium and reacted with the epoxide to give the intermediate hydroxy- $\beta$ -ketoester. This then underwent acid catalysed cyclization to give the tetrahydrofuran. Debenzylation followed by stereoselective hydrogenation of the double bond with a rhodium catalyst gave the ether shown in 49% yield, the reduction giving a 8:1 selectivity in favour of the required isomer. This was then taken on to methyl homononactate and methyl 8-*epi*-homononactate by conventional methods.

#### Miscellaneous routes to tetrahydrofurans

Several miscellaneous routes to substituted tetrahydrofurans have also been developed. These are summarized in the following schemes.

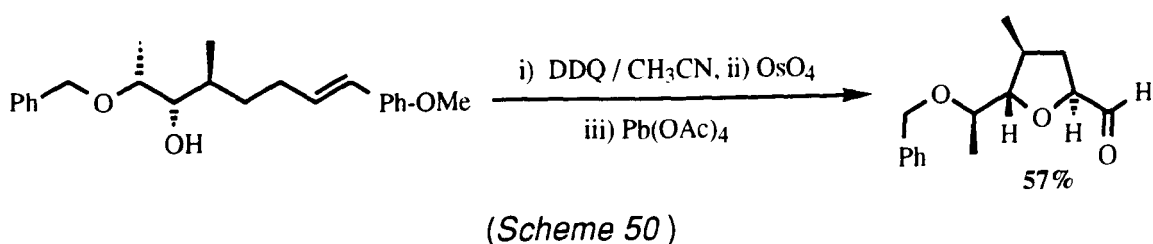

Oikawa,<sup>263</sup> Kishi<sup>264</sup> and Baldwin<sup>265</sup> have reported some significant examples of tetrahydrofuran synthesis by base catalysed ring-closures. These have been used to prepare important antibiotic and *C*-nucleoside fragments.



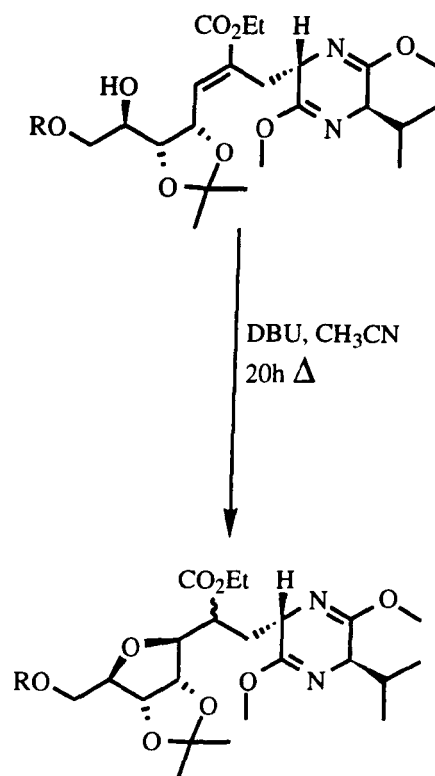

(Scheme 51)

Benzyl ethers with S<sub>N</sub>2 active sites in  $\gamma$ -position undergo spontaneous regio- and stereocontrolled tetrahydrofuran cyclization with concomitant debenzylation even under mildly acidic or neutral conditions.<sup>266</sup>

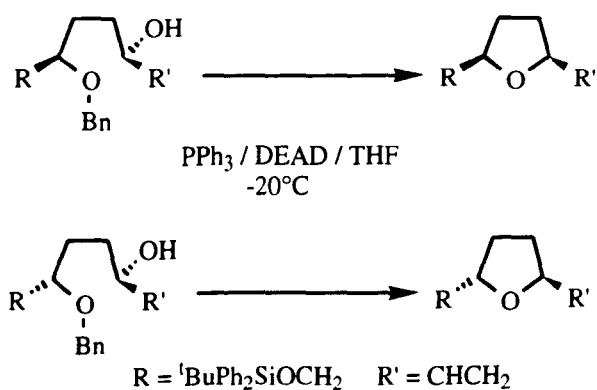

(Scheme 52)

Synthesis of a tetrahydrofuran ring by the chemical transformation of a carbohydrate precursor,<sup>267</sup> as exemplified in the total synthesis of the C<sub>18</sub>H<sub>32</sub>O<sub>5</sub>

degradation product from the Boromycin antibiotic<sup>268</sup>, is another well established method of construction.

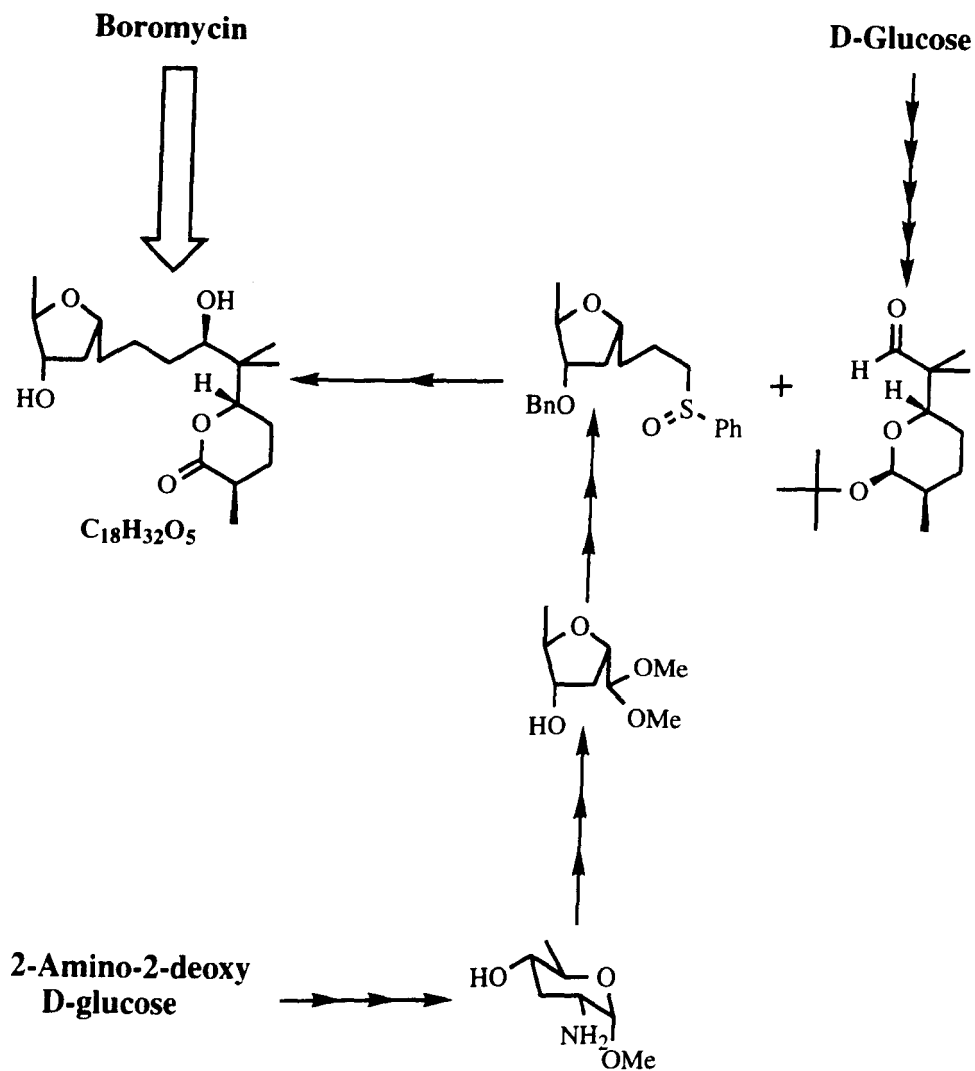

(Scheme 53)

Formation of functionalized tetrahydrofurans by the oxidative cyclization of  $\gamma$ -allenyl alcohols using the intriguing oxidant dimethyldioxirane has been recently developed by Crandall.<sup>269</sup>

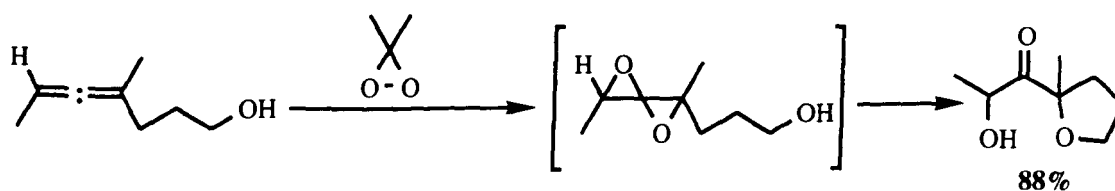

(Scheme 53)

.....O.....

# **Iodoetherification of homoallylic alcohols: A stereoselective approach to tetrahydrofurans**

- a) Introductory background information
- b) Routes to homoallylic alcohols
- c) Iodolactonizations of 3-silyloxy-5-alkenoic acids
- d) Formation of trisubstituted tetrahydrofurans
- e) Iodocyclizations of alk-5-en-3-ols
- f) Displacement transformations
- g) Future work and Natural Product targets

## Tetrahydrofurans

### **a) Introductory background information**

Initial work had shown that iodine-induced cyclizations of *Z*-3-silyloxy-5-alkenoic acids gave *trans*-disubstituted valerolactones.<sup>270-272</sup> We went on to study the reaction of the complementary *E*-silyloxyalkenoic acids and found they gave the same *trans*-disubstituted valerolactones differing only in the stereochemistry of the iodine substituent.<sup>273</sup> During these studies, it was observed that small quantities [ $\leq 5\%$ ] of by-products were formed which appeared to be tetrahydrofurans. In order to try and maximise such transformations we next examined the cyclizations of the 3-hydroxy-5-alkenoates.<sup>274</sup> These were found to give iodo and, more unusually, hydroxytetrahydrofurans. This then led to an in-depth mechanistic study and workable prospects for the reaction. Iodocyclizations of the related alk-5-en-3-ols were also developed.<sup>275</sup> Finally interconversion, transformations and Natural Product syntheses were attempted. All these reactions required numerous examples of homoallylic alcohols, the assembly of which is dealt with first.

### **b) Routes to homoallylic alcohols**

During the course of our investigations into the iodocyclization of various homoallylic alcohols it became necessary to develop several different routes to these precursors. What now follows is a detailed study as to how these molecules were constructed and the benefits and disadvantages of each approach.

### Wittig homologation route

Our studies began with syntheses of the 3-oxoalk-5-enoates which can be reduced to the desired homoallylic alcohols. Such  $\beta$ -ketoesters can be prepared by Grignard reaction between allylmagnesium chloride and methyl cyanoacetate (**085**) followed by mild hydrolysis of the resulting enamino ester (**086**).<sup>276</sup> Although this procedure was known to be particularly inefficient its mitigating feature was that it could be conveniently carried out on a large scale (*Scheme 1*). The methyl ester (**087**) prepared in this way could be isolated as a pure regioisomer by vacuum distillation below 70°C. Above this temperature, the compound displayed a marked tendency to isomerize to the conjugated hex-4-enoate isomer (**088**).

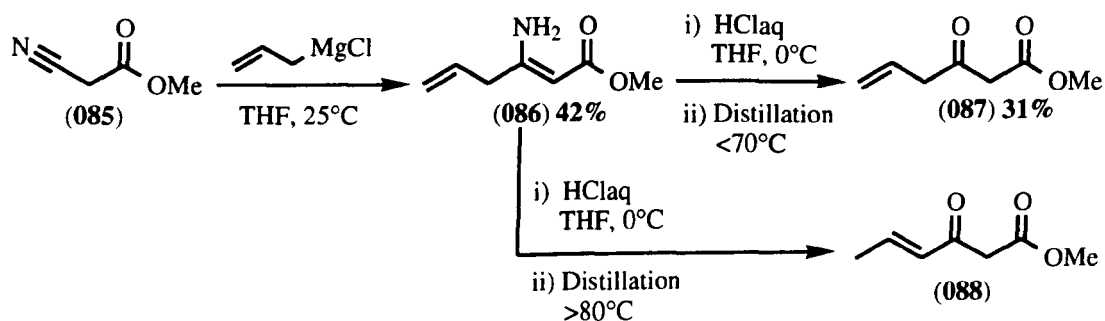

(Scheme 1)

An alternative and more efficient approach to this ester (**087**) was a procedure by Hamana and Sugawara<sup>277</sup> in which the same cyanoacetate was condensed with allyltrimethylsilane in the presence of boron trichloride (*Scheme 2*). However, in these hands the reaction never produced the required product in good yield ( $\approx 30\%$ ) and this more expensive procedure was found to be less amenable to large scale preparations of the ester.

Of a number of possibilities for the asymmetric reduction of this  $\beta$ -ketoester (**087**), the use of baker's yeast<sup>278</sup> seemed to offer several advantages, notably cheapness and ease of handling as well as the the innocuous nature of this reagent.

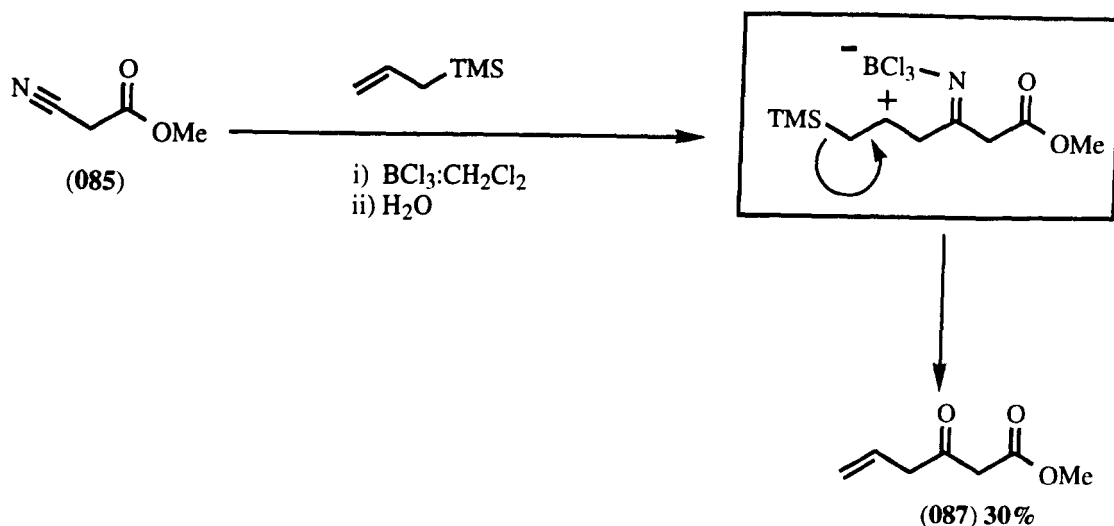

(Scheme 2)

Using the method described in detail by Seebach and his colleagues,<sup>279</sup> incubation of the ester with fermenting baker's yeast for ca 24 hr at 30°C led to the hydroxy ester (**089**) in 65-70% isolated yield (Scheme 3). The use of tap water was essential; in deionised water, the reductions tended to stop at around 50% conversion. If the ketoester substrate (**087**) was contaminated with varying amounts of the corresponding hex-4-enoate (**088**), this was of little consequence as no products arising from this compound were isolated. Possibly this conjugated isomer reacts by Michael addition process; although the fate of the resulting species was unclear, hydrolysis and decarboxylation to give volatile fragments would seem a distinct possibility. The initial yeast reduction product was virtually free from impurities when isolated by simple solvent extraction. Conversion into the Mosher's ester derivative<sup>280</sup> and subsequent NMR analysis showed this methyl ester to have an enantiomeric enrichment of 78% (89:11). Attempts to increase the enantioselectivity of the yeast reduction by the addition of allyl alcohol,<sup>281</sup> by reduction of the corresponding carboxylate salt<sup>282</sup> or by changes to the concentration or reactant ratios<sup>283</sup> were not successful.

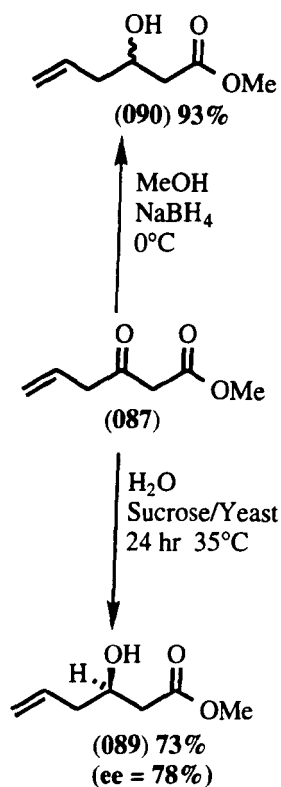

(Scheme 3)

Our samples of the hydroxy ester (**089**) showed  $[\alpha]_D^{25} -23.7$  (c, 1.1,  $\text{CHCl}_3$ ), [lit.<sup>284</sup>  $[\alpha]_D^{25} -12.6$  (c, 1.3,  $\text{CHCl}_3$ )]. In later studies the ketoester (**087**) was simply reduced using sodium borohydride under standard conditions<sup>285</sup> to give a 93% yield of the racemic hydroxy ester (**090**), identical in all spectral data to its chiral counterpart.

The required methyl 3-hydroxy-5-alkenoates could then be constructed by converting this hydroxy ester (**089** or **090**) into the reciprocal aldehyde and from there *via* a Wittig homologation reaction into the desired precursor. Our synthesis began then with conversion of the initial yeast reduction product (**089**) into either the corresponding triisopropylsilyl (**091**) or *t*-butyldimethylsilyl ether (**092**) in ca 75-80% isolated yield.<sup>286</sup> Ozonolysis of these ethers afforded the ozonides<sup>287</sup> (**093** and **094**), which were then reduced, in almost quantitative yield to the required aldehydes (**095** and **096**) (Scheme 4).

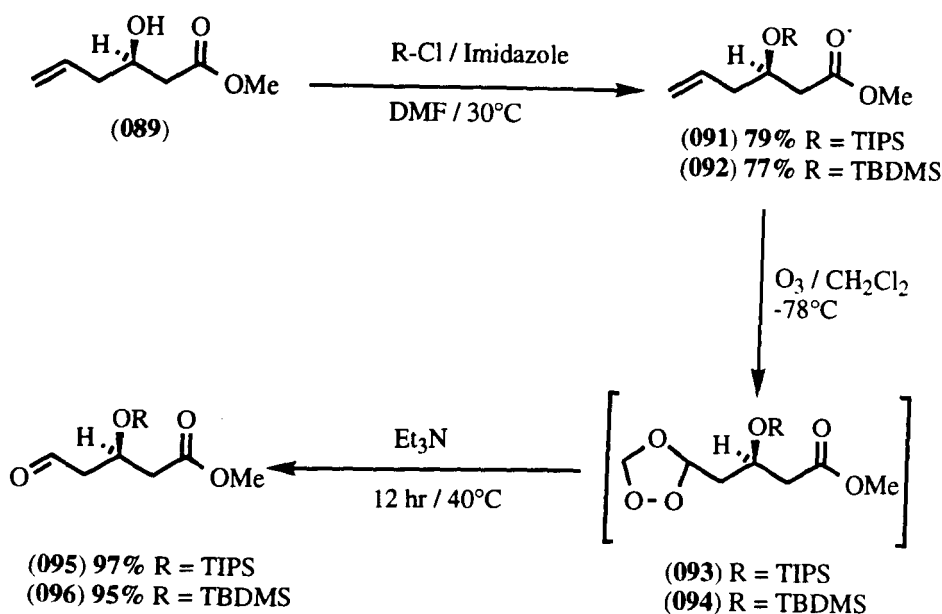

(Scheme 4)

The primary ozonide **(093)** was surprisingly stable and could be isolated by column chromatography. The reduction step from ozonide to aldehyde was achieved initially using dimethyl sulphide in dichloromethane at  $30^\circ\text{C}$  for some three to four days.<sup>288</sup> However, switching to triethylamine as reductant brought about this transformation in 12 hr at  $40^\circ\text{C}$  in a very respectable 90% yield.

Treatment of these aldehydes **(095 and 096)** with a non-stabilized ylid; either ethyltriphenylphosphorane or pentyltriphenylphosphorane, produced the expected *Z*-olefins **(097)** and **(098)**.<sup>289a</sup> The *Z*-olefin **(097)** was contaminated with approximately 9%, and the *Z*-olefin **(098)** with less than 15%, of the *E*-isomers, as estimated from analysis of high field  $^1\text{H}$  and  $^{13}\text{C}$  NMR spectra of the corresponding alcohols **(099 and 100)**. The Wittig step proceeded smoothly and in good yield without the formation of any eliminated side products from either aldehyde nor the product olefins.<sup>289b</sup> We had to assume the chiral carbinol centre was still intact; all products were still optically active and therefore complete racemization at least had not occurred (Scheme 5).



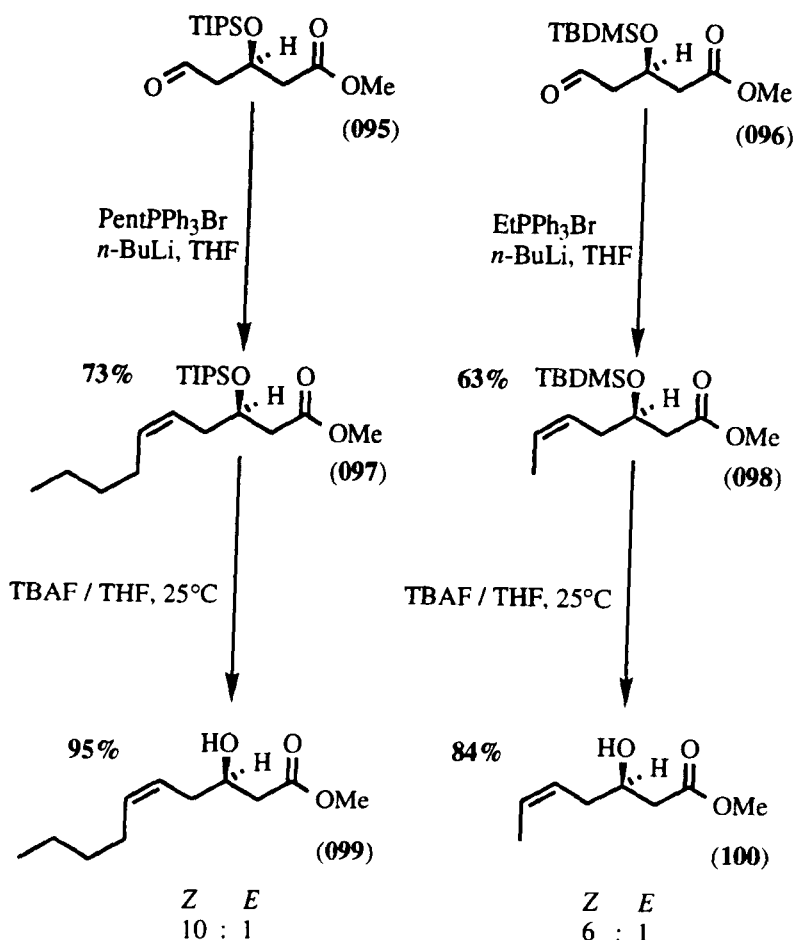

(Scheme 5)

The alcohols (**099** and **100**) were initially formed by stirring the respective silyl ether with aqueous hydrogen fluoride in acetonitrile,<sup>290</sup> but better results were obtained by switching to the tetrabutylammonium fluoride in tetrahydrofuran system.<sup>49</sup> The butyl alcohol (**099**) showed  $[\alpha]_D^{25} -15.1$  (c, 0.98,  $\text{CHCl}_3$ ) and (**100**) showed  $[\alpha]_D^{25} -21.2$  (c, 0.98,  $\text{CHCl}_3$ ).

### Acetylene approach

Having secured a viable route to chiral 3-hydroxy-5-alkenoates such as (**099** and **100**), we then required a far less complicated pathway in which these hydroxy alkenes could be accessed quickly, in high yield and with greater *cis* to *trans* ratios. Now, without the restraint of asymmetry, the acetylene route shown in *scheme 6* was our solution to this problem.

Lewis acid coupling of an acetylenic anion to a diazoacetate would furnish the necessary substituted alkyne. Lindlar reduction of this, known to produce excellent *cis* to *trans* ratios, would give the required *Z*-olefin, saponification followed by coupling with the magnesium chelate of hydrogen methyl malonate should deliver the  $\beta$ -ketoester. Having now removed the need for silyl-protection, four steps should produce the same product (**099**).

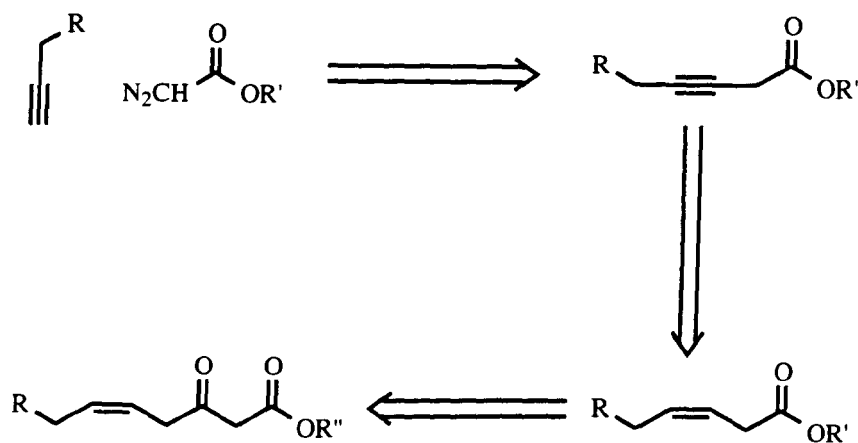

(Scheme 6)

We started with the coupling of hex-1-yne (**101**) with the available ethyl diazoacetate according to the method by Layton.<sup>291</sup> This involved formation of the lithium acetylide with *n*-butyl lithium, addition of boron trifluoride etherate to produce the corresponding trihexynyl borane, and coupling to the diazoacetate. After work up and simple chromatography the propargylic ester (**102**) was obtained in 84% yield, then hydrogenated, using Lindlar catalyst [Pd-CaCO<sub>3</sub>-PbO], to the *Z*-alkene in 86% yield (**103**).<sup>292a</sup>

Attempts to form these initial *Z*-alk-3-enoates by deconjugative protonation of the more commercially available *E*-alk-2-enoates met with only limited success.<sup>292b</sup> For example when ethyl *E*-oct-2-enoate was added to a slight excess of LDA in THF/HMPA at -78°C and the thus formed enolate quenched after 30 minutes with water, a 75% yield of the ethyl oct-3-enoate (**103**) was acquired. Unfortunately the isomeric ratio was only 70% rich in the required *Z*-isomer, less than was necessary for our investigations.

The carboxylic acid (**104**) was then secured by saponification of the ester (**103**) using methanolic potassium hydroxide, spectral data indicating that the *Z*-configuration of the olefin was still intact ( $\geq 98\%$ ).<sup>293</sup> The important  $\beta$ -ketoester forming step was accomplished using the method by Rapoport<sup>294</sup> and workers. Firstly the acid (**104**) was activated by coupling to carbonyl diimidazole and then this amide reacted with the magnesium chelate of methyl hydrogen malonate (formed by the reaction of *iso*-propylmagnesium bromide on the malonate). Break up of the magnesium complex with phosphoric acid, work up and simple column chromatography gave the  $\beta$ -ketoester (**105**) in a repeatable 50-60% yield. We were then left with the option of reducing this  $\beta$ -ketoester (**105**) to the required alcohol by chiral or non-chiral means. Since the main purpose of the route was to access such compounds quickly and in high yield we simply chose to reduce the keto function with borohydride,<sup>285</sup> although at a later stage this could be performed by bakers yeast<sup>279a</sup> or other existing methodologies.<sup>279b</sup> This then gave methyl *Z*-( $\pm$ )-3-hydroxydec-5-enoate (**106**) identical to the chiral material (**099**) produced by the Wittig route (*Scheme 7*).

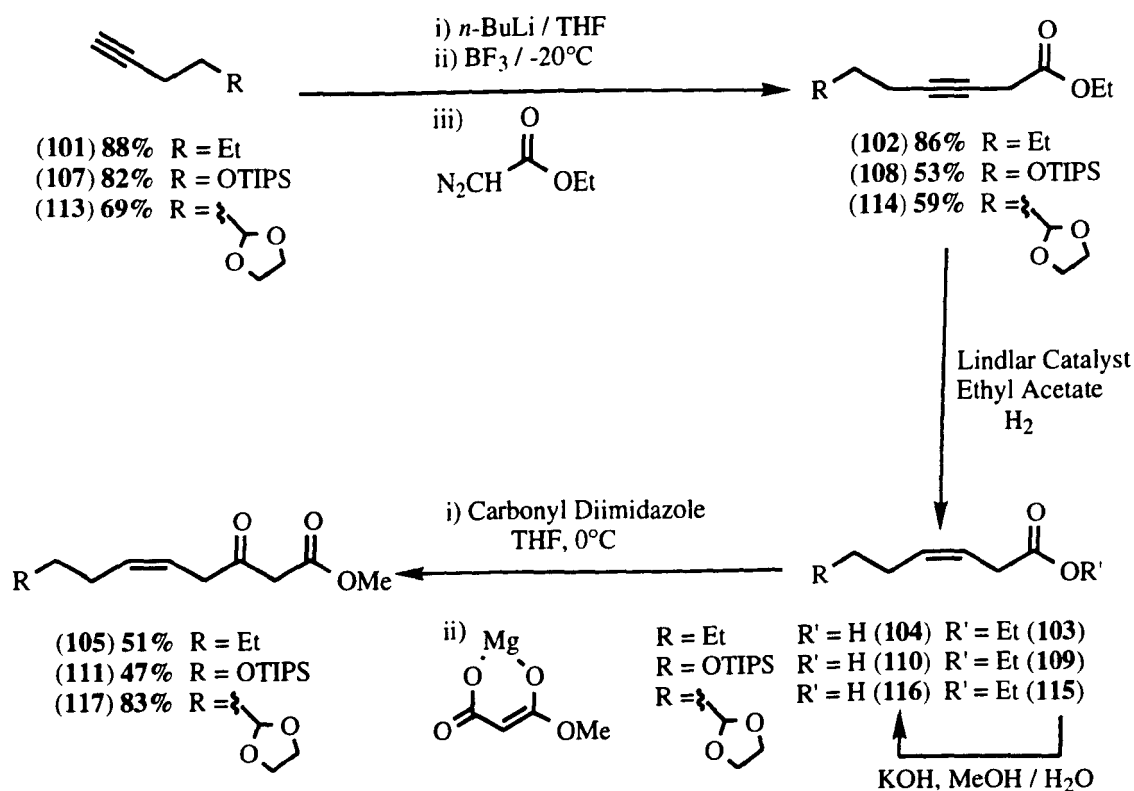

(Scheme 7)

We could then extend the scope of the reaction by synthesizing suitable substituted acetylenes, which then allowed more complex 3-hydroxy-5-alkenoates to be produced, something which was less viable in the Wittig approach. Two groups were chosen, a silyl protected alcohol (107) and dioxolane masked aldehyde (113). The first required acetylene (107) was readily produced by the reaction of triisopropylsilyl chloride on but-3-yn-1-ol under standard chemical conditions.<sup>286</sup> The latter acetylene (113) came from mixing commercial grade lithium acetylene ethylenediamine complex with 2-bromoethyl-1,3-dioxolane in dimethylsulphoxide, at ambient temperature.<sup>295</sup> This produced a 69% yield of the needed pent-4-ynyl-1,3-dioxolane. Both these acetylenes were taken through the same processes as for hex-1-yne, already mentioned above. This gave the  $\beta$ -ketoesters (111 and 117) in 47% and 83% yield respectively, the former, lower yield being accounted to desilylation of the product by the phosphoric acid used in the magnesium chelate step. This can no doubt be avoided by using water or alkali in place of the acid, which should be equally effective in breaking down the magnesium complex and since the triisopropylsilyl group is some ten times more stable in such conditions, desilylation should be avoided.

Reduction of these  $\beta$ -ketoesters (111 and 117) was then attempted, again employing sodium borohydride<sup>285a</sup> as reagent (*Scheme 8*).

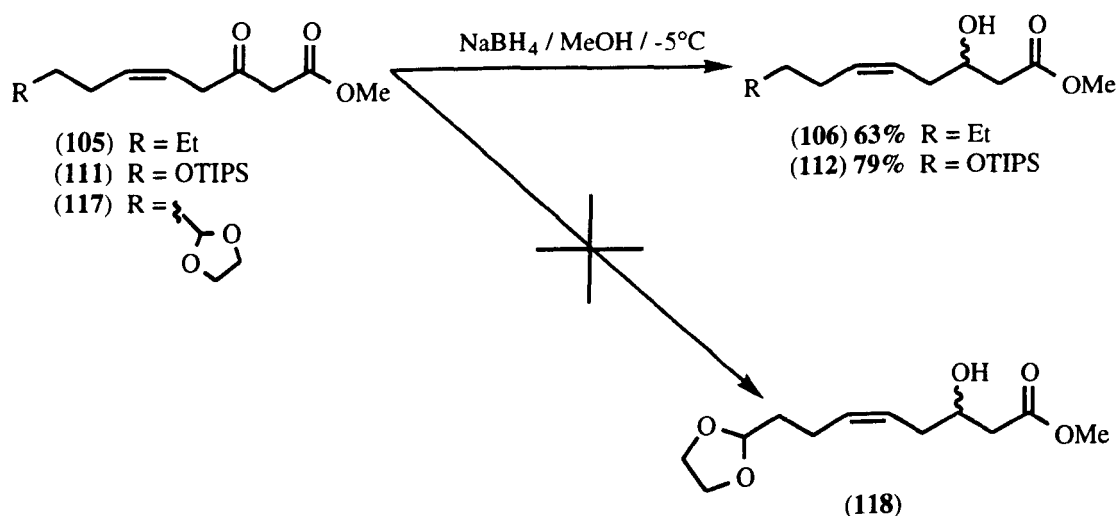

(Scheme 8)

Unfortunately, conversion to the corresponding alcohols was successful only for the triisopropylsilyl derivative (112), obtained in 79% yield. The dioxolane ketoester (117) appeared to break up and undergo double reduction. These normally mild conditions of reduction do not in general reduce carbon-carbon double bonds, although it is known in special cases where the double bond is polar.<sup>285b</sup> Double reduction can be avoided by using sodium borohydride in the presence of lanthanide chlorides<sup>285c</sup> or switching to lithium aluminium hydride reduction in the presence of silica gel, a method developed by Hojo<sup>285d</sup> *et. al* especially for ketoester reduction. Further investigation into the nature of this reaction would no doubt find a suitable solution to this problem.

#### *Knoevenagel condensations to E-alk-3-enoic acids*

Having been able to prepare a variety of simple and functionalized *cis*-3-hydroxy-5-alkenoates, some in chiral form, we now turned our attention to the elaboration of their *trans*-isomers. Again our key intermediate would be a  $\beta$ -ketoester now with an *E*-olefin in the 5-position (Scheme 9).

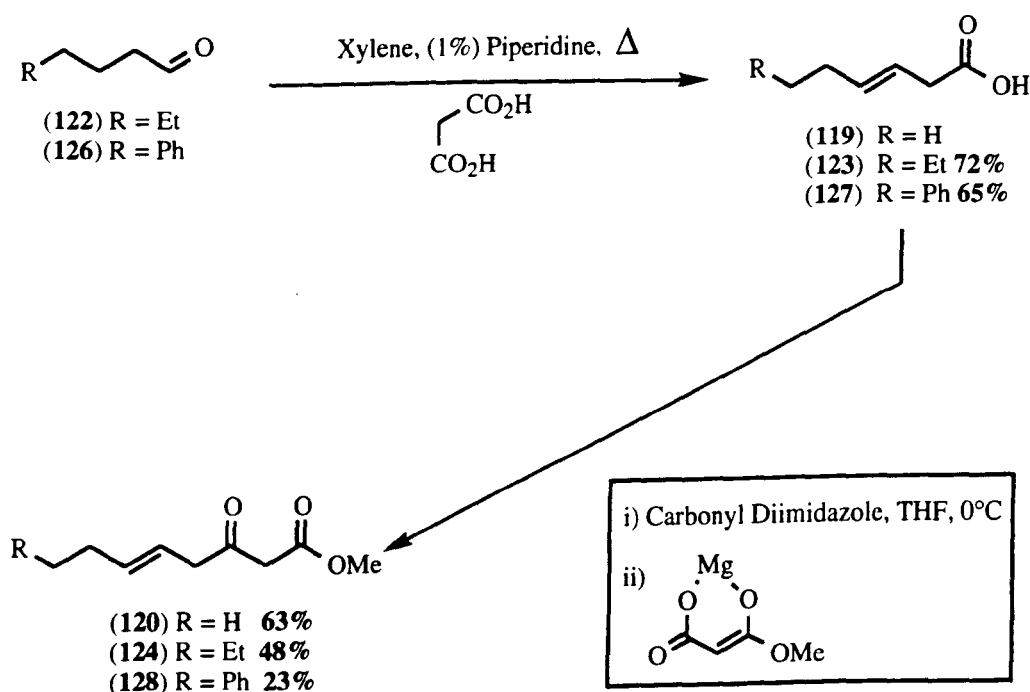

(Scheme 9)

These were clearly available from the complementary *E*-alk-3-enoic acids<sup>296</sup> by the same magnesium chelate reaction as was used above.<sup>294</sup> Simple examples of these acids are commercially available and so we were able to convert *E*-hex-3-enoic acid (**119**) through to the corresponding methyl *E*-(±)-3-hydroxyoct-5-enoate (**121**) in two steps and very high overall yield.

More functionalized *E*-alk-3-enoic acids could be derived from their reciprocal aldehydes *via* a modified Knoevenagel reaction.<sup>297</sup> For example we were able to react the aldehydes hexanal (**122**) and 4-phenylbutanal (**126**) [(**126**) from a Swern<sup>298</sup> oxidation of 4-phenylbutan-1-ol, 85%] with a refluxing mixture of malonic acid, piperidine catalyst and xylene solvent under standard Dean-Stark conditions to give *E*-oct-3-enoic (**123**) and phenylhex-3-enoic (**127**) acid in 72% and 65% yield respectively. These were then taken through to the required *E*-(±)-3-hydroxyalk-5-enoates as before (**125** and **129**).

The *E*-(±)-3-hydroxyoct-5-enoate (**121**) was converted into its *t*-butyldimethylsilyl ether (**130**)<sup>286</sup> and subsequent saponification<sup>293</sup> gave the required acid (**131**) needed for the iodolactonization work (*Scheme 10*).

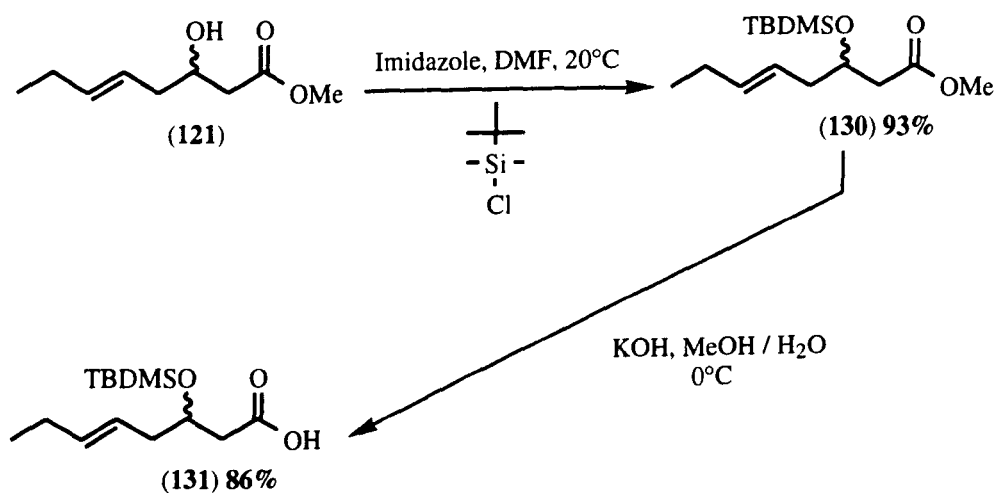

(*Scheme 10*)

### *Wittig rearrangement route to 2-hydroxy-4-alkenoates*

We required at least one example of a 2-hydroxy-4-alkenoate for our probe into the mechanism of our cyclization reaction. This actively moves the ester

function one place nearer to the cyclizing hydroxyl group and the resulting effect on the reaction was to be studied. We choose a direct route to this molecule, shown in *scheme 11*, where the key step was the Wittig rearrangement.<sup>299</sup> This rearrangement should give a mixture of olefinic isomers [*E*>*Z*] which was not thought to be a problem at the time. The readily prepared alcohol<sup>300</sup> (**132**) [*Grignard reaction of vinyl magnesium bromide and pentanal*] was coupled to bromoacetic acid under standard conditions<sup>301</sup> to give the Wittig rearrangement precursor in >75% yield (**133**). Reaction with LDA in tetrahydrofuran at -78°C for twenty or so hours produced the rearranged acid (**134**) in excellent yield.<sup>299</sup> This crude product was submitted to diazomethane esterification<sup>302</sup> without further purification.

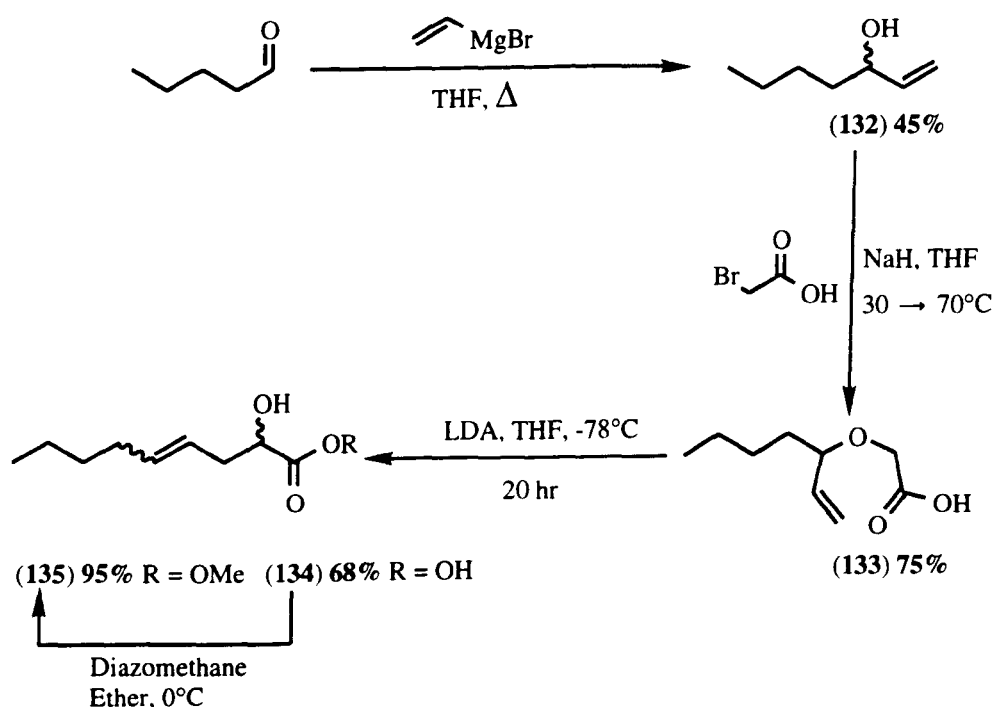

(Scheme 11)

Simple column chromatography gave methyl 2-hydroxynon-4-enoate (**135**) in 95% yield. The stereochemical outcome of the reaction was a two to one preference in favour of the *E*-isomer, this was atypical of the reaction since similar examples have been rearranged almost 95% pure *trans*.<sup>299</sup>

### Synthesis of *cis*- and *trans*-dec-5-en-3-ol derivatives.

In the later stages of our investigations into the iodocyclizations of homoallylic alcohols there was a requirement for simple examples of these alcohols where no complex functionality was present. We chose to make decenol derivatives as they were readily available from the coupling of hex-1-yne and 1,2-epoxybutane and subsequent reduction of the thus formed acetylene. Both *cis* and *trans* examples could be made from this same acetylene by applying appropriate reduction techniques.

Coupling was accomplished using a method developed by Yamaguchi<sup>303</sup> in which the terminal acetylene was first deprotonated with strong base and then the intermediate alkynyl borane formed by addition of boron trifluoride etherate solution. Addition of a suitable oxirane then gives the wanted substituted acetylene. Using hex-1-yne we were able to obtain dec-5-yn-3-ol (**136**) in an excellent 91% yield, (*Scheme 12*). Hydrogenolysis of this alkyne (**136**) using Lindlar<sup>292a</sup> catalyst gave the required *cis*-olefin (**137**) in greater than 95% yield after column chromatography.

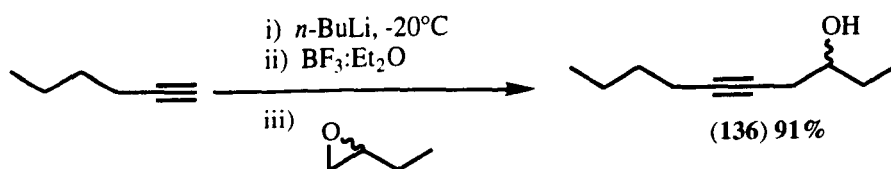

Synthesis of the *trans*-isomer (**138**) proved far more complicated than first anticipated. This should be available by submitting the acetylene (**136**) to sodium in ammonia reduction.<sup>304</sup> This however gave very poor results in which the product was isolated in <10% yield. Reduction using metal hydrides was then attempted in which we refluxed the acetylene (**136**) in lithium aluminium hydride in tetrahydrofuran suspension.<sup>305</sup> Nevertheless, despite our utmost efforts the recovered olefin yield was also abysmally low.



Successful construction of the *trans*-isomer (**138**) was only achieved when we resorted to a hydroalumination method.<sup>306</sup> Firstly hex-1-yne was reacted with diisobutylaluminium hydride and subsequent addition of *n*-butyl lithium yielded the intermediate lithium vinylalenate, which was treated with 1,2-epoxybutane at room temperature. Hydrolytic work up and column chromatography gave *trans*-dec-5-en-3-ol in 41% yield with over 99% *E*-selectivity (*Scheme 13*).

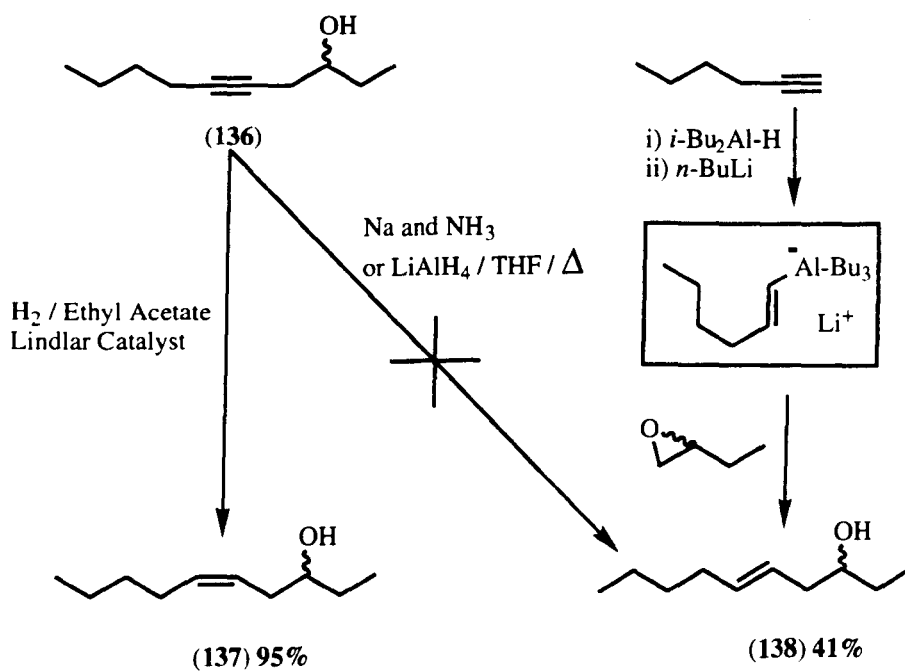

(Scheme 13)

### Advanced acetylene approach

There was still a need to develop a flexible route to chiral 3-hydroxy-5-alkenoates required for the elaboration of Natural Product targets. The chiral Wittig approach, as mentioned beforehand, suffered from three main drawbacks; the multi-sequential steps and therefore the amount of time necessary to gain access to these precursors, the inadequacy of the method to prepare authentic samples of the olefins and finally the chiral purity of the initial yeast reduction product (**089**).

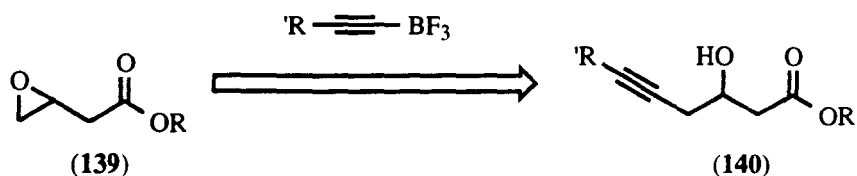

(Scheme 14)

Our new chiral route (Scheme 14) would draw upon the success of the decenol methodology. If it was possible to perform this same chemistry not only with simple alkylated epoxides but chiral ones containing the necessary ester functional group (139), then the intermediate alkyne (140) formed from such a pairing could be reduced by known methods to genuine examples of both *Z*- and *E*-olefins. The production of pure chiral *cis* and *trans*-3-hydroxy-5-alkenoates would then be a real possibility.

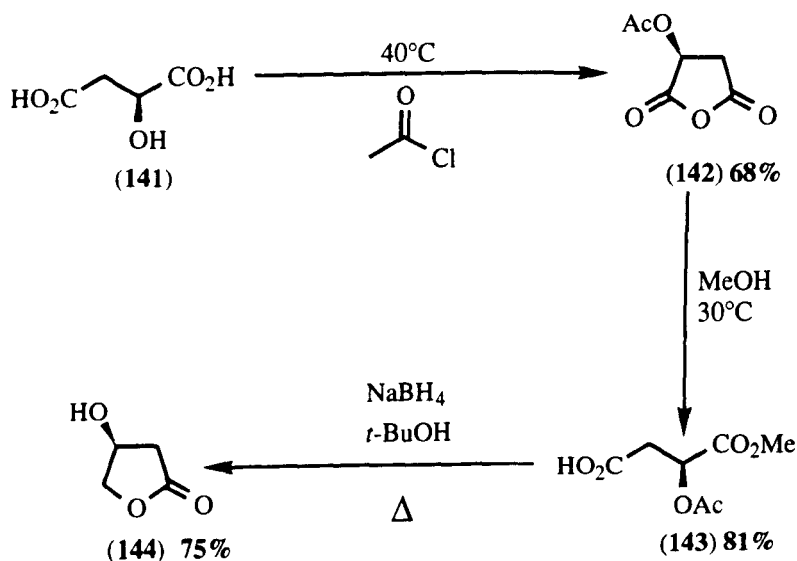

(Scheme 15)

The synthesis of the desired chiral epoxides was the next problem to overcome. We needed both (*R*) and (*S*)-3,4-epoxybutanoate with a suitable ester function for our Natural Product elaboration. The (*S*)-enantiomer was available from (*S*)-malic acid by a route developed by Larqueveque<sup>307</sup> in which the chiral acid (141) was first reacted with acetyl chloride and thus converted into the intermediate anhydride (142) shown (Scheme 15).

This anhydride (**142**) was then alcoholised into the mono-ester (**143**) and then reduced chemoselectively by sodium borohydride into a dihydroxy acid which cyclizes spontaneously into 3-hydroxy-4-butanolide (**144**). This key intermediate can then be cleaved with trimethylsilyl iodide to provide the corresponding iodoalkylcarboxylic ester after hydrolytic work up. This can then be converted to the desired epoxide by refluxing the ester in monoglyme with silver oxide for eight or so hours.

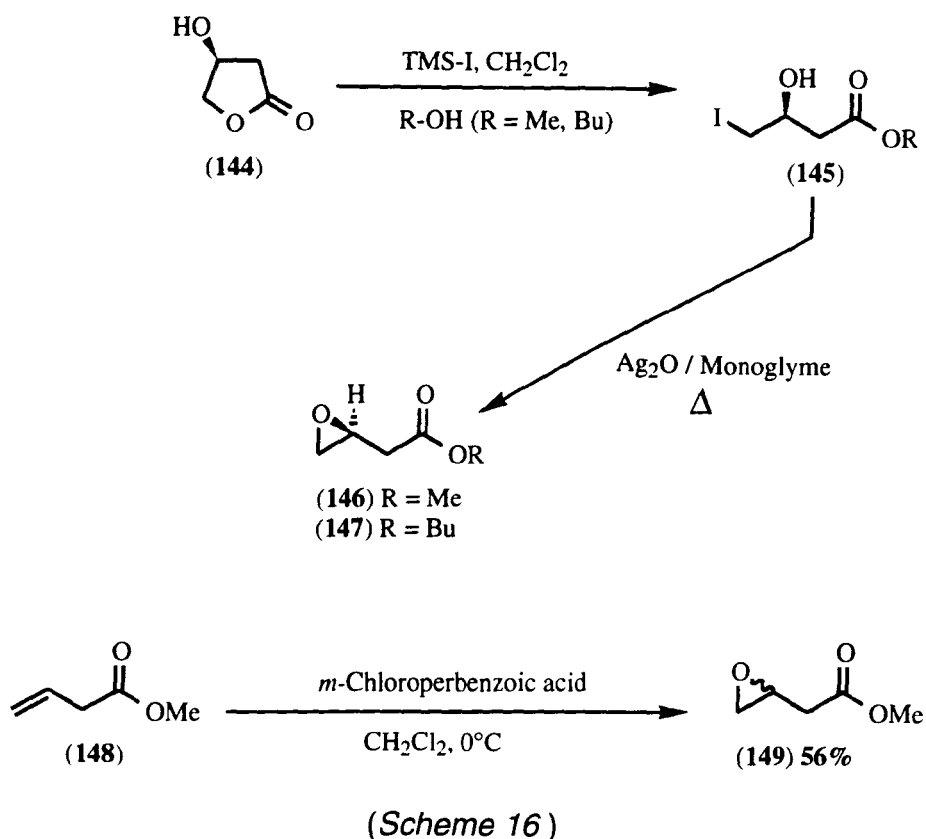

We were able to form 3-hydroxy-4-butanolide (**144**) in 75% yield as expected without any problem. However, a successful conversion to the epoxide eluded us (Scheme 16). Reaction with TMS-iodide in methanol under the prescribed conditions gave a poor yield of the iodohydrin (**145**) and no success was had in converting this through to the epoxide (**146**). We suspected that this was mainly due to volatility problems with this product since its boiling point of 60°C/13 mm makes it virtually impossible to recover from the solvent.<sup>308</sup>

Further research in our group<sup>309</sup> was to overcome this problem by

substituting butanol for methanol in the lactone cleavage step and then successful construction of butyl (S)-3,4-epoxybutanoate (**147**) was realised. Formation of the methyl, but racemic, epoxide (**149**) was achieved by the action of 3-chloroperbenzoic acid on methyl butenoate (**148**) under standard conditions.<sup>308</sup> Again problems with volatility meant the recovered yield after distillation was only 56% for the single step.

The other enantiomer (3R) was being prepared by an alternative route in which the key step involved microbial reduction of octyl 4-chloro-3-oxobutanoate (**151**),<sup>310</sup> which was readily available by known methods (*Scheme 17*).<sup>311</sup> This reduction is known to give octyl (3R)-(+)-4-chloro-3-hydroxybutanoate (**152**) of the very highest optical purity, our sample showed  $[\alpha]_D^{25} = +16.3$  (c, 10.0, CHCl<sub>3</sub>) and the literature reference sample  $[\alpha]_D^{25} = +16.8$  (c, 10.2, CHCl<sub>3</sub>).<sup>312</sup> The same product was available by hydrogenation of the ketoester (**151**) with Ru(OCOCH<sub>3</sub>)<sub>2</sub>[(S)-binap] complex to give the (R)-alcohol (**152**) in 97% ee.<sup>279b</sup> Importantly, reduction of the ethyl ketoester with the (R) form of the complex was reported to give the other enantiomer in equally high purity. The next stage was the cyclization to the chiral epoxide (**153**). This was accomplished by subjecting the chloro alcohol (**152**) to freshly prepared silver oxide in refluxing monoglyme for 16 hr.<sup>313</sup> After column chromatography the chiral epoxide (**153**) was obtained in 66% yield  $[\alpha]_D^{25} = +13.8$  (c, 1.0, CHCl<sub>3</sub>).<sup>314a</sup>

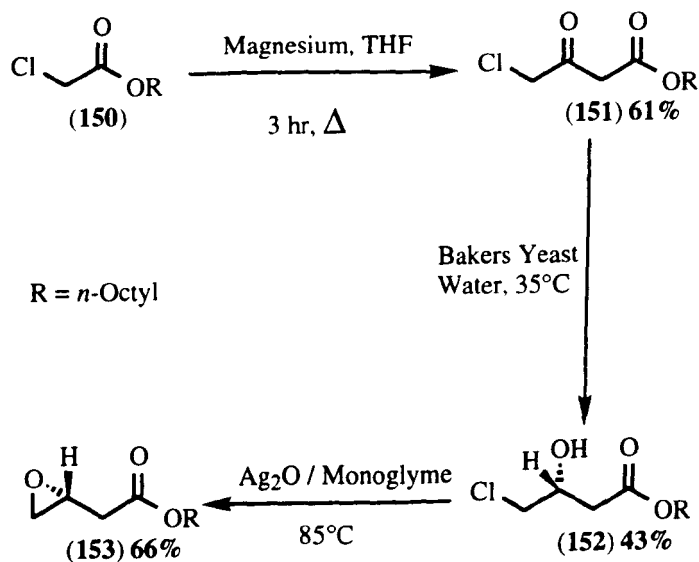

(Scheme 17)

Later work by Shaw<sup>309</sup> was to show that a wide range of the required 3-hydroxy-5-alkynoates could be constructed by applying Yamaguchi's acetylene coupling conditions to these and other complementary epoxides. However, although reduction of these acetylenes to the corresponding *cis*-olefins proved as easy as before,<sup>292a</sup> reduction techniques<sup>304</sup> to the *trans*-isomers again failed to live up to expectations. Attempts to get around this problem have included vinyl cuprate<sup>307, 314b</sup> and vinyl alane transmetalation<sup>315</sup> chemistry but these have met with limited success.

### c) Iodolactonizations of 3-silyloxy-5-alkenoic acids

Earlier work in our group had shown that iodo- and seleno-induced cyclizations of *Z*-3-silyloxy-5-alkenoic acids led very largely to the *trans*-disubstituted valerolactones, useful precursors to the mevinic acid analogues, as well as a number of other types of valerolactone.<sup>270, 271</sup> We found that selenolactonization of the hydroxy acid (**154**) under kinetic conditions [THF/1 hr] gave a 10:1 mixture of the selenolactones (**155** and **156**) but only in a modest 40% yield (*Scheme 18*). In contrast, switching to more thermodynamic conditions, [ether/triethylamine/72 hr] improved the yield to 65% but there was now no stereoselection [1:1 ratio].

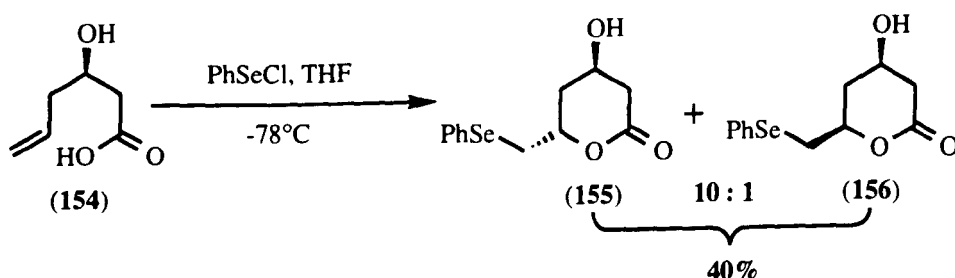

(Scheme 18)

Attention was then turned to iodolactonization of the hydroxy acid (**154**)

and its silyl derivatives (**157**, **158** and **159**). Direct iodolactonization on (**154**) under kinetically controlled conditions [ $I_2/NaHCO_3/MeCN$ ] led to a poor yield (23%) of the iodolactones (**160** and **161**) in a ratio of 3:1 respectively (*Scheme 19*). However, such cyclizations were much more productive when carried out on the corresponding silyl ethers (**157**, **158** and **159**). Thus, the *t*-butyldimethylsilyl derivative (**157**) gave a similar 3:1 ratio, *trans* to *cis*, of the expected iodolactones (**162** and **163**) respectively in 84% isolated yield.

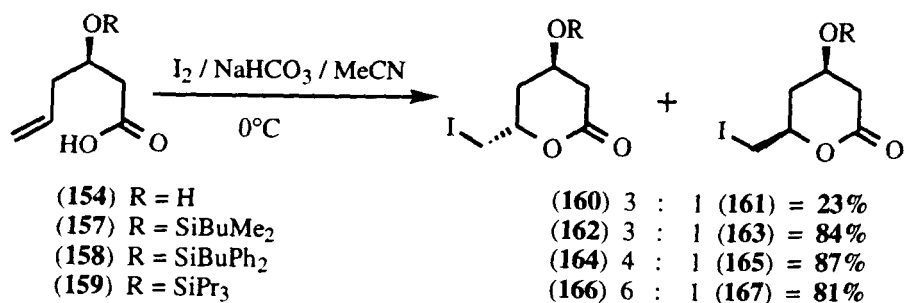

(*Scheme 19*)

Increases in the bulk of the silyl ether function resulted in higher stereoselections; *t*-butyldiphenylsilyl ether (**158**) gave a 4:1 ratio which was improved to 6:1, *trans* to *cis*, in the case of the triisopropylsilyl ether (**159**). Attempts to extrapolate this work to the selenolactonization reaction were unsuccessful.<sup>270</sup>

The relative stereochemistry of all the lactones was determined first by removal of the seleno- or iodo-group by reflux with tributyltin hydride then separation by column chromatography and finally appropriate decoupling and COSY experiments. This work was used to complete a total synthesis of natural (+)-(4*R*,6*R*)-4-hydroxy-6-pentylvalerolactone (**170**), a metabolite<sup>271</sup> of *Cephalosporium recifei*, where cyclization of (3*R*)-*Z*-3-(triisopropylsilyl)oxydec-5-enoic acid (**168**) gave a greater than 10:1 preference for the required *trans*-lactone (**169**) (*Scheme 20*).

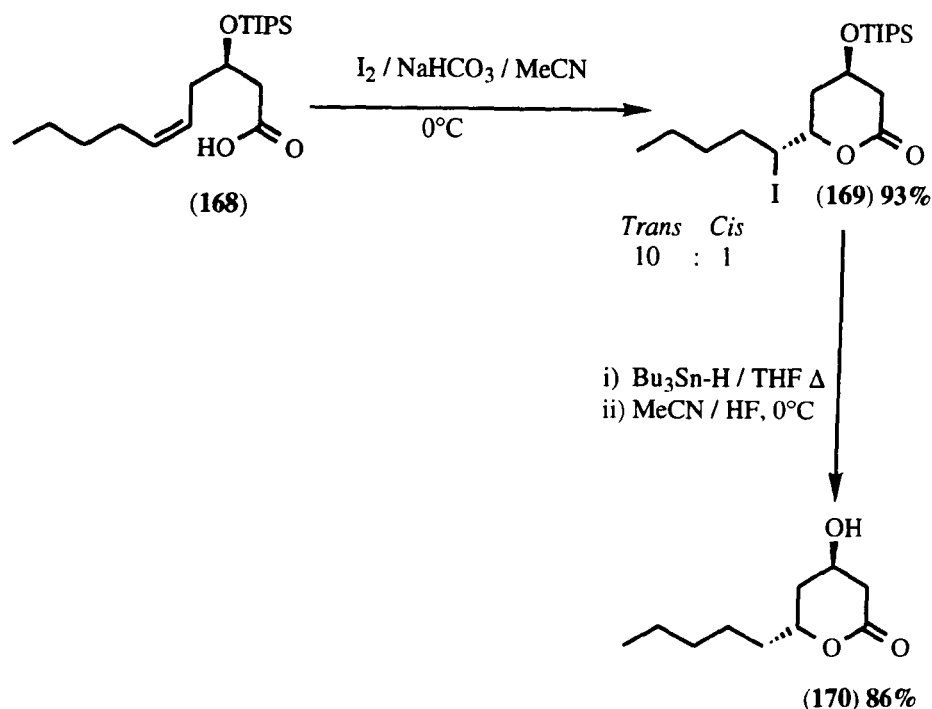

(Scheme 20)

The preferential *trans* stereoselectivity in these cyclizations was a somewhat unexpected finding in view of Bartlett's<sup>272</sup> earlier observation on a similar cyclization of 3-methyl-5-hexenoic acid (171) which gave largely the *cis*-disubstituted lactone (173) and not its *trans* partner (172) (Scheme 21). The reaction gave the best results when control was thermodynamic [ $I_2/MeCN$ ] rather than kinetic [ $I_2/NaHCO_3/MeCN$ ] in nature. Presumably, this reaction proceeds *via* a chair-like transition state, wherein the methyl group occupies an equatorial position.

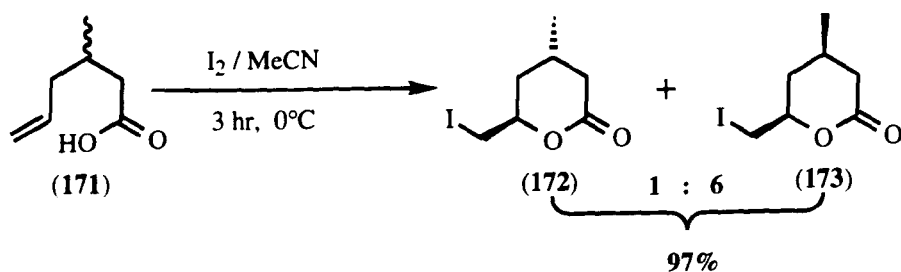

(Scheme 21)

### Stereoselection in iodolactonizations of 3-silyloxy-5-alkenoic acids

In our initial work,<sup>270, 271</sup> the stereochemistry of the iodine atom in the major diastereoisomers was not determined as our aim was to remove it to obtain the lactones. To further probe the mechanism and extend the synthetic utility of this type of cyclization, we have now determined the stereochemistry at this site and also extended the method to include the complementary *E*-3-silyloxy-5-alkenoic acids.<sup>273</sup> When the iodolactone (175) was exposed to sodium carbonate in methanol,<sup>316</sup> smooth methanolysis and intramolecular displacement occurred to give the reciprocal epoxy-ester (177). The stereochemistry of the epoxide was evidently *cis*, according to the magnitude of the coupling constant [4.6Hz] of the two epoxide protons.<sup>317</sup> Hence the initial iodolactone (175) had the relative stereochemistry shown (Scheme 22).

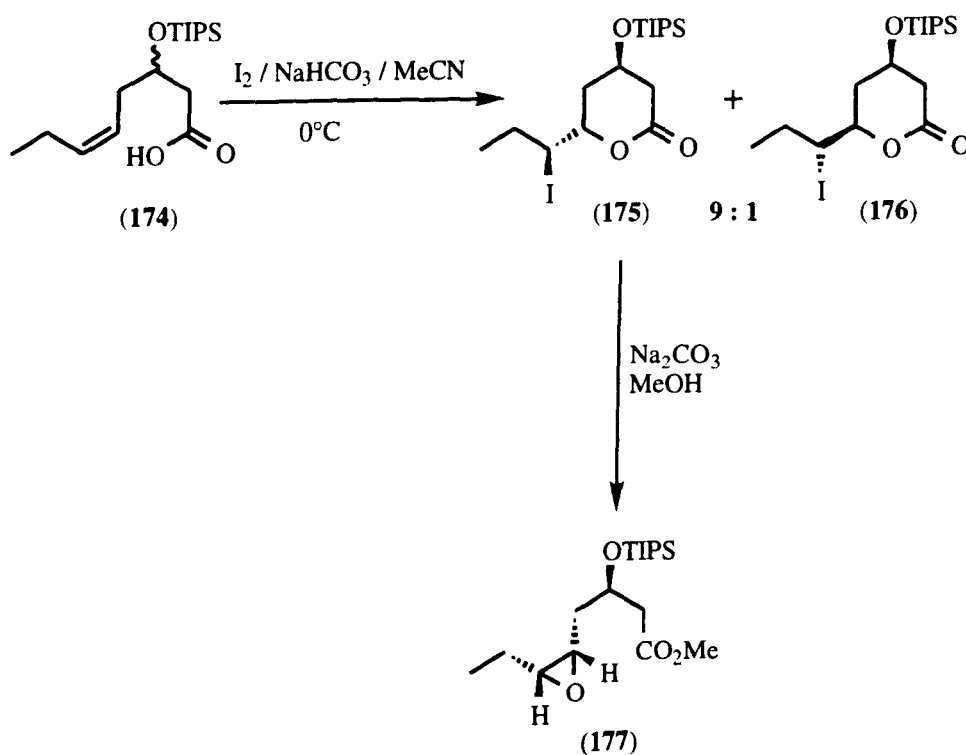

(Scheme 22)



When the corresponding *E*-3-silyloxy-5-alkenoic acid (**131**) was subjected to the same iodolactonization conditions to those used above, the resulting lactone (**178**) was isolated as a single diastereomer, according to  $^{13}\text{C}$  NMR spectroscopy in 85-90% yield, following column chromatography. The 4- and 6-substituents were clearly *trans*, according to  $^1\text{H}$  NMR analysis along the lines previously reported<sup>270, 271</sup>. It became clear that this product (**178**) differed from the reciprocal lactone (**175**), derived from the *Z*-alkenoic acid (**174**), only in the stereochemistry of the iodine substituent (*Scheme 23*). This was confirmed when the iodolactone (**178**) was transformed into the corresponding epoxy-ester (**179**) as before.<sup>316</sup> In this case, a coupling constant of 2.3Hz showed the epoxide to have the *trans*-stereochemistry.<sup>317</sup>

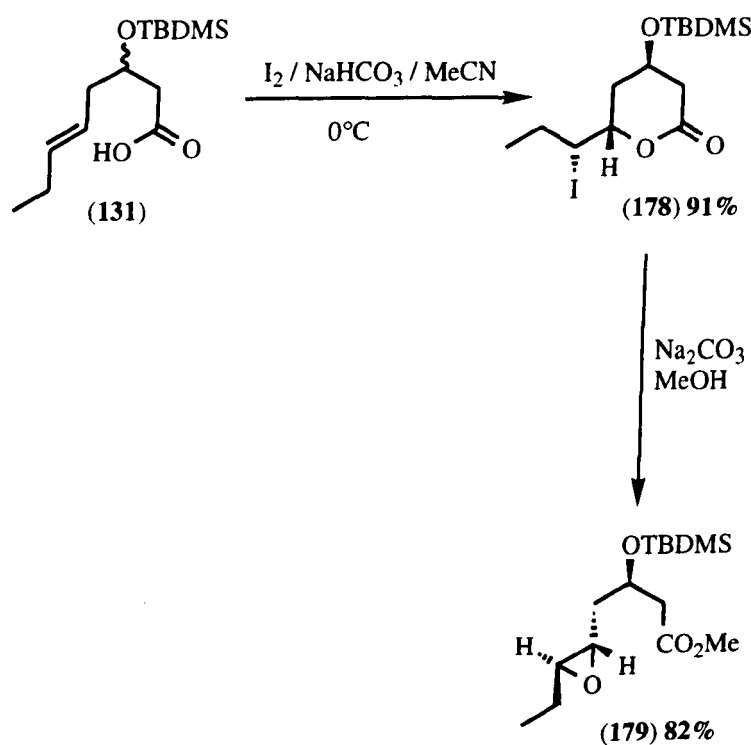

(*Scheme 23*)

This suggests that the silyloxy substituent is in the axial rather than the expected equatorial position during the iodocyclization (*Scheme 24*). These data implicate the transition state (**I**) in which the silyloxy function is held in the

less favourable axial position by intramolecular hydrogen bonding. A similar proposal was suggested by Yoshida<sup>178, 185</sup> to explain the stereochemical outcomes of his pentene diol cyclizations [see introduction page 71].

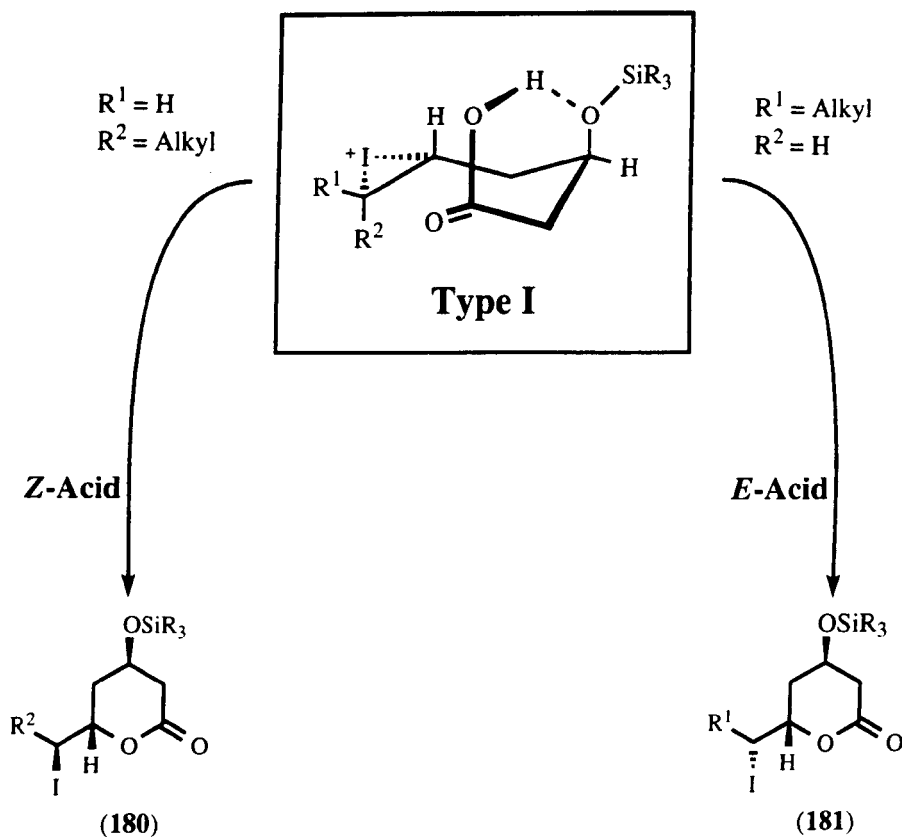

(Scheme 24)

#### d) Formation of trisubstituted tetrahydrofurans

As already stated, we had found that iodine-induced cyclizations of *E*- and *Z*-3-silyloxy-5-hexenoic acids gave the *trans*-disubstituted valerolactones.<sup>273</sup> We next tried to maximise the small quantities of tetrahydrofurans from these reactions. It seemed likely that they were formed by a *5-endo-trig* process involving loss of the silyl group and we therefore examined the related cyclizations of the complementary 3-hydroxy-5-alkenoates.<sup>274</sup> In most cases the methyl ester function was used to prevent lactone formation while the free hydroxyl group would favour tetrahydrofuran formation.

### *Iodoetherification reactions of 3-hydroxy-5-alkenoates*

When methyl *Z*-(±)-3-hydroxydec-5-enoate (**106**) was exposed to iodine and sodium bicarbonate in acetonitrile at -5 to 0°C for 60 hr, the unexpected hydroxytetrahydrofuran (**182**) was isolated, following column chromatography, in 69% yield, accompanied by no more than traces of the less polar iodotetrahydrofurans (**183** and **184**) (*Scheme 25*).

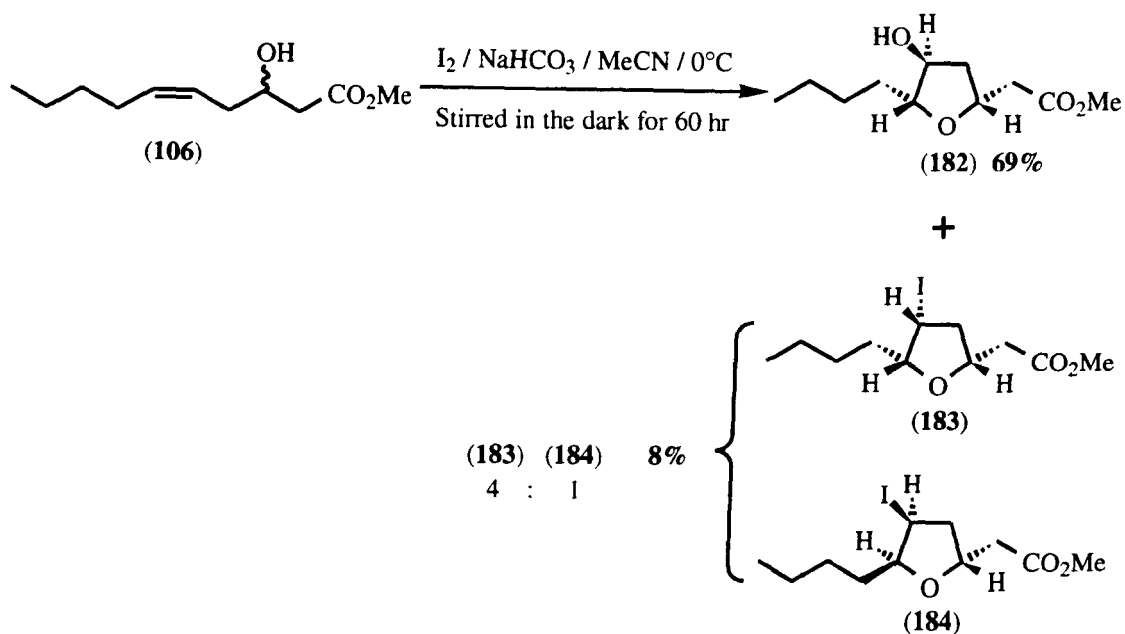

(*Scheme 25*)

The structures of these products were proven by the usual spectroscopic and analytical techniques,<sup>318a</sup> while the stereochemistry of the hydroxytetrahydrofuran was determined largely by *nOe* studies (*Scheme 26*). This assignment of stereochemistry was also consistent with those of a related series of trisubstituted 4-benzoyloxytetrahydrofurans reported by Williams and his colleagues,<sup>318b</sup> based upon chemical shift data. He was able to prepare the series of benzoate tetrahydrofurans (**185 to 188**), shown in *scheme 27*, and found that these molecules could be recognised as two distinct groups.

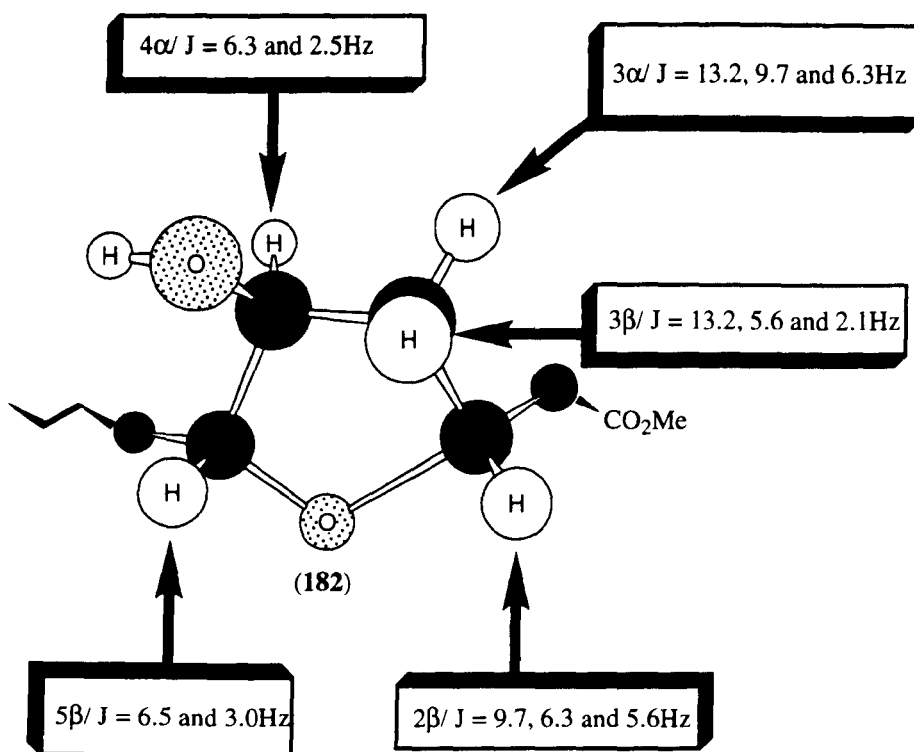

(Scheme 26)

A *trans* relationship at the C5 and C4 substituents resulted in shielding of the benzoate methine proton [5.3ppm] by the C5 aliphatic chain compared to a *cis* 4,5-substitution [5.6ppm]. The non-equivalent methylene protons at C3 were indicative of the 1,3-asymmetry at C4 and C2.

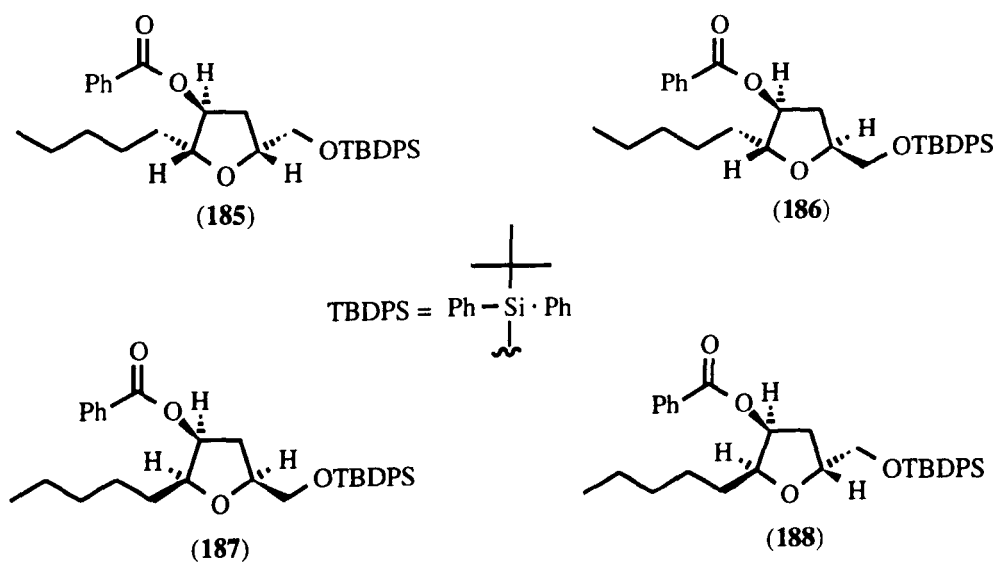

(Scheme 27)

For the isomer pair bearing a *syn* 2,5-relationship, chemical shift patterns revealed  $\geq 0.4\text{ppm}$  and for the *anti* 2,5-isomers  $\leq 0.2\text{ppm}$  difference. For a direct comparison, we converted the initial product (**182**) into the corresponding benzoate (**189**) and also into the epimeric benzoate (**190**) by Mitsunobu<sup>319</sup> reaction (*Scheme 28*).

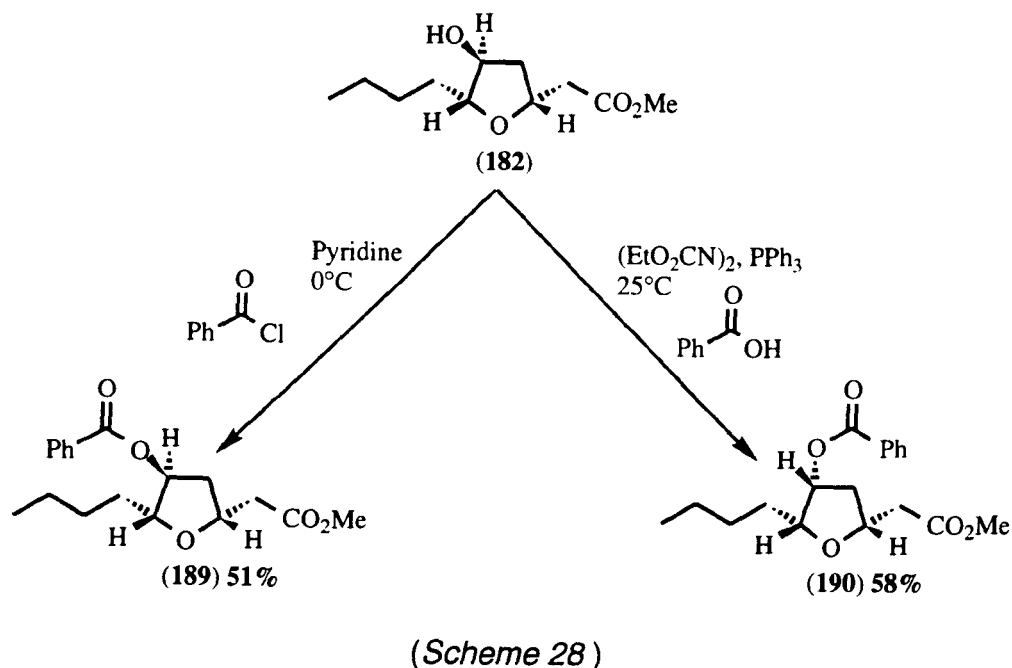

The ester (**189**) exhibited an absorption at 5.2ppm which suggested a *trans* relationship between C5 and C4, multiplets at 1.95 and 2.25ppm [ $\Delta 0.3\text{ppm}$ ] corresponded to the C3 methylene group having an *anti* 2,4-relationship and a *syn* 2,5-pattern [ $\Delta 0.7\text{ppm}$ ], hence the stereochemistry shown. The epimeric ester (**190**) also exhibited spectral data in line with the Williams<sup>318b</sup> assignments, as well as appropriate nOe data.

We made no attempt to rigorously assign the stereochemistry of the iodotetrahydrofuran products due to the low quantities of material recovered and therefore the inherent difficulty in separating them individually for nOe examination. However, it is possible that production of the iodides (**183** and **184**) can be rationalised from the chair like transition states (**II**) and (**III**)

(Scheme 29). The shown stereochemical outcomes for the two iodocyclic ethers are thus shown. Transition state (II) suffers from relatively less steric interactions and hence generates the major "all *cis*" product (**183**).

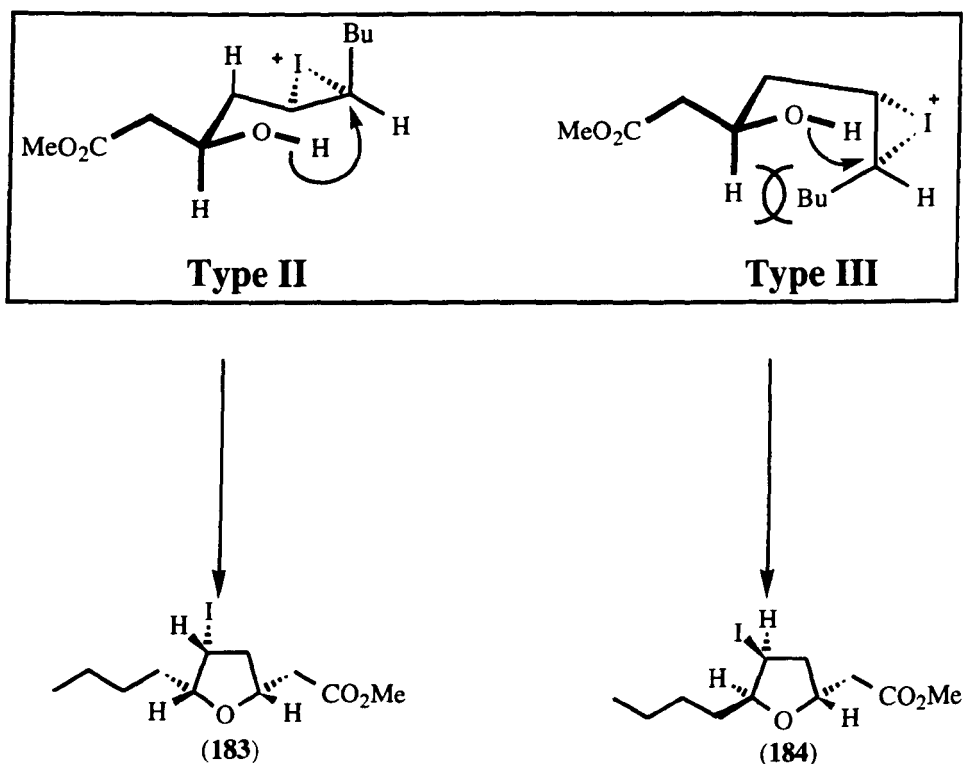

(Scheme 29)

We then undertook extensive experimentation to determine the mechanism and nature of this cyclization. Several hypotheses on the stereoselective formation of this carbinol were framed. First, the initial product iodide (**183**) could have undergone subsequent Walden<sup>320</sup> inversion with some hydroxide equivalent. This may have resulted from nucleophilic attack by a bicarbonate anion followed by decarboxylation, yielding the product. This process is known to occur for allylic bromides<sup>321</sup> so the hypothesis was tested by firstly rerunning the experiment several times to isolate enough of the iodotetrahydrofurans (**183** and **184**). Column chromatography was then successful in separating enough of each diastereomeric iodide for experimentation. Subjecting both of these independently to the cyclization conditions failed to produce any of the hydroxytetrahydrofuran (**182**). We then

repeated the reactions but this time running the reactions in a one to one mixture of acetonitrile and water in the hope that this would aid the interconversion, but again only the quantitative recovery of the initial iodotetrahydrofurans was accomplished. In any event, this was an unlikely displacement as the electrophile can be regarded as a  $\beta$ -iodoether, well known to be relatively unreactive.<sup>322</sup>

We carried out the reaction again, this time terminating the process after 3 hr and subjecting the crude reaction product to column chromatography. Surprisingly, only a small quantity of the iodides (**183** and **184**) were recovered. The major product was again the alcohol (**182**), contaminated this time with at least one other polar component (**191**). These results suggested that the small quantity of iodides (**183** and **184**) that were isolated are formed from a completely different pathway from the one that produces the alcohol (**182**). It therefore seemed unlikely that this alcohol is produced by simple displacement of the iodo group from (**183**) as this would require a very fast hydroxylation step and be selective for this iodotetrahydrofuran only.

Isolation of a secondary polar compound (**191**) at this stage seemed likely to be a possible intermediate of the reaction. Close scrutiny of this revealed it to be no more than the fully saturated precursor, methyl 3-hydroxydecanoate, [ $\delta_{\text{H}}(400)$  0.88-0.98(3H, m,  $\text{CH}_3\text{CH}_2\text{CH}_2$ ), 1.11-1.72(10H, m,  $5\times\text{CH}_2$ ), 2.62(2H, ABX,  $J_{\text{AB}} = 13.3$ ,  $J_{\text{AX}} = 6.9$  and  $J_{\text{BX}} = 6.5\text{Hz}$ ,  $\text{CH}_2\text{CO}_2\text{CH}_3$ ), 2.81(1H, bs, OH), 3.69(3H, s,  $\text{CO}_2\text{CH}_3$ ) and 3.75(1H, m,  $\text{CHOH}$ ),  $\delta_{\text{C}}(100)$  173.81(C=O), 68.32(CH), 52.01( $\text{CH}_3$ ), 41.38( $\text{CH}_2$ ), 36.77( $\text{CH}_2$ ), 31.98( $\text{CH}_2$ ), 25.43( $\text{CH}_2$ ), 22.86( $\text{CH}_2$ ) and 14.29( $\text{CH}_3$ )]. The origin of this compound is unclear; one suspects it must have been created during Lindlar<sup>292a</sup> hydrogenolysis of the earlier acetylene (**102**) although passing through the next three synthetic steps without detection seems improbable. Borohydride reduction<sup>285</sup> of the ketoester (**105**) is the next most plausible cause since we had a similar problem with the dioxolane ketoester derivative (**117**).

Perseverance with the reaction revealed a strong link with hydroxytetrahydrofuran (**182**) formation and the amount of water present in the

reaction. Most of the experiments up to then had been conducted on a small scale [0.5mmol] basis. However, when we turned to larger scale preparations [20mmol] the yields of isolated carbinol fell. We then ran similar scale reactions in one to one water/acetonitrile mixtures and recovered the alcohol (**182**) in high yields ranging from 78-83%. Water added in stoichiometric amounts gave similar results to that of the neat solvent.

Cyclization of chiral 3-hydroxy-5-decenoate (**099**), from the yeast reduction<sup>279</sup> path, gave the hydroxytetrahydrofuran (**182**) showing  $[\alpha]_D^{25} +15.0$  (c, 0.98,  $\text{CHCl}_3$ ). A study was undertaken to confirm the absolute configuration of this product by forming a suitable crystalline derivative for X-ray crystallographic analysis. Unfortunately this proved impossible to do although work to synthesize a Natural Product and hence determine which enantiomer is present is under way.

More functionalized analogues of this reaction did not fair so well. The cyclization of methyl *Z*-(triisopropylsilyloxy)-3-hydroxy-oct-5-enoate (**112**) was a case in point. TLC analysis revealed that complete conversion to a single, more polar product had occurred by 72 hr. Column chromatography isolated a compound in good yield [69% assuming the product was the hydroxytetrahydrofuran (**192**)] (Scheme 30).

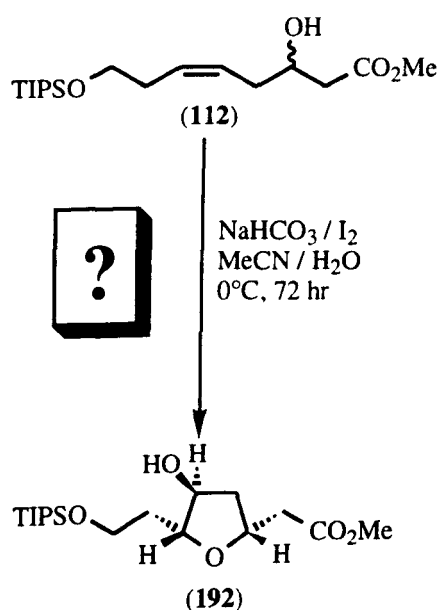

(Scheme 30)



However, the long time period required to collect sufficient NMR data on said compound resulted in its decomposition; several spots on the re-run TLC plate [*desilylation or migration of the TIPS group*]. This corrupt data still showed good signs of tetrahydrofuran formation with  $^1\text{H}$  and  $^{13}\text{C}$  spectra containing resonances in line with the earlier butyl variant though further extrapolation of these data would be an unrealistic proposition. Further repetition of the experiment was not possible, but future persistence with this work should provide a stereoselective approach to these highly functionalized tetrahydrofurans.

Later work<sup>309</sup> resulted in the construction of the 5-ethyl and 5-phenylethyl-hydroxytetrahydrofurans (**193** and **194**) which were isolated in similar yields to the 5-butyl-example [*87% and 70% respectively*], in each case as single diastereomers. However, yields were much lower from cyclizations of the corresponding butyl and benzyl esters (**195** and **196**) [*30% and 10% respectively*]. This no doubt reflects some steric<sup>323</sup> or, perhaps more likely, electronic<sup>324</sup> interference with the transition state that leads to the hydroxylated tetrahydrofurans (*Scheme 31*).

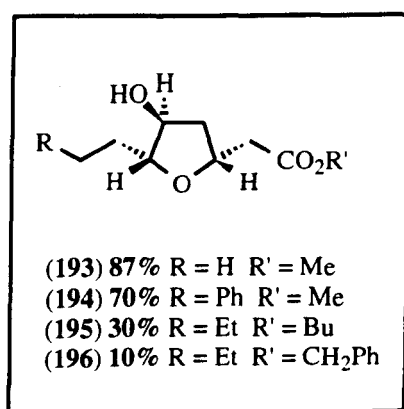

(Scheme 31)

We next examined cyclizations of the complementary *E*-3-hydroxy-5-alkenoates. When methyl *E*-3-hydroxyoct-5-enoate (**121**) was subjected to the same semi-aqueous reaction conditions it underwent cyclization, but more

rapidly [ $<1$  hr,  $0^{\circ}\text{C}$ ] and led instead to the iodotetrahydrofurans (**197** and **198**) in an excellent 86% isolated yield (*Scheme 32*). In this case, the cyclization was reasonably stereoselective; the major product (**197**) was accompanied by less than 18% of a second epimeric iodotetrahydrofuran (**198**), the stereochemistry of which was established as shown, by nOe measurements and coupling constant data.<sup>318a</sup> The cyclization of *E*-3-hydroxydec-5-enoate (**125**) was similar with an overall yield of 81% of iodotetrahydrofurans (**199** and **200**) being recovered and an almost identical level of stereoselection. The stereochemical assignments were then made by comparative  $^{13}\text{C}$  NMR.

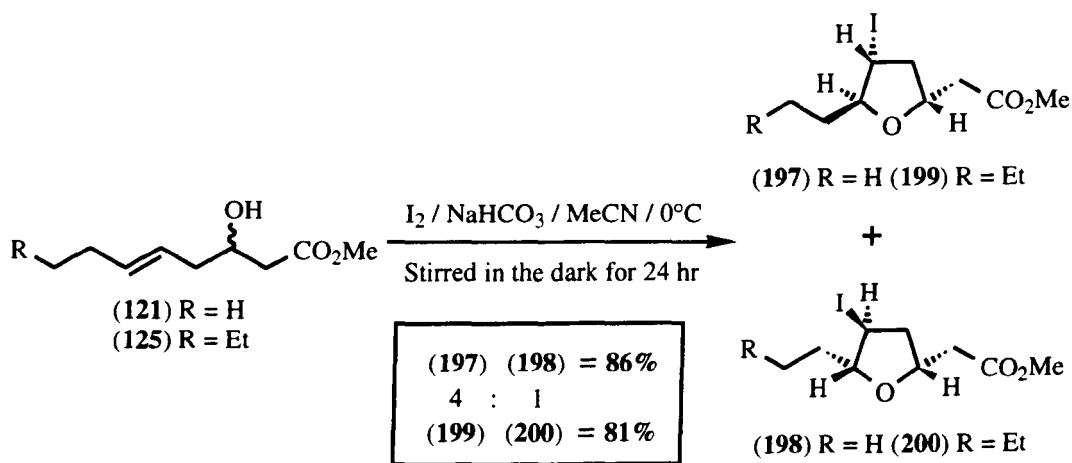

(*Scheme 32*)

We then attempted to cajole this reaction into giving the corresponding hydroxytetrahydrofuran by applying a variety of different reaction conditions. We added more water to the reaction which led to the same products, albeit in slightly reduced yield [ $<5$ -10%]. We left the reaction on for several days, ran it at elevated temperatures and used sodium carbonate in place of the usual bicarbonate. However, all these endeavours produced the same iodotetrahydrofurans as before, with similar or lower recoveries.

An important discovery was made when we compared the  $^{13}\text{C}$  data of these iodocyclic ethers (**199** and **200**) with that from the iodocyclic ethers (**183** and **184**) obtained by the cyclization of the corresponding *cis*-olefins. The ring carbons were situated at identical chemical shift positions for both pairs. We

concluded that our original stereo-assignments made to these iodotetrahydrofurans were incorrect. Presumably their formation is due to the isomerization of the *Z*-olefin and not by its direct cyclization. We then began to search for the elusive iodotetrahydrofurans (**183** and **184**) formed by straight reaction of the *Z*-olefin. The cyclic ether (**183**) was discovered in very small amounts during larger scale reactions and was suspected to have the “all *cis*” stereochemistry shown (*Scheme 33*). This was not possible to prove by *n*Oe experiments since the H<sup>2β</sup> and H<sup>4β</sup> protons had very similar chemical shifts.

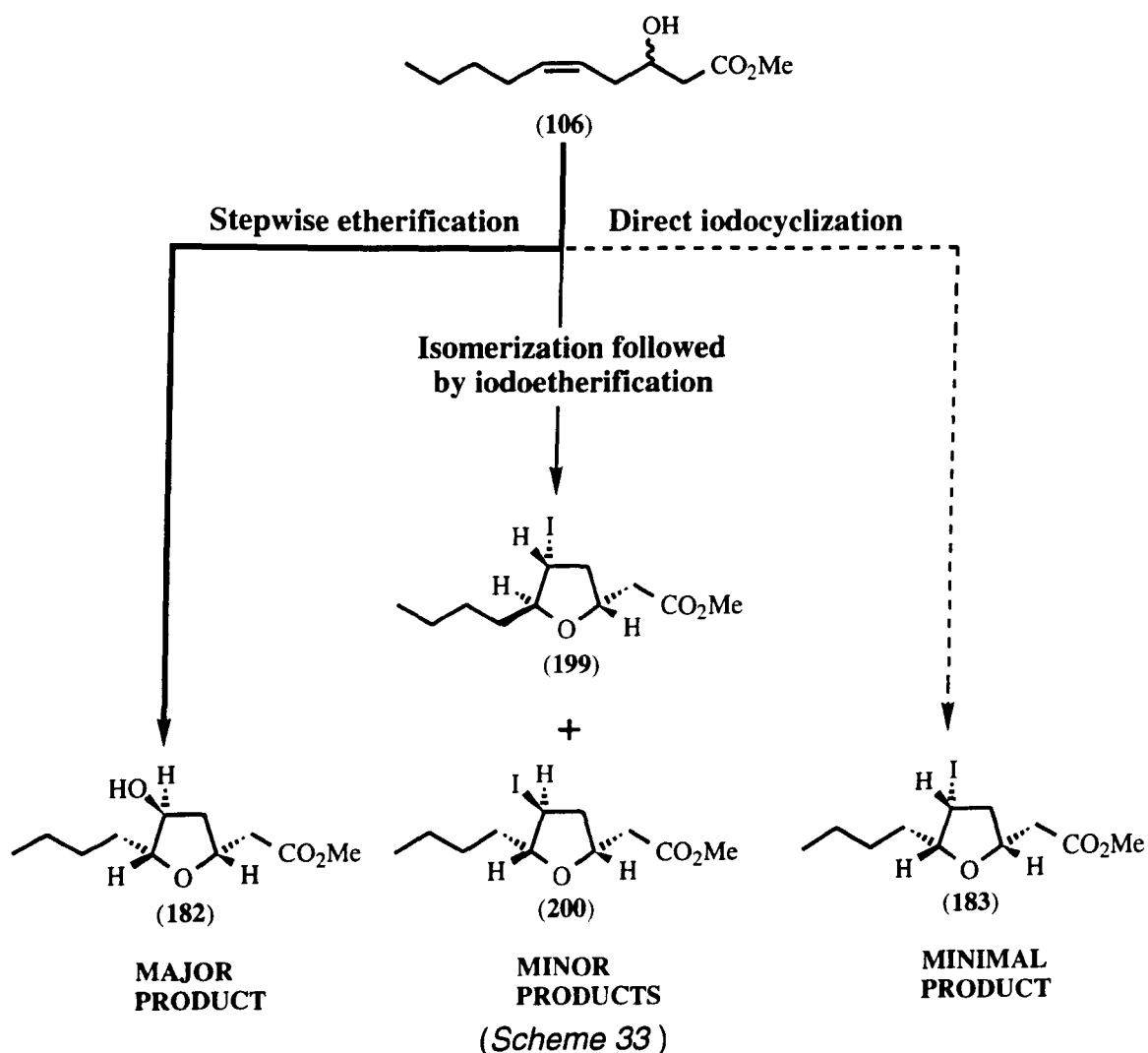

Nevertheless, this structure is consistent with the coupling constants data<sup>318a</sup> obtained and could be produced *via* transition state (**II**) which tolerates an 1,3 diaxial interaction.<sup>323</sup> The isomer with a 4,5-*cis* geometry (**184**) was never

detected although this was not surprising as the transition state (**III**) leading to such a product incurs severe steric demands.<sup>323</sup> Hence, since both transition states suffer unfavourable interactions, isomerization or hydroxy-cyclic ether (**182**) formation provides an easier, alternative route.

The mechanism of this reaction was beginning to fall into place piece by piece. We knew that in semi-aqueous conditions the *Z*-alkenoates produced hydroxytetrahydrofurans apart from some isomerization leading to iodotetrahydrofurans identical to those obtained from the corresponding *E*-alkenoates. Also, that under a variety of differing conditions pure *E*-alkenoates only gave good yields of the iodotetrahydrofurans. We then began to probe this mechanism further by trying to identify possible reaction intermediates.

Epoxides are well known in cyclizations<sup>199</sup> to tetrahydrofurans and so we considered them a strong possibility in our reaction. We synthesized the epoxide (**201**) in 53% yield by reaction of the *Z*-alkenoate (**106**) with *m*-chloroperbenzoic acid under standard conditions.<sup>308</sup> We then reacted this in the cyclization environment to see if we could isolate our novel tetrahydrofuran again. During several attempts, under the usual conditions, no tetrahydrofuran products were recovered. Instead a complex assortment of products was produced which resisted attempts to isolate samples for characterisation (*Scheme 34*).

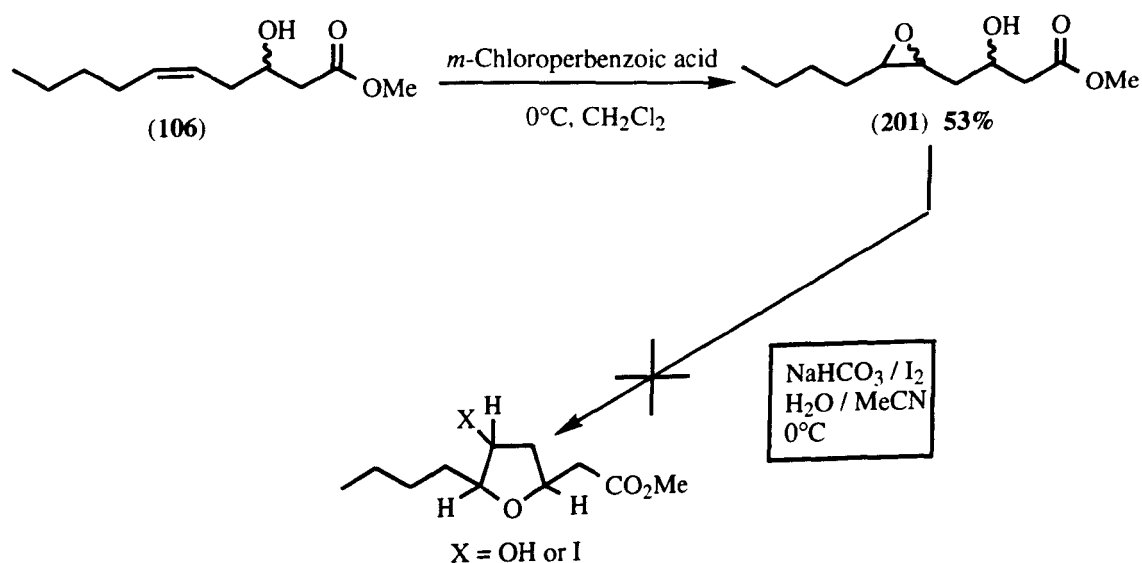

(Scheme 34)

Next we tried to ascertain the importance of the ester function in this cyclization. We therefore constructed both *cis* and *trans* examples of simple dec-5-en-3-ol derivatives for experimentation. The outcome of these “esterless” cyclizations is discussed more fully in the following sub-heading. However, it is sufficient to say at this point that they produced no hydroxytetrahydrofuran species.

We had up till then always placed the ester group in an “acetic acid” position, one carbon removed from the cyclizing hydroxyl function. We decided therefore to see what the outcome would be with a shorter spacing between these two groups. We subjected our synthesized methyl 2-hydroxynon-4-enoate (**135**) to our semi-aqueous reaction conditions. However, due to the fact that the olefin was a stereochemical mixture, a two to one dominance of the *E*-isomer, interpretation of the results was somewhat hindered.

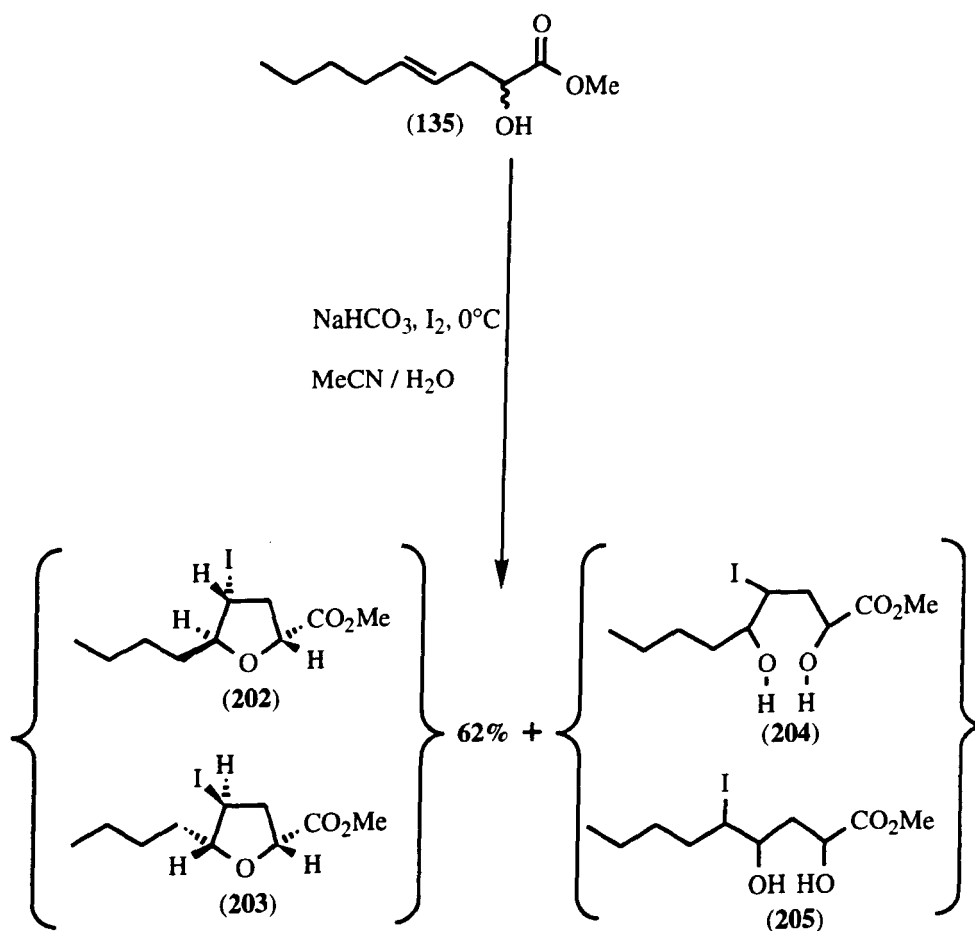

(Scheme 35)

Nevertheless, there seemed to be a two to one split between iodo- and hydroxyl-products formed. Isolation of the iodides and subsequent analysis revealed these to be the expected iodotetrahydrofurans (**202 and 203**). Presumably, learning from the previous data, these were generated from the *trans*-component of the original starting olefin, since they were not known to generate hydroxycyclic ethers. The comparative <sup>13</sup>C NMR and nOe data collected showed the major and minor isomers to have the stereochemistry of that shown in *scheme 35*. This is consistent with the data of our other *E*-olefin cyclizations. The overall recovery was only 62% but this would be boosted to above 90% when one takes into account that the precursor (**135**) was only two thirds pure in this *E*-isomer.

Detachment of the hydroxylated products was far less congenial. There appeared to be two major compounds present which were unstable when subjected to simple column chromatography. Attempts to segregate them from each other by acetate derivatization<sup>140</sup> only succeeded in forming more complicated compounds. However, this reaction did reveal that no hydroxytetrahydrofurans were present as each compound appeared now to contain two acetate groups and resonances inconsistent with a cyclic ether. We concluded that their initial structures were most likely to be the iodo-diol regioisomers (**204 and 205**) which then decomposed rapidly under such conditions to give complex mixtures. Further evidence of such species was found in the cyclizations of our decenol derivatives mentioned later. These compounds did not seem to be half way intermediates to hydroxytetrahydrofurans since leaving the reaction for longer periods still did not provide any evidence to collaborate hydroxycyclic ether formation. We concluded then that the position of the ester group was important and that it must play a direct role in the mechanism of the reaction.

We made no attempt to construct examples with further removed ester functions as the positional requirement was already obvious. Nonetheless, this may be of use in future work. Our next move was to see if we could get successful reaction by having a similarly placed, alternative functional group, an

aldehyde, ketone or amide. It was probable that the ester function was unique in performing this role but, if other groups could, then this may shine further light on the mechanism and be of considerable use in Natural Product construction where group interconversion may be a problem. Some work was undertaken in this field although insignificant to bear further comment.

All these cyclizations are somewhat surprising as such electrophilic annulations of homoallylic alcohols give very poor yields of tetrahydrofurans in general,<sup>169-171</sup> with the notable exception of phenylselenoetherifications.<sup>188</sup> These types of cyclization are formally unfavourable 5-*endo*-trig processes,<sup>175</sup> which are consistent with the typically poor yields obtained. The cationic nature of the reactions however, means that they cannot really be considered as exceptions to Baldwin's rules.<sup>175</sup> Two further examples emphasize the cationic nature of such cyclizations (*Scheme 36*). When methyl 3-hydroxy-6-methylhept-5-enoate (**206**) [from *isobutyraldehyde*] was treated with iodine and bicarbonate in acetonitrile, only the iodotetrahydrofuran (**207**) was isolated in 65% yield. When the hydroxy-acid (**208**) was treated under the same conditions, the iodotetrahydrofuran (**209**) was formed, rather than the corresponding lactone.<sup>325</sup>

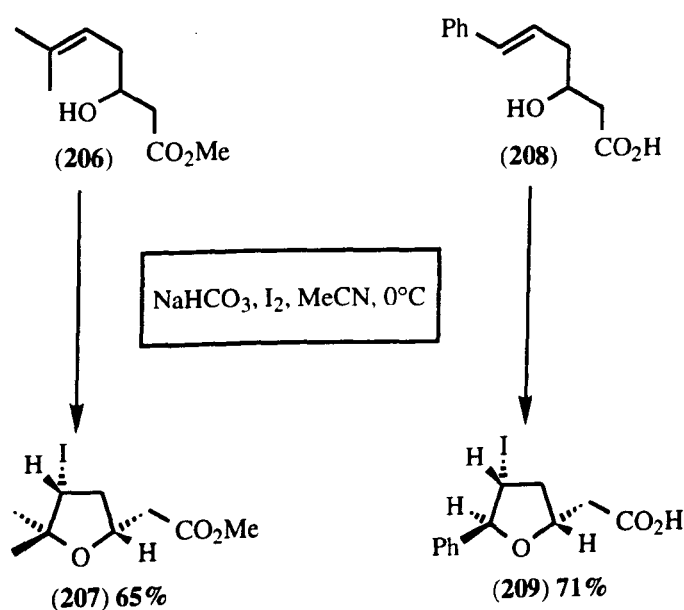

(Scheme 36)

Any mechanistic explanation of these reactions has to take into account a wide spectrum of information and results, some of which may not be strictly unambiguous.

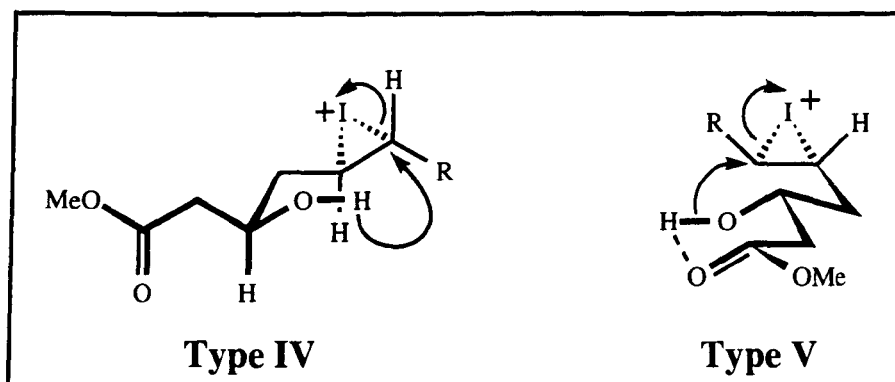

(Scheme 37)

The stereoselective cyclizations of the *trans*-hydroxyalkenoates could be explained by assuming the intermediacy of the transition state of type (IV) or (V). The latter of these features activation of the hydroxyl function with respect to cyclization by hydrogen bonding with the ester group, in much the same way as the foregoing iodolactonizations were directed (Scheme 37).<sup>273</sup> The insensitivity of such reactions to the presence of water is consistent with such activation. The removal of this activation appears to allow hydration of the intermediate iodonium ion prior to cyclization, leading to an iodohydrin [see following work on decenol cyclizations].<sup>275</sup> The cyclizations of the hydroxy-ester (206) and especially the hydroxy-acid (208) to the corresponding iodotetrahydrofurans (207 and 209) are also consistent with this model as both of these substrates would be expected to produce particularly stable carbonium ions as the penultimate precursors to the tetrahydrofurans. In the latter case, the perhaps more expected iodolactonization would result in an electron deficient centre  $\beta$ - and not  $\alpha$ - to the phenyl ring. Thus the pathway shown in scheme 38 represents the iodoetherification for the *E*-hydroxyalkenoates to the major isomer.



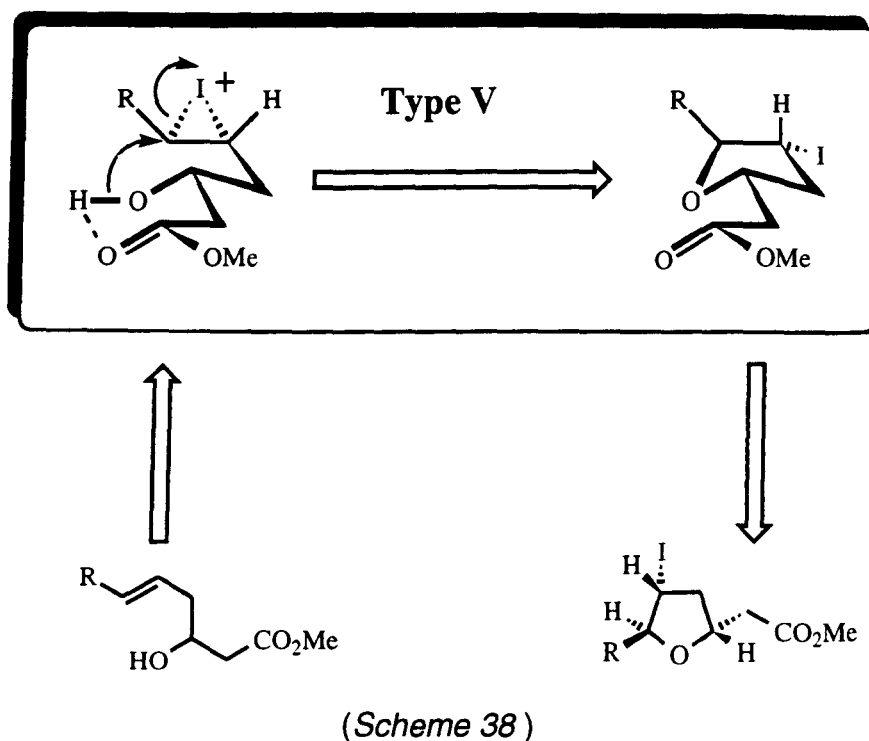

The cyclizations of the *Z*-isomers leading to the hydroxytetrahydrofurans are not so easily rationalized (Scheme 39). If it is assumed that the reaction proceeds along similar lines to that of the aforementioned *E*-alkenoates, then inspection of transition state (VI) now reveals the OH-in-plane conformer is destabilized by the *cis*-substituent and is also rather crowded [see introduction page 69].

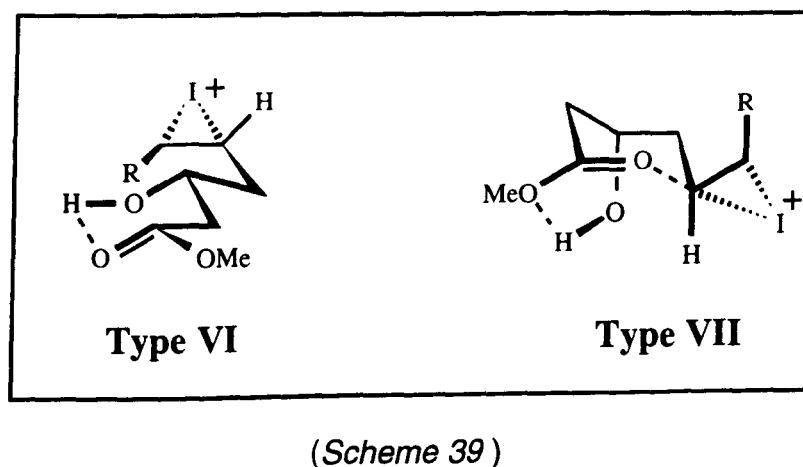

On the other hand, attack by the ester group on the iodonium function in transition state (VII) would lead to a stabilized carbonium ion. Trapping by

water would then give a *ortho*-ester and thence the iododiol, cyclization of which could again be assisted by intramolecular hydrogen bonding leading to the observed product. This sequence of steps would take into account most of the collected chemical evidence (*Scheme 40*). The involvement of the ester function in this cyclization seemed to be crucial; removal or repositioning negated the whole stereoselective route to the hydroxytetrahydrofurans. Activation of the hydroxy function in the intermediate iodo-diol by the ester would not be possible if this group were removed or repositioned.

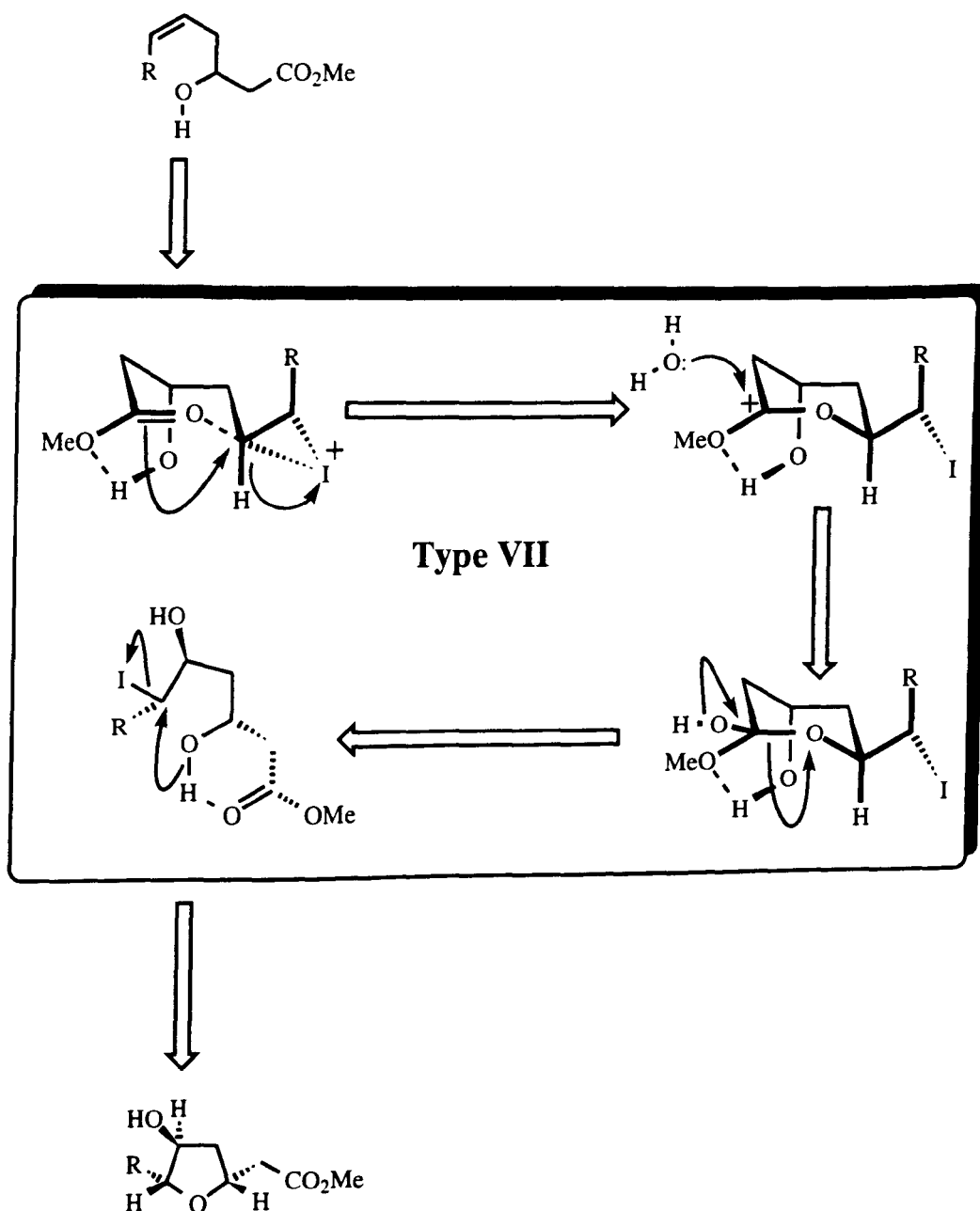

(*Scheme 40*)

This would explain the failure of the decenol (137) and 2-hydroxyalk-4-enoate (135) derivatives to cyclize at this last stage. The reduced reactivity, when other esters (195 and 196) were used, underlines the very sensitive nature of this reaction to changes. Failure to produce a cyclic ether with the epoxide derivative (201) would be justified as it would locate an oxygen moiety in place of the iodonium function and thus inhibit attack by the ester. The requirement for water in the reaction is obvious, although the precondition that more than stoichiometric amounts of this reagent have to be added means its role must be two fold and that solvation, of say the intermediate carbonium ion, could be a secondary purpose. This would also fit well with the extensive hydrogen bonding present in our proposed sequence of events. The removal of such water must imply that the reaction competes now on a reasonable time scale with the isomerization path leading to the iodotetrahydrofurans (199 and 200). This sequence represents only one of many such proposals that can be offered to explain the experimental results obtained but to date it remains the one most consistent with these data. [Note : enantiomer from (*R*)-alcohol drawn]

### **e) Iodocyclizations of alk-5-en-3-ols**

As stated beforehand, iodoetherifications of homoallylic alcohols do not lead to good yields of the corresponding iodotetrahydrofurans; notable exceptions are cyclizations using oxidised iodine species.<sup>326-328</sup> In early 1984, Mechoulam<sup>326</sup> reported that oxidation of halogen salts with *meta*-chloroperbenzoic acid in the presence of suitable hydroxyalkenes gave cyclic halogenoethers. The method was preparatively simple, fast, and led to the products (211) in good to excellent yield. Importantly no epoxide formation was observed even in the presence of double bonds which did not participate in the reaction. In cases where isomers could be formed on the olefinic carbons participating in the reaction only one isomer was observed. In the reaction the halide anion is oxidized by the peroxy acid to a positive halogen species which then attacks the double bond leading to a halonium ion; *anti*-cyclization by the

hydroxyl group led to the tetrahydrofuran. Later Schauble<sup>327</sup> reported on the reaction of *bis*-(*sym*-collidine)iodine (I) perchlorate with a series of unsaturated alcohols in dichloromethane at ambient temperature. This gave three to seven membered ring iodoethers in good yield and generally with high regioselectivity (*Scheme 41*).

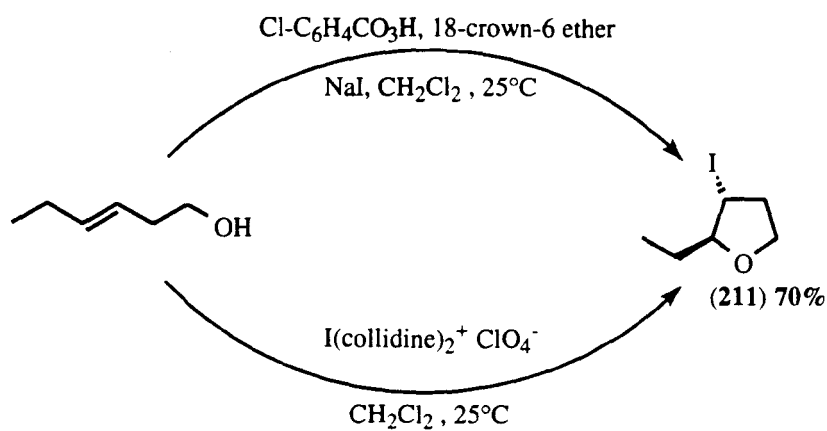

(*Scheme 41*)

This work harmonizes well with related selenoetherifications, which can often be carried out successfully and stereoselectively in a “5-*endo*-trig manner” [see *Introduction page 74*]. Orthodox iodoetherifications of simple homoallylic alcohols as mentioned, generally give poor yields. Three reports<sup>329-331</sup> hinted that such cyclizations could be effected in sizeably better yield, resulting in formation of tetrahydrofurans. Most significant of these is a very recent report by Lipshutz and Barton<sup>331</sup> in which are described some highly stereoselective etherifications of simple alkyl substituted homoallylic alcohols. In planning an approach to the tetrahydrofuran portion of *Tetronasin* their key transformation was to be an electrophilic ring closure of a homoallylic alcohol. During the study of a whole series of such alcohols they discovered that the stereochemical outcome from their cyclization could be controlled to afford either the *cis*-2,5- or *trans*-2,5-isomer simply by varying the nature of the electrophile (*Scheme 42*).

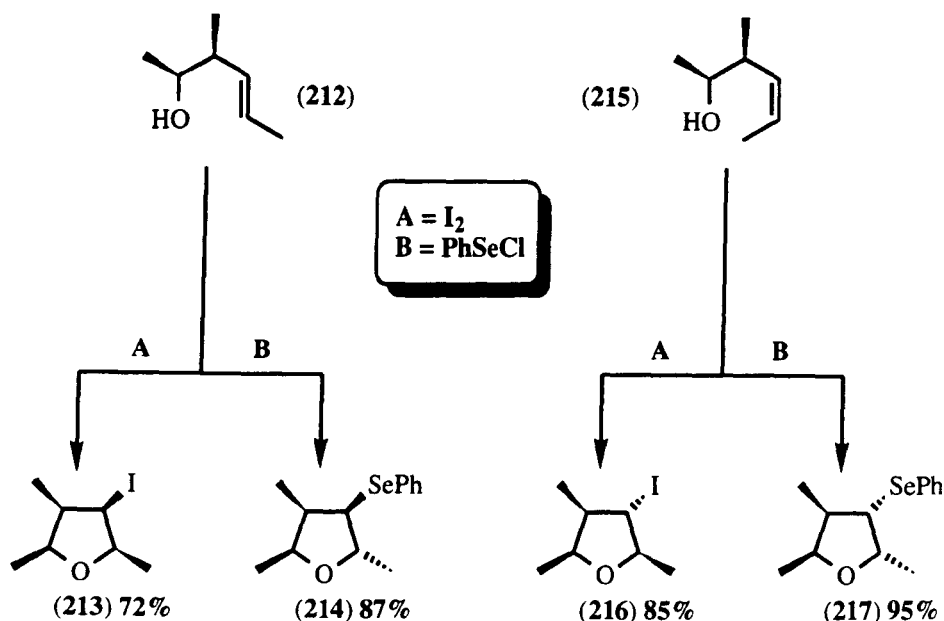

(Scheme 42)

Treatment of the *E*-olefin (212) with phenylselenenyl chloride afforded the *trans*-2,5-product (214) and the same stereochemical outcome was produced from its *Z*-counterpart (215) [both are *anti*-addition]. Remarkably, exposure of the same olefins but this time with iodine, led to the *cis*-2,5-products (213 and 216) again in excellent yield [*syn*-addition]. All the reactions were extremely rapid at temperatures between room temperature and -40°C but, were inhibited by the addition of soluble bases such as triethylamine or pyridine. The reaction allowed derivatization of the C5 alkyl group with a silyl protected alcohol group. However, no mechanistic picture was presented by the authors as to how these unusual cyclizations occur.

#### *Iodocyclization reactions of decen-3-ol derivatives*

In line with our previous work,<sup>274</sup> attempts to effect cyclizations of simple *cis* and *trans*-dec-5-en-3-ol derivatives using iodine in aqueous mixtures such as acetonitrile:water or tetrahydrofuran:water, with or without added base, gave little or no tetrahydrofuran products but instead mixtures of iodohydrins.<sup>184</sup> When *Z*-dec-5-en-3-ol (137) was reacted in the now standard semi-aqueous

environment for 72 hr a total of five compounds were isolated (*Scheme 43*). The least polar components were the iodotetrahydrofurans (**218** and **219**) recovered individually in 9% and 7% yield respectively. These were later identified as having the stereochemistry shown by the usual spectroscopic means. Three main polar components were then recovered, the first of which was identified as the hydroxyketone (**220**) (15%) and then the two iodo-diol regioisomers (**221** and **222**) (66%). Interestingly these iodo-diols have very similar spectral data to those of a trisubstituted cyclic ether. For example a carbon attached to oxygen a chemical shift value of 71-74(CH) and to iodine 47-50(CH) ppm for an iodo-diol which is comparable to those in a trisubstituted tetrahydrofuran [73-75(CH) and to iodine 33-43(CH) ppm]. The hydrogen bonding between the hydroxyl groups appears to lock the molecules into the structures shown in *scheme 43*. Only derivatization revealed the presence of two free hydroxyl groups and micro-analysis the presence of a iodine atom.

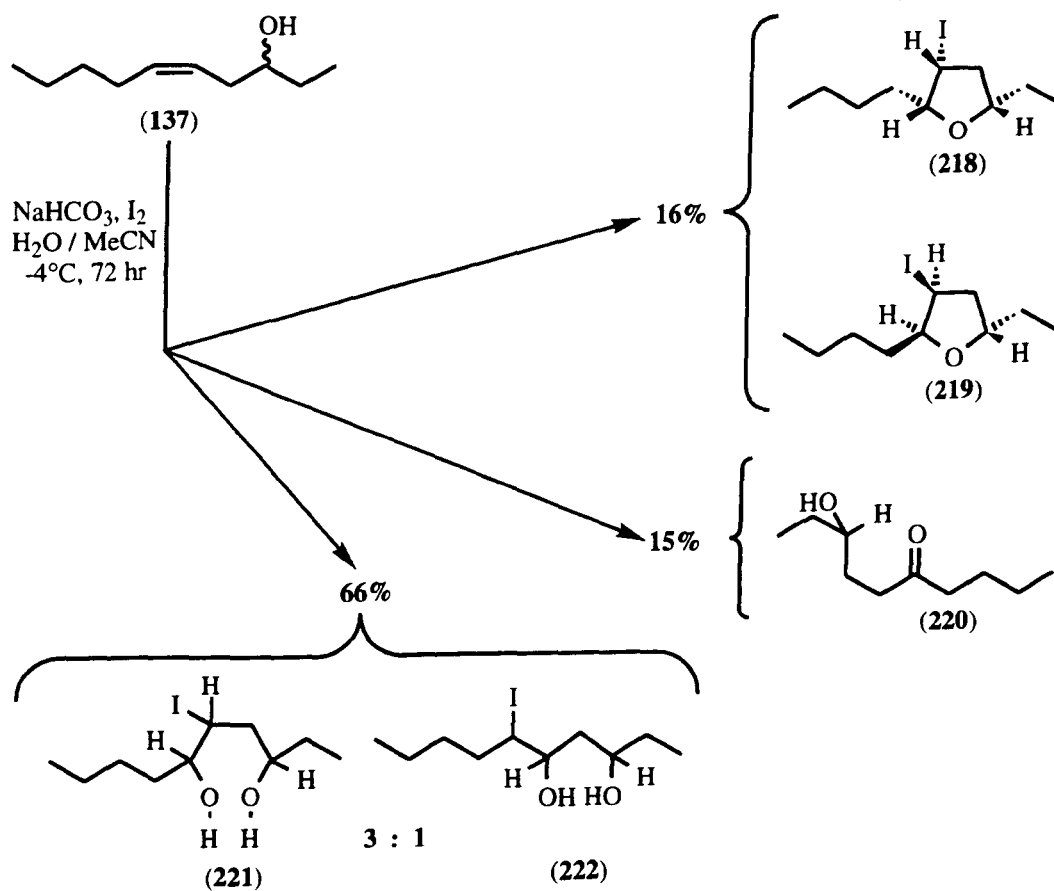

(*Scheme 43*)

Unlike the iodo-diols formed from the cyclization of methyl 2-hydroxynon-4-enoate (**135**) these were relatively stable and could be isolated by column chromatography [see page 137]. Separation of the two iodo-diols was successfully accomplished but at some expense to the major isomer which degraded down to the same hydroxyketone (**220**), presumably by elimination of a molecule of hydrogen iodide (*Scheme 44*).

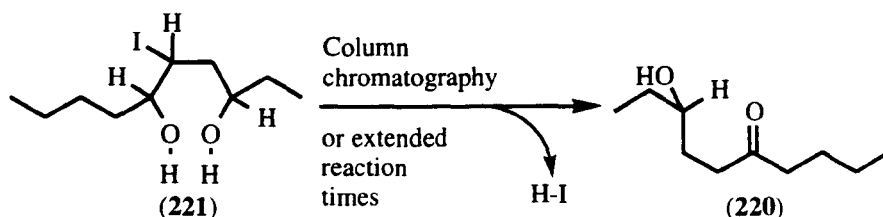

(*Scheme 44*)

Rerunning the cyclization experiment on (**137**) for shorter and longer times showed that a maximum iodo-diol (**221** and **222**) ratio of four to one could be obtained after some 24 hr, and that more extended periods reduced this to a one to one position presumably because of degradation to the ketone which was now produced in greater amounts. This was also the case when we successfully converted these compounds into their respective *bis*-benzoate derivatives<sup>332</sup> (**223** and **224**) as the major derivative was that from the minor iodo-diol (**222**) (*Scheme 45*).

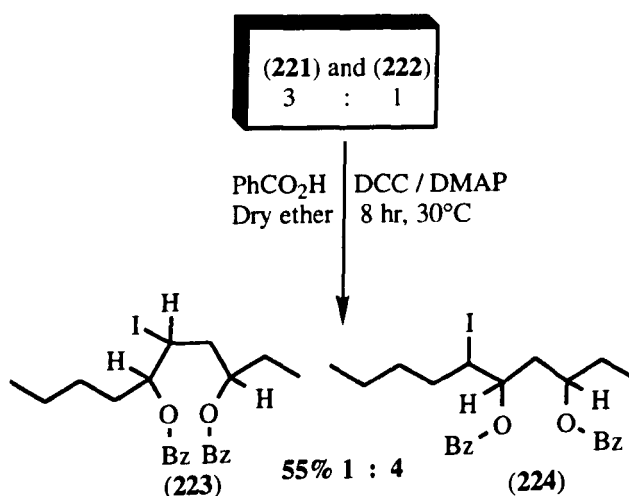

(*Scheme 45*)

We tried to elucidate the stereochemistry of the iodo-diols by forming acetal derivatives and thus lock the molecule together; this however was unsuccessful.<sup>333</sup> Evidence of the stereochemistry of these two compounds is scarce with only the more prevalent elimination from the major hinting at some preferred alignment. There must be some tight control in the transition state since only these two isomers were ever observed.

We therefore turned to the use of anhydrous solvents and found that when the *E*-homoallylic alcohol (**138**) was treated with iodine and sodium bicarbonate in anhydrous acetonitrile, cyclization occurred very rapidly [2 hr] and gave only the tetrahydrofuran (**225**) in 80% yield (*Scheme 46*). The stereochemistry was determined largely by nOe experiments.

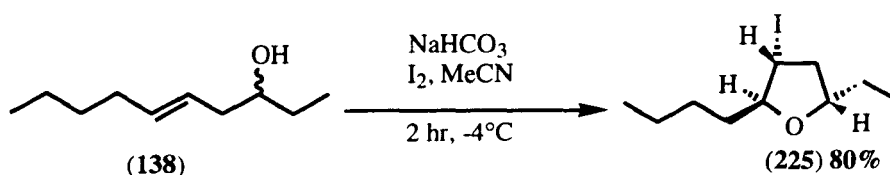

(*Scheme 46*)

In contrast, the complementary *Z*-isomer (**137**) underwent cyclization much more slowly under the same conditions and gave (**218**) as a major product, the all *cis*-trisubstituted tetrahydrofuran in 70% yield. Approximately 16% of the second isomer (**219**) was observed (*Scheme 47*). Again, the stereochemistry was assigned mainly using nOe data. These iodotetrahydrofurans were identical to those obtained under aqueous conditions; no isomerization products were detected.

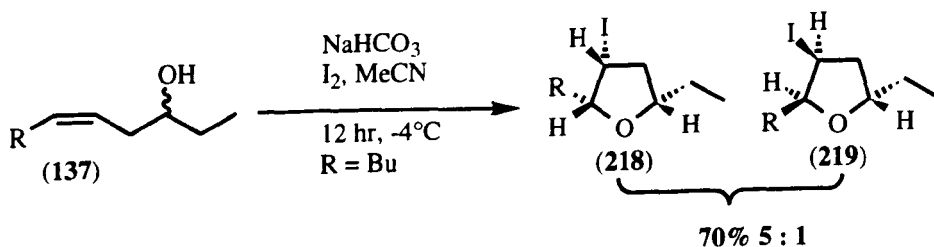

(*Scheme 47*)



Similar results were obtained in the absence of sodium bicarbonate, but the cyclizations were slower. Further work showed that the *E*-diol (**227**), prepared from the readily available diacid (**226**), can be cyclized to the single iodotetrahydrofuran (**228**) in 87% yield (*Scheme 48*).

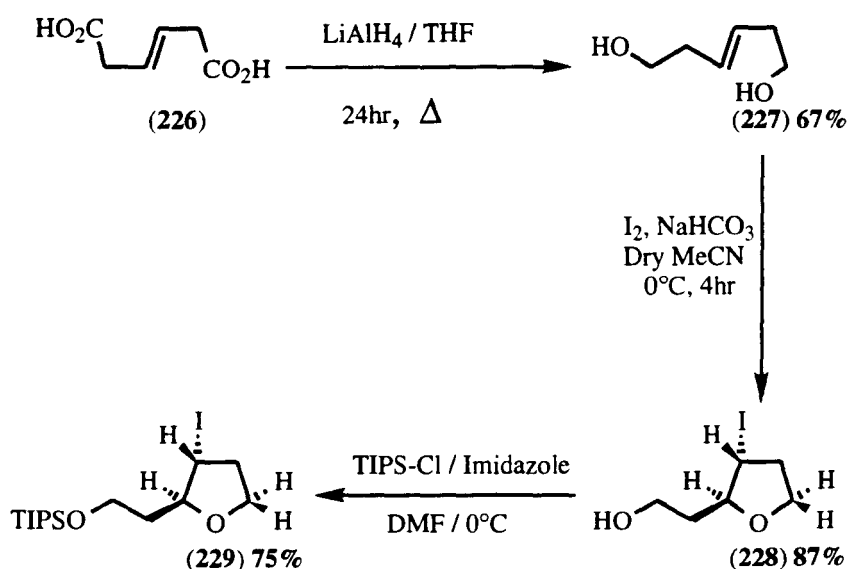

(*Scheme 48*)

All spectral data obtained from this cyclic ether were in line with previous examples, [ $\delta_{\text{C}}(63)$  87.46(CH), 67.33(CH<sub>2</sub>), 60.71(CH<sub>2</sub>), 38.12(CH<sub>2</sub>), 34.71(CH<sub>2</sub>), 23.14(CH-I)]. The stereochemistry was proven to be the expected 2,3-*trans*. This ether was then protected with a silicon group, under standard conditions,<sup>286</sup> to give (**229**) required for the later displacement work.

Work by Shaw<sup>309</sup> showed this type of cyclization was applicable to a variety of other substrates (*Scheme 49*).

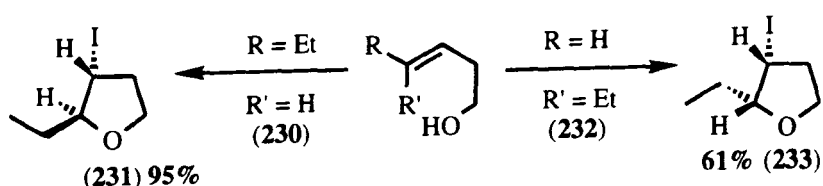

(*Scheme 49*)

For example, the primary alcohols (**230**) and (**232**) both underwent overall 5-*endo*-trig cyclizations leading to the *trans* and *cis* iodotetrahydrofurans (**231**) and (**233**) in 95% and 61% yields respectively. No other isomers were detectable in the crude samples of tetrahydrofuran derived from the *trans* alcohol (**230**). Similarly, the reactions are successful when either  $\alpha$ -position is tertiary (*Scheme 50*). Thus, the tertiary homoallylic alcohol (**234**) was converted into a single tetrahydrofuran (**235**) and the homoprenyl alcohol (**236**) into the tetrahydrofuran (**237**). In both examples, the reactions occurred very rapidly [ $<45$  min] at  $0^{\circ}\text{C}$  and in  $>90\%$  yield. Similarly, the monosilylated diol (**238**) was smoothly converted into the *trans*-2,4-disubstituted tetrahydrofuran (**239**) [92%]. In none of these examples were hydroxytetrahydrofurans isolated, as expected.<sup>274</sup>

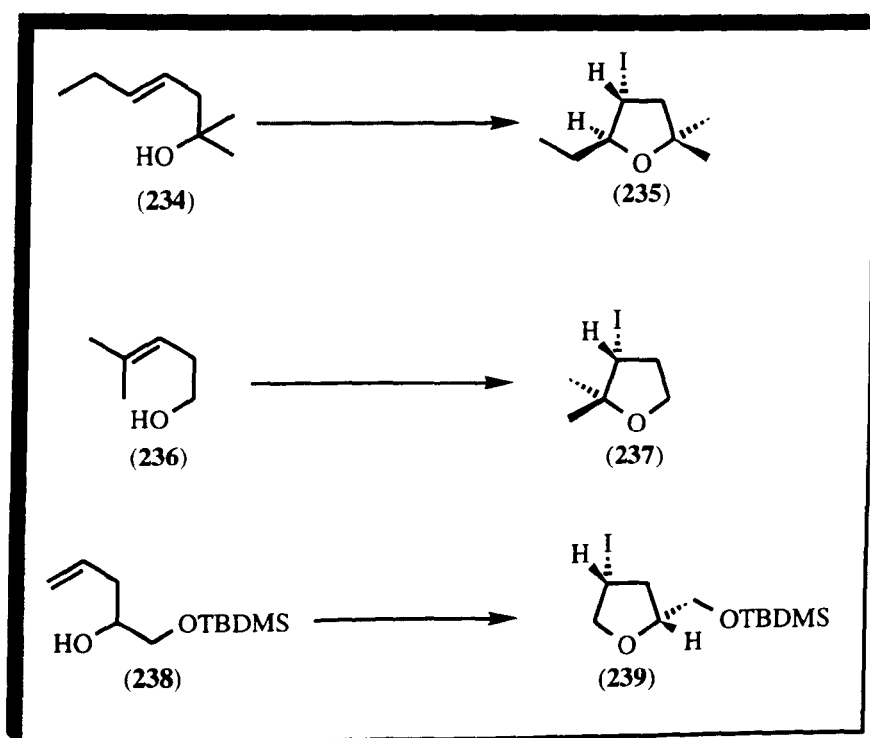

(Scheme 50)

The stereochemical outcomes of these iodoetherifications are consistent with the intermediacy of the transition states (**VIII**) and (**IX**), wherein the

pendant  $R'CH_2$  group occupies a pseudo-equatorial position, leading to the respective  $\beta$ -iodotetrahydrofurans (Scheme 51).

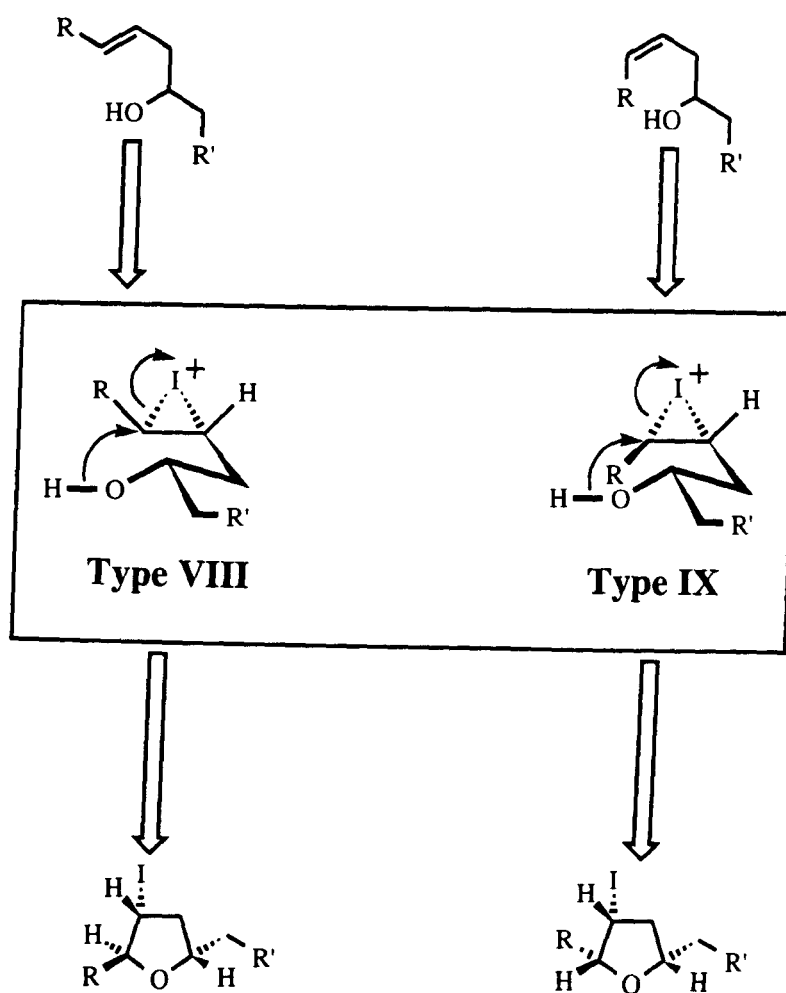

(Scheme 51)

The slower and less efficient cyclizations of the *Z*-isomers reflect the more crowded nature of transition state (IX). These conformations are similar to that proposed for the cyclizations of *E*-3-hydroxy-alkenoates mentioned beforehand.<sup>273</sup> In the latter cases, however, the cyclizations could be successfully carried out in the presence of water due to activation of the hydroxy group by the ester function. No such activation is present in the foregoing homoallylic alcohols and hence an anhydrous solvent must be employed or else water preferentially attacks the iodonium intermediates, leading to iodohydrins.

We must note that the stereochemical outcomes of these cyclizations are

at variance with those reported by Lipshutz and Barton<sup>331</sup> [see page 145]. Treatment of the *E*- and *Z*-homoallylic alcohols (**212 and 215**) with iodine in acetonitrile were found to result in overall *syn* addition to the double bond, to give *cis*-2,5-tetrahydrofurans (**213 and 216**). In contrast, treatment of the alcohols (**212 and 215**) with phenylselenenyl chloride resulted in *anti* addition to the double bond, to give the tetrahydrofurans (**214 and 217**), but as the 2,5-*trans*-diastereoisomers. The additional methyl substituent present in these substrates is unlikely to be the sole cause of such a dramatic reversal and so an explanation for these unexpected observations will have to await further experiments.

### e) Displacement transformations

As well as being useful precursors in their own right the iodotetrahydrofurans can potentially be transformed into a wide diversity of valuable compounds which makes them a rich source for future development. What follows is a brief illustration of the many possible and useful interconversions available from these starting blocks.

Our first attempt at such a conversion was to try and displace the iodo-group with suitable nucleophiles. Many such displacements are known for primary iodides<sup>334</sup> but examples on secondary centres in functionalized tetrahydrofuran rings are relatively sparse.<sup>335</sup> Reaction with azide seemed an appropriate starting point. Freshly activated sodium azide was available *via* recrystallization from acetone.<sup>336</sup> The use of a metal cation acceptor was needed to activate the nucleophile; 15-crown-5-ether is a suitable complexing agent for the sodium counter ion.

We were pleased to find that treatment of methyl (2*S*,4*R*,5*S*)-5-ethyl-4-iodotetrahydrofuranyl-2-acetate (**197**) with sodium azide in DMF at 40°C gave the corresponding azidotetrahydrofuran (**240**) in 52% yield (*Scheme 52*).

Along with the product was approximately 30% of the corresponding dihydrofuran (**241**) produced *via* elimination of the iodine group.

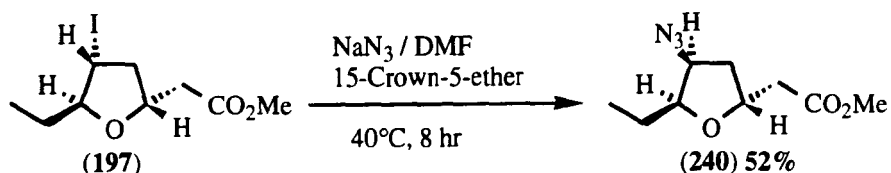

(Scheme 52)

Longer times and elevated temperatures gave significantly more of this elimination product, until reaction at 70°C for 24 hr gave solely this furan in 79% yield (Scheme 53). This result suggests that formation of the dihydrofuran (**241**) comes not only from the initial starting iodide but also from the newly formed azide (**240**). Possibly this occurs *via* hydrogen abstraction by the azido group, leading to the dihydrofuran and hydrogen azide as products.

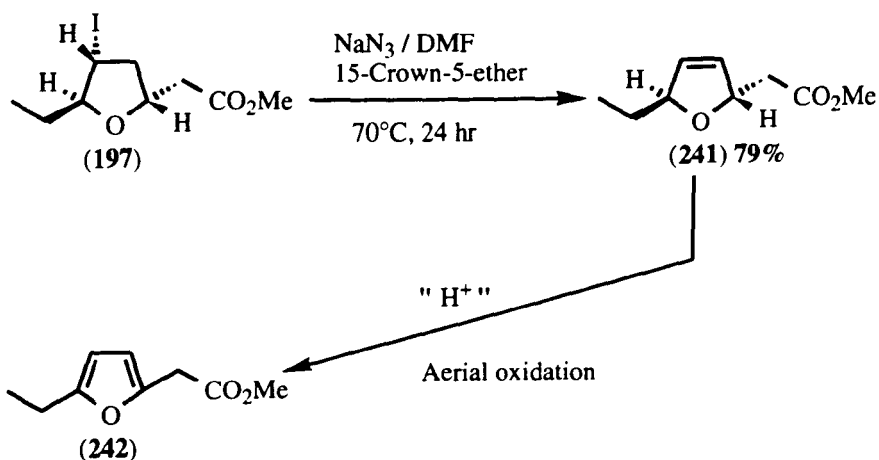

(Scheme 53)

A further development revealed that the dihydrofuran (**241**) was unstable in acidic media. In chloroform solvent for two or more days significant amounts of a new cyclic compound (**242**) were formed tentatively assigned the furan structure shown [ $\nu_{\text{max}}$  (film) 1480  $\text{cm}^{-1}$ ]. Further investigation was not possible and the mechanism of such an interconversion remains a mystery. Both products will no doubt provide an area for expansion in time to come as a

possible alternative route for the synthesis of furans and dihydrofurans.<sup>337</sup> More traditionally these have come from 1,3-dicarbonyl compounds, especially from procedures involving aldol-type condensation with  $\alpha$ -halocarbonyl derivatives<sup>338</sup> or oxidative coupling with enol ethers,<sup>339</sup> olefins, dienes or enynes<sup>340, 341</sup> in the presence of transition metal salts.

Optimization of the displacement reaction showed that more azidotetrahydrofuran (**240**) was obtained when longer times but lower temperatures were used; at room temperature for 24 hr the azide could be recovered in >65% yield, albeit with some recovered starting material. At no time were any other isomeric compounds detected or was evidence of attack on the ester functional group found. Again, nOe experiments confirmed the stereochemistry of these two new compounds and reaffirmed the original assignments for the initial iodotetrahydrofuran (**197**).

Next, we attempted reaction with an oxygen nucleophile for the obvious reason that it could provide hydroxytetrahydrofurans of the type not available from our previous experiments. Reaction under similar conditions of that above but this time employing potassium superoxide with a more suitable crown ether provided comparable results.<sup>342</sup> A good yield of the inverted hydroxytetrahydrofuran (**243**) was obtained when the functionalized iodotetrahydrofuran (**229**) was exposed to these conditions (*Scheme 54*).

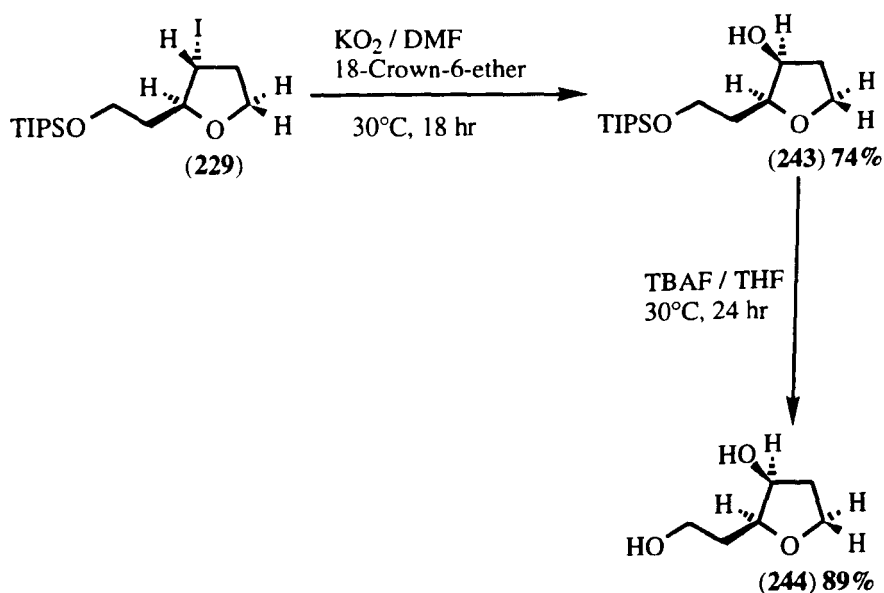

(*Scheme 54*)

After removal of the silyl protecting group this result gives us a direct comparison of iodo-(**229**) and hydroxy-cyclic ether (**244**) spectral data not available before. The displaced product (**244**) having  $^{13}\text{C}$  data of [ $\delta_{\text{C}}(63)$  82.55(CH), 72.41(CH-OH), 65.89(CH<sub>2</sub>), 60.02(CH<sub>2</sub>), 34.95(CH<sub>2</sub>), 31.01(CH<sub>2</sub>)] which clearly identifies the shift of the carbon attached to iodine from 23.14(CH-I) to 72.41(CH-OH) ppm [see page 149 for iodocyclic ether (**229**) data]. Attempts to repeat this reaction employing aqueous polar aprotic solvents such as *N*-methyl-2-pyrrolidone were unsuccessful.<sup>343</sup>

Additional experimentation by Shaw<sup>309</sup> showed that when the *trans*-iodotetrahydrofurans (**225**) and (**231**) were treated with sodium azide in DMF at 80°C for 2 hr, this gave the expected azides (**245**) and (**246**) [87% and 75% respectively], again proven using nOe studies (Scheme 55).

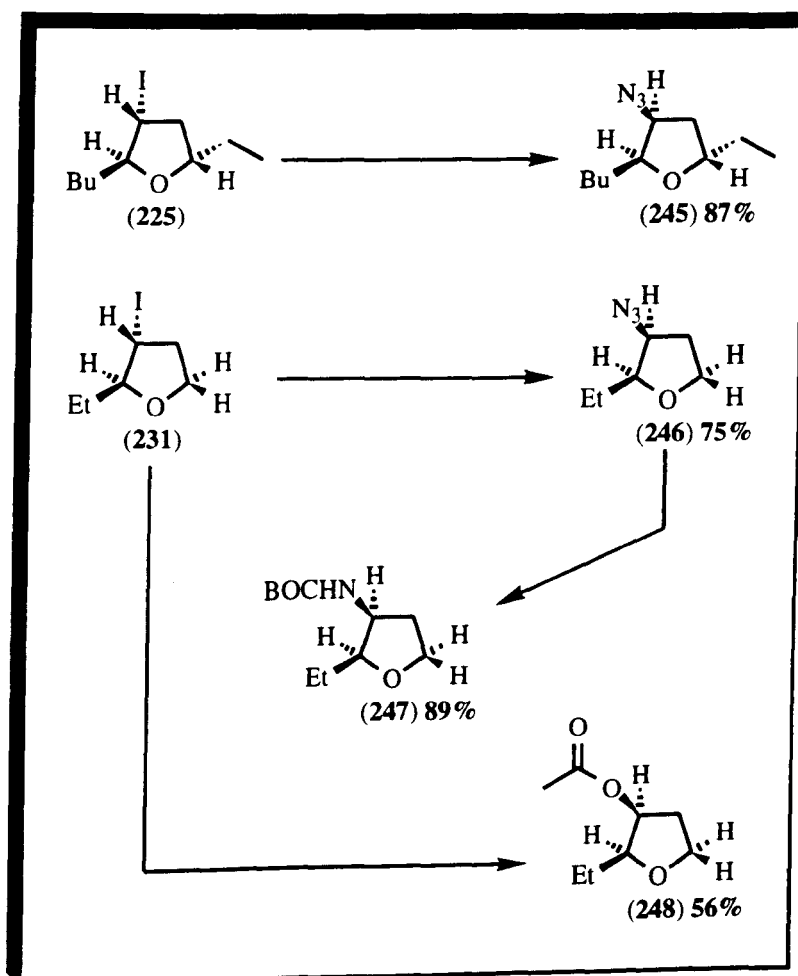

(Scheme 55)

In addition, the azide (**246**) was readily converted into the corresponding amino derivative (**247**) in 89% yield by hydrogenolysis in the presence of  $\text{BOC}_2\text{O}$ .<sup>344</sup> Finally, treatment of the initial tetrahydrofuran (**231**) with caesium acetate in DMF at  $80^\circ\text{C}$  led to the acetoxy derivative in an unoptimized 56% yield (**248**).

## f) Future work and Natural Product targets

There are enormous possibilities for extending the scope of all these cyclofunctionalization reactions, too many to exemplify here. However, to show some of the utility of these reactions in general organic synthesis, I have put together a few specific ideas to show how the methodology can be applied to the synthesis of various reaction intermediates and Natural Product targets.

### *Useful reaction intermediates*

Extrapolations include an examination of the step wise iodocyclization of the type shown in *scheme 56* which, *via* an intermediate hydroxytetrahydrofuran, could go on to yield the useful fused tetrahydrofuran (**252**).

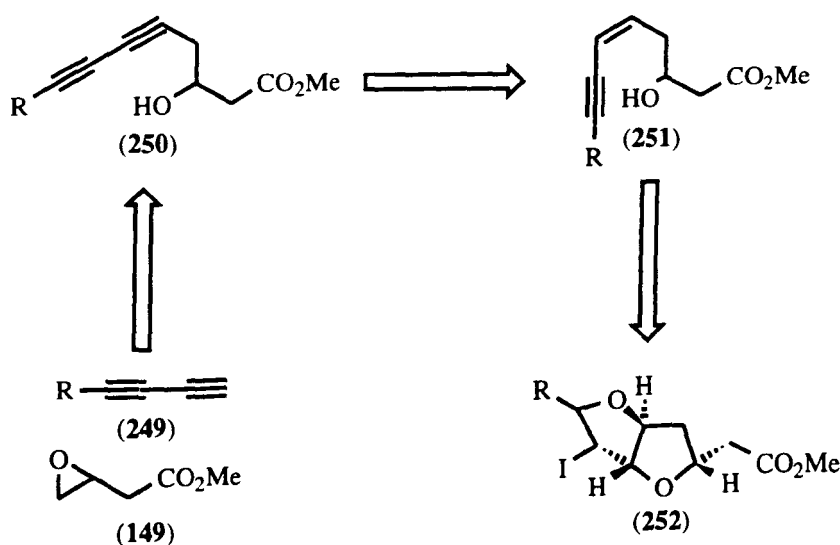

(Scheme 56)



Another compelling application is the use of the iodotetrahydrofurans (**253**) in radical reactions (*Scheme 57*). Generation of a radical at the 4-position of such a tetrahydrofuran (**254**) does not lead to  $\beta$ -elimination unlike propagation of the corresponding anion. This opens up both intra- and inter-molecular possibilities. Also a modified Stork<sup>345</sup> radical cyclization-cyanation reaction would provide a cyano group, with retention of configuration, at the four position of the tetrahydrofuran ring. Such an interconversion may be of use in nucleoside chemistry.<sup>348</sup>

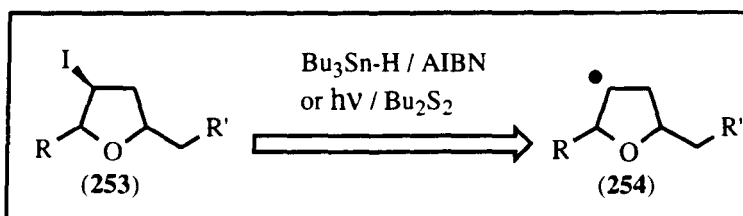

(*Scheme 57*)

The important azido- (**240**) and dihydro- (**241**) cyclic ethers that we formed from the corresponding iodotetrahydrofuran have strong connections with nucleoside analogues active against the HIV virus (*Scheme 58*).<sup>346</sup> Nearly all of the compounds tested as potential reverse transcriptase inhibitors are nucleoside analogues and AZT (**255**) is the only drug approved for treatment of AIDS.<sup>347</sup>

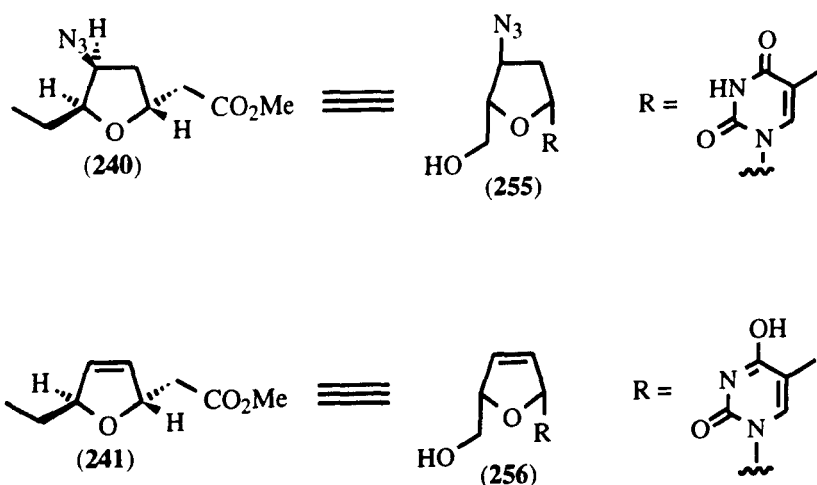

(*Scheme 58*)

Among the compounds that have shown comparable *in vitro* activity to AZT are unsaturated nucleoside analogues such as (256).<sup>348</sup> Our molecules or similar analogues of them, offer a potential worthwhile source of such compounds.

Bromoetherifications are a well established alternative to their iodo counterparts.<sup>349</sup> Typically elemental bromine is avoided, instead a substitute source such as 2,4,4,6-tetrabromo-2,5-cyclohexadienone [TBCD] or *N*-bromosuccinimide [NBS] is employed.<sup>350</sup> Bromocyclizations of homoallylic alcohols are known but are not well documented.<sup>330, 242</sup> We were pleased therefore to find that reaction of the *E*-alkenoate (121) with liquid bromine gave a good yield of the bromotetrahydrofurans (257 and 258) in an identical four to one stereoselection to that of the equivalent iodoetherification case (*Scheme 59*).

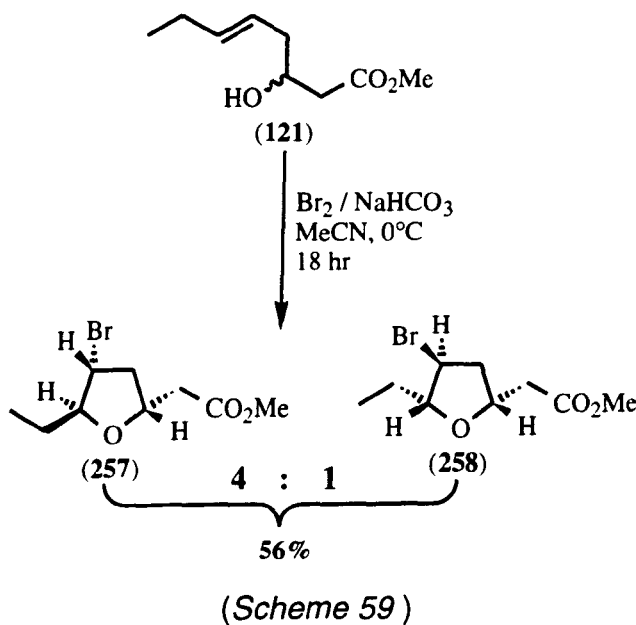

There was little or no sign of any dibromo-addition to the olefin; a process that is easily accomplished under such conditions unlike the far slower iodination reaction.<sup>351</sup> The presence of hydrobromic acid in the bromine may account for why the reaction was “messier” than in the iodine case. Perhaps reaction with one of the substitute sources of bromine would give better results. Clearly this preliminary work could be useful in constructing Natural Products (*Scheme 60*) such as laureoxolane (259) isolated recently from *Laurencia nipponica* algae.<sup>352</sup>

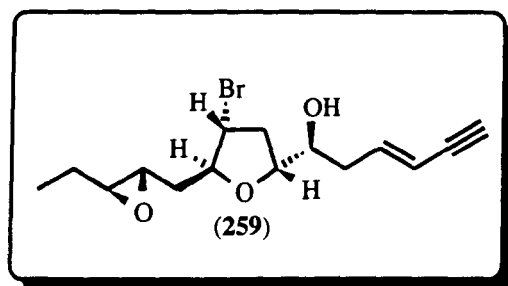

(Scheme 60)

### Natural Product targets

There are various uses in Natural Product synthesis for the products of these reactions particularly as many generate single stereoisomers and because we have a chiral route to the precursors. The flexibility in the potential side chains which can be incorporated into the tetrahydrofuran ring, the variable stereochemistries that we can obtain by using appropriate olefin configuration and displacements/transformation reactions, make a wide range of Natural Products obtainable. A few choice examples are specified.

### Synthesis of Muscarines and Allomuscarines

The interesting physiological activity of L(+)-Muscarine (260), isolated from the familiar *Amanita muscaria* toadstool, has generated much interest over the years (Scheme 61).<sup>353</sup>

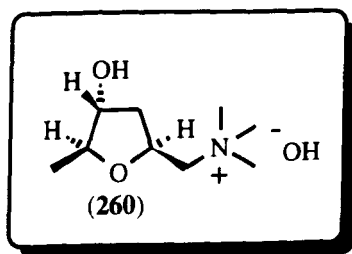

(Scheme 61)

Elucidation of the structure showed the presence of three asymmetric centres, which implied the existence of four pairs of enantiomers. All these stereoisomers have now been synthesized by a variety of methods. The majority of published syntheses afford a racemic or an isomeric mixture of natural muscarine with different stereoisomers. Only a few elegant, stereospecific syntheses have been reported.<sup>353</sup> However, these different routes required either enzymatic resolution or chromatographic separation from intermediate 3-hydroxy isomers and stereospecific syntheses of Muscarine and its analogues are still in demand. The cyclization of suitable *Z*-3-hydroxy-5-alkenoates should not only allow the synthesis of homochiral Muscarine but also of various potentially biologically active analogues, of a type not accessible using many of the previous syntheses of this molecule.

The natural L(+)-Muscarine (**260**) should be accessible by the following sequence of chemical transformations (*Scheme 62*).

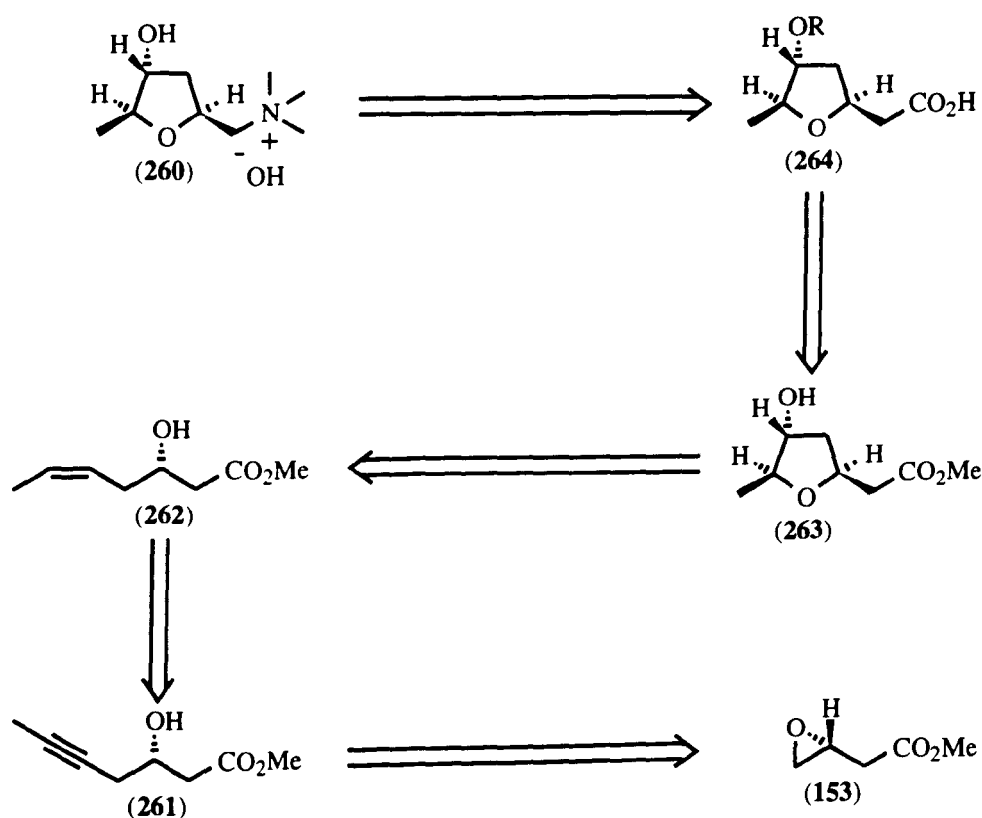

(*Scheme 62*)

Standard coupling of prop-1-yne with the chiral (R)-epoxide (**153**), available from the chloro  $\beta$ -ketoester (**151**) as before, should grant us the (S)-acetylene (**262**). Lindlar reduction of which (**262**) followed by aqueous iodoetherification will produce the key intermediate cyclic ether (**263**). {Note: it is the (S)-enantiomer that is required for Muscarine provided that is, the mechanism on page 142 is correct and no inversion of the chiral centre takes place}. Protection of the hydroxyl function on this ether (**263**) and subsequent saponification should produce the tetrahydrofuran acid (**264**). Curtius rearrangement<sup>354</sup> of this acid *via* a preformed acyl azide will give a hydrolysable isocyanate and hence the penultimate amine. Reaction then with methyl iodide and suitable ion exchange resin should give the Natural Product (**260**). Caution will have to be taken during saponification of the ester as my work on a butyl variant has already revealed that isomerization at C2 is possible with the potassium hydroxide / methanol system<sup>293a</sup> although this can be avoided.<sup>293b</sup> The more standard Curtius degradation, conversion to acid chloride and thence to the isocyanate by reaction with sodium azide, was highly successful when tested on a model cyclopentane derivative but failed to repeat this success on a tetrahydrofuran example. Conversion to the acyl azide by reaction with an azido phosphonate should prevent protic ring opening of the cyclic ether; the suspected cause of the failure.

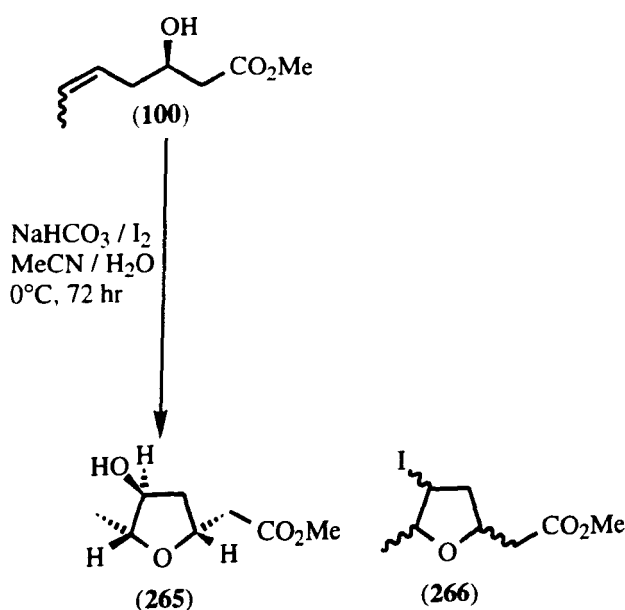

(Scheme 63)

We did manage to cyclize our synthesized (R)-alcohol (**100**), prepare *via* the Wittig homologation route, to give a crude yield of hydroxytetrahydrofuran (**265**) contaminated with a mixture of iodotetrahydrofurans (**266**) (Scheme 63). Due to the poor isomeric and optical quality of the starting olefin no further work was done on this sample.

*A suggested synthesis of Goniofufurone*

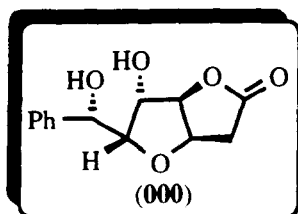

(Scheme 64)

In 1990 McLoughlin *et. al.* isolated the potent anti-tumour compound Goniofufurone (**267**) from the lily species *Goniothalamus giganteus*.<sup>355</sup> Structural elucidation disclosed a novel ring system with a tetrasubstituted tetrahydrofuran ring fused to a butyrolactone (Scheme 64). A total synthesis of such a new Natural Product is therefore a worthy challenge.

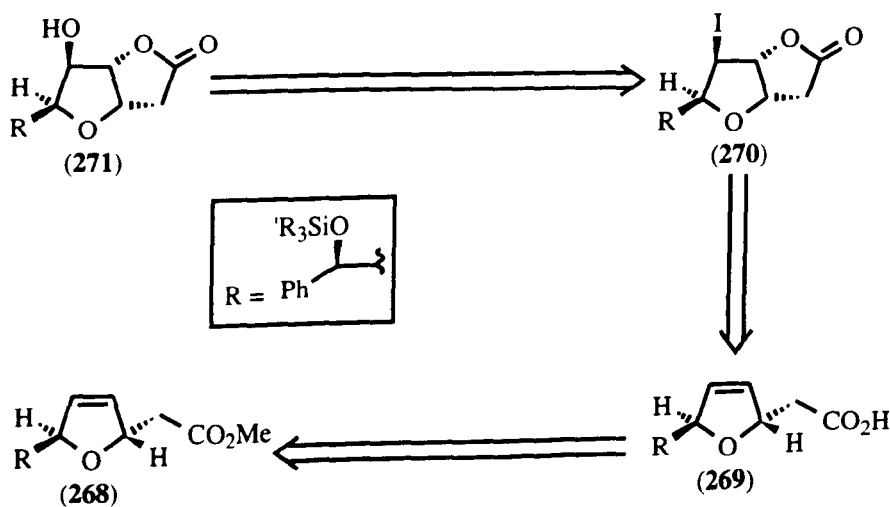

(Scheme 65)

Already at our disposal are the relevant chemical techniques (*Scheme 65*). Using a suitable iodotetrahydrofuran, available in chiral form, from the *E*-hydroxyalkenoates, we could react with sodium azide to produce the desired dihydrofuran (**268**) and saponify to the acid (**269**). From this precursor an iodolactonization will furnish stereospecifically the iodolactone (**270**). So far this chemistry has already been undertaken, albeit on isolated cases. Next we have the more difficult challenge of converting the iodo- group into its hydroxy-equivalent (**271**). This may not be possible under the robust potassium superoxide method already shown to be successful at such tasks.<sup>342</sup> Unfortunately, even if fruitful this will invert the C4 centre when retention is required for the Natural Product. Nevertheless, we have already achieved a successful Mitsunobu<sup>319</sup> inversion on a hydroxytetrahydrofuran in good yield and so this additional step may not be an encumbrance. However, work by Kocovsky<sup>356</sup> may offer a more ideal solution (*Scheme 66*). He has been able to carry out such transformations, with retention, on similar subjects (**272 to 273**) where the reaction is anchimerically assisted by an ether oxygen antiperplanarly oriented to the carbon-halogen bond to be cleaved.

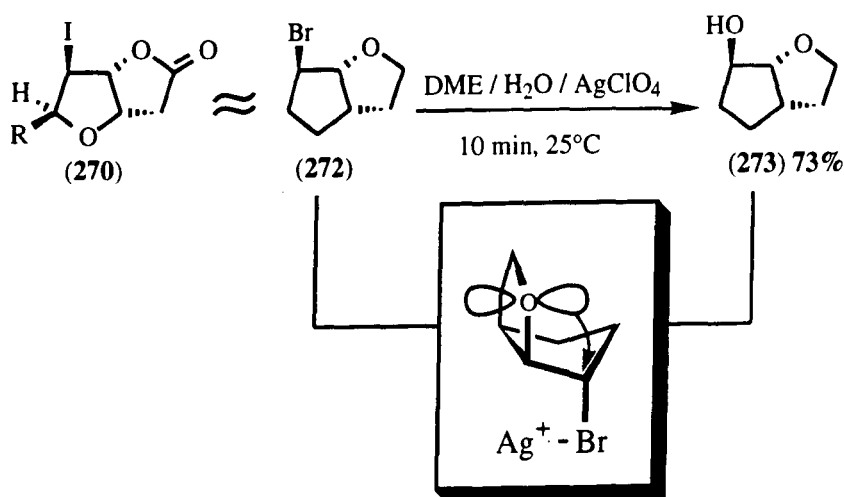

(*Scheme 66*)

Our sample will possess such a structural requirement. Elaboration of the final asymmetric centre on the side chain will have to be carried out beforehand and thus be incorporated; in protected form, into the *E*-hydroxyalkenoate before iodocyclization.

*A proposed synthesis of the C12-C17 fragment of Aplasmomycin*

Aplasmomycin (**274**), a boron containing ionophoric antibiotic from *Streptomyces griseus*, inhibits Gram-positive bacteria *in vitro* and also *Plasmodium berghei* *in vivo* (Scheme 67).<sup>357</sup> Its structure has been determined by X-ray crystallographic study as a C<sub>2</sub>-symmetric diolide composed of two identical subunits with a borate bridge spanning the macrocycle. The unique structure and biological activity of (**274**) distinguish this molecule as a very interesting target for synthesis and five independent total syntheses have so far been reported.<sup>357</sup>

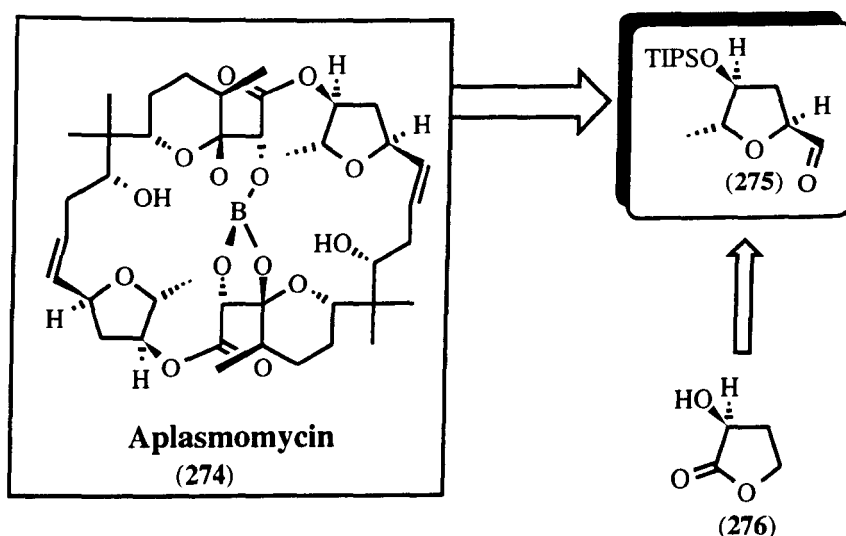

(Scheme 67)

Corey's most elegant synthesis of (**274**)<sup>358</sup> involved firstly constructing the key intermediate tetrahydrofuran (**275**). He used a procedure by Still<sup>163a</sup> to elaborate this fragment from (-)-(S)-2-hydroxy-4-butanolide (**276**), a process that involved no less than eight major synthetic steps, [(**276**) from a multi-sequential procedure itself].

Starting from methyl *E*-(2S)-2-hydroxyhex-4-enoate, anhydrous iodocyclization should give the major chiral iodotetrahydrofuran (**277**) (Scheme 68). The relative stereochemistry will be identical to the butyl variant (**202**)



previously synthesized. Unfortunately this time displacement, with potassium superoxide,<sup>342</sup> will invert the C4 centre to give (278).

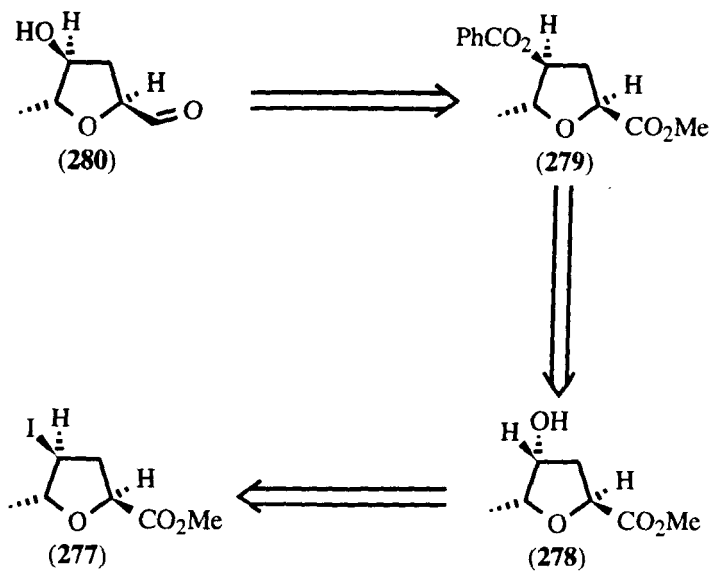

(Scheme 68)

Nevertheless, a Mitsunobu<sup>319</sup> inversion would provide the tetrahydrofuran diester (279) with the correct stereochemistry at C4. Finally diisobutylaluminium hydride reduction on this should cleave both ester groups to reveal the alcohol and aldehyde functions, [or alternatively by Swern<sup>298</sup> oxidation on the reduced alcohol]. This product (280) can then be simply silyl protected to give the key intermediate (275).

.....-O-.....

### **Experimental section**

Tetrahydrodibenzofurans and their precursors

Tetrahydrofurans and their homoallylic forerunners

## General details

Melting points were determined on a Kofler hot-stage apparatus and are uncorrected. Ultra-violet spectra were recorded on a Philips TU8720 spectrophotometer in ethanol solution. Infra-red spectra were recorded on a Perkin-Elmer 1720 FTIR or Pye-Unicam SP3-100 spectrophotometer as liquid films, chloroform solutions and KBr solids.  $^1\text{H}$  n.m.r. spectra were measured on a Bruker AM 400 (400 MHz, PFT), Bruker WM 250 (250 MHz, PFT), Bruker WP 80 SY (80 MHz, PFT), Joel FX 90 Q (90 MHz, PFT) and Perkin-Elmer R-32 (90 MHz, CW) instruments. The following abbreviations are used : s, singlet ; d, doublet ; t, triplet ; q, quartet ; m, multiplet ; br, broad and dt, doublet of triplets etc.  $^{13}\text{C}$  n.m.r. spectra were recorded on Bruker AM 400 (100 MHz, PFT), Bruker WM 250 (63 MHz, PFT) and Joel FX 90 Q (23 MHz, PFT) instruments. Chemical shifts ( $\delta_{\text{H}}$  and  $\delta_{\text{C}}$ ) are reported in ppm from tetramethylsilane (or deuteriochloroform) and are corrected to 0.00 (TMS) and 7.28 ( $\text{CHCl}_3$ ) ppm for  $^1\text{H}$  and 77.30 ( $\text{CDCl}_3$ ) ppm for  $^{13}\text{C}$ . Deuteriochloroform was used as the solvent for n.m.r. measurements unless otherwise stated. Mass spectra and molecular weights were determined using a VG MM7070E or AEI MS 902 spectrometer. Molecular formulae quoted for molecular fragment ions are converted to  $\pm 3$  mmu. Optical rotations ( $[\alpha]_{\text{D}}$ ) were measured on an Optical Activity Ltd, type-AA-10 polarimeter. All reactions using organometallic or air/moisture sensitive reagents were performed in oven-dried or flame-dried glassware under atmospheres of dry argon or nitrogen. All solvents and reagents were dried and purified according to the procedures laid down in "Purification of Laboratory Chemicals" by D. D. Perrin and W. L. F. Armarego. All organic solutions were dried by brief exposure to anhydrous magnesium sulphate unless stated otherwise.

### Ethyl 2-Phenoxy-3-oxobutanoate. (026)

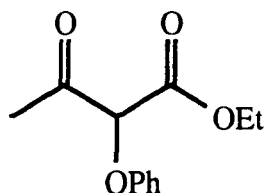

Dry sodium phenolate (58 g, 0.5 mol) and dry benzene (500 ml) were placed in a three necked flask fitted with a mechanical stirrer, dropping funnel and condenser. The stirred suspension was heated to reflux under nitrogen, moderated and then ethyl 2-chloroacetoacetate (66 g, 0.4 mol) was slowly added at such a rate as to maintain gentle reflux, 2 hr. The mixture was heated for a further 12 hr and then left to cool to room temperature. The resulting light brown suspension was washed with water (3x 100 ml), dried and the solvent removed under reduced pressure to give the crude *product* (026)<sup>137a</sup> (80 g, 90%) as a dark yellow oil, bp 73-75°C at 2.5mm Hg, [lit.<sup>137a</sup> bp 77-78°C at 4 mm Hg],  $\nu_{\max}$  (Film) 1735, 1660 and 1558  $\text{cm}^{-1}$ ,  $\delta_{\text{H}}$ (90) 1.30(3H, t,  $J = 7.0\text{Hz}$ ,  $\text{CO}_2\text{CH}_2\text{CH}_3$ ), 2.35(3H, s,  $\text{CH}_3\text{CO}$ ), 4.31(2H, q,  $J = 7.0\text{Hz}$ ,  $\text{CO}_2\text{CH}_2\text{CH}_3$ ), 4.80(1H, s,  $\text{CH}_3\text{COCH}$ ) and 6.91-7.62(5H, m,  $\text{OC}_6\text{H}_5$ ).

### Ethyl 3-Methylbenzofuran-2-carboxylate. (027)

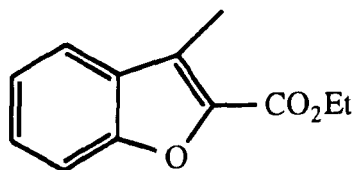

Sulphuric acid (12 M, 84 ml) was placed in a three necked flask fitted with a dropping funnel, mechanical stirrer and thermometer. The acid was cooled to -10°C (*s*-PrOH/ $\text{CO}_2$ ) and ethyl 2-phenoxy-3-oxobutanoate (026) (84 g, 0.4 mol) was slowly added to the stirred solution at such a rate so as the internal

temperature did not rise above  $-10^{\circ}\text{C}$  (2 hr). The resulting red solution was allowed to stand for a further 1 hr before being carefully poured onto a mixture of ice and water (500 g, 1:1), never allowing the temperature to rise above  $0^{\circ}\text{C}$ . The mixture was then allowed to warm to room temperature and was then extracted with ethyl acetate (3x 100 ml). The combined organic extracts were washed with water (3x 50 ml), aqueous 2M sodium hydrogen carbonate (3x 50 ml), then dried and the solvent removed under reduced pressure. The crude product was distilled, collecting the fraction with bp  $165\text{-}170^{\circ}\text{C}$  at 17mm Hg, [lit.<sup>137a</sup> bp  $162\text{-}167^{\circ}\text{C}$  at 16mm Hg] to give the *ester* (**027**)<sup>137a</sup> (49 g, 64%) as a pale yellow solid, mp  $50\text{-}51^{\circ}\text{C}$ , [lit.<sup>137a</sup> mp  $49\text{-}51^{\circ}\text{C}$ ],  $\nu_{\text{max}}(\text{KBr})$   $1741\text{ cm}^{-1}$ ,  $\delta_{\text{H}}(90)$  1.40(3H, t,  $J = 7.0\text{Hz}$ ,  $\text{CO}_2\text{CH}_2\text{CH}_3$ ), 2.61(3H, s,  $\text{CH}_3$ ), 4.45(2H, q,  $J = 7.0\text{Hz}$ ,  $\text{CO}_2\text{CH}_2\text{CH}_3$ ) and 7.10-7.71(4H, m,  $\text{C}_6\text{H}_4$ ).

### 3-Methylbenzofuran-2-carboxylic acid. (018)

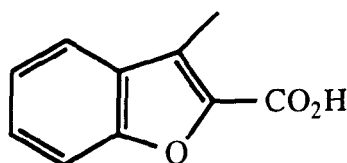

To an ice-cold solution of ethyl 3-methylbenzofuran-2-carboxylate (**027**) (6.12 g, 30 mmol) in methanol (20 ml) was slowly added a solution of potassium hydroxide (2.0 g, 36 mmol) in methanol (10 ml) and the resulting mixture stirred at ambient temperature for 24 hr. The reaction mixture was then washed with ether (2x 5 ml), acidified to pH 2 with 2M hydrochloric acid and extracted with ether (3x 20 ml). The combined organic extracts were dried and evaporated under reduced pressure to yield the *acid* (**018**)<sup>137a</sup> (5.1 g, 97%) as a white solid, mp  $191\text{-}193^{\circ}\text{C}$ , [lit.<sup>137a</sup> mp  $192\text{-}193^{\circ}\text{C}$ ],  $\nu_{\text{max}}(\text{KBr})$   $1690\text{ cm}^{-1}$ ,  $\lambda_{\text{max}}(\text{EtOH})$  197( $\epsilon$  17,702), 220( $\epsilon$  14,428) and 274( $\epsilon$  22,315)nm,  $\delta_{\text{H}}(80)$  ( $d_6$  acetone) 2.61(3H, s,  $\text{CH}_3$ ), 5.80(1H, br s,  $\text{CO}_2\text{H}$ ) and 7.20-7.91(4H, m,  $\text{C}_6\text{H}_4$ ).

### Triisopropylsilyl 3-(triisopropylsilylmethyl)benzofuran-2-carboxylate. (033)

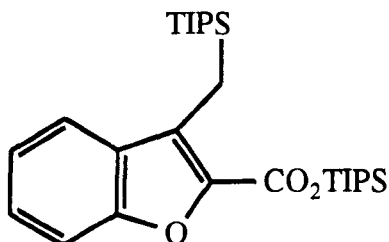

To a solution of 3-methylbenzofuran-2-carboxylic acid (**018**) (0.18 g, 1.0 mmol) in tetrahydrofuran (20 ml) at  $-78^{\circ}\text{C}$  was added lithium diisopropylamide (2.4 ml, 1.0 M) in tetrahydrofuran (4 ml). The resulting red dianion solution was left for 0.5 hr and then triisopropylsilyl chloride (0.46 g, 2.4 mmol) in tetrahydrofuran (2 ml) was slowly added at  $-78^{\circ}\text{C}$ . The mixture was allowed to warm to  $0^{\circ}\text{C}$  over the course of 3 hr at which point it was quenched with saturated ammonium chloride solution (10 ml). The mixture was poured into ether, washed with water and dried. Evaporation of the solvent under reduced pressure gave the *product* (**033**)<sup>131</sup> (0.34 g, 69%) as a deep orange oil,  $\nu_{\text{max}}$ (film)  $1680\text{ cm}^{-1}$ ,  $\lambda_{\text{max}}$  (EtOH) 202( $\epsilon$  27,698), 288( $\epsilon$  22,962) and 295( $\epsilon$  22,981)nm,  $\delta_{\text{H}}$ (90) 1.05-1.17(42H, br s,  $i\text{Pr}_6$ ), 2.78(2H, s,  $\text{CH}_2$ ) and 7.10-7.80(4H, m,  $\text{C}_6\text{H}_4$ ),  $m/z$  488(0.21%,  $\text{M}^+$ ), 445(100,  $\text{C}_{25}\text{H}_{41}\text{O}_3\text{Si}_2$ , M- $\text{C}_3\text{H}_7$ ), 315(13,  $\text{C}_{19}\text{H}_{27}\text{O}_2\text{Si}$ , M- $\text{C}_9\text{H}_{21}\text{Si}$ ), 287(21,  $\text{C}_{18}\text{H}_{27}\text{OSi}$ , M- $\text{C}_{10}\text{H}_{21}\text{O}_2\text{Si}$ ), 157(7,  $\text{C}_9\text{H}_{21}\text{Si}$ ) and 131(43,  $\text{C}_9\text{H}_7\text{O}$ ). [Found:  $\text{M}^+$ , 488.8401.  $\text{C}_{28}\text{H}_{48}\text{O}_3\text{Si}_2$  requires: M, 488.8440].

### 3-(Triisopropylsilylmethyl)benzofuran-2-carboxylic acid. (034)

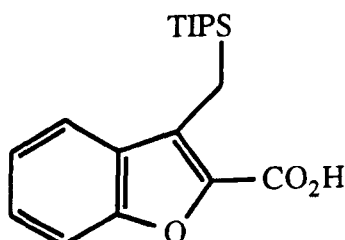

To a solution of 3-methylbenzofuran-2-carboxylic acid (**018**) (0.70 g, 4.0 mmol) in dry tetrahydrofuran (40 ml) at  $-78^{\circ}\text{C}$  was added lithium diisopropylamine (9.6 ml, 1.0 M) in tetrahydrofuran (10 ml). The resulting red dianion solution was left for 0.5 hr and then triisopropylsilyl chloride (1.84 g, 9.6 mmol) in tetrahydrofuran (5 ml) was slowly added at this temperature. The reaction mixture was then allowed to warm to  $0^{\circ}\text{C}$  over the course of 3 hr at which point it was quenched with 2M hydrochloric acid (20 ml) and left stirring for 0.5 hr. The mixture was then poured into ether (100 ml) and the resulting mixture washed with brine (3x 40 ml). The organic solution was dried and the solvents removed under reduced pressure. The crude product was then recrystallised from pentane/ether (80:20) to give the *acid* (**034**)<sup>131</sup> (0.70 g, 53%) as a white solid, mp  $216\text{-}217^{\circ}\text{C}$ ,  $\nu_{\text{max}}$ (KBr) 3200-2400, 1670 and  $1570\text{ cm}^{-1}$ ,  $\lambda_{\text{max}}$  (EtOH) 211( $\epsilon$  34,221) and 285( $\epsilon$  35,424),  $\delta_{\text{H}}$ (80) ( $d_6$  acetone) 1.05(21H, br s,  $i\text{Pr}_3\text{Si}$ ), 2.74(2H, s,  $\text{CH}_2$ ) and 7.00-7.81(4H, m,  $\text{C}_6\text{H}_4$ ),  $m/z$  332(0.2%,  $\text{M}^+$ ), 289(100,  $\text{C}_{16}\text{H}_{21}\text{O}_3\text{Si}$ ,  $\text{M}-\text{C}_3\text{H}_7$ ), 203(5,  $\text{C}_{10}\text{H}_7\text{O}_3\text{Si}$ ), 175(4,  $\text{C}_{10}\text{H}_7\text{O}_3$ ), 144(5,  $\text{C}_{10}\text{H}_8\text{O}$ ) and 130(7,  $\text{C}_9\text{H}_6\text{O}$ ). [Found: C, 68.68; H, 8.66.  $\text{C}_{19}\text{H}_{28}\text{O}_3\text{Si}$  requires: C, 68.67; H, 8.43%].

### Methyl 3-(triisopropylsilylmethyl)benzofuran-2-carboxylate. (**035**)

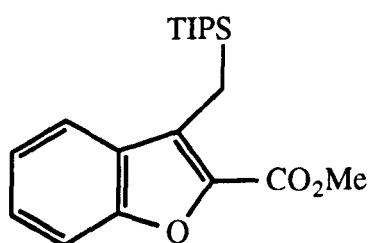

To an ice cold solution of 3-(triisopropylsilylmethyl)benzofuran-2-carboxylic acid (**034**) (1.0 g, 3.0 mmol) in ether (10 ml) was added diazomethane (excess) in ether until TLC analysis showed that all the acid had been converted into ester. The solution was left to warm to room temperature for 1 hr and then washed with aqueous 2M sodium hydroxide, dried and evaporated under

reduced pressure. The crude product was then recrystallised from pentane/ether (80:20) to give the ester (**035**)<sup>302</sup> (0.96 g, 92%) as a cream solid, mp 71-73°C,  $\nu_{\max}(\text{KBr})$  1718, 1615 and 1437  $\text{cm}^{-1}$ ,  $\delta_{\text{H}}(90)$  1.07(21H, br s,  $^i\text{Pr}_3\text{Si}$ ), 2.55(2H, s,  $\text{CH}_2$ ), 3.92(3H, s,  $\text{CO}_2\text{CH}_3$ ) and 7.25-7.91(4H, m,  $\text{C}_6\text{H}_4$ ).

### 3-(Triisopropylsilylmethyl)benzofuran-2-methanol. (**036**)

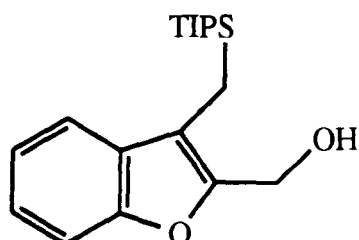

To a stirred, ice cold solution of triisopropylsilyl 3-(triisopropylsilylmethyl) benzofuran-2-carboxylate (**033**) (0.73 g, 1.5 mmol) in dry ether (20 ml) was added lithium aluminium hydride (60 mg, 1.5 mmol). The solution was stirred for 10 min, then quenched by the addition of ethyl acetate (2 ml). The reaction mixture was washed with aqueous 2M sodium hydroxide, dried and the solvent removed under reduced pressure to give the crude product. Column chromatography using silica G and hexane/ethyl acetate (80:20) as eluant gave the *alcohol* (**036**)<sup>305</sup> (0.34 g, 71%) as an off-white solid, mp 69-70°C,  $\nu_{\max}(\text{KBr})$  3350 and 1460  $\text{cm}^{-1}$ ,  $\lambda_{\max}(\text{EtOH})$  203( $\epsilon$  47,821), 265( $\epsilon$  45,011) and 290( $\epsilon$  46,721)nm,  $\delta_{\text{H}}(90)$  1.05(21H, br s,  $^i\text{Pr}_3\text{Si}$ ), 2.12(2H, s,  $^i\text{Pr}_3\text{SiCH}_2$ ), 4.75(2H, s,  $\text{CH}_2\text{OH}$ ) and 7.11-7.70(4H, m,  $\text{C}_6\text{H}_4$ ),  $m/z$  318(4%,  $\text{M}^+$ ), 275(17,  $\text{C}_{16}\text{H}_{23}\text{O}_2\text{Si}$ ,  $\text{M}-\text{C}_3\text{H}_7$ ), 157(16,  $\text{C}_9\text{H}_{21}\text{Si}$ ), 144(100,  $\text{C}_{10}\text{H}_8\text{O}$ ) and 131(62,  $\text{C}_9\text{H}_7\text{O}$ ). [Found:  $\text{M}^+$ , 318.2013.  $\text{C}_{19}\text{H}_{30}\text{O}_2\text{Si}$  requires:  $\text{M}$ , 318.2015] and the desilylation product (**037**) (43 mg, 8%) [*vide infra*].



### 3-Methylbenzofuran-2-methanol. (037)

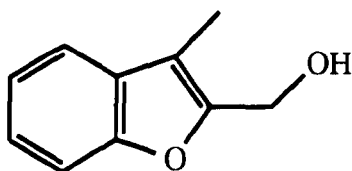

This is the desilylation product formed when 3-(triisopropylsilylmethyl) benzofuran-2-methanol (036) is purified by column chromatography over silica G using hexane/ethyl acetate (80:20) as eluant. Typically 8-12% of the desired alcohol (036) is lost due to this desilylation reaction on the column. Recrystallisation of the product using pentane/ether (50:50) gave the *alcohol* (037) as a white solid, mp 82-83°C,  $\nu_{\max}(\text{KBr})$  3236, 1454 and 1357  $\text{cm}^{-1}$ ,  $\lambda_{\max}(\text{EtOH})$  205( $\epsilon$  48,015), 265( $\epsilon$  45,127) and 282( $\epsilon$  46,791)nm,  $\delta_{\text{H}}(80)$  1.94(1H, br s, OH), 2.56(3H, s, CH<sub>3</sub>), 4.75(2H, s, CH<sub>2</sub>OH) and 7.10-7.60(4H, m, C<sub>6</sub>H<sub>4</sub>),  $m/z$  162(100%, M<sup>+</sup>), 145(97, M-OH), 144(10, M-H<sub>2</sub>O), 131(12, C<sub>9</sub>H<sub>7</sub>O) and 115(19, C<sub>8</sub>H<sub>4</sub>O). [Found: C, 71.5; H, 5.9. C<sub>10</sub>H<sub>10</sub>O<sub>2</sub> requires: C, 71.4; H, 5.9%].

### 2-Acetyloxymethyl-3-(triisopropylsilylmethyl)benzofuran. (038)

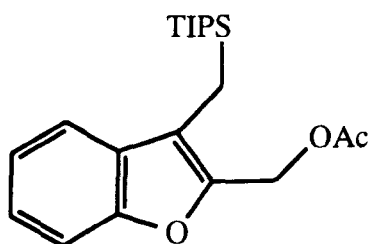

To an ice cold solution of 3-(triisopropylsilylmethyl) benzofuran-2-methanol (036) (0.95 g, 3.0 mmol) in acid free dichloromethane (20 ml) were added *N,N*-dimethylaminopyridine (3-4 crystals) and acetic anhydride (0.34 ml, 3.6 mmol) in

that order. The reaction was left for 1 hr and then the solvent was removed. The residue was redissolved in ether, washed with water, filtered through a pad of alumina, dried and the solvent removed to give the *acetate* (**038**)<sup>140</sup> (0.92 g, 86%) as an off white solid, mp 41-43°C,  $\nu_{\max}$  (KBr) 1746 and 1458  $\text{cm}^{-1}$ ,  $\lambda_{\max}$  (EtOH) 199( $\epsilon$  30,719), 201( $\epsilon$  30,827) and 261( $\epsilon$  14,070)nm,  $\delta_{\text{H}}$ (400) 1.03-1.15(18H, br s, 3x  $(\text{CH}_3)_2\text{CH}$ ), 1.10-1.23(3H, m, 3x  $(\text{CH}_3)_2\text{CH}$ ), 2.01(3H, s,  $\text{CH}_3\text{CO}_2$ ), 2.18(2H, s,  $^i\text{Pr}_3\text{SiCH}_2$ ), 5.20(2H, s,  $\text{CH}_2\text{OAc}$ ), 7.21(1H, t,  $J = 7.5\text{Hz}$ ,  $\text{CH}_c=\text{CH}_b$ ), 7.29(1H, t,  $J = 7.5\text{Hz}$ ,  $\text{CH}_d=\text{CH}_c$ ), 7.40(1H, d,  $J = 7.3\text{Hz}$ ,  $\text{CH}_d=\text{CH}_c$ ) and 7.50(1H, d,  $J = 7.3\text{Hz}$ ,  $\text{CH}_a=\text{CH}_b$ ),  $\delta_{\text{C}}$ (100) 170.77(C=O), 154.47(C), 144.99(C), 129.47(C), 124.88(CH), 122.15(CH), 120.32(CH), 118.98(C), 111.27(CH), 57.20( $\text{CH}_2$ ), 20.83( $\text{CH}_3$ ), 18.60(6x  $\text{CH}_3$ ), 11.61(3x CH) and 5.26( $\text{CH}_2$ ),  $m/z$  360(7%,  $\text{M}^+$ ), 301(6,  $\text{C}_{19}\text{H}_{29}\text{OSi}$ ,  $\text{M}-\text{C}_2\text{H}_3\text{O}_2$ ), 173(94,  $\text{C}_{10}\text{H}_9\text{OSi}$ ) and 144(100,  $\text{C}_{10}\text{H}_8\text{O}$ ). [Found:  $\text{M}^+$ , 360.2182.  $\text{C}_{21}\text{H}_{32}\text{O}_3\text{Si}$  requires:  $\text{M}$ , 360.2121].

### 2-Acetyloxymethyl-3-methylbenzofuran. (039)

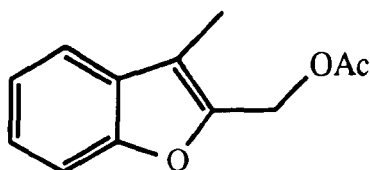

This is the product formed when 2-acetyloxymethyl-3-(triisopropylsilylmethyl)benzofuran (**038**) comes into contact with any acidic source be it directly in the form of an acid or indirectly *i.e.* in protic solvents, silica *etc.* Purification and handling should therefore be kept to a minimum. The *acetate* (**039**) showed, mp 73-76°C,  $\nu_{\max}$  (KBr) 1746 and 1450  $\text{cm}^{-1}$ ,  $\delta_{\text{H}}$ (80) 2.01(3H, s,  $\text{CH}_3\text{CO}_2$ ), 2.09(3H, s,  $\text{CH}_3$ ), 5.21(2H, s,  $\text{CH}_2\text{OAc}$ ) and 7.22-7.50(4H, m,  $\text{C}_6\text{H}_4$ ).

**Trans-Dimethyl 1,2,3,4-tetrahydrodibenzofuran-2,3-dicarboxylate. (042)**

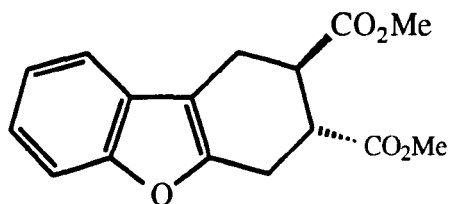

To a solution of 2-acetyloxymethyl-3-(triisopropylsilylmethyl)benzofuran (**038**) (0.36 g, 1 mmol) and dimethyl fumarate (0.3 g, 2.08 mmol) in dry, acid-free acetonitrile (20 ml) maintained at  $-4^{\circ}\text{C}$  was added tetra-*n*-butylammonium fluoride [TBAF] (1 ml of a 1.0 M solution in tetrahydrofuran, 1.0 mmol). The mixture was kept stirring for 60 hr at this temperature and then a further aliquot of TBAF (1 ml) was added. After another 60 hr at  $-4^{\circ}\text{C}$ , the solvent was removed under reduced pressure and the residue purified by column chromatography over silica G using hexane/ethyl acetate (80:20) as eluant. The resulting crude product was recrystallised from pentane/ether (90:10) to give the diester (**042**) (0.21 g, 73%) as a bright yellow solid, mp  $96-97^{\circ}\text{C}$ ,  $\nu_{\text{max}}$  (KBr) 1735, 1460 and  $1440\text{ cm}^{-1}$ ,  $\delta_{\text{H}}$ (400) 2.85(1H, dddd,  $J = 16.0, 9.5, 2.6$  and  $1.9\text{ Hz}$ ,  $\text{CH}_a\text{H}_b\text{CH}_c\text{CO}_2\text{CH}_3$ ), 2.98(1H, dddd,  $J = 16.0, 9.5, 2.6$  and  $1.9\text{ Hz}$ ,  $\text{CH}_f\text{H}_e\text{CH}_d\text{CO}_2\text{CH}_3$ ), 3.10(1H, app ddt,  $J = 16.0, 6.0$  and  $1.6\text{ Hz}$ ,  $\text{CH}_a\text{H}_b\text{CH}_d\text{CO}_2\text{CH}_3$ ), 3.18(1H, app dd,  $J = 16.0$  and  $6.0\text{ Hz}$ ,  $\text{CH}_f\text{H}_e\text{CH}_d\text{CO}_2\text{CH}_3$ ), 3.21(1H, app td,  $J = 9.5$  and  $6.0\text{ Hz}$ ,  $\text{CH}_a\text{H}_b\text{CH}_c\text{CO}_2\text{CH}_3$ ), 3.32(1H, app td,  $J = 9.5$  and  $6.0\text{ Hz}$ ,  $\text{CH}_f\text{H}_e\text{CH}_d\text{CO}_2\text{CH}_3$ ), 3.75(6H, s,  $(\text{CO}_2\text{CH}_3)_2$ ), 7.21(1H, dd,  $J = 8.3$  and  $6.5\text{ Hz}$ ,  $\text{CH}_b=\text{CH}_a$ ), 7.23(1H, dd,  $J = 8.3$  and  $6.5\text{ Hz}$ ,  $\text{CH}_c=\text{CH}_d$ ), 7.39(1H, d,  $J = 6.5\text{ Hz}$ ,  $\text{CH}_c=\text{CH}_d$ ) and 7.41(1H, d,  $J = 6.3\text{ Hz}$ ,  $\text{CH}_b=\text{CH}_a$ ),  $\delta_{\text{C}}$ (100) 174.4(C=O), 174.0(C=O), 154.9(C), 150.7(C), 127.8(C), 123.7(CH), 122.6(CH), 118.5(CH), 118.4(C), 111.1(CH), 52.3(CH<sub>3</sub>), 52.2(CH<sub>3</sub>), 41.8(CH), 41.6(CH), 25.5(CH<sub>2</sub>) and 22.9(CH<sub>2</sub>),  $m/z$  288(28%, M<sup>+</sup>), 257(12, C<sub>15</sub>H<sub>13</sub>O<sub>4</sub>, M-CH<sub>3</sub>O), 228(33, C<sub>14</sub>H<sub>12</sub>O<sub>3</sub>, M-C<sub>3</sub>H<sub>8</sub>O<sub>2</sub>), 196(9, C<sub>13</sub>H<sub>12</sub>O<sub>3</sub>, M-C<sub>3</sub>H<sub>8</sub>O<sub>3</sub>), 169(100, C<sub>12</sub>H<sub>9</sub>O, M-C<sub>4</sub>H<sub>7</sub>O<sub>4</sub>), 144(16, C<sub>10</sub>H<sub>8</sub>O) and 115(10, C<sub>9</sub>H<sub>7</sub>O). [Found: M<sup>+</sup>, 288.1000; C, 67.0; H, 5.9. C<sub>16</sub>H<sub>16</sub>O<sub>5</sub> requires: M, 288.0996; C, 66.7; H, 5.6%].

**Trans and cis-Dimethyl 1,2,3,4-tetrahydrodibenzofuran-2,3-dicarboxylate. (042) and (043)**

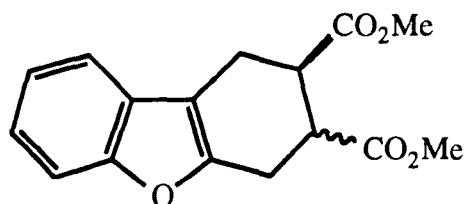

To a solution of 2-acetyloxymethyl-3-(triisopropylsilylmethyl)benzofuran (**038**) (0.36 g, 1.0 mmol) and dimethyl maleate (0.30 g, 2.08 mmol) in dry, acid free acetonitrile (10 ml) at  $-4^{\circ}\text{C}$  was added TBAF (1 ml of a 1.0 M solution in tetrahydrofuran, 1.0 mmol). The mixture was kept stirring for 48 hr at this temperature then a further portion of TBAF (1 ml) was added. After a further 24 hr, the solvent was removed under reduced pressure and the residue purified by column chromatography over silica G using hexane/ethyl acetate (80:20) as eluant. The crude product was recrystallised from pentane/ether (90:10) to give the *diesters* (**042**) and (**043**) (0.20 g, 69%) in a ratio of 2:1 *trans/cis* respectively, as a cream coloured solid, mp  $94-99^{\circ}\text{C}$ ,  $\nu_{\text{max}}$  (KBr) 1736, 1460 and  $1440\text{ cm}^{-1}$ ,  $\delta_{\text{H}}$ (400) 2.85-2.91(1H, m, *trans/cis*-CH<sub>a</sub>H<sub>b</sub>CH<sub>c</sub>CO<sub>2</sub>CH<sub>3</sub>), 2.98-3.08(1H, m, *trans/cis*-CH<sub>f</sub>H<sub>e</sub>CH<sub>d</sub>CO<sub>2</sub>CH<sub>3</sub>), 3.10-3.17(1H, m, *trans/cis*-CH<sub>a</sub>H<sub>b</sub>CH<sub>d</sub>CO<sub>2</sub>CH<sub>3</sub>), 3.18-3.20(1H, m, *trans/cis*-CH<sub>f</sub>H<sub>e</sub>CH<sub>d</sub>CO<sub>2</sub>CH<sub>3</sub>), 3.21-3.30(1H, m, *trans/cis*-CH<sub>a</sub>H<sub>b</sub>CH<sub>c</sub>CO<sub>2</sub>CH<sub>3</sub>), 3.32-3.40(1H, m, *trans/cis*-CH<sub>f</sub>H<sub>e</sub>CH<sub>d</sub>CO<sub>2</sub>CH<sub>3</sub>), 3.71(1H, s, *cis*-CO<sub>2</sub>CH<sub>3</sub>), 3.72(1H, s, *cis*-CO<sub>2</sub>CH<sub>3</sub>), 3.75(4H, s, *trans*-(CO<sub>2</sub>CH<sub>3</sub>)<sub>2</sub>), 7.21-7.22(1H, m, *trans/cis*-CH<sub>b</sub>=CH<sub>a</sub>), 7.23-7.25(1H, m, *trans/cis*-CH<sub>c</sub>=CH<sub>d</sub>), 7.39-7.40(1H, m, *trans/cis*-CH<sub>c</sub>=CH<sub>d</sub>) and 7.41-7.43(1H, m, *trans/cis*-CH<sub>b</sub>=CH<sub>a</sub>),  $\delta_{\text{C}}$ (100) 173.4(*cis*-C=O), 173.1(*cis*-C=O), 174.4(*trans*-C=O), 174.0(*trans*-C=O), 154.9(*trans*-C), 151.8(*cis*-C), 150.7(*trans*-C), 141.0(*cis*-C), 128.0(*cis*-C), 127.8(*trans*-C), 123.7(*trans/cis*-CH), 122.6(*trans*-CH), 122.5(*cis*-CH), 118.6(*cis*-CH), 118.5(*trans*-CH), 118.4(*trans*-C), 111.2(*cis*-CH), 111.1(*trans*-CH), 111.0(*cis*-C), 52.4(*cis*-

CH<sub>3</sub>), 52.3(*trans/cis*-CH<sub>3</sub>), 52.2(*trans*-CH<sub>3</sub>), 41.8(*trans*-CH), 41.6(*trans*-CH), 40.98(*cis*-CH), 40.67(*cis*-CH), 25.5(*trans*-CH<sub>2</sub>), 24.4(*cis*-CH<sub>2</sub>), 22.9(*trans*-CH<sub>2</sub>) and 21.5(*cis*-CH<sub>2</sub>), m/z 288(28%, M<sup>+</sup>), 257(11, C<sub>15</sub>H<sub>13</sub>O<sub>4</sub>, M-CH<sub>3</sub>O), 228(39, C<sub>14</sub>H<sub>12</sub>O<sub>3</sub>, M-C<sub>3</sub>H<sub>8</sub>O<sub>2</sub>), 196(8, C<sub>13</sub>H<sub>12</sub>O<sub>3</sub>, M-C<sub>3</sub>H<sub>8</sub>O<sub>3</sub>), 169(100, C<sub>12</sub>H<sub>9</sub>O, M-C<sub>4</sub>H<sub>7</sub>O<sub>4</sub>), 144(12, C<sub>10</sub>H<sub>8</sub>O) and 115(8, C<sub>9</sub>H<sub>7</sub>O). [Found: M<sup>+</sup>, 288.0985. C<sub>16</sub>H<sub>16</sub>O<sub>5</sub> requires: M, 288.0996].

### Methyl 1,2,3,4-Tetrahydrodibenzofuran-2 and 3-carboxylate. (044) and (045)

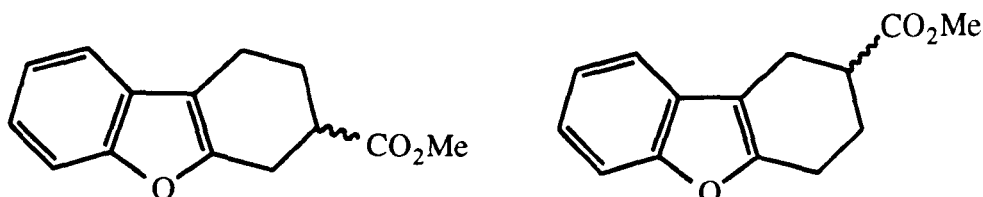

Using the foregoing procedure, reaction between the silyl-acetate (**038**) (0.36 g, 1.0 mmol), methyl acrylate (0.2 ml, 2.0 mmol) and TBAF (1 ml of 1 M, solution in tetrahydrofuran, 1.0 mmol) in dry, acid free acetonitrile (10 ml) at -4°C for 48 hr was followed by a further addition of TBAF (1 ml) and 48 hr at -4°C, and finally evaporation. The residue was purified by column chromatography over silica G using hexane/ethyl acetate (90:10) as eluant to give the *esters* (**044**) and (**045**)<sup>128</sup> (0.2 g, 87%) in a 2:1 ratio, 2-isomer/3-isomer respectively, as a yellow, low melting point solid, mp ≅ 30°C,  $\nu_{\max}$  (film) 1740, 1650, 1620 and 1460 cm<sup>-1</sup>,  $\delta_{\text{H}}$ (400) 1.95-2.00(1.32H, m, 2-isomer-CH<sub>2</sub>), 2.05-2.14(0.66H, m, 3-isomer-CH<sub>2</sub>), 2.25-2.30(1.32H, m, 2-isomer-CH<sub>2</sub>), 2.34-2.42(0.66H, m, 3-isomer-CH<sub>2</sub>), 2.61-2.63(0.66H, m, 3-isomer-CH<sub>2</sub>), 2.65-2.67(1.32H, m, 2-isomer-CH<sub>2</sub>), 2.70-3.10(2H, m, 2 and 3-isomers-CH<sub>2</sub>CH), 3.74(3H, s, 2 and 3-isomers-CO<sub>2</sub>CH<sub>3</sub>), 7.11-7.16(2H, m, 2 and 3-isomers-CH<sub>b</sub>=CH<sub>c</sub>), 7.31 (0.66H, d, J = 7.5Hz, 2-isomer-CH<sub>d</sub>=CH<sub>c</sub>), 7.33(0.33H, d, J = 5.1Hz, 3-isomer-

$\text{CH}_d=\text{CH}_c$ ), 7.34(0.66H, d,  $J = 7.4$ , 2-isomer- $\text{CH}_a=\text{CH}_b$ ) and 7.34(0.33H, d,  $J = 5.3\text{Hz}$ , 3-isomer- $\text{CH}_a=\text{CH}_b$ ),  $\delta_{\text{C}}(100)$  174.9(2-isomer-C=O), 174.3(3-isomer-C=O), 154.6(2-isomer-C), 154.9 (3-isomer-C), 152.9(2 and 3-isomers-C), 151.9(2-isomer-C), 128.3(3-isomer-C), 128.2(2-isomer-C), 123.6(2-isomer-CH), 123.3(3-isomer-CH), 122.3(2 and 3-isomers-CH), 118.4(3-isomer-CH), 118.3(2-isomer-CH), 112.4(2-isomer-C), 111.4(3-isomer-C), 110.9(2 and 3-isomers-CH), 51.9(2-isomer- $\text{CH}_3$ ), 51.8(3-isomer- $\text{CH}_3$ ), 39.9(2-isomer-CH), 39.5(3-isomer-CH), 25.8(2-isomer- $\text{CH}_2$ ), 25.6(2-isomer- $\text{CH}_2$ ), 25.4(3-isomer- $\text{CH}_2$ ), 23.2(3-isomer- $\text{CH}_2$ ), 22.4(3-isomer- $\text{CH}_2$ ) and 19.4(2-isomer- $\text{CH}_2$ ),  $m/z$  230(59%,  $\text{M}^+$ ), 185(7,  $\text{C}_{12}\text{H}_9\text{O}$ , M- $\text{C}_2\text{H}_5\text{O}$ ), 170(100,  $\text{C}_{12}\text{H}_{10}\text{O}$ , M- $\text{C}_2\text{H}_4\text{O}_2$ ), 144(59,  $\text{C}_{10}\text{H}_8\text{O}$ , M- $\text{C}_4\text{H}_6\text{O}_2$ ) and 115(21,  $\text{C}_9\text{H}_7\text{O}$ ). [Found:  $\text{M}^+$ , 230.0941; C, 73.0; H, 6.4.  $\text{C}_{14}\text{H}_{14}\text{O}_3$  requires: M, 230.0942; C, 73.0; H, 6.1%].

## 2- and 3-(1'-Oxoethyl)-1,2,3,4-tetrahydrodibenzofuran. (046) and (047)

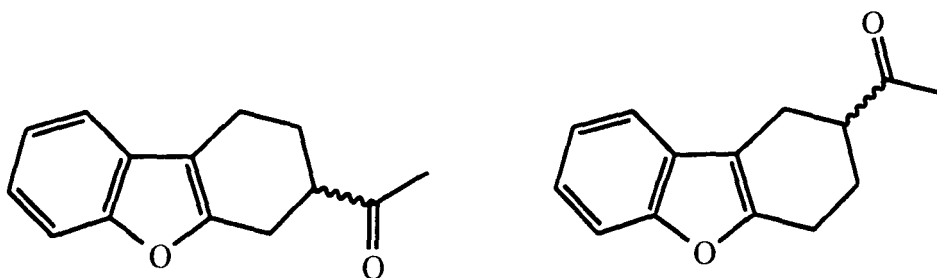

Using the foregoing procedure, reaction between the silyl-acetate (**038**) (0.72 g, 2.0 mmol), methyl vinyl ketone (0.56 g, 8.0 mmol) and TBAF (2 ml of a 1.0 M solution in tetrahydrofuran, 2.0 mmol) in acetonitrile (20 ml) at  $-4^\circ\text{C}$  for 72 hr, with the addition of further TBAF solution (2 ml) at 24 hr intervals gave, after column chromatography over silica G using hexane/ethyl acetate (90:10) as eluant, the *ketones* (**046**) and (**047**) (0.33 g, 77%) in a 4:1 ratio, 2-isomer/3-isomer respectively, as a yellow oil,  $\nu_{\text{max}}(\text{film})$  1715 and  $1450\text{ cm}^{-1}$ ,  $\delta_{\text{H}}(400)$  1.85-1.92(1.6H, m, 2-isomer- $\text{CH}_2\text{CH}_2\text{CH}$ ), 2.00-2.11(0.4H, m, 3-isomer- $\text{CH}_2\text{CH}_2\text{CH}$ ), 2.26-2.28(2H, m, 2 and 3-isomers- $\text{CH}_2\text{CH}_2\text{CH}$ ), 2.29(3H, s, 2 and

3-isomers-CH<sub>3</sub>CO), 2.68-2.71(2H, m, 2 and 3-isomers-CH<sub>2</sub>), 2.75-3.05(1H, m, 2 and 3-isomers-CH<sub>2</sub>CH), 7.20(1H, t, J = 6.8Hz, 2 and 3-isomers-CH<sub>b</sub>=CH<sub>c</sub>), 7.28(1H, t, J = 6.8Hz, 2 and 3-isomers-CH<sub>b</sub>=CH<sub>c</sub>), 7.40(0.8H, d, J = 5.7Hz, 2-isomer-CH<sub>d</sub>=CH<sub>c</sub>), 7.41(0.2H, d, J = 5.1Hz, 3-isomer-CH<sub>d</sub>=CH<sub>c</sub>), 7.42(0.8H, d, J = 5.7Hz, 2-isomer-CH<sub>a</sub>=CH<sub>b</sub>) and 7.43 (0.2H, d, J = 5.3Hz, 3-isomer-CH<sub>a</sub>=CH<sub>b</sub>), δ<sub>C</sub>(100) 209(2-isomer-C=O), 155.0(2-isomer-C), 152(2-isomer-C), 128(2-isomer-C), 123.6(3-isomer-CH), 123.4(2-isomer-CH), 122.4(2-isomer-CH), 118.7(3-isomer-CH), 118.5(2-isomer-CH), 112.1(2-isomer-C), 111.0(2-isomer-CH), 48.0(2-isomer-CH<sub>3</sub>), 47.7(3-isomer-CH<sub>3</sub>), 28.3(2-isomer-CH), 25.3(2-isomer-CH<sub>2</sub>), 25(2-isomer-CH<sub>2</sub>), 22.8(3-isomer-CH<sub>2</sub>), 22.6(3-isomer-CH<sub>2</sub>) and 19.9(2-isomer-CH<sub>2</sub>), m/z 214(71%, M<sup>+</sup>), 199(21, C<sub>13</sub>H<sub>11</sub>O<sub>2</sub>, M-CH<sub>3</sub>), 171(100, C<sub>12</sub>H<sub>11</sub>O, M-CH<sub>3</sub>O), 144(61, C<sub>10</sub>H<sub>8</sub>O, M-C<sub>4</sub>H<sub>6</sub>O) and 115(17, C<sub>9</sub>H<sub>7</sub>O, M-C<sub>4</sub>H<sub>7</sub>O<sub>4</sub>). [Found: M<sup>+</sup>, 214.0975. C<sub>14</sub>H<sub>14</sub>O<sub>2</sub> requires: M, 214.0993].

## 2- and 3-Cyano-1,2,3,4-tetrahydrodibenzofuran. (048) and (049)

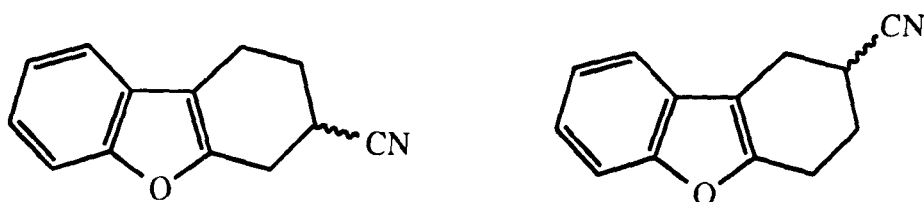

To a solution of 3-(triisopropylsilylmethyl)benzofuran-2-methyl acetate (**038**) (0.36 g, 1.0 mmol), acrylonitrile (0.2 ml, 2.0 mmol) in dry, acid free acetonitrile (10 ml) at -4°C was added tetra-*n*-butylammonium fluoride solution (1 ml, 1.0 M, 1.0 mmol). The mixture was kept stirring for 48 hr and then a further addition of tetrabutylammonium fluoride was added (1 ml, 1.0 M, 1.0 mmol). After another 48 hr the solvent was removed under reduced pressure and the residue purified by column chromatography over silica G using hexane/ethyl acetate (90:10) as eluant to give the *cyanides* (**048**) and (**049**) (0.18 g, 93%) in a 7:1 ratio, 2-isomer/3-isomer respectively, as a white

crystalline solid (cubic crystals), mp 83-84°C,  $\nu_{\max}$ (KBr) 2240, 1474 and 1451  $\text{cm}^{-1}$ ,  $\delta_{\text{H}}$ (400) 2.20(1.76H, app ddd,  $J = 14.0, 6.1$  and  $3.7\text{Hz}$ , 2-isomer- $\text{CH}_2$ ), 2.30-2.37(0.24H, m, 3-isomer- $\text{CH}_2$ ), 2.77(0.88H, app dtt,  $J = 16.4, 6.1$  and  $2.0\text{Hz}$ , 2-isomer- $\text{CH}$ ), 2.91(0.88H, app dtt,  $J = 16.4, 6.1$  and  $2.0\text{Hz}$ , 2-isomer- $\text{CH}$ ), 3.02-310(0.24H, m, 3-isomer- $\text{CH}_2$ ), 3.14(1.76H, app ddt,  $J = 16.4, 6.1$  and  $2.0\text{Hz}$ , 2-isomer- $\text{CH}_2$ ), 3.21(0.88H, dt,  $J = 8.7$  and  $6.0\text{Hz}$ , 2-isomer- $\text{CH}(\text{CN})$ ), 7.31(1H, d,  $J = 7.5\text{Hz}$ , 2-isomer- $\text{CH}_d=\text{CH}_c$ ), 7.33(0.24H, d,  $J = 5.1\text{Hz}$ , 3-isomer- $\text{CH}_d=\text{CH}_c$ ), 7.34(1.76H, d,  $J = 7.4\text{Hz}$ , 2-isomer- $\text{CH}_a=\text{CH}_b$ ) and 7.34(0.24H, d,  $J = 5.3\text{Hz}$ , 3-isomer- $\text{CH}_a=\text{CH}_b$ ),  $\delta_{\text{C}}$ (100) 154.6(2-isomer-C), 154.0(3-isomer-C), 149(2-isomer-C), 127.7(2-isomer-C), 123.9(3-isomer-CH), 124(2-isomer-CH), 122.6(2-isomer-CH), 121.2(2-isomer-C), 118.7(2-isomer-CH), 118.4(3-isomer-CH), 112.6(2-isomer-CN), 111.1(2-isomer-CH), 27.0(2-isomer- $\text{CH}_2$ ), 25.9(2-isomer- $\text{CH}_2$ ), 25.5(2-isomer-CH), 25.1(3-isomer-CH), 24.6(3-isomer- $\text{CH}_2$ ), 21.5(3-isomer- $\text{CH}_2$ ) and 18.5(2 and 3-isomers- $\text{CH}_2$ ),  $m/z$  197(44%,  $\text{M}^+$ ), 163(44,  $\text{C}_{12}\text{H}_{15}\text{O}$ ), 144(100,  $\text{C}_{10}\text{H}_8\text{O}$ ,  $\text{M}-\text{C}_3\text{H}_3\text{N}$ ) and 101(40,  $\text{C}_6\text{H}_4$ ,  $\text{M}-\text{C}_7\text{H}_7\text{NO}$ ). [Found:  $\text{M}^+$ , 197.0848; C, 79.39; H, 5.73; N, 6.93.  $\text{C}_{13}\text{H}_{11}\text{NO}$  requires: M, 197.0841; C, 79.19; H, 5.6; N, 7.11%].

#### Head to head 4+4 and 2+4 cycloadducts. (013) and (014)

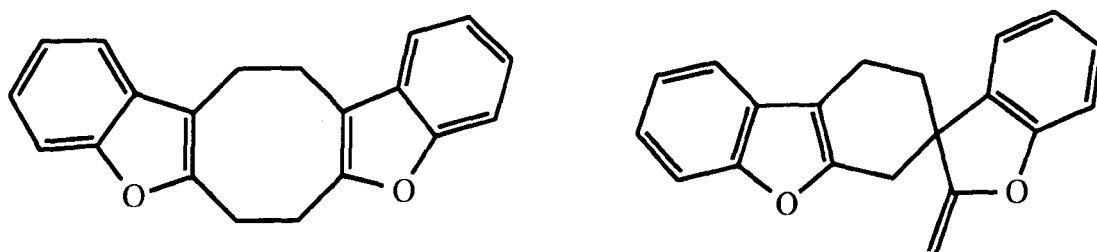

These are the by-products formed during the Diels-Alder reactions between 2-acetyloxymethyl-3-(trispropylsilylmethyl)benzofuran (**038**) and the chosen dienophile. They are produced in a roughly 4:1 ratio 4+2 / 4+4 respectively, in varying amounts dependent on the chosen dienophile. For good



dienophiles 1-2% may be expected where as when no dienophile is present the yields of these products can be as high as 60%. They may be separated by column chromatography over silica G using 100% hexane as eluant (although it must be pointed out that the 4+2 adduct is unstable and decomposes on the column to a greater extent) the 4+4 adduct (**013**) as a pale yellow oil,  $\nu_{\max}(\text{film})$  1474 and 1452  $\text{cm}^{-1}$ ,  $\lambda_{\max}$  (EtOH) 199( $\epsilon$  30,719), 201( $\epsilon$  30,827) and 261( $\epsilon$  14,070)nm,  $\delta_{\text{H}}(250)$  3.41(4H, s,  $\text{CH}_2\text{CH}_2$ ), 3.20(4H, s,  $\text{CH}_2\text{CH}_2$ ) and 6.90-7.21(8H, m,  $(\text{C}_6\text{H}_4)_2$ ),  $m/z$  288(11%,  $\text{M}^+$ ), 149(100,  $\text{C}_{10}\text{H}_{13}\text{O}$ ), 144(60,  $\text{C}_{10}\text{H}_{16}\text{O}_2$ , M- $\text{C}_{10}\text{H}_8\text{O}$ ) and 115(6,  $\text{C}_8\text{H}_3\text{O}$ , M- $\text{C}_{12}\text{H}_{13}\text{O}$ ). [Found:  $\text{M}^+$ , 288.1144.  $\text{C}_{20}\text{H}_{16}\text{O}_2$  requires: M, 288.1149] and the 4+2 (**014**) adduct as a yellow oil,  $\nu_{\max}(\text{film})$  1474 and 1452  $\text{cm}^{-1}$ ,  $\lambda_{\max}$  (EtOH) 199( $\epsilon$  30719), 201( $\epsilon$  30827) and 261( $\epsilon$  14070)nm,  $\delta_{\text{H}}(250)$  2.05-2.14(2H, m,  $\text{CH}_2\text{CH}_2$ ), 2.81-2.91(2H, m,  $\text{CH}_2\text{CH}_2$ ), 3.03(2H, s,  $\text{CH}_2$ ), 4.19(1H, d,  $J = 3.0\text{Hz}$ ,  $\text{C}=\text{CH}_a\text{H}_b$ ), 4.68(1H, d,  $J = 3.0\text{Hz}$ ,  $\text{C}=\text{CH}_a\text{H}_b$ ) and 7.20-7.71(8H, m,  $(\text{C}_6\text{H}_4)_2$ ),  $m/z$  288(17%,  $\text{M}^+$ ), 149(100,  $\text{C}_{10}\text{H}_{13}\text{O}$ ), 144(72,  $\text{C}_{10}\text{H}_{16}\text{O}_2$ , M- $\text{C}_{10}\text{H}_8\text{O}$ ) and 115(9,  $\text{C}_8\text{H}_3\text{O}$ , M- $\text{C}_{12}\text{H}_{13}\text{O}$ ). [Found:  $\text{M}^+$ , 288.1157.  $\text{C}_{20}\text{H}_{16}\text{O}_2$  requires: M, 288.1149].

### ***N,N*-Diethyl-3-methylbenzofuran-2-carboxamide. (057)**

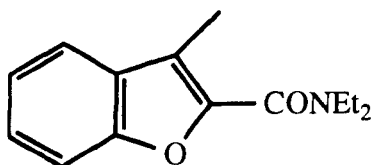

3-Methylbenzofuran-2-carboxylic acid (**018**) (3.0 g, 17.0 mmol) was dissolved in dry benzene (30 ml) and placed under an inert atmosphere of argon. To this solution was added oxalyl chloride (2.6 g, 20 mmol), then carefully dry dimethyl formamide (3-4 drops) and the resultant mixture was left stirring for 3 hr, after which time a solution in benzene (8 ml) of diethylamine (3.0 g, 42.0 mmol) was added slowly over the course of 10 min. The solution

was left stirring overnight (12 hr) and was then poured into water (100 ml) and extracted with benzene (3x 20 ml). The organic extracts were dried, filtered and the solvent removed under reduced pressure to give the *product (057)*<sup>150</sup> (3.4 g, 87%) as a white solid, mp 91-93°C,  $\nu_{\max}$ (KBr) 1628 and 1472  $\text{cm}^{-1}$ ,  $\lambda_{\max}$  (EtOH) 199( $\epsilon$  30,719), 22( $\epsilon$  30,827) and 261( $\epsilon$  14,070)nm,  $\delta_{\text{H}}$ (400) 1.26(6H, t,  $J = 7.1\text{Hz}$ ,  $\text{N}(\text{CH}_2\text{CH}_3)_2$ ), 2.43(3H, s,  $\text{CH}_3$ ), 3.50(4H, q,  $J = 7.1\text{Hz}$ ,  $\text{N}(\text{CH}_2\text{CH}_3)_2$ ), 7.25(1H, dd,  $J = 7.6$  and  $6.7\text{Hz}$ ,  $\text{CH}_c\text{CH}_b=\text{CH}_a$ ), 7.33(1H, dd,  $J = 7.6$  and  $6.7\text{Hz}$ ,  $\text{CH}_b\text{CH}_c=\text{CH}_d$ ), 7.40(1H, d,  $J = 7.6\text{Hz}$ ,  $\text{CH}_c=\text{CH}_d$ ) and 7.54(1H, d,  $J = 7.6\text{Hz}$ ,  $\text{CH}_b=\text{CH}_a$ ),  $\delta_{\text{C}}$ (100) 169.74(C=O), 153.62(C), 145.26(C), 129.46(C), 125.98(CH), 122.93(CH), 120.36(CH), 120.14(C), 111.27(CH), 41.92(2x  $\text{CH}_2$ ), 13.87(2x  $\text{CH}_3$ ) and 8.77( $\text{CH}_3$ ),  $m/z$  231(82%,  $\text{M}^+$ ), 216(14,  $\text{C}_{13}\text{H}_{14}\text{O}_2\text{N}$ ,  $\text{M}-\text{CH}_3$ ), 159(100,  $\text{C}_9\text{H}_5\text{ON}$ ), 132(41,  $\text{C}_8\text{H}_5\text{ON}$ ), 103(29,  $\text{C}_8\text{H}_6$ ). [Found:  $\text{M}^+$ , 231.1233; C, 72.8; H, 7.6; N, 5.8.  $\text{C}_{14}\text{H}_{17}\text{NO}_2$  requires: M, 231.1259; C, 72.7; H, 7.4; N, 6.0%].

### ***N,N*-Diethyl-3-ethylbenzofuran-2-carboxamide. (059)**

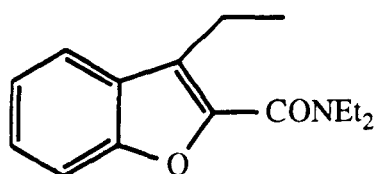

A stirred solution of lithium diisopropylamine (6.4 mmol) from diisopropylamine (1 ml) and *n*-butyl lithium (4ml of a 1.6M solution in hexanes) in tetrahydrofuran (15 ml) was maintained at -40°C (acetone/ $\text{CO}_2$ ) while a solution of *N,N*-diethyl-3-methylbenzofuran-2-carboxamide (**057**) (1.4 g, 6.0 mmol) in tetrahydrofuran (5 ml) was added dropwise *via* syringe. The resulting emerald green anion thus formed was left for a further 0.5 hr and then methyl iodide (1.2 g, 8.0 mmol) was rapidly added. The cold bath was removed and the reaction allowed to warm up to room temperature over the course of 1hr. The mixture was then poured into water (30 ml) followed by extraction with ether (3x

20 ml). The organic extracts were dried, filtered and the solvent removed under reduced pressure to give the crude product. Column chromatography over silica G using acetate/hexane (40:60) as eluant and subsequent recrystallisation from ether gave the *amide* (**059**) (1.1 g, 74%) as a white solid, mp 105-107°C,  $\nu_{\max}$ (KBr) 1624, 1464 and 1446  $\text{cm}^{-1}$ ,  $\lambda_{\max}$  (EtOH) 199( $\epsilon$  30,719), 22( $\epsilon$  30,827) and 261( $\epsilon$  14,070)nm,  $\delta_{\text{H}}$ (400) 1.26(6H, t,  $J = 7.1\text{Hz}$ ,  $\text{N}(\text{CH}_2\text{CH}_3)_2$ ), 1.31(3H, t,  $J = 7.6\text{Hz}$ ,  $\text{CH}_3$ ), 2.92(2H, q,  $J = 7.6\text{Hz}$ ,  $\text{CH}_2\text{CH}_3$ ), 3.55(4H, q,  $J = 7.1\text{Hz}$ ,  $\text{N}(\text{CH}_2\text{CH}_3)_2$ ), 7.25(1H, dd,  $J = 7.6$  and  $6.7\text{Hz}$ ,  $\text{CH}_b=\text{CH}_a$ ), 7.32(1H, dd,  $J = 7.6$  and  $6.7\text{Hz}$ ,  $\text{CH}_c=\text{CH}_d$ ), 7.45(1H, d,  $J = 7.6\text{Hz}$ ,  $\text{CH}_c=\text{CH}_d$ ) and 7.61(1H, d,  $J = 7.6\text{Hz}$ ,  $\text{CH}_b=\text{CH}_a$ ),  $\delta_{\text{C}}$ (100) 161.58(C=O), 153.44(C), 144.45(C), 128.30(C), 125.70(CH), 122.72(CH), 120.47(CH), 120.14(C), 111.55(CH), 42.99( $\text{CH}_2$ ), 40.32( $\text{CH}_2$ ), 17.27( $\text{CH}_2$ ), 14.59( $\text{CH}_3$ ), 14.22( $\text{CH}_3$ ) and 12.78( $\text{CH}_3$ ),  $m/z$  245(6%,  $\text{M}^+$ ), 216(12,  $\text{C}_{13}\text{H}_{14}\text{O}_2\text{N}$ ,  $\text{M}-\text{C}_2\text{H}_5$ ), 173(100,  $\text{C}_{11}\text{H}_9\text{O}_2$ ,  $\text{M}-\text{C}_4\text{H}_{10}$ ), 146(18,  $\text{C}_{10}\text{H}_9\text{O}$ ) and 115(29,  $\text{C}_9\text{H}_7$ ). [Found:  $\text{M}^+$ , 245.1417; C, 73.7; H, 8.0; N, 5.5.  $\text{C}_{15}\text{H}_{19}\text{NO}_2$  requires: M, 245.1416; C, 73.5; H, 7.8; N, 5.7%].

### ***N,N*-Diethyl-3-(triisopropylsilylmethyl)benzofuran-2-carboxamide. (060)**

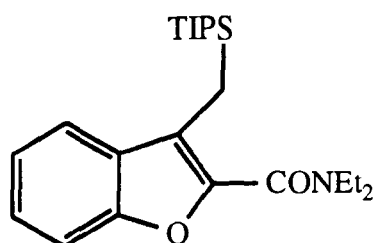

A stirred solution of lithium diisopropylamine (6.4 mmol) from diisopropylamine (1 ml) and *n*-butyl lithium (4ml of a 1.6M solution in hexanes) in tetrahydrofuran (15 ml) was maintained at -30°C (acetone/ $\text{CO}_2$ ) while a solution of *N,N*-diethyl-3-methylbenzofuran-2-carboxamide (**057**) (1.4 g, 6.0 mmol) in tetrahydrofuran (6 ml) was added dropwise *via* syringe. The resulting emerald green anion thus formed was left for a further 0.5 hr and then

triisopropylsilyl chloride (4.6 g, 24.0 mmol) was gradually added. The reaction was then kept at around -30 to -40°C and allowed to warm up to 0°C over the course of 8 to 10 hr. The mixture was then poured into ice water (30 ml) followed by extraction with ether (3x 20 ml). The organic extracts were dried, filtered and the solvent removed under reduced pressure to give the crude product. Rapid column chromatography over silica G using ethyl acetate as eluant gave the *silyl-amide* (**060**) (1.23 g, 53%) as a pale yellow oil,  $\nu_{\max}(\text{film})$  1620, 1463 and 1446  $\text{cm}^{-1}$ ,  $\lambda_{\max}(\text{EtOH})$  199( $\epsilon$  30,719), 22( $\epsilon$  30,827) and 261( $\epsilon$  14,070)nm,  $\delta_{\text{H}}(400)$  1.05(21H, br s,  $i\text{Pr}_3\text{Si}$ ), 1.28(6H, t,  $J = 6.9\text{Hz}$ ,  $\text{N}(\text{CH}_2\text{CH}_3)_2$ ), 2.45(2H, s,  $i\text{Pr}_3\text{SiCH}_2$ ), 3.50(4H, q,  $J = 6.9\text{Hz}$ ,  $\text{N}(\text{CH}_2\text{CH}_3)_2$ ), 7.28(1H, dd,  $J = 7.6$  and  $6.1\text{Hz}$ ,  $\text{CH}_b=\text{CH}_a$ ), 7.37(1H, dd,  $J = 7.6$  and  $6.1\text{Hz}$ ,  $\text{CH}_c=\text{CH}_d$ ), 7.45(1H, d,  $J = 7.7\text{Hz}$ ,  $\text{CH}_c=\text{CH}_d$ ) and 7.58(1H, d,  $J = 7.7\text{Hz}$ ,  $\text{CH}_b=\text{CH}_a$ ),  $\delta_{\text{C}}(100)$  161.42(C=O), 153.20(C), 144.02(C), 129.31(C), 125.84(CH), 122.71(CH), 120.22(CH), 120.04(C), 111.55(CH), 42.99(CH<sub>2</sub>), 40.41(CH<sub>2</sub>), 17.57(CH<sub>3</sub>), 14.59(CH<sub>3</sub>), 12.78(CH<sub>3</sub>), 12.16(CH) and 8.76(CH<sub>2</sub>),  $m/z$  344(47%,  $\text{C}_{20}\text{H}_{30}\text{O}_2\text{NSi}$ , M-C<sub>3</sub>H<sub>7</sub>), 314(7,  $\text{C}_{18}\text{H}_{24}\text{O}_2\text{NSi}$ , M-C<sub>5</sub>H<sub>13</sub>), 131(22,  $\text{C}_9\text{H}_6\text{O}$ ), 103(17,  $\text{C}_8\text{H}_7$ ) and 69(100,  $\text{C}_3\text{H}_3\text{NO}$ ). [Found: M-C<sub>3</sub>H<sub>7</sub>, 344.1998.  $\text{C}_{20}\text{H}_{30}\text{NO}_2\text{Si}$  requires: M-C<sub>3</sub>H<sub>7</sub>, 344.2045].

### 3-(But-3'-enyl)benzofuran-2-carboxylic acid. (063)

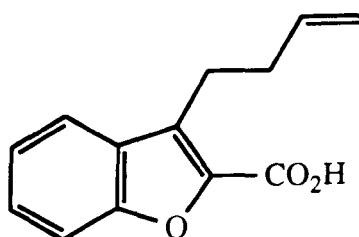

A stirred solution of lithium diisopropylamine (6.4 mmol) from diisopropylamine (1 ml) and *n*-butyl lithium (4ml of a 1.6M solution in hexanes) in tetrahydrofuran (15 ml) was maintained at -78°C (acetone/solid CO<sub>2</sub>) while a

solution of 3-methylbenzofuran-2-carboxylic acid (**018**) (0.53 g, 3.0 mmol) in tetrahydrofuran (5 ml) was added dropwise *via* syringe. The resulting red dianion solution thus formed was left for a further 0.5 hr, then allyl bromide (0.35 ml, 4.0 mmol) was rapidly added. The cooling bath was removed and the reaction allowed to warm to room temperature over the course of 1 hr. The mixture was then poured into water (30 ml) followed by washing with ether (3x 20 ml). The aqueous layer was chilled (ice/salt), acidified with 2M hydrochloric acid and extracted with ether (3x 20 ml). The combined organic extracts were dried and the solvent removed under reduced pressure to give the crude acid. Recrystallisation from tetrahydrofuran gave the *acid* (**063**) (0.58 g, 89%) as colourless rhombs, mp 130-131°C,  $\nu_{\max}(\text{KBr})$  1702  $\text{cm}^{-1}$ ,  $\lambda_{\max}(\text{EtOH})$  202( $\epsilon$  38,799), 220( $\epsilon$  31,239) and 275( $\epsilon$  39,636)nm,  $\delta_{\text{H}}(90)$  2.50(2H, t,  $J = 8.2\text{Hz}$ ,  $\text{CH}_2\text{CH}_2$ ), 3.25(2H, dt,  $J = 8.2$  and  $3.6\text{Hz}$ ,  $\text{CH}_2\text{CH}_2\text{CH}$ ), 4.80-5.21(2H, m,  $\text{CH}=\text{CH}_2$ ), 5.70-6.11(1H, m,  $\text{CH}=\text{CH}_2$ ), 6.20(1H, br s,  $\text{CO}_2\text{H}$ ) and 7.10-7.91(4H, m,  $\text{C}_6\text{H}_4$ ),  $m/z$  216(29%,  $\text{M}^+$ ), 172(4,  $\text{C}_{12}\text{H}_{12}\text{O}$ ,  $\text{M}-\text{CO}_2$ ), 175(100,  $\text{C}_{16}\text{H}_7\text{O}_3$ ,  $\text{M}-\text{C}_3\text{H}_5$ ) and 131(39,  $\text{C}_9\text{H}_7\text{O}$ ). [Found:  $\text{M}^+$ , 216.0783; C, 71.9; H, 5.8.  $\text{C}_{13}\text{H}_{12}\text{O}_3$  requires: M, 216.0785; C, 72.2; H, 5.6%].

### Methyl 3-aminohex-2,5-dienoate. (086)

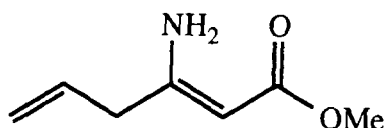

A solution of methyl cyanoacetate (**085**) (35.67 g, 0.36 mol) in dry tetrahydrofuran (100 ml) was added dropwise to a mechanically stirred solution of allyl magnesium chloride [prepared from magnesium (25.96 g, 1.08 mol) and allyl chloride (74.72 g, 0.98 mol)] in dry tetrahydrofuran (400 ml) at 25°C under an atmosphere of argon. The resulting red solution was stirred at 25°C, in the dark for 48 hr, then cooled in an ice bath and an aqueous solution of potassium carbonate (50%, 100 ml) added dropwise. When the addition was complete, the suspension was filtered and the solid washed thoroughly with ether (3x 20 ml). The filtrate was washed with brine, dried and concentrated. Distillation of the red-coloured residue afforded the desired *product* (**086**) (21.30 g, 42%) as a colourless oil, bp 74-75°C at 4 mm Hg, [lit.<sup>276</sup> bp 76-77°C at 5 mm Hg],  $V_{\max}$  (film) 3441, 3336, 1670, 1616 and 1558  $\text{cm}^{-1}$ ,  $\delta_{\text{H}}(90)$  2.98(2H, br d,  $J = 6.3\text{Hz}$ ,  $\text{H}_2\text{C}=\text{CHCH}_2$ ), 3.82(3H, s,  $\text{CO}_2\text{CH}_3$ ), 4.74(1H, br s,  $\text{CH}-\text{CO}_2\text{CH}_3$ ), 4.92-5.61(2H, m,  $\text{H}_2\text{C}=\text{CHCH}_2$ ) and 5.72-6.20(3H, m,  $\text{H}_2\text{C}=\text{CHCH}_2$  and  $\text{NH}_2$ ).

### Methyl 3-oxohex-5-enoate. (087)

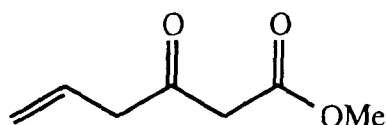

Methyl 3-aminohex-2,5-dienoate (**086**) (21.30 g, 0.15 mol) was dissolved in tetrahydrofuran (50 ml) and the solution cooled to 0°C (ice/salt bath). Aqueous hydrochloric acid (10%, 50 ml) was slowly added dropwise and the

resultant red solution stirred at 0°C for 20 min then diluted with ether (50 ml) and washed with brine (100 ml). The organic phase was separated, dried and concentrated. Distillation of the pale pink residue afforded the desired, isomerically pure *product* (**087**) (6.60 g, 31%) as a colourless oil, bp 58-59°C at 2 mm Hg, [lit.<sup>276</sup> bp 61-63°C at 3 mm Hg],  $v_{\max}$  (film) 1750 and 1718  $\text{cm}^{-1}$ ,  $\delta_{\text{H}}$ (90) 3.34(2H, d,  $J = 6.3\text{Hz}$ ,  $\text{H}_2\text{C}=\text{CHCH}_2$ ), 3.54(2H, s,  $\text{COCH}_2\text{CO}_2\text{CH}_3$ ), 3.82(3H, s,  $\text{CO}_2\text{CH}_3$ ), 4.98-5.51(2H, m,  $\text{H}_2\text{C}=\text{CHCH}_2$ ) and 5.67-6.40(1H, m,  $\text{H}_2\text{C}=\text{CHCH}_2$ ). [Found : C, 59.5; H, 7.2. Calc for  $\text{C}_7\text{H}_{10}\text{O}_3$  : C, 59.2; H, 7.1%].

### Methyl 3-oxohex-4-enoate. (**088**)

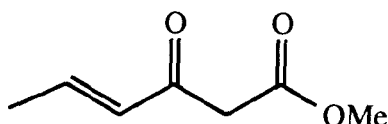

Extensive application of heat when distilling the foregoing ester (**087**) caused isomerisation to the thermodynamically more stable  $\alpha,\beta$ -unsaturated keto-ester (**088**). This also occurred if the former was subjected to prolonged exposure to light. The conjugate *ester* (**088**) showed, bp 73-74°C at 2 mm Hg,<sup>276</sup>  $v_{\max}$  (film) 1751 and 1687  $\text{cm}^{-1}$ ,  $\delta_{\text{H}}$ (90) 2.10(3H, d,  $J = 8.1\text{Hz}$ ,  $\text{HC}=\text{CHCH}_3$ ), 3.68(2H, s,  $\text{COCH}_2\text{CO}_2\text{CH}_3$ ), 3.80(3H, s,  $\text{CO}_2\text{CH}_3$ ), 5.55-6.28(1H, m,  $\text{CH}_3\text{CH}=\text{CH}$ ) and 6.50-7.03(1H, m,  $\text{CH}=\text{CHCO}$ ).

### Methyl 3R-(-)-3-hydroxyhex-5-enoate. (**089**)

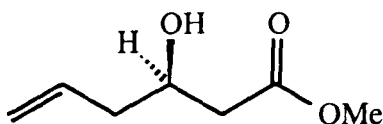

To a suspension of methyl 3-oxohex-5-enoate (**087**) (7.10 g, 50 mmol) in tap water (500 ml) maintained at 35°C was added sucrose (80 g) then dried

(Sainsbury's) yeast (55 g). The resulting mixture was vigorously stirred mechanically at this temperature for 24 hr, then celite (50 g) was added and the suspension filtered under suction. The solid was thoroughly washed with water and the filtrate was extracted with chloroform (3x 100 ml). The organic phase was separated, dried and concentrated. Chromatography of the residue over silica G using hexane/ethyl acetate (80:20) as eluant gave the desired *hydroxy ester* (**089**) (5.26 g, 73%) as a yellow oil,  $[\alpha]_D^{25} = -23.7$  (c, 1.1,  $\text{CHCl}_3$ ), [lit.<sup>284</sup>  $[\alpha]_D^{25} -12.6$  (c, 1.3,  $\text{CHCl}_3$ )] optical purity was established<sup>270-271</sup> to be not less than 78% ee (R). Other spectral data identical to the following racemic hydroxy ester (**090**).

### Methyl ( $\pm$ )-3-hydroxyhex-5-enoate. (**090**)

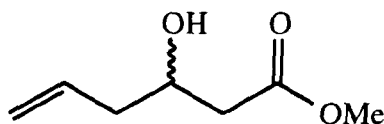

A solution of methyl 3-oxohex-5-enoate (**087**) (18.30 g, 0.13 mmol) in dry methanol (100 ml) was added to a suspension of sodium borohydride (7.60 g, 0.20 mol) in methanol (50 ml) and the resulting mixture was stirred at 0°C for 20 min. The methanol was removed under reduced pressure and the residue partitioned between water and ether. The organic phase was separated, dried and concentrated. Chromatography of the residue over silica G using hexane/ethyl acetate (80:20) as eluant gave the desired *hydroxy ester* (**090**)<sup>285</sup> (17.40 g, 93%) as a yellow oil,  $v_{\max}$  (film) 3471, 1728 and 1644  $\text{cm}^{-1}$ ,  $\delta_{\text{H}}$ (90) 2.28(2H, br t,  $J = \text{ca } 6.9\text{Hz}$ ,  $\text{H}_2\text{C}=\text{CHCH}_2$ ), 2.44(2H, d,  $J = 7.3\text{Hz}$ ,  $\text{CH}_2\text{CO}_2\text{CH}_3$ ), 3.16(1H, br s, OH), 3.75(3H, s,  $\text{CO}_2\text{CH}_3$ ), 4.16(1H, p,  $J = 6.8\text{Hz}$ ,  $\text{CHOH}$ ), 5.02-5.33(2H, m,  $\text{H}_2\text{C}=\text{CHCH}_2$ ) and 5.67-6.14(1H, m,  $\text{H}_2\text{C}=\text{CHCH}_2$ ),  $m/z$  127(90%,  $\text{C}_7\text{H}_{11}\text{O}_2$ , M-OH), 126(21,  $\text{C}_7\text{H}_{10}\text{O}_2$ , M- $\text{H}_2\text{O}$ ), 103(14,  $\text{C}_4\text{H}_7\text{O}_3$ , M- $\text{C}_3\text{H}_5$ ), 85(100,  $\text{C}_5\text{H}_9\text{O}$ , M- $\text{CH}_3$  and  $\text{CO}_2$ ) and 67(78,  $\text{C}_5\text{H}_7$ , M- $\text{H}_2\text{O}$ ,  $\text{CH}_3$  and  $\text{CO}_2$ ). [Found :  $\text{M}^+-\text{C}_3\text{H}_5$ , 103.0409. Calc for  $\text{C}_4\text{H}_7\text{O}_3$  : M- $\text{C}_3\text{H}_5$ , 103.0395].



### Methyl 3R-(-)-3-(triisopropylsilyl)oxyhex-5-enoate. (091)

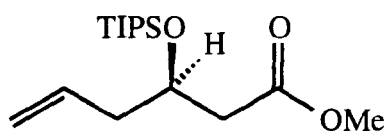

Imidazole (3.71 g, 55 mmol) was added to a stirred solution of triisopropylsilyl chloride (5.05 g, 22 mmol) and 3R-(-)-Methyl 3-hydroxyhex-5-enoate (**089**) (3.14 g, 22 mmol) in dry dimethylformamide (10 ml). The resulting mixture was stirred at room temperature for 48 hr, diluted with pentane (30 ml) and washed with water (3x 20 ml). The organic phase was separated, dried and concentrated. Chromatography of the residue over silica G using hexane/ethyl acetate (90:10) as eluant gave the desired *silyl ether* (**091**)<sup>286</sup> (5.21 g, 79%) as a colourless oil,  $[\alpha]_D^{25} = -25.7$  (c, 1.3, CHCl<sub>3</sub>),  $\nu_{\max}$  (film) 1739 and 1646 cm<sup>-1</sup>,  $\delta_{\text{H}}(90)$  1.06(2H, br s, <sup>i</sup>Pr<sub>3</sub>Si), 2.38(2H, br t, J = ca 6.9Hz, H<sub>2</sub>C=CHCH<sub>2</sub>), 2.54(2H, d, J = 7.2Hz, CH<sub>2</sub>CO<sub>2</sub>CH<sub>3</sub>), 3.68(3H, s, CO<sub>2</sub>CH<sub>3</sub>), 4.46(1H, p, J = 6.6Hz, CHOSi), 5.02-5.41(2H, m, H<sub>2</sub>C=CHCH<sub>2</sub>) and 5.72-6.14(1H, m, H<sub>2</sub>C=CHCH<sub>2</sub>), m/z 257(97%, C<sub>13</sub>H<sub>25</sub>O<sub>3</sub>Si, M-C<sub>3</sub>H<sub>7</sub>), 145(100, C<sub>7</sub>H<sub>17</sub>OSi), 117(28, C<sub>5</sub>H<sub>13</sub>OSi) and 89(23, C<sub>3</sub>H<sub>9</sub>OSi). [Found: M<sup>+</sup>-C<sub>3</sub>H<sub>7</sub>, 257.1562. Calc. for C<sub>13</sub>H<sub>25</sub>O<sub>3</sub>Si : M-C<sub>3</sub>H<sub>7</sub>, 257.1572].

### Methyl 3R-(-)-3-(*t*-butyldimethylsilyl)oxyhex-5-enoate. (092)

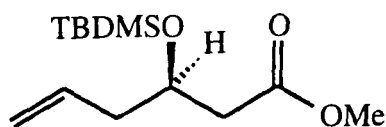

Imidazole (5.30 g, 78 mmol) was added to a stirred solution of *t*-butyldimethylsilyl chloride (4.70 g, 30 mmol) and 3R-(-)-methyl 3-hydroxyhex-5-enoate (**089**) (3.70 g, 26 mmol) in dry dimethylformamide (100 ml). The resulting mixture was stirred at room temperature for 24 hr, diluted with pentane

(50 ml) and washed with water (3x 20 ml). The organic phase was separated, dried and concentrated. Chromatography of the residue over silica G using hexane/ethyl acetate (90:10) as eluant gave the desired *silyl ether* (**092**)<sup>286</sup> (5.10 g, 77%) as a colourless oil,  $[\alpha]_D^{25} = -28.1$  (c, 1.1, CHCl<sub>3</sub>),  $\nu_{\max}$  (film) 1734 and 1636 cm<sup>-1</sup>,  $\delta_H(90)$  0.03(3H, s, SiCH<sub>3</sub>), 0.07(3H, s, SiCH<sub>3</sub>), 0.91(9H, s, C(CH<sub>3</sub>)<sub>3</sub>), 2.28(2H, br t,  $\text{ca } J = 6.4\text{Hz}$ , H<sub>2</sub>C=CHCH<sub>2</sub>), 2.44(2H, d,  $J = 6.3\text{Hz}$ , CH<sub>2</sub>CO<sub>2</sub>CH<sub>3</sub>), 3.70(3H, s, CO<sub>2</sub>CH<sub>3</sub>), 4.26(1H, p,  $J = 6.4\text{Hz}$ , CHOSi), 4.62-5.22(2H, m, H<sub>2</sub>C=CHCH<sub>2</sub>) and 5.68-5.94(1H, m, H<sub>2</sub>C=CHCH<sub>2</sub>), m/z 217(97%, C<sub>10</sub>H<sub>21</sub>O<sub>3</sub>Si, M-C<sub>3</sub>H<sub>7</sub>), 201(90, C<sub>9</sub>H<sub>17</sub>O<sub>3</sub>Si, M-C<sub>4</sub>H<sub>9</sub>) and 89(100, C<sub>3</sub>H<sub>9</sub>OSi). [Found : M<sup>+</sup>-C<sub>3</sub>H<sub>7</sub>, 217.1272. C<sub>10</sub>H<sub>21</sub>O<sub>3</sub>Si requires : M-C<sub>3</sub>H<sub>7</sub>, 217.1260].

### Methyl 3R-(-)-3-(triisopropylsilyl)oxy-5-oxopentanoate. (**095**)

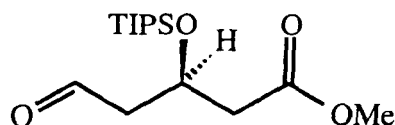

The silyl ether (**091**) (1.96 g, 6.50 mmol) was dissolved in dichloromethane (60 ml), cooled to -78°C and treated with ozonized oxygen until the reaction mixture was blue in colour. Triethylamine (0.5 ml, 5 mmol) was added and the reaction allowed to warm to 0°C where-upon more triethylamine (0.5 ml, 5 mmol) was added. The reaction mixture was then heated to 40°C for 12 hr. The solvent was removed under reduced pressure and the residue diluted with pentane and washed with water. The organic phase was separated, dried and concentrated. Chromatography of the residue over silica G using hexane/ethyl acetate (90:10) as eluant gave the desired *aldehyde* (**095**)<sup>287</sup> (1.92 g, 97%) as a pale yellow oil,  $[\alpha]_D^{28} = -6.1$  (c, 1.2, CHCl<sub>3</sub>),  $\nu_{\max}$  (film) 1727 cm<sup>-1</sup>,  $\delta_H(90)$  0.08(21H, br s,  $i\text{Pr}_3\text{Si}$ ), 2.66(2H, d,  $J = 6.5\text{Hz}$ , CH<sub>2</sub>CO<sub>2</sub>CH<sub>3</sub>), 2.78(2H, dd,  $J = 6.5$  and  $2.0\text{Hz}$ , CH<sub>2</sub>CHO), 3.70(3H, s, CO<sub>2</sub>CH<sub>3</sub>), 4.78(1H, p,  $J = 6.4\text{Hz}$ , CHOSi) and 9.90(1H, t,  $J = 2.0\text{Hz}$ , CH<sub>2</sub>CHO).

### Methyl 3R-(-)-3-(*t*-butyldimethylsilyl)oxy-5-oxopentanoate. (096)

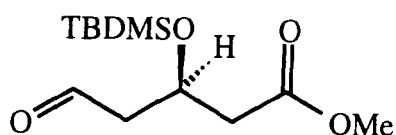

The silyl ether (**092**) (6.90 g, 26.70 mmol) was ozonized as described in the foregoing experiment and gave the *aldehyde* (**096**)<sup>287</sup> (6.6 g, 95%) as a pale yellow oil,  $[\alpha]_D^{26} = -9.1$  (c, 1.2, CHCl<sub>3</sub>),  $\nu_{\max}$  (film) 1728 cm<sup>-1</sup>,  $\delta_{\text{H}}$ (90) 0.04(3H, s, SiCH<sub>3</sub>), 0.07(3H, s, SiCH<sub>3</sub>), 0.90(9H, s, C(CH<sub>3</sub>)<sub>3</sub>), 2.55(2H, d, J = 6.5Hz, CH<sub>2</sub>CO<sub>2</sub>CH<sub>3</sub>), 2.68(2H, dd, J = 6.4 and 2.0Hz, CH<sub>2</sub>CHO), 3.71(3H, s, CO<sub>2</sub>CH<sub>3</sub>), 4.67(1H, p, J = 6.4Hz, CHOSi) and 9.91(1H, t, J = 2.0Hz, CH<sub>2</sub>CHO), m/z 245(9%, C<sub>11</sub>H<sub>21</sub>O<sub>4</sub>Si, M-CH<sub>3</sub>), 203(92, C<sub>8</sub>H<sub>15</sub>O<sub>4</sub>Si, M-C<sub>4</sub>H<sub>9</sub>), 161(38, C<sub>6</sub>H<sub>3</sub>O<sub>3</sub>Si) and 101(41, C<sub>4</sub>H<sub>9</sub>OSi). [Found : M<sup>+</sup>-C<sub>4</sub>H<sub>9</sub>, 203.0725. Calc. for C<sub>8</sub>H<sub>15</sub>O<sub>4</sub>Si : M-C<sub>4</sub>H<sub>9</sub>, 203.0738].

### Methyl (-)-3R, Z-3-(triisopropylsilyl)oxydec-5-enoate. (097)

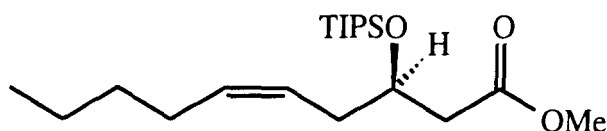

*n*-Butyl lithium (7.5 ml of a 1.6 M solution in hexane, 12 mmol) was added dropwise to a stirred suspension of *n*-amyltriphenylphosphonium bromide (4.58 g, 12 mmol) in dry tetrahydrofuran (200 ml), at 25°C under an atmosphere of nitrogen. The mixture was stirred at this temperature for 20 min, when a solution of the aldehyde (**095**) (3.58 g, 12 mmol) in dry tetrahydrofuran (5 ml) was added in one portion. The mixture was stirred for a further 30 min, poured into pentane (200 ml) and the resulting mixture washed with water. The organic phase was separated, dried and concentrated to give a mixture of products (10:1 ratio of

*cis* to *trans* respectively by NMR). Chromatography of the residue over silica G using hexane/ethyl acetate (90:10) as eluant gave the *alkene* (**097**)<sup>289</sup> (3.11 g, 73%) as a colourless oil,  $[\alpha]_D^{30} = -23.1$  (c, 1.5, CHCl<sub>3</sub>),  $\nu_{\max}$  (film) 1736 cm<sup>-1</sup>,  $\delta_H(90)$  0.80-1.40(7H, m, CH<sub>3</sub>CH<sub>2</sub>CH<sub>2</sub>), 1.08(21H, br s, <sup>i</sup>Pr<sub>3</sub>Si), 1.91-2.20(2H, m, CH<sub>2</sub>CH=CH), 2.33(2H, br t, *ca* J = 6.3Hz, CH=CHCH<sub>2</sub>CHOSi), 2.48(2H, d, J = 6.3Hz, CH<sub>2</sub>CO<sub>2</sub>CH<sub>3</sub>), 3.63(3H, s, CO<sub>2</sub>CH<sub>3</sub>), 4.34(1H, p, J = 6.3Hz, CHOSi) and 5.34-5.66(2H, m, CH=CH). [Found : M<sup>+</sup>-C<sub>3</sub>H<sub>7</sub>, 313.2181. Calc. for C<sub>17</sub>H<sub>33</sub>O<sub>3</sub>Si : M-C<sub>3</sub>H<sub>7</sub>, 313.2198].

### Methyl (-)-3R, Z- and E-3-(*t*-butyldimethylsilyl)oxyhept-5-enoate. (**098**)

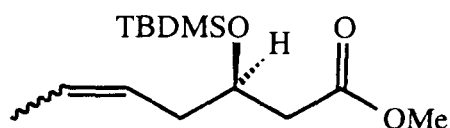

*n*-Butyl lithium (2.5 ml of a 1.6 M solution in hexane, 4 mmol) was added dropwise to a stirred suspension of ethyltriphenylphosphonium bromide (1.56 g, 4.20 mmol) in dry tetrahydrofuran (50 ml), at 25°C under an atmosphere of nitrogen. The mixture was then heated to 40°C and stirred at this temperature for 10 min, after which time a solution of the aldehyde (**096**) (0.98 g, 3.60 mmol) in dry tetrahydrofuran (3 ml) was added in one portion and the resulting mixture stirred at 40°C for a further 10 min. After cooling, the mixture was poured into pentane (100 ml) and washed with water. The organic phase was separated, dried and concentrated to give a mixture of products (6:1 ratio of *cis* to *trans* respectively by NMR). Chromatography of the residue over silica G using hexane/ethyl acetate (90:10) as eluant gave the inseparable *alkenes* (**098**)<sup>289</sup> (0.62 g, 63%) as a colourless oil,  $[\alpha]_D^{26} = -27.2$  (c, 1.2, CHCl<sub>3</sub>),  $\nu_{\max}$  (film) 1748 cm<sup>-1</sup>,  $\delta_H(80)$  0.04(3H, s, SiCH<sub>3</sub>), 0.06(3H, s, SiCH<sub>3</sub>), 0.91(9H, s, C(CH<sub>3</sub>)<sub>3</sub>),

1.65(3H, br d, ca J = 5.1Hz, CH<sub>3</sub>CH=CH), 2.32(2H, br t, ca J = 6.5Hz, CH=CHCH<sub>2</sub>CHOSi), 2.48(2H, d, J = 6.5Hz, CH<sub>2</sub>CO<sub>2</sub>CH<sub>3</sub>), 3.73(3H, s, CO<sub>2</sub>CH<sub>3</sub>), 4.26(1H, p, J = 6.5Hz, CHOSi) and 5.35-5.92(2H, m, CH<sub>3</sub>CH=CH). [Found : M<sup>+</sup>-C<sub>4</sub>H<sub>9</sub>, 215.1113. Calc. for C<sub>10</sub>H<sub>19</sub>O<sub>3</sub>Si : M-C<sub>4</sub>H<sub>9</sub>, 215.1102].

**Methyl (-)-3R, Z-3-hydroxydec-5-enoate. (099)**

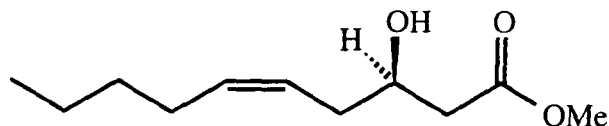

Tetra-*n*-butylammonium fluoride (5 ml of a 1.0 M solution in tetrahydrofuran, 5 mmol) was added dropwise to a stirred solution of the silyl ether (**097**) (1.40 g, 4 mmol) in dry tetrahydrofuran (20 ml) at 0°C under a nitrogen atmosphere. The mixture was stirred for 12 hr at 25°C then the solvent removed under reduced pressure to give the crude product ( $\geq 10:1$  ratio *cis* to *trans* by NMR) Chromatography of the residue over silica G using hexane/ethyl acetate (60:40) as eluant gave the *alcohol* (**099**) (0.76 g, 95%) as a colourless oil,  $[\alpha]_D^{30} = -15.1$  (c, 1.0, CHCl<sub>3</sub>),  $\nu_{\max}$  (film) 3466 and 1725 cm<sup>-1</sup>,  $\delta_H$ (250) 0.88-0.98(3H, br t, ca J = 6.8Hz, CH<sub>3</sub>CH<sub>2</sub>CH<sub>2</sub>), 1.31-1.52(4H, m, CH<sub>3</sub>CH<sub>2</sub>CH<sub>2</sub>), 2.00-2.09(2H, m, CH<sub>2</sub>CH=CHCH<sub>2</sub>), 2.21-2.38(2H, m, CH<sub>2</sub>CH=CHCH<sub>2</sub>), 2.62-2.71(2H, m, CH<sub>2</sub>CO<sub>2</sub>CH<sub>3</sub>), 2.91(1H, br s, OH), 3.69(3H, s, CO<sub>2</sub>CH<sub>3</sub>), 4.05-4.15(1H, m, CHOH) and 5.31-5.60(2H, m, CH=CH),  $\delta_C$ (23) 174.12(C=O), 134.52(CH), 124.42(CH), 69.11(CH), 52.80(CH<sub>3</sub>), 41.02(CH<sub>2</sub>), 35.37(CH<sub>2</sub>), 31.89(CH<sub>2</sub>), 28.09(CH<sub>2</sub>), 22.91(CH<sub>2</sub>) and 14.12(CH<sub>3</sub>), m/z 182(5%, C<sub>11</sub>H<sub>18</sub>O<sub>2</sub>, M-H<sub>2</sub>O), 108(10, C<sub>8</sub>H<sub>12</sub>, M-C<sub>7</sub>H<sub>13</sub>) and 71(57, C<sub>3</sub>H<sub>3</sub>O<sub>2</sub>). [Found : M<sup>+</sup>-H<sub>2</sub>O, 182.1314. Calc. for C<sub>11</sub>H<sub>18</sub>O<sub>2</sub> : M-H<sub>2</sub>O, 182.1307].

**Methyl (-)-3R, Z- and E-3-hydroxyhept-5-enoate. (100)**

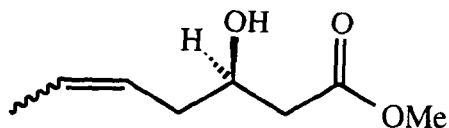

Tetra-*n*-butylammonium fluoride (4 ml of a 1.0 M solution in tetrahydrofuran, 4 mmol) was added dropwise to a stirred solution of the silyl ether (**098**) (0.82 g, 3 mmol) in dry tetrahydrofuran (10 ml) at 0°C under a nitrogen atmosphere. The mixture was stirred for 6 hr at 25°C and the solvent removed under reduced pressure to give the crude products (ca 6:1 ratio *cis* to *trans* by NMR). Column chromatography of the residue over silica G using hexane/ethyl acetate (80:20) as eluant gave the *alcohols* (**100**) (0.41 g, 84%), as a colourless oil,  $[\alpha]_D^{23} = -21.2$  (c, 1.0, CHCl<sub>3</sub>),  $\nu_{\max}$  (film) 3455, 1738 and 1656 cm<sup>-1</sup>,  $\delta_{\text{H}}$ (400) 1.64(2.6H, ddt, *J* = 6.8 and 1.6Hz, *Z*-CH<sub>3</sub>CH=CH), 1.68(0.4H, dd, *J* = 6.2 and 1.1Hz, *E*-CH<sub>3</sub>CH=CH), 2.18-2.57(0.57H, m, *E*-2xCH<sub>2</sub>), 2.26(0.86H, dt, *J* = 14.8 and 6.4Hz, *Z*-CH<sub>a</sub>H<sub>b</sub>CH=CH), 2.33(0.86H, dt, *J* = 14.8 and 6.5Hz, *Z*-CH<sub>a</sub>H<sub>b</sub>CH=CH), 2.45(0.86H, dd, *J* = 16.3 and 8.8Hz, *Z*-CH<sub>c</sub>CH<sub>d</sub>CO<sub>2</sub>CH<sub>3</sub>), 2.54(0.86H, dd, *J* = 16.3 and 3.6Hz, *Z*-CH<sub>c</sub>CH<sub>d</sub>CO<sub>2</sub>CH<sub>3</sub>), 3.10(1H, br s, *Z* and *E*-OH), 3.71(3H, s, *E* and *Z*-CO<sub>2</sub>CH<sub>3</sub>), 4.01-4.10(0.14H, m, *E*-CHOH), 4.04(0.86H, dddd, *J* = 8.8, 6.5, 6.4 and 3.6Hz, *Z*-CHOH) and 5.38-5.47(1H, m, *Z* and *E*-CH<sub>3</sub>CH=CH), 5.49-5.60(0.14H, m, *E*-CH<sub>3</sub>CH=CH) and 5.65(0.86H, dq, *J* = 11.9, 6.6 and 1.7Hz, *Z*-CH<sub>3</sub>CH=CH) with other resonances due to *E*-isomer obscured,  $\delta_{\text{C}}$ (100) 173.47(*Z* and *E*, C=O), 129.21(*E*, CH), 127.49(*Z*, CH), 126.44(*E*, CH), 125.45(*Z*, CH), 68.15(*Z*, CH), 67.95(*E*, CH), 51.93(*Z* and *E*, CH<sub>3</sub>), 40.68(*Z* and *E*, CH<sub>2</sub>), 34.22(*Z* and *E*, CH<sub>2</sub>) and 13.17(*Z* and *E*, CH<sub>3</sub>). [Found : M<sup>+</sup>-H<sub>2</sub>O, 140.0810. Calc. for C<sub>8</sub>H<sub>12</sub>O<sub>2</sub> : M-H<sub>2</sub>O, 140.0847].

### Ethyl oct-3-ynoate. (102)



A solution of hex-1-yne (**101**) (2.46 g, 30 mmol) in dry tetrahydrofuran (26 ml) was stirred under an atmosphere of nitrogen and cooled to  $-20^{\circ}\text{C}$ . *n*-Butyl lithium (19 ml of a 1.6 M solution in hexane, 30 mmol) was added dropwise to solution which was then left stirring at this temperature for 15 min. Boron trifluoride etherate (5 ml, 40 mmol) was then slowly added and the solution left stirring at  $-20^{\circ}\text{C}$  for a further 30 min. A solution of ethyl diazoacetate (2.31 g, 20 mmol) in dry tetrahydrofuran (5 ml) was carefully added over a 2 min period. The mixture was left for 90 min and then quenched by addition of water (10 ml). The resulting solution was washed with water and the organic phase evaporated. Column chromatography of the residue using silica G and hexane/ethyl acetate (85:15) as eluant gave the *alkyne* (**102**)<sup>291</sup> (4.21 g, 84%) as a colourless oil,  $\nu_{\text{max}}$  (film) 2243 and 1741  $\text{cm}^{-1}$ ,  $\delta_{\text{H}}$ (250) 0.91(3H, t,  $J = 5.8\text{Hz}$ ,  $\text{CH}_3\text{CH}_2\text{CH}_2$ ), 1.25-1.56(4H, m,  $\text{CH}_3\text{CH}_2\text{CH}_2$ ), 1.28(3H, t,  $J = 7.1\text{Hz}$ ,  $\text{CH}_3\text{CH}_2\text{O}$ ), 2.20-2.27(2H, m,  $\text{CH}_2\text{CH}_2\text{C}\equiv\text{C}$ ), 3.25(2H, t,  $J = 2.5\text{Hz}$ ,  $\text{CH}_2\text{CO}_2\text{CH}_2\text{CH}_3$ ) and 4.18(2H, q,  $J = 7.1\text{Hz}$ ,  $\text{CH}_3\text{CH}_2\text{O}$ ),  $\delta_{\text{C}}$ (23) 168.80(C=O), 83.64(C), 71.61(C), 61.21( $\text{CH}_2$ ), 30.87( $\text{CH}_2$ ), 26.05( $\text{CH}_2$ ), 21.93( $\text{CH}_2$ ), 18.47( $\text{CH}_2$ ), 14.08( $\text{CH}_3$ ) and 13.54( $\text{CH}_3$ ),  $m/z$  139(5%,  $\text{C}_8\text{H}_{11}\text{O}_2$ , M- $\text{C}_2\text{H}_5$ ), 126(17,  $\text{C}_7\text{H}_{10}\text{O}_2$ , M- $\text{C}_3\text{H}_6$ ), 95(19, M- $\text{C}_3\text{H}_5\text{O}_2$ ) and 57(100,  $\text{C}_4\text{H}_9$ ).

### Ethyl *Z*-oct-3-enoate. (103)

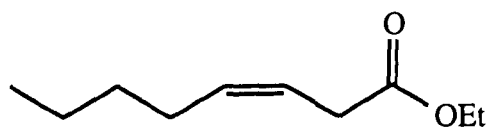

A solution of the alkyne (**102**) (2.11 g, 12.50 mmol) in dry ethyl acetate (50

ml) was hydrogenated (291 ml, 13 mmol) using Lindlar catalyst (0.20 g, 10% w/w) until hydrogen uptake was complete (ca 1 hr). The solution was filtered and the solvent removed under reduced pressure. Column chromatography of the residue using silica G and hexane/ethyl acetate (80:20) as eluant gave the *alkene* (**103**)<sup>292</sup> (1.82 g, 86%) as a colourless oil,  $\nu_{\max}$  (film) 1739  $\text{cm}^{-1}$ ,  $\delta_{\text{H}}$ (250) 0.85(3H, t,  $J = 6.9\text{Hz}$ ,  $\text{CH}_3\text{CH}_2\text{CH}_2$ ), 1.22(3H, t,  $J = 7.1\text{Hz}$ ,  $\text{CH}_3\text{CH}_2\text{O}$ ), 1.27-1.34(4H, m,  $\text{CH}_3\text{CH}_2\text{CH}_2$ ), 2.01-2.13(2H, m,  $\text{CH}_2\text{CH}_2\text{CH}=\text{CH}$ ), 3.04(2H, d,  $J = 5.6\text{Hz}$ ,  $\text{CH}_2\text{CO}_2\text{CH}_2\text{CH}_3$ ), 4.09(2H, q,  $J = 7.1\text{Hz}$ ,  $\text{CH}_3\text{CH}_2\text{O}$ ) and 5.52-5.59(2H, m,  $\text{CH}=\text{CH}$ ),  $\delta_{\text{C}}$ (23) 172.05(C=O), 133.53(CH), 121.13(CH), 60.62( $\text{CH}_2$ ), 33.26( $\text{CH}_2$ ), 31.69( $\text{CH}_2$ ), 27.30( $\text{CH}_2$ ), 22.48( $\text{CH}_2$ ), 14.35( $\text{CH}_3$ ) and 14.03( $\text{CH}_3$ ),  $m/z$  170(5%,  $\text{M}^+$ ), 140(5,  $\text{C}_8\text{H}_{12}\text{O}_2$ ,  $\text{M}-\text{C}_2\text{H}_6$ ), 128(10,  $\text{C}_7\text{H}_{11}\text{O}_2$ ,  $\text{M}-\text{C}_3\text{H}_8$ ), 125(8,  $\text{M}-\text{C}_2\text{H}_5\text{O}$ ), 97(18,  $\text{M}-\text{C}_3\text{H}_5\text{O}_2$ ) and 57(100,  $\text{C}_4\text{H}_9$ ).

#### Z-Oct-3-enoic acid. (**104**)

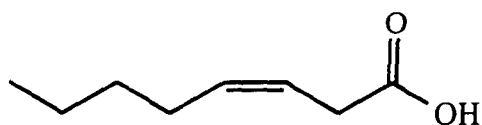

The ester (**103**) (2.70 g, 15.88 mmol) was dissolved in a methanol/water mixed solvent system (1:1, 50 ml) and the resulting solution cooled to  $-4^\circ\text{C}$ . Potassium hydroxide (0.91 g, 16 mmol) was slowly added to the stirred solution which, when complete, was left stirring at  $25^\circ\text{C}$  for 16 hr. Most of the methanol was removed under reduced pressure and the residue washed with ether (3x 5 ml). The aqueous layer was cooled to  $0^\circ\text{C}$  and slowly acidified with dilute 2M hydrochloric acid. The resulting aqueous solution was extracted with ethyl acetate (3x 10 ml) and the combined organic extracts dried, filtered and evaporated to give the *acid* (**104**)<sup>293</sup> (2.01 g, 89%) as a colourless oil,  $\nu_{\max}$  (film) 3385, 2618 and 1711  $\text{cm}^{-1}$ ,  $\delta_{\text{H}}$ (90) 0.81(3H, t,  $J = 7.0\text{Hz}$ ,  $\text{CH}_3\text{CH}_2\text{CH}_2$ ), 1.32-1.37(4H, m,  $\text{CH}_3\text{CH}_2\text{CH}_2$ ), 2.09-2.13(2H, m,  $\text{CH}_2\text{CH}_2\text{CH}=\text{CH}$ ), 3.10(2H, d,  $J = 6.1\text{Hz}$ ,  $\text{CH}=\text{CHCH}_2\text{CO}_2\text{H}$ ), 5.61-5.68(2H, m,  $\text{CH}=\text{CH}$ ) and 11.32(1H, br s,  $\text{CO}_2\text{H}$ )  $\delta_{\text{C}}$ (23) 178.77(C=O), 134.18(CH), 120.26(CH), 32.93( $\text{CH}_2$ ), 31.69( $\text{CH}_2$ ), 27.30( $\text{CH}_2$ ), 22.48( $\text{CH}_2$ ) and 14.03( $\text{CH}_3$ ).



### Methyl Z-3-oxodec-5-enoate. (105)

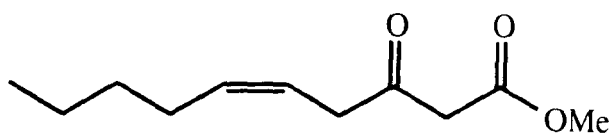

A solution of carbonyl diimidazole (2.60 g, 15.60 mmol) in dry tetrahydrofuran (20 ml) was stirred at 0°C under an atmosphere of argon. To this, Z-oct-3-enoic acid (**104**) (1.85 g, 13 mmol) in tetrahydrofuran was added dropwise. When complete, the mixture was stirred in the dark for 12 hr.

Magnesium (0.94 g, 39 mmol) which had been dry stirred under argon for 12 hr was then in dry tetrahydrofuran (50 ml). 2-propyl bromide (4.81 g, 39 mmol) in tetrahydrofuran (10 ml) was then added dropwise so as to maintain gentle reflux without external heating. After complete addition of the bromide, the mixture was left for a further 1 hr, then cooled to 0°C. This solution was then added slowly under an argon atmosphere to a solution of methyl hydrogen malonate (2.30 g, 19.50 mmol) in tetrahydrofuran (10 ml) maintained at 0°C. The resulting mixture was then stirred at this temperature for 20 min, at ambient temperature for 20 min, at 40°C for 20 min and then finally cooled back to 0°C. To this the acyl-imidazolide solution was slowly added and the whole solution left stirring for 18 hr at ambient temperature.

The mixture was poured into an ice-cold mixture of 2M, aqueous *o*-phosphoric acid (100 ml) and ethyl acetate (100 ml). The organic phase was separated and the aqueous phase extracted with ethyl acetate (3x 50 ml). The combined organic extracts were washed with saturated, aqueous sodium bicarbonate solution (3x 30 ml), then dried, filtered and evaporated. Column chromatography of the residue over silica G using hexane/ethyl acetate (80:20) as eluant gave the *keto-ester* (**105**)<sup>294</sup> (1.46 g, 57%) as a colourless oil,  $\nu_{\max}$  (film) 1746 and 1722  $\text{cm}^{-1}$ ,  $\delta_{\text{H}}$ (250) 0.89(3H, t,  $J = 6.9\text{Hz}$ ,  $\text{CH}_3\text{CH}_2\text{CH}_2$ ), 1.34-1.36(4H, m,  $\text{CH}_3\text{CH}_2\text{CH}_2$ ), 2.02-2.12(2H, m,  $\text{CH}_2\text{CH}_2\text{CH}=\text{CH}$ ), 3.29(2H, d,  $J = 6.9\text{Hz}$ ,  $\text{CH}_2\text{COCH}_2\text{CO}_2\text{CH}_3$ ), 3.49(2H, s,  $\text{COCH}_2\text{CO}_2\text{CH}_3$ ), 3.74(3H, s,

CO<sub>2</sub>CH<sub>3</sub>) and 5.42-5.68(2H, m, CH=CH), δ<sub>C</sub>(23) 187.80(C=O), 158.25(C=O), 128.31(CH), 115.73(CH), 54.19(CH<sub>3</sub>), 50.87(CH<sub>2</sub>), 44.92(CH<sub>2</sub>), 35.80(CH<sub>2</sub>), 31.95(CH<sub>2</sub>), 27.51(CH<sub>2</sub>) and 19.81(CH<sub>3</sub>), m/z 198(4%, M<sup>+</sup>), 167(4, C<sub>10</sub>H<sub>15</sub>O<sub>2</sub>, M-OCH<sub>3</sub>), 139(7, C<sub>9</sub>H<sub>15</sub>O, M-CO<sub>2</sub>CH<sub>3</sub>), 127(27, M-C<sub>3</sub>H<sub>5</sub>O<sub>2</sub>), 111(43, M-C<sub>3</sub>H<sub>5</sub>O<sub>3</sub>), 109(14, M-C<sub>3</sub>H<sub>7</sub>O<sub>3</sub>) and 57(100, C<sub>4</sub>H<sub>9</sub>).

#### Methyl Z(±)-3-hydroxydec-5-enoate. (106)

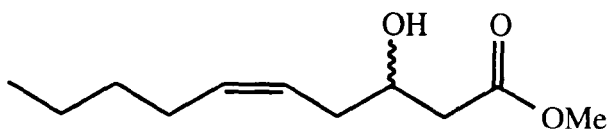

To a stirred solution of the keto-ester (**105**) (1.98 g, 10 mmol) in dry methanol (20 ml) at 0°C was added sodium borohydride (0.38 g, 10 mmol). The resulting mixture was stirred until TLC. indicated no more keto-ester was present (ca 0.5 hr) and then water (5 ml) was added. The methanol was removed under reduced pressure and the residue partitioned between water and ethyl acetate. The organic phase was separated, dried and concentrated. Column chromatography of the residue over silica G using hexane/ethyl acetate (60:40) as eluant gave the desired *alcohol* (**106**)<sup>285</sup> (1.66 g, 83%) as a colourless oil, spectral data being identical to the chiral material (**099**) in all respects.

#### 4-(Triisopropylsilyl)oxybut-1-yne. (107)

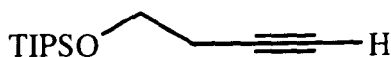

Imidazole (5.83 g, 86 mmol) was added to a stirred solution of triisopropylsilyl chloride (6.44 g, 34 mmol) and but-3-yn-1-ol (2.01 g, 28.71

mmol) in dry dimethylformamide (10 ml) at 0°C under an atmosphere of argon. The resulting solution was stirred at ambient temperature for 48 hr, then diluted with pentane (20 ml) and washed with water (3x 20 ml). The organic phase was separated, dried, filtered and concentrated. Column chromatography of the residue over silica G using hexane/ethyl acetate (90:10) as eluant gave the desired *silyl-ether* (**107**)<sup>286</sup> (5.32 g, 82%) as a pale yellow oil,  $\nu_{\max}$  (film) 3330 and 2110  $\text{cm}^{-1}$ ,  $\delta_{\text{H}}$ (80) 1.07(21H, br s,  $^i\text{Pr}_3\text{Si}$ ), 1.93(1H, t,  $J = 2.7\text{Hz}$ , C-H), 2.25(2H, td,  $J = 7.2$  and  $2.7\text{Hz}$ ,  $\text{CH}_2\text{CH}_2\text{C}\equiv\text{CH}$ ) and 3.82(2H, t,  $J = 7.2\text{Hz}$ ,  $\text{CH}_2\text{CH}_2\text{C}\equiv\text{CH}$ ),  $\delta_{\text{C}}$ (23) 81.80(CH), 69.50(C), 62.40( $\text{CH}_2$ ), 23.23( $\text{CH}_2$ ), 17.94(6x  $\text{CH}_3$ ) and 12.67(3x CH).

### Ethyl 6-(triisopropylsilyl)oxyhex-3-ynoate. (**108**)



A solution of the silyl-ether (**107**) (2.19 g, 9.70 mmol) in dry tetrahydrofuran (30 ml) was stirred under an atmosphere of nitrogen and cooled to -20°C. *n*-Butyl lithium (6.1 ml of a 1.6 M solution in hexane, 9.70 mmol) was added dropwise and the resulting solution stirred for 20 min. Boron trifluoride etherate (1.6 ml, 13 mmol) was then slowly added and the solution left stirring at -20°C for a further 30 min. A solution of ethyl diazoacetate (0.60 g, 5 mmol) in dry tetrahydrofuran (5 ml) was then carefully added over a 2 min period. The mixture was left for 1.5 hr and then quenched by the addition of water (10 ml). The resulting solution was washed with water, the organic phase dried and evaporated. Column chromatography of the residue using silica G and hexane/ethyl acetate (90:10) as eluant gave the *alkyne-ester* (**108**)<sup>291</sup> (1.60 g, 53%) as a pale yellow oil,  $\nu_{\max}$  (film) 2251 and 1744  $\text{cm}^{-1}$ ,  $\delta_{\text{H}}$ (250) 1.06(21H, br s,  $^i\text{Pr}_3\text{Si}$ ), 1.27(3H, t,  $J = 7.1\text{Hz}$ ,  $\text{CH}_3\text{CH}_2\text{O}$ ), 2.44(2H, tt,  $J = 7.4$  and  $2.4\text{Hz}$ ,  $^i\text{Pr}_3\text{SiOCH}_2\text{CH}_2$ ), 3.23(2H, t,  $J = 2.4\text{Hz}$ ,  $\text{CH}_2\text{CO}_2\text{CH}_2\text{CH}_3$ ), 3.79(2H, t,  $J =$

7.4Hz,  ${}^1\text{Pr}_3\text{SiOCH}_2\text{CH}_2$ ) and 4.18(2H, q,  $J = 7.1\text{Hz}$ ,  $\text{CH}_3\text{CH}_2\text{O}$ ),  $\delta_{\text{C}}$ (23) 168.75(C=O), 80.77(C), 72.43(C), 62.51( $\text{CH}_2$ ), 61.43( $\text{CH}_2$ ), 26.21( $\text{CH}_2$ ), 23.51( $\text{CH}_2$ ), 18.09(6x  $\text{CH}_3$ ), 14.24( $\text{CH}_3$ ) and 12.29(3x CH),  $m/z$  312(1%,  $\text{M}^+$ ), 269(100,  $\text{C}_{14}\text{H}_{25}\text{O}_3\text{Si}$ , M- $\text{C}_3\text{H}_7$ ), 239(38,  $\text{C}_{12}\text{H}_{19}\text{O}_3\text{Si}$ , M- $\text{C}_5\text{H}_{13}$ ), 226(1, M- $2\times\text{C}_3\text{H}_7$ ) and 155(4, M- $\text{C}_9\text{H}_{21}\text{Si}$ ).

### Ethyl Z-6-(triisopropylsilyl)oxyhex-3-enoate. (109)



A solution of silyl-ester (**108**) (1.61 g, 5.16 mmol) in dry ethyl acetate (30 ml) was hydrogenated (140 ml, 6.25 mmol) using Lindlar catalyst (0.2 g, 10% w/w) until hydrogen uptake was complete, (ca 2 hr). The solution was filtered and the solvent removed under reduced pressure. Column chromatography of the residue using silica G and hexane/ethyl acetate (90:10) as eluant gave the *alkene* (**109**)<sup>292</sup> (1.61 g, 99%) as a colourless oil,  $\nu_{\text{max}}$  (film)  $1741\text{ cm}^{-1}$ ,  $\delta_{\text{H}}$ (250) 1.06(21H, br s,  ${}^1\text{Pr}_3\text{Si}$ ), 1.26(3H, t,  $J = 7.1\text{Hz}$ ,  $\text{CH}_3\text{CH}_2\text{O}$ ), 2.31(2H, td,  $J = 6.8$  and  $5.8\text{Hz}$ ,  $\text{CH}_2\text{CH}_2\text{CH}=\text{CH}$ ), 3.11(2H, d,  $J = 5.4\text{Hz}$ ,  $\text{CH}_2\text{CO}_2\text{CH}_2\text{CH}_3$ ), 3.70(2H, t,  $J = 6.8\text{Hz}$ ,  $\text{CH}_2\text{CH}_2\text{CH}=\text{CH}$ ), 4.14(2H, q,  $J = 7.1\text{Hz}$ ,  $\text{CH}_3\text{CH}_2\text{O}$ ) and 5.64-5.69(2H, m,  $\text{CH}=\text{CH}$ ),  $\delta_{\text{C}}$ (23) 171.67(C=O), 129.63(CH), 122.91(CH), 62.94( $\text{CH}_2$ ), 60.51( $\text{CH}_2$ ), 33.31( $\text{CH}_2$ ), 31.58( $\text{CH}_2$ ), 18.09(6x  $\text{CH}_3$ ), 14.30( $\text{CH}_3$ ) and 12.24(3x CH),  $m/z$  271(100%,  $\text{C}_{14}\text{H}_{37}\text{O}_3\text{Si}$ , M- $\text{C}_3\text{H}_7$ ), 157(7, M- $\text{C}_9\text{H}_{21}\text{Si}$ ) and 141(2, M- $\text{C}_9\text{H}_{21}\text{OSi}$ ).

### Z-6-(Triisopropylsilyl)oxyhex-3-enoic acid. (110)



(199)

The silyl-ester (**109**) (1.62 g, 5.16 mmol) was saponified using potassium hydroxide exactly as described for the preparation of acid (**104**).<sup>293</sup> This then gave the *acid* (**110**) (1.08 g, 73%) as a colourless oil,  $\nu_{\max}$  (film) 3372 and 1718  $\text{cm}^{-1}$ ,  $\delta_{\text{H}}$ (90) 1.06(21H, br s,  $^i\text{Pr}_3\text{Si}$ ), 2.31(2H, td,  $J = 6.6$  and 5.2Hz,  $\text{CH}_2\text{CH}_2\text{CH}=\text{CH}$ ), 3.15(2H, d,  $J = 5.0\text{Hz}$ ,  $\text{CH}_2\text{CO}_2\text{CH}_2\text{CH}_3$ ), 3.72(2H, t,  $J = 6.6\text{Hz}$ ,  $\text{CH}_2\text{CH}_2\text{CH}=\text{CH}$ ), 5.66-5.71(2H, m,  $\text{CH}=\text{CH}$ ) and 12.41(1H, br s,  $\text{CO}_2\text{H}$ )  $\delta_{\text{C}}$ (23) 177.47(C=O), 130.28(CH), 122.75(CH), 62.94( $\text{CH}_2$ ), 33.04( $\text{CH}_2$ ), 31.58( $\text{CH}_2$ ), 18.14(6x  $\text{CH}_3$ ) and 12.29(3x CH),  $m/z$  271(77%,  $\text{C}_{14}\text{H}_{27}\text{O}_3\text{Si}$ , M- $\text{CH}_3$ ), 243(37,  $\text{C}_{12}\text{H}_{23}\text{O}_3\text{Si}$ , M- $\text{C}_3\text{H}_7$ ), 213(13,  $\text{C}_{10}\text{H}_{17}\text{O}_3\text{Si}$ , M- $\text{C}_5\text{H}_{13}$ ), 157(10,  $\text{C}_6\text{H}_9\text{O}_3\text{Si}$ ), 129(6,  $\text{C}_6\text{H}_9\text{O}_3$ ) and 113(20,  $\text{C}_6\text{H}_9\text{O}_2$ ). [Found :  $\text{M}^+-\text{CH}_3$ , 271.1708.  $\text{C}_{14}\text{H}_{27}\text{O}_3\text{Si}$  requires : M- $\text{CH}_3$ , 271.1729].

### Methyl Z-8-(triisopropylsilyloxy)-3-oxooct-5-enoate. (**111**)

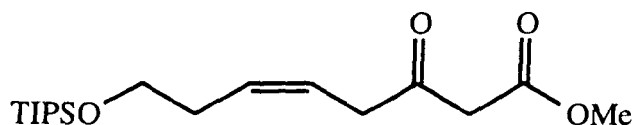

The silyl-acid (**110**) (0.50 g, 1.75 mmol) was coupled to the magnesium chelate of methyl hydrogen malonate in an identical fashion as for the preparation of keto-ester (**105**).<sup>294</sup> Column chromatography of the residue over silica G using hexane/ethyl acetate (80:20) as eluant gave the *keto-ester* (**111**) (0.28 g, 47%) as a colourless oil,  $\nu_{\max}$  (film) 1719 and 1742  $\text{cm}^{-1}$ ,  $\delta_{\text{H}}$ (250) 1.05(21H, br s,  $^i\text{Pr}_3\text{Si}$ ), 2.31(2H, td,  $J = 6.7$  and 6.5Hz,  $\text{CH}_2\text{CH}_2\text{CH}=\text{CH}$ ), 3.34(2H, d,  $J = 6.3\text{Hz}$ ,  $\text{CH}_2\text{COCH}_2\text{CO}_2\text{CH}_3$ ), 3.50(2H, s,  $\text{COCH}_2\text{CO}_2\text{CH}_3$ ), 3.73(3H, s,  $\text{CO}_2\text{CH}_3$ ), 3.74(2H, t,  $J = 6.7\text{Hz}$ ,  $^i\text{Pr}_3\text{SiOCH}_2\text{CH}_2$ ) and 5.43-5.69(2H, m,  $\text{CH}=\text{CH}$ ),  $\delta_{\text{C}}$ (23) 184.21(C=O), 153.62(C=O), 131.15(CH), 121.78(CH), 62.89( $\text{CH}_2$ ), 52.33( $\text{CH}_3$ ), 48.53( $\text{CH}_2$ ), 42.03( $\text{CH}_2$ ), 31.69( $\text{CH}_2$ ), 18.14(6x  $\text{CH}_3$ ) and 12.29(3x CH),  $m/z$  342(1%,  $\text{M}^+$ ), 299(51,  $\text{C}_{15}\text{H}_{27}\text{O}_4\text{Si}$ , M- $\text{C}_3\text{H}_7$ ), 213(6, M-3x $\text{C}_3\text{H}_7$ ) and 43(100,  $\text{C}_3\text{H}_7$ ).

**Methyl (±)-Z-8-(triisopropylsilyloxy)-3-hydroxy-oct-5-enoate. (112)**

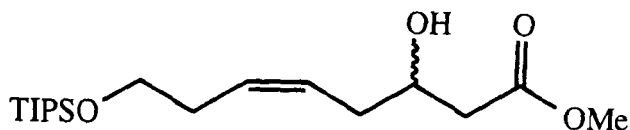

The keto-ester (111) (0.28 g, 0.82 mmol) was reduced by sodium borohydride in methanol by an analogous procedure to that used for hydroxy-ester (106).<sup>285</sup> This then gave the *hydroxy-ester* (112) (0.22 g, 79%) as a colourless oil,  $\nu_{\max}$  (film) 3460 and 1738  $\text{cm}^{-1}$ ,  $\delta_{\text{H}}$ (250) 1.06(21H, br s,  $\text{iPr}_3\text{Si}$ ), 2.33-2.39(4H, m,  $\text{CH}_2\text{CH}_2\text{CH}=\text{CHCH}_2$ ), 2.49-2.55(2H, m,  $\text{CH}(\text{OH})\text{CH}_2\text{CO}_2\text{CH}_3$ ), 2.95(1H, br s,  $\text{CH-OH}$ ), 3.71(3H, s,  $\text{CO}_2\text{CH}_3$ ), 3.71(2H, t,  $J = 6.7\text{Hz}$ ,  $\text{iPr}_3\text{SiOCH}_2\text{CH}_2$ ), 4.08-4.12(1H, m,  $\text{CH}_2\text{CHOH}$ ) and 5.52-5.59(2H, m,  $\text{CH}=\text{CH}$ ),  $\delta_{\text{C}}$ (100) 173.47(C=O), 130.06(CH), 126.33(CH), 68.17(CH), 63.19( $\text{CH}_2$ ), 52.01( $\text{CH}_3$ ), 40.84( $\text{CH}_2$ ), 34.77( $\text{CH}_2$ ), 31.58( $\text{CH}_2$ ), 18.28(6x  $\text{CH}_3$ ) and 12.27(3x CH).

**But-3-ynyl-1, 3-dioxolane. (113)**

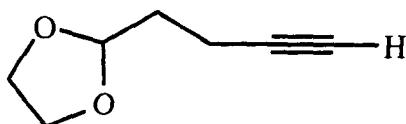

Lithium acetylenide ethylenediamine complex (20.26 g of 90% purity, 0.22 mol) in dry dimethylsulfoxide (100 ml) was stirred at 8°C. To this was added dropwise 2-bromoethyl-1,3-dioxolane (34.40 g, 0.18 mol) over the course of 1 hr maintaining the temperature at  $10 \pm 5^\circ\text{C}$  with external cooling. When the addition was completed, the reaction mixture was permitted to warm to ambient temperature and stirred for a further 2 hr.

Water (75 ml) was then added carefully to the vigorously stirred solution while the temperature was kept below 35°C. The hydrolysed reaction mixture

was poured into water (200 ml) and the resulting mixture extracted with pentane (3x 100 ml). The combined organic extracts were then dried, filtered and the solvents removed under reduced pressure. Column chromatography of the residue over silica G using hexane/ethyl acetate (60:40) as eluant gave the desired *alkyne* (**113**)<sup>295</sup> (16.52 g, 69%) as a yellow oil,  $\nu_{\max}$  (film) 3308 and 2120  $\text{cm}^{-1}$ ,  $\delta_{\text{H}}$ (250) 1.14(2H, td,  $J = 7.5$  and 4.6Hz,  $\text{OCHCH}_2\text{CH}_2$ ), 1.96(1H, t,  $J = 2.7$ Hz,  $\text{CH}_2\text{CH}_2\text{C}\equiv\text{CH}$ ), 2.31(2H, td,  $J = 7.5$  and 2.7Hz,  $\text{CH}_2\text{CH}_2\text{C}\equiv\text{CH}$ ), 3.86-3.93(2H, m,  $\text{OCH}_2\text{CH}_2\text{O}$ ), 3.95-4.08(2H, m,  $\text{OCH}_2\text{CH}_2\text{O}$ ) and 4.96(1H, t,  $J = 4.6$ Hz,  $\text{OCHCH}_2\text{CH}_2$ ),  $\delta_{\text{C}}$ (23) 102.98(CH), 83.48(CH), 68.42(C), 64.79(2x  $\text{CH}_2$ ), 32.77( $\text{CH}_2$ ) and 13.05( $\text{CH}_2$ ),  $m/z$  126(3%,  $\text{M}^+$ ), 87(22,  $\text{C}_4\text{H}_7\text{O}_2$ ,  $\text{M}-\text{C}_3\text{H}_3$ ), 85(30,  $\text{C}_4\text{H}_5\text{O}_2$ ,  $\text{M}-\text{C}_3\text{H}_5$ ) and 73(100,  $\text{C}_3\text{H}_5\text{O}_2$ ,  $\text{M}-\text{C}_4\text{H}_5$ ).

#### Ethyl 6-(1, 3-dioxolan-2-yl)hex-3-ynoate. (**114**)

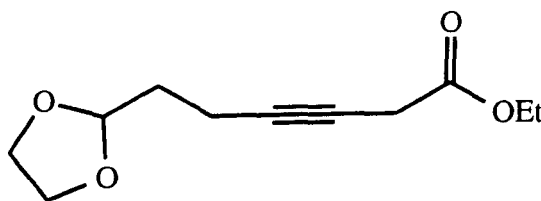

The alkyne (**113**) (3.78 g, 30 mmol) was converted into the ester (**114**) by the same method as described for the preparation of ester (**102**).<sup>291</sup> This then gave the *ester* (**114**) (1.60 g, 59%) as a pale yellow oil,  $\nu_{\max}$  (film) 2243 and 1741  $\text{cm}^{-1}$ ,  $\delta_{\text{H}}$ (400) 1.28(3H, t,  $J = 7.1$ Hz,  $\text{CH}_3\text{CH}_2\text{O}$ ), 1.86(2H, td,  $J = 7.5$  and 4.7Hz,  $\text{OCHCH}_2\text{CH}_2$ ), 2.34(2H, tt,  $J = 7.5$  and 2.5Hz,  $\text{CH}_2\text{CH}_2\text{C}\equiv\text{CCH}_2$ ), 3.23(2H, t,  $J = 2.5$ Hz,  $\text{CH}_2\text{CO}_2\text{CH}_2\text{CH}_3$ ), 3.86-3.94(2H, m,  $\text{OCH}_2\text{CH}_2\text{O}$ ), 3.96-4.09(2H, m,  $\text{OCH}_2\text{CH}_2\text{O}$ ), 4.18(2H, q,  $J = 7.1$ Hz,  $\text{CH}_3\text{CH}_2\text{O}$ ) and 4.97(1H, t,  $J = 4.7$ Hz,  $\text{OCHCH}_2\text{CH}_2$ ),  $\delta_{\text{C}}$ (100) 168.96(C=O), 103.33(CH), 82.73(C), 72.01(C), 65.07( $\text{CH}_2$ ), 61.54( $\text{CH}_2$ ), 33.04( $\text{CH}_2$ ), 26.19( $\text{CH}_2$ ), 14.24( $\text{CH}_3$ ) and 13.81( $\text{CH}_2$ ),  $m/z$  211(2%,  $\text{M}-\text{H}$ ), 183(2,  $\text{C}_9\text{H}_{11}\text{O}_4$ ,  $\text{M}-\text{C}_2\text{H}_5$ ), 139(14,  $\text{C}_8\text{H}_{11}\text{O}_2$ ,  $\text{M}-\text{C}_3\text{H}_5\text{O}_2$ ) and 101(100,  $\text{C}_5\text{H}_9\text{O}_2$ ,  $\text{M}-\text{C}_5\text{H}_9\text{O}_2$ ). [Found :  $\text{M}^+-\text{H}$ , 211.0963.  $\text{C}_{11}\text{H}_{15}\text{O}_4$  requires :  $\text{M}-\text{H}$ , 211.0969].

### Ethyl Z-6-(1, 3-dioxolan-2-yl)-hex-3-enoate. (115)

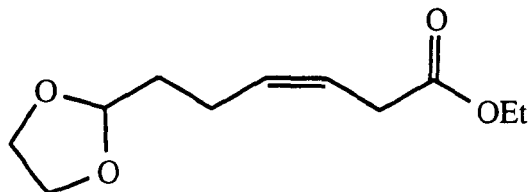

A solution of the alkyne (114) (1.27 g, 6 mmol) in dry ethyl acetate (30 ml) was hydrogenated (160 ml, 7.20 mmol) using Lindlar catalyst (0.15 g, 10% w/w) until hydrogen uptake was complete, (ca 2 hr). The solution was filtered and the solvent removed under reduced pressure. Column chromatography of the residue using silica G and hexane/ethyl acetate (90:10) as eluant gave the *alkene* (115)<sup>292</sup> (0.92 g, 72%) as a colourless oil,  $\nu_{\max}$  (film) 1744 and 1670  $\text{cm}^{-1}$ ,  $\delta_{\text{H}}$ (400) 1.26(3H, t,  $J = 7.1\text{Hz}$ ,  $\text{CH}_3\text{CH}_2\text{O}$ ), 1.73(2H, td,  $J = 7.6$  and  $4.7\text{Hz}$ ,  $\text{OCHCH}_2\text{CH}_2$ ), 2.18(2H, td,  $J = 7.6$  and  $5.6\text{Hz}$ ,  $\text{CH}_2\text{CH}_2\text{CH}=\text{CH}$ ), 3.10(2H, d,  $J = 5.1\text{Hz}$ ,  $\text{CH}=\text{CHCH}_2\text{CO}_2$ ), 3.85-3.91(2H, m,  $\text{OCH}_2\text{CH}_2\text{O}$ ), 3.96-4.11(2H, m,  $\text{OCH}_2\text{CH}_2\text{O}$ ), 4.14(2H, q,  $J = 7.1\text{Hz}$ ,  $\text{CH}_3\text{CH}_2\text{O}$ ), 4.86(1H, t,  $J = 4.7$ ,  $\text{OCHCH}_2\text{CH}_2$ ), 5.58(1H, dt,  $J = 10.3$  and  $5.6\text{Hz}$ ,  $\text{CH}=\text{CHCH}_2\text{CO}_2$ ) and 5.61(1H, dt,  $J = 10.3$  and  $5.1\text{Hz}$ ,  $\text{CH}=\text{CHCH}_2\text{CO}_2$ ),  $\delta_{\text{C}}$ (100) 172.16(C=O), 132.32(CH), 121.92(CH), 104.13(CH), 65.12(2x  $\text{CH}_2$ ), 60.82( $\text{CH}_2$ ), 33.53( $\text{CH}_2$ ), 33.14( $\text{CH}_2$ ), 22.24( $\text{CH}_2$ ) and 14.43( $\text{CH}_3$ ),  $m/z$  214(2%,  $\text{M}^+$ ), 169(4,  $\text{M}-\text{C}_2\text{H}_5\text{O}$ ), 141(2,  $\text{M}-\text{C}_3\text{H}_5\text{O}_2$ ), 127(2,  $\text{M}-\text{C}_4\text{H}_7\text{O}_2$ ) and 73(100,  $\text{C}_3\text{H}_5\text{O}_2$ ). [Found :  $\text{M}^+$ , 214.1220.  $\text{C}_{11}\text{H}_{18}\text{O}_4$  requires :  $\text{M}$ , 214.1205].

### Z-6-(1, 3-Dioxolan-2-yl)hex-3-enoic acid. (116)

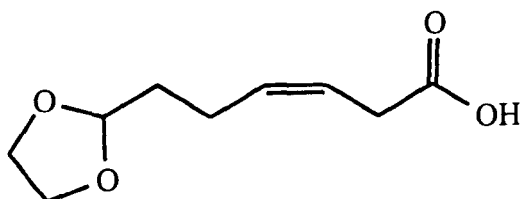



The ester (**115**) (1.24 g, 5.80 mmol) was saponified using potassium hydroxide exactly as described for the preparation of acid (**104**),<sup>293</sup> to give after recrystallisation from pentane/ether (80:20) the *acid* (**116**) (1.08 g, 73%) as a cream coloured solid, mp 52-55°C,  $\nu_{\max}$  (KBr) 3200-2800 and 1709  $\text{cm}^{-1}$ ,  $\delta_{\text{H}}$ (400) 1.74(2H, td,  $J = 7.6$  and 4.7Hz,  $\text{OCHCH}_2\text{CH}_2$ ), 2.20(2H, app q, ca  $J = 7.4$ Hz,  $\text{CH}_2\text{CH}_2\text{CH}=\text{CH}$ ), 3.17(2H, d,  $J = 6.4$ Hz,  $\text{CH}=\text{CHCH}_2\text{CO}_2\text{H}$ ), 3.89-4.50(4H, m,  $\text{OCH}_2\text{CH}_2\text{O}$ ), 4.87(1H, t,  $J = 4.7$ Hz,  $\text{OCHCH}_2\text{CH}_2$ ), 5.57(1H, dt,  $J = 10.8$  and 7.1Hz,  $\text{CH}_2\text{CH}=\text{CHCH}_2\text{CO}_2\text{H}$ ), 5.64(1H, dt,  $J = 10.8$  and 6.4Hz,  $\text{CH}_2\text{CH}=\text{CHCH}_2\text{CO}_2\text{H}$ ) and 8.84(1H, br s,  $\text{CO}_2\text{H}$ ),  $\delta_{\text{C}}$ (100) 177.98(C=O), 132.97(CH), 121.14(CH), 104.09(CH), 65.15(2x  $\text{CH}_2$ ), 33.40( $\text{CH}_2$ ), 32.79( $\text{CH}_2$ ) and 22.25( $\text{CH}_2$ ),  $m/z$ (1%,  $\text{M}^+$ ), 113(4,  $\text{C}_6\text{H}_9\text{O}_2$ ,  $\text{M}-\text{C}_3\text{H}_5\text{O}_2$ ), 73(100,  $\text{C}_3\text{H}_5\text{O}_2$ ,  $\text{M}-\text{C}_6\text{H}_9\text{O}_2$ ) and 45(21,  $\text{CHO}_2$ ). [Found :  $\text{M}^+$ , 186.0930.  $\text{C}_9\text{H}_{14}\text{O}_4$  requires :  $\text{M}$ , 186.0891].

#### Methyl *Z*-8-(dioxolan-2-yl)-3-oxo-oct-5-enoate. (**117**)

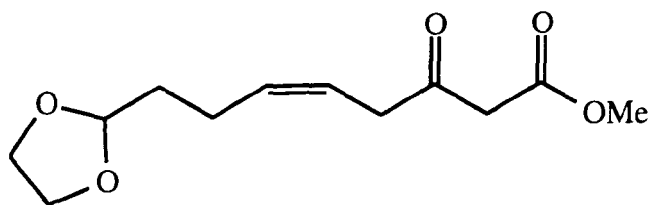

The acid (**116**) (0.56 g, 3 mmol) was coupled to the magnesium chelate of methyl hydrogen malonate in an identical fashion as for the preparation of keto-ester (**105**)<sup>294</sup> to give the crude *keto-ester* (**117**) (0.45 g, 61%) as a orange oil. No further purification was carried out on the product which showed,  $\nu_{\max}$  (film) 1722  $\text{cm}^{-1}$ ,  $\delta_{\text{H}}$ (250) 1.77(2H, td,  $J = 7.5$  and 5.0Hz,  $\text{OCHCH}_2\text{CH}_2$ ), 2.20(2H, app q, ca  $J = 7.5$ Hz,  $\text{CH}_2\text{CH}_2\text{CH}=\text{CH}$ ), 3.30(2H, d,  $J = 6.5$ Hz,  $\text{CH}=\text{CHCH}_2\text{CO}_2\text{H}$ ), 3.53(2H, s,  $\text{COCH}_2\text{CO}_2\text{CH}_3$ ), 3.76(3H, s,  $\text{CO}_2\text{CH}_3$ ), 3.89-4.40(4H, m,  $\text{OCH}_2\text{CH}_2\text{O}$ ), 4.86(1H, t,  $J = 5.0$ Hz,  $\text{OCHCH}_2\text{CH}_2$ ) and 5.53-5.78(2H, m,  $\text{CH}=\text{CH}$ ).

### Methyl *E*-3-oxooct-5-enoate. (120)

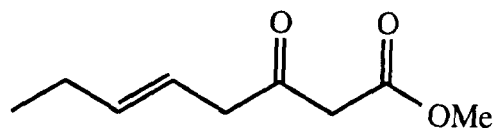

*E*-Hex-3-enoic acid (**119**) (6.04 g, 53 mmol) was coupled to the magnesium chelate of methyl hydrogen malonate in an identical fashion as for the preparation of keto-ester (**105**).<sup>294</sup> The resulting keto-ester was purified by column chromatography over silica G using hexane/ethyl acetate (90:10) as eluant. This gave the *keto-ester* (**120**) (5.67 g, 63%) as a colourless oil,  $\nu_{\max}$  (film) 1733 and 1724  $\text{cm}^{-1}$ ,  $\delta_{\text{H}}$ (250) 0.98(3H, t,  $J = 7.4\text{Hz}$ ,  $\text{CH}_3\text{CH}_2$ ), 2.06(2H, qdd,  $J = 7.4, 6.2$  and  $1.0\text{Hz}$ ,  $\text{CH}_3\text{CH}_2\text{CH}=\text{CH}$ ), 3.22(2H, dd,  $J = 6.6$  and  $0.9\text{Hz}$ ,  $\text{CH}_3\text{CH}_2\text{CH}=\text{CHCH}_2$ ), 3.48(2H, s,  $\text{COCH}_2\text{CO}_2\text{CH}_3$ ), 3.73(3H, s,  $\text{CO}_2\text{CH}_3$ ), 5.51(1H, dtt,  $J = 15.3, 6.6$  and  $1.3\text{Hz}$ ,  $\text{CH}_3\text{CH}_2\text{CH}=\text{CHCH}_2$ ) and 5.54(1H, dtt,  $J = 15.3, 6.2$  and  $1.0\text{Hz}$ ,  $\text{CH}_3\text{CH}_2\text{CH}=\text{CHCH}_2$ ),  $\delta_{\text{C}}$ (23) 201.14(C=O), 167.61(C=O), 137.70(CH), 120.04(CH), 52.16( $\text{CH}_3$ ), 48.21( $\text{CH}_2$ ), 46.75( $\text{CH}_2$ ), 25.62( $\text{CH}_2$ ) and 13.38( $\text{CH}_3$ ),  $m/z$  170(36%,  $\text{M}^+$ ), 155(6,  $\text{C}_8\text{H}_{11}\text{O}_3$ , M- $\text{CH}_3$ ), 139(8,  $\text{C}_8\text{H}_{11}\text{O}_2$ , M- $\text{OCH}_3$ ), 101(100, M- $\text{C}_5\text{H}_9$ ), 111(7, M- $\text{CO}_2\text{CH}_3$ ), 97(15, M- $\text{C}_3\text{H}_5\text{O}_2$ ) and 69(25, M- $\text{C}_4\text{H}_5\text{O}_3$ ).

### Methyl *E*(±)-3-hydroxyoct-5-enoate. (121)

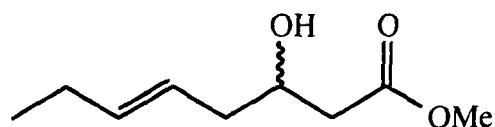

The keto-ester (**120**) (5.10 g, 30 mmol) was reduced by sodium borohydride in methanol by an analogous procedure to that used for hydroxy-ester (**106**).<sup>285</sup> Column chromatography of the residue over silica G using

hexane/ethyl acetate (80:20) as eluant gave the desired *hydroxy-ester* (**121**) (4.54 g, 88%) as a colourless oil,  $\nu_{\max}$  (film) 3422, 1735 and 1648  $\text{cm}^{-1}$ ,  $\delta_{\text{H}}$ (250) 0.98(3H, t,  $J = 7.5\text{Hz}$ ,  $\text{CH}_3\text{CH}_2$ ), 2.04(2H, qdd,  $J = 7.5, 6.2$  and  $1.1\text{Hz}$ ,  $\text{CH}_3\text{CH}_2\text{CH}=\text{CH}$ ), 2.22(2H, ddd,  $J = 6.8, 6.5$  and  $1.0\text{Hz}$ ,  $\text{CH}_3\text{CH}_2\text{CH}=\text{CHCH}_2$ ), 2.51-2.63(2H, m,  $\text{CH}_2\text{CH}(\text{OH})\text{CH}_2\text{CO}_2\text{CH}_3$ ), 2.57(1H, br s,  $\text{CH-OH}$ ), 3.71(3H, s,  $\text{CO}_2\text{CH}_3$ ), 4.04-4.13(1H, m,  $\text{CH}(\text{OH})\text{CH}_2\text{CO}_2\text{CH}_3$ ), 5.43(1H, dt,  $J = 15.3, 6.8$  and  $1.4\text{Hz}$ ,  $\text{CH}_3\text{CH}_2\text{CH}=\text{CHCH}_2$ ) and 5.56(1H, dt,  $J = 15.3, 6.2$  and  $1.1\text{Hz}$ ,  $\text{CH}_3\text{CH}_2\text{CH}=\text{CHCH}_2$ ),  $\delta_{\text{C}}$ (100) 179.71(C=O), 135.97(CH), 123.54(CH), 67.38(CH), 51.39( $\text{CH}_3$ ), 40.10( $\text{CH}_2$ ), 39.44( $\text{CH}_2$ ), 25.29( $\text{CH}_2$ ) and 13.36( $\text{CH}_3$ ),  $m/z$  154(9%, M- $\text{H}_2\text{O}$ ), 141(5,  $\text{C}_8\text{H}_{13}\text{O}_2$ , M- $\text{OCH}_3$ ), 103(100,  $\text{C}_4\text{H}_7\text{O}_3$ , M- $\text{C}_5\text{H}_9$ ) and 69(22, M- $\text{C}_4\text{H}_7\text{O}_3$ ). [Found : C, 62.52 ; H, 9.65. Calc for  $\text{C}_9\text{H}_{16}\text{O}_3$  : C, 62.78 ; H, 9.36%].

### ***E*-Oct-3-enoic acid. (123)**

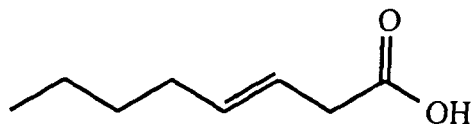

Malonic acid (15.60 g, 150 mmol), piperidine (4-5 drops) and *o*-xylene (200 ml) were heated to reflux (125°C) in a Dean-Stark apparatus. Hexanal (**122**) (0.50 g, 50 mmol) was slowly added, dropwise to the refluxing solution over the course of 5 min. The reaction was left until there was no further carbon dioxide/water formation (ca 3 hr). After cooling to ambient temperature the solvents were removed under reduced pressure and the residue taken up in ether (200 ml) and washed with water (3x 50 ml). The organic layer was then washed with sodium carbonate (2M) solution several times (3x 50 ml). This aqueous layer was cooled to 0°C and slowly acidified with dilute (2M) hydrochloric acid. The aqueous layer was extracted with ethyl acetate (3x 30

ml) and these organic extracts dried, filtered and reduced to give the *acid* (**123**)<sup>297</sup> (5.10 g, 72%) as a colourless oil,  $\nu_{\max}$  (film) 2957-2858, 1711 and 1418  $\text{cm}^{-1}$ ,  $\delta_{\text{H}}$ (90) 0.91(3H, t,  $J = 6.9\text{Hz}$ ,  $\text{CH}_3\text{CH}_2\text{CH}_2$ ), 1.30-1.38(4H, m,  $\text{CH}_3\text{CH}_2\text{CH}_2$ ), 1.95-2.50(2H, m,  $\text{CH}_2\text{CH}_2\text{CH}=\text{CH}$ ), 3.11(2H, d,  $J = 6.0\text{Hz}$ ,  $\text{CH}=\text{CHCH}_2\text{CO}_2\text{H}$ ), 5.65-6.10(2H, m,  $\text{CH}=\text{CH}$ ) and 9.45(1H, br s,  $\text{CO}_2\text{H}$ ),  $\delta_{\text{C}}$ (23) 179.02(C=O), 136.23(CH), 124.07(CH), 33.01( $\text{CH}_2$ ), 31.72( $\text{CH}_2$ ), 27.35( $\text{CH}_2$ ), 23.40( $\text{CH}_2$ ) and 14.72( $\text{CH}_3$ ).

### Methyl *E*-3-oxodec-5-enoate. (**124**)

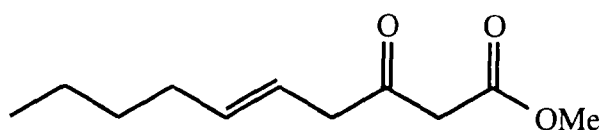

*E*-Oct-3-enoic acid (**123**) (1.23 g, 8.67 mmol) was coupled to the magnesium chelate of methyl hydrogen malonate in an identical fashion as for the preparation of keto-ester (**105**).<sup>294</sup> The resulting keto-ester was purified by column chromatography over silica G using hexane/ethyl acetate (90:10) as eluant. This gave the *keto-ester* (**124**) (1.01 g, 58%) as a colourless oil,  $\nu_{\max}$  (film) 1738 and 1727  $\text{cm}^{-1}$ ,  $\delta_{\text{H}}$ (250) 0.89(3H, t,  $J = 7.0\text{Hz}$ ,  $\text{CH}_3\text{CH}_2\text{CH}_2$ ), 1.23-1.38(4H, m,  $\text{CH}_3\text{CH}_2\text{CH}_2$ ), 2.04(2H, td,  $J = 6.6$  and  $6.4\text{Hz}$ ,  $\text{CH}_2\text{CH}_2\text{CH}=\text{CHCH}_2$ ), 3.22(2H, d,  $J = 6.1\text{Hz}$ ,  $\text{CH}=\text{CHCH}_2\text{CO}$ ), 3.49(2H, s,  $\text{COCH}_2\text{CO}_2\text{CH}_3$ ), 3.73(3H, s,  $\text{CO}_2\text{CH}_3$ ), 5.51(1H, dt,  $J = 14.8$  and  $6.6\text{Hz}$ ,  $\text{CH}_2\text{CH}_2\text{CH}=\text{CHCH}_2$ ) and 5.57(1H, dt,  $J = 14.8$  and  $6.1\text{Hz}$ ,  $\text{CH}_2\text{CH}_2\text{CH}=\text{CHCH}_2$ ),  $\delta_{\text{C}}$ (23) 201.08(C=O), 167.66(C=O), 136.40(CH), 120.96(CH), 52.22( $\text{CH}_3$ ), 48.26( $\text{CH}_2$ ), 46.91( $\text{CH}_2$ ), 32.34( $\text{CH}_2$ ), 31.41( $\text{CH}_2$ ), 25.62( $\text{CH}_2$ ) and 13.38( $\text{CH}_3$ ),  $m/z$  198(4%,  $\text{M}^+$ ), 183(2,  $\text{C}_{10}\text{H}_{15}\text{O}_3$ ,  $\text{M}-\text{CH}_3$ ), 167(4,  $\text{C}_{10}\text{H}_{15}\text{O}_2$ ,  $\text{M}-\text{OCH}_3$ ), 139(7,  $\text{C}_9\text{H}_{15}\text{O}$ ,  $\text{M}-\text{CO}_2\text{CH}_3$ ), 125(29,  $\text{C}_8\text{H}_{13}\text{O}$ ,  $\text{M}-\text{CH}_2\text{CO}_2\text{CH}_3$ ), 101(25,  $\text{M}-\text{CH}_3$ ), 97(39,  $\text{M}-\text{C}_4\text{H}_5\text{O}_3$ ), 69(25,  $\text{M}-\text{C}_4\text{H}_5\text{O}_3$ ) and

31(100, CH<sub>3</sub>O).

**Methyl *E*-(±)-3-hydroxydec-5-enoate. (125)**

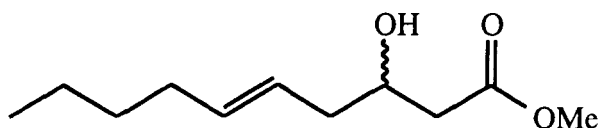

The keto-ester (**124**) (0.79 g, 4 mmol) was reduced by sodium borohydride in methanol by an analogous procedure to that used for hydroxy-ester (**106**).<sup>285</sup> Column chromatography of the residue over silica G using hexane/ethyl acetate (60:40) as eluant gave the desired *hydroxy-ester* (**125**) (0.57 g, 71%) as a colourless oil,  $\nu_{\max}$  (film) 3321-3421, 1739 and 1626 cm<sup>-1</sup>,  $\delta_{\text{H}}$ (250) 0.81(3H, t, J = 6.8Hz, CH<sub>3</sub>CH<sub>2</sub>CH<sub>2</sub>), 1.23-1.25(4H, m, CH<sub>3</sub>CH<sub>2</sub>CH<sub>2</sub>), 1.95(2H, app q, J = 6.5Hz, CH<sub>2</sub>CH<sub>2</sub>CH=CH), 2.14(2H, app t, J = 6.5Hz, CH=CHCH<sub>2</sub>CH(OH)CH<sub>2</sub>), 2.42-2.63(2H, m, CH<sub>2</sub>CH(OH)CH<sub>2</sub>), 2.85(1H, br s, CH-OH), 3.64(3H, s, CO<sub>2</sub>CH<sub>3</sub>), 3.94-4.04(1H, m, CH(OH)CH<sub>2</sub>) and 5.31-5.48(2H, m, CH<sub>2</sub>CH=CHCH<sub>2</sub>),  $\delta_{\text{C}}$ (100) 173.04(C=O), 133.66(CH), 124.60(CH), 67.351(CH), 51.54(CH<sub>3</sub>), 40.23(CH<sub>2</sub>), 39.63(CH<sub>2</sub>), 32.10(CH<sub>2</sub>), 31.33(CH<sub>2</sub>), 21.99(CH<sub>2</sub>) and 13.72(CH<sub>3</sub>), m/z 182(9%, M-H<sub>2</sub>O), 169(2, C<sub>10</sub>H<sub>17</sub>O<sub>2</sub>, M-OCH<sub>3</sub>), 127(3, C<sub>8</sub>H<sub>15</sub>O, M-C<sub>3</sub>H<sub>5</sub>O<sub>2</sub>), 103(100, M-C<sub>7</sub>H<sub>13</sub>) and 97(15, M-C<sub>4</sub>H<sub>7</sub>O<sub>3</sub>).

**4-Phenylbutanal. (126)**

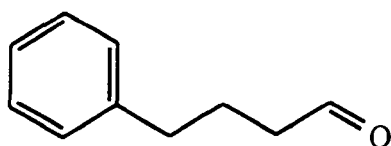

Oxidation based on method of Swern *et al.*<sup>298</sup> Dry dimethylsulphoxide (11.41 ml, 160 mmol), in dry dichloromethane (20 ml) was added dropwise to a stirred solution of freshly distilled oxalyl chloride (9.31 g, 73.33 mmol) in dichloromethane (10 ml) at -78°C under argon. After stirring for 10 min a

solution of 4-phenylbutan-1-ol (3.01 g, 20 mmol) in dichloromethane (5 ml) was added dropwise. Stirring was maintained at  $-78^{\circ}\text{C}$  for 1 hr after which time triethylamine (16.80 g, 167 mmol) was added. The resulting white suspension was allowed to warm to ambient temperature and water (50 ml) was added to dissolve the solids. The layers were separated and the aqueous phase extracted with dichloromethane (3x 10 ml). The combined organic extracts were washed with 2M hydrochloric acid (3x 5 ml), water (2x 10 ml), 2M sodium bicarbonate solution (20 ml), water (10 ml) and brine (10 ml), dried, filtered and concentrated. Chromatography of the residue over silica G using hexane/ethyl acetate (80:20) as eluant gave the desired *aldehyde* (**126**) (2.52 g, 85%) as a colourless oil,  $\nu_{\text{max}}$  (film) 1725, 1616 and  $1500\text{ cm}^{-1}$ ,  $\delta_{\text{H}}$ (90) 1.97(2H, app q,  $J = 6.7\text{ Hz}$ ,  $\text{CH}_2\text{CH}_2\text{CH}_2\text{CHO}$ ), 2.43(2H, t,  $J = 6.7\text{ Hz}$ ,  $\text{CH}_2\text{CH}_2\text{CH}_2\text{CHO}$ ), 2.64(2H, td,  $J = 6.7$  and  $1.6\text{ Hz}$ ,  $\text{CH}_2\text{CH}_2\text{CH}_2\text{CHO}$ ), 7.14-7.26(5H, m,  $\text{C}_6\text{H}_5$ ) and 9.92(1H, t,  $J = 1.6\text{ Hz}$ ,  $\text{CHO}$ ),  $\delta_{\text{C}}$ (23) 202.17(CH), 141.44(C), 128.66(4x CH), 126.27(CH), 43.33( $\text{CH}_2$ ), 35.26( $\text{CH}_2$ ) and 23.88( $\text{CH}_2$ ),  $m/z$  148(13%,  $\text{M}^+$ ), 131(11, M-OH), 117(10, M- $\text{CH}_2\text{OH}$ ), 104(100, M- $\text{C}_2\text{H}_4\text{O}$ ) and 91(85, M- $\text{C}_3\text{H}_5\text{O}$ ).

#### **E-6-Phenylhex-3-enoic acid. (127)**

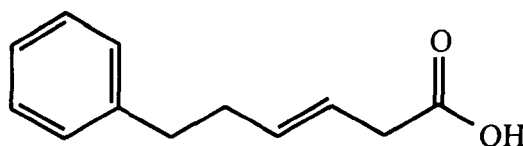

4-Phenylbutanal (**126**) (2.52 g, 17 mmol) was reacted with malonic acid under similar conditions as those outlined for the preparation of acid (**123**)<sup>297</sup> to give the *acid* (**127**) (2.10 g, 65%) as a colourless oil,  $\nu_{\text{max}}$  (film) 3021-2891, 1714, 1608 and  $1500\text{ cm}^{-1}$ ,  $\delta_{\text{H}}$ (240) 2.39(2H, td,  $J = 7.3$  and  $6.7\text{ Hz}$ ,  $\text{CH}_2\text{CH}_2\text{CH}=\text{CH}$ ), 2.70(2H, t,  $J = 7.3\text{ Hz}$ ,  $\text{CH}_2\text{CH}_2\text{CH}=\text{CH}$ ), 3.07(2H, d,  $J = 5.7\text{ Hz}$ ,  $\text{CH}=\text{CHCH}_2\text{CO}_2\text{H}$ ), 5.56(1H, dt,  $J = 15.0$  and  $6.7\text{ Hz}$ ,  $\text{CH}_2\text{CH}_2\text{CH}=\text{CHCH}_2$ ), 5.65(1H, dt,  $J = 15.0$  and  $5.7\text{ Hz}$ ,  $\text{CH}_2\text{CH}_2\text{CH}=\text{CHCH}_2$ ), 7.19-7.23(2H, m,  $o\text{-CH}=\text{CH}$ ), 7.25-7.33(3H, m,  $m$  and  $p\text{-CH}=\text{CH}-\text{CH}$ ) and

9.81(1H, br s, CO<sub>2</sub>H),  $\delta_{\text{C}}$ (23) 178.66(C=O), 152.11(CH), 141.88(C), 134.62(CH), 128.66(CH), 128.55(CH), 126.06(CH), 121.83(CH), 121.24(CH), 37.97(CH<sub>2</sub>), 35.08(CH<sub>2</sub>) and 34.40(CH<sub>2</sub>), m/z 190(2%, M<sup>+</sup>), 145(2, M-CO<sub>2</sub>H), 131(20, M-CH<sub>2</sub>CO<sub>2</sub>H), 105(18, M-CH=CHCH<sub>2</sub>CO<sub>2</sub>H), 99(12, M-CH<sub>2</sub>Ph), 91(100, M-C<sub>5</sub>H<sub>7</sub>O<sub>2</sub>) and 77(11, C<sub>6</sub>H<sub>5</sub>).

### Methyl *E*-8-phenyl-3-oxooct-5-enoate. (128)

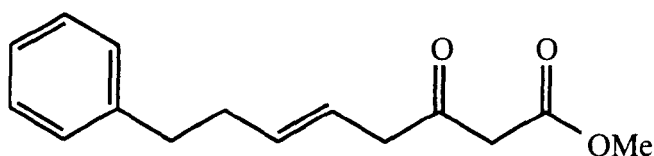

The acid (**127**) (1.53 g, 8.05 mmol) was coupled to the magnesium chelate of methyl hydrogen malonate in an identical fashion as for the preparation of keto-ester (**105**).<sup>294</sup> This gave the *keto-ester* (**128**) (0.92 g, 46%) as a pale yellow oil which was not purified further and which showed,  $\nu_{\text{max}}$  (film) 1728 cm<sup>-1</sup>,  $\delta_{\text{H}}$ (90) 2.21-2.53(2H, m, CH<sub>2</sub>CH<sub>2</sub>CH=CHCH<sub>2</sub>), 2.56-2.80(2H, m, CH<sub>2</sub>CH<sub>2</sub>CH=CHCH<sub>2</sub>), 3.16(2H, d, J = 5.4Hz, CH=CHCH<sub>2</sub>CO<sub>2</sub>CH<sub>3</sub>), 3.48(2H, s, COCH<sub>2</sub>CO<sub>2</sub>CH<sub>3</sub>), 3.75(3H, s, CO<sub>2</sub>CH<sub>3</sub>), 5.51-5.65(2H, m, CH<sub>2</sub>CH<sub>2</sub>CH=CHCH<sub>2</sub>) and 7.05-7.48(5H, m, C<sub>6</sub>H<sub>5</sub>), m/z 245(2%, M<sup>+</sup>), 174(4, C<sub>12</sub>H<sub>13</sub>O, M-CH<sub>2</sub>CO<sub>2</sub>CH<sub>3</sub>), 146(6, C<sub>11</sub>H<sub>13</sub>, M-C<sub>4</sub>H<sub>5</sub>O<sub>3</sub>), 131(7, C<sub>10</sub>H<sub>11</sub>, M-C<sub>5</sub>H<sub>7</sub>O<sub>3</sub>), 115(5, M-C<sub>10</sub>H<sub>11</sub>), 105(66, C<sub>8</sub>H<sub>9</sub>) and 91(100, C<sub>7</sub>H<sub>7</sub>).

### Methyl *E*-(±)-3-(*t*-butyldimethylsilyl)oxyoct-5-enoate. (130)

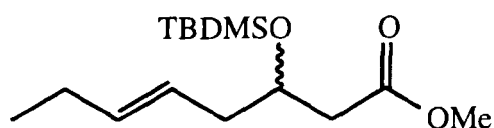

Imidazole (0.84 g, 12.30 mmol) was added to a stirred solution of *t*-

butyldimethylsilyl chloride (4.70 g, 30 mmol) and hydroxy-ester (**121**) (0.77 g, 4.92 mmol) in dry dimethylformamide (10 ml). The resulting mixture was stirred at room temperature for 24 hr, diluted with pentane (50 ml) and washed with water (3x 20 ml). The organic phase was separated, dried and concentrated. Chromatography of the residue over silica G using hexane/ethyl acetate (90:10) as eluant gave the desired *silyl-ether* (**130**)<sup>286</sup> (1.10 g, 93%) as a colourless oil,  $\nu_{\max}$  (film) 1730 and 1642  $\text{cm}^{-1}$ ,  $\delta_{\text{H}}$ (400) 0.05(3H, s, SiCH<sub>3</sub>), 0.08(3H, s, SiCH<sub>3</sub>), 0.88(9H, s, C(CH<sub>3</sub>)<sub>3</sub>), 1.15(3H, t, J = 7.0Hz, CH<sub>3</sub>CH<sub>2</sub>), 2.03(2H, qd, J = 7.0 and 6.2Hz, CH<sub>3</sub>CH<sub>2</sub>CH=CH), 2.21-2.36(2H, m, CH=CHCH<sub>2</sub>CH(OSiR<sub>3</sub>)), 2.38-2.51(2H, ABX, J<sub>AB</sub> = 14.7Hz, J<sub>BX</sub> = 7.6Hz and J<sub>AX</sub> = 5.0Hz, CH(OSiR<sub>3</sub>)CH<sub>2</sub>CO<sub>2</sub>CH<sub>3</sub>), 3.68(3H, s, CO<sub>2</sub>CH<sub>3</sub>), 3.16(1H, app dt, J = 7.2 and 6.5Hz, CH<sub>2</sub>CH(OSiR<sub>3</sub>)CH<sub>2</sub>), 5.38(1H, dt, J = 15.3 and 7.1Hz, CH<sub>3</sub>CH<sub>2</sub>CH=CHCH<sub>2</sub>) and 5.52(1H, dt, J = 15.3 and 6.2Hz, CH<sub>3</sub>CH<sub>2</sub>CH=CHCH<sub>2</sub>),  $\delta_{\text{C}}$ (100) 173.01(C=O), 135.12(CH), 123.92(CH), 69.19(CH<sub>2</sub>), 65.48(CH<sub>2</sub>), 51.04(CH<sub>3</sub>), 41.73(CH<sub>2</sub>), 40.65(CH<sub>2</sub>), 25.31(CH<sub>3</sub>), 25.31(3x CH<sub>3</sub>), 14.89(CH<sub>3</sub>) and 13.29(CH<sub>3</sub>).

### Methyl *E*-(±)-3-(*t*-butyldimethylsilyl)oxyoct-5-enoic acid. (**131**)

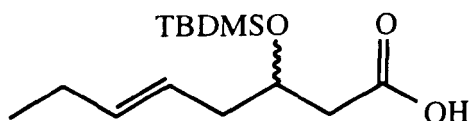

The ester (**130**) (1.00 g, 3.50 mmol) was saponified using potassium hydroxide exactly as described for the preparation of acid (**104**), to give the *acid* (**131**) (0.82 g, 86%) as a colourless oil,  $\nu_{\max}$  (film) 2858-2361 and 1714  $\text{cm}^{-1}$ ,  $\delta_{\text{H}}$ (400) 0.06(3H, s, SiCH<sub>3</sub>), 0.08(3H, s, SiCH<sub>3</sub>), 0.88(9H, s, C(CH<sub>3</sub>)<sub>3</sub>), 0.99(3H, t, J = 7.4Hz, CH<sub>3</sub>CH<sub>2</sub>), 2.03(2H, app qd, J = 7.4 and 6.2Hz, CH<sub>3</sub>CH<sub>2</sub>CH=CH), 2.23-2.30(2H, m, CH=CHCH<sub>2</sub>CH), 2.48-2.51(2H, ABX, J<sub>AB</sub> =



15.0Hz,  $J_{\text{BX}} = 7.4\text{Hz}$  and  $J_{\text{AX}} = 4.8\text{Hz}$ ,  $\text{CH}(\text{OSiR}_3)\text{CH}_2\text{CO}_2\text{H}$ ), 4.16(1H, app p,  $J = 6.1\text{Hz}$ ,  $\text{CH}_2\text{CH}(\text{OSiR}_3)\text{CH}_2$ ), 5.38(1H, dt,  $J = 15.4$  and  $7.1\text{Hz}$ ,  $\text{CH}_3\text{CH}_2\text{CH}=\text{CHCH}_2$ ), 5.53(1H, dt,  $J = 15.4$  and  $6.2\text{Hz}$ ,  $\text{CH}_3\text{CH}_2\text{CH}=\text{CHCH}_2$ ) and 8.52(1H, br s,  $\text{CO}_2\text{H}$ ),  $\delta_{\text{C}}(100)$  178.31(C=O), 135.77(CH), 124.07(CH), 69.41( $\text{CH}_2$ ), 41.95( $\text{CH}_2$ ), 40.88( $\text{CH}_2$ ), 25.75(3x  $\text{CH}_3$ ), 25.66( $\text{CH}_2$ ), 17.99(C), 13.65( $\text{CH}_3$ ), -4.23( $\text{CH}_3$ ) and -4.50( $\text{CH}_3$ ),  $m/z$  238(24%,  $\text{C}_8\text{H}_9\text{O}_3$ , M- $\text{C}_6\text{H}_{10}\text{Si}$ ), 165(100,  $\text{C}_9\text{H}_9\text{O}_3$ ) and 151(13,  $\text{C}_9\text{H}_{15}$ ).

**(±)-Hept-1-en-3-ol. (132)**

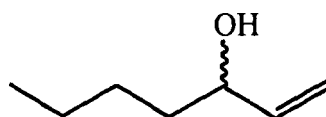

In a 3-l three necked flask fitted with a stirrer, dropping funnel and an ice-water condenser was placed magnesium (76.30 g, 3.18 mol), tetrahydrofuran (800 ml) and a few crystals of iodine. A solution of vinyl bromide (102 ml, 1.45 mol) in tetrahydrofuran (150 ml) was added in small portions until the reaction began, and then at such a rate as to maintain gentle refluxing of the solvent, 2 hr. The mixture was then heated at reflux for a further 1 hr. Pentanal (99 ml, 0.93 mol) was then added over the course of 1 hr. After an additional 1 hr at ambient temperature the reaction mixture was poured slowly into ice water (60 ml). The precipitate was dissolved by addition of sulphuric (11M) acid (10 ml). The organic layer was separated and the water layer extracted with ether (3x 100 ml). The combined extracts were dried, the solvent removed and the residue distilled through a 12 cm column packed with glass spheres, to yield the desired *hydroxy-alkene* (132)<sup>300</sup> (68.9 g, 65%) as a colourless oil, bp 153-155°C at 760 mm Hg, [lit.<sup>300</sup> bp 153-154°C at 760 mm Hg],  $v_{\text{max}}$  (film) 3400 and 1640  $\text{cm}^{-1}$ ,  $\delta_{\text{H}}(90)$  0.92(3H, t,  $J = 7.0\text{Hz}$ ,  $\text{CH}_3\text{CH}_2\text{CH}_2$ ), 1.20-1.65(6H, m,

CH<sub>3</sub>CH<sub>2</sub>CH<sub>2</sub>CH<sub>2</sub>), 3.27(1H, br s, CH(OH)), 4.15-4.21(1H, m, CH(OH)), 5.02-5.41(2H, m, CH=CH<sub>2</sub>) and 5.75-6.15(1H, m, CH=CH<sub>2</sub>).

**(±)-Hept-1-enyl-3-oxyacetic acid. (133)**

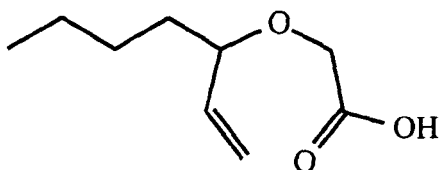

A solution of the allylic alcohol (**132**) (3.08 g, 27 mmol) in dry tetrahydrofuran (10 ml) was added dropwise to a stirred suspension of sodium hydride (1.8 g of 80% purity, 75 mmol) in tetrahydrofuran (50 ml) under an inert atmosphere. The temperature being maintained at 30°C. The suspension was left for 1 hr and then a solution of bromoacetic acid (3.75 g, 27 mmol) in tetrahydrofuran (10 ml) was slowly added over the course of 5 min. The solution was heated to reflux for 2 hr, then allowed to cool to ambient temperature. The reaction mixture was poured into a solution of ether (50 ml) and water (100 ml), then washed with more ether (3x 5 ml). The aqueous phase was separated, cooled to 0°C and carefully acidified with 2M hydrochloric acid. This was then extracted with ethyl acetate (3x 20 ml) and the organics separated, dried, filtered and the solvent removed under reduced pressure to give the pure *acid* (**133**)<sup>301</sup> (3.48 g, 75%) as a colourless oil,  $\nu_{\max}$  (film) 3201-2615 and 1708 cm<sup>-1</sup>,  $\delta_{\text{H}}$ (250) 0.90(3H, t,  $J = 6.9\text{Hz}$ , CH<sub>3</sub>CH<sub>2</sub>CH<sub>2</sub>), 1.32-1.45(4H, m, CH<sub>3</sub>CH<sub>2</sub>CH<sub>2</sub>), 1.55-1.59(1H, m, CH<sub>a</sub>CH<sub>b</sub>CH<sub>2</sub>CH<sub>2</sub>CH<sub>3</sub>), 1.70-1.78(1H, m, CH<sub>a</sub>CH<sub>b</sub>CH<sub>2</sub>CH<sub>2</sub>CH<sub>3</sub>), 3.75(1H, app q,  $J = 7.0\text{Hz}$ , OCH(CH=CH<sub>2</sub>)CH<sub>2</sub>CH<sub>2</sub>), 4.10(2H, AB,  $J_{\text{AB}} = 17.0\text{Hz}$ , OCH<sub>a</sub>CH<sub>b</sub>CO<sub>2</sub>H), 5.19-5.28(2H, m, CH=CH<sub>2</sub>), 5.58-5.69(1H, m, CH=CH<sub>2</sub>) and 8.50(1H, br s, CO<sub>2</sub>H),  $\delta_{\text{C}}$ (23) 175.68(C=O), 137.92(CH), 118.47(CH), 82.77(CH), 65.17(CH<sub>2</sub>), 34.99(CH<sub>2</sub>), 27.46(CH<sub>2</sub>), 22.69(CH<sub>2</sub>) and 14.03(CH<sub>3</sub>).

### **Z and E-(±)-2-Hydroxynon-4-enoic acid. (134)**

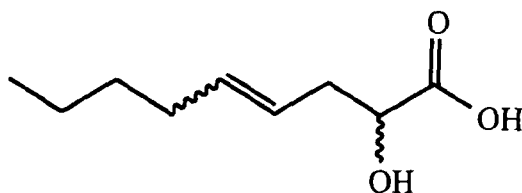

A stirred solution of lithium diisopropylamide [from diisopropylamine (6.5 ml) and *n*-butyl lithium (25 ml of a 1.6M solution in hexane), 40 mmol] in dry tetrahydrofuran (20 ml) was maintained at -78°C (acetone/CO<sub>2</sub>) while a solution of the alkenyloxyacetic acid (**133**) (3.44 g, 20 mmol) in tetrahydrofuran (10 ml) was added dropwise *via* syringe. The resulting solution was shielded from the light and allowed to slowly warm to 0°C over the course of 18 hr. 3M hydrochloric acid (30 ml) was slowly added at 0°C and then the mixture extracted with ethyl acetate (3x 10 ml). The organics were dried, filtered and reduced to give the crude *hydroxy-acid* (**134**)<sup>299</sup> (3.03 g, 88%) which was then submitted to diazomethane esterification<sup>302</sup> without further purification.

### **Methyl Z and E-(±)-2-hydroxynon-4-enoate. (135)**

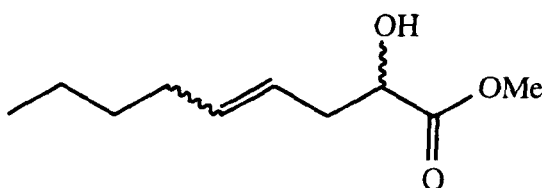

To an ice cold solution of the acid (**134**) (2.06 g, 12 mmol) in ether (20 ml) was added diazomethane in ether until TLC. analysis showed complete conversion of acid into ester. The solution was then left standing and allowed to warm to ambient temperature over the course of 1 hr. The organics were washed with 2M sodium bicarbonate solution (3x 10 ml), dried and the solvent removed under reduced pressure. Column chromatography of the residue over

silica G using hexane/ethyl acetate (80:20) as eluant gave the *esters* (135)<sup>302</sup> (2.12 g, 95%) in a 2:1 ratio *trans* to *cis*, as a colourless oil,  $\nu_{\max}$  (film) 1732  $\text{cm}^{-1}$ ,  $\delta_{\text{H}}$ (250) 0.88(3H, t,  $J = 7.0\text{Hz}$ , Z+E-CH<sub>3</sub>CH<sub>2</sub>CH<sub>2</sub>), 1.28-1.35(4H, m, Z+E-CH<sub>3</sub>CH<sub>2</sub>CH<sub>2</sub>), 2.03(2H, app q,  $J = 6.6$ , Z+E-CH=CHCH<sub>2</sub>CH<sub>2</sub>CH<sub>2</sub>CH<sub>3</sub>), 2.41-2.50(2H, m, Z+E-CH<sub>2</sub>CH=CHCH<sub>2</sub>CH<sub>2</sub>CH<sub>3</sub>), 3.02(1H, d,  $J = 6.7\text{Hz}$ , HCOH), 3.77(2H, s, E-CO<sub>2</sub>CH<sub>3</sub>), 3.78(1H, s, Z-CO<sub>2</sub>CH<sub>3</sub>), 4.26(1H, app p,  $J = 5.5\text{Hz}$ , Z+E-CH(OH)CO<sub>2</sub>CH<sub>3</sub>), 5.31-5.48(1H, m, Z+E-CH=CH) and 5.51-5.65(1H, m, Z+E-CH=CH),  $\delta_{\text{C}}$ (23) 175.03(Z+E-C=O), 135.27(E-CH), 133.97(Z-CH), 123.73(E-CH), 123.02(Z-CH), 70.74(E-CH), 70.64(Z-CH), 52.33(Z+E-CH<sub>3</sub>), 37.86(E-CH<sub>2</sub>), 32.50(Z-CH<sub>2</sub>), 32.39(E-CH<sub>2</sub>), 31.90(Z-CH<sub>2</sub>), 31.74(E-CH<sub>2</sub>), 27.24(Z-CH<sub>2</sub>), 22.48(Z-CH<sub>2</sub>), 22.26(E-CH<sub>2</sub>) and 13.97(Z+E-CH<sub>3</sub>).

**(±)-Dec-5-yn-3-ol. (136)**



A solution of hex-1-yne (101) (0.98 g, 12 mmol) in dry tetrahydrofuran (16 ml) was stirred under an atmosphere of argon and cooled to  $-20^{\circ}\text{C}$ . *n*-Butyl lithium (7.5 ml of a 1.6 M solution in hexane, 12 mmol) was added dropwise to the solution which was then left stirring at this temperature for 10 min. Boron trifluoride etherate (1.6 ml, 12.80 mmol) was then slowly added and the solution left stirring at  $-20^{\circ}\text{C}$  for a further 15 min. The temperature was lowered to  $-78^{\circ}\text{C}$  and then a solution of 1,2-epoxybutane (0.58 g, 8 mmol) in dry tetrahydrofuran (3 ml) was added over a 1 min period. The reaction was left stirring at  $-78^{\circ}\text{C}$  for 45 min. The mixture was quenched by addition of ammonium chloride solution (10 ml). The resulting solution was washed with water (3x 5 ml), separated, and the organic phase dried and evaporated. Column chromatography of the

residue using silica G and hexane/ethyl acetate (80:20) as eluant gave the *alkyne* (**136**)<sup>303</sup> (1.13 g, 91%) as a colourless oil,  $v_{\max}$  (film) 3465 and 2258  $\text{cm}^{-1}$ ,  $\delta_{\text{H}}(90)$  0.93(3H, t,  $J = 7.0\text{Hz}$ ,  $\text{CH}_3\text{CH}_2\text{CH}_2$ ), 0.98(3H, t,  $J = 7.5\text{Hz}$ ,  $\text{CH}_3\text{CH}_2$ ), 1.21-1.38(4H, m,  $\text{CH}_3\text{CH}_2\text{CH}_2$ ), 1.41-1.73(2H, m,  $\text{CH}_3\text{CH}_2\text{CH}(\text{OH})$ ), 2.13-2.40(4H, m,  $\text{CH}_2\text{C}\equiv\text{CCH}_2$ ), 2.43(1H, br s,  $\text{CH-OH}$ ) and 3.72(1H, app p,  $J = 6.3\text{Hz}$ ,  $\text{CH}(\text{OH})$ ),  $m/z$  154(5%,  $\text{M}^+$ ), 136(3,  $\text{C}_{10}\text{H}_{16}$ ,  $\text{M-H}_2\text{O}$ ), 139(3,  $\text{C}_9\text{H}_{15}\text{O}$ ,  $\text{M-CH}_3$ ), 125(6,  $\text{C}_8\text{H}_{13}\text{O}$ ,  $\text{M-C}_2\text{H}_5$ ), 111(8,  $\text{C}_7\text{H}_{11}\text{O}$ ,  $\text{M-C}_3\text{H}_7$ ), 97(15,  $\text{C}_6\text{H}_9\text{O}$ ,  $\text{M-C}_4\text{H}_9$ ), 81(47,  $\text{C}_6\text{H}_7\text{O}$ ) and 57(100,  $\text{C}_4\text{H}_{10}$ ,  $\text{M-C}_6\text{H}_7\text{O}$ ).

### **Z-(±)-Dec-5-en-3-ol. (137)**



A solution of alkyne (**136**) (0.92 g, 6 mmol) in dry ethyl acetate (25 ml) was hydrogenated (157 ml, 7 mmol) using Lindlar catalyst (0.10 g, 10% w/w) until hydrogen uptake was complete (ca 1 hr). The solution was filtered and the solvent removed under reduced pressure. Column chromatography of the residue using silica G and hexane/ethyl acetate (80:20) as eluant gave the *alkene* (**137**)<sup>292</sup> (0.89 g, 95%) as a colourless oil,  $v_{\max}$  (film) 3470 and 1414  $\text{cm}^{-1}$ ,  $\delta_{\text{H}}(400)$  0.90(3H, t,  $J = 7.1\text{Hz}$ ,  $\text{CH}_3\text{CH}_2\text{CH}_2$ ), 0.96(3H, t,  $J = 7.5\text{Hz}$ ,  $\text{CH}_3\text{CH}_2$ ), 1.25-1.39(4H, m,  $\text{CH}_3\text{CH}_2\text{CH}_2$ ), 1.42-1.60(2H, m,  $\text{CH}_3\text{CH}_2$ ), 1.80(1H, br s,  $\text{CHOH}$ ), 2.05(2H, td,  $J = 7.5$  and  $7.1\text{Hz}$ ,  $\text{CH}_2\text{CH}_2\text{CH}=\text{CH}$ ), 2.22(2H, dd,  $J = 7.3$  and  $7.0\text{Hz}$ ,  $\text{CH}=\text{CHCH}_2\text{CH}(\text{OH})$ ), 3.54(1H, tt,  $J = 7.0$  and  $5.5\text{Hz}$ ,  $\text{CH}_2\text{CH}(\text{OH})\text{CH}_2$ ), 5.40(1H, dtt,  $J = 10.9$ ,  $7.5$  and  $1.5\text{Hz}$ ,  $\text{CH}_2\text{CH}=\text{CHCH}_2\text{CH}(\text{OH})$ ) and 5.46(1H, dtt,  $J = 10.9$ ,  $7.3$  and  $1.5\text{Hz}$ ,  $\text{CH}_2\text{CH}=\text{CHCH}_2\text{CH}(\text{OH})$ ),  $\delta_{\text{C}}(100)$  133.42(CH), 125.17(CH), 72.88(CH), 34.89( $\text{CH}_2$ ), 31.89( $\text{CH}_2$ ), 29.58( $\text{CH}_2$ ), 27.15( $\text{CH}_2$ ), 22.39( $\text{CH}_2$ ), 13.99( $\text{CH}_3$ ) and 10.05( $\text{CH}_3$ ),  $m/z$  156(5%,  $\text{M}^+$ ), 141(9,  $\text{C}_9\text{H}_{17}\text{O}$ ,  $\text{M-CH}_3$ ), 138(19,  $\text{C}_{10}\text{H}_{18}$ ,  $\text{M-H}_2\text{O}$ ), 127(4,  $\text{C}_8\text{H}_{15}\text{O}$ ,  $\text{M-C}_2\text{H}_5$ ), 113(8,  $\text{C}_7\text{H}_{13}\text{O}$ ,  $\text{M-C}_3\text{H}_7$ ), 97(100,  $\text{C}_6\text{H}_{11}$ ,  $\text{M-C}_4\text{H}_9\text{O}$ ) and 59(23,  $\text{C}_4\text{H}_9\text{O}$ ,  $\text{M-C}_6\text{H}_{11}$ ).

***E*-(±)-Dec-5-en-3-ol. (138)**

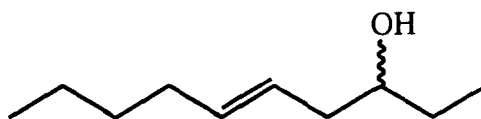

A solution of hex-1-yne (**101**) (0.49 g, 6 mmol) in dry tetrahydrofuran (10 ml) was stirred under an atmosphere of nitrogen and cooled to  $-5^{\circ}\text{C}$ . Diisobutylaluminium hydride (6 ml of a 1.0 M solution in hexane, 6 mmol) was added dropwise to the mixture and this was then left stirring for 30 min. The solution was then heated to  $50\text{-}55^{\circ}\text{C}$  for a period of 3 hr before cooling back to ambient temperature. *n*-Butyl lithium (3.8 ml of a 1.6 M solution in hexane, 6 mmol) was then added dropwise and the resulting white suspension left for 30 min at ambient temperature. A solution of 1,2-epoxybutane (0.43 g, 6 mmol) in tetrahydrofuran was then added dropwise and the reaction mixture left for 3 hr at ambient temperature. The reaction was quenched by the addition of 2M hydrochloric acid (20 ml). The reaction mixture was extracted with ether (3x 15 ml) and the organics washed with sodium bicarbonate solution (2x 10 ml), dried, filtered and the solvent removed under reduced pressure. Column chromatography of the residue using silica G and hexane/ethyl acetate (80:20) as eluant gave the *alcohol* (**138**)<sup>306</sup> (0.38 g, 41%) as a pale yellow oil,  $\nu_{\text{max}}$  (film) 3500 and 1401  $\text{cm}^{-1}$ ,  $\delta_{\text{H}}$ (250) 0.91(3H, t,  $J = 7.3\text{Hz}$ ,  $\text{CH}_3\text{CH}_2\text{CH}_2$ ), 0.95(3H, t,  $J = 7.5\text{Hz}$ ,  $\text{CH}_3\text{CH}_2$ ), 1.26-1.37(4H, m,  $\text{CH}_3\text{CH}_2\text{CH}_2$ ), 1.43-1.55(2H, m,  $\text{CH}_3\text{CH}_2$ ), 1.75(1H, br s,  $\text{CHOH}$ ), 2.03(2H, td,  $J = 7.3$  and  $5.8\text{Hz}$ ,  $\text{CH}_2\text{CH}_2\text{CH}=\text{CH}$ ), 2.22-2.32(2H, m,  $\text{CH}=\text{CHCH}_2\text{CH}(\text{OH})$ ), 3.51-3.59(1H, m,  $\text{CH}_2\text{CH}(\text{OH})\text{CH}_2$ ), 5.43(1H, dtt,  $J = 15.0, 5.8$  and  $1.2\text{Hz}$ ,  $\text{CH}_2\text{CH}=\text{CHCH}_2\text{CH}(\text{OH})$ ) and 5.49(1H, dtt,  $J = 15.0, 6.4$  and  $1.2\text{Hz}$ ,  $\text{CH}_2\text{CH}=\text{CHCH}_2\text{CH}(\text{OH})$ ),  $\delta_{\text{C}}$ (23) 130.07(CH), 121.58(CH), 70.36(CH), 39.45( $\text{CH}_2$ ), 31.87( $\text{CH}_2$ ), 31.26( $\text{CH}_2$ ), 29.14( $\text{CH}_2$ ), 22.17( $\text{CH}_2$ ), 13.99( $\text{CH}_3$ ) and 10.05( $\text{CH}_3$ ),  $m/z$  156(1%,  $\text{M}^+$ ), 141(10,  $\text{C}_9\text{H}_{17}\text{O}$ ,  $\text{M}-\text{CH}_3$ ), 138(19,  $\text{C}_{10}\text{H}_{18}$ ,  $\text{M}-$

H<sub>2</sub>O), 127(5, C<sub>8</sub>H<sub>15</sub>O, M-C<sub>2</sub>H<sub>5</sub>), 113(8, C<sub>7</sub>H<sub>13</sub>O, M-C<sub>3</sub>H<sub>7</sub>), 97(100, C<sub>6</sub>H<sub>11</sub>, M-C<sub>4</sub>H<sub>9</sub>O) and 59(22, C<sub>4</sub>H<sub>9</sub>O, M-C<sub>6</sub>H<sub>11</sub>).

### Methyl (±)-3,4-epoxybutanoate. (149)

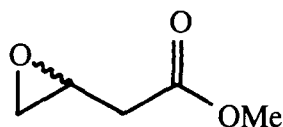

Methyl butanoate (**148**)<sup>308</sup> (10.20 g, 0.1 mol) in dry dichloromethane (30 ml) was stirred at 0°C under an atmosphere of argon. To this was added 3-chloroperoxybenzoic acid (33 g of 55% purity, 0.19 mol) in dichloromethane (50 ml). The solution was left stirring at 0°C for 20 min, allowed to warm up to ambient temperature, and stirred for a further 22 hr. Finally the solution was warmed to 40°C for 4 hr. The volatiles were then removed by vacuum distillation and condensed in liquid nitrogen cooled traps. The *epoxide* (**149**)<sup>308</sup> was then isolated by vacuum distillation employing a glass packed column, (6.6 g, 56%) as a colourless liquid, bp 74-75°C at 20 mm Hg, [lit.<sup>308</sup> bp 59-61°C at 13 mm Hg],  $\nu_{\max}$  (film) 1743, 922 and 839 cm<sup>-1</sup>,  $\delta_{\text{H}}$ (250) 2.57-2.63(1H, m, CH<sup>4 $\alpha$</sup> CH<sup>4 $\beta$</sup> -(O)-CH<sup>3</sup>-CH <sup>$\alpha$</sup> CH <sup>$\beta$</sup> -CO<sub>2</sub>), 2.58(2H, d, J = 5.7Hz, CH<sup>4 $\alpha$</sup> CH<sup>4 $\beta$</sup> -(O)-CH<sup>3</sup>-CH <sup>$\alpha$</sup> CH <sup>$\beta$</sup> -CO<sub>2</sub>), 2.85(1H, app t, J = 4.9Hz, CH<sup>4 $\alpha$</sup> CH<sup>4 $\beta$</sup> -(O)-CH<sup>3</sup>-CH <sup>$\alpha$</sup> CH <sup>$\beta$</sup> -CO<sub>2</sub>), 3.27(1H, app dt, J = 5.6 and 2.3Hz, CH<sup>4 $\alpha$</sup> CH<sup>4 $\beta$</sup> -(O)-CH<sup>3</sup>-CH <sup>$\alpha$</sup> CH <sup>$\beta$</sup> -CO<sub>2</sub>) and 3.70(3H, s, CO<sub>2</sub>CH<sub>3</sub>),  $\delta_{\text{C}}$ (23) 171.01(C=O), 51.84(CH<sub>3</sub>), 47.99(CH), 46.64(CH<sub>2</sub>) and 37.97(CH<sub>2</sub>).

### Octyl 3R-(+)-4-chloro-3-hydroxybutanoate. (152)

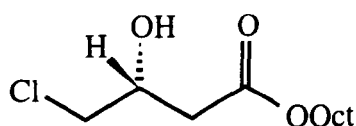

To a suspension of octyl 4-chloro-3-oxobutanoate (**151**)<sup>311</sup> (1.15 g, 4.62 mmol) in tap water (100 ml) maintained at 35°C was added (Sainsbury's) yeast (20 g). The resulting mixture was vigorously stirred mechanically at this temperature for 5 hr, then celite (10 g) was added and the suspension filtered under suction. The solid was thoroughly washed with water and the filtrate was continually extracted with chloroform for 24 hr. The organic phase was separated, dried and concentrated. Chromatography of the residue over silica G using hexane/ethyl acetate (80:20) as eluant gave the desired *hydroxy-ester* (**152**) (0.51 g, 43%)<sup>310</sup> as a light yellow oil,  $[\alpha]_D^{25} = +16.3$  (c, 10.0, CHCl<sub>3</sub>), [lit.<sup>312</sup>  $[\alpha]_D^{25} = +16.8$  (c, 10.2, CHCl<sub>3</sub>)],  $\nu_{\max}$  (film) 3500, 3100 and 1748 cm<sup>-1</sup>,  $\delta_{\text{H}}(250)$  0.89(3H, t, J = 5.6Hz, CH<sub>3</sub>CH<sub>2</sub>), 1.21-1.39(12H, m, (CH<sub>2</sub>)<sub>6</sub>), 2.65(2H, dd, J = 5.1 and 2.3Hz, CH(OH)CH<sub>2</sub>), 3.03(1H, br s, OH), 3.63(2H, dd, J = 5.1 and 1.3Hz, Cl-CH<sub>2</sub>CH(OH)), 4.11(2H, t, J = 6.6Hz, hept-CH<sub>2</sub>O), 4.25-4.71(1H, m, CH(OH)CH<sub>2</sub>).

#### Octyl 3R-(+)-3,4-epoxybutanoate. (**153**)

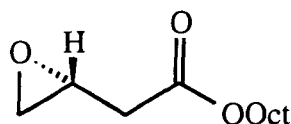

The chloro-hydroxyester (**152**) (0.10 g, 0.4 mmol) and activated silver oxide (0.19 g, 0.8 mmol) were suspended in freshly distilled monoglyme (1 ml). The suspension was heated to 85°C under an atmosphere of argon for 16 hr. The mixture was poured into water (5 ml) and extracted with pentane (5x 1 ml). The extracts were then dried, filtered and evaporated. Chromatography of the residue over silica G using hexane/ethyl acetate (80:20) as eluant gave the desired *epoxide* (**153**)<sup>313</sup> (0.08 g, 74%) as a colourless oil,  $[\alpha]_D^{25} = +13.8$  (c, 1.0, CHCl<sub>3</sub>), [lit.<sup>314a</sup>  $[\alpha]_D^{25} = +14.1$  (c, 1.0, CHCl<sub>3</sub>)],  $\nu_{\max}$  (film) 1734 cm<sup>-1</sup>,  $\delta_{\text{H}}(400)$  0.88(3H, t, J = 6.5Hz, CH<sub>3</sub>CH<sub>2</sub>), 1.20-1.43(10H, m, (CH<sub>2</sub>)<sub>5</sub>), 1.55-1.72(2H, m, CH<sub>3</sub>(CH<sub>2</sub>)<sub>5</sub>CH<sub>2</sub>), 2.57(3H, app ddd, J = 15.0, 5.5 and 2.5Hz,



$\text{CH}^{4\alpha}\text{CH}^{4\beta}\text{-(O)-CH}^{3\beta}\text{-CH}^{\alpha}\text{CH}^{\beta}\text{-CO}_2$ ), 2.85(1H, app t,  $J = 4.4\text{Hz}$ ,  $\text{CH}^{4\alpha}\text{CH}^{4\beta}\text{-(O)-CH}^{3\beta}\text{-CH}^{\alpha}\text{CH}^{\beta}\text{-CO}_2$ ), 3.29(1H, app tdd,  $J = 5.9, 3.9$  and  $2.7\text{Hz}$ ,  $\text{CH}^{4\alpha}\text{CH}^{4\beta}\text{-(O)-CH}^{3\beta}\text{-CH}^{\alpha}\text{CH}^{\beta}\text{-CO}_2$ ) and 4.12(2H, t,  $J = 6.7\text{Hz}$ , hept- $\text{CH}_2\text{O}$ ),  $\delta_{\text{C}}(100)$  170.75(C=O), 65.40( $\text{CH}_2$ ), 48.34(CH), 47.01( $\text{CH}_2$ ), 38.41( $\text{CH}_2$ ), 32.06( $\text{CH}_2$ ), 29.46(2x  $\text{CH}_2$ ), 28.83( $\text{CH}_2$ ), 26.16( $\text{CH}_2$ ), 22.93( $\text{CH}_2$ ) and 14.37( $\text{CH}_3$ ).

**(4R\*, 6S\*, 1'R\*)-4-(*t*-butyldimethylsilyl)oxy-6-(iodo-1'-propyl) tetrahydropyran-2-one. (178)**

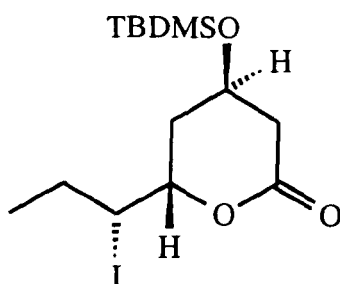

Anhydrous sodium bicarbonate (18.19 g, 0.22 mol) was added to a stirred solution of the acid (**131**) (2.18 g, 8.0 mmol) in dry acetonitrile (50 ml) while under an inert atmosphere of argon, shielded from the light and at a temperature of not greater than  $-4^{\circ}\text{C}$ . The resulting suspension was stirred at this temperature for 5 min and then iodine (5.58 g, 22 mmol) was rapidly added and the mixture vigorously stirred for a further 4 hr. It was then diluted with ether (200 ml) and washed with 2M sodium thiosulphate solution (100 ml), until excess iodine was removed. The separated organic solution was dried and evaporated to give the *lactone* (**178**)<sup>270</sup> (2.91 g, 91%) as a colourless oil,  $\nu_{\text{max}}$  (film)  $1740\text{ cm}^{-1}$ ,  $\delta_{\text{H}}(400)$  0.09(6H, s, 2x  $\text{SiCH}_3$ ), 1.09(9H, br s,  $(\text{CH}_3)_3\text{CSi}$ ), 1.09(3H, t,  $J = 7.2\text{Hz}$   $\text{CH}_3\text{CH}_2$ ), 1.85(2H, dq,  $J = 7.6$  and  $7.2$ ,  $\text{CH}_3\text{CH}_2$ ), 1.82(1H, ddd,  $J = 13.9, 11.0$  and  $2.2$ ,  $\text{CH}^{5\beta}$ ), 2.14(1H, app dt,  $J = 13.9$  and  $3.6\text{Hz}$ ,  $\text{CH}^{5\alpha}$ ), 2.61(2H, app d,  $J = 3.4\text{Hz}$ ,  $\text{CH}^{3\beta}\text{H}^{3\alpha}$ ), 4.24(1H, td,  $J = 7.6$  and  $5.7\text{Hz}$ ,  $\text{CH}^{1'\beta}\text{-I}$ ), 4.32(1H, ddd,  $J = 11.0, 5.7$  and  $3.6$ ,  $\text{CH}^{6\beta}$ ) and 4.37(1H, br p,  $J$

= 3.4Hz,  $\text{CH}^{4\alpha}$ ),  $\delta_{\text{C}}(100)$  169.30(C=O), 77.59(CH), 63.59(CH), 42.87(CH-I), 39.33(CH<sub>2</sub>), 35.62(CH<sub>2</sub>), 29.24(CH<sub>2</sub>), 25.90(3x CH<sub>3</sub>), 18.17(C), 14.38(CH<sub>3</sub>), -4.61(SiCH<sub>3</sub>) and -4.66(SiCH<sub>3</sub>),  $m/z$  398(0.2%, M<sup>+</sup>), 271(46, C<sub>14</sub>H<sub>27</sub>O<sub>3</sub>Si, M-I), 143(15, C<sub>6</sub>H<sub>10</sub>O<sub>2</sub>), 171(56, C<sub>9</sub>H<sub>15</sub>O<sub>3</sub>, M-I), 139(30, C<sub>8</sub>H<sub>11</sub>O<sub>2</sub>, M-C<sub>2</sub>H<sub>5</sub>I) and 101(100, C<sub>4</sub>H<sub>5</sub>O<sub>3</sub>, M-C<sub>3</sub>H<sub>6</sub>O<sub>2</sub>I).

**(4R\*,6R\*)-4-(*t*-butyldimethylsilyl)oxy-6-propyltetrahydropyran-2-one.**

**(178b)**

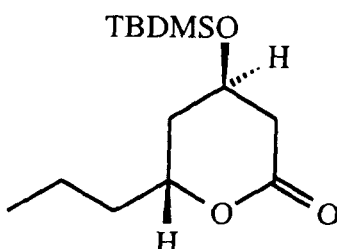

A solution of *n*-tributyltin hydride (9.1 g, 0.11 mol) in dry tetrahydrofuran (30 ml) was added to the iodolactone (**178**)<sup>271</sup> (2.87 g, 7.3 mmol) and the resulting solution was refluxed for 3 hr, then cooled and evaporated. Chromatography of the residue over silica G eluted with hexane/ethyl acetate (90:10) afforded the *lactone* (**178b**) (1.63 g, 83%) which showed,  $\nu_{\text{max}}$  (film) 1734  $\text{cm}^{-1}$ ,  $\delta_{\text{H}}(400)$  0.07(3H, s, SiCH<sub>3</sub>), 0.08(3H, s, SiCH<sub>3</sub>), 0.92(9H, s, C(CH<sub>3</sub>)<sub>3</sub>), 0.92(3H, t,  $J = 7.0\text{Hz}$ , CH<sub>3</sub>CH<sub>2</sub>CH<sub>2</sub>), 1.51-1.79(3H, m, CH<sub>3</sub>CH<sub>2</sub> and CH<sup>5 $\alpha$</sup> ), 1.85(1H, dtd,  $J = 14.1, 3.5$  and  $1.6\text{Hz}$ , CH<sup>5 $\beta$</sup> ), 2.55(1H, ddd,  $J = 17.4, 3.4$  and  $1.6\text{Hz}$ , CH<sup>3 $\beta$</sup> ), 2.61(1H, dd,  $J = 17.4$  and  $4.4\text{Hz}$ , CH<sup>3 $\alpha$</sup> ), 4.52(1H, app p,  $J = 3.8\text{Hz}$ , CH<sup>4 $\alpha$</sup> ) and 4.49(1H, tdd,  $J = 8.7, 4.5$  and  $3.1\text{Hz}$ , CH<sup>6 $\beta$</sup> ),  $m/z$  215(12%, C<sub>10</sub>H<sub>19</sub>O<sub>3</sub>Si, M-C<sub>4</sub>H<sub>9</sub>), 197(12, C<sub>10</sub>H<sub>17</sub>O<sub>2</sub>Si, M-C<sub>4</sub>H<sub>11</sub>O), 173(27, C<sub>8</sub>H<sub>17</sub>O<sub>2</sub>Si, M-C<sub>6</sub>H<sub>11</sub>O) and 101(100, C<sub>4</sub>H<sub>9</sub>OSi). [Found : M<sup>+</sup>-C<sub>4</sub>H<sub>9</sub>, 215.1087. C<sub>14</sub>H<sub>28</sub>O<sub>3</sub>Si requires : M-C<sub>4</sub>H<sub>9</sub>, 215.1102]. The sample was contaminated with ca 30% of tin residues.

## Methyl (2R, 4S, 5R)-5-butyl-4-hydroxytetrahydrofuranyl-2-acetate. (182)

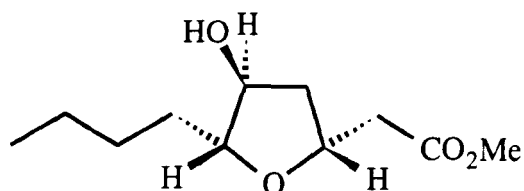

Sodium bicarbonate (1.00 g, 12 mmol) was added to a stirred solution of the chiral alkene (**099**) (0.08 g, 0.40 mmol) in a mixed solvent system, acetonitrile/water 1:1 (10 ml + 10 ml) while under an inert atmosphere of argon, shielded from the light and at a temperature of not greater than  $-4^{\circ}\text{C}$ . The resulting suspension was stirred at this temperature for 5 min and then iodine (0.31 g, 1.3 mmol) was rapidly added. The mixture was vigorously stirred at  $-4^{\circ}\text{C}$  for 48 hr, after which time 2M sodium thiosulphate solution (10 ml) was added and the mixture allowed to warm to ambient temperature. The reaction mixture was diluted with ethyl acetate (30 ml) and washed with more sodium thiosulphate solution (3x 5 ml). The organic phase was separated, dried ( $\text{Na}_2\text{SO}_4$ ) and concentrated to give a crude mixture of tetrahydrofuran products. Column chromatography of this mixture over silica G using hexane/ethyl acetate (80:20) to remove the *iodotetrahydrofurans* (**199**), (**200**) and (40:60) to isolate the *hydroxytetrahydrofuran* (**182**) (0.06 g, 72%) as a colourless oil,  $[\alpha]_D^{30} = +15.0$  (c, 0.98,  $\text{CHCl}_3$ ),  $\nu_{\text{max}}$  (film) 3442, 2956-2933 and 1739  $\text{cm}^{-1}$ ,  $\delta_{\text{H}}$ (400) 0.90(3H, t,  $J = 7.0\text{Hz}$ ,  $\text{CH}_3\text{CH}_2\text{CH}_2$ ), 1.32-1.42(4H, m,  $\text{CH}_3\text{CH}_2\text{CH}_2$ ), 1.47(2H, td,  $J = 7.0$  and  $6.5\text{Hz}$ ,  $\text{CH}_2\text{CH}_2\text{CH}^{5\beta}$ ), 1.81(1H, ddd,  $J = 13.2$ ,  $9.7$  and  $6.3\text{Hz}$ ,  $\text{CH}^{4\alpha}\text{-CH}^{3\alpha}\text{H}^{3\beta}\text{-CH}^{2\beta}$ ), 2.04(1H, ddd,  $J = 13.2$ ,  $5.6$  and  $2.1\text{Hz}$ ,  $\text{CH}^{4\alpha}\text{-CH}^{3\alpha}\text{H}^{3\beta}\text{-CH}^{2\beta}$ ), 2.26(1H, br s,  $\text{CH}^{4\alpha}(\text{OH})$ ), 2.51(1H, dd,  $J = 15.4$  and  $6.3\text{Hz}$ ,  $\text{CH}^{2\beta}\text{-CH}^{\alpha}\text{H}^{\beta}\text{-CO}_2\text{CH}_3$ ), 2.65(1H, dd,  $J = 15.4$  and  $6.7\text{Hz}$ ,  $\text{CH}^{2\beta}\text{-CH}^{\alpha}\text{H}^{\beta}\text{-CO}_2\text{CH}_3$ ), 3.69(3H, s,  $\text{CO}_2\text{CH}_3$ ), 3.73(1H, td,  $J = 6.5$  and  $3.0\text{Hz}$ ,  $\text{CH}_2\text{CH}^{5\beta}\text{-CH}^{4\alpha}$ ), 4.08(1H, app dt,  $J = 6.3$  and  $2.5\text{Hz}$ ,  $\text{CH}^{5\beta}\text{-CH}^{4\alpha}(\text{OH})\text{-CH}^{3\alpha}\text{H}^{3\beta}$ ) and 4.47(1H, app ddd,  $J = 9.7$ ,  $6.3$  and  $5.6\text{Hz}$ ,  $\text{CH}^{3\alpha}\text{H}^{3\beta}\text{-CH}^{2\beta}\text{-CH}^{\alpha}\text{H}^{\beta}$ ),  $\delta_{\text{C}}$ (100) 171.82(C=O), 87.34(CH),

76.56(CH), 74.13(CH), 51.95(CH<sub>3</sub>), 41.02(CH<sub>2</sub>), 40.80(CH<sub>2</sub>), 34.31(CH<sub>2</sub>), 28.16(CH<sub>2</sub>), 22.92(CH<sub>2</sub>) and 14.23(CH<sub>3</sub>), m/z 198(2%, C<sub>11</sub>H<sub>18</sub>O<sub>3</sub>, M-H<sub>2</sub>O), 156(5, C<sub>8</sub>H<sub>12</sub>O<sub>3</sub>, M-CH<sub>3</sub>O and C<sub>2</sub>H<sub>5</sub>), 143(12, C<sub>8</sub>H<sub>15</sub>O<sub>2</sub>), 130(19, C<sub>6</sub>H<sub>10</sub>O<sub>3</sub>, M-C<sub>5</sub>H<sub>10</sub>O), 117(18, C<sub>5</sub>H<sub>9</sub>O<sub>3</sub>, M-C<sub>6</sub>H<sub>14</sub>O<sub>2</sub>) and 98(100, C<sub>5</sub>H<sub>6</sub>O<sub>2</sub>, M-C<sub>6</sub>H<sub>14</sub>O<sub>2</sub>). [Found : M<sup>+</sup>-H<sub>2</sub>O, 198.1263. C<sub>11</sub>H<sub>18</sub>O<sub>3</sub> requires : M-H<sub>2</sub>O, 198.1256].

**(2S\*, 4R\*, 5S\*)-Methyl 5-butyl-4-iodotetrahydrofuran-2-acetate. (183)**

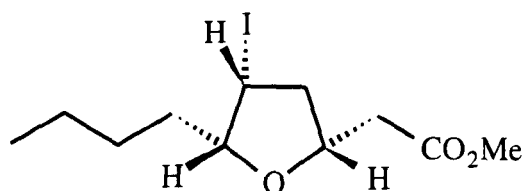

In an similar manner to that described for the preparation of the hydroxytetrahydrofuran (**182**), except neat acetonitrile solvent was employed, methyl *Z*(±)-3-hydroxydec-5-enoate (**106**) (5.20 g, 26.00 mmol) was converted to a mixture of tetrahydrofuran products [(**199**), (**200**) and (**183**) in a 4:1:1 ratio]. Column chromatography of this mixture over silica G using hexane/ethyl acetate (90:10) gave, in order, the *iodotetrahydrofurans* (**199**), (**200**) and (**183**) [(3.56 g, 42%)] and the *hydroxytetrahydrofuran* (**182**) (1.10 g, 35%), as colourless oils. The most polar, minor *iodotetrahydrofuran* (**183**) showed,  $\nu_{\max}$  (film) 1745 cm<sup>-1</sup>,  $\delta_{\text{H}}$ (400) 0.91(3H, t,  $J = 7.0\text{Hz}$ , CH<sub>3</sub>CH<sub>2</sub>CH<sub>2</sub>), 1.20-1.62(5H, m, CH<sub>3</sub>CH<sub>2</sub>CH<sub>2</sub>CH <sup>$\alpha$</sup> H <sup>$\beta$</sup> ), 1.74(1H, app dtd,  $J = 14.1, 7.4$  and  $6.9\text{Hz}$ , CH<sub>2</sub>CH <sup>$\alpha$</sup> H <sup>$\beta$</sup> -CH<sup>5 $\beta$</sup> ), 2.43(1H, ddd,  $J = 15.0, 5.3$  and  $2.3\text{Hz}$ , CH<sup>4 $\beta$</sup> -CH<sup>3 $\alpha$</sup> H<sup>3 $\beta$</sup> -CH<sup>2 $\beta$</sup> ), 2.76(1H, dd,  $J = 16.1$  and  $7.2\text{Hz}$ , CH<sup>2 $\beta$</sup> -CH <sup>$\alpha$</sup> H <sup>$\beta$</sup> -CO<sub>2</sub>CH<sub>3</sub>), 2.80(1H, td,  $J = 6.4$  and  $3.6\text{Hz}$ , CH <sup>$\alpha$</sup> H <sup>$\beta$</sup> -CH<sup>5 $\beta$</sup> -CH<sup>4 $\beta$</sup> ), 2.95(1H, dd,  $J = 16.0$  and  $6.5\text{Hz}$ , CH<sup>2 $\beta$</sup> -CH <sup>$\alpha$</sup> H <sup>$\beta$</sup> -CO<sub>2</sub>CH<sub>3</sub>), 3.09(1H, ddd,  $J = 15.0, 8.7$  and  $7.2\text{Hz}$ , CH<sup>4 $\beta$</sup> -CH<sup>3 $\alpha$</sup> H<sup>3 $\beta$</sup> -CH<sup>2 $\beta$</sup> ), 3.72(3H, s, CO<sub>2</sub>CH<sub>3</sub>), 4.42(1H, ddd,  $J = 8.9, 5.5$  and  $3.4\text{Hz}$ , CH<sup>5 $\beta$</sup> -CH<sup>4 $\beta$</sup> -CH<sup>3 $\alpha$</sup> H<sup>3 $\beta$</sup> ) and 4.44(1H, app tdd,  $J = 7.2, 6.5$  and  $2.3\text{Hz}$ , CH<sup>3 $\alpha$</sup> H<sup>3 $\beta$</sup> -CH<sup>2 $\beta$</sup> -CH <sup>$\alpha$</sup> H <sup>$\beta$</sup> ),  $\delta_{\text{C}}$ (100) 171.26(C=O), 82.38(CH), 74.24(CH), 52.04(CH<sub>3</sub>), 44.18(CH<sub>2</sub>), 41.39(CH<sub>2</sub>),

36.98(CH<sub>2</sub>), 32.01(CH), 28.29(CH<sub>2</sub>), 22.90(CH<sub>2</sub>) and 14.28(CH<sub>3</sub>), m/z 269(12%, C<sub>7</sub>H<sub>10</sub>O<sub>3</sub>I, M-C<sub>4</sub>H<sub>9</sub>), 253(11, C<sub>8</sub>H<sub>14</sub>OI, M-C<sub>3</sub>H<sub>5</sub>O<sub>2</sub>), 199(53, C<sub>11</sub>H<sub>19</sub>O<sub>3</sub>, M-I), 142(8, C<sub>7</sub>H<sub>10</sub>O<sub>3</sub>, M-C<sub>9</sub>H<sub>4</sub>I) and 140(100, C<sub>9</sub>H<sub>16</sub>O, M-I and C<sub>2</sub>H<sub>3</sub>O<sub>2</sub>).

**Methyl (2S\*, 4R\*, 5S\*) and (2S\*, 4S\*, 5R\*)-5-ethyl-4-iodotetrahydrofuranyl-2-acetate. (197) and (198)**

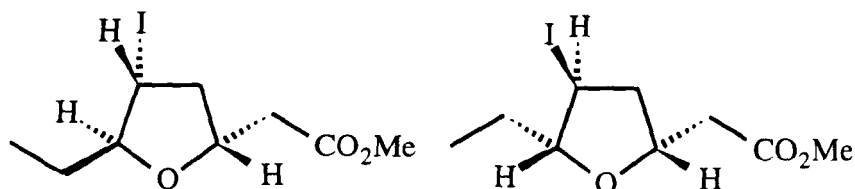

Employing super-dry conditions through out this experiment, flame dried apparatus, inert atmosphere, dry reactants and reagents was essential to optimize yields.

Anhydrous sodium bicarbonate (2.94 g, 36 mmol) was added to a stirred solution of the alkene (**121**) (0.21 g, 1.20 mmol) in tetrahydrofuran (15 ml) while under an inert atmosphere of argon, shielded from the light and at a temperature of not greater than -4°C. The resulting suspension was stirred at this temperature for 5 min and then iodine (0.91 g, 3.6 mmol) was rapidly added. The mixture was vigorously stirred at -4°C for 24 hr, after which time 2M sodium thiosulphate solution (10 ml) was added and the mixture allowed to warm to ambient temperature. The reaction mixture was diluted with ethyl acetate (30 ml) and washed with more sodium thiosulphate solution (3x 5 ml). The organic phase was separated, dried (Na<sub>2</sub>SO<sub>4</sub>) and concentrated to give a mixture of products (4:1 ratio of **(197)** and **(198)** respectively by NMR). Column chromatography of the residue over silica G using hexane/ethyl acetate (80:20) gave, in order, the *iodotetrahydrofurans* (**(197)**) and **(198)** [(0.31 g, 86%)], as a colourless oils. The less polar, major *iodotetrahydrofuran* (**(197)**) showed,  $\nu_{\max}$  (film) 2964-2878 and 1740 cm<sup>-1</sup>,  $\delta_{\text{H}}$ (400) 0.99(3H, t, J = 7.4Hz, CH<sub>3</sub>CH<sub>2</sub>), 1.51(1H, app dq, J = 14.2 and 7.4Hz, CH<sub>3</sub>CH <sup>$\alpha$</sup> H <sup>$\beta$</sup> -CH<sup>5 $\alpha$</sup> ), 1.80(1H, dqd, J = 14.2,

7.4 and 6.6Hz,  $\text{CH}_3\text{CH}^{\alpha}\text{H}^{\beta}\text{-CH}^{5\alpha}$ ), 2.10(1H, ddd,  $J = 13.1, 9.8$  and  $8.3\text{Hz}$ ,  $\text{CH}^{4\beta}\text{-CH}^{3\alpha}\text{H}^{3\beta}\text{-CH}^{2\beta}$ ), 2.55(1H, dd,  $J = 15.5$  and  $6.5\text{Hz}$ ,  $\text{CH}^{2\beta}\text{-CH}^{\alpha}\text{H}^{\beta}\text{-CO}_2\text{CH}_3$ ), 2.74(1H, dd,  $J = 15.5$  and  $6.9\text{Hz}$ ,  $\text{CH}^{2\beta}\text{-CH}^{\alpha}\text{H}^{\beta}\text{-CO}_2\text{CH}_3$ ), 2.79(1H, ddd,  $J = 13.1, 7.1$  and  $6.5\text{Hz}$ ,  $\text{CH}^{4\beta}\text{-CH}^{3\alpha}\text{H}^{3\beta}\text{-CH}^{2\beta}$ ), 3.70(3H, s,  $\text{CO}_2\text{CH}_3$ ), 3.79(1H, ddd,  $J = 9.8, 8.5$  and  $7.4\text{Hz}$ ,  $\text{CH}^{5\alpha}\text{-CH}^{4\beta}\text{-CH}^{3\alpha}\text{H}^{3\beta}$ ), 4.10(1H, dt,  $J = 8.2$  and  $4.0\text{Hz}$ ,  $\text{CH}^{\alpha}\text{H}^{\beta}\text{-CH}^{5\alpha}\text{-CH}^{4\beta}$ ) and 4.38(1H, app dq,  $J = 8.3$  and  $6.6\text{Hz}$ ,  $\text{CH}^{3\alpha}\text{H}^{3\beta}\text{-CH}^{2\beta}\text{-CH}^{\alpha}\text{H}^{\beta}$ ),  $\delta_{\text{C}}(100)$  171.44(C=O), 88.07(CH), 74.62(CH), 52.03( $\text{CH}_3$ ), 44.89( $\text{CH}_2$ ), 40.84( $\text{CH}_2$ ), 25.27( $\text{CH}_2$ ), 21.32(CH) and 10.22( $\text{CH}_3$ ),  $m/z$  298(0.2%,  $\text{M}^+$ ), 269(46,  $\text{C}_7\text{H}_{10}\text{O}_3\text{I}$ ,  $\text{M-C}_2\text{H}_5$ ), 237(15,  $\text{C}_6\text{H}_6\text{O}_2\text{I}$ ,  $\text{M-C}_2\text{H}_5$  and  $\text{CH}_3\text{OH}$ ), 225(13,  $\text{C}_6\text{H}_{10}\text{OI}$ ,  $\text{M-C}_3\text{H}_5\text{O}_2$ ), 171(56,  $\text{C}_9\text{H}_{15}\text{O}_3$ ,  $\text{M-I}$ ), 142(30,  $\text{C}_7\text{H}_{10}\text{O}_3$ ,  $\text{M-C}_2\text{H}_5\text{I}$ ) and 97(100,  $\text{C}_6\text{H}_9\text{O}$ ,  $\text{M-C}_3\text{H}_6\text{O}_2\text{I}$ ). [Found : C, 36.70 ; H, 5.32.  $\text{C}_9\text{H}_{15}\text{O}_3\text{I}$  requires : C, 36.24 ; H, 5.04%].

The more polar, minor *iodotetrahydrofuran* (**198**) showed,  $\nu_{\text{max}}$  (film) 2964-2878 and 1741  $\text{cm}^{-1}$ ,  $\delta_{\text{H}}(400)$  0.98(3H, t,  $J = 7.4\text{Hz}$ ,  $\text{CH}_3\text{CH}_2$ ), 1.50(1H, app dq,  $J = 14.1$  and  $7.4\text{Hz}$ ,  $\text{CH}_3\text{CH}^{\alpha}\text{H}^{\beta}\text{-CH}^{5\beta}$ ), 1.72(1H, dqd,  $J = 14.0, 7.6$  and  $4.6\text{Hz}$ ,  $\text{CH}_3\text{CH}^{\alpha}\text{H}^{\beta}\text{-CH}^{5\beta}$ ), 2.25(1H, ddd,  $J = 13.8, 8.1$  and  $7.3\text{Hz}$ ,  $\text{CH}^{4\alpha}\text{-CH}^{3\alpha}\text{H}^{3\beta}\text{-CH}^{2\beta}$ ), 2.47(1H, ddd,  $J = 13.8, 6.9$  and  $6.0\text{Hz}$ ,  $\text{CH}^{4\alpha}\text{-CH}^{3\alpha}\text{H}^{3\beta}\text{-CH}^{2\beta}$ ), 2.52(1H, dd,  $J = 15.4$  and  $6.6\text{Hz}$ ,  $\text{CH}^{2\beta}\text{-CH}^{\alpha}\text{H}^{\beta}\text{-CO}_2\text{CH}_3$ ), 2.67(1H, dd,  $J = 15.4$  and  $6.5\text{Hz}$ ,  $\text{CH}^{2\beta}\text{-CH}^{\alpha}\text{H}^{\beta}\text{-CO}_2\text{CH}_3$ ), 3.70(3H, s,  $\text{CO}_2\text{CH}_3$ ), 3.85(1H, ddd,  $J = 8.2, 6.7$  and  $6.1\text{Hz}$ ,  $\text{CH}^{5\beta}\text{-CH}^{4\alpha}\text{-CH}^{3\alpha}\text{H}^{3\beta}$ ), 4.08(1H, app td,  $J = 7.0$  and  $4.5\text{Hz}$ ,  $\text{CH}^{\alpha}\text{H}^{\beta}\text{-CH}^{5\beta}\text{-CH}^{4\alpha}$ ) and 4.46(1H, app p,  $J = 6.8\text{Hz}$ ,  $\text{CH}^{3\alpha}\text{H}^{3\beta}\text{-CH}^{2\beta}\text{-CH}^{\alpha}\text{H}^{\beta}$ ),  $\delta_{\text{C}}(100)$  171.37(C=O), 90.10(CH), 74.56(CH), 52.04( $\text{CH}_3$ ), 43.84( $\text{CH}_2$ ), 40.28( $\text{CH}_2$ ), 26.36( $\text{CH}_2$ ), 22.84(CH) and 10.14( $\text{CH}_3$ ).

**Methyl (2R\*, 4R\*, 5S\*) and (2S\*, 4S\*, 5R\*)-5-butyl-4-iodotetrahydrofuranyl-2-acetate. (199) and (200)**

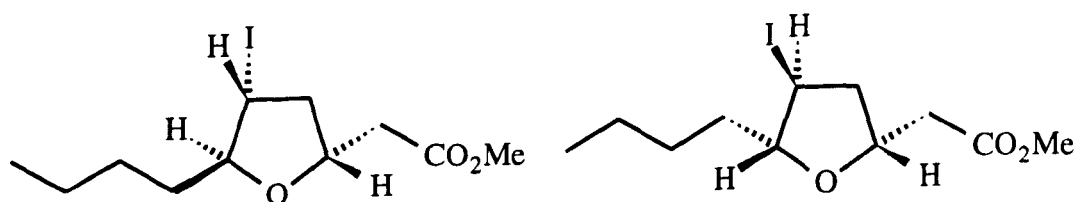

In an identical manner to that described for the anhydrous preparation of the iodotetrahydrofurans (**197** and **198**), methyl *E*-(±)-3-hydroxydec-5-enoate (**122**) (0.10 g, 0.50 mmol) was converted to a mixture of tetrahydrofuran products [(**199**) and (**200**) in a 4:1 ratio]. Column chromatography of this mixture over silica G using hexane/ethyl acetate (90:10) gave, in order, the *iodotetrahydrofurans* (**199**) and (**200**) [(0.13 g, 81%)] as colourless oils. The more polar, major *iodotetrahydrofuran* (**199**) showed,  $\nu_{\max}$  (film) 1743  $\text{cm}^{-1}$ ,  $\delta_{\text{H}}$ (400) 0.91(3H, t,  $J = 7.1\text{Hz}$ ,  $\text{CH}_3\text{CH}_2\text{CH}_2$ ), 1.25-1.50(5H, m,  $\text{CH}_3\text{CH}_2\text{CH}_2\text{CH}^{\alpha}\text{H}^{\beta}$ ), 1.76(1H, app dq,  $J = 14.1$  and  $6.9\text{Hz}$ ,  $\text{CH}_2\text{CH}^{\alpha}\text{H}^{\beta}\text{-CH}^{5\alpha}$ ), 2.09(1H, ddd,  $J = 13.1$ ,  $9.7$  and  $8.3\text{Hz}$ ,  $\text{CH}^{4\beta}\text{-CH}^{3\alpha}\text{H}^{3\beta}\text{-CH}^{2\beta}$ ), 2.54(1H, dd,  $J = 15.5$  and  $6.6\text{Hz}$ ,  $\text{CH}^{2\beta}\text{-CH}^{\alpha}\text{H}^{\beta}\text{-CO}_2\text{CH}_3$ ), 2.74(1H, dd,  $J = 15.5$  and  $6.8\text{Hz}$ ,  $\text{CH}^{2\beta}\text{-CH}^{\alpha}\text{H}^{\beta}\text{-CO}_2\text{CH}_3$ ), 2.79(1H, dt,  $J = 13.1$  and  $6.8\text{Hz}$ ,  $\text{CH}^{4\beta}\text{-CH}^{3\alpha}\text{H}^{3\beta}\text{-CH}^{2\beta}$ ), 3.70(3H, s,  $\text{CO}_2\text{CH}_3$ ), 3.76(1H, ddd,  $J = 9.7$ ,  $8.4$  and  $7.7\text{Hz}$ ,  $\text{CH}^{5\alpha}\text{-CH}^{4\beta}\text{-CH}^{3\alpha}\text{H}^{3\beta}$ ), 4.03(1H, dt,  $J = 8.0$  and  $3.5\text{Hz}$ ,  $\text{CH}^{\alpha}\text{H}^{\beta}\text{-CH}^{5\alpha}\text{-CH}^{4\beta}$ ) and 4.38(1H, app dq,  $J = 7.9$  and  $6.6\text{Hz}$ ,  $\text{CH}^{3\alpha}\text{H}^{3\beta}\text{-CH}^{2\beta}\text{-CH}^{\alpha}\text{H}^{\beta}$ ),  $\delta_{\text{C}}$ (100) 171.43(C=O), 87.00(CH), 74.58(CH), 52.02(CH<sub>3</sub>), 44.83(CH<sub>2</sub>), 40.86(CH<sub>2</sub>), 32.21(CH<sub>2</sub>), 28.29(CH<sub>2</sub>), 22.95(CH<sub>2</sub>), 22.08(CH) and 14.23(CH<sub>3</sub>),  $m/z$  326(0.3%, M<sup>+</sup>), 269(78, C<sub>7</sub>H<sub>10</sub>O<sub>3</sub>I, M-C<sub>4</sub>H<sub>9</sub>), 253(27, C<sub>6</sub>H<sub>6</sub>O<sub>3</sub>I, M-C<sub>5</sub>H<sub>13</sub>), 237(23, C<sub>6</sub>H<sub>6</sub>O<sub>2</sub>I, M-C<sub>5</sub>H<sub>13</sub>O), 199(55, C<sub>11</sub>H<sub>19</sub>O<sub>3</sub>, M-I), 167(12, C<sub>10</sub>H<sub>16</sub>O<sub>2</sub>, M-CH<sub>3</sub>OI) and 125(100, C<sub>8</sub>H<sub>12</sub>O, M-C<sub>3</sub>H<sub>7</sub>O<sub>2</sub>I).

The more polar, minor *iodotetrahydrofuran* (**200**) showed,  $\nu_{\max}$  (film) 1743  $\text{cm}^{-1}$ ,  $\delta_{\text{H}}$ (400) 0.92(3H, t,  $J = 7.0\text{Hz}$ ,  $\text{CH}_3\text{CH}_2\text{CH}_2$ ), 1.25-1.50(5H, m,  $\text{CH}_3\text{CH}_2\text{CH}_2\text{CH}^{\alpha}\text{H}^{\beta}\text{-CH}^{5\beta}$ ), 1.63-1.72(1H, m,  $\text{CH}_3\text{CH}_2\text{CH}_2\text{CH}^{\alpha}\text{H}^{\beta}\text{-CH}^{5\beta}$ ), 2.25(1H, app dt,  $J = 13.7$  and  $7.7\text{Hz}$ ,  $\text{CH}^{4\alpha}\text{-CH}^{3\alpha}\text{H}^{3\beta}\text{-CH}^{2\beta}$ ), 2.47(1H, dt,  $J = 13.7$  and  $6.5\text{Hz}$ ,  $\text{CH}^{4\alpha}\text{-CH}^{3\alpha}\text{H}^{3\beta}\text{-CH}^{2\beta}$ ), 2.52(1H, dd,  $J = 15.5$  and  $6.7\text{Hz}$ ,  $\text{CH}^{2\beta}\text{-CH}^{\alpha}\text{H}^{\beta}\text{-CO}_2\text{CH}_3$ ), 2.68(1H, dd,  $J = 15.5$  and  $6.4\text{Hz}$ ,  $\text{CH}^{2\beta}\text{-CH}^{\alpha}\text{H}^{\beta}\text{-CO}_2\text{CH}_3$ ), 3.70(3H, s,  $\text{CO}_2\text{CH}_3$ ), 3.83(1H, ddd,  $J = 8.1$ ,  $6.8$  and  $6.3\text{Hz}$ ,  $\text{CH}^{5\beta}\text{-CH}^{4\alpha}\text{-CH}^{3\alpha}\text{H}^{3\beta}$ ), 4.11(1H, app td,  $J = 7.1$  and  $4.3\text{Hz}$ ,  $\text{CH}^{\alpha}\text{H}^{\beta}\text{-CH}^{5\beta}\text{-CH}^{4\alpha}$ ) and 4.44(1H, app p,  $J = 6.8\text{Hz}$ ,  $\text{CH}^{3\alpha}\text{H}^{3\beta}\text{-CH}^{2\beta}\text{-CH}^{\alpha}\text{H}^{\beta}$ ),  $\delta_{\text{C}}$ (100) 171.45(C=O), 89.01(CH), 74.58(CH), 52.03(CH<sub>3</sub>), 43.80(CH<sub>2</sub>), 40.29(CH<sub>2</sub>), 33.27(CH<sub>2</sub>), 28.19(CH<sub>2</sub>), 23.53(CH), 22.96(CH<sub>2</sub>) and 14.23(CH<sub>3</sub>).

**(±)-Methyl 5, 6-epoxy-3-hydroxydecanoate. (201)**

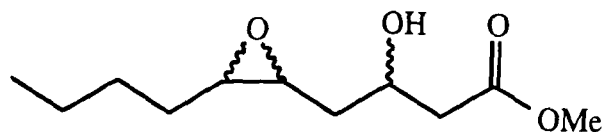

Methyl *Z*-(±)-3-hydroxydec-5-enoate (**106**) (0.10 g, 0.5 mmol) was treated with 3-chloroperoxybenzoic acid in an identical manner as for the preparation of epoxide (**149**).<sup>308</sup> Column chromatography of the crude product over silica G using hexane/ethyl acetate (90:10) gave the *epoxide* (**201**) (0.57 g, 53%) as a colourless oil,  $\nu_{\max}$  (film) 3680 and 1731  $\text{cm}^{-1}$ ,  $\delta_{\text{H}}$ (90) 1.05(3H, t,  $J = 7.4\text{Hz}$ ,  $\text{CH}_3\text{CH}_2\text{CH}_2$ ), 1.43-1.58(4H, m,  $(\text{CH}_2)_2$ ), 2.09-2.61(4H, m,  $\text{CH}_2\text{CH-O-CHCH}_2$ ), 2.73-2.81(2H, m,  $\text{CH}_2\text{CO}_2\text{CH}_3$ ), 3.01(1H, br s,  $\text{CH}(\text{OH})$ ), 3.62-4.12(2H, m,  $\text{CH-O-CH}$ ), 3.70(3H, s,  $\text{CO}_2\text{CH}_3$ ) and 4.12-4.25(1H, m,  $\text{CH}(\text{OH})$ ).

**Methyl (2R\*, 4S\*, 5R\*) and (2R\*, 4R\*, 5S\*)-5-butyl-4-iodotetrahydrofuran-2-formate. (202 and 203)**

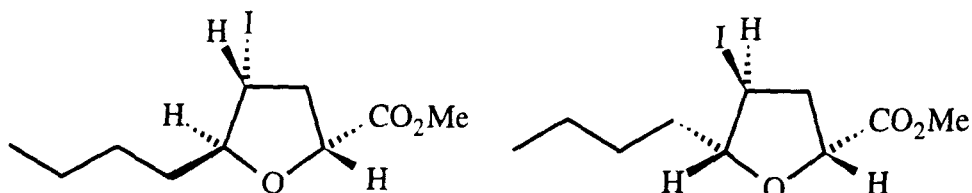

In an identical manner to that described for the aqueous preparation of the hydroxytetrahydrofuran (**182**), methyl *Z*- and *E*-(±)-2-hydroxynon-4-enoate (**135**) (0.20 g, 1.08 mmol) (2:1 ratio *E* to *Z*) was converted into a mixture of *iodotetrahydrofurans* (**202 and 203**) and *iodo-diols* (**204 and 205**). Column chromatography of this mixture over silica G using hexane/ethyl acetate (80:20) as eluant gave the inseparable *iodotetrahydrofurans* (**202**) and (**203**) [(0.21 g, 62%)] as colourless oils [1±:1 ratio of (**202**) and (**203**) by NMR],  $\nu_{\max}$  (film) 1735  $\text{cm}^{-1}$ , the major *iodotetrahydrofuran* (**202**) showing,  $\delta_{\text{H}}$ (400) 0.92(3H, t,  $J = 7.2\text{Hz}$ ,  $\text{CH}_3\text{CH}_2\text{CH}_2$ ), 1.26-1.61(4H, m,  $\text{CH}_3\text{CH}_2\text{CH}_2$ ), 1.61-1.73(1H, m,



$\text{CH}_2\text{CH}^\alpha$  either/or  $\text{H}^\beta\text{CH}^{5\alpha}$ , 1.85-1.92(1H, m,  $\text{CH}_2\text{CH}^\alpha$  either/or  $\text{H}^\beta\text{CH}^{5\alpha}$ ), 2.42(1H, ddd,  $J = 13.5, 9.2$  and  $7.1\text{Hz}$ ,  $\text{CH}^{4\beta}\text{-CH}^{3\alpha}\text{H}^{3\beta}\text{-CH}^{2\beta}$ ), 2.93(1H, app dt,  $J = 13.5$  and  $7.9\text{Hz}$ ,  $\text{CH}^{4\beta}\text{-CH}^{3\alpha}\text{H}^{3\beta}\text{-CH}^{2\beta}$ ), 3.69(1H, app dd,  $J = 9.0$  and  $7.8\text{Hz}$ ,  $\text{CH}^{5\alpha}\text{-CH}^{4\beta(l)}\text{-CH}^{3\alpha}\text{H}^{3\beta}$ ), 3.77(3H, s,  $\text{CO}_2\text{CH}_3$ ), 4.18(1H, ddd,  $J = 8.9, 7.2$  and  $4.6\text{Hz}$ ,  $\text{CH}_2\text{CH}^{5\alpha}\text{-CH}^{4\beta}$ ) and 4.49(1H, app t,  $J = 7.6\text{Hz}$ ,  $\text{CH}^{3\alpha}\text{H}^{3\beta}\text{-CH}^{2\beta}\text{-CO}_2\text{CH}_3$ ),  $\delta_{\text{C}}(100)$  173.02(C=O), 88.29(CH), 75.90(CH), 52.55( $\text{CH}_3$ ), 42.40( $\text{CH}_2$ ), 31.75( $\text{CH}_2$ ), 28.02( $\text{CH}_2$ ), 22.91( $\text{CH}_2$ ), 20.34( $\text{CH}_2$ ) and 14.20( $\text{CH}_3$ ) and the minor *iodotetrahydrofuran* (**203**) showing,  $\delta_{\text{H}}(400)$  0.92(3H, t,  $J = 7.2\text{Hz}$ ,  $\text{CH}_3\text{CH}_2\text{CH}_2$ ), 1.26-1.61(4H, m,  $\text{CH}_3\text{CH}_2\text{CH}_2$ ), 1.61-1.73(1H, m,  $\text{CH}_2\text{CH}^\alpha$  either/or  $\text{H}^\beta\text{CH}^{5\beta}$ ), 1.85-1.93(1H, m,  $\text{CH}_2\text{CH}^\alpha$  either/or  $\text{H}^\beta\text{CH}^{5\beta}$ ), 2.62(2H, app dd,  $J = 8.3$  and  $5.5\text{Hz}$ ,  $\text{CH}^{4\alpha}\text{-CH}^{3\alpha}\text{H}^{3\beta}\text{-CH}^{2\beta}$ ), 3.75(3H, s,  $\text{CO}_2\text{CH}_3$ ), 3.87(1H, app q,  $J = 7.8\text{Hz}$ ,  $\text{CH}^{5\beta}\text{-CH}^{4\alpha(l)}\text{-CH}^{3\alpha}\text{H}^{3\beta}$ ), 4.14(1H, app td,  $J = 7.8$  and  $3.9\text{Hz}$ ,  $\text{CH}_2\text{CH}^{5\beta}\text{-CH}^{4\alpha}$ ) and 4.56(1H, app dd,  $J = 8.3$  and  $5.5\text{Hz}$ ,  $\text{CH}^{3\alpha}\text{H}^{3\beta}\text{-CH}^{2\beta}\text{-CO}_2\text{CH}_3$ ),  $\delta_{\text{C}}(100)$  172.65(C=O), 89.84(CH), 76.39(CH), 52.55( $\text{CH}_3$ ), 42.40( $\text{CH}_2$ ), 32.74( $\text{CH}_2$ ), 28.30( $\text{CH}_2$ ), 22.91( $\text{CH}_2$ ), 21.36( $\text{CH}_2$ ) and 14.20( $\text{CH}_3$ ) both (**202** and **203**) showing,  $m/z$  312(0.1%,  $\text{M}^+$ ), 254(22,  $\text{C}_6\text{H}_7\text{O}_3\text{I}$ ,  $\text{M-C}_3\text{H}_{10}$ ), 253(6,  $\text{C}_8\text{H}_{14}\text{OI}$ ,  $\text{M-CO}_2\text{CH}_3$ ), 226(35,  $\text{C}_6\text{H}_{11}\text{OI}$ ), 185(56,  $\text{C}_{10}\text{H}_{17}\text{O}_3$ ,  $\text{M-I}$ ), 157(18,  $\text{C}_8\text{H}_{13}\text{O}_3$ ,  $\text{M-C}_2\text{H}_4\text{I}$ ) and 55(100,  $\text{C}_4\text{H}_7$ ) with a complex mixture of *iodo-diols* (**204** and **205**) which thwarted attempts to isolate samples for further characterisation.

**(2S\*, 4R\*, 5R\* and 2S\*, 4S\*, 5S\*)-5-Butyl-2-ethyl-4-iodotetrahydrofuran** (**218** and **219**), **3-hydroxydecan-6-one** (**220**), **(3S\*, 5S\*, 6S\*)-5-Iodo-decan-3, 6-diol** and **(3S\*, 5S\*, 6R\*)-6-Iodo-decan-3, 5-diol** (**221** and **222**).

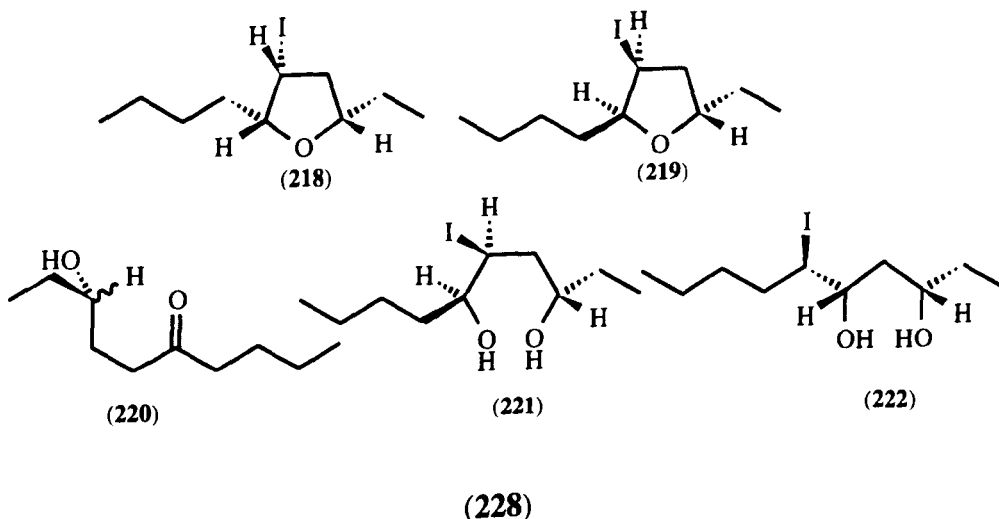

Sodium bicarbonate (1.94 g, 23.10 mmol) was added to a stirred solution of Z-decenol (**137**) (0.12 g, 0.77 mmol) in a mixed solvent system, acetonitrile/water (25 ml + 10 ml) while under an inert atmosphere of argon, shielded from the light and at a temperature of not greater than -4°C. The resulting suspension was stirred at this temperature for 5 min and then iodine (0.59 g, 2.31 mmol) was rapidly added. The mixture was vigorously stirred at -4°C for 72 hr, after which time 2M sodium thiosulphate solution (15 ml) was added and the mixture allowed to warm to ambient temperature. The reaction mixture was diluted with ethyl acetate (30 ml) and washed with more sodium thiosulphate solution (3x 5 ml). The organic phase was separated, dried (Na<sub>2</sub>SO<sub>4</sub>) and concentrated to give a crude mixture of products. Column chromatography of this mixture over silica G using hexane/ethyl acetate (90:10) to remove the *Iodotetrahydrofurans* [(**218**) (0.018 g, 9%) and (**219**) (0.016 g, 7%)] and (40:60) to isolate the *hydroxy-products* [(**220**) (0.030 g, 15%), (**221** and **222**) (0.14 g, 66%)].

The less polar, major *iodotetrahydrofuran* (**218**) was a colourless oil and showed,  $\nu_{\max}$  (film) 1679, 1549 and 1410 cm<sup>-1</sup>,  $\delta_{\text{H}}$ (400) 0.92(3H, t, J = 7.5Hz, CH<sub>3</sub>CH<sub>2</sub>CH<sub>2</sub>), 0.95(3H, t, J = 7.4Hz, CH<sub>3</sub>CH<sub>2</sub>), 1.21-1.43(4H, m, CH<sub>3</sub>CH<sub>2</sub>CH<sub>2</sub>CH<sub>2</sub>-CH<sup>5β</sup>), 1.54-1.62(1H, m, CH<sub>3</sub>CH<sup>α</sup>H<sup>β</sup>-CH<sup>2β</sup>), 1.68-1.86(2H, m, CH<sub>3</sub>CH<sub>2</sub>CH<sub>2</sub>CH<sub>2</sub>-CH<sup>5β</sup>), 1.85(1H, dqd, J = 14.6, 7.4 and 6.5Hz, CH<sub>3</sub>CH<sup>α</sup>H<sup>β</sup>-CH<sup>2β</sup>), 2.32(1H, ddd, J = 14.2, 6.2 and 2.8Hz, CH<sup>4β</sup>-CH<sup>3α</sup>H<sup>3β</sup>-CH<sup>2β</sup>), 2.77(1H, td, J = 6.4 and 3.9Hz, CH<sup>α</sup>H<sup>β</sup>-CH<sup>5β</sup>-CH<sup>4β</sup>), 2.91(1H, ddd, J = 14.2, 8.4 and 7.2Hz, CH<sup>4β</sup>-CH<sup>3α</sup>H<sup>3β</sup>-CH<sup>2β</sup>), 3.87(1H, app ddd, J = 8.4, 6.6 and 6.5Hz, CH<sup>3α</sup>H<sup>3β</sup>-CH<sup>2β</sup>-CH<sup>α</sup>H<sup>β</sup>) and 4.42(1H, ddd, J = 7.0, 3.8 and 3.0Hz, CH<sup>5β</sup>-CH<sup>4β</sup>-CH<sup>3α</sup>H<sup>3β</sup>),  $\delta_{\text{C}}$ (100) 81.78(CH), 80.14(CH), 44.06(CH<sub>2</sub>), 37.17(CH<sub>2</sub>), 32.59(CH), 29.51(CH<sub>2</sub>), 28.45(CH<sub>2</sub>), 22.91(CH<sub>2</sub>), 14.28(CH<sub>3</sub>) and 10.84(CH<sub>3</sub>), m/z 225(52%, C<sub>6</sub>H<sub>10</sub>OI, M-C<sub>4</sub>H<sub>9</sub>), 196(6, C<sub>4</sub>H<sub>5</sub>OI, M-C<sub>6</sub>H<sub>14</sub>), 155(100, C<sub>10</sub>H<sub>19</sub>O, M-I), 125(10, C<sub>8</sub>H<sub>13</sub>O, M-C<sub>2</sub>H<sub>6</sub>I), 98(41, C<sub>6</sub>H<sub>10</sub>O, M-C<sub>4</sub>H<sub>9</sub>I) and 69(80, C<sub>4</sub>H<sub>5</sub>OI, M-C<sub>6</sub>H<sub>14</sub>I).

The more polar, minor *iodotetrahydrofuran* (**219**) showed,  $\nu_{\max}$  (film) 1683 and 1410 cm<sup>-1</sup>,  $\delta_{\text{H}}$ (250) 0.86(3H, t, J = 7.5Hz, CH<sub>3</sub>CH<sub>2</sub>CH<sub>2</sub>), 0.93(3H, t, J =

7.2Hz,  $\text{CH}_3\text{CH}^\alpha\text{H}^\beta$ ), 1.23-1.47(4H, m,  $\text{CH}_3\text{CH}_2\text{CH}_2\text{CH}_2\text{-CH}^{5\beta}$ ), 1.51-1.69(3H, m,  $\text{CH}_3\text{CH}^\alpha\text{H}^\beta\text{-CH}^{2\beta}$  and  $\text{CH}_3\text{CH}_2\text{CH}_2\text{CH}_2\text{-CH}^{5\beta}$ ), 1.76(1H, dqd,  $J = 13.6, 7.5$  and  $6.4\text{Hz}$ ,  $\text{CH}_3\text{CH}^\alpha\text{H}^\beta\text{-CH}^{2\beta}$ ), 1.39(1H, dt,  $J = 11.1$  and  $7.8\text{Hz}$ ,  $\text{CH}^{4\alpha}\text{-CH}^{3\alpha}$  or  $\text{H}^{3\beta}\text{-CH}^{2\beta}$ ), 2.58(1H, dt,  $J = 11.1$  and  $6.9\text{Hz}$ ,  $\text{CH}^{4\alpha}\text{-CH}^{3\alpha}$  or  $\text{H}^{3\beta}\text{-CH}^{2\beta}$ ), 4.05(1H, app td,  $J = 8.4$  and  $4.4\text{Hz}$ ,  $\text{CH}^{3\alpha}\text{H}^{3\beta}\text{-CH}^{2\beta}\text{-CH}^\alpha\text{H}^\beta$ ), 4.52(1H, app p,  $J = 6.8\text{Hz}$ ,  $\text{CH}^{5\beta}\text{-CH}^{4\alpha}\text{-CH}^{3\alpha}\text{H}^{3\beta}$ ) and 4.66(1H, app q,  $J = 7.6\text{Hz}$ ,  $\text{CH}^\alpha\text{H}^\beta\text{-CH}^{5\beta}\text{-CH}^{4\alpha}$ ),  $\delta_{\text{C}}(100)$  80.42(CH), 77.62(CH), 42.42(CH), 33.07( $\text{CH}_2$ ), 32.11( $\text{CH}_2$ ), 31.72( $\text{CH}_2$ ), 30.87( $\text{CH}_2$ ), 22.31( $\text{CH}_2$ ), 14.20( $\text{CH}_3$ ) and 8.39( $\text{CH}_3$ ),  $m/z$  282(1%,  $\text{M}^+$ ), 253(1,  $\text{C}_8\text{H}_{14}\text{OI}$ ,  $\text{M-C}_2\text{H}_5$ ), 225(19,  $\text{C}_6\text{H}_{10}\text{OI}$ ,  $\text{M-C}_4\text{H}_9$ ), 155(100,  $\text{C}_{10}\text{H}_{19}\text{O}$ ,  $\text{M-I}$ ), 125(14,  $\text{C}_8\text{H}_{13}\text{O}$ ,  $\text{M-I}$  and  $\text{C}_2\text{H}_6$ ) and 98(18,  $\text{C}_6\text{H}_{10}\text{O}$ ,  $\text{M-I}$  and  $\text{C}_4\text{H}_9$ ).

The isolated *hydroxy-ketone* (**220**) was fully characterised by converting it into its *acetate* derivative (**220b**) by standard methods.<sup>140</sup> This then showed,  $\nu_{\text{max}}$  (film) 1735 and 1717  $\text{cm}^{-1}$ ,  $\delta_{\text{H}}(400)$  0.89(3H, t,  $J = 7.5\text{Hz}$ ,  $\text{CH}_3\text{CH}_2\text{CH}_2$ ), 0.90(3H, t,  $J = 7.3\text{Hz}$ ,  $\text{CH}_3\text{CH}_2$ ), 1.30(2H, qt,  $J = 7.5$  and  $5.8\text{Hz}$ ,  $\text{CH}_3\text{CH}_2\text{CH}_2$ ), 1.55(2H, app q,  $J = 7.3\text{Hz}$ ,  $\text{CH}_3\text{CH}_2\text{CH}(\text{OAc})$ ), 1.61(2H, tt, 7.6 and 5.8Hz  $\text{CH}_3\text{CH}_2\text{CH}_2\text{CH}_2$ ), 1.76(1H, app ddt,  $J = 14.6, 8.5$  and  $7.1\text{Hz}$ ,  $\text{CH}(\text{OAc})\text{-CH}^\alpha\text{H}^\beta\text{-CH}_2$ ), 1.87(1H, dtd,  $J = 14.6, 7.7$  and  $4.0\text{Hz}$ ,  $\text{CH}(\text{OAc})\text{-CH}^\alpha\text{H}^\beta\text{-CH}_2$ ), 2.05(3H, s,  $\text{CH}_3\text{CO}_2$ ), 2.40(2H, app t,  $J = 7.4\text{Hz}$ ,  $\text{CH}(\text{OAc})\text{-CH}^\alpha\text{H}^\beta\text{-CH}_2$ ), 2.40(2H, t,  $J = 7.6\text{Hz}$ ,  $\text{CH}^\alpha\text{H}^\beta\text{-CH}_2\text{COCH}_2$ ) and 4.79(1H, dtd,  $J = 8.5, 6.3$  and  $4.0\text{Hz}$ ,  $\text{CH}_2\text{CH}(\text{OAc})\text{-CH}^\alpha\text{H}^\beta$ ),  $\delta_{\text{C}}(100)$  210.62(C=O), 171.24(C=O), 75.12(CH), 42.89( $\text{CH}_2$ ), 38.82( $\text{CH}_2$ ), 27.78( $\text{CH}_2$ ), 27.46( $\text{CH}_2$ ), 26.21( $\text{CH}_2$ ), 22.62( $\text{CH}_2$ ), 21.45( $\text{CH}_3$ ), 14.13( $\text{CH}_3$ ) and 9.85( $\text{CH}_3$ ),  $m/z$  171(24%,  $\text{C}_{10}\text{H}_{19}\text{O}_2$ ,  $\text{M-CH}_3\text{CO}$ ), 153(19,  $\text{C}_{10}\text{H}_{17}\text{O}$ ,  $\text{M-CH}_3\text{CO}$  and  $\text{H}_2\text{O}$ ), 125(33,  $\text{C}_8\text{H}_{13}\text{O}$ ,  $\text{M-C}_4\text{H}_9\text{O}_2$ ) and 115(100,  $\text{C}_6\text{H}_{11}\text{O}_2$ ,  $\text{M-C}_6\text{H}_{11}\text{O}$ ). [Found : C, 67.29 ; H, 10.28.  $\text{C}_{12}\text{H}_{22}\text{O}_3$  requires : C, 67.48 ; H, 10.69%].

A second column was then run to separate the isolated *iodo-diol* mixture [(**221**) and (**222**) in a 3:1 ratio by NMR] using ethyl acetate as eluant. The major, less polar *iodo-diol* isomer (**221**) showed,  $\nu_{\text{max}}$  (film) 3735 and 3392  $\text{cm}^{-1}$ ,  $\delta_{\text{H}}(400)$  0.92(3H, t,  $J = 7.2\text{Hz}$ ,  $\text{CH}_3\text{CH}_2\text{CH}_2$ ), 0.97(3H, t,  $J = 7.5\text{Hz}$ ,  $\text{CH}_3\text{CH}_2$ ), 1.25-1.44(4H, m,  $\text{CH}_3\text{CH}_2\text{CH}_2$ ), 1.46-1.64(4H, m,  $\text{CH}_3\text{CH}_2\text{CH}_2\text{CH}_2\text{-CH}^{6\alpha}\text{OH}$  and  $\text{HOCH}^{3\beta}\text{-CH}_2\text{CH}_3$ ), 1.72(1H, ddd,  $J = 15.1, 10.0$  and  $3.7\text{Hz}$ ,  $\text{CH}^{5\alpha}$ ).

CH<sup>4α</sup>H<sup>4β</sup>-CH<sup>3β</sup>), 2.22(1H, ddd, J = 15.1, 11.0 and 2.0Hz, CH<sup>5α</sup>-CH<sup>4α</sup>H<sup>4β</sup>-CH<sup>3β</sup>), 2.87(1H, ddd, J = 7.2, 5.4 and 2.6Hz, CH<sub>2</sub>-CH<sup>6α</sup>-CH<sup>5α</sup>), 3.79(1H, app ddt, J = 9.8, 6.3 and 1.9Hz, CH<sup>4α</sup>H<sup>4β</sup>-CH<sup>3β</sup>-CH<sub>2</sub>) and 4.49(1H, ddd, J = 10.9, 3.6 and 2.7Hz, CH<sup>6α</sup>-CH<sup>5α</sup>-CH<sup>4α</sup>H<sup>4β</sup>), δ<sub>C</sub>(100) 75.14(CH), 73.29(CH), 47.02(CH), 44.71(CH<sub>2</sub>), 38.13(CH<sub>2</sub>), 30.93(CH<sub>2</sub>), 28.01(CH<sub>2</sub>), 22.86(CH<sub>2</sub>), 14.31(CH<sub>3</sub>) and 10.16(CH<sub>3</sub>), m/z 225(2%, C<sub>6</sub>H<sub>10</sub>OI, M-H<sub>2</sub>O and C<sub>4</sub>H<sub>9</sub>), 196(2, C<sub>4</sub>H<sub>5</sub>OI, M-H<sub>2</sub>O and C<sub>6</sub>H<sub>14</sub>), 155(19, C<sub>10</sub>H<sub>19</sub>O, M-H<sub>2</sub>O and I), 128(22, C<sub>8</sub>H<sub>16</sub>O, M-C<sub>2</sub>H<sub>6</sub>OI) and 85(100, C<sub>5</sub>H<sub>9</sub>O).

The minor, more polar *iodo-diol* isomer (**222**) showed, ν<sub>max</sub> (film) 3735 and 3392 cm<sup>-1</sup>, δ<sub>H</sub>(400) 0.92(3H, t, J = 7.3Hz, CH<sub>3</sub>CH<sub>2</sub>CH<sub>2</sub>), 0.97(3H, t, J = 7.5Hz, CH<sub>3</sub>CH<sub>2</sub>), 1.25-1.45(4H, m, CH<sub>3</sub>CH<sub>2</sub>CH<sub>2</sub>), 1.47-1.63(4H, m, CH<sub>2</sub>-CH<sup>6α</sup>(I) and HOCH<sup>3β</sup>-CH<sub>2</sub>CH<sub>3</sub>), 1.81(1H, ddd, J = 14.3, 12.4 and 2.9Hz, either H<sup>5β</sup>(OH)-CH<sup>4α</sup> or H<sup>4β</sup>-CH<sup>3β</sup>(OH)), 1.91-2.10(2H, m, 2x (OH)), 2.28-2.41(1H, m, CH<sup>5β</sup>(OH)-CH<sup>4α</sup> or H<sup>4β</sup>-CH<sup>3β</sup>(OH)), 3.42(1H, dt, J = 9.5 and 3.0Hz, CH<sup>6α</sup>(I)-CH<sup>5β</sup>(OH)-CH<sup>4α</sup>H<sup>4β</sup>), 3.84(1H, app ddt, J = 12.7, 6.5 and 2.6Hz, CH<sup>4α</sup>H<sup>4β</sup>-CH<sup>3β</sup>(OH)-CH<sub>2</sub>) and 4.19(1H, dt, J = 9.5 and 4.2Hz, CH<sub>2</sub>-CH<sup>6α</sup>(I)-CH<sup>5β</sup>(OH)), δ<sub>C</sub>(100) 71.64(CH), 70.61(CH), 50.30(CH), 43.37(CH<sub>2</sub>), 37.20(CH<sub>2</sub>), 32.19(CH<sub>2</sub>), 30.64(CH<sub>2</sub>), 22.23(CH<sub>2</sub>), 14.50(CH<sub>3</sub>) and 9.96(CH<sub>3</sub>).

**(3S\*, 5S\*, 6R\*)-6-Iododecan-3, 5-bisbenzoate and (3S\*, 5S\*, 6S\*)-5-Iododecan-3, 6-bisbenzoate. (223 and 224)**

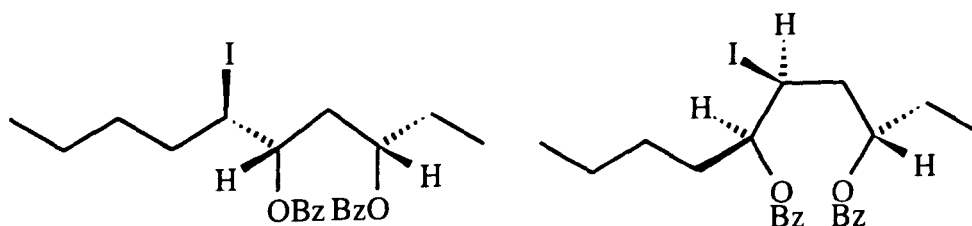

A solution of the iodo-diols [(**221** and **222**) in a 3:1 ratio by NMR], (0.17 g, 0.57 mmol) and benzoic acid (0.14 g, 1.15 mmol) in dry ether (5 ml) was slowly added to a stirred solution of D.C.C. (0.26 g, 1.25 mmol) and DMAP (1 xtal) under an atmosphere of nitrogen. When complete the mixture was left stirring at

ambient temperature for 8 hr. The mixture was then diluted with more ether (25 ml) and washed with dilute sodium (2M) carbonate solution, then the organics were dried and reduced. Column chromatography of the residue over silica G using (60:40) hexane/ethyl acetate as eluant gave the *bisbenzoates* [(**223** and **224**) in a 4:1 ratio by NMR], (0.16 g, 55%) as a pale yellow oil,  $\nu_{\max}$  (film) 1718, 1654 and 1268  $\text{cm}^{-1}$ , the major *iodo-bisbenzoate* isomer (**223**) showed NMR data,  $\delta_{\text{H}}$ (400) 0.87(3H, t,  $J = 7.1\text{Hz}$ ,  $\text{CH}_3\text{CH}_2\text{CH}_2$ ), 0.92(3H, t,  $J = 7.5\text{Hz}$ ,  $\text{CH}_3\text{CH}_2$ ), 1.23-1.39(4H, m,  $\text{CH}_3\text{CH}_2\text{CH}_2$ ), 1.66-1.92(4H, m,  $\text{CH}_2\text{-CH}^{6\alpha(\text{l})}$ ) and  $\text{PhCO}_2\text{CH}^{3\beta}\text{-CH}_2\text{CH}_3$ ), 2.21(2H, app dt,  $J = 15.3$  and  $7.7\text{Hz}$ ,  $\text{CH}^{5\beta}(\text{OCOPh})\text{-CH}^{4\alpha}\text{H}^{4\beta}\text{-CH}^{3\beta}(\text{OCOPh})$ ), 4.33(1H, ddt,  $J = 8.4$ ,  $4.8$  and  $2.8\text{Hz}$ ,  $\text{CH}^{6\alpha(\text{l})}\text{-CH}^{5\beta}(\text{OCOPh})\text{-CH}^{4\alpha}\text{H}^{4\beta}$ ), 4.77(1H, app ddd,  $J = 8.0$ ,  $4.9$  and  $2.8\text{Hz}$ ,  $\text{CH}^{4\alpha}\text{H}^{4\beta}\text{-CH}^{3\beta}(\text{OCOPh})\text{-CH}_2$ ), 5.33(1H, tdd,  $J = 8.3$ ,  $6.0$  and  $3.6\text{Hz}$ ,  $\text{CH}_2\text{-CH}^{6\alpha(\text{l})}\text{-CH}^{5\beta}(\text{OCOPh})$ ), 7.39(2H, t,  $J = 7.5\text{Hz}$ ,  $m\text{-CH}=\text{CH}$ ), 7.49(2H, t,  $J = 7.5\text{Hz}$ ,  $m\text{-CH}=\text{CH}$ ), 7.55(1H, tt,  $J = 7.5$  and  $1.3\text{Hz}$ ,  $p\text{-CH-CH}=\text{CH}$ ), 7.61(1H, tt,  $J = 7.5$  and  $1.3\text{Hz}$ ,  $p\text{-CH-CH}=\text{CH}$ ), 7.98(1H, dd,  $J = 8.5$  and  $1.2\text{Hz}$ ,  $o\text{-CH}=\text{CH}$ ) and 8.11(1H, dd,  $J = 8.5$  and  $1.2\text{Hz}$ ,  $o\text{-CH}=\text{CH}$ ),  $\delta_{\text{C}}$ (100) 166.78(C=O), 166.53(C=O), 134.02(CH), 133.68(CH), 130.59(2x CH), 130.30(2x CH), 129.25(2x CH), 129.10(2x CH), 77.34(CH), 76.03(CH), 42.26( $\text{CH}_2$ ), 35.06(CH), 34.68( $\text{CH}_2$ ), 28.15(2x  $\text{CH}_2$ ), 23.09( $\text{CH}_2$ ), 14.63( $\text{CH}_3$ ) and 10.13( $\text{CH}_3$ ) and the minor *iodo-bisbenzoate* (**224**) showed NMR data  $\delta_{\text{H}}$ (400) 0.92(3H, t,  $J = 7.2\text{Hz}$ ,  $\text{CH}_3\text{CH}_2\text{CH}_2$ ), 0.97(3H, t,  $J = 7.5\text{Hz}$ ,  $\text{CH}_3\text{CH}_2$ ), 1.25-1.44(4H, m,  $\text{CH}_3\text{CH}_2\text{CH}_2$ ), 1.46-1.64(4H, m,  $\text{CH}_3\text{CH}_2\text{CH}_2\text{CH}_2\text{-CH}^{6\alpha}\text{OH}$  and  $\text{HOCH}^{3\beta}\text{-CH}_2\text{CH}_3$ ), 2.01-2.28(2H, app ddd,  $J = 12.1$ ,  $8.0$  and  $4.2\text{Hz}$ ,  $\text{CH}^{5\alpha}\text{-CH}^{4\alpha}\text{H}^{4\beta}\text{-CH}^3$ ), 4.27(1H, ddd,  $J = 10.0$ ,  $4.5$  and  $2.8\text{Hz}$ ,  $\text{CH}^{4\alpha}\text{H}^{4\beta}\text{-CH}^{3\beta}\text{-CH}_2$ ), 5.06(1H, ddd,  $J = 7.5$ ,  $4.5$  and  $2.7\text{Hz}$ ,  $\text{CH}_2\text{-CH}^{6\alpha}\text{-CH}^{5\alpha}$ ), 5.17(1H, app q,  $J = 2.7\text{Hz}$ ,  $\text{CH}^{6\alpha}\text{-CH}^{5\alpha}\text{-CH}^{4\alpha}\text{H}^{4\beta}$ ), 7.40(2H, t,  $J = 7.5\text{Hz}$ ,  $m\text{-CH}=\text{CH}$ ), 7.50(2H, t,  $J = 7.5\text{Hz}$ ,  $m\text{-CH}=\text{CH}$ ), 7.59(1H, tt,  $J = 7.5$  and  $1.3\text{Hz}$ ,  $p\text{-CH-CH}=\text{CH}$ ), 7.68(1H, tt,  $J = 7.5$  and  $1.3\text{Hz}$ ,  $p\text{-CH-CH}=\text{CH}$ ) and 8.01(1H, dd,  $J = 8.5$  and  $1.2\text{Hz}$ ,  $o\text{-CH}=\text{CH}$ ), 8.19(1H, dd,  $J = 8.5$  and  $1.2\text{Hz}$ ,  $o\text{-CH}=\text{CH}$ ),  $\delta_{\text{C}}$ (100) 166.85(CH), 166.45(CH), 133.43(CH), 133.07(CH), 130.48(CH), 130.14(CH), 128.66(CH),

128.52(CH), 73.20(CH), 72.83(CH), 39.92(CH), 38.05(CH<sub>2</sub>), 36.37(CH<sub>2</sub>), 32.09(CH<sub>2</sub>), 27.70(CH<sub>2</sub>), 22.03(CH<sub>2</sub>), 14.18(CH<sub>3</sub>) and 9.50(CH<sub>3</sub>), m/z 381(18%, C<sub>24</sub>H<sub>29</sub>O<sub>4</sub>, M-I), 259(17, C<sub>17</sub>H<sub>23</sub>O<sub>2</sub>, M-PhCO<sub>2</sub> + HI), 155(27, C<sub>10</sub>H<sub>19</sub>O, M-(PhCO)<sub>2</sub>O and I), 138(6, C<sub>10</sub>H<sub>18</sub>, M-2x PhCO<sub>2</sub> + HI), 105(100, C<sub>7</sub>H<sub>5</sub>O) and 77(39, C<sub>6</sub>H<sub>5</sub>).

**(2S\*, 4R\*, 5S\*)-5-Butyl-2-ethyl-4-iodotetrahydrofuran. (225)**

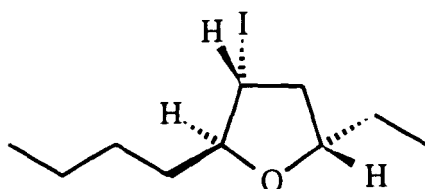

In an identical manner to that described for the anhydrous preparation of the iodotetrahydrofurans (**197** and **198**), *E*-(±)-dec-5-en-3-ol (**138**) (0.10 g, 0.64 mmol) was converted into a single tetrahydrofuran product. Column chromatography of this over silica G using hexane/ethyl acetate (90:10) gave the *iodotetrahydrofuran* (**225**) as a colourless oil showing,  $\nu_{\max}$  (film) 1686, 1534 and 1415 cm<sup>-1</sup>,  $\delta_{\text{H}}$ (400) 0.92(6H, app t, J = 7.5Hz, CH<sub>3</sub>CH<sub>2</sub>CH<sub>2</sub> and CH<sub>3</sub>CH<sub>2</sub>), 1.22-1.46(5H, m, CH<sub>3</sub>CH<sub>2</sub>CH<sub>2</sub>CH <sup>$\alpha$</sup> H <sup>$\beta$</sup> -CH<sup>5 $\alpha$</sup> ), 1.51(1H, dq, J = 14.2 and 7.5Hz, CH<sub>3</sub>CH <sup>$\alpha$</sup> H <sup>$\beta$</sup> -CH<sup>2 $\beta$</sup> ), 1.69(1H, dq, J = 14.2 and 7.5Hz, CH<sub>3</sub>CH <sup>$\alpha$</sup> H <sup>$\beta$</sup> -CH<sup>2 $\beta$</sup> ), 1.75-1.85(1H, m, CH<sub>3</sub>CH<sub>2</sub>CH<sub>2</sub>CH <sup>$\alpha$</sup> H <sup>$\beta$</sup> -CH<sup>5 $\alpha$</sup> ), 1.99(1H, ddd, J = 12.8, 10.3 and 8.5Hz, CH<sup>4 $\beta$</sup> -CH<sup>3 $\alpha$</sup> H<sup>3 $\beta$</sup> -CH<sup>2 $\beta$</sup> ), 2.65(1H, ddd, J = 12.8, 6.2 and 7.3Hz, CH<sup>4 $\beta$</sup> -CH<sup>3 $\alpha$</sup> H<sup>3 $\beta$</sup> -CH<sup>2 $\beta$</sup> ), 3.75(1H, ddd, J = 10.3, 8.7 and 7.3Hz, CH<sup>5 $\alpha$</sup> -CH<sup>4 $\beta$</sup> -CH<sup>3 $\alpha$</sup> H<sup>3 $\beta$</sup> ), 3.89(1H, app dq, J = 8.5 and 6.4Hz, CH<sup>3 $\alpha$</sup> H<sup>3 $\beta$</sup> -CH<sup>2 $\beta$</sup> -CH <sup>$\alpha$</sup> H <sup>$\beta$</sup> ) and 3.97(1H, ddd, J = 8.7, 7.6 and 3.3Hz, CH <sup>$\alpha$</sup> H <sup>$\beta$</sup> -CH<sup>5 $\alpha$</sup> -CH<sup>4 $\beta$</sup> ),  $\delta_{\text{C}}$ (100) 86.50(CH), 79.93(CH), 44.78(CH<sub>2</sub>), 32.38(CH<sub>2</sub>), 29.22(CH<sub>2</sub>), 28.48(CH<sub>2</sub>), 23.35(CH), 23.05(CH<sub>2</sub>), 14.28(CH<sub>3</sub>) and 10.23(CH<sub>3</sub>), m/z 267(1%, C<sub>9</sub>H<sub>16</sub>OI, M-CH<sub>3</sub>), 253(1, C<sub>8</sub>H<sub>14</sub>OI, M-C<sub>2</sub>H<sub>5</sub>), 239(2, C<sub>7</sub>H<sub>12</sub>OI, M-C<sub>3</sub>H<sub>7</sub>), 225(2, C<sub>6</sub>H<sub>10</sub>OI, M-C<sub>4</sub>H<sub>9</sub>), 196(1, C<sub>4</sub>H<sub>5</sub>OI, M-C<sub>6</sub>H<sub>14</sub>), 155(4, C<sub>10</sub>H<sub>19</sub>O, M-I), 140(3, C<sub>9</sub>H<sub>16</sub>O, M-I and CH<sub>3</sub>) and 125(100, C<sub>8</sub>H<sub>13</sub>O, M-C<sub>2</sub>H<sub>6</sub>I).

**(4R\*, 5S\*)-5-(Hydroxy-2'-ethyl)-4-iodotetrahydrofuran. (228)**

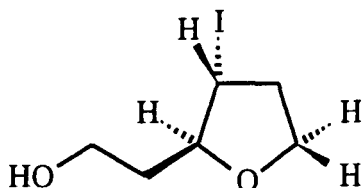

In an identical manner to that described for the anhydrous preparation of the iodotetrahydrofurans (**197 and 198**), *E*-hex-2-en-1, 6-diol (**227**) (1.04 g, 9.0 mmol) was converted into a single tetrahydrofuran product. Column chromatography of this over silica G using hexane/ethyl acetate (70:30) gave the *iodotetrahydrofuran* (**228**) (1.89 g, 87%) as a colourless oil showing,  $\nu_{\max}$  (film) 3429, 1641 and 1464  $\text{cm}^{-1}$ ,  $\delta_{\text{H}}$ (250) 1.67(1H, ddt,  $J = 14.7, 9.0$  and 6.0Hz,  $\text{CH}^{4\beta}\text{-CH}^{3\alpha}\text{H}^{3\beta}\text{-CH}^{2\alpha}\text{H}^{2\beta}$ ), 2.11(1H, ddt,  $J = 14.7, 8.2$  and 5.1Hz,  $\text{CH}^{4\beta}\text{-CH}^{3\alpha}\text{H}^{3\beta}\text{-CH}^{2\alpha}\text{H}^{2\beta}$ ), 2.22(1H, br s,  $\text{HOCH}^{\alpha}\text{H}^{\beta}$ ), 2.31(1H, ddt,  $J = 13.5, 7.6$  and 6.0Hz,  $\text{HOCH}_2\text{CH}^{\alpha}\text{H}^{\beta}$ ), 2.55(1H, ddt,  $J = 13.5, 7.6$  and 6.3Hz,  $\text{HOCH}_2\text{CH}^{\alpha}\text{H}^{\beta}$ ), 3.75-3.87(3H, m,  $\text{CH}^{5\alpha}\text{-CH}^{4\beta}\text{-CH}^{3\alpha}\text{H}^{3\beta}$  and  $\text{HOCH}_2\text{CH}^{\alpha}\text{H}^{\beta}$ ), 3.88-4.01(2H, m,  $\text{CH}^{3\alpha}\text{H}^{3\beta}\text{-CH}^{2\alpha}\text{CH}^{2\beta}$ ) and 4.15(1H, ddd,  $J = 9.1, 7.8$  and 3.1Hz,  $\text{CH}^{\alpha}\text{H}^{\beta}\text{-CH}^{5\alpha}\text{-CH}^{4\beta}$ ),  $\delta_{\text{C}}$ (63) 87.46(CH), 67.33( $\text{CH}_2$ ), 60.71( $\text{CH}_2$ ), 38.12( $\text{CH}_2$ ), 34.71( $\text{CH}_2$ ) and 23.14(CH-I),  $m/z$  242(100%,  $\text{M}^+$ ), 155(42,  $\text{C}_6\text{H}_{11}\text{O}_2$ , M-I), 211(8,  $\text{C}_5\text{H}_8\text{IO}$ , M- $\text{CH}_3\text{O}$ ), 197(15,  $\text{C}_4\text{H}_6\text{IO}$ , M- $\text{C}_2\text{H}_5\text{O}$ ), 70(60,  $\text{C}_4\text{H}_6\text{O}$ , M- $\text{C}_2\text{H}_5\text{IO}$ ), and 46(41,  $\text{C}_2\text{H}_6\text{O}$ , M- $\text{C}_4\text{H}_5\text{IO}$ ).

**(4R\*, 5S\*)-5-(Triisopropylsilyloxy-2'-ethyl)-4-iodotetrahydrofuran. (229)**

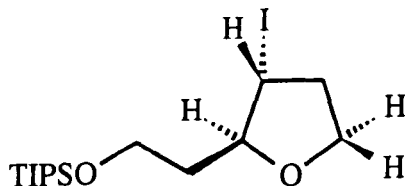

Imidazole (5.83 g, 86 mmol) was added to a stirred solution of

triisopropylsilyl chloride (1.75 g, 9.2 mmol) and *iodotetrahydrofuran* (**228**) (1.89 g, 7.8 mmol) in dry dimethylformamide (10 ml) at 0°C under an atmosphere of argon. The resulting solution was stirred at ambient temperature for 48 hr, then diluted with pentane (20 ml) and washed with water (3x 20 ml). The organic phase was separated, dried, filtered and concentrated. Column chromatography of the residue over silica G using hexane/ethyl acetate (90:10) as eluant gave the desired *iodotetrahydrofuran* (**229**)<sup>286</sup> (2.33 g, 75%) as a golden oil,  $\nu_{\max}$  (film) 2941, 1464 and 1385  $\text{cm}^{-1}$ ,  $\delta_{\text{H}}$ (250) 1.09(21H, br s,  $^i\text{Pr}_3$ ), 1.62(1H, dtd,  $J = 13.6, 8.1$  and  $5.5\text{Hz}$ ,  $\text{CH}^{4\beta}\text{-CH}^{3\alpha}\text{H}^{3\beta}\text{-CH}^{2\alpha}\text{H}^{2\beta}$ ), 1.95(1H, dddd,  $J = 13.6, 10.1, 7.6$  and  $3.9\text{Hz}$ ,  $\text{CH}^{4\beta}\text{-CH}^{3\alpha}\text{H}^{3\beta}\text{-CH}^{2\alpha}\text{H}^{2\beta}$ ), 2.24(1H, dt,  $J = 13.7$  and  $7.4\text{Hz}$ ,  $\text{SiOCH}_2\text{CH}^{\alpha}\text{H}^{\beta}$ ), 2.48(1H, dt,  $J = 13.7$  and  $7.4\text{Hz}$ ,  $\text{SiOCH}_2\text{CH}^{\alpha}\text{H}^{\beta}$ ), 3.72-3.95(5H, m,  $\text{CH}^{5\alpha}\text{-CH}^{4\beta}\text{-CH}^{3\alpha}\text{H}^{3\beta}\text{-CH}^{2\alpha}\text{CH}^{2\beta}$  and  $\text{SiOCH}_2\text{CH}^{\alpha}\text{H}^{\beta}$ ) and 4.15(1H, td,  $J = 7.4$  and  $3.9\text{Hz}$ ,  $\text{CH}^{\alpha}\text{H}^{\beta}\text{-CH}^{5\alpha}\text{-CH}^{4\beta}$ ),  $\delta_{\text{C}}$ (63) 85.65(CH), 67.04( $\text{CH}_2$ ), 60.37( $\text{CH}_2$ ), 38.52( $\text{CH}_2$ ), 36.36( $\text{CH}_2$ ), 24.21(CH-I), 18.28(6x  $\text{CH}_2$ ) and 12.19(3x CH),  $m/z$  398(100%,  $\text{M}^+$ ), 355(35,  $\text{C}_{12}\text{H}_{24}\text{SiO}_2\text{l}$ , M- $\text{C}_3\text{H}_7$ ), 325(14,  $\text{C}_{10}\text{H}_{19}\text{O}$ , M- $\text{C}_5\text{H}_{13}$ ), 271(40,  $\text{C}_{15}\text{H}_{31}\text{SiO}_2$ , M-I), 225(52,  $\text{C}_6\text{H}_{10}\text{Ol}$ , M- $\text{C}_9\text{H}_{21}\text{SiO}$ ), 98(28,  $\text{C}_6\text{H}_{10}\text{O}$ , M- $\text{C}_9\text{H}_{21}\text{SiOl}$ ), and 84(23,  $\text{C}_5\text{H}_8\text{O}$ , M- $\text{C}_9\text{H}_{21}\text{SiOl}$ ).

### Methyl (2R\*, 4S\*, 5S\*)-5-ethyl-4-azidotetrahydrofuranyl-2-acetate. (**240**)

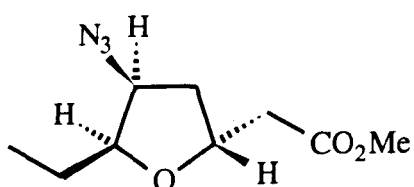

A stirred solution of the iodotetrahydrofuran (**197**) (0.10 g, 0.34 mmol) in dry dimethyl formamide (5 ml) and reactivated sodium azide (0.05 g, 0.64 mmol) and 15-crown-5-ether (1-2 drops) was heated, under an atmosphere of argon, 40°C for 8 hr. The solution was allowed to cool to ambient temperature and then poured into a mixture of water/pentane (50:50) (20 ml). The organics were washed with more pentane (3x 10 ml), dried, filtered and evaporated. Column chromatography of the residue over silica G using hexane/ethyl acetate (90:10)



gave, in order, the dihydrofuran (**241**), un-reacted iodotetrahydrofuran (**197**) and the azide (**240**)<sup>335</sup> (0.04 g, 52%) as a pale yellow oil,  $\nu_{\max}$  (film) 2105, 1741 and 1262  $\text{cm}^{-1}$ ,  $\delta_{\text{H}}(400)$  0.96(3H, t,  $J = 7.4\text{Hz}$ ,  $\text{CH}_3\text{CH}_2$ ), 1.66(2H, app qd,  $J = 7.4$  and 6.9Hz,  $\text{CH}_3\text{CH}_2\text{-CH}^{5\alpha}$ ), 2.01(1H, ddd,  $J = 14.0, 8.8$  and 5.5Hz,  $\text{CH}^{4\alpha}\text{-CH}^{3\alpha}\text{H}^{3\beta}\text{-CH}^{2\beta}$ ), 2.32(1H, ddd,  $J = 13.7, 7.6$  and 6.5Hz,  $\text{CH}^{4\alpha}\text{-CH}^{3\alpha}\text{H}^{3\beta}\text{-CH}^{2\beta}$ ), 2.50(1H, dd,  $J = 15.4$  and 6.5Hz,  $\text{CH}^{2\beta}\text{-CH}^{\alpha}\text{H}^{\beta}\text{-CO}_2\text{CH}_3$ ), 2.66(1H, dd,  $J = 15.3$  and 6.6Hz,  $\text{CH}^{2\beta}\text{-CH}^{\alpha}\text{H}^{\beta}\text{-CO}_2\text{CH}_3$ ), 3.70(3H, s,  $\text{CO}_2\text{CH}_3$ ), 3.84(1H, td,  $J = 6.9$  and 3.5Hz,  $\text{CH}_2\text{-CH}^{5\alpha}\text{-CH}^{4\alpha}$ ), 3.99(1H, app t,  $J = 4.4\text{Hz}$ ,  $\text{CH}^{5\alpha}\text{-CH}^{4\alpha}\text{-CH}^{3\alpha}\text{H}^{3\beta}$ ) and 4.56(1H, ddd,  $J = 8.8, 6.6$  and 6.5Hz,  $\text{CH}^{3\alpha}\text{H}^{3\beta}\text{-CH}^{2\beta}\text{-CH}^{\alpha}\text{H}^{\beta}$ ),  $\delta_{\text{C}}(100)$  171.43(C=O), 83.24(CH), 73.58(CH), 63.83(CH), 52.02( $\text{CH}_3$ ), 40.82( $\text{CH}_2$ ), 38.32( $\text{CH}_2$ ), 23.21( $\text{CH}_2$ ) and 10.68( $\text{CH}_3$ ),  $m/z$  185(7%,  $\text{C}_7\text{H}_{11}\text{N}_3\text{O}_3$ , M- $\text{C}_2\text{H}_4$ ), 170(3,  $\text{C}_9\text{H}_{14}\text{O}_3$ , M- $\text{HN}_3$ ), 157(8,  $\text{C}_8\text{H}_{13}\text{O}_3$ , M- $\text{CH}_2\text{N}_3$ ), 84(19, M- $\text{C}_5\text{H}_8\text{N}_3\text{O}_2$ ) and 59(100,  $\text{C}_3\text{H}_7\text{O}$ ).

#### Methyl (2S\*, 5S\*)-5-ethyl-dihydrofuranyl-2-acetate. (**241**)

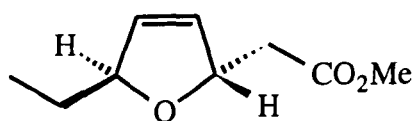

A stirred solution of the iodotetrahydrofuran (**197**) (0.20 g, 0.67 mmol) in dry dimethyl formamide (10 ml) and reactivated sodium azide (0.09 g, 1.35 mmol) and 15-crown-5-ether (2-3 drops) was heated, under an atmosphere of argon, 70°C for 24 hr. The solution was allowed to cool to ambient temperature and then poured into a mixture of water/pentane (50:50) (30 ml). The organics were washed with more pentane (3x 10 ml), dried, filtered and reduced. Column chromatography of the residue over silica G using hexane/ethyl acetate (90:10) gave the dihydrofuran (**241**) (0.09 g, 79%) as a colourless oil,  $\nu_{\max}$  (film) 1726 and 1675  $\text{cm}^{-1}$ ,  $\delta_{\text{H}}(400)$  0.90(3H, t,  $J = 7.4\text{Hz}$ ,  $\text{CH}_3\text{CH}_2$ ), 1.59(2H, app qd,  $J = 7.4$  and 5.8Hz,  $\text{CH}_3\text{CH}_2\text{-CH}^{5\alpha}$ ), 2.50(1H, dd,  $J = 15.2$  and 6.0Hz,  $\text{CH}^{2\beta}\text{-CH}^{\alpha}\text{H}^{\beta}\text{-CO}_2\text{CH}_3$ ), 2.62(1H, dd,  $J = 15.2$  and 7.0Hz,  $\text{CH}^{2\beta}\text{-CH}^{\alpha}\text{H}^{\beta}\text{-CO}_2\text{CH}_3$ ), 3.70(3H, s,  $\text{CO}_2\text{CH}_3$ ), 4.85(1H, app td,  $J = 5.8$  and 1.2Hz,  $\text{CH}^{\alpha}\text{H}^{\beta}\text{-CH}^{5\alpha}\text{-CH}^4=\text{CH}^3$ ),

5.20(1H, app ddt,  $J = 7.0, 6.0$  and  $1.2\text{Hz}$ ,  $\text{CH}^4=\text{CH}^3-\text{CH}^{2\beta}-\text{CH}^{\alpha\text{H}\beta}$ ) and 5.86(2H, dd,  $J = 1.8$  and  $1.2\text{Hz}$ ,  $\text{CH}^{5\alpha}-\text{CH}^4=\text{CH}^3-\text{CH}^{2\beta}$ ),  $\delta_{\text{C}}(100)$  171.81(C=O), 130.92(CH), 129.35(CH), 87.20(CH), 82.29(CH), 52.00(CH<sub>3</sub>), 41.40(CH<sub>2</sub>), 28.86(CH<sub>2</sub>) and 9.31(CH<sub>3</sub>),  $m/z$  170(8%, M<sup>+</sup>), 155(3, C<sub>8</sub>H<sub>11</sub>O<sub>3</sub>, M-CH<sub>3</sub>), 141(27, C<sub>7</sub>H<sub>9</sub>O<sub>3</sub>, M-CH<sub>2</sub>CH<sub>3</sub>), 139(10, C<sub>8</sub>H<sub>11</sub>O<sub>2</sub>, M-OCH<sub>3</sub>), 111(9, C<sub>7</sub>H<sub>11</sub>O, M-CO<sub>2</sub>CH<sub>3</sub>), 110(17, C<sub>6</sub>H<sub>6</sub>O<sub>2</sub>, M-CH<sub>3</sub>CH<sub>2</sub> and OCH<sub>3</sub>), 97(100, C<sub>6</sub>H<sub>6</sub>O, M-CH<sub>2</sub>CO<sub>2</sub>CH<sub>3</sub>), 82(16, C<sub>5</sub>H<sub>6</sub>O, M-C<sub>4</sub>H<sub>8</sub>O<sub>2</sub>) and 68(7, C<sub>4</sub>H<sub>4</sub>O, M-C<sub>5</sub>H<sub>10</sub>O<sub>2</sub>).

### Methyl 5-ethyl-furanyl-2-acetate. (242)

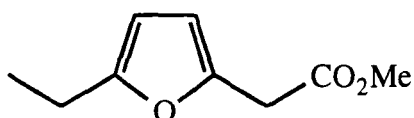

This is the decomposition product that is formed when the dihydrofuran (241) is left in deuterated chloroform for approximately 24 hr at ambient temperature,  $\nu_{\text{max}}$  (film) 1735, 1555 and  $1480\text{ cm}^{-1}$ ,  $\delta_{\text{H}}(400)$  1.21(3H, t,  $J = 7.5\text{Hz}$ , CH<sub>3</sub>CH<sub>2</sub>), 2.62(2H, app q,  $J = 7.5\text{Hz}$ , CH<sub>3</sub>CH<sub>2</sub>-C=CH<sup>4</sup>), 3.64(2H, s, CH<sup>3</sup>=C-CH<sub>2</sub>-CO<sub>2</sub>CH<sub>3</sub>), 3.72(3H, s, CO<sub>2</sub>CH<sub>3</sub>), 5.91(1H, dt,  $J = 3.1$  and  $1.1\text{Hz}$ , CH<sub>2</sub>-C=CH<sup>4</sup>-CH<sup>3</sup>) and 6.10(1H, app d,  $J = 3.1\text{Hz}$ , CH<sup>4</sup>-CH<sup>3</sup>=C-CH<sub>2</sub>),  $\delta_{\text{C}}(100)$  170.50(C=O), 157.86(C), 145.82(C), 108.78(CH), 105.03(CH), 52.51(CH<sub>3</sub>), 34.30(CH<sub>2</sub>), 21.61(CH<sub>2</sub>) and 12.34(CH<sub>3</sub>),  $m/z$  168(5%, M<sup>+</sup>), 153(5, C<sub>8</sub>H<sub>9</sub>O<sub>3</sub>, M-CH<sub>3</sub>), 139(100, C<sub>7</sub>H<sub>7</sub>O<sub>3</sub>, M-CH<sub>2</sub>CH<sub>3</sub>) and 124(4, C<sub>6</sub>H<sub>4</sub>O<sub>3</sub>, M-C<sub>3</sub>H<sub>8</sub>).

### (5S<sup>\*</sup>)-5-(Triisopropylsilyloxy-2'-ethyl)-dihydrofuran and (4S<sup>\*</sup>, 5S<sup>\*</sup>)-5-(triisopropylsilyloxy-2'-ethyl)-4-hydroxytetrahydrofuran. (243a) and (243b)

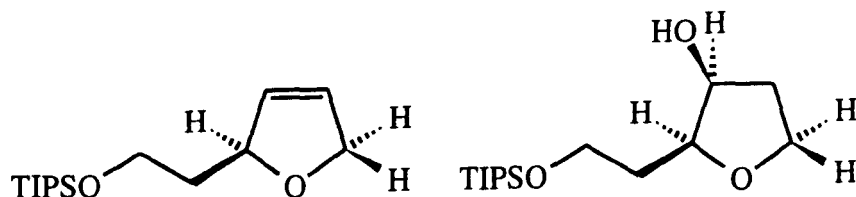

A stirred solution of the iodotetrahydrofuran (**229**) (2.2 g, 5.53 mmol) in dry dimethyl formamide (10 ml) and reactivated potassium superoxide (0.05 g, 0.64 mmol) and 18-crown-6-ether (1-2 drops) was stirred at ambient temperature, under an atmosphere of argon for 10 hr. The solution was then poured into a mixture of water/pentane (50:50) (30 ml). The organics were washed with more pentane (3x 10 ml), dried, filtered and evaporated. Column chromatography of the residue over silica G using hexane/ethyl acetate (70:30) gave in order, the *dihydrofuran* (**243a**) (0.21 g, 15%) as a colourless oil and the *hydroxytetrahydrofuran* (**243b**)<sup>342</sup> (1.2 g, 74%) as an amber oil. The *dihydrofuran* (**243a**) showed,  $\nu_{\max}$  (film) 2941, 1738, 1464 and 1385  $\text{cm}^{-1}$ ,  $\delta_{\text{H}}$ (250) 1.09(21H, br s,  $i\text{Pr}_3$ ), 1.70(2H, td,  $J = 7.2$  and 6.8 Hz,  $\text{SiOCH}_2\text{CH}_2$ ), 3.81(2H, t,  $J = 7.2$  Hz,  $\text{SiOCH}_2\text{CH}_2$ ), 4.60(2H, app t,  $J = 7.1$  Hz,  $\text{CH}^3\text{-CH}^{2\alpha}\text{H}^{2\beta}$ ), 4.89(1H, app p,  $J = 6.0$  Hz,  $\text{CH}_2\text{-CH}^{5\alpha}\text{-CH}^4$ ) and 5.83(1H, br s,  $\text{CH}^{5\alpha}\text{-CH}^4\text{-CH}^3\text{-CH}^{2\alpha}\text{H}^{2\beta}$ ),  $\delta_{\text{C}}$ (63) 130.51(CH), 126.22(CH), 83.77(CH), 75.02( $\text{CH}_2$ ), 60.57( $\text{CH}_2$ ), 39.66( $\text{CH}_2$ ), 18.20(6x  $\text{CH}_2$ ) and 12.09(3x CH),  $m/z$  270(100%,  $\text{M}^+$ ), 227(85,  $\text{C}_{12}\text{H}_{23}\text{SiO}_2$ , M- $\text{C}_3\text{H}_7$ ), 197(18,  $\text{C}_{10}\text{H}_{17}\text{SiO}_2$ , M- $\text{C}_5\text{H}_{12}$ ), 185(22,  $\text{C}_9\text{H}_{16}\text{SiO}_2$ , M- $\text{C}_6\text{H}_{14}$ ), 141(8,  $\text{C}_6\text{H}_9\text{SiO}_2$ , M- $\text{C}_9\text{H}_{21}$ ), 113(4,  $\text{C}_6\text{H}_{19}\text{O}_2$ , M- $\text{C}_9\text{H}_{21}\text{Si}$ ), 97(9,  $\text{C}_6\text{H}_9\text{O}$ , M- $\text{C}_9\text{H}_{21}\text{SiO}$ ) and 69(15, M- $\text{C}_4\text{H}_5\text{O}$ , M- $\text{C}_{11}\text{H}_{25}\text{SiO}$ ).

The *hydroxytetrahydrofuran* (**243b**) showed,  $\nu_{\max}$ (film) 3429, 2942, 1642 and 1464  $\text{cm}^{-1}$ ,  $\delta_{\text{H}}$ (250) 1.08(21H, br s,  $i\text{Pr}_3$ ), 1.84-2.32(4H, m,  $\text{CH}^{4\alpha}\text{-CH}^{3\alpha}\text{H}^{3\beta}$  and  $\text{SiOCH}_2\text{CH}^{\alpha}\text{H}^{\beta}$ ), 3.66-3.81(2H, m,  $\text{SiOCH}_2\text{CH}^{\alpha}\text{H}^{\beta}$ ), 3.74(1H, app td,  $J = 8.7$  and 4.6 Hz,  $\text{CH}^{3\alpha}\text{H}^{3\beta}\text{-CH}^{2\alpha}\text{H}^{2\beta}$ ), 3.90(1H, app dt,  $J = 10.3$  and 4.0 Hz,  $\text{CH}^{3\alpha}\text{H}^{3\beta}\text{-CH}^{2\alpha}\text{H}^{2\beta}$ ), 4.02(1H, app q,  $J = 7.9$  Hz,  $\text{CH}^{5\alpha}\text{-CH}^{4\alpha}\text{-CH}^{3\alpha}\text{H}^{3\beta}$ ), 4.34(1H, ddd,  $J = 5.7$ , 3.5 and 1.7 Hz,  $\text{CH}^{\alpha}\text{H}^{\beta}\text{-CH}^{5\alpha}\text{-CH}^{4\alpha}$ ),  $\delta_{\text{C}}$ (63) 83.50(CH), 72.38(CH-OH), 66.36( $\text{CH}_2$ ), 60.89( $\text{CH}_2$ ), 35.10( $\text{CH}_2$ ), 32.17( $\text{CH}_2$ ), 18.29(6x  $\text{CH}_2$ ) and 12.22(3x CH),  $m/z$  288(100%,  $\text{M}^+$ ), 269(25,  $\text{C}_{15}\text{H}_{29}\text{SiO}_2$ , M- $\text{H}_3\text{O}$ ), 245(27,  $\text{C}_{12}\text{H}_{25}\text{SiO}_3$ , M- $\text{C}_3\text{H}_7$ ), 202(8,  $\text{C}_9\text{H}_{18}\text{SiO}_3$ , M- $\text{C}_6\text{H}_{14}$ ), 174(5,  $\text{C}_9\text{H}_{22}\text{SiO}$ ) and 115(7,  $\text{C}_6\text{H}_{11}\text{O}_2$ , M- $\text{C}_9\text{H}_{21}\text{SiO}$ ).

**(4S\*, 5S\*)-5-(Hydroxy-2'-ethyl)-4-hydroxytetrahydrofuran. (244)**

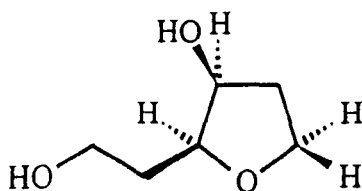

Tetra-*n*-butylammonium fluoride (5 ml of a 1.0 M solution in tetrahydrofuran, 5 mmol) was added dropwise to a stirred solution of tetrahydrofuran (**243a**) (1.0 g, 3.5 mmol) in dry tetrahydrofuran (20 ml) at 0°C under a nitrogen atmosphere. The mixture was stirred for 12 hr at 25°C and the solvent removed under reduced pressure to give the crude product. Column chromatography of the residue over silica G using hexane/ethyl acetate (50:50) as eluant gave the *dihydroxytetrahydrofuran* (**244**) (0.41 g, 89%), as a colourless oil,  $\nu_{\max}$  (film) 3377, 2949, 1703, 1441 and 1337  $\text{cm}^{-1}$ ,  $\delta_{\text{H}}$ (250) 1.91-2.03(1H, m,  $\text{CH}^4\alpha\text{-CH}^3\alpha\text{H}^3\beta\text{-CH}^2\alpha\text{H}^2\beta$ ), 1.97(1H, dtd,  $J = 12.5, 6.7$  and  $1.7\text{Hz}$ ,  $\text{HOCH}_2\text{CH}^{\alpha}\text{H}^{\beta}\text{-CH}^5\alpha$ ), 1.99(1H, dtd,  $J = 12.5, 6.7$  and  $5.6\text{Hz}$ ,  $\text{HOCH}_2\text{CH}^{\alpha}\text{H}^{\beta}\text{-CH}^5\alpha$ ), 2.18(1H, dddd,  $J = 11.1, 8.9, 7.8$  and  $5.6\text{Hz}$ ,  $\text{CH}^4\alpha\text{-CH}^3\alpha\text{H}^3\beta\text{-CH}^2\alpha\text{H}^2\beta$ ), 3.74(1H, ddd,  $J = 15.9, 8.9$  and  $5.2\text{Hz}$ ,  $\text{CH}^3\alpha\text{H}^3\beta\text{-CH}^2\alpha\text{H}^2\beta$ ), 3.77(2H, app t,  $J = 6.7\text{Hz}$ ,  $\text{HOCH}_2\text{CH}^{\alpha}\text{H}^{\beta}$ ), 3.86(1H, ddd,  $J = 15.9, 10.6$  and  $5.6\text{Hz}$ ,  $\text{CH}^3\alpha\text{H}^3\beta\text{-CH}^2\alpha\text{H}^2\beta$ ), 4.05(1H, app q,  $7.8\text{Hz}$ ,  $\text{CH}^5\alpha\text{-CH}^4\alpha\text{-CH}^3\alpha\text{H}^3\beta$ ), 4.34(1H, ddd,  $J = 5.6, 3.4$  and  $1.7\text{Hz}$ ,  $\text{CH}^{\alpha}\text{H}^{\beta}\text{-CH}^5\alpha\text{-CH}^4\alpha$ ),  $\delta_{\text{C}}$ (63) 82.55(CH), 72.41(CH-OH), 65.89( $\text{CH}_2$ ), 60.02( $\text{CH}_2$ ), 34.95( $\text{CH}_2$ ), 31.01( $\text{CH}_2$ ),  $m/z$  132(100%,  $\text{M}^+$ ), 114(27,  $\text{C}_6\text{H}_{10}\text{O}_2$ ,  $\text{M-H}_2\text{O}$ ), 87(18,  $\text{C}_4\text{H}_7\text{O}_2$ ,  $\text{M-C}_2\text{H}_5\text{O}$ ), 83(62,  $\text{C}_5\text{H}_7\text{O}$ ,  $\text{M-CH}_5\text{O}_2$ ), 69(7,  $\text{C}_5\text{H}_5\text{O}$ ,  $\text{M-C}_2\text{H}_7\text{O}_2$ ) and 15(34,  $\text{C}_2\text{H}_5\text{O}$ ,  $\text{M-C}_4\text{H}_7\text{O}_2$ ).

**(2S\*,4R\*,5S\*) and (2S\*,4S\*,2R\*)-Methyl 5-ethyl-4-bromotetrahydrofuranyl-2-acetate. (257 and 258)**

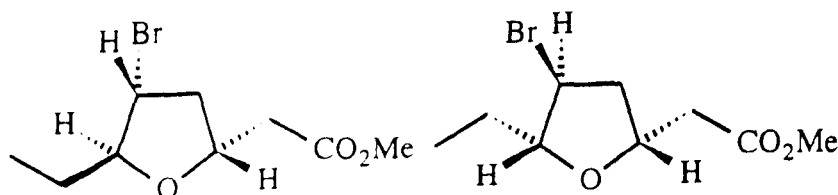

Anhydrous sodium bicarbonate (0.76 g, 9 mmol) was added to a stirred solution of the *E*-alkene (**121**) (0.05 g, 0.30 mmol) in acetonitrile (5 ml) while under an inert atmosphere of argon, shielded from the light and at a temperature of not greater than -4°C. The resulting suspension was stirred at this temperature for 5 min and then bromine (0.14 g, 0.87 mmol) was rapidly added *via* a syringe. The mixture was vigorously stirred at -4°C for 18 hr, after which time 2M sodium thiosulphate solution (10 ml) was added and the mixture allowed to warm to ambient temperature. The reaction mixture was diluted with ethyl acetate (10 ml) and washed with more sodium thiosulphate solution (2x 5 ml). The organic phase was separated, dried (Na<sub>2</sub>SO<sub>4</sub>) and concentrated to give a mixture of tetrahydrofuran products [4:1 ratio of (**257**) and (**258**) by NMR]. The *bromotetrahydrofurans* (**257**) and (**258**) (0.04 g, 56%) as a pale brown oil showed,  $\nu_{\max}$  (film) 1745 cm<sup>-1</sup>. the major isomer (**257**) had NMR data  $\delta_{\text{H}}$ (400) 0.99(3H, t, J = 7.4Hz, CH<sub>3</sub>CH<sub>2</sub>). 1.54-1.68(1H, m, CH<sub>3</sub>CH <sup>$\alpha$</sup> H <sup>$\beta$</sup> -CH<sup>5 $\alpha$</sup> ), 1.73-1.81(1H, m, CH<sub>3</sub>CH <sup>$\alpha$</sup> H <sup>$\beta$</sup> -CH<sup>5 $\alpha$</sup> ), 2.08-2.11(1H, m, CH<sup>4 $\beta$</sup> -CH<sup>3 $\alpha$</sup> H<sup>3 $\beta$</sup> -CH<sup>2 $\beta$</sup> ), 2.62-2.72(1H, m, CH<sup>2 $\beta$</sup> -CH <sup>$\alpha$</sup> H <sup>$\beta$</sup> -CO<sub>2</sub>CH<sub>3</sub>), 2.81-2.90(1H, m, CH<sup>2 $\beta$</sup> -CH <sup>$\alpha$</sup> H <sup>$\beta$</sup> -CO<sub>2</sub>CH<sub>3</sub>), 2.83-2.89(1H, m, CH<sup>4 $\beta$</sup> -CH<sup>3 $\alpha$</sup> H<sup>3 $\beta$</sup> -CH<sup>2 $\beta$</sup> ), 3.70(3H, s, CO<sub>2</sub>CH<sub>3</sub>), 3.95-4.07(1H, m, CH<sup>5 $\alpha$</sup> -CH<sup>4 $\beta$</sup> -CH<sup>3 $\alpha$</sup> H<sup>3 $\beta$</sup> ), 4.00-4.07(1H, m, CH <sup>$\alpha$</sup> H <sup>$\beta$</sup> -CH<sup>5 $\alpha$</sup> -CH<sup>4 $\beta$</sup> ) and 4.44-4.57(1H, m, CH<sup>3 $\alpha$</sup> H<sup>3 $\beta$</sup> -CH<sup>2 $\beta$</sup> -CH <sup>$\alpha$</sup> H <sup>$\beta$</sup> ).  $\delta_{\text{C}}$ (100) 171.44(C=O), 86.96(CH), 73.99(CH), 51.54(CH<sub>3</sub>), 47.67(CH<sub>2</sub>), 42.55(CH<sub>2</sub>), 40.84(CH<sub>2</sub>), 25.74(CH) and 10.08(CH<sub>3</sub>) and the minor isomer (**258**).  $\delta_{\text{H}}$ (400) 0.98(3H, t, J = 7.4Hz, CH<sub>3</sub>CH<sub>2</sub>). 1.50-1.59(1H, m, CH<sub>3</sub>CH <sup>$\alpha$</sup> H <sup>$\beta$</sup> -CH<sup>5 $\beta$</sup> ). 1.70-1.84(1H, m, CH<sub>3</sub>CH <sup>$\alpha$</sup> H <sup>$\beta$</sup> -CH<sup>5 $\beta$</sup> ), 2.22-2.35(1H, m, CH<sup>4 $\alpha$</sup> -CH<sup>3 $\alpha$</sup> H<sup>3 $\beta$</sup> -CH<sup>2 $\beta$</sup> ), 2.47-2.66(1H, m, CH<sup>4 $\alpha$</sup> -CH<sup>3 $\alpha$</sup> H<sup>3 $\beta$</sup> -CH<sup>2 $\beta$</sup> ), 2.54-2.69(1H, m, CH<sup>2 $\beta$</sup> -CH <sup>$\alpha$</sup> H <sup>$\beta$</sup> -CO<sub>2</sub>CH<sub>3</sub>), 2.68-2.79(1H, m, CH<sup>2 $\beta$</sup> -CH <sup>$\alpha$</sup> H <sup>$\beta$</sup> -CO<sub>2</sub>CH<sub>3</sub>), 3.70(3H, s, CO<sub>2</sub>CH<sub>3</sub>), 4.01-4.14(1H, m, CH<sup>5 $\beta$</sup> -CH<sup>4 $\alpha$</sup> -CH<sup>3 $\alpha$</sup> H<sup>3 $\beta$</sup> ), 3.98-4.11(1H, m, CH <sup>$\alpha$</sup> H <sup>$\beta$</sup> -CH<sup>5 $\beta$</sup> -CH<sup>4 $\alpha$</sup> ) and 4.52-4.64(1H, m, CH<sup>3 $\alpha$</sup> H<sup>3 $\beta$</sup> -CH<sup>2 $\beta$</sup> -CH <sup>$\alpha$</sup> H <sup>$\beta$</sup> ),  $\delta_{\text{C}}$ (100) 171.30(C=O), 88.19(CH), 74.16(CH), 52.09(CH<sub>3</sub>), 49.24(CH), 42.20(CH<sub>2</sub>), 40.07(CH<sub>2</sub>), 27.01(CH) and 10.01(CH<sub>3</sub>).

.....O-.....

## Chapter 6

---

### Spectral data

## Carbon and Proton NMR Spectra

- Trans*-Dimethyl 1,2,3,4-tetrahydrodibenzofuran-2,3-dicarboxylate (042)  
4-(*t*-butyldimethylsilyloxy-6-(iodo-1'-propyl)-tetrahydropyran-2-one (178)  
Methyl 5-butyl-4-hydroxytetrahydrofuran-2-acetate (182)  
Methyl 5-ethyl-4-azotetrahydrofuran-2-acetate (240)  
Methyl 5-ethyl-4-iodotetrahydrofuran-2-acetate (197)  
5-Butyl-2-ethyl-4-iodotetrahydrofuran (225)  
5-(hydroxy-2'-ethyl)-4-hydroxytetrahydrofuran (244)  
5-Iodo-decan-3, 6-diol (221)

## Nuclear Overhauser Effect NMR Spectra

- Methyl 5-butyl-4-hydroxytetrahydrofuran-2-acetate (182)  
Methyl 5-ethyl-4-iodotetrahydrofuran-2-acetate (197)  
Methyl 5-ethyl-4-iodotetrahydrofuran-2-acetate (198)  
Methyl 5-butyl-4-iodotetrahydrofuran-2-formate (202)  
Methyl 5-butyl-4-iodotetrahydrofuran-2-formate (203)  
5-butyl-2-ethyl-4-iodotetrahydrofuran (218)  
5-butyl-2-ethyl-4-iodotetrahydrofuran (219)  
5-Butyl-2-ethyl-4-iodotetrahydrofuran (225)  
Methyl 5-ethyl-4-azotetrahydrofuran-2-acetate (240)  
Methyl 5-ethyl-dihydrofuran-2-acetate (241)

**Trans-Dimethyl 1,2,3,4-tetrahydroindole-2,3-dicarboxylate (042)**

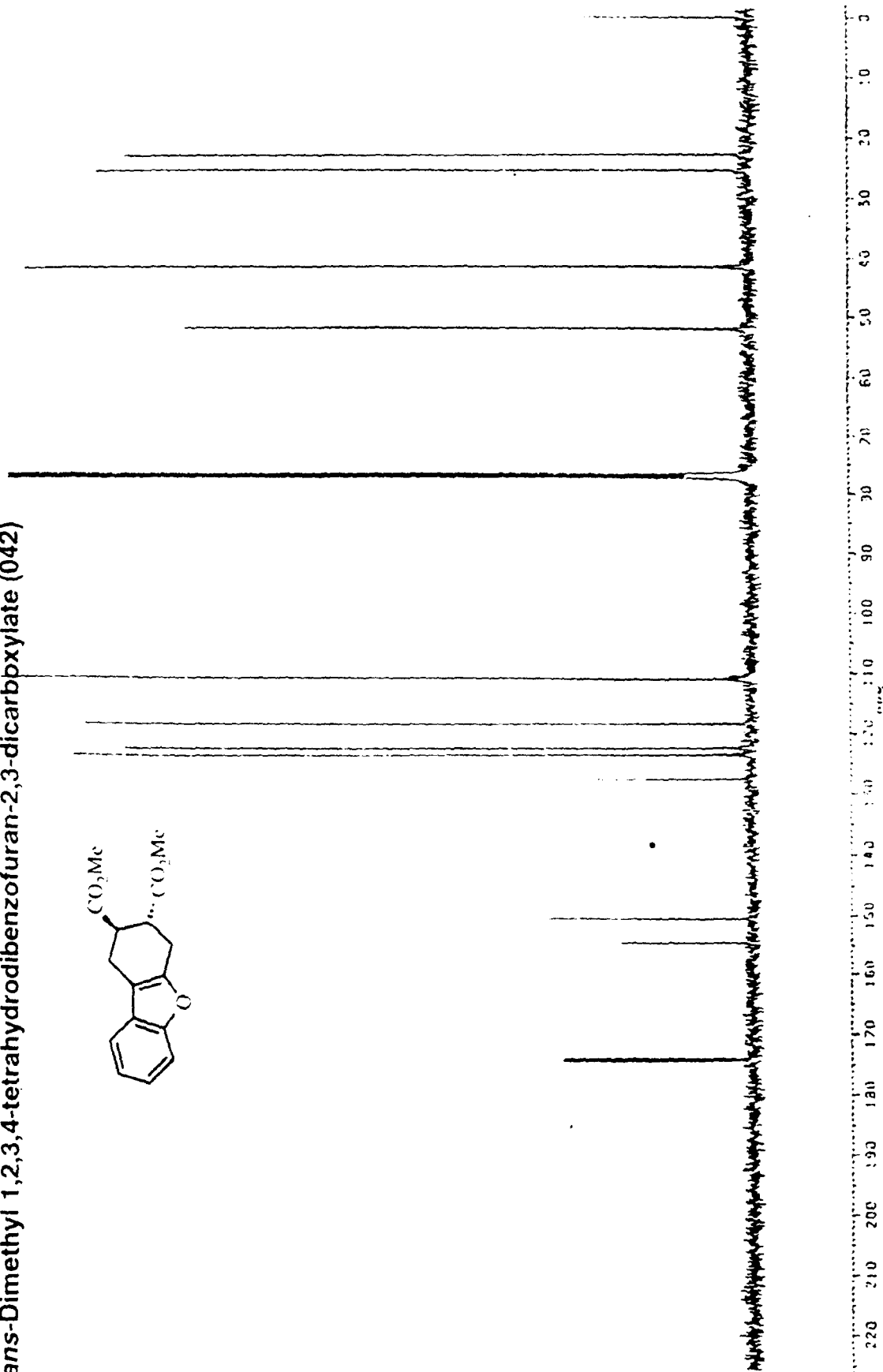
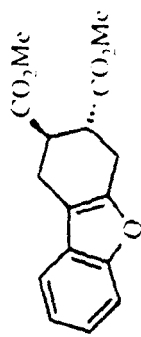



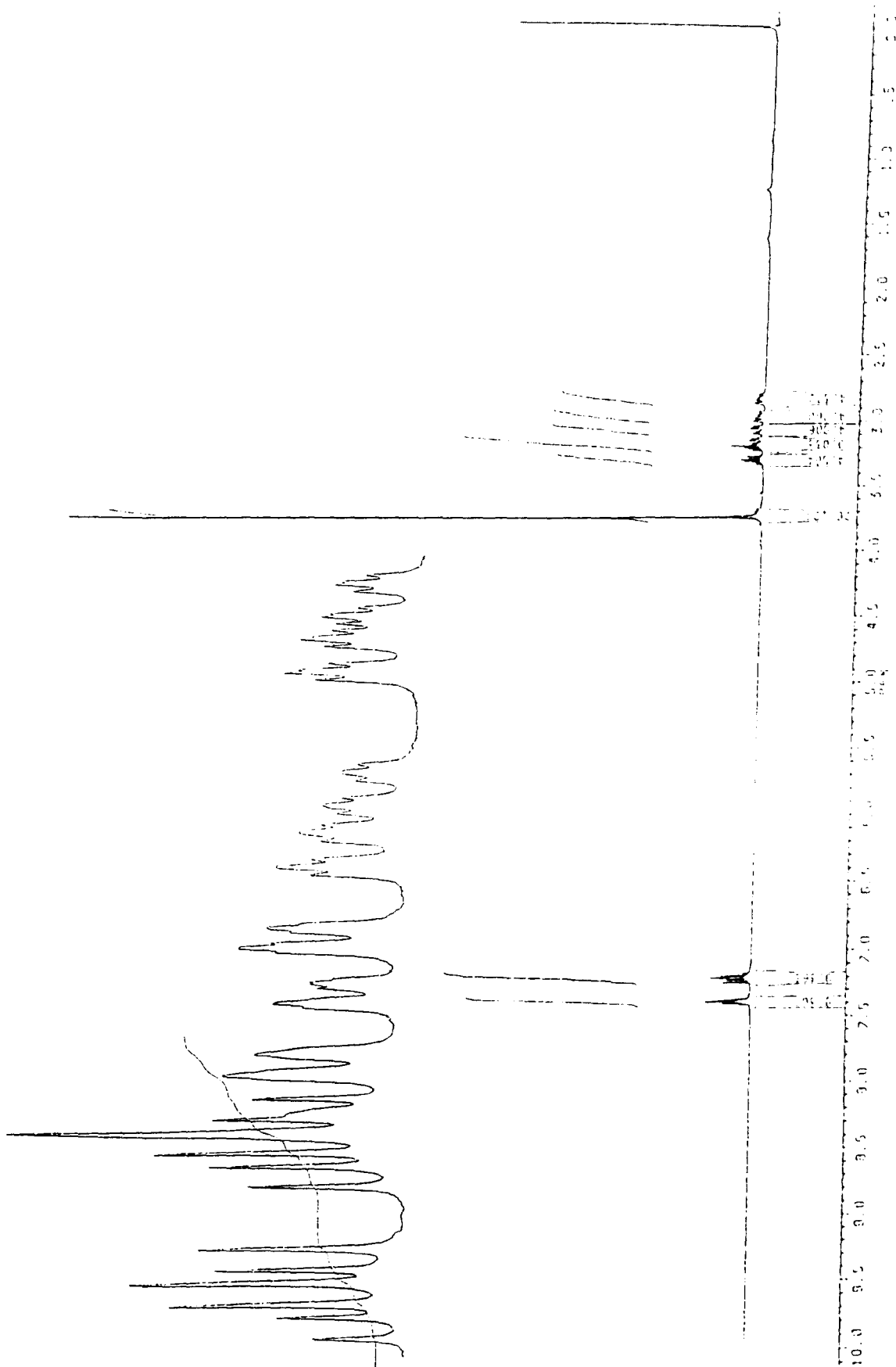

**(4R\*, 6S\*, 1'R\*)-4-(TBDMS)oxy-6-(iodo-1'-propyl)-tetrahydropyran-2-one (178)**

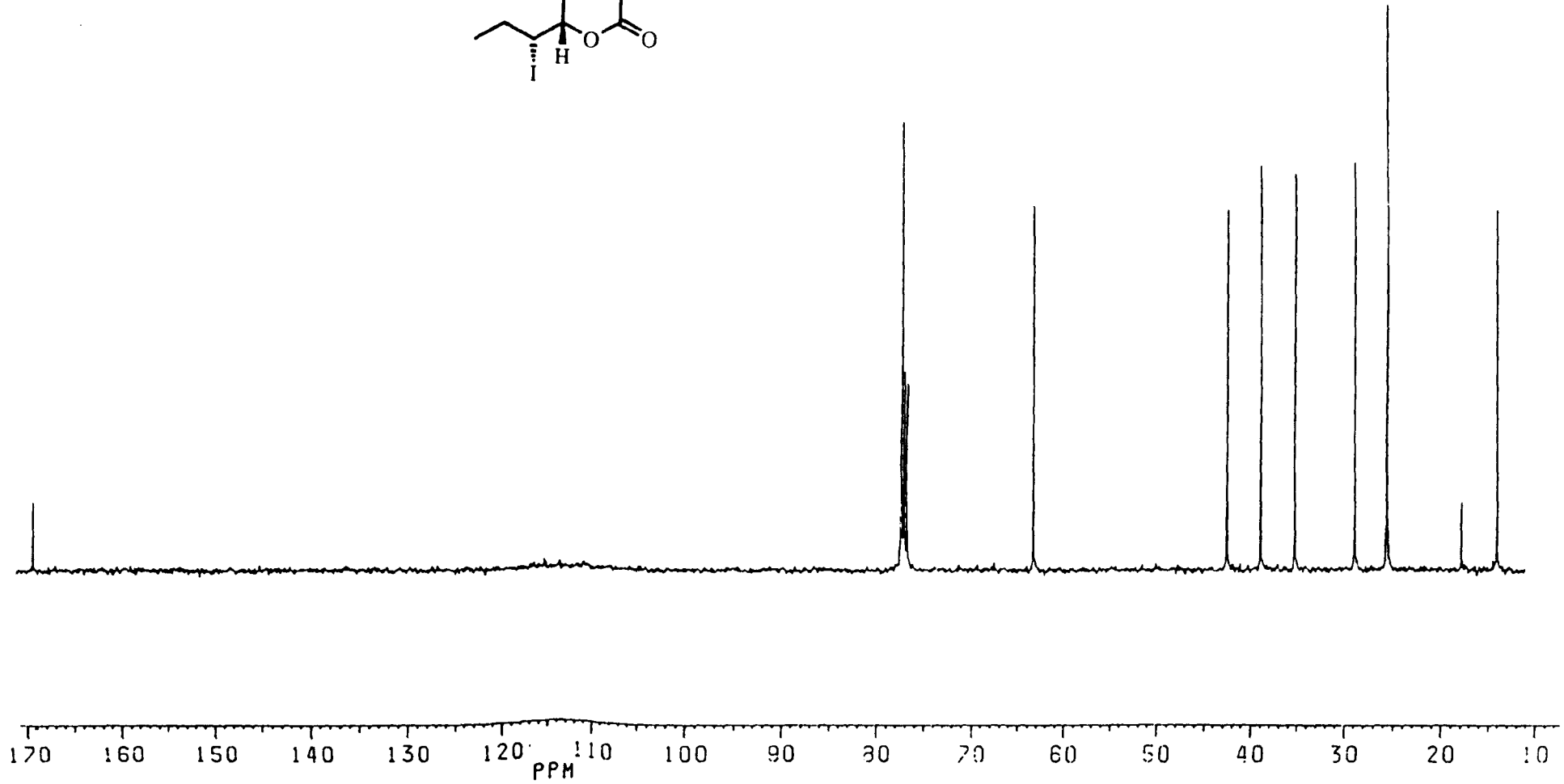
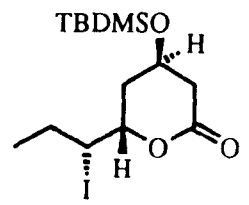

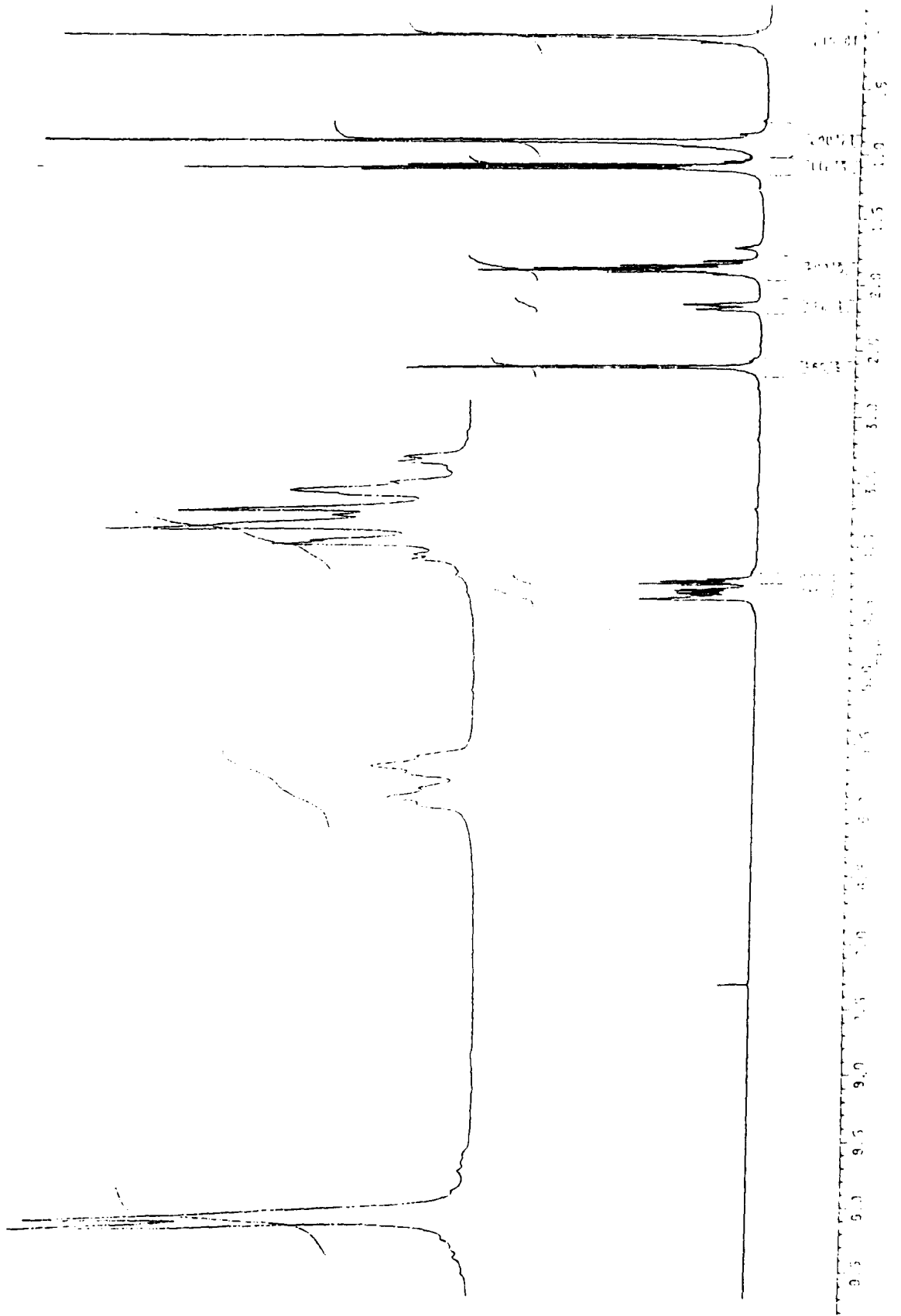

**Methyl (2R, 4S, 5R)-5-butyl-4-hydroxytetrahydrofuran-2-yl acetate (182)**

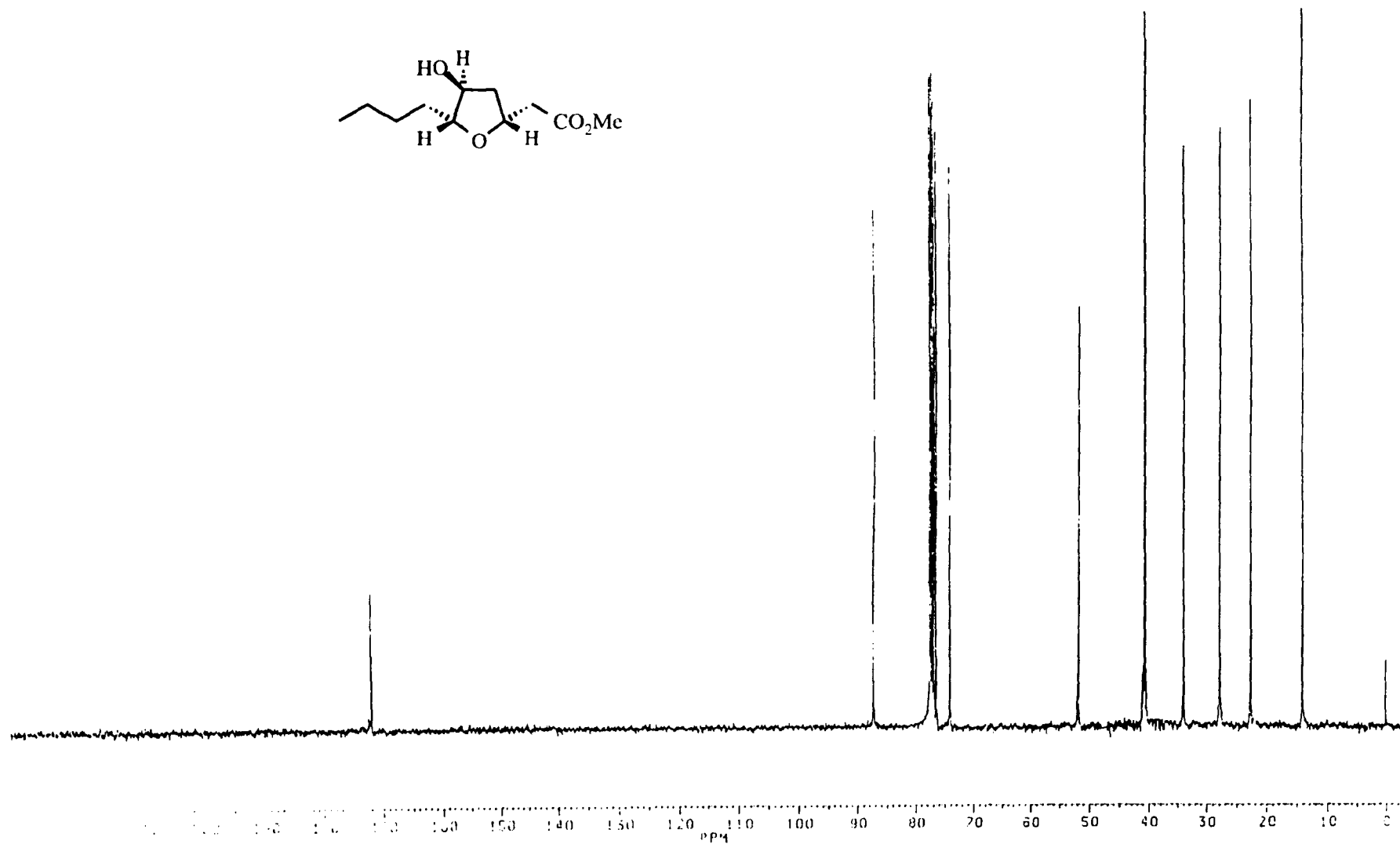
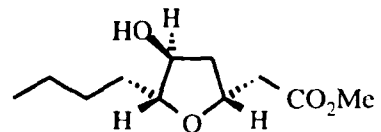

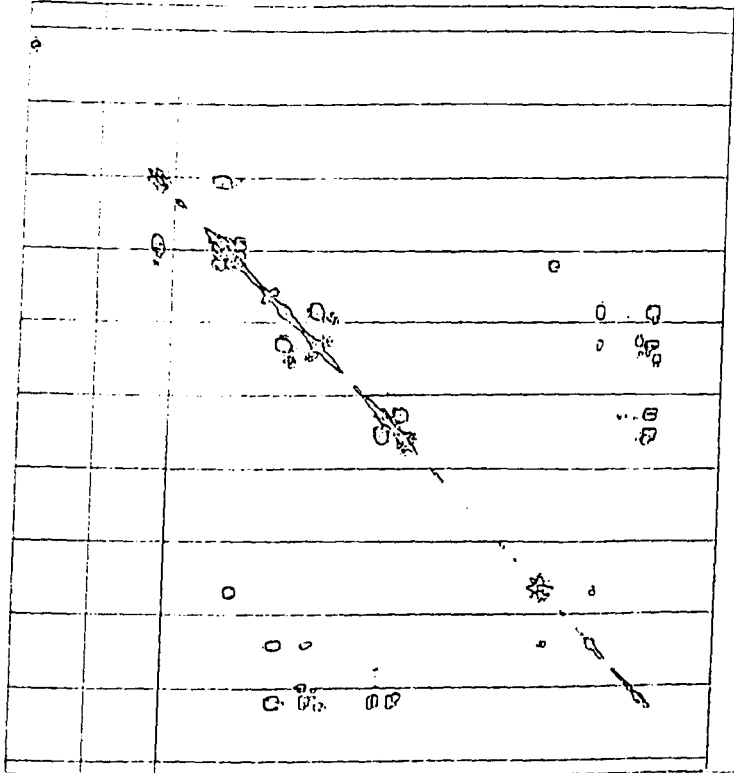

19.5 18.0 17.5 17.0 16.5 16.0 15.5 15.0 14.5  
 19.5 18.0 17.5 17.0 16.5 16.0 15.5 15.0 14.5

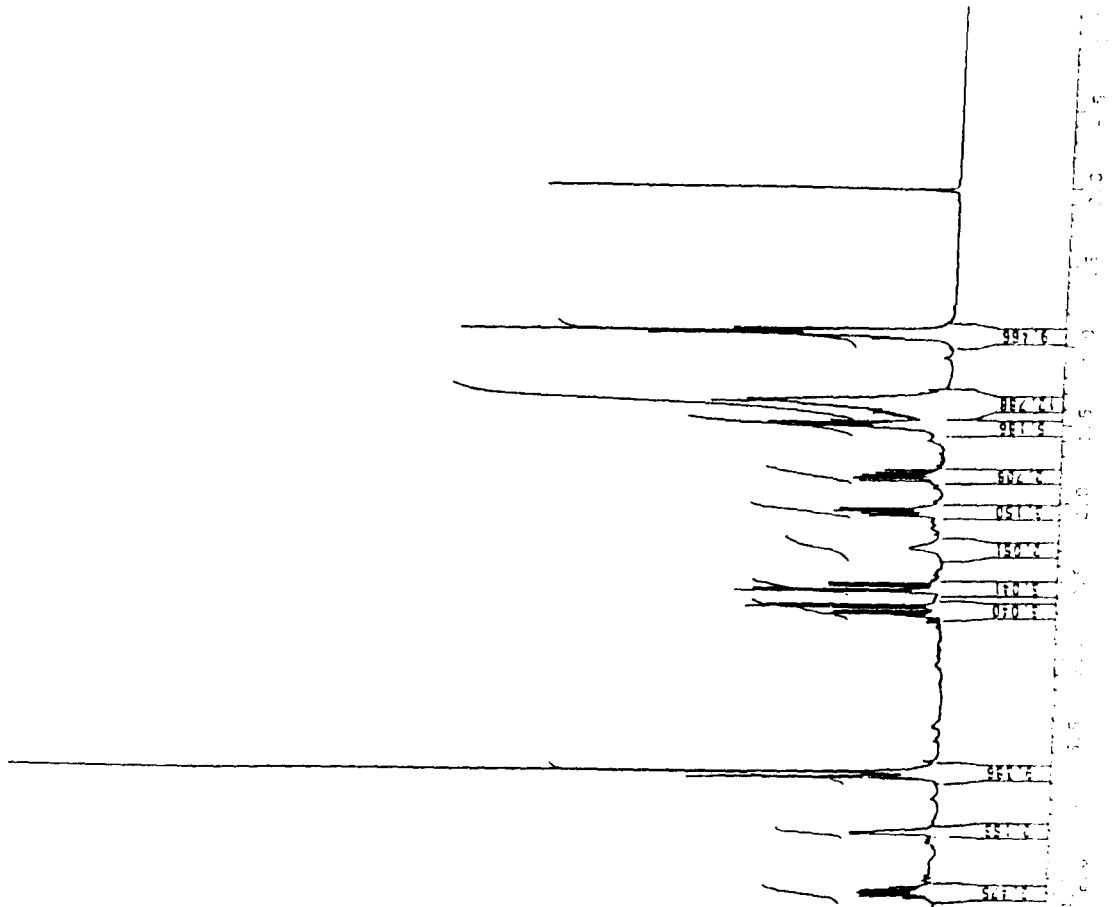

**Methyl (2R\*, 4S\*, 5S\*)-5-ethyl-4-azotetrahydrofuranyl-2-acetate (240)**

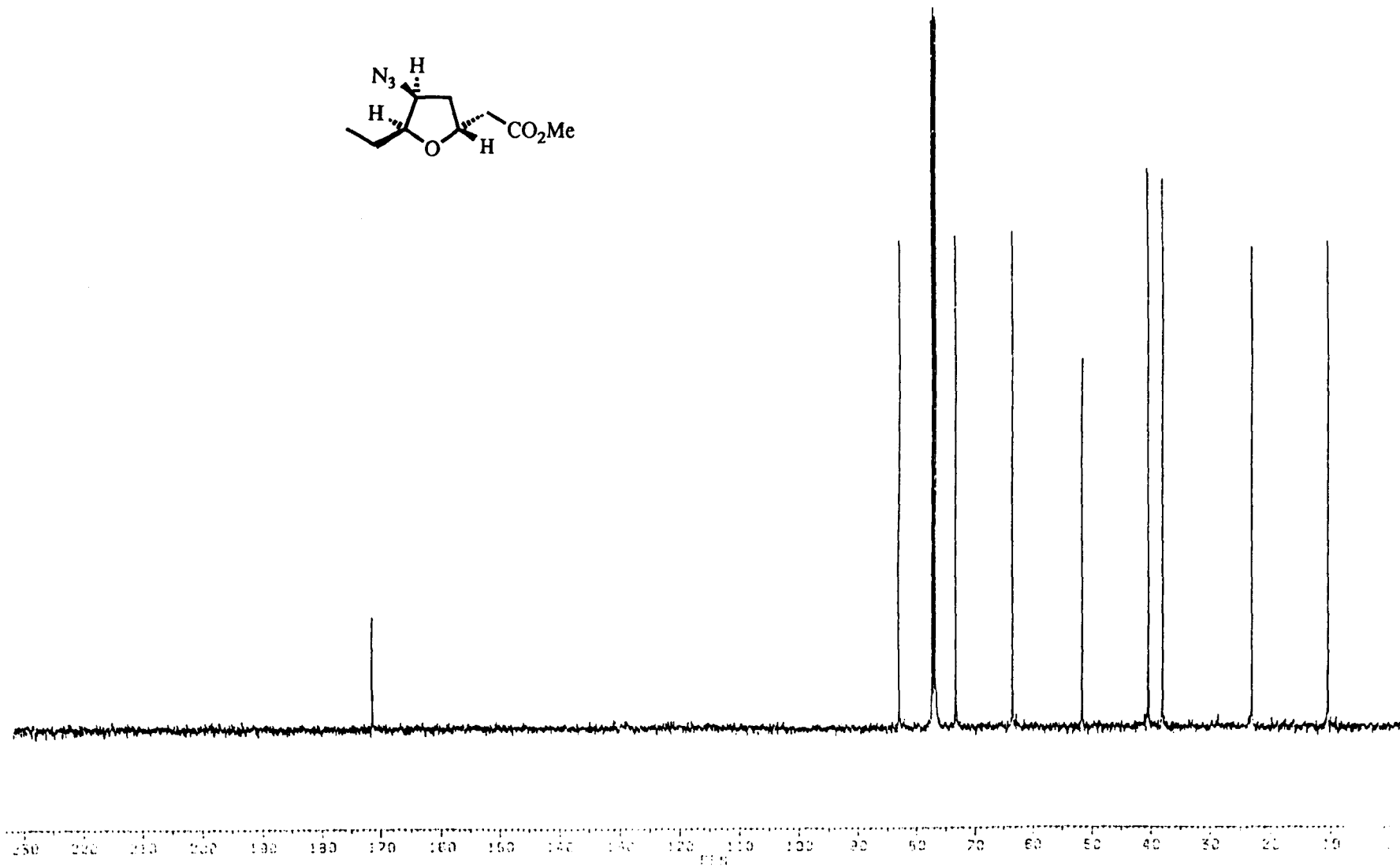
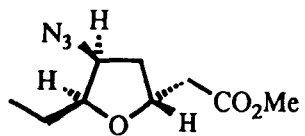

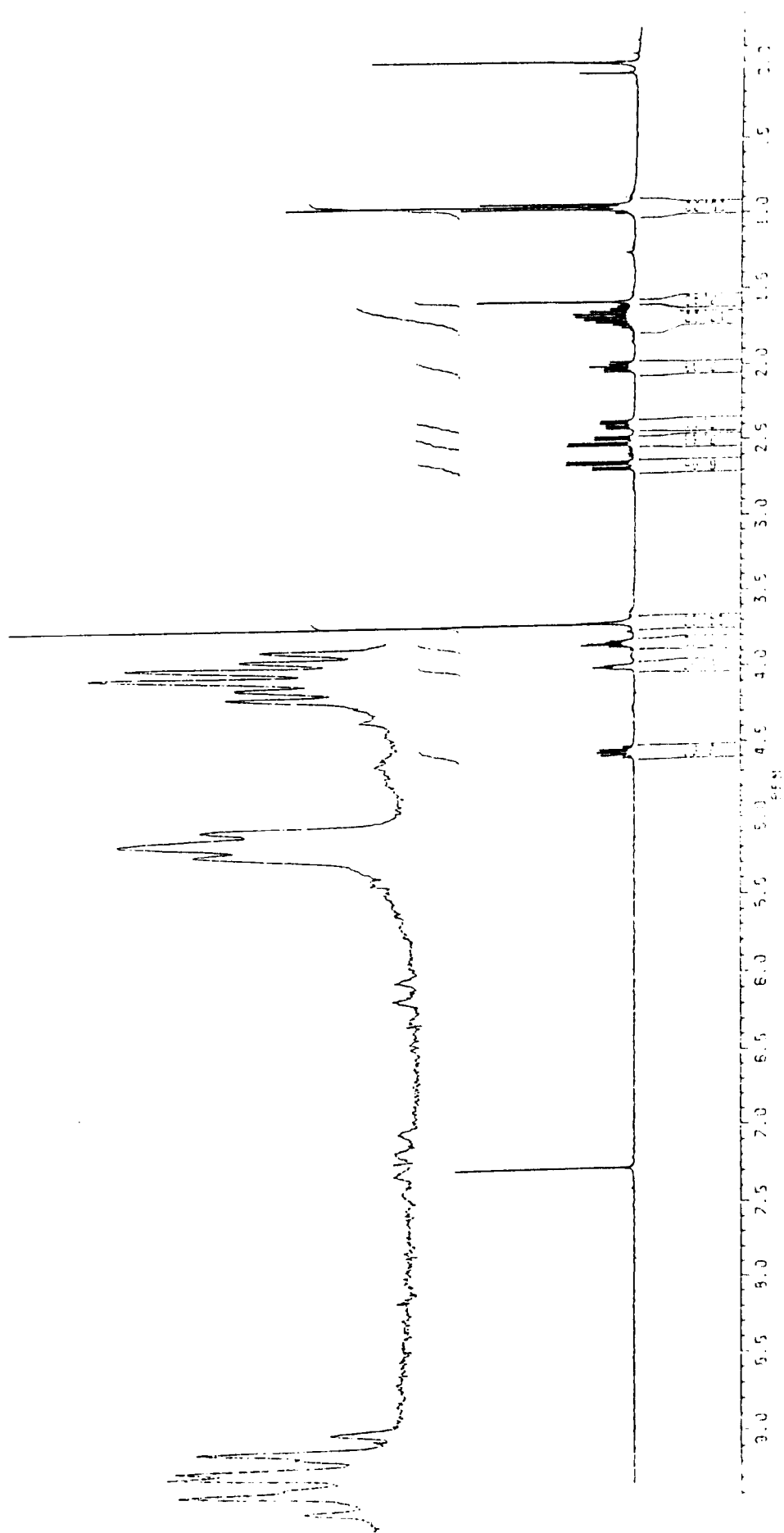

**Methyl (2S\*, 4R\*, 5S\*)-5-ethyl-4-iodotetrahydrofuranyl-2-acetate (197)**

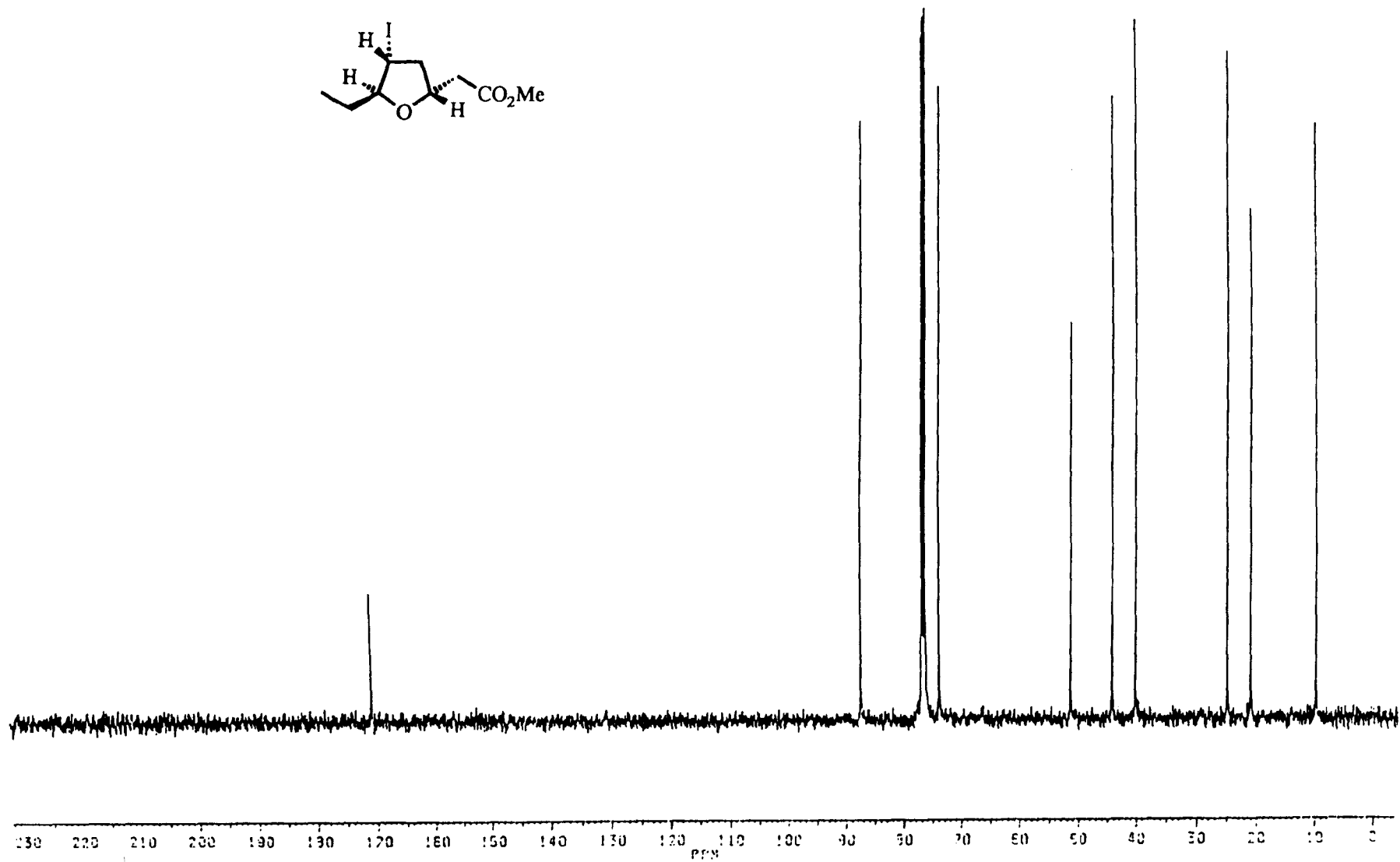
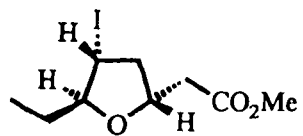



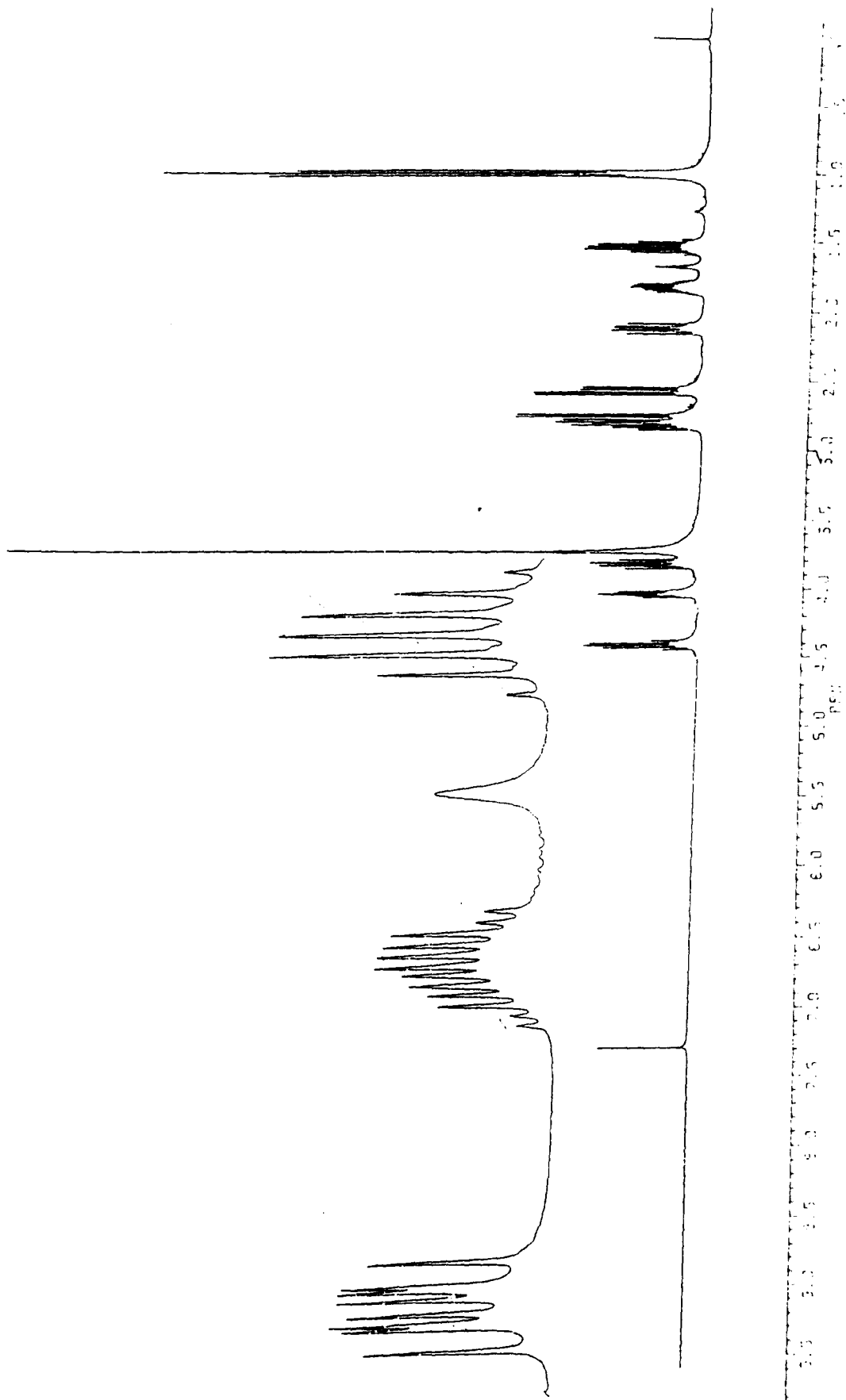

**(2S\*, 4R\*, 5S\*)-5-Butyl-2-ethyl-4-iodotetrahydrofuran (225)**

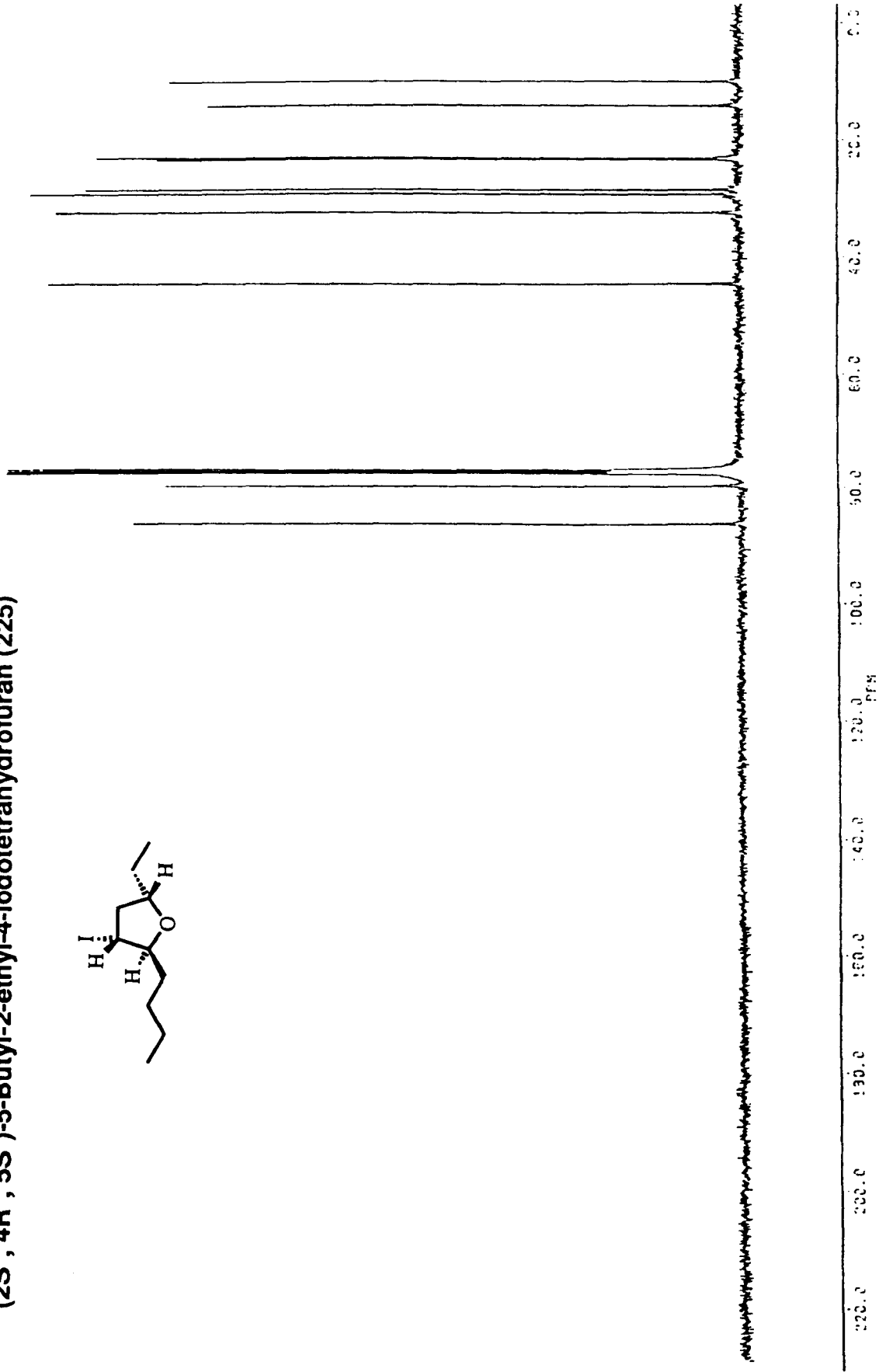
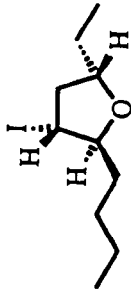

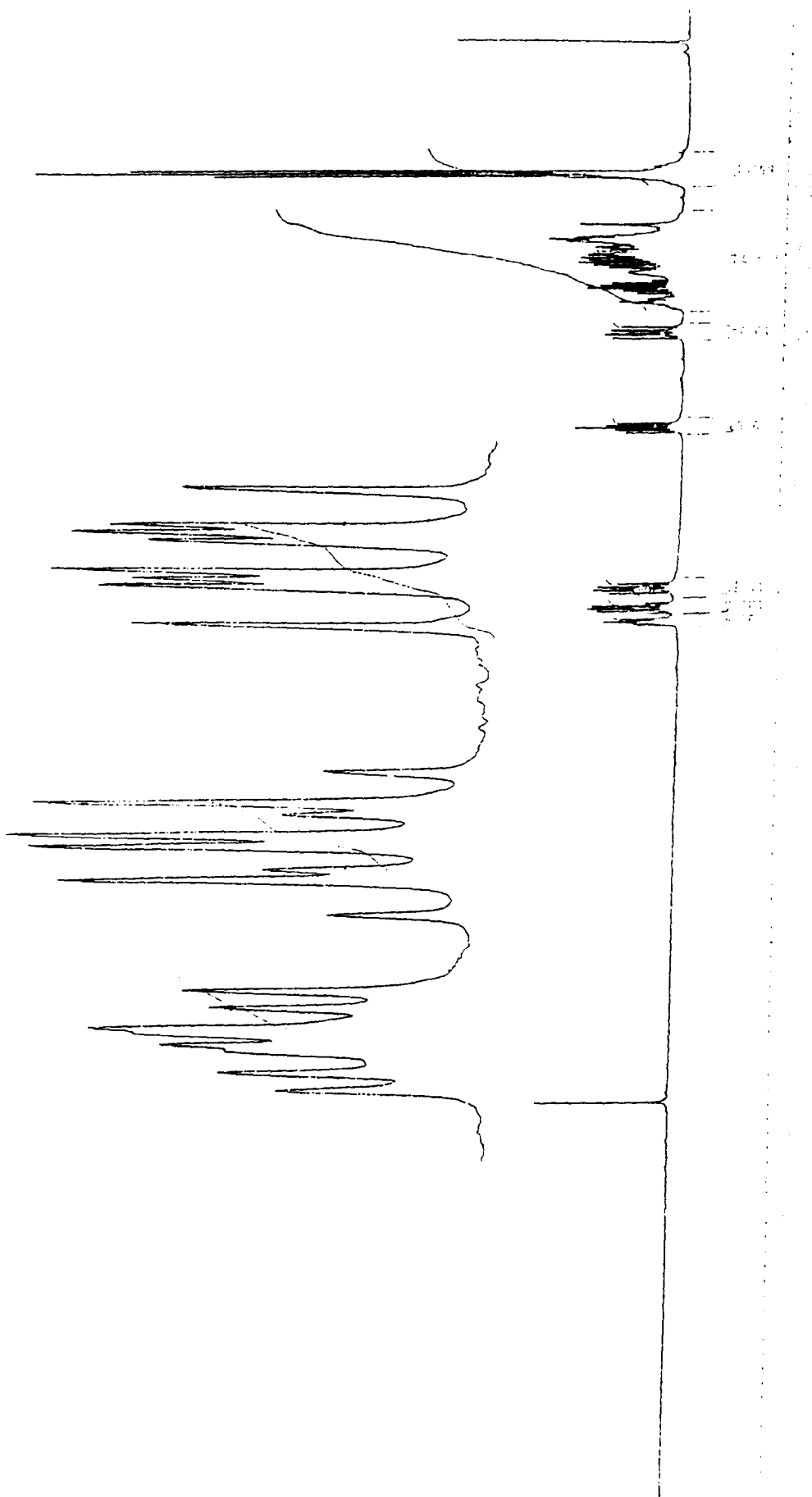

**(4S<sup>+</sup>, 5S<sup>+</sup>)-5-(hydroxy-2'-ethyl)-4-hydroxytetrahydrofuran (244)**

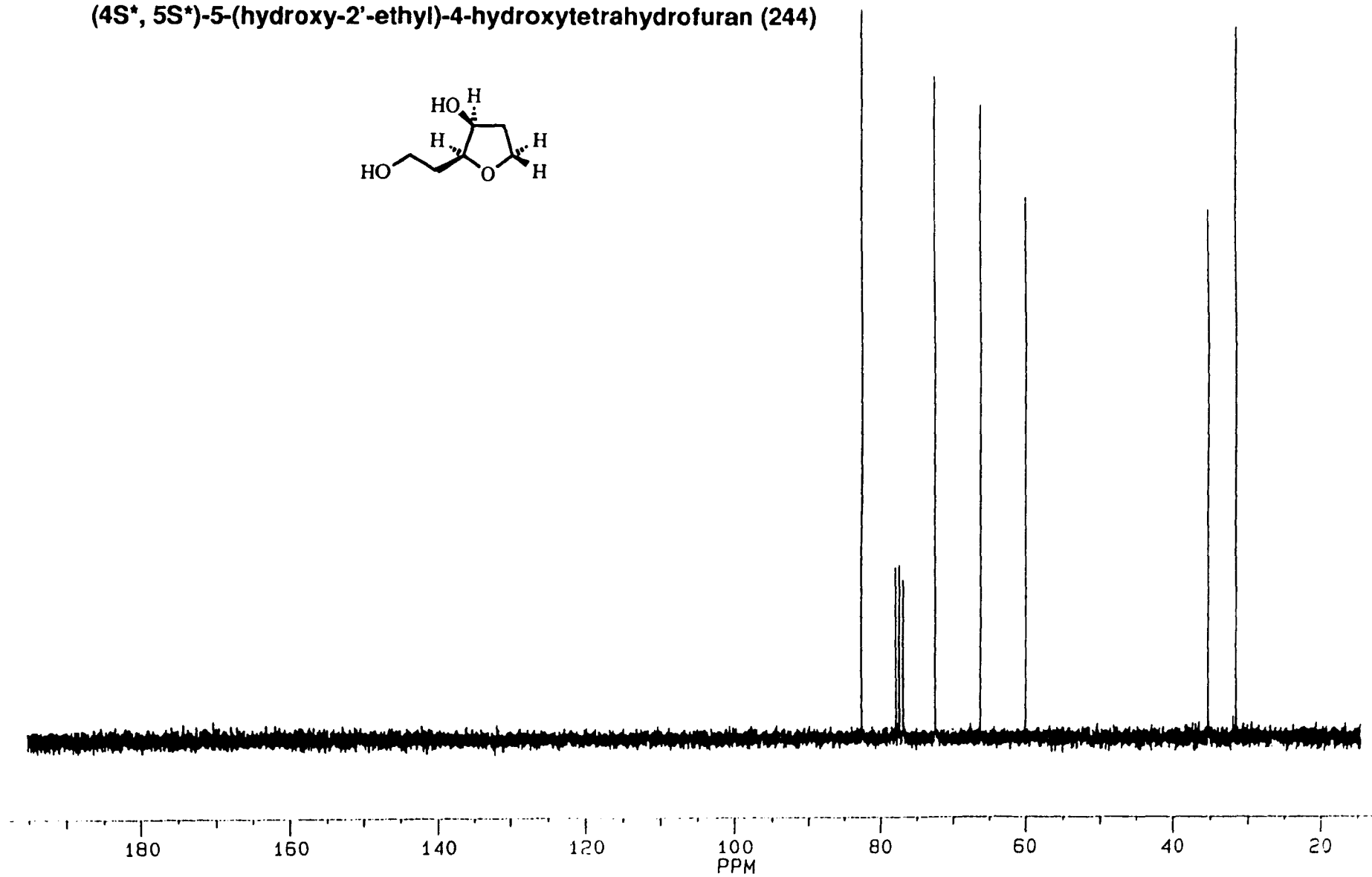
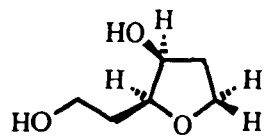

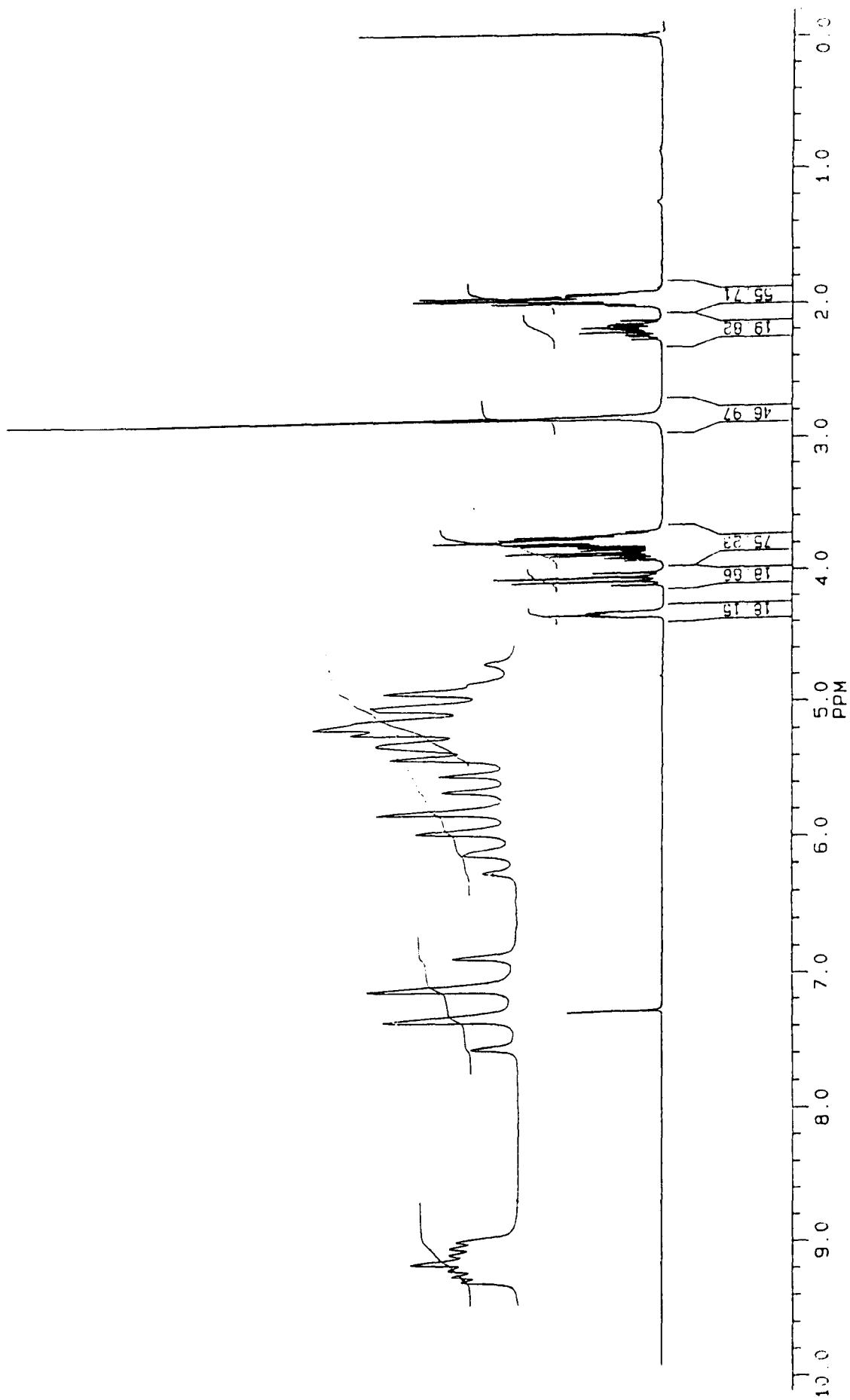

**(3S\*, 5S\*, 6S\*)-5-Iodo-decan-3, 6-diol (221)**

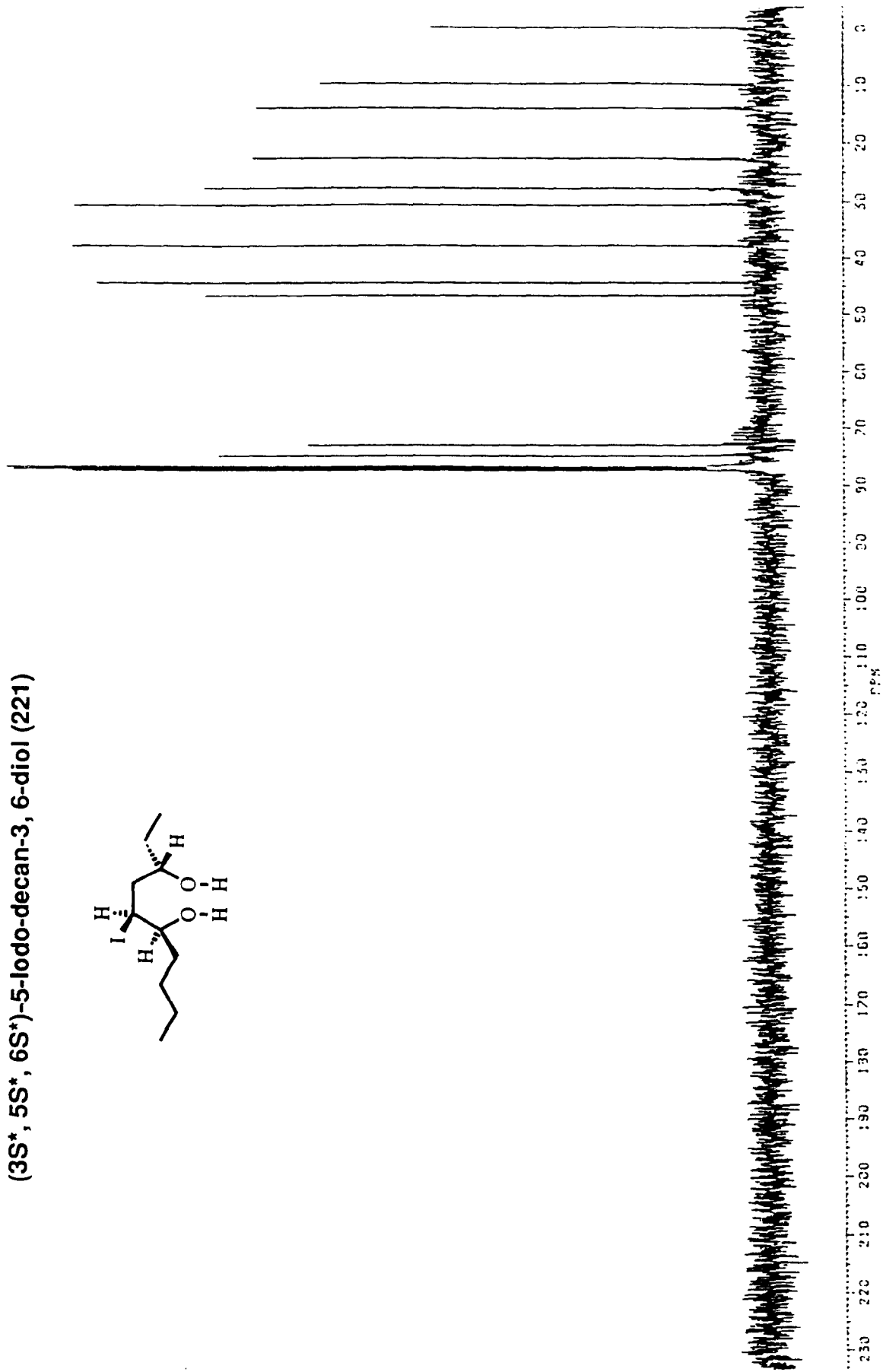
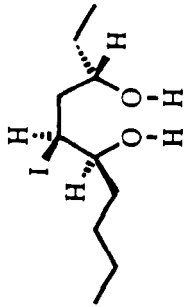

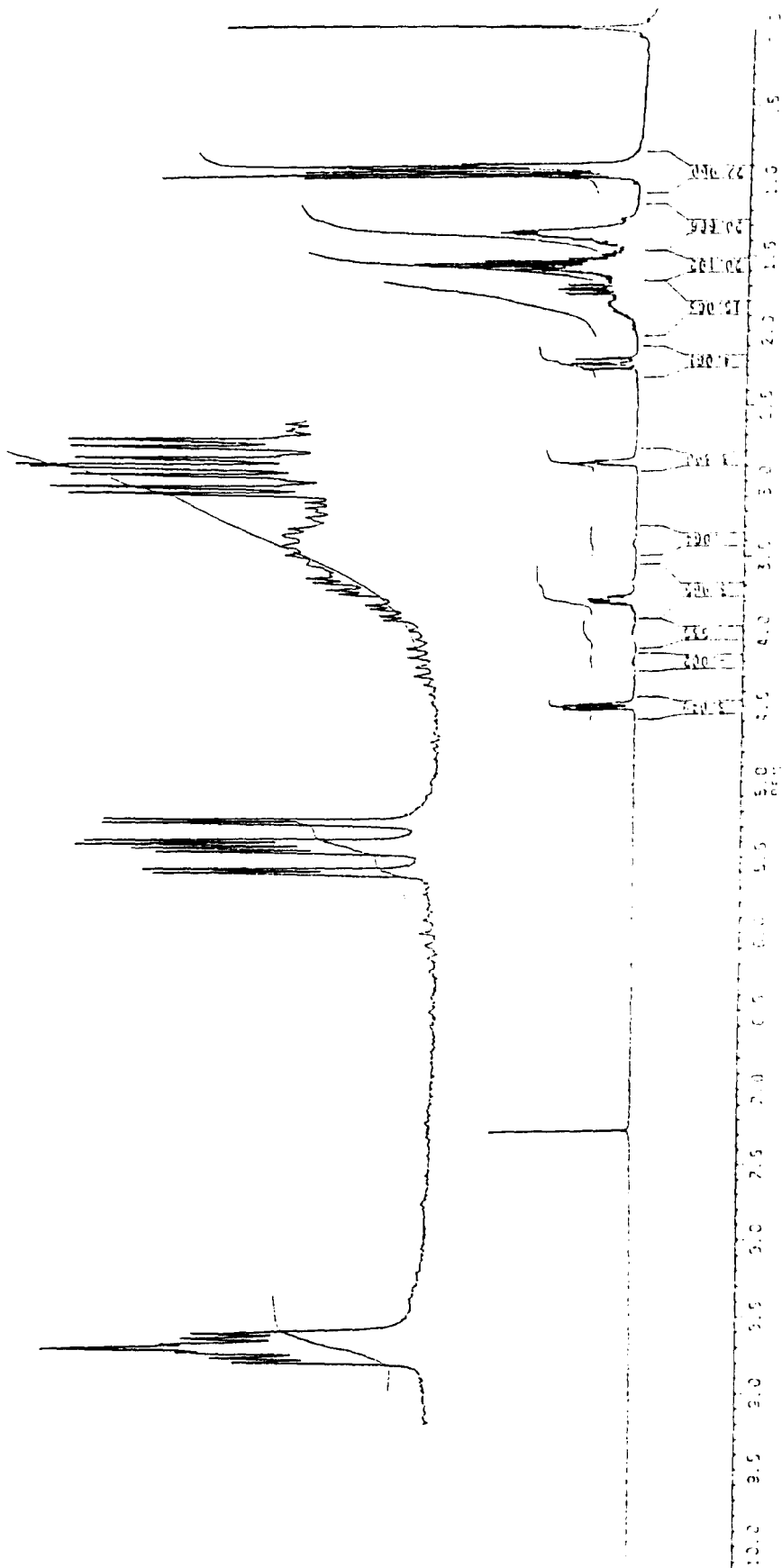

# NOE Spectral Data

## a) Data for Compound 182

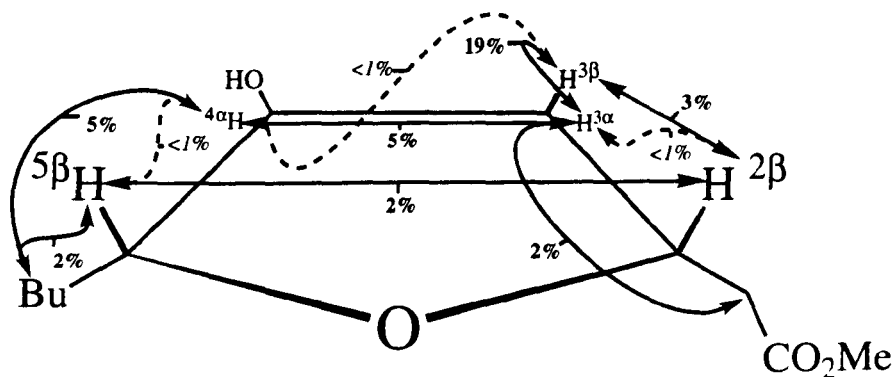

## b) Data for Compound 197

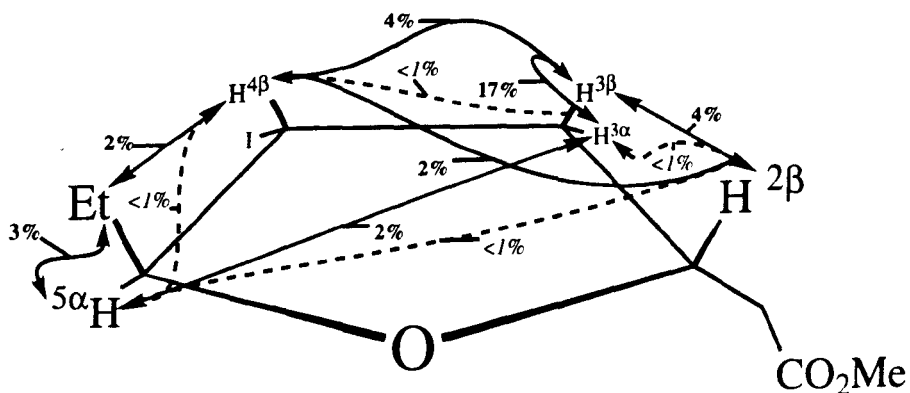

## c) Data for Compound 198

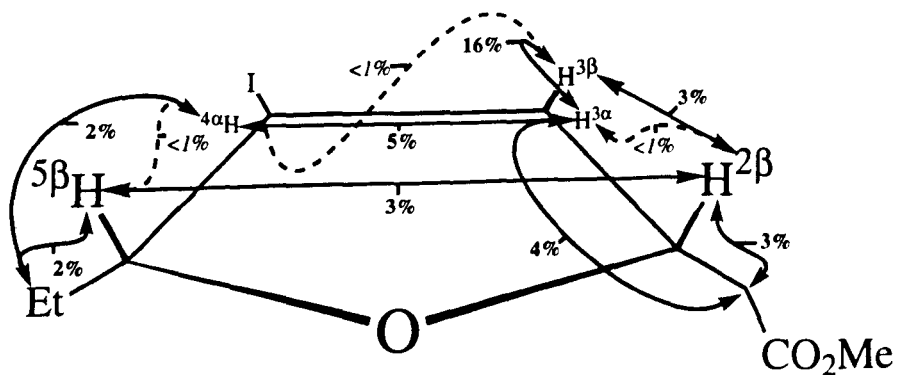



**d) Data for Compound 202**

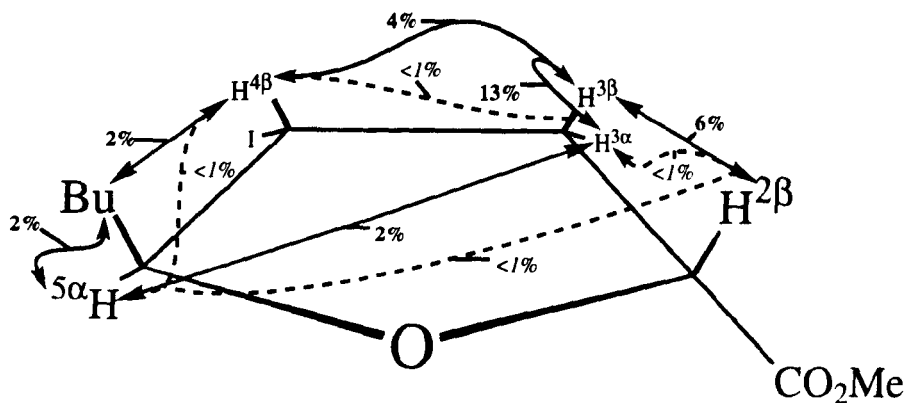

**e) Data for Compound 203**

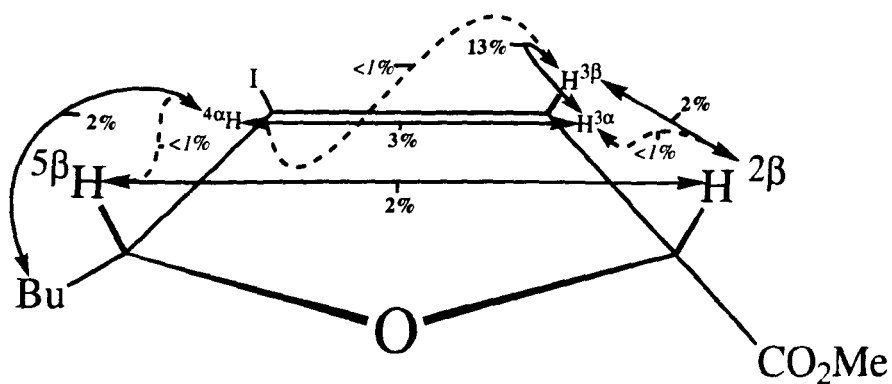

**f) Data for Compound 218**

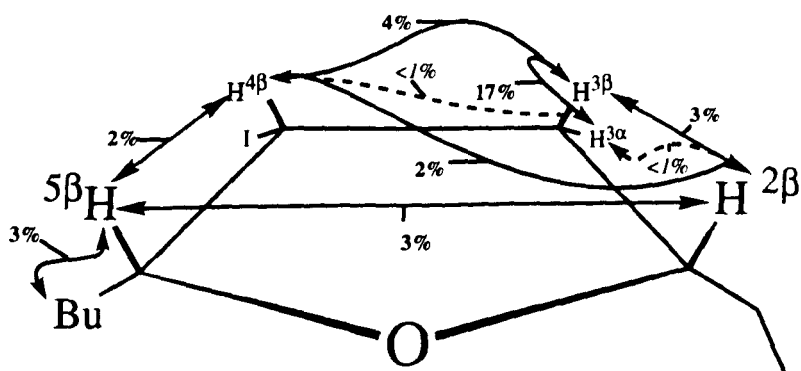

**g) Data for Compound 219**

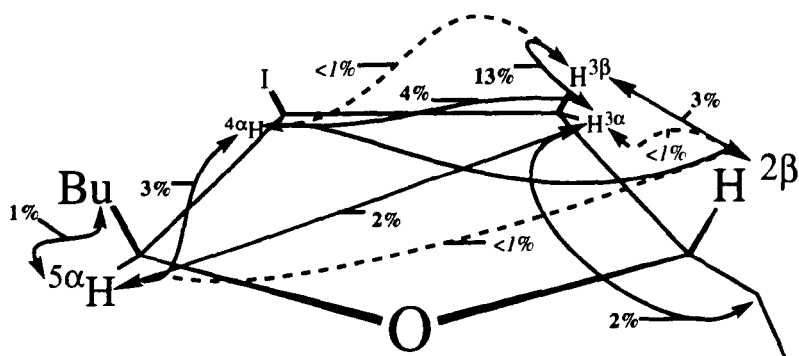

**h) Data for Compound 225**

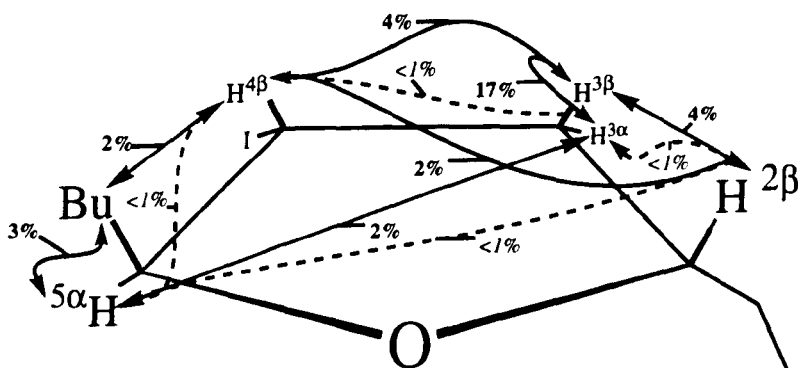

**i) Data for Compound 240**

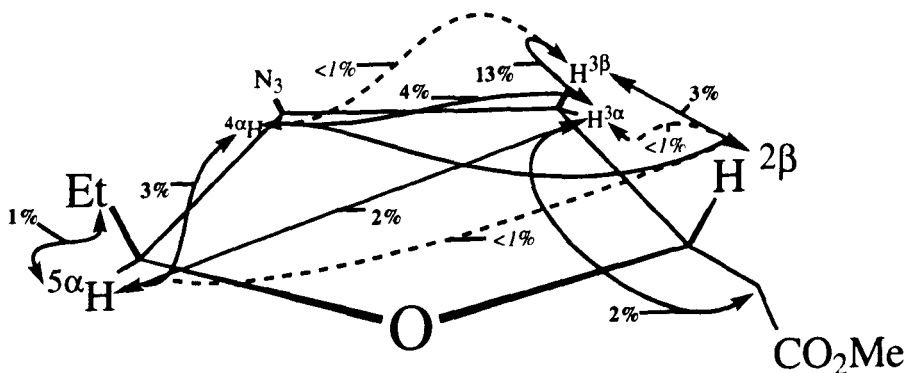

**j) Data for Compound 241**

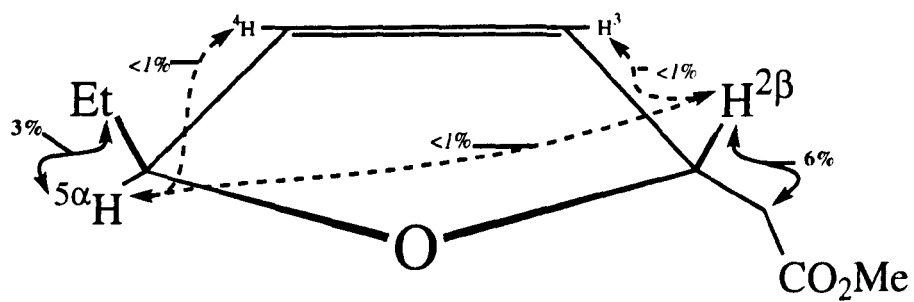

# Chapter 7

---

## References

- 1 (a) W. Oppolzer, Synthesis , 1978, 793; (b) R. L. Funk and K. P. C. Vollhardt, Chem. Soc. Rev. , 1980, 9, 41; (c) T. Kametani and H. Nemoto, Tetrahedron , 1981, 37, 3; (d) J. L. Charlton and M. M. Alauddin, Tetrahedron , 1987, 43, 2873.
- 2 H. Finkelstein, PhD Dissertation, University of Strasbourg, 1910.
- 3 M. P. Cava and A. A. Deana, J. Am. Chem. Soc. , 1959, 81, 4266.
- 4 W. Oppolzer, J. Am. Chem. Soc. , 1971, 93, 3833.
- 5 W. Oppolzer, J. Am. Chem. Soc. , 1971, 93, 3835.
- 6 W. Oppolzer and K. Keller, J. Am. Chem. Soc. , 1971, 93, 3836.
- 7 G. Quinkert, K. Opitz, W. W. Wiersdorff and M. Finke, Annalen , 1966, 693, 44.
- 8 R. B. Woodward and R. Hoffman, *The Conservation of Orbital Symmetry*, Angew. Chem., Int. Ed. Engl. , 1969, 8, 797.
- 9 W. Oppolzer, Synthesis , 1978, 793.
- 10 (a) I. L. Klundt, Chem. Rev. , 1970, 70, 471; (b) R. P. Thummel, Acc. Chem. Res. , 1980, 13, 70.
- 11 J. F. Bunnett and J. A. Skorcz, J. Org. Chem. , 1962, 27, 3836.
- 12 R. L. Funk and K. P. C. Vollhardt, J. Am. Chem. Soc. , 1980, 102, 5245.
- 13 R. L. Hillard and K. P. C. Vollhardt, J. Am. Chem. Soc. , 1977, 99, 4058.
- 14 W. G. L. Aalbersberg, A. J. Barkovich, R. L. Funk, R. L. Hillard, and K. P. C. Vollhardt, J. Am. Chem. Soc. , 1975, 97, 5600.
- 15 R. L. Funk and K. P. C. Vollhardt, J. Am. Chem. Soc. , 1976, 98, 6755.
- 16 R. L. Funk and K. P. C. Vollhardt, J. Chem. Soc., Chem. Commun. , 1976, 833.
- 17 R. L. Funk and K. P. C. Vollhardt, J. Am. Chem. Soc. , 1980, 102, 5253.
- 18 K. P. C. Vollhardt, Angew. Chem., Int. Ed. Engl. , 1984, 23, 539.
- 19 W. Oppolzer, Heterocycles , 1980, 14, 1615.
- 20 W. Oppolzer, D. A. Roberts and T. G. C. Bird, Helv. Chim. Acta. , 1979, 62, 2017.
- 21 W. Oppolzer and D. A. Roberts, Helv. Chim. Acta. , 1980, 63, 1703.

- 22 K. C. Nicolaou and W. E. Barnette, J. Chem. Soc., Chem. Commun. , 1979, 1119.
- 23 K. C. Nicolaou, W. E. Barnette, and P. Ma, J. Org. Chem. , 1980, **45**, 1463.
- 24 T. Durst, F. Jung and R. Van den Elzen, J. Am. Chem. Soc. , 1974, **96**, 935.
- 25 J. L. Charlton and T. Durst, Tetrahedron Lett. , 1984, **25**, 5287.
- 26 J. L. Charlton, T. Durst and D. B. Mount, Can. J. Chem. , 1986, **64**, 246; M. Hrytsak, N. Etkin and T. Durst, Tetrahedron Lett. , 1986, **27**, 5679.
- 27 D. C. Dittmer and M. D. Hoey, J. Org. Chem. , 1991, **56**, 1947.
- 28 K. L. Tseng and J. Michl, J. Am. Chem. Soc. , 1977, **99**, 4840.
- 29 T. Durst and L. Tetreault-Ryan, Tetrahedron Lett. , 1978, 2353.
- 30 Y. S. Shebarov, N. I. Vasilev and R. Y. Levina, Obshch. Khim. , 1961, **31**, 2478.
- 31 K. L. Tseng and J. Michl, J. Am. Chem. Soc. , 1984, **108**, 609.
- 32 R. J. Spangler and B. G. Beckmann, Tetrahedron Lett. , 1976, 2517.
- 33 R. J. Spangler and B. G. Beckmann, and J. H. Kim, J. Org. Chem. , 1977, **42**, 2989.
- 34 W. Oppolzer and B. Delpech, *appearing in review articles 1a and 19 as unpublished results.*
- 35 P. G. Sammes, Tetrahedron , 1976, **32**, 405; J. L. Charlton, K. Koh and G. L. Plourde, Tetrahedron Lett. , 1989, **30**, 3279, *Photoenolisation Review.*
- 36 N. C. Yang and C. Rivas, J. Am. Chem. Soc. , 1976, **98**, 2213; J. L. Charlton and K. Koh, Tetrahedron Lett. , 1988, **29**, 5595.
- 37 F. Nerdel and N. Brodowski, Chem. Ber. , 1968, **101**, 1398.
- 38 E. Block and R. Stevenson, J. Chem. Soc., Chem. Commun. , 1971, 21.
- 39 T. Matsuura and Y. Kitaura, Tetrahedron , 1969, **25**, 4487.
- 40 Y. Kitaura and T. Matsuura, Tetrahedron , 1971, **27**, 1597.
- 41 F. Scully and H. Morrison, J. Chem. Soc., Chem. Commun. , 1973, 529.
- 42 A. C. Pratt, J. Chem. Soc., Chem. Commun. , 1974, 183.
- 43 J. M. Hornback, Tetrahedron Lett. , 1976, 3389.

- 44 J. M. Hornback, L. G. Mawhorter, S. E. Carlson and R. A. Bedont, J. Org. Chem. , 1979, **44**, 3698.
- 45 M. P. Cava and D. R. Napier, J. Am. Chem. Soc. , 1957, **79**, 1701.
- 46 M. P. Cava, A. A. Deana and K. Muth, J. Am. Chem. Soc. , 1959, **81**, 6458; R. D. Rieke and R. M. Wehmyer, J. Org. Chem. , 1988, **53**, 339.
- 47 B. H. Han and P. Boudjouk, J. Org. Chem. , 1982, **47**, 751.
- 48 Y. Ito, M. Nakatsuka and T. Saegusa, J. Am. Chem. Soc. , 1980, **102**, 863.
- 49 Y. Ito, M. Nakatsuka and T. Saegusa, J. Am. Chem. Soc. , 1982, **104**, 7609.
- 50 S. Djuric, T. Sarkar and P. Magnus, J. Am. Chem. Soc. , 1980, **102**, 6885.
- 51 A. Aono, Y. Terao, and K. Achiwa, Chem. Lett. , **1985**, 339.
- 52 S. Askari, S. Lee, R. R. Perkins and J. R. Scheffer, Can. J. Chem. , 1985, **63**, 3526.
- 53 H. Sano and T. Migita, J. Am. Chem. Soc. , 1988, **110**, 2014.
- 54 T. Tuschka, K. Naito and B. Rickborn, J. Org. Chem. , 1983, **48**, 70.
- 55 D. L. Boger, Tetrahedron , 1983, **39**, 2869, *Review of Diels-Alder Cycloadditions of aza-dienes.*
- 56 E. M. Burgess and L. McCullagh, J. Am. Chem. Soc. , 1966, **88**, 1580.
- 57 R. D. Bowen, D. E. Davies, C. W. G. Fishwick, T. O. Glasby, S. J. Noyce and R. C. Storr, Tetrahedron Lett. , 1982, **23**, 4501.
- 58 Y. Ito, S. Miyata, M. Nakatsuka and T. Saegusa, J. Am. Chem. Soc. , 1981, **103**, 5253.
- 59 Y. Ito, E. Nakajo and T. Saegusa, Synth. Commun. , 1986, **16**, 1073.
- 60 K. Kanakarajan and H. Meier, J. Am. Chem. Soc. , 1983, **105**, 881.
- 61 (a) O. L. Chapman, M. R. Engel, J. P. Springer, and J. C. Clardy, J. Am. Chem. Soc. , 1971, **93**, 6696. (b) R. Hug, H. Hansen, and H. Schmid, Helv. Chim. Acta. , 1972, **55**, 1691. (c) L. Crombie, J. Chem. Soc., Perkin Trans. **1** , **1977**, 2402. (d) M. Matsumoto and K. Kuroda, Tetrahedron Lett. , 1981, **22**, 4437.

- 62 J. P. Marino and S. L. Dax, J. Org. Chem. , 1984, **49**, 3672.
- 63 T. Kametani, H. Nemoto, H. Ishikawa, K. Shiroyama and K. Fukumoto, J. Am. Chem. Soc. , 1976, **98**, 3378.
- 64 W. Oppolzer, K. Battig and M. Petrzilka, Helv. Chim. Acta. , 1978, **61**, 1954.
- 65 G. Quinkert, Chimia , 1977, **31**, 225.
- 66 G. Quinkert, U. Schwartz, H. Stark, W. D. Weber, H. Baier, F. Adam and G. Dumer, Angew. Chem., Int. Ed. Engl. , 1980, **19**, 1029.
- 67 (a) T. Kametani, K. Suzuki, and H. Nemoto, J. Chem. Soc., Chem. Commun. , **1979**, 1127. (b) T. Kametani, K. Suzuki and H. Nemoto, Tetrahedron Lett. , 1980, **21**, 1469. (c) T. Kametani, K. Suzuki and H. Nemoto, J. Org. Chem. , 1982, **47**, 2331.
- 68 B. J. Arnold, S. M. Mellows and P. G. Sammes, J. Chem. Soc., Perkin Trans. 1 , **1973**, 1266.
- 69 J. L. Charlton and M. M. Alauddin, J. Org. Chem. , 1986, **51**, 3490.
- 70 S. Takano, S. Otaki and K. Ogasawara, J. Chem. Soc., Chem. Commun., **1985**, 485; M. E. Jung and G. T. Lowen, Tetrahedron Lett. , 1986, **27**, 5319.
- 71 S. Takano, S. Otaki and K. Ogasawara, Heterocycles , 1985, **23**, 2811.
- 72 (a) T. Kametani and K. Fukumoto, Heterocycles , 1975, **3**, 29. (b) T. Kametani and K. Fukumoto, Heterocycles , 1977, **8**, 519. (c) T. Kametani, Y. Katoh and K. Fukumoto, J. Chem. Soc., Perkin Trans. 1 , **1974**, 1712.
- 73 T. Kametani, M. Kajiwara, T. Takahashi and K. Fukumoto, J. Chem. Soc., Perkin Trans. 1 , **1975**, 737.
- 74 Y. Ito, E. Nakajo, M. Nakatsuka, and T. Saegusa, Tetrahedron Lett. , 1983, **24**, 2881.
- 75 (a) R. Fujimoto, Y. Kishi and J. F. Blount, J. Am. Chem. Soc. , 1980, **102**, 7156. (b) R. Fujimoto and Y. Kishi, Tetrahedron Lett. , 1981, **22**, 4197.
- 76 (a) F. A. J. Kerdesky and M. P. Cava, J. Am. Chem. Soc. , 1978, **100**, 3635. (b) R. J. Ardecky, D. Dominguez and M. P. Cava, J. Org. Chem. , 1982, **47**, 409.



- 77 (a) T. Kametani, Y. Hirai, F. Satoh and K. Fukumoto, Chem. Pharm. Bull. , 1974, **22**, 2159. (b) J. R. Wiseman, N. I. French, R. K. Hallmark and K. G. Chiong, Tetrahedron Lett. , 1978, **19**, 3765. (c) T. Kametani, M. Chihiro, M. Takashita, K. Takahashi, K. Fukumoto and S. Takano, Chem. Pharm. Bull. , 1978, **26**, 3820.
- 78 *For a Review of the Asymmetric Diels-Alder Reaction, see* W. Oppolzer, Angew. Chem., Int. Ed. Engl. , 1984, **23**, 876,
- 79 Y. Ito, Y. Amino, M. Nakatsuka and T. Saegusa, J. Am. Chem. Soc. , 1983, **105**, 1536.
- 80 B. M. Trost, D. O'Krongly and J. L. Belletire, J. Am. Chem. Soc. , 1980, **102**, 7595.
- 81 J. L. Charlton, Tetrahedron Lett. , 1985, **26**, 3413.
- 82 J. L. Charlton, Can. J. Chem. , 1986, **64**, 720.
- 83 R. W. Franck, T. V. John, K. Olejniczak and J. F. Blount, J. Am. Chem. Soc. , 1982, **104**, 1106.
- 84 J. Kang, Y. R. Choi, B. J. Kim, J. U. Jeong, S. Lee, J. H. Lee and C. Pyum, Tetrahedron Lett. , 1990, **31**, 2713.
- 85 *For a review of this strategy, see* C. Kaneko and T. Naito, Heterocycles, 1982, **11**, 2183.
- 86 R. P. Thummel and D. K. Kohli, Tetrahedron Lett. , 1977, 143.
- 87 J. M. Riemann and W. S. Trahanovsky, Tetrahedron Lett. , 1977, 1867.
- 88 W. D. Crow, A. N. Khan and M. N. Paddon-Row, Aust. J. Chem. , 1975, **28**, 1741.
- 89 D. C. Neckers and F. L. Wagenaar, J. Org. Chem. , 1981, **46**, 3939.
- 90 A. Schweig and M. Munzel, Angew. Chem., Int. Ed. Engl. , 1987, **26**, 474.
- 91 C. Kaneko and T. Naito, Chem. Pharm. Bull. , 1979, **27**, 2254.
- 92 C. Kaneko and T. Naito, Tetrahedron Lett. , 1981, **22**, 2671.
- 93 H. Fujii, K. Shiba and C. Kaneko, J. Chem. Soc., Chem. Commun. , 1980, 537.
- 94 T. Naito, N. Nakayama and C. Kaneko, Chem. Lett. , 1981, 423.
- 95 Y. Momose and C. Kaneko, *appearing in review article 1c as unpublished results* .
- 96 C. Kaneko and N. Shimomura, Tetrahedron Lett. , 1982, **23**, 2571.

- 97 C. Kaneko, T. Naito and M. Ito, Tetrahedron Lett. , 1980, **21**, 1645.
- 98 C. Kaneko, T. Naito and H. Fujii, Abstracts of Papers , Osaka, Japan, April, **1982**, 475, *Presented at the 102nd Annual Meeting of the Pharmaceutical Society of Japan.*
- 99 C. Kaneko, T. Naito, H. Fujii, Y. Momose, T. Adachi and C. Miwa, Abstracts of Papers , Toyama, Japan, Nov. **1981**, 88-91, *Presented at the 8th Symposium On Progress In Organic Reactions and Synthesis.*
- 100 R. C. Storr, A. P. A. Crew, G. Jenkins and M. Yelland, Tetrahedron Lett. , 1990, **31**, 1491.
- 101 E. Spinner and G. B. Yeoh, J. Chem. Soc. Trans. 1 , 1971, 289.
- 102 T. Chou and R. C. Chang, J. Chem. Soc. , Chem. Commun. , 1992, 549.
- 103 Y. Tamura, S. Mohri, H. Maeda, T. Tsugoshi, H. Maeda and Y. Kita, Chem. Pharm. Bull. , 1985, **33**, 4723; Y. Tamura, S. Mohri, H. Maeda, T. Tsugoshi, M. Sasho and Y. Kita, Tetrahedron Lett. , 1984, **25**, 309.
- 104 C. J. Moody, P. M. Jackson and P. Shah, J. Chem. Soc. Perkin Trans. 1 , 1990, 2909.
- 105 A. M. van Leusen and K. J. van den Berg, Tetrahedron Lett. , 1988, **29**, 2689.
- 106 C. J. Moody, P. M. Jackson and P. Shah, Tetrahedron Lett. , 1988, **29**, 5817; C. J. Moody, J. Chem. Soc. , Perkin Trans. 1 , 1985, 2505.
- 107 R. A. Barnes and H. M. Fales, J. Am. Chem. Soc. , 1953, **75**, 3830.
- 108 B. Saroja and P. C. Srinivasan, Tetrahedron Lett. , 1984, **25**, 5429.
- 109 M. K. Shepherd, J. Chem. Soc. , Perkin Trans. 1 , 1986, 1495.
- 110 D. J. Chadwick and A. Plant, Tetrahedron Lett. , 1987, **28**, 6085.
- 111 A. M. van Leusen and K. J. van den Berg, J. Chem. Soc. , Perkin Trans. 1 , 1988, 1050.
- 112 W. S. Trahanovsky, T. J. Cassady and T. L. Woods, J. Am. Chem. Soc. , 1981, **103**, 6691; W. S. Trahanovsky, T. J. Cassady, J. Am. Chem. Soc. , 1984, **106**, 8197.
- 113 R. C. Storr, P. M. S. Chauhan, G. Jenkins and S. M. Walker, Tetrahedron Lett. , 1988, **29**, 117.
- 114 R. C. Storr, P. M. S. Chauhan, A. P. A. Crew, G. Jenkins, S. M. Walker

- and M. Yelland, Tetrahedron Lett. , 1990, **31**, 1487.
- 115 J. Bergman and R. Carlson, Tetrahedron Lett. , **1977**, 4663.
- 116 J. Bergman and R. Carlson, Tetrahedron Lett. , **1978**, 4055.
- 117 S. Kano, E. Sugino, S. Shibuya and S. Hibino, J. Org. Chem. , 1981, **46**, 2979.
- 118 T. Gallagher and P. Magnus, Tetrahedron , 1981, **37**, 3889.
- 119 T. Gallagher, P. Magnus and J. C. Huffman, J. Am. Chem. Soc. , 1982, **104**, 1140.
- 120 *For a review of Indole Quinodimethane Strategy in Alkaloid Synthesis.* see T. Gallagher, P. Magnus, P. Brown and P. Pappalardo, Acc. Chem. Res. , 1984, **17**, 35,
- 121 T. Gallagher and P. Magnus, J. Am. Chem. Soc. , 1983, **105**, 2086.
- 122 P. Magnus, C. Exon and N. L. Sear, Tetrahedron , 1983, **39**, 3725.
- 123 P. Magnus, C. Exon and N. L. Sear, Tetrahedron , 1984, **40**, 2795.
- 124 P. Magnus, P.M. Cairns and C. S. Kim, Tetrahedron Lett. , 1985, **26**, 1963.
- 125 K. Cardwell, B. Hewitt and P. Magnus, Tetrahedron Lett. , 1987, **28**, 3303.
- 126 E. R. Marinelli, Tetrahedron Lett. , 1982, **23**, 2745.
- 127 U. Pindur and H. Erfanian-Abdoust, Chem. Rev. , 1989, **89**, 1681.
- 128 W. S. Trahanovsky and C. H. Chou, J. Org. Chem. , 1986, **51**, 4208; T. Kametani, T. Honda, Y. Ebisawa and H. Ichikawa, Tetrahedron , 1985, **41**, 3643.
- 129 D. W. Knight and A. P. Nott, J. Chem. Soc., Perkin Trans. 1, **1981**, 1125.
- 130 D. W. Knight and A. P. Nott, J. Chem. Soc., Perkin Trans. 1, **1983**, 791.
- 131 C. D. Buttery, D. W. Knight and A. P. Nott, J. Chem. Soc., Perkin Trans. 1, **1984**, 2839.
- 132 C. D. Buttery, PhD Dissertation, University of Nottingham, **1985**; C. P. Dell and D. W. Knight, J. Chem. Soc., Chem. Commun. , **1987**, 349.
- 133 S. B. Bedford, P. Cornwall and D. W. Knight, Synlett. , **1991**, 627.
- 134 P. Cornwall, PhD Dissertation, University of Nottingham, **1990**.

- 135 F. G. Gonzalez, F. J. L. Aparicio and F. Sanchez-Laulhe, Anales Real Soc. Fis. Y Quim. (Madrid), 1954, **50b**, 407.
- 136 M. Tada and T. Takahashi, Chem. Lett., **1978**, 275; G. Beese and B. A. Keay, Synlett., **1991**, 33; E. J. Bures and B. A. Keay, Tetrahedron Lett., 1987, **28**, 5965.
- 137 (a) W. R. Beohme, Org. Synth., 1963, **Col Vol IV**, 590; (b) B. Sila, Rocz. Chem., 1969, **43**, 1413.
- 138 R. Royer, E. Bisagni, C. Hudry, A. Cheutin and M. L. Desvoye, Bull. Soc. Chim. Fr., **1963**, 1003.
- 139 B. K. Wasson, P. Hamel and C. S. Rooney, J. Org. Chem., 1977, **42**, 4265.
- 140 B. M. Trost and D. M. T. Chan, J. Am. Chem. Soc., 1983, **105**, 2315.
- 141 V. Boekelheide, Acc. Chem. Res., 1980, **13**, 65.
- 142 Y. Sekine, M. Brown and V. Boekelheide, J. Am. Chem. Soc., 1979, **101**, 3126.
- 143 C. J. Burns, M. Gill and A. Gimenez, Tetrahedron Lett., 1989, **30**, 7269.
- 144 I thank Dr M. J. Begley (University of Nottingham) for these data.
- 145 I. Fleming, "Frontier Orbitals and Organic Chemical Reactions", John Wiley and Sons, London, **1982**.
- 146 W. S. Trahanovsky and C. H. Chou, J. Am. Chem. Soc., 1986, **108**, 4138.
- 147 W. S. Trahanovsky and C. H. Chou, D. R. Fischer and B. C. Gerstein, J. Am. Chem. Soc., 1988, **110**, 6579.
- 148 R. J. Moss and B. Rickborn, J. Org. Chem., 1984, **49**, 3694.
- 149 R. J. Moss, R. O. White and B. Rickborn, J. Org. Chem., 1985, **50**, 5132.
- 150 M. Miyano, J. Am. Chem. Soc., 1965, **87**, 3958.
- 151 J. Zabicky, "The Chemistry of Amides", pp. 795-801, Interscience, New York, **1970**.
- 152 H. C. Brown, S. Narasimhan and Y. M. Choi, Synthesis, **1981**, 996.
- 153 K. Benkeser, C. H. Li and S. Mozdzen, J. Organomet. Chem., 1979, **178**, 21.
- 154 G. L. Lange and C. Gottardo, Synth. Commun., 1990, **20**, 1473.

- 155 J. W. Westley, Polyether Antibiotics: Naturally Occurring Acid Ionophores, **Vols I and II**, M. Dekker, New York, 1982.
- 156 G. R. Painter and B. C. Pressman, Top. Curr. Chem. , 1982, **101**, 83; B. C. Pressman, E. I. Harris, W. S. Jagger and J. M. Johnson, Proc. Natl. Acad. Sci. U.S.A. , 1967, **58**, 1949.
- 157 J. W. Westley, Annu. Rev. Med. Chem. , 1975, **10**, 246; J. W. Westley, Adv. Appl. Microbiol. , 1977, **22**, 172; B. C. Pressman, Annu. Rev. Biochem. , 1976, **45**, 501.
- 158 M. D. Ruff, Polyether Antibiotics: Naturally Occurring Acid Ionophores, **Vol. I**, Ch. 6, M. Dekker, New York, 1982.
- 159 H. G. Hanley and J. D. Slack, Ref. 158, Ch. 8; P. W. Reed and G. M. Bokoch, Ref. 158, Ch. 9; M. W. Osborne, J. Wenger, M. Zanko, F. Kovzelove and M. R. Cohen, Ref. 158, Ch. 10.
- 160 D. A. Evans, C. E. Sacks, W. A. Kleschick and T. R. Taber, J. Am. Chem. Soc. , 1979, **101**, 6789; P. A. Grieco, E. Williams, H. Tanaka and S. Gilan, J. Org. Chem. , 1980, **45**, 3537; G. R. Martinez, P. A. Grieco, E. Williams, K. Williams and C. V. Srinivasan, J. Am. Chem. Soc. , 1982, **104**, 1436.
- 161 T. Nakata, G. Schmid, B. Vranesic, M. Okigawa, T. Smith-Palmer and Y. Kishi, J. Am. Chem. Soc. , 1978, **100**, 2933; R. E. Ireland, R. C. Anderson, R. Badoud, B. J. Fitzsimmons, G. J. McGarvey, S. Thaisrivongs and C. S. Wilcox, J. Am. Chem. Soc. , 1983, **105**, 1988.
- 162 R. E. Ireland, L. Courtney and B. J. Fitzsimmons, J. Org. Chem. , 1983, **48**, 5186.
- 163 G. Schmid, T. Fukuyama, K. Akasaka and Y. Kishi, J. Am. Chem. Soc. , 1979, **101**, 259; T. Fukuyama, C. L. J. Wang and Y. Kishi, J. Am. Chem. Soc. , 1979, **101**, 260; T. Fukuyama, K. Akasaka, D. S. Karanewsky, C. L. J. Wang and Y. Kishi, J. Am. Chem. Soc. , 1979, **101**, 262; (a) D. B. Collum, J. H. McDonald and W. C. Still, J. Am. Chem. Soc. , 1980, **102**,

- 2117; D. B. Collum, J. H. McDonald and W. C. Still, J. Am. Chem. Soc. , 1980, **102**, 2118; J. H. McDonald and W. C. Still, J. Am. Chem. Soc. , 1980, **102**, 2120; (b) M. M. Ponpipom, R. L. Bugianesi and J. C. Chabala, Tetrahedron Lett. , 1988, **29**, 6211.
- 164 Y. Kishi, S. Hatakeyama and M. D. Lewis, Front. Chem. , Plenary Keynote Lecture , IUPAC Congr. , 28th, **1981**, p. 287. Pergamon Press, Oxford; Y. Kishi, Aldrichimica. Acta. , 1980, **13**, 23.
- 165 K. C. Nicolaou, D. P. Papahatjis, D. A. Claremon and R. E. Dole, J. Am. Chem. Soc. , 1981, **103**, 6967; K. C. Nicolaou, D. A. Claremon, D. P. Papahatjis and R. L. Magolda, J. Am. Chem. Soc. 1981, **103**, 6969; M. P. Edwards, S. V. Ley, S. G. Lister and B. D. Palmer, J. Chem. Soc. , Chem. Comm. , **1983**, 630.
- 166 M. Isobe, Y. Ichikawa and T. Goto, Tetrahedron Lett. , 1986, **27**, 963.
- 167 J. M. Tedder, A. Nechvatal, A. W. Murray and J. Carnduff, Basic Organic Chemistry, Part. 4; Natural Products, Wiley, **1972**; F. Freeman and K. D. Robarge, J. Org. Chem. , 1989, **54**, 346; M. C. Bowden and G. Pattenden, Tetrahedron Lett. , 1988, **29**, 711; E. J. Corey and D. C. Ha, Tetrahedron Lett. , 1988, **29**, 3171; B. Riss and B Muckensturm, Tetrahedron, 1989, **45**, 2591.
- 168 P. A. Bartlett, Tetrahedron, 1980, **36**, 2; P. Kocovsky and M. Pour, J. Org. Chem. , 1990, **55**, 5580.
- 169 P. A. Bartlett, "*Cyclization Forming Carbon-Heteroatom Bonds in Asymmetric Syntheses*", ed. J. D. Morrison, Academic Press, Orlanda, 1984, **3**, 144.
- 170 J. E. Semple and M. M. Joullie, Heterocycles, 1980, **14**, 1825.
- 171 T. L. B. Bolvin, Tetrahedron, 1987, **43**, 3309.
- 172 D. L. J. Clive, G Chittattu, N. Curtis, W. A. Keil and C. K. Wong, J. Chem. Soc. , Chem. Commun. , **1977**, 725.
- 173 V. I. Staninets and E. A. Shilov, Russ. Chem. Rev. (Engl. Transl.), 1971, **40**, 272.

- 174 M. D. Dowle and D. I. Davies, Chem. Soc. Rev. , **1979**, 171.
- 175 J. E. Baldwin, J. Chem. Soc. , Chem. Commun. , **1976**, 734; J. E. Baldwin, J. Org. Chem. , 1977, **42**, 3846; J. E. Baldwin, Tetrahedron , 1982, **38**, 2939.
- 176 A. Bongini, G. Cardillo, M. Orena, S. Sandri and C. Tomasini, J. Chem. Soc. , Perkin Trans 1. , **1986**, 1339.
- 177 A. Bongini, G. Cardillo, M. Orena, S. Sandri and C. Tomasini, J. Chem. Soc. , Perkin Trans 1. , **1986**, 1345.
- 178 Y. Tamaru, M. Hojo, S. Kawamura, S. Sawada and Z. Yoshida, J. Org. Chem. , 1987, **52**, 4062.
- 179 A. Hassner and C. C. Heathcock, Tetrahedron Lett. , **1964**, 1125.
- 180 L. Amaral and S. C. Melo, J. Org. Chem. , 1973, **38**, 800.
- 181 R. G. Bennett, J. T. Doi and W. K. Musker, J. Org. Chem. , 1985, **50**, 2048.
- 182 D. L. H. Williams, E. G. Bienvenue and J. E. Dubois, J. Chem. Soc. , **1969**, 517.
- 183 P. A. Bartlett and S. D. Rychnovsky, J. Am. Chem. Soc. , 1981, **103**, 3963.
- 184 A. R. Chamberlin, R. L. Mulholland, S. D. Kahn and W. J. Hehre, J. Am. Chem. Soc. , 1987, **109**, 672.
- 185 Y. Tamaru, S. Kawamura and Z. Yoshida, Tetrahedron Lett. , 1985, **26**, 2885.
- 186 D. R. Williams and F. H. White, Tetrahedron Lett. , 1986, **27**, 2195.
- 187 D. R. Williams and F. H. White, J. Org. Chem. , 1987, **52**, 5067.
- 188 *For reviews of the selenoetherification reaction, see* K. B. Sharpless, K. M. Gordon, R. F. Lauer, D. W. Patrick, S. P. Singer and M. W. Young, Chem. Scr. , 1975, **8A**, 9; H. J. Reich, *Oxidation in Organic Chemistry, Part C*, 1978, Academic Press, New York; H. J. Reich, Acc. Chem. Res. , 1979, **12**, 22; D. L. J. Clive, Tetrahedron, 1978, **34**, 1049; D. L. J. Clive, Aldrichimica Acta , 1978, **11**, 43; K. C. Nicolaou, Tetrahedron, 1981, **37**,

4097, and references therein.

- 189 K. C. Nicolaou, R. L. Magolda, W.J. Sipo, W. E. Barnette, Z. Lysenko and M. M. Joullie, J. Am. Chem. Soc. , 1980, **102**, 3784; K. C. Nicolaou and Z. Lysenko, Tetrahedron Lett. , 1977, 1257; D. L. J. Clive, G. Chittattu and C. K. Wong, Can. J. Chem. , 1977, **55**, 3894.
- 190 D. Liotta, Acc. Chem. Res. , 1984, **17**, 28.
- 191 S. Torii, K. Uneyama, M. Ono and T. Bannou, J. Am. Chem. Soc. , 1981, **103**, 4606.
- 192 K. Uneyama, M. Ono and S. Torii, Phosphorus and Sulphur. , 1983, **16**, 35.
- 193 K. Uneyama, M. Ono and S. Torii, Tetrahedron Lett. , 1980, **21**, 2653.
- 194 K. Uneyama, M. Ono and S. Torii, Tetrahedron Lett. , 1980, **21**, 2741.
- 195 M. L. Mihailovic, S. Konstantinovic and R. Vukicevic, Tetrahedron Lett. , 1987, **28**, 4343.
- 196 S. H. Kang, T. S. Hwang, W. J. Kim and J. K. Lim, Tetrahedron Lett. , 1991, **32**, 4015, and references therein.
- 197 S. H. Kang, T. S. Hwang, W. J. Kim and J. K. Lim, Tetrahedron Lett. , 1990, **31**, 5917.
- 198 G. Cardillo and M. Orena, Tetrahedron, 1990, **46**, 3321.
- 199 D. R. Williams, J. Grote and Y. Harigaya, Tetrahedron Lett. , 1984, **25**, 5231.
- 200 E. D. Mihelich, J. Am. Chem. Soc. , 1990, **112**, 8995.
- 201 E. D. Mihelich, K. Daniels and D. J. Eickhoff, J. Am. Chem. Soc. , 1981, **103**, 7690.
- 202 K. B. Sharpless and R. F. Lauer, J. Am. Chem. Soc. , 1973, **95**, 2697.
- 203 S. Murata and T. Suzuki, Tetrahedron Lett. , 1987, **28**, 4297.
- 204 S. Murata and T. Suzuki, Chem. Lett. , 1987, 849.
- 205 S. Murata and T. Suzuki, Tetrahedron Lett. , 1987, **28**, 4415.
- 206 V. K. Aggarwal and S. Warren, Tetrahedron Lett. , 1986, **27**, 101.



- 207 V. K. Aggarwal and S. Warren, Tetrahedron Lett. , 1987, **28**, 1925.
- 208 V. K. Aggarwal, I. Coldham, S. McIntyre, F. H. Sansbury, M. J. Villa and S. Warren, Tetrahedron Lett. , 1988, **29**, 4885.
- 209 I. Coldham, E. W. Collington, P. Hallett and S. Warren, Tetrahedron Lett. , 1988, **29**, 5321; A. G. M. Barrett, J. A. Flygare and C. D. Spilling, J. Org. Chem. , 1989, **54**, 4723.
- 210 D. R. Williams, B. A. Barner and J. G. Phillips, J. Am. Chem. Soc. , 1981, **103**, 7398.
- 211 D. R. Williams and J. G. Phillips, Tetrahedron, 1986, **42**, 3013.
- 212 S. M. Tuladhar and A. G. Fallis, Tetrahedron Lett. , 1987, **28**, 523; S. M. Tuladhar and A. G. Fallis, Can. J. Chem. , 1987, **65**, 1833.
- 213 S. McIntyre and S. Warren, Tetrahedron Lett. , 1990, **31**, 3457.
- 214 A. J. Kirby, Adv. in Physical Org. Chem. , 1980, **17**, 183; L. Mandolini, Ibid. , 1986, **22**, 1.
- 215 J. E. Baldwin and L. T. Kruse, J. Chem. Soc. , Chem. Commun. , **1977**, 233.
- 216 K. B. Sharpless and R. C. Michaelson, J. Am. Chem. Soc. , 1973, **95**, 6136; S. Tanaka, H. Yamamoto, H. Nozaki, K. B. Sharpless and R. C. Michaelson, J. Am. Chem. Soc. , 1973, **96**, 5254; A. O. Chong and K. B. Sharpless, J. Org. Chem. , 1977, **42**, 1587; R. L. Mulholland and A. R. Chamberlin, J. Org. Chem. , 1988, **53**, 1082.
- 217 T. Fukuyama, B. Vranesic, D. P. Negri and Y. Kishi, Tetrahedron Lett. , **1978**, 2741.
- 218 T. Nakata and Y. Kishi, Tetrahedron Lett. , **1978**, 2745.
- 219 T. Katsuki and K. B. Sharpless, J. Am. Chem. Soc. , 1980, **102**, 5974; S. S. Woodard, M. G. Finn and K. B. Sharpless, Pure Appl. Chem. , 1983, **55**, 1823.
- 220 P. G. M. Wuts, R. D'Costa and W. Butler, J. Org. Chem. , 1984, **49**, 2582.
- 221 R. Amouroux, F. Chastrette and M. Chastrette, J. Heterocyclic Chem. ,

- 1981, **18**, 565; T. Otsubo and F. Ogura, J. Org. Chem. , 1989, **54**, 4391.
- 222 B. Giese, Angew. Chem., Int. Ed. Engl. , 1983, **22**, 753.
- 223 R. Amouroux, G. Folefoc, F. Chastrette and M. Chastrette, Tetrahedron Lett. , 1981, **22**, 2259.
- 224 V. Speziale, J. Roussel and A. Lattes, J. Heterocyclic Chem. , 1974, **11**, 771; R. D. Walkup and G. Park, Tetrahedron Lett. , 1988, **29**, 5505.
- 225 B. M. Trost and A. Tenaglia, Tetrahedron Lett. , 1988, **29**, 2927; B. M. Trost, E. D. Edstrom and M. B. C. Petillo, J. Org. Chem. , 1989, **54**, 4489; J. Adams, M. A. Poupart, L. Grenier, C. Schaller, N. Ouimet and R. Frenette, Tetrahedron Lett. , 1989, **30**, 1749.
- 226 M. F. Semmelhack and N. Zhang, J. Org. Chem. , 1989, **54**, 4483.
- 227 E. Klein and W. Rojahn, Tetrahedron, 1965, **21**, 2353.
- 228 D. M. Walba, M. D. Wand and M. C. Wilkes, J. Am. Chem. Soc. , 1979, **101**, 4396.
- 229 J. E. Baldwin, M. J. Crossley and E. M. M. Lehtomen, J. Chem. Soc., Chem. Commun. , 1979, 918.
- 230 K. B. Sharpless, A. Y. Teranishi and J. E. Backvall, J. Am. Chem. Soc. , 1977, **99**, 3120; A. K. Rappe and W. A. Goddard, J. Am. Chem. Soc. , 1980, **102**, 5115.
- 231 S. Wolfe and C. F. Ingold, J. Am. Chem. Soc. , 1981, **103**, 940.
- 232 D. M. Walba and G. S. Stoudt, Tetrahedron Lett. , 1982, **23**, 727.
- 233 B. D. Hammock, S. S. Gill and J. E. Casida, J. Agric. Food Chem. , 1974, **22**, 379.
- 234 R. Ratcliffe and R. Rodehorst, J. Org. Chem. , 1970, **35**, 4000.
- 235 E. J. Corey and W. J. Suggs, Tetrahedron Lett. , 1975, 2647.
- 236 F. S. Guziec and F. A. Luzzio, Synthesis , 1980, 691.
- 237 R. E. Ireland, R. H. Mueller and A. K. Willard, J. Am. Chem. Soc. , 1976, **98**, 2868.
- 238 R. E. Ireland, S. Thaisrivongs, N. Vanier and C. S. Wilcox, J. Org. Chem. ,

- 1980, **45**, 48.
- 239 R. E. Ireland, S. Thaisrivongs and C. S. Wilcox, J. Org. Chem. , 1978, **43**, 786.
- 240 E. J. Corey and A. W. Gross, Tetrahedron Lett. , 1984, **25**, 495.
- 241 R. E. Ireland, D. W. Norbeck and D. Habich, J. Am. Chem. Soc. , 1985, **107**, 3271; R. E. Ireland and D. W. Norbeck, J. Am. Chem. Soc. , 1985, **107**, 3279; R. E. Ireland, D. W. Norbeck, G. S. Mandel and N. S. Mandel, J. Am. Chem. Soc. , 1985, **107**, 3285.
- 242 P. C. Ting and P. A. Bartlett, J. Am. Chem. Soc. , 1984, **106**, 2668.
- 243 P. A. Bartlett and C. Chapuis, J. Org. Chem. , 1986, **51**, 2799.
- 244 J. P. Michael, P. C. Ting and P. A. Bartlett, J. Org. Chem. , 1985, **50**, 2416; H. M. C. Ferraz and T. J. Brocksom, Tetrahedron Lett. , 1986, **27**, 811.
- 245 H. Frauenrath and J. Runsink, J. Org. Chem. , 1987, **52**, 2707.
- 246 S. G. Davies, M. E. C. Polywka and S. E. Thomas, J. Chem. Soc., Perkin Trans 1 , 1986, 1277; A. G. M. Barrett, T. E. Barta and J. A. Flygare, J. Org. Chem. , 1989, **54**, 4246.
- 247 C. Bruckner, H. Holzinger and H. U. Reissig, J. Org. Chem. , 1988, **53**, 2450.
- 248 E. Alvarez, E. Manta, J. D. Martin, M. L. Rodriguez and C. R. Perez, Tetrahedron Lett. , 1988, **29**, 2093; E. Alvarez, E. Manta, J. D. Martin, M. L. Rodriguez, D. Zurita and C. R. Perez, Tetrahedron Lett. , 1988, **29**, 2097. K. G. Unth, J. D. Martin and N. T. Castelluci, J. Org. Chem. , 1965, **30**, 3572.
- 249 O. Moriya, Y. Urata, Y. Ikeda, Y. Ueno and T. Endo, J. Org. Chem. , 1986, **51**, 4708.
- 250 Y. Watanabe and T. Endo, Tetrahedron Lett. , 1988, **29**, 321.
- 251 A. Johns and J. A. Murphy, Tetrahedron Lett. , 1988, **29**, 837; D. H. R. Barton, E. Castagnino and S. Corsano, Tetrahedron Lett. , 1989, **30**, 2983; D. S. Middleton and N. S. Simpkins, Tetrahedron Lett. , 1988, **29**,

1315.

- 252 R. L. Danheiser, C. A. Kwasigroch and Y. M. Tsai, J. Am. Chem. Soc. , 1985, **107**, 7233; J. P. Marino and E. Laborde, J. Org. Chem. , 1987, **52**, 1; B. M. Trost and S. A. King, Tetrahedron Lett. , 1986, **27**, 5971; R. D. Little, H. Bode and K. J. Stone, J. Org. Chem. , 1985, **50**, 2400; B. M. Trost and P. J. J. Bonk, J. Am. Chem. Soc. , 1985, **107**, 1778.
- 253 A. Padwa, S. P. Carter and H. Nimmesgern, J. Org. Chem. , 1986, **51**, 1157; J. B. Hendrickson and J. S. Farina, J. Org. Chem. , 1980, **45**, 3359; P. G. Sammes and R. J. Whitby, J. Chem. Soc., Chem. Commun. , **1984**, 702;.
- 254 K. S. Feldman and T. E. Fisher, Tetrahedron, 1989, **45**, 2969.
- 255 D. J. Hart, Science, 1984, **223**, 883; M. Huhtasaari, H. J. Schafer and L. Becking, Angew. Chem. Int. Ed. Engl. , 1984, **23**, 980.
- 256 V. N. Drozd, Y. A. Ustynyuk and M. A. Tseleva, Obsch. Khim. , 1968, **38**, 2114; J. Denis, T. Dolzine and R. J. Oliver, J. Am. Chem. Soc. , 1972, **94**, 8260; H. G. Richey and H. Veale, J. Am. Chem. Soc. , 1974, **96**, 2641; F. J. Garst, J. B. Hines and J. D. Bruhnke, Tetrahedron Lett. , 1986, **27**, 1963; E. C. Ashby, J. Org. Chem. , 1987, **52**, 1291.
- 257 C. A. Broka, W. J. Lee and T. Shen, J. Org. Chem. , 1988, **53**, 1336.
- 258 A. S. Rao, S. K. Pakniker and J. G. Kirtane, Tetrahedron, 1983, **39**, 2323; J. G. Smith, Synthesis, 1984, 629.
- 259 T. A. Bryson, J. Org. Chem. , 1973, **38**, 3428.
- 260 M. Yamaguchi and I. Hirao, Chem. Lett. , **1985**, 337.
- 261 B. Lygo, N. O'Connor and P. R. Wilson, Tetrahedron, 1988, **44**, 6881.
- 262 B. Lygo, Tetrahedron, 1988, **44**, 6889.
- 263 Y. Oikawa, K. Horita and O. Yonemitsu, Heterocycles , 1985, **23**, 553.
- 264 S. S. Ko, L. L. Klein, K. P. Pfaff and Y. Kishi, Tetrahedron Lett. , 1982, **23**, 4415.
- 265 J. E. Baldwin, R. M. Adlington and N. G. Robinson, Tetrahedron Lett. , 1988, **29**, 375.

- 266 H. Dehmlow, J. Mulzer, C. Seilz, A. R. Strecker and A. Kohlmann, Tetrahedron Lett. , 1992, **33**, 3607.
- 267 A. H. Davidson, L. R. Hughes, S. S. Qureshi and B. Wright, Tetrahedron Lett. , 1988, **29**, 693; S. Hanessian and A. G. Pernet, Adv. Carbohydr. Chem. and Biochem. , 1976, **33**, 111; J. G. Buchanan, Prog. Chem. Org. Nat. Prod. , 1983, **44**, 243; M. L. Shulman, D. Svetlana, S. D. Shiyan and A. Y. Khorlin, Carbohydr. Res. , 1974, **33**, 229; M. Chmielewski, J. N. Bemiller and D. P. Cerretti, J. Am. Chem. Soc. , 1981, **97**, 1; S. Hanessian, T. Ogawa and Y. Guindon, Carbohydr. Res. , 1974, **38**, Chap 12.
- 268 S. Hanessian, P. C. Tyler, G. Demailly and Y. Chapleur, J. Am. Chem. Soc. , 1981, **103**, 6243.
- 269 J. K. Crandall and D. J. Batal, Tetrahedron Lett. , 1988, **29**, 4791.
- 270 F. Bennett, G. Fenton and D. W. Knight, J. Chem. Soc., Perkin Trans 1 , **1991**, 133.
- 271 F. Bennett, G. Fenton and D. W. Knight, J. Chem. Soc., Perkin Trans 1 , **1991**, 1543.
- 272 P. A. Bartlett, D. P. Richardson and J. Myerson, Tetrahedron, 1984, **40**, 2317; W. Bartmann, G. Beck, E. Granzer, H. Jendralla, B. V. Kerekjarto and G. Wess, Tetrahedron Lett. , 1986, **27**, 4709.
- 273 S. B. Bedford, G. Fenton, D. Shaw and D. W. Knight, Tetrahedron Lett. , 1992, **43**, 6505.
- 274 S. B. Bedford, F. Bennett, G. Fenton, D. Shaw and D. W. Knight, Tetrahedron Lett. , 1992, **43**, 6507.
- 275 S. B. Bedford, G. Fenton, D. Shaw and D. W. Knight, Tetrahedron Lett. , 1992, **43**, 6511.
- 276 S. M. Hannick and Y. Kishi, J. Org. Chem. , 1983, **48**, 3833; G. W. Anderson, I. F. Halvstadt, W. H. Miller and R. O. Roblin, J. Am. Chem. Soc. , 1945, **67**, 2197, and references therein.

- 277 H. Hamana and T. Sugawara, Chem. Lett. , 1985, 921.
- 278 C. J. Sih and C. S. Chen, Angew. Chem. , Int. Ed. Engl. , 1984, **23**, 570; S. Butt and S. M. Roberts, Nat. Prod. Rep. , 1986, **3**, 489; S. Servi, Synthesis, 1990, 1.
- 279 (a) D. Seebach, M. A. Sutter, R. H. Weber and M. F. Zuger, Org. Synth. , 1985, **63**, 1, and references therein; (b) M. Kitamura, T. Ohkuma, H. Takaya and R. Noyori, Tetrahedron Lett. , 1988, **29**, 1555; M. Kitamura, T. Ohkuma, S. Inoue, N. Sayo, H. Kumobayashi and R. Noyori, J. Am. Chem. Soc. , 1988, **110**, 629; K. Soai, T. Yamanoi, H. Hikima and H. Oyamada, J. Chem. Soc. , Chem. Commun. , 1985, 138.
- 280 J. A. Dale, D. L. Dull and H. S. Mosher, J. Org. Chem. , 1969, **34**, 2543.
- 281 K. Nakamura, K. Inoue, K. Ushio, S. Oka and A. Ohno, Chem. Lett. , 1987, 679.
- 282 M. Hirama, M. Shimizu and M. Iwashita, J. Chem. Soc. , Chem. Commun. , 1983, 599; K. Hayakawa, F. Nogatsugi and K. Kanematsu, J. Org. Chem. , 1988, **53**, 860.
- 283 A. Manzocchi, R. Casati, A. Fiecchi and E. Santaniello, J. Chem. Soc. , Perkin Trans. 1, 1987, 2753.
- 284 P. Mohr, L. Rosslein and C. Tamm, Helv. Chim. Acta , 1987, **70**, 142.
- 285 (a) T. Schenker, Angew. Chem. , 1961, **73**, 81; (b) *For a review of the action of metallic hydrides on olefins, see Gaylord, "Reduction with complex metal hydrides," pp. 925-975, Interscience, New York, 1956;* (c) Y. Granoth, P. Segall, T. Leader and J. Alkabetz, J. Org. Chem. , 1976, **41**, 3682; (d) Y. Kamitori, M. Hojo, R. Masuda, T. Inoue and T. Izumi, Tetrahedron Lett. , 1982, **23**, 4585.
- 286 D. R. Morton and J. L. Thompson, J. Org. Chem. , 1978, **43**, 2102.
- 287 *For reviews of the ozonolysis reaction, see K. Bailey, "Ozonation in Organic Chemistry," Vol II. , Academic Press, New York, 1982.*
- 288 J. J. Pappas, W. P. Keaveney, E. Gancher and M. Berger, Tetrahedron Lett. , 1966, 4273.

- 289 For reviews of the Wittig reaction, see (a) A. J. Johnson, "Ylid Chemistry," Academic Press, New York, **1966**; (b) T. Ketcham, I. Jambotkar and D. Martinelli, J. Org. Chem. 1962, **27**, 4666.
- 290 S. G. Attina and D. Wolf, J. Chem. Soc., Chem. Commun., **1983**, 108.
- 291 J. Hooz and R. B. Layton, Can. J. Chem., **50**, 1972, 1105.
- 292 (a) H. Lindlar and J. Dubois, Org. Synth., 1983, **Col Vol 5**, 880; A. B. McEwen, M. J. Guttieri, W. F. Maier, R. M. Laine and Y. Shvo, J. Org. Chem., 1983, **48**, 4436; (b) Y. Ikeda and H. Yamamoto, Tetrahedron Lett., 1984, **25**, 5181; F. L. Harris and L. Weiler, Tetrahedron Lett., 1985, **26**, 1939; R. H. Van der Veen and H. Cerfontain, J. Org. Chem., 1985, **50**, 342; R. M. Duhaine, D. A. Lombardo, I. A. Skinner and A. C. Weedon, J. Org. Chem., 1985, **50**, 873; J. K. Whitesell, D. A. Aguilar and K. Henkel, J. Chem. Soc., Chem. Commun., **1982**, 989.
- 293 (a) D. E. Reedich and R. S. Sheridan, J. Org. Chem., 1985, **50**, 3535; (b) P. A. Bartlett and W. S. Johnson, Tetrahedron Lett., 1970, **11**, 4459.
- 294 H. A. Bates and H. Rapoport, J. Am. Chem. Soc., 1979, **101**, 1259.
- 295 W. N. Smith and O. F. Beumel, Synthesis, **1974**, 441.
- 296 For a treatise on  $\beta$ ,  $\gamma$ -unsaturated esters/acids, see T. Hirao, Y. Fujihara, K. Kurokawa, Y. Ohshiro and T. Agawa, J. Org. Chem., 1986, **51**, 2830 and references therein.; S. I. Murahashi, Y. Imada, Y. Taniguchi and S. Higashiura, Tetrahedron Lett., 1988, **29**, 4945; E. C. Taylor and H. M. L. Davies, Tetrahedron Lett., 1983, **24**, 5453; J. Tsuji, J. Kiji and M. Morikawa, Tetrahedron Lett., **1963**, 1811; C. J. Kowalski, M. S. Haque and K. W. Fields, J. Am. Chem. Soc., 1985, **107**, 1429.
- 297 N. Ragoussis, Tetrahedron Lett., 1987, **28**, 93.
- 298 K. Omura and D. Swern, Tetrahedron, 1978, **34**, 1651.
- 299 T. Nakai, K. Mikami, S. Taya, Y. Kimura and T. Mimura, Tetrahedron Lett., 1981, **22**, 69; K. Mikami, K. Fujimoto, T. Kasuga and T. Nakai, Tetrahedron Lett., 1984, **25**, 6011; K. Mikami, O. Takahashi, T. Tabei

- and T. Nakai, Tetrahedron Lett. , 1986, **27**, 4511; M. Uchikawa, T. Katsuki and M. Yamaguchi, Tetrahedron Lett. , 1986, **27**, 4581.
- 300 L. W. Butz, E. W. Butz and A. M. Gaddis, J. Org. Chem. , 1940, **5**, 171.
- 301 H. C. Brown, N. G. Bhat and J. B. Campbell, J. Org. Chem. , 1986, **51**, 3400; A. Sommer and P. Jackson, J. Org. Chem. , 1970, **35**, 1558.
- 302 *For a review of diazomethane, see Pizey, "Synthetic Reagents," Vol. II, pp. 65-142, Wiley, New York, 1974.*
- 303 M. Yamaguchi and I. Hirao, Tetrahedron Lett. , 1983, **24**, 391; H. Sakata, Y. Aoki and I. Kuwajima, Tetrahedron Lett. , 1990, **31**, 1161.
- 304 R. K. Beckman and E. W. Thomas, J. Am. Chem. Soc. , 1977, **99**, 2805; G. Henne and F. Greenlee, J. Am. Chem. Soc. , 1943, **65**, 2020.
- 305 K. E. Harding and D. R. Hollingsworth, Tetrahedron Lett. , 1988, **29**, 3789; E. B. Bates, E. R. H. Jones and M. C. Whiting, J. Chem. Soc. , **1954**, 1854.
- 306 Y. Yamamoto, Y. Saito and K. Maruyama, J. Org. Chem., 1983, **48**, 5408; D. B. Malpass, S. C. Watson and G. S. Yeargin, J. Org. Chem. , 1977, **42**, 2712; K. Utimoto, K. Uchida and H. Nozaki, Tetrahedron Lett. , **1977**, 3641.
- 307 M. Larcheveque and S. Henrot, Tetrahedron Lett. , 1987, **28**, 1781; M. Larcheveque and S. Henrot, Tetrahedron, 1990, **46**, 4277; S. Henrot, M. Larcheveque and Y. Petit, Synth. Comm. , 1986, **16**, 183.
- 308 O. Vogl, J. Muggee and D. Bansleben, J. Polym. , 1980, **12**, 677.
- 309 D. Shaw, PhD Dissertation in preparation, University of Nottingham, **1993**.
- 310 B. Zhou, A. S. Gopalan, F. VanMiddlesworth, W. R. Shieh and C. J. Sih, J. Am. Chem. Soc. , 1983, **105**, 5925; C. Fuganti and P. Grasselli, Tetrahedron Lett. , 1985, **26**, 101; K. Mori, H. Mori and T. Sugai, Tetrahedron, 1985, **41**, 919; K. Mori, Tetrahedron, 1981, **37**, 1341.
- 311 J. F. Hamel, Bull. Soc. Chim. Fr. , **1921**, 320.
- 312 P. Jacques and G. Bare, Helv. Chim. Acta , 1988, **71**, 47; R. U. Lemieux



- and J. Giguere, Can. J. Chem. , 1951, **29**, 678.
- 313 R. Tanikaga, K. Hosoya and A. Kaji, Synthesis, **1987**, 389.
- 314 (a) R. Peterson and E. Tate, J. Org. Chem. , 1988, **53**, 104; H. Bertz, C. P. Gibson and G. Dabbagh, Tetrahedron Lett. , 1987, **28**, 4251; (b) R. E. Ireland and P. Wipf, J. Org. Chem. , 1990, **55**, 1425; B. H. Lipshutz and J. A. Kozlowski, J. Org. Chem. , 1984, **49**, 1147; B. H. Lipshutz, Synthesis, **1986**, 325; B. Lipshutz, J. A. Kozlowski, D. A. Parker, S. L. Nguyen, and K. E. McCarthy, J. Organomet. Chem. , 1985, **28**, 437; B. H. Lipshutz, M. Koerner and D. A. Parker, Tetrahedron Lett. , 1987, **28**, 945.
- 315 A. Alexakis and D. Jachiet, Tetrahedron, 1989, **45**, 6197; G. Zweifel and R. B. Steele, J. Am. Chem. Soc. , 1967, **89**, 2754; G. Zweifel and C. C. Whitney, J. Am. Chem. Soc. , 1967, **89**, 2753.
- 316 P. A. Bartlett and J. Myerson, J. Org. Chem. , 1979, **44**, 1625.
- 317 H. Booth, Prog. NMR Spectroscopy, 1969, **5**, 149.
- 318 (a) G. Dana, E. Touboul, M. P. Levisalles and C. Bois, Tetrahedron, 1988, **44**, 2203; G. Dana, E. Touboul and O. Convert, Tetrahedron, 1989, **45**, 3371; (b) D. R. Williams, Y. Harigaya, J. L. Moore and A. D'Sa, J. Am. Chem. Soc. , 1984, **106**, 2641.
- 319 O. Mitsunobu, Synthesis, **1981**, 1.
- 320 P. Walden, Chem. Ber. , 1907, **40**, 3214.
- 321 A. W. Burgstahler and I. C. Nordin, J. Am. Chem. Soc. , 1961, **83**, 198; L. A. Pinck and G. E. Gilbert, J. Am. Chem. Soc. , 1946, **68**, 751.
- 322 J. Y. Gauthier and Y. Guindon, Tetrahedron Lett. , 1987, **28**, 5985.
- 323 M. Cope, T. M. Martin and G. McKervery, Q. Rev. , Chem. Soc. , 1966, **20**, 119.
- 324 T. Katritzky and J. Topsom, J. Chem. Educ. , 1971, **48**, 427.
- 325 M. J. Kurth, R. L. Beard, M. Olmstead and J. G. Macmillan, J. Am. Chem. Soc. , 1989, **111**, 3712 and references therein.

- 326 M. Srebnik and R. Mechoulam, J. Chem. Soc. , Chem. Commun. , 1984,  
1070.
- 327 R. D. Evans, J. W. Magee and J. H. Schauble, Synthesis, 1988, 862.
- 328 M. Khan, M. Hashmi, F. Ahmad and S. M. Osman, J. Chem. Soc. , Chem.  
Commun. , 1983, 1057.
- 329 P. A. Bartlett and J. Myerson, J. Am. Chem. Soc. , 1978, 100, 3950.
- 330 S. Takano, Y. Sekiguchi, Y. Shimazaki and K. Ogasawara, Tetrahedron  
Lett. , 1989, 30, 4001; M. Norte, J. J. Fernandez and J.Z. Ruano,  
Tetrahedron, 1989, 45, 5987.
- 331 B. H. Lipshutz and J. C. Barton, J. Am. Chem. Soc. , 1992, 114, 1084.
- 332 J. Hassner and H. Alexanian, Tetrahedron Lett. , 1978, 19, 4475;  
K. Holmberg and S. Hansen, Acta Chem. Scand. , 1979, 33, 410.
- 333 T. H. Chan, M. A. Brook and T. Chaly, Synthesis, 1983, 203; D. P.  
Roelafsen and H. van Bekkan, Synthesis , 1972, 419.
- 334 S. Takano, Y. Iwabuchi and K. Ogasawara, J. Chem. Soc. , Chem.  
Commun. , 1988, 1527; B. Fraser-Reid and D. E. Iley, Can. J. Chem.  
, 1979, 57, 645; J. Tsuji, T. Yamakana and T. Mandai, Tetrahedron Lett. ,  
1978, 19, 565; S. Mobashery and M. Johnson, Tetrahedron Lett. , 1986,  
27, 3333.
- 335 P. Herdewijn and A. Van Aerschot, Tetrahedron Lett. , 1989, 30, 855; N.  
Finch and E. Schlittler, Tetrahedron, 1968, 24, 5421.  
R. Grew and I Hinrichs, Chem. Ber. , 1964, 97, 443; G. W. J. Fleet and J.  
C. Son, Tetrahedron Lett. , 1987, 28, 3615.
- 336 R. C. Roemmel and H. Rapoport, J. Org. Chem. , 1989, 54, 1866.
- 337 F. M. Dean, Adv. Het. Chem. , 1982, 30, 167.
- 338 R. Antonioletti, F. Bonadies and A. Scettri, Gazz. Chim. Ital. , 1988, 118,  
73; R. Antonioletti, F. Bonadies and A. Scettri, Tetrahedron Lett. , 1988,  
29, 4987.
- 339 E. J. Corey and A. K. Ghosh, Chem. Lett. , 1987, 223.
- 340 E. I. Heiba and R. M. Dessau, J. Chem. Soc. , Perkin Trans 1 , 1974, 39,

- 3456.
- 341 M. G. Vinogradov, A. E. Kondorsky and G. L. Nikishin, Synthesis , 1988, 60.
- 342 J. S. Filippo, C. Chern and J. S. Valentine, J. Org. Chem. , 1975, 40, 1678; E. J. Corey, K. C. Nicolaou and C. S. Shiner, Tetrahedron Lett. , 1975, 16, 3183
- 343 R. O. Hutchins and I. M. Taffer, J. Org. Chem. , 1983, 48, 1360.
- 344 S. Saito, H. Nakajima, M. Inaba and T. Moriwake, Tetrahedron Lett. , 1989, 30, 837.
- 345 G. Stork and P. M. Sher, J. Am. Chem. Soc. , 1983, 105, 6765.
- 346 R. Dagani, Chem. Eng. News. , 1987, 20, 41.
- 347 M. M. Mansuri, J. E. Starrett, J. A. Wos, D. R. Tortolani, P. R. Brodfuehrer, H. G. Howell and J. C. Martin, J. Org. Chem. , 1989, 54, 4780.
- 348 J. C. Martin and T. S. Lin, J. Med. Chem. , 1987, 185; K. E. B. Parkes and K. Taylor, Tetrahedron Lett. , 1988, 29, 2995.
- 349 E. J. Corey and T. Hase, Tetrahedron Lett. , 1979, 20, 335; R. Cordova, Tetrahedron Lett. , 1984, 25, 2945
- 350 T. Kato and I. Ichinose, Chem. Lett. , 1976, 1187; T. Sasaki and K. Huttori, J. Am. Chem. Soc. , 1973, 95, 1350 and references therein; C. A. Broka and Y. T. Lin, J. Org. Chem. , 1988, 53, 5876.
- 351 W. G. Chai, M. C. Ye, L. Yan and Y. F. Zhao, J. Org. Chem. , 1987, 52, 1617; D. White and K. A. Robertson, J. Chem. Soc. , 1939, 1509.
- 352 A. Fukuzawa, M. Aye, Y. Takaya, H. Fukui, T. Masamune and A. Murai, Tetrahedron Lett. , 1989, 30, 3665.
- 353 A. Bandzouzi and Y. Chapleur, J. Chem. Soc. , Perkin Trans 1 , 1987, 661; J. Whiting, Y. K. Au-Young and B. Belleau, Can. J. Chem. , 50, 1972, 3322; R. Amouroux, B. Gerin and M. Chastrette, Tetrahedron, 1985, 41, 5321; A. M. Mubarak and D. M. Brown, Tetrahedron Lett. , 1980, 21, 2453; J. Adams, M. A. Poupart, L. Grenier, Tetrahedron Lett. ,

- 1989, **30**, 1753; T. Matsumoto, A. Ichihara and N. Ito, Tetrahedron, **1969**, 5889; J. R. Lewis, Natural Product Reports , **1989**, 503; S. Takano, Y. Iwabuchi and K. Ogasawara, J. Chem. Soc. , Chem. Commun. , **1989**, 1371; W. C. Still and J. A. Schneider, J. Org. Chem. , 1980, **45**, 3375; S Pochet and T. Huynh-Dinh, J. Org. Chem. , 1982, **47**, 193; J. R. Lewis, Natural Product Reports , **1986**, 587; J. Mulzer, A. Angermann, W. Munch, G. Schlichthorl and A. Hentzschel, Liebigs. Ann. Chem. , **1987**, 7; G. Fronza, C. Fuganti and P. Grasselli, Tetrahedron Lett. , 1978, **19**, 3941.
- 354 J. Weinstock, J. Org. Chem. , 1961, **26**, 3511; Org. React. , 1946, **3**, 337; Org. Synth. , 1981, **Col Vol 3**, 846; Org. Synth. , 1973, **51**, 48.
- 355 X-P. Fang, J. E. Anderson, C. Chang, P. E. Fanwick and J. L. McLoughlin, J. Chem. Soc. , Perkin Trans 1 , **1990**, 1655.
- 356 P. Kocovsky, J. Org. Chem. , 1988, **53**, 5816.
- 357 R. M. Soll and S. P. Seitz, Tetrahedron Lett. , 1987, **28**, 5457; J. J. Lee, P. M. Dewick, C. P. G. Allman, F. Spreafico, C. Kowal, C. J. Chan, A. G. McInnes, J. A. Walter, P. J. Keller and H. G. Floss, J. Am. Chem. Soc. , 1987, **109**, 5426; F. Matsuda, N. Tomiyosi, M. Yanagiya and T. Matsumoto, Chem. Lett. , **1987**, 2097.
- 358 E. J. Corey and D. R. Deardroff, J. Am. Chem. Soc. , 1982, **104**, 6818

.....O.....