

**EXACTLY SOLVABLE Q-EXTENDED NONLINEAR
CLASSICAL AND QUANTUM MODELS**

**A Thesis Submitted to
the Graduate School of Engineering and Sciences of
İzmir Institute of Technology
in Partial Fulfillment of the Requirements for the Degree of**

MASTER OF SCIENCE

in Mathematics

**by
Şengül NALCI**

**June 2011
İZMİR**

We approve the thesis of **Şengül NALCI**

Prof. Dr. Oktay PASHAEV
Supervisor

Prof. Dr. İsmail Hakkı DURU
Committee Member

Prof. Dr. Uğur TIRNAKLI
Committee Member

17 June 2011

Prof. Dr. Oğuz YILMAZ
Head of the Department of
Mathematics

Prof. Dr. Durmuş Ali DEMİR
Dean of the Graduate School of
Engineering and Sciences

ACKNOWLEDGMENTS

I would like to express my deepest gratitude to my advisor, Prof. Dr. Oktay Pashaev, for his academic guidance, motivating talks, help and patience throughout my graduate education, especially during preparation of this thesis. I sincerely thank Prof. Dr. Uğur Tırnaklı for being a member of my thesis committee. I would like to thank TÜBİTAK for graduate students scholarship, supporting my master programme studies. I also want to thank my colleague and close friend, Neslihan Eti, for her encouragement, support and help.

Finally, I am very grateful to my family for their support, understanding and love during my education.

ABSTRACT

EXACTLY SOLVABLE Q -EXTENDED NONLINEAR CLASSICAL AND QUANTUM MODELS

In the present thesis we study q -extended exactly solvable nonlinear classical and quantum models. In these models the derivative operator is replaced by q -derivative, in the form of finite difference dilatation operator. It requires introducing q -numbers instead of standard numbers, and q -calculus instead of standard calculus. We start with classical q -damped oscillator and q -difference heat equation. Exact solutions are constructed as q -Hermite and Kampe-de Fariet polynomials and Jackson q -exponential functions. By q -Cole-Hopf transformation we obtain q -nonlinear heat equation in the form of Burgers equation. IVP for this equation is solved in operator form and q -shock soliton solutions are found. Results are extended to linear q -Schrödinger equation and nonlinear q -Maddelung fluid. Motivated by physical applications, then we introduce the multiple q -calculus. In addition to non-symmetrical and symmetrical q -calculus it includes the new Fibonacci calculus, based on Binet-Fibonacci formula. We show that multiple q -calculus naturally appears in construction of Q -commutative q -binomial formula, generalizing all well-known formulas as Newton, Gauss, and noncommutative ones. As another application we study quantum two parametric deformations of harmonic oscillator and corresponding q -deformed quantum angular momentum. A new type of q -function of two variables is introduced as q -holomorphic function, satisfying q -Cauchy-Riemann equations. In spite of that q -holomorphic function is not analytic in the usual sense, it represents the so-called generalized analytic function. The q -traveling waves as solutions of q -wave equation are derived. To solve the q -BVP we introduce q -Bernoulli numbers, and their relation with zeros of q -Sine function.

ÖZET

TAM ÇÖZÜMLENEBİLEN DOĞRUSAL OLMAYAN Q-GENİŞLETİLMİŞ KLASİK VE KUANTUM MODELLERİ

Bu tezde, tam çözümlenebilen doğrusal olmayan q -genişletilmiş klasik ve kuantum modelleri çalışılmıştır. Modellerde türev operatörü sonlu fark dilasyon operatör formunda tanımlanan q -türev operatörü ile değiştirilmiştir. Bu çalışma, standart sayıların q -sayıları ve standart hesaplamaların q -hesaplama ile değiştirilmesini gerektirmiştir. İlk olarak klasik q -sönümlü osilasyon modeli ve q -fark ısı denklemi ile çalışıldı ve kesin çözümleri q -Hermite ve Kampe-de Feriet polinomlar ve Jackson q -üstel fonksiyonlar cinsinden bulundu. q -Cole-Hopf dönüşümü kullanılarak doğrusal olmayan q -ısı denklemi Burgers denklemi formunda elde edildi. Burgers denklemi için başlangıç değer problemini operatör cinsinden çözdük ve q -şok soliton çözümleri bulduk. Elde edilen sonuçlar, doğrusal q -Schrödinger denklemi ve doğrusal olmayan q -Maddelung akışkanlar için genişletilmiştir. Fiziksel uygulamalardan yola çıkarak çoklu q -hesaplama tanımladık. Bu çoklu hesaplama simetrik ve simetrik olmayan q -hesaplamalara ek olarak, Binet-Fibonacci formülüne dayanan yeni Fibonacci hesaplamayı da içerir. Çoklu q -hesaplamanın, bilinen Newton, Gauss ve değişmeli olmayan binom formüllerinin genel hali olan Q -değişmeli q -binom formülünün yapılandırılması sırasında ortaya çıktığı gösterildi. Bu hesaplamaların diğer bir uygulaması olarak iki parametrik deformasyonlu kuantum harmonik osilasyon modeli ve ilgili q -deforme olmuş kuantum açısal momentum çalışılmıştır. q -Cauchy-Riemann denklemlerini sağlayan iki değişkenli q -holomorfik olan yeni bir q -fonksiyon tanıtılmıştır. q -holomorfik fonksiyon alışılmış anlamda analitik olmamasına rağmen genelleştirilmiş analitik fonksiyon olarak gösterildi. q -Dalga denkleminin çözümü olan q -hareket eden dalgalar bulunmuştur. q -Sınır değer problemini çözmek için gerekli olan q -Bernoulli sayıları ve bunların q -sinüs fonksiyonunun sıfırları ile ilişkisi hesaplandı.

TABLE OF CONTENTS

LIST OF FIGURES	xi
LIST OF TABLES	xiii
CHAPTER 1. INTRODUCTION	1
CHAPTER 2. BASIC Q-CALCULUS	6
2.1. q -Numbers	6
2.1.1. Non-symmetrical q -Numbers	6
2.1.2. Symmetrical q -Numbers	9
2.2. q -Derivative	9
2.3. q -Taylor's Formula and Binomial Formulas	11
2.4. q -Pascal Triangle	12
2.5. q -Integral	13
2.6. q -Elementary Functions	14
CHAPTER 3. Q -DAMPED OSCILLATOR	17
3.1. Damped Oscillator	17
3.2. q -Harmonic Oscillator	18
3.3. q -Damped q -Harmonic Oscillator	20
3.3.1. Under-Damping Case	21
3.3.2. Over-Damping Case	21
3.3.3. Critical Case	22
3.4. Degenerate Roots for Equation Degree N	26
CHAPTER 4. Q -SPACE-TIME DIFFERENCE HEAT EQUATION	30
4.1. q -Hermite Polynomials	30
4.1.1. q -Difference Equation	33
4.2. Operator Representation	34
4.3. q -Kampe-de Feriet Polynomials	35
4.4. q -Heat Equation	36
4.5. Evolution Operator	37

CHAPTER 5. Q -SPACE-TIME DIFFERENCE BURGERS' EQUATION	39
5.1. Burger's Equation and Cole-Hopf Transformation	39
5.2. q -Burger's Equation as nonlinear q -Heat Equation	39
5.2.1. I.V.P. for q -Burgers' Type Equation	40
5.3. q -Shock Soliton	40
 CHAPTER 6. Q -SPACE DIFFERENCE AND TIME DIFFERENTIAL HEAT EQUATION	 48
6.1. q -Hermite Polynomials	48
6.1.1. q -Difference Equation.....	51
6.2. q -Kampe-de Feriet Polynomials	52
6.3. q -Heat Equation	53
6.3.1. Operator Representation	54
6.4. Evolution Operator	55
 CHAPTER 7. Q -SPACE DIFFERENCE AND TIME DIFFERENTIAL BURGER'S EQUATION	 57
7.1. q -Cole-Hopf Transformation and q -Burger's Equation	57
7.1.1. I.V.P. for q -Burgers' Type Equation	57
7.2. q -Shock Soliton	58
 CHAPTER 8. Q -SCHRÖDINGER EQUATION AND Q -MADDELLUNG FLUID .	65
8.1. Standard Time-Dependent q -Schrödinger Equation	65
 CHAPTER 9. MULTIPLE Q -CALCULUS	 68
9.1. Multiple q - Numbers	68
9.1.1. Multiple q -Derivative	70
9.1.2. $N = 1$ Case	71
9.1.3. $N = 2$ Cases	71
9.1.3.1. Non-symmetrical Case	71
9.1.3.2. Symmetrical Case.....	72
9.1.3.3. Fibonacci Case	72
9.1.3.4. Symmetrical Golden Case.....	73
9.1.4. q -Leibnitz Rule	74
9.1.5. Generalized Taylor Formula	75

9.1.6. q -Polynomial Expansion	80
9.1.7. Multiple q -Binomial Formula	81
9.2. q -Multiple Pascal Triangle	86
9.3. q -Multiple Antiderivative	87
9.3.1. q -Periodic Functions and Euler Equation	89
9.4. q -Multiple Jackson Integral	90
CHAPTER 10. NON-COMMUTATIVE Q -BINOMIAL FORMULAS	92
10.1. Gauss's Binomial Formula	92
10.2. Non-commutative Binomial Formula	95
10.3. Q -commutative q -Binomial Formula	96
10.3.1. Special Cases	106
10.3.2. q, Q - Binomial Formula	107
10.3.3. q -Function of Non-commutative Variables	107
CHAPTER 11. Q -QUANTUM HARMONIC OSCILLATOR	110
11.1. Quantum Harmonic Oscillator	110
11.2. (q_i, q_j) -Quantum Harmonic Oscillator	114
11.2.1. Binet-Fibonacci Golden Oscillator and Fibonacci Sequence ...	124
11.2.2. Symmetrical q -Oscillator	128
11.2.3. Non-symmetrical q -Oscillator	131
11.3. q -Deformed Quantum Angular Momentum	132
11.3.1. Double q -Boson Algebra Representation	132
11.3.2. $su_{(q_i, q_j)}(2)$ Angular Momentum Algebra	136
11.3.3. Double Boson Representation of $su_{(q_i, q_j)}(2)$ Angular Momentum	141
11.3.3.1. Non-symmetrical Case:	143
11.3.3.2. Symmetrical Case:	144
11.3.3.3. Binet-Fibonacci Case:	144
11.3.4. $su_{\sqrt{\frac{q_j}{q_i}}}(2)$ case:	147
11.3.4.1. Complex Symmetrical $su_{(i\varphi, \frac{i}{\varphi})}(2)$ Quantum Algebra	148
11.3.5. $\tilde{su}_{(q_i, q_j)}(2)$ Case:	149
11.3.5.1. $\tilde{su}_F(2)$ Algebra	150

CHAPTER 12. Q -FUNCTION OF ONE VARIABLE	151
12.1. q -Function of One Variable	152
12.1.1. Addition Formulas	157
12.2. Complex Analytic Function	162
12.3. q -Holomorphic Function	163
12.3.1. q -Analytic Function	165
12.3.2. q -Cauchy-Riemann Equations	166
12.3.3. q -Analytic Function as Generalized Analytic Function	167
12.4. Traveling Wave	169
12.5. q -Traveling Wave	170
12.6. D'Alembert Solution of Wave Equation	171
12.7. The q -Wave Equation	172
12.7.1. D'Alembert Solution of The q -Wave Equation	176
12.7.2. Initial Boundary Value Problem for q -Wave Equation	182
12.8. q -Bernoulli Numbers and Zeros of q -Sine Function	188
12.8.1. Zeros of Sine Function and Riemann Zeta Function	189
12.8.2. q -Bernoulli Polynomials and Numbers	193
12.8.3. q -Schrödinger Equation for a Particle in a Potential Well	201
 CHAPTER 13. CONCLUSION	 205
 REFERENCES	 207
 APPENDICES	 214
APPENDIX A. CONSTANT COEFFICIENT Q -DIFFERENCE EQUATION	214
APPENDIX B. MULTIPLE Q -POLYNOMIALS	218
APPENDIX C. Q -BINOMIAL FORMULAS	223
APPENDIX D. Q -QUANTUM HARMONIC OSCILLATOR	226
APPENDIX E. QUANTUM ANGULAR MOMENTUM REPRESENTATION	230
APPENDIX F. Q -QUANTUM ANGULAR MOMENTUM	232
APPENDIX G. Q -FUNCTION OF ONE VARIABLE	235
APPENDIX H. Q -TRAVELING WAVE	237
APPENDIX I. Q -BERNOULLI NUMBERS B_2^Q AND B_4^Q	241
APPENDIX J. ZEROS OF $\text{SIN}_Q X$ FUNCTION	243

LIST OF FIGURES

<u>Figure</u>	<u>Page</u>
Figure 2.1. Conformal mapping of complex q -number z	8
Figure 2.2. q -Pascal Triangle	13
Figure 3.1. q -Harmonic oscillator solution $\cos_q t$	19
Figure 3.2. q -Harmonic oscillator solution $\sin\left(\frac{2\pi}{\ln q} \ln t\right) \cos_q t$	20
Figure 3.3. Under-damping case $A = B = 1$	22
Figure 3.4. Under-damping case with q -periodic function	22
Figure 3.5. Over-damping case $A = B = 1$	23
Figure 3.6. Over-damping case with q -periodic function	24
Figure 3.7. Critical case	25
Figure 3.8. Critical case with periodic function	25
Figure 3.9. Self-similar micro structure at scale 0.5	26
Figure 3.10. Self-similar micro structure at scale 0.05	27
Figure 5.1. Singular q -shock soliton	42
Figure 5.2. The regular q -shock soliton for $k_1 = 1, k_2 = -1$, at range $(-50, 50)$	43
Figure 5.3. The regular q -shock soliton for $k_1 = 1, k_2 = -1$ at range $(-5000, 5000)$	44
Figure 5.4. The regular q -shock soliton for $k_1 = 1, k_2 = -1$ at range $(-500000,$ $500000)$	44
Figure 5.5. q -Shock soliton	45
Figure 5.6. q -Shock soliton with q -periodic modulation	45
Figure 5.7. Self-similar q -shock soliton micro structure at scale 0.3	46
Figure 5.8. Self-similar q -shock soliton micro structure at scale 0.03	46
Figure 5.9. Multi q -shock regular for $k_1 = 1, k_2 = -1, k_3 = 10, k_4 = -10$ at $t = 0$	47
Figure 7.1. q -Shock evolution for $\nu = 1, k_1 = 1, k_2 = -1, t = -2$ at range $(-50,$ $50)$	60
Figure 7.2. q -Shock evolution for $\nu = 1, k_1 = 1, k_2 = -1, t = 0$ at range $(-50, 50)$.	60
Figure 7.3. q -Shock evolution for $\nu = 1, k_1 = 1, k_2 = -1, t = 5$ at range $(-50, 50)$.	61
Figure 7.4. 3D plot of q -shock evolution for $k_1 = 1, k_2 = -1, k_3 = 2, k_4 = -2$ and at range $(-50, 50)$	62
Figure 7.5. Multi q -shock evolution for $k_1 = 1, k_2 = -1, k_3 = 2, k_4 = -2,$ $t = -10$ and at range $(-50, 50)$	63

Figure 7.6. Multi q-shock evolution for $k_1 = 1, k_2 = -1, k_3 = 2, k_4 = -2, t = 0$ and at range $(-50, 50)$	63
Figure 7.7. Multi q-shock evolution for $k_1 = 1, k_2 = -1, k_3 = 2, k_4 = -2, t = 7$ and at range $(-50, 50)$	64
Figure 7.8. 3D plot of multiple q-shock evolution for $k_1 = 1, k_2 = -1, k_3 = 2,$ $k_4 = -2,$ and at range $(-50, 50)$	64
Figure 9.1. (q_i, q_j) -Pascal Triangle	87
Figure 10.1. Q-commutative q-Pascal triangle	99
Figure 11.1. Fibonacci tree for spectrum of Golden Oscillator	127

LIST OF TABLES

<u>Table</u>	<u>Page</u>
Table 12.1. Table of q -sine zeros	200

CHAPTER 1

INTRODUCTION

”Here we encounter with one of that mysterious parallelism in development of mathematics and physics, when one have seen it involuntarily the thought creep in on pre-established harmony (Harmonia praestabilita) of Mind and Nature ” H. Weyl

The ancient concept of beauty in music, sculpture, architecture building etc. is connected with idea that beauty is an attribute of composite objects. And the composition is beautiful when its components have appropriate proportions. Then exact mathematical relations existing in geometry and in number fractions are realized in beautiful constructions: tone of a string depends on its length and beautiful combination of sounds corresponds to simple proportions of string lengths; architecture beauty depends on proportion of its parts. The most important proportion in architecture is the Golden Section or the Golden Ratio. Leonardo’s Vitruvian man shows that the Golden Ratio is hidden in proportion of the human body. By projecting human body to the World-Cosmos, the last one becomes the Cosmic Man-Antropos. And proportions of a human body become creative method and unit for measurement in the space (Pashaeva & Pashaev, 2008).

Growing from child to adult the humans change size and this change modify our impressions of external world and forms internal, perceptive space in our mind. Difference in the size of object is one of the method to measure distance to an object. Bigger size corresponds to close distance and smaller size to far object. This relations between size and distance became part of technic of linear and inverse perspective explored to represent images in art (Panofsky, 1993). The feelings of size re-scaling becomes subject of several famous novels, like ”Alice in Wonderland” by Lewis Carroll (drink me $q > 1$ and eat me $q < 1$ as tools) and ”Gulliver’s Travels” by J.Swift (First voyage to Lilliput country $q = \frac{1}{12}$ and another voyage to Brobdingnag country with $q = 12$). In mathematics scale transformation is part of affine conformal transformations of Euclidean space.

Calculus as invented by Newton and Leibnitz deals with smooth curves and surfaces and is based on concept of limit. The concept of limit implies that the world at least in our thought can be divided up to infinity. However, the modern science based on observation shows that the world is organized in a different way depending on size of objects: from galaxy and structure of universe as a macro-world to elementary particles as micro-world. This composite structure of the world returns us back to the ancient concept

of beauty as a harmonic proportion. This becomes the origin of developing new type of calculus based on finite difference principle, or calculus without limit. One of the popular finite difference calculus is h-calculus, intensively developed and used in numerical analysis and computer modeling.

Another type of calculus, the q-calculus, is based on finite difference re-scaling. First results in q-calculus belong to Euler, who discovered Euler's Identities for q-exponential functions and Gauss, who discovered q-binomial formula. These results lead to intensive research on q-Calculus in XIX century. Discovery of Heine's formula (Heine, 1846) for a q-Hypergeometric function as a generalization of the hypergeometric series and relation with the Ramanujan product formula; relation between Euler's identities and the Jacobi Triple product identity, are just few of the remarkable results obtained in this field. Euler's infinite product for the classical partition function, Gauss formula for number of sums of 2 squares, Jacobi's formula for the number of sums of 4 squares are natural outcomes of q-calculus. The systematic development of q-calculus begins from F.H.Jackson who 1908 reintroduced the Euler Jackson q-difference operator (Jackson, 1908). Integral as a sum of finite geometric series has been considered by Archimedes, Fermat and Pascal (Andrews et al., 1999). Fermat introduced the first q-integral of the particular function $f(x) = x^\alpha$, by introducing the Fermat measure at q-lattice points $x = aq^n$. Then Thomae in 1869 and Jackson in 1910 defined general q-integral on finite interval (Ernst, 2001). Subjects involved in modern q-calculus include combinatorics, number theory, quantum theory, statistical mechanics. In the last 30 years q-calculus becomes as a bridge between mathematics and physics and is intensively used by physicist.

A q-periodic functions as a solution of the functional equation $f(qx) = f(x)$ or $D_q f(x) = 0$ plays in the theory of the q-difference equations the role similar to an arbitrary constant in the differential equations. The famous Weierstrass function, which is continues but nowhere differentiable, is an example of q-periodic function. In XX century it becomes connected with structure of fractal sets discovered by Mandelbrot (Mandelbrot, 1982). This why q-calculus is considered as one of the tools to work with fractals.

One of the early attempts to unify gravity and electromagnetism belongs to Herman Weyl who formulated electromagnetic theory as the relativity theory of magnitude (Weyl, 1952). This work initiated creation of Quantum Gauge Field Theory as unified theory of all fundamental forces in the nature. It also becomes part of the modern conformal field theory, the string theory and physics of critical phenomena.

One of the modern directions in which q-calculus plays key role - is related with

quantum algebras and quantum groups (Ernst, 2001). These are deformed versions of the usual Lie algebras with deformation parameter q . When q is set equal to unity, quantum algebras reduce to Lie algebras. They are known also in mathematics as Hopf algebras. As a physical origin, we should mention quantum spin chains, anyons, conformal field theory. Extension of the inverse spectral method, as a tool to solve integrable nonlinear evolution equations, to quantum domain directly leads to the quantum algebras as the symmetry of quantum exactly solvable models. In nineteenth's of twenty century, a big interest to quantum symmetries initiated large amount of work devoted to application of quantum symmetries to problems of quantum physics. Q-harmonic oscillator (Biedenharn, 1989), (Macfarlane, 1989), (Arik & Coon, 1976), q-hydrogen atom (Song & Liao, 1992), (Chan & Finkelstein, 1994), (Finkelstein, 1996), boson realization of the quantum algebra $su_q(2)$ (Biedenharn, 1989), (Macfarlane, 1989), quantum optics (Chaichian et al., 1990), rotational and vibrational nuclear and molecular spectra (Bonatsos & Daskaloyannis, 1999). Construction of representation theory of quantum groups leads to developing special part of mathematical physics as q-special functions and q-difference equations (Ismail, 2005). Q-extensions of many special functions of classical mathematical physics are known (Andrews et al., 1999). These functions also have applications in classical mathematics. As an example: q-gamma function and q-beta integral have applications in number theory, combinatorics, and partition theory. The q-deformation of nonlinear integrable evolution equations started from E. Frenkel (Frenkel, 1996), by introducing a q-deformation of KdV hierarchy, a q-Toda equations (Tsuboi & Kuniba, 1996), q-deformed KP hierarchy (Iliev, 1998), the q-Calogero-Moser equations (Iliev, 1998).

Moyal's quantization (Moyal, 1949), and non-commutative geometry of A. Connes are related with q-calculus (Connes, 1994). Non-commutative Burgers equation, shock solitons and q-calculus were solved in (Martina & Pashaev, 2003). Problem of hydrodynamic images in annular domain was solved in terms of q-elementary functions in (Pashaev & Yilmaz, 2008). AKNS hierarchy and relativistic nonlinear Schrödinger equation have been studied in terms of q-calculus with integro-differential q-operator as a recursion operator in (Pashaev, 2009).

Tsallis nonextensive statistical mechanics is related with q-deformation of different type, by modifying the logarithm function for entropy (Tsallis, 1988).

The goal of the present thesis is to study exactly solvable q -extended nonlinear classical and quantum models.

In Chapter 2 we introduce basic notations of q-calculus : as q-number, q-derivative, q-integral and etc. Notations are very important in q-calculus, and in our study we follow

notations from book of Kac and Cheung.

In Chapter 3 the classical model of q -damped oscillator is introduced. Solution of this model in three cases: Under-damping, Over-damping case and critical case are derived. In the critical case with degenerate roots the second, linearly independent solution is derived by application of logarithmic derivative operator. In the limit $q \rightarrow 1$ it reduces to the well known second solution of differential equation for degenerate roots (Section 3.3). In Section (3.4), we extend our result to n degenerate roots by constructing linearly independent set of n solutions.

In Chapter 4 we introduce q -space and time modified difference heat equation. To solve this equation, by using Jackson q -exponential function as generating function, we introduce new set of q -Hermite polynomials and related q -Kampe de Feriet polynomials. It allows us to find operator representation for initial value problem and find set of exact solutions with n moving zeros. By using q -Cole-Hopf transformation we construct new nonlinear q -heat equation in the form of q -Burgers equation (Chapter 5). IVP is solved and exact solutions in the form of q -shock solitons are obtained. Due to zeros of q -exponential function our q -shock solitons become singular at finite time.

In Chapter 6 we formulate continuous time and q -space difference heat equation. Special set of q -Hermite polynomials and q -Kampe-de Feriet polynomials, related with this equation are derived. In contrast to three-terms recurrence relations from previous chapter, now we found n -terms recurrence relations for the polynomials.

In Chapter 7 we introduce related q -Burgers equation and solved corresponding initial value problem. Multi q -shock soliton solutions in this case shows regular time evolution.

In Chapter 8 we extended the previous results to the linear q -Schrodinger equation and q -Maddelung nonlinear fluid.

Motivated by physical applications in Chapter 9, we introduce q -calculus with multiple bases q_1, \dots, q_N . Multiple q -numbers as $N \times N$ as matrices and multiple q -derivatives as $N \times N$ matrix q -difference-differential operator are derived. Special reductions to non-symmetrical and symmetrical case are considered. In addition to these well-known cases, we define a special Fibonacci case, based on Binet-Fibonacci formula, treated as a q -number where the base of number is given by Golden ratio. All necessary attributes of multiple q -calculus as Leibnitz rule, Taylor formula, integral formula, are studied in details. Class of q -periodic functions and its relation with the Euler equation is obtained.

As a first application of our multiple q -calculus in Chapter 10, we derive new

general q -binomial formula for non-commutative (Q -commutative) operators. Expansion coefficients in this formula are given by binomial coefficients with two bases (q, Q) . Our formula is generalization of known binomial formulas in the form of Newton's, Gauss' and non-commutative binomials.

Another important application of two parametric q -calculus in the form of q -quantum harmonic oscillator is described in Chapter 11. Generic (q_i, q_j) quantum harmonic oscillator and its reductions to non-symmetrical and symmetrical cases are discussed. Special case the so called Golden oscillator is derived and studied in details. It is shown that spectrum of this oscillator is given by Fibonacci numbers. Ratio of successive energy levels is found as the Golden sequence and for asymptotic states it appears as Golden ratio. By double q -bosons, the q -quantum angular momentum constructed and its representation is found. Reductions to non-symmetrical, symmetrical and Binet-Fibonacci cases are described. In Fibonacci case, the Casimir operator eigenvalues are determined by successive product of Fibonacci numbers.

In Chapter 12 the q -function of one variable as a special form of two variables is introduced. Addition formulas for q -exponential, q -trigonometric and q -hyperbolic functions are derived. Then, we introduce new type of q -holomorphic function and corresponding q -Cauchy-Riemann equations. Real and imaginary parts of our q -holomorphic function are q -harmonic functions. We emphasize that our q -analytic functions are different from the ones introduced by (Ernst, 2008) on the basis of so called q -addition. We show that despite lack of standard analyticity, our q -analytic functions satisfy Dbar equation and represent class of generalized analytic functions. The q -function of one variable in the form of q -traveling wave is obtained. Using these waves we found solution of the IVP for q -wave equation in the D'Alembert form. To solve boundary value problem, we introduce new set of q -Bernoulli numbers. Then we find their relation with zeros of q -sin function. Approximate formula for zeros of q -sin function is proposed and shows good precision with numerical calculations. The last results we apply to solve the q -Shrödinger equation for a particle in a potential well.

In Conclusion we summarize main results obtained in this thesis. Details of proofs and some definitions are given in Appendices.

CHAPTER 2

BASIC Q-CALCULUS

2.1. q-Numbers

2.1.1. Non-symmetrical q -Numbers

The non-symmetrical q -number (quantum number) $[n]_q$ corresponding to the natural number n is defined as (Kac & Cheung, 2002),

$$[n]_q = \frac{q^n - 1}{q - 1} = 1 + q + q^2 + \dots + q^{n-1}, \quad (2.1)$$

which is polynomial in q with degree $n - 1$. Here q is a deformation parameter which may be a real or complex number. It is clear that in the limit $q \rightarrow 1$, q -numbers become ordinary numbers, so that, $[n]_q \xrightarrow{q \rightarrow 1} n$. A few examples of q -numbers are given here:

$$[0]_q = 0, \quad [1]_q = 1, \quad [2]_q = 1 + q, \quad [3]_q = 1 + q + q^2.$$

The definition can be extended to an arbitrary real number α

$$[\alpha]_q = \frac{q^\alpha - 1}{q - 1}. \quad (2.2)$$

As an example if we consider $\alpha = \frac{1}{2}$, the non-polynomial q -number is

$$[1/2]_q = \frac{q^{\frac{1}{2}} - 1}{q - 1} = 1 - q^{\frac{1}{2}} + q^{\frac{1}{4}} - q^{\frac{1}{8}} + \dots$$

If we replace $\alpha \rightarrow -\alpha$, then we obtain

$$[-\alpha]_q = -q^n [\alpha]_q = -\frac{1}{q} [\alpha]_{\frac{1}{q}}. \quad (2.3)$$

For the real set of all q -numbers is a subset of real numbers. For complex q it is a subset of complex numbers.

The properties of q -numbers are different from the numbers in standard calculus. For example, we have the addition rule for q -numbers

$$[x + y]_q = q^y [x]_q + [y]_q = q^x [y]_q + [x]_y, \quad (2.4)$$

the subtraction formula

$$[x - y]_q = q^{-y} ([x]_q - [y]_q) = -q^{x-y} [y]_q + [x]_q, \quad (2.5)$$

the product rule

$$[xy]_q = [x]_q [y]_{q^x} = [y]_q [x]_{q^y},$$

and the division rule

$$\left[\frac{x}{y} \right]_q = \frac{[x]_q}{[y]_{q^{\frac{x}{y}}}} = \frac{[x]_{q^{\frac{1}{y}}}}{[y]_{\frac{1}{q^y}}}, \quad (2.6)$$

where x, y are real or complex numbers.

We can extend the definition of q -number (2.2) to complex numbers. For complex q -number $z = x + iy$, we get

$$[x + iy]_q = \frac{q^{x+iy} - 1}{q - 1} = \frac{q^x \cos(y \ln q) - 1}{q - 1} + i \frac{q^x \sin(y \ln q) - 1}{q - 1},$$

which is also complex number. This why a complex q -number can be considered as a

complex function of the complex argument z . Moreover, it is clear that this function is holomorphic function. Indeed,

$$\frac{\partial}{\partial \bar{z}} [z]_q = \frac{\partial}{\partial \bar{z}} \left(\frac{q^z - 1}{q - 1} \right) = 0.$$

This function $[z]_q = \frac{e^{z \ln q} - 1}{q - 1} = -\frac{1}{q - 1} + \frac{1}{q - 1} \sum_{n=0}^{\infty} \frac{(\ln q)^n}{n!} z^n$ is analytic in whole complex plane z , so it is an entire function of z . As any analytic function it provides conformal mapping from domain to domain in Figure 2.1.

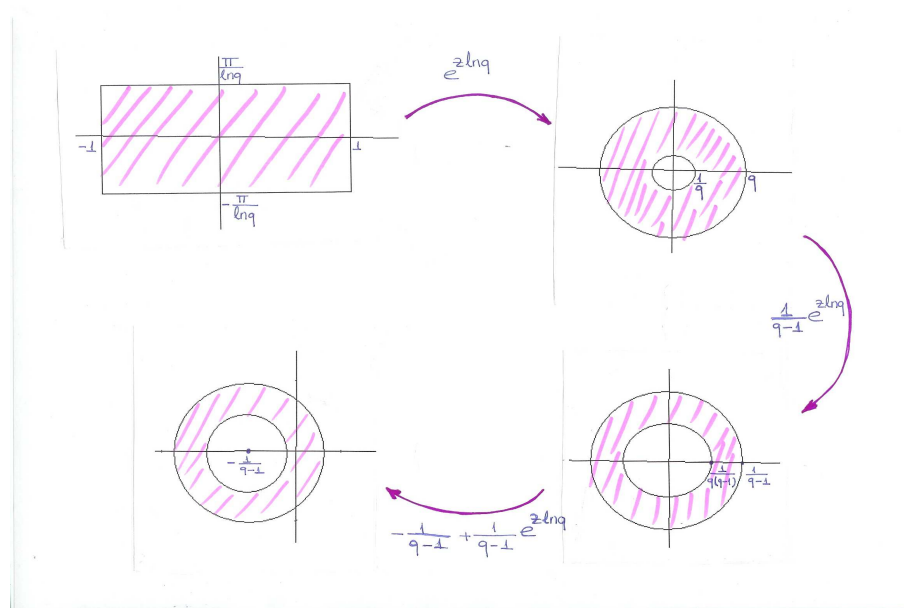

Figure 2.1. Conformal mapping of complex q -number z

Due to entire character of $[z]_q$ function we can extend definition of q -number to q -operator. As an example we consider q -operator of $x \frac{d}{dx}$ operator, by using the definition

$$\left[x \frac{d}{dx} \right]_q = \frac{q^{x \frac{d}{dx}} - 1}{q - 1} = \frac{M_q - 1}{q - 1} = x D_q,$$

where

$$M_q \equiv q^{x \frac{d}{dx}},$$

and

$$D_q = \frac{1}{(q-1)x} (M_q - 1).$$

2.1.2. Symmetrical q -Numbers

Another definition of q -numbers can be given as

$$[n]_{\tilde{q}} = \frac{q^n - q^{-n}}{q - q^{-1}}, \quad (2.7)$$

called the symmetrical q number, where q is a parameter, so that number n is the limit of $[n]_{\tilde{q}}$ as $q \rightarrow 1$. This definition can be extended to any real or complex numbers, and to operators. A few examples of symmetrical q -numbers are given here:

$$[0]_{\tilde{q}} = 0, \quad [1]_{\tilde{q}} = 1, \quad [2]_{\tilde{q}} = q + q^{-1}, \quad [3]_{\tilde{q}} = q^2 + 1 + q^{-2}.$$

We should notice that these q -numbers are invariant under the substitution $q \leftrightarrow q^{-1}$.

Therefore, we called these numbers as symmetrical numbers. In contrast, the q numbers (2.1) are not invariant under the substitution $q \leftrightarrow q^{-1}$, and we call them as the non-symmetrical of q -numbers.

2.2. q -Derivative

The q -derivative of function $f(x)$ is defined as

$$D_q^x f(x) = \frac{f(qx) - f(x)}{(q-1)x}. \quad (2.8)$$

If $f(x)$ is differentiable function, it reduces to the standard derivative when $q \rightarrow 1$

$$\lim_{q \rightarrow 1} D_q^x f(x) = \lim_{q \rightarrow 1} \frac{f(qx) - f(x)}{(q-1)x} = \lim_{q \rightarrow 1} \frac{xf'(qx)}{x} = f'(x).$$

Using the definition of q -derivative one can easily see that

$$D_q^x(ax^n) = a[n]_q x^{n-1}, \quad D_q^x e^x = \sum_{n=1}^{\infty} [n]_q \frac{x^{n-1}}{n!}.$$

The q - derivative can also be written in terms of dilatation operator M_q

$$D_q^x f(x) = \frac{1}{(q-1)x} (M_q - 1)f(x), \quad (2.9)$$

where

$$M_q f(x) = f(qx). \quad (2.10)$$

If $f(x)$ is smooth function, the operator definition of q - derivative is

$$D_q^x = \frac{1}{(q-1)x} (M_q - 1) = \frac{q^{x \frac{d}{dx}} - 1}{(q-1)x},$$

where

$$M_q^x = q^{x \frac{d}{dx}}.$$

In symmetrical q calculus, the q -derivative definition is given as

$$\tilde{D}_q^x f(x) = \frac{f(qx) - f(q^{-1}x)}{(q - q^{-1})x}, \quad (2.11)$$

which may also be written by using the M_q operator (2.10) in the following form

$$\begin{aligned} \tilde{D}_q^x f(x) &= \frac{1}{(q - q^{-1})x} (M_q - M_{\frac{1}{q}})f(x) \Rightarrow \\ \tilde{D}_q^x &= \frac{q^{x \frac{d}{dx}} - q^{-x \frac{d}{dx}}}{(q - q^{-1})x} = \frac{e^{(\ln q)x \frac{d}{dx}} - e^{-(\ln q)x \frac{d}{dx}}}{x(e^{\ln q} - e^{-\ln q})} = \frac{1}{x} \frac{\sinh(\ln q x \frac{d}{dx})}{\sinh(\ln q)}. \end{aligned}$$

The q -derivative is a linear operator

$$D_q^x(af(x) + bg(x)) = aD_q^x f(x) + bD_q^x g(x),$$

where a and b are arbitrary constants. By using the definition (2.8) we obtain the following q -Leibnitz formulas, (which are equivalent)

$$D_q(f(x)g(x)) = f(qx)D_q g(x) + g(x)D_q f(x) \quad (2.12)$$

$$= f(x)D_q g(x) + g(qx)D_q f(x). \quad (2.13)$$

The q -derivative of the quotient of $f(x)$ and $g(x)$ is

$$\begin{aligned} D_q\left(\frac{f(x)}{g(x)}\right) &= \frac{g(x)D_q f(x) - f(x)D_q g(x)}{g(x)g(qx)} \\ &= \frac{g(qx)D_q f(x) - f(qx)D_q g(x)}{g(x)g(qx)}, \end{aligned}$$

where $g(x) \neq 0$ and $g(qx) \neq 0$.

In q calculus, there is no general chain rule for q -derivatives. We have the chain rule, just for function of the following form $f(u(x))$, where $u(x) = ax^b$ with a, b being constants,

$$D_q f(u(x)) = (D_{q^b} f)(u(x)) \cdot D_q u(x).$$

2.3. q -Taylor's Formula and Binomial Formulas

For any polynomial $f(x)$ of degree N the following q -Taylor expansion is valid (Kac & Cheung, 2002)

$$f(x) = \sum_{j=0}^N (D_q^j f)(c) \frac{(x-c)_q^j}{[j]_q!}, \quad (2.14)$$

where

$$(x - c)_q^j \equiv (x - c)(x - qc)(x - q^2c)\dots(x - q^{j-1}c)$$

is q -binomial, and $[j]_q! \equiv [1]_q[2]_q\dots[j]_q$.

Expanding $f(x) = (x + a)_q^n$ about $x = 0$ by using q -Taylor's formula we get Gauss's Binomial formula

$$(x + a)_q^n = \sum_{j=0}^n \begin{bmatrix} n \\ j \end{bmatrix}_q q^{\frac{j(j-1)}{2}} x^{n-j} a^j, \quad (2.15)$$

where the q -binomial coefficients are defined by

$$\begin{bmatrix} n \\ j \end{bmatrix}_q = \frac{[n]_q!}{[n-j]_q![j]_q!}. \quad (2.16)$$

For noncommutative x and y , satisfying

$$yx = qxy,$$

which means that x and y are q -commutative, we have noncommutative binomial formula

$$(x + y)^n = \sum_{j=0}^n \begin{bmatrix} n \\ j \end{bmatrix}_q x^j y^{n-j}. \quad (2.17)$$

2.4. q -Pascal Triangle

The q -Pascal rules for q -binomial coefficients (2.16) are given by

$$\begin{bmatrix} n \\ j \end{bmatrix}_q = \begin{bmatrix} n-1 \\ j-1 \end{bmatrix}_q + q^j \begin{bmatrix} n-1 \\ j \end{bmatrix}_q \quad (2.18)$$

and

$$\begin{bmatrix} n \\ j \end{bmatrix}_q = q^{n-j} \begin{bmatrix} n-1 \\ j-1 \end{bmatrix}_q + \begin{bmatrix} n-1 \\ j \end{bmatrix}_q, \quad (2.19)$$

where $1 \leq j \leq n-1$. The above rules determine the q -analogue of Pascal triangle:

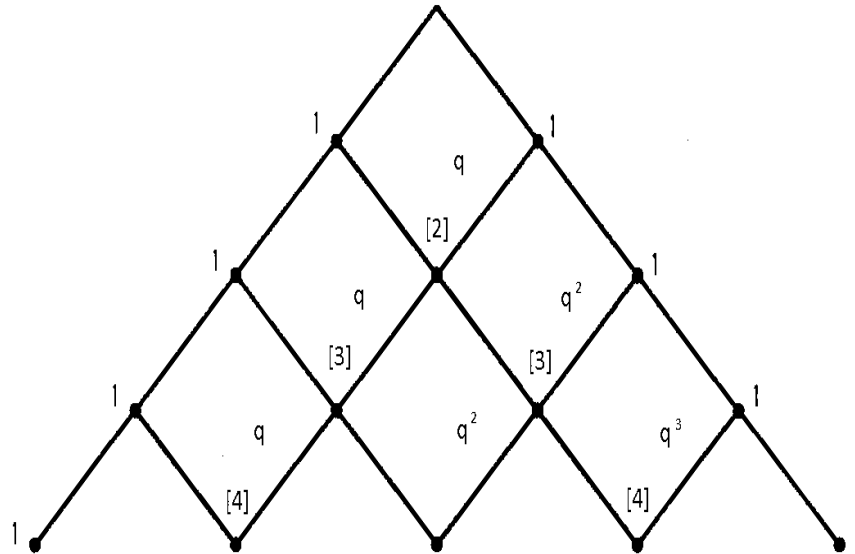

Figure 2.2. q -Pascal Triangle

2.5. q -Integral

Definition 2.5.0.1 The function $F(x)$ is a q -antiderivative of $f(x)$ if $D_q F(x) = f(x)$ and is denoted by

$$F(x) = \int f(x) d_q x. \quad (2.20)$$

In q -calculus we should note that

$$\begin{aligned}
 D_q f(x) = 0 &\Leftrightarrow F(x) = C \text{ constant} \\
 &\text{or} \\
 &\Leftrightarrow F(qx) = F(x) \text{ } q\text{-periodic function}
 \end{aligned}$$

Definition 2.5.0.2 *The Jackson Integral of function $f(x)$ is defined as*

$$\int f(x) d_q x = (1 - q)x \sum_{j=0}^{\infty} q^j f(q^j x). \quad (2.21)$$

Definition 2.5.0.3 *Given $0 < a < b$ the definite q -integral is defined as*

$$\int_0^b f(x) d_q x = (1 - q)b \sum_{j=0}^{\infty} q^j f(q^j b) \quad (2.22)$$

and

$$\int_a^b f(x) d_q x = \int_0^b f(x) d_q x - \int_0^a f(x) d_q x. \quad (2.23)$$

Theorem 2.5.0.4 (Fundamental theorem of q -calculus) *(Kac & Cheung, 2002) If $F(x)$ is an antiderivative of $f(x)$ and $F(x)$ is continuous at $x = 0$, we have*

$$\int_a^b f(x) d_q x = F(b) - F(a), \quad (2.24)$$

where $0 \leq a < b \leq \infty$.

2.6. q -Elementary Functions

Definition 2.6.0.5 *In terms of q -numbers, the Jackson q -exponential function $e_q(x)$, (Jackson) is defined by*

$$e_q(x) = \sum_{n=0}^{\infty} \frac{x^n}{[n]_q!}, \quad (2.25)$$

where $[n]_q! = [1]_q[2]_q \dots [n]_q$.

For $q > 1$ it is an entire function of x and for $q < 1$ it converges for $|x| < \frac{1}{|q-1|}$. When $q \rightarrow 1$ it reduces to the standard exponential function e^x .

The q -exponential function can be expressed in terms of the infinite product

$$e_q(x) = \prod_{n=0}^{\infty} \frac{1}{(1 - (1-q)q^n x)} = \frac{1}{(1 - (1-q)x)_q^{\infty}}, \quad (2.26)$$

when $q < 1$ and

$$e_q(x) = \prod_{n=0}^{\infty} \left(1 + \left(1 - \frac{1}{q}\right) \frac{1}{q^n} x \right) = \left(1 + \left(1 - \frac{1}{q}\right) x \right)_{1/q}^{\infty}, \quad (2.27)$$

when $q > 1$. Thus, for $q < 1$ it has the infinite set of simple poles

$$x_n = \frac{1}{q^n(1-q)}, \quad n = 0, 1, \dots \quad (2.28)$$

and for $q > 1$ the infinite set of simple zeros

$$x_n = -\frac{q^{n+1}}{(q-1)}, \quad n = 0, 1, \dots \quad (2.29)$$

Definition 2.6.0.6 *In addition to q -exponential function $e_q(x)$, there is another q -exponential*

function $E_q(x)$ defined as

$$E_q(x) = \sum_{n=0}^{\infty} q^{\frac{n(n-1)}{2}} \frac{x^n}{[n]_q!} = (1 + (1 - q)x)_q^{\infty}. \quad (2.30)$$

The q -differentiation for two q -analogues of exponential function are

$$D_q e_q(x) = e_q(x), \quad D_q E_q(x) = E_q(qx).$$

For q -exponential functions the product formula is not always valid

$$e_q(x)e_q(y) \neq e_q(x + y).$$

It is valid if x and y are q -commutative operators $yx = qxy$. But in this case

$$e_q(x)e_q(y) \neq e_q(y)e_q(x).$$

Two q -exponential functions are related by next formulas

$$e_q(x)E_q(-x) = 1$$

and

$$e_{\frac{1}{q}}(x) = E_q(x).$$

CHAPTER 3

Q-DAMPED OSCILLATOR

3.1. Damped Oscillator

We know that in reality, a spring never oscillates forever. Frictional forces will diminish the amplitude of oscillation until eventually the system is at rest. Now we will add frictional forces to the mass of spring. For example, the mass is in a liquid or oscillates in air before it comes to rest. In many situations the frictional force is proportional to the velocity of the mass as follows $f_r = -\gamma v$, where $\gamma > 0$ is the damping constant, which depends on the kind of liquid. Therefore, by adding this frictional force we have the following equation for a spring

$$m \frac{d^2x}{dt^2} + \gamma \frac{dx}{dt} + kx = 0. \quad (3.1)$$

Solution of this equation we look in the form

$$x(t) = e^{\lambda t}$$

and substituting to (3.1), we obtain the characteristic equation

$$m\lambda^2 + \gamma\lambda + k = 0. \quad (3.2)$$

The roots of this quadratic equation are

$$\lambda_1 = \frac{-\gamma + \sqrt{\gamma^2 - 4mk}}{2m}, \quad \lambda_2 = \frac{-\gamma - \sqrt{\gamma^2 - 4mk}}{2m}.$$

Then according to value of damping constant we have three cases :

i - Under-damping Case: When $\gamma^2 < 4mk$, which means that friction is sufficiently

weak, we have two complex conjugate roots

$$\lambda_{1,2} = -\frac{\gamma}{2m} \pm i\omega, \quad (3.3)$$

where $\omega \equiv \sqrt{\frac{k}{m} - \frac{\gamma^2}{4m^2}}$. Then the general solution of (3.1) is

$$x(t) = e^{-\frac{\gamma}{2m}t} (A \cos \omega t + B \sin \omega t). \quad (3.4)$$

If $\gamma = 0$, there is no decay and the spring oscillates forever. If γ is big, the amplitude of oscillations decays very fast (the exponential decay).

ii - Over-damping Case: When $\gamma^2 > 4mk$, which means that friction is sufficiently strong. In this case both roots are real, this why the solution decays exponentially

$$x(t) = Ae^{-\frac{-\gamma + \sqrt{\gamma^2 - 4mk}}{2m}t} + Be^{-\frac{-\gamma - \sqrt{\gamma^2 - 4mk}}{2m}t}. \quad (3.5)$$

This case is called as over-damping because there is no any oscillation.

iii - Critical Case: For $\gamma^2 = 4mk$, we have two degenerate roots

$$\lambda_1 = \lambda_2 = -\frac{\gamma}{2m},$$

then the general solution is

$$x(t) = Ae^{-\frac{\gamma}{2m}t} + Bte^{-\frac{\gamma}{2m}t}. \quad (3.6)$$

3.2. q-Harmonic Oscillator

Here we introduce the q -harmonic oscillator. Equation of q -deformed classical harmonic oscillator is defined as

$$D_q^2 x(t) + \omega^2 x(t) = 0. \quad (3.7)$$

Using the power series method (or the q -exponential form $x(t) = e_q(\lambda t)$), we find the general solution of q -harmonic oscillator in the following form

$$x(t) = A(t) \cos_q \omega t + B(t) \sin_q \omega t, \quad (3.8)$$

where

$$D_q A(t) = D_q B(t) = 0,$$

means $A(t), B(t)$ in general are q -periodic functions, and particularly could be arbitrary constants.

In Figure 3.1 we plot particular $\cos_q t$ solution of q -deformed classical harmonic oscillator. In contrast to standard $\sin t$ and $\cos t$ functions, $\sin_q t$ and $\cos_q t$ functions are not bounded and also have no periodicity. In Figure 3.2 we plot modulation of the same solution with q -periodic function $A(t) = \sin\left(\frac{2\pi}{\ln q} \ln t\right) \cos_q t$, which gives micro oscillations to the solution.

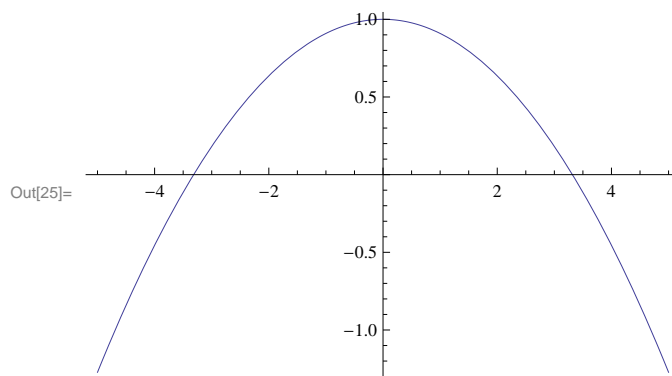

Figure 3.1. q -Harmonic oscillator solution $\cos_q t$

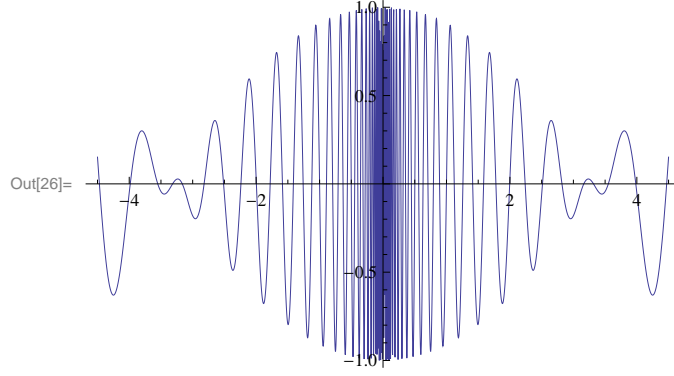

Figure 3.2. q -Harmonic oscillator solution $\sin\left(\frac{2\pi}{\ln q} \ln t\right) \cos_q t$

3.3. q -Damped q -Harmonic Oscillator

We define equation for q -analogue of damped oscillator in the form (Nalci & Pashaev, 2011c)

$$D_q^2 x(t) + \Gamma D_q x(t) + \omega^2 x(t) = 0, \quad (3.9)$$

where

$$\omega \equiv \sqrt{\frac{k}{m}}, \quad \Gamma \equiv \frac{\gamma}{m}.$$

By substituting $x(t) = e_q(\lambda t)$ into equation (3.9), we obtain

$$e_q(\lambda t) [\lambda^2 + \Gamma \lambda + \omega^2] = 0. \quad (3.10)$$

For $q > 1$, $e_q(\lambda t)$ is an entire function defined for any t and has an infinite set of zeros (no poles). Then, for characteristic equation we choose

$$\lambda^2 + \Gamma \lambda + \omega^2 = 0.$$

The roots of this characteristic equation are

$$\lambda_{1,2} = -\frac{\Gamma}{2} \pm \sqrt{\frac{\Gamma^2}{4} - \omega^2}.$$

3.3.1. Under-Damping Case

For $\Gamma^2 < 4\omega^2$, we have two complex conjugate roots

$$\lambda_1 = -\frac{\Gamma}{2} + i\Omega, \quad \lambda_2 = -\frac{\Gamma}{2} - i\Omega,$$

where

$$\Omega \equiv \sqrt{\omega^2 - \frac{\Gamma^2}{4}}.$$

Then the general solution of equation (3.9) is

$$x(t) = Ae_q \left[\left(-\frac{\Gamma}{2} + i\Omega \right) t \right] + Be_q \left[\left(-\frac{\Gamma}{2} - i\Omega \right) t \right]. \quad (3.11)$$

In Figure 3.3 and Figure 3.4 we plot particular solutions with constant ($A = B = 1$) and with q -Periodic modulation, respectively.

3.3.2. Over-Damping Case

For $\Gamma^2 > 4\omega^2$, we have two distinct real roots $\lambda_{1,2}$ and solution is

$$x(t) = A(t)e_q \left[\left(-\frac{\Gamma}{2} + \sqrt{\frac{\Gamma^2}{4} - \omega^2} \right) t \right] + B(t)e_q \left[\left(-\frac{\Gamma}{2} - \sqrt{\frac{\Gamma^2}{4} - \omega^2} \right) t \right], \quad (3.12)$$

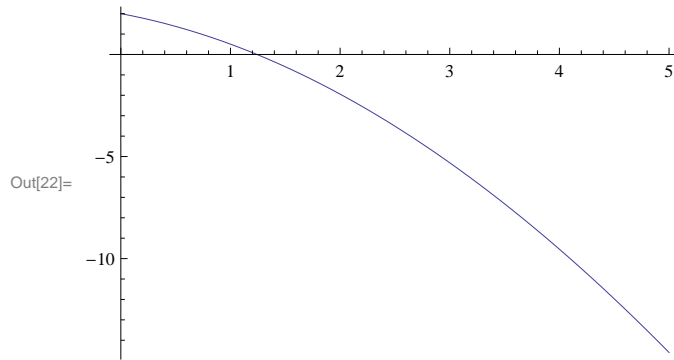

Figure 3.3. Under-damping case $A = B = 1$

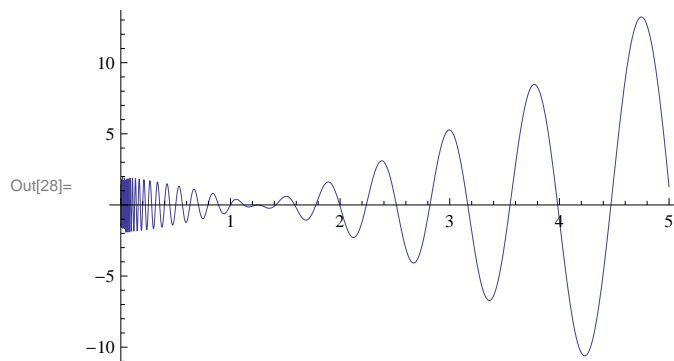

Figure 3.4. Under-damping case with q -periodic function

where $A(t), B(t)$ are q -periodic functions (or could be arbitrary constants). In Figure 3.5 and Figure 3.6 we plot particular solutions with constant ($A = B = 1$) and with q -Periodic modulation, respectively.

3.3.3. Critical Case

For $\Gamma^2 = 4\omega^2$, we have degenerate roots $\lambda_{1,2} = -\frac{\Gamma}{2}$. The first obvious solution is $e_q(-\omega t)$. However if we try the second linearly independent solution in the usual form $te_q(-\omega t)$, it doesn't work. This why we follow the next method:

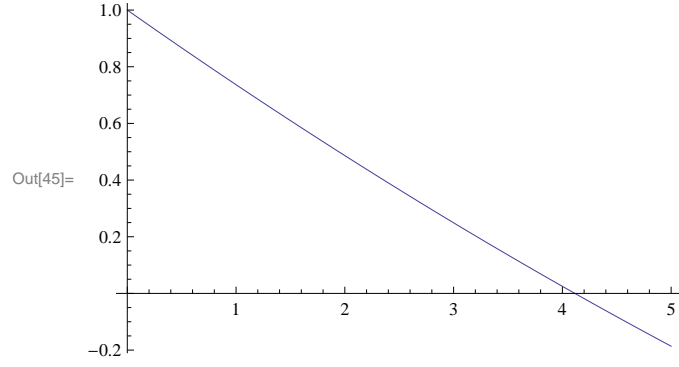

Figure 3.5. Over-damping case $A = B = 1$

We suppose that the system is very close to the critical case so that $\frac{\Gamma}{2} = \omega + \epsilon$, where $\epsilon \ll 1$.

Then the roots of characteristic equation are

$$\lambda_1 = -\omega + \sqrt{2\omega\epsilon}, \quad \lambda_2 = -\omega - \sqrt{2\omega\epsilon}, \quad (3.13)$$

and the solution is

$$x(t) = Ae_q \left((-\omega + \sqrt{2\omega\epsilon})t \right) + Be_q \left((-\omega - \sqrt{2\omega\epsilon})t \right). \quad (3.14)$$

Expanding this solution in terms of ϵ ,

$$\begin{aligned} x(t) &= A \sum_{n=0}^{\infty} \left(\frac{(-\omega)^n + n(\sqrt{2\omega\epsilon}(-\omega)^{n-1} + \dots)}{[n]!} \right) t^n \\ &+ B \sum_{n=0}^{\infty} \left(\frac{(-\omega)^n - n(\sqrt{2\omega\epsilon}(-\omega)^{n-1} + \dots)}{[n]!} \right) t^n \\ &= (A + B) \sum_{n=0}^{\infty} \frac{(-\omega)^n}{[n]!} t^n + (A - B) \sqrt{2\omega\epsilon} \sum_{n=1}^{\infty} \frac{n}{[n]!} (-\omega)^{n-1} t^n + \dots \\ &= (A + B)x_1(t) + (B - A) \sqrt{\frac{2\epsilon}{\omega}} x_2(t) + \dots, \end{aligned} \quad (3.15)$$

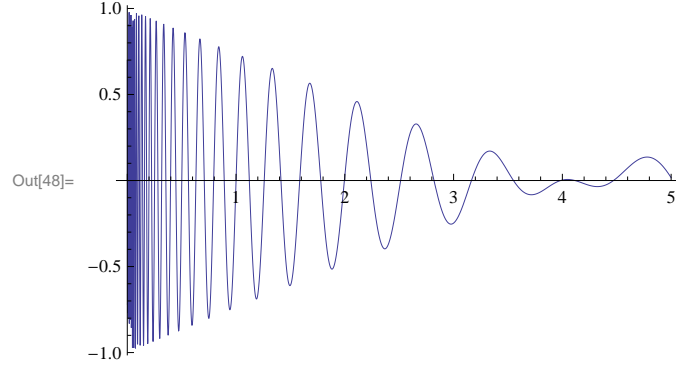

Figure 3.6. Over-damping case with q -periodic function

in zero approximation we get the first solution

$$x_1(t) = e_q(-\omega t). \quad (3.16)$$

In the linear approximation we obtain the second solution in the form

$$x_2(t) = t \frac{d}{dt} e_q(-\omega t). \quad (3.17)$$

In Appendix A, we show that solutions $x_1(t)$ and $x_2(t)$ are linearly independent. We can also rewrite this in terms of q -logarithm, which instead of linear in t term for $q = 1$ case, now includes infinite set of arbitrary powers of t ,

$$\begin{aligned} x_2(t) &= \frac{1}{1-q} \sum_{l=1}^{\infty} \frac{\left(\left(1 - \frac{1}{q}\right) \omega t \right)^l}{[l]} e_q(-\omega t) \\ &= -\frac{1}{1-q} \text{Ln}_q \left(1 - \left(1 - \frac{1}{q}\right) \omega t \right) e_q(-\omega t). \end{aligned} \quad (3.18)$$

It is easy to check that for $q \rightarrow 1$ our solution reduces to the standard second solution $te^{-\omega t}$.

Combining the above results we find the general solution in the degenerate case

as

$$x(t) = Ae_q(-\omega t) + Bt \frac{d}{dt} e_q(-\omega t). \quad (3.19)$$

In Figure 3.7 and Figure 3.8 we plot particular solutions with constant ($A = B = 1$) and with q -Periodic modulation, respectively.

In Figures 3.9 and 3.10 we plot solution with q -Periodic function modulation at different small scales. Comparing these figures we find very close similarity, this why q -periodic function modulation leads to the self-similarity property of the solution.

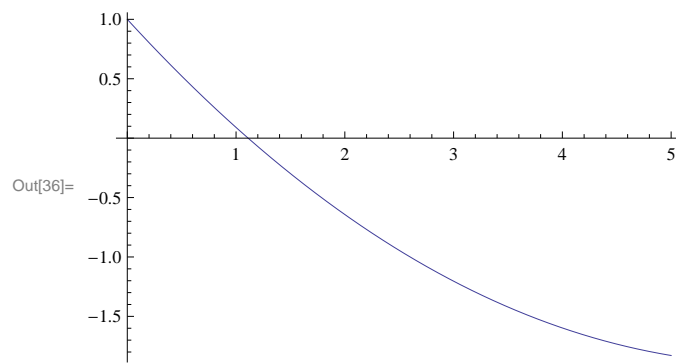

Figure 3.7. Critical case

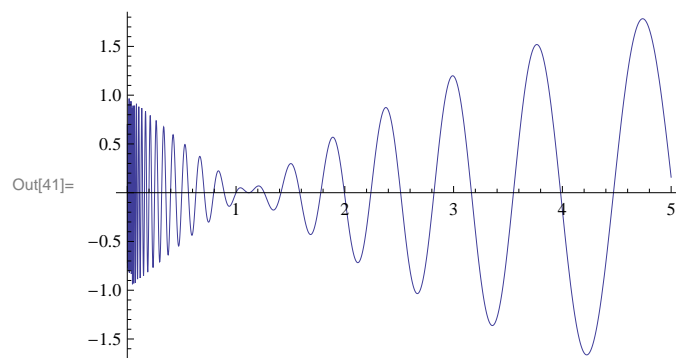

Figure 3.8. Critical case with periodic function

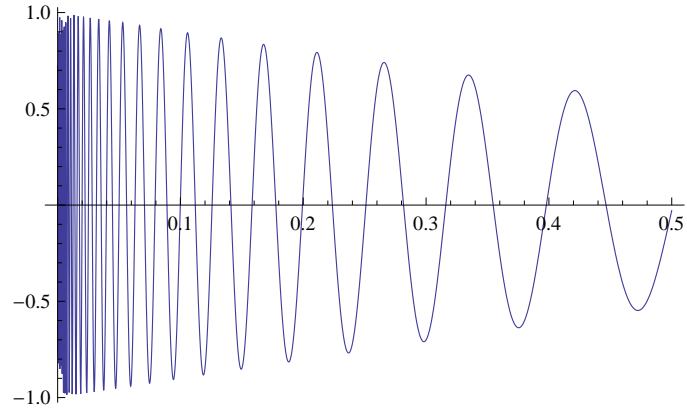

Figure 3.9. Self-similar micro structure at scale 0.5

3.4. Degenerate Roots for Equation Degree N

The result for degenerate roots obtained in previous section can be generalized to equation of an arbitrary order (Nalci & Pashaev, 2011c). The constant coefficients q -difference equation of order N is

$$\sum_{k=0}^N a_k D^k x(t) = 0, \quad (3.20)$$

where a_k are constants. By substitution

$$x = e_q(\lambda t) \quad (3.21)$$

we get the characteristic equation

$$\sum_{k=1}^N a_k \lambda^k = 0.$$

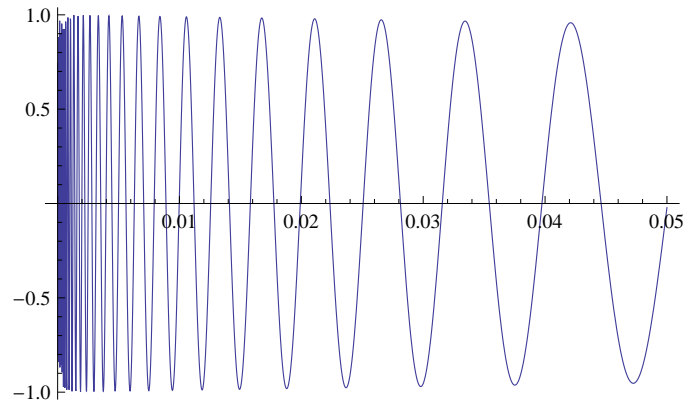

Figure 3.10. Self-similar micro structure at scale 0.05

It has N roots. Suppose $(\lambda_1, \lambda_2, \dots, \lambda_N)$ are distinct numbers. Then, the general solution of (3.20) is found in the form

$$x(t) = \sum_{k=1}^N c_k e_q(\lambda_k t). \quad (3.22)$$

In case, when we have n -degenerate roots

$$(D + \omega)^n x = 0,$$

by substituting (3.21), characteristic equation is found as

$$(\lambda + \omega)^n = 0.$$

Then the linearly independent solutions for these degenerate roots we can obtain in the

following form :

$$\begin{aligned}
x_1(t) &= e_q(-\omega t), \\
x_2(t) &= t \frac{d}{dt} e_q(-\omega t) = \frac{1}{q-1} \text{Ln}_q \left(1 - \left(1 - \frac{1}{q}\right) \omega t \right) e_q(-\omega t), \\
x_3(t) &= \left(t \frac{d}{dt} \right)^2 e_q(-\omega t),
\end{aligned}$$

or by using the commutation relation $\left[t, \frac{d}{dt} \right] = -1$, up to linearly dependent solution, it can be written as

$$\begin{aligned}
x_3(t) &= t^2 \frac{d^2}{dt^2} e_q(-\omega t), \\
&\dots \\
x_n(t) &= t^{n-1} \frac{d^{n-1}}{dt^{n-1}} e_q(-\omega t).
\end{aligned}$$

From the following commutation relation

$$\left[t \frac{d}{dt}, D \right] = -D \tag{3.23}$$

we obtain

$$t \frac{d}{dt} D^n = D^n \left(t \frac{d}{dt} - n \right)$$

and

$$t \frac{d}{dt} (\omega + D)^n = (\omega + D)^n t \frac{d}{dt} - n (\omega + D)^{n-1} D. \tag{3.24}$$

Using the operator identity (3.24) we can show that if x_0 is solution of

$$(D + \omega)x_0 = 0,$$

then it is solution of

$$(D + \omega)^n x_0 = 0.$$

Then,

$$x_1 = t \frac{d}{dt} x_0$$

is solution of

$$(D + \omega)^2 x_1 = 0,$$

and as follows

$$(D + \omega)^n x_1 = 0,$$

e.t.c. And then,

$$x_{n-1} = t \frac{d^{n-1}}{dt^{n-1}} x_0$$

is solution of

$$(D + \omega)^n x_{n-1} = 0.$$

It provides us with n linearly independent solutions x_0, x_1, \dots, x_{n-1} of N -degree equation with n -degenerate roots

$$(D + \omega)^n x = 0.$$

CHAPTER 4

Q -SPACE-TIME DIFFERENCE HEAT EQUATION

Here we introduce q -analogue of heat equation in one space dimension (Nalci & Pashaev, 2010)

$$D_t\phi(x, t) = \nu D_x^2\phi(x, t). \quad (4.1)$$

In the limit $q \rightarrow 1$ it reduces to the standard heat equation

$$\phi_t = \nu\phi_{xx}.$$

We will construct exact solutions of this equation in the form of polynomials.

4.1. q -Hermite Polynomials

We introduce the q -analogue of Hermite polynomials (Nalci & Pashaev, 2010) by the generating function

$$e_q(-t^2)e_q([2]_q tx) = \sum_{n=0}^{\infty} H_n(x; q) \frac{t^n}{[n]_q!}. \quad (4.2)$$

From the defining identity (4.2) it is not hard to derive for the q -Hermite polynomials an explicit sum formula

$$H_n(x; q) = \sum_{k=0}^{[n/2]} \frac{(-1)^k [n]_q!}{[k]_q! [n-2k]_q!} ([2]_q x)^{n-2k}. \quad (4.3)$$

This explicit sum makes it transparent in which way our polynomials $H_n(x; q)$, q -extend the $H_n(x)$ and how they are different from the known ones in literature. By

q-differentiating the generating function (4.2) with respect to x and t we derive two-term and three-term recurrence relations correspondingly

$$D_x H_n(x; q) = [2]_q [n]_q H_{n-1}(x; q), \quad (4.4)$$

$$\begin{aligned} H_{n+1}(x; q) &= [2]_q x H_n(x; q) - [n]_q H_{n-1}(qx; q) \\ &- [n]_q q^{\frac{n+1}{2}} H_{n-1}(\sqrt{q}x; q). \end{aligned} \quad (4.5)$$

From this generating function we have the special values

$$H_{2n}(0; q) = (-1)^n \frac{[2n]_q!}{[n]_q!}, \quad (4.6)$$

$$H_{2n+1}(0; q) = 0, \quad (4.7)$$

and the parity relation

$$H_n(-x; q) = (-1)^n H_n(x; q). \quad (4.8)$$

To write the three-term recurrence relation in the local form, for the same argument x , we use dilatation operator

$$M_q = q^{x \frac{d}{dx}}, \quad (4.9)$$

so that

$$M_q f(x) = f(qx), \quad (4.10)$$

and relation (4.5) can be rewritten as

$$\begin{aligned} H_{n+1}(x; q) &= [2]_q x H_n(x; q) \\ &- [n]_q (M_q + q^{\frac{n+1}{2}} M_{\sqrt{q}}) H_{n-1}(x; q). \end{aligned} \quad (4.11)$$

Substituting (4.4) into (4.11) we get

$$H_{n+1}(x; q) = \left([2]_q x - \frac{M_q + q^{\frac{n+1}{2}} M_{\sqrt{q}}}{[2]_q} D_x \right) H_n(x; q). \quad (4.12)$$

By the recursion, starting from $n = 0$ and $H_0(x) = 1$ we have next representation for the q-Hermite polynomials

$$H_n(x; q) = \prod_{k=1}^n \left([2]_q x - \frac{M_q + q^{\frac{k}{2}} M_{\sqrt{q}}}{[2]_q} D_x \right) \cdot 1. \quad (4.13)$$

We notice that the generating function and the form of our q-Hermite polynomials are different from the known ones in the literature, (Exton, 1983), (Cigler & Zeng, 2009), (Rajkovic & Marinkovic, 2001), (Negro, 1996). Moreover, the three-term recurrence relation (4.5) is q-nonlocal and different from the known ones for orthogonal polynomial sets (Ismail, 2005).

In the above expression the operator

$$M_q + q^{\frac{n}{2}} M_{\sqrt{q}} = 2q^{\frac{n}{4}} q^{\frac{3}{4}x} \frac{d}{dx} \cosh[(\ln q^{\frac{1}{4}})(x \frac{d}{dx} - n)] \quad (4.14)$$

is expressible in terms of the q-spherical means as

$$\cosh[(\ln q)x \frac{d}{dx}] f(x) = \frac{1}{2} (f(qx) + f(\frac{1}{q}x)). \quad (4.15)$$

By notation for the q -shifted product, (Kac & Cheung, 2002),

$$(x - a)_q^n = (x - a)(x - qa) \cdots (x - q^{n-1}a), \quad n = 1, 2, \dots$$

which now we apply to the noncommutative operators, so that we should distinguish the direction of multiplication, we have two cases

$$(x - a)_{q<}^n \equiv (x - a)(x - qa) \cdots (x - q^{n-1}a), \quad (4.16)$$

and

$$(x - a)_{q>}^n \equiv (x - q^{n-1}a) \cdots (x - qa)(x - a). \quad (4.17)$$

Then, we can rewrite (4.13) shortly as

$$H_n(x; q) = \left(([2]_q x - \frac{M_q D_x}{[2]_q}) - q^{\frac{1}{2}} \frac{M_{\sqrt{q}} D_x}{[2]_q} \right)_{\sqrt{q}>}^n \cdot 1.$$

First few polynomials are

$$\begin{aligned} H_0(x; q) &= 1, \\ H_1(x; q) &= [2]_q x, \\ H_2(x; q) &= [2]_q^2 x^2 - [2]_q, \\ H_3(x; q) &= [2]_q^3 x^3 - [2]_q^2 [3]_q x, \\ H_4(x; q) &= [2]_q^4 x^4 - [2]_q^2 [3]_q [4]_q x^2 + [2]_q [3]_q [2]_q^2. \end{aligned}$$

When $q \rightarrow 1$ these polynomials reduce to the standard Hermite polynomials.

4.1.1. q -Difference Equation

Applying D_x to both sides of (4.12) and using recurrence formula (4.4) we get the q -difference equation for the q -Hermite polynomials

$$\frac{1}{[2]_q} D_x (M_q + q^{\frac{n+1}{2}} M_{\sqrt{q}}) D_x H_n(x; q) - [2]_q q x D_x H_n(x; q) + [2]_q [n]_q q H_n(x; q) = 0.$$

4.2. Operator Representation

Proposition 4.2.0.1

$$e_q \left(-\frac{1}{[2]_q^2} D_x^2 \right) e_q([2]_q x t) = e_q(-t^2) e_q([2]_q x t). \quad (4.18)$$

Proof 4.2.0.2 By q -differentiating the q -exponential function with respect to x

$$D_x^n e_q([2]_q x t) = ([2]_q t)^n e_q([2]_q x t), \quad (4.19)$$

and combining then to the sum

$$\sum_{n=0}^{\infty} \frac{a^n}{[n]_q!} D_x^{2n} e_q([2]_q x t) = \sum_{n=0}^{\infty} \frac{[2]_q^{2n} a^n t^{2n}}{[n]_q!} e_q([2]_q x t), \quad (4.20)$$

we have relation

$$e_q(a D_x^2) e_q([2]_q x t) = e_q([2]_q^2 a t^2) e_q([2]_q x t). \quad (4.21)$$

By choosing $a = -1/[2]_q^2$ we get the result (4.18). ■

Proposition 4.2.0.3

$$H_n(x; q) = [2]_q^n e_q \left(-\frac{1}{[2]_q^2} D_x^2 \right) x^n. \quad (4.22)$$

Proof 4.2.0.4 *The right hand side of (4.18) is the generating function for the q -Hermite polynomials (4.2). Hence, equating the coefficients of t^n on both sides gives the result. ■*

Proposition 4.2.0.5

$$e_q \left(-\frac{D_x^2}{[2]_q^2} \right) x^{n+1} = \frac{1}{[2]_q} \left([2]_q x - \frac{(M_q + q^{\frac{n+1}{2}} M_{\sqrt{q}}) D_x}{[2]_q} \right) e_q \left(-\frac{D_x^2}{[2]_q^2} \right) x^n. \quad (4.23)$$

Proof 4.2.0.6 *We use (4.22) and relation (4.12).*

Corollary 4.2.0.7 *If function $f(x)$ is expandable to the power series $f(x) = \sum_{n=0}^{\infty} a_n x^n$, then we have the next formal q -Hermite series representation*

$$e_q \left(-\frac{1}{[2]_q^2} D_x^2 \right) f(x) = \sum_{n=0}^{\infty} a_n \frac{H_n(x; q)}{[2]_q^n}. \quad (4.24)$$

4.3. q -Kampe-de Fariet Polynomials

We define the q -Kampe-de Fariet polynomials as

$$H_n(x, \nu t; q) = (-\nu t)^{\frac{n}{2}} H_n \left(\frac{x}{[2]_q \sqrt{-\nu t}}; q \right), \quad (4.25)$$

so that from (4.12) we obtain the next recursion formula

$$H_{n+1}(x, \nu t; q) = \left(x + (M_q + q^{\frac{n+1}{2}} M_{\sqrt{q}}) \nu t D_x \right) H_n(x, \nu t; q).$$

By the recursion it gives

$$H_n(x, \nu t; q) = \prod_{k=1}^n \left(x + (M_q + q^{\frac{k}{2}} M_{\sqrt{q}}) \nu t D_x \right) \cdot 1, \quad (4.26)$$

or by notation (4.17)

$$H_n(x, \nu t; q) = \left((x + M_q \nu t D_x) + q^{\frac{1}{2}} M_{\sqrt{q}} \nu t D_x \right)_{\sqrt{q}}^n \cdot 1.$$

Then the first few polynomials are

$$\begin{aligned} H_0(x, \nu t; q) &= 1, \\ H_1(x, \nu t; q) &= x, \\ H_2(x, \nu t; q) &= x^2 + [2]_q \nu t \\ H_3(x, \nu t; q) &= x^3 + [2]_q [3]_q \nu t x, \\ H_4(x, \nu t; q) &= x^4 + [3]_q [4]_q \nu t x^2 + [2]_q [3]_q [2]_{q^2} \nu^2 t^2. \end{aligned}$$

4.4. q-Heat Equation

We introduce the q-heat equation

$$(D_t - \nu D_x^2) \phi(x, t) = 0, \quad (4.27)$$

with partial q -derivatives with respect to t and x . Solution of this equation expanded in terms of parameter k

$$\phi(x, t) = e_q(\nu k^2 t) e_q(kx) = \sum_{n=0}^{\infty} \frac{k^n}{[n]!} H_n(x, \nu t; q), \quad (4.28)$$

gives the set of q-Kampe-de Fariet polynomial solutions for the equation. Then we find the time evolution of zeroes $x_k(t)$ for these polynomials in terms of zeroes $z_k(n, q)$ of the

q-Hermite polynomials,

$$H_n(z_k(n, q), q) = 0, \quad (4.29)$$

so that

$$x_k(t) = [2]z_k(n, q)\sqrt{-\nu t}. \quad (4.30)$$

For n=2 we have two zeros determined by q-numbers,

$$x_1(t) = \sqrt{[2]_q}\sqrt{-\nu t}, \quad x_2(t) = -\sqrt{[2]_q}\sqrt{-\nu t},$$

and moving in opposite directions according to (4.30). For n=3 we have zeros determined by q-numbers,

$$x_1(t) = -\sqrt{[3]_q!}\sqrt{-\nu t}, \quad x_2(t) = 0, \quad x_3(t) = \sqrt{[3]_q!}\sqrt{-\nu t},$$

two of which are moving in opposite direction according to (4.30) and one is in the rest.

4.5. Evolution Operator

Following similar calculations as in Proposition I we have the next relation

$$e_q(\nu t D_x^2) e_q(kx) = e_q(\nu t k^2) e_q(kx). \quad (4.31)$$

The right hand side of this expression is the plane wave type solution (4.28) of the q-heat equation (4.27). Equating the coefficients of k^n on both sides we get the q-Kampe de Feriet polynomial solutions of this equation

$$H_n(x, \nu t; q) = e_q(\nu t D_x^2) x^n. \quad (4.32)$$

Consider an arbitrary, expandable to the power series function $f(x) = \sum_{n=0}^{\infty} a_n x^n$, then the formal series

$$f(x, t) = e_q(\nu t D_x^2) f(x) = \sum_{n=0}^{\infty} a_n e_q(\nu t D_x^2) x^n \quad (4.33)$$

$$= \sum_{n=0}^{\infty} a_n H_n(x, \nu t; q), \quad (4.34)$$

represents a time dependent solution of the q-heat equation (4.27). Domain of convergence for this series is determined by asymptotic properties of our q-Kampe-de Fariet polynomials for $n \rightarrow \infty$ and requires additional study.

According to this we have the evolution operator for the q-heat equation as

$$U(t) = e_q(\nu t D_x^2). \quad (4.35)$$

It allows us to solve the initial value problem

$$(D_t - \nu D_x^2) \phi(x, t) = 0, \quad (4.36)$$

$$\phi(x, 0^+) = f(x), \quad (4.37)$$

in the form

$$\phi(x, t) = e_q(\nu t D_x^2) \phi(x, 0^+) = e_q(\nu t D_x^2) f(x), \quad (4.38)$$

where we imply the base $q > 1$ so that $e_q(x)$ is an entire function.

CHAPTER 5

Q -SPACE-TIME DIFFERENCE BURGERS' EQUATION

5.1. Burger's Equation and Cole-Hopf Transformation

Nonlinear Heat equation which is also known as Burger's equation is

$$u_t + uu_x = \nu u_{xx}. \quad (5.1)$$

By using the Cole-Hopf transformation

$$u(x, t) = -2\nu \frac{\phi_x(x, t)}{\phi(x, t)}, \quad (5.2)$$

it reduces to Linear heat equation

$$\phi_t = \nu \phi_{xx}. \quad (5.3)$$

Shock soliton solutions are the particular solutions of this equation.

5.2. q -Burger's Equation as nonlinear q -Heat Equation

We introduce the q -Cole-Hopf transformation

$$u(x, t) = -2\nu \frac{D_x \phi(x, t)}{\phi(x, t)}, \quad (5.4)$$

where $\phi(x, t)$ is solution of the q-heat equation (4.27), we find that $u(x, t)$ satisfies the q-Burgers' type Equation with cubic nonlinearity (Nalci & Pashaev, 2010)

$$D_t u(x, t) - \nu D_x^2 u(x, t) = \frac{1}{2} [(u(x, qt) - u(x, t)M_q^x) D_x u(x, t)] - \frac{1}{2} [D_x (u(qx, t)u(x, t))] + \frac{1}{4\nu} [u(q^2 x, t) - u(x, qt)] u(qx, t)u(x, t). \quad (5.5)$$

When $q \rightarrow 1$ it reduces to the standards Burgers' Equation

$$u_t + uu_x = \nu u_{xx}. \quad (5.6)$$

5.2.1. I.V.P. for q-Burgers' Type Equation

Substituting the operator solution (4.38) to (5.4), we find operator solution for the q-Burgers type equation in the form

$$u(x, t) = -2\nu \frac{e_q(\nu t D_x^2) D_x f(x)}{e_q(\nu t D_x^2) f(x)}. \quad (5.7)$$

This solution corresponds to the initial function

$$u(x, 0^+) = -2\nu \frac{D_x f(x)}{f(x)}. \quad (5.8)$$

Thus, for arbitrary initial value $u(x, 0^+) = F(x)$ for the q-Burgers equation we need to solve the initial value problem for the q-heat equation (4.27) with initial function $f(x)$ satisfying the first order q-difference equation

$$(D_x + \frac{1}{2\nu} F(x))f(x) = 0. \quad (5.9)$$

5.3. q-Shock Soliton

As a particular solution of the q-heat equation we choose first

$$\phi(x, t) = e_q(k^2 t) e_q(kx), \quad (5.10)$$

then we find solution of the q-Burgers equation as a constant

$$u(x, t) = -2\nu k. \quad (5.11)$$

We notice that for this solution of the q-heat equation, we have an infinite set of zeros, and the space position of zeros is fixed during time evolution at points $x_n = -q^{n+1}/(q-1)k$, $n = 0, 1, \dots$

If we choose the linear superposition

$$\phi(x, t) = e_q(k_1^2 t) e_q(k_1 x) + e_q(k_2^2 t) e_q(k_2 x), \quad (5.12)$$

then we have the q-shock soliton solution

$$u(x, t) = -2\nu \frac{k_1 e_q(k_1^2 t) e_q(k_1 x) + k_2 e_q(k_2^2 t) e_q(k_2 x)}{e_q(k_1^2 t) e_q(k_1 x) + e_q(k_2^2 t) e_q(k_2 x)}. \quad (5.13)$$

This expression is the q-analogue of the Burgers shock soliton and for $q \rightarrow 1$ it reduces to the last one. However, in contrast to the standard Burgers case, due to zeroes of the q-exponential function this expression admits singularities for some values of parameters k_1 and k_2 .

In Figure 5.1 we plot the singular q-shock soliton for $k_1 = 1$ and $k_2 = 10$ at time $t = 0$ with base $q = 10$.

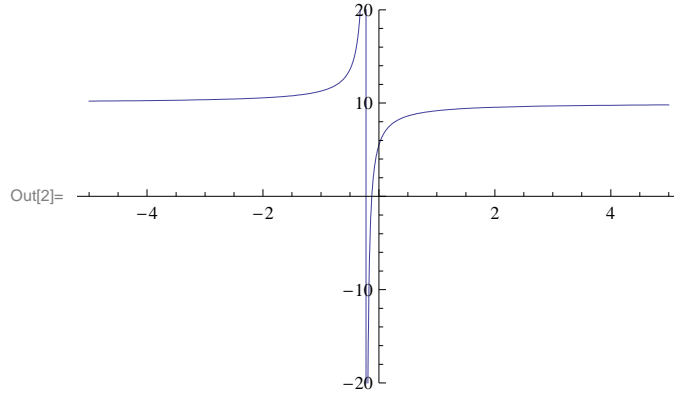

Figure 5.1. Singular q-shock soliton

It turns out that for some specific values of parameters we can find the regular q-shock soliton solution. We introduce the cosine q-hyperbolic function

$$\cosh_q(x) = \frac{e_q(x) + e_q(-x)}{2}, \quad (5.14)$$

or

$$\cosh_q(x) = \frac{1}{2} \left(e_q(x) + \frac{1}{e_{\frac{1}{q}}(x)} \right), \quad (5.15)$$

then by using the infinite product representation (2.27) for the q-exponential function we have

$$\cosh_q(x) = \frac{1}{2} \left(\left(1 + \left(1 - \frac{1}{q} \right) x \right)_{1/q}^\infty + \left(1 - \left(1 - \frac{1}{q} \right) x \right)_q^\infty \right).$$

From (2.28),(2.29) we find that zeroes of the first product are located on negative axis x , while for the second product on the positive axis x . Therefore the function has no zeros for real x and $\cosh_q(0) = 1$.

If we choose $k_1 = 1$, and $k_2 = -1$, the time dependent factors in nominator and

the denominator of (5.13) cancel each other and we have the stationary shock soliton

$$u(x, t) = -2\nu \frac{e_q(x) - e_q(-x)}{e_q(x) + e_q(-x)} \equiv -2\nu \tanh_q(x). \quad (5.16)$$

Due to the above consideration this function has no singularity on real axis and we have regular everywhere q-shock soliton solution. In the limit $q \rightarrow 1$ it reduces to the kink-soliton.

In Figure 5.2, 5.3 and 5.4 we plot the regular q-shock soliton for $k_1 = 1$ and $k_2 = -1$ at different ranges of x and $q = 10$. It is a remarkable fact that the structure of our shock soliton shows self-similarity property in space coordinate x . Indeed at the ranges of parameter $x = 50, 5000, 500000$ the structure of shock looks almost the same.

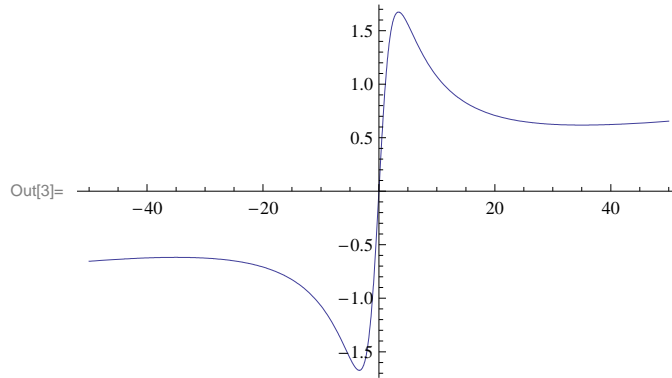

Figure 5.2. The regular q-shock soliton for $k_1 = 1, k_2 = -1$, at range $(-50, 50)$

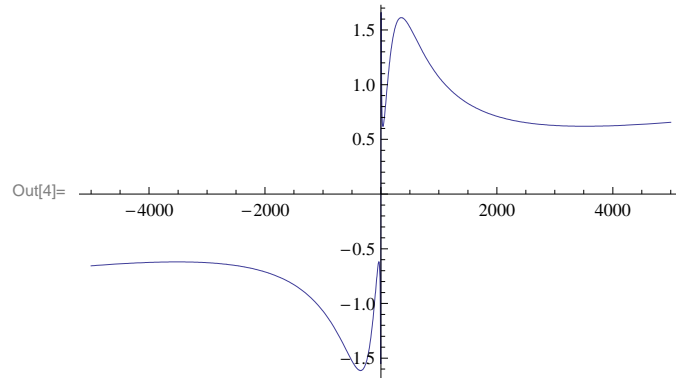

Figure 5.3. The regular q-shock soliton for $k_1 = 1$, $k_2 = -1$ at range $(-5000, 5000)$

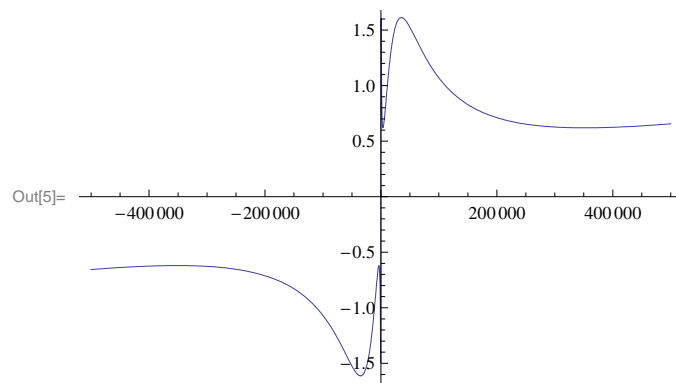

Figure 5.4. The regular q-shock soliton for $k_1 = 1$, $k_2 = -1$ at range $(-500000, 500000)$

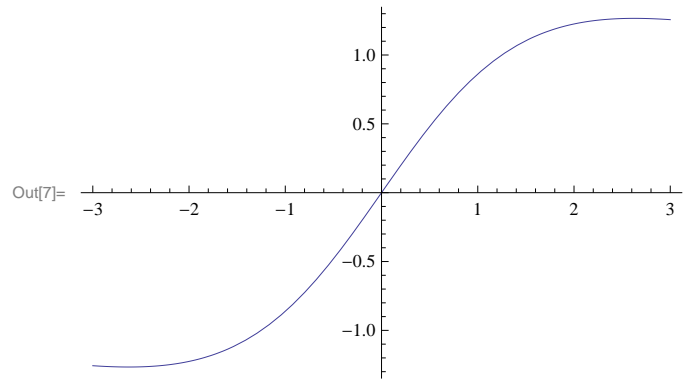

Figure 5.5. q-Shock soliton

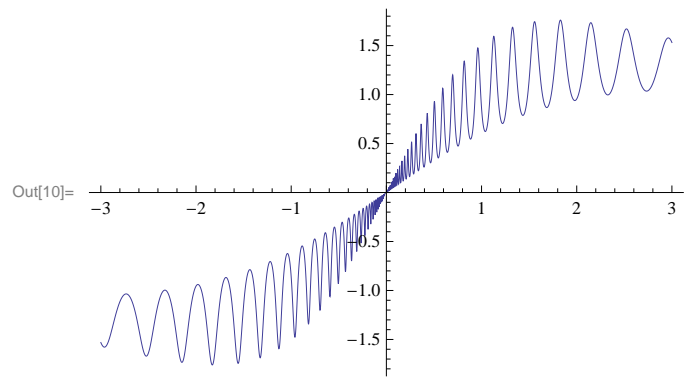

Figure 5.6. q-Shock soliton with q-periodic modulation

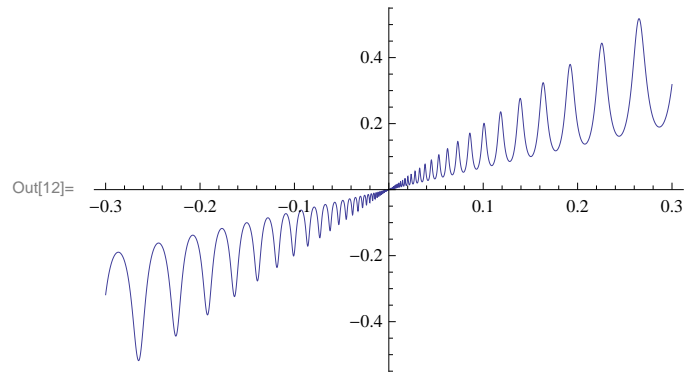

Figure 5.7. Self-similar q-shock soliton micro structure at scale 0.3

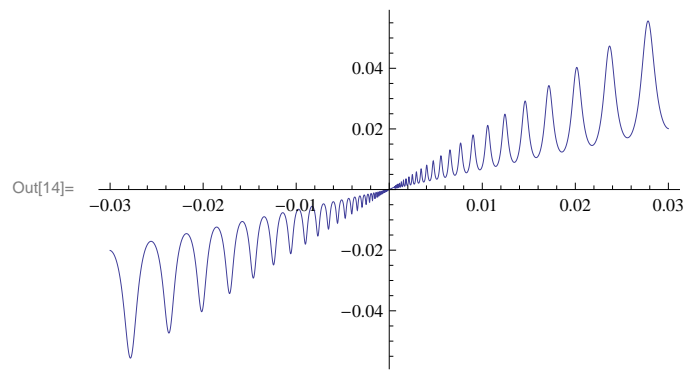

Figure 5.8. Self-similar q-shock soliton micro structure at scale 0.03

For the set of arbitrary numbers k_1, \dots, k_N

$$\phi(x, t) = \sum_{n=1}^N e_q(k_n^2 t) e_q(k_n x), \quad (5.17)$$

we have multi-shock soliton solution in the form

$$u(x, t) = -2\nu \frac{\sum_{n=1}^N k_n e_q(k_n^2 t) e_q(k_n x)}{\sum_{n=1}^N e_q(k_n^2 t) e_q(k_n x)}. \quad (5.18)$$

In general this solution admits several singularities. To have regular multi-shock solution we can consider the even number of terms $N = 2k$ with opposite wave numbers. When $N = 4$ and $k_1 = 1, k_2 = -1, k_3 = 10, k_4 = -10$ we have q-multi-shock soliton solution,

$$u(x, t) = -2\nu \frac{e_q(t) \sinh_q(x) + 10e_q(100t) \sinh_q(10x)}{e_q(t) \cosh_q(x) + e_q(100t) \cosh_q(10x)}. \quad (5.19)$$

In Figure 5.9 we plot $N = 4$ case with values of the wave numbers $k_1 = 1, k_2 = -1, k_3 = 10, k_4 = -10$ at $t = 0$ and $q = 10$. To have regular solution for any time t and given base q , we should choose proper numbers k_i which are not in the form of power of q .

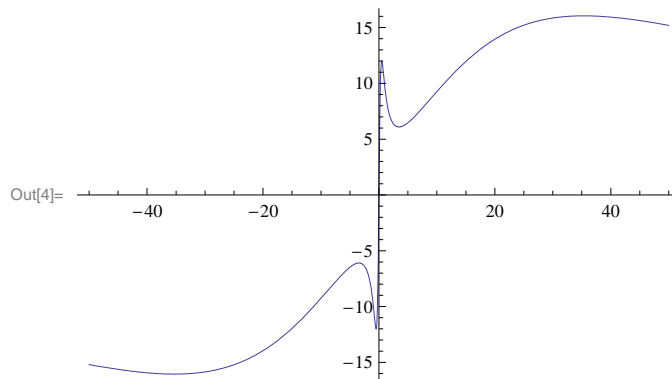

Figure 5.9. Multi q-shock regular for $k_1 = 1, k_2 = -1, k_3 = 10, k_4 = -10$ at $t = 0$

CHAPTER 6

Q-SPACE DIFFERENCE AND TIME DIFFERENTIAL HEAT EQUATION

6.1. q-Hermite Polynomials

We define the q-analog of Hermite polynomials by the generating function with the Jackson's q-exponential function and standard exponential function as (Pashaev & Nalci, 2010)

$$e^{-t^2} e_q([2]_q tx) = \sum_{N=0}^{\infty} H_N(x; q) \frac{t^N}{[N]_q!}, \quad (6.1)$$

where the Jackson's q-exponential function is defined by

$$e_q(x) = \sum_{n=0}^{\infty} \frac{x^n}{[n]_q!},$$

$[n]_q! = [1]_q [2]_q \dots [n]_q$ and q-number

$$[n]_q = \frac{q^n - 1}{q - 1}.$$

From the defining identity (6.1) it is not difficult to derive for the q-Hermite polynomials an explicit sum formula

$$H_N(x; q) = \sum_{k=0}^{[N/2]} \frac{(-1)^k ([2]_q x)^{N-2k} [N]_q!}{k! [N-2k]_q!}. \quad (6.2)$$

This explicit sum makes it transparent in which way our polynomials $H_N(x; q)$ q-extended the $H_N(x)$ and how they are different from the known ones in literature. By q-differentiating

the generating function (6.1) with respect to x we derive two-term recurrence relation correspondingly

$$D_q H_N(x; q) = [2]_q [N]_q H_{N-1}(x; q), \quad (6.3)$$

where definition of q -derivative is

$$D_x f(x) = \frac{f(qx) - f(x)}{(q-1)x}. \quad (6.4)$$

By standard differentiating the generating function (6.1) with respect to t and using the equality

$$t \frac{d}{dt} e_q([2]_q xt) = x \frac{d}{dx} e_q([2]_q xt) = \sum_{n=0}^{\infty} n \frac{([2]_q xt)^n}{[n]_q!}$$

we obtain the two-term recurrence relation

$$\left(x \frac{d}{dx} - N\right) H_N(x; q) = 2[N]_q [N-1]_q H_{N-2}(x; q). \quad (6.5)$$

By standard differentiating the generating function (6.1) with respect to t and using definition of q -logarithmic function (Pashaev & Yilmaz, 2008)

$$\text{Ln}_q(1+z) = \sum_{N=1}^{\infty} \frac{(-1)^{N-1} z^N}{[N]},$$

where $q > 1, 0 < |z| < q$ and the property

$$\frac{d}{dz} \ln e_q \left(\frac{\alpha z}{1-q} \right) = \frac{\text{Ln}_q(1-\alpha z)}{(q-1)z}$$

we derive the N-term (instead of 3-term) recurrence relation formula

$$\begin{aligned}
H_{N+1}(x; q) &= \frac{[N+1]_q}{N+1} ([2]_q x H_N(x; q) \\
&- 2[N]_q H_{N-1}(x; q) - (q-1)[2]_q [N]_q x^2 H_{N-1}(x; q) \\
&+ [2]_q [N]_q! \sum_{k=0}^{N-2} \frac{(-1)^{N-k} (q^2-1)^{N-k} x^{N-k+1} H_k(x; q)}{[k]_q! [N-k+1]_q}).
\end{aligned}$$

When $q \rightarrow 1$ this multiple term recurrence relation for q-Hermite polynomials reduces to the three-term recurrence relation for Hermite polynomials

$$H_{N+1}(x) = 2xH_N(x) - 2NH_{N-1}(x).$$

Substituting (6.3) into N-term recurrence relation formula we get

$$\begin{aligned}
H_{N+1}(x; q) &= \\
\frac{[N+1]_q}{N+1} &\left([2]_q x - \left(\frac{2}{[2]_q} + (q-1)x^2 \right) D_x + \sum_{l=2}^N \frac{(-1)^l (q^2-1)^l x^{l+1}}{[2]_q^{l-1} [l+1]_q} D_x^l \right) H_N(x; q),
\end{aligned}$$

or

$$\begin{aligned}
H_{N+1} &= \frac{[N+1]!}{N+1} \left(-2 \frac{H_{N-1}}{[N-1]!} + \sum_{k=0}^N \frac{H_k (1-q)^{N-k} ([2]_q x)^{N-k+1}}{[k]! [N-k+1]} \right) \\
&= \frac{[N+1]}{N+1} \left(-2[N]H_{N-1} + [N]! \sum_{k=0}^N \frac{H_k (1-q)^{N-k} ([2]_q x)^{N-k+1}}{[k]! [N-k+1]} \right). \quad (6.6)
\end{aligned}$$

By the recursion, starting from $n = 0$ and $H_0(x; q) = 1$ we have next representation for the q-Hermite polynomials

$$\begin{aligned}
H_{N+1}(x; q) &= \\
\prod_{k=0}^N \frac{[k+1]_q}{k+1} &\left([2]_q x - \left(\frac{2}{[2]_q} + (q-1)x^2 \right) D_x + \sum_{k=2}^N \frac{(-1)^k (q^2-1)^k x^{k+1}}{[2]_q^{k-1} [k+1]_q} D_x^k \right) \cdot 1.
\end{aligned}$$

In the limit $q \rightarrow 1$ case this product formula is reduced to

$$H_N(x) = \left(2x - \frac{d}{dx}\right)^N \cdot 1.$$

We note that the generating function and the form of our q-Hermite polynomials are different from the known ones in the literature, (Exton, 1983), (Negro, 1996), (Rajkovic & Marinkovic, 2001), (Cigler & Zeng, 2009). Moreover, instead of three-term recurrence relation we have multiple term recurrence relation which shows our q-Hermite polynomials are different from the known ones for orthogonal polynomials sets (Ismail, 2005).

Then first few q-Hermite polynomials are

$$\begin{aligned} H_0(x; q) &= 1, \\ H_1(x; q) &= [2]_q x, \\ H_2(x; q) &= [2]_q^2 x^2 - [2]_q, \\ H_3(x; q) &= [2]_q^3 x^3 - [2]_q^2 [3]_q x, \\ H_4(x; q) &= [2]_q^4 x^4 - [4]_q [3]_q [2]_q^2 x^2 + \frac{1}{2} [4]_q!, \\ H_5(x; q) &= [2]_q^5 x^5 - [5]_q [4]_q [2]_q^3 x^3 + \frac{1}{2} [5]_q! [2]_q. \end{aligned} \quad (6.7)$$

When $q \rightarrow 1$ these polynomials reduce to the standard Hermite polynomials.

6.1.1. q-Difference Equation

Applying D_x to both sides of (6.3) and using recurrence formula (6.5) we get the q-difference-differential equation for the q-Hermite polynomials

$$D_q^2 H_N(x; q) - \frac{[2]_q^2}{2} x \frac{d}{dx} H_N(x; q) + \frac{[2]_q^2}{2} N H_N(x; q) = 0. \quad (6.8)$$

In $q \rightarrow 1$ limit it reduces to the second order linear differential equation for Her-

mite polynomials

$$\frac{d^2}{dx^2}H_N(x) - 2x\frac{d}{dx}H_N(x) + 2NH_N(x) = 0.$$

6.2. q-Kampe-de Feriet Polynomials

We define the q-Kampe-de Feriet polynomials as

$$H_N(x, \nu t; q) = (-\nu t)^{\frac{N}{2}} H_N\left(\frac{x}{[2]_q \sqrt{-\nu t}}; q\right), \quad (6.9)$$

so that from N-term recurrence relation for q-Hermite polynomial we obtain N-term recurrence relation formula for q-Kampe-de Feriet polynomials

$$H_{N+1}(x, \nu t; q) = \frac{[N+1]_q}{N+1} [xH_N(x, \nu t; q) + 2\nu t[N]_q H_{N-1}(x, \nu t; q) - \frac{1}{[2]_q} (q-1)[N]_q x^2 H_{N-1}(x, \nu t; q) + [N]_q! \sum_{k=0}^{N-2} \frac{(-1)^{N-k} (q^2-1)^{N-k} x^{N-k+1} H_k(x, \nu t; q)}{[k]_q! [N-k+1]_q [2]_q^{N-k}}]$$

or

$$H_{N+1}(x, \nu; q) = \frac{[N+1]}{N+1} \left(2\nu t [N] H_{N-1} + \sum_{k=0}^N \frac{(1-q)^{N-k} x^{N-k+1} H_k}{[k]! [N-k+1]} \right).$$

This can also be written in terms of D_x operator form correspondingly

$$H_{N+1}(x, \nu t; q) = \frac{[N+1]_q}{N+1} \left[x + (2\nu t + \frac{1-q}{[2]_q} x^2) D_x + \sum_{l=2}^N \frac{(-1)^l (q^2-1)^l x^{l+1}}{[2]_q^l [l]_q} D_x^l \right] H_N(x, \nu t; q).$$

By the recursion, starting from $n = 0$ and $H_0(x, \nu t; q) = 1$ we have next representation for the q-Kampe-de Feriet polynomials

$$H_{N+1}(x, \nu t; q) = \prod_{k=0}^N \frac{[k+1]_q}{k+1} \left[x + (2\nu t + \frac{1-q}{[2]_q} x^2) D_x + \sum_{k=2}^N \frac{(-1)^k (q^2 - 1)^k x^{k+1}}{[2]_q^k [k]_q} D_x^k \right] \cdot 1.$$

In $q \rightarrow 1$ case we have

$$H_N(x) = (x + 2\nu t \frac{d}{dx})^N \cdot 1.$$

Then the first few q-Kampe-de Feriet polynomials are

$$\begin{aligned} H_0(x, \nu t; q) &= 1, \\ H_1(x, \nu t; q) &= x, \\ H_2(x, \nu t; q) &= x^2 + [2]_q \nu t, \\ H_3(x, \nu t; q) &= x^3 + [2]_q [3]_q \nu t x, \\ H_4(x, \nu t; q) &= x^4 + [3]_q [4]_q \nu t x^2 + \frac{[4]_q!}{2} \nu^2 t^2, \\ H_5(x, \nu t; q) &= x^5 + [4]_q [5]_q \nu t x^3 + \frac{[5]_q!}{2} \nu^2 t^2 x. \end{aligned}$$

When $q \rightarrow 1$ these polynomials reduce to the standard Kampe-de Feriet polynomials.

6.3. q-Heat Equation

We introduce the q-Heat equation

$$(\partial_t - \nu D_x^2) \phi(x, t) = 0 \tag{6.10}$$

with partial q -derivative with respect to x and with partial standard derivative in time t . One can easily see that

$$\phi_k(x, t) = e^{\nu k^2 t} e_q(kx)$$

is a plane wave solution of (6.10). By expanding this in terms of parameter k

$$\phi_k(x, t) = e^{\nu k^2 t} e_q(kx) = \sum_{N=0}^{\infty} H_N(x, \nu t; q) \frac{k^N}{[N]_q!} \quad (6.11)$$

we get the set of q -Kampe-de Fariet polynomial solutions for the q -Heat equation (6.10). From the defining identity (6.11) is not difficult to derive an explicit sum formula for the q -Kampe de Fariet polynomials

$$H_N(x, \nu t; q) = \sum_{k=0}^{[N/2]} \frac{(\nu t)^k x^{N-2k} [N]_q!}{k! [N-2k]_q!}. \quad (6.12)$$

6.3.1. Operator Representation

Proposition 6.3.1.1

$$e^{-\frac{1}{[2]_q^2} D_x^2} e_q([2]_q x t) = e^{-t^2} e_q([2]_q x t). \quad (6.13)$$

Proof 6.3.1.2 By q -differentiating the q -exponential function with respect to x

$$D_x^n e_q([2]_q x t) = ([2]_q t)^n e_q([2]_q x t), \quad (6.14)$$

and combining then to the sum

$$\sum_{n=0}^{\infty} \frac{a^n}{n!} D_x^{2n} e_q([2]_q x t) = \sum_{n=0}^{\infty} \frac{([2]_q t)^{2n} a^n}{n!} e_q([2]_q x t), \quad (6.15)$$

we have relation

$$e^{aD_x^2} e_q([2]_q xt) = e^{a([2]_q t)^2} e_q([2]_q xt). \quad (6.16)$$

By choosing $a = -1/[2]_q^2$ we get the result (10.31).

Proposition 6.3.1.3

$$H_N(x; q) = [2]_q^N e^{-\frac{1}{[2]_q^2} D_x^2} x^N. \quad (6.17)$$

Proof 6.3.1.4 The right hand side of (10.31) is the generating function for the q -Hermite polynomials (6.1). Hence, equating the coefficients of t^n on both sides gives the result.

Corollary 6.3.1.5 If function $f(x)$ is expandable to the formal power series $f(x) = \sum_{N=0}^{\infty} a_N x^N$ then we have next q -Hermite series

$$e^{-\frac{1}{[2]_q^2} D_x^2} f(x) = \sum_{N=0}^{\infty} a_N \frac{H_N(x; q)}{[2]_q^N}. \quad (6.18)$$

6.4. Evolution Operator

Following similar calculations as in Proposition I we have the next relation

$$e^{\nu t D_x^2} e_q(kx) = e^{\nu t k^2} e_q(kx). \quad (6.19)$$

The right hand side of this expression is the plane wave type solution of the q -heat equation (6.10). Expanding both sides in power series in k and equating the coefficients of k^N on both sides we get q -Kampe de Feriet polynomial solutions of this equation

$$H_N(x, \nu t; q) = e^{\nu t D_x^2} x^N. \quad (6.20)$$

Consider an arbitrary, expandable to the power series function $f(x) = \sum_{n=0}^{\infty} a_n x^n$, then the formal series

$$f(x, t) = e^{\nu t D_x^2} f(x) = \sum_{n=0}^{\infty} a_n e^{\nu t D_x^2} x^n \quad (6.21)$$

$$= \sum_{n=0}^{\infty} a_n H_N(x, \nu t; q), \quad (6.22)$$

represents a time dependent solution of the q-heat equation (6.10). The domain of convergence for this series is determined by asymptotic properties of our q-Kampe-de Fériet polynomials for $n \rightarrow \infty$ and requires additional study.

According to this we have the evolution operator for the q-heat equation as

$$U(t) = e^{\nu t D_x^2}. \quad (6.23)$$

It allows us to solve the initial value problem

$$\left(\frac{\partial}{\partial t} - \nu D_x^2\right)\phi(x, t) = 0, \quad (6.24)$$

$$\phi(x, 0^+) = f(x), \quad (6.25)$$

in the form

$$\phi(x, t) = e^{\nu t D_x^2} \phi(x, 0^+) = e^{\nu t D_x^2} f(x), \quad (6.26)$$

where we imply the base $q > 1$ so that $e_q(x)$ is an entire function.

CHAPTER 7

Q-SPACE DIFFERENCE AND TIME DIFFERENTIAL BURGER'S EQUATION

7.1. q-Cole-Hopf Transformation and q-Burger's Equation

We use the q-Cole-Hopf transformation (Nalci & Pashaev, 2010)

$$u(x, t) = -2\nu \frac{D_x \phi(x, t)}{\phi(x, t)}, \quad (7.1)$$

where $\phi(x, t)$ is solution of the q-heat equation (6.10). Then $u(x, t)$ satisfies the q-Burgers' type Equation with cubic nonlinearity

$$\begin{aligned} \frac{\partial}{\partial t} u(x, t) - \nu D_x^2 u(x, t) &= \frac{1}{2} [(1 - M_q^x) u(x, t) D_x u(x, t)] - \\ &\frac{1}{2} [D_x (u(qx, t) u(x, t))] + \frac{1}{4\nu} [u(q^2 x, t) - u(x, qt)] u(qx, t) u(x, t). \end{aligned}$$

When $q \rightarrow 1$ it reduces to the standards Burgers' Equation

$$u_t + uu_x = \nu u_{xx}. \quad (7.2)$$

7.1.1. I.V.P. for q-Burgers' Type Equation

Substituting the operator solution (6.26) to (7.1) we find operator solution for the q-Burgers type equation in the form

$$u(x, t) = -2\nu \frac{e^{\nu t D_x^2} D_x f(x)}{e^{\nu t D_x^2} f(x)}. \quad (7.3)$$

This solution corresponds to the initial function

$$u(x, 0^+) = -2\nu \frac{D_x f(x)}{f(x)}. \quad (7.4)$$

Thus, for arbitrary initial value $u(x, 0^+) = F(x)$ for the q-Burgers equation we need to solve the initial value problem for the q-heat equation (6.10) with initial function $f(x)$ satisfying the first order q-difference equation

$$(D_x + \frac{1}{2\nu} F(x))f(x) = 0. \quad (7.5)$$

7.2. q-Shock Soliton

As a particular solution of the q-heat equation we choose first

$$\phi(x, t) = e^{k^2 t} e_q(kx), \quad (7.6)$$

then we find solution of the q-Burgers equation as a constant

$$u(x, t) = -2\nu k. \quad (7.7)$$

We notice that for this solution of the q-heat equation, we have an infinite set of zeros, and the space position of zeros is fixed during time evolution at points $x_n = -q^{n+1}/(q-1)k$, $n = 0, 1, \dots$

If we choose the linear superposition

$$\phi(x, t) = e^{k_1^2 t} e_q(k_1 x) + e^{k_2^2 t} e_q(k_2 x), \quad (7.8)$$

then we have the q-Shock soliton solution

$$u(x, t) = -2\nu \frac{k_1 e^{k_1^2 t} e_q(k_1 x) + k_2 e^{k_2^2 t} e_q(k_2 x)}{e^{k_1^2 t} e_q(k_1 x) + e^{k_2^2 t} e_q(k_2 x)}. \quad (7.9)$$

This expression is the q-analog of the Burgers shock soliton and for $q \rightarrow 1$ it reduces to the last one. However, in contrast to the standard Burgers case, due to zeroes of the q-exponential function this expression admits singularities coming from x for some values of parameters k_1 and k_2 . To have regular solution we can follow similar approach from (Nalci & Pashaev, 2010) for $k_2 = -k_1$ we have the stationary shock soliton

$$u(x, t) = -2\nu k_1 \frac{e_q(k_1 x) - e_q(-k_1 x)}{e_q(k_1 x) + e_q(-k_1 x)} \equiv -2\nu k_1 \tanh_q(k_1 x). \quad (7.10)$$

This function has no singularity on the real axis and everywhere we have regular q-shock soliton. If we plot the regular q-shock soliton evolution for $k_1 = 1$ and $k_2 = -1$ at different ranges of x and with $q = 10$, it is remarkable fact that the structure of our q-shock soliton shows self-similar property in the space coordinate x . Indeed at the range of parameter $-50 < x < 50$, and $-5000 < x < 5000$, structure of shock looks almost the same (Figures 5.2, 5.3 and 5.4).

However time evolution of shock solitons in (Nalci & Pashaev, 2010) produce singularity at finite time. Here we like to find regular in x shock soliton which is regular at any time.

We can choose solution of q-Heat equation (6.10) as

$$\phi(x, t) = 10 + e^{k_1^2 t} e_q(k_1 x) + e^{k_2^2 t} e_q(k_2 x),$$

then for $k_1 = 1$ and $k_2 = -1$ we get the q-shock soliton

$$u(x, t) = -2\nu \frac{e_q(x) - e_q(-x)}{10e^{-t} + e_q(x) + e_q(-x)}.$$

This solution describes evolution of shock soliton, so that at $t \rightarrow -\infty$, $u(x, t) \rightarrow 0$, and for $t \rightarrow \infty$, $u(x, t) \rightarrow -2\nu \tanh_q x$. In Figures 7.1, 7.2 and 7.3 we plot the regular q-shock soliton for $k_1 = 1$ and $k_2 = -1$ at different time $t = -2, 0, 5$ with base $q = 10$. In

Figure 7.4 we show 3D plot of this q-shock evolution at space range $-50 < x < 50$ time $-20 < t < 20$ and $k_1 = 1, k_2 = -1, k_3 = 2, k_4 = -2$.

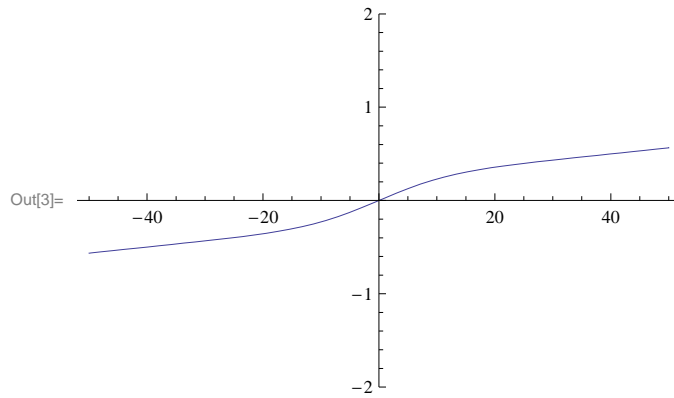

Figure 7.1. q-Shock evolution for $\nu = 1, k_1 = 1, k_2 = -1, t = -2$ at range $(-50, 50)$

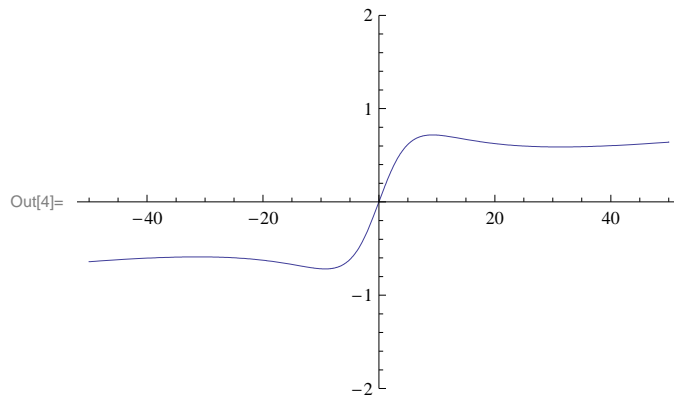

Figure 7.2. q-Shock evolution for $\nu = 1, k_1 = 1, k_2 = -1, t = 0$ at range $(-50, 50)$

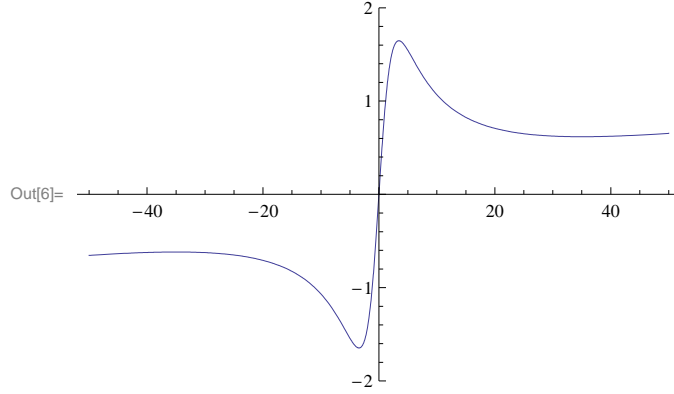

Figure 7.3. q-Shock evolution for $\nu = 1, k_1 = 1, k_2 = -1, t = 5$ at range $(-50, 50)$

For the set of arbitrary numbers k_1, \dots, k_N

$$\phi(x, t) = \sum_{n=1}^N e^{k_n^2 t} e_q(k_n x), \quad (7.11)$$

we have multi-shock solution in the form

$$u(x, t) = -2\nu \frac{\sum_{n=1}^N k_n e^{k_n^2 t} e_q(k_n x)}{\sum_{n=1}^N e^{k_n^2 t} e_q(k_n x)}. \quad (7.12)$$

In general this solution admits several singularities. To have a regular multi-shock solution we can consider the even number of terms $N = 2k$ with opposite wave numbers. When $N = 4$ and $k_1 = 1, k_2 = -1, k_3 = 2, k_4 = -2$ we have q-multi-shock soliton solution,

$$u(x, t) = -2\nu \frac{\sinh_q(x) + 2e^{3t} \sinh_q(2x)}{\cosh_q(x) + e^{3t} \cosh_q(2x)}. \quad (7.13)$$

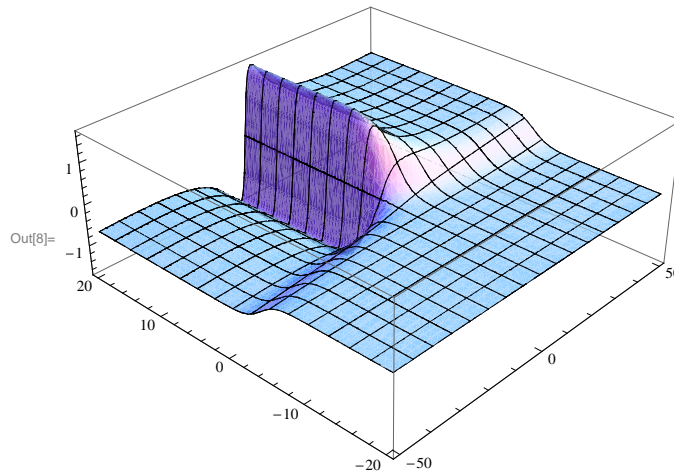

Figure 7.4. 3D plot of q-shock evolution for $k_1 = 1, k_2 = -1, k_3 = 2, k_4 = -2$ and at range $(-50, 50)$

In Figures 7.5, 7.6 and 7.7 we plot $N = 4$ case with values of the wave numbers $k_1 = 1, k_2 = -1, k_3 = 2, k_4 = -2$ at $t = -10, 0, 7$ and with $q = 10$. In Figure 7.8 we show 3D plot of of this multiple q-shock evolution. This multi-shock soliton is regular everywhere in x for arbitrary time t . This result takes place due to absence of zeros for the standard exponential function $e^{k^2 t}$.

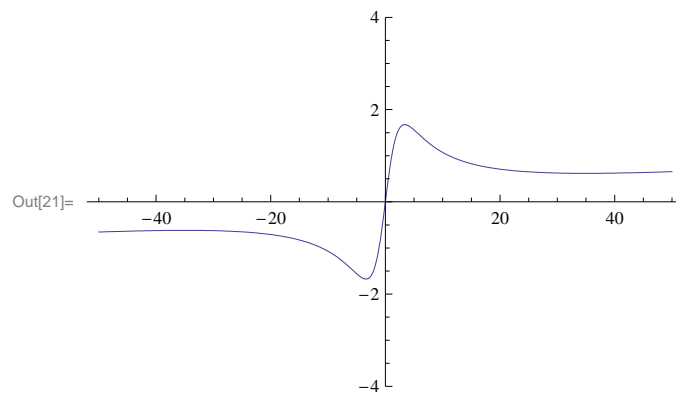

Figure 7.5. Multi q-shock evolution for $k_1 = 1, k_2 = -1, k_3 = 2, k_4 = -2, t = -10$ and at range $(-50, 50)$

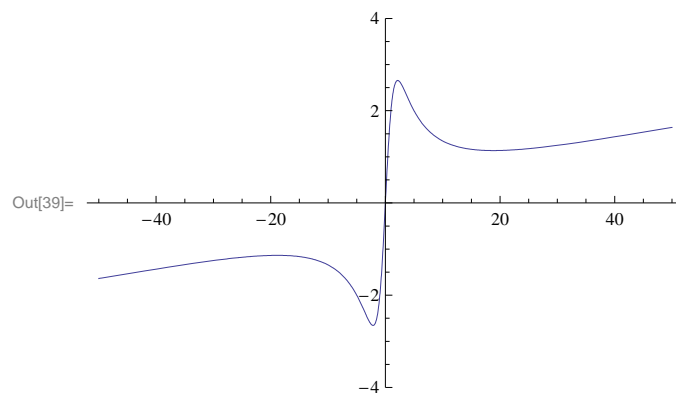

Figure 7.6. Multi q-shock evolution for $k_1 = 1, k_2 = -1, k_3 = 2, k_4 = -2, t = 0$ and at range $(-50, 50)$

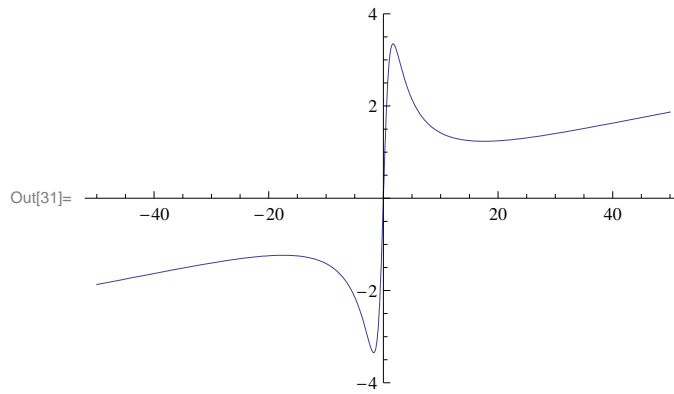

Figure 7.7. Multi q-shock evolution for $k_1 = 1, k_2 = -1, k_3 = 2, k_4 = -2, t = 7$ and at range $(-50, 50)$

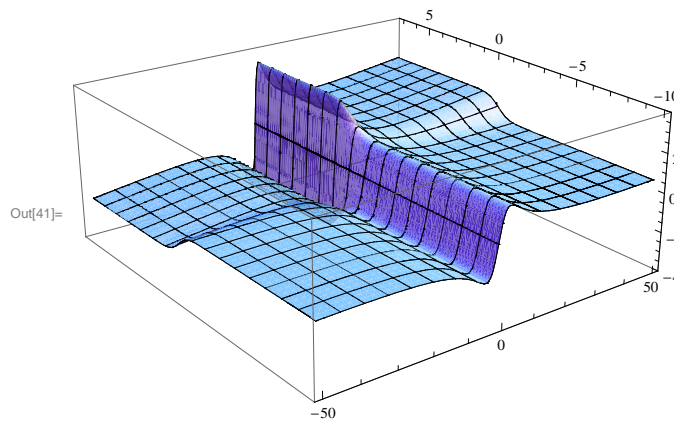

Figure 7.8. 3D plot of multiple q-shock evolution for $k_1 = 1, k_2 = -1, k_3 = 2, k_4 = -2$, and at range $(-50, 50)$

CHAPTER 8

Q -SCHRÖDINGER EQUATION AND Q -MADDELUNG FLUID

8.1. Standard Time-Dependent q -Schrödinger Equation

The above consideration can be extended to the time dependent Schrödinger equation with q -deformed dispersion. We consider the standard time-dependent q -Schrödinger equation

$$\left(\frac{\partial}{\partial t} - \frac{i\hbar}{2m} D_x^2 \right) \psi(x, t) = 0, \quad (8.1)$$

where $\psi(x, t)$ is complex wave function (Pashaev & Nalci, 2010).

One can easily see that

$$\psi(x, t) = e^{-\frac{i}{\hbar} \frac{p^2}{2m} t} e_q \left(\frac{i}{\hbar} p x \right)$$

is the plane wave solution of (8.1). By expanding this in terms of momentum p

$$\psi(x, t) = e^{-\frac{i}{\hbar} \frac{p^2}{2m} t} e_q \left(\frac{i}{\hbar} p x \right) = \sum_{N=0}^{\infty} \left(\frac{i}{\hbar} \right)^N \frac{p^N}{[N]_q!} H_N^{(s)}(x, it; q)$$

we get the set of complex q -Kampe-de Fariet polynomial solutions

$$H_N^{(s)}(x, it; q) = \sum_{k=0}^{[N/2]} \frac{\left(\frac{i\hbar t}{2m} \right)^k [N]_q! x^{N-2k}}{[N-2k]_q k!}$$

for (8.1).

Let us consider the complex q-Cole-Hopf transformation

$$u(x, t) = -\frac{i\hbar D_x \psi(x, t)}{m \psi(x, t)},$$

then complex velocity function $u(x, t)$ satisfies the complex q-Burgers Madelung equation

$$\begin{aligned} i\hbar \frac{\partial}{\partial t} u(x, t) + \frac{\hbar^2}{2m} D_x^2 u(x, t) &= \frac{i\hbar}{2} u(x, t) [1 - M_q^x] D_x u(x, t) - \\ &\frac{i\hbar}{2} [D_x (u(qx, t)u(x, t))] + \frac{m}{2} [u(q^2x, t) - u(x, t)] u(qx, t)u(x, t). \end{aligned}$$

If we write $u = u_1 + iu_2$ and separate it into real and complex parts , we get two fluid model representation.

For the real part we have

$$\begin{aligned} -\hbar \frac{\partial}{\partial t} u_2(x, t) + \frac{\hbar^2}{2m} D_x^2 u_1(x, t) &= \frac{m}{2} [(u_1(q^2x, t) - u_1(x, t))(u_1(x, t)u_1(qx, t) - \\ &u_2(x, t)u_2(qx, t)) - (u_2(q^2x, t) - u_2(x, t))(u_1(x, t)u_2(qx, t) + u_2(x, t)u_1(qx, t))] \\ &-\frac{\hbar}{2} [u_1(x, t)[1 - M_q^x] D_x u_2(x, t) + u_2(x, t)[1 - M_q^x] D_x u_1(x, t)] \\ &+\frac{\hbar}{2} D_x [u_2(qx, t)u_1(x, t) + u_1(qx, t)u_2(x, t)], \end{aligned}$$

and for imaginary part

$$\begin{aligned} \hbar \frac{\partial}{\partial t} u_1(x, t) + \frac{\hbar^2}{2m} D_x^2 u_2(x, t) &= \frac{m}{2} [(u_1(q^2x, t) - u_1(x, t)) \\ &(u_1(x, t)u_2(qx, t) + u_2(x, t)u_1(qx, t)) + \\ &(u_2(q^2x, t) - u_2(x, t))(u_1(x, t)u_1(qx, t) - u_2(x, t)u_2(qx, t))] + \\ &\frac{\hbar}{2} [u_1(x, t)[1 - M_q^x] D_x u_1(x, t) - u_2(x, t)[1 - M_q^x] D_x u_2(x, t)] - \\ &\frac{\hbar}{2} D_x [u_1(qx, t)u_1(x, t) - u_2(qx, t)u_2(x, t)]. \end{aligned}$$

When $q \rightarrow 1$, the real part reduces to the Continuity equation

$$-(u_2)_t + \frac{\hbar}{2m}(u_1)_{xx} = (u_1 u_2)_x,$$

and imaginary part reduces to the Quantum Hamilton-Jacobi equation

$$(u_1)_t + \frac{\hbar}{2m}(u_2)_{xx} = -\frac{1}{2}(u_1^2 - u_2^2)_x.$$

For $u_1 \equiv v$ and $u_2 = -\frac{\hbar}{2m}(\ln \rho)_x$ where $\rho = |\psi|^2$ the continuity equation is

$$\rho_t + (\rho v)_x = 0,$$

and the Euler equation is

$$v_t + vv_x = \left(\frac{\hbar^2}{2m^2} \frac{(\sqrt{\rho})_{xx}}{\sqrt{\rho}} \right)_x.$$

CHAPTER 9

MULTIPLE Q -CALCULUS

In previous chapters we deal with q -calculus with one base q . In general, if we consider function of several variables, every independent variable can be re-scaled by different base parameters q_1, q_2, \dots . This why even from this general consideration, emergency of multiple q -calculus becomes evident. Moreover, several physical and mathematical problems lead to necessity of multiple q -calculus. We will mention some of them. Extension of quantum groups to two parameters (Chakrabarti & Jagannathan, 1991), formulation of hierarchy of integrable systems in terms of recursion operator (Pashaev, 2009), discover of Q -commutative q -binomial expansion (Nalci & Pashaev, 2011d).

9.1. Multiple q - Numbers

Let us consider basis vector \vec{q} with coordinates q_1, q_2, \dots, q_N so that the matrix q -number can be defined as

$$[n]_{q_i, q_j} \equiv \frac{q_i^n - q_j^n}{q_i - q_j} = [n]_{q_j, q_i}, \quad (9.1)$$

which is symmetric. Hence, we can define $N \times N$ matrix with q -numbers elements in the following form

$$([n]_{q_i, q_j}) = \begin{pmatrix} [n]_{q_1, q_1} & [n]_{q_1, q_2} & \dots & [n]_{q_1, q_N} \\ [n]_{q_2, q_1} & [n]_{q_2, q_2} & \dots & [n]_{q_2, q_N} \\ \dots & \dots & \dots & \dots \\ [n]_{q_N, q_1} & [n]_{q_N, q_2} & \dots & [n]_{q_N, q_N} \end{pmatrix}. \quad (9.2)$$

Diagonal terms of this matrix are defined in the limit $q_j \rightarrow q_i$ as

$$\lim_{q_j \rightarrow q_i} [n]_{q_i, q_j} = \lim_{q_j \rightarrow q_i} \frac{q_i^n - q_j^n}{q_i - q_j} = nq_i^{n-1}.$$

So this symmetric matrix can be also written as

$$([n]_{q_i, q_j}) = \begin{pmatrix} nq_1^{n-1} & [n]_{q_1, q_2} & \cdots & [n]_{q_1, q_N} \\ [n]_{q_1, q_2} & nq_2^{n-1} & \cdots & [n]_{q_2, q_N} \\ \cdots & \cdots & \cdots & \cdots \\ [n]_{q_1, q_N} & [n]_{q_2, q_N} & \cdots & nq_N^{n-1} \end{pmatrix}. \quad (9.3)$$

As for standard numbers we may determine addition formula for q -numbers in the form

$$[n + m]_{q_i, q_j} = q_i^n [m]_{q_i, q_j} + q_j^m [n]_{q_i, q_j}. \quad (9.4)$$

The subtraction formula can be obtained by changing $m \rightarrow -m$ as

$$[n - m]_{q_i, q_j} = q_i^n [-m]_{q_i, q_j} + q_j^{-m} [n]_{q_i, q_j}, \quad (9.5)$$

or by using the equality

$$[-n]_{q_i, q_j} = -(q_i q_j)^{-n} [n]_{q_i, q_j},$$

it can be also written

$$[n - m]_{q_i, q_j} = q_j^{-m} ([n]_{q_i, q_j} - q_i^{n-m} [m]_{q_i, q_j}).$$

We can easily prove by definition, the multiplication rule are given by next formula

$$[nm]_{q_i, q_j} = [n]_{q_i, q_j} [m]_{(q_i q_j)^n} = [m]_{q_i, q_j} [n]_{(q_i q_j)^m},$$

where $(q_i q_j)^m = q_i^m \cdot q_j^m$ in the standard product, and the division rule is

$$\left[\frac{n}{m} \right]_{q_i, q_j} = \frac{[n]_{q_i, q_j}}{[m]_{q_i^{\frac{n}{m}}, q_j^{\frac{n}{m}}}} = \frac{[n]_{q_i^{\frac{1}{m}}, q_j^{\frac{1}{m}}}}{[m]_{q_i^{\frac{1}{m}}, q_j^{\frac{1}{m}}}}. \quad (9.6)$$

9.1.1. Multiple q -Derivative

In our multi-variable q -calculus we define q -derivative with base q_i, q_j as

$$D_{q_i, q_j} f(x) = \frac{f(q_i x) - f(q_j x)}{(q_i - q_j)x}. \quad (9.7)$$

It represents $N \times N$ matrix of q -derivative operators $D = (D_{q_i, q_j})$ which is symmetric : $D_{q_i, q_j} = D_{q_j, q_i}$ where $i, j = 1, 2, \dots, N$.

$$D = (D_{q_i, q_j}) = \begin{bmatrix} D_{q_1, q_1} & D_{q_1, q_2} & \cdots & D_{q_1, q_N} \\ D_{q_2, q_1} & D_{q_2, q_2} & \cdots & D_{q_2, q_N} \\ \cdots & \cdots & \cdots & \cdots \\ D_{q_N, q_1} & D_{q_N, q_2} & \cdots & D_{q_N, q_N} \end{bmatrix}. \quad (9.8)$$

If $f(x)$ is analytic function, q -multiple derivative operator is written as follows

$$D_{q_i, q_j} = \frac{M_{q_i} - M_{q_j}}{(q_i - q_j)x} = \frac{q_i^{x \frac{d}{dx}} - q_j^{x \frac{d}{dx}}}{(q_i - q_j)x} = \frac{1}{x} \left[x \frac{d}{dx} \right]_{q_i, q_j}.$$

To determine diagonal terms of this matrix D -operator (D_{q_i, q_i})

where $i = 1, 2, \dots, N$, we consider its action on analytic function $f(x)$ in the form

$$f(x) = \sum_{n=0}^{\infty} a_n x^n$$

so that

$$\begin{aligned} \lim_{q_j \rightarrow q_i} D_{q_i, q_j} f(x) &= \sum_{n=1}^{\infty} a_n \lim_{q_j \rightarrow q_i} \frac{q_i^n - q_j^n}{q_i - q_j} x^{n-1} \\ &= \sum_{n=1}^{\infty} a_n n (q_i x)^{n-1} = f'(q_i x) = M_{q_i} \frac{d}{dx} f(x), \end{aligned}$$

where $M_q f(x) = f(qx) = q^{x \frac{d}{dx}} f(x)$. Therefore, the matrix of D -operator can be rewritten in the following form

$$D = (D_{q_i, q_j}) = \begin{bmatrix} q_1^{x \frac{d}{dx}} \frac{d}{dx} & D_{q_1, q_2} & \cdots & D_{q_1, q_N} \\ D_{q_1, q_2} & q_2^{x \frac{d}{dx}} \frac{d}{dx} & \cdots & D_{q_2, q_N} \\ \cdots & \cdots & \cdots & \cdots \\ D_{q_1, q_N} & D_{q_2, q_N} & \cdots & q_N^{x \frac{d}{dx}} \frac{d}{dx} \end{bmatrix}. \quad (9.9)$$

Example of application the q -multiple derivative of function x^n is calculated by using the (9.7) as follows

$$D_{q_i, q_j} x^n = \frac{(q_i x)^n - (q_j x)^n}{(q_i - q_j)x} = \frac{q_i^n - q_j^n}{q_i - q_j} x^{n-1} = [n]_{q_i, q_j} x^{n-1}.$$

9.1.2. N = 1 Case

For $N = 1$ case, $q_1 = q_2 \equiv q$ we have $[n]_{q, q} = nq^{n-1}$ and $D_{q, q} = M_q \frac{d}{dx}$ where $M_q = q^{x \frac{d}{dx}}$. If in addition $q = 1$, then we get the standard number $[n]_{1, 1} = n$ and derivative $D_{1, 1} = \frac{d}{dx}$.

9.1.3. N = 2 Cases

For $N = 2$ case, we have

$$\begin{aligned} [n]_{q_1, q_1} &= nq_1^{n-1}, & [n]_{q_1, q_2} &= [n]_{q_2, q_1} = \frac{q_1^n - q_2^n}{q_1 - q_2}, & [n]_{q_2, q_2} &= nq_2^{n-1} \\ D_{q_1, q_1} &= M_{q_1} \frac{d}{dx}, & D_{q_1, q_2} &= D_{q_2, q_1} = \frac{M_{q_1} - M_{q_2}}{(q_1 - q_2)x}, & D_{q_2, q_2} &= M_{q_2} \frac{d}{dx}. \end{aligned}$$

9.1.3.1. Non-symmetrical Case

Choosing $q_1 = 1$ and $q_2 = q$ we obtain,

$$[n]_{1,1} = n, \quad [n]_{1,q} = [n]_{q,1} = [n]_q, \quad [n]_{q,q} = nq^{n-1}.$$

$$D_{1,1} = \frac{d}{dx}, \quad D_{1,q} = D_{q,1} = \frac{1 - M_q}{(1 - q)x} = D_q^x, \quad D_{q,q} = M_q \frac{d}{dx}.$$

In this case, for (1,1)-elements we have standard number and derivative. For non-diagonal element we have q -number $[n]_q = \frac{q^n - 1}{q - 1}$, and q -derivative $D_q^x f(x) = \frac{f(qx) - f(x)}{(q-1)x}$ which corresponds to non-symmetrical q -calculus with base q .

9.1.3.2. Symmetrical Case

When we choose $q_1 = q$ and $q_2 = \frac{1}{q}$, we get

$$[n]_{q,q} = nq^{n-1}, \quad [n]_{q,\frac{1}{q}} = [n]_{\tilde{q}}, \quad [n]_{\frac{1}{q},\frac{1}{q}} = n \left(\frac{1}{q} \right)^{n-1}.$$

$$D_{q,q} = M_q \frac{d}{dx}, \quad D_{q,\frac{1}{q}} = D_{\frac{1}{q},q} = \frac{M_q - M_{\frac{1}{q}}}{(q - \frac{1}{q})x} = D_{\tilde{q}}^x, \quad D_{\frac{1}{q},\frac{1}{q}} = M_{\frac{1}{q}} \frac{d}{dx}.$$

In this particular case we obtain symmetrical q -calculus with symmetrical q -number with $[n]_{\tilde{q}} = \frac{q^n - q^{-n}}{q - q^{-1}}$ and symmetrical q -derivative $D_{\tilde{q}}^x f(x) = \frac{f(qx) - f(q^{-1}x)}{(q - q^{-1})x}$.

We can give geometrical meaning for choosing this reduction of (q_i, q_j) - generic case to the symmetrical one. If we consider unit circle in complex plane, then two real points $q_i = q$ and $q_j = \frac{1}{q}$ are symmetrical points according to the unit circle. So in symmetrical calculus we are comparing value of function at two symmetrical points. If we extend this reduction to the complex domain so that q is complex number, then symmetrical point in the unit circle would be $\frac{1}{\bar{q}}$. It implies complexification of symmetrical case in the form $q_i = q, q_j = \frac{1}{\bar{q}}$.

9.1.3.3. Fibonacci Case

By choosing $q_1 = \frac{1+\sqrt{5}}{2} \equiv \varphi$ and $q_2 = \frac{1-\sqrt{5}}{2} \equiv -\frac{1}{\varphi}$ which are the roots of equation (Koshy, 2001)

$$\varphi^2 = \varphi + 1$$

we have q - Binet-Fibonacci numbers with bases φ and $-\frac{1}{\varphi}$ in the following form

$$[n]_{\varphi, \varphi} = n\varphi^{n-1}, \quad [n]_{\varphi, -\frac{1}{\varphi}} = F_n, \quad [n]_{-\frac{1}{\varphi}, -\frac{1}{\varphi}} = n \left(-\frac{1}{\varphi}\right)^{n-1}.$$

$$D_{\varphi, \varphi} = M_{\varphi} \frac{d}{dx}, \quad D_{\varphi, -\frac{1}{\varphi}} = D_{-\frac{1}{\varphi}, \varphi} = \frac{M_{\varphi} - M_{-\frac{1}{\varphi}}}{(\varphi + \frac{1}{\varphi})x}, \quad D_{-\frac{1}{\varphi}, -\frac{1}{\varphi}} = M_{-\frac{1}{\varphi}} \frac{d}{dx}.$$

From this particular choices of basis, we obtain the Fibonacci sequence in Binet's representation as a q -number (Pashaev & Nalci, 2011a)

$$[n]_{\varphi, -\frac{1}{\varphi}} = \frac{\varphi^n - (-\frac{1}{\varphi})^n}{\varphi + \frac{1}{\varphi}} = F_n$$

and Golden derivative (φ -derivative)

$$D_{\varphi}^x f(x) = \frac{f(\varphi x) - f(-\varphi^{-1}x)}{(\varphi + \varphi^{-1})x}.$$

Geometrical meaning for Fibonacci case is that point φ on real axis outside of unit circle ($\varphi > 1$) determines the symmetrical point $\frac{1}{\varphi}$ inside of circle, and the inverse symmetrical point $\varphi' = -\frac{1}{\varphi}$. This why, in Fibonacci case we compare function at point φ and inverse symmetrical point $-\frac{1}{\varphi}$.

9.1.3.4. Symmetrical Golden Case

The Golden ratio φ satisfies algebraic relation

$$\varphi^2 = \varphi + 1.$$

If we like to construct symmetrical calculus with base q as a Golden Ratio $\varphi : q = \varphi$, then we choose $q_i = \varphi, q_j = \frac{1}{\varphi}$,

$$[n]_{\varphi, \frac{1}{\varphi}} = \varphi^n - \frac{1}{\varphi^n}.$$

Another option is pure imaginary Golden ratio $q_i = i\varphi$ and symmetrical point $q_j = \frac{i}{\varphi}$:

$$[n]_{i\varphi, \frac{i}{\varphi}} = i^{n-1} [n]_{\tilde{\varphi}}.$$

9.1.4. q -Leibnitz Rule

We derive the q -analogue of Leibnitz formula

$$D_{q_i, q_j}(f(x)g(x)) = D_{q_i, q_j}f(x)g(q_i x) + f(q_j x)D_{q_i, q_j}g(x). \quad (9.10)$$

By symmetry, we can interchange $i \leftrightarrow j$ and the second form of the Leibnitz rule can be derived as

$$D_{q_j, q_i}(f(x)g(x)) = D_{q_i, q_j}f(x)g(q_j x) + f(q_i x)D_{q_i, q_j}g(x), \quad (9.11)$$

which is equivalent to (9.10). These formulas can be rewritten in explicitly symmetrical form :

$$\begin{aligned} D_{q_i, q_j}(f(x)g(x)) &= D_{q_i, q_j}f(x) \left(\frac{g(q_i x) + g(q_j x)}{2} \right) \\ &+ D_{q_i, q_j}g(x) \left(\frac{f(q_i x) + f(q_j x)}{2} \right). \end{aligned} \quad (9.12)$$

More general form of the q -analogue of Leibnitz formula is given with arbitrary α ,

$$\begin{aligned} D_{q_i, q_j}(f(x)g(x)) &= (\alpha f(q_j x) + (1 - \alpha)f(q_i x)) D_{q_i, q_j}g(x) \\ &+ (\alpha g(q_i x) + (1 - \alpha)g(q_j x)) D_{q_i, q_j}f(x). \end{aligned}$$

If we choose $\alpha = 1$, we have (9.10) and (9.11), and for $\alpha = \frac{1}{2}$, (9.12) is obtained.

Now we may compute the q -multiple derivative of the quotient of $f(x)$ and $g(x)$. From (9.10) we have

$$D_{q_i, q_j} \left(\frac{f(x)}{g(x)} \right) = \frac{D_{q_i, q_j} f(x)g(q_i x) - D_{q_i, q_j} g(x)f(q_i x)}{g(q_i x)g(q_j x)}. \quad (9.13)$$

However, if we use (9.11), we get

$$D_{q_i, q_j} \left(\frac{f(x)}{g(x)} \right) = \frac{D_{q_i, q_j} f(x)g(q_j x) - D_{q_i, q_j} g(x)f(q_j x)}{g(q_i x)g(q_j x)}. \quad (9.14)$$

In addition to the formulas (9.13) and (9.14) one may determine one more representation in symmetrical form

$$D_{q_i, q_j} \left(\frac{f(x)}{g(x)} \right) = \frac{1}{2} \frac{D_{q_i, q_j} f(x)(g(q_j x) + g(q_i x)) - D_{q_i, q_j} g(x)(f(q_j x) + f(q_i x))}{g(q_i x)g(q_j x)} \quad (9.15)$$

In particular application one of these forms could be more useful than others.

9.1.5. Generalized Taylor Formula

In developing q -analogue of the Taylor expansion the next theorem play the central role (Kac & Cheung, 2002):

Theorem 9.1.5.1 *Let a be a number, D be a linear operator on the space of polynomials, and $\{P_0(x), P_1(x), P_2(x), \dots\}$ be a sequence of polynomials satisfying three conditions :*

(i) $P_0(a) = 1$ and $P_n(a) = 0$ for any $n \geq 1$;

(ii) $\deg P_n = n$;

(iii) $DP_n(x) = P_{n-1}(x)$ for any $n \geq 1$, and $D(1) = 0$ Then, for any polynomial $f(x)$ of degree N , one has the following generalized Taylor formula :

$$f(x) = \sum_{n=0}^N (D^n f)(a) P_n(x).$$

Here we will construct the sequence of polynomials $\{P_0(x), P_1(x), P_2(x), \dots\}$ satisfying the three above mentioned conditions of the theorem with respect to operator $D \equiv D_{q_i, q_j}$.

a) First we consider the case $a = 0$. Then we can choose

$$P_n(x) = \frac{x^n}{[n]_{q_i, q_j}!},$$

where $[n]_{q_i, q_j}! = [1]_{q_i, q_j} [2]_{q_i, q_j} \dots [n]_{q_i, q_j}$; since as easy to see

(i) $P_0(0) = 1, P_n(0) = 0$ for $n \geq 1$,

(ii) $\deg P_n = n$,

(iii) for $n \geq 1$,

$$D_{q_i, q_j} P_n(x) = \frac{D_{q_i, q_j} x^n}{[n]_{q_i, q_j}!} = \frac{[n]_{q_i, q_j} x^{n-1}}{[n]_{q_i, q_j}!} = \frac{x^{n-1}}{[n-1]_{q_i, q_j}!} = P_{n-1}(x).$$

b) In more general case, when $a \neq 0$, to find proper polynomials $P_n(x)$ is not simple task. To do this we construct the first few $P_n(x)$ and then deduce a general form for $P_n(x)$. We have

$$P_0(x) = 1.$$

In order that $D_{q_i, q_j} P_1(x) = 1$ and $P_1(a) = 0$, we choose

$$P_1(x) = x - a.$$

For the next polynomial, $D_{q_i, q_j} P_2(x) = x - a$ and $P_2(a) = 0$, we have

$$P_2(x) = \frac{(x - q_i a)(x - q_j a)}{[2]_{q_i, q_j}!}.$$

Similarly,

$$P_3(x) = \frac{(x - q_i^2 a)(x - q_i q_j a)(x - q_j^2 a)}{[3]_{q_i, q_j}!},$$

and

$$P_4(x) = \frac{(x - q_i^3 a)(x - q_i^2 q_j a)(x - q_i q_j^2 a)(x - q_j^3 a)}{[4]_{q_i, q_j}!}.$$

Then we guess

$$P_n(x) = \frac{(x - a_1^{(n)} a)(x - a_2^{(n)} a) \dots (x - a_n^{(n)} a)}{[n]_{q_i, q_j}!}, \quad (9.16)$$

where

$$a_k^{(n)} = q_i^{n-k} q_j^{k-1},$$

and

$$P_n(x) = \frac{1}{[n]_{q_i, q_j}!} (x - q_i^{n-1} a)(x - q_i^{n-2} q_j a) \dots (x - q_i q_j^{n-2} a)(x - q_j^{n-1} a). \quad (9.17)$$

This polynomial can also be written in the following form

$$\begin{aligned} P_n(x) &= \frac{(x - q_i^{n-1} a)(x - q_i^{n-1} Q a)(x - q_i^{n-1} Q^2 a) \dots (x - q_i^{n-1} Q^{n-1} a)}{[n]_{q_i, q_j}!} \\ &= \frac{(x - q_i^{n-1} a)_Q^n}{[n]_{q_i, q_j}!}, \end{aligned} \quad (9.18)$$

where $Q \equiv \frac{q_j}{q_i}$.

If we denote $q_i^{n-1}a \equiv b_i^{(n-1)}$, then (9.18) may be written as

$$P_n(x) = \frac{(x - b_i^{(n-1)})(x - Qb_i^{(n-1)})(x - Q^2b_i^{(n-1)})\dots(x - Q^{n-1}b_i^{(n-1)})}{[n]_{q_i, q_j}!},$$

where $n = 1, 2, \dots$. We can prove that these $P_n(x)$ polynomials satisfy the condition (iii) for the above Theorem. Below we follow the next definition:

Definition 9.1.5.2 *The multiple q -analogue of $(x - a)^n$ is the polynomial*

$$(x - a)_{q_i, q_j}^n = \begin{cases} 1 & \text{if } n = 0, \\ (x - q_i^{n-1}a)(x - q_i^{n-2}q_ja)\dots(x - q_iq_j^{n-2}a)(x - q_j^{n-1}a) & \text{if } n \geq 1 \end{cases}$$

These polynomials have several properties. Factorization of symmetrical multiple q -binomial formula is

$$\begin{aligned} (x - a)_{q_i, q_j}^{n+m} &= (x - q_i^m a)_{q_i, q_j}^n (x - q_j^n a)_{q_i, q_j}^m \\ &= (x - q_j^m a)_{q_i, q_j}^n (x - q_i^n a)_{q_i, q_j}^m. \end{aligned}$$

Substituting m by $-n$, we can write

$$(x - a)_{q_i, q_j}^{n-n} = (x - q_i^{-n}a)_{q_i, q_j}^n (x - q_j^n a)_{q_i, q_j}^{-n},$$

and it gives

$$(x - q_j^n a)_{q_i, q_j}^{-n} = \frac{1}{(x - q_i^{-n}a)_{q_i, q_j}^n},$$

for any positive integer n .

In Appendix B, we give two different proofs of the relation $D_{q_i, q_j} P_n(x) = P_{n-1}(x)$: first by reduction to the non-symmetrical calculus case and second, by mathematical induction.

However, in generic case $q_i, q_j, P_n(x)$ polynomial do not satisfy condition (i) of the theorem. Indeed, $P_n(a) \neq 0$ for arbitrary q_i, q_j ; it could be satisfied only in special cases of q_i, q_j and n . If q_i, q_j are such that $P_n(a) = 0$, then we have the q -analogue of

Taylor's formula :

$$f(x) = \sum_k^N (D_q^k f)(c) \frac{(x-c)_q^k}{[k]_{q_i, q_j}!}.$$

Special Cases :

a) Non-symmetrical case :

If we choose $q_i = 1$ and $q_j = q$ we obtain

$$P_n(x) = \frac{1}{[n]_q!} (x-a)_q^n, \quad (9.19)$$

which is called non-symmetrical q -analogue of $(x-a)^n$. In this case $P_n(a) = 0$ and Taylor's formula is valid.

b) Symmetrical case :

If we choose $q_i = q$ and $q_j = \frac{1}{q}$, we get

$$P_n(x) = \frac{1}{[n]_{\bar{q}}!} (x - q^{n-1}a)(x - q^{n-3}a) \dots (x - \frac{1}{q^{n-3}}a)(x - \frac{1}{q^{n-1}}a), \quad (9.20)$$

which is symmetrical q -analogue of $(x-a)^n$.

It should be noted that for even and odd n we have

$$\begin{aligned} P_1(x) &= (x-a)_q^1 = (x-a), \\ P_2(x) &= \frac{(x-a)_q^2}{[2]_{\bar{q}}!} = \frac{(x-qa)(x-q^{-1}a)}{[2]_{\bar{q}}!}, \\ P_3(x) &= \frac{(x-a)_q^3}{[3]_{\bar{q}}!} = \frac{(x-q^2a)(x-a)(x-q^{-2}a)}{[3]_{\bar{q}}!}. \end{aligned}$$

If $a \neq 0$, $P_n(x) = \frac{(x-a)_q^n}{[n]_{\bar{q}}!}$ is not zero at $x = a$ when n is even, and thus these polynomials $P_n(x)$ do not satisfy all the conditions for the generalized Taylor formula. For $a = 0$, the Taylor expansion of a formal power series is

$$f(x) = \sum_{k=0}^{\infty} (\tilde{D}_q^k f)(0) \frac{x^k}{[k]_{\bar{q}}!}.$$

c) Fibonacci case: By choosing $q_i = \varphi$ and $q_j = -\frac{1}{\varphi}$, we obtain

$$P_n(x) = \frac{(x - \varphi^{n-1}a)(x + \varphi^{n-3}a)\dots(x - (-1)^{n-2}\varphi^{-n+3}a)(x - (-1)^{n-1}\varphi^{-n+1}a)}{[n]_{\varphi, -\frac{1}{\varphi}}!}. \quad (9.21)$$

By using the properties of Fibonacci numbers

$$\varphi^n = \varphi F_n + F_{n-1}$$

and

$$F_{-n} = (-1)^{n+1} F_n$$

we get

$$P_n(a) = \frac{(x - (\varphi F_{n-1} + F_{n-2})a)\dots(x - (\varphi F_{n-3} - F_{n-2})a)(x + (\varphi F_{n-1} - F_n)a)}{F_n} \quad (9.22)$$

If $a \neq 0$, $P_n(x) \neq 0$ for $n \neq 1$ so these polynomials also do not satisfy the condition (i) of the Theorem. For $a = 0$ we have

$$f(x) = \sum_{k=0}^{\infty} (D_{\varphi}^k f(0)) \frac{x^k}{F_k!}, \quad (9.23)$$

where $F_k! = F_1 F_2 \dots F_k$.

9.1.6. q -Polynomial Expansion

As we have seen polynomials $P_n(x)$ in general are not satisfying all requirements for the Taylor Theorem. However, if we consider arbitrary polynomial degree N , it can

be expanded in terms of our q -polynomials $P_n(x)$ as

$$f(x) = \sum_{k=0}^N c_k P_k(x).$$

Applying N times D_{q_i, q_j} -derivative to this expansion at point a , we get the linear system of $N + 1$ algebraic equations:

$$D_{q_i, q_j}^l f(a) = \sum_{k=l}^N c_k P_k(a), \quad k = 0, 1, 2, \dots, N.$$

Determinant of this system is 1, so that it has solution in the form of superposition of $D_{q_i, q_j}^l f(a)$, but expansion formula looks more complicated than the Taylor one.

9.1.7. Multiple q -Binomial Formula

Here we are going to derive multiple q -binomial formula. First let us remind Gauss's Binomial formula

$$(x + a)_q^n = \sum_{k=0}^n \begin{bmatrix} n \\ k \end{bmatrix}_q q^{k(k-1)/2} a^k x^{n-k}. \quad (9.24)$$

To find similar formula for our $P_n(x)$ polynomial, we write

$$\begin{aligned} P_n^{i,j}(x) &= (x - a)_{q_i, q_j}^n = (x - q_i^{n-1}a)(x - q_i^{n-2}q_j a) \dots (x - q_i q_j^{n-2}a)(x - q_j^{n-1}a) \\ &= q_i^{n(n-1)} \left(\frac{x}{q_i^{n-1}} - a \right) \left(\frac{x}{q_i^{n-1}} - Qa \right) \dots \left(\frac{x}{q_i^{n-1}} - Q^{n-2}a \right) \left(\frac{x}{q_i^{n-1}} - Q^{n-1}a \right) \\ &= q_i^{n(n-1)} \left(\frac{x}{q_i^{n-1}} - a \right)_Q^n, \end{aligned} \quad (9.25)$$

where $Q \equiv \frac{q_j}{q_i}$. By using the Gauss's binomial formula then we get

$$(x - a)_{q_i, q_j}^n = q_i^{n-1} \sum_{k=0}^n \begin{bmatrix} n \\ k \end{bmatrix}_Q Q^{\frac{k(k-1)}{2}} \left(\frac{x}{q_i^{n-1}} \right)^{n-k} (-a)^k, \quad (9.26)$$

where $\begin{bmatrix} n \\ k \end{bmatrix}_Q$ are non-symmetric Q -binomial coefficients. Q -numbers are related (q_i, q_j) -numbers by

$$[n]_{q_i, q_j} = q_i^{n-1} [n]_Q$$

and

$$[n]_{q_i, q_j}! = q_i^{\frac{n(n-1)}{2}} [n]_Q!. \quad (9.27)$$

By substituting (9.27) into (9.26), we obtain the multiple (q_i, q_j) Gauss Binomial formula for commutative x and a ($xa = ax$),

$$(x - a)_{q_i, q_j}^n = \sum_{k=0}^n \begin{bmatrix} n \\ k \end{bmatrix}_{q_i, q_j} (q_i q_j)^{\frac{k(k-1)}{2}} x^{n-k} (-a)^k \quad (9.28)$$

and

$$(x + a)_{q_i, q_j}^n = \sum_{k=0}^n \begin{bmatrix} n \\ k \end{bmatrix}_{q_i, q_j} (q_i q_j)^{\frac{k(k-1)}{2}} x^{n-k} a^k. \quad (9.29)$$

As is well known $n \rightarrow \infty$ limit of Gauss' Binomial formula produces the Euler infinite product identity for q -exponential function. Here we like to study $n \rightarrow \infty$ limit for our (q_i, q_j) -binomials. By using the Binomial coefficients (9.27) expression (9.29) can be written as

$$(x + a)_{q_i, q_j}^n = \sum_{k=0}^n \begin{bmatrix} n \\ k \end{bmatrix}_Q \frac{q_j^{\frac{k(k-1)}{2}}}{q_i^{\frac{k(k+1)}{2}}} x^{n-k} (aq_i^n)^k.$$

To consider the limiting case $n \rightarrow \infty$, we choose $x = 1$ and $a = y$,

$$(1 + y)_{q_i, q_j}^n = \sum_{k=0}^n \begin{bmatrix} n \\ k \end{bmatrix}_Q \frac{q_j^{\frac{k(k-1)}{2}}}{q_i^{\frac{k(k+1)}{2}}} (yq_i^n)^k, \quad (9.30)$$

or

$$\left(1 + \frac{y}{q_i^n}\right)_{q_i, q_j}^n = \sum_{k=0}^n \begin{bmatrix} n \\ k \end{bmatrix}_Q Q^{\frac{k(k-1)}{2}} \left(\frac{y}{q_i}\right)^k. \quad (9.31)$$

To find the limit

$$\lim_{n \rightarrow \infty} \left(1 + \frac{y}{q_i^n}\right)_{q_i, q_j}^n = \lim_{n \rightarrow \infty} \sum_{k=0}^n \begin{bmatrix} n \\ k \end{bmatrix}_Q Q^{\frac{k(k-1)}{2}} \left(\frac{y}{q_i}\right)^k$$

first we calculate the limit

$$\lim_{n \rightarrow \infty} \begin{bmatrix} n \\ k \end{bmatrix}_Q = \lim_{n \rightarrow \infty} \frac{[n]_Q!}{[n-k]_Q! [k]_Q!} = \frac{1}{[k]_Q! (1-Q)^k}, \quad (9.32)$$

where $Q \equiv \frac{q_j}{q_i} < 1$.

Hence,

$$\begin{aligned} \lim_{n \rightarrow \infty} \left(1 + \frac{y}{q_i^n}\right)_{q_i, q_j}^n &= \sum_{k=0}^{\infty} \frac{1}{[k]_Q!} Q^{\frac{k(k-1)}{2}} \left(\frac{y}{q_i(1-Q)}\right) \\ &= E_Q \left(\frac{y}{q_i(1-Q)}\right) = e_{\frac{1}{Q}} \left(\frac{y}{q_i(1-Q)}\right). \end{aligned} \quad (9.33)$$

In addition to this case $Q < 1$, we can consider $Q > 1$ case by simple interchanging q_i and q_j . However, we like to derive $Q > 1$ case explicitly to see some useful relations.

Writing

$$[n]_{\frac{1}{Q}} = \frac{\left(\frac{1}{Q}\right)^n - 1}{\frac{1}{Q} - 1} = \frac{[n]_Q}{Q^{n-1}}$$

so that

$$[n]_Q = Q^{n-1} [n]_{\frac{1}{Q}},$$

we have

$$[n]_{Q!} = Q^{\frac{n(n-1)}{2}} [n]_{\frac{1}{Q}}!$$

It is easy to write

$$\begin{bmatrix} n \\ k \end{bmatrix}_Q = Q^{k(n-k)} \begin{bmatrix} n \\ k \end{bmatrix}_{\frac{1}{Q}}. \quad (9.34)$$

Combining the above expression with (9.27), we get

$$\begin{aligned} \begin{bmatrix} n \\ k \end{bmatrix}_{q_i, q_j} &= q_i^{k(n-k)} \begin{bmatrix} n \\ k \end{bmatrix}_Q \\ &= q_j^{k(n-k)} \begin{bmatrix} n \\ k \end{bmatrix}_{\frac{1}{Q}}. \end{aligned} \quad (9.35)$$

Now it is possible to write the expression (9.30) for the case $Q > 1$ in the following form

$$(1 + y)_{q_i, q_j}^n = \sum_{k=0}^n \begin{bmatrix} n \\ k \end{bmatrix}_{\frac{1}{Q}} \frac{q_i^{\frac{k(k-1)}{2}}}{q_j^{\frac{k(k+1)}{2}}} (y q_j^n)^k, \quad (9.36)$$

or

$$\left(1 + \frac{y}{q_j^n}\right)_{q_i, q_j}^n = \sum_{k=0}^n \begin{bmatrix} n \\ k \end{bmatrix}_{\frac{q_i}{q_j}} \frac{q_i^{\frac{k(k-1)}{2}}}{q_j^{\frac{k(k+1)}{2}}} y^k. \quad (9.37)$$

Taking the limit we have

$$\lim_{n \rightarrow \infty} \left(1 + \frac{y}{q_j^n}\right)_{q_i, q_j}^n = E_{\frac{q_i}{q_j}} \left(\frac{y}{q_j - q_i}\right) = e_{\frac{q_j}{q_i}} \left(\frac{y}{q_j - q_i}\right), \quad (9.38)$$

where $Q \equiv \frac{q_j}{q_i} > 1$.

As an application let us denote $\frac{y}{q_j - q_i} = x$, then

$$\lim_{n \rightarrow \infty} \left(1 + \frac{x(q_j - q_i)}{q_j^n} \right)_{q_i, q_j}^n = E_{\frac{q_i}{q_j}}(x) = e_{\frac{q_j}{q_i}}(x),$$

which is the generalization of

$$\lim_{n \rightarrow \infty} \left(1 + \frac{x}{n} \right) = e^x.$$

In particular case $x = 1$,

$$\lim_{n \rightarrow \infty} \left(1 + \frac{q_j - q_i}{q_j^n} \right)_{q_i, q_j}^n = E_{\frac{q_i}{q_j}}(1) = e_{\frac{q_j}{q_i}}(1).$$

This formula in the limiting case $q_j - q_i = \frac{1}{n}$, so that $\lim_{n \rightarrow \infty} q_j = q_i$, and $q_j \rightarrow 1$ reduces to the well known limit

$$\lim_{n \rightarrow \infty} \left(1 + \frac{1}{n} \right)^n = e.$$

Definition 9.1.7.1 (q_i, q_j) -Exponential functions are defined in the following form

$$\begin{aligned} e_{q_i, q_j}(x) &\equiv \sum_{n=0}^{\infty} \frac{1}{[n]_{q_i, q_j}!} x^n, \\ E_{q_i, q_j}(x) &\equiv \sum_{n=0}^{\infty} \frac{1}{[n]_{q_i, q_j}!} (q_i q_j)^{\frac{n(n-1)}{2}} x^n. \end{aligned} \quad (9.39)$$

Proposition 9.1.7.2 For commutative x and y , ($yx = xy$) we have the addition formula

$$e_{q_i, q_j}(x + y)_{q_i, q_j} = e_{q_i, q_j}(x) E_{q_i, q_j}(y). \quad (9.40)$$

Proof 9.1.7.3

$$\begin{aligned}
e_{q_i, q_j}(x + y)_{q_i, q_j} &= \sum_{n=0}^{\infty} \frac{(x + y)_{q_i, q_j}^n}{[n]_{q_i, q_j}} \\
&= \sum_{n=0}^{\infty} \frac{1}{[n]_{q_i, q_j}!} \sum_{k=0}^n \begin{bmatrix} n \\ k \end{bmatrix}_{q_i, q_j} (q_i q_j)^{\frac{k(k-1)}{2}} x^{n-k} y^k \\
(n - k \equiv s) \Rightarrow &= \sum_{k=0}^{\infty} \sum_{s=0}^{\infty} \frac{1}{[k]_{q_i, q_j}! [s]_{q_i, q_j}!} (q_i q_j)^{\frac{k(k-1)}{2}} x^s y^k \\
&= \left(\sum_{s=0}^{\infty} \frac{1}{[s]_{q_i, q_j}!} x^s \right) \left(\sum_{k=0}^{\infty} \frac{1}{[k]_{q_i, q_j}!} (q_i q_j)^{\frac{k(k-1)}{2}} y^k \right) \\
&= e_{q_i, q_j}(x) E_{q_i, q_j}(y). \tag{9.41}
\end{aligned}$$

9.2. q-Multiple Pascal Triangle

The q -multiple binomial coefficients are defined as

$$\begin{bmatrix} n \\ k \end{bmatrix}_{q_i, q_j} = \frac{[n]_{q_i, q_j}!}{[n - k]_{q_i, q_j}! [k]_{q_i, q_j}!}, \tag{9.42}$$

with n and k being nonnegative integers and $n \geq k$. Using the addition formula for q -multiple numbers (9.4)

$$[n]_{q_i, q_j} = [n - k + k]_{q_i, q_j} = q_j^k [n - k]_{q_i, q_j} + q_i^{n-k} [k]_{q_i, q_j}.$$

With the above relation (9.42), we have

$$\begin{aligned}
\begin{bmatrix} n \\ k \end{bmatrix}_{q_i, q_j} &= \frac{q_j^k [n - 1]_{q_i, q_j}!}{[k]_{q_i, q_j}! [n - k - 1]_{q_i, q_j}!} + \frac{q_i^{n-k} [n - 1]_{q_i, q_j}!}{[n - k]_{q_i, q_j}! [k - 1]_{q_i, q_j}!} \\
&= q_j^k \begin{bmatrix} n - 1 \\ k \end{bmatrix}_{q_i, q_j} + q_i^{n-k} \begin{bmatrix} n - 1 \\ k - 1 \end{bmatrix}_{q_i, q_j} \tag{9.43}
\end{aligned}$$

$$= q_i^k \begin{bmatrix} n - 1 \\ k \end{bmatrix}_{q_i, q_j} + q_j^{n-k} \begin{bmatrix} n - 1 \\ k - 1 \end{bmatrix}_{q_i, q_j}. \tag{9.44}$$

These two rules determine the multiple q Pascal triangle, where $1 \leq k \leq n - 1$. The

q_i, q_j -symmetrical Pascal triangle has the form:

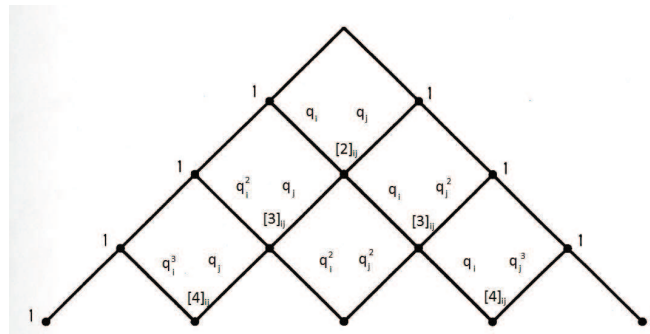

Figure 9.1. (q_i, q_j) -Pascal Triangle

9.3. q -Multiple Antiderivative

Definition 9.3.0.4 The function $F(x)$ is (q_i, q_j) -antiderivative of $f(x)$ if $D_{q_i, q_j} F(x) = f(x)$, and it is denoted by

$$F(x) = \int f(x) d_{q_i, q_j} x. \tag{9.45}$$

It implies solution of q -difference equation in the form

$$D_{q_i, q_j} F(x) = 0 \Rightarrow F(x) = C - \text{constant}.$$

In more general case, solution is

$$D_{q_i, q_j} F(x) = 0 \Rightarrow F(q_i x) = F(q_j x).$$

It is called (q_i, q_j) -periodic function for given i, j . By writing $q_i = e^{\ln q_i}$ and $x = e^{\ln x} = e^y$ we can write $F(x) = F(e^y) \equiv G(y)$ and

$$F(q_i x) = G(y + \ln q_i).$$

Using condition of (q_i, q_j) -periodicity of $F(x)$, we have

$$G(y + \ln q_i) = G(y + \ln q_j)$$

and if we denote $y + \ln q_i = z$, then we obtain

$$G(z) = G\left(z + \ln \frac{q_j}{q_i}\right),$$

which means that $G(z)$ is standard periodic function

$$G(z) = G(z + t)$$

with period $t = \ln \frac{q_j}{q_i}$.

Example: If we consider $G(z)$ in the form of sin function, then for (q_i, q_j) -periodic function we get

$$F(x) = \sin\left(\frac{2\pi}{\ln \frac{q_j}{q_i}} \ln x\right) = \sin\left(\frac{2\pi}{\ln q_j - \ln q_i} \ln x\right).$$

Applying D_{q_i, q_j} -operator to this function, we obtain

$$D_{q_i, q_j} \sin\left(\frac{2\pi}{\ln q_j - \ln q_i} \ln x\right) = 0,$$

which proves that

$$F(x) = \sin\left(\frac{2\pi}{\ln \frac{q_j}{q_i}} \ln x\right)$$

is (q_i, q_j) periodic function.

Suppose $f(x)$ is an analytic function expandable to power series $f(x) = \sum_{k=0}^{\infty} a_k x^k$,

then $f(x)$ has (q_i, q_j) - antiderivative in the following form

$$\int f(x) d_{q_i, q_j} x = \sum_{k=0}^{\infty} a_k \frac{x^{k+1}}{[k+1]_{q_i, q_j}} + C,$$

where C -constant.

9.3.1. q-Periodic Functions and Euler Equation

The Euler differential equation

$$x^2 \frac{d^2 y}{dx^2} + x \frac{dy}{dx} + \omega^2 y = 0, \quad (9.46)$$

by substitution $x = e^t$ and

$$x \frac{d}{dx} = \frac{d}{dt},$$

transforms to harmonic oscillator equation

$$\frac{d^2 y}{dt^2} + \omega^2 y = 0. \quad (9.47)$$

Solution of the last equation

$$y(t) = A e^{\pm i \omega t}$$

implies solution of the Euler equation

$$y(x) = A e^{\pm i \omega \ln x}.$$

This function is q -periodic function $y(qx) = y(x)$ with $q = e^{\frac{2\pi}{\omega}}$. So the above results we can summaries as : The Euler differential equation

$$x^2 \frac{d^2 y}{dx^2} + x \frac{dy}{dx} + \frac{4\pi^2}{(\ln q)^2} y = 0 \quad (9.48)$$

has the general solution

$$y(x) = A \cos \left(\frac{2\pi}{\ln q} \ln x \right) + B \sin \left(\frac{2\pi}{\ln q} \ln x \right),$$

or

$$y(x) = A \cos (2\pi \log_q x) + B \sin (2\pi \log_q x),$$

which is q -periodic ($y(qx) = y(x)$), and as follows $D_q y(x) = 0$.

9.4. q -Multiple Jackson Integral

Here we construct the q -multiple Jackson integral which gives us q -antiderivative $F(x)$ of an arbitrary function $f(x)$. For this we write the derivative operator D_{q_i, q_j} in terms of M_{q_i} -operator defined by $M_{q_i} F(x) = F(q_i x)$. From the definition of q derivative we have

$$D_{q_i, q_j} F(x) = \frac{1}{(q_i - q_j)x} (M_{q_i} - M_{q_j}) F(x) = f(x), \quad (9.49)$$

then the q -antiderivative is

$$F(x) = (M_{q_i} - M_{q_j})^{-1} (q_i - q_j) x f(x). \quad (9.50)$$

Now we find the inverse of $(M_{q_i} - M_{q_j})$. We have

$$M_{q_i}^{-1} f(x) = f\left(\frac{1}{q_i}x\right) = M_{\frac{1}{q_i}},$$

therefore $M_{q_i}^{-1}$ is inverse operator of M_{q_i} . Then

$$\begin{aligned} M_{q_i} - M_{q_j} &= M_{q_i} \left(1 - \frac{M_{q_j}}{M_{q_i}}\right) = M_{q_i} (1 - M_{q_i}^{-1} M_{q_j}) \\ &= M_{q_i} \left(1 - M_{\frac{q_j}{q_i}}\right), \end{aligned} \tag{9.51}$$

and

$$\begin{aligned} (M_{q_i} - M_{q_j})^{-1} &= \left(1 - M_{\frac{q_j}{q_i}}\right)^{-1} M_{q_i}^{-1} \\ &= \left(\frac{1}{1 - M_{\frac{q_j}{q_i}}}\right) M_{\frac{1}{q_i}} \\ &= \left(1 + \frac{M_{q_j}}{M_{q_i}} + \left(\frac{M_{q_j}}{M_{q_i}}\right)^2 + \dots\right) M_{\frac{1}{q_i}} \\ &= M_{\frac{1}{q_i}} + M_{\frac{q_j}{q_i^2}} + M_{\frac{q_j^2}{q_i^3}} + \dots \end{aligned}$$

Substituting into (9.50), we obtain the q -multiple Jackson integral of $f(x)$

$$F(x) = \int f\left(\frac{x}{q_i}\right) d_{\frac{q_j}{q_i}} x = (q_i - q_j) \sum_{k=0}^{\infty} \frac{q_j^k x}{q_i^{k+1}} f\left(\frac{q_j^k x}{q_i^{k+1}}\right). \tag{9.52}$$

CHAPTER 10

NON-COMMUTATIVE Q -BINOMIAL FORMULAS

10.1. Gauss's Binomial Formula

The Newton's Binomial Formula for positive integer n is given in the following form

$$(x + y)^n = \sum_{k=0}^n \binom{n}{k} x^{n-k} y^k, \quad (10.1)$$

where

$$\binom{n}{k} = \frac{n!}{k!(n-k)!}$$

denotes the corresponding binomial coefficients. And these binomial coefficients appear as the entries of Pascal's Triangle.

To obtain the q -analogue of Binomial formula (Kac & Cheung, 2002), one considers function $f(x) = (x + a)_q^n$, and expand it around $x = 0$ to q -Taylor's series . By using notation

$$(x + a)_q^n \equiv (x + a)(x + qa)(x + q^2a) \dots (x + q^{n-1}a), \quad n = 1, 2, \dots \quad (10.2)$$

and next calculations

$$(x + a)_q^{n-k} \Big|_{(x=0)} = q^{\frac{(n-k)(n-k-1)}{2}} a^{n-k},$$

$$(D_q^k f)(x) = [n]_q [n-1]_q \dots [n-k+1]_q (x + a)_q^{n-k}, \quad (10.3)$$

we get the q - Taylor's formula as

$$(x + a)_q^n = \sum_{k=0}^n \begin{bmatrix} n \\ k \end{bmatrix}_q q^{\frac{(n-k)(n-k-1)}{2}} a^{n-k} x^k. \quad (10.4)$$

From the symmetry of q - binomial coefficients $\begin{bmatrix} n \\ k \end{bmatrix}_q = \begin{bmatrix} n \\ n-k \end{bmatrix}_q$ the above expression may be rewritten as

$$(x + a)_q^n = \sum_{k=0}^n \begin{bmatrix} n \\ k \end{bmatrix}_q q^{\frac{k(k-1)}{2}} x^{n-k} a^k, \quad (10.5)$$

which is called Gauss's Binomial formula for commutative x and a ($xa = ax$).

Here we propose alternative way to obtain the above result, without using q -Taylor formula (In the next section we apply the same method for new case of Q -commutative q -binomial formula). It is based on solving the first order linear partial difference equation. Suppose the Gauss's Binomial formula (10.5) can be written in the following polynomial form

$$(x + a)_q^n = \sum_{j=0}^n \left\{ \begin{matrix} n \\ j \end{matrix} \right\}_q x^j a^{n-j}, \quad (10.6)$$

with unknown coefficients $\left\{ \begin{matrix} n \\ j \end{matrix} \right\}_q$. So, by induction

$$\begin{aligned} (x + a)_q^{n+1} &= (x + a)_q^n (x + q^n a) \\ &= \sum_{j=0}^n \left\{ \begin{matrix} n \\ j \end{matrix} \right\}_q x^j a^{n-j} (x + q^n a) \\ &= \sum_{j=0}^n \left\{ \begin{matrix} n \\ j \end{matrix} \right\}_q x^{j+1} a^{n-j} + \sum_{j=0}^n \left\{ \begin{matrix} n \\ j \end{matrix} \right\}_q x^j q^n a^{n-j+1}. \end{aligned}$$

By shifting $j \rightarrow j - 1$ in the first sum, we obtain

$$\sum_{j=0}^{n+1} \left\{ \begin{matrix} n+1 \\ j \end{matrix} \right\}_q x^j a^{n-j+1} = \sum_{j=1}^{n+1} \left\{ \begin{matrix} n \\ j-1 \end{matrix} \right\}_q x^j a^{n-j+1} + \sum_{j=0}^n \left\{ \begin{matrix} n \\ j \end{matrix} \right\}_q x^j q^n a^{n-j+1}. \quad (10.7)$$

From the above equalities we have

$$\begin{aligned}
 j = 0 &\Rightarrow \begin{Bmatrix} n+1 \\ 0 \end{Bmatrix}_q = q^n \begin{Bmatrix} n \\ 0 \end{Bmatrix}_q, \\
 j = n+1 &\Rightarrow \begin{Bmatrix} n+1 \\ n+1 \end{Bmatrix}_q = \begin{Bmatrix} n \\ n \end{Bmatrix}_q, \\
 j = k &\Rightarrow \begin{Bmatrix} n+1 \\ k \end{Bmatrix}_q = \begin{Bmatrix} n \\ k-1 \end{Bmatrix}_q + q^n \begin{Bmatrix} n \\ k \end{Bmatrix}_q, \quad 1 < k < n. \quad (10.8)
 \end{aligned}$$

It is convenient to put

$$\begin{Bmatrix} n \\ b \end{Bmatrix}_q = 0 \text{ if } b < 0 \text{ and } b > n.$$

Therefore we have the following equalities

$$\begin{aligned}
 \begin{Bmatrix} n+1 \\ 0 \end{Bmatrix}_q &= q^n \begin{Bmatrix} n \\ 0 \end{Bmatrix}_q, \\
 \begin{Bmatrix} n+1 \\ n+1 \end{Bmatrix}_q &= \begin{Bmatrix} n \\ n \end{Bmatrix}_q.
 \end{aligned}$$

By recalling the known q -Pascal rule in terms of q -combinatorial coefficients

$$\begin{bmatrix} n+1 \\ k \end{bmatrix}_q = \begin{bmatrix} n \\ k-1 \end{bmatrix}_q + q^k \begin{bmatrix} n \\ k \end{bmatrix}_q, \quad (10.9)$$

we try to find the unknown combinatorial coefficients $\begin{Bmatrix} n \\ k \end{Bmatrix}_q$ in terms of known q -combinatorial coefficients $\begin{bmatrix} n \\ k \end{bmatrix}_q$ with multiplying factor q in power of unknown function $S(n, k)$

$$\begin{Bmatrix} n \\ k \end{Bmatrix}_q = q^{S(n,k)} \begin{bmatrix} n \\ k \end{bmatrix}_q. \quad (10.10)$$

Substituting the above Ansatz into the recursion formula (10.8) and using the q -Pascal

rule (10.9), we obtain the following relation

$$q^{S(n+1,k)} \begin{bmatrix} n \\ k-1 \end{bmatrix}_q + q^{S(n+1,k)+k} \begin{bmatrix} n \\ k \end{bmatrix}_q = q^{S(n,k-1)} \begin{bmatrix} n \\ k-1 \end{bmatrix}_q + q^{S(n,k)+n} \begin{bmatrix} n \\ k-1 \end{bmatrix}_q.$$

By equating coefficients with the same power of q , we obtain the system of the first order linear partial difference equations ($h = 1$)

$$\begin{aligned} S(n+1, k) = S(n, k-1) &\Rightarrow D_n S(n, k) = -D_k S(n, k-1), \\ S(n+1, k) = S(n, k) + n - k &\Rightarrow D_n S(n, k) = n - k, \end{aligned}$$

with initial conditions

$$S(0, 0) = S(1, 0) = S(1, 1) = 0, \quad (k = 0, 1, \dots, n),$$

where

$$D_x^h f(x, y) = f(x+h, y) - f(x, y), \quad D_y^h f(x, y) = f(x, y+h) - f(x, y).$$

Solution of the above system is found in the form (see Appendix C)

$$S(n, k) = \frac{(n-k)(n-k-1)}{2}.$$

Hence,

$$\begin{Bmatrix} n \\ k \end{Bmatrix}_q = q^{\frac{(n-k)(n-k-1)}{2}} \begin{bmatrix} n \\ k \end{bmatrix}_q. \quad (10.11)$$

Then, by substituting into expansion (10.6), we come to Gauss's Binomial formula for commutative x and a ($xa = ax$).

10.2. Non-commutative Binomial Formula

For q -commutative x and y ($yx = qxy$), where q is a number, commuting with x and y ; $xq = qx$ and $yq = qy$, we have the non-commutative Binomial formula

$$(x + y)^n = \sum_{k=0}^n \begin{bmatrix} n \\ k \end{bmatrix}_q x^k y^{n-k}. \quad (10.12)$$

It can be proved by mathematical induction (see for example Kac & Chung, 2002).

10.3. Q-commutative q-Binomial Formula

In this section we construct the q - Binomial formula for non-commutative x and y , in the special case when they are Q -commutative ($yx = Qxy$) (Pashaev & Nalci, 2011d).

Firstly, we note that in notation of q -binomial we have the product

$$(x + y)_q^n = (x + y)(x + qy)(x + q^2y) \dots (x + q^{n-1}y), \quad n = 1, 2, \dots \quad (10.13)$$

which we now apply to the noncommutative operators x and y , so that we should distinguish the direction of multiplication. So we have following notation for two cases

$$(x + y)_{<q}^n \equiv (x + y)(x + qy)(x + q^2y) \dots (x + q^{n-1}y) \quad (10.14)$$

and

$$(x + y)_{>q}^n \equiv (x + q^{n-1}y) \dots (x + qy)(x + y). \quad (10.15)$$

Now we like to find expansion of these q -polynomials in terms of x and y powers. Sup-

pose we have the following expansion

$$(x + y)_{<q}^n = \sum_{k=0}^n \left\{ \begin{matrix} n \\ k \end{matrix} \right\}_{Q,q} x^{n-k} y^k, \quad (10.16)$$

where

$$(x + y)_{<q}^n = (x + y)(x + qy)(x + q^2y) \dots (x + q^{n-1}y),$$

and $\left\{ \begin{matrix} n \\ k \end{matrix} \right\}_{Q,q}$ - denote unknown coefficients, depending on k, n, q and Q . Then,

$$(x + y)_q^{n+1} = (x + y)_q^n (x + q^n y).$$

Expanding both sides

$$\begin{aligned} \sum_{k=0}^{n+1} \left\{ \begin{matrix} n+1 \\ k \end{matrix} \right\}_{Q,q} x^{n-k+1} y^k &= \sum_{k=0}^n \left\{ \begin{matrix} n \\ k \end{matrix} \right\}_{Q,q} x^{n-k} y^k (x + q^n y) \\ &= \sum_{k=0}^n \left\{ \begin{matrix} n \\ k \end{matrix} \right\}_{Q,q} x^{n-k} y^k x + \sum_{k=0}^n \left\{ \begin{matrix} n \\ k \end{matrix} \right\}_{Q,q} q^n x^{n-k} y^{k+1} \\ &= \sum_{k=0}^n \left\{ \begin{matrix} n \\ k \end{matrix} \right\}_{Q,q} Q^k x^{n-k+1} y^k + \sum_{k=0}^n \left\{ \begin{matrix} n \\ k \end{matrix} \right\}_{Q,q} q^n x^{n-k} y^{k+1} \\ &= \sum_{k=0}^n \left\{ \begin{matrix} n \\ k \end{matrix} \right\}_{Q,q} Q^k x^{n-k+1} y^k + \sum_{k=1}^{n+1} \left\{ \begin{matrix} n \\ k-1 \end{matrix} \right\}_{Q,q} q^n x^{n-k+1} y^k \end{aligned}$$

From the above equality we have the following recursion formulas :

$$\begin{aligned} k = 0 &\Rightarrow \left\{ \begin{matrix} n+1 \\ 0 \end{matrix} \right\}_{Q,q} = \left\{ \begin{matrix} n \\ 0 \end{matrix} \right\}_{Q,q}, \\ k = n+1 &\Rightarrow \left\{ \begin{matrix} n+1 \\ n+1 \end{matrix} \right\}_{Q,q} = q^n \left\{ \begin{matrix} n \\ n \end{matrix} \right\}_{Q,q}, \\ 1 \leq k \leq n &\Rightarrow \left\{ \begin{matrix} n+1 \\ k \end{matrix} \right\}_{Q,q} = Q^k \left\{ \begin{matrix} n \\ k \end{matrix} \right\}_{Q,q} + q^n \left\{ \begin{matrix} n \\ k-1 \end{matrix} \right\}_{Q,q}, \end{aligned} \quad (10.17)$$

where convenient to choose

$$\left\{ \begin{matrix} n \\ b \end{matrix} \right\}_{Q,q} = 0 \text{ if } b < 0 \text{ and } b > n.$$

Suppose the unknown binomial coefficient factor $\left\{ \begin{matrix} n \\ k \end{matrix} \right\}_{Q,q}$ can be written in terms of the known combinatorial coefficient $\left[\begin{matrix} n \\ k \end{matrix} \right]_{Q,q}$ with multiplication factor as

$$\left\{ \begin{matrix} n \\ k \end{matrix} \right\}_{Q,q} = q^{t(n,k)} \left[\begin{matrix} n \\ k \end{matrix} \right]_{Q,q}, \quad (10.18)$$

where $\left[\begin{matrix} n \\ k \end{matrix} \right]_{Q,q}$ is (q, Q) - combinatorial coefficient with $[n]_{Q,q} = \frac{Q^n - q^n}{Q - q}$ (see section 9.2). Substituting this relation to (10.17) and using (9.43), (9.44) we have following expression

$$Q^k q^{t(n+1,k)} \left[\begin{matrix} n \\ k \end{matrix} \right]_{Q,q} + q^{n+1-k+t(n+1,k)} \left[\begin{matrix} n \\ k-1 \end{matrix} \right]_{Q,q} = Q^k q^{t(n,k)} \left[\begin{matrix} n \\ k \end{matrix} \right]_{Q,q} + q^{n+t(n,k-1)} \left[\begin{matrix} n \\ k-1 \end{matrix} \right]_{Q,q}$$

By equating terms with the same power of q and Q , we obtain two difference equations

$$\begin{aligned} t(n+1, k) &= t(n, k) \\ t(n, k) &= t(n, k-1) + k - 1 \end{aligned} \quad (10.19)$$

with the initial conditions

$$t(0, 0) = t(1, 0) = t(1, 1) = 0. \quad (10.20)$$

Solution of this first order system of linear difference equations gives (see Appendix C)

$$t(n, k) = \frac{k(k-1)}{2}. \quad (10.21)$$

Hence, we obtain the q - Binomial formula for Q -commutative x and y in the form

$$(x + y)_{<q}^n = \sum_{k=0}^n \begin{bmatrix} n \\ k \end{bmatrix}_{Q,q} q^{\frac{k(k-1)}{2}} x^{n-k} y^k, \quad (10.22)$$

where $yx = Qxy$, and

$$\begin{bmatrix} n \\ k \end{bmatrix}_{Q,q} = \frac{[n]_{Q,q}!}{[n-k]_{Q,q}! [k]_{Q,q}!}, \quad [n]_{Q,q} = \frac{Q^n - q^n}{Q - q}.$$

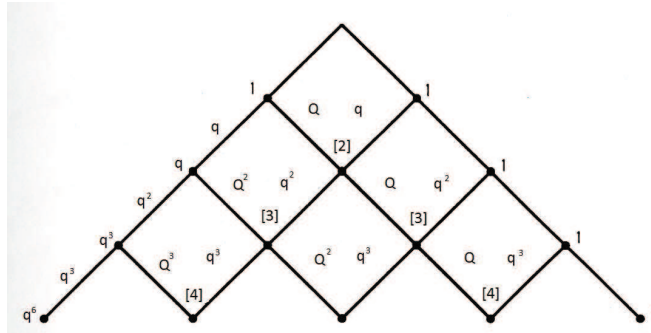

Figure 10.1. Q -commutative q -Pascal triangle

It is instructive now to prove this Binomial formula by using mathematical induction. We have

$$\begin{aligned} (x + y)_q^{n+1} &= (x + y)_q^n (x + q^n y) \\ &= \sum_{k=0}^n \begin{bmatrix} n \\ k \end{bmatrix}_{Q,q} q^{\frac{k(k-1)}{2}} x^{n-k} y^k (x + q^n y) \\ &= \sum_{k=0}^n \begin{bmatrix} n \\ k \end{bmatrix}_{Q,q} q^{\frac{k(k-1)}{2}} x^{n-k} y^k x + \sum_{k=0}^n \begin{bmatrix} n \\ k \end{bmatrix}_{Q,q} q^{\frac{k(k-1)}{2}} q^n x^{n-k} y^{k+1}. \end{aligned}$$

From the Q - commutativity relation $yx = Qxy$, we get $y^k x = Q^k x y^k$ and the above

expression is written as follows

$$\begin{aligned}
(x+y)_q^{n+1} &= \sum_{k=0}^n \begin{bmatrix} n \\ k \end{bmatrix}_{Q,q} q^{\frac{k(k-1)}{2}} Q^k x^{n-k+1} y^k + \sum_{k=0}^n \begin{bmatrix} n \\ k \end{bmatrix}_{Q,q} q^{\frac{k(k-1)}{2}} q^n x^{n-k} y^{k+1} \\
&= \sum_{k=0}^n \begin{bmatrix} n \\ k \end{bmatrix}_{Q,q} q^{\frac{k(k-1)}{2}} Q^k x^{n-k+1} y^k + \sum_{k=1}^{n+1} \begin{bmatrix} n \\ k-1 \end{bmatrix}_{Q,q} q^{\frac{(k-1)(k-2)}{2}} q^n x^{n-k+1} y^k \\
&= \begin{bmatrix} n \\ 0 \end{bmatrix}_{Q,q} x^{n+1} + \begin{bmatrix} n \\ n \end{bmatrix}_{Q,q} q^{\frac{n(n+1)}{2}} y^{n+1} \\
&+ \sum_{k=1}^n \left(\begin{bmatrix} n \\ k \end{bmatrix}_{Q,q} q^{\frac{k(k-1)}{2}} Q^k + \begin{bmatrix} n \\ k-1 \end{bmatrix}_{Q,q} q^{\frac{(k-1)(k-2)}{2}} q^n \right) x^{n-k+1} y^k. \quad (10.23)
\end{aligned}$$

In Pascal rule for binomial coefficients (9.44) by choosing $q_i = Q$ and $q_j = q$ we have the following relation

$$Q^k \begin{bmatrix} n \\ k \end{bmatrix}_{Q,q} = \begin{bmatrix} n+1 \\ k \end{bmatrix}_{Q,q} - q^{n+1-k} \begin{bmatrix} n \\ k-1 \end{bmatrix}_{Q,q}.$$

By substituting this relation into equation (10.23) we have desired result

$$\begin{aligned}
(x+y)_q^{n+1} &= \begin{bmatrix} n \\ 0 \end{bmatrix}_{Q,q} x^{n+1} + \begin{bmatrix} n \\ n \end{bmatrix}_{Q,q} q^{\frac{n(n+1)}{2}} y^{n+1} + \sum_{k=1}^n \begin{bmatrix} n \\ k \end{bmatrix}_{Q,q} q^{\frac{k(k-1)}{2}} x^{n-k+1} y^k \\
&= \sum_{k=0}^{n+1} \begin{bmatrix} n+1 \\ k \end{bmatrix}_{Q,q} q^{\frac{k(k-1)}{2}} x^{n-k+1} y^k. \quad (10.24)
\end{aligned}$$

■

Example: Consider the Q - derivative operator $D_Q = \frac{M_Q - 1}{x(Q-1)}$ with Q -dilatation operator $M_Q = Qx \frac{d}{dx}$ operators. These operators are Q -commutative

$$D_Q M_Q = Q M_Q D_Q.$$

Then we have expansion

$$\begin{aligned} (M_Q + D_Q)_{<q}^n &= (M_Q + D_Q)(M_Q + qD_Q)(M_Q + q^2D_Q)\dots(M_Q + q^{n-1}D_Q) \\ &= \sum_{k=0}^n \begin{bmatrix} n \\ k \end{bmatrix}_{Q,q} q^{\frac{k(k-1)}{2}} M_Q^{n-k} D_Q^k. \end{aligned} \quad (10.25)$$

The above result shows that Q -commutative q -binomials are expressed in terms of our (q, Q) numbers, introduced in Section 9. Then we have next generalization of this formula. Let operators x and y are q_i commutative $yx = q_jxy$, then

$$(x + y)_{<q_i}^n = \sum_{k=0}^n \begin{bmatrix} n \\ k \end{bmatrix}_{q_i, q_j} q_i^{\frac{k(k-1)}{2}} x^{n-k} y^k, \quad (10.26)$$

where $\begin{bmatrix} n \\ k \end{bmatrix}_{q_i, q_j}$ are combinatorial coefficients .

Example: The unitary operator $D(\alpha) = e^{\alpha a^+ - \bar{\alpha} a}$ for Heisenberg-Weyl group is generating operator for Coherent states

$$|\alpha \rangle = D(\alpha)|0\rangle,$$

where α is complex parameter. These operators satisfy relation

$$D(\alpha)D(\beta) = e^{2i\Im(\alpha\bar{\beta})} D(\beta)D(\alpha),$$

hence they are Q -commutative with $Q = e^{2i\Im(\alpha\bar{\beta})}$. Then we have next operator q -Binomial expansion

$$(D(\beta) + D(\alpha))_{<q}^n = \sum_{k=0}^n \begin{bmatrix} n \\ k \end{bmatrix}_{Q,q} q^{\frac{k(k-1)}{2}} D^{n-k}(\beta) D^k(\alpha). \quad (10.27)$$

If we apply this expansion to vacuum state $|0\rangle$, then we get

$$\begin{aligned} (D(\beta) + D(\alpha))_{<q}^n |0\rangle &= \sum_{k=0}^n \begin{bmatrix} n \\ k \end{bmatrix}_{Q,q} q^{\frac{k(k-1)}{2}} D^{n-k}(\beta) |k\alpha\rangle \\ &= \sum_{k=0}^n \begin{bmatrix} n \\ k \end{bmatrix}_{Q,q} q^{\frac{k(k-1)}{2}} e^{i\delta} |(n-k)\beta + k\alpha\rangle, \end{aligned} \quad (10.28)$$

where

$$\delta = 2\Im [(n-k)k\alpha\bar{\beta}].$$

Proposition 10.3.0.1 *Above we have derived Q -commutative (10.14) q -binomial formula for ordered product $< q$. Now we like to construct similar formula for opposite ordered product $> q$ (10.15). The following relation for two different ordered products is valid*

$$\prod_{k=0}^N (x + q^k y)_{<q} = \prod_{k=0}^N (x + Q^{N-2k} q^k y)_{>q}, \quad (10.29)$$

where $yx = Qxy$ and

$$\begin{aligned} \prod_{k=0}^N (x + q^k y)_{<q} &= (x + y)(x + qy)(x + q^2 y) \dots (x + q^N y) = (x + y)_{<q}^{N+1}, \\ \prod_{k=0}^N (x + Q^{N-2k} q^k y)_{>q} &= (x + q^N y)(x + q^{N-1} y) \dots (x + qy)(x + y). \end{aligned}$$

Proof 10.3.0.2 *This formula can be proved by the method of mathematical induction.*

$$\begin{aligned} N = 1 \Rightarrow \prod_{k=0}^1 (x + q^k y)_{<q} &= (x + y)(x + qy) = x^2 + qQ^{-1}yx + Qxy + qy^2 \\ &= (x + Q^{-1}qy)(x + Qy) = \prod_{k=0}^1 (x + Q^{1-2k} q^k y)_{>q} \end{aligned}$$

and we suppose that the formula is true for some N . Let us show that it is also valid for

$N + 1 :$

$$\begin{aligned}
\prod_{k=0}^{N+1} (x + q^k y)_{<q} &= \prod_{k=0}^N (x + q^k y)_{<q} (x + q^{N+1} y) \\
&= \prod_{k=0}^N (x + Q^{N-2k} q^k y)_{>q} (x + q^{N+1} y) \\
&= (x + Q^{-N} q^N y) \dots (x + Q^{(N-2)} q y) (x + Q^N y) (x + q^{N+1} y).
\end{aligned}$$

By using equality

$$(x + q^m y)(x + q^k y) = (x + Q^{-1} q^k y)(x + Q q^m y),$$

we move the last term to the left-end by commutating with every term of the product

$$\begin{aligned}
\prod_{k=0}^{N+1} (x + q^k y)_{<q} &= (x + Q^{-N} q^N y) \dots (x + Q^{(N-2)} q y) (x + Q^{-1} q^{N+1} y) (x + Q^{N+1} y) \\
&= (x + Q^{-N} q^N y) \dots (x + Q^{-2} q^{N+1} y) (x + Q^{(N-1)} q y) (x + Q^{N+1} y) \\
&= \dots \\
&= (x + Q^{-(N+1)} q^{N+1} y) (x + Q^{-(N-1)} q^N y) \dots (x + Q^{N+1} y) \\
&= \prod_{k=0}^{N+1} (x + Q^{N+1-2k} q^k y)_{>q}.
\end{aligned}$$

Proposition 10.3.0.3 *For $q = 1$ we have the following relation*

$$(x + y)^n = (x + y)_{<\tilde{Q}}^n, \quad (10.30)$$

where

$$(x + y)_{<\tilde{Q}}^n = (x + Q^{-(n-1)} y) (x + Q^{-(n-3)} y) \dots (x + Q^{(n-3)} y) (x + Q^{(n-1)} y)$$

is non-commutative binomial in symmetrical calculus case.

Proof 10.3.0.4 By mathematical induction, for $n = 1$, it is obvious. Suppose we have

$$(x + y)^n = (x + y)_{<Q}^n,$$

for arbitrary n . Then for $n + 1$ we have

$$\begin{aligned} (x + y)^{n+1} &= (x + y)^n(x + y) = (x + y)_{<Q}^n(x + y) \\ &= (x + Q^{-(n-1)})(x + Q^{-(n-3)}) \dots (x + Q^{(n-3)})(x + Q^{(n-1)})(x + y) \\ &= (x + Q^{-(n-1)})(x + Q^{-(n-3)}) \dots (x + Q^{(n-3)})(x + Q^{-1}y)(x + Q^{(n)}) \\ &= (x + Q^{-(n-1)})(x + Q^{-(n-3)}) \dots (x + Q^{-2}y)(x + Q^{(n-2)})(x + Q^{(n)}) \\ &= \dots \\ &= (x + Q^{-n})(x + Q^{-(n-2)}) \dots (x + Q^{(n-2)})(x + Q^n) = (x + y)_{<Q}^{n+1}. \end{aligned}$$

We summarize our results in the next q -binomial formula for Q -commutative operators x and y :

$$\begin{aligned} (x + y)_{<q}^N &= \prod_{k=0}^{N-1} (x + q^k y)_{<q} = (x + y)(x + qy)(x + q^2y) \dots (x + q^{N-1}y) \\ &= \sum_{k=0}^N \begin{bmatrix} N \\ k \end{bmatrix}_{q,Q} q^{\frac{k(k-1)}{2}} x^{n-k} y^k, \end{aligned} \quad (10.31)$$

where $yx = Qxy$.

Proposition 10.3.0.5 Two opposite ordered q -binomials are related by formula

$$(x + y)_{<q}^N = (x + Q^{N-1}y)_{>\frac{q}{Q^2}}^N, \quad (10.32)$$

where $yx = Qxy$.

Proof 10.3.0.6 From equation (10.29) we have

$$\prod_{k=0}^N (x + q^k y)_{<q} = \prod_{k=0}^N (x + Q^{N-2k} q^k y)_{>q} = \prod_{k=0}^N (x + (\frac{q}{Q^2})^k Q^N y)_{>q} = (x + Q^N y)_{>\frac{q}{Q^2}}^{N+1};$$

$$(x + y)_{<q}^{N+1} = (x + Q^N y)_{>\frac{q}{Q^2}}^{N+1} \Rightarrow (x + y)_{<q}^N = (x + Q^{N-1} y)_{>\frac{q}{Q^2}}^N.$$

Proposition 10.3.0.7 For $yx = Qxy$ we obtain the following relation

$$(x + y)_{>q}^N = \prod_{k=0}^{N-1} (x + q^k y)_{>q} = \sum_{k=0}^N \left[\begin{matrix} N \\ k \end{matrix} \right]_{qQ^2, Q} (qQ^2)^{\frac{k(k-1)}{2}} x^{N-k} \left(\frac{y}{Q^{N-1}} \right)^k. \quad (10.33)$$

Proof 10.3.0.8 We start from relation between direction of two multiplication rules (10.29)

$$\begin{aligned} \prod_{k=0}^{N-1} (x + q^k y)_{<q} &= \prod_{k=0}^{N-1} (x + Q^{N-1-2k} q^k y)_{>q} \\ &= \prod_{k=0}^{N-1} (x + (\frac{q}{Q^2})^k Q^{N-1} y)_{>q}. \end{aligned} \quad (10.34)$$

By choosing $Q^{N-1} y \equiv z \Rightarrow y = \frac{z}{Q^{N-1}}$, the above equation becomes

$$\prod_{k=0}^{N-1} \left(x + \left(\frac{q}{Q^2} \right)^k z \right)_{>q} = \prod_{k=0}^{N-1} \left(x + q^k \frac{z}{Q^{N-1}} \right)_{<q}.$$

Let us call $\frac{q}{Q^2} \equiv q_1$, then according to Proposition 10.3.05

$$\begin{aligned} \prod_{k=0}^{N-1} (x + q_1^k z)_{>q_1} &= (x + z)_{>q_1}^N = \prod_{k=0}^{N-1} \left(x + (q_1 Q^2)^k \frac{z}{Q^{N-1}} \right) = \left(x + \frac{z}{Q^{N-1}} \right)_{<q_1 Q^2}^N \\ &= \sum_{k=0}^N \left[\begin{matrix} N \\ k \end{matrix} \right]_{q_1 Q^2, Q} (q_1 Q^2)^{\frac{k(k-1)}{2}} x^{N-k} \left(\frac{z}{Q^{N-1}} \right)^k. \end{aligned} \quad (10.35)$$

Relation $yx = Qxy$ implies $zx = Qxz$, this is why, if we replace $q_1 \rightarrow q$ and $z \rightarrow y$, we obtain the required result. ■

Finally, q -Binomial formulas for Q -commutative operators x and y with different order are summarized in equations (10.31) and (10.33).

In the next section we show that all known binomial formulas like Gauss Binomial formula etc. are particular cases of our non-commutative binomial formula.

10.3.1. Special Cases

Let us consider some particular cases of this generalized Q commutative q - Binomial formula:

(i) for $Q = 1$, which means commutative x and y , this formula becomes the Gauss Binomial formula

$$(x + y)_q^n = \sum_{k=0}^n \begin{bmatrix} n \\ k \end{bmatrix}_q q^{\frac{k(k-1)}{2}} x^{n-k} y^k,$$

where $yx = xy$.

(ii) for Q - commutative x and y ($yx = Qxy$) and $q = 1$ we have Non-commutative Binomial formula

$$(x + y)^n = \sum_{k=0}^n \begin{bmatrix} n \\ k \end{bmatrix}_Q x^{n-k} y^k.$$

(iii) for $Q = \frac{1}{q}$, we obtain the symmetrical binomial formula

$$(x + y)_q^n = \sum_{k=0}^n \begin{bmatrix} n \\ k \end{bmatrix}_{\bar{q}} q^{\frac{k(k-1)}{2}} x^{n-k} y^k,$$

where $yx = \frac{1}{q}xy$.

(iv) for $q = Q \Rightarrow \lim_{Q \rightarrow q} [n]_{q,q} = nq^{n-1}$, and the formula transforms to the

following one

$$(x + y)_q^n = \sum_{k=0}^n \binom{n}{k} q^{k(n-\frac{k+1}{2})} x^{n-k} y^k,$$

where $\binom{n}{k} = \frac{n!}{(n-k)!k!}$ - standard Newton binomials.

(v) By choosing $q = -\frac{1}{\varphi}$ and $Q = \varphi$, where φ is the Golden ratio, we obtain the Binet-Fibonacci Binomial formula for Golden Ratio non-commutative plane ($yx = \varphi xy$) (Pashaev and Nalci, 2011a)

$$\begin{aligned} (x + y)_{-\frac{1}{\varphi}}^n &= \sum_{k=0}^n \left[\begin{matrix} n \\ k \end{matrix} \right]_{\varphi, -\frac{1}{\varphi}} \left(-\frac{1}{\varphi}\right)^{\frac{k(k-1)}{2}} x^{n-k} y^k \\ &= \sum_{k=0}^n \frac{F_n!}{F_k! F_{n-k}!} \left(-\frac{1}{\varphi}\right)^{\frac{k(k-1)}{2}} x^{n-k} y^k, \end{aligned} \quad (10.36)$$

where F_n are Fibonacci numbers, and q -binomial coefficients become Fibonomial.

10.3.2. q, Q - Binomial Formula

The above formulas we can compare with the one appearing from general commutative multiple binomial formula. If we choose $q_i = q$ and $q_j = Q$ in (q_i, q_j) multiple binomial formula (9.29), the following formula may obtained

$$(x + y)_{q,Q}^n = \sum_{k=0}^n \left[\begin{matrix} n \\ k \end{matrix} \right]_{q,Q} (qQ)^{\frac{k(k-1)}{2}} x^{n-k} y^k,$$

where $yx = xy$.

10.3.3. q -Function of Non-commutative Variables

In Chapter 12 we introduce q -function of two variables. If

$$f(x) = \sum_{n=0}^{\infty} c_n x^n,$$

then q -function of two variables x and y is defined as

$$f(x + y)_q = \sum_{n=0}^{\infty} c_n (x + y)_q^n. \quad (10.37)$$

We use these functions for definition of q -analytic functions and q -traveling waves. If we take into account non-commutative binomial formulas derived in this section we can extend our results from the Chapter 12 to the q -function of non-commutative (Q -commutative) variables x and y . This why non-commutative q - analytic functions and non-commutative q -traveling waves could be derived.

As an example below we briefly consider case of q -exponential function.

Definition 10.3.3.1 (q, Q) analogues of exponential function are defined as

$$\begin{aligned} e_{q,Q}(x) &\equiv \sum_{n=0}^{\infty} \frac{1}{[n]_{q,Q}!} x^n, \\ E_{q,Q}(x) &\equiv \sum_{n=0}^{\infty} \frac{1}{[n]_{q,Q}!} q^{\frac{n(n-1)}{2}} x^n. \end{aligned} \quad (10.38)$$

Proposition 10.3.3.2 For Q -commutative operators x and y , ($yx = Qxy$), we have the following factorization for q - exponential function $e_{q,Q}$,

$$e_{q,Q}(x + y)_{<q} = e_{q,Q}(x)E_{q,Q}(y),$$

where

$$e_{q,Q}(x) \equiv \sum_{n=0}^{\infty} \frac{1}{[n]_{q,Q}!} x^n,$$

$$E_{q,Q}(x) \equiv \sum_{n=0}^{\infty} \frac{1}{[n]_{q,Q}!} q^{\frac{n(n-1)}{2}} x^n.$$

Proof 10.3.3.3

$$\begin{aligned} e_{q,Q}(x+y)_{<q} &= \sum_{N=0}^{\infty} \frac{(x+y)_{<q}^N}{[N]_{q,Q}!} \\ &= \sum_{N=0}^{\infty} \frac{1}{[N]_{q,Q}!} \sum_{k=0}^N \begin{bmatrix} N \\ k \end{bmatrix}_{q,Q} q^{\frac{k(k-1)}{2}} x^{N-k} y^k \\ &= \sum_{N=0}^{\infty} \sum_{k=0}^N \frac{1}{[N-k]_{q,Q}! [k]_{q,Q}!} q^{\frac{k(k-1)}{2}} x^{N-k} y^k. \end{aligned}$$

By choosing $N - k \equiv s$,

$$\begin{aligned} e_{q,Q}(x+y)_{<q} &= \left(\sum_{s=0}^{\infty} \frac{1}{[s]_{q,Q}!} x^s \right) \left(\sum_{k=0}^{\infty} \frac{1}{[k]_{q,Q}!} q^{\frac{k(k-1)}{2}} y^k \right) \\ &= e_{q,Q}(x) E_{q,Q}(y). \end{aligned} \tag{10.39}$$

■

CHAPTER 11

Q -QUANTUM HARMONIC OSCILLATOR

As an application of multiple q calculus developed in Chapter 9, here we study quantum oscillator, deformed by two parameters q and Q . Different types of q -deformation for quantum oscillator where intensively studied in a several papers. We will mention here only most important papers: for non-symmetric oscillator (Arik & Coon, 1976), for the symmetrical one (Biedenharn, 1989), (Macfarlane, 1989), and for generic (p,q) (Chakrabarti & Jagannathan, 1991) and in (Arik et al., 1992).

11.1. Quantum Harmonic Oscillator

We consider simple harmonic oscillator with mass m and with spring constant k . The motion is governed by Hooke's law and Newton's equation

$$F = -kx = m \frac{d^2x}{dt^2},$$

which can be written as

$$\frac{d^2x}{dt^2} + \omega^2 x = 0, \tag{11.1}$$

where $\omega \equiv \sqrt{\frac{k}{m}}$ is the angular frequency of oscillator.

The general solution is

$$x(t) = A \sin(\omega t) + B \cos(\omega t)$$

and the potential energy stored in a simple Harmonic oscillator at position x is

$$V(x) = \frac{1}{2} kx^2.$$

For quantum oscillator in Schrodinger picture we have to solve the Schrödinger equation with potential

$$V(x) = \frac{1}{2}m\omega^2x^2.$$

Then the time-independent Schrödinger equation for harmonic oscillator is written as

$$-\frac{\hbar}{2m} \frac{d^2\psi}{dx^2} + \frac{1}{2}m\omega^2x^2\psi = E\psi. \quad (11.2)$$

The above equation in terms of the momentum operator $p \equiv \frac{\hbar}{i} \frac{d}{dx}$ and the position operator x is

$$\frac{1}{2m}[p^2 + (m\omega x)^2]\psi = E\psi. \quad (11.3)$$

These operators satisfy the canonical commutation relation $[x, p] = i\hbar$, where the commutator of operators A and B is $[A, B] \equiv AB - BA$. The basic Hamiltonian

$$H = \frac{1}{2m}[p^2 + (m\omega x)^2]. \quad (11.4)$$

in terms of annihilation and creation operators

$$\begin{aligned} a &= \sqrt{\frac{1}{2\hbar m\omega}}(i\hat{p} + m\omega\hat{x}), \\ a^+ &= \sqrt{\frac{1}{2\hbar m\omega}}(-i\hat{p} + m\omega\hat{x}), \end{aligned} \quad (11.5)$$

can be written as

$$H = \hbar\omega(a^+a + \frac{1}{2}).$$

The commutation relation $[x, p] = i\hbar$ in terms of a and a^+ becomes

$$[a, a^+] = 1. \quad (11.6)$$

The number operator

$$N = a^+a$$

which is obviously Hermitian, satisfies the following commutation relations

$$[a, a^+] = 1, \quad [N, a] = -a, \quad [N, a^+] = a^+. \quad (11.7)$$

From (11.6) it is easy to get

$$aa^+ = N + 1.$$

Then Hamiltonian expressed in terms of N is

$$H = \hbar\omega\left(N + \frac{1}{2}\right).$$

The Schrodinger equation (11.2) for the Harmonic oscillator can also be written in terms of a and a^+ in the form

$$\hbar\omega\left(a^+a + \frac{1}{2}\right)\psi = E\psi.$$

For eigenstates $N|n\rangle = n|n\rangle$, we get the energy levels as

$$E_n = \left(n + \frac{1}{2}\right)\hbar\omega, \quad (n = 0, 1, 2, 3, \dots).$$

As a result of commutation relations, we have

$$Na^+|n\rangle = ([N, a^+] + a^+N)|n\rangle = a^+|n\rangle + a^+N|n\rangle = (n + 1)a^+|n\rangle \quad (11.8)$$

$$Na|n\rangle = ([N, a] + aN)|n\rangle = -a|n\rangle + aN|n\rangle = (n - 1)a|n\rangle \quad (11.9)$$

and

$$a^+|n\rangle = \sqrt{n+1}|n+1\rangle \quad (11.10)$$

$$a|n\rangle = \sqrt{n}|n-1\rangle. \quad (11.11)$$

The vacuum state is defined by

$$a|0\rangle = 0,$$

which is the minimum energy state with eigenvalue

$$E_0 = \frac{1}{2}\hbar\omega.$$

Applying the creation operator a^+ n times to the ground state $|0\rangle$, we obtain all eigenstates of the Hamiltonian in the form

$$|n\rangle = \left(\frac{(a^+)^n}{\sqrt{n!}} \right) |0\rangle. \quad (11.12)$$

The energy eigenfunctions in position space are found by starting with the ground state $a|0\rangle = 0$

$$\begin{aligned} \langle x|a|0\rangle &= \frac{1}{\sqrt{2\hbar m\omega}} \langle x|i\hat{p} + m\omega\hat{x}|0\rangle \\ &= \frac{1}{\sqrt{2\hbar m\omega}} \left(\frac{\hbar}{m\omega} \frac{d}{dx} + x \right) \langle x'|0\rangle = 0 \end{aligned}$$

$$\frac{\hbar}{m\omega} \frac{d\Psi_0}{dx} + x\Psi_0 = 0$$

$$\Psi_0 = Ae^{-\frac{m\omega}{2\hbar}x^2}.$$

By normalizing Ψ_0

$$1 = |A|^2 \int_{-\infty}^{\infty} e^{-\frac{m\omega}{\hbar}x^2} dx,$$

we obtain

$$A^2 = \sqrt{\frac{m\omega}{\pi\hbar}}.$$

So the ground state of the quantum harmonic oscillator is

$$\Psi_0(x) = \left(\frac{m\omega}{\pi\hbar}\right)^{1/4} e^{-\frac{m\omega}{\hbar}x^2}. \quad (11.13)$$

Hence, the excited states, increasing the energy by $\hbar\omega$ with each step, are constructed by applying the creation operator repeatedly to the ground state as follows :

$$\Psi_n(x) = A_n(a^+)^n\Psi_0(x) = \left(\frac{m\omega}{\pi\hbar}\right)^{1/4} \frac{1}{\sqrt{2^n n! \hbar m \omega}} \left(-\frac{\hbar}{m\omega} \frac{d}{dx} + x\right)^n e^{-\frac{m\omega}{\hbar}x^2} \quad (11.14)$$

with the energy spectrum

$$E_n = \left(n + \frac{1}{2}\right) \hbar\omega \quad (11.15)$$

where $n = 0, 1, 2, \dots$

11.2. (q_i, q_j) -Quantum Harmonic Oscillator

In this section, we consider the general (q_i, q_j) -analogue of quantum harmonic oscillator for $N = 2$. Such type of oscillators for two basis q, p were constructed by (Chakrabarti & Jagannathan, 1991) and q_1, q_2 basis by (Arik et al., 1992). Then, we consider the special cases of this harmonic oscillator as non-symmetrical, symmetrical and Fibonacci cases.

Firstly, we define the q -bosonic creation operator a_q^+ , its hermitian conjugate the q -bosonic annihilation operator a_q and the boson vacuum state $|0\rangle_{i,j}$ defined by $a_q|0\rangle_{i,j} = 0$. (in following we skip indices i, j for operators a_q^+, a_q .)

Instead of the Heisenberg (Lie) algebra ,we postulate the algebraic relation

$$a_q a_q^+ - q_i a_q^+ a_q = q_j^N, \quad (11.16)$$

or by using the symmetry property of the (q_i, q_j) -number under the exchange $q_i \leftrightarrow q_j$ we have another algebraic relation

$$a_q a_q^+ - q_j a_q^+ a_q = q_i^N, \quad (11.17)$$

where N is the hermitian number operator and q_i, q_j are deformation parameters. The bosonic q -oscillator is defined by three operators a_q^+, a_q and N which satisfy the commutation relations:

$$[N, a_q^+] = a_q^+, \quad [N, a_q] = -a_q. \quad (11.18)$$

The algebra (11.16)-(11.18) is the (q_i, q_j) -analogue generalization of the Heisenberg algebra. In the limiting case $q_i \rightarrow 1$ and $q_j \rightarrow 1$, these algebraic relations reduce to the standard Heisenberg algebraic relations .

By using definition of (q_i, q_j) -number operator

$$[N]_{i,j} = \frac{q_i^N - q_j^N}{q_i - q_j}$$

for $q_i \neq q_j$, we find following equalities

$$[N + 1]_{i,j} - q_i [N]_{i,j} = q_j^N, \quad (11.19)$$

$$[N + 1]_{i,j} - q_j [N]_{i,j} = q_i^N. \quad (11.20)$$

If we choose $q_i = q_j$, then the q -number operator is $[N]_{q_i, q_j} = N q_i^{N-1}$. By com-

parison the above operator relations with algebraic relations (11.16) and (11.17) we have

$$a_q^+ a_q = [N]_{i,j}, \quad a_q a_q^+ = [N + 1]_{i,j}.$$

Here we should note that the number operator N is not equal to $a_q^+ a_q$ as in ordinary case.

The basis of the Fock space is defined by repeated action of the creation operator a_q^+ on the vacuum state $|0\rangle_{i,j}$, which is annihilated by $a_q|0\rangle_{i,j} = 0$

$$|n\rangle_{i,j} = \frac{(a_q^+)^n |0\rangle_{i,j}}{\sqrt{[n]_{i,j}!}}. \quad (11.21)$$

And the action of the operators on this basis is given by

$$\begin{aligned} N|n\rangle_{i,j} &= n|n\rangle_{i,j}, \\ [N]_{i,j}|n\rangle_{i,j} &= [n]_{i,j}|n\rangle_{i,j}, \\ a_q^+|n\rangle_{i,j} &= \sqrt{[n+1]_{i,j}}|n+1\rangle_{i,j}, \\ a_q|n\rangle_{i,j} &= \sqrt{[n]_{i,j}}|n-1\rangle_{i,j}. \end{aligned}$$

(Proofs of these actions are in Appendix D)

Proposition 11.2.0.4

$$[N^n, a_q^+] = \{N^n - (N-1)^n\}a_q^+. \quad (11.22)$$

Proof 11.2.0.5 *It is easy to prove by induction. (See Appendix D)*

Proposition 11.2.0.6

$$\begin{aligned} [[N]_{i,j}, a_q^+] &= \{[N]_{i,j} - [N-1]_{i,j}\}a_q^+ \\ &= a_q^+ \{[N+1]_{i,j} - [N]_{i,j}\}. \end{aligned} \quad (11.23)$$

Proof 11.2.0.7 For the first equality we use definition of q -number operator.

$$\begin{aligned}
[N]_{i,j} &= \frac{q_i^N - q_j^N}{q_i - q_j} = \frac{1}{q_i - q_j} (e^{N \ln q_i} - e^{-N \ln q_j}) \\
&= \frac{1}{q_i - q_j} \sum_{k=0}^{\infty} \left(\frac{(\ln q_i)^k N^k}{k!} - \frac{(\ln q_j)^k N^k}{k!} \right) \\
&= \frac{1}{q_i - q_j} \sum_{k=0}^{\infty} \frac{(\ln q_i)^k - (\ln q_j)^k}{k!} N^k, \tag{11.24}
\end{aligned}$$

$$\begin{aligned}
[[N]_{i,j}, a_q^+] &= \frac{1}{q_i - q_j} \sum_{k=0}^{\infty} \frac{(\ln q_i)^k - (\ln q_j)^k}{k!} [N^k, a_q^+] \\
&= \frac{1}{q_i - q_j} \sum_{k=0}^{\infty} \frac{(\ln q_i)^k - (\ln q_j)^k}{k!} \{N^k - (N-1)^k\} a_q^+ \\
&= \frac{1}{q_i - q_j} (e^{N \ln q_i} - e^{(N-1) \ln q_i} - e^{N \ln q_j} + e^{(N-1) \ln q_j}) a_q^+ \\
&= \frac{1}{q_i - q_j} (q_i^N - q_j^N - (q_i^{N-1} - q_j^{N-1})) a_q^+ \\
&= \{[N]_{i,j} - [N-1]_{i,j}\} a_q^+.
\end{aligned}$$

For second equality 11.23, we use the commutator properties :

$$\begin{aligned}
[[N]_{i,j}, a_q^+] &= [a_q^+ a_q, a_q^+] = a_q^+ [a_q, a_q^+] = a_q^+ (a_q a_q^+ - a_q^+ a_q) \\
&= a_q^+ \{[N+1]_{i,j} - [N]_{i,j}\}.
\end{aligned}$$

■

Proposition 11.2.0.8 We have following equality for $n = 0, 1, 2, \dots$

$$[[N]_{i,j}^n, a_q^+] = \{[N]_{i,j}^n - [N-1]_{i,j}^n\} a_q^+ \tag{11.25}$$

Proof 11.2.0.9 By using mathematical induction to show the above equality is not difficult.

For $n = 1$ case : It is obviously true due to (11.23).

Suppose this equality is true for n

$$[[N]_{i,j}^n, a_q^+] = \{[N]_{i,j}^n - [N-1]_{i,j}^n\} a_q^+$$

we should prove it for $n+1$,

$$\begin{aligned} [[N]_{i,j}^{n+1}, a_q^+] &= [N]_{i,j}^n [[N]_{i,j}, a_q^+] + [[N]_{i,j}^n, a_q^+] [N]_{i,j} \\ &= [N]_{i,j}^n \{[N]_{i,j} - [N-1]_{i,j}\} a_q^+ + \{[N]_{i,j}^n - [N-1]_{i,j}^n\} a_q^+ [N]_{i,j} \end{aligned}$$

Using $a_q^+ [N]_{i,j} = [N-1]_{i,j} a_q^+$, we obtain the desired result

$$[[N]_{i,j}^{n+1}, a_q^+] = \{[N]_{i,j}^{n+1} - [N-1]_{i,j}^{n+1}\} a_q^+. \quad (11.26)$$

■

Corollary 11.2.0.10

$$N^n a_q^+ = a_q^+ (N+1)^n \quad (11.27)$$

and

$$a_q N^n = (N+1)^n a_q \quad (11.28)$$

Proof 11.2.0.11 By using the commutation relation and the equality (11.22)

$$[N^n, a_q^+] = N^n a_q^+ - a_q^+ N^n = \{N^n - (N-1)^n\} a_q^+$$

we obtain

$$N^n a_q^+ = a_q^+ (N+1)^n.$$

And by taking the hermitian conjugate of this equation, we write

$$a_q N^n = (N + 1)^n a_q.$$

■

Corollary 11.2.0.12 For any function expandable to power series (analytic) $F(x) = \sum_{n=0}^{\infty} c_n x^n$ we have the following relation

$$\begin{aligned} [F([N]_{i,j}), a_q^+] &= \{F([N]_{i,j}) - F([N - 1]_{i,j})\} a_q^+ \\ &= a_q^+ \{F([N + 1]_{i,j}) - F([N]_{i,j})\} \end{aligned} \quad (11.29)$$

and

$$a_q^+ F([N + 1]_{i,j}) = F([N]_{i,j}) a_q^+ \quad (11.30)$$

or

$$F(N) a_q^+ = a_q^+ F(N + 1) \quad (11.31)$$

Proof 11.2.0.13

$$\begin{aligned} [F([N]_{i,j}), a_q^+] &= \left[\sum_{n=0}^{\infty} c_n [N]_{i,j}^n, a_q^+ \right] = \sum_{n=0}^{\infty} c_n [[N]_{i,j}^n, a_q^+] \\ &= \sum_{n=0}^{\infty} c_n \{[N]_{i,j}^n - [N - 1]_{i,j}^n\} a_q^+ \\ &= \{F([N]_{i,j}) - F([N - 1]_{i,j})\} a_q^+ \end{aligned} \quad (11.32)$$

$$[F([N]_{i,j}), a_q^+] = F[N]_{i,j} a_q^+ - a_q^+ F[N]_{i,j} = F([N]_{i,j}) - F([N - 1]_{i,j}) a_q^+$$

As a result, we obtain

$$a_q^+ F[N]_{i,j} = F[N-1]_{i,j} a_q^+,$$

$$\begin{aligned} a_q^+ F[N+1]_{i,j} - a_q^+ F[N]_{i,j} &= F[N]_{i,j} a_q^+ - a_q^+ F[N]_{i,j} \\ &= a_q^+ (F[N+1]_{i,j} - F[N]_{i,j}) = [F([N]_{i,j}), a_q^+]. \end{aligned}$$

■

If we use the definition of function of an operator

$$\begin{aligned} F(N)|n\rangle_{i,j} &= F(n)|n\rangle_{i,j} \\ F(N)a_q^+|n\rangle_{i,j} &= \sqrt{[n+1]_{i,j}} F(N)|n+1\rangle_{i,j} = \sqrt{[n+1]_{i,j}} F(n+1)|n+1\rangle_{i,j}, \end{aligned}$$

and

$$a_q^+ F(N+1)|n\rangle_{i,j} = a_q^+ F(n+1)|n\rangle_{i,j} = \sqrt{[n+1]_{i,j}} F(n+1)|n+1\rangle_{i,j},$$

then we have equality

$$F(N)a_q^+ = a_q^+ F(N+1),$$

in a weak sense, i.e. it is valid on eigenstates $|n\rangle_{i,j}$ of number operator N . According to above, we postulate that the relation (11.31) is valid for **any function** F .

Example: For negative power it gives

$$N^{-k} a_q^+ = a_q^+ (N+1)^{-k}.$$

Indeed,

$$\begin{aligned} N^k N^{-k} a_q^+ &= N^k a_q^+ (N+1)^{-k} \\ a_q^+ &= a_q^+ (N+1)^k (N+1)^{-k} = a_q^+. \end{aligned}$$

Now we find the normalization of (q_i, q_j) -boson state (11.21):

$$|n\rangle_{i,j} = \frac{(a_q^+)^n |0\rangle_{i,j}}{\sqrt{[n]_{i,j}!}}, \quad (11.33)$$

$$\begin{aligned} {}_{i,j}\langle n|n\rangle_{i,j} &= \frac{1}{[n]_{i,j}!} {}_{i,j}\langle 0|a_q^n (a_q^+)^n |0\rangle_{i,j} = \frac{1}{[n]_{i,j}!} {}_{i,j}\langle 0|a_q^{n-1} a_q a_q^+ (a_q^+)^{n-1} |0\rangle_{i,j} \\ &= \frac{1}{[n]_{i,j}!} {}_{i,j}\langle 0|a_q^{n-2} a_q [N+1]_{i,j} a_q^+ (a_q^+)^{n-2} |0\rangle_{i,j} \\ &= \frac{1}{[n]_{i,j}!} {}_{i,j}\langle 0|a_q^{n-2} a_q a_q^+ [N+2]_{i,j} (a_q^+)^{n-2} |0\rangle_{i,j} \\ &= \frac{1}{[n]_{i,j}!} {}_{i,j}\langle 0|a_q^{n-3} a_q [N+1]_{i,j} [N+2]_{i,j} a_q^+ (a_q^+)^{n-3} |0\rangle_{i,j} \\ &= \frac{1}{[n]_{i,j}!} {}_{i,j}\langle 0|a_q^{n-3} a_q [N+1]_{i,j} a_q^+ [N+3]_{i,j} (a_q^+)^{n-3} |0\rangle_{i,j} \\ &= \frac{1}{[n]_{i,j}!} {}_{i,j}\langle 0|a_q^{n-3} a_q a_q^+ [N+2]_{i,j} [N+3]_{i,j} (a_q^+)^{n-3} |0\rangle_{i,j} \\ &\dots \\ &= \frac{1}{[n]_{i,j}!} {}_{i,j}\langle 0|[N+1]_{i,j} [N+2]_{i,j} [N+3]_{i,j} \dots [N+n]_{i,j} |0\rangle_{i,j} \\ &= \frac{1}{[n]_{i,j}!} [1]_{i,j} [2]_{i,j} \dots [n]_{i,j} = 1. \end{aligned} \quad (11.34)$$

By introducing the position and momentum operators related to the (q_i, q_j) -bosonic creation and annihilation operators

$$\begin{aligned} \mathbf{X}_q &= \sqrt{\frac{\hbar}{2m\omega}} (a_q^+ + a_q) \\ \mathbf{P}_q &= i\sqrt{\frac{m\hbar\omega}{2}} (a_q^+ - a_q) \end{aligned} \quad (11.35)$$

we find Hamiltonian of the q-Harmonic Oscillator

$$H_q = \frac{\mathbf{P}_q^2}{2m} + \frac{1}{2} m\omega^2 \mathbf{X}_q^2 \quad (11.36)$$

which can also be written as

$$H_q = \frac{\hbar\omega}{2}(a_q a_q^+ + a_q^+ a_q). \quad (11.37)$$

Its eigenvalues

$$H_q |n\rangle_{i,j} = E_n |n\rangle_{i,j},$$

$$\begin{aligned} H_q |n\rangle_{i,j} &= \frac{\hbar\omega}{2}(a_q a_q^+ + a_q^+ a_q) |n\rangle_{i,j} \\ &= \frac{\hbar\omega}{2}([N]_{i,j} + [N+1]_{i,j}) |n\rangle_{i,j} \\ &= \frac{\hbar\omega}{2}([n]_{i,j} + [n+1]_{i,j}) |n\rangle_{i,j} \end{aligned} \quad (11.38)$$

give the energy spectrum

$$E_n = \frac{\hbar\omega}{2}([n]_{i,j} + [n+1]_{i,j}), \quad (11.39)$$

where $n = 0, 1, 2, \dots$. We note that these energy levels are not equally spaced for $q \neq 1$, but the ground state energy still is the same $\frac{\hbar\omega}{2}$.

Finally, we notice that the (q_i, q_j) -deformed boson operators a_q^+ , a_q can be expressed in the form

$$a_q^+ = a^+ \sqrt{\frac{[N+1]_{i,j}}{N+1}} = \sqrt{\frac{[N]_{i,j}}{N}} a^+, \quad (11.40)$$

$$a_q = \sqrt{\frac{[N+1]_{i,j}}{N+1}} a = a \sqrt{\frac{[N]_{i,j}}{N}}, \quad (11.41)$$

where a^+ and a are the creation and annihilation operators for quantum harmonic oscillator. As a result of these relations, we can obtain the commutation relation between a_q^+ and a_q as

$$[a_q, a_q^+] = a_q a_q^+ - a_q^+ a_q = [N+1]_{i,j} - [N]_{i,j}.$$

To compare n-particle states for both oscillators we consider next relations. From (11.40)-(11.41) we have

$$\begin{aligned}
(a_q^+)^n &= \left(a^+ \sqrt{\frac{[N+1]_{i,j}}{N+1}} \right)^n \\
&= a^+ \sqrt{\frac{[N+1]_{i,j}}{N+1}} a^+ \sqrt{\frac{[N+1]_{i,j}}{N+1}} \dots a^+ \sqrt{\frac{[N+1]_{i,j}}{N+1}} \\
&= (a^+)^2 \sqrt{\frac{[N+2]_{i,j}}{N+2}} \sqrt{\frac{[N+1]_{i,j}}{N+1}} a^+ \sqrt{\frac{[N+1]_{i,j}}{N+1}} \dots a^+ \sqrt{\frac{[N+1]_{i,j}}{N+1}} \\
&= (a^+)^3 \sqrt{\frac{[N+3]_{i,j}}{N+3}} \sqrt{\frac{[N+2]_{i,j}}{N+2}} \sqrt{\frac{[N+1]_{i,j}}{N+1}} \dots a^+ \sqrt{\frac{[N+1]_{i,j}}{N+1}} \\
&= (a^+)^n \sqrt{\frac{[N+n]_{i,j}}{N+n} \dots \frac{[N+2]_{i,j}}{N+2} \frac{[N+1]_{i,j}}{N+1}} \\
&= (a^+)^n \sqrt{\frac{[N+n]_{i,j}!}{[N]_{i,j}!} \frac{N!}{(N+n)!}} \tag{11.42}
\end{aligned}$$

And by taking the hermitian conjugate of this result we obtain

$$a_q^n = \sqrt{\frac{[N+n]_{i,j}!}{[N]_{i,j}!} \frac{N!}{(N+n)!}} a^n. \tag{11.43}$$

Our next step is to show that the same set of eigenvectors $|n\rangle$ expands the whole Hilbert space both for the standard harmonic oscillator and for its q -analogue. Firstly, we consider the vacuum state $|0\rangle$ for ordinary quantum harmonic oscillator satisfies $a|0\rangle = 0$, and the vacuum state $|0\rangle_{i,j}$ for generic quantum harmonic oscillator satisfies $a_q|0\rangle_{i,j} = 0$. From the relation (11.41) we write

$$a_q|0\rangle_{i,j} = \sqrt{\frac{[N+1]_{i,j}}{N+1}} a|0\rangle_{i,j} = 0,$$

which gives that

$$a|0\rangle_{i,j} = 0.$$

From another side, if $a|0\rangle_{i,j} = 0$, it implies $a_q|0\rangle_{i,j} = 0$.

Therefore, the vacuum state $|0\rangle$ for ordinary oscillator is exactly the same for q -deformed oscillator vacuum state $|0\rangle \equiv |0\rangle_{i,j}$. By applying the $(a_q^+)^n$ to the vacuum state $|0\rangle_{i,j}$ and

using the $N|n\rangle_{i,j} = n|n\rangle_{i,j}$

$$\begin{aligned} (a_q^+)^n |0\rangle_{i,j} &= (a^+)^n \sqrt{\frac{[N+n]_{i,j}!}{[N]_{i,j}!} \frac{N!}{(N+n)!}} |0\rangle_{i,j} \\ &= \sqrt{\frac{[n]_{i,j}!}{n!}} (a_q^+)^n |0\rangle \end{aligned} \quad (11.44)$$

which implies that

$$|n\rangle_{i,j} = |n\rangle.$$

As a result we found that both the standard and q -deformed harmonic oscillators have the same set of eigenstates, but with different energy eigenvalues. If for standard oscillator $q_{i,j} = 1$ eigenstates are determined by positive integer numbers n ; $E_n = \hbar\omega (n + \frac{1}{2})$, then for deformed oscillator they are given by q -deformed number $[n]_{q_i, q_j}$; $E_n = \frac{\hbar\omega}{2} ([n]_{i,j} + [n+1]_{i,j})$.

11.2.1. Binet-Fibonacci Golden Oscillator and Fibonacci Sequence

As a new and interesting example of the (q_i, q_j) generic quantum harmonic oscillator with $N = 2$, we consider the Binet-Fibonacci Golden harmonic oscillator (Pashaev & Nalci, 2011a). Our Golden Harmonic oscillator is a particular case of so called generalized Fibonacci oscillator considered by (Arik et al., 1992) for arbitrary base q_1, q_2 . However Binet formula for Fibonacci numbers can be interpreted as a q -number with base in the form of the Golden Ratio, and this base has many interesting properties. Due to this and importance of the Golden Ratio in many phenomena, we will treat this special case in all details.

To obtain the Golden harmonic oscillator, we choose (q_i, q_j) as roots of equation $x^2 - x - 1 = 0$, which $q_i = \frac{1+\sqrt{5}}{2} \equiv \varphi$ and $q_j = \frac{1-\sqrt{5}}{2} \equiv \varphi' = -\frac{1}{\varphi} = 1 - \varphi$. The number φ is called the Golden ratio (section).

Then, the Fibonacci sequence in Binet's representation is the q -number

$$F_n = \frac{\varphi^n - \varphi'^n}{\varphi - \varphi'} = [n]_{\varphi, \varphi'} \equiv [n]_F,$$

and due to addition rule the sequence F_n of Fibonacci numbers satisfies recurrence rela-

tion

$$F_n = F_{n-1} + F_{n-2},$$

with $F_0 = 0$ and $F_1 = 1$. First few Fibonacci numbers are

$$1, 1, 2, 3, 5, 8, 13, 21, \dots$$

In the limit

$$\lim_{n \rightarrow \infty} \frac{F(n+1)}{F(n)} = \lim_{n \rightarrow \infty} \frac{[n+1]_{\varphi, -\frac{1}{\varphi}}}{[n]_{\varphi, -\frac{1}{\varphi}}} = q_i = \frac{1 + \sqrt{5}}{2} \equiv \varphi \approx 1,6180339887,$$

which is the Golden ratio.

For Binet-Fibonacci case, the algebraic relations (11.16) and (11.17) transform into following form

$$bb^+ - \varphi b^+ b = \left(-\frac{1}{\varphi}\right)^N, \quad (11.45)$$

$$bb^+ + \frac{1}{\varphi} b^+ b = \varphi^N. \quad (11.46)$$

By using eigenvalues of the Number operator $N|n\rangle_F = n|n\rangle_F$,

$$[N]_F |n\rangle_F = F_N |n\rangle_F = [n]_F |n\rangle_F = F_n |n\rangle_F$$

we get Fibonacci numbers as eigenvalues of operator $[N]$ (or Fibonacci number operator).

The basis of the Fock space is defined by repeated action of the creation operator b^+ on the vacuum state, which is annihilated by $b|0\rangle_F = 0$

$$|n\rangle_F = \frac{(b^+)^n}{\sqrt{F_1 \cdot F_2 \cdot \dots \cdot F_n}} |0\rangle_F, \quad (11.47)$$

where $[n]_F! = F_1 \cdot F_2 \cdot \dots \cdot F_n$.

The number operator N for Fibonacci case is written for two different forms according to even or odd eigenstates $N|n\rangle_F = n|n\rangle_F$. For $n = 2k$, we get

$$N = \log_{\varphi} \left(\frac{\sqrt{5}}{2} F_N + \sqrt{\frac{5}{4} F_N^2 + 1} \right), \quad (11.48)$$

and for $n = 2k + 1$,

$$N = \log_{\varphi} \left(\frac{\sqrt{5}}{2} F_N - \sqrt{\frac{5}{4} F_N^2 - 1} \right), \quad (11.49)$$

where Fibonacci number operator is defined as

$$[N]_F = \frac{\varphi^N - (-\frac{1}{\varphi})}{\varphi - (-\frac{1}{\varphi})} \equiv F_N.$$

As a result, the Fibonacci numbers are the example of (q_i, q_j) numbers with two basis and one of the base is Golden Ratio. This is why we called the corresponding q -oscillator as a Golden oscillator or Binet-Fibonacci Oscillator. The Hamiltonian for Golden oscillator is written as a Fibonacci number operator

$$H = \frac{\hbar\omega}{2}(b^+b + bb^+) = \frac{\hbar\omega}{2}F_{N+2},$$

where $bb^+ = [N + 1]_F = F_{N+1}$, $b^+b = [N]_F = F_N$. According to the Hamiltonian, the energy spectrum of this oscillator is written in terms of Fibonacci numbers sequence,

$$E_n = \frac{\hbar\omega}{2} ([n]_F + [n + 1]_F) = \frac{\hbar\omega}{2} (F_n + F_{n+1}) = \frac{\hbar\omega}{2} F_{n+2},$$

$$E_n = \frac{\hbar\omega}{2} F_{n+2}. \quad (11.50)$$

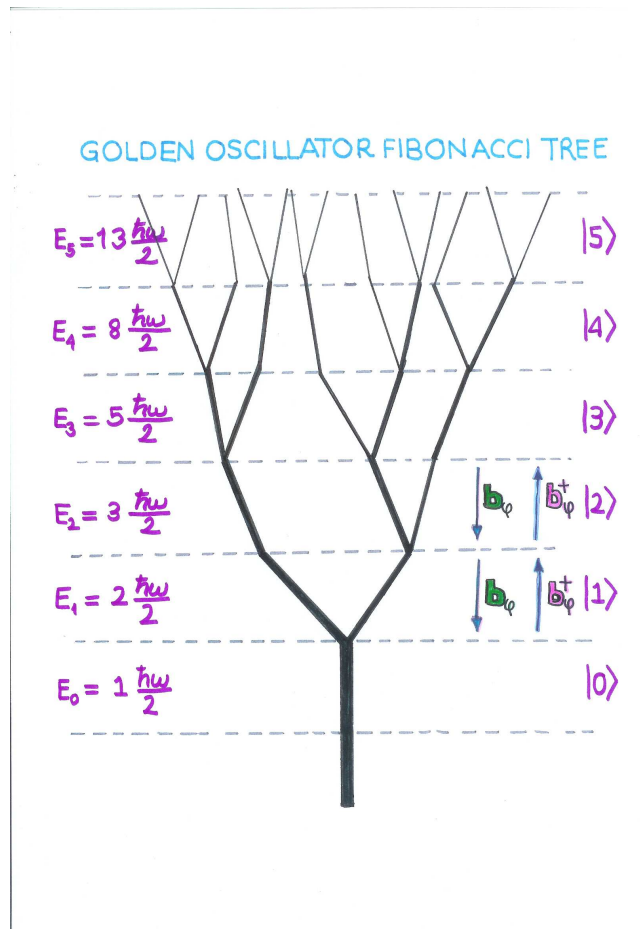

Figure 11.1. Fibonacci tree for spectrum of Golden Oscillator

and satisfies the Fibonacci property

$$E_{n+1} = E_n + E_{n-1}.$$

A first energy eigenvalue is

$$E_0 = \frac{\hbar\omega}{2} F_2 = \frac{\hbar\omega}{2},$$

which is exactly the same ground state as in the ordinary case. The higher energy excited

states are given by Fibonacci sequence

$$E_1 = \frac{\hbar\omega}{2}F_3 = \hbar\omega, \quad E_2 = \frac{3\hbar\omega}{2}, \quad E_3 = \frac{5\hbar\omega}{2}, \dots$$

The difference between two consecutive energy levels of our oscillator is found as

$$\Delta E_n = E_{n+1} - E_n = \frac{\hbar\omega}{2}F_{n+1}.$$

Then the ratio of two successive energy levels $\frac{E_{n+1}}{E_n}$ gives the Golden sequence, and for the limiting case of higher excited states $n \rightarrow \infty$ it becomes the Golden ratio

$$\lim_{n \rightarrow \infty} \frac{E_{n+1}}{E_n} = \lim_{n \rightarrow \infty} \frac{F_{n+3}}{F_{n+2}} = \lim_{n \rightarrow \infty} \frac{[n+3]_{\alpha,\beta}}{[n+2]_{\alpha,\beta}} = \frac{1 + \sqrt{5}}{2} \approx 1,6180339887.$$

This property of asymptotic states to relate each other by a Golden ratio, leads us to call this oscillator as a Golden oscillator.

For this case we have the following relation between q - creation and annihilation operators and standard creation and annihilation operators

$$\begin{aligned} b^+ &= a^+ \sqrt{\frac{F_{N+1}}{N+1}} = \sqrt{\frac{F_N}{N}} a^+ \\ b &= \sqrt{\frac{F_{N+1}}{N+1}} a = a \sqrt{\frac{F_N}{N}}, \end{aligned} \tag{11.51}$$

where $[a, a^+] = 1$.

11.2.2. Symmetrical q -Oscillator

For completeness here we review the important for quantum groups applications, the symmetrical case (Biedenharn, 1989), (Macfarlane, 1989) as the special cases of (q_i, q_j) - quantum harmonic oscillator.

For symmetrical case $q_i = q$ and $q_j = \frac{1}{q}$ the algebraic relations (11.16) and (11.17)

transform into following form

$$a_q a_q^+ - q a_q^+ a_q = q^{-N}, \quad (11.52)$$

or by using the invariance of the q -number under the exchange $q \leftrightarrow q^{-1}$ we have another algebraic relation

$$a_q a_q^+ - q^{-1} a_q^+ a_q = q^N, \quad (11.53)$$

where N is the Hermitian number operator and q is the deformation parameter. The commutation relations satisfied by three operators a_q^+ , a_q and N are the same (11.18). By using the definition of symmetric q -number operator we write following equalities

$$[N + 1]_{\tilde{q}} - q[N]_{\tilde{q}} = q^{-N}, \quad (11.54)$$

$$[N + 1]_{\tilde{q}} - q^{-1}[N]_{\tilde{q}} = q^N, \quad (11.55)$$

where $[x]_{\tilde{q}} = \frac{q^x - q^{-x}}{q - q^{-1}}$. By comparison the above operator relations with algebraic relations (11.52) and (11.53) we have

$$a_q^+ a_q = [N]_{\tilde{q}}, \quad a_q a_q^+ = [N + 1]_{\tilde{q}}.$$

In this special case, we find the number operator N in terms of $[N]_{\tilde{q}} = a_q^+ a_q$ operator as follows (Appendix D)

$$N = \log_q \left([N]_{\tilde{q}} \frac{q - q^{-1}}{2} + \sqrt{\left([N]_{\tilde{q}} \frac{q - q^{-1}}{2} \right)^2 + 1} \right) \quad (11.56)$$

or in the following form,

$$N = \frac{\operatorname{arcsinh}([N]_{\tilde{q}} \sinh(\ln q))}{\ln q}. \quad (11.57)$$

Like we did for generic case, the basis of the Fock space is defined by repeated action of the creation operator a_q^+ on the vacuum state, which is annihilated by $a_q|0\rangle_{\bar{q}} = 0$

$$|n\rangle_{\bar{q}} = \frac{(a_q^+)^n |0\rangle_{\bar{q}}}{\sqrt{[n]_{\bar{q}}!}}. \quad (11.58)$$

And the action of the operators on the basis are given by

$$N|n\rangle_{\bar{q}} = n|n\rangle_{\bar{q}} \quad (11.59)$$

$$[N]_{\bar{q}}|n\rangle_{\bar{q}} = [n]_{\bar{q}}|n\rangle_{\bar{q}} \quad (11.60)$$

$$a_q^+|n\rangle_{\bar{q}} = \sqrt{[n+1]_{\bar{q}}}|n+1\rangle_{\bar{q}} \quad (11.61)$$

$$a_q|n\rangle_{\bar{q}} = \sqrt{[n]_{\bar{q}}}|n-1\rangle_{\bar{q}}. \quad (11.62)$$

The energy spectrum E_n , is written as

$$E_n = \frac{\hbar\omega}{2}([n]_{\bar{q}} + [n+1]_{\bar{q}}), \quad (11.63)$$

where $n = 0, 1, 2, \dots$. We notice that they are not equally spaced for $q \neq 1$ case. For real q the energy spectrums increase more rapidly than the ordinary equidistant case. In particular, for $q = e^\alpha$ the energy spectrum is written in the following form

$$E_n = \frac{\hbar\omega}{2} \frac{\sinh(\alpha(n + \frac{1}{2}))}{\sinh(\frac{\alpha}{2})}.$$

For complex q where ($q = e^{i\alpha}$) is the phase factor and α is real, the eigenvalues of the energy increase less rapidly than the ordinary case

$$E_n = \frac{\hbar\omega}{2} \frac{\sin(\alpha(n + \frac{1}{2}))}{\sin(\frac{\alpha}{2})},$$

but the ground state still gives the same value $1/2$.

In these two particular cases, in the limit $q \rightarrow 1$ ($\alpha = 0$) the ordinary expression for

energy spectrum

$$E_n = \hbar\omega \left(n + \frac{1}{2} \right)$$

is obtained.

11.2.3. Non-symmetrical q -Oscillator

For non-symmetrical case $q_i = q$ and $q_j = 1$ (Arik & Coon, 1976) we have the following two algebraic relations

$$a_q a_q^+ - q a_q^+ a_q = 1$$

and

$$a_q a_q^+ - a_q^+ a_q = q^N.$$

By using definition of non-symmetrical q - number we obtain

$$[N + 1]_q - q[N]_q = 1$$

$$[N + 1]_q - [N]_q = q^N$$

where $[x]_q = \frac{q^x - 1}{q - 1}$. And we have

$$a_q^+ a_q = [N]_q, \quad a_q a_q^+ = [N + 1]_q$$

The basis of the Fock space is

$$|n\rangle_q = \frac{(a_q^+)^n |0\rangle_q}{\sqrt{[n]_q!}}. \quad (11.64)$$

And the action of the operators on the basis is given by

$$N|n\rangle_q = n|n\rangle_q \quad (11.65)$$

$$[N]_q|n\rangle_q = [n]_q|n\rangle_q \quad (11.66)$$

$$a_q^+|n\rangle_q = \sqrt{[n+1]_q}|n+1\rangle_q \quad (11.67)$$

$$a_q|n\rangle_q = \sqrt{[n]_q}|n-1\rangle_q. \quad (11.68)$$

The eigenvalues of energy are written in non-symmetrical q basis as follows

$$E_n = \frac{\hbar\omega}{2}([n]_q + [n+1]_q) \quad (11.69)$$

where $n = 0, 1, 2, \dots$

From the values of energy spectrum we can note that for $q > 1$, the spectrum increases more rapidly than the ordinary equidistant spectrum. In contrast, for $0 < q < 1$ the spectrum is increasing less rapidly than the ordinary equidistant case.

11.3. q -Deformed Quantum Angular Momentum

It is well known that algebra of angular momentum $su(2)$ may be described in terms of double oscillator representation, also known as the Schwinger representation (Matis, 1965). The pair of bosonic operators $[a_i, a_j^+] = \delta_{ij}$, ($i, j = 1, 2$) generates $su(2)$ algebra $[J_i, J_j] = \epsilon_{ijk}J_k$, where $J_+ = J_1 + iJ_2 = a_1^+a_2$, $J_- = J_1 - iJ_2 = a_2^+a_1$ and $J_3 = \frac{1}{2}(a_1^+a_1 - a_2^+a_2)$.

Now by using pair of q - bosons we derive q - deformed quantum angular momentum algebra $su_q(2)$, such that for $q \rightarrow 1$ it reduces to $su(2)$ (Biedenharn, 1989), (Macfarlane, 1989):

$$\lim_{q \rightarrow 1} su_q(2) = su(2).$$

11.3.1. Double q -Boson Algebra Representation

In order to find this representation we consider two uncoupled q - oscillator systems : the q - creation and q - annihilation operators, denoted by b_1^+ and b_1 for the first system and b_2^+ and b_2 for second one. We consider the algebraic relations among b_a^+ , b_a and N_a

$$b_1 b_1^+ - q_i b_1^+ b_1 = q_j^{N_1} \quad \text{or} \quad b_1 b_1^+ - q_j b_1^+ b_1 = q_i^{N_1}, \quad (11.70)$$

and

$$b_2 b_2^+ - q_i b_2^+ b_2 = q_j^{N_2} \quad \text{or} \quad b_2 b_2^+ - q_j b_2^+ b_2 = q_i^{N_2}, \quad (11.71)$$

$$\begin{aligned} [N_a, b_a^+] &= b_a^+, \\ [N_a, b_a] &= -b_a, \end{aligned}$$

where $a = 1, 2$, N_1 is the hermitian number operator for the first quantum harmonic system and N_2 is also hermitian number operator for the second one which are defined by

$$N_1 = a_1^+ a_1, \quad N_2 = a_2^+ a_2,$$

where $[a_a, a_b^+] = \delta_{ab}$.

In addition to these relations, any pair of operators between different oscillators commute

$$[b_a, b_b^+] = [b_a, b_b] = [N_a, N_b] = 0,$$

where $a \neq b$.

Commutativity of N_1 and N_2 , implies that they have common eigenvector $|n_1, n_2\rangle_{i,j}$ with eigenvalues n_1 and n_2 respectively. So, we can write the following eigenvalue equa-

tions for N_1, N_2

$$\begin{aligned} N_1 |n_1, n_2\rangle_{i,j} &= n_1 |n_1, n_2\rangle_{i,j} \\ N_2 |n_1, n_2\rangle_{i,j} &= n_2 |n_1, n_2\rangle_{i,j} \end{aligned}$$

and from the above equations we also write

$$[N_1]_{i,j} |n_1, n_2\rangle_{i,j} = \frac{q_i^{N_1} - q_j^{N_1}}{q_i - q_j} |n_1, n_2\rangle_{i,j} = \frac{q_i^{n_1} - q_j^{n_1}}{q_i - q_j} |n_1, n_2\rangle_{i,j} = [n_1]_{i,j} |n_1, n_2\rangle_{i,j}.$$

Similarly,

$$[N_2]_{i,j} |n_1, n_2\rangle_{i,j} = [n_2]_{i,j} |n_1, n_2\rangle_{i,j},$$

where

$$[N_1]_{i,j} = b_1^+ b_1, \quad [N_1 + 1]_{i,j} = b_1 b_1^+, \quad [N_2]_{i,j} = b_2^+ b_2, \quad [N_2 + 1]_{i,j} = b_2 b_2^+.$$

As a result of the commutation relations, we have

$$\begin{aligned} N_1 (b_1^+ |n_1, n_2\rangle_{i,j}) &= (b_1^+ N_1 + b_1^+) |n_1, n_2\rangle_{i,j} = n_1 b_1^+ |n_1, n_2\rangle_{i,j} + b_1^+ |n_1, n_2\rangle_{i,j} \\ &= (n_1 + 1) (b_1^+ |n_1, n_2\rangle_{i,j}). \end{aligned} \tag{11.72}$$

According to the above relation, vector $b_1^+ |n_1, n_2\rangle_{i,j}$ is also eigenket of N_1 with eigenvalue increased by one. Then, Equation (11.72) implies that $b_1^+ |n_1, n_2\rangle_{i,j}$ and $|n_1 + 1, n_2\rangle_{i,j}$ are the same vectors with only difference in a complex constant

$$b_1^+ |n_1, n_2\rangle_{i,j} = c |n_1 + 1, n_2\rangle_{i,j}$$

fixed value of c is a constant. Then, from normalization condition we can find

$$\begin{aligned}\langle n_1, n_2 | b_1 b_1^+ | n_1, n_2 \rangle_{i,j} &= |c|^2 \langle n_1 + 1, n_2 | n_1 + 1, n_2 \rangle_{i,j} \\ \langle n_1, n_2 | [N_1 + 1]_{i,j} | n_1, n_2 \rangle_{i,j} &= [n_1 + 1]_{i,j} = |c|^2,\end{aligned}$$

so taking c to be real and positive, we eventually obtain

$$b_1^+ | n_1, n_2 \rangle_{i,j} = \sqrt{[n_1 + 1]_{i,j}} | n_1 + 1, n_2 \rangle_{i,j}. \quad (11.73)$$

For the q -creation and annihilation operators b_1^+, b_2^+ and b_1, b_2 correspondingly, action on states $| n_1, n_2 \rangle_{i,j}$ can be found as follows :

$$b_1^+ | n_1, n_2 \rangle_{i,j} = \sqrt{[n_1 + 1]_{i,j}} | n_1 + 1, n_2 \rangle_{i,j} \quad (11.74)$$

$$b_2^+ | n_1, n_2 \rangle_{i,j} = \sqrt{[n_2 + 1]_{i,j}} | n_1, n_2 + 1 \rangle_{i,j} \quad (11.75)$$

$$b_1 | n_1, n_2 \rangle_{i,j} = \sqrt{[n_1]_{i,j}} | n_1 - 1, n_2 \rangle_{i,j} \quad (11.76)$$

$$b_2 | n_1, n_2 \rangle_{i,j} = \sqrt{[n_2]_{i,j}} | n_1, n_2 - 1 \rangle_{i,j}. \quad (11.77)$$

The vacuum ket is defined by

$$b_1 | 0, 0 \rangle_{i,j} = 0,$$

$$b_2 | 0, 0 \rangle_{i,j} = 0.$$

By applying b_1^+ and b_2^+ creation operators to the vacuum state $| 0, 0 \rangle_{i,j}$ we obtain the general eigenvectors of N_1, N_2

$$| n_1, n_2 \rangle_{i,j} = \frac{(b_1^+)^{n_1} (b_2^+)^{n_2}}{\sqrt{[n_1]_{i,j}!} \sqrt{[n_2]_{i,j}!}} | 0, 0 \rangle_{i,j}. \quad (11.78)$$

By using the (q_i, q_j) - boson state, we can prove the normalization of state $| n_1, n_2 \rangle_{i,j}$ in the

following way

$${}_{i,j}\langle n_1, n_2 | n_1, n_2 \rangle_{i,j} = \frac{\langle 0, 0 | (b_2)^{n_2} (b_1)^{n_1} (b_1^+)^{n_1} (b_2^+)^{n_2} | 0, 0 \rangle}{[n_1]_{i,j}! [n_2]_{i,j}!}.$$

And applying the relation (11.30), we calculate

$$\begin{aligned} 1 &= \frac{\langle 0, 0 | (b_2)^{n_2} (b_1)^{n_1-1} b_1 b_1^+ (b_1^+)^{n_1-1} (b_2^+)^{n_2} | 0, 0 \rangle}{[n_1]_{i,j}! [n_2]_{i,j}!} \\ &= \frac{\langle 0, 0 | (b_2)^{n_2} (b_1)^{n_1-2} b_1 [N_1 + 1]_{i,j} b_1^+ (b_1^+)^{n_1-2} (b_2^+)^{n_2} | 0, 0 \rangle}{[n_1]_{i,j}! [n_2]_{i,j}!} \\ &= \frac{\langle 0, 0 | (b_2)^{n_2} (b_1)^{n_1-3} b_1 [N_1 + 1]_{i,j} [N_1 + 2]_{i,j} b_1^+ (b_1^+)^{n_1-3} (b_2^+)^{n_2} | 0, 0 \rangle}{[n_1]_{i,j}! [n_2]_{i,j}!} \\ &= \frac{\langle 0, 0 | (b_2)^{n_2} [N_1 + 1]_{i,j} [N_1 + 2]_{i,j} \dots [N_1 + n_1]_{i,j} (b_2^+)^{n_2} | 0, 0 \rangle}{[n_1]_{i,j}! [n_2]_{i,j}!} \\ &= \frac{[1]_{i,j} [2]_{i,j} \dots [n_1]_{i,j} \langle 0, 0 | (b_2)^{n_2} (b_2^+)^{n_2} | 0, 0 \rangle}{[n_1]_{i,j}! [n_2]_{i,j}!} \\ &= \frac{\langle 0, 0 | [N_2 + 1]_{i,j} [N_2 + 2]_{i,j} \dots [N_2 + n_2]_{i,j} | 0, 0 \rangle}{[n_2]_{i,j}!} \\ &= \frac{[1]_{i,j} [2]_{i,j} \dots [n_2]_{i,j} \langle 0, 0 | 0, 0 \rangle}{[n_2]_{i,j}!} = 1. \end{aligned}$$

11.3.2. $su_{(q_i, q_j)}(2)$ Angular Momentum Algebra

Now, by using operators b_1, b_1^+, b_2, b_2^+ we construct $su_{(q_i, q_j)}(2)$ algebra, which is the (q_i, q_j) -multiple deformation of $su(2)$. Firstly, we define (q_i, q_j) angular momentum operators and corresponding algebra. Then from this algebra we construct the set of eigenstates and eigenvalues for this angular momentum.

We define the following angular momentum operators :

$$J_+^q = \hbar b_1^+ b_2 \quad (11.79)$$

$$J_-^q = \hbar b_2^+ b_1 \quad (11.80)$$

$$J_z^q = \frac{\hbar}{2} (N_1 - N_2) = \frac{\hbar}{2} (b_1^+ b_1 - b_2^+ b_2) = J_z, \quad (11.81)$$

where b_1, b_2 are q -bosonic operators satisfying commutation relations (11.70), (11.71).

These operators satisfy the deformed angular momentum commutation relations :

$$[J_z, J_+^q] = \hbar J_+^q \quad (11.82)$$

$$[J_z, J_-^q] = -\hbar J_-^q \quad (11.83)$$

$$[J_+^q, J_-^q] = \hbar^2 (q_i q_j)^{N_2} \left[\frac{2}{\hbar} J_z \right]_{i,j} = -\hbar^2 (q_i q_j)^{N_1} \left[-\frac{2}{\hbar} J_z \right]_{i,j} \quad (11.84)$$

where $[J_z]_{i,j} = \frac{q_i^{J_z} - q_j^{J_z}}{q_i - q_j}$.

The proves are as follows

$$\begin{aligned} 1) \quad [J_+^q, J_-^q] &= \hbar^2 \{ b_1^+ b_2 b_2^+ b_1 - b_2^+ b_1 b_1^+ b_2 \} \\ &= \hbar^2 \{ q_j^{N_2} b_1^+ b_1 + q_i b_1^+ b_1 b_2^+ b_2 - q_j^{N_1} b_2^+ b_2 - q_i b_2^+ b_2 b_1^+ b_1 \} \\ &= \hbar^2 (q_j^{N_2} [N_1]_{i,j} - q_j^{N_1} [N_2]_{i,j}) \\ &= \hbar^2 \left(\frac{q_i^{N_1} q_j^{N_2} - q_i^{N_2} q_j^{N_1}}{q_i - q_j} \right) \\ &= \hbar^2 \left((q_i q_j)^{N_2} \left(\frac{q_i^{N_1 - N_2} - q_j^{N_1 - N_2}}{q_i - q_j} \right) \right) \\ &= \hbar^2 \left((q_i q_j)^{N_1} \left(\frac{q_j^{N_2 - N_1} - q_i^{N_2 - N_1}}{q_i - q_j} \right) \right) \\ &= \hbar^2 (q_i q_j)^{N_2} [N_1 - N_2]_{i,j} = -\hbar^2 (q_i q_j)^{N_1} [N_2 - N_1]_{i,j} \\ &= \hbar^2 (q_i q_j)^{N_2} \left[\frac{2}{\hbar} J_z \right]_{i,j} = -\hbar^2 (q_i q_j)^{N_1} \left[-\frac{2}{\hbar} J_z \right]_{i,j}, \end{aligned}$$

where

$$[N_1 - N_2]_{i,j} = -(q_i q_j)^{N_1 - N_2} [N_2 - N_1]_{i,j}.$$

$$\begin{aligned}
2) \quad [J_z, J_+^q] &= \frac{\hbar^2}{2} [N_1 - N_2, b_1^+ b_2] \\
&= \frac{\hbar^2}{2} ([N_1, b_1^+ b_2] - [N_2, b_1^+ b_2]) \\
&= \frac{\hbar^2}{2} ([N_1, b_1^+] b_2 - b_1^+ [N_2, b_2]) = \hbar J_+^q. \tag{11.85}
\end{aligned}$$

Hermitian conjugate of this relation gives

$$3) \quad ([J_z, J_+^q])^\dagger = [J_-^q, J_z] = -[J_z, J_-^q] = \hbar J_-^q$$

so that we have

$$[J_-^q, J_z] = -\hbar J_-^q.$$

■

Now we construct eigenvalue problem for this (q_i, q_j) angular momentum operator algebra. We have next proposition.

Proposition 11.3.2.1

$$[J_z^n, J_+^q] = (J_z^n - (J_z - 1)^n) J_+^q. \tag{11.86}$$

In more general case,

$$[f(J_z), J_+^q] = (f(J_z) - f(J_z - 1)) J_+^q$$

where f is function expandable to power series. We suppose that it is valid also for arbitrary function f .

(Proof of this proposition is given in Appendix F)

The Casimir operator for this generic algebra (11.82)-(11.84) case is written as

$$\begin{aligned} C^q &= (q_i q_j)^{-J_z} ([J_z]_{i,j} [J_z + 1]_{i,j} + (q_i q_j)^{-N_2} J_-^q J_+^q) \\ &= (q_i q_j)^{-J_z} ((q_i q_j) [J_z]_{i,j} [J_z - 1]_{i,j} + (q_i q_j)^{-N_2} J_+^q J_-^q) \end{aligned}$$

where for simplicity we choose $\hbar = 1$.

Due to this proposition, we can prove that $[C^q, J_\pm^q] = 0$ and $[C^q, J_z^q] = 0$. For details of proof see (Appendix F). Commutativity of C^q and J_z^q , implies that they have common eigenvector $|\lambda, m\rangle_{i,j}$ with eigenvalues m and λ respectively. This why the eigenvalue equations for C^q and J_z^q are

$$\begin{aligned} J_z^q |\lambda, m\rangle &= m |\lambda, m\rangle \\ C^q |\lambda, m\rangle &= \lambda |\lambda, m\rangle. \end{aligned}$$

The eigenvalues m and λ , belonging to same eigenvector, satisfy the inequality $\lambda \geq (q_i q_j)^{-m} [m]_{i,j} [m + 1]_{i,j}$. For a given value of λ , the above inequality restricts the value of m .

Suppose $Max(m) = j$, for any given λ . Then, $J_+^q |\lambda, j\rangle = 0$, implies that

$$\begin{aligned} J_-^q J_+^q |\lambda, j\rangle &= 0 \\ (q_i q_j)^{N_2} \{ (q_i q_j)^{J_z} C^q - [J_z]_{i,j} [J_z + 1]_{i,j} \} |\lambda, j\rangle &= 0 \\ \{ (q_i q_j)^j \lambda - [j]_{i,j} [j + 1]_{i,j} \} |\lambda, j\rangle &= 0, \end{aligned} \quad (11.87)$$

so for $Max(m) = j$ we obtain,

$$\lambda = (q_i q_j)^{-j} [j]_{i,j} [j + 1]_{i,j}. \quad (11.88)$$

And for $Min(m) = j'$, we have $J_-^q |\lambda, j'\rangle = 0$. From the Casimir operator we write

$$\begin{aligned} J_+^q J_-^q |\lambda, j'\rangle &= 0 \\ (q_i q_j)^{N_2} \{ (q_i q_j)^{J_z} C^q - (q_i q_j) [J_z]_{i,j} [J_z - 1]_{i,j} \} |\lambda, j'\rangle &= 0 \\ \{ (q_i q_j)^{j'} \lambda - (q_i q_j) [j']_{i,j} [j' - 1]_{i,j} \} |\lambda, j'\rangle &= 0, \end{aligned} \quad (11.89)$$

so we have

$$\lambda = (q_i q_j)^{-j'} [j']_{i,j} [j' - 1]_{i,j}. \quad (11.90)$$

For $Min(m) = j'$ from the equalities of (11.88) and (11.90) we choose $j' = -j$.

So, j must be either a nonnegative integer or a half integer ($j = 0, 1/2, 1, 3/2, 2, \dots$)

As a result of commutation relations (11.82) and (11.83) we have

$$J_z^q J_+^q |\lambda, m\rangle = (m + 1) J_+^q |\lambda, m\rangle \quad (11.91)$$

$$J_z^q J_-^q |\lambda, m\rangle = (m - 1) J_-^q |\lambda, m\rangle. \quad (11.92)$$

Hence, $J_\pm |\lambda, m\rangle$ is also an eigenket of J_z^q with eigenvalues $m \pm 1$. Equation (11.91) implies that $J_+^q |\lambda, m\rangle$ and $|\lambda, m + 1\rangle$ are the same up to a constant

$$J_+^q |\lambda, m\rangle = C_+ |\lambda, m + 1\rangle,$$

where C_+ is a constant.

$$\begin{aligned} |C_+|^2 &= \langle \lambda, m | J_+^q J_-^q | \lambda, m \rangle \\ &= \langle \lambda, m | (q_i q_j)^{N_2} \{ (q_i q_j)^{J_z} C^q - [J_z]_{i,j} [J_z + 1]_{i,j} \} | \lambda, m \rangle \\ &= [j]_{i,j} [j + 1]_{i,j} - (q_i q_j)^{j-m} [m]_{i,j} [m + 1]_{i,j} \langle \lambda, m | \lambda, m \rangle \\ &= [j - m]_{i,j} [j + m + 1]_{i,j} \end{aligned}$$

$$C_+ = \sqrt{[j - m]_{i,j} [j + m + 1]_{i,j}},$$

where we use $j = \frac{N_1+N_2}{2}$, $J_z = \frac{N_1-N_2}{2}$ and $j|\lambda, m\rangle = j|j, m\rangle$.

The equation (11.92) implies that

$$J_-|\lambda, m\rangle = C_-|j, m-1\rangle,$$

where C_- is a constant. By using the same procedure we obtain

$$C_- = \sqrt{[j+m]_{i,j}[j-m+1]_{i,j}}.$$

Finally, we find the action of operators J_+^q , J_-^q , J_z^q , C^q on states $|\lambda, m\rangle \equiv |j, m\rangle$

$$J_+^q|j, m\rangle = \sqrt{[j-m]_{i,j}[j+m+1]_{i,j}}|j, m+1\rangle, \quad (11.93)$$

$$J_-^q|j, m\rangle = \sqrt{[j+m]_{i,j}[j-m+1]_{i,j}}|j, m-1\rangle, \quad (11.94)$$

$$J_z^q|j, m\rangle = m|j, m\rangle, \quad (11.95)$$

$$C^q|j, m\rangle = (q_i q_j)^{-j} [j]_{i,j} [j+1]_{i,j} |j, m\rangle, \quad (11.96)$$

where $\lambda = (q_i q_j)^{-j} [j]_{i,j} [j+1]_{i,j}$.

The (q_i, q_j) deformed angular momentum operators may be written in terms of standard angular momentum operators as follows

$$J_+^q = J_+ \sqrt{\frac{[N_1+1]_{i,j}}{N_1+1}} \sqrt{\frac{[N_2]_{i,j}}{N_2}} = \sqrt{\frac{[N_1]_{i,j}}{N_1}} \sqrt{\frac{[N_2+1]_{i,j}}{N_2+1}} J_+ \quad (11.97)$$

$$J_-^q = J_- \sqrt{\frac{[N_1]_{i,j}}{N_1}} \sqrt{\frac{[N_2+1]_{i,j}}{N_2+1}} = \sqrt{\frac{[N_1+1]_{i,j}}{N_1+1}} \sqrt{\frac{[N_2]_{i,j}}{N_2}} J_- \quad (11.98)$$

where $J_+ = a_1^+ a_2$, $J_- = a_2^+ a_1$. This representation shows that eigenvectors for J and J^q operators are the same. And the only difference is in eigenvalues.

11.3.3. Double Boson Representation of $su_{(q_i, q_j)}(2)$ Angular Momentum

In previous section we found representation of $su_{(q_i, q_j)}(2)$ angular momentum algebra. Now we construct representation of the same (q_i, q_j) algebra, but in terms of couple of bosons b_1, b_2 . First we find how J_{\pm}^q and J_z^q act on state $|n_1, n_2\rangle_{i,j}$ (11.78). By using (11.74)-(11.77) we get

$$J_+^q |n_1, n_2\rangle_{i,j} = \hbar \sqrt{[n_1 + 1]_{i,j} [n_2]_{i,j}} |n_1 + 1, n_2 - 1\rangle_{i,j}, \quad (11.99)$$

$$J_-^q |n_1, n_2\rangle_{i,j} = \hbar \sqrt{[n_1]_{i,j} [n_2 + 1]_{i,j}} |n_1 - 1, n_2 + 1\rangle_{i,j}, \quad (11.100)$$

$$J_z^q |n_1, n_2\rangle_{i,j} = \frac{\hbar}{2} (N_1 - N_2) |n_1, n_2\rangle_{i,j} = \frac{\hbar}{2} (n_1 - n_2) |n_1, n_2\rangle_{i,j}. \quad (11.101)$$

Then we can verify the defining commutation relations (11.82), (11.83) and (11.84) acting on the state

$$\begin{aligned} [J_+^q, J_-^q] |n_1, n_2\rangle_{i,j} &= (J_+^q J_-^q - J_-^q J_+^q) |n_1, n_2\rangle_{i,j} \\ &= \hbar \sqrt{[n_1]_{i,j} [n_2 + 1]_{i,j}} J_+ |n_1 - 1, n_2 + 1\rangle_{i,j} \\ &\quad - \hbar \sqrt{[n_1 + 1]_{i,j} [n_2]_{i,j}} J_- |n_1 + 1, n_2 - 1\rangle_{i,j} \\ &= \hbar^2 ([n_1]_{i,j} [n_2 + 1]_{i,j} - [n_1 + 1]_{i,j} [n_2]_{i,j}) |n_1, n_2\rangle_{i,j} \\ &= \hbar^2 (q_i q_j)^{N_2} \left[\frac{2}{\hbar} J_z \right]_{i,j} |n_1, n_2\rangle_{i,j} \\ &= -\hbar^2 (q_i q_j)^{N_1} \left[-\frac{2}{\hbar} J_z \right]_{i,j} |n_1, n_2\rangle_{i,j} \end{aligned}$$

$$\begin{aligned} [J_z^q, J_+^q] |n_1, n_2\rangle_{i,j} &= (J_z^q J_+^q - J_+^q J_z^q) |n_1, n_2\rangle_{i,j} \\ &= \hbar \sqrt{[n_1 + 1]_{i,j} [n_2]_{i,j}} J_z |n_1 + 1, n_2 - 1\rangle_{i,j} - \frac{\hbar}{2} (n_1 - n_2) J_+ |n_1, n_2\rangle_{i,j} \\ &= \frac{\hbar^2}{2} \sqrt{[n_1 + 1]_{i,j} [n_2]_{i,j}} ((n_1 - n_2 + 2) - (n_1 - n_2)) |n_1 + 1, n_2 - 1\rangle_{i,j} \\ &= \hbar^2 \sqrt{[n_1 + 1]_{i,j} [n_2]_{i,j}} |n_1 + 1, n_2 - 1\rangle_{i,j} = \hbar J_+ |n_1, n_2\rangle_{i,j} \end{aligned}$$

and similar way for J_-^q we get (11.83).

Let us define $j \equiv \frac{n_1+n_2}{2}$, $m \equiv \frac{n_1-n_2}{2}$, and $|n_1, n_2\rangle_{i,j} \equiv |j, m\rangle_{i,j}$. If we substitute $n_1 \rightarrow j + m$ and $n_2 \rightarrow j - m$ to (11.99)-(11.101), we find

$$J_+|j, m\rangle_{i,j} = \hbar\sqrt{[j-m]_{i,j}[j+m+1]_{i,j}}|j, m+1\rangle_{i,j} \quad (11.102)$$

$$J_-|j, m\rangle_{i,j} = \hbar\sqrt{[j+m]_{i,j}[j-m+1]_{i,j}}|j, m-1\rangle_{i,j} \quad (11.103)$$

$$J_z|j, m\rangle_{i,j} = m\hbar|j, m\rangle_{i,j}. \quad (11.104)$$

This representation (for $\hbar = 1$) coincides with the angular momentum representation (11.93)- (11.95). And the corresponding eigenvector is

$$|j, m\rangle_{i,j} = \frac{(b_1^+)^{j+m}(b_2^+)^{j-m}}{\sqrt{[j+m]_{i,j}!}\sqrt{[j-m]_{i,j}!}}|0, 0\rangle_{i,j}.$$

In the next sections we consider particular reductions of $su_{(q_i, q_j)}(2)$, corresponding to non-symmetrical, symmetrical and Binet-Fibonacci cases.

11.3.3.1. Non-symmetrical Case:

In non-symmetrical case : $q_i = q$ and $q_j = 1$ (Arik & Coon, 1976) we have the following algebraic relations

$$bb^+ - qb^+b = 1 \quad \text{or} \quad bb^+ - b^+b = q^N$$

and instead of the commutation relations (11.82)-(11.84) we have the following ones

$$[J_+, J_-] = \hbar^2 q^{N_2} \left[\frac{2}{\hbar} J_z \right]_q = -\hbar^2 q^{N_1} \left[-\frac{2}{\hbar} J_z \right]_q, \quad (11.105)$$

$$[J_z, J_{\pm}] = \pm \hbar J_{\pm}, \quad (11.106)$$

where

$$[N_1 - N_2]_q = -q^{N_1 - N_2} [N_2 - N_1]_q$$

and $[N]_q = \frac{q^N - 1}{q - 1}$. For non-symmetrical case the Casimir operator ($\hbar = 1$) is

$$\begin{aligned} C^q &= q^{-J_z} ([J_z]_q [J_z + 1]_q + q^{-N_2} J_-^q J_+^q) \\ &= q^{-J_z} ([J_z]_q [J_z + 1]_q - [2J_z]_q + q^{-N_2} J_+^q J_-^q). \end{aligned} \quad (11.107)$$

11.3.3.2. Symmetrical Case:

In symmetrical case : $q_i = q$ and $q_j = 1/q$ (Biedenharn, 1989), (Macfarlane, 1989), we have the following algebraic relations

$$bb^+ - qb^+b = q^{-N} \quad \text{or} \quad bb^+ - q^{-1}b^+b = q^N$$

and the commutation relations (11.82)-(11.84) reduce to the following form

$$\begin{aligned} [J_+, J_-] &= \hbar^2 \left[\frac{2}{\hbar} J_z \right]_{\tilde{q}} \\ [J_z, J_{\pm}] &= \pm \hbar J_{\pm}, \end{aligned}$$

where

$$[N_1 - N_2]_{\tilde{q}} = -[N_2 - N_1]_{\tilde{q}}$$

and $[N]_{\tilde{q}} = \frac{q^N - q^{-N}}{q - q^{-1}}$.

The Casimir operator for symmetrical case is written as

$$\begin{aligned} C^{\tilde{q}} &= [J_z]_{\tilde{q}} [J_z + 1]_{\tilde{q}} + J_-^q J_+^q \\ &= [J_z]_{\tilde{q}} [J_z + 1]_{\tilde{q}} - [2J_z]_{\tilde{q}} + J_+^q J_-^q, \end{aligned} \quad (11.108)$$

where $\hbar = 1$.

11.3.3.3. Binet-Fibonacci Case:

If $q_i = \varphi$ and $q_j = \varphi' = -\frac{1}{\varphi}$, then we have the Golden boson algebra (Pashaev & Nalci, 2011a)

$$\begin{aligned} b_a b_a^+ - \varphi b_a^+ b_a &= \left(-\frac{1}{\varphi}\right)^{N_a}, \\ b_a b_a^+ + \frac{1}{\varphi} b_a^+ b_a &= \varphi^{N_a}, \end{aligned}$$

where $a = 1, 2$. It produces $su_F(2)$ the Golden quantum angular momentum algebra with operators are

$$J_+^F = b_1^+ b_2, \quad J_-^F = b_2^+ b_1, \quad J_z^F = \frac{N_1 - N_2}{2},$$

with commutation relations

$$[J_+^F, J_-^F] = (-1)^{N_2} F_{2J_z} = -(-1)^{N_1} F_{-2J_z}, \quad (11.109)$$

$$[J_z^F, J_\pm^F] = \pm J_\pm^F, \quad (11.110)$$

where the Binet-Fibonacci operator is

$$F_N = \frac{\varphi^N - \left(-\frac{1}{\varphi}\right)^N}{\varphi + \frac{1}{\varphi}} = [N]_F.$$

The Binet-Fibonacci quantum angular momentum operators J_\pm^F may be written in terms of Fibonacci sequence and standard quantum angular momentum operators J_\pm as

$$J_+^F = J_+ \sqrt{\frac{F_{N_1+1}}{N_1+1}} \sqrt{\frac{F_{N_2}}{N_2}} = \sqrt{\frac{F_{N_1}}{N_1}} \sqrt{\frac{F_{N_2+1}}{N_2+1}} J_+ \quad (11.111)$$

$$J_-^F = J_- \sqrt{\frac{F_{N_1}}{N_1}} \sqrt{\frac{F_{N_2+1}}{N_2+1}} = \sqrt{\frac{F_{N_1+1}}{N_1+1}} \sqrt{\frac{F_{N_2}}{N_2}} J_-. \quad (11.112)$$

The Casimir operator for Binet-Fibonacci case is

$$\begin{aligned} C^F &= (-1)^{-J_z} (F_{J_z} F_{J_z+1} + (-1)^{-N_2} J_-^F J_+^F) \\ &= (-1)^{-J_z} (-F_{J_z} F_{J_z-1} + (-1)^{-N_2} J_+^F J_-^F). \end{aligned} \quad (11.113)$$

From equations (11.93)-(11.95), we obtain how the angular momentum operators J_{\pm}^F and J_z^F act on state $|j, m\rangle_F$:

$$J_+^F |j, m\rangle_F = \sqrt{F_{j-m} F_{j+m+1}} |j, m+1\rangle_F, \quad (11.114)$$

$$J_-^F |j, m\rangle_F = \sqrt{F_{j+m} F_{j-m+1}} |j, m-1\rangle_F, \quad (11.115)$$

$$J_z^F |j, m\rangle_F = m |j, m\rangle_F. \quad (11.116)$$

The eigenvalues of Casimir operator C^F are determined by product of two successive Fibonacci numbers:

$$C_j^F = (-1)^{-j} F_j F_{j+1},$$

then the asymptotic ratio of two successive eigenvalues of Casimir operator gives Golden Ratio

$$\lim_{j \rightarrow \infty} \frac{(-1)^{-j} F_j F_{j+1}}{(-1)^{-j+1} F_{j-1} F_j} = -\varphi^2.$$

We can also construct representation of our F -deformed angular momentum algebra in terms of double Golden boson representation b_1, b_2 . The action of F -deformed angular momentum operators to state $|n_1, n_2\rangle_F$ are given as follows:

$$J_+^F |n_1, n_2\rangle_F = b_1^+ b_2 |n_1, n_2\rangle_F = \sqrt{F_{n_1+1} F_{n_2}} |n_1+1, n_2-1\rangle_F, \quad (11.117)$$

$$J_-^F |n_1, n_2\rangle_F = b_2^+ b_1 |n_1, n_2\rangle_F = \sqrt{F_{n_1} F_{n_2+1}} |n_1-1, n_2+1\rangle_F, \quad (11.118)$$

$$J_z^F |n_1, n_2\rangle_F = \frac{1}{2}(N_1 - N_2) |n_1, n_2\rangle_F = \frac{1}{2}(n_1 - n_2) |n_1, n_2\rangle_F. \quad (11.119)$$

The above expressions reproduce expressions (11.114)-(11.116), provided we define

$$j \equiv \frac{n_1 + n_2}{2}, \quad m \equiv \frac{n_1 - n_2}{2},$$

$$|n_1, n_2\rangle_F \equiv |j, m\rangle_F,$$

and substitute

$$n_1 \rightarrow j + m, \quad n_2 \rightarrow j - m.$$

11.3.4. $su_{\sqrt{\frac{q_j}{q_i}}}(2)$ case:

Generic (q_i, q_j) - number can be related with symmetrical number with base $\sqrt{\frac{q_j}{q_i}}$ according to formula

$$[n]_{q_i, q_j} = (q_i q_j)^{\frac{n-1}{2}} [n]_{\sqrt{\frac{q_j}{q_i}}}.$$

This relation motivates us to construct symmetrical angular momentum algebra associated with (q_i, q_j) -angular momentum.

Our (q_i, q_j) angular momentum operator J_{\pm}^q, J_z^q may be related with symmetrical q - deformed $su_q(2)$ algebra with $q = \sqrt{\frac{q_j}{q_i}}$ (Chakrabarti & Jagannathan, 1991). In this case ($\hbar = 1$) the angular momentum operators $J_{\pm}^{(s)}, J_z^{(s)}$ are defined in terms of (q_i, q_j) (see above section) angular momentum operators J_+^q, J_-^q and J_z^q (11.79)-(11.81) as follows:

$$J_+^{(s)} = (q_i q_j)^{\frac{1}{2}(\frac{1}{2} - \frac{N_1 + N_2}{2})} b_1^+ b_2 = (q_i q_j)^{\frac{1}{2}(\frac{1}{2} - \frac{N_1 + N_2}{2})} J_+^q, \quad (11.120)$$

$$J_-^{(s)} = b_2^+ b_1 (q_i q_j)^{\frac{1}{2}(\frac{1}{2} - \frac{N_1 + N_2}{2})} = J_-^q (q_i q_j)^{\frac{1}{2}(\frac{1}{2} - \frac{N_1 + N_2}{2})}, \quad (11.121)$$

$$J_z^{(s)} = \frac{1}{2}(N_1 - N_2) = J_z^q = J_z. \quad (11.122)$$

Here we also expressed symmetrical operators in terms of generic (q_i, q_j) double q -bosons. From the above relation we notice that the z component of generic case (q_i, q_j) and symmetrical case $\sqrt{q_j/q_i}$ are exactly the same as the standard quantum angular momentum operator J_z .

According to definition of these angular momentum operators we obtain the following commutation relations for symmetrical $su_{\sqrt{q_j/q_i}}(2)$

$$[J_+^{(s)}, J_-^{(s)}] = [2J_z] \sqrt{\frac{q_j}{q_i}} = [2J_z]_{i,j} (q_i q_j)^{(\frac{1}{2}-J_z)}, \quad (11.123)$$

where

$$[2J_z] \sqrt{\frac{q_j}{q_i}} = \frac{\left(\frac{q_j}{q_i}\right)^{J_z} - \left(\frac{q_j}{q_i}\right)^{-J_z}}{\left(\frac{q_j}{q_i}\right)^{1/2} - \left(\frac{q_j}{q_i}\right)^{-1/2}}$$

$$[J_z^{(s)}, J_{\pm}^{(s)}] = \pm J_{\pm}^{(s)}. \quad (11.124)$$

The Casimir operator is given as

$$\begin{aligned} C^{(s)} &= (q_i q_j)^{-1/2} \left([J_z] \sqrt{\frac{q_j}{q_i}} [J_z + 1] \sqrt{\frac{q_j}{q_i}} + J_-^{(s)} J_+^{(s)} \right) \\ &= (q_i q_j)^{-1/2} \left([J_z] \sqrt{\frac{q_j}{q_i}} [J_z + 1] \sqrt{\frac{q_j}{q_i}} - [2J_z] \sqrt{\frac{q_j}{q_i}} + J_+^{(s)} J_-^{(s)} \right). \end{aligned} \quad (11.125)$$

11.3.4.1. Complex Symmetrical $su_{(i\varphi, \frac{i}{\varphi})}(2)$ Quantum Algebra

As an example of complex symmetrical q -deformed $su_q(2)$ algebra we choose the base as $q_i = i\varphi$ and $q_j = \frac{i}{\varphi}$ (Section 9.1.3.4), then our complex equation for base becomes

$$(i\varphi)^2 = i(i\varphi) - 1.$$

The φ -deformed symmetrical angular momentum operators remain the same as $J_{\pm}^{(s)}, J_z^{(s)}$. The complex symmetrical quantum algebra with base $(i\varphi, \frac{i}{\varphi})$ becomes

$$[J_+^{\varphi}, J_-^{\varphi}] = [2J_z]_{\frac{i}{\varphi}} = [2J_z]_{i\varphi, \frac{i}{\varphi}} (-1)^{(\frac{1}{2}-J_z)}, \quad (11.126)$$

where

$$[2J_z]_{\frac{i}{\varphi}} = \frac{\varphi^{2J_z} - \varphi^{-2J_z}}{\varphi - \varphi^{-1}}$$

and

$$[J_z^{(s)}, J_{\pm}^{(s)}] = \pm J_{\pm}^{(s)}. \quad (11.127)$$

11.3.5. $\tilde{su}_{(q_i, q_j)}(2)$ Case:

Following (Chakrabarti & Jagannathan, 1991) we can also construct a $\tilde{su}_{(q_i, q_j)}(2)$ algebra with $(\tilde{J}_+^q, \tilde{J}_-^q, \tilde{J}_z^q)$ as the generators which are defined as

$$\tilde{J}_+^q = (q_i q_j)^{\frac{1}{2}(J_z - \frac{1}{2})} J_+^{(s)} = (q_i q_j)^{-\frac{N_2}{2}} J_+^q \quad (11.128)$$

$$\tilde{J}_-^q = J_-^{(s)} (q_i q_j)^{\frac{1}{2}(J_z - \frac{1}{2})} = J_-^q (q_i q_j)^{-\frac{N_2}{2}} \quad (11.129)$$

$$\tilde{J}_z^q = \frac{1}{2}(N_1 - N_2) = J_z^{(s)} = J_z^q = J_z, \quad (11.130)$$

in terms of the generators $J_{\pm}^{(s)}, J_z^{(s)}$ of $su_{\sqrt{\frac{q_j}{q_i}}}(2)$ algebra or the generators J_{\pm}^q, J_z^q of $su_{(q_i, q_j)}(2)$. For these generators we obtain the $q_i q_j$ -commutative commutation relations

$$[\tilde{J}_z^q, \tilde{J}_{\pm}^q] = \pm \tilde{J}_{\pm}^q, \quad (11.131)$$

$$\tilde{J}_+^q \tilde{J}_-^q - (q_i q_j)^{-1} \tilde{J}_-^q \tilde{J}_+^q = [2J_z]_{q_i, q_j}, \quad (11.132)$$

where

$$[2J_z]_{q_i, q_j} = \frac{q_i^{2J_z} - q_j^{2J_z}}{q_i - q_j}.$$

The Casimir operator in the case is

$$\begin{aligned} \tilde{C}^q &= (q_i q_j)^{-J_z} ([J_z]_{i,j} [J_z + 1]_{i,j} + (q_i q_j)^{-1} \tilde{J}_-^q \tilde{J}_+^q) \\ &= (q_i q_j)^{-J_z} (\tilde{J}_+^q \tilde{J}_-^q + (q_i q_j) [J_z]_{i,j} [J_z - 1]_{i,j}). \end{aligned} \quad (11.133)$$

11.3.5.1. $\tilde{s}u_F(2)$ Algebra

The special cases of $\tilde{s}u_{(q_i, q_j)}(2)$ algebra, considered in previous section, is constructed by choosing Binet-Fibonacci base ($q_i = \varphi$, $q_j = -\frac{1}{\varphi}$). The generators of $\tilde{s}u_F(2)$ algebra $\tilde{J}_\pm^F, \tilde{J}_z^F$ are given as follows :

$$\tilde{J}_+^F = (-1)^{-\frac{N_2}{2}} J_+^q, \quad (11.134)$$

$$\tilde{J}_-^F = J_-^q (-1)^{-\frac{N_2}{2}}, \quad (11.135)$$

$$\tilde{J}_z^F = J_z^q. \quad (11.136)$$

The commutation relation (11.132) becomes anti-commutation relation

$$\tilde{J}_+^F \tilde{J}_-^F + \tilde{J}_-^F \tilde{J}_+^F = \{\tilde{J}_+^F, \tilde{J}_-^F\} = [2J_z]_F, \quad (11.137)$$

and $[\tilde{J}_z^F, \tilde{J}_\pm^F] = \pm \tilde{J}_\pm^F$. The Casimir operator is written in the following forms

$$\begin{aligned} \tilde{C}^F &= (-1)^{J_z} \{F_{j_z} F_{j_z+1} - \tilde{J}_-^F \tilde{J}_+^F\} \\ &= (-1)^{J_z} \{\tilde{J}_+^F \tilde{J}_-^F - F_{j_z} F_{j_z-1}\}. \end{aligned} \quad (11.138)$$

The actions of the F -deformed angular momentum operators to the states $|j, m\rangle_F$ are

$$\tilde{J}_+^F |j, m\rangle_F = (-1)^{\frac{j-m}{2}} \sqrt{F_{j-m} F_{j+m+1}} |j, m+1\rangle_F, \quad (11.139)$$

$$\tilde{J}_-^F |j, m\rangle_F = (-1)^{\frac{j-m}{2}} \sqrt{F_{j+m} F_{j-m+1}} |j, m-1\rangle_F, \quad (11.140)$$

$$\tilde{J}_z^F |j, m\rangle_F = m |j, m\rangle_F. \quad (11.141)$$

And the eigenvalues of Casimir operators are given in terms of Fibonacci numbers

$$\begin{aligned} \tilde{C}^F |j, m\rangle_F &= \{(-1)^m F_m F_{m+1} - (-1)^j F_{j-m} F_{j+m+1}\} |j, m\rangle_F \\ &= \{(-1)^j F_{j-m+1} F_{j+m} - (-1)^m F_m F_{m-1}\} |j, m\rangle_F. \end{aligned}$$

CHAPTER 12

Q-FUNCTION OF ONE VARIABLE

In this chapter we consider functions of two variables, combined in a specific form and providing solution for some partial q -difference equations.

If differentiable function $f(x, y)$ has dependence in the form $f(x, y) = f(x + y)$, then it is a solution of the first order PDE: $f_x = f_y$. Indeed, replacing $\zeta = x + y$ and using the chain rule we have $\partial_x f = \partial_y f$. However, if we apply q -partial derivatives to this function, due to the absence of the chain rule in the q case, we can not get suitable q -difference equation. This is why we follow in opposite direction. We start from q -partial difference equation and will find what kind of dependence for $f(x, y)$ it implies.

Example 1: (q -traveling wave) For equation

$$M_{\frac{1}{q}}^t D_t f = c D_x f, \quad (12.1)$$

(one-directional q -wave equation) we denote solution in the form $f(x, t) = f(x + ct)_q$.

Example 2: (q -holomorphic function) For equation

$$D_x f = i M_{\frac{1}{q}}^y D_y f, \quad (12.2)$$

(q -Cauchy-Riemann equations) we have solution in the form $f(x, y) = f(x + iy)_q$.

Here we introduce notation for function of two variables $f(x, y)$ with specific dependence on x and y proposed by (Hahn, 1949).

If function $f(x)$ is given by Laurent series

$$\sum_{n=-\infty}^{\infty} a_n x^n,$$

then q -extension of this function of two variables is defined as

$$f(x+y)_q = \sum_{-\infty}^{\infty} a_n (x+y)_q^n, \quad (12.3)$$

where

$$(x+y)_q^n = (x+y)(x+qy)(x+q^2y)\dots(x+q^{n-1}y), \quad \text{for } n = 1, 2, 3, \dots$$

and

$$(x+y)_q^{-n} = \frac{1}{(x+q^{-n}y)_q^n}.$$

If we apply this extension to q -exponential function $e_q(x)$, so that we have function of two variables

$$e_q(x+y)_q = \sum_{n=0}^{\infty} \frac{(x+y)_q^n}{[n]_q!}, \quad (12.4)$$

then we get next multiplication formula

$$e_q(x+y)_q = e_q(x)E_q(y). \quad (12.5)$$

This specific dependence on two variables x and y we will call q -function of one variable $(x+y)_q$. According to definition it includes $x+y, x+q^{\pm 1}, x+q^{\pm 2}, \dots$ terms. In what follows we apply this notation to functions of two variables, as a q -complex holomorphic function, and q -traveling wave functions. We will find corresponding q -partial PDE-s as q -Cauchy-Riemann and q -wave equations.

12.1. q -Function of One Variable

Given $f(x, y)$ function of two variables. The partial q -derivatives are defined as

$$D_x f(x, y) = \frac{f(qx, y) - f(x, y)}{(q-1)x}, \quad (12.6)$$

$$D_y f(x, y) = \frac{f(x, qy) - f(x, y)}{(q-1)y}. \quad (12.7)$$

The total q -differential of function $f(x, y)$ is

$$d_q f(x, y) \equiv f(qx, qy) - f(x, y). \quad (12.8)$$

Then we get

$$d_q f(x, y) = (M_q^y D_x f(x, y)) d_q x + (D_y f(x, y)) d_q y, \quad (12.9)$$

where $d_q x \equiv (q-1)x$, $d_q y \equiv (q-1)y$.

Consider q -differential form $A d_q x + B d_q y$. When this form is exact $A d_q x + B d_q y = d_q f$, we have

$$d_q f = (M_q^y D_x f) d_q x + (D_y f) d_q y.$$

It implies

$$A = M_q^y D_x f, \quad B = D_y f.$$

Applying

$$M_{\frac{1}{q}}^y A = D_x f, \quad B = D_y f,$$

due to $D_x D_y = D_y D_x$,

$$D_y M_{\frac{1}{q}}^y A = D_y D_x f = D_x B,$$

then the q -integrability condition is

$$D_x B - D_y M_{\frac{1}{q}}^y A = 0. \quad (12.10)$$

In particular case $B = A$, we have

$$D_x B = D_y M_{\frac{1}{q}} B \Rightarrow D_y f = M_{\frac{1}{q}}^y D_x f \Rightarrow D_x f = M_{\frac{1}{q}} D_y$$

Let $f(x, y)$ satisfies q -partial difference equation of the first order

$$D_x f(x, y) = M_{\frac{1}{q}}^y D_y f(x, y). \quad (12.11)$$

Then

$$\begin{aligned} d_q f(x, y) &= \left(M_{\frac{1}{q}}^y M_{\frac{1}{q}}^y D_y f(x, y) \right) d_q x + (D_y f(x, y)) d_q y \\ &= D_y f(x, y) (d_q x + d_q y) \\ &= D_y f(x, y) ((q-1)x + (q-1)y) \end{aligned}$$

$$d_q f(x, y) = D_y f(x, y) d_q(x+y) = (M_{\frac{1}{q}}^y D_x f(x, y)) d_q(x+y). \quad (12.12)$$

Definition 12.1.0.1 *Function of two variables $f(x, y)$ is a q -function of "one" variable $x + y$ if*

$$\begin{aligned} d_q f(x, y) &= D_y f(x, y) d_q(x + y) \\ &= (M_q^y D_x f(x, y)) d_q(x + y) \end{aligned} \quad (12.13)$$

(it is a specific function of both x and y variables).

We denote this function as

$$f(x, y) \equiv f(x + y)_q.$$

According to our definition this function is a solution of the following q -partial difference equation

$$(D_x - M_q^y D_y) f(x + y)_q = 0 \quad (12.14)$$

and $f(x + 0)_q = f(x)$.

Now we derive structure of this function. Before this we formulate two propositions :

Proposition 12.1.0.2

$$D_x \frac{1}{(x + q^{-n}y)_q^n} = [-n] (x + y)_q^{-(n+1)} \quad (12.15)$$

Proposition 12.1.0.3

$$D_y (x + y)_q^{-n} = \frac{-[n]}{q^n} (x + qy)_q^{-(n+1)}. \quad (12.16)$$

For proof of these Propositions see Appendix G.

We suppose that $f(x)$ is an analytic function

1) in a disk, expandable to power series of the form

$$f(x) = \sum_{n=0}^{\infty} a_n x^n \quad (12.17)$$

or

2) in an annular domain, expandable to the Laurant series

$$f(x) = \sum_{n=-\infty}^{\infty} a_n x^n. \quad (12.18)$$

Theorem 12.1.0.4 *Functions*

$$f(x + y)_q = \sum_{n=0}^{\infty} a_n (x + y)_q^n. \quad (12.19)$$

$$f(x + y)_q = \sum_{n=-\infty}^{\infty} a_n (x + y)_q^n \quad (12.20)$$

are solutions of equation (12.14) with 'boundary conditions' (12.17) and (12.18), respectively. This theorem means that $f(x + y)_q$ is a 'q-analytic' extension of function $f(x)$.

Proof 12.1.0.5 First we show that $f(x + y)_q$ defined as (12.19) and (12.20) satisfies equation (12.14).

Taylor part: By direct substitution

$$(D_x - M_{\frac{1}{q}}^y D_y) f(x + y)_q = \sum_{n=0}^{\infty} a_n (D_x - M_{\frac{1}{q}}^y D_y) (x + y)_q^n. \quad (12.21)$$

$$D_x (x + y)_q^n = [n]_q (x + y)_q^{n-1}$$

and by using the derivative formula for q polynomials according to second argument (Kac, 2002)

$$D_q^y (x + y)_q^n = [n] (x + y)_q^{n-1}, \quad (12.22)$$

then we have

$$M_{\frac{1}{q}}^y D_y F_1(x+y)_q = M_{\frac{1}{q}}^y [n] (x+qy)_q^{n-1} = [n]_q (x+y)_q^{n-1}.$$

Combining together it becomes clear that $f(x+y)_q$ satisfies equation (12.14).

Laurent part: The proof for the Laurent part

$$f(x+y)_q = \sum_{n=-\infty}^{-1} a_n (x+y)_q^n = \sum_{n=1}^{\infty} a_{-n} (x+y)_q^{-n}$$

includes next proposition. We use the above propositions to get

$$\begin{aligned} \left(D_x - M_{\frac{1}{q}}^y D_y \right) F_2(x+y)_q &= \sum_{n=1}^{\infty} a_{-n} \left(-\frac{[n]}{q^n} M_{\frac{1}{q}}^y (x+qy)_q^{-(n+1)} \right. \\ &\quad \left. - [-n] (x+y)_q^{-(n+1)} \right) \\ &= - \sum_{n=1}^{\infty} a_{-n} \left([-n] + \frac{[n]}{q^n} \right) (x+y)_q^{-(n+1)} \\ &= 0, \end{aligned} \tag{12.23}$$

where due to identity

$$[-n]_q = -\frac{[n]}{q^n}$$

expression in parenthesis vanishes. Then the Laurent part of function $f(x+y)_q$ also satisfies equation (12.14)

It is easy to see that $(x+0)_q^n = x^n$, so that $f(x+0)_q = f(x)$, which means that 'boundary conditions' (12.17) and (12.18) are satisfied. Question of convergency of the above q -series is related with range of values for q . ■

12.1.1. Addition Formulas

Here we explicitly reproduce addition formulas for q -function of one variable, in the form of Jackson's q -exponential functions

$$e_q(x) = \sum_{n=0}^{\infty} \frac{x^n}{[n]!}, \quad (12.24)$$

$$E_q(x) = \sum_{n=0}^{\infty} q^{\frac{n(n-1)}{2}} \frac{x^n}{[n]!}. \quad (12.25)$$

Extending these functions to one q -variable we derive

$$e_q(x+y)_q \equiv \sum_{n=0}^{\infty} \frac{(x+y)_q^n}{[n]!}, \quad (12.26)$$

$$E_q(x+y)_q \equiv \sum_{n=0}^{\infty} q^{\frac{n(n-1)}{2}} \frac{(x+y)_q^n}{[n]!}. \quad (12.27)$$

Proposition 12.1.1.1 For $q > 1$ in strip, $-\infty < x < \infty$, $-1 < y < 1$:

$$e_q(x+y)_q = e_q(x)E_q(y); \quad (12.28)$$

for $q > 1$, in strip $-\infty < y < \infty$, $-1 < x < 1$, we have

$$E_q(x+y)_q = E_q(x)e_q(y). \quad (12.29)$$

Proof 12.1.1.2 By substituting the Gauss Binomial formula (10.5) into (12.26), we have

$$\begin{aligned} e_q(x+y)_q &= \sum_{n=0}^{\infty} \sum_{j=0}^n \frac{1}{[n]!} \begin{bmatrix} n \\ j \end{bmatrix} q^{\frac{j(j-1)}{2}} x^{n-j} y^j \\ &= \sum_{n=0}^{\infty} \sum_{j=0}^n \frac{x^{n-j}}{[n-j]!} q^{\frac{j(j-1)}{2}} \frac{y^j}{[j]!}, \end{aligned}$$

changing $n - j \equiv k$, we obtain

$$e_q(x + y)_q = \sum_{k=0}^{\infty} \frac{x^k}{[k]!} \sum_{j=0}^{\infty} q^{\frac{j(j-1)}{2}} \frac{y^j}{[j]!} = e_q(x)E_q(x).$$

By using $E_q(x) = e_{\frac{1}{q}}(x)$, we have the second relation

$$E_q(x + y)_q = e_{\frac{1}{q}}(x + y)_q = e_{\frac{1}{q}}(x) E_{\frac{1}{q}}(y) = E_q(x) e_q(y).$$

■

Definition 12.1.1.3 q -Hyperbolic functions are defined as

$$\begin{aligned} \cosh_q x &= \frac{e_q(x) + e_q(-x)}{2}, & \sinh_q x &= \frac{e_q(x) - e_q(-x)}{2}, \\ \text{Cosh}_q x &= \frac{E_q(x) + E_q(-x)}{2}, & \text{Sinh}_q x &= \frac{E_q(x) - E_q(-x)}{2}. \end{aligned}$$

This definition implies Hyperbolic Euler formulas

$$e_q(x) = \cosh_q x + \sinh_q x, \quad e_q(-x) = \cosh_q x - \sinh_q x. \quad (12.30)$$

$$E_q(x) = \text{Cosh}_q x + \text{Sinh}_q x, \quad E_q(-x) = \text{Cosh}_q x - \text{Sinh}_q x. \quad (12.31)$$

Extension of these functions to q -functions of one variable is given in the next proposition.

Proposition 12.1.1.4 We define

$$\begin{aligned} \cosh_q(x + y)_q &\equiv \frac{e_q(x + y)_q + e_q(-x - y)_q}{2}, \\ \sinh_q(x + y)_q &\equiv \frac{e_q(x + y)_q - e_q(-x - y)_q}{2}, \end{aligned}$$

and

$$\begin{aligned}\text{Cosh}_q(x + y)_q &\equiv \frac{E_q(x + y)_q + E_q(-x - y)_q}{2}, \\ \text{Sinh}_q(x + y)_q &\equiv \frac{E_q(x + y)_q - E_q(-x - y)_q}{2}.\end{aligned}\quad (12.32)$$

Euler formulas for q -exponentials of one q -argument are

$$e_q(x + y)_q = \cosh_q(x + y)_q + \sinh_q(x + y)_q, \quad (12.33)$$

$$E_q(x + y)_q = \text{Cosh}_q(x + y)_q + \text{Sinh}_q(x + y)_q. \quad (12.34)$$

They imply addition formulas

$$\cosh_q(x + y)_q = \cosh_q x \text{Cosh}_q y + \sinh_q x \text{Sinh}_q y, \quad (12.35)$$

$$\sinh_q(x + y)_q = \cosh_q x \text{Sinh}_q y + \sinh_q x \text{Cosh}_q y, \quad (12.36)$$

$$\text{Cosh}_q(x + y)_q = \text{Cosh}_q x \cosh_q y + \text{Sinh}_q x \sinh_q y, \quad (12.37)$$

$$\text{Sinh}_q(x + y)_q = \text{Cosh}_q x \sinh_q y + \text{Sinh}_q x \cosh_q y. \quad (12.38)$$

Proof of these formulas is straightforward.

To get Euler formulas for complex one q -variable argument replace $y \rightarrow iy$ in (12.28) we obtain

$$e_q(x + iy)_q = e_q(x)E_q(iy) = e_q(x)e_{\frac{1}{q}}(iy) = E_{\frac{1}{q}}(x)e_{\frac{1}{q}}(iy) = E_{\frac{1}{q}}(x + iy)_q, \quad (12.39)$$

and then changing order of arguments we have

$$e_q(iy + x)_q = e_q(iy)E_q(x) = e_q(iy)e_{\frac{1}{q}}(x) = E_{\frac{1}{q}}(iy)e_{\frac{1}{q}}(x) = E_{\frac{1}{q}}(iy + x)_q, \quad (12.40)$$

Comparing the above formulas we see the non-commutativity of addition

$$e_q(x + iy)_q \neq e_q(iy + x)_q.$$

In terms of complex variable $z = x + iy$, we can write

$$\cos_q(z)_q = \frac{e_q(iz)_q + e_q(-iz)_q}{2}, \quad \sin_q(z)_q = \frac{e_q(iz)_q - e_q(-iz)_q}{2i}, \quad (12.41)$$

$$\text{Cos}_q(z)_q = \frac{E_q(iz)_q + E_q(-iz)_q}{2}, \quad \text{Sin}_q(z)_q = \frac{E_q(iz)_q - E_q(-iz)_q}{2i} \quad (12.42)$$

then as a reduction

$$\begin{aligned} \cos_q(0 + iy)_q &= \text{Cosh}_q y = \text{Cos}_q(iy), & \cos_q(x + i0)_q &= \cos_q x \\ \sin_q(0 + iy)_q &= i \text{Sinh}_q y, & \sin_q(x + i0)_q &= \sin_q x \\ \text{Cos}_q(0 + iy)_q &= \sinh_q y, & \text{Cos}_q(x + i0)_q &= \text{Cos}_q x \\ \text{Sin}_q(0 + iy)_q &= i \sinh_q y, & \text{Sin}_q(x + i0)_q &= \text{Sin}_q x \\ \cosh_q(iy + 0)_q &= \cosh_q(iy) = \cos_q y, & \cos_q(iy + 0)_q &= \cosh_q y \\ \sinh_q(iy + 0)_q &= \sinh_q(iy) = i \sin_q y, & \sin_q(iy + 0)_q &= i \sinh_q y \end{aligned}$$

$$\begin{aligned} \sin_q(iz)_q &= i \sinh_q(z)_q & \xrightarrow{q \rightarrow 1} & \sin(iz) = i \sinh z \\ i \sin_q(z)_q &= \sinh_q(iz)_q & \xrightarrow{q \rightarrow 1} & i \sin z = \sinh(iz) \\ \cos_q(iz)_q &= \cosh_q(z)_q & \xrightarrow{q \rightarrow 1} & \cos(iz) = \cosh z \\ \cos_q(z)_q &= \cosh_q(iz)_q & \xrightarrow{q \rightarrow 1} & \cos z = \cosh(iz) \end{aligned}$$

$$\begin{aligned} \sinh_q(y + 0)_q &= \sinh_q y, & \sinh_q(0 + y)_q &= \text{Sinh}_q y, \\ \cosh_q(x + 0)_q &= \cosh_q x, & \cosh_q(0 + x)_q &= \text{Cosh}_q x. \end{aligned}$$

The q -Euler formula (12.39) implies next addition formulas

$$\sin_q(x \pm y)_q = \sin_q x \text{Cos}_q y \pm \cos_q x \text{Sin}_q y,$$

$$\cos_q(x \pm y)_q = \cos_q x \text{Cos}_q y \mp \sin_q x \text{Sin}_q y.$$

The above formulas imply the following product formulas

$$\sin_q x \text{Cos}_q y = \frac{1}{2} [\sin_q(x + y)_q + \sin_q(x - y)_q], \quad (12.43)$$

$$\cos_q x \text{Cos}_q y = \frac{1}{2} [\cos_q(x + y)_q + \cos_q(x - y)_q], \quad (12.44)$$

$$\sin_q x \text{Sin}_q y = \frac{1}{2} [\cos_q(x - y)_q - \cos_q(x + y)_q]. \quad (12.45)$$

and the identity

$$\cos_q x \text{Cos}_q x + \sin_q x \text{Sin}_q x = 1. \quad (12.46)$$

12.2. Complex Analytic Function

Here we consider complex function $f(z)$ of complex argument $z = x + iy$. This function is analytic or holomorphic if in some domain it satisfies the first order PDE

$$\frac{1}{2} \left(\frac{\partial}{\partial x} + i \frac{\partial}{\partial y} \right) f(z, \bar{z}) = \frac{\partial}{\partial \bar{z}} f(z, \bar{z}) = 0 \quad (12.47)$$

and implies $f = f(z)$ is function only of z variable (not \bar{z}). Depending on domain (disk or annular domain) it is expandable to Taylor or Laurent series

$$f(z) = \sum_{n=-\infty}^{\infty} a_n z^n.$$

The above equation written in terms of real and imaginary parts

$$f(x, y) = u(x, y) + iv(x, y)$$

gives the Cauchy-Riemann equations

$$\frac{\partial u}{\partial x} = \frac{\partial v}{\partial y}, \quad \frac{\partial u}{\partial y} = -\frac{\partial v}{\partial x}.$$

Now we are going to apply our generic approach developed above, to introduce special class of complex functions $f(z)$ of complex argument z , which we call as q -analytic or q -holomorphic functions.

12.3. q -Holomorphic Function

Here we introduce the q -holomorphic function (Pashaev & Nalci, 2011b):

Definition 12.3.0.5 *Complex function of complex argument $f(x + iy)_q$ is called q -holomorphic function if*

$$(D_x + iM_{\frac{1}{q}}^y D_y)f(x + iy)_q = 0. \quad (12.48)$$

Definition 12.3.0.6 *Complex function of complex argument $f(x - iy)_q$ is called q -anti-holomorphic function if*

$$(D_x - iM_{\frac{1}{q}}^y D_y)f(x - iy)_q = 0. \quad (12.49)$$

We note that q -holomorphic function is determined by equation (12.48) up to arbitrary constant as in usual case. But in addition, we can have more general solution in terms of q -periodic function of z :

- 1) $f(z)_q \Rightarrow D_{\bar{z}}f(z)_q = 0$,
- 2) $D_{\bar{z}}f(z)_q = 0 \Rightarrow f(z)_q + A(\bar{z})_q, D_{\bar{z}}A(\bar{z})_q = 0$, where $A(\bar{z})_q$ - q -periodic function.

Example : From definition of q -exponential function $e_q(x)$ we have

$$e_q(x + iy)_q \equiv \sum_{n=0}^{\infty} \frac{(x + iy)_q^n}{[n]_q!}$$

or in terms of

$$z \equiv x + iy, \quad z_q \equiv x + iqy, \quad \dots \quad z_{q^n} \equiv x + iq^n y, \dots,$$

$$e_q(z)_q = \sum_{n=0}^{\infty} \frac{z z_q \dots z_{q^{n-1}}}{[n]_q!}.$$

This function $e_q(x + iy)_q$ is q -holomorphic $D_{\bar{z}} e_q(x + iy)_q = 0$ for $q > 1$ in the strip $-\infty < x < \infty$, $-1 < y < 1$, and $e_q(x + iy)_q = e_q(x)E_q(iy)$. The function $e_q(x - iy)_q$ is q -anti-holomorphic function.

Here we like to stress that the q -holomorphic functions are not holomorphic functions in the usual sense, because the arguments

$$z_q = x + iqy = \frac{(1+q)}{2}z + \frac{(1-q)}{2}\bar{z},$$

include both z and \bar{z} , so that $\frac{\partial}{\partial \bar{z}} e_q(x + iy)_q \neq 0$. Only exception is a linear function $f = az + b$.

Geometrically, we can represent every complex variable $z_{q^n} = x + iq^n y$, $n = 0, \pm 1, \pm 2, \dots$ as a plane with coordinates $(x, q^n y)$ (with re-scaled y coordinate). All these planes are intersecting along real axis x . Then q -analytic function depends on infinite set of complex variables on these planes $z, z_{q^{\pm 1}}, z_{q^{\pm 2}}, \dots$ and not on $\bar{z}, \bar{z}_{q^{\pm 1}}, \bar{z}_{q^{\pm 2}}, \dots$. In the limiting case $q \rightarrow 1$, all planes are coinciding with the complex plane z , and q -holomorphic function becomes standard holomorphic function. Finally, we should emphasize that due to $M_q^x = q^{x \frac{d}{dx}}$, $M_q^y = q^{y \frac{d}{dy}}$, the first-order q -difference equation (12.48) contains standard PDE of infinite order.

In terms of holomorphic q -derivatives

$$D_z \equiv \frac{1}{2}(D_x - iM_{\frac{1}{q}}^y D_y), \quad (12.50)$$

$$D_{\bar{z}} \equiv \frac{1}{2}(D_x + iM_{\frac{1}{q}}^y D_y). \quad (12.51)$$

we define the q -**Laplace operator**

$$\begin{aligned} \Delta_q \equiv 4D_z D_{\bar{z}} &= D_x^2 + \left(M_{\frac{1}{q}}^y D_y\right)^2 \\ &= D_x^2 + \frac{1}{q} M_{\frac{1}{q}}^y D_y^2 \\ &= D_x^2 + q D_y M_{\frac{1}{q^2}}^y D_y, \end{aligned} \quad (12.52)$$

where we used $D_y^q M_Q^y = Q M_Q^y D_y^q$.

Operator D_z is acting on q -holomorphic function $f(x + iy)_q$ as D_x derivative. Indeed, due to (12.48) we have

$$D_z f(x + iy)_q = \frac{1}{2}(D_x - iM_{\frac{1}{q}}^y D_y) f(x + iy)_q = \frac{1}{2}(D_x + D_x) f(x + iy)_q = D_x f(x + iy)_q.$$

Definition 12.3.0.7 *The real function $\phi(x, y)$ is a q -harmonic function if it satisfies the q -Laplace equation*

$$\Delta_q \phi(x, y) = 0. \quad (12.53)$$

12.3.1. q -Analytic Function

Complex function of complex argument, represented by convergent power series

$$f(x + iy)_q = \sum_{n=0}^{\infty} a_n (x + iy)_q^n \quad (12.54)$$

is q -analytic function. Indeed,

$$\begin{aligned}
(D_x + iM_{\frac{1}{q}}^y D_y)f(x + iy)_q &= \sum_{n=0}^{\infty} a_n \left[D_x(x + iy)_q^n + iM_{\frac{1}{q}} D_y(x + iy)_q^n \right] \\
&= \sum_{n=0}^{\infty} a_n \left[[n](x + iy)_q^{n-1} + iM_{\frac{1}{q}} (i[n](x + iy)_q^{n-1}) \right] \\
&= 0,
\end{aligned} \tag{12.55}$$

where we used the identity (12.22)

12.3.2. q -Cauchy-Riemann Equations

Consider q -holomorphic function

$$\begin{aligned}
f(x + iy)_q &= u(x, y) + iv(x, y), \\
\overline{f(x + iy)_q} &= u(x, y) - iv(x, y),
\end{aligned}$$

then, we have for real and imaginary parts

$$\begin{aligned}
u(x, y) &= \frac{f(x + iy)_q + \overline{f(x + iy)_q}}{2}, \\
v(x, y) &= \frac{f(x + iy)_q - \overline{f(x + iy)_q}}{2i}.
\end{aligned}$$

Due to $f(x + iy)_q$ is q -holomorphic function,

$$D_{\bar{z}}f(x + iy)_q = 0 \Rightarrow D_z \overline{f(x + iy)_q} = 0.$$

Then from expression for the Laplace operator $\Delta_q = 4D_{\bar{z}}D_z$, we have $\Delta_q f(x + iy)_q = 0$ and $\Delta_q \overline{f(x + iy)_q} = 0$, implying that

$$\Delta_q u(x, y) = 0, \quad \Delta_q v(x, y) = 0.$$

It means that $u(x, y)$ and $v(x, y)$ are q -harmonic functions.

By using the q -holomorphic function equation (12.48)

$$D_{\bar{z}}f(x + iy)_q = 0 \Rightarrow \frac{D_x + iM_{\frac{1}{q}}^y D_y}{2}(u + iv) = 0,$$

we obtain the q -Cauchy-Riemann Equations in the following form (Pashaev & Nalci, 2011b)

$$D_x u = M_{\frac{1}{q}}^y D_y v, \quad (12.56)$$

$$D_x v = -M_{\frac{1}{q}}^y D_y u. \quad (12.57)$$

Here, $u(x, y)$ and $v(x, y)$ are q -harmonic conjugate functions.

Our q -analytic functions are different from the ones introduced by Ernst (Ernst, 2008) on the basis of so-called q -addition. The main difference is that as we show in next section, our q -analytic functions are generalized analytic functions.

12.3.3. q -Analytic Function as Generalized Analytic Function

As we have seen above, q -analytic functions are not analytic in the usual sense.

Example: Given function of complex argument $f(z)_q = (x + iy)_q^2 = (x + iy)(x + qiy)$ is not analytic ($\partial_{\bar{z}} \neq 0$), but is q -analytic since

$$D_{\bar{z}} \equiv \frac{1}{2}(D_x + iM_{\frac{1}{q}}^y D_y) ((x^2 - qy^2) + i[2]_q xy) = 0.$$

And when we write real and imaginary parts as $u_q(x, y) = x^2 - qy^2$ and $v_q(x, y) = [2]_q xy$, then it is easy to show that they satisfy q -Cauchy-Riemann equations (12.56),(12.57) and $\Delta_q u(x, y) = 0$, $\Delta_q v(x, y) = 0$, which means that $u(x, y)$ and $v(x, y)$ are q -harmonic functions. Taking $\bar{\partial}$ derivative

$$\begin{aligned} \partial_{\bar{z}}(x + iy)_q^2 &= \frac{1}{2}(\partial_x + i\partial_y)(x^2 - qy^2 + i(1 + q)xy) \\ &= \frac{1}{2}(1 - q)z = \frac{1}{2}(2 - [2])z, \end{aligned} \quad (12.58)$$

we see that it is not vanishing identically.

However some class of q -analytic functions could be interpreted as a generalized analytic functions (Vekua, 1962). The scalar equation

$$\frac{\partial \Phi(z, \bar{z})}{\partial \bar{z}} = f(z, \bar{z}) \quad (12.59)$$

for simple connected domain in complex z -plane called $\bar{\partial}$ -problem (Ablowitz & Fokas, 1997). For complex function

$$\Phi = u + iv, \quad f = \frac{g + ih}{2}, \quad z = x + iy$$

it is equivalent to the system

$$\frac{\partial u}{\partial x} - \frac{\partial v}{\partial y} = g(x, y), \quad \frac{\partial u}{\partial y} + \frac{\partial v}{\partial x} = h(x, y) \quad (12.60)$$

as a generalized Cauchy-Riemann equations. In case of analytic function, $g(x, y) = h(x, y) = 0$, or $f(x, y) = 0$ it recovers the Cauchy-Riemann equations.

Definition 12.3.3.1 *Complex function $\Phi(z, \bar{z})$ in a region R , satisfying equation*

$$\frac{\partial \Phi}{\partial \bar{z}} = A(z, \bar{z})\Phi + B(z, \bar{z})\bar{\Phi} \quad (12.61)$$

is called generalized analytic function.

In particular case $B = 0$ it reduces to equation

$$\frac{\partial \Phi}{\partial \bar{z}} = A(z, \bar{z})\Phi \quad (12.62)$$

which can be solved in a closed form:

$$\Phi(z, \bar{z}) = \omega(z) e^{\frac{1}{2\pi i} \int \int_D \frac{A(\zeta, \bar{\zeta})}{\zeta - z} d\zeta \wedge d\bar{\zeta}}, \quad (12.63)$$

where $\omega(z)$ is an arbitrary analytic function.

As an example we consider complex polynomial $\Phi(z, \bar{z}) = (x + iy)_q^n$. This function is q -analytic due to $D_{\bar{z}}(x + iy)_q^n = 0$.

Calculating $\frac{\partial}{\partial \bar{z}}$ -derivative we have

$$\begin{aligned}\frac{\partial}{\partial x}(x + iy)_q^n &= \frac{\partial}{\partial x} \ln(x + iy)_q^n = \sum_{k=0}^{n-1} \frac{1}{x + iq^k y} \\ \frac{\partial}{\partial x}(x + iy)_q^n &= (x + iy)_q^n \sum_{k=0}^{n-1} \frac{1}{x + iq^k y}, \\ \frac{\partial}{\partial y}(x + iy)_q^n &= (x + iy)_q^n \sum_{k=0}^{n-1} \frac{iq^k}{x + iq^k y}, \\ \frac{\partial}{\partial \bar{z}}(x + iy)_q^n &= \frac{1-q}{2}(x + iy)_q^n \sum_{k=0}^{n-1} \frac{[k]}{x + iq^k y}\end{aligned}$$

$$\frac{\partial}{\partial \bar{z}}\Phi(z, \bar{z}) = \Phi(z, \bar{z})(1-q) \sum_{k=0}^{n-1} \frac{[k]}{(1+q^k)z + (1-q^k)\bar{z}}. \quad (12.64)$$

It shows that function $\Phi(z, \bar{z})$ satisfies equation (12.62) and is the generalized analytic function, where

$$A(z, \bar{z}) = \sum_{k=0}^{n-1} \frac{[k]_q}{\frac{1+q^k}{1-q}z + [k]_q \bar{z}}.$$

12.4. Traveling Wave

Real functions $f(x, t) = f(x - ct)$ and $g(x, t) = g(x + ct)$ of two real variables x and t are called the traveling waves. These functions satisfy the first order PDE's

$$\left(\frac{\partial}{\partial t} + c \frac{\partial}{\partial x} \right) f(x - ct) = 0, \quad (12.65)$$

and

$$\left(\frac{\partial}{\partial t} - c\frac{\partial}{\partial x}\right)g(x + ct) = 0, \quad (12.66)$$

and describe waves with fixed shape $f(x)$ and $g(x)$, propagating with speed c to the right and to the left direction, correspondingly.

For the wave equation

$$\frac{\partial^2 u}{\partial t^2} - c^2 \frac{\partial^2 u}{\partial x^2} = 0 \quad (12.67)$$

by factorization

$$\begin{aligned} \left(\frac{\partial}{\partial t} - c\frac{\partial}{\partial x}\right)\left(\frac{\partial}{\partial t} + c\frac{\partial}{\partial x}\right)u &= 0, \\ \left(\frac{\partial}{\partial t} + c\frac{\partial}{\partial x}\right)\left(\frac{\partial}{\partial t} - c\frac{\partial}{\partial x}\right)u &= 0, \end{aligned}$$

we find the general solution as a superposition of two traveling waves of arbitrary shape

$$u(x, t) = f(x - ct) + g(x + ct). \quad (12.68)$$

12.5. q-Traveling Wave

Solutions of the first order q -PDE's

$$(M_q^t D_t + c D_x)f(x - ct)_q = 0 \quad (12.69)$$

and

$$(M_q^t D_t - c D_x)g(x + ct)_q = 0 \quad (12.70)$$

we call the q -traveling waves (Nalci & Pashaev, 2011b). In the limit $q \rightarrow 1$, equations (12.69),(12.70) reduce to (12.65),(12.66) and q -traveling waves $f(x - ct)_q$ and $g(x + ct)_q$ give standard traveling waves.

Convergent series of the form

$$f(x \pm ct)_q = \sum_{n=0}^{\infty} a_n (x \pm ct)_q^n$$

gives an example of q -traveling wave. It should be noted here that q -traveling wave is not traveling wave in the standard sense. For example, the traveling wave polynomial $(x - ct)_q^n = (x - ct)(x - qct)(x - q^2ct) \dots (x - q^{n-1}ct)$ includes the set of moving frames (as zeros of this polynomial) with re-scaled set of speeds $(c, qc, q^2c, \dots, q^{n-1}c)$. It means that zeros of this polynomial are moving with different speeds and therefore the shape of polynomial wave is not preserving. Only in the linear case and in the case $q = 1$, when speed of all frames coincide, we are getting standard traveling wave. For traveling wave at time 0 : $f(x - c0) = f(x)$ and for q -traveling wave at time 0 : $f(x - c0)_q = f(x)$, we have the same initial profile $f(x)$. But for standard traveling wave this profile is propagating with the speed c as an extension of function $f(x)$ in direction of time t (evolution). In contrast, in the case of q -traveling wave, we have the set of frames with re-scaled speeds or the set of re-scaled times; $t, qt, q^2t, \dots, q^{n-1}t$, corresponding to evolution in every of these frames.

12.6. D'Alembert Solution of Wave Equation

First we remind the standard one dimensional wave equation

$$\frac{\partial^2 u}{\partial t^2} = c^2 \frac{\partial^2 u}{\partial x^2} \quad (12.71)$$

with the initial conditions

$$u(x, 0) = f(x), \quad u_t(x, 0) = g(x), \quad -\infty \leq x \leq \infty. \quad (12.72)$$

Substituting the general solution (12.68) to these conditions we get the D'Alembert solution of the wave equation in the form

$$u(x, t) = \frac{1}{2} (f(x + ct) + f(x - ct)) + \frac{1}{2c} \int_{x-ct}^{x+ct} g(x') dx'. \quad (12.73)$$

In particular case, if the initial velocity is zero, $g(x) \equiv 0$, it reduces to two plane waves moving in the right and in the left directions

$$u(x, t) = \frac{1}{2} (f(x + ct) + f(x - ct)). \quad (12.74)$$

12.7. The q-Wave Equation

Here we introduce the q -analogue of the wave equation as

$$\left[\left(M_{\frac{1}{q}}^t D_t \right)^2 - c^2 D_x^2 \right] u(x, t) = 0, \quad (12.75)$$

where c is a constant with dimension of speed. In the limiting case $q \rightarrow 1$ equation (12.75) reduces to the standard wave equation (12.71).

By using the Q commutativity relation:

$$D_q M_Q = Q M_Q D_q,$$

the q -wave equation can be also rewritten as

$$\left[\frac{1}{q} \left(M_{\frac{1}{q}}^t \right)^2 D_t^2 - c D_x^2 \right] u(x, t) = 0.$$

Proposition 12.7.0.2 *The general solution of the one dimensional q -wave equation (12.75) is superposition*

$$u(x, t) = F(x + ct)_q + G(x - ct)_q, \quad (12.76)$$

where $F(x+ct)_q$ and $G(x-ct)_q$ are the q -traveling wave functions. In the limit $q \rightarrow 1$ this solution reduces to D'Alembert solution, and q -traveling waves to the standard traveling waves.

Proof 12.7.0.3 First of all we factorize the q -wave operator in two forms

$$\left(M_{\frac{1}{q}}^t D_t + cD_x\right) \left(M_{\frac{1}{q}}^t D_t - cD_x\right) f = 0, \quad (12.77)$$

$$\left(M_{\frac{1}{q}}^t D_t - cD_x\right) \left(M_{\frac{1}{q}}^t D_t + cD_x\right) g = 0. \quad (12.78)$$

Then, solution of the first order equations

$$\left(M_{\frac{1}{q}}^t D_t - cD_x\right) f(x, t) = 0 \quad (12.79)$$

and

$$\left(M_{\frac{1}{q}}^t D_t + cD_x\right) g(x, t) = 0 \quad (12.80)$$

are solutions of the q -wave equation (12.75). Solutions of the last two equations as we discussed in (12.69), (12.70) are given by the next form :

$$f(x, t) = F(x + ct)_q, \quad (12.81)$$

$$g(x, t) = G(x - ct)_q, \quad (12.82)$$

and called the q -traveling waves. ■

Equation (12.79) shows that $f(x, t)$ is q -function of one variable $(x + ct)$ as we defined in Section 12.1 :

$$d_q F(x + ct)_q = D_x(x + ct)_q d_q(x + ct).$$

According to general consideration in Section 12.1 we can find explicit form of this function in terms of Laurent series and by replacing $y \rightarrow ct$ get q -traveling wave in Laurent

series form. However we find it would be useful to derive this result explicitly for q -traveling wave without referring to general consideration in Section 12.1. We have next propositions :

Proposition 12.7.0.4

$$D_x \frac{1}{(x + q^{-n}t)_q^n} = [-n](x + t)_q^{-(n+1)} \quad (12.83)$$

Proposition 12.7.0.5

$$D_t(x + ct)_q^{-n} = \frac{-c[n]}{q^n}(x + cqt)_q^{-(n+1)}. \quad (12.84)$$

For proofs see the Appendix H.

The function f expandable to Laurent series has the form

$$f = F(x + ct)_q = \sum_{n=-\infty}^{\infty} a_n(x + ct)_q^n \quad (12.85)$$

where $(x + ct)_q^n = (x + ct)(x + cqt)\dots(x + cq^{n-1}t)$.

Similar way we can interpret (12.80) and

$$g = G(x - ct)_q = \sum_{n=-\infty}^{\infty} b_n(x - ct)_q^n \quad (12.86)$$

where $(x - ct)_q^n = (x - ct)(x - cqt)\dots(x - cq^{n-1}t)$.

This formulas show that instead of one moving frame $x' = x - ct$ with speed c in the standard polynomial form $(x - ct)^n$, giving n -degenerate zeros, in q -case we have n -moving frames with speeds $c, qc, q^2c, \dots, q^{n-1}c$, giving velocity of motion for zeros of q -binomial $(x - ct)_q^n$.

Firstly, we solve the first order wave equation (12.77). Function f has Laurent

series expansion as

$$f = F(x + ct)_q = \sum_{n=-\infty}^{\infty} a_n(x + ct)_q^n = \sum_{n=0}^{\infty} a_n(x + ct)_q^n + \sum_{n=-\infty}^{-1} a_n(x + ct)_q^n, \quad (12.87)$$

where $(x + ct)_q^n = (x + ct)(x + cqt)\dots(x + cq^{n-1}t)$.

In the above expression let us call the Taylor part as $F_1(x + ct)_q$ and Laurent principal part as $F_2(x + ct)_q$.

Taylor part: Now we show that $F_1(x + ct)_q$ is solution of equation (12.77)

$$\begin{aligned} F_1(x + ct)_q &= \sum_{n=0}^{\infty} a_n(x + ct)_q^n, \\ M_{\frac{1}{q}}^t D_t F_1(x + ct)_q &= cM_{\frac{1}{q}}^t \sum_{n=1}^{\infty} a_n[n](x + cqt)_q^{n-1} = c \sum_{n=1}^{\infty} a_n[n](x + ct)_q^{n-1}, \\ D_x F_1(x + ct)_q &= \sum_{n=1}^{\infty} a_n[n](x + t)_q^{n-1}, \end{aligned}$$

where derivative of q polynomials according to second argument is

$$D_q^t(x + t)_q^n = [n](x + qt)_q^{n-1}.$$

Then it is clear that $F_1(x + ct)_q$ is one of the solutions of (12.77).

Laurent part The proof for the Laurent part

$$F_2(x + t)_q = \sum_{n=-\infty}^{-1} a_n(x + t)_q^n = \sum_{n=1}^{\infty} a_{-n}(x + t)_q^{-n}$$

includes above propositions, then we get

$$\begin{aligned} &\left(M_{\frac{1}{q}}^t D_t - cD_x \right) F_2(x + ct)_q \\ &= \sum_{n=1}^{\infty} a_{-n} \left(-c \frac{[n]}{q^n} M_{\frac{1}{q}}^t (x + cqt)_q^{-(n+1)} - c[-n](x + ct)_q^{-(n+1)} \right) \end{aligned}$$

$$= -c \sum_{n=1}^{\infty} a_{-n} \left([-n] + \frac{[n]}{q^n} \right) (x+t)_q^{-(n+1)} = 0, \quad (12.88)$$

where due to identity

$$[-n]_q = -\frac{[n]}{q^n}$$

expression in parenthesis vanishes. Then $F_2(x+ct)_q$ is also solution of (12.77).

Hence, $f(x,t) = F(x+ct)_q = F_1(x+ct)_q + F_2(x+ct)_q$ is the solution of (12.77).

By following the same strategy (in fact for this we need in equation (12.77) just replace $c \rightarrow -c$) we can show that

$$g(x,t) = G(x-ct)_q = \sum_{n=-\infty}^{\infty} a_n (x-ct)_q^n = \sum_{n=0}^{\infty} a_n (x-ct)_q^n + \sum_{n=-\infty}^{-1} a_n (x-ct)_q^n$$

is the solution of (12.78).

Therefore, we found that the sum of two q -traveling wave functions is the general solution of q -wave equation (12.75)

$$u(x,t) = F(x+ct)_q + G(x-ct)_q$$

where

$$F(x+ct)_q = \sum_{n=-\infty}^{\infty} a_n (x+ct)_q^n,$$

$$G(x-ct)_q = \sum_{n=-\infty}^{\infty} a_n (x-ct)_q^n.$$

12.7.1. D'Alembert Solution of The q -Wave Equation

Now we are going to solve I.V.P for the q -wave equation (Nalci & Pashaev, 2011b)

$$\left[\left(M_{\frac{1}{q}}^t D_t \right)^2 - c^2 D_x^2 \right] u(x, t) = 0, \quad (12.89)$$

$$u(x, 0) = f(x), \quad (12.90)$$

$$D_t u(x, 0) = g(x), \quad (12.91)$$

where $-\infty < x < \infty$.

It has the general solution in the following q -traveling wave form

$$u(x, t) = F(x - ct)_q + G(x + ct)_q \quad (12.92)$$

From the first initial condition (12.90) we have

$$u(x, 0) = F(x) + G(x) = f(x). \quad (12.93)$$

Applying the second initial condition (12.91) we obtain

$$D_t u(x, t)|_{t=0} = (D_t F(x - ct)_q + D_t G(x + ct)_q)|_{t=0}. \quad (12.94)$$

To calculate q -derivative according time variable we will use definitions of q -traveling wave as solutions of first order wave equations (12.69),(12.70):

$$c D_x F(x + ct)_q = M_{\frac{1}{q}}^t D_t F(x + ct)_q, \quad (12.95)$$

and

$$-c D_x F(x - ct)_q = M_{\frac{1}{q}}^t D_t F(x - ct)_q. \quad (12.96)$$

Then for (12.94) we have

$$D_t u(x, t)|_{t=0} = (-cM_q^t D_x F(x - ct)_q + cM_q^t D_x G(x + ct)_q)|_{t=0}$$

or

$$\begin{aligned} D_t u(x, 0) = g(x) &= -cD_x F(x - 0)_q + cD_x G(x + 0)_q \\ &= -cD_x F(x) + cD_x G(x). \end{aligned} \quad (12.97)$$

By integrating this equation we get

$$-F(x) + G(x) = F(0) - G(0) + \frac{1}{c} \int_0^x g(x') d_q x', \quad (12.98)$$

where the last term is the Jackson integral, defined in (2.22). By using the both initial conditions we find

$$F(x) = \frac{1}{2}f(x) - \frac{1}{2}(F(0) - G(0)) - \frac{1}{2c} \int_0^x g(x') d_q x', \quad (12.99)$$

$$G(x) = \frac{1}{2}f(x) + \frac{1}{2}(F(0) - G(0)) + \frac{1}{2c} \int_0^x g(x') d_q x'. \quad (12.100)$$

By replacing $x \rightarrow (x - ct)_q$ in first and $x \rightarrow (x + ct)_q$ in second equation, the solution of given I.V.P for q -wave equation in D'Alembert form is obtained

$$u(x, t) = \frac{f(x + ct)_q + f(x - ct)_q}{2} + \frac{1}{2c} \int_{(x-ct)_q}^{(x+ct)_q} g(x') d_q x', \quad (12.101)$$

where

$$\begin{aligned} \int_{(x-ct)_q}^{(x+ct)_q} g(x') d_q x' &= (1 - q)(x + ct) \sum_{j=0}^{\infty} q^j M_q^t g(q^j(x + ct))_q \\ &\quad - (1 - q)(x - ct) \sum_{j=0}^{\infty} q^j M_q^t g(q^j(x - ct))_q. \end{aligned} \quad (12.102)$$

In Appendix H, we derive explicit form for Jackson integral with q -traveling wave upper limit.

Below we explicitly derive solution of given I.V.P. for generic form of function $F(z)$ as a complex function of complex variable z , expandable to the Laurent series

$$F(z) = \sum_{n=-\infty}^{\infty} a_n z^n.$$

It implies that $F(z)$ is analytic in an annular domain with isolated singular point $z = 0$. Then we consider a q -traveling wave as the Laurent expansion in terms of q -binomials

$$F(x - ct)_q = \sum_{n=-\infty}^{\infty} a_n (x - ct)_q^n. \quad (12.103)$$

From the first initial condition (12.90) we have

$$u(x, 0) = F(x) + G(x) = f(x). \quad (12.104)$$

Before applying the second initial condition let us consider the following proposition:

Proposition 12.7.1.1 *For given function which has Laurent expansion*

$$F(x - ct)_q = \sum_{n=-\infty}^{\infty} a_n (x - ct)_q^n$$

we have the identity

$$D_t F(x - ct)_q|_{t=0} = -c D_x F(x). \quad (12.105)$$

Proof 12.7.1.2 q -function $F(x - ct)_q$ has Laurent expansion as follows

$$F(x - ct)_q = \sum_{n=-\infty}^{\infty} a_n (x - ct)_q^n = \sum_{n=0}^{\infty} a_n (x - ct)_q^n + \sum_{n=-\infty}^{-1} a_n (x - ct)_q^n.$$

Firstly, to prove it for Taylor part we consider a function with one variable which is

$$F(x) = \sum_{n=0}^{\infty} a_n x^n \quad \Rightarrow \quad D_x F(x) = \sum_{n=1}^{\infty} [n] a_n x^{n-1}. \quad (12.106)$$

If we replace $x \rightarrow (x - ct)$, the two variable function becomes q -function

$$D_t F(x - ct)_q = D_t \sum_{n=0}^{\infty} a_n (x - ct)_q^n. \quad (12.107)$$

By using the definition of q -derivative (2.8)

$$\begin{aligned} D_t (x - ct)_q^n &= \frac{(x - cqt)_q^n - (x - ct)_q^n}{(q - 1)t} \\ &= \frac{(x - cqt)(x - cq^2t) \dots (x - cq^n t) - (x - ct)(x - cqt) \dots (x - cq^{n-1}t)}{(q - 1)t} \\ &= \frac{(x - cqt)(x - cq^2t) \dots (x - cq^{n-1}t)(-ct(q^n - 1))}{(q - 1)t} \\ &= -c[n](x - cqt)_q^{n-1} \end{aligned}$$

we obtain

$$D_t F(x - ct)_q = -c \sum_{n=1}^{\infty} [n] a_n (x - cqt)_q^{n-1}$$

and at point $t = 0$ the result is

$$D_t F(x - ct)_q|_{t=0} = -c \sum_{n=1}^{\infty} [n] a_n x^{n-1} = -c D_x F(x). \quad (12.108)$$

For Laurent part by replacing $n \rightarrow -n$ we have $F(x - ct)_q = \sum_{n=1}^{\infty} a_{-n} (x - ct)_q^{-n}$ and its derivative is

$$D_t F(x - ct)_q = \sum_{n=1}^{\infty} a_{-n} D_t (x - ct)_q^{-n} = -c \sum_{n=1}^{\infty} a_{-n} [-n] (x - ct)_q^{-(n+1)}.$$

And

$$D_t F(x - ct)_q|_{t=0} = -cD_x F(x), \quad (12.109)$$

where

$$F(x) = \sum_{n=1}^{\infty} a_{-n} x^{-n} \Rightarrow D_x F(x) = \sum_{n=1}^{\infty} a_{-n} [-n] x^{-(n+1)}.$$

■

By applying both initial conditions we obtain

$$F(x) + G(x) = f(x), \quad (12.110)$$

$$-cD_x F(x) + cD_x G(x) = g(x). \quad (12.111)$$

Integrating second equation we get

$$\begin{aligned} -F(x) + G(x) &= \frac{1}{c} \int_0^x g(x') d_q x' \\ &= \frac{1}{c} (1 - q)x \sum_{j=0}^{\infty} q^j g(q^j x) + G(0) - F(0). \end{aligned} \quad (12.112)$$

After finding $G(x)$ and $F(x)$ from equations (12.110) and (12.111), we replace $x \rightarrow x - ct$ in $F(x)$ and $x \rightarrow x + ct$ in $G(x)$. This why one variable functions $F(x)$ and $G(x)$ become two variables functions or q -function of one variable,

$$F(x - ct)_q = \frac{f(x - ct)_q}{2} - \frac{1}{2c} \int_0^{(x-ct)_q} g(x') d_q x' \quad (12.113)$$

$$G(x + ct)_q = \frac{f(x + ct)_q}{2} - \frac{1}{2c} \int_0^{(x+ct)_q} g(x') d_q x'. \quad (12.114)$$

Then, the solution of a given I.V.P. for q -wave equation in D'Alembert form is obtained

(Nalci and Pashaev 2011b)

$$u(x, t) = \frac{f(x + ct)_q + f(x - ct)_q}{2} + \frac{1}{2c} \int_{(x-ct)_q}^{(x+ct)_q} g(x') d_q x', \quad (12.115)$$

where

$$\begin{aligned} \int_{(x-ct)_q}^{(x+ct)_q} g(x') d_q x' &= (1 - q)(x + ct) \sum_{j=0}^{\infty} q^j M_q^t g(q^j(x + ct))_q \\ &\quad - (1 - q)(x - ct) \sum_{j=0}^{\infty} q^j M_q^t g(q^j(x - ct))_q. \end{aligned} \quad (12.116)$$

If the initial velocity is zero, $g(x) = 0$, we see that this reduces to

$$u(x, t) = \frac{1}{2} (f(x + ct)_q + f(x - ct)_q). \quad (12.117)$$

12.7.2. Initial Boundary Value Problem for q -Wave Equation

Here we consider the model of a q - vibrating elastic string with fixed ends, satisfying the one-dimensional q -wave equation

$$\left[\left(M_{\frac{1}{q}}^t D_t \right)^2 - c^2 D_x^2 \right] u(x, t) = 0, \quad (12.118)$$

on finite interval $0 < x < L$. L is length of the string and $u(x, t)$ denotes the vertical displacement of string from the x - axis at position x and time t .

The I.B.V.P for q - wave equation is written as :

$$\left[\left(M_{\frac{1}{q}}^t D_t \right)^2 - c^2 D_x^2 \right] u(x, t) = 0, \quad (12.119)$$

with the Boundary conditions :

$$\begin{aligned} u(0, t) &= 0 \\ u(L, t) &= 0 \quad \text{for all } t > 0 \end{aligned} \quad (12.120)$$

and with the Initial conditions:

$$\begin{aligned} u(x, 0) &= f(x) \\ D_t u(x, 0^+) &= g(x) \quad \text{for all } 0 \leq x \leq L. \end{aligned} \quad (12.121)$$

By the Method of Separation of Variables we search a solution of the wave equation (12.119) in the special form

$$u(x, t) = F(x) \cdot G(t). \quad (12.122)$$

By q -differentiating (12.122) according to q -Leibnitz Rule (2.12)

$$\begin{aligned} D_x^2 u(x, t) &= G(t) D_x^2 F(x) \\ \left(M_{\frac{1}{q}}^t D_t\right)^2 u(x, t) &= F(x) \left(M_{\frac{1}{q}}^t D_t\right)^2 G(t), \end{aligned}$$

and substituting to equation (12.119) we get separation of variables as

$$\frac{D_x^2 F(x)}{F(x)} = \frac{\left(M_{\frac{1}{q}}^t D_t\right)^2 G(t)}{c^2 G(t)} = k. \quad (12.123)$$

So we have two ordinary q -difference equations with separation constant k (in more general situation k is an arbitrary q -periodic function of x and t):

$$D_x^2 F(x) - kF(x) = 0, \quad (12.124)$$

$$\left(M_{\frac{1}{q}}^t D_t\right)^2 G(t) - c^2 k G(t) = 0. \quad (12.125)$$

We are looking for solutions $F(x)$ and $G(t)$ of (12.124) and (12.125) so that $u(x, t) = F(x)G(t)$ satisfies the boundary conditions (12.120)

$$\begin{aligned}u(0, t) &= F(0)G(t) = 0, \\u(L, t) &= F(L)G(t) = 0,\end{aligned}$$

for all t . For $G \neq 0 \Rightarrow F(0) = 0$, and $F(L) = 0$. Below we consider three cases, depending on values of k :

(a) $k = 0$: then the general solution is $F(x) = Ax + B$ (we consider A and B are constants, but possible to have A, B as a q -periodic functions) and applying the boundary conditions $F(0) = 0 \Rightarrow B = 0$ and $F(L) = 0 \Rightarrow A = 0$ imply that $F(x) = 0$, which gives no interesting solution $u(x, t) = 0$.

(b) $k > 0$: by choosing $k = \mu^2$ the general solution of (12.124) is

$$F(x) = Ae_q(\mu x) + Be_q(-\mu x),$$

where A and B are constants (or could be q -Periodic functions).

i) For $q > 1 \Rightarrow e_q(\mu x)$ is entire function for $\forall \mu x$, and without loss of generality we can choose $\mu > 0$.

ii) For $q < 1 \Rightarrow e_q(\mu x)$ converges in disk with radius $R = \mu L = \frac{1}{|1-q|}$. This poses restriction on parameter μ so that the solution should be convergent inside of interval $(0, L)$; $\mu = \frac{1}{|1-q|L}$.

When we apply the boundary conditions, we get

$$\begin{aligned}F(0) = 0 &\Rightarrow A = -B, \\F(L) = 0 &\Rightarrow Ae_q(\mu L) + Be_q(-\mu L) = 0 \Rightarrow B(e_q(-\mu L) - e_q(\mu L)) = 0.\end{aligned}$$

Suppose the term in parenthesis is zero

$$\begin{aligned}e_q(\mu L) - e_q(-\mu L) = 0 &\Rightarrow e_q(\mu L) = e_q(-\mu L) = \frac{1}{E_q(\mu L)} \\&\Rightarrow e_q(\mu L)E_q(\mu L) = 1 \Rightarrow e_q(\mu L + \mu L)_q = 1\end{aligned}$$

and then we expand the q -exponential function in terms of q -binomials

$$\begin{aligned}
 e_q(\mu L + \mu L)_q &= \sum_{n=0}^{\infty} \frac{(\mu L + \mu L)_q^n}{[n]!} = 1 \\
 &= 1 + (\mu L + \mu L) + \frac{(\mu L + \mu L)(\mu L + q\mu L)}{[2]!} + \dots = 1 \\
 &\Rightarrow (\mu L + \mu L) \left[1 + \frac{(\mu L + q\mu L)}{[2]!} + \dots \right] = 0.
 \end{aligned}$$

Since we choose $\mu > 0$ and $L > 0$, it implies that only option is $B = 0 \Rightarrow A = 0 \Rightarrow F = 0 \Rightarrow u(x, t) = 0$ which is also not interesting solution.

(c) $k < 0 \Rightarrow k = -p^2$, then (12.124) becomes $D_x^2 F(x) + p^2 F(x) = 0$, which is equation of q -harmonic oscillator from Section 3.2.

We suppose its solution in the form

$$F(x) = e_q(sx) \Rightarrow (s^2 + p^2)e_q(sx) = 0.$$

Since $e_q(sx)$ for $q > 1$ has no poles, it is satisfied by $s = \pm ip$ for any x . Then the general solution of (12.124) is

$$F(x) = ae_q(ipx) + be_q(-ipx) = A \cos_q(px) + B \sin_q(px). \quad (12.126)$$

Applying the Boundary conditions

$$F(0) = F(L) = 0,$$

we get

$$F(0) = 0 \Rightarrow A \cos_q 0 + B \sin_q 0 = 0 \Rightarrow A = 0$$

$$F(L) = 0 \Rightarrow B \sin_q(pL) = 0 \Rightarrow$$

$$\sin_q(pL) = 0. \quad (12.127)$$

Then constant p is restricted by

$$p_n = \frac{x_n(q)}{L}, \quad (n = 1, 2, \dots), \quad (12.128)$$

where $x_n(q)$ are the zeros of $\sin_q x$ function: $\sin_q x_n(q) = 0$.

As we show in Section 12.8, the $\sin_q x$ function possess several zeros. In fact we have conjecture that this function has infinite number of zeros. However the exact formula for these zeros is not known. In Section 12.8.2 we propose approximation of these zeros in the form

$$x_n = (q^2)^{n-1} x_1(q), \quad n = 1, 2, \dots,$$

which provides good precision comparing with numerical estimation.

Then, we have

$$F_n(x) = B_n \sin_q(p_n x) = B_n \sin_q\left(\frac{x_n}{L} x\right) \Rightarrow F(x) = B_n \sin_q\left(\frac{x_n}{L} x\right),$$

where $n = 1, 2, \dots$

Now we solve time dependent part (12.125) with $k = -p^2$. Then, we have

$$(s^2 + p^2 c^2) E_q(st) = 0. \quad (12.129)$$

For $q > 1$ the evolution is restricted to this interval

$$|t| < \frac{1}{|s||1 - q|}.$$

If in definition of q -traveling wave we use another form $f(ct + x)_q$ and $g(ct - x)_q$, then

we get opposite situation with restricted x :

$$|x| < \frac{1}{|s||1-q|}, \quad \forall t,$$

which is good for finite interval B.V.P. In this case

$$L \leq \frac{1}{|s||1-q|} \Rightarrow |s| \leq \frac{1}{L|1-q|},$$

where $s = \pm ip \Rightarrow |s| = |p| \Rightarrow |p| \leq \frac{1}{L|1-q|}$.

Suppose $E_q(st) \neq 0$, so we can choose $s = \pm ipc$ to satisfy (12.129). It implies particular solutions in the form $E_q(ipct)$ and $E_q(-ipct)$. Function $E_q(sx)$ has infinite set of poles at $t = \frac{1}{iq^n(1-q)}$. Then, $E_q(ipct)$ has pole singularity at positions $t = \frac{1}{icq^n(1-q)}$, which are in complex domain. In (12.129) first term has two pure imaginary zeros $s = \pm ip$. At the same time the $E_q(st)$ has no pole singularities for real t . This why equation is valid for any real x .

Therefore the general solution for the equation (12.125) is

$$\begin{aligned} G_n(t) &= c_n E_q(p_n ct) + d_n E_q(-p_n ct) \\ &= C_n \text{Cos}_q(p_n ct) + D_n \text{Sin}_q(p_n ct). \end{aligned} \quad (12.130)$$

Hence, solution of (12.119) satisfying the boundary conditions (12.120) is

$$u(x, t) = \sum_{n=1}^{\infty} \sin_q(p_n x) (C_n \text{Cos}_q(p_n ct) + D_n \text{Sin}_q(p_n ct)), \quad (12.131)$$

where $p_n = \frac{x_n(q)}{L}$. Arbitrary constants C_n, D_n can be fixed by initial conditions. For initial displacement (12.121) we have

$$u(x, 0) = f(x) = \sum_{n=1}^{\infty} C_n \sin_q(p_n x). \quad (12.132)$$

For the initial velocity $g(x)$, by q -differentiating the $u_n(x, t)$ with respect to t

$$D_t u_n(x, t) = \sum_{n=1}^{\infty} \sin_q(p_n x) (-C_n p_n c \text{Sin}_q(p_n q ct) + D_n p_n c \text{Cos}_q(p_n q ct))$$

and applying the initial condition $D_t u(x, 0^+) = g(x)$, we have

$$g(x) = \sum_{n=1}^{\infty} D_n p_n \sin_q(p_n x), \quad (12.133)$$

where $p_n = \frac{x_n(q)}{L}$. Hence, to choose C_n and D_n we have to solve the system (12.132) and (12.133). However solving this system (12.132) and (12.133) is not simple problem. It is related with orthogonality property of $\text{Sin}_q x$ functions. If we consider more restricted problem with vanishing initial velocity $g(x) = 0$, then

$$D_t u(x, 0^+) = \sum_{n=1}^{\infty} \sin_q(p_n x) D_n p_n = 0 \Rightarrow D_n = 0$$

so that solution for q -wave equation is

$$u(x, t) = \sum_{n=1}^{\infty} C_n \sin_q(p_n x) \text{Cos}_q(p_n ct), \quad (12.134)$$

where $p_n = \frac{x_n}{L}$, and $x_n = x_n(q)$ -zeros of $\sin_q x$ function. Even in this case constants C_n still should be fixed by initial displacements (12.132).

The solution (12.134) may also be written in explicit form

$$u(x, t) = \sum_{n=1}^{\infty} \tilde{C}_n (\sin_q(p_n(x + ct))_q + \sin_q(p_n(x - ct))_q). \quad (12.135)$$

This shows that our solution of q -wave equation has form of superposition of q -traveling waves.

12.8. q -Bernoulli Numbers and Zeros of q -Sine Function

In previous section we have solved the B.V.P. for q -wave equation in terms of zeros of q -sin function. In this section we are going to study zeros of \sin_q function and their relation to q -Bernoulli numbers (Nalci & Pashaev, 2011a).

12.8.1. Zeros of Sine Function and Riemann Zeta Function

First we briefly review the known relation between the zeros of $\sin x$ function, Bernoulli numbers and Riemann Zeta function. The generating function for Bernoulli polynomials is

$$F_x(z) = \frac{ze^{zx}}{e^z - 1} \quad (12.136)$$

and Taylor series expansion of it determines the Bernoulli polynomials in x , $B_n(x)$, $\forall n > 0$

$$\frac{ze^{zx}}{e^z - 1} = \sum_{n=0}^{\infty} B_n(x) \frac{z^n}{n!}. \quad (12.137)$$

By differentiating this expression we get the recursion formula for Bernoulli polynomials

$$B'_n(x) = nB_{n-1}(x), \quad n \geq 1. \quad (12.138)$$

Proposition 12.8.1.1

$$\forall n \geq 1, \quad B_n(x+1) - B_n(x) = nx^{n-1}. \quad (12.139)$$

Proof 12.8.1.2

$$\begin{aligned} B_n(x+1) - B_n(x) &= \sum_{n=0}^{\infty} B_n(x+1) \frac{z^n}{n!} - \sum_{n=0}^{\infty} B_n(x) \frac{z^n}{n!} \\ &= \frac{ze^{z(x+1)}}{e^z - 1} - \frac{ze^{zx}}{e^z - 1} = \frac{d}{dx} e^{zx}. \end{aligned}$$

$$\frac{d}{dx} e^{zx} = \sum_{n=1}^{\infty} \frac{nz^n x^{n-1}}{n!} = \sum_{n=0}^{\infty} B_n(x+1) \frac{z^n}{n!} - \sum_{n=0}^{\infty} B_n(x) \frac{z^n}{n!}$$

By equating the power of z , we get the desired result. ■

Definition 12.8.1.3 *Bernoulli numbers* are defined as $B_n(0) = b_n$.

Then the generating function for Bernoulli numbers is obtained by taking $x = 0$ in generating function (12.137)

$$\frac{z}{e^z - 1} = \sum_{n=0}^{\infty} b_n \frac{z^n}{n!}. \quad (12.140)$$

Below we display first few Bernoulli polynomials and numbers

$$\begin{aligned} B_0(x) &= 1, & B_1(x) &= x - \frac{1}{2}, & B_2(x) &= x^2 - x + \frac{1}{6}, & B_3(x) &= x^3 - \frac{3}{2}x^2 + \frac{1}{2}x \\ b_0 &= 1, & b_1 &= -\frac{1}{2}, & b_2 &= \frac{1}{6}, & b_3 &= 0. \end{aligned}$$

Proposition 12.8.1.4

$$\forall n > 0 \quad B_n(x) = \sum_{j=0}^n \binom{n}{j} b_j x^{n-j}. \quad (12.141)$$

Proof 12.8.1.5 We consider $F_n(x)$ as polynomial of degree n :

$$F_n(x) = \sum_{j=0}^n \binom{n}{j} b_j x^{n-j}.$$

It satisfies obviously

$$F_n(0) = b_n, \quad (n = j).$$

By differentiating

$$\frac{d}{dx}F_n(x) = \sum_{j=1}^{n-1} \binom{n}{j} (n-j)b_j x^{n-j-1} = n \sum_{j=0}^{n-1} \binom{n-1}{j} b_j x^{n-j-1} = nF_{n-1}(x),$$

we get the recursion formula

$$F'_n(x) = nF_{n-1}(x), \quad n \geq 1.$$

This formula as the first order differential equation with initial value $F_n(0) = b_n$, determines $F_n(x)$ uniquely for any n and x . Since recursion formula and initial values for $F_n(x)$ and $B_n(x)$ coincide, $F_n(x) = B_n(x)$. ■

Bernoulli numbers allows one to calculate the values of Riemann Zeta function at even numbers on usual case (Sury, 2003). We consider infinite product representation for $\sin z$:

$$\sin z = z \prod_{n=1}^{\infty} \left(1 - \frac{z^2}{\pi^2 n^2}\right). \quad (12.142)$$

$$\begin{aligned} \frac{d}{dz} \ln(\sin z) &= \frac{d}{dz} \left(\ln \left(z \prod_{n=1}^{\infty} \left(1 - \frac{z^2}{\pi^2 n^2}\right) \right) \right) = \frac{d}{dz} \left(\ln z + \ln \sum_{n=1}^{\infty} \left(1 - \frac{z^2}{\pi^2 n^2}\right) \right) \\ &= \frac{\cos z}{\sin z} = \frac{1}{z} + \sum_{n=1}^{\infty} \frac{\frac{-2z}{\pi^2 n^2}}{1 - \frac{z^2}{\pi^2 n^2}} \end{aligned}$$

$$z \cot z = 1 - 2 \sum_{n=1}^{\infty} \frac{z^2}{n^2 \pi^2} \frac{1}{1 - \frac{z^2}{n^2 \pi^2}} = 1 - 2 \sum_{n=1}^{\infty} \frac{z^2}{n^2 \pi^2} \left(1 + \frac{z^2}{n^2 \pi^2} + \frac{z^4}{n^4 \pi^4} + \dots\right)$$

$$z \cot z = 1 - 2 \sum_{n=1}^{\infty} \sum_{k=1}^{\infty} \frac{z^{2k}}{n^{2k} \pi^{2k}} \quad (12.143)$$

The Bernoulli numbers are written (12.140)

$$\frac{x}{e^x - 1} = \sum_{n=0}^{\infty} b_n \frac{x^n}{n!},$$

where $b_{2n+1} = 0$ for $n \geq 1$. By choosing $x = 2iz$ in the above expression

$$\frac{2iz}{e^{2iz} - 1} = \frac{ze^{-iz}}{\sin z} = \frac{z(\cos z - i \sin z)}{\sin z} = \sum_{n=0}^{\infty} b_n \frac{(2iz)^n}{n!} = b_0 + \sum_{k=1}^{\infty} b_{2k} \frac{(2iz)^{2k}}{(2k)!}$$

we get

$$z \cot z = 1 - \sum_{k=1}^{\infty} b_{2k} (-1)^{k-1} \frac{2^{2k} z^{2k}}{(2k)!}. \quad (12.144)$$

Here we used the fact that $b_{2k+1} = 0$ for $k = 1, 2, \dots$. It follows obviously from observation that l.h.s. is even function of z .

In this form, function on the l.h.s has infinite set of simple poles at $z = \pm\pi, \pm 2\pi, \dots$. If $|z| < \pi$, then it is analytic and has unique expansion to Taylor series around $z = 0$.

From the equality of the expressions (12.143) and (12.144), we obtain

$$\sum_{n=1}^{\infty} \frac{1}{n^{2k}} = (-1)^{k-1} b_{2k} \frac{2^{2k-1}}{(2k)!} \pi^{2k}. \quad (12.145)$$

Definition 12.8.1.6 For any real number $s > 1$, the **Riemann Zeta function** is defined by

$$\zeta(s) = \sum_{n=1}^{\infty} \frac{1}{n^s}. \quad (12.146)$$

Actually, it can be defined as a complex valued function for any complex number s with

$Re(s) > 1$ by the same series.

Then, by using the (12.145) the Riemann Zeta function is written in terms of Bernoulli Numbers as follows

$$\zeta(2k) = (-1)^{k-1} b_{2k} \frac{2^{2k-1}}{(2k)!} \pi^{2k}. \quad (12.147)$$

The following are the first few values of the Riemann zeta function:

$$\zeta(2) = \sum_{n=1}^{\infty} \frac{1}{n^2} = \frac{\pi^2}{6}, \quad (12.148)$$

$$\zeta(4) = \sum_{n=1}^{\infty} \frac{1}{n^4} = \frac{\pi^4}{90}, \quad (12.149)$$

$$\zeta(6) = \sum_{n=1}^{\infty} \frac{1}{n^6} = \frac{\pi^6}{945}. \quad (12.150)$$

12.8.2. q -Bernoulli Polynomials and Numbers

Now we introduce the q -analogue of Bernoulli polynomials and Bernoulli numbers. The generating function for q -Bernoulli polynomials we define as (Nalci & Pashaev, 2011a)

$$F_x(z)_q = \frac{ze_q(xz)}{E_q(\frac{z}{2})(e_q(\frac{z}{2}) - e_q(-\frac{z}{2}))} = \frac{ze_q(xz)e_q(-\frac{z}{2})}{e_q(\frac{z}{2}) - e_q(-\frac{z}{2})} = \sum_{n=0}^{\infty} B_n^q(x) \frac{z^n}{[n]!}, \quad (12.151)$$

where we have used the relation $e_q(x)E_q(-x) = 1$.

By q -differentiation the generating function with respect to x , it is easy to obtain the recursion formula

$$D_x B_n^q(x) = [n] B_{n-1}^q(x), \quad (12.152)$$

where $B_0^q(x) = 1$.

Definition 12.8.2.1 For $n \geq 0$, $b_n^q \equiv B_n^q(0)$ are called the q -Bernoulli numbers.

According to above definition the generating function for q -Bernoulli numbers is given by

$$F_0(z)_q = \frac{z}{E_q\left(\frac{z}{2}\right) \left(e_q\left(\frac{z}{2}\right) - e_q\left(-\frac{z}{2}\right)\right)} = \sum_{n=0}^{\infty} b_n^q \frac{z^n}{[n]!}. \quad (12.153)$$

By using definition of q -exponential functions we expand the generating function as

$$\begin{aligned} \frac{z}{E_q\left(\frac{z}{2}\right) \left(e_q\left(\frac{z}{2}\right) - e_q\left(-\frac{z}{2}\right)\right)} &= \frac{1}{1 + \frac{z}{2} + \frac{z^2}{4[3]!} + q \frac{z^2}{4[2]!} + \dots} & (12.154) \\ &= 1 - \left(\frac{z}{2} + \frac{z^2}{4[3]!} + q \frac{z^2}{4[2]!} + \dots \right) \\ &+ \left(\frac{z}{2} + \frac{z^2}{4[3]!} + q \frac{z^2}{4[2]!} + \dots \right)^2 + \dots \\ &= b_0^q + b_1^q z + b_2^q \frac{z^2}{[2]!} + \dots & (12.155) \end{aligned}$$

Comparing terms with the same power of z we get first few q -Bernoulli numbers (see Appendix I):

$$b_0^q = 1, \quad b_1^q = -\frac{1}{2}, \quad b_2^q = \frac{1}{4} \left([2] - \frac{1}{[3]} - q \right), \quad b_3^q = 0, \quad (12.156)$$

$$b_4^q = \frac{[4]}{2^4} \left([3]! - [2]^3 + \frac{[4]^2}{[3]!} - \frac{q}{[2]!} - \frac{[5]q^6 + 1}{[5][4]} \right). \quad (12.157)$$

By choosing $z \equiv 2it$ in generating function (12.153), we obtain

$$F_0(2it)_q = \frac{2it}{E_q(it) \left(e_q(it) - e_q(-it)\right)} = \frac{t}{E_q(it) \sin_q t} = \frac{te_q(-it)}{\sin_q t}. \quad (12.158)$$

From the q -analogue of Euler identity $e_q(ix) = \cos_q x + i \sin_q x$, we have

$$\begin{aligned} F_0(2it)_q &= \frac{t}{\sin_q t} (\cos_q t - i \sin_q t) = t \cot_q t - it = \sum_{n=0}^{\infty} b_n^q \frac{(2it)^n}{[n]!} \\ &= b_0^q + b_1^q(2it) + \sum_{n=2}^{\infty} b_n^q \frac{(2it)^n}{[n]!}. \end{aligned}$$

Then, substituting b_0^q and b_1^q into the above equality we get

$$t \cot_q t = 1 + \sum_{n=2}^{\infty} b_n^q \frac{(2it)^n}{[n]!}, \quad (12.159)$$

or

$$t \cot_q t = 1 + \sum_{k=1}^{\infty} b_{2k}^q \frac{(2it)^{2k}}{[2k]!}. \quad (12.160)$$

Here the l.h.s. is even function of t , so that in the last sum odd coefficients vanish $b_{2k+1} = 0$ for $k = 1, 2, \dots$

In this expression the l.h.s. has set (infinite) of simple poles $t = \pm t_1, \pm t_2, \dots$, ordered as $|t_1| < |t_2| < |t_3| < \dots$. Then if we choose value of t in the disk $|t| < |t_1|$, the function is analytic and possesses unique expansion to Taylor series around $t = 0$.

Now we like to express the l.h.s. of (12.160) in terms of zeros of $\sin_q x$ function. We start with proposition :

Proposition 12.8.2.2 q -Generalized Leibnitz Rule:

$$\begin{aligned} D_q(f_1(x)f_2(x)\dots f_n(x)) &= (D_q f_1(x)) f_2(x)\dots f_n(x) \\ &+ f_1(qx) (D_q f_2(x)) f_3(x)\dots f_n(x) \\ &+ \dots \\ &+ f_1(qx)f_2(qx)\dots f_{n-1}(qx) (D_q f_n(x)) \end{aligned} \quad (12.161)$$

Proof 12.8.2.3 For $n = 1$ it is evident. By using the q -Leibnitz rule (2.12) for $n = 2$,

$$D_q(f_1(x)f_2(x)) = (D_q f_1(x)) f_2(x) + f_1(qx) (D_q f_2(x)).$$

Suppose it is true for some n . Then by induction, we show that it is true for $n + 1$

$$\begin{aligned} D_q(f_1(x)f_2(x)\dots f_n(x)f_{n+1}(x)) &= D_q(f_1(x)f_2(x)\dots f_n(x))f_{n+1}(x) \\ &+ f_1(qx)f_2(qx)\dots f_n(qx) (D_q f_{n+1}(x)) \\ &= ((D_q f_1(x))\dots f_n(x) + \dots \\ &+ f_1(qx)\dots (D_q f_n(x))f_{n+1}(x) \\ &+ f_1(qx)f_2(qx)\dots f_n(qx)(D_q f_{n+1}(x)), \end{aligned}$$

which is the desired result. ■

According to the above proposition we have the following rule of differentiation (q -analogue of logarithmic derivative)

$$\frac{D_q(f_1 f_2 \dots f_n)}{f_1 f_2 \dots f_n} = \frac{f'_1(x)}{f_1(x)} + \frac{f_1(qx)}{f_1(x)} \frac{f'_2(x)}{f_2(x)} + \dots + \frac{f_1(qx)}{f_1(x)} \dots \frac{f_{n-1}(qx)}{f_{n-1}(x)} \frac{f'_n(x)}{f_n(x)} \quad (12.162)$$

Example: If $f_k = (x - x_k)$ and $f_1 \dots f_n = \prod_{k=1}^n (x - x_k)$ is function with n zeros, x_1, \dots, x_n , then we have

$$\begin{aligned} \frac{D_q(\prod_{k=1}^n (x - x_k))}{\prod_{k=1}^n (x - x_k)} &= \frac{1}{(x - x_1)} + \frac{(qx - x_1)}{(x - x_1)} \frac{1}{(x - x_2)} \\ &+ \frac{(qx - x_1)(qx - x_2)}{(x - x_1)(x - x_2)} \frac{1}{(x - x_3)} + \dots \\ &+ \frac{(qx - x_1)(qx - x_2)(qx - x_3)}{(x - x_1)(x - x_2)(x - x_3)} \dots \frac{(qx - x_{n-1})}{(x - x_{n-1})} \frac{1}{(x - x_n)}, \end{aligned}$$

as a simple pole expansion. Expanded to simple fractions this expression can be rewritten as

$$\frac{D_q(\prod_{k=1}^n (x - x_k))}{\prod_{k=1}^n (x - x_k)} = \sum_{k=1}^n \frac{A_k}{x - x_k}, \quad (12.163)$$

where coefficients

$$A_k = Res_{|x=x_k} \frac{D_q \left(\prod_{k=1}^n (x - x_k) \right)}{\prod_{k=1}^n (x - x_k)} = Res_{|x=x_k} \left(\frac{1}{(x - x_1)} + \frac{(qx - x_1)}{(x - x_1)} \frac{1}{(x - x_2)} + \dots + \frac{(qx - x_1)(qx - x_2)}{(x - x_1)(x - x_2)} \dots \frac{1}{(x - x_n)} \right)$$

Particularly, for $n = 2$,

$$\begin{aligned} A_1 &= \lim_{x \rightarrow x_1} \left((x - x_1) \left(\frac{1}{x - x_1} + \frac{qx - x_1}{(x - x_1)(x - x_2)} \right) \right) \\ &= 1 + \frac{x_1(q - 1)}{(x_1 - x_2)} = \frac{qx_1 - x_2}{x_1 - x_2}, \end{aligned} \quad (12.164)$$

$$\begin{aligned} A_2 &= \lim_{x \rightarrow x_2} \left((x - x_2) \left(\frac{1}{x - x_1} + \frac{qx - x_1}{(x - x_1)(x - x_2)} \right) \right) \\ &= \frac{qx_2 - x_1}{x_2 - x_1}, \end{aligned} \quad (12.165)$$

and we get

$$\frac{D_q((x - x_1)(x - x_2))}{(x - x_1)(x - x_2)} = \left(\frac{qx_1 - x_2}{x_1 - x_2} \right) \frac{1}{x - x_1} + \left(\frac{qx_2 - x_1}{x_2 - x_1} \right) \frac{1}{x - x_2}. \quad (12.166)$$

■

We consider $\sin_q x$ function as an infinite product in terms of its zeros $x_n \equiv x_n(q)$ in the following form

$$\sin_q x = x \prod_{n=1}^{\infty} \left(1 - \frac{x^2}{x_n^2} \right) = x \left(1 - \frac{x^2}{x_1^2} \right) \left(1 - \frac{x^2}{x_2^2} \right) \dots \quad (12.167)$$

By using the above property (12.162), we have

$$\begin{aligned}
\frac{D_q \sin_q x}{\sin_q x} &= \cot_q x = \frac{D_q \left(x \prod_{n=1}^{\infty} \left(1 - \frac{x^2}{x_n^2} \right) \right)}{x \prod_{n=1}^{\infty} \left(1 - \frac{x^2}{x_n^2} \right)} \\
&= \frac{1}{x} + \frac{qx}{x} \frac{(-[2] \frac{x}{x_1^2})}{\left(1 - \frac{x^2}{x_1^2} \right)} + \frac{qx}{x} \frac{\left(1 - q^2 \frac{x^2}{x_1^2} \right) \left(-[2] \frac{x}{x_2^2} \right)}{\left(1 - \frac{x^2}{x_1^2} \right) \left(1 - \frac{x^2}{x_2^2} \right)} + \dots \\
&+ \frac{qx}{x} \frac{\left(1 - q^2 \frac{x^2}{x_1^2} \right) \left(1 - q^2 \frac{x^2}{x_2^2} \right) \left(-[2] \frac{x}{x_n^2} \right)}{\left(1 - \frac{x^2}{x_1^2} \right) \left(1 - \frac{x^2}{x_2^2} \right) \dots \left(1 - \frac{x^2}{x_n^2} \right)} + \dots, \tag{12.168}
\end{aligned}$$

where we ordered zeros as $|x| < |x_1| < |x_2| < \dots < |x_n| < \dots$, so that $|\frac{x}{x_k}| < 1$, for any k . The above expression can be written in a compact form as follows

$$x \cot_q x = 1 - [2]q \sum_{n=1}^{\infty} \frac{\frac{x^2}{x_n^2}}{\left(1 - \frac{x^2}{x_n^2} \right)} \prod_{k=1}^{n-1} \frac{\left(1 - q^2 \frac{x^2}{x_k^2} \right)}{\left(1 - \frac{x^2}{x_k^2} \right)}. \tag{12.169}$$

Now we compare expressions (12.160) and (12.169) by equating equal powers in x^2 :

$$\begin{aligned}
1 + b_2^q \frac{-4x^2}{[2]!} + b_4^q \frac{2^4 x^4}{[4]!} + \dots &= \\
\sum_{n=1}^{\infty} \frac{x^2}{x_n^2} \left(1 + \frac{x^2}{x_n^2} + \left(\frac{x^2}{x_n^2} \right)^2 + \dots \right) \cdot \left(1 + (1 - q^2) \frac{x^2}{x_1^2} + (1 - q^2) \left(\frac{x^2}{x_1^2} \right)^2 + \dots \right) \cdot \\
\left(1 + (1 - q^2) \frac{x^2}{x_2^2} + (1 - q^2) \left(\frac{x^2}{x_2^2} \right)^2 + \dots \right) \cdot \\
\dots \\
\left(1 + (1 - q^2) \frac{x^2}{x_{n-1}^2} + (1 - q^2) \left(\frac{x^2}{x_{n-1}^2} \right)^2 + \dots \right). \tag{12.170}
\end{aligned}$$

At the order x^2 we have

$$[2]q \sum_{n=1}^{\infty} \frac{1}{x_n^2} = b_2^q \frac{4}{[2]!}$$

and using (12.156) for the value of Bernoulli number $b_2^q = \frac{1}{4} \left([2] - q - \frac{1}{[3]} \right)$, we obtain

$$\sum_{n=1}^{\infty} \frac{1}{x_n^2(q)} = \frac{1}{[3]!}. \quad (12.171)$$

In the limiting case $q \rightarrow 1$, $[3]! = 6$ and we have

$$\lim_{q \rightarrow 1} \sum_{n=1}^{\infty} \frac{1}{x_n^2(q)} = \frac{1}{6}.$$

Due to relation (12.148)

$$\frac{1}{\pi^2} \zeta(2) = \sum_{n=1}^{\infty} \frac{1}{n^2 \pi^2} = \frac{1}{6},$$

it implies

$$\lim_{q \rightarrow 1} x_n(q) = n\pi.$$

At the order x^4 after long calculations (See details in Appendix J) we get the relation :

$$[2]_q \left(1 + \frac{q^2 - 1}{2} \right) \sum_{k=1}^{\infty} \frac{1}{x_k^4} = \frac{8(q^2 - 1)}{[2]_q^3} (b_2^q)^2 - \frac{4^2 b_4^q}{[4]!}, \quad (12.172)$$

where

$$b_2^q = \frac{1}{4} \left([2] - \frac{1}{[3]} - q \right)$$

$$b_4^q = \frac{[4]}{2^4} \left([3]! - [2]^3 + \frac{[4]^2}{[3]!} - \frac{q}{[2]!} - \frac{[5]q^6 + 1}{[5][4]} \right).$$

In the limiting case $q \rightarrow 1$,

$$\lim_{q \rightarrow 1} \sum_{n=1}^{\infty} \frac{1}{x_n^4(q)} = \frac{1}{90}.$$

From the relation (12.149) we get

$$\frac{1}{\pi^4} \zeta(4) = \sum_{n=1}^{\infty} \frac{1}{n^4 \pi^4} = \frac{1}{90}.$$

The exact form of zeros $x_n(q)$ of $\sin_q x$ is not known. It is an obstacle in further exact calculations. However by analyzing graph of $\sin_q x$ with several values of q we found next table :

Table 12.1. Table of q -sine zeros

q	x_1^*	x_1	x_2	$q^2 x_1$
5	13.65	13.6	350	340
10	34.945	34.945	3513	34.95
12	45.179	45.2	6500	6509
15	62.079	62.1	14000	13973

Comparing values at last two columns we see that with quite good approximation we can put $x_2 = q^2 x_1$. It implies next form of the zeros for $q > 1$

$$x_2 = q^2 x_1, \quad x_3 = q^2 x_2 = q^4 x_1, \dots, x_n = q^{2(n-1)} x_1,$$

then,

$$\begin{aligned} \frac{1}{[3]!} &= \sum_{n=1}^{\infty} \frac{1}{x_n^2} = \frac{1}{x_1^2} + \frac{1}{x_2^2} + \dots = \frac{1}{x_1^2} + \frac{1}{q^4 x_1^2} + \frac{1}{q^8 x_1^2} + \dots \\ &= \frac{1}{x_1^2} \left(1 + \frac{1}{q^4} + \left(\frac{1}{q^4} \right)^2 + \dots \right) \end{aligned} \quad (12.173)$$

and from sum of geometric series in $\frac{1}{q^4}$ we have

$$\frac{1}{[2][3]} = \frac{1}{x_1^2} \frac{q^4}{q^4 - 1}.$$

From this expression we have the first root as

$$x_1 = \pm \sqrt{[2][3] \frac{q^4}{q^4 - 1}}.$$

In table (12.1) in second column we display particular values for $x_1(q) = x_1^*$. Comparison with the third column shows quite good agreement. As a result, (12.167) can be written in the following form

$$\sin_q x = x \prod_{n=1}^{\infty} \left(1 - \frac{[4](q-1)x^2}{q^{4n}[3]!} \right), \quad (12.174)$$

where for wave number we have the discrete set $x_n^2 = \frac{q^{4n}[2][3]}{[4](q-1)}$.

These results can be used now for solving B.V.P. for q -wave equation. As we found the solution is in the form (12.134)

$$u(x, t) = \sum_{n=1}^{\infty} C_n \sin_q(p_n x) \text{Cos}_q(p_n ct), \quad (12.175)$$

where now

$$p_n = \frac{x_n}{L} = \pm \frac{1}{L} \frac{q^{2n}}{\sqrt{q-1}} \sqrt{\frac{[2][3]}{[4]}}.$$

12.8.3. q -Schrödinger Equation for a Particle in a Potential Well

Here we like to apply our results for solving q -Schrödinger equation

$$H\psi = E\psi \quad (12.176)$$

or

$$\left(-\frac{\hbar^2}{2m}D_x^2 + U(x)\right)\psi = E\psi, \quad (12.177)$$

where potential $U(x)$ is in the form

$$U(x) = \begin{cases} 0 & \text{if } 0 < x < L, \\ \infty & \text{otherwise} \end{cases}$$

For $0 < x < L$, we have

$$-\frac{\hbar^2}{2m}D_x^2\psi = E\psi$$

and the general solution

$$\psi(x) = Ae_q(ikx) + Be_q(-ikx)$$

with energy

$$E = \frac{\hbar^2 k^2}{2m}.$$

In a real form it gives

$$\psi(x) = a \sin_q(kx) + b \cos_q(kx)$$

with boundary conditions :

$$i) \psi(0) = 0, \quad ii) \psi(L) = 0$$

First boundary condition i) implies that $b = 0$, this why

$$\psi(x) = a \sin_q(kx),$$

then from ii) we have

$$\sin_q(kL) = 0,$$

where $k_n = \frac{x_n}{L}$. As a result the wave function is found as

$$\psi_n(x) = a \sin_q\left(\frac{x_n}{L}x\right), \quad (12.178)$$

with discrete energy spectrum

$$E_n = \frac{\hbar^2 k_n^2}{2m} = \frac{\hbar^2 x_n^2}{2mL^2}. \quad (12.179)$$

The approximate formula for $x_n^2 = \frac{q^{4n} [2][3]}{[4](q-1)}$ gives the energy spectrum explicitly

$$E_n = \frac{\hbar^2}{2mL^2} \frac{q^{4n}}{(q-1)} \frac{[2][3]}{[4]}.$$

The ground state wave function is obtained in the following form

$$\psi_1(x) = a \sin_q\left(\frac{x_1}{L}x\right),$$

where $x_1 = \pm \sqrt{[2][3] \frac{q^4}{q^4-1}}$ with ground state energy

$$E_1 = \frac{\hbar^2}{2mL^2} \frac{q^4}{(q-1)} \frac{[2][3]}{[4]}.$$

CHAPTER 13

CONCLUSION

In the present thesis we studied q -extended exactly solvable linear and nonlinear classical and quantum models. We formulated and solved classical q -harmonic oscillator and q -damped harmonic oscillator. For the last one, solutions in the form of Jackson's q -exponential functions were obtained for three different cases: under-damping, over-damping and critical cases. For critical case, we constructed complete set of independent solutions different from the standard degenerate solution roots. Our second solution appears as the standard logarithmic derivative of q -exponential function. These results were generalized for arbitrary constant coefficient q -difference equation with n -degenerate roots. We showed that it admits n -linearly independent solutions in terms of standard logarithmic derivative of proper order and q -logarithm function.

We constructed q -space time difference heat equation and q -space difference and time differential heat equation. For solving these equations we introduced a new set of q -Hermite polynomials with three-terms recurrence relations and n -terms recurrence relations, correspondingly. In terms of these polynomials we get solution of our equations as the q -Kampe-de Fariet polynomials. By using q -Cole-Hopf transformation nonlinear heat equation in the form of q -Burgers' type equation with cubic nonlinearity were obtained. Then we solved I.V.P. for this equation and found exact solutions in the form of q -shock solitons. By proper choice of parameters we succeeded in getting regular shock soliton structure for our solutions. We extended our results to linear q -Schrödinger equation and related nonlinear q -Maddelung equation.

To treat more general problems in classical and quantum physics, we introduced calculus with multiple base q . In addition to non-symmetrical and symmetrical reductions of this calculus, we studied in details the Fibonacci case, based on Binet-Fibonacci formula with q -deformation as Golden ratio. Relation between q -periodic functions and Euler equations was established. We have derived new Q -commutative q -binomial formula, completely determined in terms of (Q, q) calculus, which includes all known Newton's, Gauss' and non-commutative binomials as particular cases.

We reviewed q -deformed quantum harmonic oscillator with generic parameters and corresponding reductions as non-symmetrical, symmetrical cases. Special attention we paid for the Binet-Fibonacci Golden oscillator, producing spectrum in the form of Fi-

bonacci sequence. Asymptotic ratio of successive energy levels for this oscillator is given by Golden ratio number. Double boson representation of q -deformed angular momentum in all three cases was described. In Golden oscillator case the Casimir eigenvalues were found as product of successive Fibonacci numbers. The q -deformed angular momentum as nonlinear transformation of the usual angular momentum was shown.

The q -function of two variables was introduced and addition formulas for q -exponential functions were derived. We constructed q -holomorphic function and corresponding q -Cauchy-Riemann equations. It was shown that this function is analytic in the set of complex planes with q -re-scaled imaginary axis and intersecting along the real line x . Though the q -holomorphic function is not analytic in the standard complex analysis sense, we were able to show that some class of q -analytic functions satisfies the special form of Dbar equation and belongs to generalized analytic functions, introduced by Vekua and having many applications in mathematical physics. Hyperbolic form of analytic function we treat as traveling wave problem. For the q -traveling wave, existence of a set of moving frames with q -re-scaled speeds was shown. The q -traveling wave was constructed and q -D'Alembert solution of q -wave equation in terms of these functions was derived. In order to solve the B.V.P. for q -wave equation we introduced generating function and q -Bernoulli polynomials and numbers. Using these results, zeros of q -Sine function we related with our q -Bernoulli numbers. Approximate formula for zeros of q -Sine function and solution of q -Schrödinger equation for particle in a box were obtained.

REFERENCES

- Ablowitz, M.J. and Fokas, A.S., 1997. *Complex variables: Introduction and Applications*. Cambridge University Press.
- Adler, M., Horozov, E. and van Moerbeke P., 1998. The solution to the q-KdV equation. *Physics Letters A*, Vol. 242, pp.139-151.
- Algin, A., 2008. Bose-Einstein condensation in a gas of the Fibonacci oscillators. *arXiv:0810.1827v1*.
- Al-Salam, W.A., 1959. q-Bernoulli numbers and polynomials. *Math. Nachr.* Vol. 17, pp.239-260.
- Ahmedov, H. and Duru, I.H., 1997. A q-oscillator Green Function. *J. Math. Phys.* , Vol. 38, pp.3889-3894.
- Andrews, G.E., 1986. q-series: their development and applications in analysis, number theory, combinatorics, physics and computer algebra *AMS*.
- Andrews, G.E., Askey, R. and Roy R., 1999. *Special functions. Encyclopedia of Mathematics and its applications*, 71, (Cambridge University Press).
- Arik, M. and Coon, D.D., 1976. Hilbert spaces of analytic functions and generalized coherent states. *J. Math. Phys.* , Vol. 17, p.524.
- Arik, M., Demircan, E., Turgut, T., Ekinici, L. and Mungan, M., 1992. Fibonacci Oscillators. *Z. Phys. C - Particles and Fields* , Vol. 55, pp.89-95.
- Askey, R., 1996. A Brief Introduction to the World of q. *Centre de Recherches Mathématiques, CRM Proceedings and Lecture Notes*, Vol.9.
- Avancini, S.S. and Krein, G., 1995. Many-body problems with composite particles and q-Heisenberg algebras. *J. Phys.A*, Vol. 28, pp. 685-691.
- Biedenharn, L.C., 1989. The quantum group $SU_q(2)$ and a q-analogue of the boson operators. *J.Phys. A: Math. Gen.*, Vol. 22, pp.873-878.
- Bonatsos, D. and Daskaloyannis, C., 1999. Quantum Groups and Their Applications in Nuclear Physics. *Progress in Particle and Nuclear Physics*, Vol. 43, pp.537-618.
- Chakrabarti, R. and Jagannathan, R., 1991. A (p,q)-oscillator realization of two-parameter quantum algebras. *J. Phys. A: Math. Gen.*, Vol. 24, p.L711.

- Carlitz, L., 1948. q -Bernoulli numbers and polynomials. *Duke math. Jour.*, Vol. 15, pp.987-1000.
- Carlitz, L., 1974. Fibonacci notes. III. q -Fibonacci numbers. *Fibonacci Quart.*, Vol.12, pp.317-322.
- Chan, F.L. and Finkelstein, R.J., 1994. q -deformation of the Coulomb problem. *J. Math. Phys.*, Vol.35, pp.3273-3284.
- Chung, K.S., Chung, W.S., Nam, S.T. and Kang, H.J., 1994. New q -derivative and q -logarithm. *International Journal of theoretical physics*, Vol. 33, pp.2019-2029.
- Cigler, J., 2003. A new class of q -Fibonacci polynomials. *The Electronic Journal of Combinatorics* 10, R19.
- Cigler, J. and Zeng, J., 2009. Two curious q -Analogues of Hermite Polynomials. *arXiv:0905.0228*.
- Chaichian, M., Ellinas, D. and Kulish, P., 1990. Quantum Algebra as the Dynamical Symmetry of the Deformed Jaynes-Cumming Model. *Phys. Rev. Lett.*, Vol. 65, pp.980-983.
- Connes, A., 1994. *Noncommutative Geometry*. Academic Press.
- Dayi, Ö.F. and Duru, I.H., 1997. q -Schrödinger Equations for $v = u^2 + 1/u^2$ and Morse Potentials in terms of q -Canoniacal Transformations. *Int. J. Mod. Phy. A*, Vol. 12, pp.2373-2384.
- Ernst, T., 2008. q -Complex Numbers, A natural consequence of umbral calculus. *Preprint*.
- Ernst, T., 2001. *The history of q -calculus and a new method*.
- Exton, H., 1983. *q -Hypergeometric Functions and Applications*. John Wiley and Sons.
- Feigenbaum, J. and Freund, P.G.O., 1996. A q -deformation of the Coulomb problem. *J. Math. Phys.*, Vol. 37, pp.1602-1616.
- Feinsilver, P., 1987. Discrete analogues of the Heisenberg-Weyl algebra. *Monatshefte für Mathematik*, Vol. 104, pp.89-108.
- Floeanini, R. and Vinet, L., 1993. Automorphisms of the q -oscillator algebra and basic orthogonal polynomials. *Phys. Lett. A*, Vol. 180, pp.393-401.
- Floeanini, R. and Vinet, L., 1994. Symmetries of the q -difference heat equation. *Lett.*

- Phys. A* , Vol. 32, pp.37-44.
- Floeanini, R. and Vinet, L., 1995. Quantum symmetries of q-difference equations. *J. Math. Phys. A*, Vol. 36, pp.3134-3156.
- Floeanini, R., LeTourneux, J. and Vinet, L., 1995. More on the q-oscillator algebra and q-orthogonal polynomials. *J.Phys. A*, Vol. 28, pp.287-293.
- Finkelstein, R.J. and Marcus, E., 1995. Transformation theory of the q-oscillator. *J. Math. Phys.* , Vol. 36, pp.2652-2672.
- Finkelstein, R.J., 1998. q-Uncertainty relations. *J. Modern Phys. A* , Vol. 13, pp.1795-1803.
- Finkelstein, R.J., 1992. q-deformations of the oscillator. *J. Math. Phys.*, Vol. 33, pp.4259-4266.
- Finkelstein, R.J., 1996. The q-Coulomb problem. *J. Math. Phys.*, Vol. 37, pp.2628-2636.
- Frenkel, E., 1996. Deformations of the KdV Hierarchy and related soliton equations. *International mathematics research notices* 2, pp.55-76.
- Gessel, I., 1982. A q-analog of the exponential formula. *Discrete Math.*, Vol. 40, pp.69-80.
- Gray, R.W. and Nelson, C.A., 1990. A completeness relation for the q-analogue coherent states by q-integration. *J. Phys. A* , Vol. 23, pp.945-950.
- Hahn, W., 1949. Beiträge zur Theorie der Heineschen Reihen. *Mathematische Nachrichten* , Vol. 2, pp.340-379.
- Heine, E., 1846. Über die Reihe... . *J. reine angew. Math.*, Vol. 32, pp.210-212.
- Iliev, P., 1998. Tau function solutions to a q-deformation of the KP hierarchy. *Lett. Math. Phys.*, Vol. 44, pp.187-200.
- Iliev, P., 1998. Solutions to Frenkel's deformation of the KP hierarchy. *J. Phys. Math. Gen.* , Vol. 31, pp.241-244.
- Iliev, P., 1999. q-KP hierarchy, bispectrality and Calogero-Moser systems. *preprint*.
- Iliev, P., 1999. Commutative algebras of q-difference operators and Calogero-Moser hierarchy. *C.R. Acad. Sci. Paris.*, Vol. 329.

- Ismail, M., 2005. *Classical and Quantum Orthogonal Polynomials in One Variable*. Cambridge University Press.
- Jackson, F.H. 1908. On q-functions and a certain difference operator. *Trans. Roy Soc. Edin.*, Vol. 46, pp.253-281.
- Jackson, F.H., 1909. A q-form of Taylor's theorem. *Mess. Math.*, Vol. 38, pp.62-64.
- Jackson, F.H., 1910. On q-definite integrals. *Quart. J. Pure and Appl. Math.* , Vol. 41, pp.193-203.
- Jagannathan, R., Srinivasa Rao, K., 2006. Two-parameter quantum algebras, twin-basin numbers, and associated generalized hypergeometric series. *arXiv:math/0602613v1*.
- Jagannathan, R. and Sridhar, R., 2010. (p,q)-Rogers-Szegö polynomial and the (p,q)-oscillator. *arXiv:1005.4309v1*.
- Jannussis, A., Brodimas, G. and Mignani, R., 1991. Quantum groups and Lie-admissible time evolution. *J. Phys. A: Math. Gen.*, Vol. 24, pp.775-778.
- Kac, V. and Cheung, P., 2002. *Quantum Calculus*. New York: Springer.
- Kalnins, E.G., Manocha, H.L. and Miller, W.Jr., 1992. Models of q-algebra representations: tensor products of special unitary and oscillator algebras. *J. Math. Phys.*, Vol. 33, pp.2365-2383.
- Kaniadakis, G., Lavagno, A. and Quarati, P., 1997. Kinetic model for q-deformed bosons and fermions. *Phys. Lett. A*, Vol. 227, pp.227-231.
- Koshy, T., 2001. *Fibonacci and Lucas Numbers with Applications*. John Wiley and Sons.
- Kuang, L., 1993. A q-deformed harmonic oscillator in a finite-dimensional Hilbert space. *J.Phys. A: Math. Gen.*, Vol. 26, pp.1079-1083.
- Koblitz, N., 1982. On Carlitz's q-Bernoulli numbers. *Journal of number theory* , Vol. 14, pp.332-339.
- Lavagno, A., Scarfone A.M. and Narayana Swamy, P., 2006. Classical and quantum q-deformed physical systems. *arXiv:quant-ph/0605026v1*.
- Lavagno, A., 2008. Deformed quantum mechanics and q-Hermitian operators. *arXiv:0808.1976v1*.

- Lavagno, A. and Gervino, G., 2009. Quantum mechanics in q-deformed calculus. *Journal of Physics*, Conference Series. 147, 012071.
- Lee, C.R., 1990. On q-analogues of the quantum harmonic oscillators. *Chinese Journal of Physics*, Vol. 28, No.5.
- Macfarlane, A.J., 1989. On q-analogues of the quantum harmonic oscillator and the quantum group $SU(2)_q$. *J.Phys. A: Math. Gen.*, Vol. 22, pp.4581-4588.
- Mandelbrot, B.B., 1982. *The Fractal Geometry of Nature*. WH Freeman.
- Martina, L. and Pashaev, O.K., 2003. *In Nonlinear Physics: Theory and Experiment II. Noncommutative Burgers' Equation*. World Scientific.
- Mattis, D.C., 1965. *The Theory of Magnetism*. New York: Harper and Row.
- Moyal, J., 1990. Quantum Mechanics as a statistical Theory. *Proc. Camb. Philos. Soc.*, Vol. 45, pp.99.
- Nalci, S. and Pashaev, O.K., 2010. q-Analog of shock soliton solution. *J.Phys.A:Math.Theor.*, Vol. 43, 445205.
- Nalci, S. and Pashaev, O.K., 2011. q-Bernoulli Numbers and Zeros of q-Sine Function. *in preparation*.
- Nalci, S. and Pashaev, O.K., 2011. q-Traveling Waves and D'Alembert Solution of q-Wave Equation. *in preparation*.
- Nalci, S. and Pashaev, O.K., 2011. Q-Damped Oscillator and Degenerate Roots of q-ODE. *in preparation*.
- Nalci, S. and Pashaev, O.K., 2011. Q-commutative q-Binomial Formula. *in preparation*.
- Negro, J., 1996. *The Factorization Method and Hierarchies of q-Oscillator Hamiltonians Centre de Recherches Mathematiques CRM Proceedings and Lecture Notes*, Vol. 9, p.239.
- Panofsky, E., 1993. *Perspective as Symbolic Form*. Zone books.
- Pashaeva, S. and Pashaev O.K., 2008. Ancient Myth and Modern Science. *Matematik, Mantık ve Felsefe, İstanbul Kültür Üniversitesi*.
- Pashaev, O.K., 2009. Relativistic Burgers and Nonlinear Schrödinger equations. *Theoretical and Mathematical Physics*, Vol. 160, pp.1022-1030.

- Pashaev, O.K. and Yilmaz, O., 2008. Vortex images and q-elementary functions. *J.Phys.A:Math.Theor.*, Vol. 41, 135207.
- Pashaev, O.K. and Nalci, S., 2010. q-Shock Soliton Evolution. *arXiv: 1010.2675* ;
submitted to Chaos, Solitons and Fractals.
- Pashaev, O.K. and Nalci, S., 2011. Binet-Fibonacci Golden Oscillator. *in preparation.*
- Pashaev, O.K. and Nalci, S., 2011. q-Holomorphic Function as Generalized Analytic Function. *in preparation.*
- Rajkovic, P. and Marinkovic, S., 2001. On Q-analogies of generalized Hermite's polynomials. *Filomat*, Vol. 15, p.277.
- Rideau, G. and Winternitz, P., 1993. Representations of the quantum algebra $su_q(2)$ on a real two-dimensional sphere. *J. Math. Phys.* , Vol. 34, pp.6030-6044.
- Rosu, H.C. and Castro, C., 2000. q-deformation by interwinning with application to the singular oscillator. *Physics Letters A* , Vol. 264, pp.350-356.
- Ryoo, C.S., 2007. A note on q-Bernoulli numbers and polynomials. *Applied Mathematics Letters*, Vol. 20, pp.524-531.
- Salam, M.A. and Wybourne, B.G., 1991. The q-deformation of symmetric functions and the symmetric group. *J. Phys. A* , Vol. 24, pp.317-321.
- Satoh, J., 1989. q-Analogue of Riemann's ζ -function and q-Euler numbers. *Journal of number theory* , Vol. 31, pp.346-362.
- Song, X.C. and Liao, L., 1992. The quantum Schrödinger equation and the q-deformation of hydrogen atom. *J.Phys. A: Math. Gen.*, Vol. 25, pp.623-634.
- Song, X., 1990. The construction of the q-analogues of the harmonic oscillator operators from ordinary oscillator operators. *J.Phys. A: Math. Gen.*, Vol. 23, pp.L821-L825.
- Sury, B., 2003. Bernoulli Numbers and the Riemann Zeta Function. *Resonance*.
- Swarttouw, R.F. and Meijer, H.G., 1994. A q-analogue of the Wronskian and a second solution of the Hahn-Exton q-Bessel difference equation. *Proc. Amer. Math. Soc.* , Vol. 120, pp.855-864.
- Thuswaldner, J.M., 1996. q-Difference equations and their applications to combinatorial problems. *Grazer Mth. Ber.* , Vol. 328, pp.103-112.

Tsallis, C., 1988. *J. Stat. Phys.*, Vol. 52, p.479.

Tsuboi, Z. and Kuniba, A., 1996. Solutions of discretized Toda field equation for D_r from analytic Bethe ansatz. *J. Phys. A*, Vol. 29, pp.7785-7796.

Vekua, I.N., 1962. *Generalized Analytic Functions*. Pergamon.

Weyl, H., 1952. *Space-Time-Matter*. Dover.

Yang, Q.G. and Xu, B.W., 1993. Energy spectrum of a q-analogue of the hydrogen atom. *J.Phys.A*, Vol. 26, pp.365-368.

Yang, K.W., 1988. Solution of q-difference equations. *Bull.London Math.Soc.*, Vol. 20, pp.1-4.

APPENDIX A

Q-DIFFERENCE EQUATION WITH CONSTANT COEFFICIENTS

The constant coefficients q -difference equation of order N is

$$\sum_{k=0}^N a_k D^k x(t) = 0, \quad (\text{A.1})$$

where a_k are constants.

A.1. Wronskian of $x_1(t)$ and $x_2(t)$:

In order to prove that solutions $x_1(t) = e_q(-\omega t)$ and $x_2(t) = t \frac{d}{dt} e_q(-\omega t)$ are linearly independent, we check the q -Wronskian :

$$W_q = \begin{vmatrix} e_q(-\omega t) & t \frac{d}{dt} e_q(-\omega t) \\ D_q(e_q(-\omega t)) & D_q(t \frac{d}{dt} e_q(-\omega t)) \end{vmatrix}$$

, or

$$W_q = -\omega e_q(-\omega t) \left(e_q(-\omega t) - t \frac{d}{dt} e_q(-\omega t) \right). \quad (\text{A.2})$$

Here we show that the term in parenthesis is not identically zero. For $q > 1$, by using the infinite product representation of $e_q(x)$ (2.27), we get

$$e_q(-\omega t) = \prod_{n=0}^{\infty} \left(1 - \left(1 - \frac{1}{q} \right) \frac{1}{q^n} \omega t \right), \quad (\text{A.3})$$

$$t \frac{d}{dt} \ln e_q(-\omega t) = \sum_{n=0}^{\infty} \frac{-w \left(1 - \frac{1}{q}\right) \frac{1}{q^n} t}{1 - \left(1 - \frac{1}{q}\right) \frac{1}{q^n} \omega t},$$

or

$$t \frac{d}{dt} e_q(-\omega t) = A e_q(-\omega t), \quad (\text{A.4})$$

where

$$A \equiv \sum_{n=0}^{\infty} \frac{-w \left(1 - \frac{1}{q}\right) \frac{1}{q^n} t}{1 - \left(1 - \frac{1}{q}\right) \frac{1}{q^n} \omega t}$$

Expanding the denominator, we have

$$\begin{aligned} A &= \sum_{n=0}^{\infty} \left(- \left(1 - \frac{1}{q}\right) \frac{1}{q^n} \omega t \right) \sum_{l=0}^{\infty} \left(1 - \frac{1}{q}\right)^l \frac{1}{q^{nl}} (\omega t)^l \\ &= - \sum_{l=0}^{\infty} \left(1 - \frac{1}{q}\right)^{l+1} (\omega t)^{l+1} \sum_{n=0}^{\infty} \frac{1}{q^{n(l+1)}} \\ &= - \sum_{l=1}^{\infty} \frac{\left(\left(1 - \frac{1}{q}\right) \omega t \right)^l}{[l]} \frac{1}{1 - q} \end{aligned} \quad (\text{A.5})$$

where $|t| < \frac{q}{w}$. We know that

$$\ln(1 - x) = -x - \frac{x^2}{2} - \frac{x^3}{3} - \dots = - \sum_{l=1}^{\infty} \frac{x^l}{l}$$

and the q -analogue of this expression is given as

$$\text{Ln}_q(1 - x) = - \sum_{l=1}^{\infty} \frac{x^l}{[l]_q}. \quad (\text{A.6})$$

Then we rewrite

$$A = - \frac{1}{1 - q} \text{Ln}_q \left(1 - \left(1 - \frac{1}{q}\right) \omega t \right). \quad (\text{A.7})$$

The second solution $x_2(t)$ can also be rewritten in terms of q -logarithmic function

$$x_2(t) = t \frac{d}{dt} e_q(-\omega t) = \frac{1}{q-1} L n_q \left(1 - \left(1 - \frac{1}{q} \right) \omega t \right) e_q(-\omega t), \quad (\text{A.8})$$

where $|t| < \frac{q}{\omega}$. Finally, the q -Wronskian is not vanish

$$W_q = -\omega (e_q(-\omega t))^2 \left(1 - \frac{1}{q-1} L n_q \left(1 - \left(1 - \frac{1}{q} \right) \omega t \right) \right) \neq 0,$$

since the term

$$1 - \frac{1}{q-1} L n_q \left(1 - \left(1 - \frac{1}{q} \right) \omega t \right)$$

couldn't be identically zero.

A.2. Commutation Relations

Here we prove operator relations which we use in Chapter 3 for construction solutions with degenerate roots. By definition of D_q operator the commutation relation can be found as follows

$$\begin{aligned} \left[t \frac{d}{dt}, D \right] f &= t \frac{d}{dt} D f - D t \frac{d}{dt} f \\ &= t \frac{d}{dt} \left(\frac{f(qt) - f(t)}{(q-1)t} \right) - D \left(t \frac{df}{dt} \right) \\ &= t \left(\frac{(q-1)t (q f'(qt) - f'(t)) - (q-1) (f(qt) - f(t))}{(q-1)^2 t^2} \right) - \frac{qt \frac{df(qt)}{d(qt)} - t f'(t)}{(q-1)t}, \\ &= -D f \end{aligned} \quad (\text{A.9})$$

which implies

$$\left[t \frac{d}{dt}, D \right] = -D.$$

By using mathematical induction, let us prove the identity :

$$t \frac{d}{dt} D^n = D^n \left(t \frac{d}{dt} - n \right). \quad (\text{A.10})$$

For $n = 1$, from the above commutation relation it is easy to see, and we should show that it is true for $n + 1$,

$$\begin{aligned} t \frac{d}{dt} D^{n+1} &= t \frac{d}{dt} D^n D = D^n t \frac{d}{dt} D - n D^{n+1} \\ &= D^n D \left(t \frac{d}{dt} - 1 \right) - n D^{n+1} \\ &= D^{n+1} \left(t \frac{d}{dt} - (n + 1) \right). \end{aligned} \quad (\text{A.11})$$

Similar way easy to prove more general relation

$$t \frac{d}{dt} (\omega + D)^n = (\omega + D)^n t \frac{d}{dt} - n (\omega + D)^{n-1} D. \quad (\text{A.12})$$

APPENDIX B

MULTIPLE Q -POLYNOMIALS

B.1. Definition of Multiple q -Polynomials

In Section 9.1.5 we have introduced multiple q -analogue of q -binomials and in terms of it we define multiple q -polynomials as

$$P_n^{i,j}(x) = \frac{(x - a_1^{(n)}a)(x - a_2^{(n)}a)\dots(x - a_n^{(n)}a)}{[n]_{q_i, q_j}!}, \quad (\text{B.1})$$

where

$$a_k^{(n)} = q_i^{n-k} q_j^{k-1}.$$

The roots of this polynomial can be rewritten in the form

$$a_1^{(n)} = q_i^{n-1}$$

$$a_2^{(n)} = q_i^{n-1} Q_{ji}$$

$$a_3^{(n)} = q_i^{n-1} Q_{ji}^2$$

...

$$a_n^{(n)} = q_i^{n-1} Q_{ji}^{n-1}, \text{ where } Q_{ji} = \frac{q_j}{q_i}. \text{ Then}$$

$$P_n^{i,j}(x) = \frac{(x - q_i^{n-1}a)(x - q_i^{n-1}Q_{ji}a)\dots(x - q_i^{n-1}Q_{ji}^{n-1}a)}{[n]_{q_i, q_j}!}. \quad (\text{B.2})$$

By using the relations of Q_{ji} -numbers with (q_i, q_j) -numbers

$$[n]_{q_i, q_j} = q_i^{n-1} [n]_{Q_{ji}},$$

$$[n]_{q_i, q_j}! = q_i^{\frac{n(n-1)}{2}} [n]_{Q_{ji}}!$$

and by definition of the q -analogue of $(x - a)^n$ polynomial, which is given in Section 2.3 we can write (B.2) in the following form

$$P_n^{i,j}(x) = \frac{1}{q_i^{\frac{n(n-1)}{2}} [n]_{Q_{ji}}!} (x - q_i^{n-1} a)_{Q_{ji}}^n. \quad (\text{B.3})$$

B.1.1. Proof I of Recursion Derivative Property

In Section 9.1.5 we formulate following relation for multiple q -polynomials

$$D_{q_i, q_j} P_n(x) = P_{n-1}(x).$$

Here and in the next section we give two different proofs of this relation. By using the definition of q -multiple derivative

$$\begin{aligned} D_{q_i, q_j} P_n(x) &= \frac{(q_i x - b_i^{(n-1)}) \dots (q_i x - Q^{n-1} b_i^{(n-1)}) - (q_j x - b_i^{(n-1)}) \dots (q_j x - Q^{n-1} b_i^{(n-1)})}{[n]_{q_i, q_j}! (q_i - q_j) x} \\ D_{q_i, q_j} P_n(x) &= \frac{q_i^n \left(\left(x - \frac{b_i^{(n-1)}}{q_i} \right) \dots \left(x - \frac{Q^{n-1} b_i^{(n-1)}}{q_i} \right) - \left(Qx - \frac{b_i^{(n-1)}}{q_i} \right) \dots \left(Qx - \frac{Q^{n-1} b_i^{(n-1)}}{q_i} \right) \right)}{[n]_{q_i, q_j}! q_i \left(1 - \frac{q_j}{q_i} \right) x} \\ &= \frac{q_i^{n-1}}{[n]_{q_i, q_j}!} \frac{P_n^Q(x) - P_n^Q(Qx)}{(1 - Q)x}, \end{aligned}$$

where

$$P_n^Q(x) = \left(x - \frac{b_i^{(n-1)}}{q_i} \right) \left(x - Q \frac{b_i^{(n-1)}}{q_i} \right) \dots \left(x - Q^{n-1} \frac{b_i^{(n-1)}}{q_i} \right) = \left(x - \frac{b_i^{(n-1)}}{q_i} \right)_{Q}^n$$

Then from the definition of non-symmetrical Q -derivative $D_Q f(x) = \frac{f(Qx) - f(x)}{(Q-1)x}$,

$$\begin{aligned}
D_{q_i, q_j} P_n(x) &= \frac{q_i^{n-1}}{[n]_{q_i, q_j}!} D_Q^x P_n^Q(x) \\
&= \frac{q_i^{n-1}}{[n]_{q_i, q_j}!} D_Q^x \left(x - \frac{b_i^{(n-1)}}{q_i} \right)_Q^n \\
&= \frac{q_i^{n-1}}{[n]_{q_i, q_j}!} [n]_Q \left(x - \frac{b_i^{(n-1)}}{q_i} \right)_Q^{n-1} \\
&= \frac{1}{[n-1]_{q_i, q_j}!} \left(x - \frac{b_i^{(n-1)}}{q_i} \right)_Q^{n-1} \\
&= \frac{1}{[n-1]_{q_i, q_j}!} \left(x - \frac{b_i^{(n-1)}}{q_i} \right) \left(x - Q \frac{b_i^{(n-1)}}{q_i} \right) \dots \left(x - Q^{n-2} \frac{b_i^{(n-1)}}{q_i} \right)
\end{aligned} \tag{B.4}$$

and if we write $b_i^{(n-1)} \equiv q_i^{n-1} a$ and $Q = \frac{q_j}{q_i}$ into above expression, then we obtain

$$D_{q_i, q_j} P_n(x) = \frac{(x - q_i^{n-2} a)(x - q_i^{n-3} q_j a) \dots (x - q_i q_j^{n-3} a)(x - q_j^{n-2} a)}{[n-1]_{q_i, q_j}!} = P_{n-1}(x) \tag{B.5}$$

■

B.1.2. Proof II of Recursion Derivative Property

Before we give another way to prove that $P_n^{i,j}$ polynomials satisfy the relation $D_{q_i, q_j} P_n^{i,j} = P_{n-1}^{i,j}$, in addition to above formulated relations between q -numbers with basis (q_i, q_j) and Q , where $Q \equiv \frac{q_j}{q_i}$, we can find the relation between corresponding derivatives in the following form

$$\begin{aligned}
D_{q_i, q_j} &= \frac{q_i^{x \frac{d}{dx}} - q_j^{x \frac{d}{dx}}}{(q_i - q_j)x} = \frac{1}{(q_i - q_j)x} \left(1 - Q^{x \frac{d}{dx}} \right) q_i^{x \frac{d}{dx}} = \frac{1}{(1-Q)x} \left(1 - Q^{x \frac{d}{dx}} \right) \frac{q_i^{x \frac{d}{dx}}}{q_i} \\
D_{q_i, q_j} &= D_Q^x \frac{M_{q_i}}{q_i}
\end{aligned} \tag{B.6}$$

Now by using these relations we will show that

$$D_{q_i, q_j} P_n^{i,j}(x) = P_{n-1}^{i,j}(x) \quad (\text{B.7})$$

Rewriting

$$\begin{aligned} P_n^{i,j}(x) &= \frac{1}{[n]_{i,j}!} (x - q_i^{n-1}a)(x - q_i^{n-2}q_ja) \dots (x - q_i q_j^{n-2}a)(x - q_j^{n-1}a) \\ &= \frac{1}{[n]_Q! q_i^{\frac{n(n-1)}{2}}} (x - q_i^{n-1}a)(x - q_i^{n-1}Qa)(x - q_i^{n-1}Q^2a) \dots (x - q_i^{n-1}Q^{n-1}a) \\ &= \frac{1}{[n]_Q! q_i^{\frac{n(n-1)}{2}}} (x - q_i^{n-1}a)_Q^n \\ &= \frac{1}{q_i^{\frac{n(n-1)}{2}}} P_n^Q(x; q_i^{n-1}a) \end{aligned} \quad (\text{B.8})$$

and applying D_{q_i, q_j} -operator to the polynomial $P_n^{i,j}(x)$, we have

$$\begin{aligned} D_{q_i, q_j} P_n^{i,j}(x) &= \frac{1}{q_i} D_Q^x M_{q_i} \frac{1}{q_i^{\frac{n(n-1)}{2}}} P_n^Q(x; q_i^{n-1}a) \\ &= \frac{1}{q_i q_i^{\frac{n(n-1)}{2}}} D_Q^x P_n^Q(q_i x; q_i^{n-1}a) \\ &= \frac{1}{q_i q_i^{\frac{n(n-1)}{2}}} \frac{P_n^Q(Qq_i x; q_i^{n-1}a) - P_n^Q(q_i x; q_i^{n-1}a)}{(Q-1)x} \\ &= \frac{1}{q_i^{\frac{n(n-1)}{2}}} \frac{P_n^Q(Qq_i x; q_i^{n-1}a) - P_n^Q(q_i x; q_i^{n-1}a)}{(Q-1)q_i x} \\ &= \frac{1}{q_i^{\frac{n(n-1)}{2}}} D_n^Q P_n^Q(z; q_i^{n-1}a) \\ &= \frac{1}{q_i^{\frac{n(n-1)}{2}}} P_{n-1}^Q(z; q_i^{n-1}a) \\ &= \frac{1}{q_i^{\frac{n(n-1)}{2}}} P_{n-1}^Q(q_i x; q_i^{n-1}a) \\ &= \frac{1}{q_i^{\frac{n(n-1)}{2}}} \frac{1}{[n-1]_Q!} (q_i x - q_i^{n-1}a)_Q^{n-1} \end{aligned}$$

$$\begin{aligned}
&= \frac{1}{q_i^{\frac{n(n-1)}{2}}} \frac{1}{[n-1]_Q!} q_i^{n-1} (x - q_i^{n-2} a)_Q^{n-1} \\
&= \frac{1}{[n-1]_{q_i, q_j}!} (x - q_i^{n-2} a)(x - q_i^{n-3} q_j a) \dots (x - q_i q_j^{n-3} a)(x - q_j^{n-2} a) \\
&= P_{n-1}^{i,j}(x).
\end{aligned}$$

■

APPENDIX C

Q -BINOMIAL FORMULAS

C.1. Gauss Binomials as Solution of q -Difference System

Here we find q -combinatorial coefficients from Section 10.1 as a solution of q -difference system of equation.

$$S(n+1, k) = S(n, k-1) \quad \Rightarrow \quad D_n S(n, k) = -D_k S(n, k-1), \quad (\text{C.1})$$

$$S(n+1, k) = S(n, k) + n - k \quad \Rightarrow \quad D_n S(n, k) = n - k \quad (\text{C.2})$$

$$S(0, 0) = S(1, 0) = S(1, 1) = 0, \quad (k = 0, 1, \dots, n). \quad (\text{C.3})$$

From the second difference equation

$$n = 1, k = 2 \Rightarrow S(2, 2) = S(1, 1) = 0,$$

$$n = 2, k = 3 \Rightarrow S(3, 3) = S(2, 2) = 0,$$

which implies that

$$S(0, 0) = S(1, 1) = S(2, 2) = S(3, 3) = \dots = S(k, k) = 0.$$

For $k = 0$ we have the initial conditions $S(0, 0) = S(1, 0) = 0$, so from the first difference equation

$$n = 1 \quad \Rightarrow \quad S(2, 0) = S(1, 0) + 1 = 1$$

$$n = 2 \quad \Rightarrow \quad S(3, 0) = S(2, 0) + 2 = 1 + 2$$

$$\begin{aligned}
n = 3 &\Rightarrow S(4, 0) = S(3, 0) + 3 = 1 + 2 + 3 \\
&\cdot \\
&\cdot \\
n = n &\Rightarrow S(n, 0) = 1 + 2 + \dots + (n - 1) = \frac{n(n - 1)}{2} \quad (\text{C.4})
\end{aligned}$$

From the second difference equation we can calculate

$$\begin{aligned}
k = 1 &\Rightarrow S(n + 1, 1) = S(n, 0) + \frac{n(n - 1)}{2} \Rightarrow S(n, 1) = \frac{(n - 1)(n - 2)}{2}, \\
k = 2 &\Rightarrow S(n + 1, 2) = S(n, 1) + \frac{(n - 1)(n - 2)}{2} \Rightarrow S(n, 2) = \frac{(n - 2)(n - 3)}{2}, \\
\forall k &\Rightarrow S(n + 1, k) = S(n, k - 1) + \frac{(n - k)(n - (k - 1))}{2} \quad (\text{C.5})
\end{aligned}$$

$$\Rightarrow S(n, k) = \frac{(n - k - 1)(n - k)}{2}$$

C.2. Q -Commutative q -Binomials as Solution of q -Difference System

Here we find Q -commutative q -binomials from Section 10.3 as solution of q -difference system. We have the difference equations with the initial conditions :

$$t(n + 1, k) = t(n, k) \quad (\text{C.6})$$

$$t(n, k) = t(n, k - 1) + k - 1 \quad (\text{C.7})$$

$$t(0, 0) = t(1, 0) = t(1, 1) = 0. \quad (\text{C.8})$$

From the first equation for $k = 0$ we have $t(n + 1, 0) = t(n, 0)$. So, if $n = 1 \Rightarrow t(2, 0) = t(1, 0) = 0$, which means that $t(n, 0) = 0$. By using the second equation we easily write

$$t(n, 1) = t(n, 0) = 0$$

$$t(n, 2) = t(n, 1) + 1 = 1$$

$$\begin{aligned}t(n, 3) &= t(n, 2) + 2 = 1 + 2 \\t(n, 4) &= t(n, 3) + 2 = 1 + 2 + 3 \\&\dots \\t(n, k) &= 1 + 2 + 3 + \dots + (k - 1) = \frac{k(k - 1)}{2}.\end{aligned}$$

Therefore, the solution of the above system is

$$t(n, k) = \frac{k(k - 1)}{2}. \tag{C.9}$$

APPENDIX D

Q -QUANTUM HARMONIC OSCILLATOR

D.1. Number Operator for Symmetrical q -Oscillator

In section 11.2.2 we studied symmetrical q -oscillator. The number operator for this oscillator appears as symmetrically q -deformed number operator which is not equal to a^+a . Here we derive expression for the number operator N in terms of q -number operator $[N]_{\bar{q}}$. By multiplying $[N]_{\bar{q}}$ with q^N from the left side

$$q^N [N]_{\bar{q}} = q^N \frac{q^N - q^{-N}}{q - q^{-1}} = q^N a_q^+ a_q$$

and from the commutation relation $[N, a_q^+ a_q] = 0$, the above expression is written as follows

$$q^N a_q^+ a_q = \frac{q^{2N} - 1}{q - q^{-1}}$$

and it can also be written

$$q^{2N} - 2q^N \frac{a_q^+ a_q (q - q^{-1})}{2} \mp \left(\frac{a_q^+ a_q (q - q^{-1})}{2} \right)^2 - 1 = 0. \quad (\text{D.1})$$

The solution of this equation is

$$q^N = \sqrt{1 + \left(\frac{a_q^+ a_q (q - q^{-1})}{2} \right)^2} + \frac{a_q^+ a_q (q - q^{-1})}{2}$$

Here we choose the positive sign, since we considered q as a real number. Then, the number operator is

$$N = \log_q \left(a_q^+ a_q \frac{q - q^{-1}}{2} + \sqrt{\left(a_q^+ a_q \frac{q - q^{-1}}{2} \right)^2 + 1} \right). \quad (\text{D.2})$$

To get another expression for the number operator, we use definition of sinh function in order to write q -number operator $[N]_q$

$$[N]_q = \frac{\sinh(N \ln q)}{\sinh(\ln q)},$$

then we get

$$N = \frac{\operatorname{arc\,sinh}([N]_q \sinh(\ln q))}{\ln q}.$$

D.1.1. Commutation Relation for q -Oscillator

In Section 11.2 we formulated several commutation relations for q -operators. Here, by mathematical induction we prove the following relation :

$$[N^k, b^+] = \{N^k - (N - 1)^k\}b^+.$$

For $n = 1$ from the commutation relation we know that $[N, b^+] = b^+$, and suppose the relation is true for $n = k$ case :

$$[N^k, b^+] = \{N^k - (N - 1)^k\}b^+.$$

We should show that the relation is also correct for $n = k + 1$ case,

$$[N^{k+1}, b^+] = N^k[N, b^+] + [N^k, b^+]N = N^k b^+ + \{N^k - (N - 1)^k\}b^+ N$$

and by using the relation $b^+ N = (N - 1)b^+$ we get desired result

$$[N^{k+1}, b^+] = [N^{k+1} - (N - 1)^{k+1}].$$

■

Below we list some important formulas :

$$[N, b^+] = b^+$$

$$[N^n, b^+] = \{N^n - (N - 1)^n\}b^+$$

$$[f(N), b^+] = \{f(N) - f(N - 1)\}b^+$$

$$[[N], b^+] = \{[N] - [N - 1]\}b^+$$

$$b^+ f(N) = f(N - 1)b^+.$$

If function f is real then

$$f(N)b = bf(N - 1).$$

D.1.2. Action of q -Operators on States

In Section 11.2 we showed how q -operators are acting on n -particle states. Below we prove these relations. From the eigenvalue equation $N|n\rangle_{i,j} = n|n\rangle_{i,j}$, it is easy to obtain

$$[N]_{i,j}|n\rangle_{i,j} = \frac{q_i^N - q_j^N}{q_i - q_j}|n\rangle_{i,j} = \frac{q_i^n - q_j^n}{q_i - q_j}|n\rangle_{i,j} = [n]_{i,j}|n\rangle_{i,j}.$$

The n -particle eigenstate is defined as

$$|n\rangle_{i,j} = \frac{(a_q^+)^n |0\rangle_{i,j}}{\sqrt{[n]_{i,j}!}}. \quad (\text{D.3})$$

By applying the creation operator to above state, we have

$$a_q^+ |n\rangle_{i,j} = \frac{(a_q^+)^{n+1} |0\rangle_{i,j}}{\sqrt{[n]_{i,j}!}} \frac{\sqrt{[n+1]_{i,j}}}{\sqrt{[n+1]_{i,j}}} = \sqrt{[n+1]_{i,j}} |n+1\rangle_{i,j}.$$

From the above relation, we write

$$a_q^+ |n-1\rangle_{i,j} = \sqrt{[n]_{i,j}} |n\rangle_{i,j},$$

and applying annihilation operator a_q ,

$$a_q a_q^+ |n-1\rangle_{i,j} = \sqrt{[n]_{i,j}} a_q |n\rangle_{i,j}$$

$$\begin{aligned} a_q |n\rangle_{i,j} &= \frac{1}{\sqrt{[n]_{i,j}}} a_q a_q^+ |n-1\rangle_{i,j} = \frac{1}{\sqrt{[n]_{i,j}}} (q_j^N + q_i [N]_{i,j}) |n-1\rangle_{i,j} \quad (\text{D.4}) \\ &= \frac{1}{\sqrt{[n]_{i,j}}} (q_j^{n-1} + q_i [n-1]_{i,j}) |n-1\rangle_{i,j} = \sqrt{[n]_{i,j}} |n-1\rangle_{i,j}. \end{aligned}$$

APPENDIX E

QUANTUM ANGULAR MOMENTUM REPRESENTATION

Here we remind basic definition and representation of quantum angular momentum algebra. Let us consider three hermitian operators J_x, J_y, J_z which satisfy the commutation relations:

$$[J_x, J_y] = i\hbar J_z, \quad [J_y, J_z] = i\hbar J_x, \quad [J_z, J_x] = i\hbar J_y$$

or

$$[J_z, J_{\pm}] = \pm\hbar J_{\pm} \quad [J_+, J_-] = 2\hbar J_z,$$

where $J_+ = J_x + iJ_y$, $J_- = J_x - iJ_y$ and $J^2 = J_x^2 + J_y^2 + J_z^2$. We have relation

$$J_{\pm}J_{\mp} = J^2 - J_z^2 \pm \hbar J_z.$$

Let us denote $Max(m) = j$, then for any given λ

$$J_+|\lambda, j\rangle = 0,$$

and for $Min(m) = j'$ we have

$$J_-|\lambda, j'\rangle = 0.$$

This way we find that $j' = -j$. Therefore, j should be either a nonnegative integer or a half-integer $j = 0, \frac{1}{2}, 1, \frac{3}{2}, 2, \dots$

For $\lambda = j(j+1)$ and $|\lambda, m\rangle \equiv |j, m\rangle$, we get representation

$$J_+|j, m\rangle = \sqrt{(j-m)(j+m+1)}\hbar|j, m+1\rangle$$

$$J_-|j, m\rangle = \sqrt{(j+m)(j-m+1)}\hbar|j, m-1\rangle$$

$$J_z|j, m\rangle = m\hbar|j, m\rangle$$

$$J^2|j, m\rangle = j(j+1)\hbar^2|j, m\rangle.$$

APPENDIX F

Q-QUANTUM ANGULAR MOMENTUM

F.1. Proof of Proposition 11.3.21

Here we prove proposition 11.3.21. First we calculate

$$[J_z^2, J_+^q] = J_z J_+^q + J_+^q J_z = J_z J_+^q + [J_+^q, J_z] + J_z J_+^q = (2J_z - 1)J_+^q = (J_z^2 - (J_z - 1)^2)J_+^q$$

$$[J_z^3, J_+^q] = J_z^2 [J_z, J_+^q] + [J_z^2, J_+^q] J_z = J_z^2 J_+^q + (2J_z - 1)([J_+^q, J_z] + J_z) J_+^q = (J_z^3 - (J_z - 1)^3) J_+^q$$

So we guess for arbitrary n the next relation :

$$[J_z^n, J_+^q] = (J_z^n - (J_z - 1)^n) J_+^q,$$

and then prove this by using mathematical induction. For $n = 1$ case we know that it is correct from the commutation relation. And suppose the equality is correct for $n = k$,

$$[J_z^k, J_+^q] = (J_z^k - (J_z - 1)^k) J_+^q.$$

So the last step is to show that it is also correct for $n = k + 1$ case.

$$\begin{aligned} [J_z^{k+1}, J_+^q] &= J_z^k [J_z, J_+^q] + [J_z^k, J_+^q] J_z \\ &= J_z^k J_+^q + (J_z^k - (J_z - 1)^k) J_+^q \\ &= J_z^k J_+^q + J_z^k J_+^q J_z - (J_z - 1)^k J_+^q J_z \\ &= J_z^k J_+^q + J_z^k (J_z - 1) J_+^q - (J_z - 1)^k (J_z - 1) J_+^q \\ &= (J_z^{k+1} - (J_z - 1)^{k+1}) J_+^q. \end{aligned}$$

In the above proof we use the following relations :

$$J_+^q J_z^n = (J_z - 1)^n J_+^q,$$

and

$$J_z^n J_-^q = J_-^q (J_z - 1)^n.$$

This result can be extended to more general case. For real function expandable to the power series

$$f(x) = \sum_{n=0}^{\infty} c_n x^n,$$

we have

$$[f(J_z), J_+^q] = \sum_{n=0}^{\infty} c_n [J_z^n, J_+^q] = \sum_{n=0}^{\infty} c_n (J_z^n - (J_z - 1)^n) = (f(J_z) - f(J_z - 1)) J_+^q$$

and due to the reality of function f , the hermitian conjugate of the above expression gives

$$[f(J_z), J_-^q] = J_-^q (f(J_z - 1) - f(J_z)).$$

F.2. q -Casimir Operator

In Section 11.3.2 we introduced q -Casimir operator for q -quantum angular momentum algebra. Here we prove that $[C^q, J_x^q] = [C^q, J_y^q] = [C^q, J_z^q] = 0$. The commutator is

$$\begin{aligned} [C^q, J_+^q] &= (q_i q_j)^{-J_z} [[J_z]_{i,j} [J_z + 1]_{i,j} + (q_i q_j)^{-N_2} J_-^q J_+^q, J_+^q] \\ &+ [(q_i q_j)^{-J_z}, J_+^q] ([J_z]_{i,j} [J_z + 1]_{i,j} + (q_i q_j)^{-N_2} J_-^q J_+^q) \\ &= (q_i q_j)^{-J_z} \{ [J_z]_{i,j} [[J_z + 1]_{i,j}, J_+^q] + [[J_z]_{i,j}, J_+^q] [J_z + 1]_{i,j} \\ &+ (q_i q_j)^{-N_2} [J_-^q J_+^q, J_+^q] + [(q_i q_j)^{-N_2}, J_+^q] J_-^q J_+^q \} \\ &+ [(q_i q_j)^{-J_z}, J_+^q] \{ [J_z]_{i,j} [J_z + 1]_{i,j} + (q_i q_j)^{-N_2} J_-^q J_+^q \}. \end{aligned} \quad (\text{F.1})$$

By using the following properties :

$$[J_+^q, J_-^q] = (q_i q_j)^{N_2} [2J_z]_{i,j},$$

$$[f(J_z), J_+^q] = \{f(J_z) - f(J_z - 1)\},$$

$$J_+^q [J_z + 1]_{i,j} = [J_z]_{i,j} J_+^q.$$

and Proposition 11.3.21 after long calculations we get

$$[C^q, J_+^q] = (q_i q_j)^{-J_z} ([J_z]_{i,j} \{[J_z + 1]_{i,j} - (q_i q_j) [J_z - 1]_{i,j}\} - [2J_z]_{i,j}) = 0.$$

In addition, Hermitian conjugate of this expression gives $[C^q, J_-^q] = 0$.

$$\begin{aligned} [C^q, J_z] &= (q_i q_j)^{-J_z} [(q_i q_j)^{-N_2} J_-^q J_+^q, J_z] \\ &= (q_i q_j)^{-J_z} (q_i q_j)^{-N_2} [J_-^q J_+^q, J_z] + (q_i q_j)^{-J_z} [(q_i q_j)^{-N_2}, J_z] J_-^q J_+^q = 0. \end{aligned}$$

APPENDIX G

Q-FUNCTION OF ONE VARIABLE

Here we prove some identities for q -function of one variable from Section 12.1.

Proposition G.0.0.1

$$D_x \frac{1}{(x + q^{-n}y)_q^n} = [-n](x + y)_q^{-(n+1)} \tag{G.1}$$

Proof G.0.0.2 *We know (Kac and Cheung 2002)*

$$(x - a)_q^{-n} \equiv \frac{1}{(x - q^{-n}a)_q^n}, \tag{G.2}$$

if we choose $-a = y$, this expression is written as

$$(x + y)_q^{-n} = \frac{1}{(x + q^{-n}y)_q^n}.$$

By definition of q derivative (2.8)

$$\begin{aligned} D_x \frac{1}{(x + q^{-n}y)_q^n} &= \frac{\frac{1}{(qx + q^{-n}y)_q^n} - \frac{1}{(x + q^{-n}y)_q^n}}{(q - 1)x} \\ &= \frac{\frac{1}{(qx + q^{-n}y) \dots (qx + q^{-n+n-1}y)} - \frac{1}{(x + q^{-n}y) \dots (x + q^{-n+n-1}y)}}{(q - 1)x} \\ &= \frac{\frac{1}{(x + q^{-n}y) \dots (x + q^{-2}y)} \left[\frac{1}{q^n(x + q^{-n-1}y)} - \frac{1}{(x + q^{-1}y)} \right]}{(q - 1)x} \\ &= \frac{q^{-n} - 1}{q - 1} \frac{1}{(x + q^{-(n+1)}y)_q^{n+1}} = [-n] \frac{1}{(x + q^{-(n+1)}y)_q^{n+1}} \end{aligned}$$

and we get desired result. ■

Proposition G.0.0.3

$$D_y(x + y)_q^{-n} = \frac{-[n]}{q^n}(x + qy)_q^{-(n+1)}. \quad (\text{G.3})$$

Proof G.0.0.4 *By using the equality (G.2) we have*

$$(x + y)_q^{-n} \equiv \frac{1}{(x + q^{-n}y)_q^n}, \quad (\text{G.4})$$

and we write

$$\frac{1}{(x + q^{-n}y)_q^n} = \frac{1}{q^{-n^2}} \frac{1}{(q^n x + y)_q^n}. \quad (\text{G.5})$$

According to (Kac 3.12) the following identity is valid

$$D_y \frac{1}{(a - y)_q^n} = \frac{[n]}{(a - y)_q^{n+1}}. \quad (\text{G.6})$$

By using this identity

$$D_y \frac{1}{(b + y)_q^n} = (-1)^n D_y \frac{1}{(-b - y)_q^n} = (-1)^n \frac{[n]}{(-b - y)_q^{n+1}} = -\frac{[n]}{(b + y)_q^{n+1}} \quad (\text{G.7})$$

Hence,

$$D_y(x + y)_q^{-n} = \frac{1}{q^{-n^2}} D_y \frac{1}{(q^n x + y)_q^n} = \frac{-[n]}{q^{-n^2}(q^n x + y)_q^{n+1}} = \frac{-[n]}{q^n(x + cq^{-n}y)_q^{n+1}}$$

From the identity (G.2)we obtain

$$D_y(x + y)_q^{-n} = \frac{-[n]}{q^n}(x + qy)_q^{-(n+1)}.$$

■

APPENDIX H

Q-TRAVELING WAVE

H.1. q -Traveling Wave and Jackson Integral

Here we derive the Jackson integral for q -traveling wave from Section 12.7. The Jackson integral of function $f(x)$ is defined as

$$F(x) = (1 - q) \sum_{j=0}^{\infty} q^j x f(q^j x) + F(0) \equiv \int_0^x f(x') d_q x' \quad (\text{H.1})$$

Let us define

$$F(x - ct)_q \equiv \int_0^{(x-ct)_q} f(x') d_q x'$$

$$F(x - ct)_q = (1 - q) \sum_{j=0}^{\infty} (q^j (x - ct) f(q^j (x - ct)))_q + F(0) \quad (\text{H.2})$$

Taylor Part : For Taylor part, we have expansion $f(x) = \sum_{n=0}^{\infty} a_n x^n$,

$$F(x) = (1 - q) \sum_{j=0}^{\infty} \sum_{n=0}^{\infty} a_n x^{n+1} q^{j(n+1)} + F(0). \quad (\text{H.3})$$

By using the above equality the q -function

$$\begin{aligned} F(x - ct)_q &= (1 - q) \sum_{j=0}^{\infty} \sum_{n=0}^{\infty} a_n (x - ct)_q^{n+1} + F(0) \\ &= (1 - q)(x - ct) \sum_{j=0}^{\infty} \sum_{n=0}^{\infty} a_n (q^j (x - cqt))_q^n q^j + F(0) \\ &= (1 - q)(x - ct) \sum_{j=0}^{\infty} q^j f(q^j (x - cqt))_q \\ &= (1 - q)(x - ct) \sum_{j=0}^{\infty} q^j M_q^t f(q^j (x - ct))_q \\ &= \int_0^{(x-ct)_q} f(x') d_q x' \end{aligned} \quad (\text{H.4})$$

Laurent Part : We have

$$f(x) = \sum_{n=1}^{\infty} a_{-n}x^{-n} \Rightarrow F(x) = (1-q) \sum_{j=0}^{\infty} \sum_{n=1}^{\infty} a_{-n}q^j x(q^j x)^{-n} + F(0).$$

If we replace $x \rightarrow (x - ct)_q$, we have

$$\begin{aligned} F(x - ct)_q &= (1-q) \sum_{j=0}^{\infty} \sum_{n=1}^{\infty} a_{-n}(x - ct)_q^{-n+1} (q^j)^{-n+1} + F(0) \\ &= (1-q) \sum_{j=0}^{\infty} \sum_{n=1}^{\infty} a_{-n} \frac{1}{(x - q^{-n+1}ct)_q^{n-1}} (q^j)^{-n+1} + F(0) \\ &= (1-q) \sum_{j=0}^{\infty} \sum_{n=1}^{\infty} a_{-n} \frac{(x - ct)}{(x - q^{-n}(qct))_q^n} (q^j)^{-n+1} + F(0) \\ &= (1-q) \sum_{j=0}^{\infty} \sum_{n=1}^{\infty} a_{-n}(x - ct)(x - qct)_q^n (q^j)^{-n+1} + F(0) \\ &= (1-q)(x - ct) \sum_{j=0}^{\infty} \sum_{n=1}^{\infty} a_{-n}(x - qct)_q^{-n} q^{-jn} q^j + F(0) \\ &= (1-q)(x - ct) \sum_{j=0}^{\infty} f(q^j(x - qct))_q q^j + F(0) \\ &= (1-q)(x - ct) \sum_{j=0}^{\infty} q^j M_q^t f(q^j(x - ct))_q \\ &= \int_0^{(x-ct)_q} f(x') d_q x'. \end{aligned}$$

H.2. q -Traveling Wave Polynomial Identities

Here we prove the following proposition:

Proposition H.2.0.5

$$D_x \frac{1}{(x + q^{-n}t)_q^n} = [-n](x + t)_q^{-(n+1)} \quad (\text{H.5})$$

Proof H.2.0.6 From (G.2) we know

$$(x - a)_q^{-n} \equiv \frac{1}{(x - q^{-n}a)_q^n}, \quad (\text{H.6})$$

if we choose $-a = t$, this expression is written as

$$(x + t)_q^{-n} = \frac{1}{(x + q^{-n}t)_q^n}.$$

By using the definition of q derivative (2.8)

$$\begin{aligned} D_x \frac{1}{(x + q^{-n}t)_q^n} &= \frac{\frac{1}{(qx + q^{-n}t)_q^n} - \frac{1}{(x + q^{-n}t)_q^n}}{(q - 1)x} \\ &= \frac{\frac{1}{(qx + q^{-n}t)\dots(qx + q^{-n+n-1}t)} - \frac{1}{(x + q^{-n}t)\dots(x + q^{-n+n-1}t)}}{(q - 1)x} \\ &= \frac{\frac{1}{(x + q^{-n}t)\dots(x + q^{-2}t)} \left[\frac{1}{q^n(x + q^{-n-1}t)} - \frac{1}{(x + q^{-1}t)} \right]}{(q - 1)x} \\ &= \frac{q^{-n} - 1}{q - 1} \frac{1}{(x + q^{-(n+1)}t)_q^{n+1}} = [-n] \frac{1}{(x + q^{-(n+1)}t)_q^{n+1}} \end{aligned}$$

and from (G.2) we get desired result. ■

Proposition H.2.0.7

$$D_t(x + ct)_q^{-n} = \frac{-c[n]}{q^n} (x + cqt)_q^{-(n+1)}. \quad (\text{H.7})$$

Proof H.2.0.8 By using the equality (G.2) we have

$$(x + ct)_q^{-n} \equiv \frac{1}{(x + cq^{-n}t)_q^n}, \quad (\text{H.8})$$

and we write

$$\frac{1}{(x + cq^{-n}t)_q^n} = \frac{1}{q^{-n^2}} \frac{1}{(q^n x + ct)_q^n}. \quad (\text{H.9})$$

According to (G.6) the following identities is valid

$$D_t \frac{1}{(a-t)_q^n} = \frac{[n]}{(a-t)_q^{n+1}}. \quad (\text{H.10})$$

By using this identity

$$D_t \frac{1}{(b+t)_q^n} = (-1)^n D_t \frac{1}{(-b-t)_q^n} = (-1)^n \frac{[n]}{(-b-t)_q^{n+1}} = -\frac{[n]}{(b+t)_q^{n+1}} \quad (\text{H.11})$$

Hence,

$$D_t (x+ct)_q^{-n} = \frac{1}{q^{-n^2}} D_t \frac{1}{(q^n x + ct)_q^n} = \frac{-c[n]}{q^{-n^2} (q^n x + ct)_q^{n+1}} = \frac{-c[n]}{q^n (x + cq^{-n}t)_q^{n+1}}$$

From the identity (G.2) we obtain

$$D_t (x+ct)_q^{-n} = \frac{-c[n]}{q^n} (x+cqt)_q^{-(n+1)}.$$

APPENDIX I

Q-BERNOULLI NUMBERS B_2^Q AND B_4^Q

Here we calculate first two even q -Bernoulli numbers from Section 12.8.2. By definition of q -exponential functions we expand the generating function as

$$\begin{aligned}
 & \frac{z}{E_q\left(\frac{z}{2}\right) \left(e_q\left(\frac{z}{2}\right) - e_q\left(-\frac{z}{2}\right)\right)} \\
 = & \frac{z}{\left(1 + \frac{z}{2} + q \frac{z^2}{2^2[2]!} + q^3 \frac{z^3}{2^3[3]!} + q^6 \frac{z^4}{2^4[4]!} + \dots\right) \left(z + \frac{z^3}{2^2[3]!} + \frac{z^5}{2^4[5]!} + \dots\right)} \\
 = & b_0^q + b_1^q z + b_2^q \frac{z^2}{[2]!} + b_4^q \frac{z^4}{[4]!} + \dots \\
 = & \frac{1}{1 + \frac{z}{2} + z^2 \left(\frac{1}{2^2[3]!} + \frac{q}{2^2[2]!}\right) + z^3 \left(\frac{1}{2^3[3]!} + \frac{q^3}{2^3[3]!}\right) + z^4 \left(\frac{q}{2^4[2]![3]!} + \frac{q^6}{2^4[4]!} + \frac{1}{2^4[5]!}\right) + \dots} \\
 = & \frac{1}{1 + \frac{z}{2} + Az^2 + Bz^3 + Cz^4 + \dots} = 1 - \left(\frac{z}{2} + Az^2 + Bz^3 + Cz^4 + \dots\right) \\
 + & \left(\frac{z}{2} + Az^2 + Bz^3 + Cz^4 + \dots\right)^2 - \left(\frac{z}{2} + Az^2 + Bz^3 + Cz^4 + \dots\right)^3 \\
 + & \left(\frac{z}{2} + Az^2 + Bz^3 + Cz^4 + \dots\right)^4 + \dots, \tag{I.1}
 \end{aligned}$$

where

$$\begin{aligned}
 A & \equiv \frac{[4]}{2^2[3]!}, \\
 B & \equiv \frac{q^3 + 1}{2^3[3]!}, \\
 C & \equiv \frac{[5]q^6 + 1}{2^4[5]!} + \frac{q}{2^4[2]![3]!}
 \end{aligned}$$

For term z^2 we have

$$-A + \frac{1}{4} = b_2^q \frac{1}{[2]!} \Rightarrow b_2^q = \frac{1}{4} \left([2] - \frac{1}{[3]} - q \right)$$

and

$$b_2^q = \frac{1}{4} \left([2] - \frac{1}{[3]} - q \right).$$

For term z^4 we get

$$\begin{aligned} -C + A^2 + B - \frac{3}{4}A + \frac{1}{16} &= b_4^q \frac{1}{[4]!} \Rightarrow \\ b_4^q &= \frac{[4]}{2^4} \left([3]! - [2]^3 + \frac{[4]^2}{[3]!} - \frac{q}{[2]!} - \frac{[5]q^6 + 1}{[5][4]} \right) \end{aligned} \quad (\text{I.2})$$

and as a result

$$b_4^q = \frac{[4]}{2^4} \left([3]! - [2]^3 + \frac{[4]^2}{[3]!} - \frac{q}{[2]!} - \frac{[5]q^6 + 1}{[5][4]} \right).$$

APPENDIX J

ZEROS OF $\text{SIN}_q X$ FUNCTION

We consider the following relation between q -trigonometric functions and q -Bernoulli numbers

$$x \cot_q x = 1 - [2]_q \sum_{n=1}^{\infty} \frac{x^2}{x_n^2} \prod_{k=1}^{n-1} \frac{\left(1 - q^2 \frac{x^2}{x_k^2}\right)}{\left(1 - \frac{x^2}{x_k^2}\right)} = 1 + b_2^q \frac{-4x^2}{[2]!} + b_4^q \frac{2^4 x^4}{[4]!} + \dots \quad (\text{J.1})$$

In section 12.8.2 we found relation between zeros x_k of q -sine function and b_2^q at order x^2 . Now we will find relation at the order x^4 , this why let us call

$$\frac{x^2}{x_n^2} \equiv \xi_n,$$

then the above expression is written in terms of ξ as follows

$$x \cot_q x = 1 - [2]_q \sum_{n=1}^{\infty} \frac{\xi_n}{1 - \xi_n} \prod_{k=1}^{n-1} \frac{1 - q^2 \xi_k}{1 - \xi_k} = 1 - b_2^q \frac{2^2}{[2]!} x^2 + b_4^q \frac{2^4}{[4]!} x^4 + \dots \quad (\text{J.2})$$

For simplicity we denote

$$A \equiv \sum_{n=1}^{\infty} \frac{\xi_n}{1 - \xi_n} \prod_{k=1}^{n-1} \frac{1 - q^2 \xi_k}{1 - \xi_k},$$

then open form of the above expression gives

$$\begin{aligned} A &= \frac{\xi_1}{1 - \xi_1} + \frac{\xi_2}{1 - \xi_2} \frac{(1 - q^2 \xi_1)}{1 - \xi_1} + \frac{\xi_3}{1 - \xi_3} \frac{(1 - q^2 \xi_1)(1 - q^2 \xi_2)}{1 - \xi_1} \\ &+ \dots + \frac{\xi_n}{1 - \xi_n} \frac{(1 - q^2 \xi_1)}{1 - \xi_1} \dots \frac{(1 - q^2 \xi_{n-1})}{1 - \xi_{n-1}} + \dots \end{aligned} \quad (\text{J.3})$$

For $|\frac{x}{x_n}| = |\xi_n| < 1$, Taylor expansion of the above expression is

$$\begin{aligned}
A &= \xi_1(1 + \xi_1 + \xi_1^2 + \dots) + \xi_2(1 + \xi_2 + \xi_2^2 + \dots) (1 + (1 - q^2)\xi_1 + (1 - q^2)\xi_1^2 + \dots) \\
&+ \xi_3(1 + \xi_3 + \xi_3^2 + \dots) (1 + (1 - q^2)\xi_1 + (1 - q^2)\xi_1^2 + \dots) \\
&\quad (1 + (1 - q^2)\xi_2 + (1 - q^2)\xi_2^2 + \dots) + \dots \\
&+ \xi_n(1 + \xi_n + \xi_n^2 + \dots) \dots (1 + (1 - q^2)\xi_{n-1} + (1 - q^2)\xi_{n-1}^2 + \dots) + \dots \quad (J.4)
\end{aligned}$$

Here we should consider just ξ^2 terms to collect order x^4 , so we denote

$$\begin{aligned}
B &= \xi_1^2 + \xi_2^2 + \dots + \xi_n^2 + \dots + \xi_1\xi_2(1 - q^2) + \xi_1\xi_3(1 - q^2) + \xi_2\xi_3(1 - q^2) + \dots \\
&+ \xi_n\xi_1(1 - q^2) + \xi_n\xi_2(1 - q^2) + \dots + \xi_n\xi_{n-1}(1 - q^2) + \dots \\
&= \sum_{k=1}^{\infty} \xi_k^2 + (1 - q^2)C, \quad (J.5)
\end{aligned}$$

where

$$C \equiv \sum_{k=2}^{\infty} \xi_1\xi_k + \sum_{k=3}^{\infty} \xi_2\xi_k + \dots + \sum_{k=n+1}^{\infty} \xi_n\xi_k + \dots \quad (J.6)$$

By

$$\sum_{k=1}^n \xi_k \equiv S_n$$

and

$$\lim_{n \rightarrow \infty} S_n = S,$$

then we can write the sums as

$$\begin{aligned}
\sum_{k=1}^{\infty} \xi_k &= S \\
\sum_{k=2}^{\infty} \xi_k &= \sum_{k=1}^{\infty} \xi_k - \xi_1 = S - S_1 \\
\sum_{k=3}^{\infty} \xi_k &= \sum_{k=1}^{\infty} \xi_k - \xi_1 - \xi_2 = S - S_2 \\
&\dots \\
\sum_{k=n}^{\infty} \xi_k &= S - S_{n-1} \quad (J.7)
\end{aligned}$$

Rewriting (J.5) in terms of S , we obtain

$$\begin{aligned}
B &= S^2 + (1 - q^2) (\xi_1(S - S_1) + \xi_2(S - S_2) + \dots + \xi_n(S - S_n) + \dots) \\
&= S^2 + (1 - q^2) (S^2 - \xi_1\xi_1 - \xi_2(\xi_1 + \xi_2) - \dots - \xi_n(\xi_1 + \xi_2 + \dots + \xi_n)) \\
&= S^2 + (1 - q^2) \left(S^2 - \sum_{k=1}^{\infty} \xi_k^2 + D \right), \tag{J.8}
\end{aligned}$$

where

$$D \equiv -\xi_2\xi_1 - \xi_3(\xi_1 + \xi_2) - \dots - \xi_n(\xi_1 + \xi_2 + \dots + \xi_{n-1}) + \dots \tag{J.9}$$

or

$$\begin{aligned}
D &= -\xi_1(\xi_2 + \xi_3 + \dots + \xi_n) - \xi_2(\xi_3 + \xi_4 + \dots + \xi_n) - \dots - \xi_n(\xi_{n+1} + \dots) - \dots \\
&= -\xi_1(S - S_1) - \xi_2(S - S_2) - \dots - \xi_n(S - S_n). \tag{J.10}
\end{aligned}$$

Comparing with (J.6) we find $D = -C$, then by equating (J.5) and (J.8)

$$B = S^2 + (1 - q^2) \left(S^2 - \sum_{k=1}^{\infty} \xi_k^2 - C \right) = S^2 + (1 - q^2)C, \tag{J.11}$$

we get

$$C = \frac{1}{2}S^2 - \frac{1}{2} \sum_{k=1}^{\infty} \xi_k^2. \tag{J.12}$$

It gives

$$\begin{aligned}
B &= \sum_{k=1}^{\infty} \xi_k^2 + (1 - q^2)C \\
&= \sum_{k=1}^{\infty} \xi_k^2 + (1 - q^2) \left(\frac{1}{2}S^2 - \frac{1}{2} \sum_{k=1}^{\infty} \xi_k^2 \right) \\
&= \left(1 + \frac{q^2 - 1}{2} \right) \sum_{k=1}^{\infty} \xi_k^2 - \left(\frac{q^2 - 1}{2} \right) S^2. \tag{J.13}
\end{aligned}$$

For x^4 term then we have

$$b_4^q \frac{2^4}{[4]!} x^4 = -[2]qB, \tag{J.14}$$

and substituting $\xi_k = \frac{x^2}{x_k}$ and $S = \sum_{k=1}^{\infty} \xi_k = \sum_{k=1}^{\infty} \frac{x^2}{x_k}$ in B , finally we obtain

$$[2]q \left(1 + \frac{q^2 - 1}{2} \right) \sum_{k=1}^{\infty} \frac{1}{x_k^4} = \frac{8(q^2 - 1)}{[2]^3 q} (b_2^q)^2 - \frac{16}{[4]!} b_4^q, \quad (\text{J.15})$$

where

$$b_2^q = \frac{1}{4} \left([2] - \frac{1}{[3]} - q \right),$$

$$b_4^q = \frac{[4]}{2^4} \left([3]! - [2]^3 + \frac{[4]^2}{[3]!} - \frac{q}{[2]!} - \frac{[5]q^6 + 1}{[5][4]} \right).$$