



UNCLASSIFIED



Evaluation of Brush Seals for Oil Sealing Applications

Mahmut Faruk Aksit

Faculty of Engineering and Natural Sciences

Sabanci University

Istanbul, Turkey

aksit@sabanciuniv.edu

ABSTRACT

After proven performance in gas turbine secondary flow and hot gas path sealing applications, brush seals are being considered for oil and oil mist applications in aero-engines and industrial turbines. In oil sealing applications shear heating and oil coking are major concerns. The field experience indicates that shear heating and oil coking issues can be managed if seal is designed properly. When seal stiffness is well controlled, combined with proper fiber material selection and leakage cooling, shear heating and oil coking issues can be managed. Field experience from early gas turbine bearing sump applications suggest reduced oil mist ingestion and compressor blade fouling with no observable coking issues. Brush seal operating clearance determines leakage rate and oil temperature rise. Balancing these two conflicting performance criteria requires the knowledge of bristle hydrodynamic lift. In this work, some background on analytical solution to bristle lifting force and shear heating is presented. Based on short bearing approximation, the analytical solution suggests a strong dependence of seal clearance and hydrodynamic lift force on oil temperature and viscosity. The hydrodynamic lift force relation has been expanded to include oil temperature variability due to rotor speed and lift clearance. Results are also compared with the experimental data obtained from the dynamic oil seal test rig.

1.0 INTRODUCTION

Last few decades, brush seals have been extensively used in turbomachinery secondary flow sealing applications, and demonstrated excellent leakage performance. Brush seals perform very well under rotor transients owing to the inherent compliance of bristles. As illustrated in Figure 1, a brush seal is a set of fine diameter metallic wires densely packed between two retaining plates. A support plate that is called as "backing ring" or "backing plate" is positioned downstream of the bristles to provide mechanical support for differential pressure loads. The bristles touch the rotor with an angle in the direction of the rotor rotation. As illustrated in Figure 1, L denotes free bristle length, and BH shows free bristle height. Fence height (backing plate clearance) is denoted by FH , and R is used for rotor radius. The circular seal is installed in a static member with bristles touching the rotor at an angle in the direction of the rotor rotation. This bristle angle is called as 'cant angle' or 'lay angle'. Typically, the cant angle θ is around 45° . In the case of rotor excursions, cant angle helps reduce the contact loads, allowing bristles to bend rather than buckle. Brush seals perform very well under rotor transients owing to the inherent compliance of bristles.

Although there have been some trials to use brush seals in oil and oil mist sealing applications, there is only a few publications about these attempts. There are a limited number of recent patents covering various oil brush seal applications [1-4]. Ingistov [5] was one of the first to report the use of brush seals in an oil sealing application. Later, Bhate et al. [6] reported successful application of brush seals in bearing oil sealing for General Electric Frame 7EA gas turbines. Both of these applications [5,6] employed nonmetallic brush seals to prevent bearing oil from being ingested into the compressor (see Figure 2). More detailed performance characteristics were reported by Aksit et al. [7] on subscale seals demonstrating feasibility of brush seals for oil sealing applications. Their experimental data clearly

UNCLASSIFIED

Evaluation of Brush Seals for Oil Sealing Applications

indicated presence of hydrodynamic lift appearing as increased oil leakage with speed. This is contrary to typical brush seal leakage performance in air. Brush seal dynamic air leakage is less than the static leakage as increasing tangential air velocity helps impede axial leakage flow. In gas flow applications, due to low fluid viscosity, aerodynamic lift forces generated on very small bristle tip surfaces cannot overcome blow-down forces driven by radial pressure gradients within the bristle pack.

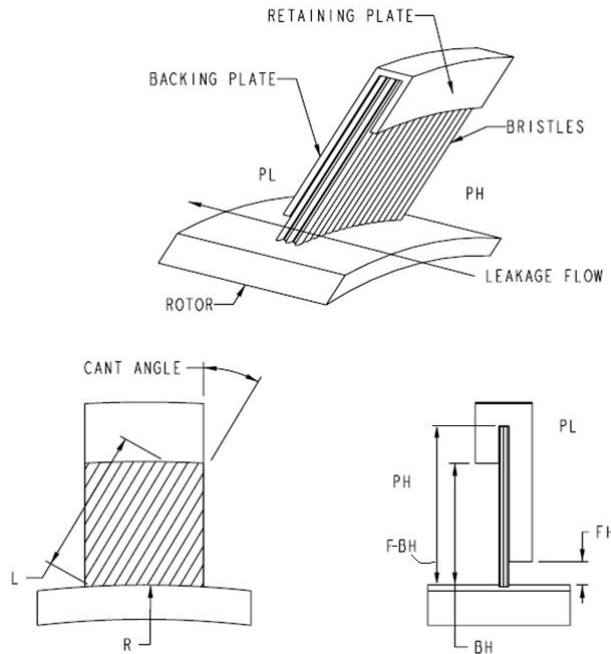

Figure 1: Brush seal schematic and main design parameters.

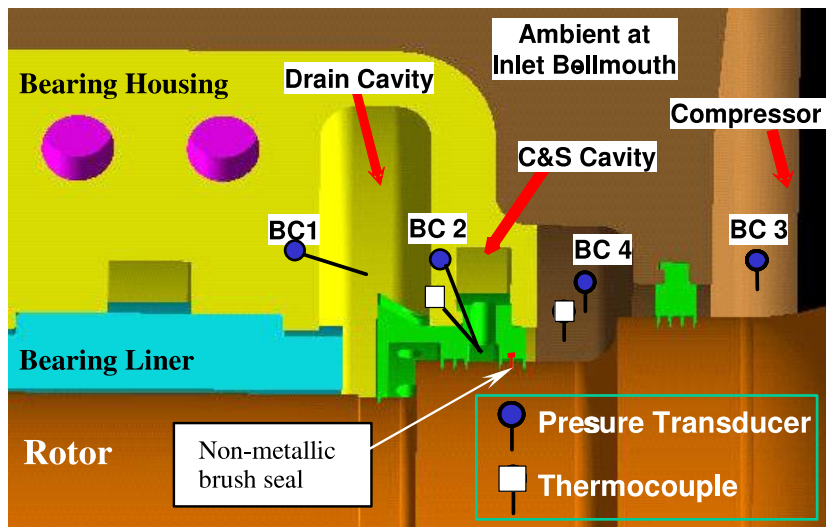

Figure 2: The 7EA gas turbine inlet bearing brush seal application [6].

2.0 FIBER SELECTION

Fiber material selection is critical. Due to heavy pressure loads high strength is needed at elevated working temperatures. As bristles may come into contact with rotor at high surface speeds, low friction and high wear resistance are other desirable features that are needed to achieve extended service lives. When an oil or oil mist seal is considered, additional requirements come in to picture due to concerns of metal particle generation near bearings. Therefore, alternative fibers to common metallic brush seals are needed. Among the non-metallic fibers, ceramic fibers were excluded due to the abrasive nature of wear debris they generate. A loose ceramic or metal fiber in bearing oil can be hazardous. Alternative non-metallic fibers were searched for the gas turbine bearing oil sealing applications. Typically, organic fibers are limited in temperature capability, and tend to shrink with increase in temperature. Considering the fact that oil or oil mist in bearing cavities may reach temperatures in excess of 150 °C (300 °F), bristle shrinkage may result in increased leakage. Inertness and moisture absorption rates are the other important considerations [6]. During initial trials with some polyester fibers Aksit et al. [7] observed bristle melting. Further nonmetallic fiber studies indicated aramid fibers as the best alternative. Aramid fibers are organic polymers that typically exhibit high strength and low density. They can be used for applications up to 150 °C operating temperatures, and show negligible amount of shrinkage and moisture absorption [6].

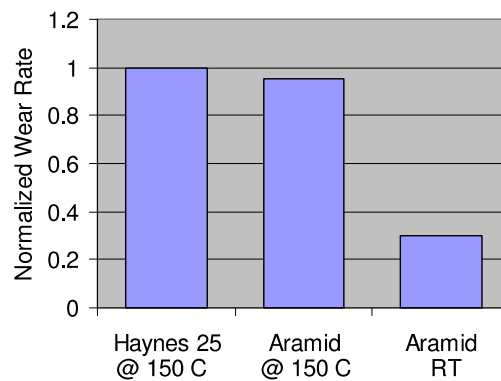

Figure 3: Wear test results for aramid and Haynes 25 tufts against Ni-Cr-Mo-V. Data are normalized with wear rate of Haynes 25 bristles at 150 °C [6].

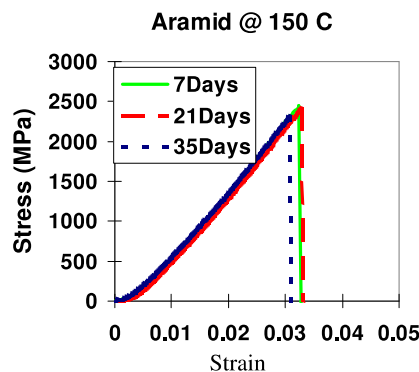

Figure 4: Aramid fiber strength upon exposure to 150 °C (300 °F) [6].

Aramid is known for its very high strength. They also have excellent wear (Figure 3) and creep resistance (Figure 4) even with continuous exposure to 150 °C [6]. Due to their higher bristle density, aramid oil

Evaluation of Brush Seals for Oil Sealing Applications

brush seals achieve much lower leakage rates, which remain only at a fraction of the leakage through their metallic counterparts.

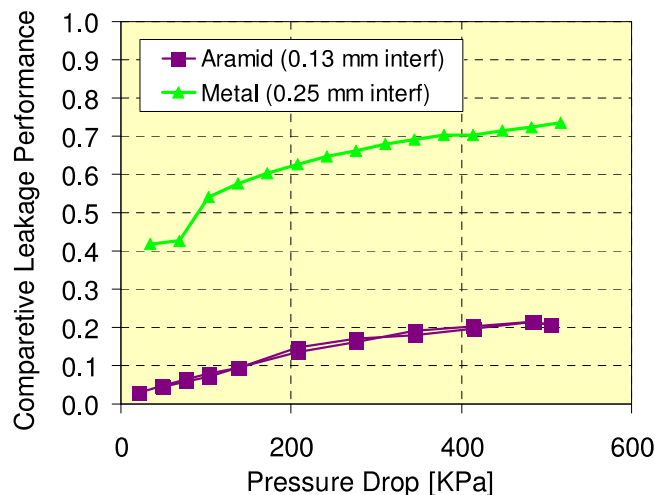

Figure 5: Comparison of leakage rates of aramid and metallic brush seals [6].

3.0 HYDRODYNAMIC LIFT

Hydrodynamic lift behavior of brush seals has been studied by Aksit et. al. [7] in detail. Their measurements in continuous oil flow showed quick rise in leakage rate with initial rotor speed, a clear indication of hydrodynamic lift of bristles. It is observed that around 15 m/s surface speed leakage gets stabilized, which indicates that shear thinning offsets further lift due to speed increase (Figure 6).

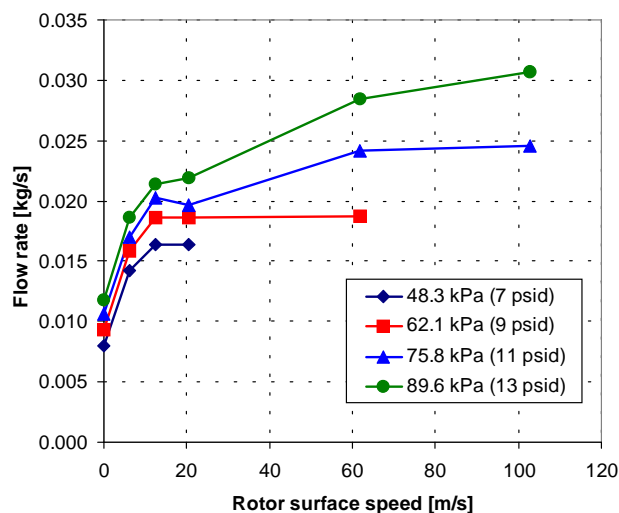

Figure 6: Hydrodynamic lift of brush seals with rotor speed [7].

When bristle-rotor interaction is considered, the inclined approach at the tip of individual bristles creates small hydrodynamic bearing surfaces at brush seal bristle tips as illustrated in Figure 7 [8]. In fact, an oil brush seal can be considered as a series of small thrust bearings (one at each bristle tip) with characteristic lengths of S_T as illustrated in Figure 8 [9]. This characteristic length and the actual oil lift surface at a single bristle tip depend on the radial penetration of the oil pumped by the rotating shaft and axial pressure drop. The thin fluid film generated by hydrodynamic lift allows reduction of general Navier-Stokes

equations to the well-known Reynolds equations for bearing surfaces. The ratio of the bearing width (bristle diameter in brush seal applications) to bearing length (circumferential length of the wedge) dictates how these tiny micro-bearings behave [10].

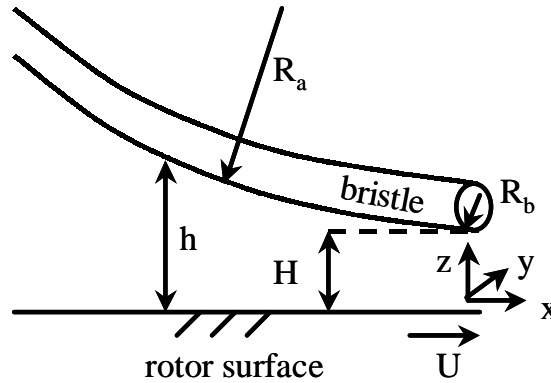

Figure 7: Hydrodynamic lift geometry for bristles [8].

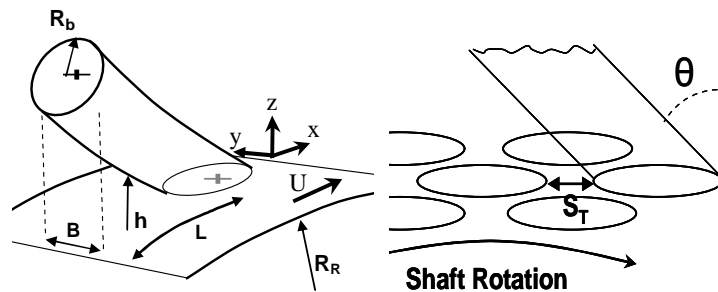

Figure 8: Bristle spacing (S_T) characterizes oil lift region at bristle tips. [9].

Depending on seal design and operating conditions bristles can remain as packed very tight, allowing fluid lift pressure to act only at the very tip. In this case bearing length L is characterized by the tangential bristle spacing S_T shown in Figure 8, which is an order of magnitude smaller than the bearing width B , or bristle diameter. These scale differences allow reduction of Reynolds equations, leading to a simplified solution, which is commonly known in tribology as a “long-bearing,” solution. The long-bearing pressure and lift solution is rather complex, and it is provided by Cetinsoy et al. [9].

In most applications, bristles deflect under differential pressure load and axially bloom, losing their tight spacing near the rotor. Typical high surface speeds in turbomachinery applications pump sealing fluid strongly into the brush pack. Therefore, actual bearing length of a bristle exposed to the fluid lift pressure is much longer than the bristle spacing, S_T . Expressing the clearance h in terms of fixed height H , flexure and bristle radii (R_a and R_b), one can write

$$h = H + \frac{x^2}{2R_a} + \frac{y^2}{2R_b}$$

For the case where the bristle width and characteristic spacing are of the same order, it leads to

Evaluation of Brush Seals for Oil Sealing Applications

$$\frac{dh}{dx} = \frac{x}{R_a}$$

Taking advantage of long bearing length, it is possible to obtain another simplified solution, which is commonly known in tribology as a “short-bearing” solution.[11,12]. Details of the short-bearing solution of for bristles are presented in reference [8]. The short-bearing solution results in a pressure distribution as

$$P - P_a = \frac{3\mu UR_b}{R_a} \frac{x}{h^2}$$

where P_a is the ambient sump pressure. Integrating over the bearing area yields the approximate hydrodynamic lift force as

$$W = \frac{6\pi}{\sqrt{2}} \mu UR_b \sqrt{\frac{R_b}{H}}$$

Hydrodynamic lift force is balanced by a reaction force due to beam/bristle deflection, frictional forces, and so-called “blow-down” forces occurring due to radial pressure gradients within the bristle pack [8]. Figure 9 compares the lift force estimates by short and long-bearing theory with beam theory bristle tip force calculations. Analyses are conducted using typical turbine oil data presented in Table 1, and published experimental oil temperature rise data [7].

In general, the lift force increases with speed, viscosity, and bristle diameter. When the lift/radial clearance increases, the hydrodynamic lift force decreases, while the bristle tip force (due to bristle bending, blow-down and frictional interactions) increases. Multiple bristle interactions and packing are not readily modeled or determined without experiments, yet contribute to brush leakage, stiffness, and durability as pressure drop increases. The seal operating clearance occurs when these forces are balanced.

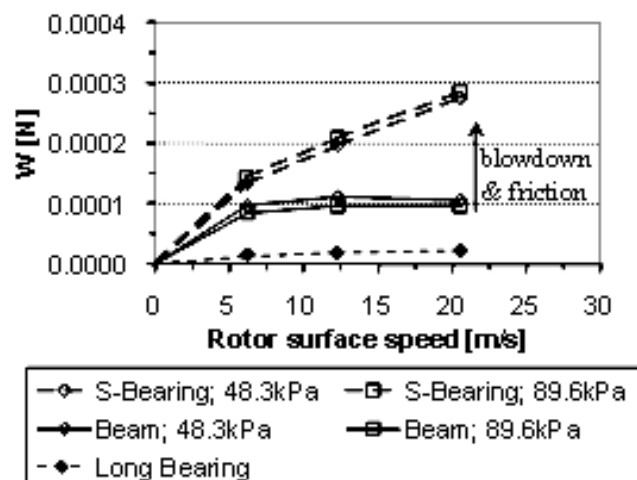

Figure 9: Comparison of the lift force estimates by long and short bearing theories with beam theory deflection force calculations [10].

Results indicate that long-bearing theory underestimates the hydrodynamic lift. On the other hand, beam

theory force results are lower than short bearing theory estimates. Actual bristle lift stabilizes where bristle reaction force is balanced by the hydrodynamic lift force. However, bristle reaction force is expected to increase over beam theory deflection force estimates when friction and blow-down forces are also considered. Therefore, the short bearing solution better represents the seal behavior.

Density	$\rho = 884.61 \text{ [kg/m}^3\text{]}$
Specific heat	$c_p = 2030.5 \text{ [J/kg-}^\circ\text{C]}$
Dynamic viscosity	$\mu = 0.0195 \text{ [Pa-s]}$
Kinematic viscosity	$\nu = 2.2 \times 10^{-5} \text{ [m}^2\text{/s]}$
Conductivity	$k = 0.142 \text{ [W/m-}^\circ\text{C]}$

Table 1: Typical turbine oil properties at 50 °C [10].

4.0 SHEAR HEATING

When oil is present at high speed junctions, shear heating and oil thinning is inevitable. The analytical bristle lift solutions discussed above assume constant geometry and viscosity, yet experimental data (Figure 6) indicate that hydrodynamic lift stabilizes after certain shaft speed because of shear thinning of oil and geometry changes.

Oils are quite sensitive to changes in temperature. For the turbine oil in Table 1, using the supplier data for coefficient $\beta=0.0294$ with $\mu_0= 0.028 \text{ Pa-s}$ at $T_0=37.78 \text{ }^\circ\text{C}$ as the reference point, the viscosity relation can be calculated as

$$\mu = 0.028e^{-0.0294(T-37.78)}$$

In order to calculate the average effective fluid temperature at a given rotor speed and lift clearance, a thermal energy equation needs to be solved. Based on the experimental leakage data of Aksit et al. [7], flow rate in leakage direction (y) is taken to be around $0.4\text{cm}^3\text{/s}$. With this flow rate and other properties of the fluid medium listed in Table 1, the Peclet number, which is the ratio of forced convection to heat conduction, takes a value around 15, indicating the contribution of heat conduction to energy transfer is small in comparison to convection terms [13]. Based on the short bearing solution, convection and viscous dissipation dominate, and the energy equation reduces to

$$\rho c_p v_y \frac{\partial T}{\partial y} = \mu \left(\left(\frac{\partial v_x}{\partial z} \right)^2 + \left(\frac{\partial v_y}{\partial z} \right)^2 \right)$$

After a long and tedious process, the temperature distribution is reached as

$$T = T_0 + \frac{1}{2\beta} \ln \left(\frac{f_1}{f_2} + f_3 \cdot f_4 \right)$$

Evaluation of Brush Seals for Oil Sealing Applications

where

$$f_1 = \exp(2\beta(T_u - T_0))$$

$$f_2 = \exp\left[\frac{(2z - H)^2}{\rho c_p (z^2 - zH)} \cdot \frac{\Delta P}{w} \cdot \beta \cdot y\right]$$

$$f_3 = \frac{4(u \cdot w \cdot \mu_0)^2}{[H \cdot \Delta P \cdot (2z - H)]^2}$$

$$f_4 = \exp\left[-\frac{(2z - H)^2}{\rho c_p (z^2 - zH)} \cdot \frac{\Delta P}{w} \cdot \beta \cdot y\right] - 1$$

Using the seal data provided by Aksit et al [7], the calculated temperature rise values in Table 2 [13] compare well with the experimental measurements [7]. Higher sealing pressures derive higher leakage rates and provide more cooling at the same rotor speed. Therefore, fluid temperature rise decreases with increasing pressure load (leakage). Further details on the shear heating in brush seals for oil sealing applications can be found in references [13-16].

	$\Delta P = 48.3\text{kPa}$	$\Delta P = 89.6\text{kPa}$
Rotor surface speed, u	Temperature rise of the fluid across the seal	Temperature rise of the fluid across the seal
6.2m/s	5.4 °C	5.5 °C
12.5m/s	8.8 °C	9.3 °C
20.5m/s	19.9 °C	16.6 °C

Table 2: Temperature rise along y-axis (from upstream side to downstream side) for different cases [13].

5.0 CONCLUSION

Oil sealing at high surface speeds remains a challenge for most turbomachinery applications. Due to high shear rates, oil temperature increase and coking are the most challenging issues that needs to be addressed. The experimental investigations reveal the following conclusions about the brush seal applications in high speed oil sealing.

- Brush seal leakage performance is better than labyrinth seal for air and oil mist applications. Leakage performance is further increased when bristles are wetted by oil.
- Field experience about brush seal gas turbine bearing applications indicate that when designed properly, brush seals can be successfully applied in gas turbine sump applications.
- When used in continuous liquid oil flow applications, hydrodynamic lift appears to decrease leakage performance with speed. However, it stabilizes at higher speeds. For a successful design, one should optimally control seal stiffness to find ta correct balance between hydrodynamic lift and oil temperature rise.

- Heat generation should be kept under control through proper seal stiffness. Oil coking needs further investigation.

6.0 REFERENCES

- [1] Mayer R.R., Aksit M.F., and Bagepalli B.S., Brush seal for a bearing cavity, US Patent No. US6502824B2, 2003.
- [2] Aksit M.F., Dinç O.S., and Mayer R.R., Brush seal and machine having a brush seal, US Patent No. US 6406027B1, 2002.
- [3] Mayer R.R., Bagepalli B.S., and Aksit M.F., Low flow fluid film seal for hydrogen cooled generators, US Patent No. US 6378873B1, 2002.
- [4] Bagepalli B.S., Aksit M.F., and Mayer R.R., Brush seal and rotary machine including such brush seal, US Patent No. US 6257588B1, 2001.
- [5] Ingistov, S., "Power Augmentation and Retrofits of Heavy Duty Industrial Turbines model 7EA," Proc. Of Power-Gen International Conference, Las Vegas, NV, 2001.
- [6] Bhate, N., Thermos, A.C., Aksit, M.F., Demiroglu, M., Kizil, H., "Non-Metallic Brush Seals For Gas Turbine Bearings", Procs. of ASME Turbo Expo 2004, GT2004-54296, 2004.
- [7] Aksit, M.F., Bhate, N., Demiroglu, M., and Bouchard, C., "Evaluation of Brush Seal Performance for Oil Sealing Applications," 39th AIAA/ASME/SAE/ASEE Joint Propulsion Conference & Exhibit, AIAA-2003-4695, 2003.
- [8] Aksit, M.F., Dogu, Y., J.A. Tichy and Gursoy M., "Hydrodynamic Lift of Brush Seals in Oil Sealing Applications," Proceedings of 40th AIAA/ASME/SAE/ASEE Joint Propulsion Conference & Exhibit, Fort Lauderdale, Florida, AIAA-2004-3721, July 2004.
- [9] Cetinsoy, E., Aksit, M.F., and Kandemir, I., "A Study Of Brush Seal Oil Lift Through Long Bearing Analysis," Proceedings of IJTC2006 STLE/ASME International Joint Tribology Conference, San Antonio, TX, ASME Paper IJTC2006-12370, 2006.
- [10] Chupp R.E., Hendricks R.C., Lattime S.B., Steinetz B.M., Aksit M.F., "Turbomachinery Clearance Control," NASA Technical Report ID: 20070005016, NASA Glenn Research Center, NASA Scientific and Technical Aerospace Reports (STAR), No.3, Vol.45, pp.114, February, 2007.
- [11] Bhushan, B., Modern Tribology Handbook, CRC Press, New York, 2001.
- [12] Harnoy, A., Bearing design in machinery: engineering tribology and lubrication, Marcel Dekker, 2003.
- [13] Duran, E.T., Aksit, M.F., and Dogu, Y., "Effect of Shear Heat on Hydrodynamic Lift of Brush Seals in Oil Sealing," Proceedings of 42nd AIAA/ASME/SAE/ASEE Joint Propulsion Conference & Exhibit, Sacramento, California, AIAA Paper AIAA-2006-4755, 2006.
- [14] Duran E.T., Aksit M.F., and Dogu Y., "Oil Temperature Analysis Of Brush Seals," Proceedings of STLE/ASME International Joint Tribology Conference, San Diego, California USA, ASME Paper IJTC2007-44397, 2007.
- [15] Duran E.T., and Aksit, M.F., "A study of brush seal oil pressure profile including temperature-viscosity effects," 44th AIAA/ASME/SAE/ASEE Joint Propulsion Conference and Exhibit, Reston, VA, USA, AIAA Paper AIAA-2008-4622, 2008.
- [16] Duran, E. T. and Akşit, M.F., "Effect of Shear Heat on Hydrodynamic Lift of Brush Seals in Oil Sealing," Proceedings of The STLE 65th Annual Meeting & Exhibition, Atlanta, GA, USA, 2010.



Evaluation of Brush Seals for Oil Sealing Applications

