

We are IntechOpen, the world's leading publisher of Open Access books Built by scientists, for scientists

4,800

Open access books available

122,000

International authors and editors

135M

Downloads

Our authors are among the

154

Countries delivered to

TOP 1%

most cited scientists

12.2%

Contributors from top 500 universities



WEB OF SCIENCE™

Selection of our books indexed in the Book Citation Index
in Web of Science™ Core Collection (BKCI)

Interested in publishing with us?
Contact book.department@intechopen.com

Numbers displayed above are based on latest data collected.

For more information visit www.intechopen.com



Conditioning Monitoring and Fault Diagnosis for a Servo-Pneumatic System with Artificial Neural Network Algorithms

Mustafa Demetgul¹, Sezai Taskin² and Ibrahim Nur Tansel³

¹Marmara University, Technical Education Faculty, Mechanical Education Department, Goztepe, Istanbul,

²Celal Bayar University, Department of Electronics and Automation, Turgutlu, Manisa,

³Florida International University, Department of Mechanical and Materials Engineering, 10555 W. Flagler St. EC 3400, Miami, FL,

^{1,2}Turkey

³USA

1. Introduction

On-line monitoring of manufacturing process is extremely important in modern manufacturing for plant safety, maximization of the production and consistency of the product quality (Song et al., 2003). The development of diagnostic systems for the industrial applications has started in early 1970s. The recent developments in the microelectronics have increased their intelligence and let them found many industrial applications in last two decades (Mendonca et al., 2009; Shi & Sepehri, 2004). The intelligent data analysis techniques are one of the most important components of the fault diagnosis methods (Uppal et al, 2002; Uppal & Patton, 2002). In this study, the faults of a pneumatic system will be monitored by using the artificial neural networks (ANN).

When the speed control and magnitude of the applied force is not critical, pneumatic systems are the first choice. They are cheap, easy to maintain, safe, clean, and components are commercially available. They have even been used for precise control of industrial systems (Nazir & Shaoping, 2009; Ning & Bone, 2005). Unfortunately, their nonlinear properties and some limitations at their damping, stiffness and bandwidth characteristics avoid their widespread applications (Belforte et al., 2004; Tsai & Huang, 2008, Bone & Ning, 2007; Taghizadeh et al., 2009; Takosoglu et al., 2009).

The interest for the development of diagnostic methods for pneumatic and hydraulic systems has increased in the last decade (Nakutis & Kaškonas, 2008). Researchers concentrated on the detection of the faults of the components. The condition of the pneumatic and hydraulic cylinders (Wang et al., 2004), and digitally controlled valves (Karpenko et al., 2003) were the main focus of the studies. Some of the other considered faults were leakage of the seals (Nakutis & Kaškonas, 2005, 2007; Yang, 2006; Sepasi & Sassani, 2010), friction increase (Wang et al., 2004; Nogami et al., 1995) and other

malfuctions (Bouamama et al., 2005). The monitored signals can be divided into two groups according to their frequencies. Acoustic emission is an excellent example of high frequency monitoring signal (Yang, 2006; Chena et al., 2007). The frequency of the pressure, flow, and timing signals are low (Sepasi & Sassani, 2010; Nogami et al., 1995; Bouamama et al., 2005; Nakutis & Kaškonas, 2005, 2008; Wang et al., 2004; Karpenko et al., 2003; Li & Kao, 2005; McGhee et al., 1997). The gathered signals are encoded to obtain their most descriptive features. The encoded signals were classified by using various classification techniques such as ANNs (Karpenko et al., 2003; Nakutis & Kaškonas, 2003; Sepasi & Sassani, 2010; Nogami et al., 1995; McGhee et al., 1997), fuzzy method (Mendonca et al., 2009; Uppal & Patton, 2002), neuro fuzzy method (Shi & Sepehri, 2004; Uppal & Patton, 2002), statistical technique (Song et al., 2003), bond graphs (Bouamama et al., 2005), genetic programming (Wang et al., 2004; Yang, 2006), and expert/intelligent systems (Chen & Mo, 2004).

It is not difficult to develop programs for classification of the sensory signals of pneumatic systems. However, these programs should be carefully modified when the characteristics of the signals change. Many researchers have worked on the development of ANNs. Generally, most of the ANNs are ready to take the advantage of future parallel hardware. By considering these facts ANNs will be used for the classification in this study.

Mainly, there are two types of ANNs: supervised and unsupervised. The supervised ANNs require an initial training. Unsupervised ones may start to monitor the signals without any training. Among the supervised ANNs, the feed-forward ANNs (FFNN) have been widely used. The Back-propagation (BP) algorithm is the most popular one for estimation of the weights and were used in many applications (Bryson & Ho, 1969, Rumelhart et al., 1976, Huang et al., 2007; Lu et al., 2000; Tansel et al., 2009; Aykut et al., 2010; Tansel & Demetgul & Sierakowski, 2009; Demetgul et al., 2009). Quasi-Newton approaches such as Levenberg-Marquardt was developed to increase the speed of the estimation and is available in the MATLAB ANN Toolbox (Beale et al., 2010). Fuzzy ARTMAP method (Carpenter et al., 1991, Carpenter et al., 1992) allowed the use of the Adaptive Resonance Theory (ART) for the supervised learning (Grossberg, S., 1987). Among the unsupervised ANNs Adaptive Resonance Theory 2 (ART2) (Grossberg, S., 1987, Carpenter & Grossberg, 1987, Rajakarunakaran et al., 2008, Lee et al., 2003, Belforte et al., 2004) has been successfully used for classification in many applications. This approach was improved further by the development of fuzzy ART (Carpenter et al., 1991a, Carpenter et al., 1991b). In this study the data was classified by using the BP, fuzzy ARTMAP, ART2 and fuzzy ART.

In the following section the theoretical background of the ANNs will be presented very briefly. The experimental setup, results and the conclusion will follow it.

2. Theoretical background of the tested ANNs

In this section the ANNs will be very briefly reviewed since detailed information is available at the listed references.

2.1 Supervised ANN

In this study, two supervised ANNs were used. FFNN became popular with the widespread use of the BP (Bryson & Ho, 1969, Rumelhart et al., 1976) algorithm. The FFNN have multiple layers. Generally, single hidden layer is used. The user determines the number of the hidden neurons of this layer by trial and error. The number of the neurons of the input

and output layers depends on the application. The BP estimates the weights of the neurons by updating them after the forward and backward propagation of error. The learning rate and the momentum are two important parameters of the BP for training the network successfully (Chen & Mo, 2004; McGhee et al., 1997). Levenberg-Marquardt algorithm (Beale et al., 2010) generally estimates the parameters of the FFNNs. It finds the best weights by minimizing the function. It works effectively for many applications. Levenberg-Marquardt algorithm available at the MATLAB toolbox was used in this study (Beale et al., 2010).

Fuzzy ARTMAP (Carpenter et al., 1991, Carpenter et al., 1992) use the fuzzy logic and ART ANNs. It evaluates the similarity by considering the fuzzy subthreshold and ART category choice. The vigilance is used to determine the size of the "category boxes" or sensitivity of the ANN. One of the very important advantages of the ARTMAP with or without the fuzzy component over the FFNNs is the use of the vigilance based on our experience. Aaron Garrett's (Garrett, 2003) code was used for the training and testing of the fuzzy ARTMAP method.

2.2 Unsupervised ANN

ART2 type ANN evaluates the characteristics of the inputs and assign them a category (Carpenter & Grossberg, 1987; Lee et al., 2003, Yang et al., 2004, Na et al., 2008). If the signal looks like one of the previously presented signals, it will be classified in the same category. On the other hand, if the signal is different than the previously presented ones a new category is assigned for it. The sensitivity of ART2 depends to the vigilance. At the low vigilances, it has higher tolerance. When the vigilance approaches to one it will be more selective.

Fuzzy ART use fuzzy set theory in the ART1 type ANN structure. With the help of the MIN operator of the fuzzy set theory the classification of the binary and analog input patterns is possible. The vigilance parameter adjust the selectivity of the ANN. In this study Aaron Garrett (Garrett, 2003) implementation of the fuzzy ART was used.

3. Experimental setup and performed experiments:

The diagram of the experimental setup is presented in Fig.1. The pneumatic system created motions along the X and Y axes. The operation of the system was managed by an SPC 200 two axis servopneumatic controller. Each axes could be operated in the coordinated or autonomous mode. Controller was also responsible from the digital I/O including the communications with the other devices. A pressure transducer was used to measure the supply pressure of the system. 5/3-way proportional valves controlled the flow of the pressurized air into the proper chambers of the cylinders.

A proportional valve (Festo MPYE-5 1/8 LF-010B) controlled the displacement of pneumatic cylinder in the x direction. The valve was connected to the both chambers of the pneumatic rodless cylinder (Festo DGPL-25-450-PPV-A-B-KF-GK-SV). The stroke length and the diameter of the cylinder were 450 mm and 25 mm respectively. A linear potentiometer (Festo MLO-POT-450-TLF) was attached to the side on the actuator to measure the piston position. The valve had the neutral spool position under 5 V control voltage.

Another pneumatic rodless cylinder (Festo DGPIL-25-225-PPV-B-KF-AIF-GK-SV-AV) created the motion in the Y direction. The stroke length and the diameter of the cylinder were 225 mm and 25 mm respectively. A contactless absolute magnetostrictive linear displacement sensor was used to measure the strokes of the piston. A gripper was attached to the cylinder.

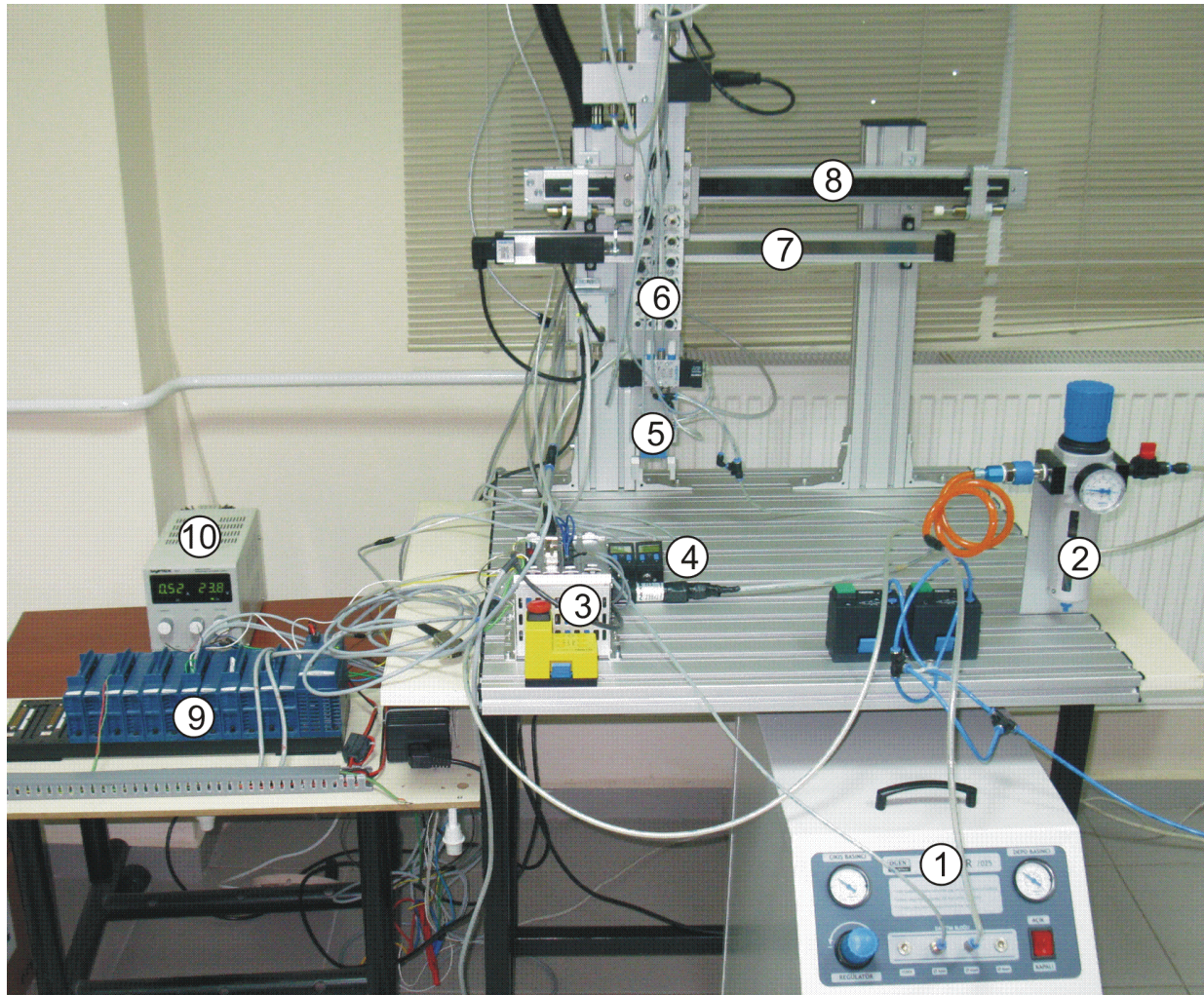

1. Air compressor
2. Service Unit
3. SPC 200 Controller
4. Analog Pressure Transducers
5. Gripper
6. Y axis
7. Linear Potentiometer for x axis
8. X axis
9. NI Compact FieldPoint System
10. Power Supply

Fig. 1. Servo-pneumatic positioning system of the Festo Didactic. The components of the system are the following:

Experimental data was collected by using the National Instrument (NI) compact FieldPoint measurement system with control modules. The LabVIEW program environment controlled the measurement system. The values of four analog parameters were monitored. Three of these parameters were the pressure readings of the cylinders creating the motion in the x and y directions and the overall system. The Fourth analog input was the readings from the linear potentiometer. The gripper action was monitored from the digital signals coming from data acquisition card. The diagram of the components of the servo-pneumatic system is shown in Figure 2.

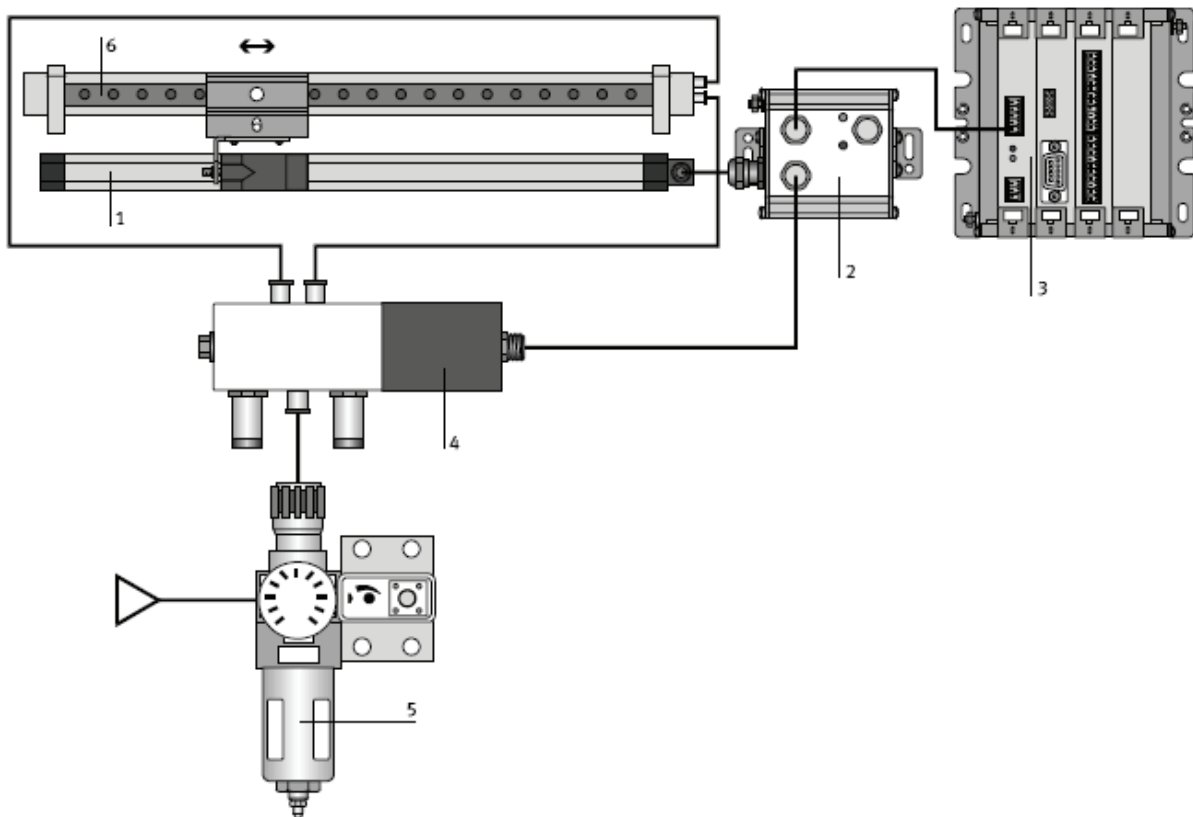

Fig. 2. The servo-pneumatic system components for X axis. (1. Measuring system, 2. Axis interface, 3. Smart positioning controller SPC 200, 4. Proportional directional control valve, 5. Service unit, 6. Rodless cylinder) ((festodidactic.com, 2010)

The servo-pneumatic system simulated the operation of food preparation. Jars were put individually on a conveyor belt by the packaging system. A handling device with servo-pneumatic NC axis transferred these jars to a pallet. The precise motion of the NC axis is essential for completion of the task (Festo Didactic, 2010).

The user interface of the LabVIEW program is presented in Fig. 3. The display shows the pressures of the overall system and two cylinders creating the motions along the X and Y axes. Also the displacement of one of the cylinder and gripper action (pick and place) is demonstrated.

In this study, the pneumatic system was operated at the normal and 4 different faulty conditions. The experimental cases are listed in Table 1. There were 15 experimental cases. The data was collected at the same condition 3 times when the system was operated in the normal and 4 faulty modes.

Operational condition	Experiment #	Recalled as
Normal operation of the Servo Pneumatic System	1	Normal
x axis error positioning	2	Fault 1
y axis error positioning	3	Fault 2
Pick faults for gripper	4	Fault 3
Place faults for gripper	5	Fault 4

Table 1. Operating conditions

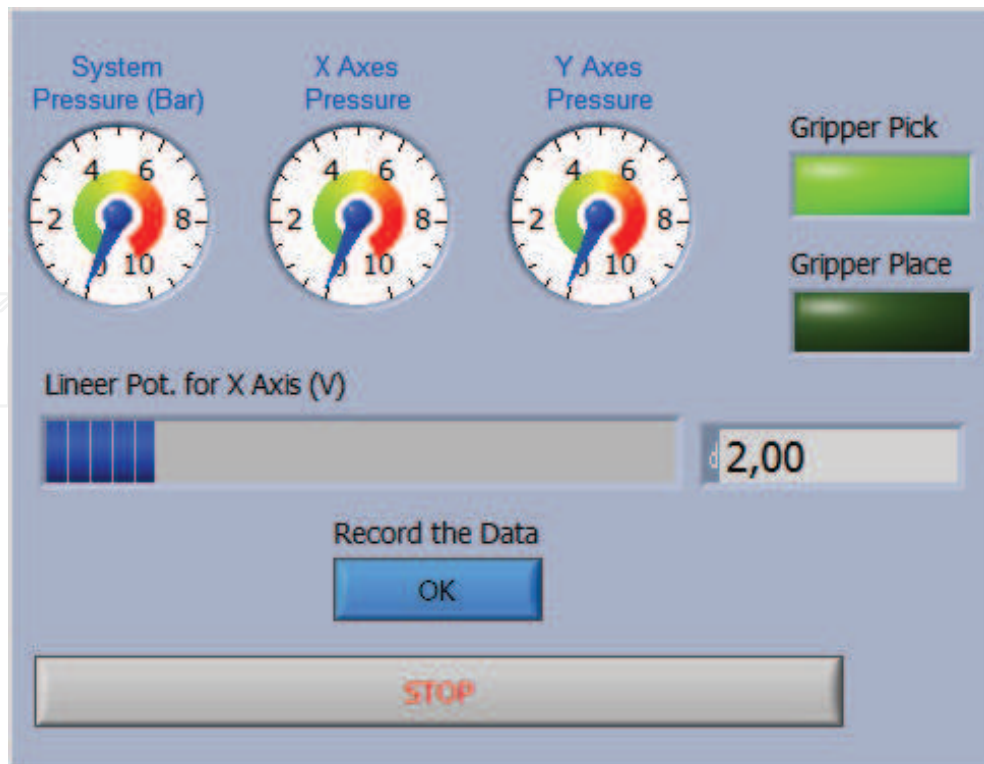

Fig. 3. Data collection visual front panel of LabVIEW

The signals of the gripper pick (Fig.4) and place (Fig.5) sensors, the pressure sensors of the cylinders in the x (Fig.6) and y (Fig.7) directions, the voltage output of the linear potentiometer of the x axis (Fig.8) are presented in the corresponding figures.

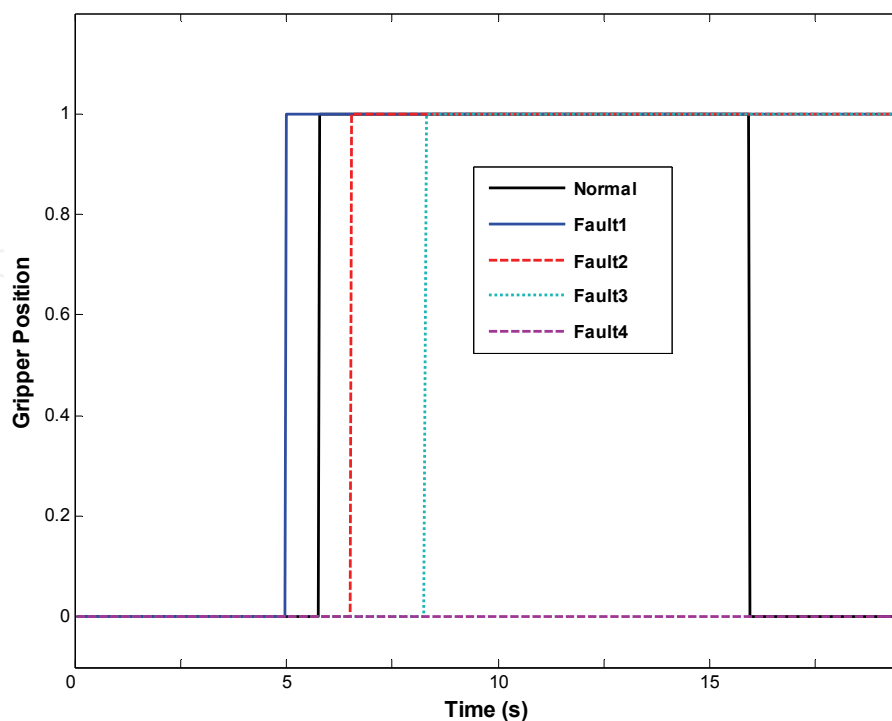

Fig. 4. Gripper Pick

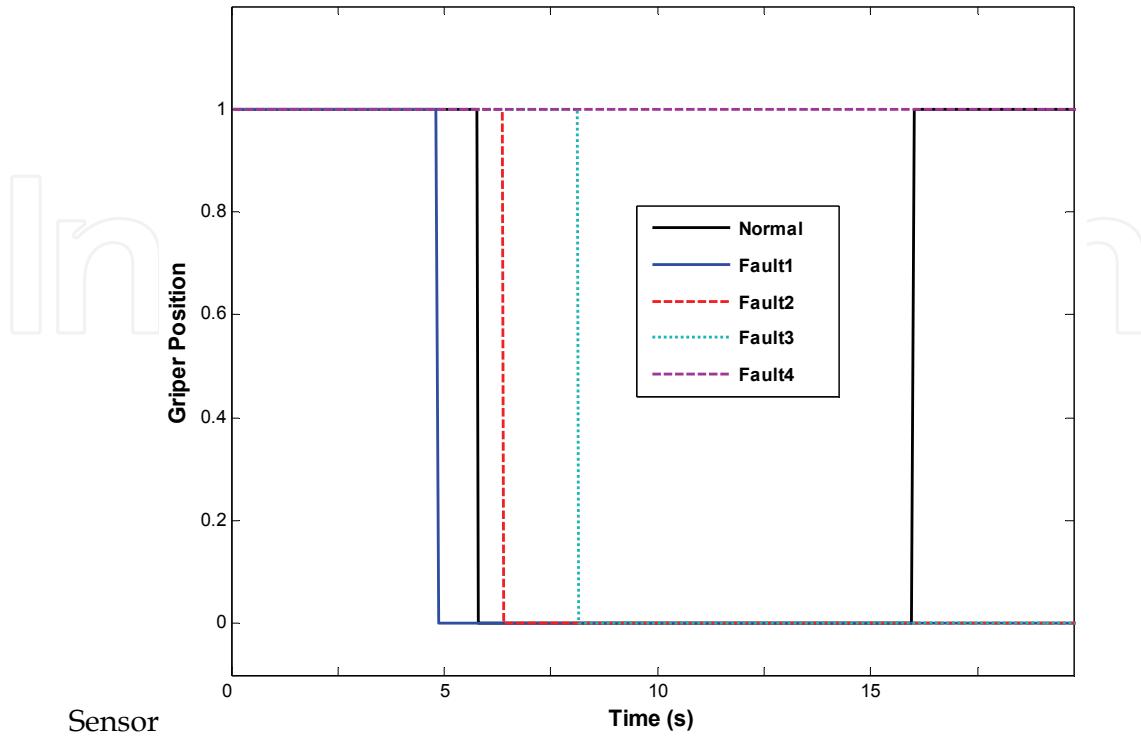

Fig. 5. Gripper Place Sensor

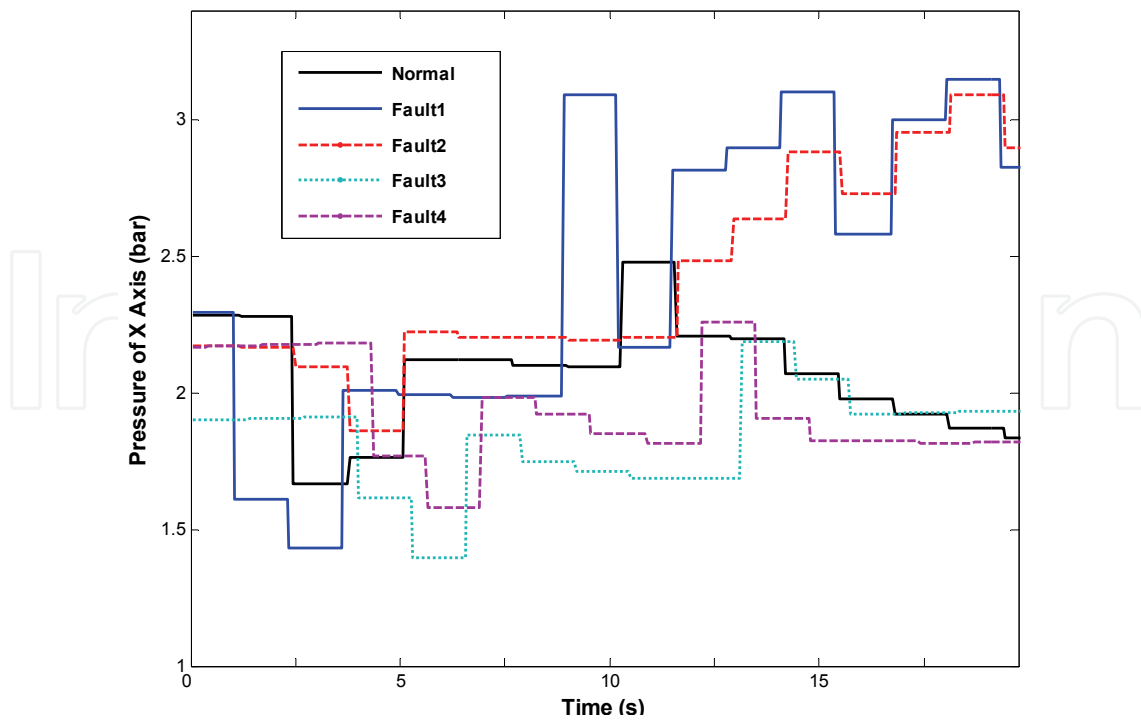

Fig. 6. X Axis Pressure

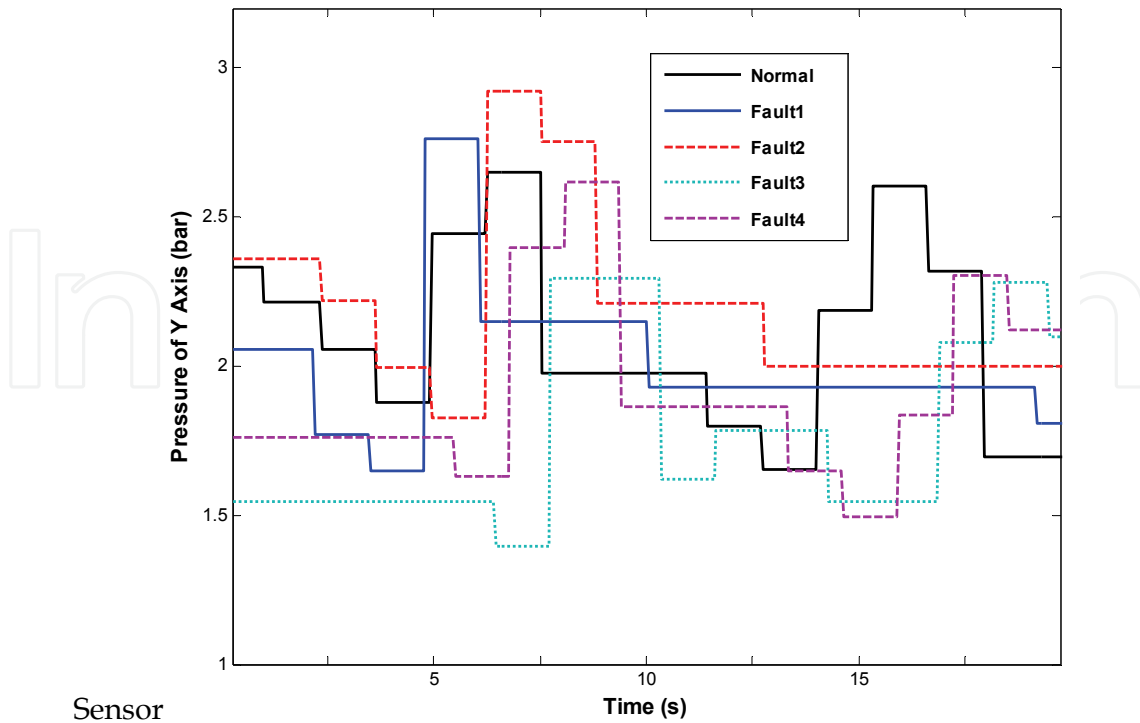

Fig. 7. Y Axis Pressure Sensor

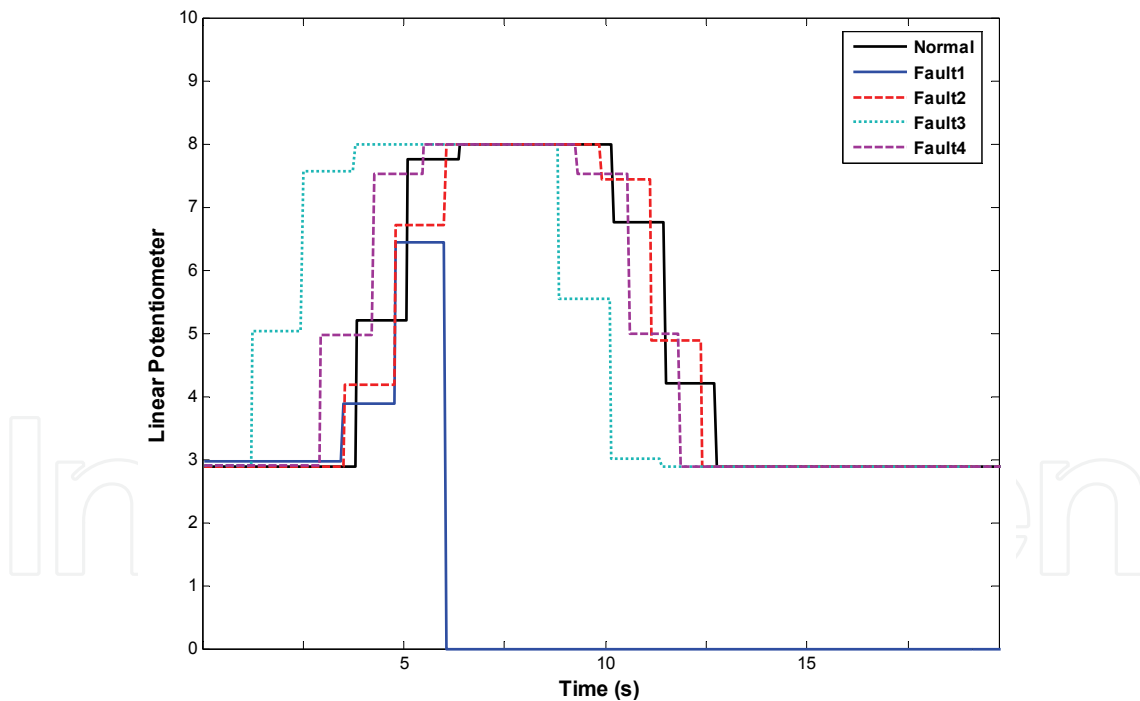

Fig. 8. X Axis linear potentiometer signal

4. Proposed encoding method

The sensors provided long data segments during the operation of the system. To represent the characteristics of the system the sensory signals were encoded by selecting their most descriptive futures and presented to the ANNs.

Two gripper sensor signals were monitored one for pick (Fig.4) and one for place (Fig.5). Their outputs were either 0 V or 1V. The gripper pick and place signals were encoded by identifying the time when the value raised to 1V and when it fell down to 0V. The signals of the pressure of x axis (Fig.6), pressure of y axis (Fig.7) and main pressure were encoded by calculating their averages. For the linear potentiometer (Fig.8) the times when the signal fell below 7V and when it went over 7V were identified and used during the classification.

5. Results

The expected results from the ANN classification are presented in Fig.9. Ideally, once the ANN experiences the normal and each faulty mode, someone may expect it to identify each one of them accurately. In our case this means, an unsupervised ANN create maximum 5 categories and assign each one of them to the normal and 4 fault modes. Similarly, the output of the supervised ANNs are supposed to be an integer value between 1 and 5 depending on the case. It is very difficult to classify the experimental data in 5 different categories unless the encoded cases have very different characteristics, repeatability is very high and noise is very low. In the worst case, we expect the ANN to assign at least two categories and locate the normal operation and faulty ones in separate categories. The output of the supervised ANN could be 0 and 1 in such cases. The ANN estimates in the ideal and accdptialbe worst case scenario are demonstrated in Fig.9. In the following sections, the performance of the supervised and the unsupervised ANNs are outlined.

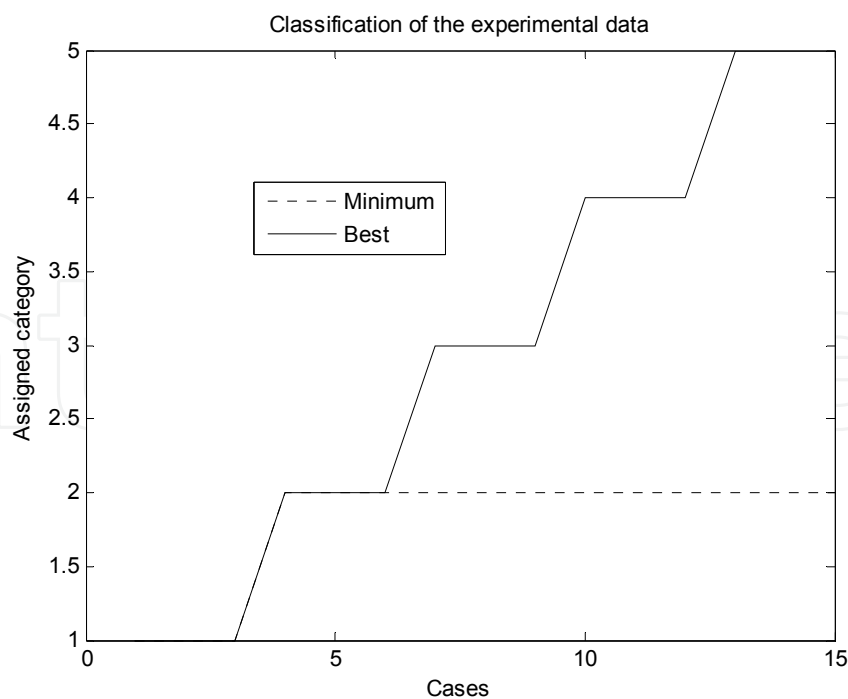

Fig. 9. The output of the ANNs for classification of normal and 4 faulty modes.

5.2 Performance of the supervised ANNs:

Performance of the feed-forward-network (FFN) was evaluated by using the Levenberg Marquardt algorithm. The FFN had 9 inputs and 1 output. The outputs of the cases were 1, 2, 3, 4, 5 for Normal, Fault1, Fault2, Fault3 and Fault4 respectively. For training only one sample of the normal and 4 faulty cases were used. Since the FNN type ANNs do not have any parameters to adjust their sensitivity they have to be trained with very large number of cases which will teach the network expected response for each possible situation. Since, one sample for each one of the normal and 4 faulty cases was too few for effective training, we generated semi experimental cases. The semi-experimental cases were generated from these samples by changing the each input with $\pm 1\%$ steps up to $\pm 10\%$. We generated 100 semi-experimental cases in addition to the original 5 cases with this approach. The FNN had 8 neurons at the hidden layer. The FFN was trained with 105 cases.

The FFN type ANN was trained by using the Levenberg-Marquardt algorithm of the Neural Network Toolbox of the MATLAB. The training was repeated several times. The same semi-experimental data generation procedure was used to generate 200 additional test cases from the 10 experimental cases which had 2 tests at each condition (1 normal and 4 faulty ones). The average estimation errors were $5.55e-15\%$ for the training and 8.66% for the test cases. The actual and estimated values for the training and test cases are presented in Fig.10 and Fig.11 respectively. The ANN always estimated the training cases with better than 0.01% accuracy. The accuracy of the estimations of the test cases was different at each trail. These results indicated that, without studying the characteristics of the sensory signals very

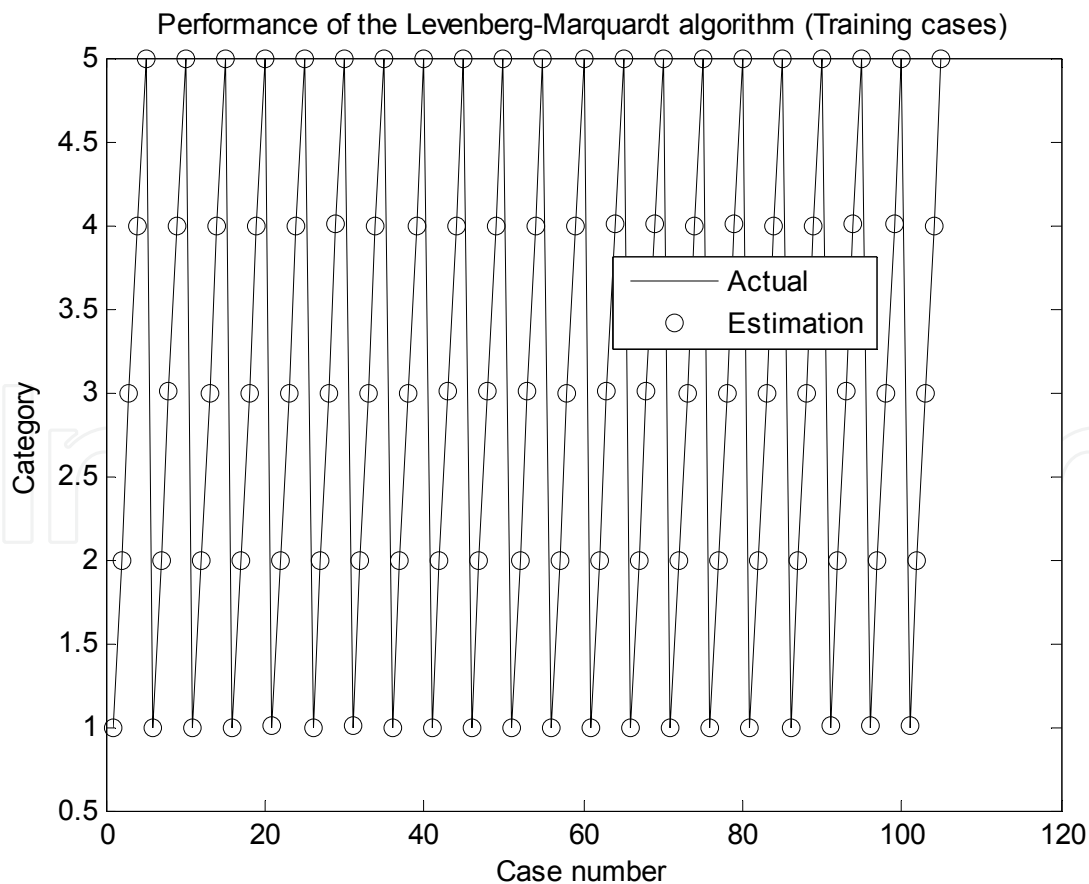

Fig. 10. The FFN type ANN estimations for the training cases.

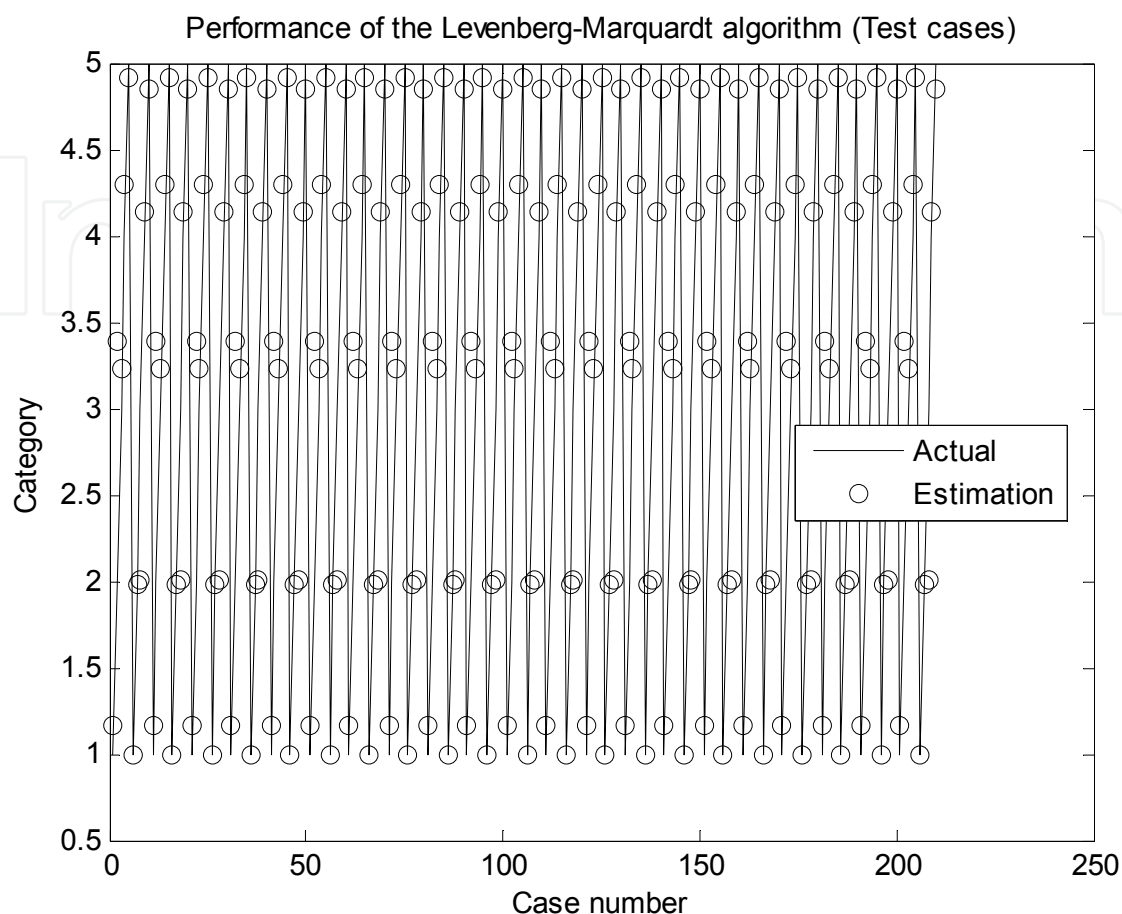

Fig. 11. The FFN type ANN estimations for the test cases.

carefully, the ANN may estimate the normal and faulty cases; however, for industrial applications the characteristics of the data may change in much larger range than ours and working with much larger experimental samples are advised.

The same analysis was repeated by using the fuzzy ARTMAP. The fuzzy ARTMAP adjusts the size of the “category boxes” according to the selected vigilance value. The ANN estimates the category of the given case as -1 if the fuzzy ARTMAP do not have proper training. So, we did not need to use the semi-experimental data. The fuzzy ARTMAP was trained by using 5 cases (normal and 4 fault modes). It was tested by using the 10 cases (2 normal and 8 faulty cases (2 samples at each fault modes)). The vigilance was changed from 0.52 to 1 with the steps of 0.02. The identical performance was observed for the training and test cases when the vigilance was selected between 0.52 and 0.83 (Fig.12). All the training cases were identified perfectly. The normal and all the faulty ones were distinguished accurately. The fuzzy ARTMAP only confused two test cases belong to Fault 2 and 3. The performance of the fuzzy ARTMAP started to deteriorate at the higher vigilances since the “category boxes” were too small and the ANN could not classify some of the test cases. The number of the unclassified cases increased with the increasing vigilance.

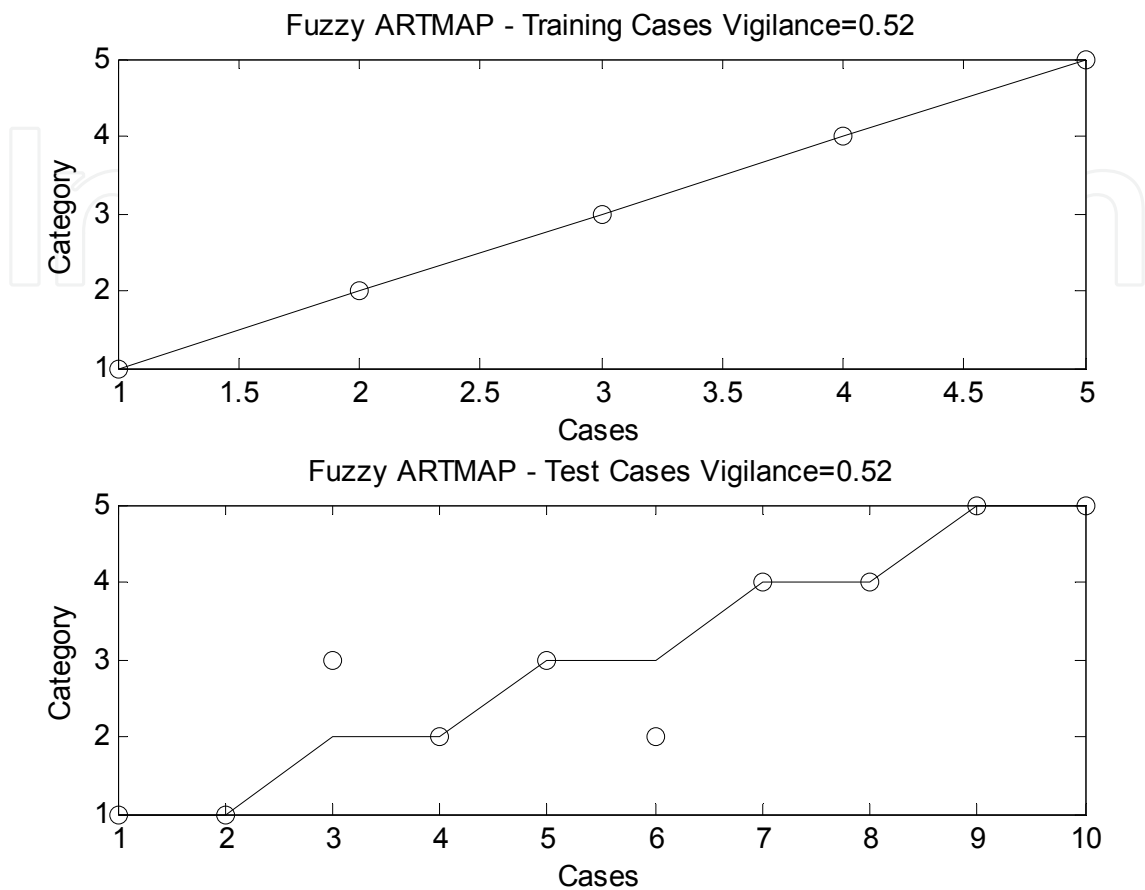

Fig. 12. The performance of the fuzzy ARTMAP type ANN.

5.1 Performance of the unsupervised ANNs:

Performance of the ART2 is shown in Table 2. It distinguished the normal and faulty cases. Among the faults, the Fault 3 was identified all the time by assigning a new category and always estimating it accurately. The ART2 could not distinguish Fault 1, 2 and 4 from each other. The best vigilance values were in the range of 0.9 and 0.9975. When these vigilances were used ART2 distinguished the normal operation, faulty cases and Fault 3. The same results are also presented with a 3D graph in Fig.13.

The results of the Fuzzy ART program are presented in Fig.14. The number of assigned categories varied between 2 and 15 for the vigilance values of 0.5 and 1. When the vigilance was 0.5, the Fuzzy ART distinguished the normal and faulty operation but could not classify the faults. Fuzzy ART started to distinguish Fault 4 when the vigilance was 0.65. It started to distinguish Fault 3 and 4 for the vigilance value of 0.77. When the vigilance reached to 0.96 it could distinguished 10 categories and classified all the cases accurately. Multiple categories were assigned to the normal and some of the faulty operation modes.

Condition of the system	Experiment	Vigilance values				
		0.9 - 0.9975	0.998	0.9985	0.999	0.9995
Normal	Test 1	1	1	1	1	1
	Test 2	1	2	2	2	2
	Test 3	1	2	2	2	2
Fault 1	Test 1	2	3	3	3	3
	Test 2	2	3	3	3	4
	Test 3	2	3	3	3	4
Fault 2	Test 1	2	3	3	3	4
	Test 2	2	3	3	3	4
	Test 3	2	3	3	3	5
Fault 3	Test 1	3	4	4	4	6
	Test 2	3	4	4	4	6
	Test 3	3	4	4	4	6
Fault 4	Test 1	2	3	3	3	5
	Test 2	2	3	3	3	5
	Test 3	2	3	3	3	7

Table 2. The estimated categories with the ART 2 algorithm

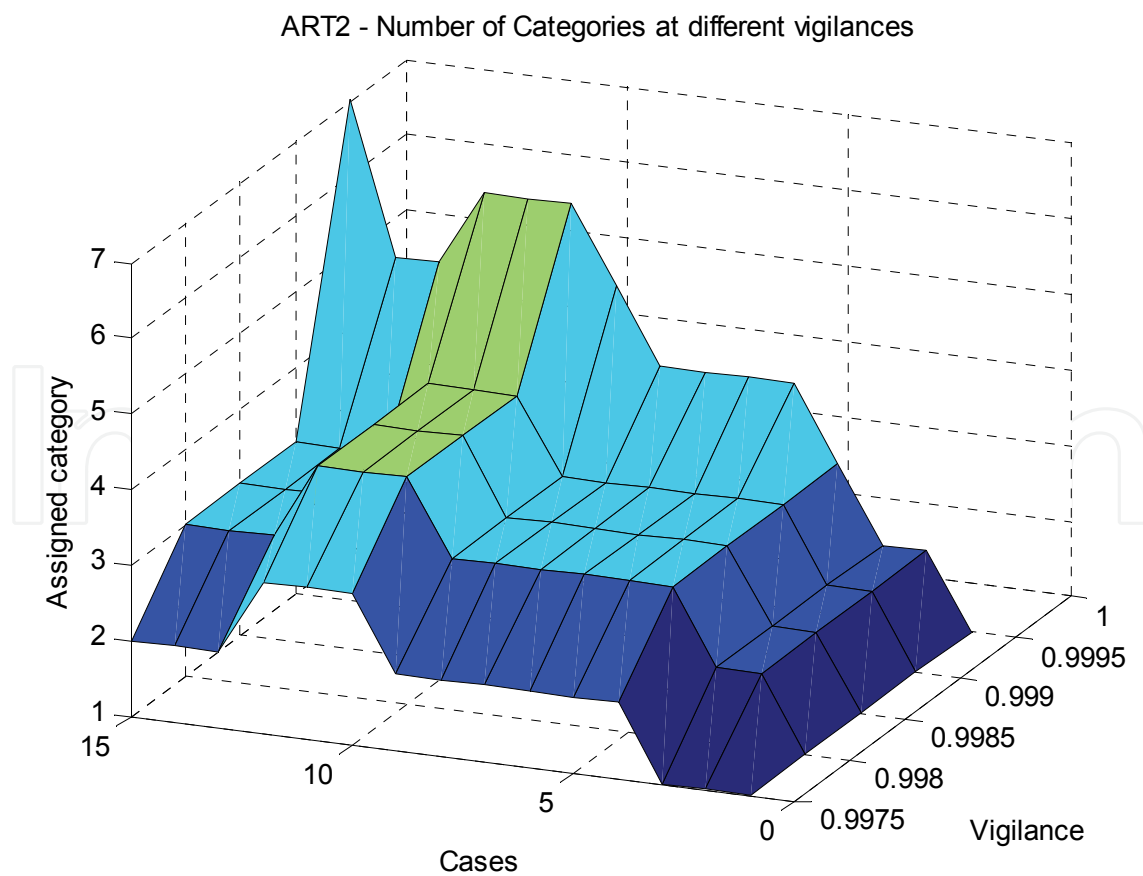

Fig. 13. The graphical presentation of the ART2 results in the Table 1.

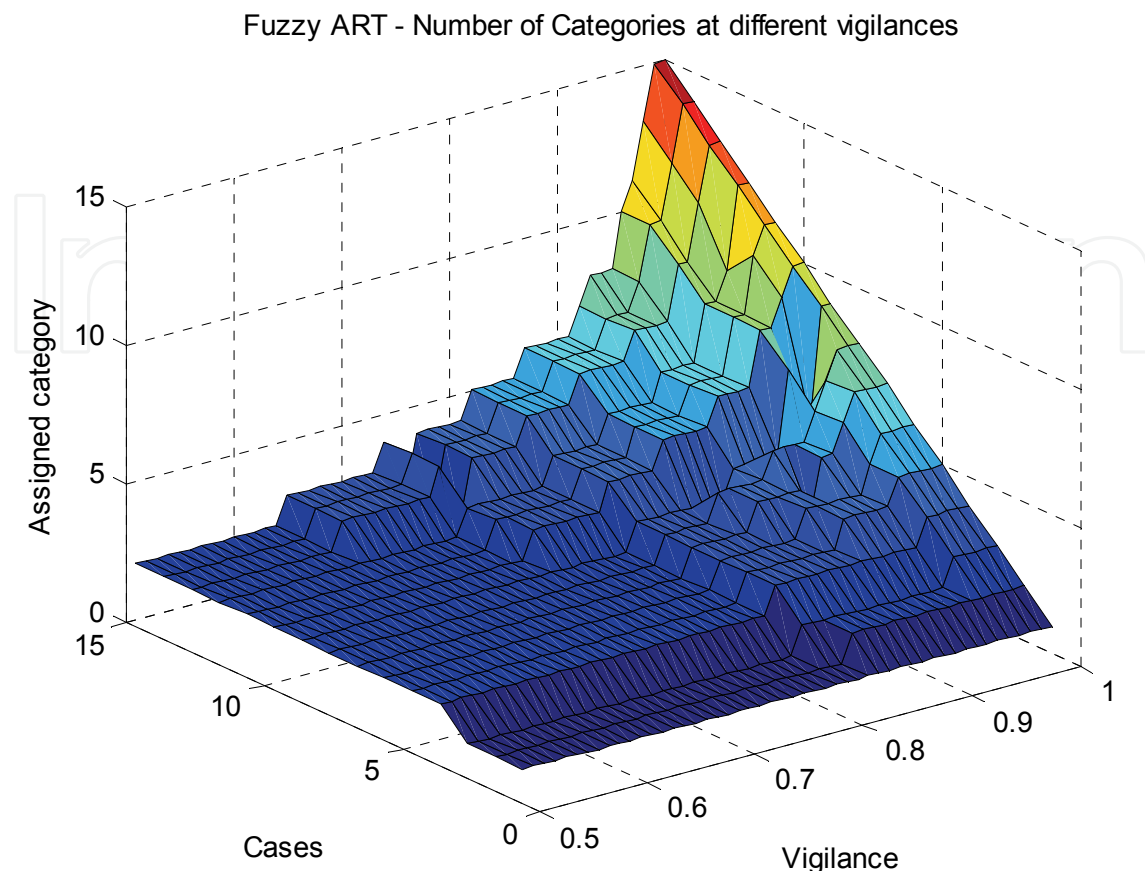

Fig. 13. The estimations of the Fuzzy ART

6. Conclusion

A two axis servopneumatic system was prepared to duplicate their typical operation at the food industry. The system was operated at the normal and 4 faulty modes. The characteristics of the signals were reasonably repetitive in each case. Three pressure, one linear displacement and two digital signals from the gripper were monitored in the time domain. The signals were encoded to obtain their most descriptive futures. There were 15 experimental cases. The data was collected at the same condition 3 times when the system was operated in the normal and 4 faulty modes. The encoded data had 9 parameters. The performances of two supervised and two unsupervised neural networks were studied.

The 5 experimental cases were increased to 105 by generating semi experimental data. The parameters of the FFN was calculated by using the Levenberg-Marquardt algorithm. The average estimation errors were $5.55e-15\%$ for the training and 8.66% for the test cases. The fuzzy ARTMAP was trained with 5 cases including one normal and 4 faulty modes. It estimated the 8 of the 10 test cases it never saw before perfectly. It confused the two faulty cases among each other.

The ART2 and fuzzy ART were used to evaluate the performance of these unsupervised ANNs on our data. Both of them distinguished the normal and faulty cases by assigning different categories for them. They had hard time to distinguish the faulty modes from each

other. Since they did not need training, they are very convenient for industrial applications. However, it is unrealistic to expect them to assign different categories for the normal operation and each fault modes, and classify all the incoming cases accurately.

7. References

- Aykut, S., Demetgul, M. & Tansel, I. N. (2010). Selection of Optimum Cutting Condition of Cobalt Based Alloy with GONN. *The International Journal of Advanced Manufacturing Technology*, Vol. 46, No. 9-12, pp. 957-967.
- Beale, M. H., Hagan, M. T. & Demuth, H. B. (2010). Neural Network Toolbox 7 User Guide, Mathworks.
http://www.mathworks.com/help/pdf_doc/nnet/nnet.pdf.
- Belforte, G., Mauro, S. & Mattiazzo, G. (2004). A method for increasing the dynamic performance of pneumatic servo systems with digital valves, *Mechatronics*, Vol.14, pp. 1105-1120.
- Bryson, A. E., Ho, Y. C. (1975). Applied optimal control: optimization, estimation, and control. *Taylor & Francis Publishing*, pp. 481.
- Bouamama, B.O. et al. (2005). Fault detection and isolation of smart actuators using bond graphs and external models, *Control Engineering Practice*, Vol. 13, pp.159-175.
- Carpenter, G. A & Grossberg, S. (1987). ART-2: Self-Organization of Stable Category Recognition Codes for Analog Input Pattern, *Applied Optics*, Vol. 26, pp. 4919-4930.
- Carpenter, G. A., Grossberg S., & Reynolds J. H. (1991). ARTMAP: Supervised real-time learning and classification of nonstationary data by a self-organizing neural network, *Neural Networks* , Vol. 4, pp.565-588.
- Carpenter, G. A., Grossberg, S. & Rosen, D. B. (1991a). ART 2-A: An adaptive resonance algorithm for rapid category learning and recognition, *Neural Networks* , Vol. 4, pp. 493-504.
- Carpenter, G. A., Grossberg, S. & Rosen, D. B. (1991b). Fuzzy ART: Fast stable learning and categorization of analog patterns by an adaptive resonance system, *Neural Networks* , Vol. 4, pp. 759-771.
- Carpenter, G. A. et al. (1992). Fuzzy ARTMAP: A neural network architecture for incremental supervised learning of analog multidimensional maps, *IEEE Transactions on Neural Networks*, Vol. 3, pp. 698-713.
- Chen, C. & Mo, C. (2004). A method for intelligent fault diagnosis of rotating machinery, *Digital Signal Processing*, Vol. 14, pp. 203-217.
- Chena, P. et al. (2007). A study of hydraulic seal integrity. *Mechanical Systems and Signal Processing*, Vol. 21, pp.1115-1126.
- Demetgul M.; Tansel IN. & Taskin S. (2009). Fault Diagnosis of Pneumatic Systems with Artificial Neural Network Algorithms. *Expert Systems with Applications*, Vol. 36, No. 7, pp. 10512-10519.
- Festo Didactic GmbH & Co. PneuPos Manuel, 2010.
<http://www.festodidactic.com/ov3/media/customers/1100/0922765001121243194.pdf>.
- Garrett, A. (2003). Fuzzy ART and Fuzzy ARTMAP Neural Networks,

- <http://www.mathworks.com/matlabcentral/fileexchange/4306>.
- Gary M. & Ning, S., (2007). Experimental Comparison of Position Tracking Control Algorithms for Pneumatic Cylinder Actuators, *IEEE/ASME Transactions on Mechatronics*, October 2007.
- Grossberg S. (1987). Competitive learning: From interactive activation to adaptive resonance, *Cognitive Science*, Vol. 11, pp. 23-63.
- Huang, R.; Xi, L.; Li, X.; Liu, C.R.; Qiu, H. & Lee, J. (2007). Residual life predictions for ball bearings based on self-organizing map and back propagation Neural network methods, *Mechanical Systems and Signal Processing*, Vol. 21, pp.193-207.
- Karpenko, M.; Sepehri, N. & Scuse, D. (2003). Diagnosis of process valve actuator faults using a multilayer Neural network. *Control Engineering Practice*, Vol. 11, pp.1289-1299.
- Lee, I. S.; Kim, J. T.; Lee, J. W.; Lee, D. Y. & Kim, K. Y. (2003). Model-Based Fault Detection and Isolation Method Using ART2 Neural Network, *International Journal of Intelligent Systems*, Vol.18, pp. 1087-1100.
- Li, X. & Kao, I. (2005). Analytical fault detection and diagnosis (FDD) for pneumatic systems in robotics and manufacturing automation. *Intelligent Robots and Systems, IEEE/RSJ International Conference*, pp.2517-2522.
- Lu, P. J.; Hsu, T. C.; Zhang, M. C. & Zhang, J. (2000), An Evaluation of Engine Fault Diagnostics Using Artificial Neural Networks, *ASME J. Eng. Gas Turbines Power*, Vol. 123, pp. 240-246.
- McGhee, J.; Henderson, I. A. & Baird, A. (1997). Neural networks applied for the identification and fault diagnosis of process valves and actuators, *Measurement*, Vol. 20, No. 4, pp. 267-275.
- Mendonça, L. F.; Sousa, J. M. C. & Costa, J. M. G. (2009). An architecture for fault detection and isolation based on fuzzy methods, *Expert Systems with Applications*. Vol. 36 pp. 1092-1104.
- Na, C. & Lizhuang, M. (2008). Pattern Recognition Based on Weighted and Supervised ART2. *International Conference on Intelligent System and Knowledge Engineering*, Xiamen, China, Nov. 17-18, 2008, Vol. 2, pp. 98-102.
- Nakutis, Ž., Kaškonas, P. (2005). Application of ANN for pneumatic cylinder leakage diagnostics. *Matavimai*, Vol. 36, No.4, pp.16-21.
- Nakutis, Ž. & Kaškonas, P. (2007). Pneumatic cylinder diagnostics using classification methods. *Instrumentation and Measurement Technology Conference Proceedings*, Warsaw, 1-3 May 2007, pp.1-4.
- Nakutis, Ž. & Kaškonas, P. (2008). An approach to pneumatic cylinder on-line conditions monitoring. *Mechanika. Kaunas: Technologija*, Vol. 4, No. 72, pp.41-47.
- Nazir, M. B. & Shaoping, W. (2009). Optimization Based on Convergence Velocity and Reliability for Hydraulic Servo System, *Chinese Journal of Aeronautics*, Vol. 22, pp. 407-412.
- Ning, S. & Bone, G. M. (2005). Development of a nonlinear dynamic model for a servo pneumatic positioning system, *Proc. IEEE Int. Conf. Mechatronics Autom.*, pp. 43-48.

- Nogami, T. et al. (1995). Failure diagnosis system on pneumatic control valves by neural networks. *IEEE International Conference on Neural Networks*, Vol. 2, pp. 724-729.
- Rajakarunakaran, S.; Venkumar, P.; Devaraj, D. & Rao, K.S.P. (2008). Artificial neural network approach for fault detection in rotary system, *Applied Soft Computing*, Vol. 8, No. 1, pp.740-748.
- Rumelhart, D. E., Hinton, G. E., and Williams, R. J. (1976). Learning internal representations by error propagation. In Rumelhart, D. E. and McClelland, J. L., editors, *Parallel Distributed Processing: Explorations in the Microstructure of Cognition*. Volume 1: Foundations, MIT Press, Cambridge, MA. pp 318-362.
- Sepasi, M. & Sassani, F. (2010). On-line Fault Diagnosis of Hydraulic Systems Using Unscented Kalman Filter, *International Journal of Control and Automation Systems*, Vol. 8, No. 1, pp. 149-156.
- Shi, L. & Sepehri, N. (2004). Adaptive Fuzzy-Neural-Based Multiple Models for Fault Diagnosis of a Pneumatic Actuator, *Proceeding of the 2004 American Control Conference*, Boston, Massachusetts, June 30 -July 2, 2004.
- Song, S. O.; Lee, G. & Yoon, E.N. (2004). Process Monitoring of an Electro-Pneumatic Valve Actuator Using Kernel Principal Component Analysis, *Proceedings of the International Symposium on Advanced Control of Chemical Processes*. Hong Kong, China, 11-14 January 2004.
- Taghizadeh, M.; Ghaffari, A. & Najafi, F. (2009). Improving dynamic performances of PWM-driven servo-pneumatic systems via a novel pneumatic circuit, *ISA Transactions*, Vol.48, pp. 512-518.
- Takosoglu, J. E.; Dindorf, R. F. & Laski, P. A. (2009). Rapid prototyping of fuzzy controller pneumatic servo-system. *International Journal of Advanced Manufacturing Technology*, Vol. 40, No.3/4, pp. 349-361.
- Tansel, I. N. ; Demetgul, M. ; Leon, R. A. ; Yenilmez, A. & Yapici A. (2009). Design of Energy Scavengers of Structural Health Monitoring Systems Using Genetically Optimized Neural Network Systems, *Sensors and Materials*, Vol. 21, No. 3, pp. 141-153.
- Tansel I. N.; Demetgul M. & Sierakowski R. L. (2009). *Determining Initial Design Parameters By Using Genetically Optimized Neural Network Systems*. *Sapuan SM, Selangor S, Muftaba IM(ed) Composite Materials Technology: Neural Network Applications*. Taylor & Francis(CRC Press).
- Tsai Y. C. & Huang, A. (2008). Multiple-surface sliding controller design for pneumatic servo systems, *Mechatronics*, Vol. 18, pp. 506-512.
- Uppal, F.J.; Patton, R.J. & Palade, V. (2002). Neuro-fuzzy based fault diagnosis applied to an electro-pneumatic valve, *Proceedings of the 15th IFAC World Congress*, Barcelona, Spain, 2002, pp. 2483-2488.
- Uppal, F. J.; & Patton, R. J. (2002). Fault Diagnosis of an Electro-pneumatic Valve Actuator Using Neural Networks With Fuzzy Capabilities, *European Symposium on Artificial Neural Networks*, Bruges, Belgium, 24-26 April 2002, pp. 501-506.
- Wang, J. et al. (2004). Identification of pneumatic cylinder friction parameters using genetic algorithms. *IEEE/ASME Transactions on Mechatronics*, Vol. 9, No.1, pp. 100-104.

- Yang, B. S.; Han, T. & An J. L. (2004). ART-KOHONEN neural network for fault diagnosis of rotating machinery, *Mechanical Systems and Signal Processing*, Vol. 18, pp. 645-657.
- Yang, W.X. (2006). Establishment of the mathematical model for diagnosing the engine valve faults by genetic programming. *Journal of Sound and Vibration*, Vol. 293, pp.213- 226.

IntechOpen

IntechOpen



Artificial Neural Networks - Industrial and Control Engineering Applications

Edited by Prof. Kenji Suzuki

ISBN 978-953-307-220-3

Hard cover, 478 pages

Publisher InTech

Published online 04, April, 2011

Published in print edition April, 2011

Artificial neural networks may probably be the single most successful technology in the last two decades which has been widely used in a large variety of applications. The purpose of this book is to provide recent advances of artificial neural networks in industrial and control engineering applications. The book begins with a review of applications of artificial neural networks in textile industries. Particular applications in textile industries follow. Parts continue with applications in materials science and industry such as material identification, and estimation of material property and state, food industry such as meat, electric and power industry such as batteries and power systems, mechanical engineering such as engines and machines, and control and robotic engineering such as system control and identification, fault diagnosis systems, and robot manipulation. Thus, this book will be a fundamental source of recent advances and applications of artificial neural networks in industrial and control engineering areas. The target audience includes professors and students in engineering schools, and researchers and engineers in industries.

How to reference

In order to correctly reference this scholarly work, feel free to copy and paste the following:

Mustafa Demetgul, Sezai Taskin and Ibrahim Nur Tansel (2011). Conditioning Monitoring and Fault Diagnosis for a Servo-Pneumatic System with Artificial Neural Network Algorithms, *Artificial Neural Networks - Industrial and Control Engineering Applications*, Prof. Kenji Suzuki (Ed.), ISBN: 978-953-307-220-3, InTech, Available from: <http://www.intechopen.com/books/artificial-neural-networks-industrial-and-control-engineering-applications/conditioning-monitoring-and-fault-diagnosis-for-a-servo-pneumatic-system-with-artificial-neural-netw>

INTECH
open science | open minds

InTech Europe

University Campus STeP Ri
Slavka Krautzeka 83/A
51000 Rijeka, Croatia
Phone: +385 (51) 770 447
Fax: +385 (51) 686 166
www.intechopen.com

InTech China

Unit 405, Office Block, Hotel Equatorial Shanghai
No.65, Yan An Road (West), Shanghai, 200040, China
中国上海市延安西路65号上海国际贵都大饭店办公楼405单元
Phone: +86-21-62489820
Fax: +86-21-62489821

© 2011 The Author(s). Licensee IntechOpen. This chapter is distributed under the terms of the [Creative Commons Attribution-NonCommercial-ShareAlike-3.0 License](#), which permits use, distribution and reproduction for non-commercial purposes, provided the original is properly cited and derivative works building on this content are distributed under the same license.

IntechOpen

IntechOpen