



Pertanika Journal of  
**SOCIAL SCIENCES  
& HUMANITIES**

**JSSH**

**VOL. 28 (S1) 2020**

*A special issue devoted to*  
**Innovative Business Excellence for Sustainability  
with ICT as an Enabler**

**Guest Editor  
Bachtiar H. Simamora**



**PERTANIKA  
JOURNALS**

**A scientific journal published by Universiti Putra Malaysia Press**

## *Journal of Social Sciences & Humanities*

### About the Journal

#### Overview

Pertanika Journal of Social Sciences & Humanities (JSSH) is the official journal of Universiti Putra Malaysia published by UPM Press. It is an open-access online scientific journal which is free of charge. It publishes the scientific outputs. It neither accepts nor commissions third party content.

Recognized internationally as the leading peer-reviewed interdisciplinary journal devoted to the publication of original papers, it serves as a forum for practical approaches to improving quality in issues pertaining to social and behavioural sciences as well as the humanities.

JSSH is a **quarterly** (*March, June, September and December*) periodical that considers for publication original articles as per its scope. The journal publishes in **English** and it is open to authors around the world regardless of the nationality.

The Journal is available world-wide.

#### Aims and scope

Pertanika Journal of Social Sciences & Humanities aims to develop as a pioneer journal for the social sciences with a focus on emerging issues pertaining to the social and behavioural sciences as well as the humanities.

Areas relevant to the scope of the journal include Social Sciences—Accounting, anthropology, Archaeology and history, Architecture and habitat, Consumer and family economics, Economics, Education, Finance, Geography, Law, Management studies, Media and communication studies, Political sciences and public policy, Population studies, Psychology, Sociology, Technology management, Tourism; Humanities—Arts and culture, Dance, Historical and civilisation studies, Language and Linguistics, Literature, Music, Philosophy, Religious studies, Sports.

#### History

Pertanika was founded in 1978. A decision was made in 1992 to streamline Pertanika into three journals as Journal of Tropical Agricultural Science, Journal of Science & Technology, and **Journal of Social Sciences & Humanities** to meet the need for specialised journals in areas of study aligned with the interdisciplinary strengths of the university.

After almost 25 years, as an interdisciplinary Journal of Social Sciences & Humanities, the revamped journal focuses on research in social and behavioural sciences as well as the humanities, particularly in the Asia Pacific region.

#### Goal of *Pertanika*

Our goal is to bring the highest quality research to the widest possible audience.

#### Quality

We aim for excellence, sustained by a responsible and professional approach to journal publishing. Submissions are guaranteed to receive a decision within 14 weeks. The elapsed time from submission to publication for the articles averages 5-6 months.

#### Abstracting and indexing of *Pertanika*

The journal is indexed in SCOPUS (Elsevier), Clarivate-Emerging Sources Citation Index (ESCI)-Web of Science, BIOSIS, National Agricultural Science (NAL), Google Scholar, MyCite, ISC. In addition, Pertanika JSSH is recipient of "CREAM" Award conferred by Ministry of Higher Education (MoHE), Malaysia.

### Future vision

We are continuously improving access to our journal archives, content, and research services. We have the drive to realise exciting new horizons that will benefit not only the academic community, but society itself.

### Citing journal articles

The abbreviation for *Pertanika Journal of Social Sciences & Humanities* is *Pertanika J. Soc. Sci. Hum.*

### Publication policy

Pertanika policy prohibits an author from submitting the same manuscript for concurrent consideration by two or more publications. It prohibits as well publication of any manuscript that has already been published either in whole or substantial part elsewhere. It also does not permit publication of manuscript that has been published in full in Proceedings.

### Code of Ethics

The Pertanika Journals and Universiti Putra Malaysia takes seriously the responsibility of all of its journal publications to reflect the highest in publication ethics. Thus all journals and journal editors are expected to abide by the Journal's codes of ethics. Refer to Pertanika's **Code of Ethics** for full details, or visit the Journal's web link at [http://www.pertanika.upm.edu.my/code\\_of\\_ethics.php](http://www.pertanika.upm.edu.my/code_of_ethics.php)

### International Standard Serial Number (ISSN)

An ISSN is an 8-digit code used to identify periodicals such as journals of all kinds and on all media—print and electronic. All Pertanika journals have ISSN as well as an e-ISSN.

Journal of Social Sciences & Humanities: ISSN 0128-7702 (*Print*); ISSN 2231-8534 (*Online*).

### Lag time

A decision on acceptance or rejection of a manuscript is reached in 3 to 4 months (average 14 weeks). The elapsed time from submission to publication for the articles averages 5-6 months.

### Authorship

Authors are not permitted to add or remove any names from the authorship provided at the time of initial submission without the consent of the Journal's Chief Executive Editor.

### Manuscript preparation

Refer to Pertanika's **INSTRUCTIONS TO AUTHORS** at the back of this journal.

Most scientific papers are prepared according to a format called IMRAD. The term represents the first letters of the words **I**ntroduction, **M**aterials and **M**ethods, **R**esults, **A**nd, **D**iscussion. IMRAD is simply a more 'defined' version of the "IBC" [Introduction, Body, Conclusion] format used for all academic writing. IMRAD indicates a pattern or format rather than a complete list of headings or components of research papers; the missing parts of a paper are: *Title, Authors, Keywords, Abstract, Conclusions, and References*. Additionally, some papers include Acknowledgments and Appendices.

The *Introduction* explains the scope and objective of the study in the light of current knowledge on the subject; the *Materials and Methods* describes how the study was conducted; the *Results* section reports what was found in the study; and the *Discussion* section explains meaning and significance of the results and provides suggestions for future directions of research. The manuscript must be prepared according to the Journal's **INSTRUCTIONS TO AUTHORS**.

### Editorial process

Authors are notified with an acknowledgement containing a *Manuscript ID* on receipt of a manuscript, and upon the editorial decision regarding publication.

Pertanika follows a **double-blind peer-review** process. Manuscripts deemed suitable for publication are usually sent to reviewers. Authors are encouraged to suggest names of at least three potential reviewers at the time of submission of their manuscript to Pertanika, but the editors will make the final choice. The editors are not, however, bound by these suggestions.

Notification of the editorial decision is usually provided within ten to fourteen weeks from the receipt of manuscript. Publication of solicited manuscripts is not guaranteed. In most cases, manuscripts are accepted conditionally, pending an author's revision of the material.

### **The Journal's peer-review**

In the peer-review process, three referees independently evaluate the scientific quality of the submitted manuscripts.

Peer reviewers are experts chosen by journal editors to provide written assessment of the **strengths and weaknesses** of written research, with the aim of improving the reporting of research and identifying the most appropriate and highest quality material for the journal.

### **Operating and review process**

What happens to a manuscript once it is submitted to *Pertanika*? Typically, there are seven steps to the editorial review process:

1. The Journal's Chief Executive Editor (CEE) and the Editorial Board Members examine the paper to determine whether it is appropriate for the journal and should be reviewed. If not appropriate, the manuscript is rejected outright and the author is informed.
2. The CEE sends the article-identifying information having been removed, to three reviewers who are specialists in the subject matter represented by the article. The CEE requests them to complete the review in three weeks.

Comments to authors are about the appropriateness and adequacy of the theoretical or conceptual framework, literature review, method, results and discussion, and conclusions. Reviewers often include suggestions for strengthening of the manuscript. Comments to the editor are in the nature of the significance of the work and its potential contribution to the field.

3. The CEE, in consultation with the Editor-in-Chief (EiC), examines the reviews and decides whether to reject the manuscript, invites the author(s) to revise and resubmit the manuscript. The CEE may seek additional reviews. Final acceptance or rejection rests with the CEE and EiC, who reserve the right to refuse any material for publication. In rare instances, the manuscript is accepted with almost no revision. Almost without exception, reviewers' comments (to the author) are forwarded to the author. If a revision is indicated, the editor provides guidelines for attending to the reviewers' suggestions and perhaps additional advice about revising the manuscript.
4. The authors decide whether and how to address the reviewers' comments and criticisms and the editor's concerns. The authors return a revised version of the paper to the chief executive editor along with specific information describing how they have answered the concerns of the reviewers and the editor, usually in a tabular form. The author(s) may also submit a rebuttal if there is a need especially when the author disagrees with certain comments provided by reviewer(s).
5. The CEE sends the revised paper out for re-review. Typically, at least one of the original reviewers will be asked to examine the article.
6. When the reviewers have completed their work, the CEE in consultation with the EiC and Editorial Board Members examine their comments and decide whether the paper is ready to be published, needs another round of revisions, or should be rejected.



7. If the decision is to accept, an acceptance letter is sent to all the author(s), the paper is sent to the Press. The article should appear in print in approximately three months.

The Publisher ensures that the paper adheres to the correct style (in-text citations, the reference list, and tables are typical areas of concern, clarity, and grammar). The authors are asked to respond to any minor queries by the Publisher. Following these corrections, page proofs are mailed to the corresponding authors for their final approval. At this point, **only essential changes are accepted**. Finally, the article appears in the pages of the Journal and is posted on-line.



Pertanika Journal of  
**SOCIAL SCIENCES  
& HUMANITIES**

*A special issue devoted to*

Innovative Business Excellence for Sustainability  
with ICT as an Enabler

**VOL. 28 (S1) 2020**  
(Special Issue)

Guest Editor  
Bachtiar H. Simamora



A scientific journal published by Universiti Putra Malaysia Press



## EDITOR-IN-CHIEF

**Wong Su Luan**

*Information and Communication  
Technology in Education*

## CHIEF EXECUTIVE EDITOR

**Abu Bakar Salleh**

*Biotechnology and Biomolecular  
Science*

## CHAIRMAN

**UNIVERSITY PUBLICATIONS  
COMMITTEE**

**Zulkifli Idrus**

## EDITORIAL STAFF

### Journal Officers:

Kanagamalar Silvarajoo, *ScholarOne*  
Siti Zuhaila Abd Wahid, *ScholarOne*  
Tee Syn Ying, *ScholarOne*  
Ummi Fairuz Hanapi, *ScholarOne*

### Editorial Assistants:

Rahimah Razali  
Siti Juridah Mat Arip  
Zulinaardawati Kamarudin

## PRODUCTION STAFF

### Pre-press Officers:

Nur Farrah Dila Ismail  
Wong Lih Jiu

## WEBMASTER

### IT Officer:

Muhammad Zamiruddin Sahar

## PUBLICITY & PRESS RELEASE

Magdalene Pokar (*ResearchSEA*)

## EDITORIAL OFFICE

### JOURNAL DIVISION

Putra Science Park  
1<sup>st</sup> Floor, IDEA Tower II  
UPM-MTDC Technology Centre  
Universiti Putra Malaysia  
43400 Serdang, Selangor Malaysia.  
Gen Enq.: +603 9769 1622  
E-mail:  
[executive\\_editor.pertanika@upm.edu.my](mailto:executive_editor.pertanika@upm.edu.my)  
URL: [www.journals-ij.upm.edu.my](http://www.journals-ij.upm.edu.my)

## PUBLISHER

UPM Press

Universiti Putra Malaysia  
43400 UPM, Serdang, Selangor, Malaysia.  
Tel: +603 9769 8851  
Fax: +603 9769 3623  
E-mail: [penerbit@upm.edu.my](mailto:penerbit@upm.edu.my)  
URL: <http://penerbit.upm.edu.my>

## EDITORIAL BOARD

2018-2020

**Abdul Mansur M. Masih**  
*Economics, Econometrics, Finance*  
King Fahd University of Petroleum and  
Minerals, Saudi Arabia.

**Ain Nadzimah**  
*Modern Languages and  
Communication,*  
Universiti Putra Malaysia, Malaysia.

**Alan Maley**  
*English Language Studies, Teaching of  
English Language and Literature*  
Leeds Metropolitan University, UK.

**Ali Reza Kaldi**  
*Medical Sociology, Sociology of  
Development Ageing, Gerontology*  
University of Social Welfare and  
Rehabilitation, Tehran, Iran.

**Brian Tomlinson**  
*English Language Studies, The  
Evaluation, Adaptation and  
Development*  
Leeds Metropolitan University, UK.

**Deanna L. Sharpe**  
*Economics, Consumer and Family  
Economics, Personal Finance*  
University of Missouri, Columbia, USA.

**Dessy Irawati**  
*Economist and Business Development  
Strategist*  
BNI Bank Representative in the  
Netherlands, EduPRIME Consulting, the  
Netherlands.

**Jacqueline Pugh-Kitingan**  
*Music, Ethnomusicology, Borneo and  
Papua New Guinea Studies*  
Universiti Malaysia Sabah, Malaysia.

**James R. Stock**  
*Management Studies, Marketing,  
Logistics and Supply Chain  
Management, Quantitative Method*  
University of South Florida, USA.

**Jayum A. Jawan**  
*Sociology, Politics and Government,  
Civilization Studies*  
Tun Abd Razak Chair & Visiting  
Professor of Political Science  
Ohio University, Athens Ohio, USA  
(2015-2017).  
Universiti Putra Malaysia, Malaysia.

**Jonathan Newton**  
*Classroom-based Second Language  
Acquisition, Language Teaching  
Methodology, the Interface of Culture  
and Language in Language Teaching  
and Learning, and Language/  
Communication Training and Material  
Design for the Multicultural Workplace*  
Victoria University of Wellington, New  
Zealand.

**Marcus Bion GRIFFIN**  
*Human Ecology, Anthropology, Tropical  
Agriculture, Fisheries*  
Cultural Learning Solutions, USA.

**Mary Susan Philip**  
*English Language Theatre in Malaysia  
and Singapore; Postcolonial Theatre*  
University of Malaya, Malaysia.

**Muzafar Shah Habibullah**  
*Economics, Monetary Economics,  
Banking, Macroeconomics*  
Universiti Putra Malaysia, Malaysia.

**Patricia Matusky**  
*Music, Ethnomusicology, Malay and  
Indonesian language, Literature and  
Culture*  
Grand Valley State University, USA.

**Rama Mathew**  
*Teacher Education, English Language  
Education including Young Learners and  
Language Assessment*  
Delhi University, India.

**Rohany Nasir**  
*Psychology-Career counseling,  
Counseling for Adolescents and Adults,  
Marriage and Family counseling,  
Counseling Industry and Organization*  
Universiti Kebangsaan Malaysia,  
Malaysia.

**Shameem Rafik-Galea**  
*English Language Studies, Linguistics,  
Applied Linguistics, Language and  
Communication*  
University College Sedaya International,  
Malaysia.

**Stephen J. HALL**  
*English Language Studies, Linguist,  
Teacher Educator, TESOL*  
Sunway University, Malaysia.

**Stephen J. THOMA**  
*Psychology, Educational Psychology,  
The University of Alabama, USA.*

**Vahid Nimehchisalem**  
*Modern Languages and  
Communication,*  
Universiti Putra Malaysia, Malaysia.

**Victor T. King**  
*Anthropology / Southeast Asian Studies*  
White Rose East Asia Centre,  
University of Leeds, UK.

## INTERNATIONAL ADVISORY BOARD

2018-2021

**Barbara Wejnert**  
*Political Sociologist: Gender Studies,  
Macro Political and Social Changes*  
University at Buffalo, SUNY, USA.

**Carolyn Graham**  
*Music, Jazz Chants*  
Harvard University, USA.

**Dileep K. Mohanachandra**  
*Psychology, Sociology, Technology*  
Mohammed VI Polytechnic University,  
Morocco.

**Faith Trent AM FACE**  
*Education: Curriculum development*  
Flinders University, Adelaide, Australia.

**Gary N. Mclean**  
*Community and Social Development,  
International Human Resource  
Development, Organizational  
Development*  
Executive Director, International Human  
Resource Development Programs,  
EAHR, Teas A&M University, USA.

**Graham Thurgood**  
*English Language Studies, General  
Linguistics, Discourse and Syntax*  
California State University, Chico., USA.

**Handoyo Puji Widodo**  
*English Language Teaching, ESP,  
Language Curriculum-Materials Design  
and Development, and Language  
Methodology*  
English Language Center  
Shantou University, China.

**John R. Schermerhorn Jr.**  
*Management Studies, Management  
and Organizational Behaviour,  
International Business*  
Ohio University, USA.

**Kent Matthews**  
*Economics, Banking and Finance,  
Modelling and Forecasting the Macro  
Economy*  
Cardiff Business School, UK.

**Lehman B. Fletcher**  
*Economics, Agricultural Development,  
Policy Analysis and Planning*  
Iowa State University, USA.

**Mohamed Ariff**  
*Economics, Finance, Capital Market,  
Islamic Finance, Fiscal Policy*  
Sunway University, Malaysia.

**Pal Ahluwalia**  
*African Studies, Social and Cultural  
Theory, Post-colonial Theory*  
Pro Vice-Chancellor  
(Research and Innovation),  
University of Portsmouth, UK.

**Phillip Jones**  
*Architectural Science, Sustainability in  
the Built Environment*  
Welsh School of Architecture,  
Cardiff University, UK.

**Rance P. L. Lee**  
*Sociology*  
The Chinese University of Hong Kong,  
China.

**Royal D. Colle**  
*Communication*  
Cornell University, USA.

**Shonda Buchanan**  
*American Literature Interim Chair*  
Hampton University, USA.

**Vijay K. Bhattia**  
*Education: Genre Analysis and  
Professional Communication*  
City University of Hong Kong, China.

## ABSTRACTING AND INDEXING OF PERTANIKA JOURNALS

The journal is indexed in SCOPUS (Elsevier), Clarivate-Emerging Sources Citation Index (ESCI), BIOSIS, National Agricultural Science (NAL), Google Scholar, MyCite, ISC. In addition, Pertanika JSSH is recipient of "CREAM" Award conferred by Ministry of Higher Education (MoHE), Malaysia.





**Pertanika Journal of Social Sciences & Humanities**  
**Vol. 28 (S1) 2020**

**Contents**

**Innovative Business Excellence for Sustainability with ICT as an Enabler**

**Preface**

<i>Bachtiar H. Simamora</i>	i
The Effect of Corporate Governance, E-Business and Innovation on Competitive Advantage and Implication on Financial Performance <i>Mulyono, Adler Haymans Manurung, Firdaus Alamsjah and Mohammad Hamsal</i>	1
Resource Development Analysis in Indonesia Listed Bank Type IV: An Overview of Resource Base Theory in Indonesia Banking Industry in Developing Competitive Advantage <i>Hardijanto Saroso and Agus Ridwan</i>	15
Design and Commercialization Critics of Batik Lasem <i>Vera Jenny Basiroen</i>	29
The Survival of Batik Madura in Digital Era: A Case Study of Small Medium Enterprises (SME) at Batik Madura Center <i>Alwiyah, Evi Steelyana, Sayyida and Izah Tahir</i>	43
Analysis of Factors Affecting the Consumer Behavior of Indonesian Banking Industry <i>Rahmat Siauwijaya and Evi Steelyana</i>	59
Exploring Employee's Motivation and Performance Factors: Evidence in a 3 Star Hotel in Indonesia by Contrasting Maslow's and Çetin's Model <i>Dewi Tamara, Respati Wulandari and Sanvenia Veronica</i>	75
The Urgency of Community Participation in the Establishment of a Local Regulation <i>Dani Sintara, Suhaidi and Faisal Akbar Nasution</i>	87
Sustainability Report Analysis: Content and Quality GRI-G4 <i>Acep Komara, Imam Ghozali and Indira Januarti</i>	103
Tourist Segmentation in Jakarta: An Analysis of Jakarta's City Branding <i>Natalia, Louis Mordekhai and Fiona Cownie</i>	121
Managerial Efforts in Building Organization Behaviour ( <i>Study of Entrepreneurs in Indonesia</i> ) <i>Rano Kartono, Sasmoko, Yasinta Indrianti, Lasmy and Hendry Hartono</i>	141



Enhancing the Economic Potential of Indigenous People in the Jababeka Industrial Area through Corporate Social Responsibility <i>Ulani Yunus, Triadi Sumbogo, Gayes Mahestu and Wajid Zulqarnain</i>	155
PCAOB Sanction and Client Stock Market Reactions: Evidence from the Case of Ernst & Young Indonesia <i>Gatot Soepriyanto and Arfian Erma Zudana</i>	167
Innovation in Traditional Food Products as Local Wisdom on <i>Dodol Mandai</i> Trias Septyoari Putranto, Tri Wiyana and Sarim	181
@_TNIAU: Case Study on Interactive Public Communication in Indonesia <i>Yuanita Safitri and Mia Angeline</i>	191
Internet of Things (IoT) for Energy Efficiency in Tourism-Related Industry <i>Kasih Cakaputra Komsary, Tati Ernawati, Ade Hodijah and Dian Wardiana</i>	203
Consumer Perceived Value, Attitude, Trust and Purchase Intention of <i>Kuku Bima Ener-G</i> Product <i>Selly Novela, Didiet Gharnaditya, Novita and Patricia Marie Wibisono</i>	215
Training Model for Improving Human Resource Performance and Quality in a Parking Insurance Company <i>Respati Wulandari, Anita Maharani, David Young and Tania Winoto</i>	229
Tobit Regression Analysis on Factors Influencing Dividend Policy of Indonesian Manufacturing Firms <i>Dezie L. Warganegara, Titik Indrawati, Evi Steelyana, Doni S. Warganegara and Mark Kam Loon Loo</i>	243
Factors Affecting Earnings Quality in Companies Listed in Indonesia Stock Exchange <i>Stefanus Ariyanto, Sasya Sabrina and Theresia Lesmana</i>	253
Inflation Effect, Interest Rate of Bank Indonesia Certificates (SBI) and Economic Growth on Rupiah Exchange Rate in Indonesia <i>Darman and Karyana Hutomo</i>	261
The Effect of Banking Efficiency, Earnings Per Share and Price-Earnings Ratio towards the Stock Return of Banking Companies in Indonesia Rahmat Siauwijaya	277
Voluntary Disclosure Level and Firm Valuation of Kompas100 Listed Firms <i>Yanthi Hutagaol-Martowidjojo and Kevin Richard</i>	289
The Effect of Website Quality on e-Trust of Customers: “The Case of ZEN Rooms” <i>Lucina Iswi Hapsari Sulistyono and Wenly Pranata</i>	301

Control of the Right to Strike Affecting the Productivity of State-Owned Enterprises <i>Christian Orchard Perangin-Angin and Bismar Nasution</i>	311
Design Thinking Corporate Training Effectiveness and the Attributes of the Trainers <i>Ari Margiono and Tubagus Hanafi</i>	323
Donald Digital Marketing: An Exploratory Study of Digital Political Marketing in Trump Presidential Campaign <i>Irmawan Rahyadi and Muhammad Aras</i>	337
Chinese Ethnic Perspective on the Confucius Values of Leadership in West Java Fuqing Organization <i>Mulyani and Chyntia Ika Ratnapuri</i>	347
Improving the Intensity of Sales through Digital Banking: The Case of Indonesian Banking Behaviour <i>Janita Sembiring Meliala and Puti Sinansari</i>	359



## Preface

We are very pleased to present this special edition of the *Pertanika Journal of Social Sciences and Humanities*. The articles were selected from those presented at the International Conference on Management, Hospitality & Tourism and Accounting 2018 (IMHA 2018). These articles were contributed by some of the 300 participants mainly from Indonesia with collaborators from Malaysia, Canada, Thailand, United Kingdom, Pakistan and New Zealand.

The total number of articles received was 107 articles. However, this *Special Edition (Volume I)*, contains only 28 accepted articles. The topics include but not limited to; Leadership, Strategic Planning, Customer and Market Focus, Information, Measurement, Knowledge Management, and Information Technology, Human Resource, Operational Focus, and Communication for Performance Excellence.

All the articles published in this special edition underwent peer-review process coordinated by the Guest Editor and approved by *Pertanika*.

We highlight a few articles that may be of interest to you as follow. A selected regular article from the scope of Hospitality, is titled *“Exploring Employee’s Motivation and Performance Factors: Evidence in a 3 Star Hotel in Indonesia by Contrasting Maslow’s and Çetin’s Model”* by Dewi Tamara, Respati Wulandari and Sanvenia Veronica. This study aims to analyze employee’s motivation factors in a three-star hotel. The approach used in this study is the qualitative approach in reference to Maslow’s Hierarchy of Needs and Cetin’s Conceptual Model. The results show that employees were motivated by brand management, hotel vision, the owner, employee component, salary, teamwork, and promotion. Details of this study are available on page 75.

Next, a selected regular article from the scope of Tourism, is titled *“Tourist Segmentation in Jakarta: An Analysis of Jakarta’s City Branding”* by Natalia, Louis Mordekhai and Fiona Cownie. The purpose of this research is to analyse Jakarta’s city branding by profiling the groups of international tourists based on their travel behaviour and socio-demographic profile. The study surveyed 100 foreign tourists who visited Jakarta and stayed at least one night during the previous 12 months. The results suggested there were three groups of foreign tourists with different characteristics and preferences during their visits in Jakarta. These are named On Duty Traveler, Deja Vu Traveler and New Face Traveler. Understanding the differences between these different market segments and their demands provide the government with important information to inform Jakarta’s City Branding and the creation of distinct marketing programs to appeal to each segment. Further details of the study can be found on page 121.

In the Management scope, is a regular article titled "*Managerial Efforts in Building Organization Behavior: Study of Entrepreneurs in Indonesia*" by Rano Kartono, Sasmoko, Yasinta Indrianti, Lasmy and Hendry Hartono. The aim of this paper is to examine the relationship between self-confidence, hope, optimism, and resilience as managerial efforts in building organization behaviour in Indonesia's entrepreneurs. Major research questions pursued are: What is the influence of managerial effects in building organizational behaviour? What is the most significant variable in building organizational behaviour in Indonesia's entrepreneurs? Apparently, the verified managerial efforts has a negative influence on building organizational behaviour of Indonesia's entrepreneurs, and self-confidence is the most significant variable in building the organizational behaviour of the entrepreneurs. The detailed information of this article is presented on page 141.

We would like to thank the contributors as well as the reviewers for their commitment and patience which made this edition a successful endeavour. It is hoped that this publication would be an encouragement for researchers from around the world to be more active in publishing many more research articles from good quality social sciences research that is insightful for academics and practitioners alike.

Special thanks to the Chief Executive Editor, UPM Journals, Prof. Dato' Dr. Abu Bakar Salleh for his support and understanding of the needs in making this publication possible. This has certainly motivated us to do more and better in the near future.

**Guest Editor**

Bachtiar H. Simamora (*Assoc. Prof. Dr.*)

## **The Effect of Corporate Governance, E-Business and Innovation on Competitive Advantage and Implication on Financial Performance**

**Mulyono\*, Adler Haymans Manurung, Firdaus Alamsjah and Mohammad Hamsal**

*Department of Management, BINUS Business School, Undergraduate Program, Bina Nusantara University, Jakarta Barat 11480, Indonesia*

### **ABSTRACT**

This research examined the effect of implementing corporate governance, e-business and innovation to competitive advantage, and assessed the implication to the company's financial performance. It was conducted among 67 companies in the financial industry listed on the Indonesian Stock Exchange. The research was conducted using a cross-sectional study with a questionnaire to obtain a response from top management, during the period of May to November 2016. Multivariate analysis was done to test the hypothesis, using Structural Equation Modelling based on variance or Partial Least Square (PLS). In the research, it was found that implementation of corporate governance had a negative impact on competitive advantage, but had a positive effect on financial performance. Application of E-Business had a positive impact on financial performance, while the application of innovation had a positive effect on competitive advantage and financial performance. This research also confirmed that competitive advantage had a positive impact on the company's financial performance.

*Keywords:* Competitive advantage, corporate governance, e-business, financial performance, innovation

### ARTICLE INFO

#### *Article history:*

Received: 9 October 2019

Accepted: 3 January 2020

Published: 17 March 2020

#### *E-mail addresses:*

[mulyono@binus.ac.id](mailto:mulyono@binus.ac.id) (Mulyono)

[adler.manurung@binus.ac.id](mailto:adler.manurung@binus.ac.id) (Adler Haymans Manurung)

[alamsjah@binus.edu](mailto:alamsjah@binus.edu) (Firdaus Alamsjah)

[mhamsal@binus.edu](mailto:mhamsal@binus.edu) (Mohammad Hamsal)

\*Corresponding author

### **Current affiliations**

**Adler Haymans Manurung and  
Mohammad Hamsal**

*Binus Business School, Doctor in Research  
Management, Bina Nusantara University,  
Jakarta Barat 11480, Indonesia*

**Firdaus Alamsjah**

*Industrial Engineering Department, Faculty of  
Engineering, Bina Nusantara University,  
Jakarta Barat 11480, Indonesia*

## INTRODUCTION

Listed financial companies on the Indonesia Stock Exchange need to improve their performance to become a sector with high growth. The improved corporate performance will increase investor confidence, lower risk levels and improve operational efficiency (Bebchuk & Weisbach, 2010). According to Bianchini et al. (2015), to improve performance, company management needs to implement good corporate governance. In addition to being influenced by corporate governance, Chen et al. (2014) stated that the application of innovation affected the competitive advantage owned by the company, further enhancing the competitive advantage that would eventually affect the company's performance.

As a public company, it is a necessity to provide information access to stakeholders; this is reflected in the company disclosure to the stockholders and stakeholders. In addition, companies need to implement good corporate governance, so it could provide relevant information to external users through financial reports with high quality (Hasnan et al., 2017; Tan, 2015). Furthermore, Becerra (2009) suggested that the corporate governance mechanism to be applied by a company to improve the efficiency of company activity.

In an effort to improve competitiveness, especially in the financial industry, a company needs to develop information technology that supports its operation among them is e-business. Prasad (2008) concluded that the company invested in information technology for various purposes, among

them to gain competitive advantage. Hence, many companies try to maintain their quality in applying e-business. Research conducted by Bauer et al. (2005) concluded that e-business application to the financial industry would affect the competitive advantage owned by the company, increasing its competitive advantage and eventually its performance. In general, the management of a company recognizes the importance of using information technology to improve competitive advantage and to stay competitive in the global market.

Monks and Minow (2011) argued that there was a distinction between compulsory rules and regulations that needed to be explained in detail, giving companies an opportunity to adapt to various conditions depending on their circumstances, thus promoting innovation. Hana (2013) stated that the implementation of innovation would affect the company's competitive advantage. Innovation as the application of successful creative ideas within the company in a dynamic environment was expected to increase the company's ability to adapt through producing new innovative products and services, Hurley and Hult (1998) also proposed innovation as a mechanism that companies did to adapt to a dynamic environment.

Various studies have shown the relationship between innovation and firm performance. Han et al. (1998) and Wahid et al. (2017) concluded that innovation improved company performance. Kluge et al. (2000) suggested that innovation was related to company performance in the



industry and services sectors. They also found that innovation helped a company to increase its competitive advantage. Furthermore, Zahra and Das (1993) suggested that the dimensions of innovation strategies influenced company financial performance.

Company performance is an evaluation of all the efforts made to realize the company's business objectives (Yildiz & Karakas, 2012). Overall company performance depends on business processes application and the company's position in the market. Companies that have a good position in the industry will have a performance that tends to increase (Ray et al., 2004).

In the discussion that has been given, it could be concluded that the role of good corporate governance, innovation and e-business are important to improve the company's financial performance. These factors affect the ability to increase the competitive advantage of financial companies listed on the Indonesia Stock Exchange. Increasing company competitive advantage will, in turn, increase the company's financial performance.

## LITERATURE REVIEW

A company can be defined as a set of resources and owners, who are bound by a coalition of contracts for more effective production (Szenberg & Ramrattan, 2008). According to Hirschey (2009), a company is a combination of management, physical assets, finances and information technology. Thus, the company is essentially an economic unity. The basic model of a

company is derived from the company's theory, where a company is seen to have the main goal of profit maximization and to further attempt increasing the company's value. According to Thomas and Maurice (2013), a shareholder that acts as the company's owner and management will try to increase the company's profits and increase the company's value.

Resource-Based View (RBV) as a resource-based strategy theory has become increasingly influential in recent years. Competitive advantage discussion using RBV approach is a company performance model that focuses on capabilities and resources controlled by the company as a source of competitive advantage. The ability and resources of the company can be classified into four broad categories: financial resources, physical resources, human resources, and organizational resources (Barney & Hesterly, 2015).

Agency theory suggests that in a modern corporation, where stocks are widely held, the company's management action could deviate from the one needed to maximize shareholders profit. Ross et al. (2009) found that if left unchecked, managers tended to maximize the number of resources under their control. Therefore, to optimize the company's benefit, it is necessary that management is monitored to act for the optimal benefit of the company.

Information technology is an electronic means used for processing, storing and applying information communications, as well as products and services that produce and support such services (Prasad, 2008).

Along with technological development, the digital era presents a new and exciting way to do business; nevertheless, new market opportunity has a unique basic structure and is an interaction of internal and external company's forces. The internet is increasing in popularity as an additional channel of distribution in the banking sector (Jayawardhena & Foley, 2000). According to Otoritas Jasa Keuangan (OJK, 2015) e-banking is a service that allows bank customers to obtain information, communicate, and perform banking transactions through electronic media.

Information technology application that supports company competitive advantage includes e-business. Carpenter and Nakamoto (1994) stated that e-business involved all commercial activities, dynamic set of technologies, applications, and business processes performed by various computer devices. The purpose is to connect companies with customers, suppliers, and other business partners via electronic services. E-business could also be defined as a process and tools that enable companies to use internet-based information technology to conduct business internally and externally. E-business can also be understood as one of a technology-dependent strategic choice to create competitive advantage (Pilinkiene et al., 2013).

Furthermore, Beheshti et al. (2006) stated that advancement of information and communication technology had enabled various application models developed to support e-business, this application provided a competitive advantage for the company

by creating efficiency and cost reduction. Phillips (2003) concluded that the most significant influence of e-business was to cut the cost of interaction, for example in searching, coordinating and monitoring company management when conducting business activities.

In a discussion related to innovation diffusion theory, Rogers (2003) stated that innovation diffusion was a theory of how a new idea and technology become scattered. The theory of innovation diffusion believes that innovation can be diffused throughout society in a predictable pattern. The measurement of innovations made by companies according to Tidd and Bessant (2014) can be divided into five dimensions: strategy, process, organizational innovation, relationships and learning. Tidd and Bessant (2014) provided an example that companies who allocated funds for research and development would have better innovation resources compared to companies who did not allocate funds for research and development.

Companies that take advantage of strategic competitive advantage and exploit their competitive advantage will be able to achieve its main goal of gaining above average profitability (Hitt et al., 2001). The competitive advantage relates to how companies choose and execute the strategy within the company's operation. Ismail et al. (2010) suggested that competitive advantage was a significant factor that supported the performance of a company.

Nag et al. (2007) suggested that companies needed to improve resource-

based competitiveness as well as assessments of the company's internal and external environments. Related to the competitive advantage Bowman et al. (2002) and Surjaatmadja and Adriansyah (2016), argued that increased competitive advantage could improve company performance. In other research, Barney and Hesterly (2015) stated that the ultimate goal of management was realizing a competitive advantage to improve company financial performance.

Company performance is an evaluation of all efforts made to realize the business goals of the company. Santos and Brito (2012) argued that company performance was an important topic in strategic management research and was often used as a dependent variable. The measurement of company performance based on financial indicators is assumed as a reflection of the achievement of the company's economic goals. Hence, company performance has become a dominant strategic model in empirical research (Hult et al., 2008).

Based on the literature review for the implementation of corporate governance, innovation, e-business, and their effect to competitive advantage and company financial performance, the framework in this research can be described as seen in Figure 1.

The hypothesis is a logically expected relationship between two or more variables expressed in the form of a testable statement. The relationship is estimated based on the theoretical framework formulated for the study. The hypothesis proposed can be tested empirically, and conclude whether the proposed hypothesis is rejected or accepted (Sekaran & Bougie, 2013).

Research conducted by Madhani (2014) showed that corporate governance was a key driver of competitive advantage and company growth. Corporate governance can be represented as different factors among companies, and it could provide higher market valuation through competitive advantage. Today, corporate governance

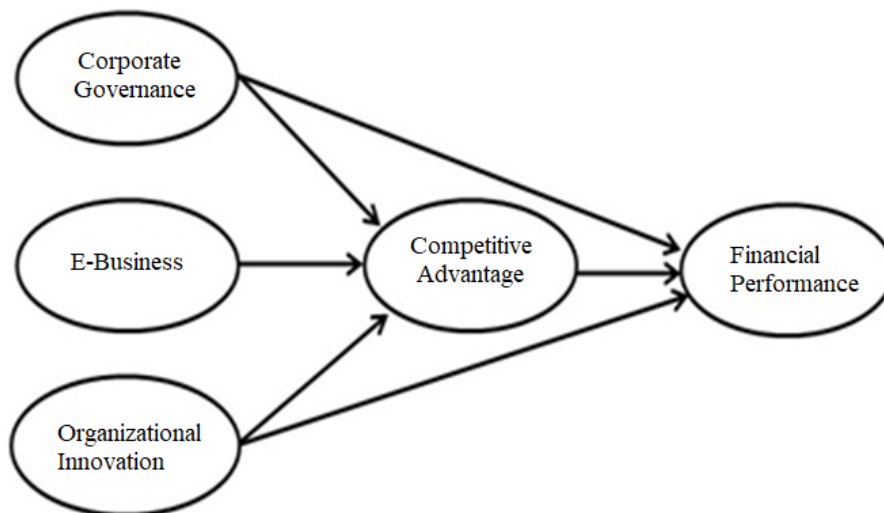

Figure 1. Research model

is indispensable; this is due to the dependencies on new technologies such as the Internet, which has increase company business exposure to technology. As a result, companies require corporate governance of security management and convenience for the users (Robles et al., 2008). This research first hypothesis (H1) is corporate governance significantly impacts company competitive advantage.

Research conducted by Bauer et al. (2005) concluded that e-business implementation in the financial industry would affect company competitive advantage, and increased competitive advantage would affect company performance. E-business application results in competitive advantage in the context of the financial service industry in Australia. Research result by Troshani and Rao (2007), showed that e-business application enabled the company to enhance competitive advantage provide more effective and efficient services. The second hypothesis (H2) is E-business significantly impacts company competitive advantage.

Innovation required is generally identical in many companies, regardless of the company size and industrial sector. The study of innovation in the financial industry states that financial companies received benefits from collaboration with external partners, such as developing new employee, accessing knowledge and technologies, reducing costs and finding new approaches to solving problems (Martovoy et al., 2015). Research conducted by Hana (2013) showed small and large companies placed

an emphasis on innovation as the source of competitive advantage that determined the success of company performance. The third hypothesis (H3) is an organizational innovation significantly impacts company competitive advantage.

In a research conducted by Abdullah and Page (2009), which analyzed the relationship between corporate governance and company performance, they concluded that corporate governance affected the company's financial ratios, such as market to book ratio, sales to total assets ratio and profit to asset ratio. The fourth hypothesis (H4) is corporate governance significantly impacts company financial performance.

Research conducted by Hassan et al. (2013) explored the effect of innovation on the company's performance. It was found that innovation produced a competitive advantage for a company and improves company financial performance. The fifth hypothesis (H5) is organizational innovation significantly impacts company financial performance.

Competitive advantage supports a company in achieving high performance (Ismail et al., 2010). Research conducted by Bahri et al. (2015) explores the competitive advantage of Regional Owned Enterprise in Aceh province, Indonesia. It concludes that competitive advantage affects company performance. Research conducted by Koksal and Ozgul (2010) examined exporting company competitive advantage in Turkey and concluded that company, who want to have high performance, must build competitive advantage, and improve

its export capability to compete in the international market. The sixth hypothesis (H6) is competitive advantage significantly impacts company financial performance.

## **MATERIALS AND METHODS**

The purpose of this research was to identify the effect of the independent variable on the dependent variable. The research objective was to investigate the effect of corporate governance, e-business, and organizational innovation on competitive advantage and financial performance. The samples for this research were 67 companies top management in the financial industry sector on the Indonesia Stock Exchange. The data was collected using Likert-scale survey questions through the mail, e-mail, or one-on-one interview.

The operationalization of variables aimed to measure the variables used in research. There were five variables in this research: corporate governance, e-business, organizational innovation, competitive advantage, and financial performance. Variable Corporate Governance is the balanced control system for both the company's external and internal interests, ensuring that the company can be held accountable by the stakeholders and is socially responsible for its activities. The five dimensions of corporate governance are transparency, accountability, responsibility, independence, and fairness.

Variables E-Business is the process and tool that allows the company to use information technology to conduct business internally and externally. The five

dimensions of e-business are the alignment of business strategies, the quality of the online system, the drivers of investment, the commitment and support of management, and the transaction support services. Variable Organizational Innovation is the process of integrating components that work together to create an environment where innovation can flourish. The seven dimensions of organizational innovation are application, organizational structure, company activity, information systems, objectives, mobilization, and external relationships.

Variable Competitive Advantage is the ability and resources that are owned and controlled by company management. The five dimensions of competitive advantage are service efficiency, cost flexibility, variety of online transaction services, duplication barriers, and learning organization. Variable Financial Performance is the evaluation of efforts made to realize the company's business objectives. The three dimensions of financial performance are net profit margin, return on assets, and return on equity.

Methods used in this research were descriptive analysis and multivariate analysis. Descriptive analysis was done to know the top management perspective regarding corporate governance, e-business, organizational innovation, and competitive advantage in the financial industry sector on the Indonesian Stock Exchange. Multivariate analysis was done to test the hypothesis using Structural Equation Modeling (SEM) based on variance or Partial Least Square (PLS). The result from the test was obtained

using the application SmartPLS 3.0 version.

PLS method has an optimal research objective that is oriented toward implication and prediction, the sample used does not have to be large, different type of scales (ordinal, interval and ratio) can be used on the same model, the data does not have to be normally distributed and the estimation of parameter can be done without the goodness of fit test (Latan & Ghazali, 2012). SEM-PLS analysis consists of two sub-models, measurement model or outer model and structural model or inner model.

## RESULTS AND DISCUSSIONS

The respondents in this research were representing the population of the financial company listed on the Indonesia Stock Exchange. The samples of 67 companies in the financial industry sector were listed on the Indonesia Stock Exchange. The research used PLS analysis second-order confirmatory analysis, with latent variables of Corporate Governance, E-Business, Innovation and Competitive advantage, and non-latent variable of Financial Performance.

The structural equation analysis section discussed the influence of independent latent variables on dependent latent variables. The

discussion of structural equation analysis consisted of Goodness of fit (R-Square) test, significance test, and influence of independent latent variable. Variable Corporate Governance, E-Business, and “Organizational Innovation” effect on Competitive Advantage model gives an R-square value of 0.640, which can be interpreted that 64% of variable Competitive Advantage is explained by the variable Corporate Governance, E-Business, and Organizational Innovation.

Analysis of the measurement model or outer model consisted of a validity test and reliability test. The validity test criteria, according to Latan and Ghazali (2012) was that the loading factor value for all indicators must be greater than 0.6. The validity test results obtained from the indicators in the research showed that the loading factor value all exceeded 0.60, which meant it met the criteria for the validity test. The reliability test was done by using Cronbach’s Alpha measurement with a value greater than 0.70. The result of the reliability test is shown in Table 1.

The influence of variable Corporate Governance, Organizational Innovation and Competitive Advantage on Financial Performance provides an R-square value of

Table 1

### *Reliability test analysis*

Variable	Cronbach’s Alpha	Decision
GCG	0.904	Reliable
EBS	0.924	Reliable
INV	0.932	Reliable
CAD	0.834	Reliable
CFP	0.850	Reliable

0.026, which can be interpreted that 2.6% of the Financial Performance variable can be explained by the variable Corporate Governance, Organizational Innovation, and Competitive Advantage. The results for path coefficients using  $\alpha = 5\%$  are shown in Table 2.

Based on the data analysis, variable Corporate Governance on Competitiveness Advantage has a negative and significant impact. The results of this research support previous research, which suggests that the influence of corporate governance on achieving company goal, involves the responsibility of decision-makers regarding different objectives between company operations and regulations that must be obeyed.

Variable E-Business on Competitive Advantage has a positive and significant impact. Implementation of e-business in the financial industry has a positive influence

on competitive advantage, then, increasing competitive advantage will impact on the overall company financial performance.

Variable Organizational Innovation on Competitive Advantage has a positive and significant impact. Organizational innovation as a source of competitive advantage has an impact on the success of company performance. Variable Corporate Governance on Financial Performance has a positive but not significant impact. A company that implements corporate governance can improve the company's financial performance, but the impact of corporate governance on financial performance is not strong.

Variable Organizational Innovation on Financial Performance has a negative but not significant impact. Company in the financial industry must develop products and systems, that support the company operations to develop products and systems,

Table 2  
*Path coefficients and significance*

	Original sample	T statistics	P values	Decision
GCG → CAD	-0.233	2.351	0.010	Negative, Significant
EBS → CAD	0.593	4.370	0.000	Positive, Significant
INV → CAD	0.397	2.659	0.004	Positive, Significant
GCG → CFP	0.192	1.529	0.063	Positive, Not Significant
INV → CFP	-0.306	0.985	0.163	Negative, Not Significant
CAD → CFP	0.144	0.413	0.340	Positive, Not Significant



the company needs to spend more resources and expenses that affect the company's financial performance. Variable Competitive Advantage to Financial Performance has a positive but not significant impact. The results show that competitive advantage is a basis for the company in increasing financial performance.

Based on the research results, the implementation of corporate governance is the decision and mandate of the management, employees should be understood and familiar with the implementation of corporate governance in conducting company operations. E-business applied by the company supported the company's competitive advantage, therefore increasing company activities through the application of information technology is recommended. Organizational innovation becomes an important aspect of improving company business. A company that allocates funds for research and development will have better innovation resources and experience growth in the competitive industry. Furthermore, management needs company competitive advantage to improve financial performance.

## CONCLUSIONS

Corporate governance results in better company monitoring and transparency, it has a positive effect on financial performance. These results conclude that corporate governance will eventually be able to improve company financial performance. Implementation of e-business by the company provides services that are more

effective and efficient, which then improves the competitive advantage of the company.

Organizational innovation applied by the company gives the company a competitive advantage but has a negative effect on financial performance as organizational innovation depletes resources and increases expenses. However, organizational innovations applied by the company in the financial industry use more resources and expenses, thus negatively affecting company finances. Competitive advantage has a positive impact on company financial performance; this result shows that competitive advantage increases the company ability to have better financial performance.

The suggestion that can be given based on this research is for company management in the financial industry to pursue competitive advantage through the implementation of corporate governance, e-business, and organizational innovation. Competitive advantage is expected to improve company financial performance. For the next research, the researcher can study in other industries, such as companies in the financial technology (FinTech) industry.

## ACKNOWLEDGEMENT

The authors wish to acknowledge and thank all IMHA 2018 committee members and UPM *Pertanika* journal team that help publish this article.

## REFERENCES

- Abdullah, A., & Page, M. (2009). *Corporate governance and corporate performance: UK FTSE 350 Companies*. Edinburgh, Scotland: The Institute of Chartered Accountants of Scotland.
- Bahri, S., Yahya, D. K., Kusman, M., & Hilmiana. (2015). The core competence effect of competitive strategy and its impact on the corporate performance of bumd: A study on bumd Aceh Province, Indonesia. *International Journal of Economics, Commerce and Management*, 3(6), 732 - 754.
- Barney, J. B., & Hesterly, W. S. (2015). *Strategic management and competitive advantage concepts and cases* (5th Ed.). London, England: Pearson Education Limited.
- Bauer, H. H., Hammerschmidt, M., & Falk, T. (2005). Measuring the quality of e-banking portals. *International Journal of Bank Marketing*, 23(2), 153-175.
- Bebchuk, L. A., & Weisbach, M. S. (2010). The state of corporate governance research. *Review of Financial Studies*, 23(3), 939-961.
- Becerra, M. (2009). *Theory of the firm strategic management economic value analysis*. Cambridge, UK: Cambridge University Press.
- Beheshti, H. M., Sangari, E. S., & Engstrom, A. (2006). Competitive advantage with e-business: A survey of large American and Swedish firms. *Competitiveness Review*, 16(2), 150-157.
- Bianchini, S., Krafft, J., Quattraro, F., & Ravix, J. (2015). *Corporate governance innovation and firm age: Insights and new evidence*. (GREDEG Working Paper No.2014-05). University of Turin, Italy.
- Bowman, E. H., Singh, H., & Thomas, H. (2002). The domain of strategic management: history and evolution. In A. Pettigrew, H. Thomas & R. Whittington (Eds.), *Handbook of strategy and management* (pp. 31-51). London, England: Sage.
- Carpenter, G. S., & Nakamoto, K. (1994). Reflections on “consumer preference formation and pioneering advantage”. *Journal of Marketing Research*, 31(4), 570-573.
- Chen, L., Tang, O., & Feldman, A. (2015). Applying GRI report for the investigation of environmental management practices and company performance in Sweden, China and India. *Journal of Cleaner Production*, 98(1), 36-46.
- Han, J. K., Namwoon K., & Rajendra K. S. (1998). Market orientation and organizational performance: Is innovation a missing link? *Journal of Marketing*, 62(4), 30-45.
- Hana, U. (2013). Competitive advantage achievement through innovation and knowledge. *Journal of Competitiveness*, 5(1), 82-96.
- Hasnan, S., Marzuki, H., & Shuhidan, S. M. (2017). Effects of board characteristics on financial restatement in Malaysia. *Pertanika Journal of Social Sciences and Humanities*, 25(S), 259-268.
- Hassan, M. U., Shaukat, S., Nawaz, M. S., & Naz, S. (2013) Effect of innovation types on firm performance: An empirical study on Pakistan’s manufacturing sector. *Pakistan Journal of Commerce and Social Sciences*, 7(2), 243-262.
- Hirschey, M. (2009). *Managerial economics* (12th Ed.). Mason, USA: South-Western Cengage Learning.
- Hitt, M. A., Ireland, R. D., & Hoskisson, R. E. (2001). *Strategic management: Advantages and globalization concepts*. Medan, Indonesia: Publisher Salemba Empat.

- Hult, G. T. M., Ketchen, D. J., Griffith, D. A., Chabowski, B. R., Hamman, M. K., Dykes, B. J., Pollitte, W. A., & Cavusgil, S. T. (2008). An assessment of the measurement of performance in international business research. *Journal of International Business Studies*, 39(6), 1064-1080.
- Hurley, R. F., & Hult, G. T. M. (1998). Innovation, market orientation and organizational learning: An integration and empirical examination. *Journal of Marketing*, 62(3), 42-54.
- Ismail, A. I., Rose, R. C., Abdullah, H., & Uli, J. (2010). The relationship between organisational competitive advantage and performance moderated by the age and size of firms. *Asian Academy of Management Journal*, 15(2), 157-173.
- Jayawardhena, C., & Foley, P. (2000). Changes in the banking sector – the case of internet banking in the UK. *Internet Research: Electronic Networking Applications and Policy*, 10(1), 19-31.
- Kluge, J., Meffert, J., & Stein, L. (2000). The German road to innovation. *The McKinsey Quarterly*, 2(1), 99-105.
- Köksal, M. H., & Özgül, E. (2010). The export competitive advantages of Turkish manufacturing companies. *Marketing Intelligence and Planning*, 28(2), 206-222.
- Latan, H., & Ghozali, I. (2012). *Partial least squares concepts and application SmartPLS 2.0 M3*. Semarang, Indonesia: Publisher Diponegoro University.
- Madhani, P. M. (2014). Corporate governance: Compliance or competitive advantage? *Vision Research - A National Research Journal*, 4(1), 96-104.
- Martovoy, A., Mention, A. L., & Torkkeli, M. (2015). Inbound open innovation in financial services. *Journal of Technology Management and Innovation*, 10(1), 117-131.
- Monks, R. A. G., & Minow, N. (2011). *Corporate governance* (5th Ed.). Chichester, United Kingdom: John Wiley & Sons.
- Nag, R., Hambrick, D. C., & Chen, M. J. (2007). What is strategic management, really? Inductive derivation of a consensus definition of the field. *Strategic Management Journal* 28(9), 935-955.
- Otoritas Jasa Keuangan. (2015). *Wise use electronic banking*. Retrieved March 25, 2018, from <https://www.ojk.go.id/en/kanal/perbankan/ikhtisar-perbankan/Pages/Peraturan-dan-Pengawasan-Perbankan.aspx>
- Phillips, P. (2003). *E-business strategy text and cases*. Maidenhead, United Kingdom: McGraw-Hill Education.
- Pilinkiene, V., Kurschus, R., & Auskalnyte, A. (2013). E-business as a source of competitive advantage. *Economics and Management*, 18(1), 77-85.
- Prasad, A. (2008). *The impact of information technology investments on firm processes and performance: Developing economy perspectives*. New York, USA: Nova Science Publisher.
- Ray, G., Barney, J. B., & Muhanna, W. A. (2004). Capabilities business processes and competitive advantage: Choosing the dependent variable in empirical test of the resource-based view. *Strategic Management Journal*, 25(1), 23-37.
- Robles, R. J., Kim, N., & Kim, T. (2008). IT security governance for e-business. *International Journal of Software Engineering and Its Applications*, 2(3), 99-106.

- Rogers, E. M. (2003). *Diffusion of innovations* (5th Ed.). New York, USA: Free Press.
- Ross, S. A., Westerfield, R. W., & Jordan, B. D. (2009) *Corporate finance* (8th Ed.). Semarang, Indonesia: Publisher Salemba Empat.
- Santos, J. B., & Brito, L. A. L. (2012). Toward a subjective measurement model for firm performance. *Brazilian Administration Review*, 9(SPE), 95-117.
- Sekaran, U., & Bougie, R. (2013). *Research methods for business: A skill building approach* (6th Ed.). New York, USA: Publisher John Wiley & Sons Ltd.
- Surjaatmadja, S., & Adriansyah, A. (2016) Does Islamic banking have a competitive advantage over conventional banking in Indonesia?: A study of perspectives. *Pertanika Journal of Social Sciences and Humanities*, 24(S), 205-214.
- Szenberg, M., & Ramrattan, L. (2008). Book review: Theories of the firm (2nd Ed.). *The American Economist Journal*, 52(1), 117-120.
- Tan, J. B. (2015). Compliance to corporate governance among publicly-listed companies in the Philippines. *Business and Economics Journal*, 6(1), 1-4.
- Thomas, C. R., & Maurice, S. C. (2013). *Managerial economics: Foundations of business analysis and strategy* (11th Ed.). International Edition, Singapore: McGraw Hill.
- Tidd, J., & Bessant, J. (2014). *Managing innovation: Integrating technological, market and organizational change* (5th Ed.). West Sussex, England: John Wiley & Sons.
- Troshani, I., & Rao, S. (2007). Enabling e-business competitive advantage: Perspective from the Australian financial services industry. *International Journal of Business and Information*, 2(1), 80-103.
- Wahid, A. W., Aziz, N. N. A., & Halim, R. A. (2017). Networking and innovation performance of micro-enterprises in Malaysia: The moderating effects of geographical location. *Pertanika Journal of Social Sciences and Humanities*, 25(S), 277-288.
- Yildiz, S., & Karakas, A. (2012). Defining methods and criteria for measuring business performance: A comparative research between the literature in Turkey and foreign. *Procedia - Social and Behavioral Sciences*, 58, 1091-1102.
- Zahra, S. A., & Das, S. R. (1993). Innovation strategy and financial performance in manufacturing companies: An empirical study. *Production and Operation Management*, 2(1), 15-37.



## **Resource Development Analysis in Indonesia Listed Bank Type IV: An Overview of Resource Base Theory in Indonesia Banking Industry in Developing Competitive Advantage**

**Hardijanto Saroso\* and Agus Ridwan**

*Department of Management, BINUS Business School, Undergraduate Program, Bina Nusantara University, Jakarta, Indonesia 11480*

### **ABSTRACT**

Competition among banks in Indonesia, including the listed companies in the Indonesia Stock Exchanges, encourages every bank to develop its resources to anticipate the market challenge and win the competition. Those include the Banks with category IV. In many cases, the companies recruit the most talented person and continue to initiate training to improve the current resources capabilities and competencies. This research evaluated the impact of the recruitment of a higher level of education person, training costs, and investment of corporate assets, to the performance of the company. This research used secondary longitudinal data in the period between 2011 until 2015. The calculations of data and research model analysis used SPSS version 19 and WarpPLS software. This study concluded that training and asset development had a significant influence on company performance. Therefore, evaluation on training cost allocation to improve the competency and capacity of the company becomes one of the important indicators for the sustainability of

the company's performance, especially with today's business disruption by information technology as a key challenge in the bank industry.

*Keywords:* Competition, education, Indonesia Bank Type IV, RBT, resource development

### ARTICLE INFO

*Article history:*

Received: 9 October 2019

Accepted: 3 January 2020

Published: 17 March 2020

*E-mail addresses:*

hardijanto.saroso@binus.edu (Hardijanto Saroso)

arid\_ukm@yahoo.com (Agus Ridwan)

\*Corresponding author

### **INTRODUCTION**

The development of the competition in the banking industry is likely to enter a

new competition era, especially with the introduction of information technology that encourages innovations in administration and banking transactions. The technology promotes speed, efficiency, and new features. Managing quality resources becomes critical as the centre activities of total quality management (Arora & Arora, 2015). As a result, banks are initiating all activities necessary to develop themselves through training and new initiatives so the company could keep up with the market trend and market demand. This condition is consistent with Bank Indonesia regulation no. 6/25/PBI/2004 (Bank Indonesia, 2004), about Business Plan of Commercial Banks, in particular, Article 5j on organizational development and human resources plans. This provision is reaffirmed in Articles 15 a and 15 b in the same rules which require the development and training of human resources to adapt its competence to market needs. Inter-bank competition is not the only challenge for banking operators. New competitors emerge from other industries.

Tighter competition from time to time also changed the map of the Indonesian banking industry, because, since April 2017, Bank Niaga succeeded in positioning itself as a category IV bank, parallel to four other banks that have entered the category IV. This category is the highest level in the categorization of bank companies based on Bank Indonesia regulation No. 14, 2012 (Bank Indonesia, 2012). Bank with category IV is a Bank with a core capital of at least 30 trillion Rupiah. With this massive capital size, it encourages this research to assess

how the bank is expanding its business, including developing its company resources.

The development of E-Commerce also provides a challenge for the banking industry. The development of diverse and complex product offerings also attracted the attention of many banking leaders to think of strategic steps to anticipate the increasingly competitive rivalry of the company. Some banking activities such as payment intermediaries have already begun being replaced by non-bank players who can execute and pay transactions such as in bank operation. Not to mention the high value of E-Commerce activities encourage many new entrepreneurs and investors entering this new industry. The CAGR of transaction value in E-Money, from 2012 to 2016, rise to 38% (SWA, 2017). The CAGR in phone banking, Mobile Banking, and Internet Banking with the same period consecutively were 0.88%, 33.59% and 3.02% (SWA, 2017).

Ramdan (2017), stated that online transactions in E-Commerce in 2016 could reach US\$ 14.8 Billion, and in 2020 was predicted by the Government that it could reach US\$ 130 Billion. Various financial services based on digital technology are also increasingly demanding by start-up entrepreneurs. This type of service provides convenience, a very low-cost budget, and some of the services are free. It gives broad access to funds that even in sectors are not supported by the banking world. Based on data from the Association of FinTech Indonesia, the number of technology-based financing companies has reached



153 companies. It is exceeding the number of commercial banks by 120 (Data on the website of Bank Indonesia May 2017) and continues to grow. The business disruption seems to be unstoppable, and the company must manage their talent (Elia et al., 2017). With this kind of business challenges, banks must initiate strategic changes by strengthening their systems and resources. Recruiting postgraduate, investing in new assets or initiating a training activity is among the actions that were done by the company. But the question is “how these items behave or give impact to the company performance in delivering sustainable profitability?”. The next question was “which one has the most significant impact to profit?” and “what kind of relationship that exists among this component?” By using secondary data, this research is intended to find a strategic measure to identify the most critical initiatives between recruiting postgraduate, investing in new assets or initiating training activities for the company’s resources that could support company’s performance.

## LITERATURE REVIEW

Sixty-five (65) years ago, Penrose (1959) raised the important statement of innovation in anticipating competition. Price and product quality are an essential part of the industrial competition. But in the long run, to sustain the company performance, a company must allocate its budget to develop its resource, process, and product to pursue the new improvement and innovation. For most of the strategy in anticipating competition,

Porter (1980) pointed out the importance of the knowledge and capability of the company. These all reflected the company’s employee skill and competency, and also the company’s capability and capacity. In 1992, Kaplan and Norton introduced the “Balanced Scorecard” technique that helped managers to measure company performance from different perspectives (i.e., knowledge development perspective, infrastructure perspective, customer perspective, and financial perspective). Since then the research among scholars in the area of company resources such as human capital, knowledge management, infrastructure/ physical and financial capital are widely initiated.

Thompson et al. (2015) pointed out that improvement in current resources and capability could improve the company performance. Furthermore, the quality of company resources and company capability are the company assets that will determine the ability of the company to strongly compete or disappointingly weak. These resources include tangible and intangible resources. In the industry that is entering a new era or business disruption, Thompson (2015) suggested developing its internal resources to build new capabilities in entering a new business. Bhatti and Zaheer (2014) added that the Intellectual capital (knowledge) was a critical force that creates and adding value to the company. The creation of new capabilities and knowledge are intended to fill the gap from the existing capability to the future requirement (Massingham, 2014). When the requirement of knowledge and

skill continues to evolve, the continuous process of employee training becomes important (Kotur & Anbazhagan, 2014). In today's globalization, the new landscape of modern business is driven by the intellectual capital and the human capital that provide the organizations to establish and sustain their competitive advantage (MacDougall & Hurst, 2005).

Ikapel (2016) stated that many companies were still keeping focusing on physical capital to drive its profitability, while it was the human capital that played an important role. Nevertheless, Murthy and Moritsen (2011) mentioned the linkage between physical and financial capital in contributing the intellectual capital that took place through the firm's budgeting processes, to promote profitability.

In this research, we took the assumption from Barney (1986) that the Firm must rationalize its decision and made any necessary consideration that the potential return should be higher than normal from implementing their development Corporate Strategy or HR Strategy, including when the company acquires its resources. In addition to this concept, the Firm must implement its long strategy plan in developing sustainable competitive advantages (Barney, 1986) through (1) new value creation, (2) rarity target result, (3) low imitability and (4) substitutability. This strategy will include the development of human resources, knowledge management system, company competencies and capabilities.

It has been revealed that there is a significant relationship between human

capital, efficiency and financial performance (Madininos et al., 2011). Knowledge measured as the Human Capital has a significant effect on economic performance (Rafiei et al., 2011). Human capital or the workforce is one of the precious assets in an organization (Hajiha & Hasanloo, 2012). In fact, human capital plays an important role in organizational performance (Ahmadi et al., 2011). Lettmayr and Nehls (2011), in their research, found that vocational education and training had a positive effect on company performance. In such a dynamic market, when the time window of competition was short, the company that could improve their competency and capability through training or education becomes critical to winning the competition.

## MATERIALS AND METHODS

This research was focused on the financial industry, especially in the banking sector, ultimately bank companies with Category IV. Since this category is the highest category in Indonesia Bank Industry, it is predicted that the company has a larger capacity in developing its internal resources to sustain its business performance as compared to Bank Category III. The numbers of Bank Company that can be categorized in this level are only five companies. For this research, data is collected from the entire population and using homogeneity principal with longitudinal data.

The research was conducted in early April 2017, and one bank just recently entered the category IV. There could probably a gap between the first four companies that

already in this category. So the data period selection is intended to minimize the gap. The period of this study was from 2011-2015, and the total data collected was only 25 data. The number of data is quite small. The author referred to two journals in discussing a low size number of data: Kar and Ramalingam (2013) and Tenenhaus et al. (2005). If the classic statistical data evaluation is satisfactory, then the PLS software will provide additional information such as the data condition, error rate, level of significance to analyze data or phenomena with a low size number of data (Tenenhaus et al., 2005). Since this research was in the preliminary stage, and the Warp PLS 5.0 software would be used to analyze the data, the author proceeded to the research. Since the number of samples was low, further research with bigger samples should be initiated.

This research used secondary data. The whole five companies were listed

companies, so the data of these five companies were available at the company website. The data collected consists of: 1. the total number of the employee who took the postgraduate degree (PASCA), 2. total cost of employee training (TC), 3. total cost on investment on new asset (IONA) and 4. the company's profit (PROFIT). When this research had been conducted, one of the banks did not release its 2016 annual report. So, this research was using longitudinal data from 5 banks, starting from 2011 until 2015. Postgraduate degree employee data was taken, since, in this research context, we were trying to measure the aggregate number of the employee who was highly possibilities having a big part in the decision-making process.

## RESULTS AND DISCUSSIONS

The detailed breakdown of Secondary Data that was taken from five Banks was presented in Table 1.

Table 1  
*Breakdown data*

Bank	Year	Employee		Training Cost (TC) in Rp Bio	Investment on New Asset (IONA) IN Rp Bio	Profit (PROFIT) in Rp Bio
		Postgraduate (PASCA)	Total Employee			
Bank Mandiri	2011	1571	27907	265	1541	12695
	2012	1562	30773	319	1669	16043
	2013	1540	33982	381	1584	18829
	2014	1525	34622	454	2251	20654
	2015	1542	36737	492	1136	21152

Table 1 (Continued)

Bank	Year	Employee		Training Cost (TC) in Rp Bio	Investment on New Asset (IONA) IN Rp Bio	Profit (PROFIT) in Rp Bio
		Postgraduate (PASCA)	Total Employee			
Bank BRI	2011	1039	40044	460	601	15088
	2012	1072	72625	485	1445	18687
	2013	1109	80238	545	1948	21354
	2014	1175	91364	664	3065	24227
	2015	1202	92574	617	3285	25411
Bank BNI	2011	2254	23639	261	718	5808
	2012	2269	24861	277	1134	7048
	2013	2320	26100	203	1582	9058
	2014	2377	26536	238	1366	10829
	2015	2382	26875	219	3022	9141
Bank BCA	2011	543	19962	170	1727	10818
	2012	578	20285	201	3212	11718
	2013	610	21013	217	2937	14256
	2014	663	22161	266	2661	16512
	2015	712	23982	256	2533	18036
Bank Niaga	2011	434	13612	114	447	3177
	2012	491	14224	143	529	4250
	2013	492	14342	152	733	4296
	2014	517	15003	152	871	2344
	2015	493	13577	164	1305	428

Four variables would be used in this research: PASCA, TC, IONA, and PROFIT. Prior to the use of these data, this research checked the normality, the autocorrelation and the multicollinearity of the data. Relying on the Kolmogorov & Smirnov Test; we found that all the data were normally distributed. It had been seen that the values of significance were greater than 0.05 (PASCA = 0.457; TC = 0.181; IONA = 0.693; PROFIT = 0.995). Detail of the normality test can be seen in Table 2.

All the data in Table 2 does not have autocorrelation with each other. It can be seen at the result of Durbin-Watson test which indicates the value between 1 and 3 (1.016). Relying on the testing result that indicated the value of VIF factor was less than 10 (IF PASCA = 1.043; IF TC = 1.185; IF IONA = 1.141), so all data was not multicollinear. The details are in Table 3 and Table 4.

Table 2

*Normality test*

		PASCA	TC	IONA	PROFIT
N		25	25	25	25
Normal Parameters <sup>a,b</sup>	Mean	1218.88	308.65	1732.18	12872.97
	Std. Deviation	682.822	158.03	905.02	7198.27
Most Extreme Differences	Absolute	0.171	0.218	0.142	0.084
	Positive	0.171	0.218	0.142	0.084
	Negative	-0.135	-0.109	-0.108	-0.083
Kolmogorov-Smirnov Z		0.855	1.091	0.711	0.418
Asymp. Sig. (2-tailed)		0.457	0.185	0.694	0.995

Table 3

*Autocorrelation test*

Model	R	R Square	Adjusted R Square	Std. Error of the Estimate	Durbin-Watson
1	0.920 <sup>a</sup>	0.846	0.824	3015.73374	1.016

Table 4

*Multicollinearity test*

Model		Unstandardized Coefficients		Standardized Coefficients		Collinearity Statistics	
		B	Std. Error	Beta	T	Sig.	Tolerance VIF
1	(Constant)	-1819.260	1828.821		-0.995	0.331	
	PASCA	-0.345	0.921	-0.033	-0.375	0.711	0.959 1.043
	TC	34.923	4.240	0.767	8.237	0.000	0.844 1.185
	IONA	2.504	0.727	0.315	3.447	0.002	0.876 1.141

Based on the result above, it can be concluded that the data can be used for Multiple Linear Regression analysis with the result:

$$Y = -1819.260 - 0.345X_1 + 34.923X_2 + 2.504X_3 + e, \text{ Where: } X_1 = \text{PASCA}, X_2 = \text{TC}, X_3 = \text{IONA}, Y = \text{PROFIT}$$

In the structural model Figure 1, the coefficient determination (R2) is 0,87. It means the variable Postgraduate Employee (PASCA), Training Cost (TC) and Investment on New Asset (IONA) could explain the diversity of Profit variables by 87.0%, and the remaining 13% is explained by other factors outside the model. In other words, this setup could describe the contribution of PASCA, TC, and IONA toward Profit performance as in Table 5.

The Q2 is 0.867 or greater than zero, or the latent exogen variable can determine the endogen variable. Additionally, based on the above table, the result of the analysis shows that there is a slight effect of IONA on Profit since the p-value (0.049) is slightly lower than  $\alpha$  (0.05) with a coefficient ( $\beta =$

0.29). However, the results of the analysis showed that there was a positive direct and significant influence of TC to the Profit indicated by the value of p-value ( $<0.001$ ) which was smaller than  $\alpha$  (0.05) with the coefficient ( $\beta = 0.77$ ). Pasca had a direct and significant influence to TC (p-value =  $<0.001$ , coefficient  $\beta = 0.91$ ). So the total value from Pasca-TC-Profit was 0.700. It strongly indicated that Pasca, the postgraduate employee could have a significant effect on profit by giving specific training to them.

Below, we could see the best-fitting curve for the multivariate relationship between two dominant paths: 1. Pasca to TV and 2. TC to Profit.

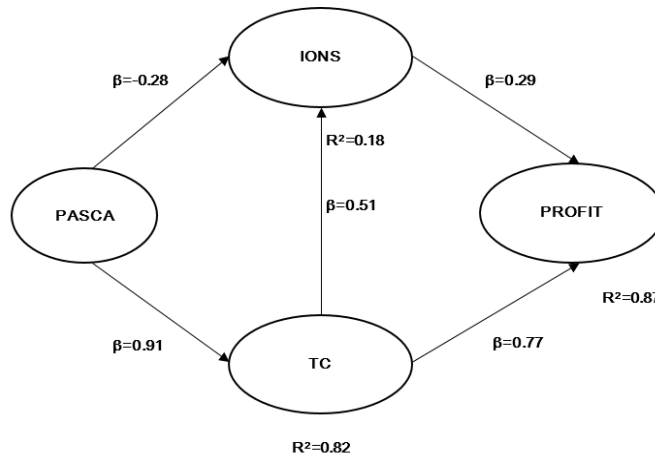

Figure 1. Research model and final analysis

Tabel 5

Data analysis

	PASCA	TC	IONA	PROFIT
R <sup>2</sup> coefficients	-	-	-	0.869
Adjusted R <sup>2</sup> coefficients	-	-	-	0.857
Q <sup>2</sup> coefficients	-	-	-	0.857

Tabel 5 (Continued)

*Effect Sizes for Path Coefficients*

	PASCA	TC	IONA	PROFIT
PASCA	-	-	-	-
TC	0.819	-	-	-
IONA	0.15	0.327	-	-
PROFIT	-	0.687	0.182	-

*P Value*

	PASCA	TC	IONA	PROFIT
PASCA	-	-	-	-
TC	<0.001	-	-	-
IONA	0.057	0.001	-	-
PROFIT	-	<0.001	0.049	-

If we refer to Figure 2, the relationship between variable PASCA and TC is nonlinear, while in Figure 3, the relationship between variable TC to PROFIT is quasi-linear. It is suggested that based on Figure 2, more postgraduate employee will not continue to support a positive sustainability trend. On the contrary, based on Figure

3, more training will continue to have a positive trend, although to some degree it will start to have a lower coefficient. To enrich our understanding of the research model, this research also initiated a different research model. However, the final model that was used for this research gives the highest coefficient determination ( $R^2$ ).

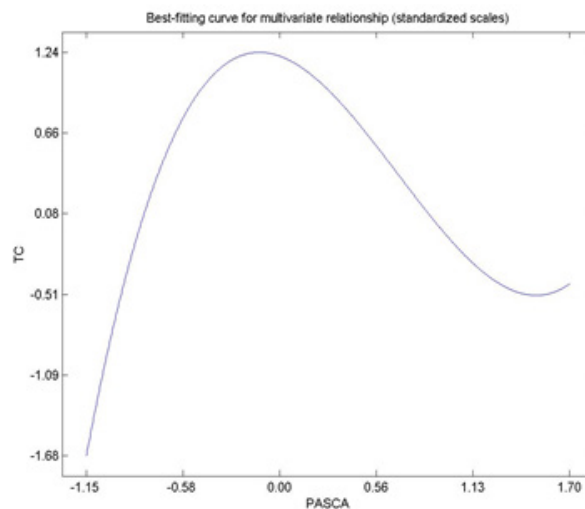

Figure 2. Pasca to TC

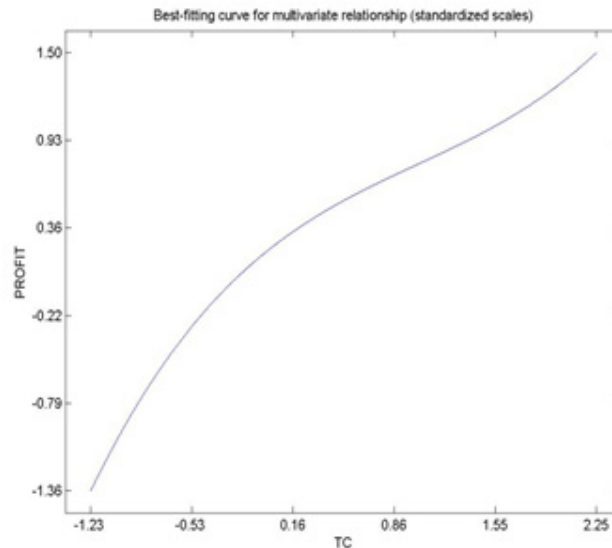

Figure 3. TC to Profit

## CONCLUSIONS

This research shows a prediction of the positive trend and the strong relation between training cost allocation and profitability trend of these companies. Based on this research, it is noted that training to the employee plays a significant role in the development of company performance and sustainability. In the conditions of hyper-competition, the anticipation and the development process must be executed in parallel. The anticipation process is intended to withstand the market pressure and attempt to win the competition. The development process aims to achieve superior performance and sustain the company's positive trend going forward.

Regarding the competition in the banking industry, which demands continuous innovation in banking service with the support of technology, it drives the

bank to keep up and follow the market trend as well as the market demand, especially in the current emerging trend of Digital Banking, and E-Commerce. Today, winning the competition would be done through the repetition of a small step (Hess, 2010) and keeping the initiation of creative action (Christensen, 1997; Schumpeter, 1942). So, it is important for the company to have a continuation of system improvement and skill update.

Therefore, improving employee or management skills through ongoing and proper training becomes very important, especially if the window of competition becomes narrowed. With the development of technology in the field of banking and the growing development of non-bank financial services causes the company must focus more on the ability of its resources in anticipating the competition.



Any new or existing postgraduate employee could give the best impact to the company if it is “equipped” with the best fit of knowledge and skills. This statement should be challenged further by looking at other countries situation or other industries. It could generate the next possibility of new research. Other conditions that inspire us are a critical issue on the local setting, company environment, local culture, local teamwork, and commonalities. Training gives adjustment and simultaneous enrichment to the employee of the company. Datta (2009) reminded that a company that invested in training should promote innovation and support differentiation strategies. In today’s business situation, with the disruption from technology and the shifted of customer preference, a differentiation strategy should be acknowledged as a new path for the next cycle of sustainability development. Datta (2009) said that differentiation strategies were more profitable than cost leadership strategies as it was stated in Porter (1980) because the top market leaders preferred to compete more by differentiation than the low cost.

In the service industry, like in the bank, improving and developing asset could provide new possibilities and opportunities in providing and improving the current services. The challenges are which type of asset that could provide the biggest contribution to profit. How can we identify this asset? With today’s technology, the leader must also consider the implications of technology.

Finally, it should be in our mindset that any training should be taken under careful consideration of cost, strengthen the existing structures and resources, and bring future benefits, even though the correlation is in quasi-linear. The world activities are integrated with the help of technology implementation. Internationalization is also closer everywhere. For traditional business, this situation becomes a threat if the company stops to learn and innovate (Saroso, 2015). So, future research in these areas is still wide open. This research is in the preliminary stage. Research on resources development in anticipation of hyper-competition should be continued to be explored. Other industries might have different complexity and setup that require different ways of developing their resources. The component of the research could be different, and the structure could also be different.

Other future research that can be initiated is 1. The addition of the controlling factors such as economic growth, 2. Customer acceptance of modern technology or application in bank services, and 3. The number of postgraduate degrees that fall into generation Y. It is hoped that these new researches will promote better management ideas and sustainable growth for the company.

#### **ACKNOWLEDGEMENT**

The authors wish to acknowledge and thank all IMHA 2018 committee members and UPM *Pertanika* journal team that help in publishing this article.

## REFERENCES

- Ahmadi, S. A. A., Salamzadeh, Y., Daraei, M., & Akbari, J. (2012). Relationship between organizational culture and strategy implementation: typologies and dimensions. *Global Business and Management Research: An International Journal*, 4(3-4), 286-299.
- Arora, N., & Arora, V. K. (2015). Life-Long education for the global workforce in the socio-engineering age. *Pertanika Journal of Social Sciences and Humanities*, 23(1), iii-xxvi.
- Barney, J. B. (1986). Organizational culture: can it be a source of sustained competitive advantage?. *Academy of Management Review*, 11(3), 656-665.
- Bank Indonesia. (2012). *Regulation No 14: Business activities and office networks based on core capital of the bank*. PBI No 14/26/PBI/2012. Retrieved March 15, 2018, from <https://aksetlaw.com/news-event/newsflash/new-bank-indonesia-regulation-on-multiple-licensing-policy/>
- Bank Indonesia. (2004). *Regulation No 6: General Bank Business Plan*. PBI No 6/25/PBI/2004. Retrieved March 15, 2018, from <https://www.bi.go.id/en/peraturan/perbankan/Documents/f486c261fccc491ebffb059ad768d580pbi6240eng.pdf>
- Bhatti, W., & Zaheer, A. (2014). The role of intellectual capital in creating and adding value to organizational performance: A conceptual analysis. *The Electronic Journal of Knowledge Management*, 12(3), 187-194.
- Christensen, C. M. (1997). *The innovator's dilemma: When new technologies cause great firms to fail*. Boston, USA: Harvard Business School Press.
- Datta, Y. (2009, June 24-26). *A critique of Porter's cost leadership and differentiation strategies*. Research paper presented at the 9th Oxford Business & Economics Conference, Oxford University, Oxford, UK.
- Elia, P. T., Ghazzawi, K. A., & Badih. (2017). Talent management implications in the Lebanese banking industry. *Human Resource Management Research*, 7(2), 83-89.
- Hajiha, Z., & Hasanloo, S. (2012). An empirical study of the relationships among human capital value and profitability and market value: Comparison of knowledge-based industries and non knowledge-based industries. *Asian Journal of Business and Management Sciences*, 1(3), 105-114.
- Hess, E. H. (2010). *Smart growth: building and enduring business by managing the risk of growth*. New York, USA: Columbia University Press.
- Ikapel, O. F. (2016). Analysis of intellectual capital and financial performance of commercial banks in Kenya: An application of Value Added Intellectual Coefficient (VAIC™). *International Journal of Research in Finance and Marketing (IJRFM)*, 6(7), 1-16.
- Kaplan, R. S., & Norton, D. P. (1992). *The balanced scorecard: Measures that drive performance*. Boston, MA: Harvard Business Review.
- Kar, S. S., & Ramalingam, A. (2013). Is 30 the magic number? Issues in sample size estimation. *National Journal of Community Medicine*, 4(1), 175-179.
- Kotur, B., & Anbazhagan, S. (2014). Education and work-experience - influence on the performance. *Journal of Business and Management*, 16(5), 104-110.
- Lettmayr, C. F., & Nehls, H. (2011). *The impact of Vocational Education and Training*. Research Paper No. 19. Luxembourg Germany: Publications Office of the European Union.
- MacDougall, S. L., & Hurst, D. (2005). Identifying tangible costs, benefits and risks of an investment in intellectual capital: Contracting contingent

- knowledge workers. *Journal of Intellectual Capital*, 6(1), 53-71.
- Maditinos, D., Chatzoudes, D., Tsairidis, C., & Theriou, G. (2011). The impact of intellectual capital on firms' market value and financial performance. *Journal of Intellectual Capital*, 12(1), 132-151.
- Massingham, P. (2014). An evaluation of knowledge management tools: Part 1 – managing knowledge resources. *Journal of Knowledge Management*, 18(6), 1075-1100.
- Murthy, V., & Mouritsen, J. (2011). The performance of intellectual capital: Mobilising relationships between intellectual and financial capital in a bank. *Accounting, Auditing and Accountability Journal*, 24(5), 622-646.
- Penrose, E. T. (1959). *The theory of the growth of the firm*. London, England: Basil Blackwell.
- Porter, M. E. (1980). *Competitive strategy: Techniques for analyzing industries and competitors*. New York, USA: Free Press.
- Rafiei, S., Delkhosh, B., Rad, A. H. S., & Peiman, Z. (2011). Effect of sowing dates and irrigation regimes on agronomic traits of Indian mustard in semi-arid area of Takestan. *Journal of American Science*, 7(10), 721-728.
- Ramdan, D. M. (2017, April). Unggul Dalam Layanan Meski Produk Sederhana [Superior in Service Delivery Despite of It Is a Simple Product]. *KONTAN Special Edition*, pp. 4.
- Saroso, H. (2015). A conceptual framework in building dynamic capabilities in highly competitive industry. *Advanced Science Letters*, 21(4), 800-804.
- Schumpeter, J. A. (1942). *Capitalism, socialism and democracy*. London, England: Routledge.
- SWA. (2017). *Bank Indonesia*. Retrieved April 16, 2018, from <https://swa.co.id/tag/bank-indonesia>.
- Tenenhaus, M., Pages, J., Ambroisine, L., & Guinot, C. (2005). PLS methodology to study relationships between hedonic judgements and product characteristics. *Food Quality and Preference*, 16(4), 315–325.
- Thompson, A., Peteraf, M., Gamble, J., & Strickland, A. (2015). *Crafting and executing strategy: The quest for competitive advantage, concepts and cases* (20th Ed.). Maidenhead, United Kingdom: McGraw Hill.



## **Design and Commercialization Critics of Batik Lasem**

**Vera Jenny Basiroen**

*Graphic Design and New Media Program, Department of Visual Communication Design,  
BINUS Northumbria School of Design, Bina Nusantara University, Jakarta 11480, Indonesia*

---

### **ABSTRACT**

This paper presents the new creation of batik Lasem versus commercialization critics from four critics from different fields. Using the design thinking process, the writer was finally able to create five new pattern designs involving five steps which were research, analysis, ideation, experimentation, and implementation. The town of Lasem and batik Lasem were chosen because the town held an important role, as the producer of a particular batik in Indonesia that was influenced by Chinese culture. Despite the rich and deep-rooted heritage this particular Batik is now dying along with the younger generation lack of interest in the creation or promotion of the Batik to preserve their culture. This research could be used as a base to create a new style derived from the existing motif that had been analyzed. By interviewing and analyzing four experts from different fields, the writer developed the new and fresh motif design that had both the culture and commercial value and could be accepted by the new millennial generation to achieve preservation batik tulis Lasem.

*Keywords:* Critics, gen millennia, Lasem, new design motif, preserved batik

---

### ARTICLE INFO

*Article history:*

Received: 9 October 2019

Accepted: 3 January 2020

Published: 17 March 2020

---

*E-mail address:*

nonjane@binus.edu

### **INTRODUCTION**

Lasem is a small town in Central Java. It is considered as the evidence of acculturation between the Chinese ethnics and the Javanese, becoming an example of how different cultures in one area can exist in harmony. The town is titled *The Little Tiongkok* or *Le Petit Chi noise* in some literatures for its similarity to a Chinatown with the abundant amount of *peranakan* style houses and Chinese temples. Based

on a report by Liong (2006), the locals believed that Bi Nang Un together with his wife, Na Li Ni, brought the resist technique which was more advanced than what the locals were familiar with, and introduced the technique to locals. Lasem batik industry experienced a golden peak in the 1970's. In between 1950's and 1980's, about 90% of the population in Lasem, especially women, to work as a batik craftsman. However, at this time less than 10% of the population of women are still working as batik (Wibisono, 2006). This is caused by a number of bankrupt businesses that threaten the business and culture of batik Lasem. It is estimated that the number of small businesses batik Lasem has fallen sharply from about 140 units in 1950's into only 20 units of small businesses at the end of July 2006. The younger generation prefers to work in the modern sector, both inside and outside of Rembang (Indonesia, 2006). According to Liong (2006), this leads to two critical issues:

Reduced employment and income for the population in poor rural areas and the threat of cultural extinction Batik Lasem because of the declining competitiveness of the industry.

The difficulty of the regeneration of employers and workers Lasem batik (Liong, 2006). This leads to our current situation with the perilous possibility of batik Lasem extinction. With the lack of interest by the younger generation in succeeding and learning the techniques of the trade, batik Lasem is slowly fading out along with the last few longstanding batik artist remaining.

### **The Four Main Characteristic Motif Designs of Lasem**

#### **The Great Post Road (road from Anyer - Panarukan) and Watu Pecah Motive.**

The great post road or *De Grote Postweg* is a road that spans from West Java in Anyer to East Java in Panarukan along the northern coast of Java. The road was built in 1808 during the reign of Herman Willem Daendels who decided on the construction of the road due to his concern of the British Invasion ("IndeArchipel.com, 2013). During this period, many of the residents in the areas passed by the road construction were recruited as stonebreakers and death count were rising rapidly especially due to the outbreak of plagues such as Malaria and Influenza (Buana, 2013). Seeing such conditions batik artists in Lasem create a motif representing their deep sympathy toward the situation. Moreover, it is to reflect their loyalty and respect for their comrades struggling and suffering while working as stonebreakers. The motif is called *watu pecah* or sometimes it is also called *krecak* or *kricak*. It can be seen in Figure 1. These shapes resemble the stones that had been hand broken using traditional tools and served as a reminder of the people's hardships in building the road from Anyer to Panarukan during that time (Gunawan, 2013).

#### **Kawista Fruit and Bledak Kawista Motive.**

Kawista is a fruit tree that grows abundantly in Lasem. The shape of its fruit is round. The fruit is hard on the exterior but having soft and paste-like consistency on the inside. Kawista plants are considered

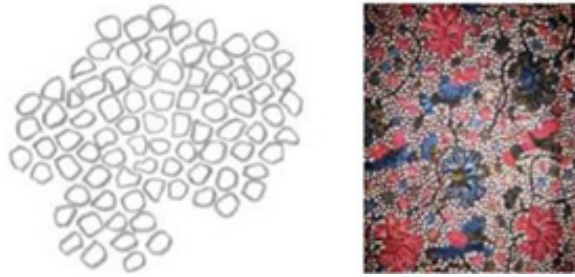

Figure 1. Motif Watu Pecah (Basiroen & Lapian, 2016)

rare in Indonesia because of its nature of thriving in dry/hot areas such as Lasem and Rembang. They also processed the fruit into drinkable syrup and a kind of carbonated drink resembling the western colas and thus, it is dubbed as Java Cola or *Kola Jawa* (Batik Art, n.d.). The attachment and constant interaction between the locals and this particular fruit plant inevitably lead to a creation of batik motif that is derived from this unique plant. The motif is called *Bledak Kawista*. The shape of the motif symbolizes or resembles the shape and texture of Kawista fruit is the stylization of the real fruit itself. Motif Bledak Kawista can be seen in Figure 2 below.

**Gunung Ringgit Motive.** *Gunung Ringgit* is considered as classic/ancient motif in Lasem as it can be found in the early development of batik Lasem. The motif

bears the symbolic meaning of heaps of riches. The philosophy behind the motif itself is to find and build riches, although by means that are not prohibited by law. Aside from its philosophical meanings, the motif *gunung ringgit* is most likely influenced by the geographical condition of the town of Lasem that is surrounded by mountains, one of them being mounted Lasem. Motif *Gunung Ringgit* can be seen in Figure 3.

**Latohan Motive.** *Latoh* (*Caulerpa racemosa*) is a type of seaweed from *Chlorophyceae*, or green algae (Nuraini, 2006), that thrives in Lasem area. The particular algae are popular locally as food sources. People in Lasem usually cook the algae in a local cuisine called *urap*. As *latoh* seaweed is easily found in Lasem, it was then naturally implemented into the local's



Figure 2. Motif Bledak Kawista (Basiroen & Lapian, 2016)





Figure 3. Motif Gunung Ringgit (Basiroen & Lapian, 2016)

creation that then called *Motif Latohan*. Motif Latohan can be seen in Figure 4 below.

### Problem Identification

Batik work in Lasem is seasonal. Batik artists were generally women farmers who used their spare time between planting and harvest time to supplement the family income through batik creation. In 1970, Lasem batik took off and the industry became one of the main economic pillars of almost all households in Lasem city and villages. The period 1997 - 2006 marks the start of hardship in the industry of batik Lasem due to economic crisis and political instability in the country (Indonesia, 2006). In 2007 batik Lasem started back in the form of small businesses and this time many

small businesses and batik entrepreneurs of Lasem combined their marketing effort to create a new market for Batik Lasem. While the new marketing effort is a sufficient start in the revitalization of batik Lasem it does not solve the problem of the overused and obsolete existing style or motifs (Basiroen & Lapian, 2016). The writer expected that this paper would be able to be used as a base to create a new style derived from the existing motifs that have been analyzed and critiques. And by creating more contemporary motif, the writer hoped that the interest in batik Lasem would increase and resulted in the improvements of the economy of the Lasem batik artists. The growth in batik industry would be hoped to attract the interest of younger generation in or near Lasem area to return and develop both the batik culture



Figure 4. Motif Latohan (Basiroen & Lapian, 2016)



and business, reducing unemployment and reducing poverty in rural areas of Rembang.

## OBJECTIVES

1. To create new motif designs that could be accepted by the younger generation who was born in generation Millennial.
2. To evaluate & analyze the critics on the motifs. By interviewing and analyzing of the four experts, the writer develops the motif design required that become suitable and match with the gen millennia and the new design has the commercialization value.
3. To revise and improve the visual into the new design motif that suitable for the target market and the capability from the batik crafter to make the motifs.

## Theoretical Foundation

### Design and Age (Millennial Generation).

Demographers William Straus and Neil Howe define Millennia's as people born between 1982 and 2004. According to Howe and Strauss, this group is poised to become the next great generation, one that will provide a more positive, group-oriented, can-do ethos (Howe & Strauss, 2000). Jean Twenge attributes Millennia's with the traits of confidence and tolerance but also identifies a sense of entitlement and narcissism based on personality surveys that showed increasing narcissism among Millennia's compared to preceding generations when they were teens and in

their twenties (Twenge, 2014).

According to Alina Wheeler, a Brand Identity Design specialist, eighty million Millennial is the first generation to have grown up in a digital culture. They're also the first generation of digital natives, and their affinity for technology helps shape how they live and communicate (Safitri & Evelina, 2018; Wheeler, 2013). Millennials have come of age during a time of technological change, globalization and economic disruption. In relation to design style, millennials have a freestyle that is simple, digitized and unique, but still has a sense of the motif itself. The researcher aimed to generate interest in the youth of Lasem town to return and preserve their traditional cultural heritage by creating batik Lasem with contemporary motifs and simplified and unique designs.

**Colour Theory.** Colour is a fundamental part of how we experience the world by means of interaction. It is the basic guidance to colour mixing and the visual effects of colour combination, which includes a large group of definitions, concepts and design applications. Although the effect of colour projected onto people varies in terms of several factors, from personal and psychological perspectives to cultural background, colour theory in itself is a scientific study (Chapman, 2010).

**Colour Psychology.** Most commonly and widely used in designing and branding, the study of hues to determine human behaviour influences human perception and emotion. There is, however, a difference between

colour psychology and colour symbolism with the latter referring to our “conscious associations we are conditioned to make”. For instance in Lasem, red *getih pithik* (chicken blood red) is considered lucky, it is produced from natural dyes that colour the roots of noni tree, indicating the presence of nature.

**Semiotic Theory.** Semiotics is the study of meaning-making, the study of sign processes and meaningful communication. A science that studies the life of signs within society is conceivable. It would be part of social psychology and consequently of general psychology (Danesi, 2004).

**Thematic Theory.** Thematic analysis is one of the most common forms of analysis in qualitative research (Guest et al., 2012). It emphasizes pinpointing, examining, and recording patterns within data (Braun & Clarke, 2006). Themes are patterns across data sets that are important to the description of a phenomenon and are associated with a specific research question (Daly et al., 1997). Thematic analysis is performed through the process of coding in six phases to create established, meaningful patterns. The themes become the categories for analysis (Fereday & Muir-Cochrane, 2006).

## MATERIALS AND METHODS

This research was done through four approaches. Firstly is qualitative research through an interview with the critics, which were divided into three categories

which are academic category, designers and general category. In this case, the critics were professional, entrepreneur, teacher and designer. Secondly is ethnography, a method of close observation of a given environment placing great emphasis on behaviour viewed as contextual. Thirdly is direct observation, a method of observing people gain insight into their social interactions and behavioural changes. Fourthly is semi-structured interviews, one-to-one interviews provide information about individual actions and motivations that cannot be obtained in-group discussions.

## RESULTS AND DISCUSSIONS

### The New Design Motif, Critics

**Bicycle with *Latohan*.** The conclusion of Bicycle with *latohan* as seen in Figure 5, that the pattern tells a rather strong story about Lasem daily activities and through this contrast background in the design, it will be appealing to the younger market.

**Koi Fish Combined with *Kricak*.** The conclusion of Koi fish combined with kricak as seen in Figure 6, that shows cultural influences from Chinese and modern Dutch, which makes the young generation appreciate the cultural history and story that shaped Lasem. The painting from the combination of Koi fish and kricak motif creates a new dimension of a new fresh modern batik design that suitable for the young generation market.



Figure 5. Bicycle with Latohan

Table 1

Meaning of Latohan Motif based on different factors

	Cultural Factor	Psychological Factor	Aesthetic Factor
Expert 1	A glance of this motif gives out very Javanese vibe. The latohan could easily spotted and recognized as a trademark of Lasem's batik.	The style of illustration of the bike and warm colouring create a sense of nostalgia and calm.	The variation of pattern is minimum in this motif especially with the bicycle's. The latohan motifs with its subtle difference in colour are giving the slight depth needed.
Expert 2	The bicycle motif gave an old and rustic feeling, while there is a shape of latohan clearly visible in reference to Lasem's trademark.	The design of bicycle motif gave a warm nostalgic feeling of an old era long forgotten.	There is no significant depth in this design especially since there are not many variations from the bicycle motif (only rotated and slightly varied in sizes).
Expert 3	It is a mixed motif, between one of the characteristic motif, Latoh mix with modern illustrated bicycle.	Striking contrast to the background design, appealing for the younger market.	Fine line bicycle design and latoh design with watercolour in earth tone and vivid hues on bicycle.
Expert 4	The pattern tells a rather strong story about Lasem daily activities. It portrays a beautiful sunny day in a village of Java where shore is the heart of it all. The bicycle on the pattern showing the dynamic & energetic vibe of the villagers amongst the natures	The combination of what comes out from the nature (Latohan) and the man- made technology (bicycles) delivers a feeling of balance yet soothing.	The warm colour of the bicycle gives out a nostalgic and rustic traditional feeling that matches sweetly and calmly with the greens of Latohan.



Figure 6. Koi fish combined with kricak

Table 2

Meaning of Koi Fish Motif based on different factors

	Cultural Factor	Psychological Factor	Aesthetic Factor
Expert 1	The Koi fish motif makes it clear that there is Chinese influence involved.	The choice of colour (Deep magenta/purple) and motifs (the intricate scale of the Koi and the watu pecah motif) create a sophisticated or dare I say almost a regal feeling into it.	The design mixes the two cultures (Lasem and chinese) nicely and subtly. The intricate illustrations of the scally Koi fishes complement the watu pecah pattern.
Expert 2	Koi fishes was easy to identify with Chinese influence.	The direction of the Koi fishes in the pattern to create a closed space in the design together with the many small intricate pattern of watu pecah motif might be the reason to the overwhelmingly crowded and stuffy feeling of the design.	The colour chosen (purple and orange) and the intricate pattern on both the fishes scales and the watu pecah creates a more serious pattern with a nice balance of Chinese cultural infusion.
Expert 3	Mix motif seen a strong chinese influence through the koi fish motif and the red colour.	Detailed painting from the combination of Koi fish and kricak motif, create a new dimension of new fresh modern batik design.	Flowing motifs create a detailed driven aesthetic design shape and form.
Expert 4	Showing a cultural influences from the Chinese and the modern Dutch. It strengthen what Lasem is today.	It makes us appreciate the cultural history and story that shaped Lasem.	The deep and the contrasting colour bring out the mix cultural background in a traditional arrangement. The Koi images are showing a movement that makes the pattern more vibrant and dynamic.

**Kawis Fruit.** The conclusion of *Kawis* fruit, that this fruit educates us how this rare fruit can become the source of a famous Javanese Cola drink (Figure 7). The pattern clearly

shows a fruity feeling that leads us to a fresh natural mood that fits the young generation mood and character.

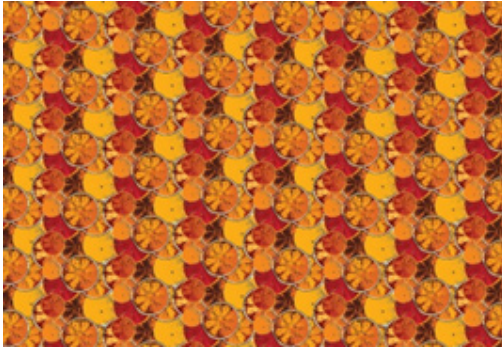

Figure 7. *Kawis* fruit.

Table 3

Meaning of *Kawis* Fruit Motif based on different factors

	Cultural Factor	Psychological Factor	Aesthetic Factor
Expert 1	While the <i>Kawis</i> fruit is local to Lasem, the shape is general thus looks like any other citrus family fruits. I would think it will not be easy to connect the motif to its cultural root of Lasem, especially if they haven't read or been informed about it beforehand.	The warm and inviting colours created a sweet and warm feeling to the design.	The textures of sliced <i>Kawi</i> 's combined with the use of various shades of orange and yellow created a great depth within the pattern. The design is definitely contemporary while still retaining the rustic and muted feeling of traditional.
Expert 2	The shape evokes no particular memory into any cultural reference.	The warm and rustic colouring creates a warming effect.	The pattern is varied in sizes with different texture and colouring on each motif. This created visual depth that gives this new contemporary feeling into the design.
Expert 3	<i>Kawis</i> fruit is one of the Lasem most famous fruit that only could be found at Rembang area,	The warm colour represent the ripe and freshness color earth tone, which will work well with modern outfit.	Fine line <i>Kawis</i> design and with colour and balance composition and suitable for the commercial market.

Table 3 (Continued)

	Cultural Factor	Psychological Factor	Aesthetic Factor
Expert 4	This fruity pattern educates us how this rare fruit can become a source of famous Javanese Cola drink.	The pattern clearly shows a fruity feeling that lead us to a fresh natural mood.	This image of the Kawis fruit doesn't really show the 'taste' of the fruit itself, it instead reminds us the look of citrus kind of fruit.

**Ancient Lifeboat in Rembang.** The conclusion of Ancient Lifeboats in Rembang (Figure 8). This motif is inspired by the archaeological findings of one of Cheng Ho's lifeboats that were stranded in Lasem, which makes the young generation appreciate

the cultural history that surrounds Lasem. Traditional *latoh* and historic lifeboats are in harmony and balance as composition and also give the designer an option for a young contemporary style.

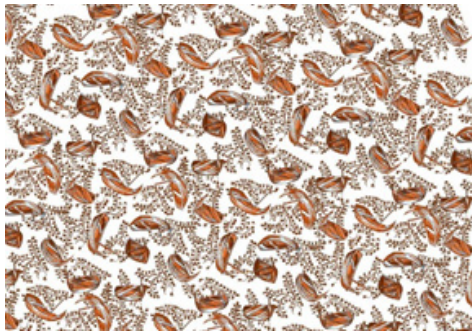

Figure 8. Ancient lifeboat in Rembang

Table 4

Meaning of Ancient Lifeboat in Rembang Motif based on different factors

	Cultural Factor	Psychological Factor	Aesthetic Factor
Expert 1	The mixture of latohan and boat motifs complemented with the brown colouring creates that distinctive Javanese Batik look and feel.	The design has a strong vintage feeling.	A very interesting motifs that requires you to take a second or third look to truly understand and appreciate. While a glance will get you think of those old intricate batik motifs, a second look will reward you with the detailed illustration of the boat, which complement the whole design.
Expert 2	While difficult to identify at a glance the boat gave a nice cultural reference to the seas that surround Lasem.	The design has an old and familiar feeling of Javanese style batik.	While the design is pretty flat the variation of boats mixed with latohan motifs creates an interesting pattern.



Table 4 (Continued)

	Cultural Factor	Psychological Factor	Aesthetic Factor
Expert 3	This motif is inspired by the archaeological findings of one of Cheng Ho's lifeboat that was stranded in Lasem, a nice story for Lasem batik cloth.	Traditional latoh and historic lifeboat give designer an optional for a young contemporary style.	Traditional latoh and vintage wooden lifeboat orderly harmony and balance as a beautiful composition
Expert 4	It'll be a history drawn beautifully on a batik clothes.	It gives an instant traditional feeling in a woody appearance, warm and soothing.	The warm woody colour of the boats supported by the like monochromatic Latohan colour on white background make this pattern design traditional yet light and pretty.

**Lasem Farmer with *Latohan*.** The conclusion of Lasem farmers with *latohan* (Figure 9). This motif is a feminine story told in the design of how the Lasem women put faith in the historical mountain that brings luck and prosperity, as influenced

by the Chinese culture. It raises up hopes and willingness to keep aiming to improve welfare. It is a painting-like pattern with a vibrant set of colours. It is a fresh way of telling a history that fit for the young generation style.



Figure 9. Lasem farmer with *Latohan*

Table 5

Meaning of Lasem Farmer with *Latohan* Motif based on different factors

	Cultural Factor	Psychological Factor	Aesthetic Factor
Expert 1	The illustration of famers certainly relates to Javanese culture of farming.	The feeling that came when I saw this image is "childlike abandon".	The motifs are incorporating many elements and different textures that clashed with one another, you really need to have a double take on each element to truly understand their meaning. While this makes it harder to appreciate

Table 5 (Continued)

	Cultural Factor	Psychological Factor	Aesthetic Factor
			the motifs in a glance, I find the semiotic behind this motif interesting and accurately depicting the daily lives of the people in Lasem.
Expert 2	The drawing of farmers standing on top of what looks like mountains is a clever representation of farmers in Lasem.	The motifs are fun and cheerful, the feeling might come from the choice of vibrant colours or the simplistic shapes that clashes with one another.	An interesting motif that has many different elements merged into one. This is definitely a busy and contemporary pattern that requires you to take a second look to decipher.
Expert 3	influenced by Chinese, the mount ringgit means to wealth, money or property that is abundant piled up, a reflection of the desire for rich or have a big fortune, mixed with the farmer that relates to Javanese culture.	The mount ringgit represents big fortune or treasure has become something of beauty essentials. To search and to collect money of the most beautiful treasure. The whole motif and colour combination feel really fresh and had a sense of elegance to casual wear collection.	Nice traditional composition layout with fresh background.
Expert 4	A feminine story told on the design in a way of telling how the role of Lasem women put faith in the historical mountain that brings luck prosperous, influenced by the Chinese culture.	It raises up hopes and willingness to keep aiming and reaching the welfare.	A painting-like pattern with the vibrant set of colour. A fresh way of telling a history.

**CONCLUSIONS**

The writer found that moreover, the social and geographical aspects of the town of *Lasem*, could be a source of inspiration in order to create a new pattern of batik, combined as well as derived from the old, traditional pattern. Through the process

of analyzing the point of view from the experts, the writer found that by creating and developing new and fresh motif design that had both the culture and commercial value, could evoke the interest of the younger generation. The data collected from the qualitative interview also showed that a new contemporary design could arouse



the interest of the younger generation in joining the batik Lasem conservation effort. This newly gained interest is hoped to slowly create new demand for *Batik Lasem* to ensure the continuation of the age-old knowledge and tradition. Throughout the research and data gathering process, the writer got a recommendation from some interviewees to put more consideration and attention into the limitations and skills in processing batik process, contemplating the feasibility of the design production from the crafter point of view.

## ACKNOWLEDGEMENT

The author wishes to acknowledge and thank all IMHA 2018 committee members and UPM *Pertanika* journal team that help publish this article.

## REFERENCES

- Basiroen, V.J., & Lopian, M. E. (2016). Implementation of design thinking process in creating new batik lasem design. *Pertanika Journal of Social Sciences and Humanities*, 24(S), 119-136.
- Batik Art, L. (n.d.). *Batik Tulis Lasem Bledak Kawista* [Handmade Batik Lasem Bledak Kawista]. Retrieved July 26, 2018, from <http://www.lasembatikart.com/menu.php?id=438>
- Braun, V., & Clarke, V. (2006). Using thematic analysis in psychology. *University of the West of England*, 3(2), 77-101.
- Buana, L. (2013). *Batik Lasem, Akulturasi Tionghoa dan Jawa - La Galigo for Nusantara* [Lasem Batik, Chinese and Javanese Acculturation - La Galigo for Nusantara]. Retrieved July 26, 2018, from <https://lontarproject.com/galigo-ku/batik-lasem-akulturasi-tionghoa-dan-jawa/>
- Chapman, C. (2010). *Color theory for designers: How to create your own color schemes - smashing magazine*. Retrieved July 26, 2018, from <https://www.smashingmagazine.com/2010/02/color-theory-for-designer-part-3-creating-your-own-color-palettes/>
- Daly, J., Kellehear, A., & Gliksman, M. (1997). *The public health researcher : A methodological guide*. (Lucy Davidson, Ed.). South Melbourne: Oxford University Press.
- Danesi, M. (2004). *Messages, signs, and meaning: a basic textbook in semiotics and communication*. Canadian Scholars' Press. Retrieved June 15, 2018 from [http://www.academia.edu/24166004/Danesi\\_messages\\_signs\\_and\\_meanings](http://www.academia.edu/24166004/Danesi_messages_signs_and_meanings)
- Fereday, J., & Muir-Cochrane, E. (2006). Demonstrating rigor using thematic analysis: a hybrid approach of inductive and deductive coding and theme development. *International Journal of Qualitative Methods*, 5(1), 80-92.
- Guest, G., MacQueen, K., & Namey, E. (2012). *Applied thematic analysis*. Thousand Oaks, USA: SAGE Publications.
- Gunawan, W. (2013). *Lasem, Kota Tua di Pantura* [Lasem, the Old City in Pantura]. Retrieved July 26, 2018, from <http://www.pesona.co.id/article/lasem--kota-tua-di-pantura?p=1>
- Howe, N., & Strauss, W. (2000). *Millennials rising: The next great generation*. (Vol. 19). New York, USA: Vintage Books.
- IndeArchipel.com. (2013). *De Grote Postweg van Java In de Archipel* [Java Great Post Road In the Archipelago]. Retrieved July 26, 2018, from <https://indearchipel.com/2013/02/26/de-grote-postweg/>
- Indonesia, I. P. (2006). *Hasil Analisis Tim Peneliti Berdasar Studi Lapangan di Kabupaten Rembang, Jakarta* [Results of Analysis of Research Teams Based on Field Studies in Rembang Regency, Jakarta]. Retrieved June

28, 2018, from <http://worldcat.org/identities/nc-institut%20pluralisme%20indonesia%20ipi%20jakarta/>

- Liong, K. H. (2006). *Catatan awal hasil studi revitalisasi budaya dan usaha kecil batik Batik Lasem.* [Initial notes on the results of a study of cultural revitalization and batik small business: Workshop “Batik Revitalization of culture and business Batik]. Forum for Economic Development and Employment Promotion (FEDEP) Rembang Regency and Institut Pluralisme Indonesia (IPI).
- Nuraini, R. A. (2006). Percobaan berbagai macam metode budidaya Latoh (*Caulerpa racemosa*) sebagai upaya menunjang kontinuitas produksi [Experimental various methods of cultivation of Latoh (*Caulerpa racemosa*) as an effort to support the continuity of production]. *Indonesian Journal of Marine Sciences*, 11(2), 101 -105.
- Safitri, Y., & Evelina, L. W. (2018). Impression management for digital corporate image. *International Journal of Organizational Business Excellence*, 1(2), 121-128.
- Twenge, J. M. (2014). *Generation me: why today's young Americans are more confident, assertive, entitled--and more miserable than ever before.* New York, USA: Atria Paperback.
- Wheeler, A. (2013). *Designing brand identity: an essential guide for the whole branding team.* Retrieved June 20, 2018 from <https://www.wiley.com/en-us/dhhdhdDesigning+Brand+Identity+%3A+An+Essential+Guide+for+the+Whole+Branding+Team%2C+4th+Edition-p-9781118099209>
- Wibisono, D. (2006). *Manajemen kinerja: Konsep, desain dan teknik meningkatkan daya saing perusahaan* [Performance management: Concepts, designs and techniques enhance company competitiveness]. Jakarta, Indonesia: Erlangga.

## **The Survival of Batik Madura in Digital Era: A Case Study of Small Medium Enterprises (SME) at Batik Madura Center**

**Alwiyah<sup>1\*</sup>, Evi Steelyana<sup>2</sup>, Sayyida<sup>3</sup> and Izah Tahir<sup>4</sup>**

<sup>1</sup>*Department of Accounting, Wiraraja University, Madura, East Java 69451, Indonesia*

<sup>2</sup>*Department of Accounting, Faculty of Economics and Communication, Bina Nusantara University, Jakarta 11480, Indonesia*

<sup>3</sup>*Department of Management, Wiraraja University, Madura, East Java 69451, Indonesia*

<sup>4</sup>*Department of Management, Universiti Sultan Zainal Abidin, 21300 Kuala Terengganu, Terengganu, Malaysia*

### **ABSTRACT**

Batik Madura industry was developed in 1293 during the reign of Majapahit. Since its creation, it has significantly contributed to the development and growth of the regional economy with massive growth in the creative industry. It comprises cultural heritage, art, and economic values. Batik Madura is made up of unique colours which are inspired by the nature, culture, and environment of Madura. In recent years, most of the Small Medium Enterprises (SME) businesses carried out by Batik Madura merchants have been facing challenges on how to survive in the current globalization and digital era. Similarly, batik artisans (craftsmen) are decreasing drastically, leading to a decrease in productivity and

cultural preservation. The purpose of this research work is to analyze the key factors affecting batik entrepreneurs, to analyze factors affecting their existence and to change their view on the use of social media platforms and information technology to support their businesses. Furthermore, this research work aims at analyzing the ways batik artisans could survive and increase their craftsmanship quality. Data were collected using the quantitative method of data collection which involves the use of questionnaires. The results of the analysis obtained show that the economic growth of

### ARTICLE INFO

#### *Article history:*

Received: 9 October 2019

Accepted: 3 January 2020

Published: 17 March 2020

#### *E-mail addresses:*

[alwiyahmahdaly@wiraraja.ac.id](mailto:alwiyahmahdaly@wiraraja.ac.id) (Alwiyah)

[evi.wiyarto@gmail.com](mailto:evi.wiyarto@gmail.com) (Evi Steelyana)

[sayyida@wiraraja.ac.id](mailto:sayyida@wiraraja.ac.id) (Sayyida)

[profizah@gmail.com](mailto:profizah@gmail.com) (Izah Tahir)

\*Corresponding author

Batik Madura is greatly influenced by family and relatives and not by skills.

*Keywords: Batik Artisan, Batik Madura, digital era, information technology, Small Medium Enterprise Industry (SME)*

---

## INTRODUCTION

Batik is a by-product of Nusantara; however, there are researches which claims batik as being cultural by-product produced by on Central Java only. Indonesia which is also known as Nusantara, consists of several islands, with each Island producing a unique kind of batik. Batik can be found in Cirebon (West Java), Semarang (Central Java), Parahyangan (West Java), and in Madura (East Java). Madura is an island located some 100 km away from Surabaya, the capital of East Java. Batik rich value is one of the numerous reasons why is being used and known throughout Nusantara. Batik is significantly grown in large amounts on Java Island, Central Java and Special Region of Yogyakarta (DIY Yogyakarta). It can also be found in large amounts in Sumatra or Celebes Islands (Ramelan, 2010).

Batik as part of a nation's culture comprises of tradition, value, and spirit of the people of Indonesia. Indonesians use batik in their day-to-day activities and on special occasions. Similarly, batik is a national product used to support local entrepreneurs and to strengthen the economy since most of the batik entrepreneurs and batik artisan are Small Medium Enterprises (SME) (Alwiyah, 2017).

Batik Madura has been in existence since the reign of King Aria Wiraraja, a Madura king who had a close relationship with Raden Wijaya, the ruler of the Majapahit Kingdom, which was the biggest kingdom in Indonesia around 1290 (Alwiyah, 2017). Batik Madura was introduced between 1415-1460 at Keraton Sumenep. Afterwards, Tanjung Bumi, Bangkalan and Sampang, and Pamekasan regions of Indonesia also launched batik Madura in their respective regions. Batik is not just about fashion, it has great cultural values behind it. The people of Indonesia, wear batik to depict and preserve their culture. It is also believed to contain their national spirit. Batik on some occasions could be used as diplomatic tools in local and international forums. It also creates an impact on economic value and socio-cultural which is part of the nation's pride (Steelyana, 2012).

Batik Sumenep industry located in Pekandangan Madura is not growing significantly. There is a low level of knowledge with regards to production technique, finance, accounting, marketing, and promotion. Batik entrepreneurs still perform their businesses traditionally just as it was inherited from their ancestors (Sayyida & Zakki, 2014). Batik Madura is one of their national assets and their pride which should be worn by the locals in a bid to promote their heritage. SME should also develop their capacity to meet with the digital era, in other to survive and expand their businesses. They should also expand their market access and Information Technology.

In this digital and global era, the batik industry needs to enhance its competitive sector and human resource quality to meet the millennial age (Alwiyah, 2017). The focus should be on the digital era, and in Information Technology as these are fast-growing areas. Unfortunately, these areas have not been followed up. The ability and skill of the human resource in the batik industry; fast-growing global market (export-import trade) could also create a huge impact on the batik industry in Indonesia if properly looked into. Batik artisans and entrepreneurs should strive to stay in touch with the global competition. Similarly, entrepreneurs and artisans should adapt to the current marketing strategies such as the use of social media platforms, online shops and digital marketing techniques to promote and sell their goods and services. Several factors should also be taken into consideration by the local government in Madura to support the development of batik industry such as; the minimum standard wages for batik artisans, increased productivity, making the batik industry as part of tourism industry; making the batik industry as a Center for Research and Development to preserve and develop batik as cultural heritage in the modern era (Steelyana et al., 2017). Although Batik Madura has existed since the Majapahit era and it has high artistic value, in terms of quantity, batik entrepreneurs and craftsmen are performing poorly. This is shown in the data obtained from the

Department of Cooperative as well as the Department of Industry and Commerce of each district in Madura, which shows the number of entrepreneurs and craftsmen to be decreasing. For example, the data obtained from the Department of Cooperative showed the number of batik entrepreneurs in Sumenep to be 15 entrepreneurs while in actual fact, there were only 5 active batik entrepreneurs.

The objectives of this research were to analyze the perception of Batik Madura Entrepreneurs (BME) on several factors significant to the digital era, such as; accounting information system, for their financial report and the use of social media as a marketing strategy to expand the market access. This research work also analysed the factors that impact significantly on the sustainability of batik artisan, especially on Batik Madura industry. Some factors chosen to analyze the various effects associated with these inconsistencies are skill, family relationship, financial factor.

The methodology adopted in carrying out this research work was the quantitative method with descriptive statistic and Structural Equation Model (SEM) used to carry out the various hypotheses test. Researches were conducted from 1 April 2017 to 31 September 2017 by the use of questionnaires and interviewing of batik artisans and entrepreneurs. Literature research was also conducted to have a thorough understanding and knowledge of Batik Madura. The methodology section

would further explain the quantitative data analysis as well as the result obtained. The conclusion section will explain the various recommendations towards the survival of Batik Madura in the digital era.

### **Literature Review**

Culture is fundamental to human life. It is intended to make people adapt to a community as well as its surrounding environment (Samovar et al., 2010), Culture can also be defined as ethics, philosophy and the value of universal at the certain society of (Soehardi, 2002; Trujillo et al., 2018).

Batik has its philosophy and aesthetic value as well as national pride. On 2nd October 2009, the United Nations Educational, Scientific and Cultural Organization (UNESCO), recognized batik as one of the world cultural heritage products (UNESCO, 2009) Javanese, defines batik as an art product used in the palace and also as a cultural instrument that represents the natural beauty and Javanese philosophy. Batik is a reflection of social status and expectation from the user (Dwiyanto & Nugrahani, 2002). Batik can also be used, during celebrations or great events such as engagement, wedding, Sidomukti, Sidoluhur, and Sidomulyo (Djoemena, 1986). Batik Gunungan is used to represent elements in supernatural authority and power, which is believed to support the user aura (Fraser-Lu, 1986 ). Currently, the number of batik artisan leaving in Madura is declining. Entrepreneurs in the batik industry in Indonesia still need the support of the local banking sector, to increase and

expand their businesses. This can be seen by the huge number of batik entrepreneurs who seek loans from these local banks (Steelyana, 2013).

The Business Network International (BNI) has it that over 75% of SME business owners are ignored owing to the fact that the lack of social media presence. With over 270 million twitter users and 1.2 billion Facebook users, social media can be said to be one of the most powerful tools for business owners. However, many SMEs are still reluctant to build an online following presence (Business Matters, 2017).

Accounting information system is important for SME businesses. Research has it that the use of this system is important for the successful management of any business entity whether large or small (European Commission, 2008).

The changes that occurred in the business environment have led to an increasing number of unprocessed information. Thus the critical part is the quality of information produced by the business itself which will be used in making business decisions then a structured financial report which supported by accounting information system is a significant factor for providing reliable information (Mukherji, 2002).

Small and medium-sized enterprises (SMEs) are the backbone of the Asian economy. In every 96% of all Asian businesses, two out of three private-sector jobs in the region are made up of SMEs. Therefore, it is vitally important for the Asian economic to provide fully functioning support measures for SMEs. One of the



major challenges SMEs face is in accessing finances in banks. This is as a result of the asymmetric information problem between suppliers and demanders of funds, which hinders their growth (Yoshino & Taghizadeh-Hesary, 2017).

Financial Report which well structured will open access to bank credit is a structural problem in the Asia Finance SME Monitor region. SMEs have continued to influence trades. The latest data show that SMEs in the People's Republic of China (PRC) and India accounted for more than 40% of total export values, followed by 26% in Thailand, 19% in the Republic of Korea, and 16% in Indonesia. Bank loans to SMEs made up averages of 11.6% of GDP and 18.7% of total bank lending in the region, with a decreasing trend to the latter since the 2008/2009 global financial crisis. Most SMEs have no connection with capital markets. Financial institutions can closely and continuously observe borrowers, but it is costly to do so for borrowers of small loans.

Most SME firms in batik Madura industry are family businesses. The family provides a positive influence on strategic initiatives in business units under certain conditions. It influences business units and surpasses corporate centre. Family influence in Indonesian family business groups occurs not only due to the influence of certain power dynamics within the family (ownership and management) but also due to experience and leadership qualities where company management has passed through

more than two generations and the influence of family culture on company business management (Pendrian et al., 2018).

For Asian economies, especially for lower-income Asian countries, SMEs is the main sector of their economies. Asian economies also need to accumulate the SME data in a nationwide database for categorizing SMEs based on their creditworthiness. Those who are ranked higher get higher credits guaranteed by the government and at lower costs so that they can grow and expand their business. SMEs have a significant role in job creation and production. In addition, the risky type of SMEs should avoid borrowing money from banks, as they could lead to nonperforming loans. In order to promote SME startups and as well as risky SMEs, community-based lending such as hometown investment trust fund should be adopted (Yoshino & Taghizadeh-Hesary, 2017).

## **MATERIALS AND METHODS**

This research made use of the quantitative method with descriptive analysis and Structural Equation Model (SEM) in its hypothesis test analysis. In this research work, the batik entrepreneurs and batik artisans are used as a sample population using a convenience sampling method. Batik Entrepreneurs and Batik Artisan were visited to spread the questionnaires to participants, so they fill them in. At the first stage, data from 21 respondents of batik entrepreneurs and 40 batik artisans were collected and analyzed with descriptive

analysis. On another occasion, another data from 203 respondents are going through Structural Equation Method (SEM) analysis.

All respondents (batik entrepreneurs and batik artisan) were allocated in Tanjung Bumi (Bangkalan), Pamekasan and Pekandangan (Sumenep) and they were considered as Small Medium Enterprise (SME) entrepreneurs with assets size around 500 Million IDR (USD 49,000) and 65-100 employees including batik artisan. Most craftsmanship in Batik Madura were home industry owners, who still made use of natural colouring resources.

In another sample, 40 questionnaires were spread out to batik artisan (craftsmanship) between the ages of 35-54 years old. Detail of respondents can be seen in Table 1 as follows:

Definition of (a) financial factor: income that is earned (b) skill: craftsmanship ability to use batik (c) family relationship: the relationship between batik artisan and batik entrepreneurs (as extended family or close family relationship)

## RESULTS AND DISCUSSIONS

### The Result from Batik Entrepreneurs

**Small Medium Enterprise.** In this section, 3 (three) factors were analysed which are business sustainability, social media as a promotional tool, and accounting information system.

#### *Analysis of Business Sustainability (as seen in Table 2):*

1. Average Batik Entrepreneurs strongly agree that the business was inherited from previous generations.
2. Average Batik Entrepreneurs strongly agree that a good relationship with Batik Artisan creates a significant impact on business sustainability.
3. Average Batik Entrepreneurs, do not agree to the fact that it is difficult to locate a qualified batik artisan.
4. Average Batik Entrepreneurs have doubts about expanding their businesses outside Madura.
5. Average Batik Entrepreneurs strongly agree to inherit the business from the past generation

Table 1

*Respondents data*

Age (years old)	Total (persons)
15-24	4
25-34	4
35-44	14
45-54	15
55 and above	3
Total	40



Table 2  
*Business sustainability*

No.	Statements	Median	Modus
1	The Business (Batik Shop) is a heritage business	5	5
2	Relationship with Batik Artisan creates a significant impact to your business	5	5
3	The past 5 years, it has been difficult to find qualified batik artisan	1	1
4	Have Plan to expand the business outside Madura	3	2
5	The business will be passed to the next generation	5	5
6	One of the business objective is cultural preservation	5	5

***Analysis of Social Media as a Promotion tool (as seen in Table 3):***

- |  |  |
|--|--|
| <ol style="list-style-type: none"> <li>1. The average entrepreneur agrees that social media has a significant impact on product promotion.</li> <li>2. The average entrepreneur is starting to make use of social media in promoting their goods and services.</li> <li>3. On average, most entrepreneurs assume that their employee does</li> </ol> | <ol style="list-style-type: none"> <li>4. The average entrepreneurs still doubt that social media could raise the sales volume</li> <li>5. The average entrepreneurs agree that social media creates a beneficially impact and expands market access.</li> </ol> |
|--|--|

Table 3  
*Social media as a promotion tool*

No.	Statements	Median	Modus
1	Social media has significant role for product promotion	4	4
2	Using social media (Instagram, Facebook, Line, BBM) as part of promotion tools	3	4
3	Employees have sufficient knowledge in using social media for promotion tool	1	1
4	Promoting the product through social media will raise sales volume	3	3
5	Using social media in promoting a product will expand market access.	4	4

**Analysis of Accounting Information System Implementation (as seen in Table 4):**

1. An average number of entrepreneurs already used accounting information system in preparing financial statement but it is still in low numbers
2. Batik entrepreneurs still has doubt that accounting information system will benefit the business, raise effectiveness and enhance the business quality.

**The Result from Batik Artisans**

**Descriptive Batik Artisan.** The sustainability of batik artisan as a profession can be seen from the total value of the median shown in Table 5. Result obtained showed the average batik artisan was willing to pass their skill to their family and others. The skill of craftsmanship showed in Table 5, shows that the majority of batik artisan have enough good skill in their works. Family relationship, the result showed in Figure 1, shows that the majority of the batik artisan have a family relationship between

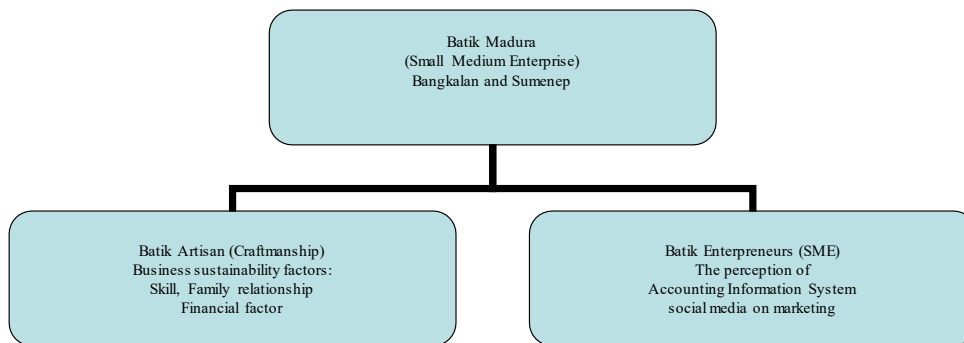

Figure 1. The framework of research

Table 5  
Statistics

Value Measurement		Sustainability of profession	Skill	Family relationship	Financial factor
N	Valid	40	40	40	40
	Missing	0	0	0	0
Mean		4.350	3.988	0.90	1.00
Median		4.500	4.000	1.00	1.00
Mode		4.5	4.0 <sup>a</sup>	1	1

Notes: <sup>a</sup> Multiple modes exist. The smallest value is shown.

the artisan and the entrepreneurs, as well as between the artisan themselves. Financial factor, the survey result showed that the modus of the factor is 1, it means that the significant factor to keep batik artisan to stay in the profession is the financial factor.

**Frequency Table**

As seen in Table 6, the sustainability of batik artisan as a profession was being measured by number 1 to 5, the result is better if it is closer to number 5. The result above showed 85% cumulatively, it means 85% of the batik artisan contribute to support the sustainability of their profession.

Table 6  
*Sustainability of Batik Artisan profession*

Sustainability Measurement	Frequency	Percent	Valid percent	Cumulative percent
Valid 2.5	1	2.5	2.5	2.5
3.0	2	5.0	5.0	7.5
3.5	3	7.5	7.5	15.0
4.0	7	17.5	17.5	32.5
4.5	16	40.0	40.0	72.5
5.0	11	27.5	27.5	100.0
Total	40	100.0	100.0	

Table 7  
*Skill*

Skill Measurement	Frequency	Percent	Valid percent	Cumulative percent
Valid 2.5	2	5.0	5.0	5.0
3.0	2	5.0	5.0	10.0
3.5	6	15.0	15.0	25.0
4.0	15	37.5	37.5	62.5
4.5	15	37.5	37.5	100.0
Total	40	100.0	100.0	

Table 8

*Family relationship*

Relationship Measurement		Frequency	Percent	Valid percent	Cumulative percent
Valid	0	4	10.0	10.0	10.0
	1	36	90.0	90.0	100.0
Total		40	100.0	100.0	

As seen in Table 7, the skill factor shows 75% as a result. This means that batik artisans are skilled in their works.

As seen in Table 8, family relationship results showed that 90% of respondents have a family relationship, it is between the batik artisans as well as between batik artisan and batik entrepreneurs.

As seen in Table 9, financial factor is the ultimate factor for respondents to continue their works, since the result showed 100%.

### Analysis Structural Equation Model (SEM)

In the next step, this research explored the factors that affected the sustainability of batik artisan profession. Besides the financial factors that already showed 100%, this paper used Structural Equation Model (SEM) to analyse the other 3 factors which are skill, family relation, and sustainability as a latent variable. 203 respondents filled the questionnaire which was later calculated with AMOS software.

### Result for Batik Artisan

On the first step, this research used the Measurement Model Test to check normality, validity and reliability test.

**Normality Test.** Data is considered as normally distributed if multivariate CR (Critical Ratio) Skewness value or curtsies are between -1.96 up to 1.96 (as per table  $Z_{0,05}$  (Chahal et al., 2016). This research obtained multivariate CR value to be -0.489 which means that data is normally distributed.

**Validity Construct Test.** Confirmatory Factor Analysis (CFA) test aims to test validity and reliability as variable indicators in measuring variable latent. Validity value describes by Value of Standardised Regression Weights (SRW) more than 0.5 and CR value more than 1,96 or probability less than 0.05 (Chahal et al., 2016 ). Result of the test, shows all indicators are valid.

**Reliability Test.** Reliability is the consistency value from the indicators and

Table 9

*Financial factor*

Financial Factor Measurement		Frequency	Percent	Valid percent	Cumulative percent
Valid	1	40	100.0	100.0	100.0

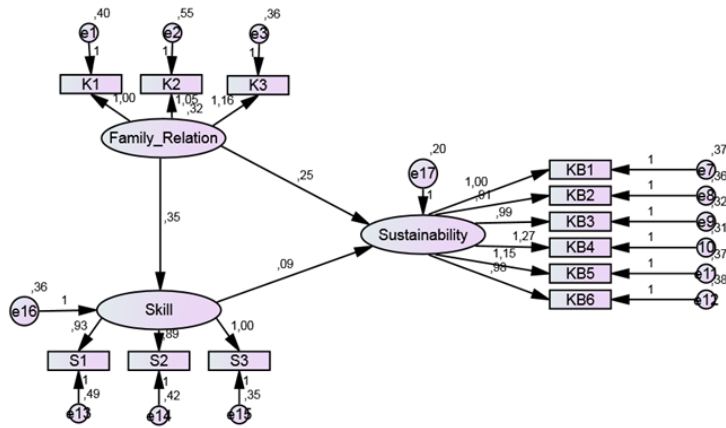

Figure 2. Goodness of Fit Structural Model (Result of SEM Test and AMOS)

it is shown if AVE (Average Variance Extracted) > 0,6 (Nunnally, 1978) using the formula below:

$$AVE = \frac{\sum \lambda^2}{\sum \lambda^2 + (1 - \lambda^2)}$$

All the values of AVE value of Variable Laten are > 0.6, it, therefore, means that all variables are reliable.

**Structural Model Test.** The Goodness of fit value is used to see the model feasibility from several calculation as per the above table (Awang, 2014). Figure 2 describes the model to be already fit and feasible. The next Parameter Estimation is some hypotheses shown below:

H1: Family relationship has an influence on skill

H2: Family relationship has an influence on sustainability

H3: Skill has an influence on sustainability

The relation between variables could be seen from data in Table 10, it shows that the influence of family relation to skill is significant with estimation parameter value = 0.352. Therefore, H1 is accepted. P-value shows that the influence of family relation factor to the sustainability factor is significant with parameter estimation value of 0.251. Therefore, H2 is accepted. On the other hand, P-value shows the

Table 10

Relation between variables

Variable relations	Estimate	P-value	Label
Skill <--- Family_Relation	0.352	0.002	Significant
Sustainability <--- Family_Relation	0.251	0.005	Significant
Sustainability <--- Skill	0.092	0.216	Not significant

Table 11

*Direct, indirect, and total effect*

	Direct effects	Indirect effects	Total effects
Family relation ==> Sustainability	0.293	0.038	0.331
Family relation ==> Skill	0.314	-	0.314

influence of skill factor to sustainability factor is not significant since the estimation value, P-value = 0.216, therefore, H3 is not accepted. Family relation factor significant to influence sustainability factor and skill but skill does not influence sustainability.

From Table 11, family relation has an influence on sustainability with value 0.331, and direct influence value of 0.293. It also has an indirect influence on Skill as 0.038. Meanwhile, family relation has an influence on skill with the value of 0.314. The summary on Descriptive Statistic from the result obtained discusses the following perspectives:

**Business Sustainability.** Most of the batik entrepreneurs strongly agree that their business in the batik industry is a heritage from the previous generation and will also pass down the business to their next generation. They are being supported by qualified batik artisans to produce a good quality of batik and they agree that based on a good relationship with batik artisans, they could maintain their business. Similarly, these entrepreneurs still have doubts about expanding their business outside Madura.

**Social Media as Promotion Tools.** Most of the batik entrepreneurs agree that social

media has a significant impact on product promotion and they are starting to use social media to promote their product, but they assume that their employees still do not have sufficient knowledge in social media usage. Similarly, batik entrepreneurs agree that social media could beneficially impact and expand their market access but still doubt that it could raise their sales volume.

**Accounting Information System Implementation.** The average batik entrepreneur already used accounting information system in preparing their financial statement though the number of people that make use of this technique is still pretty low, as they still have doubt that Accounting Information System will benefit the business, raise effectiveness and enhance the business quality. Descriptive Statistics based on the result obtained above from Batik Artisan are discussed below:

**Sustaining the Batik Artisan Profession.** On the average batik, artisan are willing to pass their skill to their family and others.

**The skill of Craftmanship.** Majority of batik artisans have adequate skill to produce high quality of batik.

**Family Relationship.** A good number of batik artisans have a good relationship with fellow artisans and entrepreneurs.

**Financial Factor.** Batik artisans stay in the profession owing to financial reasons. They need to earn the income as batik artisan and this factor is the strongest factor that influences the profession's sustainability.

Based on SEM Analysis, the family relationship has a significant influence on skill and profession sustainability. Furthermore, skill does not have a significant influence on professions sustainability. The young generation who are already skilled in the art of batik craftsmanship, do not seem interested in becoming batik artisans, since these workers tend to earn low-income wages, compared to the regions minimum wage standard. Therefore the batik artisan as a profession cannot promise a bright future. Low labour wage is as a result of the low price tag associated with the sale of batik in Madura. This, however, is as a result of the fact that there is no institution guiding batik entrepreneurs.

## CONCLUSIONS

Based on the objective of this study, which analysed the perception of Batik Madura entrepreneurs on several factors which are business sustainability, accounting information system and social media for their marketing strategy to expand the market access, it can be concluded that batik as a hereditary business should expand and develop its human resources through learning and development and through

enhancing skills. The positive perception of the use of social media tools to expand the market access and raise sales volume should be used as an SM marketing strategy. The benefits for using social media as part of marketing tools include: (1) increased traffic (2) builds branding (3) online presence (4) building trust and personality (5) time and cost-efficient (Business Matters, 2017).

Based on the analysis, it can be concluded that batik entrepreneurs have a positive perception on the accounting information system. They believe that it will develop the financial report to be more structured and enhance the quality of the financial report. However, they still feel reluctant to use it. Based on the previous section data and result obtained, Batik SME in Madura should start having structured financial and accounting system, for accessing the relationship with banks. This will create an opportunity to get a lower Cost of Capital and could expand and growth of their business.

In Asia, start-up companies, in particular, are finding it increasingly difficult to borrow money from banks because of strict Basel capital requirements. Risky SMEs also face difficulty in borrowing money from banks. It is difficult for banks to evaluate SMEs since they often do not have structured accounting systems. Many SMEs in Asia borrow money by paying high-interest rates or offering costly collateral. Many banks prefer to lend to large enterprises rather than SMEs. The reason for this is that for large enterprises the financial statements are clearer and audited (Yoshino & Taghizadeh-Hesary, 2017).

Several factors are responsible for the sustainability of the batik profession such as family relationship, finance, skill and lots more. Most batik artisans are willing to transfer their knowledge to the next generation whether there is any form of family relationship or not. However, one of the strongest factors keep them in the profession is that of finance as they are able to earn contribute to their family welfare. This, therefore, means that batik artisans profession in Madura will be sustained based on local wisdom, good family relationship, and business based on the family system.

Financial Factor also become one of the significant factors why Batik Artisans stay their profession since more than 50% of the total population of the Indonesian population is junior high school graduated (Biro Pusat Statistik, 2015). To this set of people, getting a job that pays well is difficult. Since that already possess a skill which was passed down to them from their forefathers, they make use of it to survive. Another point that should be put into consideration is the fact that most times the wage paid to these artisans is pretty poor compared to the value of the artwork.

Batik Madura as part of the creative economy and cultural heritage, needs to be more flexible in making rules with regards to art and business. We are currently in the digital era where changes happen rapidly. information technology and accounting information system are tools for business expansion and sustainability. Using these tools will, in the end, raise local community welfare and still maintain traditional values

and preserve the batik culture as a national asset. The research limitation associated with this research work is that of limited materials used. Owing to the fact that there was little or no previous research work done on this topic. This research also recommends that an institution should be created which oversees and support batik entrepreneurs in enhancing their business, and in determining the selling price. Also, digital marketing needs to be encouraged and there should be public education or workshop on it. This will increase the number of goods sold daily and expand the market.

## ACKNOWLEDGEMENT

The authors wish to acknowledge and thank all IMHA 2018 committee members and UPM *Pertanika* journal team that help publish this article.

## REFERENCES

- Alwiyah. (2017). *Batik Madura: Sejarah jati diri dan motif* [Batik Madura: History of identity and motives]. Madura, Indonesia: Universitas Wiraraja Sumenep.
- Awang, Z. (2014). *A handbook on SEM for academicians and practitioners*. Bandar Baru Bangi, Selangor: MPWS Rich Resources.
- Business Matters. (2017). *Why social media marketing is important for an SME*. Retrieved March 15, 2018, from <http://www.bmmagazine.co.uk/marketing/social-media/social-media-marketing-important-sme/>
- Biro Pusat Statistik. (2015). *Statistik Sektor* [Sectoral Statistics]. Retrieved November 22, 2017, from <https://www.bps.go.id/subject/28/pendidikan.html#subjekViewTab4>



- Chahal, H., Dangwal, R. C., & Raina, S. (2016). Marketing orientation, strategic orientation and their synergistic impact on business performance: A case of SMEs in emerging context (India). *Journal of Research in Marketing and Entrepreneurship*, 18(1), 27-52.
- Djoemena, N. S. (1986). *Ungkapan sehelai batik: Its mistery and meaning*. Jakarta, Indonesia: Djambatan.
- Dwiyanto, D., & Nugrahani, D. S. (2002). Perubahan konsep gender dalam seni batik tradisional, pedalaman dan pesisiran [Transformation of gender concept in traditional batik art, inland and coastal area]. *Humaniora*, 14(2), 152-153.
- European Commission. (2008). *Final report of the expert group: Accounting system for small enterprises - Recommendations and good practices*. Retrieved April 25, 2017, from [https://ec.europa.eu/growth/smes\\_en](https://ec.europa.eu/growth/smes_en)
- Fraser-Lu, S. (1986). *Indonesian batik: Processes, patterns and places*. Singapore: Oxford University Press.
- Mukherji, A. (2002). The evolution of information systems: Their impact on organizations and structures. *Management Decision*, 40(5), 497-507.
- Nunnally, J. C. (1978). *Psychometric theory*. New York, USA: McGraw-Hill.
- Pendrian, O., Karnen, K. A., Rachmawati, R., & Kusumastuti, R. D. (2018). Entrepreneurial orientation and strategic initiatives in family business groups: The role of corporate centres and family influence. *Pertanika Journal of Social Sciences and Humanities*, 26(S), 167-184.
- Ramelan, T. (2010). *The 20th-century batik masterpiece*. Jakarta, Indonesia: KR Communication.
- Samovar, L. A., Porter, R. E., & McDaniel, E. R. (2010). *Communication between cultures*. Boston, USA: Wadsworth, Cengage Learning.
- Sayyida, & Zakki, N. (2014). Kebanggaan terhadap Batik Madura bagi warga Sumenep [Pride in Batik Madura of Sumenep residents]. *Jurnal Performance "Bisnis dan Akuntansi"*, 4(2), 45-56.
- Soehardi, S. (2002). Nilai-nilai tradisi lisan dalam budaya jawa [Values of verbal traditions in Javanese culture]. *Humaniora*, 14(3), 11-12.
- Steelyana, E. (2012). Batik, a beautiful cultural heritage that preserve culture and support economic development in Indonesia. *Binus Business Review*, 3(1), 116-130.
- Steelyana, E. (2013). Perempuan dan perbankan sebuah tinjauan tentang inklusi keuangan terhadap pengusaha UMKM perempuan di Indonesia [Woman and banking: A review of the role of financial inclusion on woman SME entrepreneurs in Indonesia]. *Economics, Business and Information System Journals*, 14(2), 1412-1212.
- Steelyana, E., Alwiyah, & Cahyadi, Y. (2017). The Influence of Culture and Behavior on Business Strategy, A Case Study in Batik Madura Industry. *International Journal of Applied Business Economics Research*, 15(24), 709-712.
- Trujillo, M. S., Alvarez, V. V., Morales, L. C., Ayala, E., & Manosalvas, T. S. (2018). The tattoo as ancestral legacy and dichotomic element of national identity. *International Journal of Organizational Business Excellence*, 1(2), 129-138.
- United Nations Educational, Scientific and Cultural Organization. (2009). *Indonesian Batik*. Retrieved August 19, 2017, from <https://ich.unesco.org/en/RL/indonesian-batik-00170>
- Yoshino, N., & Taghizadeh-Hesary, F. (2017). *Solutions for mitigating SMEs' difficulties in accessing finance: Asian experiences*. ADBI (Working Paper No. 768). Tokyo, Japan: Asian Development Bank Institute.



## **Analysis of Factors Affecting the Consumer Behavior of Indonesian Banking Industry**

**Rahmat Siauwijaya\* and Evi Steelyana**

*Department of Accounting, Faculty of Economics and Communication,  
Bina Nusantara University, Jakarta Barat 11480, Indonesia*

### **ABSTRACT**

This research was aimed at analyzing the factors that influence consumers' behaviour with regards to banking in Indonesia. This research work made use of panel data gotten from 31 banks listed in the Indonesian Stock Exchange for the period of 2007 - 2017. The analysis technique used was the fixed effect model. The result obtained showed that the variables of BI-Rate, exchange rate and inflation influenced the consumer behaviour variables (credit interest rate and deposit interest rate). Variables such as gross domestic products and liquidity significantly affect the deposit interest rate and the credit interest rate. The deposit value is significantly affected by the deposit interest rate, exchange rate and the gross domestic product while the credit outstanding value is significantly affected by the credit interest rate, liquidity and all macro and monetary economic variables in the models.

*Keywords:* Consumer behaviour, liquidity, macroeconomics, monetary policy

### ARTICLE INFO

*Article history:*

Received: 9 October 2019

Accepted: 3 January 2020

Published: 17 March 2020

*E-mail addresses:*

rahmat.siauwijaya@binus.ac.id (Rahmat Siauwijaya)

evi.wiyarto@gmail.com (Evi Steelyana)

\*Corresponding author

### **INTRODUCTION**

Banks need customers who either deposit their money or collect loans from the banks. Practically, customers behave differently and have their preferences when it comes to owing a deposit interest rate or a credit interest rate (Ruangkanjanases & Wongprasopchai, 2018). The volume of the credit and deposit rates are influenced by both internal and external factors of the banks. Customer behaviour can be represented by the demand of the deposit

interest rates and the credit interest rates as well as the outstanding deposit and credit interest rates. Regardless of the external factors, it is also influenced by the change in monetary policy and macroeconomic variables. Dynamic change in the monetary and macroeconomic policies causes a change in consumer behaviour. As a result, researches relating to customer behaviour are feasible. For instance, determination of the BI-Rate by the Bank of Indonesia will influence the determination of the interest rates by banks frequently used by the customers. Kashyap and Stein (2000), Haryati (2009), Levy-Yeyati et al. (2010), Bassett et al. (2014), Chang and Li (2015) arrived at the conclusion that macroeconomic and monetary factors could affect consumer behaviour.

Customer's preferences are highly dependent on risks that are obtainable. Perceived risk can be reflected in the various macroeconomic conditions that occur. Levy et al. (2010) discovered a relationship between consumer behaviour and macroeconomic variables. Jimborean and Mesonnier (2010) examined the impact of gross domestic product, inflation, monetary policy and the company's financial condition on the credit disbursed. It was therefore concluded that macroeconomic and monetary variables have a great influence on the credit disbursed. The impact of macroeconomy on consumer behaviour can be explained as the predicted macroeconomic conditions that decrease the asset value of a deposit. Usually, under such condition, customers will demand a high-interest rate

in order to protect the value of their money deposited in the bank. Conversely, if the economy is predicted to be better, there would be an increase in the demand for credit as a result of the increasing demand for money.

The monetary economic variables affect banking because of the determination of the BI-Rate issued by The Bank of Indonesia. Kashyap and Stein (2000) discovered that the monetary policy would affect the credit and deposit rates in banks. This indicates that the monetary policy can also affect customers' preferences to save their money in banks both directly or indirectly. When the central bank sets the interest rate, banks will consequently respond through the deposit and credit interest rates.

According to Solomon and Rabolt (2004), there are several criteria for customers to choose products. They are knowing the problem, seeking information, evaluating the product selected, selecting a product, and the production outcome. These criteria, help customers to choose products. According to Berger (1991), the interest rate is an indicator of the capital cost or return, which is risk customers have to face. If the bank is faced with the issue of high risk, then customers will tend to ask for a higher deposit interest rate. If the rate given is not suitable, customers will transfer their funds to banks that can provide the expected return. The actual interest rate on the deposit and credit rates indicates how customers make their choice and the bargaining process by the customers and banks regardless of the return and cost capital. The interest rate

accepted by the customers actually depicts the final selection process by the customers to the selected banks. The amount of money saved as deposit or credit received shows how the customers respond to the various bank policies related to their products.

This research work is important for policymaking in the banking sector. In addition, this research also provides a clearer picture of the relationship that assist in policymaking especially when it is related to consumer behaviour. Partial and comprehensive models were compared in order to depict the consistency of the relationship between these variables. The alternative model offered in this research work would assist in stabilizing banking operation that will guarantee the nation's economic wellbeing as well as prevent the reoccurrence of banking crises.

## LITERATURE REVIEW

**The Influence of Monetary Policy, Macroeconomic, Liquidity on Deposit Interest Rate.** Bansal and Coleman (1996) stated that there was a negative correlation between inflation and the real interest rate. An increase in the nominal interest rate had to catch up to the increase in inflation. This implies that there is a negative relationship between the inflation rate and the real interest rate. According to Gordon (2011), a high exchange rate (depreciation) causes a huge export value thereby leading to an increase in foreign exchange. The increase in foreign exchange is responded to by a stable or decreasing deposit interest rate by the bank. This is because there's enough

foreign currency in the Bank of Indonesia. Bassett et al. (2014) stated that an increase in the gross domestic product indicated that there was an increase in the economic performance thereby causing the banks to provide a static or lower deposit interest rate due to the decreasing economic risks.

**The Influence of Monetary Policy, Macroeconomic, Credit Interest Rate Liquidity.** Increase in the BI rate drives greater funding cost as a result of the strict monetary policy by the Bank of Indonesia. Chang and Li (2018) showed that the monetary policy could affect the bank's interest rates. Inflation, exchange rate, gross domestic product, and liquidity negatively affect the credit interest rate. Theoretically, an increase in inflation will be responded to by the government, with an increase in the nominal interest rate. Nevertheless, Caglayan and Xu (2016) argued that inflation volatility would make bank managers behave more conservatively in issuing out loans. In contrast, when inflation volatility is low, bank managers would have to lend more idiosyncratically. In other words, there's a little increase in the nominal interest compared to that of inflation. Increase in inflation leads to a decrease in the interest rate.

Gordon (2011) stated that high exchange rate (depreciation) caused high export value thereby leading to an increase in foreign exchange due to exports on one side. Nevertheless, in Indonesia, this can lead to high inflation rates which cause a high nominal interest rate. In several cases, the

Bank of Indonesia has reported that the real interest rates decreased due to an increase in inflation that is greater than the increase in the nominal interest rate. According to Bassett et al. (2014), an increase in gross domestic product depicts an increase in the economic performance and this persuades banks to give lower interest rates due to the decrease in economic risks. The higher level of liquidity lowers the credit interest rates making it possible for the customers to absorb the banking fund.

**The Influence of Monetary Policy, Macroeconomic, Deposit Interest Rate, and Liquidity to Deposit Value.** Kraft and Galac (2004) argued that an increase in the deposit interest rate could cause an increase in the customer deposit value stored in the bank. This is because it yields more. High exchange rates prompt customers to deposit their money in banks (Gordon, 2011). This is due to increased export values. More foreign exchange is being deposited in rupiah in Indonesia. According to Taylor's regulations, high inflation leads to high economic performance and this leads to an increase in national gross domestic product. A monetary policy such as a rising BI-Rate would increase the deposit interest rate and that would turn to increase the deposit value. Chang and Li (2018) concluded that the higher the fraction kept as reserves, the less liquefied the money was. Unexpected money injections raise output and lower nominal interest rates if and only if the newly injected money is more liquefied than the initial money stocks. If banks hold

no liquidity buffers, liquidity effects are eliminated.

**The Influence of Monetary Policy, Macroeconomic, Credit Interest Rate, and Liquidity To Credit Outstanding.**

According to previous researches, credit interest rates, BI rate, and inflation negatively affect outstanding credit. Bassett et al. (2014) discovered that, credit interest rate showed the cost of obtaining funds from the society and that the higher the credit interest rate, the higher the cost of obtaining these funds thereby leading to a decrease in the demand for credit. Furthermore, gross domestic product, exchange rate and liquidity positively affect the outstanding credit. Bassett et al. (2014) also discovered that the gross domestic product negatively affected the credit interest rate and that the cost of the fund became cheaper leading to an increase in the demand for credit. According to Gordon (2011), a depreciated exchange rate causes a high export value which in turn raises the economy and the demand for credit by customers. A study by Haryati (2009) found that macroeconomic liquidity and loan growth significantly affected credit growth. Furthermore, this research would test the paradigm that has been briefly drawn in Figure 1.

Figure 1 shows the monetary policy of the Bank of Indonesia using the BI-Rate, alongside the macroeconomic variables which are the gross domestic product, exchange rate, and inflation and how they affect consumer behaviour. A research model was made by combining several partial models and research variables that

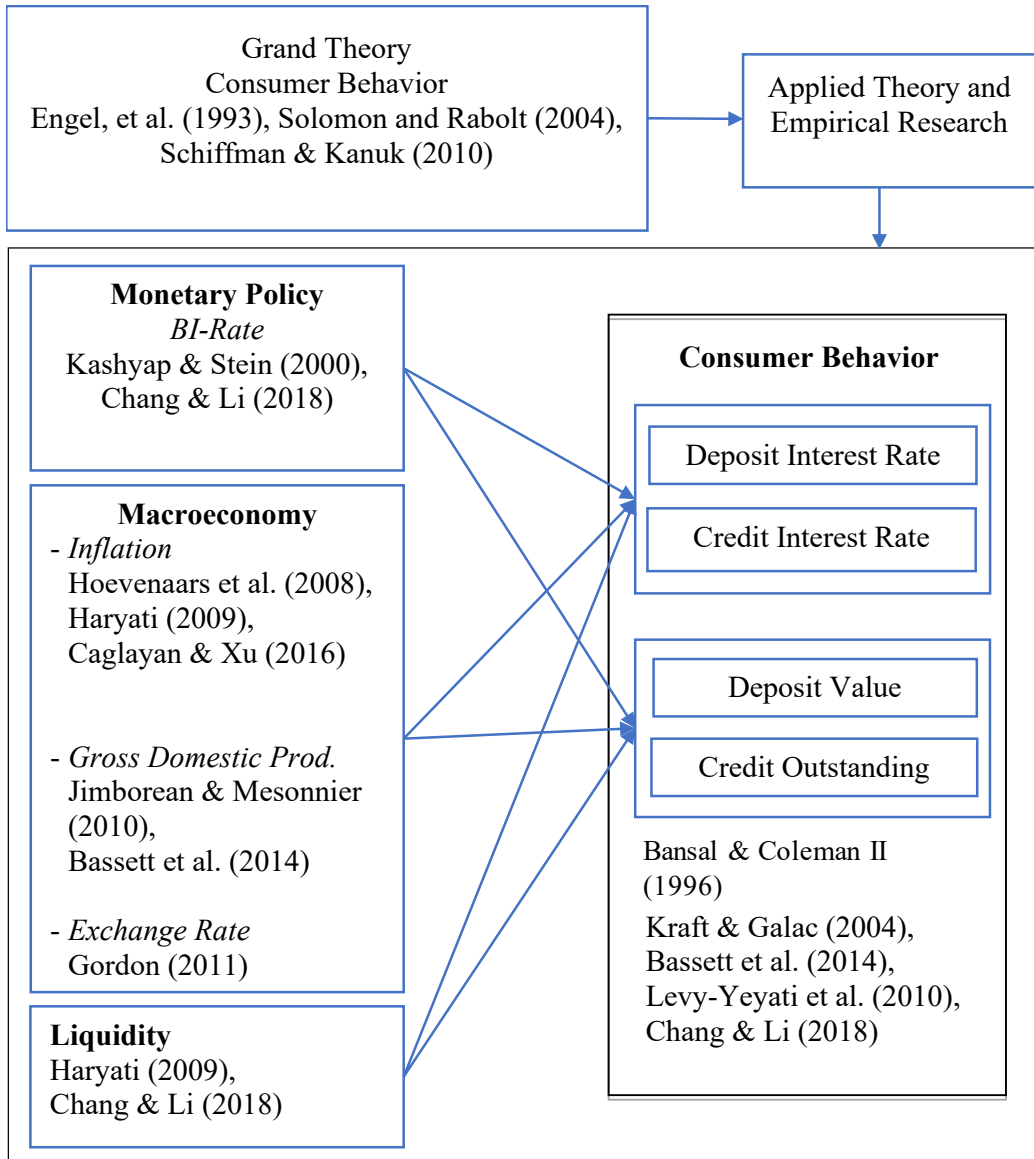

Figure 1. Thought flow framework

are relevant from Keeton (1993), Kashyap and Stein (2000), Haryati (2009), and Levy-Leyati et al. (2010), as follows:

*Credit and Deposit Interest Rate Model*

$$Rdep = f_1 (RBI, Infl, GDP, ER, Liq)$$

$$(1)$$

(+) (-) (-) (-) (+)

$$Rcredit = f_2 (RBI, Infl, ER, PDB, Liq)$$

$$(2)$$

(+) (-) (-) (-) (-)

*Credit and Deposit Value Model*

$$Deposit = f_3 (Rdep, RBI, Infl, GDP, ER,$$

$$Liq)$$

(3)

$$\begin{array}{cccccc}
 (+) & (+) & (+) & (+) & (+) & (+) \\
 \text{Credit} = f_4(\text{Rkredit}, \text{RBI}, \text{Infl}, \text{PDB}, \text{ER}, \\
 \text{Liq}) & & & & & (4) \\
 & & (-) & (-) & (-) & (+) \\
 (+) & (+) & & & & 
 \end{array}$$

Where:

- Dep = the amount/value of deposit,
- Credit = customer’s credit outstanding,
- Rdep = customer’s deposit interest rate,
- Rcredit = customer’s credit interest rate,
- Liq = liquidity,
- Infl = inflation,
- ER = exchange rate,
- GDP = gross domestic product,
- RBI = BI-Rate.

Looking at the research model above, one would see that this research is different from the previous research works in at least in two ways. Firstly, this research model was thoroughly made. This model was made to show the influence of the macroeconomic, monetary policy and liquidity on the consumer behaviour and it also showed the influence of the deposit interest rate on the deposit value and that of the credit interest rate to the credit outstanding. Both variables were focused on consumer behaviour factors and external factors such as macroeconomic and monetary policy asides from other internal bank variables.

## MATERIALS AND METHODS

### The Research Model Used

The methods used in this research work were descriptive and explanative. The model selection used was a hypothesis-generating study in which the end model was the

model that had been through a selection process from the model estimation result. The descriptive method in this research was done in order to describe the data condition of its normality and validity. The explanative method was performed in order to depict the causal relationship between the variables. The arrows were used to show the relationship between variables and also generate sensitivity between the variables.

### Data and Research Model

This research work used the inflation variable, exchange rate, gross domestic product, BI-Rate, deposit value, credit outstanding, and liquidity data. An Econometric Model was used to answer research objectives. Based on model 2.1 the econometric model is made as follows:

$$\text{Rcredit}_{it} = \theta_{1i} + \beta_{11}\text{RBI}_t + \beta_{12}\text{Infl}_t + \beta_{13}\text{GDP}_t + \beta_{14}\text{ER}_t + \beta_{15}\text{Liq}_{it} + e_{1it} \quad (1)$$

$$\text{RDEP}_{it} = \theta_{2i} + \beta_{21}\text{RBI}_t + \beta_{22}\text{Infl}_t + \beta_{23}\text{GDP}_t + \beta_{24}\text{ER}_t + \beta_{25}\text{Liq}_{it} + e_{2it} \quad (2)$$

$$\text{Dep}_{it} = \theta_{3i} + \beta_{31}\text{RDEP}_t + \beta_{32}\text{RBI}_t + \beta_{33}\text{Infl}_t + \beta_{34}\text{GDP}_t + \beta_{35}\text{ER}_t + \beta_{36}\text{Liq}_{it} + e_{3it} \quad (3)$$

$$\text{Credit}_{it} = \theta_{4i} + \beta_{41}\text{Rcredit}_t + \beta_{42}\text{RBI}_t + \beta_{43}\text{Infl}_t + \beta_{44}\text{GDP}_t + \beta_{45}\text{ER}_t + \beta_{46}\text{Liq}_{it} + e_{4it} \quad (4)$$

Where:

- Dep=the amount/value of deposit,
- Credit=customer’s credit outstanding,
- Rdep=customer’s deposit interest rate,
- Rcredit=customer’s credit interest rate,
- Liq=liquidity, Infl=inflation, ER=exchange rate, GDP=gross domestic product, RBI=BI-Rate.



Panel data model with either fixed or random effect model using selection with the Hausman test was used for this research work. Furthermore, equations 1-4 needs a recursive model if there is a significant endogeneity testing result as in Gujarati (2003).

**RESULTS AND DISCUSSIONS**

The Influence of Inflation, Exchange Rate, Gross Domestic Product, BI-Rate, and Liquidity Variables on Credit Interest Rate

Based on the results from Table 1 and Table 2, it can be concluded that BI-Rate positively affects the credit interest rate. This result is in accordance with the previous research conducted by Keeton (1993) which had in conclusion that monetary policy such as a decreasing BI-Rate will cause a decrease in the credit interest rate.

Furthermore, banks have a lower money supply when BI-Rate increases because more money is deposited in the Indonesia bank certificates.

Inflation negatively affects the real credit interest rate. It is a known fact that when inflation rises, the nominal credit interest rate will naturally increase as the BI-Rate increases, but in real terms, it seems that the credit interest rate could decrease because the real interest rate is the nominal interest rate reduced by inflation. This result is in accordance with the research done by Caglayan and Xu (2016), inflation volatility would make bank managers be more conservative in issuing out loans because banks in Indonesia do not anticipate inflation. Difficulties in banking are associated with the ongoing banking problems where the real credit interest

Table 1

*Regression estimation of influence of inflation, exchange rate, GDP, BI-Rate, and liquidity on credit interest rate*

Dependent variable: Credit interest rate	Coefficient	Std. error	Significance probability
Constant	16.7107	1.6094	***
RBI-Rate	0.3919	0.0641	***
Inflation	-0.5547	0.0541	***
GDP	-0.0001	6.28.10 <sup>-5</sup>	**
Exchange Rate	-0.0004	0.0001	***
Liquidity	-0.0775	0.1137	NS
R-squared	0.839		
Adjusted R-squared	0.811		
F-statistic	29.310		
Prob(F-statistic)	***		

Source: Data processing.

Notes: \*Significance to  $\alpha=10\%$  , \*\* Significance to  $\alpha=5\%$ ,\*\*\* Significance to  $\alpha=1\%$ , NS = Not significant

Table 2

*T-Statistic testing result*

Independent variable	t-stat	Hypothesis $H_0$	Conclusion
BI Rate	6.119	$H_0$ rejected	Significance to $\alpha = 1\%$
Inflation	-10.254	$H_0$ rejected	Significance to $\alpha = 1\%$
GDP	-2.117	$H_0$ rejected	Significance to $\alpha = 5\%$
Exchange rate	-3.706	$H_0$ rejected	Significance to $\alpha = 1\%$
Liquidity	-0.682	$H_0$ not rejected	Not significance to $\alpha = 10\%$

Source: Data processing

rate will relatively decrease as inflation increases. Furthermore, this research is in accordance with Taylor's concept which states that without a significant monetary policy, the inflation rate will keep causing a decrease in the interest rate which then raises the output and inflation continuously.

Gross domestic product negatively affects the credit interest rate. This is in accordance with the research by Baset et al. (2012) which stated that an increase in the gross domestic product would have a negative effect even if it's insignificant. An increase in a gross domestic product is usually characterized by an increase in the economic performance and this makes the bank interested in giving a lower credit interest rate with lower economic risks.

The exchange rate negatively affects the credit interest rate. In the standard exchange rate theory (Gordon, 2011), a high exchange rate causes a high export value, leading to an increase in foreign exchange. On the other hand, in Indonesia, the raw material used for production mainly comes from imported goods. Furthermore, the high exchange rate leads to an increase in the production costs thereby causing an increase in prices.

If the impact of inflation triggered by this, is higher than the increase in nominal rate there would be a decrease in the real interest rate.

Liquidity does not affect the credit interest rate. In this case, it is assumed that the determination of the credit interest rate by banks is not based on liquidity but on factors such as monetary policy and monetary economics.

### **The Influence of Inflation, Exchange Rate, Gross Domestic Product, BI-Rate, and Liquidity Variables on the Deposit Interest Rate**

Based on the results from Table 3 and Table 4, it can be concluded that the BI-Rate affected the deposit interest rate positively. This result is consistent with the Chang and Li (2018) study, which stated that the deposit interest rates reacted positively to changes in the monetary policy.

Inflation affected the real deposit interest rate negatively. There was a significant decrease in the real deposit interest rate as inflation increased. according to the explanation of the credit interest rate, when there's an increase in inflation, there would

Table 3

*Regression estimation of the influence of inflation, exchange rate, gross domestic product, BI-Rate, and liquidity variables on deposit interest rate*

Dependent variable: Deposit interest rate	Coefficient	Std. error	Significance probability
Constant	6.9088	1.7188	***
RBI-Rate	0.3921	0.0701	***
Inflation	-0.4189	0.0586	***
RGDP	-2.33*10 <sup>-5</sup>	6.67*10 <sup>-5</sup>	NS
Exchange Rate	-0.0003	0.0001	***
Liquidity	0.2307	0.0967	**
R-squared	0.719		
Adjusted R-squared	0.669		
F-statistic	14.324		
Prob(F-statistic)	***		

Source: Data processing

Notes: \*Significance to  $\alpha=10\%$ , \*\* Significance to  $\alpha=5\%$ ,\*\*\* Significance to  $\alpha=1\%$ , NS = Not significant

Table 4

*Test Result t-statistics*

Independent variable	t-stat	Hypothesis H <sub>0</sub>	Conclusion
BI Rate	5.5958	H <sub>0</sub> rejected	Significance to $\alpha = 1\%$
Inflation	-7.1492	H <sub>0</sub> rejected	Significance to $\alpha = 1\%$
GDP	-0.3495	H <sub>0</sub> not rejected	Not Significant
Exchange rate	-2.7649	H <sub>0</sub> rejected	Significance to $\alpha = 1\%$
Liquidity	2.3856	H <sub>0</sub> rejected	Significance to $\alpha = 5\%$

Source: Data processing

Notes: \*Significance to  $\alpha=10\%$ , \*\* Significance to  $\alpha=5\%$ ,\*\*\* Significance to  $\alpha=1\%$ , NS = Not significant

be a rise in the nominal of the deposit interest rate as the BI-Rate increase. But in real terms, the interest rate of the deposit may decrease as the real interest rate was the nominal interest rate reduced by inflation. This result is in accordance with Bansal and Coleman (1996) research, which found a negative influence of inflation on

the real interest rates where the increase of nominal interest rate could not catch up with inflation.

The gross domestic product had no significant effect on the deposit interest rates because it was thought that the deposit interest rates were more affected by the monetary policy such as the BI-Rate.

The increase in gross domestic product showed better economic performance, thus attracting more banks to distribute loans by reducing lending rates rather than increasing deposit rates.

The exchange rate negatively affected the real depreciation rate. In the standard exchange rate theory (Gordon, 2011), high exchange rates led to high export values causing an increase in foreign exchange. Nevertheless, an increase in the exchange rate would encourage inflation due to domestic products with high import values. If the nominal interest rate increase is less than the inflation, caused by the impact of the increasing exchange, there would be a decrease in the real deposit interest rate.

Liquidity affected the deposit interest rate positively. This depicts that a higher level of banking liquidity would lead to an increase in the deposit interest rates. This was in accordance with Rocheteau and López (2014) study, which showed that the level of liquidity increased the interest rate especially if the increase in liquidity was obtained from external funding such as the sales of bonds.

### **Variable Influence of Deposit Interest Rate, Inflation, Exchange Rate, Gross Domestic Product, BI-Rate, Liquidity towards Deposit Value**

Based on the results from Table 5 and Table 6, it can be concluded that the deposit interest rate affected the deposit value positively. High deposit rates became an incentive for customers to keep their money in large amount through deposits. This result

was in accordance with Kraft and Galac (2004) research, which stated that higher deposit interest rates could cause an increase in the deposit value of customers in the bank. The higher the deposit interest rate, the greater the incentive or the interest that the customers would get if they deposited their money.

The BI-Rate had no significant effect on the values of the deposits because it was suspected that in this model the deposit interest rate was more dominant in affecting the value of the deposits. The impact of BI-Rate depends on the policy of each bank and the determined deposit interest rate.

Inflation did not significantly affect the value of the deposit in the short term, this means there was an increase in the economy; therefore, more funds were absorbed in the real sector than into the bank deposits. High inflation could also be seen as high demand for production so that more money is being circulated in the real sector than in the banking sector.

The gross domestic product was positively influenced by the value of the deposits. The better the economic performance the more customers were able to save money in the banking in the form of deposits. This was in accordance with the theory of economic flow where excess funds from society would go into savings or deposits when the economy has a good performance (Gordon, 2011). This result was also consistent with Kraft and Galac (2004) research, which found that real gross domestic product, could influence the value of deposits in banks positively.

Table 5

*Variable influence of deposit interest rate, inflation exchange rate, GDP, BI-Rate and liquidity against deposit value (Regression Estimation)*

Variable	Dependent variable: Deposit value		Significance probability
	Coefficient	Std. error	
Constant	-420388.7	112914.9	***
RDeposit	5722.655	3311.438	*
RBI-Rate	720.0409	6208.813	TS
Inflation	3022.527	3548.485	TS
GDP	30.20209	4.815355	***
Exchange Rate	18.86842	7.872915	**
Liquidity	16127.56	14922.73	TS
R-squared	0.914		
Adjusted R-squared	0.889		
F-statistic	36.691		
Prob(F-statistic)	0.000		

Source: Data processing

Notes: \*Significance to  $\alpha=10\%$  , \*\* Significance to  $\alpha=5\%$ ,\*\*\* Significance to  $\alpha=1\%$ , NS = Not significant

Table 6

*Test result t-statistics*

Independent variable	t-stat	Hypothesis $H_0$	Conclusion
Constanta	-3.723059	$H_0$ Rejected	Significance to $\alpha = 1\%$
Deposit interest rate	1.728148	$H_0$ Rejected	Significance to $\alpha = 10\%$
BI Rate	0.115971	$H_0$ Not Rejected	Not Significant
GDP	6.272038	$H_0$ Rejected	Significance to $\alpha = 1\%$
Inflation	0.851779	$H_0$ Not Rejected	Not Significant
Exchange rate	2.396624	$H_0$ Rejected	Significance to $\alpha = 5\%$
Liquidity	1.080739	$H_0$ Not Rejected	Not Significant

Source: Data processing

The value of the deposits was positively affected by the exchange rate. The high exchange rate prompted customers to save their money in deposits in banks (Gordon, 2011). This was as a result of the higher export value, causing the more foreign

exchange to be saved in rupiah deposits in Indonesia.

The liquidity variable had no significant effect on the value of the deposits because it was suspected that liquidity was affecting the lending process than the deposit value.

**Variable Influence of Credit Interest Rate, Inflation, Exchange Rate, Gross Domestic Product, BI-Rate, Liquidity to Credit Outstanding**

Based on the results from Table 7 and Table 8, it can be concluded loan interest rates negatively affected the credit outstanding. Credit interest rates indicated the price of funds, consequently the higher the loan interest rate, the lower the demand for the customer’s credit. This study supported the results of the previous research from Bassett

et al. (2014) arrived at the conclusion that the credit interest rates could significantly reduce the credit outstanding with a very high response from customers. Obviously, this was quite rational because the credit interest rates indicate the price or cost of funds thus if the cost of funds was higher than the demand for credit will be lower.

The credit outstanding was adversely affected by the BI-Rate. BI-Rate became the limit of banks in distributing credit. Higher BI-Rate, would cause the bank

Table 7

*Influence of variable interest rate of credit, inflation, exchange rate, GDP, BI-Rate, and liquidity to credit outstanding (Regression Estimation)*

Dependent variable: Credit outstanding			Significance probability
Variable	Coefficient	Std. error	
Constant	-317822.9	75512.01	***
RCredit	-8424.225	2223.172	***
RBI-Rate	-11151.52	2707.059	***
Inflation	-13229.50	2664.955	***
RGDP	37.09523	2.546367	***
Exchange Rate	30.41264	4.940198	***
Liquidity	-8151.800	3676.369	**
R-squared	0.863		
Adjusted R-squared	0.838		
F-statistic	33.990		
Prob(F-statistic)	0.000		

Source: Data processing

Notes: \*Significance to  $\alpha=10\%$  , \*\* Significance to  $\alpha=5\%$ , \*\*\* Significance to  $\alpha=1\%$ , NS = Not significant

Table 8

*Test result t-statistics*

Independent Variable	t-stat	Hypothesis $H_0$	Conclusion
Credit Interest Rate	-3.789282	$H_0$ Rejected	Significance to $\alpha = 1\%$
BI Rate	-4.119422	$H_0$ Rejected	Significance to $\alpha = 1\%$

Table 8 (Continued)

Independent Variable	t-stat	Hypothesis H <sub>0</sub>	Conclusion
Inflation	-4.964247	H <sub>0</sub> Rejected	Significance to $\alpha = 1\%$
GDP	14.56790	H <sub>0</sub> Rejected	Significance to $\alpha = 1\%$
Exchange Rate	6.156157	H <sub>0</sub> Rejected	Significance to $\alpha = 1\%$
Liquidity	-2.217351	H <sub>0</sub> Rejected	Significance to $\alpha = 5\%$

Source: Data processing

to save more money in the form of Bank Indonesia certificates and reduce lending. In relation to risks, saving money in the Bank Indonesia certificates were safer than lending to customers. These results were in accordance with the Chang and Li (2018) study, which came to the conclusion that the interest rate reacted positively to the contraction of monetary policy related to the interest rate.

Inflation negatively affected credit outstanding. As inflation rises, the Bank of Indonesia usually responds by raising the BI-Rate, and this increases the lending rates. A rise in the interest rate would reduce the demand for credit, thus reducing the credit outstanding. This was similar to the research of Hoevenaars et al. (2008), which concluded that very high inflation might decrease the allocation of funds in various investment portfolios, one of which was credit.

The gross domestic product positively affected the credit outstanding. This result was in accordance with the research of Bassett et al. (2014) and previous findings in his study where the gross domestic product had a positive effect on credit outstanding because the higher value of gross domestic product depicts better economic growth and economic risks decline. This encourages

banks to continue lending to customers.

The exchange rate positively affected credit outstanding. An increase in the exchange rate indicates that there was a depreciation in the exchange rate. hence export products become more competitive on one side. This then pushed the economy higher and the credit distribution also increased. As explained earlier, in the standard exchange rate theory (Gordon, 2011), the depreciated exchange rate causes high export values on one hand. Increased export performance shows improved economic performance and boosts demand for credit by customers and the allocation of credit by banks.

Liquidity negatively affected the credit outstanding. Increased liquidity increases the interest rates according to Rocheteau and López (2014) study, thus lowering the demand for credit by customers.

### Final Model Findings

Based on the estimation model result, it was found that not all variables studied had a significant influence in accordance with the researched hypothesis. Here are some of the findings in this study:

From the result of Table 9, it is deduced that not all the macroeconomic variables had a significant influence on each interest rate

Table 9

*Findings of Customer Behavior Model*

Independent Variable	Customer Behavior Model			
	Deposit interest rate	Credit interest rate	Deposit	Credit
Deposit value				
Deposit interest rate			(+)	
Credit interest rate				(-)
BI-Rate	(+)	(+)	NS	(-)
Inflation	(-)	(-)	NS	(-)
GDP	NS	(-)	(+)	(+)
Exchange rate	(-)	(-)	(+)	(+)
Liquidity	(+)	NS	TS	(-)

Source: Data processing

(deposit and credit), deposit value and credit outstanding. This result was in accordance with the previous study of Bassett et al. (2014).

## CONCLUSIONS

Based on the discussion of the research model, the decline in credit interest rates was caused by the increasing inflation, exchange rate, and liquidity while the increase in credit interest rates was due to the increase in BI-Rate. Furthermore, lending rates are not influenced by gross domestic product. The deposit interest rate will decrease if there is an increase in inflation, exchange rate, and GDP while deposit interest rate will increase if BI-Rate increases. Changes in liquidity have no effect on deposit interest rates. Increase in deposits is caused by a rise in deposit interest rates, GDP, and exchange rates. Increase in credit interest rate, BI-Rate, Inflation, and liquidity is caused by the decline in credit outstanding. Furthermore,

GDP and exchange rate boosts the credit outstanding.

## ACKNOWLEDGEMENT

The authors wish to acknowledge and thank all IMHA 2018 committee members and UPM *Pertanika* journal team that help publish this article.

## REFERENCES

- Bansal, R., & Coleman, W. J. (1996). A monetary explanation of equity premium, term premium, and risk-free rate puzzles. *Journal of Political Economy*, 104(6), 1135-1171.
- Bassett, W. F., Chosak, M. B., Driscoll, J. C., & Zakrajsek, E., (2014). Changes in the bank lending standard and the macroeconomy. *Journal of Monetary Economics*, 62(C) 23-40.
- Bank Indonesia. (2010). *Monetary policy review: economy, monetary, and banking*. Retrieved August 15, 2016, from [https://www.bi.go.id/en/publikasi/kebijakan-moneter/tinjauan/Pages/mpr\\_0810.aspx](https://www.bi.go.id/en/publikasi/kebijakan-moneter/tinjauan/Pages/mpr_0810.aspx)



- Berger, A. N. (1991, May 1-3). Market discipline in banking. In *Proceedings of a Conference on Bank Structure and Competition* (pp. 419-437). Chicago, USA: Federal Reserve Bank of Chicago.
- Caglayan, M., & Xu, B. (2016). Inflation volatility effects on the allocation of bank loans. *Journal of Financial Stability*, 24(C), 7-39.
- Chang, T. T., & Li, Y. (2018). Banking, liquidity effects and monetary policy. *Macroeconomic Dynamics*, 22(5), 1267-1297.
- Engel, J. F., Blackwell, R. D., & Miniard, P. W. (1993). *Consumer behaviour* (8th Ed.). New York, USA: Dryden Press.
- Gordon, R. J. (2011). *Macroeconomics* (12th Ed.). Essex, UK: Pearson Education Limited.
- Gurajati, D. N. (2003). *Basic econometrics*. New York, USA: McGraw-Hill.
- Haryati, S. (2009). Credit growth in Indonesia: Intermediation and effect of macroeconomy. *Journal of Finance and Banking*, 13(2), 299-310.
- Hoevenaars, R. P., Molenaar, R. D., Schotman, P. C., & Steenkamp, T. B. (2008). Strategic asset allocation with liabilities: Beyond stocks and bonds. *Journal of Economic Dynamic and Control*, 32(9), 2939-2970.
- Jimborean, R., & Mésonnier, J. S. (2010). Bank's financial conditions and the transmission of monetary policy: A FAVAR Approach. *International Journal of Central Banking*, 6(4), 71-117.
- Kashyap, A. K., & Stein, J. C. (2000). What do a million observations on banks say about the transmission of monetary policy?. *American Economic Review*, 90(3), 407-428.
- Keeton, W. R. (1993). The impact of monetary policy on bank lending: The role of securities and large CDs. *Economic Review-Federal Reserve Bank of Kansas City*, 78(2), 35-47.
- Kraft, E., & Galac, T. (2007). Deposit interest rates, asset risk, and bank failure in Croatia. *Journal of Financial Stability*, 2(4), 312-336.
- Levy-Yeyati, E., Martinez-Peria, S. M., & Schmukler, S. L. (2010). Depositor behaviour under macroeconomic risk: Evidence from bank runs in emerging economies. *Journal of Money, Credit, and Banking*, 42(4), 585-614.
- Rocheteau, G., & López, A. R. (2014). Liquidity provision, interest rates, and unemployment. *Journal of Monetary Economics*, 65(C), 80-101.
- Ruangkanjanases, A., & Wongprasopchai, S. (2018). Adoption of mobile banking services: An empirical examination between generation Y and generation Z in Thailand. *International Journal of Organization Business and Excellence*, 1(1), 1-12.
- Schiffman, L. G., & Kanuk, L. L. (2010). *Consumer behavior* (8th Ed.) New Jersey, USA: Prentice Hall.
- Solomon, M., & Rabolt, N. J. (2004). *Consumer behaviour: in fashion*. New Jersey, USA: Prentice Hall.



## **Exploring Employee's Motivation and Performance Factors: Evidence in a 3 Star Hotel in Indonesia by Contrasting Maslow's and Cetin's Model**

**Dewi Tamara<sup>1\*</sup>, Respati Wulandari<sup>2</sup> and Sanvenia Veronica<sup>2</sup>**

*<sup>1</sup>Executive in Strategic Management Program, Department of Management, BINUS Business School Master Program, Bina Nusantara University, Jakarta, Indonesia 11480*

*<sup>2</sup>Business Management Program, Department of Management, BINUS Business School Undergraduate Program, Bina Nusantara University, Jakarta, Indonesia 11480*

---

### **ABSTRACT**

The success of a company is strongly influenced by employee performance as the human resources driving it. In carrying out their work, employees need the motivation to optimize performance. This study aimed to analyze employee's motivation factors in a three-star hotel. The approach used in this study was the qualitative approach in reference to Maslow's Hierarchy of Needs and Çetin's Conceptual Model. Data collection was conducted by interviewing 22 hotel staff members. Interviews were conducted to determine the motivation factors that influenced the performance of the employees and the hotel. A model was designed based on the literature, linking factors of employee motivation with the employees and organizational performance. The results showed that employees were

motivated by brand management, hotel vision, the owner, employee component, salary, teamwork, and promotion.

### ARTICLE INFO

---

#### *Article history:*

Received: 9 October 2019

Accepted: 3 January 2020

Published: 17 March 2020

---

#### *E-mail addresses:*

dtamara@binus.edu (Dewi Tamara)

respatiwulandari@yahoo.com (Respati Wulandari)

sanveniaveronica@yahoo.com (Sanvenia Veronica)

\*Corresponding author

---

*Keywords:* Cetin's Model, employee motivation, employee performance, organizational performance

---

### **INTRODUCTION**

Human resources, especially in the hospitality business, play a crucial role in providing success in the business (Çetin, 2013). One of the keys to an organization's

success depends on the ability of managers to provide a motivating environment for their employees (Osabiya, 2015). In a survey conducted by the Institute for Management Development, employee motivation was the result of one of the elements to achieve talent competitiveness. Motivation has become one of the criteria for measuring the competitiveness of human resources ([www.imd.org](http://www.imd.org)). Lack of motivation among employees at hotels or employees who work at the organizational level can lead to unfavourable outcomes. Impacts such as not enjoying a given job, reluctance, disagreement, failure to complete work on time and even the desire to quit work can happen. Although it is often not realized at the beginning, the existence of motivational problems can be expressed after reviewing employee performance (Kappa et al., 1990 cited in Cetin, 2013).

This study was conducted in one of the best known three-star hotels in Jakarta. The hotel has employees that have worked for more than 5 years and also many who have worked for a short period of one to two years. This indicates that many employees are likely to resign with no hesitation and some that endure working at the hotel. A high staff churn can be an obstacle for a three-star hotel because it can cause declining employee performance and impact the hotel's performance as well as the organization's effectiveness.

The purpose of this research was to describe the factors that became obstacles in improving employee performance on organizational performance and to examine

the factors that needed to be improved to increase the motivation and performance of the work to the organization's performance by contrasting Maslow's Hierarchy of Needs Theory and Cetin's conceptual model. We provide a model proposition as the results of this study.

## LITERATURE REVIEW

Maslow (1954) developed a theory of motivation based on needs known as the Hierarchy of Needs Theory. According to Gibson, Donnelly, Ivancevich and Konopaske (2012), Maslow defined human needs using five categories: physiological, safety and security, belongingness, social, and love, self-esteem/respect for others, and self-actualization.

According to Manzoor (2012), motivation means to move, encourage or influence to fulfil a desire. Flippo (as cited in Maduka & Okafor, 2014), stated that motivation was a psychological process that began with the emergence of needs accompanied by good actions and behaviours aimed at satisfying certain desires. Kalimullah et al. (as cited in Manzoor, 2012) stated that motivation was a series of matters relating to the power to improve performance and led to the achievement of a definite goal. For employees, motivation is how to produce higher results and stay longer in one workplace.

In order to improve employee productivity, business owners use several driving tools. The organizational motivational tools are different because the

individual needs of different individuals can be changed over time (Cetin, 2013). According to Bingöl (as cited in Cetin, 2013), the motivating factors of individuals can be categorized into nine groups: instinctive, physiological, social, physiological, success, energy, attachment, belief, and attitude factors. These factors can be used easily to motivate individuals. Moreover, motivation factors for individuals can be categorized in three groups: 1) economic, including higher incomes, increased salaries, premium pay, participation in profits, and economic rewards (Bingöl as cited in Cetin, 2013), 2) psycho-social, which includes autonomy, personal power and authority, social status, respect for personal life, work and psychological security (Bingöl et al. as cited in Cetin, 2013), and 3) organizational and administration include goal congruence, manpower planning, loyalty to job and involvement in decision-making processes (Şimşek et al. as cited in Cetin, 2013).

According to Mangkunegara (as cited in Aima et al., 2017), employee performance is the performance of an employee when he or she did the job based on the quality and quantity required. According to Mathis and Jackson (2008), performance criteria will vary based on the job description, but employee performance should be measured by the dimensions of the presence at work, the quantity of output, quality of output, and timeliness of output.

According to Cho and Dansereau (as cited in Almatrooshi et al., 2016), organizational performance is the performance by a company compared with

its goals and objectives. In addition, Tomal and Jones (as cited in Almatrooshi et al., 2016), defined organizational performance as the actual outcome or output of an organization as measured against the output of the organization. There are seven aspects of organizational performance such as the external environment, internal motivation, capacity, efficiency, effectiveness, relevance and financial visibility (Bwire et al., 2014). Higher or better employee performance will impact positively on hotel performance.

## MATERIALS AND METHODS

The study was conducted in an international chain-group hotel in Jakarta, under Archipelago International as the operator of the hotel. The hotel chain has 57 branches in Indonesia. It offers 203 guest rooms, several functional meeting rooms, and a lounge. The rooms are stylish, clean, and equipped with top of the line beds and linen, LED TVs, and free “truly high speed” WIFI. There are 52 members of staff.

This study used the qualitative method with a grounded theory approach. Data collection techniques were done by conducting interviews with participants. Interviews were conducted for around 15-30 minutes for each participant and interviews were conducted four times. Open-ended questions were designed to collect data from participants. Participants of this study were 22 employees of the hotel. This study was conducted in a four month period between September 2017 and December 2017. The study followed Cetin's framework about ‘Motivation and its impact on labor

productivity at hotel business: A conceptual study (Figure 1).

**RESULTS**

The demographic characteristics of participants were viewed by gender, age, working period and income. Data showed that 64% of employees were male and 36% of the employees were female. 41% of the employees were 18-22 years old, 14% 23-27 years old, 23% 28-32 years old, 4% 33-37 years old, and 38 years and above described 18% of the employees. The working period of employees was divided into four types. The employees who were working for less than one year (38%), 1-2 years (19%), 2-3 years (24%) and 3-4 years (19%). The salary was divided into 5 types. A total of 68.3% of an employee were paid Rp 3-5 million, 18.2% were paid Rp 6-8 million, 4.5% were paid Rp 9-11 million, 4.5% were paid Rp 12-14 million, and 4.5% were paid more than Rp 15 million.

This study was conducted by asking research questions to 22 hotel staff members. Two participants worked to fund their own education to a higher level; 7 participants worked to earn money. Seven participants worked to support their family; one participant worked to study and seek knowledge. One participant worked to improve their skills and career; one employee worked to gain discipline. In addition, employees worked for their lifestyles, to get to know the world of work and to live independently. Six employees felt that their work was in line with their expectations both in terms of position, salary, educational background, working time and education. Eleven employees felt that their work was still not in accordance with their expectations. The findings of the interviews were related to Luthans (as cited in Hazra et al., 2015), which mentioned that employees were motivated when their needs and expectations were satisfied. The

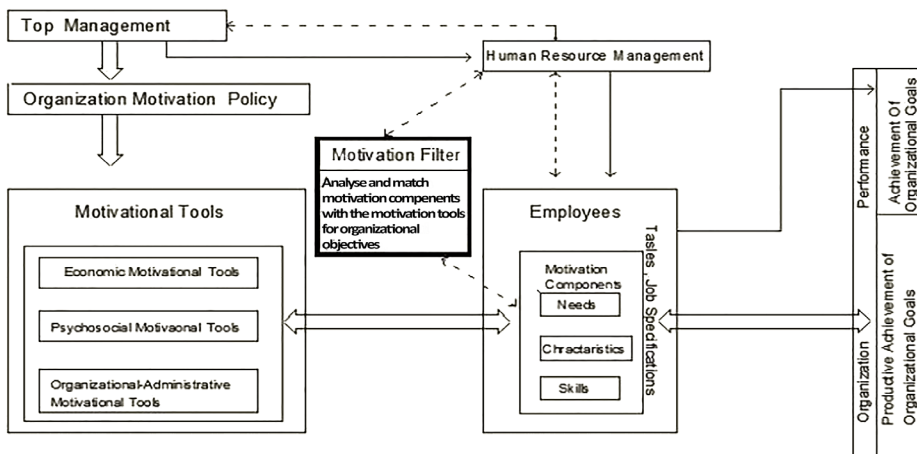

Figure 1. Cetin Conceptual Model (Cetin, 2013)

motivation of employees based on their needs was fulfilled by working at the hotel. However, there were still employees who felt unsatisfied with their expectations.

## DISCUSSIONS

The three-star hotels provided several facilities for employees such as food, drink, lockers to keep their goods and places to rest, and vitamins during events. Managers on duty were also provided rooms to stay in while at work and could dine in the hotel restaurant. However, based on interviews with one of the staff, the nutrition of meals provided to employees needed to be improved. Taormina and Gao (2013) stated that the individual's satisfaction of basic needs was not enough to just be fulfilled, but the individual would also achieve satisfaction needs by paying attention to the quality of the given needs. The findings suggest that the hotel needs to pay more attention to meals and locker quality and the place for employees to rest.

### Safety and Security of Needs

The need for security was met by the hotel providing BPJS (Social Security Insurance Agency) health and employment insurance for each employee. The hotel involved its employees in the hotel's profit-sharing by providing service charges. These were obtained from a percentage of the price of the goods or services paid by the guests staying at the hotel either from room sales, food, beverage and laundry. The findings of the interviews showed similar circumstances with the research conducted by Kaur (2013)

which stated that financial security was one of the important types of safety needs. To motivate employees, an organization not only should provide tools to ensure employee safety, but the organization also needed to make its employees felt financially secure by engaging them in profit-sharing within the organization.

### Belongingness, Social and Love Needs

Osabiya (2015) explained that the need for affection was usually referred to as social needs that included affection, belonging, social activity, friendship and mutual giving and receiving affection. Based on interviews at the hotel, their social needs were provided by people in their neighbourhood or from family, co-workers and even managers. Families provided support and encouragement to employees to work. Co-workers provided affection by caring, helping, and appreciating each other. The hotel also involved all employees in activities such as outings, staff parties, Zumba, and donations to orphans. Embodiments of social needs can be realized in various ways. This was in line with a previous study where social needs referred to the need for affection in which individuals felt loved and accepted by other individuals, giving and receiving affection. Organizations could also encourage employee participation to engage in social events such as picnics and bowling competitions (Kaur, 2013; Osabiya, 2015).

### Esteem Needs

According to Taormina and Gao (2013),



the need for esteem within the hotel was demonstrated through self-respect and appreciation from others. Self-esteem was reflected by how much appreciation they were given in their jobs. Based on the results of interviews with employees, it was known that 16 employees scored above 4, and 2 employees were assigned a score of 3 (from the range of 1 = dissatisfied to 5 = very satisfied). The rewards of others were felt by nonverbal rewards such as door prizes, salary increases and positions, best employee, trust and verbal praise. Taormina and Gao (2013) described the esteem from others as defined by a person's acceptance of an attitude and respect received by a person in respect of the person's character and feelings of worthiness, or a value that existed within the person. The hotel rewarded employees through appreciation and employees showed mutual respect with their workers. The interview results also showed that awards from others could increase employees' confidence in doing their work.

### **Economic Motivation Tools**

The hotel used economic motivational means such as salary and rewards such as allowances, promotions, bonuses, and recognition. Based on the interviews with employees, it was found that the salary given was in accordance with the work undertaken by its employees. A total of 18 employees said that their salaries were in accordance with the type of job and their positions; one of them said that the salary was given in accordance with the qualifications he had.

Another employee said the salary given was still better than other workplaces. Previous research conducted by Kovach (as cited in Safiullah, 2015) stated that along with the increasing income of an employee, money became less of a motivation. Likewise, with the increasing age of employees, interest in working became more attractive. This is similar to the state of employees at the hotel where older employees were more interested in workplace conditions that could give employees the opportunity to become leaders or challenged them in their work. Rewards received by the hotel's employees were fringe benefits such as the Hari Raya allowance (Tunjangan Hari Raya), work promotions, bonuses such as door prizes, discounts for employees staying at the Archipelago brand hotel, and recognition such as verbal praise and non-verbal awards such as 'Best Employee of the Quarter'. The results of this study found that working a period was not a measurement for a person to get an award in any form, but their capabilities and abilities showed that they could get an award.

### **Psycho-social Motivation Tools**

The findings showed similar circumstances to the research conducted by Naqvi et al. (2013) which stated that work autonomy results in improving job performance because individuals think and consider themselves skilled and creative in completing their tasks. The hotel's employees felt that the freedom that was given was not only to complete their responsibility, but that freedom became a tool for them to improve



the performance of the hotel. In addition, employees also respected each other's personal lives.

### **Organizational-Administration Motivational Tools**

Cetin (2013) said goal congruence was achieved when employees and hotels could achieve both the goals and expectations of both. Data showed that 35.5% of employees said that their work was in accordance with their goals in terms of position, salary, educational background and working time with education. 64.7% of employees stated that their work had not met their expectations. Employees at the hotel also had a poor understanding of the hotel's vision and mission that reflected the achievements of the hotel. Goal congruence could also be reflected in the extent to which employees and co-workers adhere to the same set of organizational goals (Nahapiet & Ghoshal, 1998; Clerq et al., 2017). In manpower planning, the hotel did not provide encouragement or educational opportunities to employees, especially since the majority of the employees were young employees. A total of 16 employees stated that education was important and that they needed to gain knowledge, and learn the system used in the hotel, to improve their career and to continue their education. Age was also a factor where education became something important and necessary. The majority of employees who claimed that education was important and needed were aged 18-27 years old.

The findings in a previous study by Chilembwe & Baluti (2014) explained

that staff performed better if there was a chance to continue their education or studies (including better salary and work security). The hotel had also provided training opportunities in the hotel to its employees such as department training and cross-training program in which employees could get training from other departments within the hotel. Employees also got training outside the hotel such as team-building in recreational places. Employees also had the opportunity to attend seminars held both inside and outside the hotel.

A study by Aima et al. (2017) stated that employees felt that managers needed to provide direction to employees to complete their tasks and to achieve targets according to the standards of the organization. They also needed to provide rules to motivate employees to complete the assigned tasks, delegate authority and ensure equal responsibility for every employee. Employees also demonstrated work loyalty in completing their responsibilities and were also involved in providing ideas and decision-making in accordance with employee level positions.

### **Employee Motivation Component**

According to Cetin (2013), the components of employee motivation are divided into 3 types:

1. Needs are reflected from the goal of every employee in the work to meet their needs. The needs of employees at the hotel were currently dominated by the need to earn money to support their

- own needs, family and education funding.
2. Different characteristics for each employee can be seen from gender, age, last education, status, and income or salary.
  3. Employee skills also varied according to the level of education and the majority of employees had experience working in the hotel industry.

### **Employee Performance**

The findings in the study stated that the most dominant motivation factors in employees were salary, co-workers and promotion factors. Employees demonstrated the positive performance of colleagues when an exciting work environment enabled employees to work passionately and chose to stay at the hotel. In fact, employees who left later returned to the hotel.

The performance policy of the hotel regarding the number of employees and shareholder determined the employees' performance. Hotel policies related to cost efficiency led to a reduction in the number of employees and the lack of capital from the owners of capital affected the employee performance. According to Iqbal et al. (2015), employee performance indicates the effectiveness of specific employee actions that contribute to achieving organizational goals. The findings within the case hotel resulted in the fact that being aware of their existence and duties was not enough if the employees were not supported by adequate

human resources in terms of the quantity of the human resources itself.

### **Organizational Performance**

The findings in this study were the performance of the organization was not only influenced by the performance of employees in the hotel. Motivation acted as a factor that would affect employee performance but hotel policies in the number of employees also affected the performance of employees and hotels. The findings of the study indicated that there were internal factors and external factors that could affect hotel performance. Internal factors consisted of internal motivation from within the hotel, hotel capacity, efficiency and effectiveness of hotel, hotel relevance in following technological development, and hotel's financial viability. These things were directly related to the activities within the hotel whether carried out by employees within the hotel or shareholders. The external factors consisted of government policies that indirectly affected the development of hotels. The findings from the interviews showed similar circumstances with previous research conducted by Raravi and Timmanagoudar (2014) that government policy (inspection method, product legal process, industry regulation, and regulation) had a positive relationship with the growth of an organization. The case hotel felt that there was a supporting element of the government in improving the hotel through tourism and local regulations.

**Proposition Model**

Figure 2 proposes a model of the proportion of organizational motivation models in three-star hotels. In contrasting Maslow's Hierarchy Needs of Theory and the Çetin conceptual model, we found that the two concepts complement each other. Both theories emphasized the needs of every employee and tools that the company could use to meet the needs of their employees. The study revealed that employees were motivated by two type's factors: external and internal motivation. The external motivating factor comes from outside the hotel, without any employee interference or not directly related to the job of the

employee. The external factors that motivated employees were the benefits given by brand management, the vision of the hotel that would reflect on the implementation of the hotel, and the loyalty of capital owners perceived by employees in support of their work. The internal motivation factors came from within the hotel itself or were directly related to the employee's job. Internal factors that motivated employees were salaries, co-workers or teamwork, and promotional opportunities. The results found that the main motivation of the employees was economic or income. In addition to the salary, a sense of kinship among co-workers also motivated employees to work comfortably and not burden each other.

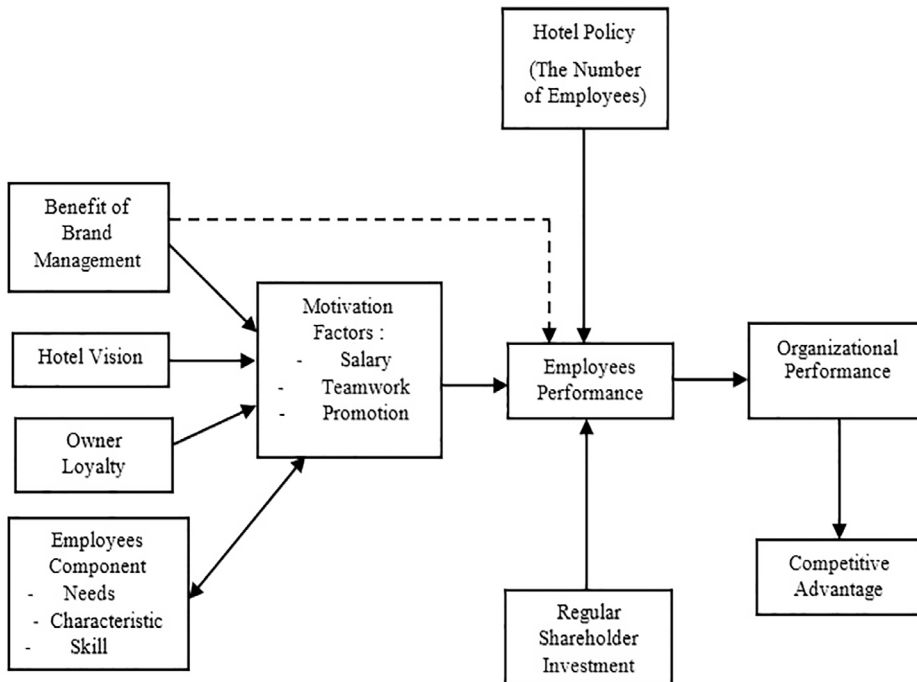

Figure 2. Proposition Model.

The opportunity of being promoted also motivated employees with the career path mindset. It was confirmed by the fact that a former employee resigned from the job because he did not get any promotion as a contract worker after 3 years of work.

Motivation affected the performance of employees. Osabiya (2015) suggested that employees with high motivation in carrying out their function would strive to fulfil job responsibility, humility, and efficiency. The most dominant factors were salary, co-workers, and promotional opportunities. Other factors were brand management, hotel vision and owner loyalty.

This research finds that the flexibility of the brand management also affected the case hotel's ability to be flexible on the job. With the positive integration of all aspects, the hotel would have a competitive advantage to compete. Ismajli et al. (2015) stated that managing human resources was essential because human factors as a resource could produce a competitive advantage for the organization. Drucker (2006) as cited in Ismajli et al. (2015) stated that the most valuable asset of the twentieth century was the production machine, but the most valuable asset of the twenty-first century, for all types of organizations were employees with high knowledge and productivity.

## CONCLUSIONS

The study concludes that the case hotel faced some obstacles in improving employee performance that impacted on organizational performance. The obstacles faced in improving employee performance

were the lack of manpower and lack of capital injection from the shareholders. The results showed that the lack of manpower caused the performance of both employees and hotels to be less efficient and effective. In addition, the lack of funds from the shareholder caused employees' difficulty to perform activities that may have affected the performance of the hotel especially when the hotel required urgent costs. The results also showed that there were several factors that needed to be improved to boost employee motivation, such as training programs that were provided equally to every employee such as seminars, workshops, and other skill improvement programs so that every employee felt the opportunity to develop from within the hotel. In addition, the millennial's recruitment strategy adopted by the case hotel could be supported by the increased educational opportunities that are still the needs of the millennial. To achieve the hotel's goal, the hotel must inform the vision and mission that reflect the hotel's own achievements so that employees are aware of the mutual goal. Information on employee tools could also motivate employees such as cross-training where employees could learn things from other departments. Some employees claimed that they needed these opportunities to develop themselves.

## ACKNOWLEDGEMENT

The authors wish to acknowledge and thank all IMHA 2018 committee members and UPM *Pertanika* journal team that help publish this article.

## REFERENCES

- Aima, H., Adam, R., & Ali, H. (2017). Model of employee performance: Competence analysis and motivation. *Journal of Research in Business and Management*, 4(11), 49-59.
- Almatrooshi, B., Singh, S. K., & Farouk, S. (2016). Determinants of organizational performance: a proposed Framework. *International Journal of Productivity and Performance Management*, 65(6), 844-859.
- Bwire, J., Ssekakubo, J., Lwanga, F., & Ndiwalana, G. (2014). Employee motivation, job satisfaction and organizational performance in Uganda's oil sub-sector. *Global Advanced Research Journal of Management and Business Studies*, 3(7), 315-324.
- Çetin, I. (2013). Motivation and its impact on labour productivity at hotel business: "A conceptual study". *International Journal of New Trends in Arts, Sports, and Science Education*, 2(1), 70-79.
- Chilembwe, J. M., & Baluti, J. (2014). Motivation and supervision in hospitality industry with focus on hotels and lodges in Mzuzu City. *International Journal of Social Sciences and Entrepreneurship*, 1(10), 1-13.
- Clerq, D. D., Rahman, Z. M., & Belausteguigoitia, I. (2017). Task conflict and employee creativity: The critical roles of learning orientation and goal congruence. *Human Resource Management*, 56(1), 93-109.
- Gibson, J. L., Donnelly, J. H., Ivancevich, J. M., & Konopaske, R. (2012). *Organizations behaviour, structure, processes*. New York, USA: McGraw-Hill.
- Hazra, K., Ghosh, P., & Sengupta, P. P. (2015). Motivation and performance linkages: A comparative study between two sectors of hospitality industry. *Journal of Business Studies Quarterly*, 7(1), 77-87.
- IMD World Competitiveness Center Team. (2016). *IMD world talent report*. Switzerland. Retrieved January 25, 2018, from [https://www.imd.org/research-knowledge/articles/com\\_november\\_2016/](https://www.imd.org/research-knowledge/articles/com_november_2016/)
- Iqbal, A., Ijaz, M., Latif, F., & Mushtaq, H. (2015). Factor affecting the employee's performance: A case study of banking sector in Pakistan. *European Journal of Business and Social Sciences*, 4(8), 309-318.
- Ismajli, N., Zekiri, J., Qosja E., & Krasniqi, I. (2015). The importance of motivation factors on employee performance in Kosovo municipalities. *Journal of Political Sciences & Public Affairs*, 3(2), 1-6.
- Kaur, A. (2013). Maslow's need hierarchy theory: Applications and criticisms. *Global Journal of Management and Business Studies*, 3(10), 1061-1064.
- Maduka, C. E., & Okafor, O. (2014). Effect of motivation on employee productivity: A study of manufacturing companies in Nnewi. *International Journal of Managerial Studies and Research*, 2(7), 137-147.
- Manzoor, Q. A. (2012). Impact of employees motivation on organizational effectiveness. *Business and Management Strategy*, 3(1), 1-12.
- Maslow, A. (1954). *Motivation and personality*. New York, USA: Harper & Row Publisher, Inc.
- Mathis, R. L., & Jackson, J. H. (2008). *Human resource management*. Mason, USA: South-Western Cengage Learning.
- Naqvi, S. M. M. R., Ishtiaq, M., Kanwal, N., & Ali, M. (2013). Impact of job autonomy on organizational commitment and job satisfaction: The moderating role of organizational culture in fast food sector of Pakistan. *International Journal of Business and Management*, 8(17), 92-102.

- Osabiya, B. J. (2015). The effect of employees' motivation on organizational performance. *Journal of Public Administration and Policy Research*, 7(4), 62-75.
- Raravi, P., & Timmanagoudar, S. N. (2014). Study on government policies and regulation factors which are affecting the performance of SME's (Manufacturing). *IOSR Journal of Business and Management*, 16(7), 23-28.
- Safiullah, A. B. (2015). Employee motivation and its most influential factors: A study on the telecommunication industry in Bangladesh. *World Journal of Social Sciences*, 5(1), 79-92.
- Taormina, R. J., & Gao, J. H. (2013). Maslow and the motivation hierarchy: Measuring satisfaction of the needs. *American Journal of Psychology*, 126(2), 155-177.

## **The Urgency of Community Participation in the Establishment of a Local Regulation**

**Dani Sintara\*, Suhaidi and Faisal Akbar Nasution**

*Law Program, Graduate School, University of Sumatera Utara, Jl. Dr. T. Mansyur No.9, Medan 20155, Indonesia*

### **ABSTRACT**

One of the realizations of the implementation of local autonomy is the authority to establish a local regulation. The establishment process should involve the community to provide inputs both in oral and written form in order to obtain an aspirational local regulation. However, in its implementation, the establishment of local regulation that ignores community participation is often found. This is contrary to the principle of democracy in the rule of law. This research used a normative legal method and analytical prescriptive approach. The theory employed to answer the research problems was the theory of democracy. Community participation in the establishment of local regulation is not fulfilled because of the community's ignorance of the mechanisms and the forms to participate. As a result, the local regulation produced does not represent local people's aspirations. A local regulation which is not aspirational is difficult to implement and is potential to be cancelled through a judicial review. The purpose of this study is to see the importance of community participation in making local regulations. Since one of the good ways of producing a Local

Regulation is through the involvement of the community in the process.

### ARTICLE INFO

#### *Article history:*

Received: 9 October 2019

Accepted: 3 January 2020

Published: 17 March 2020

#### *E-mail addresses:*

[danisintara@yahoo.co.id](mailto:danisintara@yahoo.co.id) (Dani Sintara)

[suhaididunant1962@gmail.com](mailto:suhaididunant1962@gmail.com) (Suhaidi)

[fakbarnst@gmail.com](mailto:fakbarnst@gmail.com) (Faisal Akbar Nasution)

\*Corresponding author

*Keywords:* Community participation, establishment regulation, local regulation

### **INTRODUCTION**

Decentralization as a principle in constructing local government in the Republic of Indonesia will produce authorities and rights to the community



of the local region (Joeniarso, 1992). Such authorities and rights allow a local government to take care of its own domestic affairs without further regulation by the Central Government (Nasution, 2003).

The government agencies should not be managed as an enterprise but they should have a role in promoting democracy, supporting the market, providing public services and performing good governance. Moreover, decentralization and regional autonomy have also brought a new phenomenon, in which many local governments are newly formed and established. There are now nearly 400 local governments (more than previously reported at a total of 300) as a result of decentralisation and regional autonomy in Indonesia. A new local government is usually more open and innovative in governing the work and is more adaptive to change than the previous centralized local government. As a new local government, they do not have the expertise and resources similar to the old local government, thus it requires more guidance from the central government in terms of good governance policies (Yunus et al., 2016).

Allowing a local government to take care of its own domestic affairs implies that everything related to the local affairs becomes the concern of the local government (Noor, 2012). Nevertheless, such affairs exclude the authority of the central government as stipulated by the law as regulated in Article 10 of Law Number 9 of 2015 on Local Government.

For local affairs, the Local Government is given an authority to establish a local

regulation (Yusdiyanto, 2012) Establishing local regulation is a manifestation of the local government's authority and independence in regulating its domestic affairs (Rawasita, 2009). Thus, the local regulation making under this circumstance will be a participatory local regulation, with the process of involving the community for inputs both in oral and written form (Indrati, 2005).

Community involvement is considered important because it is a realization of implementing a democratic country (Suseno, 1987). In addition, involving the community will result in a responsive or populist local regulation, i.e. the local regulation that reflects the sense of justice and meets the community expectations (Tjandra & Darsono, 2009). In formulating the regulation, full participation of social groups or individuals within the community plays an important role (Mahfud, 2001).

Furthermore, community participation becomes a power to check and balance the interests of the government and society (Kusumah, 1986). Consequently, the established local regulation will really meet the requirements of good legislation. Such a process of participation will foster a sense of ownership and responsibility for the established local regulation (Sirajuddin, 2007).

In its realization, the establishment of the local regulation often ignores the rights of the community to participate in providing input (Muhiddin, 2013). The exclusion of the community from participating would be contrary to the principle of a democratic state



(Meyer, 2012). This is related to the right to express opinions as stipulated in Article 28 E of the 1945 Constitution. Participation in expressing opinions is carried out in legislation forums for the establishment of the local regulation (Manan, 2001).

When a local regulation is established without community participation, such regulation will be difficult to implement. In addition, such regulation will impede the efficiency of the Local Government and is potential to be cancelled through a judicial review to the Supreme Court.

This study aims at seeing how urgent public participation in making the Local Regulation, in case of creating an aspirational Local Regulation. Since ignoring community participation in local regulation-making is against the principle of a democratic state.

### **Formulation of the Problem**

Currently, Indonesia is undergoing a process of reform and regional autonomy. In the process, a negative phenomenon is developing particularly in the field of legislation, both at the provincial, district and city levels, where community participation has not been optimally involved in making the Local Regulations.

In fact, the community participation's main objective is to be able to take part meaningfully in the process of governing the region. Officially, the right to participate will be violated if the local government ignores such participation. Community participation is very important since the implementation

of the local regulation will have an impact on the area and the life of the community.

Therefore, the problem of this research is formulated as: "How is the urgency of community participation in the establishment of local regulation and how is the legal effect of the establishment of non-participatory local regulation?"

### **Literature Review**

**Democratic State Theory (Popular Sovereignty).** In this theory, there are 2 (two) terms which must be first understood, namely: sovereignty and people. Sovereignty is the supreme authority in a state which applies to all territory and peoples of a certain state. While the people of a state are all those who are in the territory of the state and subject to the power of the state (Sudarsono, 1991).

The theory of popular sovereignty emerged in the Renaissance era which bases the law on reason and ratio. In the 18th century, Jean Jacques Rousseau introduced his theory that the basis of the existence of a state was a "social contract" held by and between members of society to establish a state. Rousseau's theory was put forward in his book entitled *Le Contract Social*. This theory is the basis of the ideology of popular sovereignty which teaches that the state is based on the will of the people, so all the rules are the manifestation of the people's will. (Sudarsono, 1991).

The relationship between the people and the power of the state commonly developed based on two theories: 1) direct

democracy theory, where the sovereignty of the people can be done directly in the sense of the people themselves who exercise the supreme power they have, and 2) indirect democracy theory (representative democracy). In today's modern world with the complexity of problems, the doctrine of representative democracy becomes more popular. Usually, the implementation of this sovereignty is called a representative institution (Asshiddiqie, 1994).

Regarding the theory, Indonesia adheres to popular sovereignty. The owner of the ultimate supreme power is the people. That power must be realized from the people, by the people, and for the people. Based on the Constitution, the exercise of popular sovereignty is channelled and organized according to constitutional procedures established in the law and the constitution (constitutional democracy).

Therefore, the realization of democracy must be regulated by law. The embodiment of democracy requires legal instruments, effectiveness and leadership examples, support from the community education system, and socio-economic welfare which is growing more evenly and equitably (Asshiddiqie, 2004).

The principle of popular sovereignty (democracy) and the rule of law (nomocracy) should be held concordantly as two sides of a coin. For this reason, the Constitution of the Republic of Indonesia should cover the fundamental belief that the law rules the state and the democratic state is based on laws where both the law and the state are inseparable from each other. They both

are the real manifestations of the belief that Indonesia is a whole nation with the principle of the Almighty God (Belief in the One and Only God).

The democratic principle is not only contained in the central government but must also be realized in the structure of local government as mentioned in Article 18 of the 1945 Constitution, covering a principle that a regional governmental unit should be constructed in the state government system. This principle requires social participation in overseeing the local governing, as well as participating in the formulation of legislation including the Local Regulation (Manan, 1993).

## **MATERIALS AND METHODS**

This is standard legal research aiming at normative regulations. This study is closely related to the library review because the standard legal research requires secondary data from the library review. The nature of the research is descriptive-analytical. This means that this study illustrates how a legal provision in the context of legal theories in the presentation describes the various issues related to the urgency of community participation in the establishment of local regulation. The data was secondary data consisting of (a) primary legal materials in the form of legislation, (b) secondary law materials in the form of writings, both books and articles containing comment or analysis related to the subject matter, and (c) tertiary legal materials in the form of dictionaries. The data was collected using literature reviews and document analysis

using a qualitative method based on a logic deductive thinking.

## RESULTS AND DISCUSSIONS

### **The Urgency of the Community Participation in the Establishment of Local Regulation**

Participation is defined as taking part in an activity (Departemen Pendidikan Nasional, 2007). When associated with the establishment of local regulation, it is defined as the community participation in the establishment of local regulation (Departemen Hukum dan Hak Asasi Manusia RI, 2009). Such participation is the right of people guaranteed by the law as regulated in Article 96 of Law Number 12 of 2011 and Article 237 Paragraph (3) of Law Number 9 of 2015.

The right of the community to participate in the establishment of local regulation is a form of Human Rights (Saragih, 2011) which is the right to express opinions as regulated in Article 28 E Paragraph (3) of the 1945 Constitution. In this respect, Human Rights provide recognition of the participation of the community in government affairs. The actualization of the role of the community in the realm of government will create public empowerment (El-Muhtaj, 2008), including participation in the establishment of local regulation.

Direct community participation will certainly have important impacts, such as avoiding the opportunity for manipulation of the community involvement and clarifying what is desired. In addition, it will add value to the legitimacy of the local regulation.

Another added value is increasing public awareness and political skills (Abe, 2005).

The establishment of non-participatory local regulation will result in ineffective local regulation (Piliang et al., 2003), in the sense of not achieving the intended objectives. Besides, such local regulation will not be implemented (Wiratraman, 2010), in the sense of being unworkable or failure since its early establishment. Furthermore, such local regulation is unresponsive, in the sense of getting a prominent rejection from society since its drafting until its enactment (Halim, 2013). Finally, such local regulation will not solve social problems but instead creates new problems for society (Sihombing & Hasibuan, 2017).

Therefore, community participation in the establishment of a local regulation can be optimized into several principles. First, it creates an effective publication obligation (Patlis, 2004). Second, it creates information and documentation obligations which are systematic, free and accessible (Badan Pembinaan Hukum Nasional, 2011). Third, it creates a guarantee of open and effective procedures and forums for the community to be involved in overseeing the process since the planning stage (Kementerian Hukum dan Hak Asasi Manusia Republik Indonesia, 2014). Fourth, it creates a procedure that guarantees the public opportunity to propose a draft of local regulation (Warouw, 2014). Fifth, it provides a guarantee of an appeal to the public if the process of a local regulation establishment is not done in a participatory manner (Dewan Perwakilan Daerah Republik Indonesia, 2012). Sixth,

it creates an adequate time frame for all the establishment process: drafting, discussing the draft and dissemination of the formulated local regulation (Pambudi, 2006). Seventh, it creates clear and adequate accountability for the local regulation makers that deliberately close the opportunity for the community to participate (Makhfudz, 2012).

The main objective of community participation in the establishment of local regulation is to make the community able to give meaningful influence to the government process in a broad sense (Kurnia, 2007). So legally, the right of the community to participate will be violated if the local regulation makers do not open a space for that (Isra, 2010). In other words, the purpose of participation in the process of a local regulation establishment is to raise the community sense of ownership and responsibility because the applicable local regulation is made by them so that their compliance can be improved (Santosa, 2001).

In addition to providing space for the community to know the possible implications of the establishment of a local regulation since the early process (Surbakti, 1992), involving the community to participate in the establishment of a local regulation is also needed to ensure that their interests are not ignored by the local regulation makers in accordance with the principles of a democratic state (Nonet & Selznick, 2007).

In a democratic state, community participation in the activity of society

members to act as individuals in order to influence government decision-making (Budiardjo, 2008). Participation can be either individual or collective, organized or spontaneous, constant or sporadic (Thohari, 2011). The statement above explicitly emphasizes that participation could not only be done formally but also informally (Marzuki, 2010).

The community participation in the establishment of local regulation is the implementation of the consensus principle, i.e. the community agreement to carry out their obligations and bear the consequences caused by such local regulation (Vlies, 2005). Consensus should, therefore, involve the community in the process of preparing and discussing the local regulation that will be formulated (Attamimi, 1990). As a result, the desired goal can be achieved, i.e. the establishment of an aspirational local regulation.

The implementation of the consensus principle is regulated in the provisions of Article 5 and Article 96 of Law Number 12 of 2011 which require community participation in the establishment of legislation, including the establishment of local regulation.

The elucidation of Article 5 states that the community participation is made possible in the planning, drafting, discussion, approval and enactment stages. Meanwhile, Article 96 determines that community participation can be done through public hearings, business trips, socialization, seminars, workshops and discussions. Therefore, the efforts to strengthen the community participation in

the establishment of a local regulation can be done through three stages, among others are:

First, at the stage of planning and preparing the local regulation draft (Huntington & Nelson, 1994), four forms of community participation can be realized which is participation in the form of research (Sastropetro, 1986), participation in the form of a discussion, workshop and seminar conducted as the follow-up of the research findings (Dahl, 2001), participation in the form of an initiative proposal submission, and participation in the form of designing a local regulation (Sunarno, 2006).

Second, at the stage of discussing the local regulation draft, three forms of community participation can be realized: participation in the form of public hearings with the Local People's Representative Assembly (Griadhi & Utari, 2008), participation in the form of providing an alternative local regulation draft (Saifudin, 2009), participation in the form of providing inputs through both printed and electronic media (Gauraf, 2002).

Third, at the stage after becoming a local regulation, community participation is realized with respect to the authority of the Supreme Court. The community can conduct a judicial review on the local regulation to the Supreme Court if they feel that their constitutional rights are violated by the enactment of such local regulation (Hamidi, 2011).

The above-mentioned opinions are in line with Yuliandri (2011) who argued that in the process of establishing a sustainable

and participatory legislation, several efforts should be made, including the need to plan the legislation establishment through the preparation of academic texts, the existence of public or community participation in the legislation establishment, and the existence of conformity between the content material and the requirements of legislation establishment.

Community participation is one of the absolute requirements to obtain a participatory local regulation. Thus, ignoring community participation should be regarded as a factor leading to a formally flawed local regulation that can be reviewed to the Supreme Court.

Finally, it can be affirmed that the urgency of public participation in the formation of a Local Regulation is to fulfil the Human Rights of the citizens as stipulated in the Constitution. Therefore, involving the community in making Local Regulations is a concrete manifestation of the government's commitment to recognize and protect Human Rights, so as to obtain a participative Local Regulation.

### **Legal Effects of Non-Participatory Local Regulation**

Legal thinkers understand that legislation is a binding contract between a community and a state, or a contract made among the community members to form a government (Palmer, 2006). It presupposes the community to empower the state and then develop a democratic system. Democracy is a mechanism for fulfilling individual choice which is done collectively. This instrument allows all members of the community to

raise normative questions about whether the existing institutions really reflect orderliness (Syahrizal, 2006).

This explains that on the one hand, the state institutions should be able to articulate the people's choices properly. On the other hand, state institutions enlighten people's ignorance (Mahfud, 1999). Thus, the state institutions that exercise the sovereignty of the people should be able to provide the best assistance to resolve the various problems arising in society (Putra et al., 2014).

Therefore, the establishment of a local regulation should provide a space for the community to participate. If there is no space for the community to participate, then the local regulation will be conservative or elitist which is the local regulation that reflects the social vision of the political elite. In addition, such local regulation tends to reflect the desires of the Government and tends to be positivist-instrumentalist which is closed to the demands of groups and individuals in the community (Triyono, 2013), Power offers an individual the latitude to act according to what he or she wants. Those authorities also often force individuals or members of society to follow what they decide. Individual points and opinion are often dismissed by the powerful and therefore, those in power commit abuses

A conservative or elitist local regulation has legal consequences to be cancelled (Siahaan, 2012). The cancellation can be done through a judicial review to the Supreme Court. The Supreme Court is authorized to conduct a judicial review

of subordinate law against the Law, as regulated in Article 24A Paragraph (1) of the 1945 Constitution.

The judicial review of legislation in Indonesia has two models, including the review of law against the Constitution, and the review of subordinate law against the law. Then, the benchmark of the review is the Constitution and the Law (Hasibuan, 2017).

When closer attention is addressed to the hierarchy of legislation as regulated in Article 7 Paragraph (1) of Law Number 12 of 2011, the benchmark of the local regulation review shall be the law. This means that the process of establishing local regulation should not be contrary to the one determined by the law (Widjaja, 2010).

The hierarchy of legislation as stated by Hans Kelsen on *stufenbau des rechts* theory says that the lower norm is determined by the higher norm, and the basic norm becomes a consideration for the overall truth of the rule of law (Purbacaraka, 1979) (Figure 1).

*Stufenbau des rechts* theory put forward by Hans Kelsen has been developed by his disciple, Hans Nawiasky, who said that a legal norm in a country was always levelled. The levels were (i) fundamental norms of the state, (ii) basic rules of the state, (iii) laws, and (iv) implementing regulations and autonomous regulations (Asshiddiqie & Safa'at, 2006) (Figure 2).

Law Number 12 of 2011 and Law Number 9 of 2015 give the right to the community to participate in the establishment





Figure 1. Hans Kelsen's hierarchy of norms theory



Figure 2. Hans Nawiasky's category of norms theory

of local regulation to provide input. If the established local regulation does not provide a space for the community to provide input, it means that the established local regulation contains a process contrary to the law. It can result in the cancellation of the local regulation through a judicial review to the Supreme Court.

The Supreme Court is authorized to declare invalid legislation under the Act, including a local regulation, if it is substantially contrary to a higher regulation or if the process of its establishment does not meet the applicable provision as regulated in Article 31 of Law Number 3 of 2009 on Supreme Court.

The cancellation of local regulation to the Supreme Court cannot be separated from the concept of Rechtsstaats (the rule of law). Allen and Thompson (2003) presented four basic judicial reviews which are the prerogative order, illegality, procedural impropriety and irrationality. Regarding the second reason, illegality can be specified

into several principles that can be used individually or collectively as a proposition to conduct a judicial review. First, an authority must not exceed its jurisdiction by purporting to exercise powers which it does not process. Second, an authority must direct itself properly to the law. Third, an authority must not use its power for an improper purpose. Fourth, an authority must take into account all relevant considerations and disregard all irrelevant considerations. Fifth, an authority to which the exercise of a discretion has been entrusted cannot delegate the exercise of its discretion to another unless clearly authorized to do so. Sixth, an authority must not fetter its discretion. Seventh, an authority acts unlawfully if it fails to fulfil a statutory duty. Eighth, an authority must not excessively interfere with fundamental rights.

A judicial review is one of the instruments created to oversee the deviations of state power (Wood, 1996). Supervision is important because it can be used as an early

detection tool for potential abuse of power (Huda, 2005). The deviation of state power is often poured into the product of law and is manipulation as well as a violation through the instrument of rules of those in power (Komisi Yudisial Republik Indonesia, 2002).

Therefore, the judicial review authority granted to the Supreme Court to cancel a local regulation is a safety net for the constitution in order not to be distorted in its practice (Fuady, 2001).

In addition, the formation of non-participatory local regulations will certainly have an impact on business and other economic activities. Principally, the regulation, in this case, the local regulation, can be grouped into 3 (three) categories, firstly the Local Economic Regulations which regulate the framework for economic, corporate and market players, secondly the Local Social Regulations that formulate the health, safety, and environmental standards as well as the mechanisms for their realization, and thirdly the Local Administrative Regulations pertaining to formalities and government administration (den Hertog, 1999).

Hence, local regulation making is the authority of the local government as stipulated in the Regional Autonomy Law of 1999 where the district/city government gains wider authority in issuing regulations. This is based on the regulation concerning the establishment of local regulation for a sustainable local autonomy as regulated in the Law Number 9 of 2015 on local government.

Although hierarchically the status of local regulations is under the national regulations, the local regulations become the spirit of local autonomy implementation in which the local government has the authority to regulate and administer its trade and industry, including business licenses and levies. However, in many cases, the local regulation does not solve the problems and is often contrary to the higher laws and regulations. TKED study in 2011 proves that about 72% of local regulations bring problems because they are formed without considering the community participation, and the substances often give burdens to people, particularly to the business actors (Ford Foundation & Komite Pemantauan Pelaksanaan Otonomi Daerah, 2013).

Thus, the non-participatory local regulations will give a burden to the business sector, which in turn will have an impact on the welfare of the people in fulfilling their economic rights.

## CONCLUSIONS

Establishing a local regulation without community participation will result in a non-aspirational local regulation, and is contrary to the principle of a democratic state. A non-aspirational local regulation will be difficult to be implemented because it does not provide solutions for the society and even causes social problems and can be cancelled through a judicial review to the Supreme Court. The cancellation of a local regulation will impede the efficiency of the local government.



There should be a strengthening action through the Code of Conduct of the Local People's Representative Assembly as well as the Decree of the Head of Local Government in each region that provides certainty about at which stage the community can participate in the establishment of local regulation and how the mechanism is. Therefore, to obtain an aspirational local regulation, the space for the community to participate should be given in three stages: at the stage of planning and preparing the local regulation draft, at the stage of discussing the local regulation draft, and at the stage of after becoming a local regulation.

## ACKNOWLEDGEMENT

The authors wish to acknowledge and thank all IMHA 2018 committee members and UPM *Pertanika* journal team that help publish this article.

## REFERENCES

- Abe, A. (2005). *Perencanaan daerah partisipatif* [Participatory regional planning]. Yogyakarta, Indonesia: Pembaruan.
- Allen, M., & Thompson, B. (2003). *Case and materials on constitutional and administrative law* (7th Ed.). London, England: Oxford University Press.
- Asshiddiqie, J. (2004). *Konstitusi dan konstitusionalisme Indonesia* [Constitution and constitutionalism in Indonesia]. Jakarta, Indonesia: Mahkamah Konstitusi Republik Indonesia dan Pusat Studi Hukum Tata Negara Fakultas Hukum Universitas Indonesia.
- Asshiddiqie, J. (1994). *Gagasan kedaulatan rakyat dalam konstitusi dan pelaksanaannya di Indonesia* [The idea of popular sovereignty in the constitution and its implementation in Indonesia]. Jakarta, Indonesia: PT. Ichtiar Baru Van Hoeve.
- Asshiddiqie, J., & Safa'at, M. A. (2006). *Teori Hans Kelsen tentang hukum* [Hans Kelsen's theory of law]. Jakarta, Indonesia: Sekretariat Jenderal dan Kepaniteraan Mahkamah Konstitusi Republik Indonesia.
- Attamimi, A. H. S. (1990). *Peranan keputusan presiden republik Indonesia dalam penyelenggaraan pemerintahan negara: Suatu studi analisis mengenai pengaturan dalam kurun waktu PELITA I-PELITA IV* [The role of the president's decision of the Republic of Indonesia in the administration of state government: An analytical study of the arrangements in the period of PELITA I – PELITA IV]. Jakarta, Indonesia: Fakultas Pasca Sarjana, Universitas Indonesia.
- Badan Pembinaan Hukum Nasional. (2011). Hasil pertemuan berkala XX kegiatan jaringan dokumentasi dari informasi hukum wilayah Jawa Barat di Palembang [The results of the regular meeting XX of documentation network activities from legal information in the West Java region in Palembang]. Jakarta, Indonesia: BPHN.
- Budiardjo, M. (2008). *Dasar-dasar ilmu politik* [The fundamentals of political science]. Jakarta, Indonesia: Gramedia Pustaka Utama.
- Dahl, R. A. (2001). *Perihal demokrasi, menjelajahi teori dan praktik demokrasi secara singkat* [Democracy: Exploring the theory and brief practice of democracy]. Jakarta, Indonesia: Yayasan Obor Indonesia.
- den Hertog, J. (1999). General theories of regulation. In B. Bouckaert & G. de Geest (Eds.), *Encyclopedia of Law and Economics* (pp. 223-270). Ghent, Belgium: Edward Elgar Publishing.
- Departemen Hukum dan Hak Asasi Manusia RI. (2009). *Panduan praktis memahami perancangan*

- peraturan daerah* [A practical guide in understanding the design of local regulations]. Jakarta, Indonesia: Dirjen Perundang-undangan.
- Departemen Pendidikan Nasional. (2007). *Kamus besar bahasa Indonesia*. Third edition. Jakarta, Indonesia: Balai Pustaka.
- Dewan Perwakilan Daerah Republik Indonesia. (2012). *Susunan dalam satu naskah rancangan undang-undang republik Indonesia tentang partisipasi masyarakat* [Composition in one script of the Republic of Indonesia law on community participation]. Jakarta, Indonesia: DPD RI.
- El-Muhtaj, M. (2008). *Dimensi-dimensi HAM, mengurai hak ekonomi, sosial, dan budaya* [Human rights dimensions, explaining economic, social and cultural rights]. Jakarta, Indonesia: Rajawali Press, RajaGrafindo Persada.
- Ford Foundation & Komite Pemantauan Pelaksanaan Otonomi Daerah. (2013). *Panduan pembuatan kebijakan (Perda ramah investasi)* [A guide in policy making (Investment friendly regional regulations)]. Jakarta, Indonesia: Ford Foundation dan KPPOD.
- Fuady, M. (2001). *Teori negara hukum modern* [Modern law state theory]. Bandung, Indonesia: Refika Aditama.
- Gauraf, D. (2002). *Belajar politik bersama masyarakat membangun demokrasi menuju masyarakat partisipatif* [Learning politics with the community in establishing democracy towards a participatory society]. Jakarta, Indonesia: JeMP.
- Griadhi, N. M. A. Y., & Utari, A. A. S. (2008). Partisipasi masyarakat dalam pembentukan peraturan daerah [Community participation in the formation of regional regulations]. *Kertha Patrika*, 33(1), 1-5.
- Halim, H. (2013). *Cara praktis menyusun dan merancang peraturan daerah: Suatu kajian teoritis dan praktis disertasi manual* [Practical ways of compiling and designing local regulations: A theoretical and practical study of a manual dissertation]. Jakarta, Indonesia: Kencana.
- Hamidi, J. (2011). *Optik hukum peraturan daerah bermasalah* [Legal optics in problematic regional regulations]. Jakarta, Indonesia: PT Prestasi Pustakaraya.
- Hasibuan, A. M. (2017). *Konsep judicial review dan pelembagaannya di berbagai negara* [The concept of judicial review and institutionalization in various countries]. Malang, Indonesia: Setara Press.
- Huda, N. (2005). *Negara hukum, demokrasi dan judicial review* [Rule of law, democracy and judicial review]. Jakarta, Indonesia: UII Press.
- Huntington, S. P., & Nelson, J. (1994). *Partisipasi politik di negara berkembang* [Political participation in developing countries]. Jakarta, Indonesia: Rineka Cipta.
- Indrati, M. F. (2005). Pembentukan peraturan perundang-undangan pasca amandemen UUD 1945 [Formation of laws and regulations after the amendment to the 1945 Constitution]. *Majalah Hukum Nasional*, 1, 98-98.
- Isra, S. (2010). *Pergeseran fungsi legislasi: Menguatnya model legislasi parlementer dalam sistem presidensial Indonesia* [Shifting the function of legislation: Strengthening the parliamentary legislation model in Indonesia's presidential system]. Jakarta, Indonesia: PT Rajagrafindo Persada.
- Joeniarto, R. (1992). *Perkembangan pemerintahan lokal* [Development of local government]. Jakarta, Indonesia: Bumi Aksara.
- Kementerian Hukum dan Hak Asasi Manusia Republik Indonesia. (2014). *Partisipasi masyarakat dalam penentuan arah kebijakan prioritas penyusunan*

- perundang-undangan* [Community participation in determining the direction of policy priorities in the formulation of legislation]. Jakarta, Indonesia: Badan Pembinaan Hukum Nasional, Kementerian Hukum dan Hak Asasi Manusia RI.
- Komisi Yudisial Republik Indonesia. (2002). *Dialektika pembaruan sistem hukum Indonesia* [The dialectics of Indonesia's legal system renewal]. Jakarta, Indonesia: Sekretariat Jenderal Komisi Yudisial Republik Indonesia.
- Kurnia, M. P. (2007). *Pedoman naskah akademik peraturan daerah partisipatif* [Guidelines for the academic script of participatory regional regulation]. Yogyakarta, Indonesia: Kreasi Total Media.
- Kusumah, M. W. (1986). *Perspektif, teori dan kebijaksanaan hukum* [Perspectives, theories and legal wisdom]. Jakarta, Indonesia: Rajawali.
- Mahfud, M. D. M. (2001). *Politik hukum Indonesia* [Indonesian legal politics]. Jakarta, Indonesia: LP3ES.
- Mahfud, M. D. M. (1999). *Pergulatan politik dan hukum di Indonesia* [Political and legal struggle in Indonesia]. Yogyakarta, Indonesia: Gama Media.
- Makhfudz, M. (2012). Kontroversi pelaksanaan otonomi daerah [The controversy over the implementation of regional autonomy]. *ADIL: Jurnal Hukum*, 3(2), 380-407.
- Manan, B. (1993). *Perjalanan historis pasal 18 Undang-Undang Dasar 1945, perumusan dan undang-undang pelaksanaannya* [Historical journey of article 18 of the 1945 Constitution, formulation and the law for its implementation]. Jawa Barat, Indonesia: Karawang, UNSIKA.
- Manan, B. (2001). *Menyongsong fajar otonomi daerah* [Welcoming the dawn of regional autonomy]. Yogyakarta, Indonesia: Pusat Studi Hukum, Fakultas Hukum, Universitas Islam Indonesia.
- Marzuki, M. L. (2010). Konstitusi dan konstitusionalisme [Constitution and constitutionalism]. *Jurnal Konstitusi*, 7(4), 1-8.
- Meyer, T. (2012). *Kompromi jalur ideal menuju demokrasi* [Compromise the ideal path to democracy]. Jakarta, Indonesia: Friedrich-Ebert-Stiftung (FES).
- Muhiddin, A. (2013). Partisipasi masyarakat dalam pembuatan peraturan daerah [Community participation in forming local regulations]. *Otoritas: Jurnal Ilmu Pemerintahan*, 3(1), 1-9.
- Nasution, F. A. (2003). *Dimensi hukum dalam pemerintahan daerah* [The legal dimension in local government]. Medan, Indonesia: Pustaka Bangsa Press.
- Nonet, P., & Selznick, P. (2007). *Hukum responsif* [Responsive law]. Bandung, Indonesia: Penerbit Nusamedia.
- Noor, M. (2012). *Memahami desentralisasi Indonesia* [Understanding Indonesia's decentralization]. Yogyakarta, Indonesia: Interpena.
- Palmer, D. (2006). *Looking at philosophy: The unbearable heaviness of philosophy made lighter*. New York, USA: McGraw-Hill Companies.
- Pambudi, P. A. (2007). Peraturan daerah dan hambatan investasi [Regional regulations and investment barriers]. *JENTERA: Jurnal Hukum*, 14(4), 42-42.
- Patlis, J. M. (2004). *Pedoman umum penyusunan peraturan daerah pengelolaan hutan* [General guidelines for preparing forest management regional regulations]. Jakarta, Indonesia: Center for International Forestry Research (CIFOR).
- Piliang, I. J., Ramdani, R., & Pribadi, R. (2003). *Otonomi daerah: evaluasi dan proyeksi* [Regional autonomy: evaluation and projection]. Jakarta, Indonesia: Yayasan Harkat Bangsa.
- Purbacaraka, P. (1979). *Perihal kaidah hukum* [Rule of law]. Bandung, Indonesia: Opset Alumni.

- Putra, A., Silitonga, I., & Wardhani, T. (2014). *Menuju demokrasi bermakna: Persoalan-persoalan perbaikan representasi politik di Indonesia* [Meaningful democracy: Problems of improving political representation in Indonesia]. Jakarta, Indonesia: Indonesian Centre for Democracy and Human rights (DEMOS).
- Rawasita, R. (2009). *Menilai tanggung jawab sosial peraturan daerah* [Assessment on the social responsibility of local regulations]. Jakarta, Indonesia: Pusat Studi Hukum dan Kebijakan Indonesia (PSHK).
- Saifudin. (2009). *Partisipasi publik dalam pembentukan peraturan perundang-undangan* [Public participation in the formation of laws and regulations]. Yogyakarta, Indonesia: Fakultas Hukum, Universitas Islam Indonesia Press (FH UII).
- Santosa, M. A. (2001). *Akseptabilitas sosial sebagai faktor penentu kualitas peraturan perundang-undangan* [Social acceptability as a determining factor in the quality of laws and regulations]. Jakarta, Indonesia: ICEL.
- Saragih, T. M. (2011). Konsep partisipasi masyarakat dalam pembentukan peraturan daerah, rencana detail tata ruang dan kawasan [The concept of community participation in the formation of regional regulations, detailed spatial and regional plans]. *Jurnal Sasi*, 17(3), 11-20.
- Sastropoetro, A. S. (1986). *Partisipasi, komunikasi, persuasi dan disiplin dalam pembangunan nasional* [Participation, communication, persuasion and discipline in national development]. Bandung, Indonesia: Alumni.
- Siahaan, P. (2012). *Politik hukum pembentuk undang-undang pasca amandemen UUD 1945* [Political law forming laws after the 1945 amendment]. Jakarta, Indonesia: Konstitusi Press.
- Sihombing, E. N. A. M., & Hasibuan, A. M. (2017). *Ilmu perundang-undangan* [Legislation]. Medan, Indonesia: Pustaka Prima.
- Sirajuddin. (2007). *Legislative drafting: Pelembagaan metode partisipatif dalam pembentukan peraturan perundang-undangan* [Legislative drafting: Institutional participatory methods in the formation of laws and regulations]. Malang, Indonesia: MCW and YAPPIKA.
- Sudarsono. (1991). *Pengantar ilmu hukum* [Introduction to law]. Jakarta, Indonesia: PT. Rineka Cipta.
- Sunarno, H. S. (2006). *Hukum pemerintahan daerah di Indonesia* [Local government law in Indonesia]. Jakarta, Indonesia: Sinar Grafika.
- Surbakti, R. (1992). *Memahami ilmu politik* [Understanding political science]. Jakarta, Indonesia: PT. Gramedia Widiasarana Indonesia.
- Suseno, F. M. (1987). *Etika politik: prinsip-prinsip moral dasar kenegaraan modern* [Political ethics: basic moral principles of modern statehood]. Jakarta, Indonesia: Gramedia Pustaka Utama.
- Syahrizal, A. (2006). *Peradilan konstitusi: Suatu studi tentang adjudikasi konstitusional sebagai mekanisme penyelesaian sengketa normatif* [Constitutional justice: A study of constitutional adjudication as a normative dispute resolution mechanism]. Jakarta, Indonesia: Pradnya Paramita.
- Thohari, A. A. (2011). Reorientasi fungsi legislasi dewan perwakilan: Upaya menuju undang-undang responsif [Reorientation of legislative functions of the representative council: Efforts towards responsive legislation]. *Journal Legislasi Indonesia*, 8 (4), 569-569.
- Tjandra, W. R., & Darsono, K. B. (2009). *Legislative drafting*. Yogyakarta, Indonesia: Atma Jaya.
- Trijono, R. (2013). *Dasar-dasar ilmu pengetahuan perundang-undangan* [The fundamentals of legislative science]. Jakarta, Indonesia: Papas Sinar Sinanti.
- Vlies, I. C. V. D. (2005). *Buku pegangan perancangan peraturan perundang-undangan* [Handbook on

- the drafting of laws and regulations]. Jakarta, Indonesia: Dirjen Peraturan Perundang-undangan Departemen Hukum dan HAM.
- Warouw, A. R. (2014). Tugas dan tanggung jawab masyarakat dalam pembentukan peraturan daerah [Duties and responsibilities of the community in forming regional regulations]. *Journal Lex Administratum*, 2(1), 9-10.
- Widjaja, H. A. W. (2010). *Otonomi daerah* [Regional autonomy]. Jakarta, Indonesia: Grafindo.
- Wiratraman, R. H. P. (2010). Dinamika otonomi daerah dalam pengembangan metode partisipasi publik pembentukan peraturan perundang-undangan [The dynamics of regional autonomy in developing methods of public participation in the formation of laws and regulations]. *Journal Yuridika*, 25(2), 128-150.
- Wood, D. (1996). Judicial invalidation of legislation and democratic principles. In C. Sampford & K. Preston (Eds.), *Interpreting constitutions: Theories, principles and institutions* (pp. 169-183). Sydney, Australia: The Federation Press.
- Yuliandri. (2011). *Asas-asas pembentukan peraturan perundang-undangan yang baik: Gagasan pembentukan undang-undang berkelanjutan* [Principles for establishing good legislation: Ideas for establishing sustainable laws]. Jakarta, Indonesia: Rajawali Press.
- Yunus, U., Sari, S. A., & Patriana, R. C. (2016). Excellent communication in Indonesian government culture to reach good public governance. *Pertanika Journal of Social Sciences and Humanities*, 24(S), 11-18.
- Yusdiyanto. (2012). Implementasi kewenangan kepala daerah dalam pembuatan perda dan peraturan lainnya [Implementation of the authority of regional heads in making regulations and other regulations]. *Journal Ilmu Hukum Fiat Justitia*, 6(3), 1 – 9.



## Sustainability Report Analysis: Content and Quality GRI-G4

**Acep Komara<sup>1\*</sup>, Imam Ghozali<sup>2</sup> and Indira Januarti<sup>2</sup>**

*<sup>1</sup>Faculty of Business and Economics, Diponegoro University, Kota Semarang, Jawa Tengah 50275, Indonesia*

*<sup>2</sup>Department of Accounting, Faculty Business and Economic, Diponegoro University, Kota Semarang, Jawa Tengah 50275, Indonesia*

### ABSTRACT

The purpose of this study was to measure the content and quality of sustainability report companies listed on Indonesia Stock Exchange (IDX) related to aspects of strategy, general analysis, and economic aspects in accordance with the principles of reporting set GRI-G4. This research used qualitative methods, the research data was obtained indirectly (secondary data) from the official website of the Global Reporting Initiative. Sampling in this research was done by using purposive sampling method so that there were 13 samples which had characteristic and representative conformity. The results of this study noted that the average existence of Indonesian companies in the sustainability report was very low. They generally used only 1 indicator in the aspect of strategy and company analyst (G4-1) and 3 indicators on economic aspects (G4-EC1, G4-EC7, and G4-EC8). In addition, statistically descriptive of content test results and quality of sustainability report, especially on indicators of G4-1, G4-2, G4-EC1 to G4-EC9 had low rates as well.

*Keywords:* Assessment, completeness, context, inclusiveness, CSR, reporting

### ARTICLE INFO

#### *Article history:*

Received: 9 October 2019

Accepted: 3 January 2020

Published: 17 March 2020

#### *E-mail addresses:*

[acepkomara@unswagati.ac.id](mailto:acepkomara@unswagati.ac.id) (Acep Komara)

[ghozali\\_imam@yahoo.com](mailto:ghozali_imam@yahoo.com) (Imam Ghozali)

[ienjanuarti@gmail.com](mailto:ienjanuarti@gmail.com) (Indira Januarti)

\*Corresponding author

### INTRODUCTION

CSR is now an important issue in many parts of the world and as the times progressed, companies are required to pay not only profit or shareholder but the company should participate responsibly with the condition and situation of society and environment around companies where they run their regular operations (Wolniak & Hąbek, 2016).



One form of corporate responsibility communication to the condition of society and the environment is to publish company sustainability report in a voluntary. Sustainability report plays an important role in solving some social and environmental problems in the organization, especially related to organizational legitimacy, help management to manage public perceptions and maintain good relationships with communities (Michelonet et al., 2015).

Limijaya (2014) and Junior et al. (2014) identified the underlying weaknesses of sustainability reports supported by previous research references, as well as those deficiencies which are 1) the absence of the same unit of measure for each component in the report, 2) tends to narrative report content, 3) has not been fully standardized (quality assurance services or benchmarking are made separately); 4) is just a medium of improving corporate image in the public eye; 5) not much different from traditional financial report and 6) unclear definition of sustainability development concept. According to Sethi et al. (2017) sustainability report does not reflect strict and objective report to increase public confidence and potentially lead conflicts of interest and heighten suspicions on the public auditor.

In contrast to previous research, the main objective of this study was to analyze the degree of economic aspects and the quality of voluntary sustainability reports in accordance with the reporting principles laid down by GRI-G4 Guidelines. Therefore, the

research question in the study is formulated as follows:

Has the sustainability report of Indonesian companies met the aspects of strategic, analyzes and economic that are consistent with the GRI-G4 guidelines?

1. Is the Indonesian content sustainability report based on GRI's reporting principles?
2. Is the quality of Indonesia's sustainability report based on GRI's reporting principles?

## Literature Review

**Sustainability Report.** Sustainability report can be defined as a form of report from the results of data collection/information of development company sustainability program measured, analyzed, communicated periodically to stakeholders and shareholders (Junior et al., 2014), to assist management in setting goals, governance, and operations (Kozlowski et al., 2015) in supporting the raising of awareness on environmental, social, and economic responsibilities and issues (Ioannou & Serafeim, 2017; Maas et al., 2016) especially related to organizational legitimacy (Michelon et al., 2015).

By publishing a good sustainability report, according to Ioannou and Serafeim (2017) indirectly the company seeks to enhance the company's reputation, create superior brand value, improve employee and employee welfare, open opportunities to improve operational efficiency and minimize hidden risks, and open access to financially better institutions.



**GRI-G4 Reporting Principles Assessment.**

Data quality plays an important role in all business and government applications and as a requirement of inter-organizational cooperation, especially in sustainability reports using GRI-G4 Guidelines. However, the quality of the data is recognized as having problems relevant to the operation and decision-making process (Batini et al., 2009), developed ad-hoc to solve specific problems (Pipino et al., 2002).

Assessment of data in sustainability report is an evaluation methodology of statistical and scientific report characteristics using the information on GRI G4 Guidelines so that it can describe the context, structure and language commonly used, both quantitatively and qualitatively in helping the business process of its users. The purpose of the assessment data is to expose the problem of technical and business data that enable the organization to maintain system integrity, quality assurance standards and compliance issues. In general, the problem of structure consistency and data loss can be easily identified easily and repaired as early

as possible (Batini et al., 2009; Pipino et al., 2002; Wolniak & Habek, 2016).

According to Wolniak and Habek (2016) the principles of reporting on GRI guidelines are divided into two, content principle (quantitative) covering the elements of stakeholder inclusiveness, sustainability context, materiality, and completeness. While the quality principle (qualitative) includes elements of balance, comparability, accuracy, timeliness, clarity and reliability (Figure 1).

**Content Principle.** The principle of content measurement in GRI-G4 guidelines is how to report users can assess data or information in numbers or quantitative numbers, so it can be said that the content report assessment is used to know the amount of an object that the company publishes in report to safeguard data or published information remains tangible and acceptable to the five senses (analyzed carefully and accurately in order to obtain a degree of compliance with the GRI-G4 guidelines). The elements in the content principle studied are described as follows:

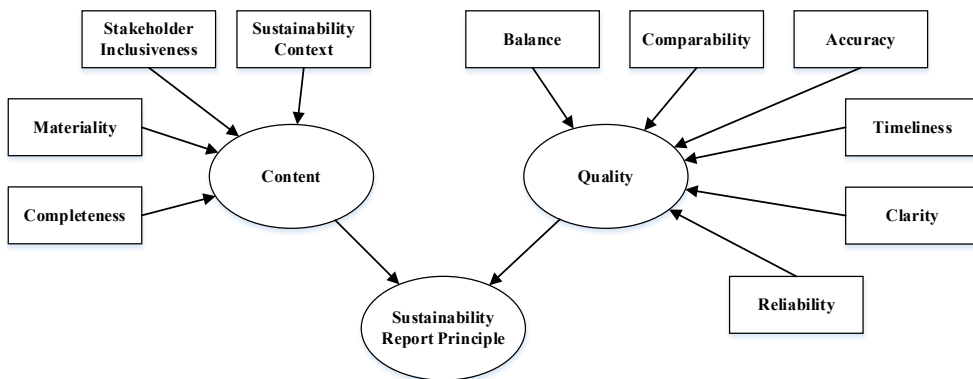

Figure 1. GRI G4 Reporting Principles Scheme (Wolniak & Habek, 2016)

**Stakeholder Inclusiveness.** Stakeholder inclusiveness can be defined as the degree of stakeholder involvement of interests and expectations that reasonably deserves to be considered in order to meet the achievement of long-term good and sustainable development (Eskerod et al., 2015; Guixet al., 2017; Herremans et al., 2016; Steyn & Niemann, 2014).

**Sustainability Context.** Sustainability context is the degree of conformity of statements and intra/inter-company support on the fair expectations of stakeholders on the main issues of sustainable development, especially in the economic, environmental or social, both short and long term (Amini & Bienstock, 2014; Chen et al., 2017; Searcy, 2016; Strand et al., 2015).

**Materiality.** Materiality is the degree of clarity of the coverage of key aspects or details of the main issues of the company that reflect significant economic, environmental, social and organizational impacts that influence the outcomes of stakeholder assessments involved (Baviera-Puiget al., 2015; Eccles & Krzus, 2015; Guix et al., 2017; Jones et al., 2016).

### **Completeness**

Completeness is the degree of data or information collected has been completed in accordance with the scope, limitations, needs, rules, guidelines, and time set (Batini et al., 2009; Baviera-Puig et al., 2015; Cai & Zhu, 2015; Wolniak & Hąbek, 2016).

**Quality Principle.** The principle of quality measurement in GRI-G4 guidelines is

how to measure reports in narrative form, not in the form of numbers (qualitative). Quality assessment is used to determine the quality of an object to be studied that tends to be abstract so that users need a deep understanding. The elements in the quality principle studied are described as follows:

**Balance.** Balance is defined as the degree of representation of data or information that is equal between the actual condition with the contribution, impact and risk of the development of the company's sustainability ( Chauvey et al., 2015; Carroll, 1999; Junior et al., 2014; Tchernykh et al., 2016).

**Comparability.** Comparability is the degree of comparison of similarities or differences in the important criteria of a data or information with a report format similar in other time periods so as to enable users to evaluate the performance of each company (Chauvey et al., 2015; Diouf & Boiral, 2017; Fonseca et al., 2012; Ștefănescu et al., 2016).

**Accuracy.** Accuracy is a detailed data or information that has breadth, depth, surrounds the entity, and represents the reality of the original source (Batini et al., 2009; Cai & Zhu, 2015; Wolniak & Hąbek, 2016).

**Timeliness.** Timeliness is a capacity of data or information that is periodically relevant to the actual event in order to be able to help users make decisions (Cai & Zhu, 2015; Ghozali & Chariri, 2007; Keller et al., 2017; Wolniak & Hąbek, 2016).

**Clarity.** Clarity is the degree of meaning of specific data or information that is

disclosed and presented not blur, it can be understood and presented in a structured report related to the main issues so that can be accessed and used by stakeholders without a great effort in making decisions (Chauvey et al., 2015; Diouf & Boiral, 2017; Ștefănescu et al., 2016; Unerman & Zappettini, 2014).

**Reliability.** Reliability can be defined as the degree of consistency of data or information resulting in the same decision of selective test results over time free from error, material bias and can be accounted for by verified evidence so that it can be deduced (Golafshani, 2003; Manetti & Becatti, 2009; Milne & Adler, 1999; Ștefănescu et al., 2016).

## MATERIALS AND METHODS

This research used a qualitative method in analyzing the sustainability report of listed companies in IDX related to the aspect of strategy, general analysis, and economic in accordance with GRI-G4's reporting principles. This research data was obtained indirectly (secondary data) from the official website of GRI.

The population of this study were all companies listed in IDX (2018), sampling in this research used purposive sampling method with consideration of characteristic suitability with sample criterion in order to get a representative sample. The condition or serenteristic that was observed, manipulated in the research was the data quality of the strategy and general analysis and the economic aspects related to sustainable

development, both the report content and quality.

This research instrument used available GRI-G4 guidelines and focused on strategic and analytical aspects (G4-1 and G4-2) and economic aspects (G4-EC1 to G4-EC9). The measurement of all indicators used Guttman scale to produce binary values (1 = No and 2 = Yes) and indicated the condition under study really had included quantitative data and qualitative data on sustainability report.

### Content Report Test

Content sustainability report testing would be measured based on the degree of stakeholder inclusiveness, sustainability context, materiality, and completeness. The quantitative data testing research instrument had been provided in the guidance of GRI (2014), in Table 1-4.

### Quality Report Test

Quality sustainability report will be measured based on the degree of balance, comparability, accuracy, timeliness, clarity and reliability. The qualitative research data testing instrument has been provided in the guide of GRI (2014) on Table 5-10.

Data processing of this research is only limited to describe the state of content and report quality sustainability report and control variables as it is with some other statistical parameters (descriptive statistics) and crosstab analysis. Descriptive statistics would be presented in this study, namely a) measures of central tendency and b) measures of spread.

Table 1

*Stakeholder inclusiveness indicators*

Code	Question Items	Scales
Inclu1	Companies can sort out their responsibilities based on stakeholder groups.	Binary
Inclu2	The content of the report refers to the outcomes of stakeholder relations processes in ongoing activities based on the legal framework and company rules.	
Inclu3	The content of the report refers to the outcome of any stakeholder relations process undertaken specifically for the report	
Inclu4	The stakeholder relations process informs decisions that are consistent with the boundary aspects	

Table 2

*Sustainability context indicators*

Code	Question Items	Scales
Suscon1	The Company demonstrates its understanding of sustainable development that refers to objective and available information along with sustainable development measures on topics report	Binary
Suscon2	The Company demonstrates its performance with reference to the conditions of sustainable development and broader targets, as reflected in sectoral and global publications	
Suscon3	The Company demonstrates its performance in an effort to convey the magnitude of the impact and contribution in the appropriate geographical context	
Suscon4	The report describes how sustainability topics are linked to strategies, risks, and opportunities.	

Table 3

*Materiality indicators*

Code	Question Items	Scales
Matre1	The Company has reasonably considered the impacts, risks or opportunities of sustainability identified through adequate research by recognized experts.	Binary 1= No 2=Yes
Matre2	Key interests and topics of sustainability and indicators are addressed by stakeholders.	
Matre3	Future topics and future challenges for sectors are reported by other companies.	

Table 3 (Continued)

Code	Question Items	Scales
Matre4	International laws or regulations that are relevant to strategic interests for organizations and stakeholders	
Matre5	Values, policies, strategies, operational management systems, objectives, and targets of the organization	
Matre6	The interests and expectations of stakeholders are invested specifically in the success of the company.	
Matre7	Significant risk to the company	
Matre8	Important factors that enable the success of the company	
Matre9	The main competencies and ways the company contributes to sustainable development	
Matre10	Reports prioritize indicators on material aspects	

Table 4

*Completeness indicators*

Code	Question Items	Scales
Comple1	The report takes into account the impacts inside and outside the company and includes and prioritizes.	Binary
Comple2	The information in the report covers all significant impacts in the reporting period and future fair estimates if they are predictable and unavoidable.	
Comple3	The report does not remove any relevant information affecting or informing stakeholder assessments	

Table 5

*Balance indicators*

Code	Question Items	Scales
BALAN1	Reports reveal both favourable and unfavourable outcomes	Binary
BALAN2	The information in the report is presented in a format that allows users to see positive and negative trends over performance from year to year	
BALAN3	The emphasis on various aspects of the report is proportional to its relative materiality aspect	

Table 6

*Comparability indicators*

Code	Question Items	Scales
COMPAR1	The report shows the measured data	Binary
COMPAR2	The data measurement techniques and calculation basis are clearly defined and can be repeated with the same results	
COMPAR3	The margin of errors for quantitative data will not substantially affect the stakeholder decision to reach the right final conclusions about performance	
COMPAR4	The report shows estimation data there are basic assumptions and techniques used in generating these estimates.	
COMPAR5	The qualitative statements in the report are valid based on information in other reports and other available evidence	

Table 7

*Accuracy indicators*

Code	Question Items	Scales
ACCURA1	The report shows the measured data	Binary
ACCURA2	The data measurement techniques and calculation basis are clearly defined and can be repeated.	
ACCURA3	The margin of errors for quantitative data will not substantially affect the stakeholder decision to reach the right final conclusions about performance	
ACCURA4	The report shows estimation data there are basic assumptions and techniques used in generating these estimates.	
ACCURA5	The qualitative statements in the report are valid based on information in other reports and other available evidence	

Table 8

*Timeliness indicators*

Code	Question Items	Scales
TIME1	The information in the report has been revealed during the reporting period	Binary
TIME2	The collection and publication of key performance information is aligned with the reporting schedule	
TIME3	The information in the report clearly shows the related time period.	

Table 9

*Clarity indicators*

Code	Question Items	Scales
CLARI1	The report shows the measured data	Binary
CLARI2	The data measurement techniques and calculation basis are clearly defined and can be repeated.	
CLARI3	The margin of errors for quantitative data will not substantially affect the stakeholder decision.	
CLARI4	The report shows estimation data there are basic assumptions and techniques used in generating these estimates.	

Table 10

*Reliability indicators*

Code	Question Items	Scales
RELIA1	The report shows the measured data	Binary
RELIA2	The data measurement techniques and calculation basis are clearly defined and can be repeated with the same results	
RELIA3	The margin of errors for qualitative data will not substantially affect the stakeholder decision	
RELIA4	The report shows estimation data there are basic assumptions and techniques used in generating these estimates	

## RESULTS AND DISCUSSIONS

Filtering involves checking raw data before performing data analysis. Based on purposive sampling method, companies that match with criterion in research was as many as 13 companies that had given voluntarily sustainability report on GRI period 2017-2018 (Table 11).

The total of 555 listed companies in IDX in 2017-2018, only 13 companies or 2.3% had voluntarily provided sustainability reports to the GRI. Based on firm size, the reporting companies were nominated by Large-scale companies as many as 11 companies and the rest were Multinational Enterprise as many as 2 companies. Firm size in the GRI-G4 guide follows the EU

size definition, while the firm size of the Indonesian company voluntarily published a sustainability report, i.e. 2 MNE scale companies or only 0.3% of the total listed companies in IDX and 11 companies in LARGE scales or just 2% of total companies registered in IDX. While based on the report type, adherence level, assurance standards and external opinions are described in Table 12.

The following shows the existence of the company in fulfilling the aspects of strategy and general analysis and economic aspects of their sustainability report on GRI-G4 guidelines for the period of 2016-2017.

Figure 2 shows clearly only 1 of 2 indicators on aspects of strategy and general

Table 11  
Listed IDX volunteer company on GRI 2017-2018

List of IDX volunteer company	
1	Astra Agro Lestari Tbk
2	Astra International Tbk
3	Bank Central Asia Tbk
4	Bank Mandiri Tbk
5	PT Bank Maybank Indonesia Tbk
6	Bank Permata Tbk
7	Vale Indonesia Tbk
8	Indo Tambangraya Megah Tbk
9	Jasa Marga Tbk
10	Holcim Indonesia Tbk
11	Semen Indonesia (Persero) Tbk
12	Timah Tbk
13	Telekomunikasi Indonesia Tbk

Table 12  
Characteristics of the Indonesian sustainability report on GRI

Description	Q Firm	%	
Report Type	Non-GRI	1	0.15%
	Citing - GRI	1	0.15%
	GRI-G4	11	2.00%
Adherence Level	None GRI	2	0.36%
	Undeclared	1	0.18%
	In Accordance-Core	10	1.80%
Assurance standard	5	0.90%	
External opinion	2	0.36%	

analysis of G4-1, while of the 9 indicators on economic aspects of sustainability report only 3 indicators used, namely G4-EC1, G4-EC7 and G4-EC8. From all indicators in the research, only 5 companies consistently followed GRI-G4 guidelines in the sustainability report.

Based on Table 13, it can be seen the results of content test on G4-1, G4-2, G4-EC1 to G4-EC9 sustainability report indicator is 285,8 or 53,8% from sample (7 companies) having value in for its mean, while the value of  $\sigma$  quantitative data sustainability report of 249.4 tends to approach the sample mean.



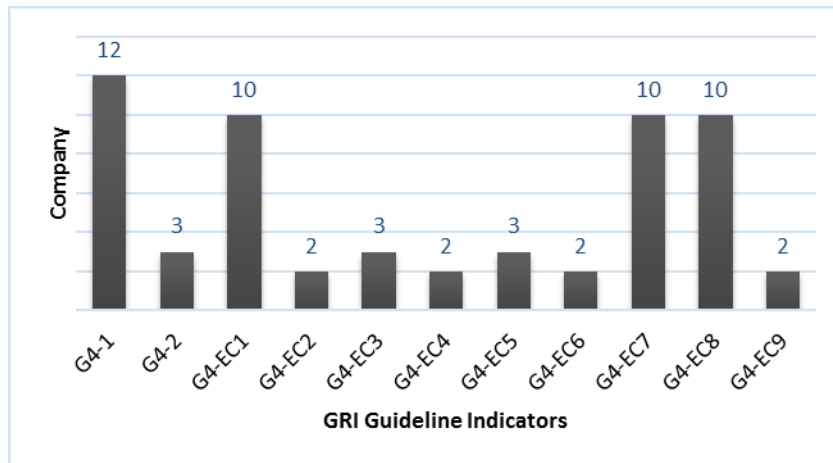

Figure 2. GRI-G4 Indicators

Table 13

*Descriptive statistics of content test*

Content test measurement		Inclusiveness	Context	Materiality	Completeness
N	Valid	13	13	13	13
	Missing	0	0	0	0
Mean		55.46	54.92	134.77	40.69
Percentage		46.2%	46.2%	53.8%	46.2%
X Company		6	6	7	6
$\sigma$ Result		48.110	47.116	118.698	35.864
		Approaching	Approaching	Approaching	Approaching

Based on Figure 3, the average degree of completeness is the lowest compared with the other content dimensions of 40.7 while the highest is the degree of materiality of 134.8.

Based on Table 14, the result of the quality test on G4-1, G4-2, G4-EC1 to G4-EC9 sustainability report indicator is 747,7 or 53,8% from the sample (7 companies) which has value above its mean, while  $\sigma$  quality of sustainability report of 405.5 tends to approach the sample mean.

Based on Figure 4, the average degree of balance is the lowest compared with other report quality dimensions of 85.0 while the highest is the degree of comparability that is equal to 156.8.

The average accumulated degree of the sustainability report is 1033.6 or 46.2% of the sample (6 companies) which has a value above the mean, while the  $\sigma$  quantitative and qualitative sustainability report of 618.3 tend to approach the sample mean.

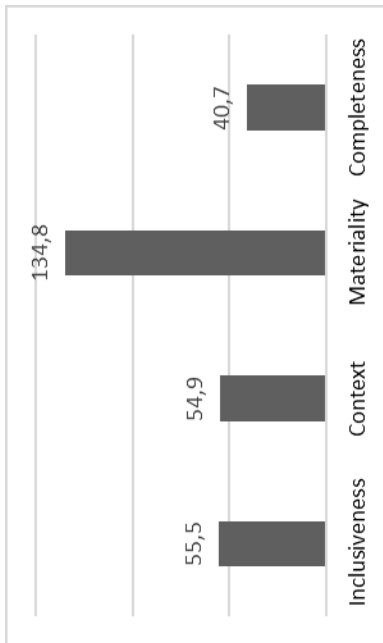

Figure 3. Content sustainability report

Table 14

*Descriptive statistics of quality test*

Quality test measurement	Balance	Comparability	Accuracy	Timeliness	Clarity	Reliability
N Valid	13	13	13	13	13	13
Missing	0	0	0	0	0	0
Mean	85.00	153.46	156.77	97.62	126.85	128.08
Percentage	46.2%	61.5	53.8%	53.8%	53.8%	53.8%
X Company	6	8	7	7	7	7
σ Result	54.935	79.342	86.188	51.547	68.977	67.900
	Approaching	Approaching	Approaching	Approaching	Approaching	Approaching

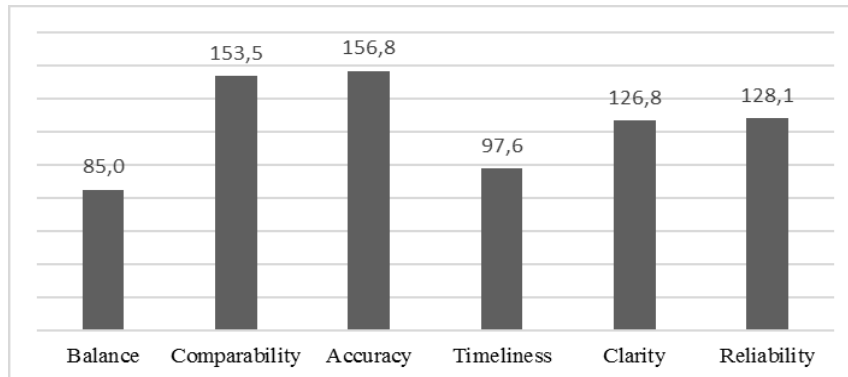

Figure 4. Quality sustainability report

Chi-square test results are known that the whole dimension of content has Asymp. Sig value  $<0.05$  which means that the overall dimension of the report content is significantly correlated with the degree of sustainability content of other companies (Table 15).

While the results of Chi-square test for all quality dimensions are known to have value Asymp.Sig.  $<0.05$  or the overall degree of report quality correlated

significantly with the degree of quality of sustainability reports from other firms (Table 16).

Overall the content dimensions and report quality are known to have Asymp. Sig value  $<0.05$  or the overall degree of content report correlated significantly with the degree of sustainability reports of other firms (Table 17).

Table 15

*Chi-Square test of report content*

Quantitative data	Asymp. Sig.		Result
Inclusiveness	0.002	$<0.05$	Correlated
Context	0.002	$<0.05$	Correlated
Materiality	0.000	$<0.05$	Correlated
Completeness	0.002	$<0.05$	Correlated

Table 16

*Chi-Square test of quality*

Qualitative data	Asymp. Sig.		Result
Balance	0.002	$<0.05$	Correlated
Comparability	0.002	$<0.05$	Correlated
Accuracy	0.000	$<0.05$	Correlated
Timeliness	0.000	$<0.05$	Correlated

Table 16 (Continued)

Qualitative data	Asymp. Sig.		Result
Clarity	0.000	<0.05	Correlated
Reliability	0.000	<0.05	Correlated

Table 17

*Chi-Square test of sustainability reports*

Data quality	Asymp. Sig.		Result
Content	0.048	<0.05	Correlated
Quality	0.002	<0.05	Correlated

## CONCLUSIONS

The existence of Indonesian companies in meeting the various aspects of the GRI-G4 guidelines for the period 2016-2017 is very low, as seen from the 11 indicators of GRI-G4 are only 4 indicators (G4-EC1, G4-EC7 and G4-EC8) shown in the sustainability report. This study supports the opinion of Mahoney et al. (2013) where sustainability report is out of the ordinary, report makers and users are confronted with the many hidden indicators that make it difficult for users to rate their reports in a short period of time. In general, it can be concluded that the voluntary reporting of sustainability report of Indonesian companies in GRI is just for greenwash.

The result of content test, especially on indicator of G4-1, G4-2, G4-EC1 to G4-EC9 is known to have low average, so it can be concluded that companies in Indonesia in making content sustainability report do not follow the guidance report that has been set on GRI-G4 and tend to have similarities with other companies in Indonesia. The result of quality test especially on the

indicator of G4-1, G4-2, G4-EC1 to G4-EC9 is known to have low average, so it can be concluded that the quality of sustainability report company in Indonesia does not meet the quality of reports set in GRI-G4 and tend to have in common with other companies in Indonesia.

This study supports the opinion of Limijaya (2014) where the main strategy presented in the sustainability report of companies in Indonesia only focus on the interests of shareholders rather than stakeholders. The phenomenon in this study supports the opinion of Wolniak & Hąbek (2016), wherefrom the many sustainability reports of Indonesian companies publishing on the GRI there is still a considerable gap between good and relevant reports with inadequate reports. Qualitatively, this study also supports the opinion of Junior et al. (2014) and Sethi et al. (2017) where voluntary reporting of sustainability reports of companies in Indonesia does not reflect rigorous, objective, and undoubtedly the reliability and accuracy of the reports, although some companies have used quality certification from third parties and away

from the actual conditions that stakeholders want.

## ACKNOWLEDGEMENT

The authors wish to acknowledge and thank all IMHA 2018 committee members and UPM *Pertanika* journal team that help publish this article.

## REFERENCES

- Amini, M., & Bienstock, C. C. (2014). Corporate sustainability: An integrative definition and framework to evaluate corporate practice and guide academic research. *Journal of Cleaner Production*, 76(2014), 12–19.
- Batini, C., Cappiello, C., Francalanci, C., & Maurino, A. (2009). Methodologies for data quality assessment and improvement. *ACM Computing Surveys*, 41(3), 1-52.
- Baviera-Puig, A., Gómez-Navarro, T., García-Melón, M., & García-Martínez, G. (2015). Assessing the communication quality of CSR reports. A case study on four Spanish food companies. *Sustainability (Switzerland)*, 7(8), 11010-11031.
- Cai, L., & Zhu, Y. (2015). The challenges of data quality and data quality assessment in the big data era. *Data Science Journal*, 14(0), 2-11.
- Carroll, A. B. (1999). Corporate social responsibility: Evolution of a definitional construct. *Business and Society*, 38(3), 268-295.
- Chauvey, J. N., Giordano-Spring, S., Cho, C. H., & Patten, D. M. (2015). The normativity and legitimacy of CSR disclosure: Evidence from France. *Journal of Business Ethics*, 130(4), 789-803.
- Chen, H., Zeng, S., Lin, H., & Ma, H. (2017). Munificence, dynamism, and complexity: How industry context drives corporate sustainability. *Business Strategy and the Environment*, 26(2), 125-141.
- Diouf, D., & Boiral, O. (2017). The quality of sustainability reports and impression management. *Accounting, Auditing and Accountability Journal*, 30(3), 643-667.
- Eccles, R. G., & Krzus, M. P. (2015). *The integrated reporting movement*. New York, USA: John Wiley & Sons, Inc..
- Eskerod, P., Huemann, M., & Ringhofer, C. (2015). Stakeholder inclusiveness: Enriching project management with general stakeholder theory. *Project Management Journal*, 46(6), 42-53.
- Fonseca, A., McAllister, M. L., & Fitzpatrick, P. (2012). Sustainability reporting among mining corporations: A constructive critique of the GRI approach. *Journal of Cleaner Production*, 84(1), 70-83.
- Ghozali, I., & Chariri, A. (2007). *Teori Akuntansi [Accounting Theory]*. Semarang, Indonesia: Badan Penerbit Universitas Diponegoro.
- GRI. (2014). *G4 sustainability reporting guidelines*. Retrieved November 18, 2017, from <https://www.globalreporting.org/standards>
- Golafshani, N. (2003). Understanding reliability and validity in qualitative research understanding reliability and validity in qualitative research. *The Qualitative Report*, 8(4), 597-606.
- Guix, M., Bonilla-Priego, M. J., & Font, X. (2017). The process of sustainability reporting in international hotel groups: an analysis of stakeholder inclusiveness, materiality and responsiveness. *Journal of Sustainable Tourism*, 0(0), 1-22.
- Herremans, I. M., Nazari, J. A., & Mahmoudian, F. (2016). Stakeholder relationships, engagement, and sustainability reporting. *Journal of Business Ethics*, 138(3), 417-435.

- Indonesia Stock Exchange. (2018). *Indonesia stock exchange*. Retrieved April 23, 2018, from <http://www.idx.co.id/en-us/listed-companies/company-profiles/>
- Ioannou, I., & Serafeim, G. (2017). *The consequences of mandatory corporate sustainability reporting* (Harvard Business School Research Working Paper No. 11-100). Retrieved September 23, 2017, from [https://papers.ssrn.com/sol3/papers.cfm?abstract\\_id=1799589](https://papers.ssrn.com/sol3/papers.cfm?abstract_id=1799589)
- Jones, P., Comfort, D., & Hillier, D. (2016). Managing materiality: A preliminary examination of the adoption of the new GRI G4 guidelines on materiality within the business community. *Journal of Public Affairs, 16*(3), 222-230.
- Junior, R. M., Best, P. J., & Cotter, J. (2014). Sustainability reporting and assurance: a historical analysis on a world-wide phenomenon. *Journal of Business Ethics, 120*(1), 1-11.
- Keller, S., Korkmaz, G., Orr, M., Schroeder, A., & Shipp, S. (2017). The evolution of data quality: Understanding the transdisciplinary origins of data quality concepts and approaches. *Annual Review of Statistics and Its Application, 4*(1), 85-108.
- Kozłowski, A., Searcy, C., & Bardecki, M. (2015). Corporate sustainability reporting in the apparel industry: an analysis of indicators disclosed. *International Journal of Productivity and Performance Management., 64*(3), 377-397.
- Limijaya, A. (2014). Triple bottom line dan sustainability. *Bina Ekonomi, 18*(1), 14-27.
- Maas, K., Schaltegger, S., & Crutzen, N. (2016). Integrating corporate sustainability assessment, management accounting, control, and reporting. *Journal of Cleaner Production, 136*, 237-248.
- Mahoney, L. S., Thorne, L., Cecil, L., & LaGore, W. (2013). A research note on standalone corporate social responsibility reports: Signaling or greenwashing? *Critical Perspectives on Accounting, 24*(4-5), 350-359.
- Manetti, G., & Becatti, L. (2009). Assurance services for sustainability reports: Standards and empirical evidence. *Journal of Business Ethics, 87*(SUPPL. 1), 289-298.
- Michelon, G., Pilonato, S., & Ricceri, F. (2015). CSR Reporting practices and the quality of disclosure: An empirical analysis. *Critical Perspectives on Accounting, 33*, 59-78.
- Milne, M. J., & Adler, R. W. (1999). Exploring the reliability of social and environmental disclosures content analysis. *Accounting, Auditing and Accountability Journal, 12*(2), 237-256.
- Pipino, L. L., Lee, Y. W., & Wang, R. Y. (2002). Data quality assessment. *Communications of the ACM, 45*(4), 211-218.
- Searcy, C. (2016). Measuring enterprise sustainability. *Business Strategy and the Environment, 25*(2), 120-133.
- Sethi, S. P., Martell, T. F., & Demir, M. (2017). Enhancing the Role and effectiveness of corporate social responsibility (CSR) reports The missing element of content verification and integrity assurance. *Journal of Business Ethics, 144*(1), 59-82.
- Ștefănescu, C. A., Opreșor, T., Sîntejudeanu, M. A., & Sîntejudeanu, M. A. (2016). An original assessment tool for transparency in the public sector based on the integrated reporting approach. *Accounting and Management Information Systems, 15*(3), 542-564.
- Steyn, B., & Niemann, L. (2014). The strategic role of public relations in enterprise strategy, governance and sustainability-A normative framework. *Public Relations Review, 40*(2), 171-183.

- Strand, R., Freeman, R. E., & Hockerts, K. (2015). Corporate social responsibility and sustainability in Scandinavia: An overview. *Journal of Business Ethics*, 127(1), 1-15.
- Tchernykh, A., Schwiegelsohn, U., Talbi, E., & Babenko, M. (2016). Towards understanding uncertainty in cloud computing with risks of confidentiality, integrity, and availability. *Journal of Computational Science*, 36, 1-9. <https://usuario.cicese.mx/~chernykh/papers/JoCS%20Uncertainty.pdf>
- Unerman, J., & Zappettini, F. (2014). Incorporating materiality considerations into analyses of absence from sustainability reporting. *Social and Environmental Accountability Journal*, 34(3), 172-186.
- Wolniak, R., & Hąbek, P. (2016). Quality assessment of CSR reports - factor analysis. *Procedia - Social and Behavioral Sciences*, 220(2016), 541-547.





## **Tourist Segmentation in Jakarta: An Analysis of Jakarta's City Branding**

**Natalia<sup>1\*</sup>, Louis Mordekhai<sup>1</sup> and Fiona Cownie<sup>2</sup>**

*<sup>1</sup>Department of Management, BINUS Business School, Undergraduate Program, Bina Nusantara University, Jakarta Barat 11480, Indonesia*

*<sup>2</sup>Bournemouth University, Weymouth W420, Talbot Campus, Fern Barrow, Poole BH12 5BB, United Kingdom*

### **ABSTRACT**

The purpose of this research was to analyse Jakarta's city branding by profiling the groups of international tourists based on their travel behaviour and socio-demographic profile. This small-scale study surveyed 100 foreign tourists who visited Jakarta and stayed at least one night during the previous 12 months. The research employed cluster analysis to group foreign tourists with similar characteristics and preferences. Using a city branding hexagon as measurement variables, the results suggested there were three groups of foreign tourists with different characteristics and preferences during their visits in Jakarta. These are named On Duty Traveler, Deja Vu Traveler and New Face Traveler. The On Duty Traveler segment is the most dominant type of traveller, visiting Jakarta for working purposes and comprising travellers from the Asia-Pacific region. Understanding the differences between these three market segments and their demands provide the government with important information to inform Jakarta's City Branding and the creation of distinct marketing programs to appeal to each segment.

### ARTICLE INFO

#### *Article history:*

Received: 9 October 2019

Accepted: 3 January 2020

Published: 17 March 2020

#### *E-mail addresses:*

[natalia@binus.edu](mailto:natalia@binus.edu) (Natalia)

[loui\\_kai@yahoo.co.id](mailto:loui_kai@yahoo.co.id) (Louis Mordekhai)

[fjcownie@bournemouth.ac.uk](mailto:fjcownie@bournemouth.ac.uk) (Fiona Cownie)

\*Corresponding author

*Keywords:* City branding, city branding hexagon, cluster analysis, segmentation

### **INTRODUCTION**

The world of tourism is experiencing great development making it one of the largest and fastest-growing industries in the world ([setkab.go.id](http://setkab.go.id)). This is a potential factor for economic growth (Cheam et al.,

2013). Indonesia’s tourism industry has experienced rapid growth from 7 million tourists in 2010 to 9.7 million tourists in 2015 (data.jakarta.go.id, 2017). The sector is Indonesia’s fourth-largest national foreign exchange contributor, larger than the agriculture, automotive and mining sectors (Indonesian Ministry of Tourism, 2016). As the capital of the Republic of Indonesia, Jakarta is one of the main entrances for foreign tourists to visit Indonesia. Jakarta has contributed 24% to Indonesian GDP and foreign exchange from its foreign tourist visits (data.jakarta.go.id, 2017). However, the number of foreign tourists visiting Jakarta is still far below the other capital cities in neighbouring countries such as Bangkok, Singapore and Kuala Lumpur. The city ranking details are presented in Figure 1.

Bangkok, Singapore, and Kuala Lumpur also have the same functions with Jakarta as the metropolitan city, economic and government centre. However, it can be seen from Figure 1 that Jakarta international tourist arrivals are still far below those in neighbouring countries. For example, the growth of Bangkok as another large ASEAN

capital city has experienced a significant increase in international tourists every year, while Jakarta has stagnant growth since 2013.

Jakarta as the capital city of Indonesia offers many destinations and attractions such as historical museum and buildings, marine tourism in Kepulauan Seribu (Thousand Islands), shopping centres (Tanah Abang as one of the largest shopping centres in ASEAN), theme parks and traditional Betawi cultural tourism. Betawi is terminology for local people in Jakarta when it was occupied by the Netherlands a hundred years ago. The terminology remains until now for people whose ancestors are originally from Jakarta. Betawi cultural tourism includes Betawi traditional culinary festivals, traditional dance (Topeng Betawi Dance, Jaipong dance, Japin dance), traditional musical instruments (Tanjidor, Marawis, Keroncong) and other festivals that usually happens in May to August along with the celebration of Jakarta’s birthday and Independence Day of Indonesia.

However, these destinations and attractions are not well promoted and have not become priority tourist destinations

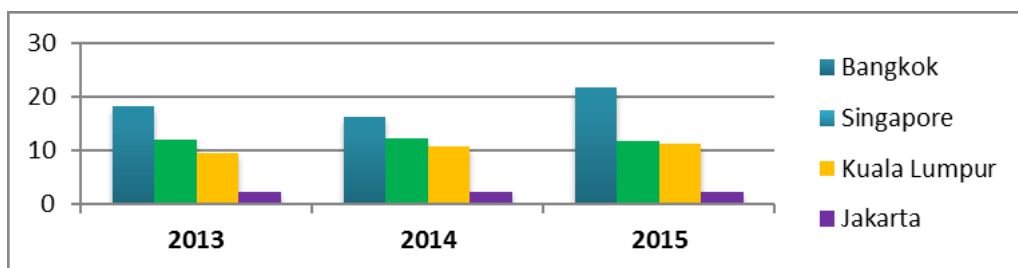

Figure 1. International tourist arrivals in several countries in Southeast Asia from 2013 – 2015 (newsroom.mastercard.com; data.jakarta.go.id)

when visiting Indonesia. Therefore, Jakarta needs to re-brand its image internationally, rather than just as a centre of business. In comparison to neighbouring capital cities such as Bangkok, Kuala Lumpur or Singapore, Jakarta offers traditional festivals, shopping centres, museum and historical buildings and maritime tourism, which are as attractive as those neighbouring capital cities. Jakarta is still lacking in the ease of access or transportation. However, such infrastructures have become the focus of government attention right now.

City branding is a tool of urban renewal including the creation of an identity with its own experiential value aimed to increase local development, city attractiveness and international visibility (Kavaratzis, 2004; Sabah, 2016).

Although cities are not products, Kavaratzis (2004) argued that cities could be promoted in a similar way to corporate brands because cities are complex entities that deal with multiple identities, address various stakeholders and have social responsibilities. For example, Jakarta can be promoted as a place to live, to do business, with destinations to visits and as an opportunity to invest. Therefore, there is an opportunity for Jakarta to draw from the city branding concept to develop and manage its image and reputation by communicating it to various target groups via visuals, narratives and events locally and internationally to gain a competitive advantage among other capital cities in ASEAN (Prilenska, 2012; Sabah, 2016).

The city branding concept is integral to the relationship between a city brand, city branding, and city image. A city brand is a brand identity, which is a combination of name, symbol or design that represents an existing display to establish a different identity from its competitors (Blain et al., 2005). Jakarta has previously used “Enjoy Jakarta” as its strapline to promote itself. However, city branding is not limited to utilizing a logo and strapline and communicating the value of a brand to get positive perceptions or images in consumers’ minds (Dwiputrianti & Saragih, 2015; Sabah, 2016). Brand image is a reflection of the response to the perceived value consumers see within a brand, as branding is derived in part through mutual communication (Kavaratzis & Ashworth, 2005). Knowing the city image of Jakarta is useful in understanding the different perceptions received by foreign tourists and determining the right strategy for future city branding. To create a more positive brand image or city image, Jakarta must identify its attractiveness in tourists’ perceptions and then create an appropriate branding strategy to promote it. Each segment of tourists displays a different character and preferences; thus, understanding these differences allows distinct marketing activities to be developed (Kotler et al., 2014).

This study aimed to segment Jakarta international tourists into several clusters. The City Branding Hexagon is a measurement index of a city’s characteristics

developed by Anholt-GfK Roper City Brands Index (ACBI) and used to inform the city branding strategies of Boston and New York City (Sevin, 2014). There are six variables in the City Branding Hexagon that were used in this research to segment Jakarta’s international tourists: presence, prerequisite, place, people, potential and pulse. By using the City Branding Hexagon as the segmentation variable, the study results provide new insights about Jakarta’s international tourist travel behaviour by segmentation based on tourists’ preferences and socio-demographics. Such an approach underpins the development of recommendations to improve Jakarta’s city branding.

**Literature Review**

**City Branding.** City branding, also known as city marketing, is a concept of designing a location to satisfy the needs of consumers in the target market (Dwiputrianti & Saragih, 2015). City branding is the process of defining a vision for a city, planning and executing efforts toward achieving its goals, and measuring the direction of progress

in its achievements (Hultén, 2012). Every city is undeniably competing with other cities, so to get a competitive advantage, a city can benefit from a city branding strategy. A number of scholars (Sabah, 2016; Sevin, 2014) have examined city branding, Kavaratzis & Ashworth (2005) proposing the conceptualization illustrated in Figure 2.

Kavaratzis and Ashworth (2005) proposed that the overall concept of city branding comprised the city brand, city branding, and city image. A positive city image means that the current city branding strategy is suitable and can be enhanced while a negative city image means the city has to engage in rebranding or create new branding strategies. City image is an image that is formed in the minds of people because of the typical characteristics of the city, where its uniqueness forms its city brand. For example, Singapore the nearest neighbour country of Indonesia has unveiled a new joint business and tourism brand “Passion made possible” in 2017 as it believes Singaporean spirit was “passion” and “possibilities”. Therefore, the ‘Passion made possible’ brand reflects Singapore as

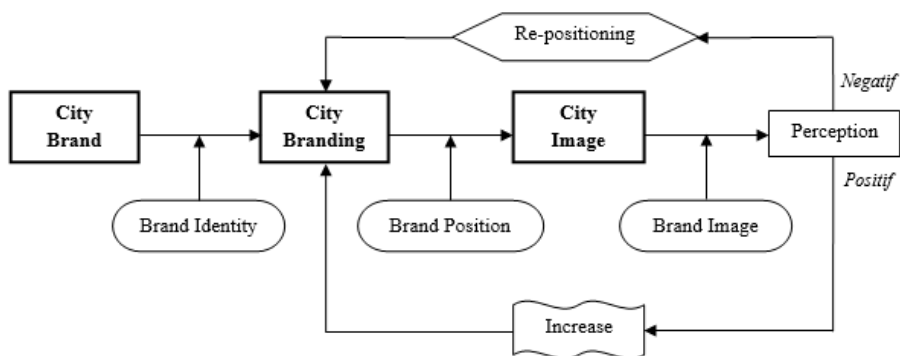

Figure 2. City brand, city branding, and city image relationship (Kavaratzis & Ashworth, 2005)

a destination to visits and in which to invest (www.traveldailymedia.com). City branding is beneficial in building a more distinctive and widely applied identity for urban areas. This is the basis for identifying and bringing together the images and meanings associated with the city brand in a marketing message, aimed at creating differentiation and preferences.

**City Branding Hexagon.** After clarifying the concept of city branding, we highlight concepts that have been used as segmentation variables for Jakarta’s international tourists. According to Simon Anholt via the Anholt-GfK Roper City Brands Index (ACBI), there are six measurements to define a city’s characteristics. The City Branding Hexagon consists of six variables that are considered appropriate in measuring Jakarta’s city branding program and segmenting Jakarta international tourists. These variables are shown in Table 1.

This segmentation aims to improve the marketing mix of variables divided into product, price, place, promotion (Luigi & Mircea, 2015). In this sense, market segmentation is a process of dividing the market into smaller groups according to needs, characteristics, or behaviours that may require different or mixed marketing strategies (Kotler & Armstrong, 2012). Therefore, existing or potential customers (where Jakarta international tourists fit in this context) can be based on a two-segment basis: socio-demographic and travel behaviour.

Socio-demographic segmentation is based on the collection and analysis of information according to consumer suitable demography, geography and psychographic.

Travel behaviour segmentation is based on the City Branding Hexagon with six variables for segmenting Jakarta international tourists: presence, prerequisite, place, people, potential and pulse.

Table 1  
*City Branding Hexagon*

Variable	Definition
Presence	Measures the international status of a city that consists of its contribution to the world.
Prerequisite	Assesses the basic qualities of a city to meet the needs of tourists.
Place	Rates through the perceptions of tourists about the physical condition of the city.
People	Expresses the hospitality, welcome, culture and language of local residents, as well as communities that provide a sense of security to tourists.
Potential	Measures the attractiveness that has an opportunity in the city branding of a city.
Pulse	Measures tourists' perceptions of the attractions found in a city that feel new or different.

In conducting market segmentation, a researcher should consider MASDA (Measurable, Accessible, Substantial, Differentiable, and Actionable) aspects to avoid improper analysis of targets (Kotler & Armstrong, 2012).

**MATERIALS AND METHODS**

**Research Design and Procedures**

Survey research was conducted with a sample from international tourists visiting Jakarta. The field survey was conducted between May and July 2017. Screening criteria required the respondents to travel to Jakarta for at least one overnight in the previous 12 months. Based on data from the Provincial Government of DKI Jakarta’s website, the average number of foreign tourists visiting Jakarta from 2014 to 2016 is 2,402,843 tourists per year. Using this number of tourists, the number of samples was calculated using the Slovin formula (Sugiyono, 2015).

$$n = \frac{N}{1 + Ne^2} = \frac{2402842,6}{1 + 2402842,6(0,1)^2} = 99,99$$

Where:

n = sample size

N = population

e = margin of error 10%

**Respondents**

This study used descriptive analysis to determine the characteristics of traveller respondents as shown in Table 2.

**K-Means Cluster**

The survey used the six dimensions of the City Branding Hexagon: presence, prerequisite, place, people, potential and pulse (Sevin, 2014) as a segmentation basis. Cluster analysis was then used to search for homogeneous groups of shared characteristics and travel behaviours. Cluster analysis is a statistical technique that classified respondents who have similar characteristics and behaviours as intro groups (Hudson & Ritchie, 2002). This analysis is used to provide recommendations for classifying populations. Grouping aims to facilitate the analysis of large data. K-means is an algorithm calculation to a cluster, which is dividing data into several groups (sub-populations). The method of the K-means algorithm was processed by a computer system to classify the group data without the first specified category. The sig value < 0.05 indicates there is a significant difference between the clusters formed and eliminates items that show sig > 0.05 or do not have a difference (Malhotra, 2010).

Table 2  
*Traveller respondent characteristics*

	Characteristics			
Gender	Male (40%)	Female (60%)		
Age	<22 yrs. (22%)	22-40yrs.(72%)	41-60 yrs. (6%)	
Budget	<\$500 (13%)	\$500-\$1,000 (53%)	\$1,000-\$2,000 (23%)	>\$2,000 (11%)
Companion	Single (39%)	Friend (23%)	Spouse (36%)	Family (2%)

**Cross-Tabulation**

This analysis is used to look at the relationship between variables and can be used to analyze more than two variables (Malhotra, 2010). The Cross-tabulation analysis enables the tabulation of several different variables into a matrix. The Chi-square table shows the significance of the variable: if sig < 0.05 then the variable has a relationship with other variables and if sig > 0.05 then the variable has no relation with other variables.

**Measurement Variable**

The survey questionnaire for this study has two parts. The first part consists of questions related to consumer demographics, where the second part is statements related to tourist preferences based on the City Branding Hexagon variable (Table 3).

Table 3

*Variable dimensional measurement*

Variable	Dimension	Indicator
Segmentation (Kotler & Armstrong, 2012)	Demographic	a. Gender
		b. Age
		c. Travel budget
		d. Occupation
		e. Travel companions
City Branding Hexagon (Sevin, 2014)	Presence	a. Nationality
		b. Days spent
		c. Visit history
		d. Travel information
		e. Travel motivation
	Prerequisite	a. Travel arrangement
		b. Travel accommodation
		c. Travel transportation
	Place	d. Information guideline
		City Potential Value
People	People Potential Value	
	a. City's landmark	
Potential	b. City's museum	
	c. City's island	
	d. City's shopping centre	
Pulse	e. City's theme park	
	City's event	

**RESULTS AND DISCUSSIONS**

**Analysis of Dimensions Underlying Tourists’ Behavior**

Cluster analysis was employed using the ANOVA test from K-means. ANOVA test was employed to identify the underlying dimensions of tourists’ behaviour. Items with a significant level lower than 0.50 were removed, only items with a significant level above 0.50 were attained.

**Clusters of Tourists’ Behaviour.** A cluster analysis was applied to classify tourists with similar characteristics and behaviours into groups. The analysis was performed using a K-Means clustering procedure. Trials with two to five clusters were executed,

and the results were compared to identify the most appropriate number of clusters. Based on the results of cluster formation, the solution with three-clusters appeared to be the most appropriate in terms of cluster interpretation, meaningfulness, and size. The Final Cluster Center table (Table 4) is the average score of each attribute of the 3 clusters formed. The greater each member score each attribute indicates those attributes are the most related to the members. For example, Cluster 1 members rate the Asia Pacific attributes greater than cluster 2 and 3 members. Thus, cluster 1 is dominated by members from the Asia Pacific region, and so on for other attributes.

Table 4  
*Summary statistics of cluster analysis and ANOVA test*

Final Cluster Centers	Cluster			ANOVA Test	
	1	2	3	F-value	Sig
Asia Pasific	1.67	1.12	1.45	8.78	0.00
Mid East	1.91	2	1.79	2.92	0.06
Europe	1.64	1.88	1.79	2.237	0.11
America	1.78	2	1.97	5.756	0.00
Days	1.38	1	1	16.2	0.00
Weeks	1.76	2	2	8.63	0.00
Months	1.87	2	2	4.104	0.02
First time	1.6	1.24	1.84	11.28	0.00
More than once	1.67	2	1.26	19.94	0.00
Every years	1.73	1.76	1.89	1.766	0.18
Social media	1.51	1.24	1.13	8.102	0.00
Advert	1.73	1.65	1.58	1.093	0.34
Family friend	1.18	2	1.45	25.47	0.00
Travel agent	1.82	1.24	2	35	0.00



Table 4 (continued)

Final Cluster Centers	Cluster			ANOVA Test	
	1	2	3	F-value	Sig
Gov expo	2	2	1.89	3.538	0.03
Business trip	1.91	1.59	1.89	6.025	0.00
Events	2	2	1.79	8.019	0.00
Study trip	1.96	2	1.76	5.582	0.01
Holiday	1.13	1.41	1.55	9.661	0.00
Flights hotel	1.42	1.47	1	14.34	0.00
All in tour	1.91	1.76	2	4.752	0.01
Motel/homestay	1.27	2	1.97	62.85	0.00
Budget hotel	1.58	1.18	1.34	5.2	0.01
Lux hotel	1.91	1.82	1.87	0.477	0.62
Rent apt	1.82	2	1.79	2.055	0.13
Public (bus/train)	1.49	1.88	1.76	6.252	0.00
Private public(taxi/uber)	1.51	1.06	1	24.1	0.00
Rental bus/car	1.56	1.71	1.89	6.31	0.00
Tour leader	1.78	1.12	1.76	17.82	0.00
Guide book	1.82	1.65	1.66	1.779	0.17
Online map	1.73	1.65	1.24	13.3	0.00
Previous visit	1.42	2	1.89	21.47	0.00
Clean	1.91	1.59	2	12.67	0.00
Diversity	1.82	1.76	1.34	13.65	0.00
Art	1.96	1.94	1.79	3.29	0.04
Healthy	2	2	1.89	3.538	0.03
Tolerance	1.84	1.76	1.97	3.006	0.05
Religious	1.91	2	1.89	0.917	0.40
HiTech	1.91	2	1.89	0.917	0.40
Global	1.84	1.76	1.89	0.777	0.46
Confident	1.89	1.59	1.89	5.189	0.01
Competitive	1.82	1.94	1.68	3.337	0.04
Funny	1.84	2	1.66	5.151	0.01
HardWorker	1.71	2	1.87	4.189	0.02
Smart	2	1.59	2	28.18	0.00
Honest	1.87	2	1.97	3.337	0.04

Table 4 (continued)

Final Cluster Centers	ANOVA Test				
	Cluster			F-value	Sig
	1	2	3		
HI	1.42	1.06	1.63	9.062	0.00
Monas	1.09	1.41	1.21	4.52	0.01
Istiqlal	1.62	1.76	1.74	0.889	0.41
Sunda Kelapa	1.98	2	1.58	18.32	0.00
Fatahilah Park	1.91	1.88	1.76	1.866	0.16
National Museum	1.24	1.24	1.58	6.292	0.00
Fatahilah Museum	1.69	1.94	1.26	17.71	0.00
Puppet Museum	1.58	1.76	1.34	5.09	0.01
Maritime Museum	1.87	1.94	1.87	0.355	0.70
Bank Mandiri	1.73	1.88	1.95	3.817	0.03
Bank Indonesia	1.82	1.29	1.58	9.188	0.00
Textile Mueum	1.98	1.59	2	21.56	0.00
Ceramic Art Museum	1.98	1.71	1.92	6.135	0.00
Pramuka	1.96	1.76	1.95	3.5	0.03
Tidung	1.78	1.94	1.79	1.146	0.32
Pari	1.89	1.47	1.76	6.744	0.00
Bidadari	2	1.94	1.84	4.177	0.02
Putri	1.96	1.88	1.87	1.041	0.36
Harapan	1.96	1.94	1.97	0.178	0.84
Mangga Dua	1.93	1.94	1.97	0.361	0.70
Gajah Mada	1.71	1.94	1.61	3.337	0.04
Pasar Baru	1.58	1.94	1.61	4.047	0.02
MKG	1.98	1.82	2	5.508	0.01
Tanah Abang	1.91	1.76	1.92	1.658	0.20
GI	1.42	1.12	1.5	3.832	0.03
TA	1.67	1.59	1.61	0.237	0.79
CP	1.71	1.65	1.53	1.523	0.22
Sency	1.93	2	1.87	1.48	0.23
PP	1.98	1.94	2	1.037	0.36
Ancol	1.93	1.53	1.97	15.45	0.00
Ragonan	1.89	1.94	1.79	1.403	0.25

Table 4 (continued)

Final Cluster Centers	Cluster			ANOVA Test	
	1	2	3	F-value	Sig
TMII (Indonesia Miniature Park)	1.98	1.76	1.76	5.048	0.01
Festival	1.69	1.71	1.95	4.897	0.01
Entertainment	1.71	1.76	1.74	0.094	0.91
Live Show	1.82	1.47	1.87	6.416	0.00
Nightlife	1.47	1.53	1.26	2.544	0.08
Expo	1.8	1.94	1.87	1.036	0.36
Conference	1.93	2	2	1.905	0.15
Charity	1.96	2	2	1.241	0.29
Workshop	1.98	1.71	1.92	6.135	0.00

**Demographic Profiles within Clusters**

To better understand the demographic characteristics of the respondents within three clusters, Chi-square tests were conducted using cross-tabulation analysis

as seen in Table 5. The results showed statistically significant differences between the three clusters in terms of gender, age, travel budget and travel companion.

Table 5

*Cross tabulation analysis*

n (%)	Cluster 1	Cluster 2	Cluster 3	Chi-square Sig
<b>Gender</b>				
Male	67%	94%	37%	0.000
Female	33%	6%	63%	
<b>Age</b>				
Teen (under 21)	29%	0%	24%	0.003
Adult (22-40)	58%	100%	76%	
Elder (41-60)	13%	0%	0%	
<b>Travel Budget</b>				
Low budget (Under US\$ 500)	0%	56%	62%	0.002
High budget (US\$ 1000 – 2000)	100%	44%	38%	

Table 5 (Continued)

n (%)	Cluster 1	Cluster 2	Cluster 3	Chi-square Sig
Travel Companion				
Couple	72%	8%	13%	0.000
Friend	10%	0%	47%	
Family	17%	92%	40%	

Table 6

*Segmentation of Jakarta International Tourist: Combining City Branding Hexagon and socio-demographic as segmentation variables*

Variables	On Duty Traveler (45%)	Deja Vu Traveler (17%)	New Face Traveler (38%)
PRESENCE			
a. Nationality	Asia pacific	America, Middle east, Europe	Europe
b. Days spent	A few days	Several weeks, Several months	Several weeks
c. Visit history	More than once	More than once	First time
d. Travel information	Social media	Family friends	Travel agent
e. Travel motivation	Business trip, events	Events, study trip	Holiday
PREREQUISITE			
a. Travel arrangement	Flights and Hotel,	Flights and Hotel	All in Tour Package
b. Travel accommodation	Budget hotel / 3*	Motel / Homestay, Rent apartment	Motel / Homestay
c. Travel transportation	Taxi, Uber	Bus, Train	Rental Bus/Car
d. Information guideline	Online map	Previous visit, Online map	Tour leader
PLACE			
City's space, building, service	Diversity, Art	Healthy	Clean

Table 6 (Continued)

Variables	On Duty Traveler (45%)	Deja Vu Traveler (17%)	New Face Traveler (38%)
<b>POTENTIAL</b>			
a. Landmark	Sunda Kelapa	Sunda Kelapa, Monas	HI Monument
b. Museum	Ceramic Art, Textile Museum	Puppet Museum	Bank Mandiri, Textile
c. Island	Pramuka, Pari, Bidadari	Bidadari	Pramuka
d. Shopping	Mall Kelapa Gading	Gajah Mada plaza, Pasar Baru	Mall Kelapa Gading, Grand Indonesia
e. Theme Park	Ancol Dreamland, Indonesia Miniature park		Ancol Dreamland
<b>PULSE</b>			
City's Events	Workshop	Nightlife	Festival, Live Show
<b>DEMOGRAPHIC</b>			
Gender	Male	Male	Female
Age	Adult (22-40 y.o.)	Adult (22-40 y.o.)	Adult (22-40 y.o.)
Travel Budget	High budget	Low budget	Low budget
Travel Companion	Couple	Family	Friend & Family

Table 6 combines the City Branding Hexagon and socio-demographic as segmentation variables. As seen in Table 6, the research results show that every group of foreign tourists in the city of Jakarta had some differences that could be explained as follows.

**Cluster A: On Duty Traveler**

This cluster appears to be motivated by business trip assignment or attending events during his/her visit to Jakarta. Dominated by tourists from Asia-Pacific, the “On Duty Traveler” made several previous visits

and stayed only for a few days. They got their travel information mostly from social media. They arranged their travel only for flights and hotels, with no trip arrangements previously. Having a higher travel budget, the “On Duty Traveler” stayed at three-star hotels and depended on taxis or Uber for his/her mobility. Their information guideline was based on online maps. Their favourite attractions are related to diversity and arts; for example, ceramic art or a textile museum were their favourite places to visit. Furthermore, this segment demonstrated positive perceptions of Jakartans seeing

inhabitants of Jakarta as confident, smart and tolerant. The “On Duty Traveler” segment was dominated by adult males aged between 22-40 years and preferred their spouses as travel companions. For tourist-orientated activities, they had allocated budgets of \$1,000 to \$2,000 during their trips to Jakarta. In terms of size, the “On Duty Traveler” segment was the largest of the three segments, representing 45% of all respondents.

### **Cluster B: Deja Vu Traveler**

This cluster appears to be motivated by study trips or attending events during their visits to Jakarta. Dominated by tourists from America, the Middle East and Europe, the “Deja Vu Traveler” made several visits previously and stayed for a few weeks or months. They got their travel information from friends or family. They arranged their travel only for flights and hotels, with no trip arrangements previously. Having lower travel budgets, they stayed at motels, hostels or rented an apartment. They depended on public transportation such as buses or trains for their mobility. Their information guideline was based on their previous experience and online maps. Their favourite city spaces or building concepts were Sunda Kelapa, national monuments, or puppet museums. Furthermore, this segment also demonstrated positive perceptions to Jakartans seeing Jakartans as a funny, hard worker, honest and competitive. The “Deja Vu Traveler” segment was dominated by adult males aged between 22-40 years and preferred their family as travel companions.

For tourist-orientated activities, they allocated low budgets of about \$500 to \$1,000 during their trips to Jakarta. In terms of size, the “Deja Vu Traveler” segment represented 17% of all respondents. Both cluster A (On duty Traveler) and B.

(De Javu Traveler) are frequent visitors, they visited Jakarta more than once. However, they differed by the motivation to visit Jakarta, where tourists from Cluster A are mostly come to Jakarta for business purposes, while tourists from Cluster B are mostly come to Jakarta for study trip or attending events and stay longer in Jakarta.

### **Cluster C: New Face Traveler**

This cluster assumes a traveller motivated by a holiday during his/her visit to Jakarta. Dominated by tourists from Europe, “New Face Traveler” has never made a trip to Jakarta previously and usually stayed for a few weeks during their trip. They got their travel information from a travel agency. They arranged all their travel in a tour package. Having lower travel budgets, they prefer to stay in motels or hostels. They rent buses or cars for their mobility. Their information guideline is from the tour leader. As their motivation to visit Jakarta was for holiday, their favourite places to visit are Ancol Dreamland Park, festivals or live shows. Furthermore, this segment also demonstrated positive perceptions to Jakartans such as confident, smart, tolerant and honest. “New Face Traveler” was dominated by adult females aged between 22-40 years and preferred their friends or families as travel companions. For tourist-

orientated activities, they prepared a low budget of about \$500 to \$1,000 during their trips to Jakarta. In terms of size, the “New Face Traveler” segment represented 38% of all respondents. The differences between this cluster with cluster A and B are tourists from cluster C are new visitors. They never visited Jakarta previously, and motivated by holiday, while cluster A and B motivated by business purpose, study trip or attending events.

## DISCUSSIONS

The results of this study clarify the distinction between each segment of Jakarta international tourists and enables the government to plan its marketing effort to promote Jakarta as the capital city. Previous research has been studied regarding the tourism market of Jakarta by segmenting foreign visitors’ lifestyle typologies (Srihadi et al., 2016). However, in terms of analyzing Jakarta’s city branding by profiling the groups of international tourists based on their travel behaviour and socio-demographic profile, this research contributes to new knowledge.

As seen in Figure 1, Jakarta international tourist visits are still far below other capital cities in neighbouring countries such as Bangkok, Kuala Lumpur or Singapore. Therefore, by clustering each group of Jakarta international tourists, the government is able to offer products more efficiently as they know what kind of destination attributes that each segment values. This is supported by Kotler et al. (2014), who stated that each type of tourist displayed different

character and preferences; ideally, specific marketing programs should be developed for each type of customer.

The results of this study suggest tourists who visit Jakarta are not a homogeneous group and instead are divided into three clusters: On Duty Traveler, Deja Vu Traveler and New Face Traveler segments.

Based on the study results, one can conclude that the “On Duty Traveler” dominated most of the tourists who visited Jakarta by 45%, while the “Deja Vu Traveler” only represented 17%, meaning the number of tourists who visited Jakarta more than once besides being motivated by working arrangement was still low. To increase the number of international tourists who visit Jakarta, the government should distinguish marketing programs for each cluster because each segment shows different characteristics and preferences.

For example, the “On Duty Traveler” (the largest international tourist group in Jakarta) visit Jakarta because of working purposes; this suggests government should amplify Jakarta’s current image as a city of business by hosting international forums or becoming the host of international events such as the Asian Games to be held in 2018.

Furthermore, the “Deja Vu Traveler” segment has the fewest international tourists in Jakarta, indicating there is a lower number of international tourists who repeatedly visit Jakarta for other than working purpose. Thus, this suggests the government should use a pulsing strategy such as promoting local celebrations or festivals to attract more “Deja Vu Traveler” to visit Jakarta

repeatedly such as Palang Pintu festivals, Kampung Betawi culinary festivals, the celebrations of Jakarta's birthday and Indonesia Independence day. Such a strategy is adopted by Bournemouth, a major seaside tourist destination in the UK. Bournemouth has a programme of varied festivals during the course of the year (including the Arts by the Sea Festival, Wheels Festival, Running Festival), each targeting a distinct tourist population. In addition, the "Deja Vu Traveler" segment obtains their information about Jakarta from family or friends that have visited Jakarta previously. Therefore, the government should use word-of-mouth as a strategy to improve awareness of Jakarta among international tourists.

Finally, the "New Face Traveler" segment represents the second largest group of tourists who visit Jakarta. They visit Jakarta for the first time with family or friends and prefer to use travel agents to arrange their trips in Jakarta. Considering this suggests government should collaborate with tourism companies by promoting "mandatory" places in Jakarta that should be visited by international tourists, such as Jakarta historical building and museum (National Monument, Bank Mandiri Museum and Fatahillah Museum), shopping centres (Tanah Abang as one of the largest shopping centres in ASEAN), Kepulauan Sribu (Thousand Island) and Ancol Theme Park.

In this study, only international tourists were examined. In developing tourism, domestic tourists might sometimes be neglected. However, for the government,

international tourism is the most effective way to promote a country. By taking into account what kind of Jakarta city branding is needed internationally, it is possible for the government to design attractive marketing programs that would also encourage potential destinations.

The sample size of 100 respondents within this study might not be as large as would be preferred. While it is to be assumed that larger sample sizes improve data analysis. Little research has been conducted to date to understand the effect of sample size on the correctness of segment recovery, although some researchers noted that increasing sample size can increase the confidence in a particular structure (Dolnicar et al., 2016). Thus, it is suggested for future research to use a larger number of respondents.

## **CONCLUSIONS AND RECOMMENDATIONS**

Considering the segmentation of Jakarta international tourists using the City Branding Hexagon as measurement variables this study indicated that Jakarta international tourists can be divided into three segments based on their travel behaviour: On Duty Traveler, Deja Vu Traveler and New Face Traveler. Therefore, a "one-market" approach to viewing tourists is questionable. It is recommended that the government approaches tourists visiting Jakarta using a more segmented strategy as foreign tourists visiting Jakarta are not homogenous but can be segmented into groups with common characteristics. To increase Jakarta city branding, it is suggested to distinguish



marketing programs for each cluster because each segment shows different characteristics and preferences. The results of this research should provide new input to improve marketing programs for each cluster.

On Duty Travelers appear to be the largest dominant group of international tourists, dominated by males aged between 22 - 40 years old and motivated by working purposes when visiting Jakarta. Therefore, it is suggested that the government promote Jakarta current image as the city of business by hosting or organizing international events. This may possibly lead these travellers to give positive word-of-mouth about Jakarta and attract more international tourists. Hosting or organizing international events in Jakarta is one way to promote Jakarta through the mass media and press conferences. Furthermore, it is suggested to use social media to promote Jakarta city branding because the "On Duty Traveler" mostly gets information about Jakarta from social media rather than other means of information distribution. In addition, it is also suggested to promote Jakarta to the Asia-Pacific region because most "On-Duty Travelers" are from this region.

Deja Vu Travelers appear to be the smallest group of international tourists, dominated by males aged between 22 – 40 years old, with this type of tourist motivated by events or study trip purposes when visiting Jakarta. However, considering it represents only 17% of this sample of international tourists, it is suggested that the government use a pulsing strategy such as promoting local celebrations to attract more Deja Vu

Travelers to visit Jakarta repeatedly. In addition, it is suggested that the government use a new city tag line and create a new slogan to show the attachment of a person to the city. Examples of other cities with such slogans that show attachment are Singapore with "Your Singapore", Amsterdam with "I Amsterdam", Seoul with "I Seoul U", or New York with "I ♥ NY". A suggested Jakarta tagline might be "Enjoy Jakarta," using additional words that show attachment such as "We enjoy Jakarta".

New Face Traveler appears to be the second-largest group of international tourists within this sample, dominated by females aged between 22 – 40 years old, with their motivation when visiting Jakarta is for holiday. With family or friends becoming their companions, they prefer to use travel agents to arrange their first trip to Jakarta. Thus, it is suggested that the government collaborate with tourism companies by giving them "mandatory" places that should be visited in Jakarta by international tourists. This strategy has been done by several countries such as South Korea, and it becomes an effective way to promote local destinations.

This study has indicated that Jakarta's tourism market can be divided into distinct segments, therefore, the "one-market" approach is questionable and the practice of aggregating a distinctly different group of travellers appears to be masking potentially viable niche markets. Previous research has been conducted about the tourism market of Jakarta by segmenting foreign visitors' lifestyle typologies (Srihadi et al., 2016).

However, in terms of analyzing Jakarta's city branding by profiling the groups of international tourists based on their travel behaviour and socio-demographic profile, this is still limited. Thus, this paper suggests that any marketers targeting foreign tourists can use city branding analysis as a basis for segmentation because the international tourist market in Jakarta is definitely not homogeneous. Bespoke branding strategies as a response to these findings would be an excellent example of a research-based marketing program. This study seeks to provide useful guidelines for other destinations and managers of tourism organizations.

## ACKNOWLEDGEMENT

The authors wish to acknowledge and thank all IMHA 2018 committee members and UPM *Pertanika* journal team that help publish this article.

## REFERENCES

- Blain, C., Levy, S. E., & Ritchie, B. (2005). Destination branding: Insights and practices from destination management organizations. *Journal of Travel Research, 43*(4), 328-338.
- Cheam, C. L., Mahmood, R., & Abdullah, H. (2013). Tourism, selected macroeconomics variables and economic growth: An econometrics of long run and short run relationship. *International Journal of Economics and Management, 7*(1), 67-83.
- Dolnicar, S., Grün, B., & Leisch, F. (2016). Increasing sample size compensates for data problems in segmentation studies. *Journal of Business Research, 69*(2), 992-999.
- Dwiputrianti, S., & Saragih, N. K. (2015, September 27-29). Better City, Better Local Competitiveness? City Branding and Marketing Toward Economic Development. In *The Unima-IAPA International Seminar and Annual Conference (UNISAC) 2015* (pp. 1-8). Universitas Negeri Manado, Indonesia: State University of Manado.
- Hudson, S., & Ritchie, B. (2002). Understanding the domestic market using cluster analysis: A case study of the marketing efforts of Travel Alberta. *Journal of Vacation Marketing, 8*(3), 263-276.
- Hultén, B. (2012). Sensory cues and shoppers' touching behaviour: The case of IKEA. *International Journal of Retail & Distribution Management, 40*(4), 273-289.
- Indonesian Ministry of Tourism. (2016). *Laporan akuntabilitas kinerja kementerian pariwisata tahun 2016* [Report on Accountability, Ministry of Tourism 2016]. Retrieved October 10, 2017, from [http://www.kemepar.go.id/userfiles/LAPORAN%20KINERJA%20KEMENPAR%202016\\_FINAL.pdf](http://www.kemepar.go.id/userfiles/LAPORAN%20KINERJA%20KEMENPAR%202016_FINAL.pdf)
- Kavaratzis, M. (2004). From city marketing to city branding: Towards a theoretical framework for developing city brands. *Place Branding, 1*(1), 58-73.
- Kavaratzis, M., & Ashworth, G. J. (2005). City Branding: An effective assertion of identity or a transitory marketing trick? *Tijdschrift voor Economische en Sociale Geografie, 96*(5), 506-514.
- Kotler, P., & Armstrong, G. (2012). *Principles of marketing* (14th Ed.). New Jersey, USA: Pearson Education Inc.
- Kotler, P., Bowen, J. T., & Makens, J. C. (2014). *Marketing for hospitality and tourism*. Boston, MA: Pearson Education.

- Luigi, D., & Mircea, F. (2015). Consumer behaviour in the tourist segmentation process - A marketing research. *Studies in Business and Economics*, 10(1), 66-76.
- Mallhotra, N. K. (2010). *Marketing research an applied orientation*. New Jersey, USA: Pearson Education.
- Prilenska, V. (2012). City branding as a tool for urban regeneration: Towards a theoretical framework. *Architecture and Urban Planning*, 6, 12-16.
- Sabah, H. (2016). Setif as a city brand. *International Journal of Tourism and Hospitality Reviews*, 3(1), 21-29.
- Sevin, H. E. (2014). Understanding cities through city brands: City branding as a social and semantic network. *Cities*, 38(2014), 47-56.
- Srihadi, T. F., Hartoyo, Sukandar, D., & Soehadi, A. W. (2016). Segmentation of the tourism market for Jakarta: Classification of foreign visitors' lifestyle typologies. *Tourism Management Perspectives*, 19(A), 32-39.
- Sugiyono. (2015). *Metode penelitian bisnis* [Business research methods]. Bandung, Indonesia: Alfabeta.



## **Managerial Efforts in Building Organization Behaviour (Study of Entrepreneurs in Indonesia)**

**Rano Kartono<sup>1\*</sup>, Sasmoko<sup>2,3</sup>, Yasinta Indrianti<sup>3</sup>, Lasmy<sup>1</sup> and Hendry Hartono<sup>1</sup>**

<sup>1</sup>*Department of Management, BINUS Business School, Undergraduate Program,  
Bina Nusantara University, Jakarta Barat 11480, Indonesia*

<sup>2</sup>*Faculty of Humaniora, Bina Nusantara University, Jakarta Barat 11480, Indonesia*

<sup>3</sup>*Research Interest Group in Educational Technology, Bina Nusantara University,  
Jakarta Barat 11480, Indonesia*

### **ABSTRACT**

The aim of this paper is to examine the relationship between self-confidence, hope, optimism, and resilience as managerial efforts in building organization behaviour in Indonesia's entrepreneurs. Major research questions pursued are what is the influence of managerial effects in building organizational behaviour? What is the most significant variable in building organizational behaviour in Indonesia's entrepreneurs? The research was conducted from a sample of 148 entrepreneurs in Indonesia. The result of this research verified managerial efforts had a negative influence on building organizational behaviour of Indonesia's entrepreneurs, and self-confidence was the most significant variable in building the organizational behaviour of Indonesia's entrepreneurs.

*Keywords:* Entrepreneurs, hope, managerial effects, optimism, organizational behaviour, resilience, self-confidence

### **ARTICLE INFO**

#### *Article history:*

Received: 9 October 2019

Accepted: 3 January 2020

Published: 17 March 2020

#### *E-mail addresses:*

[rano.kartono@binus.ac.id](mailto:rano.kartono@binus.ac.id) (Rano Kartono)

[sasmoko@binus.edu](mailto:sasmoko@binus.edu) (Sasmoko)

[yasintaindrianti@gmail.com](mailto:yasintaindrianti@gmail.com) (Yasinta Indrianti)

[lasmy@binus.edu](mailto:lasmy@binus.edu) (Lasmy)

[hhartono@binus.edu](mailto:hhartono@binus.edu) (Hendry Hartono)

\*Corresponding author

### **INTRODUCTION**

As the world's fourth-largest populated country, with a population of around 260 million people, Indonesia has huge market potential to encourage local entrepreneurs to develop managerial efforts in building organizational behaviour (Donaldson & Ko, 2010; Fatimah et al., 2011; Luthans, 2002).

The managerial effort is not just about human and social capital; it is also about a

positive psychological state of development in regards to self-confidence, optimism, hope, and resilience (Luthans, 2007). Meanwhile, organizational behaviour is a special field of study of the impact that individuals, groups, and organizational structure have on behaviour within organizations in order to apply such knowledge to improve organizational performance (Ivanko, 2013).

Further support for the unique contribution of hope, optimism, and resilience to performance and other desirable attitudinal outcomes can be found in Fredrickson's (2001, 2003) broaden-and-build theory. Fredrickson's research revealed that positivity broadens one's spectrum of problem-solving skills, adaptive mechanisms, and thought-action repertoires while building inventories and buffers of intellectual, physical, social, and, most importantly, psychological resources such as optimism, resilience, and goal orientation (Youssef & Luthans, 2007).

However, for Indonesia's entrepreneurs, there has been a substantial gap and debate between managerial effects in building organizational behaviour. The purpose of this paper is to investigate the relationship between managerial effects and building organizational behaviour of Indonesia's entrepreneurs. The article proceeds in the following manner: First, we present a review of the literature regarding the managerial effects and organizational behaviour concept. Next, we reveal two hypotheses: managerial effects tend to have a positive influence on building organizational behaviour of Indonesian entrepreneurs,

and self-confidence is a significant variable on building organizational behaviour of Indonesian entrepreneurs, as revealed using representative data from 146 Indonesian entrepreneurs. The data collection method and research tools are explained. Finally, the findings and conclusions are discussed.

### Literature Review

The purpose of this paper is to investigate the relationship among self-confidence, hope, optimism, and resilience (*managerial efforts*) and organizational behaviour of Indonesian entrepreneurs.

**Managerial Efforts Concept.** Managerial efforts include discussions about human capital as state of the art for an organization to achieve sustainable competitive advantage; social capital as the networks of relationships and friendships that are helpful to all business; and psychological capital as an individual's positive psychological state of development that is characterized as follows: 1) confidence means being able to take on and put in the necessary effort to succeed at challenging tasks; 2) optimism is making a positive attribution about succeeding, now and in the future; 3) hope is persevering toward goals and, when necessary, redirecting paths to goals in order to succeed; 4) resiliency means the ability to sustain and bounce back from problems and adversity to attain success (Luthans, 2007).

Psychological capital (PsyCap) is a recent multidimensional construct, made up of four basic components: resilience, hope, optimism, and self-efficacy (Luthans &

Youssef, 2007). Such dimensions correspond to individual characteristics meeting POB main criteria, that is, being measurable, having the potential for development, and is related to performance. PsyCap is a higher-order “core construct,” unique and measurable, and is a more effective predictor of performance and work satisfaction than the individual variables composing it (Luthans, 2007). A significant negative relationship exists between the PsyCap construct and the perception of work-related stress symptoms; likewise, existing between PsyCap and intentions to resign and to find a new job are turnover indicators that should be contrasted through enhancing and developing positive resources (Luthans, 2007).

To measure managerial efforts, Allen and Hall (2007) considered how the managerial efforts might translate to observable activities of the management team. Further, an obvious measure of managerial effort is the amount of time start-up team principals typically devote to a firm that involves action by reinforcing the efficiency of labour and physical capital the firm employs to enhance managerial resources efficiency and increase profits for an organization.

**Organizational Behaviour Concept.** In any organization, organizational behaviour is defined as the nature and scope of activities to perform specific processes. In terms of the dynamics of the organization, business functions within an organization are classified into two main groups: 1) fundamental process (operational), which

is the provision of operational functions, production, or other work functions; 2) management process in which control functions are implemented, which is management, management, and leadership (Ivanko, 2013).

Luthans (2002) argued that the general perspective and relative attention in organizational behaviour had been characterized more by negativity than by positivity. For example, more attention has been given to negative as opposed to positive affectivity, stress, and burnout as opposed to eustress, resistance to change as opposed to acceptance/celebration of change, and the deficiencies, problems, and dysfunctions of managers and employees rather than their strengths and psychological capacities for development and performance improvement.

Furthermore, Luthans (2002) defined organizational behaviour as “the study and application of positively oriented human resource strengths and psychological capacities that can be measured, developed, and effectively managed for performance improvement in today’s workplace.” Besides positivity, to be included as a psychological resource capacity within this defined organizational framework, it must meet the following criteria: (a) the capacity must be theory- and research-based and validly measurable, and (b) the capacity must also be “state-like.”

**Indonesian Entrepreneurs Study.** The number of entrepreneurs in 2014 equals only 1.56% of the total population of Indonesia’s citizen (Pangestu et al., 2014); further,

the higher the rate of entrepreneurs in a country could intensify its economic growth, and it may also decrease unemployment and increase competition in Indonesia to generate economic growth.

According to the Cooperatives and Small and Medium Enterprise (UKM) Minister in 2018, the ratio of entrepreneurship in Indonesia currently reaches 3.01%. This is because the government of Indonesia actively develops the local economy by providing training, boosting production on small and medium enterprises (UKM), and provides people's business credit (KUR) with low-interest rates.

## MATERIALS AND METHODS

The object hypotheses tested using the quantitative method used multivariate analysis on surveyed data, to maintain the objective of this research. The research used statistics as analytical tools to reveal how the results relate to hypotheses. This research was empirical in nature, whereby a quantitative method was used to substantiate the relationships among the variables. The research itself was carried out in the period of March-April 2018. The study was conducted on a sample of 200 entrepreneurs in Indonesia through online questionnaires by using the 5-point Likert scales; in addition, from 200 questionnaires distributed, 158 (79%) completed questionnaires were returned to the author; however, 10 (0.05%) participants did not fulfil the requirement to be further analyzed, and 42 (21%) were not returned

to the author. Therefore, the effective data for this analysis are 148 respondents from 200 questionnaires.

There are 2 hypotheses and a 2 stages analysis in this research: firstly, self-confidence ( $X_1$ ), hope ( $X_2$ ), optimism ( $X_3$ ), and resilience ( $X_4$ ) of the variables and dimensions of managerial efforts ( $X$ ) independently of organizational behaviour ( $Y$ ). And second, the simultaneous analysis of the variables and dimensions of managerial efforts ( $X$ ) against organizational behaviour ( $Y$ ). The analysis is conducted in order to see the consistency of the most dominant variable or dimension in realizing organizational behaviour ( $Y$ ) of entrepreneurs in Indonesia.

## RESULTS AND DISCUSSIONS

### Demographic Descriptive

Of the total 154 respondents, 60% were women and 40% were men. Viewed from age, 36.4% were under 25 years old, 26% were aged 25-40 years, 31.2% were aged 41-55 years, and 6.5% were over 55 years old (Figure 1).

Viewed from Figure 2 the level of education, 3.2% are elementary school graduates, 1.9% are junior high school graduates, 49.4% are senior high school graduates, 94.2% are bachelor graduates, and 5.8% are master's graduates.

Meanwhile, Figure 3 based on ownership, 90.8% are owners, 9.2% is the staff.



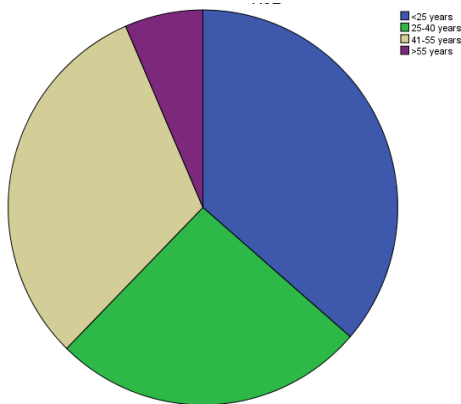

Figure 1. Respondents by age

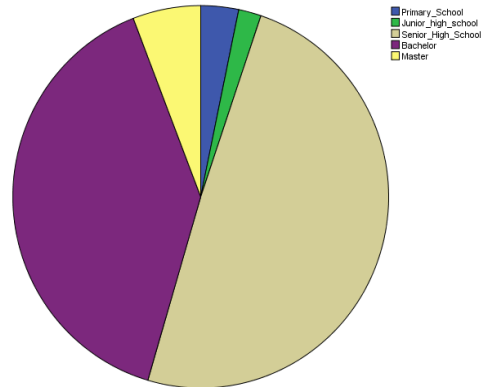

Figure 2. Respondents by the level of education

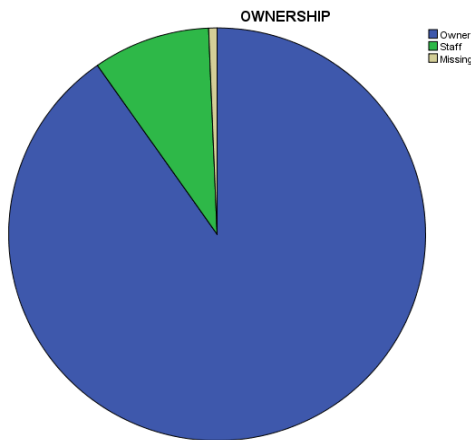

Figure 3. Respondents by ownership

### Calibration of Managerial Efforts in Building Organizational Behaviour of Indonesian Entrepreneurs (Y)

Instrument calibration of managerial efforts in building organizational behaviour entrepreneur Indonesia (Y) was conducted through 3 stages: firstly, content validity was conducted by the expert judgment that consisting of entrepreneurs and academics. Content validity results generate 4 dimensions, 8 indicators and 16 items; secondly, construct validity was conducted

through orthogonal iteration approach, the sample of research instrument is 30 people, with r-criterion 0.361 at 5% significance level. The result of construct validity from the 16 items planned, turns out all the items are valid; and thirdly, the result was conducted from entrepreneurs in the reliability index of managerial efforts in establishing organizational behaviour entrepreneur Indonesia (Y) with Cronbach Alpha formula is 0.919 as shown in Table 1.

### Data Normality Test of Managerial Efforts in Building Organizational Behaviour of Indonesian Entrepreneurs (Y)

The data normality test is conducted to test the distribution of exogenous variables data including self-confidence (X1), hope (X2), optimism (X3), and resilience (X4) and building organizational behaviour of Indonesian entrepreneur (Y) variable as an endogenous variable. Normality test is done by proportion estimation through Blom formula with P-P Plot approach. The P-P plot approach was taken because the sample size was < 200 persons. Based on the calculation

Table 1

*Reliability statistics of managerial efforts*

Cronbach's Alpha	N of Items
0.919	16

of Normal P-P Plot produce all endogenous and exogenous normal distributed variables, and the data distribution has no outlier. Likewise, when viewed from the Detrended Normal P-P Plot, the data distribution does

not represent sinus or cosine curves. So, it can be concluded that the distribution of all data variables is normally distributed. Graphically the results can be seen below in Figure 4.

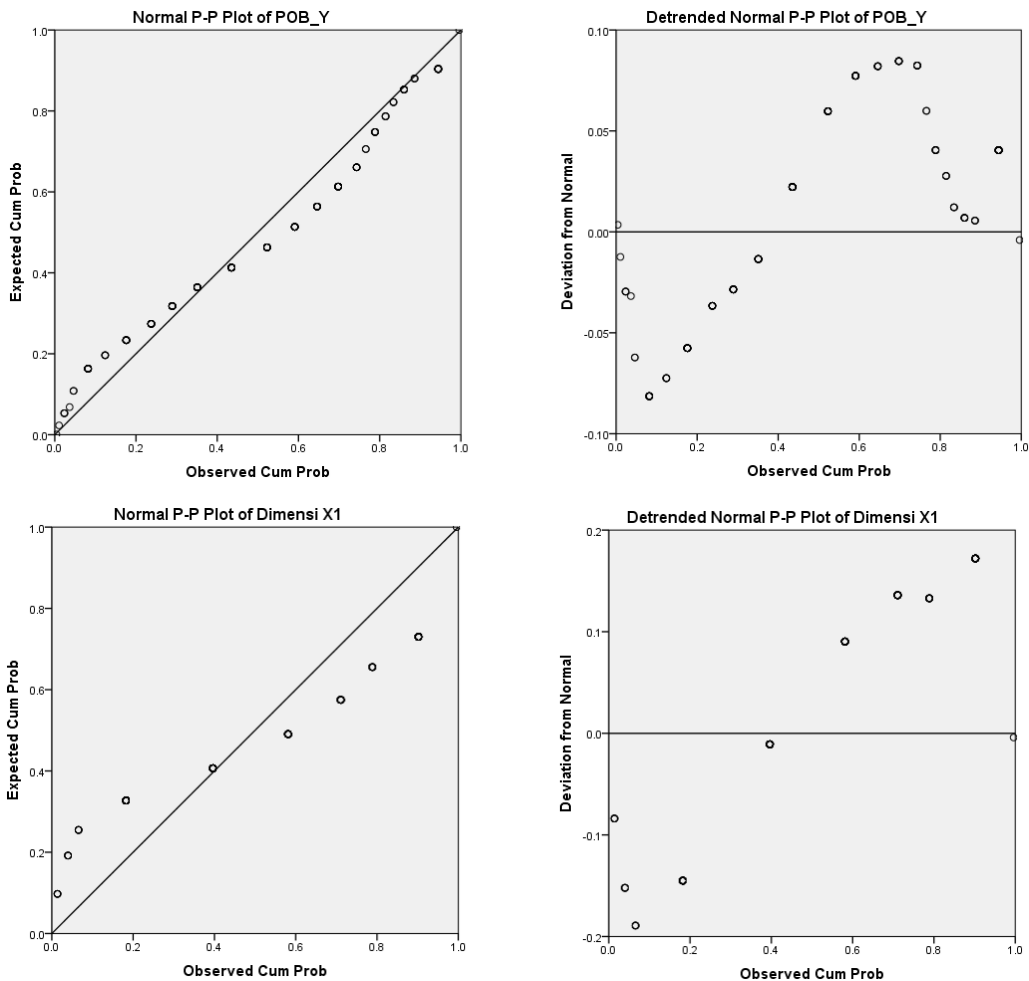

Figure 4. P-P Plot of Dimension X1, X2, X3 and X4

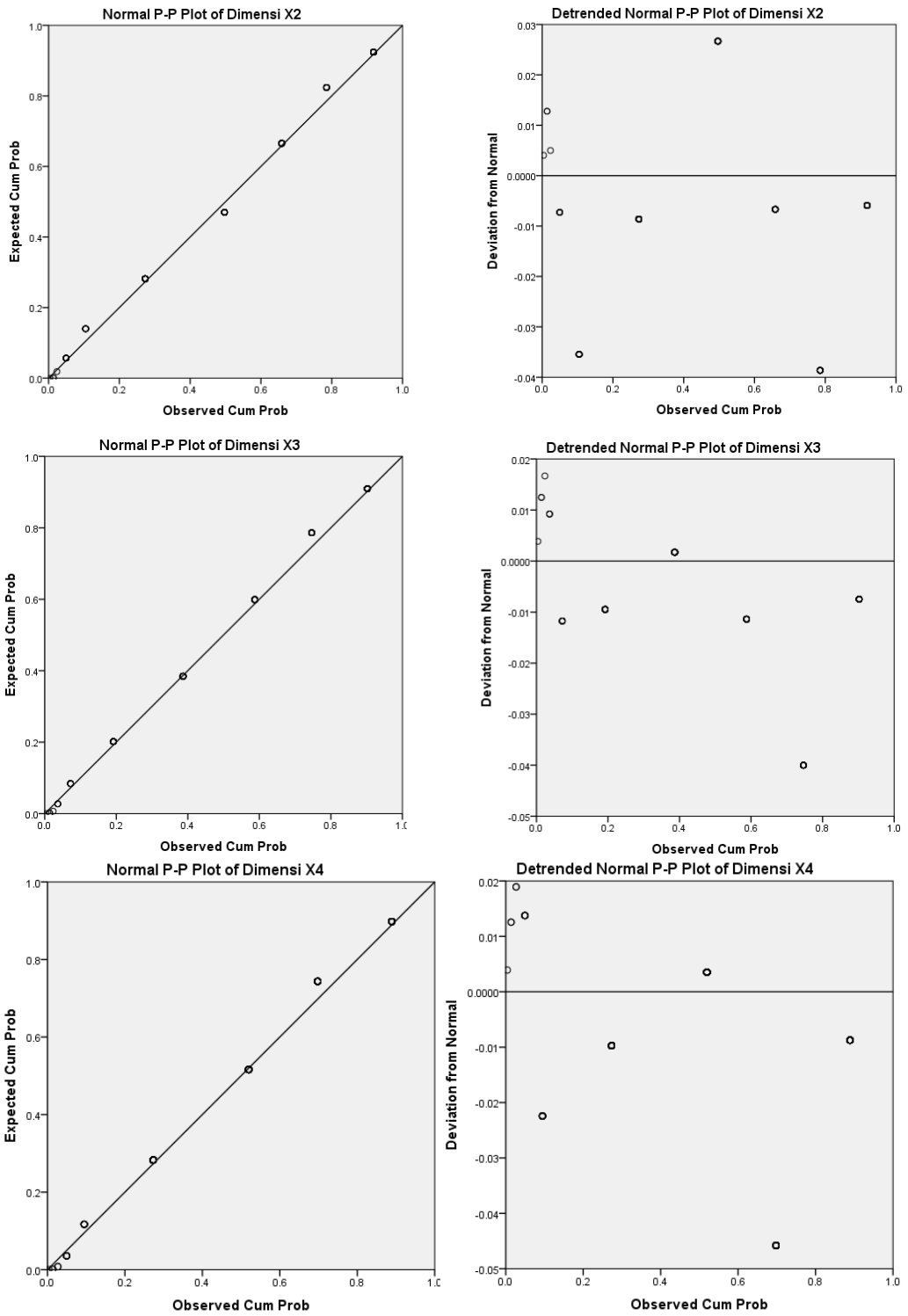

Figure 4. Continued

**Information:**

Endogenous Variable:

Y : Variable of Positive Organizational Behaviours of Indonesia Entrepreneur

Exogenous Variables:

X<sub>1</sub> : Dimension Self Confidence

X<sub>2</sub> : Dimension Hope

X<sub>3</sub> : Dimension Optimism

X<sub>4</sub> : Dimension Resilience

Figure 4. Continued

**Instrument**

The instrument of managerial effects in building organizational behaviour in Indonesia’s entrepreneurs had been validated both in content and construct validity. The instrument consisted of four dimensions, eight indicators, and 16 items. The validity construct results show *r*-criterion 0.361 at a 5% significance level, and all items are valid.

**Linearity Test Line Relationship between Exogenous Variable and Managerial Efforts in Building Organizational Behaviour of Indonesian Entrepreneurs (Y) as Endogenous Variable**

The results of linearity test between exogenous variable include self-confidence (X1), hope (X2), optimism (X3), and Resilience (X4) with endogenous variable, managerial efforts in building organizational behaviour of Indonesia entrepreneur (Y) can be seen in Table 2.

Table 2

*Linearity test line relationship between an exogenous variable and managerial efforts*

No	Linearity Y from X	Deviation from Linearity		F from 11 Curve’s Estimation	Sig	Remarks
		F	Sig.			
1.	Self confidence (X <sub>1</sub> ) → Positive organizational behaviour (Y)	15.317	0.000	403.557	0.000	Linear
2.	Hope (X <sub>2</sub> ) → Positive organizational behaviour (Y)	1.829	0.076	-	-	Linear
3.	Optimism (X <sub>3</sub> ) → Positive organizational behaviour (Y)	2.076	0.042	155.841	0.000	Linear
4.	Resilience (X <sub>4</sub> ) → Positive organizational behaviour (Y)	2.563	0.016	126.679	0.000	Linear

**Hypothesis Test Results**

**Hypothesis Test 1 Result: Managerial Effects (Self-confidence (X1), Hope (X2), Optimistic (X3) and Resilience (X4) has no significant influence in Building Organization Behaviour of Indonesian Entrepreneur (Y).** For this hypothesis, each variable has been specified by 3 categories, which result shown in Table 3.

Based on the result, it can be concluded that Indonesian entrepreneur tends to have negative behaviour toward business developed; tend not to believe in their business but have a significant expectation with their business; tend to start a have high optimism with their business and have a good business resilience at moderate level with level of significantly of  $\alpha < 0.05$ .

Table 3  
*Hypothesis 1 test result*

Variable	Categories	95% Confidence interval for Mean		Analysis results
		Lower bound	Upper bound	
Positive organizational behaviour (Y)	Negative Sometimes +/- Positive	68.4790	70.9885	Entrepreneurs of Indonesia tend to have negative behaviour toward business developed significantly at $\alpha < 0.05$
Self-confidence (X <sub>1</sub> )	Not confident Sometimes Confident	21.3594	22.8614	Entrepreneurs of Indonesia tend not to believe in their business significantly at $\alpha < 0.05$
Hope (X <sub>2</sub> )	No hope Sometimes Hope	16.8326	17.4661	Entrepreneurs of Indonesia tend to have a significant expectation with their business at $\alpha < 0,05$
Optimism (X <sub>3</sub> )	Not optimistic Sometimes Optimism	17.2460	17.8320	Entrepreneurs of Indonesia tend to start to have a high optimism with their business significantly at $\alpha < 0.05$
Resilience (X <sub>4</sub> )	Not confident Sometimes Confident	12.6759	13.1942	Entrepreneurs of Indonesia tend to have good business resilience significantly $\alpha < 0,05$

**Hypothesis Test 2 Result: Self-Confidence (X1) is the Most Significant Variable in Building Organization Behaviour of Indonesian Entrepreneurs.** For this hypothesis, 2 stages of analysis are conducted to be analyzed: Firstly, self-analysis of X variables and the dimension of X1, X2, X3 and X4 individually in building organizational behaviour of Indonesian Entrepreneurs (Y); and secondly, the joint analysis of the variables and dimension of X1, X2, X3 and X4 together against building organizational behaviour of Indonesia entrepreneurs (Y), which result as shown in Table 4.

**Analysis of Exogenous Variables include Self Confidence (X1), Hope (X2), Optimism (X3), and Resilience (X4) With Endogenous Variables in Building Organizational Behaviour (Y)**

The results of the analysis of exogenous variables include self-confidence (X1), hope (X2), optimism (X3), and resilience (X4) with endogenous variables in building organizational behaviour (Y) can be seen in Figure 2. From Figure 2, it can be explained that self-confidence (X1) is a dimension that most dominant exogenous variable determines the realization of organizational behaviour of Indonesian entrepreneurs (Y) after being influenced by the optimism dimension of the entrepreneur itself (X3).

Table 4  
*Hypothesis 2 test result*

No.	Analysis	Symbol	$X_1 \rightarrow Y$	$X_2 \rightarrow Y$	$X_3 \rightarrow Y$	$X_4 \rightarrow Y$
1.	X relationship with Y in sample	$r_{yn}$	0.852	0.731	0.712	0.674
2.	Variance determination	$r^2_{yn}$	0.725	0.531	0.503	0.451
3.	The relative contribution of X in forming Y	$r^2_{yn}(\%)$	72.5	53.1	50.3	45.1
4.	X relationship with Y in population	t	20.089	13.198	12.484	11.255
5.	Significance value	Sig.	0.000	0.000	0.000	0.000
6.	The effect of X on Y in the sample	$\hat{Y}$	$1.424X_1$	$2.895X_2$	$3.047X_3$	$3.265X_4$
7.	The effect of X on Y in the population	$F_{Reg}$	403.557	174.191	155.841	126.679
8.	Significance value	Sig	0.000	0.000	0.000	0.000
9.	The greatest pure relationship	$r^2_{yn.m}$	0.911	0.824	0.833	0.775
10.	A relatively pure donation of X with Y	$r^2_{yn.m}(\%)$	83	67.9	69.4	60.1

Ability to give 83% contribution in building positive organizational behaviour (Y). The conclusion of the analysis individually can be shown in Figure 5.

**Influence Analysis Exogenous Variables include Self Confidence (X1), Hope (X2), Optimism (X3), and Resilience (X4) with Endogenous Variable Building Organizational Behaviour (Y)**

This hypothesis test is done by a binary segmentation analysis approach called Classification and regression trees. In this analysis, the researchers set the pruning of depth by 2, parent 2, and child by 1, with significance level  $\alpha < 0.05$ . The result of the analysis proves that the dimension of self-confidence of entrepreneur Indonesia (X1) is the most dominant variable determining the formation of building organizational behaviour of Indonesian entrepreneurs (Y) where it is driven by ownership of motivation in achieving goals (X7). If the level of self-

confidence of Indonesian entrepreneurs is enhanced through 1 (one) priority program, then building organizational behaviour of Indonesian entrepreneurs (Y) will increase by 91.75 times from current condition. The summary can be seen in Figure 6 and Figure 7.

Indicators have motivation in achieving goals (X) that determine the dimension of Self Confidence of Indonesian entrepreneurs (X1) Impacting on its influence on positive organizational behaviour of Indonesian entrepreneurs (Y).

Based on the analysis above, it can be concluded that Indonesia’s entrepreneurs tend to exhibit negative behaviour toward business developed; tend not to believe in their business (but have a significant expectation with their business); tend to have high optimism with their business, and have a good business resilience at moderate level with level of significantly of  $\alpha < 0.05$ .

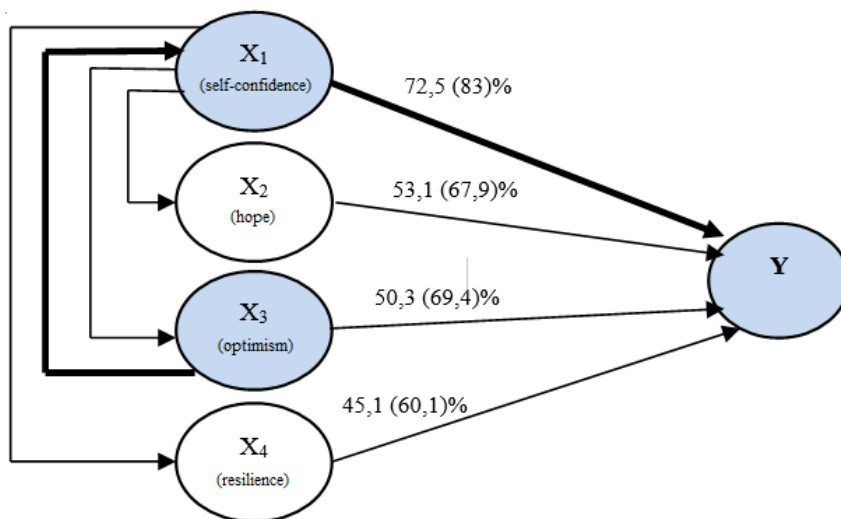

Figure 5. Analysis of exogenous variables with endogenous variables in building positive organizational behaviour (Y)

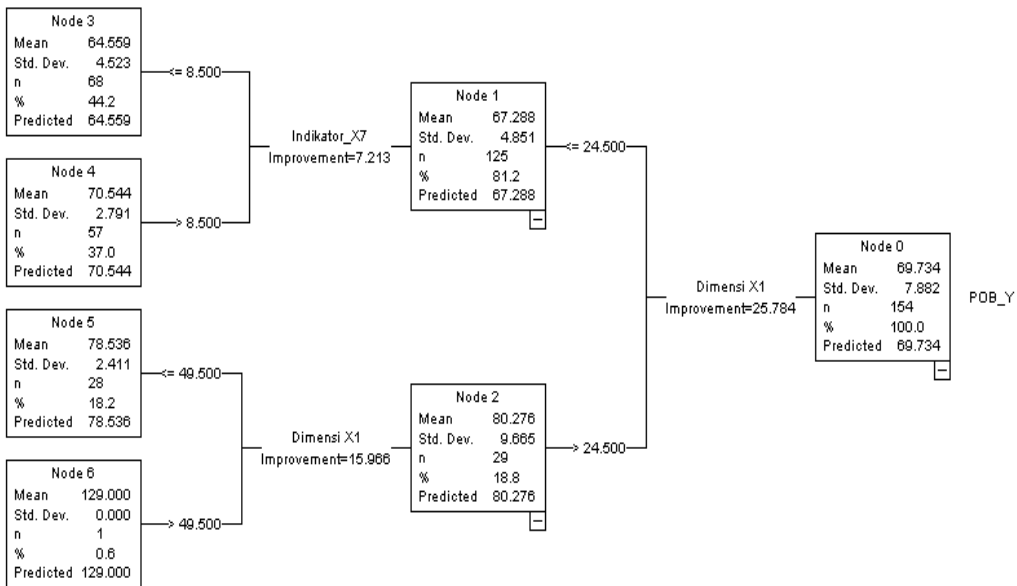

Figure 6. Influence Analysis Exogenous variables with endogenous variable Building Positive Organizational behaviour (Y)

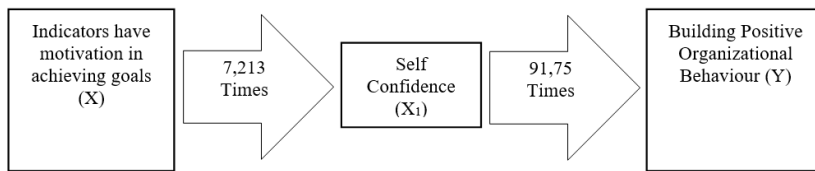

Figure 7. Motivation in achieving goals

**CONCLUSIONS**

The research of the managerial efforts in building organizational behaviour of Indonesian entrepreneurs could be concluded by summarizing the main empirical findings. Firstly the managerial effect has negative influence behaviour on business, self-confidence, hope, optimism, and resilience to their business development. The test results of Indonesian entrepreneurs reveal an exciting finding, which is contrary

to some of the earlier research studies, i.e., managerial effects have a significant influence when building organizational behaviour. It can be inferred that managerial effects may cause an unclear strategy for Indonesia’s entrepreneurs, which leads to a negative influence on their business. Still, managerial effects are important to drive corporate strategies to build organization behaviour, although they do not directly influence Indonesia’s entrepreneurs when building organizational behaviour.



Secondly, Self-confidence is the most significant variable in building organizational behaviour of Indonesia's entrepreneurs. The test result shows the significant difference among self-confidence (X1), optimism (X2), hope (X3), and resilience (X4) in managerial effects in building organizational behaviour of Indonesia's entrepreneurs. Based on the results of the above research, it can be concluded that self-confidence (X1) is the most dominant dimension to determine the realization of building organizational behaviour of Indonesia's entrepreneurs (Y), as evident in this study.

## ACKNOWLEDGEMENT

The authors thank the entrepreneurs who took part in the online questionnaires and Bina Nusantara University for providing funds and full support for the accomplishment of this research paper.

## REFERENCES

- Allen, W. D., & Hall, T. W. (2007) Innovation, managerial effort, and start-up performance. *The Journal of Entrepreneurial Finance and Business Ventures*, 12(2), 1-48.
- Donaldson, S. I., & Ko, I. (2010). Positive organizational psychology, behaviour, and scholarship: A review of the emerging literature and evidence base. *Journal of Positive Psychology*, 5(3), 177-191.
- Fatimah, O., Amiraa, A. M., & Halim, F. W. (2011). The relationships between organizational justice, organizational citizenship behaviour and job satisfaction. *Pertanika Journal of Social Science and Humanities*, 19(S), 115-121.
- Fredrickson, B. L. (2001). The role of positive emotions in positive psychology. *National of Health Institutes*, 56(3), 218-226.
- Fredrickson, B. L. (2003). The value of positive emotions. *American Scientist*, 97, 330-335.
- Ivanko, S. (2013). *Organizational behavior*. Ljubljana, Slovenia: University of Ljubljana.
- Luthans, F., & Youssef, C. M. (2007). Emerging positive organizational behaviour, *Journal of Management*, 33(3), 321-349.
- Luthans, F. (2002). The need for and meaning of positive organizational behaviour. *Journal of Organizational Behavior*, 23(6), 695-706.
- Luthans, F. (2007). Hope, optimism, and other business assets: Why "Psychological Capital" is so valuable to your company. *Comportamento Organizacional E Gestão*, 13(1), 137-142.
- Pangestu, G., Nicky, P. F., & Kumar, M. S. (2014). The factor that affects the entrepreneur's growth in Bekasi region, Indonesia. *International Journal of Scientific and Research Publication*, 4(1), 1-8.
- Youssef, C. M., & Luthans, F. (2007). Positive organizational behaviour in the workplace: The impact of hope, optimism, and resilience. *Journal of Management*, 33(3), 774-800.



## **Enhancing the Economic Potential of Indigenous People in the Jababeka Industrial Area through Corporate Social Responsibility**

**Ulani Yunus<sup>1\*</sup>, Tri Adi Sumbogo<sup>1</sup>, Gayes Mahestu<sup>1</sup> and Wajid Zulqarnain<sup>2</sup>**

*<sup>1</sup>Marketing Communication Program, Department of Communication,*

*Faculty of Economics and Communication, Bina Nusantara University, West Jakarta 11480, Indonesia*

*<sup>2</sup>Faculty of Media Sciences, Shaheed Zulfikar Ali Bhutto Institute of Science and Technology (SZABIST), Islamabad, Plot No. 67, Street No. 9, H-8/4, Islamabad, Pakistan*

### **ABSTRACT**

Jababeka is a brand of an industrial area located in Cikarang, Bekasi Regency, West Java Province, Indonesia. The purpose of this study was to find how were the CSR programs of the tenants of Jababeka could enhance the economic potential of indigenous peoples. The methodology used descriptive qualitative research. Data collection technique used were interviews, literature, and observations. The results showed that Jababeka used CSR as continuous improvements in succession planning to support company performance excellent. Jababeka CSR program such as Economic, Fellowship, and Environmental. Economic pillar relates to improving the quality of human resources through entrepreneurship

training and micro-finance, as well as community empowerment and economic improvement through the provision of assistance in the form of revolving capital, farm or business equipment, including mentoring. This research concluded that CSR Program of tenants could enhance the economic potential of indigenous peoples through Jababeka CSR program especially in training of entrepreneurship and be mentoring in business. The selection of the program was based on the type of products owned by tenant and the practical way of economic empowerment of local

### ARTICLE INFO

#### *Article history:*

Received: 9 October 2019

Accepted: 3 January 2020

Published: 17 March 2020

#### *E-mail addresses:*

[uyunus@binus.edu](mailto:uyunus@binus.edu) (Ulani Yunus)

[tri.sumbogo@binus.ac.id](mailto:tri.sumbogo@binus.ac.id) (Tri Adi Sumbogo)

[gayesmahestu@binus.ac.id](mailto:gayesmahestu@binus.ac.id) (Gayes Mahestu)

[dr.wajid@szabist-isb.edu.pk](mailto:dr.wajid@szabist-isb.edu.pk) (Wajid Zulqarnain)

\*Corresponding author

communities such as opening a beauty salon of L'Oreal products.

*Keywords:* CSR, economic potential, indigenous people, industrial area, Jababeka

---

## INTRODUCTION

Jababeka is a brand of an industrial area located in Cikarang, Bekasi Regency, West Java Province, Indonesia. Jababeka is a residential area with an industrial park. Based on the official release, Jababeka is the house of more than 1,600 local and multinational companies from over 30 countries including Australia, France, Japan, France, Korea, Malaysia, Taiwan, Netherlands, United Kingdom, and others. Jababeka has employed more than 700,000 workers and 4,300 expats. Multinational companies such as *L'Oreal*, *ICI Paints*, *Mattel*, *Samsung*, *Unilever*, *United Tractors*, *Akzo Nobel*, and *Nissin Mas* joined the corporation (Jababeka, 2017). Informant mentioned that in 2015, Bekasi was one of the areas which experienced inflation. The percentage of West Java population living in Bekasi is 5.74 per cent. Bekasi has the largest population compared to other urban areas in West Java. Thus, the government of Bekasi has been focusing on developing Human Resources (HR).

To measure the success of HR development, Human Development Index is made as an indicator. The income of Bekasi in 2014 reached 64.2 Billion Rupiahs, while at constant prices of 5.3 Billion Rupiahs. Economic Growth Rate of Bekasi in 2014 was 5.61%. The performance of economic

activities in Bekasi has decreased compared to the previous years. According to the data until August 2016, unemployment in West Java reached 8.89%; Poverty: 4.22 million people or 8.95% (Pemkot Bekasi, 2017). Under these conditions, programs that can enhance the economic potential of local communities which includes various cultures for Bekasi as an urban city is needed. International organizations and the government plays an important role in the development agenda and global sustainability, where the participation of the private sector in this regard is often viewed from its contribution to economic growth, job creation, and tax payments. From now, the private sector should start taking the role of social responsibility. Increasing the potential of the community is included in the Corporate Social Responsibility (CSR) program. Jababeka is a company located in Bekasi which has the responsibility to develop the region. From socio-cultural perspective, Bekasi, consists of various ethnics such as *Sundanese*, *Batak*, *Minang*, *Javanese*, and the most dominant ethnic, especially in Jababeka area, is *Betawi*. When the company, as a new community, intervenes the local community, it is important to adapt and contribute to the community, because their presence has both positive and negative impacts.

The present core value, which previously related to social responsibility, has been retitled and rewritten to reflect the larger sustainability concepts embodied in societal responsibility. According to Malcolm Baldrige Criteria, corporate

social responsibility has been an element of the Performance Excellence since 1988. Baldrige Criteria provides frameworks for the design and improvement of high-performing organizations; as such, it implies that corporate social responsibility is an important factor for achieving performance excellence. The frameworks can be seen in Figure 1 (Foote et al., 2010).

Baldrige Method is a tool to investigate the position of an organization or visions of the organization (Baldrige Performance Excellence Program, 2017). This method allows knowing the detail of strengths and opportunities of an organization for improvisation. The criteria in this method will determine the success of an organization. The categories such as leadership, operation, workforce, customer, measurement, analysis and knowledge management, and Strategy, are the keys to define organization result.

The problem in this research is: how CSR programs of Jababeka tenants enhance the economic potential of indigenous people? This question is broken down into three questions, namely: (a) what is the programs implemented by CSR Jababeka team? (b) what are the considerations in selecting those programs? (c) what types of communication carried out by CSR Jababeka team?

### Literature Review

Baldrige Glossary stated that the term “performance excellence” referred to an integrated approach to organizational performance management that resulted in (1) delivery of ever-improving value to customers and stakeholders, contributing to organizational sustainability; (2) improvement of overall organizational effectiveness and capabilities; and (3)

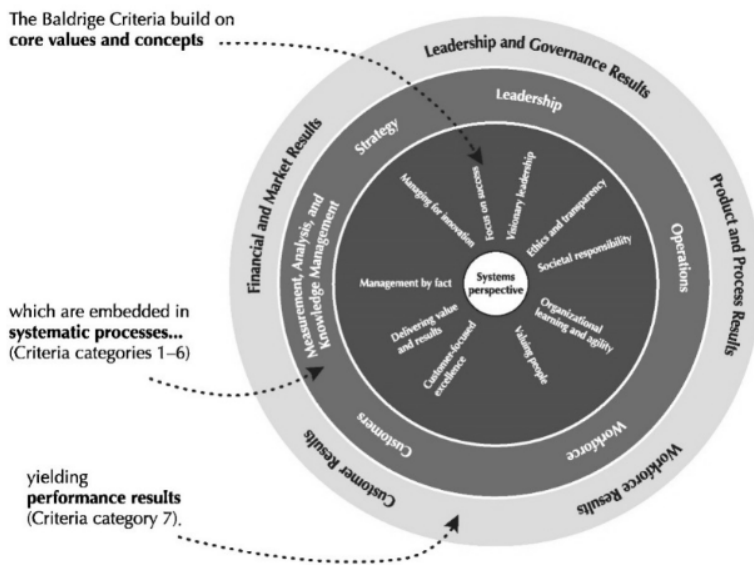

Figure 1. The role of core value and concept (Baldrige Performance Excellent Program (2017))

organizational and personal learning (Simamora as cited in Caesar, 2016). Based on the definition, the term “performance excellence” includes an integrated approach to management with organizational level effect (Caesar, 2016).

After working with stakeholders around the world, in 2002 World Business Council for Sustainable Development (WBCSD) defined CSR as “continuation of business commitment to behave ethically and contribute to sustainable economic development, working with employees, their families, the local community and society at large to improve their quality of life.”

Business organizations cannot operate successfully without the cooperation with a society where they are located. According to corporate communication approach, cooperation should not only having discussions with the stakeholders. For example, manufacture industry in Nigeria, the cooperation with youth and women empowerment should be incorporated into the organization business strategies (Akinyomi, 2012). Porter and Kramer as cited in Rana et al. (2009) noted that the relationship between business and society that did not treat corporate success and social welfare was a zero-sum game.

Public Advise International Foundation (2011) defined CSR as an organic link between enterprising, profit-making and social development that was conducted as a win-win solution in areas where a company required something from the society that could not be bought and required investment through a double business plan, one for the

company and one for the society (Aghashahi et al., 2013).

From corporate citizenship perspective, corporate social responsibility (CSR) organizations tend to focus on making positive contributions towards their stakeholders as opposed to citizens. Organizations are bond into mutually beneficial exchanges that protect fundamental human rights and responsibilities (Cornelissen, 2014).

According to Financial Times Lexicon, Corporate Social Responsibility CSR-Global Executive MBA, CSR implementation varies among companies and countries. Incorporating many additional subjects -organizational governance, human rights, labour practices, environment, fair operating practices, consumer issues, community involvement and development - corporate social responsibility has the main purpose of maintaining the path to sustainability (Dragu & Tiron-Tudor, 2014).

Discussion on CSR had already been conducted by previous researchers in 2012. However, we still have many things to learn about the welfare properties of CSR, both absolutely and relatively as the alternative of public goods provision. The main question of the theory includes: what is implied by the difference in welfare definitions about CSR optimality? It is a promising direction for future research to investigate that difference to determine classic welfare measures and actual welfare outcomes in the real world. Consequently, the development of empirical strategies to evaluate welfare is promising (Kitmueller & Shimshack, 2012). Based on its territory, the following is an overview of

how CSR is implemented in some places, namely:

### **Jababeka Area**

In 2009 - 2010 period, Jababeka industrial area had been carrying out CSR activities through community-developed programs by providing assistance to women. The corporate social activities were conducted together among industrial area manager and tenant. The program was implemented with economic empowerment approach through the creation of regaining in 2009 and salted egg household business in 2010 (Azam, 2012). The study found that on a practical level, people were not familiar with social programs tended to be passive against the company.

### **Philippine Area**

The implementation of community welfare programs is perceived to have a high impact on the social and economic improvement of the community. The greater the level of the community welfare programs implementation, the higher its impact on the community enhancement as perceived by the respondents. However, in some conditions such as the implementation of community welfare programs, constraints are encountered by the implementers. Strategies, therefore, have been proposed as a response to the constraints encountered in the implementation of the community welfare programs (Yango, 2013).

### **Batam Area**

The policy of corporate social responsibility

by PT. Batamindo Investment Cakrawala should focus on local social values. This approach is very important in order to make the CSR program by the corporate-run effectively and efficiently. Besides, the CSR program must involve all people in the company to allow getting even benefits of CSR program (Mapisanga, 2009).

## **MATERIALS AND METHODS**

This study used descriptive qualitative research. Data were collected through interviews, literature, and observations to gather data and then analyzed the facts relating to the implementation of CSR Jababeka programs that were related to the economic empowerment as well as explored how CSR Jababeka team communication to these communities. Data collection was conducted by interviews with local government and internal sources. Interview technique was chosen to collect primary data, while data on government web, results of previous studies and literature were included as secondary data.

The data was analyzed using triangulation. Gliner as cited in Meijer et al. (1999) stated that triangulation was the highest priority method in determining internal validity in qualitative research. By referring the concept of triangulation by Miles and Huberman (1994), this research used *first*, the triangulation by the data source (data collected from different people, or at different time, or from different places). *Second*, triangulation by method (observations, interviews, documents) (Meijer et al., 1999). In the implementation,



research triangulation is conducted by CSR specialist in Indonesia and news reporter on the issues related to CSR Jababeka. Necessary information allows us to expand our understanding of the competition among corporate philanthropy, its meanings, practices, and results (Haynes, 2013). This study was focused on the practice and results of CSR conducted by Jababeka.

## RESULTS AND DISCUSSIONS

### Results

Jababeka CSR had applied the Baldrige concept that implied that it went beyond compliance orientation. Some opportunities should be considered to promote the well-being of environmental, social, and economic systems in which an organization might contribute and support key factors available for the organization.

**Programs Implemented by CSR Jababeka Team.** The results showed that CSR in Jababeka was conducted and managed together by managerial boards and companies (tenant) in Jababeka industrial area. CSR was conducted in the form of preservation of local culture in the community to cooperate with the board of neighbourhood for performing arts and cultural activities.

In West Java, including PT Jababeka, for the past 5 years, there have been 100 companies with CSR funds reaching up to Rp1.1 trillion. There are 6,052 companies in West Java. The number of partner companies of West Java CSR is 127, consists of 3 state enterprises, 40 state-owned enterprises,

and 88 private companies. During 2016, there were 117 CSR projects based on the Partnership and Community Development Program. General Manager of PT Jababeka Infrastructure, Kukuh Sulaksono, expressed his gratitude to the tenants in his interview.

Jababeka CSR program, in general, consists of three pillars: Economic, Fellowship, and Environmental. The economic pillar is related to quality improvement of human resources through entrepreneurship training and micro-finance, as well as community empowerment and economic improvement through the provision of assistance in the form of revolving capital, farm or business equipment, including mentoring. Fellowship pillar is divided into four areas, namely education, health, religious and social. The third pillar, environment, is implemented by making Bio Pori holes in factories, schools, and housing, as well as forming a gardening community in Cikarang.

If combined with the previous studies, the steps of CSR program are as follows:

1. Community need assessment
2. Formulation strategy to make the priority of the social program
3. Capacity development through community development training
4. Pilot project income-generating activity through the economic group:
  - a. Cultural conservation through production handicraft such as *tenun* making
  - b. Natural resources-based entrepreneur – beekeeping, sauce production, tofu and *tempe* production



5. Monitoring and evaluations (Amerta, 2015).

**Consideration to Choose Programs.** The selection of the program was based on the type of products owned by the tenants and practical way of economic empowerment of local communities such as opening a beauty salon with L'Oréal products. The results showed that CSR organized by Jababeka as mentioned by CSR Manager of Dexa Group, Mateus Ramidi "*Sharing Jababeka's CSR program is very helpful for the tenants who inhabit the Jababeka Industrial Estate. CSR programs can be helpful, coordinated and targeted*". The same thing mentioned by Edi Supratomo as Community Development PT Showa Indonesia MFG "*Jababeka's CSR sharing is very helpful to the people living around Jababeka Industrial Estate, especially in the villages as Jababeka's first ring*". Stephen Orlando, Public Relations Manager of PT Nippon Indosari Corpindo (Sari Roti) added "*It is very helpful, both to the tenant and to the development of communities around the industrial area.*"

As mentioned in the introduction, the economic condition of Bekasi as the most populated city in West Java, has experienced inflation, so empowering human resources is chosen for Jababeka CSR program. Learning from America, according to the study by McKinsey (2015), many corporations do not focus on developing the capacity of employees. Lack of focus on training program led to the absence of high skills in the corporation. It can be implemented in a CSR program and should be invested in the community through training (Bevly,

2012). This is in accordance with the code of the conduct of L'Oréal. According to the 2015 Annual Report of L'Oréal's, the Board of Directors placed great importance on the respect of L'Oréal's Ethical Principles - Integrity, Respect, Courage and Transparency - and more generally on the Code of Ethics. There are some fundamental commitments, which are the group's policies on compliance, responsible innovation, environmental stewardship, social and societal responsibility and philanthropy. The Board considers that these ethics policies form an integral part of L'Oréal's growth model, and therefore supports their implementation and regularly measures the advances made (L'Oréal, 2015).

**Types of Communication Carried Out by CSR Jababeka Team.** Jababeka CSR team communicates with the local and central government so that the CSR program can be implemented according to the target area as well as meeting face-to-face with the indigenous people with art and culture performances. The company has set up a 24-hour telephone line for residents/customers at +62 21 8983 4321 or send comments and suggestions via email: info@jababekainfrastruktur.com. In addition, the team also holds gatherings and HR Forum on a regular basis for tenants in the industrial estate regarding their past and upcoming events and activities as the development and implementation of regulations and policies established by the government through the relevant apparatus as well. This is in accordance with the previous study, that communication by GRI responsibility

report is a crucial explanatory factor for corporation market value, and point at theoretical, managerial, as well as legislative implications. People perception on the use of CSR-related donations is influenced by vivid messages and communication that increase consumers' emotional involvement toward a product-cause association, raising several crucial ethical concerns (Dobers & Springett, 2010). In the framework of awareness and appreciation of local culture in society, CSR Jababeka cooperates with the neighbourhood and community groups to perform arts and cultural performances. This is part of the communication with the government.

### Discussions

An overview of the Jababeka industrial area like Industrial Parks (IPs) and other forms of business agglomerations forms an important part of the economy of modern societies, not only to their value creation activities and their effects on employment but also on the natural and artificial environment and society as a whole (Zilahy & Milton, 2008). ISO 26000 standard provides guidance on voluntary social responsibility of an institution which covers all sectors of public or private institutions in both the developing and developed countries. With ISO 26000, the organization will provide additional value to social responsibility which is currently developing in the following manner: 1) develop a consensus on the notion of social responsibility and the issue; 2) provide guidance on translating principles into effective activities; 3) sort out the best

practices that have been developed and disseminated for the good of the community or the international community.

ISO 26000 Standard Guidance on Social Responsibility that consistently develops social responsibility Consistent with sustainable development and social welfare is constructed based on the following considerations: 1) taking into account the interests of stakeholders; 2) under applicable law and consistent with international norms; 3) integrated with all activities of the organization, in this sense covers both activities, products, and services (ISO, 2017).

Various regulations above with its advantages and shortcomings raise both optimism and concern. Optimism, because the various parties looked at the potential magnitude of CSR in support of the government to improve the welfare. Concerns arise, however, because the company restrained by the various rules of CSR both at the level of the central government, provinces, up to the area. Though in almost all companies, CSR is budgeted from 'corporate profits', not all companies organize it specifically, because the company is the core business. The most visible CSR program and results can be observed from L'Oréal in targeting the female population.

The interviewee said that L'Oréal had a program called "Beauty for a Better Life", which was a hairdressing program for people in Bekasi Regency. The program provided hairstyling in accordance with the curriculum and standard module of L'Oréal

Matrix, which after the program finished, the participants would get certificates from L'Oréal signed by the President Director. "Beauty for Better Life" program is directed to women of poverty, women workers, widows, disabled or victims of violence. The best participants would get salon equipment, so they could be independent and built their own business. In total, there are 3 people who had received these benefits and then they opened their own salon for their community.

We found that the gap was greatly reduced in female consumer. We used social identity theory to explain the phenomenon of gender differences and how were they related to CSR. Along with providing insight to CSR at the individual level with attitudes and behaviours, our findings also had implications at the firm level for how organizations chose and strategically signaled their CSR strategies toward specific consumer segments (Jones et al., 2017). This is also supported by Yunus et al. (2016) that women by nature preferred listening for information and looked forward to receiving information in interesting ways such as through listening to story. Presenting information is important because the public is selective (Yunus et al., 2016).

## CONCLUSIONS

This research concludes that the Jababeka program should consider the contributions in areas of their core competencies. CSR Program of tenants in Jababeka can enhance the economic potential of indigenous people (*Betawi* ethnic) through the first

pillar of CSR program Jababeka, economic, especially in the training of entrepreneurship and business mentoring. The programs are selected based on the type of products owned by the tenants and practical way of economic empowerment of local communities such as opening a beauty salon of L'Oreal products. The type of communication carried out with indigenous people approach is using art performance and local culture.

The implications and significance of this research are to ensure that CSR program is not just branding for the company but should bring improvement in the economic empowerment as well as education and preserve the environment. It makes the presence of Jababeka as an industrial area desired by the local community, including as the preservation of local culture.

## ACKNOWLEDGEMENT

The authors wish to acknowledge and thank all IMHA 2018 committee members and UPM *Pertanika* journal team that help publish this article.

## REFERENCES

- Aghashahi, B., Rasid, S. Z. A., Sarli, M., & Mand, A. A. (2013). Corporate social responsibility reporting of food industry major players. *Interdisciplinary Journal of Contemporary Research in Business*, 5(2), 751-761.
- Akinyomi, O. J. (2012). Examination of fraud in the Nigerian banking sector and its prevention. *Asian Journal of Management Research*, 3(1), 184-192.
- Amerta. (2015). *Nurturing social capital, weaving harmony, community development program*

- support in 2015*. Jakarta, Indonesia: Sumbawa Timur Mining.
- Azam, M. (2012). *Corporate social responsibility programme at industrial estate PT Jababeka, Tbk*. Jakarta, Indonesia: Universitas Indonesia.
- Baldrige Performance Excellence Program. (2017). *2017 – 2018 Baldrige excellence framework: A system approach to improving your organization's performance*. Retrieved July 15, 2018, from <https://www.nist.gov/baldrige>
- Bevly, B. (2012). *Corporate social responsibility, hikmah kegagalan dan keberhasilan, strategi bisnis di Amerika Serikat* [Corporate social responsibility, wisdom of failure and success, business strategy in the United States of America]. San Fransisco, California: Mountain House.
- Caesar, L. A. Y. (2016). Performance excellence by transformational leadership in developing collectivistic culture for Indonesian companies. *Pertanika Journal of Social Sciences and Humanities*, 24(S), 19-32.
- Cornelissen, J. (2014). *Corporate Communication: A guide to theory and practice*. London, UK: SAGE Publications.
- Dobers, P., & Springett, D. (2010). Corporate social responsibility: discourse, narrative, and communication. *Corporate Social Responsibility and Environmental Management*, 17(2), 63-69.
- Dragu, I. M., & Tiron-Tudor, A. (2014). Integrating best reporting practices for enhancing corporate social responsibility. In A. Y. Mermod & S. O. Idowu (Eds.), *Corporate Social Responsibility in the Global Business World* (pp. 27-47). Heidelberg, Germany: Springer.
- Foote, J., Gaffney, N., & Evans, J. R. (2010). Corporate social responsibility: Implications for performance excellence. *Total Quality Management and Business Excellence*, 21(8), 799- 812.
- Haynes, K. M. (2013). *Corporate social responsibility, a research handbook*. New York, USA: Routledge.
- ISO. (2017). *ISO 26000 social responsibility*. Retrieved April 16, 2018, from <https://www.iso.org/iso-26000-social-responsibility.html>
- Jababeka. (2017). *Corporate structure*. Retrieved April 20, 2018, from <http://www.jababeka.com/corporate>
- Jones, R. J., Reilly, T. M., Cox, M. Z., & Cole, B. M. (2017). Gender makes a difference: Investigating consumer purchasing behavior and attitudes toward corporate social responsibility policies. *Corporate Social Responsibility and Environment Management*, 24(2), 133-144.
- Kitmueller, M., & Shimshack, J. (2012). CSR, an Economic Perspective. *Journal of Economic Literature*, 50(1), 51-84.
- L'Oréal. (2015). *Annual report of L'Oréal's*. Retrieved April 16, 2018, from [https://www.loreal-finance.com/sites/default/files/2019-09/LOreal\\_2015\\_Annual\\_Report.pdf](https://www.loreal-finance.com/sites/default/files/2019-09/LOreal_2015_Annual_Report.pdf)
- Mapisanga, A. (2009). Implementation of CSR to society life welfare. *Journal of Experimental Social Psychology*, 1(1), 39-47.
- McKinsey. (2015). *Building capabilities for performance*. Retrieved April 20, 2018, from <https://www.mckinsey.com/business-functions/organization/our-insights/building-capabilities-for-performance>.
- Meijer, P. C., Verloop, N., & Beijaard, D. (1999). Exploring language teachers' practical knowledge about teaching reading comprehension. *Teaching and Teacher Education*, 15(1), 59-84.
- Miles, M. B., & Huberman, A. M. (1994). *Qualitative data analysis: A sourcebook of new methods*. Beverly Hills, USA: Sage.

- Pemkot Bekasi. (2017). *Badan Pusat Statistik Kota Bekasi* [Central Bureau of Statistics in Bekasi]. Retrieved April 16, 2018, from <https://bekasikota.bps.go.id>.
- Rana, P., Platts, J., & Gregory, M. (2009). *Exploration of corporate social responsibility (CSR) in multinational companies within the food industry* (Queen's Discussion Paper Series on Corporate Responsibility Research No. 2/2009, Queen's University Management School, Belfast). Retrieved April 22, 2019, from [www.qub.ac.uk/mgt/sustainability/downloads/022009ranaplattsgregory.pdf](http://www.qub.ac.uk/mgt/sustainability/downloads/022009ranaplattsgregory.pdf)
- World Business Council for Sustainable Development. (2002). *The business case for sustainable development: Making a difference toward the Johannesburg Summit 2002 and beyond*. Geneva, Switzerland: WBCSD.
- Yango, A. D. (2013). Laguna industries' corporate social responsibility (CSR) programs: Laguna international industrial park, Philippines. *International Journal of Research in Computer Application and Management*, 3(10), 1-8.
- Yunus, U., Budihardjo, H. S., & Hartanto, B. (2016). Building image of government through radio Taiwan international for Indonesian female listeners. *Pertanika Journal of Social Sciences and Humanities*, 24(S), 81-94.
- Zilahy, G., & Milton, S. (2008). The environmental activities of industrial park organisations in Hungary. *Progress in Industrial Ecology – An International Journal*, 5(5/6), 422-447.



## **PCAOB Sanction and Client Stock Market Reactions: Evidence from the Case of Ernst and Young Indonesia**

**Gatot Soepriyanto<sup>1</sup> and Arfian Erma Zudana<sup>2\*</sup>**

<sup>1</sup>*Department of Accounting, Faculty of Economics and Communication, Bina Nusantara University, Jakarta 11480, Indonesia*

<sup>2</sup>*School of Accounting and Commercial Law, Victoria University of Wellington Faculty of Law, Wellington 6012, New Zealand*

### **ABSTRACT**

The objective of this study was to examine the client share prices to news of the Public Company Accounting Oversight Board (PCAOB) censure on Ernst & Young Indonesia (EY-Indonesia) – the first against a Big Four auditor in Indonesia. Using an event study analysis, we found some evidence that EY-Indonesia clients had a significantly positive market reaction compared to the none EY-Indonesia clients in regard to the news of the PCAOB sanction. The results indicate that the remedial effects of EY's actions taken after the sanction outweigh the negative effects. The results of this study are robust if compared to the abnormal returns for EY-Indonesia clients versus other Big 4 clients. This study is important to highlight the positive effects of the PCAOB sanction and monitoring to improve the audit quality in a developing market.

*Keywords:* Audit quality, auditor reputation, EY-Indonesia, Indosat, market reaction, PCAOB sanction

### **INTRODUCTION**

Capital market investors heavily rely on accounting information to make informed decisions. However, as firms also hinge on financial resources provided by investors,

they are sometimes motivated to provide accounting information that meets their own interests. The assurance from an independent party, such as an auditor, therefore, is vital to ensure the reliability of a firm's accounting information. In particular, investors may perceive an audit as a service to provide assurance for information reliability and minimize the opportunistic behaviour related to companies' financial statements (Francis & Wilson, 1988; Krishnamurthy et al., 2006; ). Accordingly, an audit firm

#### **ARTICLE INFO**

*Article history:*

Received: 09 October 2019

Accepted: 03 January 2020

Published: 17 March 2020

*E-mail addresses:*

[arfian.zudana@vuw.ac.nz](mailto:arfian.zudana@vuw.ac.nz) (Arfian Erma Zudana)

[gsoepriyanto@binus.edu](mailto:gsoepriyanto@binus.edu) (Gatot Soepriyanto)

\* Corresponding author



with a reputation problem may also reduce the credibility of its clients' financial statements (Krishnamurthy et al., 2006; Rauterkus & Song, 2005; Weber et al., 2008). Indeed, in the midst accounting profession commercialisation, including the provision of non-audit services, auditor independence is perceived to be compromised (Sori et al., 2010).

On February 9, 2017, the Public Company Accounting Oversight Board (PCAOB) released a sanction to KAP Purwantono, Sungkoro, & Surja (EY-Indonesia) related to the audit of PT Indosat Tbk (Indosat)'s December 31, 2011, financial statements and internal control over financial reporting (ICFR). The PCAOB's sanction to EY-Indonesia was the first time for PCAOB to use its enforcement power against a Big 4 auditor in Indonesia. In the investors' point of view, this sanction may provide additional information that can alter their perceived EY-Indonesia audit work. In that case, the sanction may influence investors to revise their decisions in the capital market. This study seeks to investigate that issue by examining the effect of the PCAOB's sanction on investors' valuation on share prices of EY-Indonesia's audit clients.

The PCAOB order against EY-Indonesia contains three possible value-relevant pieces of information. First, it may demonstrate that EY-Indonesia did not perform a high-quality audit on Indosat's 2011 financial statements ("Indosat audit failure"). In other words, EY-Indonesia failed to conduct an audit with due professional care and professional

scepticism by releasing an unqualified audit report on Indosat's 2011 financial statements before obtaining sufficient appropriate audit evidence to do so. Second, it underscores the fact that EY-Indonesia had severe quality control policy and procedure problems. These include the issuance of an audit report despite a notification from an internal reviewer that adequate evidence had not been gathered for a significant accounting issue. In addition, Indonesia's quality control problems go beyond Indosat's audit failure with the creation of misleading documents during the PCAOB inspection fieldwork. Finally, the PCAOB sanction may accentuate the corrective actions EY-Indonesia took to improve its quality control policies, which may alleviate investors' concerns and signal improvements in the firm's future audit quality.

Based on the above explanation, this study predicts that investors may have different reactions to PCAOB's sanction which was based on their perceived value of that sanction. First, the market will react negatively to PCAOB's sanction because it is considered as bad news. However, to support this assertion, the sanction should be perceived as new or additional information for investors. Second, investors may disregard the news about the PCAOB sanction because they have learned the misjudgement from the restatement of Indosat's 2011 financial statements in 2013. In that case, the negative effect from the PCAOB sanction is impounded around that restatement period. As such, the PCAOB sanction may not be considered as new information for investors which then will



make investors inactive regarding the announcement of the sanction. Third, aside from the restatement, Indosat released a response letter related to the PCAOB sanction which emphasis various measures taken by Indosat to prevent similar incidents. For example, Indosat has re-evaluated its ICFR to make sure it is compliant with the existing standards. In addition, EY-Indonesia took a similar step by strengthening its internal control processes and qualities. This action may provide a good signal from EY-Indonesia to ensure a better audit quality in the future. Accordingly, PCAOB's sanction may be viewed as value-enhancing information by the market, and thus, there may be a positive market reaction near the PCAOB sanction date.

Tested on 370 Indonesian companies, this study found that the abnormal returns (AR) and cumulative abnormal returns (CAR) for EY-Indonesia audit clients are more positive relative to non-EY clients in all event windows for day (0), days (-1, +1), days (-2, +2), and days (0, +5). However, the only significant result is found in three-day (-1, +1) event windows. The results are robust for both the ordinary least square (OLS) and MM regression method.<sup>1</sup> As the PCAOB's sanction was specifically related to audit engagement between EY-Indonesia and Indosat, this study further tested the effects of that sanction on Indosat's share prices. In this case, this study ran a test on one-day (0), two-day (0, +2), and five-day

(0, +4) event windows. It was found that around the sanction date, the abnormal returns of Indosat share prices were positive. Those results may indicate that generally, investors do not perceive the PCAOB sanction as new negative information. The evidence of a positive market reaction around the sanction date may suggest that investors value the sanction as a good signal of improvements provided by EY-Indonesia and Indosat.

To provide further evidence on this matter, this study tested the market reaction around the restatement date of Indosat's 2011 financial statements. Supporting previous results, the findings suggest that the market reacted negatively around the Indosat restatement date in all event windows, including day (0), days (0, +2), and days (0, +4). Overall, the results support the argument that investors have learned about the PCAOB's sanction news from the Indosat 2011 restatement date. Accordingly, the announcement of the PCAOB sanction does not provide new negative information to investors, and they even reacted positively as an effect of the good commitment from EY-Indonesia and Indosat.

This study contributes to the growing literature on the information content of PCAOB's sanction. Although Dee et al. (2011) had provided evidence about the stock market reaction around PCAOB's sanction of Deloitte in the US, their results might not be extended to Indonesia's growing capital market. By exploiting a different market setting, this study may provide further insights into how PCAOB's

<sup>1</sup>The MM regression estimation method is considered as robust to outliers and high leverage data points when one conducts event studies (Sorokina et al., 2013).

enforcement activities are perceived by stakeholders in developing countries. In addition, this study can provide evidence of investors' reactions toward the restatement of financial statements. This study found that the restatement of financial statements is considered as an undesirable action from investors' perspectives. As such, this study supports the notion that firms should increase the quality of their ICFR in order to prevent restatements.

The remainder of this paper proceeds as follows: Section 2 provides background and theoretical development. Section 3 discusses the empirical model, followed by Section 4 that presents the sample selection process. Section 5 reports the results and Section 6 concludes.

## RESEARCH SETTING

PT Indosat Tbk is an Indonesian telecommunications network and service provider which is incorporated in Indonesia. To date, Indosat is listed in the Indonesia Stock Exchange (IDX) and also files financial statements with the Securities and Exchange Commission (SEC) as a foreign private issuer. As the Indosat business is mainly in Indonesia, it possesses thousands of cellular towers throughout Indonesia to serve its customers. However, in 2008, Indosat started to lease its open slots on its towers to other cellular companies to use its networks. Those leasing activities are commonly done for a period of 10 years with a renewal option. In 2010, Indosat concluded that its lease-out arrangements were operating on a lease based on International

Accounting Standard 17 (IAS 17). However, Roy Iman Wirahardja, hereafter Wirahardja, as an engagement partner of EY-Indonesia for Indosat, asked the firm to perform further analysis to assess whether Indosat's lease-out arrangements should be classified as a finance or operating leases. In that case, Wirahardja realised that the analysis results might drive Indosat to change its historical and future lease accounting which finally led to restatements of its financial statements.

Responding to Wirahardja's request, the management of Indosat performed an economic life test and a present value test. Specific for performing the present value test, Indosat's management used a discounted cash flow method, in which Indosat's management made an assumption regarding the average utilization rate of slots in Indonesia. In addition, Wirahardja, the engagement team, and Appendix K<sup>2</sup> reviewer of EY-Indonesia recognized that the misapplication of accounting guidance on the tower slot leases was considered as a control deficiency. Accordingly, they frequently communicated with James Randall Leali (Leali) as the EY area professional practice director for the Asia-Pacific region to further discuss the matter.

Initially, Indosat's management used a 100 per cent utilisation rate assumption. Not until Wirahardja, the Appendix K reviewer, and the audit engagement team continuously objected to that assumption, did Indosat's

<sup>2</sup> Appendix K is a PCAOB rule for member firms which seek to enhance the quality of SEC filings by SEC registrants (in this case: Indosat) whose financial statements are audited by foreign associated firms (in this case EY-Indonesia).

management change the assumption to an 80 per cent utilisation rate. In that situation, the Appendix K reviewer asked Wirahardja and the engagement team to find supporting evidence for the management's assumption. However, Wirahardja and the engagement team failed to gather sufficient appropriate evidence about the reasonableness of the assumption. In that case, on April 28, 2012, the Appendix K reviewer mentioned that he believed that Indosat failed to provide supporting evidence for the 80 per cent utilisation rate which made the financial statements in 2009, 2010, and 2011 having a lack of support. The reviewer, therefore informed Wirahardja that he could not conclude that significant unresolved matters did not exist in Indosat's financial statement and the effectiveness of Indosat's ICFR. He then advised Wirahardja to communicate with Leali to discuss the situation.

After a discussion with Wirahardja, Leali gave Wirahardja permission to release the audit report for Indosat which was subject to Wirahardja obtaining supporting evidence of Indosat's lease-out accounting treatment in the near future. In addition, Wirahardja had to explain to the management that the result of the analysis might require Indosat to restate its financial statements. In that case, on April 30, 2012, the SEC received Indosat's Form 20-F filing that was attached by EY-Indonesia's unqualified audit report opinion for Indosat's 2011 financial statements and ICFR.

In those above situations, based on the investigation conducted, PCAOB found that Wirahardja failed to exercise

due professional care and professional scepticism as an engagement partner of Indosat's 2011 audit work. He failed to consider that at the time he released the audit report, a detailed analysis was needed to support Indosat's accounting leases. In addition, he also failed to consider that the analysis might lead to restatements of Indosat's financial statements. Aside from that, he failed to acknowledge the Appendix K reviewer's disagreement. For the same case, PCAOB also charged Leali as he failed to exercise due professional care and professional scepticism.

Furthermore, the case developed to a more severe problem as Wirahardja and the engagement team created or modified and added documents to their 2011 work papers. Although that activity is allowed, it should be followed by a proper disclosure to indicate the date that the documentation was added, the name of the preparer, and the reasons for adding it in which Wirahardja and his team failed to provide that information. Moreover, the activity of altering documents continued during the period of the PCAOB inspection. The engagement team, with Wirahardja's knowledge and participation, added a new memo which was backdated to the 2011 audit period regarding the evaluation of the qualifications prepared by the Telecom specialist hired by Indosat as it was asked by the inspection team.

Related to such an audit failure, PCAOB gave a sanction by censuring EY-Indonesia, Roy Iman Wirahardja, and James Randall Leali. Specifically, PCAOB obligated EY-

Indonesia, Wirahardja, and Leali to pay US\$1,000,000, US\$20,000, and US\$10,000, respectively. In addition, PCAOB restricted Wirahardja to be associated with a registered public accounting firm and limited the audit activities of Leali for a one-year period from the sanction date.

## **THEORETICAL BACKGROUND**

High quality of audit work is supposed to help management ensure the reliability and accuracy of their company's financial statements (Wilson & Grimlund, 1990; Barton, 2005). In addition, related to the relationship between the agent and principle, that audit process is intended to minimize agency problems which may decrease agency costs (DeAngelo, 1981; Francis & Wilson, 1988). As investors heavily rely on the information provided in financial statements, that audit work, therefore, helps investors to reduce the risk of misleading information. Investors perceive the value of audit work because it ensures reliability and reduces the uncertainty of financial statements (Francis & Wilson, 1988). In this case, the value derived by investors from audit work stems from the quality of the audit work itself (Wilson & Grimlund, 1990).

Prior literature provides mixed evidence regarding the value of PCAOB's actions. On one hand, Lennox and Pittman (2010) found that PCAOB's inspection reports were not valuable for signalling audit quality to audit clients. Specifically, they discovered that there was no relation between audit engagement weaknesses disclosed by

PCAOB and the subsequent changes in audit firms' market shares. That result indicated that the inspection report did not influence audit firms' choices of audit clients. On another hand, Abbott et al. (2013) revealed that clients of auditors whose PCAOB inspection reports showed that the auditors failed to identify a material departure from a generally accepted accounting standard were more likely to dismiss their auditors. In this case, those clients are more likely to replace the dismissed auditor with a non-GAAP deficient auditor. In a similar vein, Dee et al. (2011) found that the abnormal returns of Deloitte audit clients were more negative relative to non-Deloitte clients as an effect of PCAOB's sanction against Deloitte. Overall, Abbott et al. (2013) and Dee et al. (2011) discovered an indication that PCAOB's action was valued both by audit clients and investors. Bringing that literature together, this study, therefore, predicts that investors' valuation on PCAOB's sanction against EY-Indonesia may range from being negative to positive.

PCAOB's sanction against EY-Indonesia may be perceived as negative news by investors. In that case, the sanction may be interpreted as evidence that EY-Indonesia has provided low-quality audit work which may reduce the reputation of EY-Indonesia. That condition may lead to a decrease in the investors' perceived value on the reliability and accuracy of EY-Indonesia audit clients' accounting information. As a consequence, investors may revise their valuation on those audit clients as compensation for greater uncertainty faced by those investors. In

that kind of situation, investors may react negatively by discounting the share prices of EY-Indonesia audit clients around the sanction date relative to non-EY-Indonesia audit clients.

However, negative reactions are more likely to happen if the PCAOB's sanction against EY-Indonesia is new information and it is material enough to affect investors' valuation. In that case, the PCAOB's sanction may not be new information for investors in the market. They may have learned from the Indosat audit failure in 2013 when Indosat restated its 2011 financial statements. Thus, the negative market reaction around PCAOB's sanction date may have been impacted around that restatement date. In addition, in a small capital market like Indonesia, investors may not pay too much attention to the identity of auditors when valuing companies' financial statements. As a consequence, investors may fail to alter their valuation when there is new information regarding the quality of an auditor's work. In those above situations, investors may not react or reevaluate the share prices of EY-Indonesia audit clients. Furthermore, if investors perceive that PCAOB's sanction is an isolated incident related to a specific accounting issue of Indosat, investors may react negatively towards Indosat's share prices.

As a reaction against PCAOB's sanction, Indosat released a statement that aside from the restatement that was made, the company also improved its ICFR. In addition, the management of EY-Indonesia has taken

remedial action against the PCAOB sanction by strengthening their internal quality control. Those actions, therefore, may rebound the investors' confidence in both the EY-Indonesia audit work quality and Indosat financial statements. In this case, PCAOB's order against EY-Indonesia may provide a good signal for improvements in the future. If the remedial actions taken by EY-Indonesia and Indosat offset the negative effects of PCAOB's sanction as explained before, then there will be no negative effects around PCAOB's sanction date. Moreover, around that date, investors may even react positively as a consequence of the positive impacts resulting from PCAOB's sanction against EY-Indonesia.

This study, therefore, examined all those above conjectures by examining the market reaction around PCAOB's sanction date on EY-Indonesia audit clients with some other tests as robustness checks.

## MATERIALS AND METHODS

### Empirical Model

As the objective of this study was to investigate the market reaction towards the PCAOB sanction of EY-Indonesia, an event study methodology was employed. This methodology facilitated measuring the effect of a particular event on the share returns of the firm. To estimate the abnormal returns for each day related to the event dates, a standard market model was used (see Equation 1).

$$R_{it} = \alpha_i + \beta_i R_{mt} + \varepsilon_{it} \quad (1)$$

Equation 1 was operationalised to estimate the OLS parameters,  $\hat{\alpha}_i$  and  $\hat{\beta}_i$ . The estimation period used in this study covered 219 days prior to the event date. The abnormal returns surrounding each event are determined based on Equation 2.

$$AR_{it} = R_{it} - (\hat{\alpha}_i + \hat{\beta}_i R_{mt}) \quad (2)$$

In addition to a daily event window, a 3-day event window (-1 to +1) was calculated. It was assumed that the length of the event window was enough to capture a possible expectation or information leakage before the event, while not being too long to face problems with confounding events falling within the event window. Cumulative abnormal returns (CAR<sub>it</sub>) for each firm were computed by summing up the firm's abnormal returns during the event window, as follows:  $CAR_{it} = \frac{1}{N} \sum_{t=1}^{t=N} \varepsilon_{it}$ . Note that the cumulative abnormal returns for firm *i* in time *t* and N is the number of days in the event window.

### Sample Selection

This study started with 472 companies with their available 2016 financial statements. In particular, this study began with 95 EY-Indonesia clients and 377 non-EY-Indonesia clients. Those financial statements were used to obtain information about the identity of the auditor who performed the audit work. Despite the PCAOB sanction date being on February 9, 2017, the auditor information from the 2016 financial statements was collected because those financial statements were the most recent statements available when this study began.<sup>3</sup> To be included in the sample, the companies had to return data for at least 230 days around the PCAOB sanction date. Specifically, the companies had to return information from 219 days before the sanction date to 11 days after the date. Furthermore, due to their unique nature and specific regulations, financial companies were excluded from the sample. Table 1 shows the sample selection criteria as explained below.

<sup>3</sup> In that case, this study assumes that the audits for companies' 2017 financial statements are similar to those audits from the 2016 financial statements.

Table 1  
Sample selection

OLS sample	EY Clients	Non-EY Clients
Initial sample	95	377
Less: financial companies and missing data to calculate returns	28	74
Final sample	67	303
MM sample		
Less: financial companies and missing data to calculate returns	34	114
Final sample	61	263

Notes: PCAOB announced its sanctions against Ernst & Young (EY) on February 9, 2017. However, this study sets the event date on February 10, 2017, because of the time difference between Indonesia and the United States. The estimation period for calculating the cumulative abnormal returns (CAR) is 219 days before the event date. An OLS sample is the sample used when running the regression using OLS, while an MM sample is used when this study runs the regression using the MM method.



**RESULTS AND DISCUSSIONS**

**Main Results**

Table 2 presents the results for the abnormal returns of EY-Indonesia and non-EY-Indonesia audit clients. It shows that for a day (0), days (-1, +1), days (-2, +2), and days (0, +5), the median abnormal returned of EY-Indonesia audit clients were higher than the counterparts.<sup>4</sup> The median values for EY-Indonesia (non-EY-Indonesia) audit clients for day (0), days (-1, +1), days (-2, +2), and days (0, +5) were 0.0004 (-0.0001), 0.0034 (-0.0014), 0.0001 (-0.0007), and -0.0002 (-0.0024), respectively. However,

the only significant difference was found on the days (-1, +1) as shown in Panel C of Table 2, which is significant at a 5 per cent level. Using the MM regression model (unreported), this study also discovered were the median values of abnormal returns for EY-Indonesia audit clients were higher than non-EY-Indonesia audit clients. Similarly, the only significant results were observed in days (-1, +1). The results suggest that investors do not value PCAOB’s sanction against EY-Indonesia as negative news. Moreover, the results may indicate that investors value PCAOB’s sanction against EY-Indonesia as a good signal in the future as an effect of EY-Indonesia’s internal control improvements.

<sup>4</sup> As the data is not normally distributed, this study uses the Wilcoxon sum rank test to compare the median values of abnormal returns.

Table 2  
*Ordinary Least Square (OLS) regression abnormal returns for EY and non-EY clients*

Panel A: Day 0				
Clients	N	Mean	Median	Std Dev
EY	67	0.0086	0.0004	0.0307
Non-EY	303	0.0051	-0.0001	0.0378
Wilcoxon sum rank test <i>p</i> value		0.2301		
Panel B: Day -1, 0, +1				
Clients	N	Mean	Median	Std Dev
EY	67	0.0201	0.0034	0.0508
Non-EY	303	0.0085	-0.0014	0.0681
Wilcoxon sum rank test <i>p</i> value		0.0153**		
Panel C: Day -2, -1, 0, +1, +2				
Clients	N	Mean	Median	Std Dev
EY	67	0.0158	0.0001	0.0747
Non-EY	303	0.0072	-0.0007	0.0918
Wilcoxon sum rank test <i>p</i> value		0.5968		
Panel D: Day 0, +1, +2, +3, +4, +5				
Clients	N	Mean	Median	Std Dev
EY	67	0.0147	-0.0002	0.0931
Non-EY	303	-0.0073	-0.0024	0.1007
Wilcoxon sum rank test <i>p</i> value		0.1501		

Notes: \*\* significant at a 5% level

In addition, the results presented in Table 2 may imply that the sanction was not new information. Investors may have learned about the news when Indosat restated its financial statements. In that case, as expected, this study finds that the abnormal returns of Indosat on the restatement date are negative for all event windows as presented in Table 3. In particular, Table 3 shows that the abnormal returns of Indosat on the restatement date were -3.5 per cent, -4.6 per cent, and -9.4 per cent for event windows on day (0), days (0, +2), and days (0, +4), correspondingly. Similarly, in testing using the MM regression model (unreported), this study found negative abnormal returns for Indosat around the restatement date. Specifically, the abnormal returns for Indosat around the restatement date were -3.3 per cent, -4.1 per cent, and -8.3 per cent for the same event window days.

To further test the investors' reactions to PCAOB's sanction against EY-Indonesia, this study calculated the abnormal returns of Indosat around the sanction date as shown in Table 4. The results show that Indosat

did not experience negative abnormal returns around the sanction date for all event windows for day (0), days (0, +2), and days (0, +4). These results further supported the evidence that investors did not treat PCAOB's sanction against EY-Indonesia as a new negative event. As Indosat restated its financial statements before PCAOB's sanction date to indicate an accounting error, the negative effects of PCAOB's sanction had been absorbed in that restatement event. In that case, investors adjusted their valuation of Indosat share prices as shown in the negative abnormal return experienced by Indosat around the restatement date. In addition, investors valued the PCAOB sanction as a good signal of improvement in the future as proven by the positive abnormal returns for EY-Indonesia audit clients and Indosat share prices around the sanction date.

### Additional Analysis

For an additional check, this study compared the abnormal returns of EY-Indonesia audit clients with other companies audited

Table 3  
*The abnormal returns of Indosat on the restatement day (OLS)*

	Event Period (day)		
	0	0, +1, +2	0, +1, +2, +3, +4
Abnormal Returns	-0.0350	-0.0465	-0.0936

Note: The event day was April 19, 2013.

Table 4  
*Abnormal returns of Indosat on the sanction day (OLS)*

	Event Period (day)		
	0	0, +1, +2	0, +1, +2, +3, +4
Abnormal Returns	0.0073	0.0490	0.0331

Note: The event day was February 10, 2017.



by other Big 4 audit firms which is PwC, Deloitte, and KPMG. Table 5 shows the results using OLS. Table 5 reveals that the median abnormal returns for EY-Indonesia audit clients were higher compared to other companies audited by other Big 4 audit firms with the exception for event window day (0). Similar to the test comparing EY-Indonesia audit clients and non-EY-Indonesia audit clients, the only significant difference was found in days (-1, +1) at a 5 per cent significance level. Similar results were also found for the MM regression model (non-tabulated). EY-Indonesia audit clients experience a higher abnormal return compared to companies audited by non-Big

4 audit firms, in which the only significant returns were found in the event window days (-1, +1) at a 5 percent significant level.<sup>5</sup>

Overall, the additional analysis results supported the main finding that investors did not value PCAOB’s sanction against EY-Indonesia as negative news. Instead, investors value PCAOB’s sanction against EY-Indonesia as a good signal for

<sup>5</sup> Finally, specific to Wirahardja’s clients, the abnormal returns for companies audited by the Wirahardja team experienced higher but insignificant returns compared to all non-Wirahardja clients with the exception for days (-1, +1), in which the abnormal returns for Wirahardja’s clients are lower than non-Wirahardja clients (the results are not reported). However, the difference is not significant. The results using the MM regression also mirror the results of the OLS regression.

Table 5  
*Ordinary Least Square (OLS) regression abnormal returns for EY and non-EY big 4 clients*

Panel A: Day 0				
Clients	N	Mean	Median	Std Dev
EY	67	0.0086	0.0004	0.0307
Non-EY	67	0.0054	0.0004	0.0217
Wilcoxon sum rank test <i>p</i> value		0.7260		
Panel B: Day -1, 0, +1				
Clients	N	Mean	Median	Std Dev
EY	67	0.0201	0.0034	0.0511
Non-EY	67	0.0038	-0.0028	0.0485
Wilcoxon sum rank test <i>p</i> value		0.0172**		
Panel C: Day -2, -1, 0, +1, +2				
Clients	N	Mean	Median	Std Dev
EY	67	0.0158	0.0001	0.0747
Non-EY	67	0.0054	-0.0044	0.0563
Wilcoxon sum rank test <i>p</i> value		0.6006		
Panel D: Day 0, +1, +2, +3, +4, +5				
Clients	N	Mean	Median	Std Dev
EY	67	0.0147	-0.0002	0.0931
Non-EY	67	0.0047	-0.0018	0.0783
Wilcoxon sum rank test <i>p</i> value		0.4860		

Note: \*\* significant at a 5% level

improvements in the future as an effect of EY-Indonesia doing internal control improvements.

## CONCLUSIONS

The PCAOB order against EY-Indonesia contains three potentially value-relevant pieces of information. As such, this study predicts that investors may have different reactions to PCAOB's sanction which is based on their perceived value of that sanction. It was found that the abnormal returns (AR) and cumulative abnormal returns (CAR) for EY-Indonesia audit clients were more positive relative to non-EY clients in all event windows. However, the only significant results were found in the three-day (-1, +1) event windows. Next, it was found that around the sanction date (i.e., February 10, 2017), the abnormal returns of Indosat share prices were positive. The results may indicate that generally, investors do not perceive the PCAOB sanction as being new negative information. The evidence of a positive market reaction around the sanction date may suggest that investors value the sanction as a good signal of improvements provided by EY-Indonesia and Indosat. Furthermore, it was discovered that the market reacted negatively around the Indosat restatement date (which is April 19, 2013) in all event windows. Overall, the results support the argument that investors have learned from the PCAOB sanction news on Indosat's 2011 restatement date. Accordingly, the announcement of PCAOB's sanction does not provide new negative information to investors, and they

even reacted positively as an effect of the good commitment from EY-Indonesia and Indosat. This study is significant to highlight the positive effects of the PCAOB sanction and monitoring to improve the audit quality in an emerging market like Indonesia.

## ACKNOWLEDGEMENT

The authors wish to acknowledge and thank all IMHA 2018 committee members and UPM *Pertanika* journal team that help publish this article.

## REFERENCES

- Abbott, L. J., Gunny, K. A., & Zhang, T. C. (2013). When the PCAOB talks, who listens? Evidence from stakeholder reaction to GAAP-deficient PCAOB inspection reports of small auditors. *Auditing: A Journal of Practice and Theory*, 32(2), 1-31.
- Barton, J. (2005). Who cares about auditor reputation?. *Contemporary Accounting Research*, 22(3), 549-586.
- DeAngelo, L. E. (1981). Auditor size and audit quality. *Journal of Accounting and Economics*, 3(3), 183-199.
- Dee, C. C., Lulseged, A., & Zhang, T. (2011). Client stock market reaction to PCAOB sanctions against a big 4 auditor. *Contemporary Accounting Research*, 28(1), 263-291.
- Francis, J. R., & Wilson, E. R. (1988). Auditor changes: A joint test of theory relating to agency costs and auditor differentiation. *Accounting Review*, 63(4), 663-682.
- Krishnamurthy, S., Zhou, J., & Zhou, N. (2006). Auditor reputation, auditor independence, and the stock-market impact of Andersen's indictment on its client firms. *Contemporary Accounting Research*, 23(2), 465-490.

- Lennox, C., & Pittman, J. (2010). Auditing the auditors: Evidence on the recent reforms to the external monitoring of audit firms. *Journal of Accounting and Economics*, 49(1), 84-103.
- Rauterkus, S. Y., & Song, K. R. (2005). Auditor's reputation and equity offerings: The case of Arthur Andersen. *Financial Management*, 34(4), 121-135.
- Sori, Z. M., Karbhari, Y., & Mohamad, S. (2010). Commercialization of accounting profession: The case of non-audit services. *International Journal of Economics and Management*, 4(2), 212-242.
- Sorokina, N., Booth, D. E., & Thornton Jr, J. H. (2013). Robust methods in event studies: Empirical evidence and theoretical implications. *Journal of Data Science*, 11(2013), 575-606.
- Weber, J., Willenborg, M., & Zhang, J. (2008). Does auditor reputation matter? The case of KPMG Germany and ComROAD AG. *Journal of Accounting Research*, 46(4), 941-972.
- Wilson Jr., T. E., & Grimlund, R. A. (1990). An examination of the importance of an auditor's reputation. *Auditing: A Journal of Practice and Theory*, 9(2), 43-59.



## **Innovation in Traditional Food Products as Local Wisdom on *Dodol Mandai***

**Trias Septyoari Putranto\*, Tri Wiyana and Sarim**

*Department of Hotel Management, Faculty of Economics and Communication, Bina Nusantara University, Jakarta 11480, Indonesia*

### **ABSTRACT**

*Mandai* is *cempedak* (*Artocarpus champeden*) peel that has been through the process of fermentation in brine for 3 hours to 1 month. People in South Kalimantan usually serve *mandai* as a side dish, but on this occasion, *mandai* will be used as a material to make *dodol*, chewy, sweet, and thick cake which usually made from glutinous rice flour, coconut milk, and palm sugar. This study aims to determine public acceptance of *dodol mandai* through the distribution of product samples and the distribution of questionnaires regarding its aroma, colour, texture and taste. This research used a descriptive analysis method that is divided into statistical descriptive analysis and frequency analysis. The result shows that the public accepts processed products made from *mandai*. The products are different from the others and are innovation products based on local wisdom and thus, they add traditional culinary repertoire. The result is as predicted, that *mandai* can be processed into *dodol*.

*Keywords:* Dodol, mandai, product innovation

### **INTRODUCTION**

Geographically as part of Indonesia, South Kalimantan is a province located in the southeastern part of Borneo. The province has lowland areas on the western and

eastern shores, as well as the highlands formed by the Meratus Mountains in the middle part. South Kalimantan consists of two main geographic features, lowland and highland. Lowland areas, mostly peat swamps, are so rich in biodiversity of freshwater animals. The upland areas are still part of the natural tropical forest and are protected by the government. Most of the population is engaged in shifting cultivation for subsistence. They usually grow rice, corn (maize), and cassava. They also produce natural rubber (caoutchouc) and copra (dried

#### **ARTICLE INFO**

##### *Article history:*

Received: 09 October 2019

Accepted: 03 January 2020

Published: 17 March 2020

##### *E-mail addresses:*

tputranto@binus.edu (Trias Septyoari Putranto)

triyayana@binus.edu (Tri Wiyana)

sarim@binus.ac.id (Sarim)

\* Corresponding author

coconut meat) (The Editors of Encyclopedia Britannica, 2018).

*Cempedak* (*Artocarpus champeden*) tastes like jackfruit but it smells stronger than jackfruit does. *Cempedak* is a species of plant that spreads in the region of Sumatra, Java, Kalimantan, Sulawesi, Maluku and Papua. Especially in South Kalimantan, the inner skin of *Cempedak* fruit is processed into traditional food called *mandai* through the fermentation process. *Mandai*, which previously is only complimentary food or appetizers served at home, now become food that is served in large restaurants, especially in typical restaurants that serve *Banjar* cuisine (Supriyadi, 2018). The people of South Kalimantan generally process *mandai* into side dishes, *oseng*, or just enjoy *mandai* with green mango chutney. *Mandai* is recognized to be beneficial to health because of its richness of nutrients, vitamins, and large amounts of fibre and protein. The three selected fruits of the *Artocarpus* species are *Artocarpus odoratissimus* (*Tarap*), *Artocarpus kemando* (*Pudu*) and *Artocarpus integer* (*Cempedak*). The total compositions of phenolics and flavonoids are significantly correlated with antioxidant activity. However, total carotenoids are correlated insignificantly with antioxidant activity. Because of the findings in this study, it was observed that phytochemical compounds are a major contributor to antioxidant activity (Bakar et al., 2015).

Through food processing, one type of food can be processed into various products with different flavours. One of the processed products is *dodol*. *Dodol* is a traditional food that has been known and widely consumed,

thus the research regarding traditional foods can contribute to the continuation of nation's culinary heritage and culture, which will allow not only future generations but also International foreign tourist to enjoy and savour the local food (Trichopoulou et al., 2006). As time goes, materials used in *dodol* making has changed little. There are new flavour and aroma variations as well as a new component in the ingredients. In conclusion, innovation is positively perceived if it respects consumers' perception of fruit as long as it keeps being intrinsically natural. Innovation in fruit and fruit products should be tested in order to know consumers' acceptance (Samoggia & Nicolodi, 2017).

The main issue is that *mandai*, the fermentation of *Cempedak* peel, is often thrown away by people. However, in fact, *mandai* can be processed into a food product that can be consumed. So, the idea is to cultivate *dodol* innovation made from *mandai*. As a new innovation from *dodol*, it aims for the utilization of *Cempedak* fruit. From the background above, this study was conducted to determine the end result of *dodol mandai* innovation whether it can be accepted and utilized by the public as a new product.

## Literature Review

***Cempedak* (*Artocarpus champeden*).** *Cempedak* (*Artocarpus champeden*), is one of the native plants of Indonesia. Currently, its spread is penetrating to Malaysia and Papua New Guinea. In Indonesia, *Cempedak* plants spread in the area of Sumatra, Kalimantan, Sulawesi, Maluku and Java.

Compared to jackfruit, *Cempedak* is less popular. *Cempedak* is sweeter than jackfruit. Although it looks similar to jackfruit, *Cempedak* is usually smaller, has smoother bumps and a long thin shape. It also has a noticeably less latex than a jackfruit. The flesh of a *Cempedak* is soft and fibrous and explodes with a creamy juice. It has a strong, earthy odour and it is said to be the second fruit with strong smells after durian (Rob & Lindsay, 2016).

The *Cempedak* fruit contains antioxidants of about  $126 \pm 19.1$  mg / 100 g and is classified as fruit with medium antioxidant (70-200 mg / 100 g) (Leong & Shui, 2002). A knowledge about *Artocarpus champeden* product in Phytomedicine may be a springboard for new *phytotherapies* that more affordable to treat malaria, especially among the less privileged native people living in endemic areas of the tropics (Widyawaruyanti, 2013). Furthermore, the processing aspect shows that the fruits and seeds of the *Cempedak* tree can also be consumed. *Cempedak* processing is divided into 3 parts, namely ripe fruit, unripe fruit, and seeds (Nauw et al., 2016).

**Mandai.** *Mandai* is a *Cempedak* peel that has been through the process of fermentation. A processed cuisine that the main ingredient is this *Cempedak* peel can be used as a side dish to accompany the main food like rice. It is very delicious with a fibrous and soft texture. Its tenderness depends on how thick the peel of *Cempedak* in the sack. *Mandai* is a kind of traditional food made with salt-fermentation. The raw material used is the

inner peel of *Cempedak* fruit. In making *mandai*, it needs three stages of preparation that includes stripping and leaching the inner part of the fruit and brining. Traditionally processed products use lactic acid bacteria in the fermentation process (Rahayu, 2000). *Mandai* is a fermented food made from *dami* or the pith of *Cempedak*. Research on PDQGDL, especially the bacteria involved in PDQGDL fermentation, has not been done (Emmawati et al., 2015). *Mandai* is a typical food in South Kalimantan, which is made of *Cempedak* peel, or the people of South Kalimantan call it *tiwadak* preserved in a long time (Natalia, 2018).

**Dodol.** *Dodol* is kind of confectionery, made from glutinous rice, coconut milk, and brown sugar, sometimes mixed with fruits, such as durian, soursop, etc. (Indonesia Dictionary, 2018). According to the Indonesian National Standard (SNI), *dodol* is food made from glutinous rice flour, coconut milk, and sugar with or without the addition of food and other materials. Things to consider in the manufacture of *dodol* are ingredients mixed together in large cauldrons and cooked with medium heat. Cooked *dodol* should not be left unguarded, otherwise *dodol* will burn at the bottom and will crust. Therefore, in the process of making *dodol* mixture, the mixture has to be stirred continuously to get good results. The cooking time of *dodol* takes approximately 2-3 hours at 80-900°C. If the cooking time and cooking temperature are less than that, *dodol* will be less delicious. The *dodol* is one kind of processed products of agricultural products

that is semi-wet, white to brown in colour, made from a mixture of glutinous rice, sugar, and coconut milk. Process of producing *dodol* is already known to the public. The process is simple, cheap and absorbs many labours (Soemaatmadja, 1997).

### **Product Innovation in Traditional Food.**

Traditional food products are very complex and the scientific literature does not provide a general definition of them so far. It is quite difficult to define this term. In the following, different approaches for a definition which are stated in scientific and regulatory literature are provided and afterwards compared and discussed. The local cuisine is not only presented as a food product but also as an integral part of the culture of the native people (Boonpienpon et al., 2015). Furthermore, food consumption is an integral part of tourism and its economic impact can be important, not only directly for businesses that directly provide food for tourists (such as hotels, restaurants and tourist attractions), but also for economic impact across the food supply chain, especially if the food is produced locally (Hall, 2012). Traditional foods are a resource that should be developed and utilized. Traditional foods need to be developed through small and medium industries, so it needs special attention from the government and private sector. Traditional food and traditional cake which have an idea of a daily diet in the form of staple food, snack or special offerings are passed down from one generation to the next. Traditional food is commonly

consumed by ethnic group in a specific area and conserved for generations (Marwati, 2013). New products should be ensured that they meet sustainability criteria and at the same time, are appealing to consumers. A chain oriented approach should be applied in product innovation, from the marketing process to raw material composition and properties (Jongen & Meerdink, 2013).

Consumers acceptance of innovation was investigated using a quantitative survey approach with 2429 respondents in Belgium, Italy and Poland. In general, both the sector and the consumers were open towards innovations in traditional food products. In addition, the innovation activities of the sector well-matched consumers' acceptance. Throughout the process, preserving the traditional character of the food is important as it is a prerequisite for innovations in traditional food products (Kuhne et al., 2010). In the context of tourism, traditional food is a destination. UNESCO has determined to recognize traditional food. The food has finally received status as a real part of the heritage in general. Thus, food gradually replaces the geographical location as the brand goal (Williams et al., 2014). Innovation is a complex phenomenon. Different models for innovation processes can be found in the scientific literature. Two common models used are sequential or linear models and integrative models. Until the 1980s, the idea of a linear sequential model of the innovation process applies in the innovation research shown in Figure 1. The researcher developed the following model of the research framework:



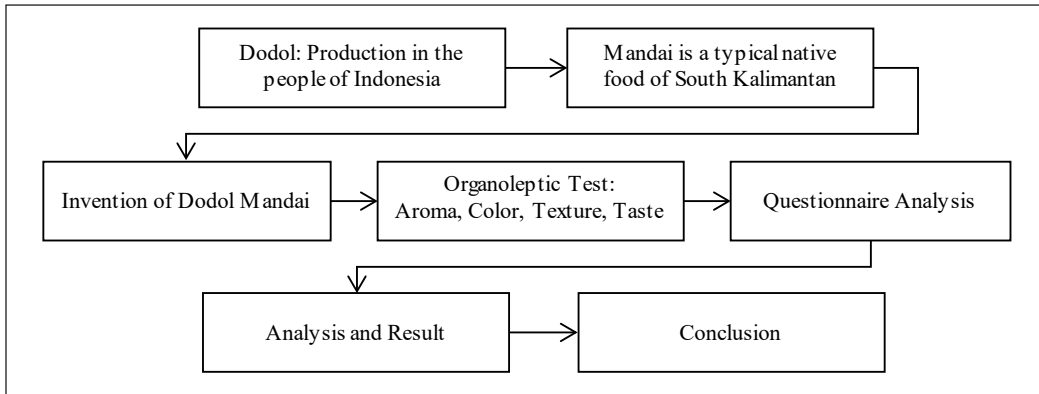

Figure 1. Research framework (Source: Data research)

## MATERIALS AND METHODS

The term “design experiments” was introduced in 1992, in articles by Ann Brown and Allan Collins. Design experiments were developed as a way to carry out formative research to test and refine educational designs based on principles derived from prior research. Recently, the term design research has been applied to this kind of work (Collins et al., 2004). Research design conducted by the author was research by way of experiment. Table 1 is presented the research design of this article. This approach allowed us to make more confident claims about the development of experimental research in technical communication journals. We also examined the data using a qualitative approach to illustrate the correlations and significant findings of our results. Experiments conducted by this author aimed to find out the results of *dodol* made by adding *mandai* and to know the level of preference results of *dodol* experiments. The experimental form used by the author was a one-shot case study. The one-shot case study is a study in

which a group is given treatment/treatment then subsequently observed to get a result (Sugiyono, 2014).

Table 1  
Research design

Research Design	Research Method
Types of research	Experimental
Experimental design	One-shot case study
Environment research	A laboratory experiment
Unit of analysis	Individual

Variables of research are anything in the form that is determined by the researcher to be studied. Then from the obtained information, the conclusion is drawn. In this research, one of the variables is operational *mandai* variable. A hypothesis is a temporary answer to the formulation of research problems, therefore the formulation of research problems are usually arranged in the form of statement sentences. It is said “temporary” because the given answer is based on a relevant theory, not based on empirical facts obtained through data collection yet (Sugiyono, 2014). The hypotheses of this research can be seen in Table 2.

Table 2  
*Research hypothesis*

Hypothesis 1	There is a panellist fondness for the aroma of <i>dodol</i> made from <i>mandai</i>
Hypothesis 2	There is a panellist preference for the colour of <i>dodol</i> that made from <i>mandai</i>
Hypothesis 3	There is a panellist preference for the texture of <i>dodol</i> that made from <i>mandai</i>
Hypothesis 4	There is a panellist fondness for the taste of <i>dodol</i> made from <i>mandai</i>
Hypothesis 5	There is a panellist acceptance of <i>dodol</i> made from <i>mandai</i>

The scale used in this study is the hedonic scale (preferred level) as presented in Table 3. On this scale, analysis is transformed into a numerical scale, and then this numerical data can be analyzed statistically. Giving the hedonic test numerical scale indirectly can be used to determine the difference.

Table 3  
*Hedonic scale*

Hedonic Scale	Numerical Scale
Extremely likes	6
Very likes	5
Likes	4
Somewhat likes	3
Neutral	2
Disliked	1

*Dodol Mandai* recipe consists of 125 gr *mandai*, 250gr white glutinous flour,

Table 4  
*Assessment of untrained panellists*

	1	2	3	4	5	6	Number of Frequency
Aroma	0	0	12	23	21	24	80
Color	0	6	19	22	18	15	80
Texture	0	8	17	16	23	16	80
Taste	0	7	21	17	14	21	80

500gr palm sugar, 200ml coconut milk, a pandan leaf. How to make *dodol mandai*: (1) Measure all ingredients in accordance with the recipe above; (2) Make *mandai* puree using a blender; (3) Put coconut milk and *pandan* leaf, stir well continuously; (4) When the coconut milk has warmed up, add the palm sugar into the pan, then stir until mixed; (5) Add *mandai* puree into the pan, then alternately add the glutinous rice flour; (6) Stir *dodol mandai* dough constantly, stir from the bottom of the wok upwards. This process takes approximately 3-5 hours, so *dodol* will be well cooked; (7) When the dough has developed brownish colour, and the dough is no longer stuck on the wok or pan, then it means that the *dodol* is cooked well, thus ready to be packaged, or to be eaten directly.

## RESULTS AND DISCUSSIONS

To facilitate the non-trained panellists in answering the preferred test, the questionnaires were given a scale of 1 to scale 6 with the following words: 1 (dislike), 2 (neutral), 3 (quite like). 4 (like), 5 (very like) and 6 (extremely likes) (based on hedonic scale):

Variable panellist responses from Table 4 can be seen on the preferred test of *dodol mandai* distributed to panellists. In terms

of the aroma of *dodol mandai*, among non trained panellists, no one answered “dislike”, no one answered “neutral”, 12 people answered “quite like”, 23 people answered “like”, 21 people answered “very like”, and 24 people answered, “extremely like”.

In terms of the colour of *dodol mandai*, among non trained panelists, no one answered “dislike”, “neutral” stated by 6 people, 19 people quite liked, 22 people liked, 8 people very liked, and 15 people extremely liked. In terms of the texture of *dodol mandai*, among non trained panellists, no one answered dislike, 8 people stated “neutral”, 17 people quite liked, 16 people liked, 23 people very liked and 16 people extremely liked. In terms of taste of *dodol mandai*, among non trained panellists, no one answered dislike, 7 people stated as neutral, 21 people quite liked, 17 people liked, 14 people very liked, and 21 people extremely liked.

In this research, 80 questionnaires were distributed to 80 non-trained panellists. Data from the questionnaire is valid if r count value on *dodol mandai* greater than r table. From the data obtained using SPSS 20, it can be seen on r test on *dodol mandai* in terms of aroma 0.531, colour aspect 0.423, texture aspect 0.392, and 0.535 in terms of taste, while r table is 0.22 (calculation of data amounting to 80). The detail of the validity test can be seen in Table 5. Because r test > r table, it can be said that all data from questionnaire regarding *dodol mandai* is valid.

Table 5  
Validity of the questionnaire

	r Table	r Test	Description r test > r Table
Aroma	0.22	0.531	Valid
Color	0.22	0.423	Valid
Texture	0.22	0.392	Valid
Taste	0.22	0.535	Valid

The results of data obtained from SPSS 20 on the research “*Dodol Mandai Innovation*” is considered reliable, by getting Cronbach’s Alpha exceeding 0.6 as presented in Table 6, so it is considered to have good reliability. The result of Cronbach’s Alpha based on standardized items on *dodol mandai* is 0.697 which can be said that the data is reliable because it is above 0.6.

Table 6  
Reliability of questionnaire

Reliability statistics	
Cronbach's Alpha	N of Items
0.697	4

In Table 7, it can be seen the results of one sample Chi-Square Test using SPSS 20 and from the results, information is generated as follows:

- In sub-variable “Aroma of *Dodol Mandai*”, it can be seen sig. (2-tailed) of 0.000 which is smaller than sig. 0.05, so it can be concluded that Ho is rejected and Ha is accepted that there are panic preferences to aroma on *dodol Mandai*.

- In sub-variable of “Colour of *Dodol Mandai*”, it can be seen sig. (2-tailed) of 0.000 which is smaller than sig. 0.05, so it can be concluded that Ho is rejected and Ha is accepted that there is a panellist preference on the colour on *dodol Mandai*.
- In sub-variable “*Dodol Mandai* Texture”, it can be seen sig. (2-tailed) of 0.000 which is smaller than sig. 0.05, so it can be concluded that Ho is rejected and Ha is accepted that there is a panellist preference on texture on *dodol mandai*.
- In sub-variable “Taste of *Dodol Mandai*”, it can be seen sig. (2-tailed) of 0.000 which is smaller than sig. 0.05, so it can be concluded that Ho is rejected and Ha is accepted that there is a panellist preference on the taste in *dodol Mandai*.

Table 7  
One sample Chi-Square Test

Hypothesis Test Summary				
	Null Hypothesis	Test	Sig.	Decision
1	The categories of Aroma Dodol Mandai occur with equal probabilities	One-Sample Chi-Square Test	0.000	Reject the null hypothesis
2	The categories of Warna Dodol Mandai occur with equal probabilities	One-Sample Chi-Square Test	0.000	Reject the null hypothesis
3	The categories of Tekstur Dodol Mandai occur with equal probabilities	One-Sample Chi-Square Test	0.000	Reject the null hypothesis
4	The categories of Rasa Dodol Mandai occur with equal probabilities	One-Sample Chi-Square Test	0.000	Reject the null hypothesis

Notes: Asymptotic significances are displayed. The significance level is 0.05.

## CONCLUSIONS

This *Dodol Mandai Innovation* research was conducted with the aim to know the level of preference of aroma, colour, texture and taste. This research was also conducted with the aim to know whether *dodol mandai* could be accepted by the public as a new kind of *mandai* innovation that had never been produced before.

The non-trained panellists liked *dodol mandai*, because this *dodol mandai* had a distinctive aroma and flavour from the *mandai*. This *dodol* also has better texture

and colour than other *dodol* products. *Dodol mandai* has a chewy texture and has a brighter colour. This indicates the taste quality of food. After this experimental research, the result is as predicted, that *mandai* can be processed into *dodol*.

During the research process, the authors had tried several times to make *dodol mandai*, so the authors have some suggestions regarding the product, and on cooking process techniques until it becomes *dodol mandai*. The author tried to make *mandai* which had a salty taste as an ingredient of processed foods that

had a sweet taste like *dodol*. In selecting *Cempedak* peel for making *mandai*, authors suggest the peel of thick *Cempedak* fruit be chosen so it will bring out good *mandai*. The salted water in the *mandai* storage process is expected to always be changed once in two weeks. It is also suggested to use low flame and stir continuously so the texture of *dodol* will not harden. In the making process of *dodol*, do not use glutinous rice flour that has been in the open air for a long time, because it will affect the quality of the flour. In dough mixing process, add the glutinous rice flour little by little, so that the flour does not clot on the dough. After finishing cooking *dodol mandai* must be chilled first. After that, it can be directly packaged and stored for 2 weeks. It also can be directly served and consumed. The key of the success in making *dodol mandai* is the accuracy and the consistency of materials measurement as already given.

## ACKNOWLEDGEMENT

The authors are grateful to Prof. Bahtiar Saleh Abbas as Director of Research & Technology Transfer Office and Dezie Leonarda Warganegara, as the Dean of the Faculty of Economics and Communication, as well as the Hotel Management Lecturer who provided the facilities required for the preparation of this paper.

## REFERENCES

- Bakar, M. F. A., Karim, F. A., & Perisamy, E. (2015). Comparison of phytochemicals and antioxidant properties of different fruit parts of selected artocarpus. *Sains Malaysiana*, 44(3), 355-563.
- Boonpienpon, N., Maneenetr, T., Siritwong, P., & Kovathanakul, D. (2015). Indigenous Islamic food: An ideal product innovation for creativity in cultural tourism: a case study Khao Tung Pla (Thai Crispy Rice Crackers with Anchovies). *Mediterranean Journal of Social Sciences*, 6(5), 445-453.
- Collins, A., Joseph, D., & Bielaczyc, K. (2004). Design research: Theoretical and methodological issues. *Journal of the Learning Sciences*, 13(1), 15-42.
- Emmawati, A., Jenie, B. S., Nuraida, L., & Syah, D. (2015). Characterization of lactic acid bacteria isolates from Mandai function as probiotic. *Agritech*, 35(2), 146-155.
- Hall, C. M. (2012). Boosting food and tourism-related regional economic development. In *OECD, Food and the Tourism Experience: The OECD-Korea* (pp. 46-92). Paris, France: OECD Publishing.
- Indonesia Dictionary. (2018, April 27). *Meaning dodol*. Retrieved May 25, 2018 from <https://www.apaarti.com/dodol.html>
- Jongen, W. M., & Meerdink, G. (1998, November 15-18). Food product innovation: How to link sustainability and market. In *7th International Conference of the Greening of Industry Network* (pp. 1-15). Rome, Italy.
- Kuhne, B., Vanhonacker, F., Gellynck, X., & Marbeke, W. (2010). Innovation in traditional food products in Europe: Do sector innovation activities match consumers' acceptance? *Food Quality and Preference*, 21(6), 629-638.
- Leong, L. P., & Shui, G. (2002). An investigation of antioxidant capacity of fruit in Singapore markets. *Food Chemistry*, 76(1), 69-75.
- Marwati, S. (2013). *Pembuatan pewarna alami makanan dan aplikasinya* [Developing natural food coloring and its applications]. Yogyakarta, Indonesia: Universitas Negeri Yogyakarta.

- Natalia, D. (2018, May 16). *Kuliner*. Retrieved May 25, 2018, from sumber.com: <https://www.sumber.com/index.php/jalan-jalan-kuliner/kalimantan-selatan/kuliner-kalimantan-selatan/sumber/mandai.html>
- Nauw, A. J., Fatem, S. M., Husodo, S. B., & Sagrim, M. (2016). Pemanfaatan tumbuhan cempedak (*Artocarpus chamedon*) oleh masyarakat Kampung Sabun Distrik Aitinyo Tengah, Kabupaten Maybrat, Papua Barat [Utilization of Cempedak (*Artocarpus chamedon*) by the people of Kampung Sabun Tengah Aitinyo District, Maybrat Regency, West Papua]. *Jurnal Ilmu Kehutanan*, 10(1), 46-56.
- Rahayu, E. S. (2000). Bakteri asam laktat dalam fermentasi dan pengawetan [Lactic acid bacteria in fermentation and pickling]. In *Seminar Nasional Industri Pangan* (pp. 299-308). Surabaya, Indonesia: Indonesian Food Technology Expert Association.
- Rob, & Lindsay. (2016, 04 01). *The fruits of Thailand*. Retrieved May 27, 2018, from <http://www.yearofthedurian.com/wp-content/uploads/2016/04/Fruits-of-Thailand.pdf>
- Samoggia, A., & Nicolodi, S. (2017). Consumer's perception of fruit innovation. *Journal of International Food and Agribusiness Marketing*, 29(1), 92-108.
- Soemaatmadja. (1997). *Pengawetan pangan di Indonesia* [Indonesia food preservation]. Bogor, Indonesia: Bogor Agricultural Institute.
- Sugiyono. (2014). *Metode penelitian pendidikan: Pendekatan kuantitatif, kualitatif dan R & D* [Education research methodology: R&D quantitative and qualitative approach]. Bandung, Indonesia: Alfabeta.
- Supriyadi, R. (2018, May 8). *AntaraKalsel*. Retrieved May 27, 2018 from Antaranews.com: <https://kalsel.antaranews.com/berita/60802/mandai-makanan-penggugah-selera-dari-kulit-cempedak>
- The Editors of Encyclopaedia Britannica. (2018, May 8). *South Kalimantan*. Retrieved May 27, 2018 from Encyclopaedia Britannica: <https://www.britannica.com/place/South-Kalimantan>
- Trichopoulou, A., Vasilopoulou, E., Georga, A., Soukara, S., & Dilis, V. (2006). Traditional foods: why and how to sustain them. *Trends in Food Science and Technology*, 17(9), 498-504.
- Widyawaruyanti, A. (2013). Development of antimalarial phytomedicine of *artocarpus chamedon*: A model for antimalarial drugs discovery. *The Open Conference Prosiding Journal*, 4(10), 4-10.
- Williams, H. A., William Jr., R. L., & Omar, M. (2014). Gastro-tourism as destination branding in emerging markets. *International Journal of Leisure and Tourism Marketing*, 4(1), 1-18.

## **@\_TNIAU: Case Study on Interactive Public Communication in Indonesia**

**Yuanita Safitri\* and Mia Angeline**

*Marketing Communication Program, Department of Communication, Faculty of Economics and Communication, Bina Nusantara University, Jakarta 11480, Indonesia*

### **ABSTRACT**

@\_TNIAU is a Twitter account managed by DISPENAU (Indonesian Air Force Public Relations). The account gains popularity among citizens because of the approach they used, such as humour and using conversational tone on each tweet, which is not common for government agencies, especially the military. The purpose of this research is to explore how government agency uses a new platform to increase engagement to the public and to generate some conceptual communication strategies used by TNI AU. This article used a qualitative methodology. Data was collected using virtual observation, interviews with representatives from the Public Relations of TNI AU and Twitter Indonesia. The result shows these strategies include fact-finding, using a conversational tone, emoticon power, stay up to date with the current situation, promote credibility via activation, and timely distribution. The conversational tone will also improve interactivity especially on Twitter. The result suggests that government agencies should use social media to increase the quality of public communication.

*Keywords:* Interactive communication, public communication, TNI AU, twitter

### **INTRODUCTION**

Public communication is a prominent issue in Indonesia. Even Indonesian President Joko Widodo pays great attention to the lack of public communication from government agencies to citizens (Harliantara, 2017). For 32 years Indonesia had been under the dictatorship of President Soeharto, who left a strong culture of one-way communication in government agencies (Holik, 2005; Sandra, 2013). In the New Order era,

#### **ARTICLE INFO**

*Article history:*

Received: 09 October 2019

Accepted: 03 January 2020

Published: 17 March 2020

*E-mail addresses:*

yuanita.safitri@binus.edu (Yuanita Safitri)

mia.angeline@binus.edu (Mia Angeline)

\* Corresponding author



government officials were deemed more exclusive and high-class than entrepreneurs or private employees. This means that government officials were allowed and expected to build a barrier between them and the citizens. Moreover, in the New Order era, people were not allowed to express their opinions freely, and the press was allowed limited freedom. One of the biggest communication challenges that are currently faced by Indonesia is to break the barrier and become an inclusive country. After 20 years of reform, the government began to clean up, starting with the implementation of the principles of good governance, with transparency being the most notable one. The government hopes that with the improvement in transparency, the level of public trust can be increased.

In 2017, Indonesia reached an internet penetration rate of 50 per cent, equal to approximately 143.26 million internet users (Maulani, 2018). The internet penetration rate nearly doubled since 2015. Setyawan et al. (2018) summarized that people aged 19 to 34 years old constituted the largest group of internet users with preferred activities ranging from visiting social networks and using a search engine to watching online videos. This massive internet penetration rate shows that the Internet has a big potential as a tool for public communication. However, it seems that internet usage is only maximized by private sectors.

A study by Picazo-Vela et al. (2012) into risks, benefits and strategic alternatives of social media applications in the public sector stated several results: (1) governments' participation on social media may result

in improved communication and citizen participation, higher transparency and transfer of best practices among government agencies; (2) a good implementation strategy is necessary to realize these benefits and to avoid risks; (3) the implementation of social media highlights the importance of updating laws and regulations, and of promoting changes in government culture and organizational practices. From that perspective, we argue that social media, especially in Indonesia, has a strong possibility to be developed and used in the public sector. Social media represents a powerful instrument for promoting interactions between the government and the citizens (Khan et al., 2013; Panagiotopoulos et al., 2011).

The pioneer of interactive government communication in Indonesia is the Indonesian Air Force or TNI AU. On 6 June 2012, TNI AU made a Twitter account, @\_TNIAU, and as of 29 April 2018, had gained 264k followers. TNI AU had an impressive achievement; they won the Marketeers Netizen Award in 2016 from Markplus Inc. In April 2016, the account @\_TNIAU became the first Twitter-verified account of a governmental agency. We intended to explore three main questions in this paper: (1) How did TNI AU become a pioneer of interactive public communication in Indonesia? (2) How do they motivate other government agencies to use social media as a platform to engage with the public? and (3) How does TNI AU use communication strategies for their Twitter account? Meanwhile, the purposes of this paper were to explore how a government



agency uses a new platform to increase its engagement with the public and to generate some conceptual communication strategies to be used by TNI AU. We hope other government agencies will consider using social media to have better engagement with the citizens.

## Literature Review

**Social Media and Government.** As a social site, social media has gained a huge number of users and become an interaction hub. There are seven functionalities of social media — the extent of how users; 1) disclose their identities; 2) converse with one another; 3) share contents; 4) make known their presence; 5) form relationships; 6) know the reputation of others and 7) form groups (Kietzmann et al., 2011). Meanwhile, to government agencies, social media is expected to escalate information sharing, increase transparency, create opportunities for collaboration and enhance government responsiveness (Bertot et al., 2010, 2012; Panagiotopoulos et al., 2014; Picazo-Vela et al., 2012; Patrice, 2010).

The idea of spreading information through mediated communication in the public sector is not new. It has already been used by multiple countries around the world (Zheng & Zheng, 2014). One example is research by Zheng & Zheng (2014), which focused on content analysis on selected Chinese government microblogs. The result obtained is quite outrageous. They found that most messages on Chinese government microblogs were posted for self-promotion rather than service delivery.

Generally, the public relations division is responsible for communicating the organization's values to the public. Moreover, since the main function of the public relations division is to serve the public interest, it should never discriminate between public and private audience (Liu & Horsley, 2007). Public relations division is termed as '*Humas*' or '*Hubungan Masyarakat*' in Bahasa Indonesia. The term '*Humas*' to refer to government agencies is used in several regulations, such as the Regulation of the Ministry of State Civil Apparatus and Bureaucratic Reform No. 6/2014 and No. 30/2011 (Kriyantono, 2017).

However, in the case of Indonesia, it takes a bigger effort to change the way government agencies communicate with the public. Many Indonesian government agencies are still using one-way communication (Purworini, 2014). These agencies refuse to use social media because of human resources issues and uncertainty in work regulations. Suryadharma and Susanto (2017) also found that of 34 provincial governments in Indonesia only 9 used Facebook and 9 others used Twitter. This data shows how limited was the usage of social media for the public sector.

This paper focuses on the official Twitter account of TNI AU. Twitter is a microblogging service that has tremendous growth in the number of users over the past several years. Twitter's average monthly number of active users (MAU) grew by 4 per cent per year to 330 million in the fourth quarter of 2017 (Team, 2018). In Politics, Twitter becomes an important platform. A

lot of politicians have been using Twitter as a medium to communicate values to their audience, for example, Barack Obama, Donald Trump and Indonesian President, Joko Widodo.

**Interactive Communication.** Social media sites are virtual platforms for interactivity and information exchange (Perlmutter, 2008; Smith, 2010). These platforms encourage Hallahan (2003) and Kelleher (2009) to examine the qualities of interactive online communication and how they may be related to become a key factor in relational online outcomes. The effectiveness of interactive communication varies according to several elements, namely message, sender, receiver, medium and feedback.

This paper classified Twitter as a medium for interactive communication between TNI AU and citizens. The senders were TNI AU officers called “*airmins*,” an abbreviation of air force admins. TNI AU considered netizens, especially high school students and parents, as their receivers in order to increase the rate of military student intake each year. The message and feedback are to be analyzed further in this article.

The interactive communication concept is similar to the concept of open communication. Without openness, there will always be rejection to use social media in the effort to achieve relational results important to the government and the citizens. Open communication is defined as a key to effective communication and

assurance that information is conveyed in a way that individuals can converge on shared meanings, and it may require the use of multiple formats (Dennis & Valacich, 1999). To have open communication, the government needs some strategies, including storytelling, informal communication and coaching (Mishra et al., 2014). This study will observe how interactive communication tools, such as Twitter can enhance interactivity in public communication.

## MATERIALS AND METHODS

This paper used a qualitative method with a case study approach. This research was conducted as a single case study because of the uniqueness of TNI AU’s Twitter account and TNI AU’s being a pioneer of interactive public communication in Indonesia. Yin (2014) stated that the case study approach would employ two main questions: how and why it served as an explanatory way to understand the case. Data was collected through semi-structured interviews with representatives of the Public Relations Division of TNI AU (DISPENAU) and Twitter Indonesia. In addition, a virtual observation of TNI AU’s Twitter account and other Indonesian online mass media was conducted for five months from January to May 2018. We have requested permission from TNI AU to observe their official Twitter account. Field notes were written in a narrative format, and data from online media were compared with the interview results.

## RESULTS AND DISCUSSIONS

### TNIAU as Pioneer of Public Communication through Twitter

On 6 June 2012, the Indonesian Air Force or TNI AU made a Twitter account named @\_TNIAU. As of 7 May 2018, they had gained 265k followers. These figures are considered big for a governmental agency account in Indonesia. DISPENAU is a division that runs the functions of Public Relations in the Indonesian Air Force. The initial idea of making a Twitter account came up when DISPENAU intended to share information about Sukhoi Superjet 100 plane crash in Bogor, Jawa Barat back in 2012. They needed a medium to share information directly without any third party (media) intervention. One of DISPENAU's staff members came up with the idea to use Twitter since it mostly consists of text, enabling DISPENAU to cut expenses considerably.

After the Sukhoi incident, DISPENAU realized that sharing information through Twitter is a brilliant idea. Citizens are able to read the news directly from the first party, minimizing misunderstanding. Additionally, DISPENAU will be able to answer netizens' questions in real-time. DISPENAU later set another goal—to increase the rate of student intake of the Indonesian Military Air Force with the use of Twitter. To appeal to millennials, DISPENAU learned to use simple words and limited jargon. Also, they added humour to everyday tweets, which Indonesian millennials could relate to in an instant. In a year, the rate of student intake

of TNI AU increased to 250 per cent (based on an interview with DISPENAU). This massive figure was considered extraordinary since TNI AU was deemed as the least popular military division in Indonesia.

However, TNI AU also faced both internal and external challenges. Internally, TNI AU's military members were afraid that DISPENAU would share classified information with the citizens. Therefore, at first, DISPENAU received a lot of complaints from internal colleagues. Meanwhile, the main external challenge came from the netizens who doubted whether @\_TNIAU is an official account or a scam. This scepticism is not for nothing. In Indonesia, the army carries many negative stereotypes: being unfriendly, strict and exclusive. However, TNI AU's Twitter account is far from the stereotypes.

These challenges have urged TNI AU to prove themselves. They want the army to be perceived as humanists. This means that TNI AU needs to release “down to earth” publications on Twitter with some humour and contemporary “millennials” languages. DISPENAU release Twitter posts containing student application information, events or additional info regarding TNI AU and air force on a daily basis. DISPENAU aims to re-brand the image of TNI AU through their posts.

Several informative contents, for example, the information on jet fighter planes, have been published through TNI AU's Twitter account. A representative of DISPENAU stated “...*people love the*

*contents about jet planes, especially if we make them in a simple and easy-to-understand language. We avoid using complex terms and prefer to translate them so everybody can understand the meaning.”*

TNI AU's Twitter account stood in the spotlight in mid-May 2016 after responding to a tweet from the Chairman of Presidium Save Indonesia Movement or *Gerakan Selamatkan Indonesia* (GSI) Ratna Sarumpaet. Sarumpaet claimed that Ahok (former governor of Jakarta) had bought the Indonesian Army, the Police and the Corruption Eradication Commission (KPK). To counter that claim, TNI AU used a personal approach as if they were not a government agency. They asked Sarumpaet to show the buyer's receipt, which was hilarious and became viral (BBC, 2016).

TNI AU also came under the spotlight when Fahri Hamzah, deputy speaker of the Indonesian People's Representative Council, who claimed that TNI AU had sold Halim Perdanakusuma International Airport to a private company. Netizens praised the way TNI AU handled this accusation. TNI AU did not show any bit of anger in their response, but they managed to prove the accusation wrong completely. TNI AU presented statistical data and facts about the regions of military airbases and used hashtag #BandaraHLP which stands for Halim Perdanakusuma International Airport (Tribunnews.com, 2016). TNI AU uses hashtags to group a large amount of information based on themes or topics for easier tracking.

The way TNI AU handled these accusations has been considered as a breakthrough in public communication in Indonesia. It was uncommon in 2012 for the government to use social media as the main medium to engage with citizens. Before that point in time, Indonesia's government agencies used to practice one-way communication. This practice is in contrast with the public relations division's (Humas) functions, which are to serve as a gateway from the government to the citizens, to serve as a public policy interpreter and to establish effective public communication (Regulation of the Ministry of State Civil Apparatus and Bureaucratic Reform No. 30, 2011 in Purworini, 2014).

Even though the number of followers increases drastically, not all followers have the same perception of TNI AU. Most of them are considered "enthusiasts" who like, retweet and reply in a positive way. Some followers are considered as "haters", who reply with hate comments. Some others are considered as "neutrals", who are silent readers with no interactivity. However, TNI AU's efforts have earned the public trust. Twitter has verified TNI AU's account, making them the first agency to have a verified account among Indonesian government agencies. This is proof that @\_TNIAU is an official account of the Indonesian Air Force (TNI AU). Today, DISPENAU is constantly being asked by other government agencies to share its strategies for having effective public communication (interview with DISPENAU, April 2018).

### **TNIAU's Interactive Communication Strategies**

Twitter, one of the existing interactive online platforms, can be used to mediate communication between the government and the citizens. As previously mentioned, TNI AU is a pioneer in interactive online communication for Indonesian government agencies. Based on the interviews and observations conducted, there are several strategies used by TNI AU which can be divided into the following components:

**Fact-finding before Tweeting.** TNI AU stated that it is a taboo for them to delete tweets, meaning that they must be careful with every post. Research before making a post is a must. Any mistake will hurt their credibility.

**Using Conversational Tones.** One of their objectives is to make TNI AU perceived as humanists and a credible government agency. To achieve that, it started by using easy-to-understand sentences in their posts avoiding any use of jargon that is hard to understand. Also, TNI AU uses the conversational tone of a friend rather than the tone of a government agency, and most of the time they add some humour to their tweets.

**Emoticon Power.** While others use hashtags to differentiate their tweets, @\_TNIAU uses an emoticon in every tweet. This uniqueness has become a trademark of TNI AU tweets. A lot of TNI AU's followers gave positive comments about the emoticons. The term

'emoticons'-short for 'emotion icons'-refers to graphic signs, such as smileys, that often accompany computer-mediated textual communication (Dresner & Herring, 2010). This form of communication is often considered as a form of informal communication, which in TNI AU's case is used to give a conversational tone normally used by a person in his or her communication with his or her friend.

**Staying up-to-date.** Another strategy is to be up-to-date with current situations and trends. One way to stay updated is to be active on informal WhatsApp Groups, from which TNI AU gain insights on current trends. DISPENAU admitted that they received a lot of funny tweet ideas from WhatsApp Groups.

**Holding Several Contests to Ensure Credibility.** During these past six years, @\_TNIAU has held several competitions with unique prizes, for example, a tour by an official military aeroplane to Iswahjudi Military Airport, the main base of TNI AU operations. These competitions have been intended to ensure the credibility of TNI AU's Twitter account. DISPENAU stated that in the first four years a lot of people did not trust their Twitter Account. Therefore, they made several contests and activities to enhance public engagement and public trust

**Timely Distribution.** To make a social media persona, one needs to become social (Twitter Indonesia, 2018). One thing important to becoming social is to

choose the best time to post. A lot of people say that content is the king, but it is not necessarily true because when we fail to distribute at the right time, it still would not work. DISPENAU pays great attention to the timely distribution of their tweets with trial and error to gain a higher level of engagement.

Another interesting thing about TNI AU's Twitter account is, they have an internal agreement to never publish the identities of "*airmins*." DISPENAU only announced that *airmins* consist of several people and their identities will never be published. DISPENAU received several invitations to events relating to digital communication, but these *airmins* showed up in full pilot helmet and uniform, making it impossible for the audience to see their faces. This was so agreed to prevent discrimination and hate speech against the *airmins*.

TNI AU has made quite a lot of changes in Indonesian government communication. They brought a new perspective as an effort to restore the ideal public communication. TNI AU stimulated government communication style to change from passive to assertive. In the concept of interpersonal communication, assertiveness refers to a dimension in everyday perceptions reflecting an individual's interpersonal willingness to stand up and speak out for their own interests and ideas, pursuing their objectives and resisting others' impositions (Ames, 2009). Initially, TNI AU's Twitter account has a younger target audience to persuade them to pursue military education. Younger target audience is favoured by TNI AU

since they adapt to technology better and respond faster on Twitter than older users (Sakdulyatham et al., 2018).

The way TNI AU presents its identity on Twitter is closer to an assertive style. For instance, when they received hate comments, they countered with relevant data. Moreover, they also taught their followers to speak based on data and facts rather than assumptions, which might lead to hoaxes. In this case, to promote understanding of the government and citizens to each other, government agencies need interactive instead of one-way communication.

Kelleher (2009) introduced the concept of the "conversational human voice," defined as the engagement and natural style of organizational communication as perceived by the organization's audience based on interactions between individuals in the organization and individuals in the audience. This concept can be applied to the government's social media activities. Government agencies need to use a conversational tone to decrease the gap between the government and the citizens, which will improve interactivity, especially with the help of social media.

## DISCUSSIONS

Based on the results, we can draw an interactive public communication chart that shows the process of Twitter usage by a government agency, as seen in Figure 1. The chart starts with the illustration of how easy disinformation occurs in government agencies, and it can come from internal or external sources. Disinformation often leads



to misinformation, hoaxes and rumours spread between citizens. A major impact of it is distrust of the government.

This situation has driven TNI AU to try an alternative tool such as Twitter that offers a possibility to enhance the engagement between government and citizens. However, to make it work, they need to be more open to the public and

try to eliminate the gap between them and the citizens. There are several factors that can contribute to the interactivity applied in government agencies' communication strategy, namely fact-finding before every post, conversational tone, emoticon usage, up-to-dateness, credibility via contests and timely distribution.

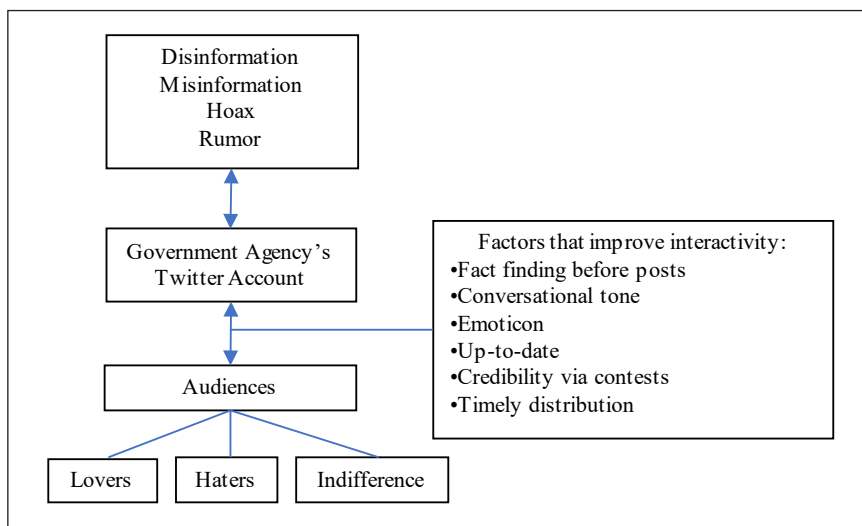

Figure 1. Interactive public communication through twitter's chart

## CONCLUSIONS

As a final thought, we can conclude that the one thing Indonesian government agencies need is the willingness to break the exclusive culture, to be more adaptive to changes and to be more eager to explore new ways of communication. TNI AU has successfully brought a silver lining to better public communication in Indonesia. Some other agencies like @bank\_indonesia (Bank of Indonesia), @Kemdikbud\_RI (Indonesian Ministry of Education and Culture) and @DitjenPajakRI (Indonesian Tax Government

Agency) are in their way to follow TNI AU's success by adopting the same strategies, like using informal communication and humour in their tweets. According to the results, we encourage government agencies to use social media to decrease the gap between the government and the citizen.

## ACKNOWLEDGEMENT

The authors wish to acknowledge and thank all IMHA 2018 committee members as well as DISPENAU team.

## REFERENCES

- Ames, D. (2009). Pushing up to a point: Assertiveness and effectiveness in leadership and interpersonal dynamics. *Research in Organizational Behavior*, 29(2009), 111-133.
- BBC. (2016, March 31). #TrenSosial: Kicauan-kicauan Lucu TNI AU lewat akun Twitter [#SocialTrend: Hilarious tweets of TNI AU (Indonesian Air Force) through Twitter accounts]. Retrieved September 11, 2017, from [https://www.bbc.com/indonesia/majalah/2016/03/160331\\_trensosial\\_tni\\_au](https://www.bbc.com/indonesia/majalah/2016/03/160331_trensosial_tni_au)
- Bertot, J. C., Jaeger, P. T., & Grimes, J. M. (2010). Using ICTs to create a culture of transparency: E-government and social media as openness and anti-corruption tools for societies. *Government Information Quarterly*, 27(3), 264-271.
- Bertot, J. C., Jaeger, P. T., & Grimes, J. M. (2012). Promoting transparency and accountability through ICTs, social media, and collaborative e-government. *Transforming Government: People, Process and Policy*, 6(1), 78-91.
- Dennis, A. R., & Valacich, J. S. (1999). Rethinking media richness: Towards a theory of media synchronicity. In *Systems Sciences, 1999. HICSS-32. Proceedings of the 32nd Annual Hawaii International Conference on* (pp. 10-pp). Maui, HI, USA: Leibniz-Gemeinschaft.
- Dresner, E., & Herring, S. C. (2010). Functions of the nonverbal in CMC: Emoticons and illocutionary force. *Communication Theory*, 20(3), 249-268.
- Hallahan, K. (2003, May 25-29). *A model for assessing web sites as tools in building organizational-public relationships*. Paper presented to the Public Relations Division at the annual meeting of the International Communication Association. San Diego, CA.
- Harliantara. (2017). *Membenahi komunikasi publik pemerintah* [Fixing government's public communication]. Retrieved September 14, 2017, from <https://www.jawapos.com/opini/sudut-pandang/10/02/2017/membenahi-komunikasi-publik-pemerintah>.
- Holik, I. (2005). Komunikasi politik dan demokratisasi di Indonesia: Dari konsolidasi menuju pematangan [Political communication and democratization in Indonesia: From consolidation to maturation]. *Jurnal FISIP: MADANI*, 2(2), 56-74.
- Kelleher, T. (2009). Conversational voice, communicated commitment, and public relations outcomes in interactive online communication. *Journal of Communication*, 59(1), 172-188.
- Khan, G. F., Yoon, H. Y., & Park, H. W. (2014). Social media communication strategies of government agencies: Twitter use in Korea and the USA. *Asian Journal of Communication*, 24(1), 60-78.
- Kietzmann, J. H., Hermkens, K., McCarthy, I. P., & Silvestre, B. S. (2011). Social media? Get serious! Understanding the functional building blocks of social media. *Business Horizons*, 54(3), 241-251.
- Kriyantono, R. (2017). Do the different terms affect the roles? A Measurement of excellent and managerial role of business and government public relations practices in Indonesia. *International Journal of Applied Business and Economic Research*, 15(6), 193-209.
- Liu, B. F., & Horsley, J. S. (2007). The government communication decision wheel: Toward a public relations model for the public sector. *Journal of Public Relations Research*, 19(4), 377-393.
- Maulani, A. M. A. (2018). *Internet penetration in Indonesia reaches 143M people: APJII Report*. Retrieved September 17, 2017, from <https://e27.co/internet-user-penetration-indonesia-reaches-143m-people-report-20180220/>
- Mishra, K., Boynton, L., & Mishra, A. (2014). Driving employee engagement: The expanded role of



- internal communications. *International Journal of Business Communication*, 51(2), 183-202.
- Panagiotopoulos, P., Bigdeli, A. Z., & Sams, S. (2014). Citizen–government collaboration on social media: The case of Twitter in the 2011 riots in England. *Government Information Quarterly*, 31(3), 349-357.
- Patrice, M. (2010). Building open government. *Government Information Quarterly*, 27(4), 401-13.
- Perlmutter, D. (2008). *Blogwars*. New York, USA: Oxford.
- Picazo-Vela, S., Gutiérrez-Martínez, I., & Luna-Reyes, L. F. (2012). Understanding risks, benefits, and strategic alternatives of social media applications in the public sector. *Government Information Quarterly*, 29(4), 504-511.
- Purworini, D. (2014). Model informasi publik di era media sosial [Public information model in social media era]. *KomuniTi*, 6(1), 3-14.
- Sakdulyatham, R., Preeyanont, S., Lipikorn, R., & Watakakosol, R. (2018). Smartphone usage capabilities among younger and elderly users. *Pertanika Journal of Social Sciences and Humanities*, 26(1), 181-198.
- Sandra, L. J. (2013). Political branding Jokowi selama masa kampanye Pemilu Gubernur DKI Jakarta 2012 di media sosial twitter [Jokowi's political branding during the 2012 DKI Jakarta Governor Election campaign period on social media Twitter]. *Jurnal E-komunikasi*, 1(2), 276-287.
- Setyawan, R. A., Setyohadi, D. B., & Pranowo. (2018). Understanding customers' intention to use social network sites as complaint channel: An analysis of young customers' perspectives. The 2<sup>nd</sup> International Conference of Energy, Environmental and Information System (ICENIS 2017), Semarang, Indonesia: Library of Atmajaya University, Yogyakarta.
- Smith, B. G. (2010). Socially distributing public relations: Twitter, Haiti, and interactivity in social media. *Public Relations Review*, 36(4), 329-335.
- Suryadharma, B., & Susanto, T. D. (2017). Faktor penerimaan media sosial instansi pemerintah di Indonesia [Factors of social media acceptance of government agencies in Indonesia]. *INTEGER: Journal of Information Technology*, 2(2), 1-10.
- Team, T. (2018). *Twitter's Q4 profitability bodes well for 2018*. Retrieved September 20, 2017, from <https://www.forbes.com/sites/greatspeculations/2018/02/09/twitters-q4-profitability-bodes-well-for-2018/#5f6e353a1cae>
- Tribunnews.com. (2016). Lagi-lagi, kicauan 'nyeleneh' akun twitter TNI AU bikin netizen ngakak [Again, ridiculous tweets of the Indonesian Air Force Twitter account made netizens laugh]. *Tribunnews*. Retrieved September 21, 2017, from <http://www.tribunnews.com/techno/2016/03/31/lagi-lagi-kicauan-nyeleneh-akun-twitter-tni-au-bikin-netizen-ngakak>
- Yin, R. K. (2014). *Studi kasus desain dan metode* [Case study design and methods]. Jakarta, Indonesia: PT Raja Grafindo Persada.
- Zheng, L., & Zheng, T. (2014). Innovation through social media in the public sector: Information and interactions. *Government Information Quarterly*, 31(2014), S106-S117.



## Internet of Things (IoT) for Energy Efficiency in Tourism-Related Industry

Kasih Cakaputra Komsary<sup>1\*</sup>, Tati Ernawati<sup>2</sup>, Ade Hodijah<sup>3</sup> and Dian Wardiana<sup>2</sup>

<sup>1</sup>*Department of Tourism, Faculty of Economics and Communication, Bina Nusantara University, Jakarta 11480, Indonesia*

<sup>2</sup>*Informatics Engineering, Politeknik TEDC Bandung, Bandung 40513, Indonesia*

<sup>3</sup>*Informatics and Computer Engineering, Politeknik Negeri Bandung, Bandung 40012, Indonesia*

### ABSTRACT

Internet of Things (IoT) has been considered as an alternative solution to the problem of energy efficiency in the tourism industry. IoT can be applied in supporting an environmentally friendly tourism industry. This study aims to see the possibilities of implementing IoT in the tourism SMEs (small-medium enterprises) by designing a simple prototype of a light controlling device as a solution to reduce energy consumption in the tourism-related industry. The prototype was designed by collaborating IoT, mobile devices and sensors in an electronic device (microcontroller Atmega 328P-PU) for lighting control. Furthermore, the switching device can be operated using an Android-based smartphone. The black box test examining the functionality of an application without peering into its internal structures or workings was carried out in the system, both server and client. The test results indicate that the device is functional, and wider use of IoT in the tourism industry in Indonesia is possible with a breakthrough in exploring the use of information technology.

*Keywords:* Atmega 328P microcontroller, Internet of Things (IoT), lights controlling

### ARTICLE INFO

#### *Article history:*

Received: 09 October 2019

Accepted: 03 January 2020

Published: 17 March 2020

#### *E-mail addresses:*

kkomsary@binus.edu (Kasih Cakaputra Komsary)

tatiernawati@poltektedc.ac.id (Tati Ernawati)

adehodijah@jtk.polban.ac.id (Ade Hodijah)

dian.wardiana90@gmail.com (Dian Wardiana)

\* Corresponding author

### INTRODUCTION

The evolution of internet usage is very significant, and it is predicted that there would be over 50 billion interconnections by 2020 (Guarda et al., 2017). Internet of Things (IoT) is a technology where users can access the network anytime and anywhere through the multifunctional devices such as sensors. IoT has been considered as an alternative solution to the problems in

real-life aspects. IoT in business becomes a technology platform to create added value for the organization (Guarda et al., 2017).

IoT can be applied in the tourism industry especially related to energy saving (Napitupulu et al., 2016). The tourism industry has changed to be more environmentally friendly and given impact to the business such as energy cost reduction (Micioni, 2018). In accordance with the Union of Concerned Scientists, the key actions to reduce environmental impacts are applied in three categories, such as energy efficiency, water conservation and consumption and waste. Energy efficiency options can appear in the form of energy-saving lighting, heating, and cooling, building materials and appliances (Pennisi, 2010).

Several other studies have reviewed energy-efficiency using IoT. Previous studies have shown that IoT is less implemented in the tourism industry, but is prevalent in other areas such as in the public buildings (Zhang et al., 2017), and household industry in the monitoring system of the solar water heater (Hertzog, 2017). The energy-saving potential of the tourism-related SMEs is significant. A large part of the energy used is due to unnecessary wastage and uncontrolled use (Parpairi, 2017). Some small and medium-sized tourism industries, especially in Indonesia, have not utilized simple IoT-based technology, given the widespread use of smartphones and the Internet. By the year 2017, there were 76.11 million people in Indonesia accessing the internet through their mobile phones

(Statista, 2018). This number is very huge, and it will be promising to be utilized in the tourism sector related to energy efficiency. The IoT sensor only costs \$1.30 on average (King & Perry, 2017) so the technology is very affordable for small-medium tourism enterprises. Therefore, related to the energy efficiency, this study aims to see the possibilities of implementing IoT in the tourism sector by designing a simple prototype of light controlling device as a solution to reduce energy consumption in the tourism-related industry. The prototype was designed by collaborating IoT, mobile devices and sensors in an electronic device (microcontroller Atmega328P-PU) to control the lights. This microcontroller is considered affordable for the small tourism industry and easy to be installed. The light controlling prototype was tested in a small hotel located in Garut, West Java-Indonesia. The design of this device is done in the small and medium tourism industry in the hope that the industry can cut operating costs by utilizing technology that is relatively cheap and easy to assemble. Guarda et al. (2017) suggested that energy efficiency was the most important factor for going green in the tourism-related industry, thus IoT interconnections were useful for tourism industry operators in developing reduced-cost better-performing energy efficiency systems that have a good impact on the environment.

This paper is organized into five sections. The first section gives a brief overview of the background of the study. The second section examines the literature review related to IoT, interfaces and tourism

industry. A research method is outlined in the third section. The study findings are outlined in section 4. Some conclusions are drawn in the final section.

## Literature Review

**Internet of Things (IoT) in the Tourism-Related Industry.** Internet of Things (IoT) is a field where any devices or objects can be made smart and identifiable through radio frequency tags. These devices can communicate with many other smart devices through the network (Kaur & Kaur, 2016). IoT is a concept where an object has the ability to transfer data over a network without requiring human-to-human or human-to-computer interaction. Through a device or a sensor connected to the internet, IoT behaves like internet with an open connection, sharing the data freely so that the computer can understand the world around it and become a part of human life (Ashton, 2017). IoT can also be integrated with sensing, networking, communication, and cloud computing technologies (John et al., 2017). Thus, IoT becomes a device that is fully controlled to perform certain actions based on the data entered (Deshpande & Iyer, 2017).

Regarding the implementation of IoT, early studies have explored the IoT use in several fields such as education (Sharma, 2016; Windarto & Eridani, 2017), transportation (Dubey et al., 2017; Eswaraprasad & Raja, 2017), fish-farming (Tseng et al., 2016), agriculture (Abhijith et al., 2017; Pandithurai et al., 2017; Uddin et al., 2017) and tourism (Kaur & Kaur, 2016).

The tourism industry in the world accounts for 5 to 12% of global greenhouse gas emissions. Therefore, in the perspective of the passage towards a low carbon environment and a sustainable economy, the term sustainable tourism was recently coined and starts to get recognition from both sides: tourists on one side and tour operators and the interesting territory on the other side (Nitti et al., 2017). Thus, there are certain implications need to be addressed by the tourism industry in using IoT. These relate to the energy efficiency, especially the dependence of the system on technology and network services and the possibility to implement such system with the use of a smartphone (device) and high-end infrastructure (Kaur & Kaur, 2016). Some ideas about bringing the tourism industry into the technology-based industry are already proposed. The idea of smart tourism destination has become an interesting issue by integrating tourism industry with a technology platform. This integrated platform can be accessed through a variety of end-user devices which will support the creation and facilitation of real-time tourism experiences and improve the effectiveness of tourism resources management throughout the destination at both the micro and macro level (Buhalis & Amaranggana, 2013). Another application of IoT in tourism is to identify real-time positioning of visitors and automatically mark them on the resort map (Yang et al., 2014). Recent research in Indonesia concluded that IoT could be used to monitor solar power generation (Photovoltaic Generation

System) especially through a wireless sensor network (Hidayatullah & Sudirman, 2017). Another example of IoT implementation is used in setting the temperature at the museum (Perles et al., 2018). As we know that some collections of museums require stable temperature conditions to keep them in good condition. A recent work on a street lighting system using a wireless system could reduce 50% - 70% operational cost (Parkash & Dandu, 2016). This will be very useful if the technology can be applied in small and medium industries. The use of automation in electrical devices in large hotels in developed countries is no longer a novelty. Some hotels have implemented light-controlling devices in guest rooms using IoT-based technology (De Pinto, 2018).

#### **IoT Interfaces (User-Side Requirements).**

There are three simple components used for building IoT interface, namely the Arduino, ATmega328P-PU microcontroller, and The ESP8266-01 WiFi module system. The Arduino is physical open-source computing, consisting of various hardware, programming languages and Integrated Development Environment (IDE). The Arduino IDE is a software that has been prepared by Arduino for designers to perform various processes related to Arduino programming. The IDE itself is the software for writing programs, compiling the binary code and uploading it into microcontroller memory (Djuandi, 2011). The ATmega328P-PU is an 8-bit low-power microcontroller based on AVR-RISC and has 32 MB ISP flash memory

used as the second component. This system is designed for device optimization in power consumption versus processing speed. The ATmega328 chip consists of 23 General Purpose Input/Output (GPIO) paths, 32 registers, 3 timers/counters with comparison mode, internal and external interrupt, USART programmable serial, 2-wire serial interface, SPI serial port, 6 channels 10-bit A/D converter, programmable watchdog timer with internal oscillator, and five power saving modes. The chip works with voltages between 1.8V ~ 5.5V. Computational output can reach 1 MIPS per MHz. The maximum operating frequency is 20 MHz (Atmel, 2016).

The ESP8266-01, the third component, is a WiFi module system on chip (Hertzog, 2017). This module can be programmed directly to ESP8266 without requiring an additional microcontroller. The ESP8266 is equipped with General Purpose Input/Output (GPIO). This GPIO can perform input or output functions like a microcontroller (Sinararduino, 2016).

## **MATERIALS AND METHODS**

The User-Centered Design (UCD) was used as the methodology (Siebenhandl et al., 2013). The three stages of the design are shown in Figure 1.

The primary data in this research were obtained by conducting on-site observation in a hotel in Garut, West Java-Indonesia. The data collection related to the existing problems of the light controlling system was conducted in an interview with hotel staffs. The information gathered was focused on

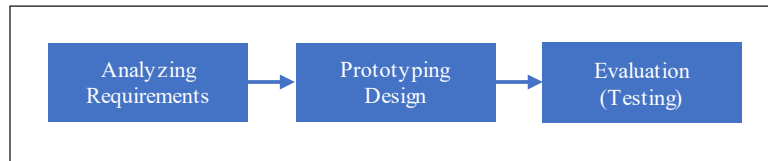

Figure 1. The process of UCD (Siebenhandl et al., 2013)

the environment in which the prototype would be used. The needs and expectations of the users were investigated as the basis for designing the prototype. The secondary data (hardware and software requirements) were obtained by using content analysis techniques derived from various references based on the problems studied.

In the prototyping stage, an outlined design and implementation were divided into two main parts such as hardware and software (server and client). The prototype design, focusing on the conceptual and detailed design of the light controlling system consists of two stages, namely device design, and component preparation. The implementation of the prototype was focused on two stages, namely device assembling and device programming.

The final stage was completed by testing the prototype (light controlling system), software and usability. The tests of hardware and software device were performed by the authors, whereas the test of device usability was performed by the users with the guidance of the authors. The test of usability was performed through a demonstration by the participants (users), i.e. the hotel staffs responsible for light control.

## RESULTS AND DISCUSSIONS

Based on the on-site observation and data processing result, the light controlling system was needed, particularly in the areas of room corridor because the hotel staffs often forget to switch the lights off, resulting in inefficient use of electricity. The hardware (ESP8266-01, ATmega328P-PU, and relay) and software requirements (web servers, data structures, interface representation, and coding procedures) were based on the users' needs. Lighting controlling system is an integrated system with three main parts, namely input (database, current sensor, ESP8266-01, light), process (ATmega328P-PU), and output (relay, light, ESP8266-01, database) as shown in Figure 2.

This system uses a manual switch as a relay between the lights and ATmega328P-PU microcontroller. The relay serves to connect or disconnect the flow of electricity to the lights. The ATmega328P microcontroller-PU will retrieve data from the database to set lights ON/OFF, while ESP8266-01 is used as a medium for the transmission to the database. This transmission is performed by using Android-based applications connected to the internet. Meanwhile, the microcontroller will send the data via ESP8266-01 to the smartphone. The app provides the feature of ON/OFF light switching based on the hour and can be



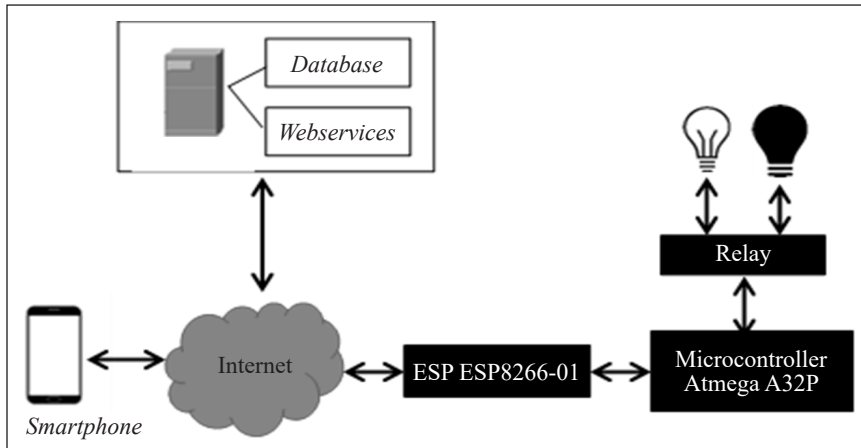

Figure 2. Block of input and output of the microcontroller system diagram

changed from the smartphone. If the manual switch is used to switch light ON/OFF, a sensor will send the low or high signal to the Atmega328P microcontroller, providing the light status.

The device consists of ATmega328P-PU, shift register, relay, push-button, female header, crystal 16MHz, ESP8266-01, converter USB to TTL serial module and power supply. The device testing was conducted to determine the performance of the device, whether it can function accordingly (Table 1). The test was done through the serial monitor. The application testing was done both on the server and client using a black-box method (Table 2 and Table 3).

The server application test was conducted through a browser. The server itself consists of database structure and web server application. The function of a database structure for connecting application uses a microcontroller. The web server application consists of 11 PHP files (connect\_db, from\_micro, getData, inputData, seeSchedule, login, forgottenPassword, register, changeSchedule, changePassword, changeStatus), used for communication between server and client applications. These results are shown in Table 2 as follows.

The Android-based smartphone was used as a client app. The features of the application include *main display*, *account*

Table 1  
Device testing result

No	Type of testing	Result
1	The device can connect to the hotspot	Successful
2	The device can connect to the server	Successful
3	The device can retrieve data from the server	Successful
4	The device can detect the change of the light status (ON/OFF) and send the data to the server	Successful



Table 2  
Server testing result

No	Type of testing	Result
1	The server application is connected to the database	Successful
2	Logging in via the URL	Successful
3	Register via the URL	Successful
4	Retrieving password via the URL	Successful
5	Control lights via the URL	Successful
6	Changing the schedule of turning lights ON/OFF via URL	Successful
7	The server application is connected to the database	Successful

list view, 'forgot password' display, main page view, light control display, schedule change display, and password change display. We used the Marshmallow Android operating system as a client. The features of the client application include main display, account list view, 'forgot password' display, main page view, light control display, schedule change display, and password display.

In this paper, only the main splash screens are shown. In the initial view, there are fields for email and password, used as the user authentication process. There

are also three buttons, i.e. login, register and forgotten password (Figure 3). The main page view shows the buttons of light control, change schedule, change password and log out. This view will appear if the user logs in for the first time (Figure 4). In the light control display, there are several buttons including log out. Through the toggle button, the user can control the lights where there are indicators connected to the microcontroller server (Figure 5). On the change schedule display, there is a feature to automatically change the schedule of light ON/OFF (Figure 6).

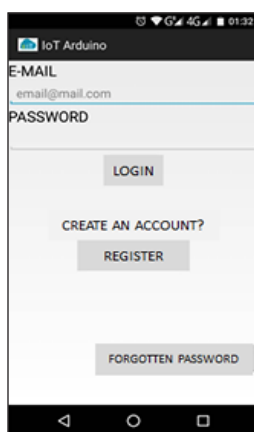

Figure 3. Initial view client applications

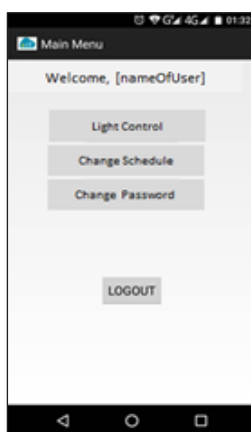

Figure 4. Main page display

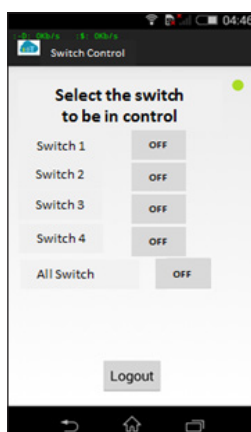

Figure 5. Controlling pageview

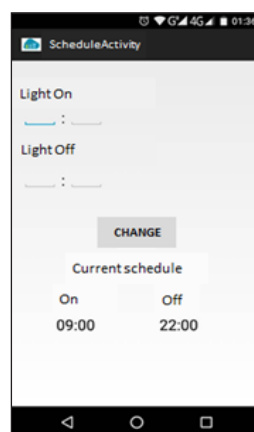

Figure 6. Schedule display

The client test result is shown in Table 3. A usability test was carried out to understand the user experience with the application. A series of Likert scale questionnaires were distributed to the users to find out whether applications meet their expectations. Based on the results (Table 4), it was found that user's eagerness to use the prototype has the highest average value of 4.67 (93.4%).

Table 3  
*Testing results on android client app*

No	Type of Testing	Result
1	The login process by entering email and user password	Successful
2	The main page appears automatically after the login process	Successful
3	New account registration process based on predefined ID and serial number, e-mail input, password, and username	Successful
4	The main page automatically appears after the successful account registration process	Successful
5	Retrieving password by entering ID and e-mail	Successful
6	The light control page appears automatically after tapping the light control button	Successful
7	Controlling the lights	Successful
8	The display page of the schedule appears after tapping the change schedule button	Successful
9	Applying schedule to turn the lights of microcontroller ON/OFF	Successful
10	Changing the schedule to turn ON/OFF the lights	Successful
11	Tapping the button to change the password on the main page and directed automatically to the change password display	Successful
12	Changing the user password and then redirected to the main page if a password change is successful	Successful
13	The login process by entering email and user password	Successful

Table 4  
*Usability test questions and result*

No	Questions	Results	
		Score	Average
1	I would like to use this system frequently.	14	4.67
2	The system is unnecessarily complex.	10	3.33
3	The system is easy to use.	11	3.67
4	I think that I would need the support of a technician to use the system.	11	3.67
5	The various functions in this system are well integrated.	11	3.67
6	There is consistency in this system.	10	3.33
7	I think most people would learn to use this system very quickly.	11	3.67
8	The system is practical to use.	14	4.67
9	I am confident in using the system.	11	3.67
10	I need to learn a lot of things before I could get through with this system.	8	2.67

The prototype does not only need easy to reach and low-cost resources (as shown in Table 5), but it is also easy to assemble. So, the small and medium enterprises in

the tourism industry can use it not only for lighting but also for other energy-saving appliances.

Table 5  
*Hardware and software requirements*

Part	Hardware	Software
Device	ATmega328P-PU, shift register, relay, push-button, female header, crystal 16MHz, ESP8266-01, converter USB to TTL serial module and power supply	C programming language Arduino IDE
Server	Processor (Intel(R) Core (TM)2 Duo CPU @1.40GHz), RAM (Sodim DDR2 667 4GB), VGA (Mobile Intel(R) 965 Express Chipset Family), Hard disk (500 GB)	Windows 7 operating system, XAMPP (Database)
Client	Smartphone with the Android operating system, microcontroller module based on Atmega328P-PU	Android minimal ICS

## CONCLUSIONS

This paper proposes a low-cost IoT architecture for energy-saving application in tourism SMEs. The application of a light controlling prototype based on the Internet of Thing (IoT) in a hotel in Garut, West Java Indonesia was considered successful. This illustrates that the application of IoT-based technologies in the tourism sector is wide open not only for light control but also for other energy-saving applications, such as water, air conditioning and anything else requiring energy efficiency. The prototype can be used as an alternative solution in reducing operational costs. The benefits of employing technology and internet in conventional business models beyond the use of mere websites are diverse (Kaur & Kaur, 2016). Although the use of the internet over smartphones in Indonesia is currently quite high, the application in the tourism industry is still relatively low, especially in the energy-saving application. One

problem often encountered is the stability of the internet connection. Not all areas in Indonesia have a good and stable internet connection. This can lead to user reluctance in implementing Internet-based applications such as IoT.

## Future Work

The design of Android-based applications is currently very wide open, so with one application in the smartphone, the tourism industry can operate various electronic devices with high electricity consumption. The future work on IoT-based technology should focus on improving the applications for multiple users with a single device to enable some energy-saving features.

## ACKNOWLEDGEMENT

We wish to thank Politeknik TEDC Bandung for supporting us in the preparation for the presentation of this paper. We also thank the Research and Technology Transfer Office

(RTTO) of Bina Nusantara University for providing great assistances so this paper could be presented at 5th International Conference on Management, Hospitality & Tourism, and Accounting (5th IMHA 2018).

## REFERENCES

- Abhijith, H. V., Jain, D. A., & Rao, A. A. (2017, September 13-16). Intelligent Agriculture mechanism using Internet of Things. In *Proceedings from ICACCI: International Conference on Advances in Computing, Communications and Informatics* (pp. 2185-2188). Udipi, India.
- Ashton, K. (2017). *Making sense of IoT how the internet of things became humanity's nervous system*. Retrieved May 3, 2018 from [http://chieffit.me/wp-content/uploads/2017/03/HPE-Aruba\\_IoT\\_Research\\_Report.pdf](http://chieffit.me/wp-content/uploads/2017/03/HPE-Aruba_IoT_Research_Report.pdf).
- Atmel. (2016). *Atmel 42735 8 bit AVR microcontroller ATmega328 328P summary*. Retrieved May 10, 2018, from [http://www.atmel.com/Images/Atmel-42735-8-bit-AVR-Microcontroller-ATmega328-328P\\_Summary.pdf](http://www.atmel.com/Images/Atmel-42735-8-bit-AVR-Microcontroller-ATmega328-328P_Summary.pdf)
- Buhalis, D., & Amaranggana, A. (2013). Smart tourism destinations. In Z. Xiang, & I. Tussyadiah (Eds.), *Information and communication technologies in tourism 2014* (pp. 553-564). Cham, Switzerland: Springer.
- De Pinto, J. (2018). *7 trends for IoT in hospitality*. Retrieved May 5, 2018, from [https://d1io3yog0oux5.cloudfront.net/\\_910b5f4e2cc0dc366b9f4da01a85f8c0/telkonet/db/274/931/pdf/7-Trends-in-IoT-for-Hospitality.pdf](https://d1io3yog0oux5.cloudfront.net/_910b5f4e2cc0dc366b9f4da01a85f8c0/telkonet/db/274/931/pdf/7-Trends-in-IoT-for-Hospitality.pdf)
- Deshpande, P., & Iyer, B. (2017). Research directions in the internet of every things (IoET). In *2017 International Conference on Computing, Communication and Automation* (pp. 1353-1357). Greater Noida, Indi.
- Djuandi, F. (2011). *Pengenalan arduino* (Edisi kedua) [Introduction of Arduino]. Bandung, Indonesia: Erlangga.
- Dubey, A., Lakhani, M., Dave, S., & Patoliya, J. (2017). Internet of things based adaptive traffic management system as a part of intelligent transportation system (ITS). In *2017 International Conference on Soft Computing and its Engineering Applications* (pp. 1-6). Changa, India.
- Eswaraprasad, R., & Raja, L. (2017). Improved intelligent transport system for reliable traffic control management by adapting internet of things. In *2017 International Conference on Infocom Technologies and Unmanned Systems (Trends and Future Directions)* (pp. 597-601). Dubai, United Arab Emirates.
- Guarda, T., Leon, M., Augusto, M., Haz, L., Cruz, M., Orozco, W., & Alvarez, J. (2017). Internet of things challenges. In *2017 12th Iberian Conference on Information Systems and Technologies* (pp. 1-4). Lisbon, Portugal.
- Hertzog, P. (2017). Cost-effective solar water heater monitoring system using the internet of things. In *2017 4th International Conference on Engineering Technologies and Applied Sciences*. Salmabad, Bahrain.
- Hidayatullah, N., & Sudirman, D. (2017). Desain dan aplikasi internet of thing (IoT) untuk smart grid power system [Internet of things (IoT) design and application for smart grid power systems]. *Jurnal Ilmiah Pendidikan Teknik Elektro*, 2(1), 35-44.
- John, A., Rajput, A., & Babu, K. V. (2017). Energy-saving cluster head selection in wireless sensor networks for internet of things applications. In *2017 International Conference on Communication and Signal Processing*. Chennai, India.
- Kaur, K., & Kaur, R. (2016). Internet of things to promote tourism: An insight into smart tourism.

- International Journal of Recent Trends in Engineering and Research (IJRTER)*, 2(4), 357-361.
- King, J., & Perry, C. (2017). *Smart buildings: Using smart technology to save energy in existing buildings*. Washington, USA: American Council for an Energy-Efficient Economy.
- Micioni, C. (2018). *Digital scholarship*. Retrieved May 10, 2018 from <http://digitalscholarship.unlv.edu/thesisdissertations/642/>
- Napitupulu, T., Rampengan, D., & Gaol, D. F. (2016). IS/IT strategy does matter: An empirical evidence from hospitality industry. In 2016 11th *International Conference on Knowledge, Information and Creativity Support Systems* (pp. 1-5). Yogyakarta, Indonesia.
- Nitti, M., Pilloni, V., Giusto, D., & Popescu, V. (2017). IoT architecture for a sustainable tourism application in a smart city environment. *Mobile Information Systems*, 2017, 1-9.
- Pandithurai, O., Aishwarya, S., Aparna, B., & Kavitha, K. (2017, March 23-24). Agro-tech: A digital model for monitoring soil and crops using internet of things (IoT). In 2017 *Third International Conference on Science Technology Engineering and Management*. Chennai, India.
- Parkash, & Dandu, P. V. (2016). Internet of things based intelligent street lighting system for smart city. *International Journal of Innovative Research in Science, Engineering and Technology*, 5(5), 7684-7691.
- Parpairi, K. (2017). Sustainability and energy use in small scale Greek hotels: Energy saving strategies and environmental policies. *Procedia Environmental Sciences*, 38, 169-177.
- Pennisi, L. (2010). *Greening the hospitality industry*. Retrieved April 20, 2018, from [extensionpublications.unl.edu/assets/pdf/g2026.pdf](http://extensionpublications.unl.edu/assets/pdf/g2026.pdf)
- Perles, A., Perez-Marin, E., Mercado, R., Segrelles, J., Blanquer, I., Zarzo, M., & Garcia-Diego, F. (2018). An energy-efficient internet of things (IoT) architecture for preventive conservation of cultural heritage. *Future Generation Computer Systems*, 81, 566-581.
- Sharma, R. (2016, August 12-14). Internet of things: An approach for advancement in educational institution. In 2016 *1st India International Conference on Information Processing* (pp. 1-4). Delhi, India.
- Siebenhandl, K., Schreder, G., Smuc, M., Mayr, E., & Nagl, M. (2013). A user-centered design approach to self-service ticket vending machines. *IEEE Transactions on Professional Communication*, 56(2), 138-159.
- Sinararduino. (2016, December 31). *Modul wifi ESP8266*. Retrieved April 28, 2019, from <http://www.sinuarduino.com/artikel/esp8266/>
- Statista. (2018, April 12). *Number of mobile phone internet users in Indonesia from 2015 to 2022 (in millions)*. Retrieved May 12, 2018, from <https://www.statista.com/statistics/558642/number-of-mobile-internet-user-in-indonesia/>
- Tseng, S., Li, Y., & Wang, M. (2016, December 18-20). An Application of Internet of Things on Sustainable Aquaculture System. In 2016 *International Conference on Orange Technologies* (pp. 17-19). Melbourne, VIC, Australia.
- Uddin, M. A., Mansour, A., Jeune, D. J., & Aggoune, H. M. (2017). Agriculture internet of things: AG-IOT. In 2017 *27th International Telecommunication Networks and Applications Conference* (pp. 1-6). Melbourne, VIC, Australia.
- Windarto, Y. E., & Eridani, D. (2017). Door and light control prototype using intel galileo based internet of things. In 2017 *4th International Conference on Information Technology, Computer, and Electrical Engineering (ICITACEE)* (pp. 176-180). Semarang, Indonesia.

- Yang, G., Hongbo, L., & Chai, L. (2014). The embedding convergence of smart cities and tourism internet of things in China: And advance perspective. *Advances in Hospitality and Tourism Research*, 2(1), 54-69.
- Zhang, G., Ma, S., & Tian, C. (2017). Public building energy-saving analysis method and its application based on electrical equipment internet of things. In *2017 12th Conference on Industrial Electronics and Applications* (pp. 444-448). Siem Reap, Cambodia..

## **Consumer Perceived Value, Attitude, Trust and Purchase Intention of *Kuku Bima Ener-G* Product**

**Selly Novela\*, Didiet Gharnaditya, Novita and Patricia Marie Wibisono**

*Department of Management, BINUS Business School Undergraduate Program, Bina Nusantara University, Jl. Jalur Sutera Barat Kav.21 Alam Sutera-Tangerang 15143, Indonesia*

### **ABSTRACT**

Consumers are the target of all marketing activities; thus, it is important for marketers to understand consumer behaviours and perceptions. These considerations relate to a consumer's desire to purchase a product. The purpose of this study is to know the perception from the consumer profile, in this case, the socioeconomic characteristics of respondents toward a popular energy drink brand from Sido Muncul, i.e., Kuku Bima Ener-G, and to identify the impact of all variables, i.e., perceived value, attitude, and trust, toward purchase intention of that product as well. The research methods used are descriptive analysis and multiple regression. Using the nonprobability sampling technique to gather 181 respondents, the results obtained the three dominant factors from each variable and a description of the dominant characteristics from respondents; thus, we found a significant influence among all independent variables on purchasing decisions of energy drinks products.

*Keywords:* Consumer behaviour, consumer profile, energy drink, purchase intention

### **INTRODUCTION**

Consumers in developing and developed countries rely on medicinal plant products to maintain health and/or treat diseases (Smith-Hall et al. as cited in Jokar et al., 2017). There are two groups, namely, the herbal-based health food industry (herbal supplement industry) and the herbal medicine industry (herbal medicine industry). Indonesia is among the countries that have utilized traditional medicine in medicinal methods since antiquity – especially because Indonesia geographically

#### **ARTICLE INFO**

*Article history:*

Received: 09 October 2019

Accepted: 03 January 2020

Published: 17 March 2020

*E-mail addresses:*

enovela@binus.edu (Selly Novela)

didiet.g@gmail.com (Didiet Gharnaditya)

novita.ib@binus.edu (Novita)

patriciamarie1906@gmail.com (Patricia Marie Wibisono)

\* Corresponding author



is on the equator; as such, it is a tropical country with the potential to grow hereditary crops.

With such potential, Indonesia has prospects for the development of herbs for the benefit of health, industrial, and tourism products, targeting both domestic and international markets. The herbal medicine industry has entered into 10 prospective products that need to be developed because they have promising potential in local and global markets (Warta Ekspor, 2014). Several factors in the natural medicine industry and herbal medicine must be supported in order to further strengthen their existence. Further, if diversity continues to be developed, it will strengthen the herbal industry structure (Badan Pengkajian Penerapan Teknologi (BPPT, 2017).

According to IMS Health data, the Indonesian pharmaceutical industry market grew 7.49% until the fourth quarter of 2016, which is higher than in the same period last year of 4.92%. IPMG estimates this growth will continue in 2017 (Dahwilani, 2017). Based on data collected by PT UBM, the Indonesian drug trade grew an average of 20.6% per year. Currently, there are about 239 pharmaceutical companies operating in Indonesia. Most of the pharmaceutical industry in West Java is 39%, East Java 20%, and DKI Jakarta 15% (Good Manufacturing Practice, 2017).

Based on the data, soft drink industry growth has continued to decline since 2010, with only about 4% to 5% compared the previous years, except for energy drinks that still grew above 10% in the first quarter of 2017 (Deny, 2017).

Kuku Bima Ener - G, one of the herbal products produced by a famous jamoo and pharmaceutical company in Indonesia, is a powdered herbal energy drink with varied tastes that proclaims benefits such as enhancing stamina for men and women (Sidomuncul, n.d.). Based on the Corporate Image Award 2017, Kuku Bima Ener - G ranks second among several leading brands of energy drink products (Corporate Image Award, 2017).

Among young people in Saudi Arabia, there is a trend of widespread use of energy drinks, which also indicates a high level of social acceptance of energy drink consumption in the region (Alam, 2017). Meanwhile, the research conducted by Chang et al. (2017) obtained that, among 606 surveyed undergraduate students, 24.8% reported consuming energy drinks in the past 30 days, with 31.3% of them stating that they enjoyed the flavour. This indicates that energy drinks are still a choice for consumption, in Indonesia and in other countries as well.

The fact that energy drinks are still in high demand in Indonesia is not in line with the financial performance of the Kuku Bima Ener-G product. Based on observations, revenue decreased in the last three years. One reason indicated as causing a decrease in revenue is people's health concerns about the ingredients in the energy drink.

According to Rezai et al. (2013), herbal product characteristics and their perceived benefits are among the factors that influence Malaysians to buy herbal products via online shopping. The specific herbal product characteristics, including



quality of ingredients, safety, and freshness of packaging, typically affect the attitude of respondents. This could become a concern for herbal product producers - including the makers of healthy or energy drink products - to pay attention to product ingredients.

People generally understand that good health must be maintained. The main reason someone uses an energy drink is to help him or her remain fresh and active. However, energy drinks may cause adverse effects directly on the body due to the ingredients if consumed too often (Etika, 2017). Many countries outside of Indonesia prohibit the sale of energy drinks as a result of more than 20,000 emergency room visits in the United States attributable to the ingestion of energy drinks, per a 2011 government report that expressed real concern about the emerging problem posed by energy drinks and energy shots (Campbell, 2017). Of course, there are pros and cons arising in regard to the consumption of energy drinks, and consumer behaviour is decisive, i.e., consumers are interested in consuming products that are safe for the community.

Consumers are the target of all marketing mix activities, so it is important for marketers and businesses to understand why and how consumers behave (Ko & Megehee, 2012). Besides that, Kittikowit et al. (2018) pointed out that the purchase intention from the consumer can be influenced by the brand, product quality, social influence and the price itself. However, they continued that purchase intention might not always end up with actual purchasing activity since there was a possibility of encountering blocking

factors like high price and the consideration that such a product was not necessary. Therefore, investigating factors affecting consumer buying behaviour and evaluating the impact of these factors on behavioural intentions leads to a true understanding and recognition of consumer behaviour itself, which will enable marketers to supply and introduce products that are more in line with the consumer's needs and demands open or implied. In other words, companies or industry players can provide products or services that are the result of factors that influence consumer behaviour and maximize consumer buying intentions (Bian & Forsythe, 2012; Ko et al. as cited in Salehzadeh & Pool 2016).

Many factors influence consumers in determining buying interest based on consumer behaviour. Perceived value is defined as the result of a comparison between perceived benefits and customer sacrifice (Zeithaml, 1988; McDougall & Levesque, 2000). When perceived value increases, it is likely that customers will remain loyal and have increasing expectations, while a decrease in perceived value will make it easier for customers to accept the marketing of other competitors (Grönroos as cited in Khan & Kadir, 2011). According to Mahesh (2013), consumers with high education and high income tend to buy products with high perceived value.

Other factors that influence consumer behaviour include attitude. Attitude plays a central role in consumer studies because it affects thoughts, feelings, and, most importantly, the consumer decision-making

process (Bagozzi & Warshaw as cited in Das, 2014). According to Alwitt and Pitts as cited in Rana and Paul (2017), a positive attitude toward the environment has no effect on a consumer’s purchasing intentions; many consumers not only trust fair trade practices but also want to buy ethically by the manufacturer.

Trust is another factor that affects consumer behaviour as well. According to McKnight et al. as cited in Stevina et al. (2015), trust is established between those who have not known each other well in interactions and the process of the transaction. In previous research, the role of trust influences consumers in determining their buying interest (Giampietri et al., 2017)

Because there is a concern about consumer perceptions of energy drink products, research is needed to determine the consumer behaviour of the Kuku Bima Ener-G product. Henceforth, further analysis could be done to discern the cause of problems faced by a company from those behaviours. The scope of consumer

behaviour in this research comprises variables of perceived value, attitudes, and trust as a measure of consumer measurement in the intention to buy a product.

**Literature Review**

**Consumer Behaviour.** According to Howard and Sheth (1969), consumer behaviour is described in a model, as seen in Figure 1, that explains how the purchasing decision-making process can occur from the beginning of stimulus, perception, learning process to decision-making and even repeat purchases (Handayani, 2013).

**Perceived Value.** Zeithaml as cited in Ariyanti and Iriani (2014) explained that perceived consumer value was the overall assessment of the consumer against the usefulness of a product of what was received and provided by the product. Schiffman and Kanuk (2008) posited that perceptions of measured value were based on monetary and nonmonetary costs combined with perceptions of quality.

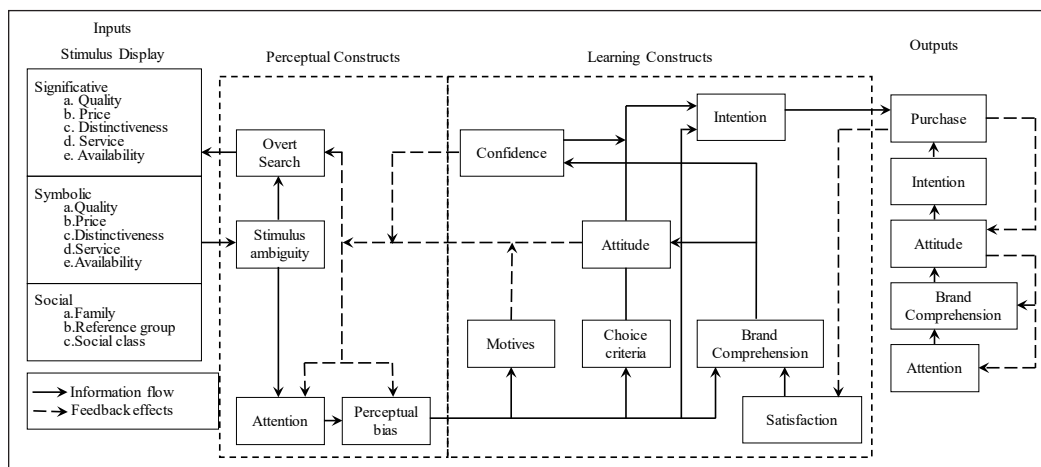

Figure 1. Howard-Sheth Consumer Behavior Model (Howard & Sheth, 1969)

**Attitude.** Consumer attitude is considered an evaluation of the extent to which a person likes or dislikes a certain object (Finlay et al. as cited in Das, 2014). Attitude can be defined as a person's positive or negative evaluation of a particular behavioural performance (Ajzen & Fishbein as cited in Yadav & Pathak, 2017). According to Kotler as cited in Aquarista and Widyawati (2016), attitudes are the tendency, emotional feelings, and evaluation of the favourable or not and enduring actions of a person against some objects or ideas.

According to Simamora as cited in Oentario et al., (2017), consumer attitude can be measured by the following indicators: 1) cognitive component. knowledge and perception of an attitude object. knowledge and perception can take the form of trust; 2) affective component. one's feelings and emotions toward a product or brand. Affective disclose consumer ratings of a product whether good or bad, favoured or disliked.

**Trust.** Mowen & Minor as cited in Stevina et al. (2015) suggested trust as all knowledge possessed by consumers and conclusions made about objects, attributes, and other benefits. McKnight et al. as cited in Stevina et al. (2015) presented two dimensions of consumer confidence: trusting belief and trusting intention. Trusting belief indicates the extent to which a person believes and believes in others in a situation. There are three elements that build trusting belief: benevolence (how much each individual can trust a company to behave

well to consumers where the willingness of the company to serve the interests of consumers is the ultimate goal); integrity (how much confidence each individual has on a company's honesty to fulfil the promise made to the consumer); competence (individual confidence in the ability of a company to meet the needs of consumers and the success of a company to produce what consumers want).

Trusting intention is based on one's cognitive beliefs to others. McKnight et al. as cited in Adji & Semuel (2014) stated that there were two elements that built trusting intention: willingness to depend (willingness to accept whatever the company provides in terms of acceptance of risk and possible negative consequences); and subjective probability of depends (subjective willingness of consumers in the form of providing personal information to the company, make transactions, and willing to follow the advice or request from the company).

**Purchase Intention.** Purchase intention is the determination of the buyer to perform an action such as buying a product and service. Intention itself is a combination of trust and consumer attitudes toward products and services (Mowen as cited in Ariyanti & Iriani, 2014). Suwandari as cited in Rizky and Yasin (2014) used AIDA as an indicator of buying interest of a prospective consumer, consisting of attention which is attention of potential consumers to products offered by producers; interest which is the interest of the prospective consumer on the product

offered by the producer; desire which is the desire of the prospective consumer to have the product offered by the manufacturer; action which is prospective customers make purchases of products offered.

**Framework of Thinking.** From the model in Figure 2, the objectives of this research are:

1. To analyze the perceived value, attitude, trust, and purchase

- intention of the Kuku Bima Ener-G product
2. To examine the consumers' characteristics of the Kuku Bima Ener-G product
3. To discern how perceived value, attitude, and trust influence consumer purchase intention of the Bima Ener-G product.

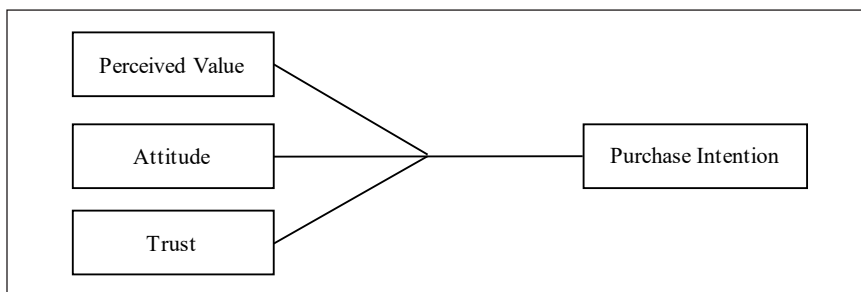

Figure 2. Research model

## MATERIALS AND METHODS

This research used the quantitative analysis method. According to Creswell (2016), the notion of quantitative methods is a method to test certain theories by examining relationships among variables. This research was conducted on consumers of the Kuku Bima Ener-G product. The type of research adopted in this study is descriptive and causal associative. According to Sugiyono (2012), descriptive research is a study conducted to determine the value of independent variables, either one or more variables without making a comparison or linking variables with each other. According to Malhotra and Birks (2012), associative research is the study of independent

variables (that affect) with the dependent variable (which is affected).

The data sources used were primary and secondary data. The primary data were collected by spreading the questionnaire containing the items of question distributed to the consumers of the Kuku Bima Ener-G product. The questionnaire contained a statement with an answer option using a Likert scale of 1 to 5, where 1 = strongly disagree and 5 = strongly agree. Secondary data were obtained from the annual report retrieved from the official company website and from the institution S & P Capital IQ. In addition, other supporting data were obtained from books and references such as journals, printed media, and the Internet.

Based on information from the average company, consumption of the Kuku Bima Ener-G product per month is in the range of 100,000,000 to 200,000,000 sachets. The focus of the research was domiciled in Jabodetabek area.

According to Maholtra as cited in Aquarista and Widyawati (2016), the number of samples must meet the minimum size for analysis, i.e., as many as 10 times the number of indicators. In this study, there were 18 indicators, so the minimum number of respondents required was 18 x 10, which is 180 respondents. The sampling technique used was nonprobability sampling.

**RESULTS AND DISCUSSIONS**

The results obtained from 181 respondents indicate that men make up the dominance of energy drink consumers. This is because men tend to do much more physical work than women, so restoring stamina is needed. Most of the respondents are domicile in Tangerang with the age range of 18-21 years. Respondents are mostly field workers, which is a job that requires good physicality; the respondents also include a security guard, construction worker, sales promotion

girl, sales promotion boy, office boy, and office girl. Because the work that dominates is the fieldworker, the high school level is the most common education, where the age in completing this level of education is 17 years. However, there are also primary and junior secondary-education levels recorded in the study, but those are not as dominating as the high school level.

As a consequence of the occupations, the expenditure of respondents is in the range of Rp 1,000,000 - Rp 2,000,000. Because the age trend is 18 - 21 years old, then unmarried status dominates this research. At that age, the individual is still in the spirit of working to raise money for his or her future. Respondents know that the Kuku Bima Ener-G product tends to be based on advertisements contained in the media rather than from friends or friends.

Based on the data-processing results in Table 1, it can be seen that the tendency of respondents' answers to the questionnaire of research lies in the answer "agree," where there is between 37% - 42%. It can be concluded that most of the respondents know and agree with the statements on this research.

Table 1  
*Distribution of per centage by respondents to perceived value, attitude, trust, purchase intention of Kuku Bima product*

Perceived value	Attitude	Trust	Purchase intention
SDA : 6%	SDA : 5%	SDA : 7%	SDA : 9%
DA: 10 %	DA: 9 %	DA: 13 %	DA: 9%
SA : 28%	SA : 23%	SA : 30%	SA : 24%
A : 41%	A : 42%	A : 37%	A : 39%
SA : 15%	SA : 15%	SA : 13%	SA : 19%

Notes: SDA = strongly disagree, A = agree, DA = disagree, SA = somewhat agree, SA = strongly agree

**Perceived Value of Kuku Bima Ener-G Product**

The data in Table 2 show the perceived value of respondents to the Kuku Bima Ener-G product from the positive feelings arising from the product, including its taste and quality. Overall, quality is the main reason

for consumers in choosing the Kuku Bima Ener-G product. With the quality provided by the company, consumers feel confident that, by consuming a product, it is good for the health as well as beneficial to the body. Consumers believe that Kuku Bima Ener-G is a good supplement for increasing stamina.

Table 2  
*Perceived value of Kuku Bima Ener-G products*

Statements	Level of Agreement (%)					F-Score
	STS	TS	AS	S	SS	
Positive feelings towards the product	5	12.7	35.4	36.5	10.5	140.8*
Accepted by the environment	19.3	17.7	37.6	20.4	5	134.4
Consumer impression	12.2	14.4	35.9	32	5.5	133.4
Price according to quality	3.3	2.8	14.9	58	21	57.53
The price matches the benefits	2.8	6.1	23.8	48.6	18.8	120
Flavors	1.7	7.2	18.2	44.8	28.2	153.6*
Product quality	2.2	5	26	46.4	20.4	155.7*
Product performance	5.5	14.4	31.5	37.6	11	68.39

**The Attitude of Kuku Bima Ener-G Product**

Table 3 shows the respondent’s attitude to the Kuku Bima Ener-G product; as seen from the impact of the product on the body, they liked the product and therefore selected

the product. Overall, it can be seen that liking the Kuku Bima Ener-G product is the main reason for consumers in assessing the product. Consumers judge and feel confident to consume Kuku Bima Ener-G after they like the product.

Table 3  
*Consumer attitude of Kuku Bima Ener-G Product*

Statements	Level of Agreement (%)					F-Score
	STS	TS	AS	S	SS	
Variant flavor of the product	1.1	0.6	11.6	44.2	42.5	22.73
Product benefits	3.9	9.4	22.1	48.1	16.6	75.37
The impact of the product on the body	4.4	11.6	21.5	45.3	17.1	198.2*
Loved Kuku Bima Ener-G product	6.6	10.5	28.2	36.5	18.2	270.6*
Choose Kuku Bima Ener-G product	7.2	13.8	29.3	37	12.7	182.2*

### Trust of Kuku Bima Ener-G Product

The data in Table 4 shows the trust of respondents to the product derived from how the company serves the needs of consumers which is keep promises and success of the product. Moreover, it can be seen that the company's capability to serve the consumer is the biggest factor that underlies the consumers' belief in the product. With the totality given by the company to meet its needs, the trust of the

product will strengthen, and consumers will keep consuming the product.

Based on the results of the descriptive research presented in Tables 2, 3, and 4, it can be summarized that each variable has a different assessment. Results of the research survey stated that, for the perceived value role, the consumer's positive feeling is that Kuku Bima Ener-G is able to meet the needs supported by the product's taste and quality. For the role of attitude, consumers like and

Table 4  
*Trust of Kuku Bima Ener-G product*

Statements	Level of Agreement (%)					F-Score
	STS	TS	AS	S	SS	
Serve consumers' need	9.4	12.7	35.9	33.1	8.8	302.8*
Honesty Product information	5	13.8	22.1	44.8	14.4	188.1
Keep the promise	6.1	8.8	34.3	36.5	14.4	280.6*
Successful of the Product	6.1	14.9	28.2	37	13.8	291.1*
Product content	8.3	13.3	30.9	35.9	11.6	167.3
Benefits to the body	8.3	17.1	33.7	28.7	12.2	186.9
Suggestion of usage	3.3	11	22.1	44.8	18.8	120.8

choose the Kuku Bima Ener-G product compared with other similar products supported by consumer knowledge about the benefits of the product itself. As for the role of trust, the Kuku Bima Ener-G product increases stamina to help a consumer remains in the spirit of continuing work.

The data summary supported by the results of research on the characteristics of respondents in Table 5 to the variables used in this study, which found that the status and knowledge of the social environment had a role in determining consumer perceptions of the Kuku Bima Ener-G products.

Table 5  
*Test Result of consumer characteristics'*

Socio-Economic Characteristic	Chi Value Score
<b>Perceived Value</b>	
Status	0.001
Knowledge of the social environment	0.001
<b>Attitude</b>	
Status	0.019
Knowledge of the social environment	0.007
<b>Trust</b>	
Status	0.002
Knowledge of the social environment	0.001
<b>Purchase Intention</b>	
Status	0.001
Knowledge of the social environment	0.003



There is an influence among perceived value, attitude, and trust to purchase intention on the Bima Ener-G product (Table 6). Because that coefficient determination is 0.798, it means 79.8% of impact factors come from perceived value, attitude, and trust, and the remaining 20.2% come from

other unknown factors. It is expected that the company should increase the perceived value, attitude, and trust of the consumer to purchase its products, by looking at the tendency of each variable that has been analyzed as in previous descriptions.

Table 6  
*The impact*

Variable	Impact	Equation	Notes
X - Y	79.80%	$Y = -0.108 + 0.139 X_1 + 0.310 X_2 + 0.586 X_3$	Significant

## CONCLUSIONS

Perceived value is the overall assessment of the product by the consumer, which, in this study, shows that the perceived positive feelings, product taste, and product quality of Kuku Bima Ener-G are the assessment given by consumers to the Bima Ener-G product. Consumer attitudes are consumer evaluations of a product or service, based on this research, as can be seen from the impact of the product on the body, whether consumers like the product and want to choose the product Kuku Bima Ener-G. Trust is where consumers want to accept and trust a product or service provided. From this research, serving the needs of consumers, keeping promises, and continued success of products will affect consumers in believing in a product on the market.

Based on socioeconomic characteristic analysis of every variable used in this research which is perceived value, attitude, trust, and purchase intention, it is found that characteristics of respondents having a relation with the research variables

above is status and knowledge to the social environment.

Perceived value, attitude, and trust have a significant influence on the purchase intention of the Kuku Bima Ener-G product, as much as 79.8%. Only 20.2% is influenced by other factors. This finding was consistent with that of the previous study that attitude toward herbal products is able to influence actual purchase significantly (Ismail & Mokhtar, 2016).

Consumers have more perceptions of the taste of the Kuku Bima Ener-G product. Therefore, the company should enhance the taste of this product by providing new flavour variants to cultivate a consumer's curiosity. Win flavour is a favourite, but other flavours can also be used as a sense of consumer favourite. It is best to evaluate and market research flavours of the current beverage variant so that the new taste approach will be more easily accepted.

In order to get closer to the community, the producer may conduct roadshow activities in various regions in Indonesia



that are useful to establish good relations with the community. This roadshow can be in the form of visits randomly and suddenly and can provide questions to conduct the interaction. In addition to the visit, as described above, it can also be done by holding a music event to entertain the community, thus having a venue to provide more knowledge about the product Kuku Bima Ener-G.

To provide comprehensive education to the public at large that consuming Kuku Bima Ener-G does not endanger health, the purpose is to reduce the tendency of people who pay attention to the impact of consumption of Kuku Bima Ener-G products. Education can be done in various ways, for instance following big events like the Idul Fitri homecoming event.

## ACKNOWLEDGEMENT

The authors wish to acknowledge and thank all IMHA 2018 committee members and UPM *Pertanika* journal team that help publish this article.

## REFERENCES

- Adji, J., & Samuel, H. (2014). Pengaruh satisfaction dan trust terhadap minat beli konsumen (Purchase Intention) di Starbucks The Square Surabaya [The influence of satisfaction and trust on consumers' Purchase Intention at Starbucks The Square Surabaya]. *Jurnal Manajemen Pemasaran*, 2(1), 1-10.
- Alam, M. Z. (2017). The buying patterns of energy drink and its use among the young generation of Saudi Arabia. *British Journal of Marketing Studies*, 5(3), 32-50.
- Aquarista, Y. T., & Widyawati, N. (2016). Pengaruh desain kemasan, persepsi harga terhadap minat dengan sikap sebagai variabel intervening [The effect of packaging design, price perception on interest with attitude as an intervening variable]. *Thesis*. Sekolah Tinggi Ilmu Ekonomi Indonesia (STIESIA), Surabaya.
- Ariyanti, K., & Iriani, S. S. (2014). Pengaruh persepsi nilai dan persepsi resiko terhadap niat beli kosmetik organik [The effect of perceived value and perceived risk on purchase intentions of organic cosmetics]. *Jurnal Ilmu Manajemen*, 2(4), 1186-1196.
- Badan Pengkajian Penerapan Teknologi (2017). *Jadikan obat herbal alami tuan rumah di negeri sendiri* sendiri [Make natural herbal medicines the host in their own country]. Retrieved September 15, 2017, from <https://www.bppt.go.id/teknologi-agroindustri-dan-bioteknologi/2850-bppt-jadikan-obat-herbal-alami-tuan-rumah-di-negeri-sendiri>
- Campbell, K. (2017). *Caffeine can kill: The dangers of energy drinks*. Retrieved September 16, 2017, from <https://health.usnews.com/health-care/for-better/articles/2017-05-24/caffeine-can-kill-the-dangers-of-energy-drinks>
- Chang, Y., Peng, C., & Lan, Y. (2017). Consumption of energy drinks among undergraduate students in Taiwan: Related factors and associations with substance use. *International Journal of Environmental Research and Public Health*, 14(9), 954-962.
- Corporate Image Award. (2017). *Archive for the 'Energy Drink' category*. Retrieved October 13, 2017, from <http://imacaward.com/category/survey-categories/energy-drink/>
- Creswell, J. (2014). *Research design pendekatan metode kualitatif, kuantitatif dan campuran* [Research design approaches qualitative, quantitative and mixed methods]. Yogyakarta, Indonesia: Pustaka Pelajar.

- Dahwilani, D. (2017). *Peluang dan tantangan industri farmasi di Indonesia 2017* [Opportunities and challenges of the pharmaceutical industry in Indonesia 2017]. Retrieved October 23, 2017, from <https://ekbis.sindonews.com/read/1190701/34/peluang-dan-tantangan-industri-farmasi-di-indonesia-2017-1490187954>
- Das, G. (2014). Factors affecting Indian shoppers' attitude and purchase intention: An empirical check. *Journal of Retailing and Consumer Service*, 21(4), 561-569.
- Deny, S. (2017). *Industri minuman ringan tumbuh negatif pada kuartal I* [The soft drink industry grew negatively in the first quarter]. Retrieved October 23, 2017, from <https://www.liputan6.com/bisnis/read/2944872/industri-minuman-ringan-tumbuh-negatif-pada-kuartal-i>
- Etika, N. M. (2017). *Ini yang terjadi pada tubuh anda setelah minum minuman energi* [This is what happens to your body after drinking an energy drink]. Retrieved October 24, 2017, from <https://hellosehat.com/hidup-sehat/nutrisi/setelah-minum-minuman-energi/>
- Giampietri, E., Verneau, F., Giudice, T. D., Carfora, V., & Finco, A. (2017). A Theory of planned behavior persepective for investigating the role of trust in consumer purchasing decision related to short food supply chains. *Food Quality and Preference*, 64, 160-166. doi: 10.1016/j.foodqual.2017.09.012.
- Good Manufacturing Practice. (2017). *Updates: Peluang investasi di sektor farmasi Indonesia* [Updates: Investment opportunities in Indonesia pharmaceutical sector]. Retrieved October 24, 2017, from <http://www.gmp-platform.com/files/user/industri%20farmasi%20indonesia.pdf>
- Handayani. (2013). Model Howard & Seth sebagai alternatif memahami perilaku konsumen dalam manajemen pemasaran [The Howard & Seth Model as an alternative to understanding consumer behaviour in marketing management]. *Dharma Ekonomi*, 20(37), 1-13.
- Howard, J. A., and Sheth, J. N. (1969). *The theory of buyer behaviour*. London, UK: John Wiley and Sons.
- Ismail, S., & Mokhtar, S.S.M. (2016). *The actual purchase of herbal products in Malaysia: the moderating effect of perceived benefit*. Paper presented at *International Soft Science Conference. The European Proceedings of Social & Behavioural Sciences* (pp. 83-88). London, UK: Future Academy.
- Jokar, N. K., Noorhosseini, S. A., Allahyari, M. S., & Damalas, C. (2017). Consumers' acceptance of medicinal herbs: An application of the technology acceptance model (TAM). *Journal of Ethnopharmacology*, 207(1), 203-210. doi: 10.1016/j.jep.2017.06.017
- Khan, N., & Kadir, S. L. S. A. (2011). The impact of perceived value dimension on satisfaction and behavior intention: Young-adult consumers in banking industry. *African Journal of Business Management*, 5(11), 4087-4099.
- Kittikowit, S., Suwanabubpa, K. and Sithisomwong, S. (2018). Factors influencing purchase intention of cosmetic products of female consumers in Yangon, Myanmar. *International Journal of Organizational Business Excellence*, 1(2), 77-90.
- Ko, E., & Megehee, C.M. (2012). Fashion marketing of luxury brands: Recent research issues and contributions. *Journal of Business Research*, 65(10), 1395-1398.
- Mahesh, N. (2013). Consumer's Perceived Value, Attitude and Purchase Intention of Green Products. *Management Insight*, 9(1), 36-43.
- Malhotra, N. K., & Birks, D.F. (2012). *Marketing research: An applied approach 3rd European edition*. Harlow, England: Prentice-Hall.

- McDougall, G.H.G., & Levesque, T. (2000). Customer satisfaction with services: putting perceived value into the equation. *Journal of Services Marketing*, 14(5), 392-410.
- Oentario, Y., Harianto, A., & Irawati, J. (2017). Pengaruh *usefulness*, *ease of use*, *risk* terhadap *intention to buy Online Patisserie* melalui *consumer attitude* berbasis media sosial di Surabaya. *Jurnal Manajemen Pemasaran*, 11(1), 26-31.
- Rana, J., & Paul, J. (2017). Consumer behavior and purchase intention for organic food: A review and research agenda. *Journal of Retailing and Consumer Services*, 38(2017), 157-165.
- Rezai, G., Zahran, M.Z.M., Mohamed Z., & Sharifuddin, J. (2013). Factors influencing Malaysian consumers' online purchase of herbal products. *Pertanika Journal of Social Science & Human*, 21(S), 109-122.
- Rizky, M. F., & Yasin, H. (2014). Pengaruh promosi dan harga terhadap minat beli perumahan Obama PT. Nailah Adi Kurnia Sei Mencirim Medan. *Jurnal Manajemen dan Bisnis*, 14(2), 135-143.
- Salehzadeh, R., & Pool, J. K. (2016). Brand attitude and perceived value and purchase intention toward Global Luxury Brands. *Journal of International Consumer Marketing*, 29(2), 74-82.
- Schiffman, L. G., & Kanuk, L.L. (2000). *Consumer behavior* (7<sup>th</sup> ed.). Upper Saddle River, NJ: Prentice-Hall.
- Sidomuncul. (n.d.). *Kuku Bima Ener-G product*. Retrieved September 20, 2017, from <https://www.sidomunculstore.com/search?type=product&q=kuku+bima+ener+g>
- Stevina, E., Karina, R., & Brahmana. (2015). Pengaruh brand identity terhadap purchase intention melalui trust di UD. Makin Hasil Jember [The influence of brand identity on purchase intention through trust on UD. Makin Hasil Jember]. *Jurnal Manajemen Pemasaran*, 3(1), 1-8.
- Sugiyono. (2014). *Metode penelitian kuantitatif, kualitatif dan R&D* [Quantitative, qualitative and R&D research methods]. Bandung, Indonesia: Alfabeta.
- Warta Ekspor. (2014). *Obat herbal tradisional* [Traditional herbal medicine]. Retrieved October 23, 2017, from [http://djpen.kemendag.go.id/app\\_frontend/webroot/admin/docs/publication/4651421058307.pdf](http://djpen.kemendag.go.id/app_frontend/webroot/admin/docs/publication/4651421058307.pdf)
- Yadav, R., & Pathak, G. (2017). Determinants of consumers' green purchase behavior in a developing nation: Applying and extending the theory of planned behavior. *Ecological Economic*, 134(C), 114-122.
- Zeithaml, V. A. (1988). Consumer perceptions of price, quality, and value: A means-end model and synthesis of evidence. *Journal of Marketing*, 52(3), 2-22.



## **Training Model for Improving Human Resource Performance and Quality in a Parking Insurance Company**

**Respati Wulandari<sup>1\*</sup>, Anita Maharani<sup>2</sup>, David Young<sup>1</sup> and Tania Winoto<sup>1</sup>**

<sup>1</sup>*International Business Management Program, Department of Management, BINUS Business School, Undergraduate Program, Bina Nusantara University, Jakarta 11480, Indonesia*

<sup>2</sup>*Business Management Program, Department of Management, BINUS Business School, Master Program, Bina Nusantara University, Jakarta 11480, Indonesia*

### **ABSTRACT**

This paper aims to develop a model of training for one parking insurance company. This company was chosen as our object since they struggled with the human resources they employed. Training concept is used as a primary theoretical framework. This research used qualitative methods, through focus group discussion to collect data, using qualitative data analysis to interpret information. Based on the results of this research, the parking insurance company should develop training by implementing the original concepts of the training development phase, where the company must go through four stages of training development, which are assessment, design, implementation, and evaluation to develop a training program.

*Keywords:* Development, human resources, model, training

### **INTRODUCTION**

Nowadays, it is said that the greatest and most valuable asset every company has is its human resources (Dalal & Pahuja,

2012). Companies strive to maximize their human resources through various ways, such as developing a talent acquisition program to screen qualified prospective employees, offering attractive incentives or benefits, developing a conducive work culture, and providing employees with training and development programs, because talented human resources with abilities, knowledge, and skills can be a major source of competitive advantage in the global market (McKinsey, as cited in Elnaga & Imran, 2013). This increment in

#### **ARTICLE INFO**

*Article history:*

Received: 09 October 2019

Accepted: 03 January 2020

Published: 17 March 2020

*E-mail addresses:*

respati.wulandari@binus.edu (Respati Wulandari)

anita.maharani@binus.edu (Anita Maharani)

david96young@gmail.com (David Young)

taniawinoto@gmail.com (Tania Winoto)

\* Corresponding author

the business competition encourages every company to maximize all of its resources to survive in competing with competitors. Of the various resources owned by a company, one of the most important resources for a company is its human resources (Mulang, 2015). At the global level, the importance of human resources can be seen in the rankings of companies with the best human resource performance, as issued by Workforce magazine (2017), where large companies have excellent human resource performance and quality. This is proof of the importance of human resources for the growth of the company. One of the many industries in Indonesia that are currently striving to develop their human resources is the insurance industry. Insurance companies are intensively developing strategies to improve the quality of human resources while raising awareness and providing insight to employees that they are an important part of the company's business. A concrete example of the effort to improve the quality of human resources in the insurance industry is an appeal from the Association of Indonesian Life Insurance to all insurance companies to set aside five per cent of their budget to develop their human resources, especially for underwriting, actuarial, and reinsurance (Pernando, 2016). One insurance company in Indonesia, Reliance Life, realizes that the existence and survival of the company cannot be separated from the role of human resources. Reliance Life has conducted several regular training programs in order to improve employee competence, such as the standardization of the professional

life insurance sector test, in-house training, discussion forums, and knowledge sharing so that employees can have a better understanding and be able to apply their knowledge optimally (Reliance-life, 2013). In addition, one insurance company, Prudential Indonesia, also states that it always has a commitment to continuously improve the quality of its human resources, including marketing personnel by providing training programs and seminars to expand their knowledge and insight for their careers as a salesforce. These insurance companies emphasize the development of their human resources through the implementation of training programs for their employees.

Training plays an important role in business because it meets the needs of human resources to provide better performance in doing their work. Training becomes one of the human resource development methods that can develop things such as knowledge, values, attitudes, and behaviour, as well as the special ability to carry out their duties (Kulkarni, 2013). A lack of training for employees will reduce the commitment and competence of the employees, causing the company to be unable to exploit the maximum potential of the employees. A lack of training can also lead to communication problems, where employees do not know the direction of the company, causing the employees to only do their work based on their own perceptions rather than on what the company wants and needs (Atieno & Orwa, 2015). Effective training programs can result in better commitment and reduced employee turnover. The higher the employee

commitment, the greater the bonds that employees have with the company, thereby increasing the performance and productivity of employees in doing their work (Anitha & Kumar, 2016). For this research, the company that was observed is a company operating in the field of parking insurance service and supported by several companies in running the business. The headquarters is located in Jakarta, established in 1991. This company is the only one out of many parking insurance companies that still exist until now. The other competitors collapsed due to fierce competition. It has two office branches in Medan and Semarang and has representatives in 18 cities in Indonesia, namely Jakarta, Tangerang, Depok, Bogor, Bandung, Cianjur, Tasikmalaya, Majalengka, Semarang, Jogjakarta, Salatiga, Solo, Surabaya, Malang, Medan, Batam, Makassar, and Manado.

Based on a preliminary study, the company does not have a specific system in managing human resource training. The training program given is limited; for example, training is only given through several meetings or discussions and through the Internet (chat/email), so the output of the training is not maximal enough. There is an urgency for this company to start thinking about how to manage its human resources, especially its marketing agents so that when this company keeps growing, the company will not encounter any problems for the agents due to a lack of training. Due to the lack of training programs in the parking insurance company and limited empirical evidence in previous research, it was necessary to conduct this research.

Here, more emphasis is placed on the organizational support for the training and development of the insurance agents. Based on the background description above, there are several objectives that will be achieved in this research. These include: 1) finding out the current condition of the training program in the parking insurance company to help in developing a training program for the parking insurance company; 2) discovering the competencies and skills that are required and needed to be developed by marketing agents of the parking insurance company to help in determining what kind of training program could fulfil the necessary skills; 3) proposing a training program model for the parking insurance company; and 4) ascertaining the possibility of implementing a training program to produce a competitive advantage for the parking insurance company.

### **Literature Review**

Training is the basic skill in the teaching process that employees need to do their work, both for new employees and senior employees (Dessler, 2015). Training is a systematic development of the knowledge, skills, and behaviour required of a person to do a given job well (Armstrong, 2010; Kulkarni, 2013). Meanwhile, training is a term used by the business for the members of the organization to acquire the skills, knowledge, and behaviour relevant to the organization (Latham & Dello Russo, 2008; Mulang, 2015). Training is also a short-term educational process that uses a systematic procedure in which



non-managerial personnel learn technical knowledge and skills for a definite purpose (Mulang, 2015).

There are four steps of training program development (Kulkarni, 2013), as follows: 1) assessment, 2) design, 3) implementation, and 4) evaluation. Evaluation is a part of the training that is often forgotten, but in fact, an evaluation can determine the effectivity of the training process (Mulang, 2015). An evaluation can be done using two methods: 1) a pre-training evaluation, to know the knowledge, capabilities, and attitudes of the training participants before they participate in training, compared to the knowledge, capabilities, and attitudes prepared in the training; and 2) a post-training evaluation which is done after the training to compare the knowledge, capabilities, and attitudes of the training participants before they participate in training compared to the knowledge, capabilities, and attitudes of the training participants after they participate in training.

A manager can measure the results and effects of training based on four basic categories (Dessler, 2015), as follows: 1) reaction, to evaluate training participants' reactions to the training program, such as whether the trainees like the training program or not; 2) learning, to test the training participants to determine whether the trainees have learned about the principals, skills, and facts that should have been mastered; 3) attitude, to ask whether the trainees' working attitudes have changed because of the training program; and 4) result, which is meant to see what kinds of

results the trainees have achieved related to the learning objectives which have been determined in the beginning, and to see if there are any changes in the employees' performance.

The reasons why training is so important, according to Rue et al. (2016), are 1) economic, social, technological, and political changes can make a mastered skill obsolete and useless in the future; 2) planned organizational changes (such as the use of new equipment) require employees to upgrade or acquire new skills; 3) performance problems in organizations such as low productivity can be overcome by training; and 4) regulatory, contractual, professional, or certification issues may require the organization to provide training programs.

The training methods that can be applied are 1) on-the-job training (OJT), 2) apprenticeship training, 3) job instruction training, 4) lectures, 5) programmed learning, 6) behaviour modelling, 7) an electronic performance support system (EPPS), 8) computer-based training (CBT), 9) lifelong and literacy training techniques, 10) learning portals, 11) a learning management system (LMS), 12) a virtual classroom, and 13) mobile learning (Dessler, 2015).

A resource-based view, according to Armstrong (2010), is a view about the resources within an organization, including human resources, that have unique characteristics and create a competitive advantage for the company. To determine whether a resource is capable of creating a competitive advantage for the company, a

resource-based view is applied with a VRIO analysis (Armstrong, 2010). Specifically, Barney and Hesterly as cited in Kozlenkova et al. (2013), mentioned that competitive advantage could only be achieved when a resource was a valuable, rare, inimitable resource, and had organizational support from the company. A VRIO analysis consists of various aspects (Armstrong, 2010). It is valuable as it explains how big the role and value of a resource owned by the company is in facing external threats and answering the opportunities that exist. The value of a resource is determined from its economic value, where the resource is capable to generate above-average revenue for the company. A resource is categorized as valuable if the resource allows the company to decrease its total costs or increase its revenue significantly (Barney & Arikani, 2001; Kozlenkova et al., 2013). It is rare as it explains how much a resource is being controlled by a small group of companies (Barney & Hesterly, 2012; Kozlenkova et al., 2013). A generic human resource is not capable to generate a competitive advantage, because it will be easily copied by another company. Meanwhile, a unique and rare resource is capable to generate a temporary competitive advantage and become the strength of the company because there are not many other companies that have the resource. It is inimitable as it explains whether a company that does not have a valuable and rare resource will be in a cost disadvantage situation or not when the company tries to develop a valuable and

rare resource. An inimitable resource is an expensive resource to develop or acquire (Barney & Hesterly, 2012; Kozlenkova et al., 2013). An inimitable resource is heavily protected by a company so that competitors will not easily copy the resource or look for a substitute resource. It has organizational support as it explains whether the policies and procedures from a company are able to support the usage of the resource.

## MATERIALS AND METHODS

A qualitative research method was used in this research. Observations and in-depth interviews were used with the interviewees. The data collection method used was by conducting interviews and participant observations of a parking insurance company. The interviewees are HM, the *marketing agent* for the South Jakarta area; HL, the *marketing agent* for the Bogor area; AS, the *marketing agent* for the Yogyakarta area; TD, the *marketing agent* for the Salatiga and surrounding area; AD, the *marketing agent* for the Central Java area; T, the *marketing agent* for the Bandung area; and HW, operational director of the company.

The interviews were done by telephone and direct interviews. On average, the interviews lasted about 45 minutes and were recorded. A qualitative data analysis method was used (Sekaran & Bougie, 2013) as follows: 1) a data reduction phase, 2) a data presentation phase, and 3) a conclusion drawing phase.

## RESULTS AND DISCUSSIONS

### Assessment

#### **Current Conditions of the Training Program in the Parking Insurance Company.**

The company already has a training program for its marketing agents. The training is held the first time an agent joins the company, and the training location is held in the domicile city or the placement area of the marketing agent. Unfortunately, the training is only done once, when the marketing agent joins the company. After that, no more training programs are followed by the marketing agent. When there is a particular problem, there is no training to deal with the problem, but there is a kind of discussion forum between fellow agents, where agents who are working in one area gather together regularly every 2 weeks or once a month to share their experiences and suggestions as well the problems they face in the field. If there is a distance barrier, then the discussion forum is done through online media, namely WhatsApp.

The training materials provided consist of two main materials, namely material about product knowledge that contains the company's insurance product information and material about marketing skills. Meanwhile, the training methods used are varied. For training about product knowledge, the training method applied is by using a proposal and explanation from a senior party in a classroom/ seminar. For training about marketing ability, the training method used is in the form of role-play where the trainee will alternate in the role as a marketing agent and as a prospective

client. Another method is that the trainee will be directly deployed to the field to meet prospective clients accompanied by a senior agent as a mentor. The company's training program is not equipped with an evaluation form for the training, so the effectiveness of the training program cannot be known. The company does not know whether the training participants are able to apply the material given, and how they respond to the training program has not been evaluated.

#### **Competence and Skills Required by Parking Insurance Company Marketing Agents.**

There are two main skills that must be owned by the parking insurance company's marketing agents. The first skill is mastery of the company's insurance product or in other words, they must have good product knowledge. Meanwhile, the second ability that is considered important is their marketing skills, given that their main task is to find clients and offer the company's product.

### Design

#### **Proposed Training Program Development for the Company.**

There are several learning objectives that should be prioritized in the development of training programs. The first learning objective is about product and company knowledge, where the learning objectives that should be achieved are that the trainees must understand the roles, duties, and work in their positions. Then they must be able to explain the company profile, vision and mission of the company, and the insurance product

owned by the company. The second learning objective is related to marketing skills, where the learning objectives that should be achieved are that the trainees are able to persuade prospective clients to use the company's insurance product, or at least pay attention and consider to use the product. The participants also should be able to explain the importance of parking insurance and explain the differences between regular insurance products and parking insurance in simple language. The third learning objective is about communication skills and the ability to establish and maintain good relationships, where the learning objectives that should be achieved are the trainees should be able to communicate effectively and remain calm in various situations and with an assortment of clients.

Regarding the training media used, there are several options. Based on the results of company observations, there is enough sufficient equipment and media that can be used for training media such as a projector, meeting room, computer and Internet access, and teleconference equipment. Evaluations for the training programs still need to be developed. Currently, the company does not need a pre-training evaluation because the training is only done once the marketing agents join the company because not all agents have knowledge about parking insurance, which means the pre-training evaluation will be less useful. But if in the future the company conducts additional training from existing training, it would be beneficial if the company made a pre-training evaluation to assess the skills and

knowledge of the trainees before the training begins, so that it can be compared with the post-training evaluation to assess whether the training is effective or not. The company also needs to make post-training evaluations for existing training as well as for future follow-up training, since post-training evaluations can be used to assess trainees' skills and knowledge after the training so the company can determine whether the training is effective or not, or whether the participants have sufficiently understood the content and objectives of the training or not, or need a further action such as training repetition if the evaluation results have not met the company's standards.

### **Implementation**

The company then should implement a training program that has been developed for all marketing agents throughout Indonesia. According to Dessler (2015), in this stage, the training method to be used is selected. Based on the research, the company needs to set a standard for the marketing agent training programs in different cities. To achieve the standard, trainers need to deliver standard training content but also be allowed to add information or content according to the characteristics of each area. In addition, to overcome the problem of a time distance barrier, companies can implement online training for trainees. Computer-based training (CBT) can be utilized for training materials that can be delivered through online media, such as product knowledge material. Meanwhile, the virtual classroom can be used for

post-training evaluations. In addition, the currently applied training method such as lectures, on-the-job training, and modelling behaviour will be maintained because they have been effectively implemented. A sharing forum already exists in the company, but it could be better if it could be developed further. Currently, the sharing forum only occurs when there are marketing agents who have difficulty in doing their jobs and need to contact headquarters to find a solution, and the information from this sharing forum will be limited to both parties only, and it will only be discussed with other marketing agents during the annual meeting. This sharing forum method can be developed by disseminating the information faster. The number of marketing agents throughout Indonesia will be a challenge, so the presence of area leaders can be very useful because they represent the headquarter office for marketing agents in the areas, so the headquarter office is expected to hold more intense communication with area leaders, especially through a sharing forum so the solution of a problem in one area can be distributed to another area more quickly, which means communication will be more effective because it does not involve the headquarter office continuously. The information that has been received by an area leader can be delivered to marketing agents in other areas.

### **Evaluation**

An evaluation is conducted to determine whether the training programs that have been developed have been able to answer the

needs of companies and marketing agents to carry out their duties. If the evaluation results are good, then the company can be said to be able to develop training that can improve the performance of marketing agents, but if the evaluation results are still not good, then the company needs to re-evaluate the training from the four stages of training development to determine which factors can be developed to achieve the results desired by the company.

The company's human resources can be a source of competitive advantage for the company together with its product, as long as the human resources are qualified, have good skills, and demonstrate good performance. To see whether the implementation of training programs can trigger human resources to be a source of competitive advantage, the analysis was conducted using a VRIO analysis from a resource-based view theory. Based on the VRIO analysis, training can produce valuable human resources for a company, and training is also a form of organizational support from the company. According to the company management, implementing a training program can make the company's human resources become valuable and give a huge impact on the company and create revenue, because the human resources of the company, in this case, the marketing agents, are the spearhead in searching for new clients. But training alone is not sufficient to produce rare and inimitable human resources in accordance with the VRIO analysis, because a large number of good and qualified human resources is

needed. Furthermore, every company should have qualified human resources. To that end, every company needs to have its own training program that usually has the same goal, which is to create qualified human resources. To meet the requirements of the VRIO analysis, training alone is not enough, as it needs to be combined with other human resource practices such as stricter employee recruitment and selection, a comfortable working environment, and a good reward system.

Based on the observations that were done, a model was constructed to develop training programs in a parking insurance company to achieve a competitive advantage. Training is the systematic development of the knowledge, skills, and behaviour required of a person to do a given job well (Armstrong as cited in Kulkarni, 2013). This is in accordance with the conditions at the company, where the training materials provided by the company are about product knowledge and marketing skills. This matches with the duties and skills required by the employees of the company, where the main task of the marketing agents is to look for new clients and offer the company's insurance products. The capabilities that are considered necessary are an understanding of the products offered and marketing skills in terms of communicating and convincing potential clients to use the insurance products. The results reveal that the theory of training is in accordance with the conditions found in the company. Training is important for several reasons (Rue et al., 2015), and in this case, the training program of the

company itself is only done once when the first-time employees join the company. This is certainly not in accordance with the theory of the importance of training programs, where the company will face difficulties if there are certain changes that occur in the field. A marketing agent said that no training is done even if the marketing agency has a particular problem in the field. Through this information, it can be said that the theory of the importance of training is not realized by the company.

The final stage after implementing the training program is the evaluation stage (Dessler, 2015; Mulang, 2015). The company unfortunately, does not have a form of evaluation of the current training program, so the company cannot assess whether the training program that has been used has been effective in improving the quality and ability of marketing agents or not. The training method applied by the company itself is divided into three types. The first training method is through classroom theory, where the trainees read and listen to training materials from the trainers. The training materials that use this method are about product knowledge and also the theory about marketing skills. Meanwhile, the second training method used is in the form of a simulation or role model, where the trainees practice the material that has been studied in class theories in the form of a simulation where the training participants act as marketing agents offering their products to prospective clients. The third training method used is in the form of plunging directly into the field, where the



trainees are deployed in the field and directly meet with prospective clients accompanied by other agents who are more senior. These three training methods are consistent with the various training methods described by Dessler (2015), where the first method of training is called by Dessler as a lecture method, which is a simple and quick way to convey information to training participants in large groups. The second method of training mentioned by Dessler as a method of behaviour modelling is a training method in which trainees are given examples of how to do something right first and then given the opportunity to practice what they have seen in a simulation to be assessed and given feedback by the supervisor. The third method of training according to Dessler is the method of on-the-job training (OJT), which is a training method in which a person learns about a job by directly doing the job. Because the company uses OJT and a lecture method, it can be said that the company has a set apprenticeship training, which is training where a worker is trained with the method of lessons in the class and added with on-the-job training.

What has happened at the company, as the management mentioned, about supporting the human resources' work optimally and producing a competitive advantage, will not only rely on training alone, but other things such as strict recruitment, a comfortable working environment, and a good salary to motivate employees. It can be said that the research results from Dalal

and Pahuja (2012) also occurred in the company. This study found that there were some deficiencies that needed to be improved. The company could utilize a performance appraisal so that the company would know about the performance of each employee and see whether a training program was needed, or something else such as a decline in performance or any other particular problem. In addition, the company could also improve the current training program by doing various improvements. First, it could increase the frequency of the training conducted. To increase the frequency of the training, the company could perform any training needs analysis required by employees. Second, it could implement an evaluation of the training program that had been running. Through evaluation, the company could see the effectiveness of the current training program and whether the trainees were able to apply the material given in the training. Third, it could support training materials and methods. It could clearly determine the learning objectives of each training material, and it could also be through e-learning, where the company might apply a digital platform.

Therefore, a training model was developed. Based on the phase of the training development theory, the company must go through four stages of training development, which are assessment, design, implementation, and evaluation to develop a training program as follows in Figure 1.



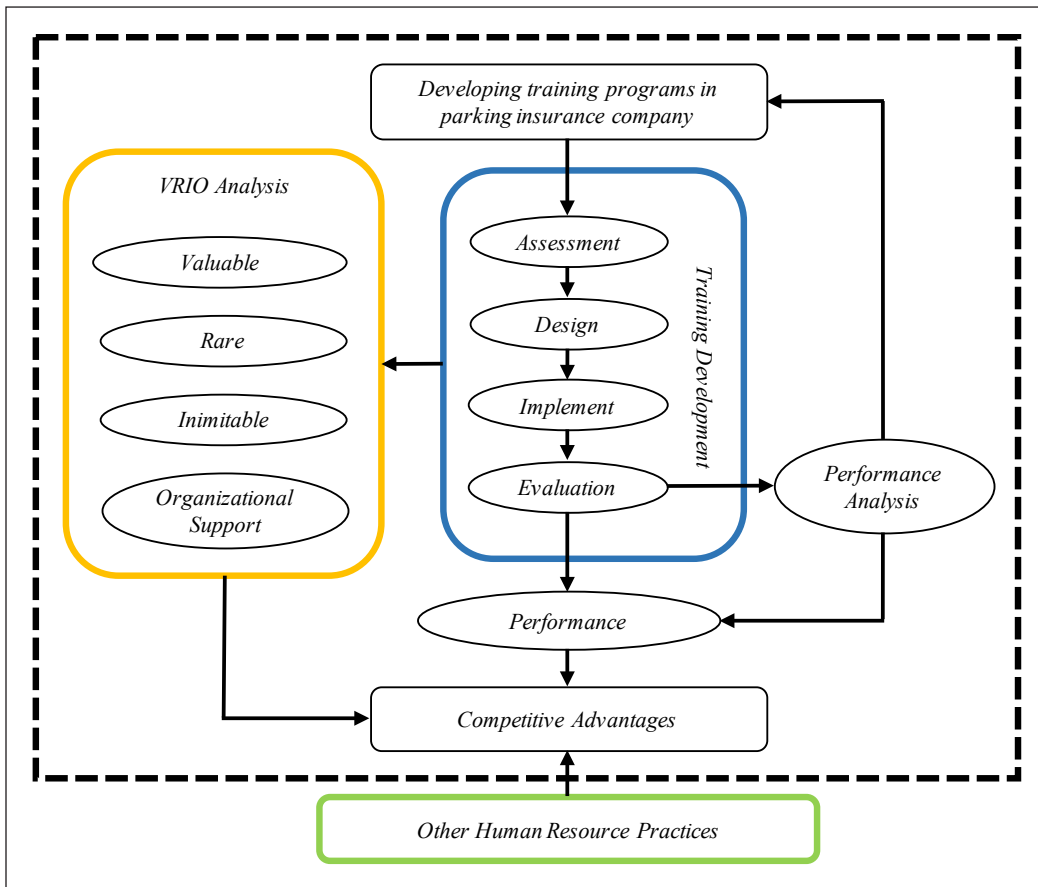

Figure 1. Proposed training model in the parking company

**CONCLUSIONS**

Based on the analysis of the data, it can be concluded that the company already has a training program, which is applied only once when first-time employees join the company. The training materials delivered are about product knowledge or information about the company’s insurance product, as well as material about marketing skills. The training methods used are class theory/ lectures, role play, and direct practice in the field. There is no form of evaluation on the implementation of the training programs conducted.

The competence and skills required by the company marketing agents are divided into two main skills, namely the mastery and understanding of the company insurance product, and also good marketing skills. The training programs that can be developed for the company can be based on the existing training programs by fixing the deficiencies found and developing new training materials or methods that meet the needs of the company. A training program alone is not enough to achieve a competitive advantage for the company. To produce human resources that can be a source of

competitive advantage, it is necessary to combine it with other human resource practices.

## ACKNOWLEDGEMENTS

The authors wish to acknowledge and thank all IMHA 2018 committee members and UPM *Pertanika* journal team that help publish this article.

## REFERENCES

- Anitha, R., & Kumar, M. A. (2016). A study on the impact of training on employee commitment in the private insurance sector in Coimbatore district. *International Journal of Commerce and Management Research*, 2(11), 73-79.
- Armstrong, M. (2010). *Armstrong's essential human resource management practice: A guide to people management*. Great Britain, UK: Kogan Page Publisher.
- Atieno, O. L., & Orwa, B. H. (2015). An investigation of the impact of employee training and reward on performance at Union Des Assurances De Paris Insurance (UAP) in Nairobi - Kenya. *International Journal of Education and Research*, 3(12), 2411-5681.
- Barney J. B., & Arikan, A. (2001). Resource-based view: Origins and implications. In M. Hitt, R. Freeman & J. Harrison (Eds). *The Blackwell handbook of strategic management* (pp. 124-188). Malden, MA: Blackwell.
- Barney, J. B., & Hesterly, W. S. (2012). *Strategic management and competitive advantage: Concepts* (4th Ed.). Essex, Englan: Pearson Education Limited.
- Dalal, R. C., & Pahuja, S. (2012). Achieving competitive advantage through HR practices: A case study. *IIMS Journal of Management Science*, 7(3), 292-300.
- Dessler, G. (2015). *Human resource management*. New Jersey, USA: Pearson.
- Elnaga, A., & Imran, A. (2013). The effect of training on employee performance. *European Journal of Business and Management*, 5(4), 137-147.
- Kozlenkova, I. V., Samaha, S. A., & Palmatier, R. W. (2013). Resource-based theory in marketing. *Journal of the Academy of Marketing Science*, 42(1), 1-21.
- Kulkarni, P. P. (2013). A literature review on training and development and quality of work life. *Researchers World - Journal of Arts, Science and Commerce*, IV(2), 136-143.
- Latham, G. P., & Dello Russo, S. (2008). The influence of organizational politics on performance appraisal. In C. Cooper & S. Cartwright (Eds.), *The Oxford handbook of personnel psychology* (pp. 388-410). Oxford, UK: Oxford University Press.
- Mulang, A. (2015). The importance of training for human resource development in organization. *Journal of Public Administration and Governance*, 5(1), 190-197.
- Pernando, A. (2016). *Perusahaan asuransi diminta sisihkan 5% untuk SDM* [Insurance companies are asked to set aside 5% for HR]. Retrieved June 5, 2017, from <http://finansial.bisnis.com/read/20160331/215/532969/perusahaan-asuransi-diminta-sisihkan-5-untuk-sdm>
- Reliance-Life. (2016). *Sumber daya manusia* [Human resources]. Retrieved July 24, 2017, from <http://reliance-life.com/sumber-daya-manusia/>
- Rue, L. W., Ibrahim, N. A., & Byars, L. L. (2015). *Human resource management*. New York, USA: McGraw-Hill Education.

Sekaran, U., & Bougie, R. (2013). *Research methods for business*. New York, NY: Wiley.

Workforce. (2017). 2017 workforce 100: Ranking the world's top companies for HR. Retrieved

June 24, 2017, from <http://www.workforce.com/2017/04/21/2017-workforce-100-ranking-the-worlds-top-companies-for-hr/>



## **Tobit Regression Analysis on Factors Influencing Dividend Policy of Indonesian Manufacturing Firms**

**Dezie L. Warganegara<sup>1\*</sup>, Titik Indrawati<sup>1</sup>, Evi Steelyana<sup>1</sup>, Doni S. Warganegara<sup>2</sup> and Mark Kam Loon Loo<sup>3</sup>**

<sup>1</sup>*Department of Accounting, Faculty of Economics and Communication, Bina Nusantara University, Jakarta 11480, Indonesia*

<sup>2</sup>*Department of Accounting, Universitas Lampung, Jl. Prof. Dr. Ir. Sumantri Brojonegoro, RW.No: 1, Gedong Meneng, Kec. Rajabasa, Bandar-Lampung, Lampung 35145, Indonesia*

<sup>3</sup>*Mihalcheon School of Management, Concordia University of Edmonton, T5B 4E4, Edmonton, Canada*

### **ABSTRACT**

This study seeks to examine the determinants of dividend policies of manufacturing companies in Indonesia. The data for this study were drawn from a balanced sample of 111 public manufacturing firms listed in the Indonesia Stock Exchange between 2009 and 2013. A Tobit regression analysis with cluster-robust standard errors was then employed to find the effects of firm size, profitability, sales growth, financial leverage, and inter-period on the magnitude of dividend yield. This study finds that firm size, profitability, and sales growth positively influence the magnitude of dividends paid relative to stock prices received by shareholders. On the other hand, it also finds that financial leverage negatively affects dividends. Another result suggests the levels of dividends vary across time.

*Keywords:* Dividend policies, Indonesia Stock Exchange, manufacturing firms, Tobit regression

### **ARTICLE INFO**

*Article history:*

Received: 09 October 2019

Accepted: 03 January 2020

Published: 17 March 2020

*E-mail addresses:*

dezie@binus.edu (Dezie L. Warganegara)

titik\_tiw@binus.ac.id (Titik Indrawati)

evi.steelyana@binus.ac.id (Evi Steelyana)

doni.warganegara@feb.unila.id (Doni S. Warganegara)

mark.loo@concordia.ab.ca (Mark Kam Loon Loo)

\* Corresponding author

### **INTRODUCTION**

Researchers have advanced numerous theories that relate the dividends with a firm's value. Miller and Modigliani (1961) proposed the theory of dividend irrelevance that, in a perfect capital market, a firm's value depended only on its investment policy and the return that its assets offered. Other researchers pinpoint various factors that cause dividends in practice to be value-relevant. Regardless of the attempts for

decades to analyze dividend behaviours by researchers, however, still, no universally accepted explanation has been set. Black (1976) noted that “The harder we look at the dividend picture, the more it seems like a puzzle, with pieces that don’t fit together.”

The present study investigates the factors that affect dividend policies in Indonesian manufacturing firms. There are three contributions of this study to the existing literature. Firstly, the manufacturing industry is a capital intensive sector that requires huge resources to acquire and replenish its tangible assets. Looking at dividend policies in this kind of environment permits an investigation where firms have relatively illiquid assets because the resources have competed for business needs.

Secondly, this study employs dividend yields to proxies for dividend behaviours. The use of dividend yields allows for looking at dividend behaviours from investors’ viewpoints and, thus, incorporates market factors in analyzing dividend behaviours. The final contribution of this study is the use of a Tobit regression model to investigate the effects of sales growth, profitability, financial leverage, firm size, and inter-period effects on dividend yields. The use of the model is a necessity because the sample is a censored sample that consists of dividend-paying and non-dividend paying firms as explained in McDonald and Moffitt (1980) and Long (1997).

This study found that firm size, profitability, and sales growth positively influenced the magnitude of dividends paid relative to stock prices received by

shareholders. On the other hand, it also found that financial leverage negatively affected dividends. Another result suggested the levels of dividends varied across time. The rest of the article is organized as follows. The next section gives a review of the extant literature on dividend behaviours. Section three discusses the data and methodology. Section four presents and explains the results of the empirical analysis. Finally, section five concludes the study.

### **Literature Review**

A dividend is a prorated distribution of assets, especially cash, to shareholders. It has been more than a half-century since Miller and Modigliani (1961) stated that in perfect capital market dividends were irrelevant in determining the value of a company. Researchers seek the relevancy of dividend policies in the real world where capital markets are not perfect. They have devoted considerable efforts to advance dividend theories, not necessarily mutually exclusive, about dividend policies implemented by firms. In addition, De Angelo and DeAngelo (2006) argued that, even in a frictionless market, dividend policy was not irrelevant and a firm’s investments, capital structure, and dividend policies were interrelated.

As mentioned earlier, this study attempted to investigate the determinants of dividend payments in Indonesian manufacturing firms. The choices of some financial and non-financial variables that affected the generosity of dividend payments in this study were based on previous empirical findings in both Indonesia and the

rest of the world. Those variables are firm size, profitability, financial leverage, sales growth, and inter-period as independent variables, while dividend yield as the dependent variable. There are, of course, more factors that have been found to affect corporate dividend policies in the literature. Nevertheless, this study focuses on those items because they can be easily obtained by the public through firms' and the Indonesia Stock Exchange's publications.

The firm life cycle theory of dividends contends that firms' dividend policies follow a natural life-cycle path, from a start-up to a maturity stage, associated with a shrinking growth opportunity set, growth rate reduction, and decreasing cost of raising external capital (Mulyani et al., 2016). Larger firms are generally in a more mature stage and more likely to pay higher dividends because they are able to generate ample amounts of cash and fewer growth opportunities for their investments.

According to the pecking order theory, firms that face information asymmetry and transaction costs prefer to use their retained earnings to invest rather than raise external funds through debt and equity issuances (Mulyani et al., 2016; Setiawan & Phua, 2013). Highly profitable firms tend to have highly internally generated funds available for reinvestment and less likely to have their internal funds diminish, so they are more willing to pay dividends generously.

A high degree of debt in a firm's capital exposes the firm to higher financial risk related to the inability to service the debt. In the realm of the pecking order theory, having fixed financial charges and paying

generous dividends at the same time may lead firms to seek external funding more often and this leads to reductions on firms' dividend level payments (Mahdzan et al., 2016; Mulyani et al., 2016). To ensure their survivability as ongoing concerns, firms with high financial leverage have fewer incentives to pay generous dividends.

Asymmetric information and the dividend signalling theory imply that high growth firms are in dire need of more capital to expand their operations (Gul, 1999). The necessity to convince investors and gain their trust is an urgent matter for firms that are most likely to enter the capital markets for raising new funds. Sawicki (2009), as well as Setiawan and Phua (2013), noted that the high level of dividend payments provided a signal to investors that the firms had good prospects in the future.

On the other hand, according to the agency of free cash flow theory of Jensen (1986) and Lang and Litzenberger (1989) and the pecking order theory of Myers and Majluf (1984), firms with high growth and investment opportunities have no motivations to pay generous dividends because they have a high demand for the internally generated funds to finance those investments, while firms with slow growth and fewer investment opportunities are in the position to pay more dividends due to readily available funds and the need to control for overinvestment problems.

Lin et al. (2012) argued that firms' decisions to increase and decrease dividends across periods depend on whether market placed positive (negative) dividend



premiums in those periods. Observations across periods may find indirect evidence that an investor's preference toward dividends is not steady due to the economy, demography, taste, or investor behaviour changes.

In formulating dividend policies, companies are more likely to take external and internal factors into consideration. This study used dividend yield because it allowed a firm to see dividend payments as a part of total returns on investing in a stock and provides a single measure to evaluate an internal factor (dividend payment) and an external factor (stock price) at the same time.

## **MATERIALS AND METHODS**

The initial sample of this study included all firms in manufacturing industries that are continuously listed in the Indonesia Stock Exchange (IDX) from the periods of 2009 to 2013. The stock exchange classifies manufacturing firms into three industry sectors. These sectors are Basic and Chemical Industry, Miscellaneous, and Consumer Goods Industry sectors. There were 61 companies in Basic and Chemical, 42 companies in Miscellaneous, and 38 companies in Consumer Goods industry sectors in 2013. These 141 companies made up the initial samples, and their financial reports for the five-year period were collected from their websites and the IDX library.

To be included in the final sample, the firms must have data for dividend payments, size, profitability, leverage, and growth for

the whole 5-year period. After eliminating some firms that had incomplete data for at least one period, the final sample was a panel data with balanced samples of 111 firms for a total of 555 firm-year observations. This final sample consisted of 51 companies in Basic and Chemical, 34 companies in Miscellaneous, and 26 companies in Consumer Goods industry sectors.

Dividend yields were used to proxy for dividend payments. The yields were found by dividing annual cash dividends with beginning-period stock prices. The independent variables in this study were logged total assets, return on assets (net income divided by total assets), debt to equity ratio (total liabilities divided by book value of equity), and annual sales change (the difference between the current and previous period sales divided by previous period sales). These variables were used to proxy for size, profitability, leverage, and growth respectively. Besides these four independent variables, there were also dummy variables to represent periods. The year 2009 was the base period for the dummies.

Furthermore, the sample in this study was a censored sample since there were two kinds of firms in the final sample; firms that paid dividends (positive cash dividends) and firms that did not pay dividends (zero cash dividends). The appropriate model for such a censored sample is the Tobit model as explained in McDonald and Moffitt (1980) and Long (1997). Also, this study used panel data that introduced a statistical complication such that the observations might be independent across companies but

not independent within firms. To overcome this statistical problem, this study employed cluster-robust standard errors as suggested in Petersen (2009). This method allows correlations from observations on the same company in different years. The complete model in this study, therefore, is as follows:

$$Div_{i,t} = \alpha + \beta_1 Size_{i,t} + \beta_2 Profit_{i,t} + \beta_3 Lev_{i,t} + \beta_4 Grow_{i,t} + \beta_5 Period_t + \epsilon_{i,t}$$

Where;

Div<sub>i,t</sub> = Dividend yield of firm i in year t

Size<sub>i,t</sub> = Log total assets of firm i in year t

Profit<sub>i,t</sub> = Returns on assets of firm i in year t

Lev<sub>i,t</sub> = Debt to equity ratio of firm i in year t

Grow<sub>i,t</sub> = Sales growth from year t-1 to year t of firm i

Period<sub>t</sub> = Dummy variable to represent the periods from 2009 to 2013, where 2009 is the base period

ε<sub>i,t</sub> = A cluster-robust standard error term

from 2009 to 2013 for a total of 555 firm-year observations. The table shows the mean, standard deviation, maximum, and minimum of all the variables.

The dividend yield is the ratio of cash dividends to beginning-period stock price. Size is the log of total assets. Profit is the ratio of net income to total assets. Leverage is the debt to equity ratio. Growth is the annual sales growth.

The mean value of the dividend yield was 2.3% with a standard deviation of 6.2%, and the maximum and minimum values were 75% and 0% respectively. With regard to the minimum value of the dividend yield, 318 of 555 firms did not pay dividends between the 5-year periods of the observation. The mean value of the size (log of total assets) was 27.24 with a variation of 2.14 and 33.36 to 22.48 values of maximum and minimum points. Size appears to be in less variation among the manufacturing firms in the sample. The mean value of the profitability (returns on assets) was 7.51% with a standard deviation of 19.44%, and the maximum and minimum values were 347.5% and -75.6% respectively. The mean value of the leverage (debt to equity ratio) was 177.7% with a variation of 613.9%, and the 7.561% to -3.178% values of maximum

## RESULTS AND DISCUSSIONS

Table 1 presents the descriptive statistics for the variables of the regression model in this study. It covers the data of 111 firms

Table 1  
Descriptive statistics

Variable	Mean	Std Dev	Max.	Min.
Dividend Yield	0.023	0.062	0.750	0.000
Size	27.24	2.14	33.36	22.48
Profitability	0.0751	0.194	3.475	-0.756
Leverage	1.777	6.139	75.61	-31.78
Growth	0.114	0.346	3.407	-0.746

and minimum points. Financial leverage has great variation in the sample and negative numbers in the leverage occur because some firms have negative equities, so that their debt is higher than their total assets. Triady et al. (2016) noted that a larger proportion of assets financed by debt led to a higher financial risk for firms. The last independent variable of the study was firm growth (sales growth), and its mean value was 11.4% with a variation of 34.6% and a maximum value of 340.7% and a minimum value of -74.6%.

Table 2 below depicts the Pearson's correlation matrix between the financial variables in this study. The table shows all the independent variables, except leverage, have positive relationships with dividend yield. In addition, the table shows low degrees of correlations between the independent variables. This implies the absence of multicollinearity. Further colinearity diagnostics using the Tolerance and Variance Inflated Factor (not reported here) support the results of the Pearson's correlation coefficients that there is no evidence of any multicollinearity problem in the regression model.

The dividend yield is the ratio of cash dividends to beginning-period stock prices. Size is the log of total assets. Profit is the

ratio of net income to total assets. Leverage is the debt to equity ratio. Growth is the annual sales growth.

The results of hypothesis testing are reported in Table 3. The results on testing the relationship between size and dividend yield confirm the expectation that the association is positive and highly significant at the 1% level. The firm life cycle theory implies that large firms are mature firms that have ample amounts of cash and fewer growth opportunities for their investment. The agency cost theory of equity prescribes that large firms run complex operations that hamper the ability of external or minority shareholders to closely monitor a firm's operations. Similarly, large firms usually have no difficulty to access capital markets and bear fewer transaction costs in raising external funds. The results support the prediction that large firms tend to pay higher dividends than small ones. This finding confirms a study on dividends for Indonesian companies that was conducted by Mulyani et al. (2016) but in contrast to that of Sawicki (2009) and Setiawan and Phua (2013). Sawicki (2009) argued that small and large firms might still want to retain earnings if they had abundant growth opportunities. For the rest of the

Table 2  
*Pearson's Correlation matrix*

Variable	Dividend yield	Size	Profitability	Leverage	Growth
Dividend Yield	1.000				
Size	0.035	1.0000			
Profitability	0.125	0.283	1.000		
Leverage	-0.029	-0.113	-0.093	1.000	
Growth	0.021	0.143	0.046	0.055	1.000

world, the results are also mixed. A study on Thai firms by Komrattanapanya and Suntrauk (2013) and Persian Gulf country firms by Al-Kuwari (2009) confirmed a positive relationship. Meanwhile, a study on Malaysian firms by Mahdzan et al. (2016); a study on Danish firms by Hedensted and Raaballe (2008); and a study on Hong Kong firms by Zhang and Jia (2014) found a negative relationship. Different from those studies, a study on firms from the U.S. and developing countries (South Korea, India, Malaysia, Thailand, Zimbabwe, Jordan, Pakistan, and Turkey) by Aivazian et al. (2003) found that size did not affect dividend payments.

$Div_{i,t} = \alpha + \beta_1 Size_{i,t} + \beta_2 Profit_{i,t} + \beta_3 Lev_{i,t} + \beta_4 Grow_{i,t} + \beta_5 Period_t + \varepsilon_i$ . Div is the ratio of cash dividends to beginning-period stock price. Size is the log of total assets. Profit is the ratio of net income to total assets. Lev is the debt to equity ratio. Growth is the annual sales growth. A period is a dummy variable for 2009 to 2013, where 2009 is the base period. The parameters of the model are estimated using a Tobit regression analysis. \*,\*\* and \*\*\* denote statistical

significance at the 10%, 5% and 1% levels respectively, and it is based on a one-tailed test if the expected sign on the hypothesis is directional, and is based on a two-tailed test otherwise. *t*-statistics are adjusted for in-company dependence by using clustered robust standard errors.

Table 3 shows that, as expected, there is a positive association between profitability and dividend yield, and this association is significant at the 10% level. The more profitable the company, the higher the dividend yield received is by investors. The pecking order theory prescribes that firms, facing information asymmetry and transaction costs, tend to use retained earnings for investment purposes. Highly profitable firms are in a position to have sufficient internally generated funds for both investment and generous dividend payments without incurring the need to obtain costly external financing. The importance of profitability in determining a dividend level is also documented by Baker and Powel (2012) through a survey on executives in Indonesia, where profitability measures are ranked as the top three factors in influencing

Table 3  
*Tobit Regression results*

Variable	Expected sign	Coefficient	<i>t</i> -Statistics
Size	+	0.014	3.92***
Profitability	+	0.084	1.48*
Leverage	-	-0.002	-1.92**
Growth	+/-	0.035	2.1**
2010	+/-	-0.017	-1.08
2011	+/-	-0.049	-2.72***
2012	+/-	-0.056	-2.84***
2013	+/-	-0.105	-4.63***

dividends. This positive relationship is also confirmed by studies on dividends for Indonesian firms conducted by Setiawan and Phua (2013), as well as Mulyani et al. (2016).

Sawicki (2009), however, found no relationship between profitability and dividend level. She attributed this finding to the volatility of firms' profitability around the Great East Asian Financial Crisis. The positive relationship between profitability and dividends is currently also found for firms in the US and developing countries (Aivazian et al., 2003), Ghana (Amidu & Abor, 2006), Denmark (Hedensted & Raaballe, 2007), Persian Gulf countries (Al-Kuwari, 2009), Thailand (Komrattanapanya & Suntrauk, 2013), and Hong Kong (Zhang & Jia, 2014). In contrast, Mahdzan et al. (2016) found that for Malaysian firms, the relationship was influenced by the industry variation, so that it could have a significant negative or positive relationship between the two.

The agency cost of free cash flow, the pecking order, and signalling theories prescribe that firms with high financial leverage have fewer incentives to pay generous dividends because debt provides a control mechanism and it requires fixed payments that lead toward raising costly external capital due to transaction costs and the emission of unfavourable news regarding the future of firms. The result of a test on the relationship between leverage and dividend payments confirms the theories that there is a negative relationship between

the variables. This relationship is significant at the 5% level. Current studies on the subject for firms in Indonesia, Thailand, Hong Kong, Persian Gulf countries, the USA, and other developing countries, and Malaysia also find the same result that the relationship is negative (Al-Kuwari, 2009; Aivazian et al., 2003; Komrattanapanya & Suntrauk, 2013; Mahdzan et al., 2016; Mulyani et al., 2016; Zhang & Jia, 2014).

The next test relates firm growth with dividend level. As mentioned previously, the hypothesis on the relationship is unidirectional because there are conflicting predictions regarding the relationship. The agency of the free cash flow theory and the pecking order theory predict that the relationship is negative because of the high demand for the internally generated funds. On the other hand, the asymmetric information and dividend signalling theory prescribes that the relationship is inverse because high growth firms are most likely to raise external capital, so they need to convince investors by paying high dividends so that they have good prospects.

Table 3 shows that the relationship between firm growth and dividends is found to be positive and significant at the 5% level. The results for Indonesian firms show that the relationship is positive, which is also documented by Sawicki (2009) as well as Setiawan and Phua (2013). For firms in Ghana and Thailand, however, the relationship is negative as predicted by the agency of the free cash flow theory and the pecking order theory for companies

(Amidu & Abor, 2006; Komrattanapanya & Suntrauk, 2013), and there is no relationship between the variables for companies in Malaysia, Persian Gulf countries, and Hong Kong (Al-Kuwari, 2009; Mahdzan et al., 2016; Zhang & Jia, 2014).

Finally, Table 3 also reveals that inter-periods have an impact on dividend yield. Except for 2010, in 2011, 2012, and 2013, on average, companies had fewer dividend yields than in 2009. All the differences are significant at the 1% level. The results provide preliminary evidence on the extended version of the catering theory of the dividend policy that the investors' preference towards dividends may change across periods and, accordingly, firms adjust their dividend policies to match the changes, as found in Lin et al. (2012).

## CONCLUSIONS

The objective of this study was to investigate the factors that determine the dividend policies of manufacturing firms listed in the Indonesia Stock Exchange. The investigation was conducted on panel data with a balanced sample of 111 firms for a total of 555 firm-year observations. A Tobit regression analysis with cluster-robust standard errors was employed to find evidence on the relationship between dependent and independent variables. The independent variable was dividend yield and the independent variables were firm size, profitability, financial leverage, sales growth, and the dummy variable to represent the inter-period factor.

The analysis found that firm size, profitability, and sales growth positively influenced the magnitude of dividends paid relative to stock prices received by shareholders. On the other hand, it was also found that financial leverage negatively affected dividends. A high degree of debt in a firm necessitates the firm to maintain an internal cash flow to avoid the costly transaction costs of raising external funds. Another result suggests the level of dividends varies across time. There is indirect evidence that investors' preference towards dividends may change across periods.

## ACKNOWLEDGEMENTS

The authors gratefully acknowledge the support of the Indonesian Higher Education for funding this research.

## REFERENCES

- Aivazian, V., Booth, L., & Cleary, S. (2003). Do emerging market firms follow different dividend policies from U.S. firms? *Journal of Financial Research*, 26(3), 371-387.
- Al-Kuwari, D. (2009). Determinants of dividend policy in emerging stock exchanges: The case of GCC countries. *Global Economy and Finance Journal*, 2(2), 38-63.
- Amidu, M., & Abor, J. (2006). Determinants of dividend payout ratios in Ghana. *Journal of Risk Finance*, 7(2), 136-145.
- Baker, H. K., & Powell, G. E. (2012). Dividend policy in Indonesia: Survey evidence from executives. *Journal of Asia Business Studies*, 6(1), 79-92.
- Black, F. (1976). The dividend puzzle. *Journal of Portfolio Management*, 2(2), 5-8.



- De Angelo, H., & DeAngelo, L. (2006). The irrelevance of the MM dividend irrelevance theorem. *Journal of Financial Economics*, 79(2), 293-315.
- Gul, F. A. (1999). Growth opportunities, capital structure, and dividend policies in Japan. *Journal of Corporate Finance*, 5(2), 141-168.
- Hedensted, J., & Raaballe, J. (2008). *Dividend determinants in Denmark* (Working Paper 2008-3). Aarhus, Denmark: Institut for Økonomi.
- Jensen, M. (1986). Agency cost of free cash flow, corporate finance, and takeovers. *The American Economic Review*, 76(2), 323-329.
- Komrattanapanya, P., & Suntrauk, P. (2013). Factors influencing dividend payout in Thailand: A Tobit regression analysis. *International Journal of Accounting and Financial Reporting*, 3(2), 255-268.
- Lang, L. H. P., & Litzenberger, R. H. (1989). Dividend announcements: Cash flow signalling vs. free cash flow hypothesis. *Journal of Financial Economics*, 24, 181-191.
- Lin, H., Wen-Yi, L., & Ya-Chiu, A. L., (2012). Dividend catering and the information content of dividend changes. *Journal of Interdisciplinary Mathematics*, 15(1), 1-21.
- Long, J. S. (1997). *Regression models for categorical and limited dependent variables*. Thousand Oaks, CA: Sage Publications.
- Mahdzan, N. S., Zainudin, R., & Shahri, N. K. (2016). Interindustry dividend policy determinants in the context of an emerging market. *Economic Research-Ekonomika Istraživanja*, 29(1), 250-262.
- McDonald, J. F., & Moffitt, R. A. (1980). The uses of Tobit analysis. *Review of Economics and Statistics*, 62(2), 318-321.
- Miller, H., & Modigliani, F. (1961). Dividend policy, growth, and the valuation of shares. *Journal of Business*, 34(4), 411-433.
- Mulyani, E., Singh, H., & Mishra, S. (2016). Dividends, leverage, and family ownership in the emerging Indonesian market. *Journal of International Financial Markets, Institutions and Money*, 43(C), 16-29.
- Myers, S. C., & Majluf, N. S. (1984). Corporate financing and investment decisions when firms have information the investors do not have. *Journal of Financial Economics*, 13(2), 187-221.
- Petersen, M. A. (2009). Estimating standard errors in finance panel data sets: Comparing approaches. *Review of Financial Studies*, 22(1), 435-480.
- Sawicki, J. (2009). Corporate governance and dividend policy in Southeast Asia pre- and post-crisis. *European Journal of Finance*, 15(2), 211-30.
- Setiawan, D., & Phua, L. K. (2013). Corporate governance and dividend policy in Indonesia. *Business Strategy Series*, 14(5/6), 135-143.
- Triady, M. T., Kurniasari, R., Utami, A. F., & Sofyan, M. I. (2016). Investigation of leverage effect in the Indonesian stock market. *International Journal of Economics and Management*, 10(S1), 1-17.
- Zhang, X., & Jia, F. (2014). Does ownership structure matter for dividend yield? Evidence from the Hong Kong stock exchange. *Business and Economic Research*, 4(2), 2014-221.



## **Factors Affecting Earnings Quality in Companies Listed in Indonesia Stock Exchange**

**Stefanus Ariyanto, Sasya Sabrina\* and Theresia Lesmana**

*Department of Accounting, Faculty of Economics and Communication, Bina Nusantara University,  
Jl. K. H. Syahdan No. 9 Kemanggisian, Palmerah, Jakarta 11480, Indonesia*

### **ABSTRACT**

This study aims to analyze the factors affecting the quality of accounting profit which include management ownership, IFRS convergence, and debt covenant. The sample taken was from manufacturing companies listed on the Indonesia Stock Exchange that published audited financial report in the year of 2011-2014. The final data used in this study was as many as 401 data. With multiple linear regression analysis techniques, t-test and F test conducted for hypothesis testing. The conclusion obtained from this research shows that managerial ownership has no significant influence on earnings quality, IFRS convergence has no significant influence on earnings quality, and debt covenant has significant influence on earnings quality.

*Keywords:* Earnings quality, debt covenant, IFRS Convergence, managerial ownership

### **INTRODUCTION**

Accounting earnings is usually used as one of the indicators of firms' financial performance (Alves, 2012). Managers have the opportunity to manage earnings to attract

investors or to get personal gain through bonus sharing. That earnings management affects the quality of earnings. How can investors trust the information provided by the company if the information especially earnings information had been managed by the manager?

Earnings quality can be described as how strong a firm's financial performance provides information for decision-maker

#### **ARTICLE INFO**

*Article history:*

Received: 09 October 2019

Accepted: 03 January 2020

Published: 17 March 2020

*E-mail addresses:*

stefanus.ariyanto@umn.ac.id (Stefanus Ariyanto)

ssabrina@binus.edu (Sasya Sabrina)

tlemana@binus.edu (Theresia Lesmana)

\* Corresponding author

*Current affiliation:*

**Stefanus Ariyanto**

*Universitas Multimedia Nusantara, Scientia*

*Boulevard, Gading Serpong, Tangerang, Banten*

*15227, Indonesia*

to make the right decision. Dechow et al. (2010) explained that the higher quality of earnings, the more relevant information about the firm's financial performance to decision-maker provided. Many bankruptcy cases in the world caused by the low quality of earnings. Investors failed to make the right decisions because the information provided did not describe the real conditions of the firms. Firms need to improve corporate governance (Hashim & Devi, 2008).

Many factors affect earnings quality based on the previous study. Researches on managerial ownership and earnings quality still generate different results. Jensen and Meckling (1976) theorized if the level of managerial ownership was high, the firms need lower monitoring by the board since the managers' interests would be closely aligned with the owners'. The higher the level of managerial ownership, the lower the possibility of financial statement fraud done by the management. Managerial ownership in Indonesian company is still low (Fendiani & Tandiono, 2016).

International Financial Reporting Standards (IFRS) is an accounting standard developed by the International Accounting Standards Board (IASB) that provides a common global language for business. One of the important benefits is to improve the comparability and understandability of financial statements, especially the financial statements of multinational corporations.

Another benefit of international accounting standards according to Ball (2006) is that an international accounting standard may open up the possibility of

comparing financial statements across countries, increasing transparency in financial reporting, reducing information costs, and suppressing asymmetric information. Moreover, for developing countries, which have not been able to make strong accounting standards, the adoption of international accounting standards may strengthen the competitive ability in the capital market (Peavey & Webster, 1990).

However, the adoption of international accounting standards also has controversial issues, such as in the research of Choi and Meek (2005) which concluded that the adoption of international accounting standards would only be beneficial for multinational corporations, whereas, for smaller companies (for instance Small and Medium Enterprise - SME), the standards would be useless and complicated.

Other studies indicate that a country that is likely to succeed in the adoption of international accounting standards is a State that has strong capital markets with Anglo-American based accounting (Zeghal & Mhedhbi, 2006). Another obstacle to the adoption of international accounting standards is that uniformity in the application of accounting standards is difficult because each company has different goals and strategies, different investment and financing policies and political situations (Ball, 2006). Furthermore, as known as international accounting standards developed in developed countries would be better suited for decision making in developed countries, and would not necessarily be appropriate if applied to

decision-making in developing countries. After 2012, the second phase of convergence would be conducted in 2013 which would be effective in 2015. Gradually, IFRS has been implemented following the implementation of the relevant PSAK. Implementation of the principle-based accounting principles enables entities to apply them more closely to each other's characteristics, but on the other hand, judgment and subjectivity play a very important role in the application of this standard both in the selection of accounting policies, methods, estimates and elements - other elements. Subjective judgments are sometimes used to generate desired profits (Lobo & Zhou, 2001).

When the company's debt is relatively low, the managers are less likely to manipulate earnings because the probability of violating a covenant is not high. However, when the company has high debt levels, managers tend to manipulate earnings because the risk of breaching a covenant becomes so high. When the managers try to manipulate earnings, the quality of earnings becomes low (Ghosh & Moon, 2010).

### Literature Review

Many firms especially publicly listed firm separate the ownership of the shares and the control. This separation could create conflicts between the owner of the firms or shareholders and the managers. Managers have the motivation to get a bonus, while the owner or shareholder have the motivation to get the dividend. In this regard, shareholders need to control and monitor the manager from unethical behaviour. Controlling and

monitoring may incur costs. Fleming et al. (2005) found that agency conflict and the degree of separation between ownership and control had a significant positive relationship.

The agency theory suggests a relationship between the principal (owner) and the agent (manager) concerning corporate management, where the principal is an entity that delegates the authority to manage the company to the agent (management). According to Jensen and Meckling (1976), agency theory explains the contractual relationship between the party delegating a particular decision (principal/owner/shareholder) to the party receiving the delegation (agent/management). Conflict of interest between the owner and the agent may occur because the possibility of the agent acting not in accordance with the interests of the principal, thus triggering agency costs. As an agent, managers are morally responsible for optimizing the principal's profits by obtaining compensation in accordance with the contract. Thus, there are two distinct interests within the enterprise in which each party seeks to attain or maintain the desired level of prosperity.

Profit is the main information presented in the financial statements, so the figures in the financial statements become crucial things that must be observed by users of financial statements. This is because the figures in the financial statements are a function of the policies and accounting methods chosen by the company. Profit is an indicator that can be used to measure the company's operational performance

that can affect the value of the company. Information about earnings measures the success or failure of a business in achieving its defined operating objectives. Both creditors and investors, use profits to evaluate management performance, predict earnings power, and predict future earnings. Profit quality is a profit that correctly and accurately describes the operational profitability of the company. Accrual accounting earnings raise the issue of earnings quality, as profit from the accrual accounting process becomes the object of profit engineering (earnings management). Some earnings management techniques may affect earnings reported by management. Earnings management practices will result in lower reported earnings quality. Earnings can be said to be of high quality if reported earnings can be used by users to make the best decisions, i.e. investor can use the information to decide to buy or sell the shares of other company, and can be used to explain or predict stock prices and returns.

**Managerial Ownership.** Some researchers define that managerial ownership is the largest share ownership by company management (Sujoko & Soebiantoro, 2007). Managerial ownership can be defined as the percentage of shares owned by the managers (LaFond & Roychowdhury, 2008). Managerial ownership is a percentage of ownership of the board of directors and board of commissioners of the company's shares. The managerial ownership structure has several roles or functions that can be seen from two perspectives; the agency

approach and the asymmetric information approach. The agency approach considers the managerial ownership structure as an instrument or tool to reduce agency conflicts between claims against the company so that the firm increases managerial ownership to align the manager's position with the shareholders so to act following the wishes of shareholders. With an increase in ownership, the percentage will align the manager's position (Jensen & Meckling, 1976). Managers who have portions of shares of the firms have less incentive to manage or manipulate earnings and accounting information. The higher the level of the ownership by managers, the interest gap between managers and shareholders will decrease. Therefore as management ownership increases, the incentives to manage earnings will decrease. The decrease in earnings management will increase earnings quality (Warfield et al., 1995). The level of management ownership can limit earnings management activities so the quality of earnings remains high (Ali et al., 2008).

*H1: Managerial ownership affects earnings quality.*

**IFRS Convergence.** International Financial Reporting Standards (IFRS) is a principle-based accounting standard that provides the basic principles of accounting practices. Many countries have fully or partially adopted IFRS. Indonesia is a country that uses IFRS as a reference in the preparation of Financial Accounting Standards (SAK).

Accounting standard can limit the managers to manipulate or manage accounting earnings, but it depends on how well the standards are enforced (Leuz et al., 2003). Previous research has suggested that IFRS convergence improves the quality of earnings as indicated by lower earnings management and increased comparability of accounting earnings (Cai et al., 2012; Manzano & Conesa, 2014).

*H2: IFRS convergence affects earnings quality*

**Debt Covenant.** Debt financing is one of the sources of external funding. There are two types of debt financing, private and public debt markets. Private debt markets have concentrated lenders, i.e. banks. Public debt is held by bondholders. The differences between both types of debt financing are the access of information, the ability to monitor borrower, flexibility in resetting contract terms, and the contract renegotiation cost (Bharath et al., 2008). Debt covenant explains how managers deal with debt agreements. The manager in responding to a breach of a debt agreement that becomes due will attempt to avoid it by choosing an accounting policy that benefits him. A debt covenant is an agreement to protect the lender from the actions of the manager against the interests of the creditor, such as excessive dividend payout, or leaving the equity below the prescribed level. Debt can have a positive and negative influence on earnings quality. In the positive side, debt can push the manager to carefully provide

private information about the future of the company to lower financing cost. In the negative side or in the condition when companies have high debt, managers tend to use accruals aggressively to manage earnings (Ghosh & Moon, 2010).

*H3: Debt covenant affects earnings quality*

## MATERIALS AND METHODS

The observed population was all manufacturing companies listed on the Indonesia Stock Exchange within 4 years (2011-2014). The sample was selected using a purposive sampling method with the condition that the company must be listed during the study period or had been listed before 2011 and not delisted before end of 2014, and published financial statements during the study period. The final sample size for this study was 401 data. The data was collected from the financial statement of the listed company in 2011 – 2014. The collected data were analyzed using multiple regression analysis with 95% confidence level. Managerial ownership was measured using a dummy variable with values 0 and 1. A value of 0 would be given to the companies that did not have managerial ownership and the value of 1 would be given to the companies that had managerial ownership. IFRS convergence was measured using a dummy variable with values 0 and 1. A value of 0 would be given in 2011 data, i.e. the year before IFRS implementation stage in Indonesia and the value 1 would be given in 2012, 2013 and

2014, i.e. the year of IFRS implementation in Indonesia. Debt covenants were measured using debt to total assets ratio.

$$COV = \frac{Total\ Debt}{Total\ Assets}$$

The dependent variable in this research is earnings quality and measured using cash flow from operation to the total asset.

$$EARN = \frac{Cash\ Flow\ from\ Operation}{Total\ Assets}$$

The research model is:

$$EARN = \beta_0 + \beta_1 MOWN + \beta_2 IFRS + \beta_3 COV + \varepsilon$$

MOWN = managerial ownership

IFRS = IFRS convergence

COV = debt covenant

## RESULTS AND DISCUSSIONS

### Descriptive Statistics

Descriptive statistics are used to describe data viewed from the mean, median, maximum, minimum. This test is done to make it easier to understand the variables used in the research. The descriptive statistical test results can be seen in Table 1.

### Multiple Regression Analysis

The multiple regressions result shows that managerial ownership variable has sig or p-value more than alpha 0.05. Therefore, it indicates that managerial ownership variable has no effect on earnings quality variable. This can happen because in manufacturing companies in Indonesia listed on the Stock Exchange, ownership by management is low, so it can not affect management decisions to make earnings management that can reduce the quality of corporate profits.

Table 1  
Descriptive statistics

	Minimum	Maximum	Mean	Std. Deviation
MOWN	0.00	1.00	0.4763	0.50006
IFRS	0.00	1.00	0.7531	0.43174
COV	0.00	4.30	0.5431	0.45430
EARN	-0.17	0.43	0.0663	0.09113

Table 2  
Multiple Linear regression

Variables	Estimated Coefficient	t-statistic
Intercept	0.086	7.413***
MOWN	-0.007	-0.727
IFRS	0.009	0.903
COV	-0.044	-4.353***

Note: \*\*\* statistical significant at the 5% level



As for the IFRS variable, the multiple regressions result show that IFRS convergence variable has sig or p-value more than alpha 0.05. Therefore, it indicates that the IFRS variable has no effect on earnings quality variable. This can happen because in the early years of IFRS implementation, companies still use a lot of old accounting methods (US GAAP) that are also allowed in IFRS. Companies definitely consider the cost and benefits before deciding to change the method.

Based on the multiple regressions result, debt covenant variable has a significant coefficient value of -0.044 because the sig or p-value is less than alpha 0.05. It indicates that a debt covenant has a negative effect on earnings quality. The higher the company's debt, the lower the earnings quality of the company generated. This can happen because companies with high debt will tend to make earnings management to still look attractive by investors and other stakeholders. That earnings management activity makes the earnings quality becomes lower.

F-test examines the effect of management ownership, IFRS convergence, and debt covenant simultaneously to earnings quality. In this research, the F-test result shows that F value is 6,546, while F table is 3.87 for total sample 401 and 5% significance. Therefore, it can be concluded that the independent variables in this study significantly affect the dependent variable simultaneously because of the value of F arithmetic greater than F table.

## CONCLUSIONS

The purpose of this study was to determine the effect of management ownership, IFRS convergence, and debt covenant on earnings quality. Based on the results of the study, it can be concluded that management ownership does not affect the quality of earnings because the number of shares owned by management is so small that it cannot affect management decisions to make earnings management. IFRS convergence also does not affect earnings quality in the early years of implementation due to cost and benefit considerations. Debt covenant negatively affects the quality of earnings because the companies will find a way to keep its financial statements attractive if they have high debt, thus allowing the occurrence of earnings management resulting in decreased earnings quality.

## ACKNOWLEDGEMENTS

The authors wish to acknowledge and thank all IMHA 2018 committee members and UPM *Pertanika* journal team that help publish this article.

## REFERENCES

- Ali, S. M., Salleh, N. M., & Hassan, M. S. (2008). Ownership structure and earnings management in Malaysian listed companies: The size effect. *Asian Journal of Business and Accounting*, 1(2), 89-116.
- Alves, S. (2012). Ownership structure and earnings management: Evidence from Portugal. *Australasian Accounting Business and Finance Journal*, 6(1), 57-74.



- Ball, R. (2006). International financial reporting standards (IFRS): Pros and cons for investors. *Accounting and Business Research*, 36(Sup1), 5-27.
- Bharath, S. T., Sunder, J., & Sunder, S. V. (2008). Accounting quality and debt contracting. *The Accounting Review*, 83(1), 1-28.
- Cai, L., Rahman, A., & Courtenay, S. (2012). Is it IFRS adoption or convergence to IFRS that matters? In *TLJA Symposium* (pp. 1-39). Ontario, Canada: Elsevier.
- Choi, F., & Meek, G. (2005). *International accounting* (5th Ed.). New Jersey, USA: Prentice Hall.
- Dechow, P., Ge, W., & Schrand, C. (2010). Understanding earnings quality: A review of the proxies, their determinants and their consequences. *Journal of Accounting and Economics*, 50(2-3), 344-401.
- Fendiani, A., & Tandiono, R. (2016). Family business and managerial ownership: the effect on the degree of accounting conservatism practised in Indonesian-listed firms. *Pertanika Journal of Social Sciences and Humanities*, 24(S), 109-118.
- Fleming, G., Heaney, R., & McCosker, R. (2005). Agency cost and ownership structure in Australia. *Pacific-Basin Finance Journal*, 13(1), 29-52.
- Ghosh, A., & Moon, D. (2010). Corporate debt financing and earnings. *Journal of Business Finance and Accounting*, 37(5 & 6), 538-559.
- Hashim, H. A., & Devi, S. (2008). Board characteristics, ownership structure and earnings quality: Malaysian evidence. *Research in Accounting in Emerging Economies*, 8(97), 97-123.
- Jensen, M. C., & Meckling, W. H. (1976). Theory of the firm: Managerial behavior, agency costs and ownership structure. *Journal of Financial Economics*, 3(1/2), 305-360.
- LaFond, R., & Roychowdhury, S. (2008). Managerial ownership and accounting conservatism. *Journal of Accounting Research*, 46(1), 101-135.
- Leuz, C., Nanda, D., & Wysocki, P. D. (2003). Earnings management and investor protection: An international comparison. *Journal of Financial Economics*, 69(3), 505-527.
- Lobo, G., & Zhou, J. (2001). Disclosure quality and earnings management. *Asia-Pacific Journal of Accounting and Economics*, 8(1), 1-20.
- Manzano, M. P., & Conesa, M. I. (2014). Assessing the impact of IFRS adaptation on earnings management: An emerging market perspective. *Transformations in Business and Economics*, 13(1), 21-40.
- Peavey, D. E., & Webster, S. K. (1990). Is GAAP the gap to international market? *Management Accounting Journal*, 72, 31-35.
- Sujoko & Soebiantoro, U. (2007). Pengaruh struktur kepemilikan saham, leverage, faktor intern dan faktor ekstern terhadap nilai perusahaan [Effect of stock ownership structure, leverage, internal factors and external factors on the value of the company]. *Jurnal Manajemen dan Kewirausahaan*, 9(1), 41-48.
- Warfield, T. D., Wild, J. J., & Wild, K. L. (1995). Managerial ownership, accounting choices, and informativeness of earnings. *Journal of Accounting and Economics*, 20(1), 61-91.
- Zeghal, D., & Mhedhbi, K. (2006). An analysis of the factors affecting the adoption of international accounting standards by developing countries. *The International Journal of Accounting*, 41(4), 373-386.

## **Inflation Effect, Interest Rate of Bank Indonesia Certificates (SBI) and Economic Growth on Rupiah Exchange Rate in Indonesia**

**Darman\* and Karyana Hutomo**

*Department of Management, BINUS Business School Undergraduate Program, Bina Nusantara University, Jl.KH Syahdan No.9, Kemanggisian, West Jakarta 11480, Indonesia*

### **ABSTRACT**

The main purpose of this study is to prove whether inflation, the interest rate of Bank Indonesia Certificates (SBI) and economic growth affect the exchange rate of IDR against USD in Indonesia from 2000 to 2016 in both partial and simultaneous inflation. The hypothesis of this study is that there is a connection among the inflation, the SBI rate and the economic growth to the exchange rate of IDR against USD in both simultaneously and partially inflation. In order to prove this theory, this study used secondary data from Bank Indonesia (BI) and the Central Bureau of Statistics (BPS) websites. In addition, this study used multiple linear regression as a method of analysis, which had been tested by classical assumption test, coefficient of determination test (R squared), F-test and T-test using SPSS program version 22. The reason for applying this method of analysis is because the capability of multiple linear regression to detect Kurs value in both simultaneous and partial inflation, which is not viewed on a simple linear regression method. The result showed that in simultaneous inflation, SBI interest rate and economic growth did not affect the exchange rate of IDR against USD. In partial inflation, inflation and SBI interest rate did not affect the IDR exchange rate towards USD. Yet, economic growth affected the exchange rate of IDR against USD.

*Keywords:* Economic growth and exchange rate, Inflation, interest rate of SBI

### **ARTICLE INFO**

*Article history:*

Received: 09 October 2019

Accepted: 03 January 2020

Published: 17 March 2020

*E-mail addresses:*

darman@binus.ac.id (Darman)

khutomo@binus.edu (Karyana Hutomo)

\* Corresponding author

### **INTRODUCTION**

The international trading activity involves countries cooperations, which ties them to one another under specific terms. Therefore, since this is a globalization era in which all countries are connected to one another, none of them, including Indonesia, could

avoid any kind of interactions with other countries. One of the important interactions that could further support the relationship between countries is trading. However, trading is proven to be a delicate matter that needs more attention. Thus, in order to facilitate international trading transactions, specific terms have to be agreed by all countries, especially in terms of currency. In this regard, American Dollar (USD) has been decided to be the international currency; this means that there will be currency exchange to USD when a country undertakes the international transaction. The reason for using USD as an international currency is because it is one of the strongest currency and a reference currency for most developing countries. Besides, the United States is the dominant trading partner in Indonesia.

However, the currency exchange rate is not always stable. The occurrence of changes in currency exchange rates arises from uncertainty in the exchange rate, which gives a direct effect on currency instability in both the domestic and international market. Furthermore, the instability of the exchange rate will affect capital flows or investment and international trade (Ulfia & Aliasuddin, 2011). Also, it will affect on appreciation and depreciation of the currency.

Appreciation is an increase of certain country's exchange rate against the value of other countries currency (Berlianta, 2005), while currency depreciation, according to Berlianta (2005), is a decrease in the exchange rate of a particular country's currency against other countries currency. Since the currency that is used as a

comparison in currency exchange is USD, indeed there will be conversion to USD from one country's currency when a country does an international transaction. As a result, In Indonesia, for example, when IDR against USD is unstable, the trading activity would be disturbed, which, in turn, could cause economic losses because USD is used as the main currency

The exchange rate of IDR to USD is influenced by many factors. One of them is the macroeconomic condition of a country. The macroeconomic conditions used as independent variables affecting the changes in the exchange rate are the inflation rate, the interest rate of Bank Indonesia Certificates (SBI), and economic growth. The importance of these variables to the exchange rate is strongly stated by Coordinating Minister for Economic Affairs Darmin Nasution,

*"...If not well prepared, the strengthening of the exchange rate will not be high, economic growth, inflation and labour will not get better either."* (Suryowati, 2015).

The exchange rate of a country's currency can basically be used as a benchmark for a country's economic condition. Stability on the growth of the value of currency indicates that the state has a relatively good economic condition and vice versa. Thus, if the economic condition is unstable, macroeconomic stability will also be affected. One of the results of instability on economic condition is weakening of the exchange rate.

The weakening of the exchange rate resulted in increasing on SBI rate. This is followed by a decrease in basic necessity's cost (CSPI). This phenomenon illustrates fluctuation on the exchange rate, SBI and CSPI rates, which, in turn, gives a strong reason to explain intervariables relationship between the exchange rate and the SBI rate with the stock price (Delta, 2016). This relationship is described by Indonesia's Finance

Minister Sri Mulyani Indrawati who stated that "although the world economy is still covered with uncertainty, Indonesia's economic condition is relatively better." This statement is not without proof: economic growth in Indonesia has reached an average of 5.7 percent in the last ten years (Utami, 2017).

As for the macroeconomic indicators that are closely related to the exchange rate, inflation is considered to be one of the marks. Inflation is an increase in the price of goods that are general and ceaseless (Rahardja & Manurung, 2008), which means that any changes in the inflation rate can affect international trading activities. Samuelson and Nordhaus (2004) and Madura (2006) in International Financial Management also mentioned that inflation was a decisive factor in an exchange rate conversion. Therefore, the inflation rate is selected as the primary independent variable to influence the exchange rate of IDR.

The second macroeconomic indicator that affects the IDR exchange rate is SBI rate. The fluctuation on the exchange rate could implicate in alteration on the inflation

rate, which ultimately resulted in the rise and decline of domestic interest rates. This is because alteration on interest rates will affect the flow of funds in a country that will also affect the demand and supply of currency exchange rates. Also, another condition that can cause changes in the IDR exchange rate is per capita income level that is usually measured by using Gross Domestic Product (GDP). Therefore, Bank Indonesia, as an institution that has the policy to control interest rates, is expected to compose the stability of IDR value.

One of the methods that Bank Indonesia (BI) created to control the IDR value is by issuing a letter called SBI. SBI is securities issued by Bank Indonesia in recognition of short-term debt (1-3 months) with a discount/interest system. By selling SBIs, Bank Indonesia can absorb the surplus of primary money. The interest rate applicable to each SBI trading is determined by a market mechanism based on an auction system. Since early July 2005, BI has used the BI rate mechanism (BI rate) by announcing BI's desired target of SBI interest rate for auction at a certain period of time. BI rate is then used as a reference by market participants in following the auction.

The last macroeconomic indicator that could affect the IDR exchange rate is economic growth. Economic growth is the main source in an effort to improve people standard of living. Nanga (2005) revealed that the ability of a country to improve the living standards of the population was eminently dependent and determined by the rate of long-term economic growth.

Nanga's revelation is further supported by Ulfia and Aliasuddin (2011) studies that emphasized that the exchange rate instability could affect capital flows or investment and international trade. Therefore, an increase in economic growth is expected to create better economic conditions in the future and more stability on the rupiah exchange rate.

An economist of the Institute for Development of Economics and Finance (Indef), Hartati & Oktavianti (2015) supported that revelation by stating that:

*“Indonesia's economic growth on a quarterly basis tends to increase from 4.73 percent in Q3 / 2015 to 5.04 percent in Q4 2015.”*

Yet, when it comes to the annual growth rate, Indonesia's economic growth continues to slow down (Suryowati, 2016).

## Literature Review

**Inflation.** According to Central Bureau of Statistics, the definition of inflation is an increase in prices of goods and services in general where goods and services are the basic needs of society or a decline in purchasing power of a country's currency (Delta, 2016). In another word, inflation is a process where prices rise generally and continuously for goods that are needed by society (not momentary goods) (Hady, 2016). In general, inflation occurs on a long-term basis (Rahardja & Manurung, 2008). Therefore, an increase in the price of one or two items alone could not be called inflation (Latumaerissa, 2015).

Friedman (1976) stated that inflation was everywhere and always became a monetary phenomenon that reflected excessive and unstable monetary growth. Ergo, this phenomenon is not happening only in developing countries, such as Indonesia, and Malaysia but also in developed countries. Dynamics and economic growth that influence the increasing demand for goods and services were considered as one of the factors that caused inflation. This rate of inflation is usually expressed in percent per year (Berlianta, 2005).

In order to determine the changes in prices from one period to another, the inflation rate is usually used. Hence, it is important to observe consumers' index price data from one certain period and compare it with the previous index price.

The most commonly used indicator to measure the inflation rate is the Consumer Price Index (CPI). In general, the calculation of inflation from the CPI follows the following formula:

$$INF_t = \frac{IHKt - IHKt - 1}{IHKt - 1} \times 100$$

**SBI Interest Rate.** Sunariyah (2006) defined an interest rate as the price of a loan. Interest rate is proclaimed as a basic money percentage per unit. Incidentally, interest is a measurement on the source's price that is used by the debtor to pay the creditor. As mentioned before, the interest rate is also one of the macroeconomic indicators for an exchange rate, especially because

the interest rate has close relations with economic growth. This connection between the interest rate and economic growth is shown by Sundjaja and Barlian (2003) in their book *Financial Management*,

*“Generally, the lower the interest rate, the more capital flows resulted in increasing economic growth. In comparison, the higher the interest rate, the more scanty capital flows, which contributes to lower economic growth.”*

Furthermore, according to Mishkin (2008), interest rate stability is highly desirable because it can boost financial market stability. When the financial market is stable, its ability to distributing capital from people who has productive investment opportunity will be going smoothly, and economic activity will stay stable. Therefore, Bank Indonesia as a central bank is in charge to keep interest rate stability for creating a more stable financial market.

As part of its role as a macroeconomic indicator, the interest rate is also one of the monetary instrument that could influence or motivate both society and businessmen to saving and investing. Indeed, interest rate here is referred to Bank Indonesia’s interest rate that is conducted by issuing Bank Indonesia Certificate (SBI).

SBI is securities in rupiah issued by Bank Indonesia as admittance for a short-term loan with discount system and one of the components used by the government to control the money supply in society or,

in more general term, to regulate national economy in a way of amplifying interest rate. This is what usually called monetary policy. On the other hand, the SBI rate is a reference to the return rate earned by investors when investing in risk-free investments (Puspitaningrum et al., 2014).

Escalation on SBI interest rate will push banks and other financial organizations to buy SBI. The higher interest rate in SBI will definitely make banks and other financial organization give a higher interest rate to their products. The purpose of this action is to attract as much as people’s capital in order to buy SBI again. With SBI as a monetary authority, Bank Indonesia has to keep the stability of Rupiah exchange rate. In order to fulfil its duty, BI uses several monetary instruments including Minimum Mandatory Bank Account (reserve requirement), discount facility, morality call, and Open Market Operation. In an open market operation, BI could perform a securities trading transaction, including SBI.

**Economic Growth.** Economic growth is a major source of efforts to improve people standards of living. Nanga (2005) defined economic growth as an improvement in the ability of an economy to produce goods and services. Economic growth shows more quantitative change and is usually measured using gross domestic product (GDP) data or per capita income.

Economic growth can be interpreted as a process of increasing per capita output on a long-term basis (Latumaerissa, 2015). Economic growth is usually measured using



the Gross Domestic Product (GDP) at a constant price, as follows:

$$G = \frac{\text{GDPT} - \text{GDPo}}{\text{GDPo}} \times 100$$

Where,

G = economic growth rate

GDPT = Gross Domestic Product period t

GDPo = Gross Domestic Product period 0

**Exchange Rate.** According to Musdholifah & Tony (2007), exchange rate or Kurs is a comparison of one country's currency value with other country currencies. Triyono (2008) also stated that the exchange rate was a conversion between two different currencies, which means a comparison for the value of currencies. For example, the rupiah exchange rate against the US dollar is showing the amount needed to convert into one US dollar.

Furthermore, Nugroho (2008) stated that the exchange rate reflected the balance between demand and offer regarding domestic currency or foreign currency, i.e US dollar. This means that deteriorating in rupiah exchange rate reflects declining people's demand on rupiah as a result of declining of the national economy; otherwise, it is because of the increasing demand on foreign currency as an international transaction tool. In this sense, the foreign currency is USD. Hence, the stronger rupiah exchange rate, until a certain limit, the better performance in the capital market. However, if the inflation rate is increasing, then the domestic exchange rate against foreign currency is weakened. This,

in turn, will be resulted in deteriorating in the company's performance, which led to a weaker investigation in the capital market.

In addition, Tiwari (2003) stated that exchange rates could be divided into two categories: fixed exchange rates and flexible exchange rates. Fixed exchange rates are set by the government, while flexible exchange rates are set by the market with or without government influence in an effort to stabilize monetarily (Kuncoro, 2001).

This study used the middle rate as a proxy of the exchange rate. The average annual rate gauge indicator can be calculated using the following formula:

$$\text{Middle Rate} = \frac{\text{Kurs jual} + \text{kurs beli}}{2}$$

**Previous Studies.** This study indeed is not the first study that features inflation, interest rate, and economic growth: there are several studies that highlight these matters previously. The first study that features these matters is a study done by Noor (2011), titled "Inflation Effect, Interest Rate, and Money Supply on Exchange Rate". This study concluded that in simultaneous inflation, SBI interest rate and the amount of money supply had significant influence towards IDR exchange rate against USD. Partially, however, inflation and SBI interest rate have no significant effect towards IDR exchange rate against USD.

Then, there is a study done by Puspitaningrum et al. (2014), titled "Inflation Effect, SBI exchange rate, and Economic Growth on Rupiah Exchange



Rate – A Study on Bank Indonesia from 2003-2012”. This study concluded that in simultaneous inflation, SBI interest rate and economic growth gave significant influence towards IDR exchange rate against USD. Partially, inflation and economic growth gave a positive and significant impact on the exchange rate, while SBI interest rate variable gave a significantly negative effect on the exchange rate.

Furthermore, there is a study done by Ebiringa and Anyaogu (2014), titled “Exchange Rate, Inflation, and Interest Rate Relationship”. The conclusion of this study is that simultaneously, the inflation variable and SBI interest rate had a significant impact on the exchange rate. On the other hand, simultaneously, only the inflation variable that has a significant impact on the exchange rate.

The last, there was a study done by Theo and Juwita (2013), titled “Interest Rate Impact, Inflation and National Income against Rupiah Exchange Rate in 2008-2012”. This study concluded that different from previous studies, inflation had no significant effect on the rupiah exchange rate in Indonesia in 2008-2012.

**Framework of Thought.** This framework is a temporary explanation of the symptoms that are the object of the problem. The main criterion for a framework to be able to convince the fellow scientists is the logical thinking in constructing a framework that leads to a hypothetical conclusion (Sugiyono, 2004). In other word, frameworks are a synthesis/conclusion

about the relationship between variables compiled from various theories that have been described. Based on those theories, those variables are analyzed critically and systematically in order to produce synthesis/conclusion about the studied relationship between variables. This synthesis of variable relationship is then used to formulate a hypothesis (Sugiyono, 2004).

***Inflation Rate Influence on Exchange Rates.*** According to Madura in Puspitaningrum et al. (2014), changes in the inflation rate can affect the activities of international trade. If a country’s inflation increases, the demand for that country’s currency declines as its exports is also falling (due to high prices). In addition, consumers and domestic companies tend to increase their imports. Both of them will suppress high inflation in a country’s currency. Since there is a difference in the inflation rate between countries, the pattern of international trade and exchange rate will alter accordingly. Furthermore, Keown et al. (2010) explained that the relationship between the inflation rate and economic growth could be explained by the theory of Purchasing Power Parity (PPP).

Long-term changes in the exchange rate are influenced by various international differences on the inflation rate and the purchasing power of a country’s currency; the exchange rate of countries with high inflation tends to decline. According to Purchasing Power Parity (PPP) theory, in the long run, the exchange rate will be adjusted so that the purchasing power of

each currency would tend to be equal. Thus, change in exchange rate tends to reflect international differences on inflation rates.

**Interest Rate and Exchange Rate.** Changes in interest rates tend to influence investment in foreign securities, which will further affect the demand and supply of foreign exchange. This will also affect the exchange rate of the currency. The perfect relationship between the relative interest rate and the exchange rate between two countries is explained by the International Fisher Effect (IFE). Berlianta (2005) argued that the theory of International Fisher Effect showed the movement of one country's currency than any other countries because of the differences in the nominal interest rate in every country. The implication of International Fisher Effect is that people are not able to enjoy higher profits simply by investing in countries with high-interest rates because the currency of a country with high-interest rate will be depreciated by the difference in nominal interest against the country with lower nominal interest rate.

**Influence of Economic Growth on Exchange Rates.** According to Nanga in Puspitaningrum et al. (2014), one form of economic development of a country is through conducting foreign relations, which manifested in international trade involving countries in the world. However, international trade raises a problem for both importing and exporting countries, namely the difference in the value of the currency used by those countries. This theory is supported by research conducted by Puspitaningrum et al. (2014), which stated that simultaneous economic growth affected significantly the Rupiah exchange rate. Ulfia and Aliasudin (2011) reaffirmed that the rupiah exchange rate simultaneously got pressure from economic growth. Based on the previous description, the paradigm/research model can be seen in Figure 1:

**Research Hypothesis**

Based on the theory and frame of thinking that has been described in the previous section, this study has the following hypothesis:

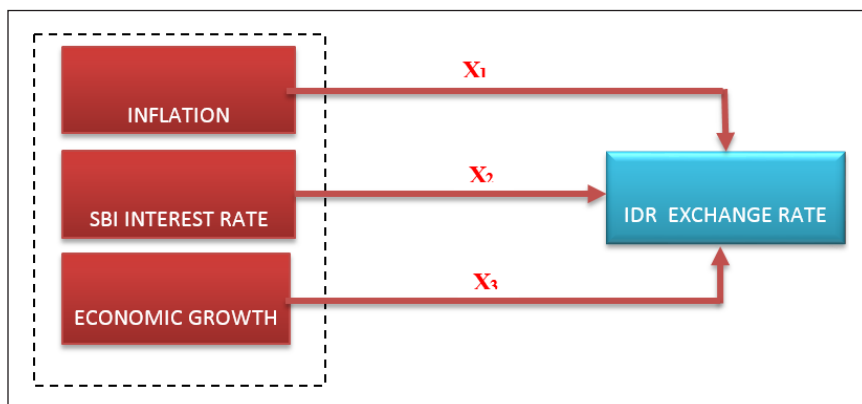

Figure 1. Research model

*H<sub>1</sub>: There is a significant influence between the inflation rate, the SBI rate and the economic growth of the IDR exchange rate towards USD simultaneously*

*H<sub>2</sub>: There is a significant effect between inflation rate and SBI interest rate to IDR exchange rate against USD partially*

*H<sub>3</sub>: There is a significant impact between SBI interest rate on IDR exchange rate against USD partially*

*H<sub>4</sub>: There is a significant influence between economic growth towards IDR exchange rate against USD partially*

## MATERIALS AND METHODS

This research was conducted in order to understand the effect of the inflation rate, SBI interest rate and economic growth against exchange rate of IDR over USD based on a case study at Bank Indonesia period 2000-2016. Type of research used was descriptive research with a quantitative approach, while data analysis technique used was multiple linear regression analysis of mathematical equation as follows:

$$Y = a + b_1X_1 + b_2X_2 + b_3X_3 + E$$

Where,

Y = Exchange rate

X<sub>1</sub> = Inflation rate

X<sub>2</sub> = SBI rate

X<sub>3</sub> = Economic growth

a = Constants

b<sub>1</sub>, b<sub>2</sub>, b<sub>3</sub> = Regression coefficients

E = Nuisance variable

## RESULTS AND DISCUSSIONS

### Multiple Linear Regression Analysis

Multiple linear regression model was used to calculate the magnitude of influence between independent variables, namely inflation rate (X<sub>1</sub>), SBI interest rate (X<sub>2</sub>), and economic growth (X<sub>3</sub>) to the dependent variable, which is IDR to USD (Y) exchange rate. Results of regression coefficient calculation using SPSS program version 22 obtains regression model can be seen in Table 1.

Based on Figure 1, multiple linear regression models are  $Y = -0.619 - 0.626X_1 + 2.091X_2 + 10.717X_3$ . The constant in Figure 1 shows "a" = -0.619, which means that if there is no change in Inflation variable, SBI Interest Rate, and Economic Growth constant (X<sub>1</sub> = X<sub>2</sub> = X<sub>3</sub> = 0), the IDR exchange rate weakens by 0.619 points in a year. The regression coefficient X<sub>1</sub> to Y is -0.626 if SBI interest rate and economic growth is constant (X<sub>2</sub> = X<sub>3</sub> = 0). This means that if Inflation rises to 1%, then the exchange rate weakens by 0.626%.

The regression coefficient of X<sub>2</sub> to Y is 2,091 if the inflation and economic growth is constant (X<sub>1</sub> = X<sub>3</sub> = 0). This means that if the SBI rate rises to 1%, then the exchange rate of IDR against USD strengthens by 2,091%.

Coefficient regression of X<sub>3</sub> to Y is 10.717 if inflation and SBI rate is constant (X<sub>1</sub> = X<sub>2</sub> = 0). This means that if economic growth increases to 1%, then the exchange rate of IDR against USD strengthened by 10.717%.

Table 1  
Multiple Linear Regression model

Model	Unstandardized coefficients		Standardized coefficients	t	Sig.
	B	Std. Error	Beta		
(Constant)	-0.617	0.399		-1.547	0.146
Inflation	-0.626	1.687	-0.146	-0.371	0.716
Interest Rate of SBI	2.091	2.181	0.448	0.959	0.355
Economic Growth	10.717	6.009	0.598	1.784	0.098

Notes: (i) Dependent variable: KURS. (ii) Predictors: (Constant), inflation, SBI rate, economic growth

### Classical Assumption Test

Classical assumption test is conducted in order to ascertain that the obtained regression parity has estimation accuracy, not bias, and consistent. It is necessary to note that there is a possibility that the actual fact does not fulfil the classical assumption. In response, some revisions either rechecking data or recollecting data is highly advisable. Classical assumption test in this study involves the normality test and multicollinearity test.

**Normality Test.** Normality test is a test conducted with an aim to assess the distribution of data in a group of data or variables, whether the distribution of data is normally distributed or not. The normality test is useful for determining which collected data has been normally distributed or taken

from the normal population. Based on the empirical experience of some statisticians, the data of more than 30 numbers ( $n > 30$ ) can be assumed to be normally distributed. This method is commonly said as a large sample. Nonetheless, it is highly recommended to do the normality test in order to clarify whether the obtained data is normally distributed or not. Verification through this test is important since it is not yet certain that the data of more than 30 is normally distributed, and vice versa.

Table 2 shows that if Sig. Kolmogorof-Smirnov test  $> 0.05$ , the data is normally distributed, and vice versa. The inflation variables, economic growth and exchange rates have Sig. greater than 0.05; therefore,  $H_0$  is accepted, and the data is normally distributed.

Table 2  
Tests of normality

Model	Statistic	Kolmogorov-Smirnova		Statistic	Shapiro-Wilk	
		df	Sig.		df	Sig.
Inflation	0.170	17	0.200*	0.922	17	0.160
Interest rate of SBI	0.201	17	0.066	0.865	17	0.018
Economic growth	0.143	17	0.200*	0.953	17	0.513
Exchange rate	0.193	17	0.093	0.920	17	0.146

Note: \*This is a lower bound of real significance

**Multicollinearity Test.** Multicollinearity test is used to understand whether there is a deviation of the classical assumption of multicollinearity or not, that is the existence of a linear relationship between the independent variable in the regression model. The prerequisite requirement that must be met in the regression model is the absence of multicollinearity. There are several testing methods that can be used among others, that are: 1) by looking at the value of inflation factor (VIF) in the regression model, 2) by comparing the value of coefficient of individual determination (R squared) with the value of determination simultaneously (R squared),

and 3) by observing the eigenvalue and index values. In this section, this study shows multicollinearity test by observing at the value of inflation factor (VIF) in the regression model and comparing the value of individual determination coefficient (R squared) with the value of determination simultaneously (R squared).

In basic decision making, if the VIF value <10, there will be no symptom of multicollinearity among independent variables, and vice versa. In Table 3, variable inflation, SBI rates and economic growth have VIFs less than 10, so there is no multicollinearity.

Table 3  
*Test of multicollinearity*

Model	Correlations			Collinearity Statistics	
	Zero-order	Partial	Part	Tolerance	VIF
(Constant)					
Inflation	0.290	0.142	0.130	0.395	2.533
Interest rate of SBI	0.107	0.103	0.093	0.277	3.605
Economic growth	0.269	0.302	0.286	0.539	1.855

**Hypothesis Test Results**

Hypothesis testing is a procedure performed with the purpose of deciding whether to accept or reject the hypothesis. In testing the hypothesis, the made decision is uncertain, which means that the decision could be true or false that will be causing risk; the magnitude of risk is expressed in terms of probability. Hypothesis testing is the most important part of statistical inference (inductive statistics) since decision-making

or problem solving as a basis for further research can be resolved based on these tests.

**Coefficient Determination Test Results**

Based on Table 4, R squared coefficient value on the obtained results is 0.211. This means that 21.1% of the IDR exchange rate variable is affected by independent variables, namely the inflation rate (X1), SBI interest rate (X2) and economic growth

(X3). On the other hand, the remaining 78.9% of the IDR variable exchange rate is affected by other variables that are not discussed in this study. The percentage coefficient of determination can be said to

be weak because of less than 50%. This is because the change of IDR exchange rate is influenced by multiple complex factors that can come from domestic and abroad (global).

Table 4  
*Correlation and determination coefficients*

Model	R	R-square	Adjusted R-square	Std. error of the estimate
1	0.459a	0.211	0.029	0.1608779

Notes: (i) Predictors: (Constant), economic growth, inflation, SBI interest rate. (ii) Dependent variable: Exchange rate.

**Simultaneous Test Results (F-Test)**

The F-Statistic test is conducted to determine the influence of all independent variables simultaneously to the dependent variable.

Based on Table 5, obtained F estimation of 1.158 and F table with alpha 5% = 3.41. Thus, it is decided that H0 is accepted

while Ha is rejected. In other words, this means that, together, independent variables covering the rate of inflation, SBI interest rates and economic growth have no significant effect on the dependent variable, that is the exchange rate of IDR.

Table 5  
*Simultaneous test results (Test F)*

Model	Sum of squares	df	Mean square	F	Sig
Regression	0.090	3	0.030	1.158	0.363b
Residual	0.336	13	0.026		
Total	0.426	16			

Notes: (i) Dependent variable: Exchange rate. (ii) Predictor: (Constant), economic growth, inflation, SBI interest rate.

**Partial Test Results (T-test)**

The T-test is known as a partial test. This test is conducted in order to determine how each independent variable individually influences the dependent variable. This test can be done by comparing T-count with t table or by charting at the significant column at each T-arithmetic, T-test process is identical with

F-test (see SPSS calculation on Coefficient Regression Full Model/Enter) or it can be replaced by Stepwise Test method. The T-test is used to test the partial coefficient regression of the independent variables.

Based on the partial test table that presented in Table 6, it can be explained that the inflation rate variables have T-value of

Table 6  
*T-test*

Model	Unstandardized coefficients		Standardized coefficients	t	Sig.
	B	Std. Error	Beta		
(Constant)	-0.617	0.399	table	-1.547	0.146
Inflation	-0.626	1.687	-0.146	-0.371	0.716
Interest rate of SBI	2.091	2.181	0.448	0.959	0.355
Economic growth	10.717	6.009	0.598	1.784	0.098

-0.371 and T-alpha of - 1.771. This means that H<sub>0</sub> is accepted, while H<sub>a</sub> is rejected; so, it can be concluded that the inflation rate variable partially has no effect on the exchange rate of IDR. SBI interest rate variable has T-value of 0.959 and T-alpha 1.771. This means that H<sub>0</sub> is accepted, while H<sub>a</sub> is rejected; so it can be concluded that the SBI interest rate variable partially has no effect on the exchange rate.

The economic growth variable measured by Gross Domestic Product (GDP) has a T-value of 1.784 with an alpha value of 1.771. This means H<sub>0</sub> rejected, while H<sub>a</sub> accepted; so it can be concluded that the variable of economic growth partially has a significant effect on the exchange rate of IDR.

## CONCLUSIONS

The purpose of this research was to discover the influence of independent variable rate of inflation, SBI interest rate and economic growth to the dependent variable of IDR rate over USD from 2000 to 2016. Based on the results of research and discussion, it can be concluded that there is no simultaneous influence between independent variables, including inflation rate, SBI interest rate and economic growth, on the dependent

variable of IDR rate. This is showed by the simultaneous test (F-test) which shows F-arithmetic = 1.158 smaller than F-table = 3.41 at 95% confidence level; 2) Inflation rate, SBI rate and economic growth have an effect of 21.1%. This is addressed by the coefficient determination test while the remaining 78.9% of the variable exchange rate of IDR is influenced by other variables that are not discussed in this study; 3) Inflation rate variable, SBI interest rate partially has no effect on exchange rate IDR. This is shown with 95% level of confidence; 4) The variable of economic growth partially affect the exchange rate, where T-arithmetic = 1.784 is greater than T-table = 1.771.

## ACKNOWLEDGEMENT

The authors wish to acknowledge and thank all IMHA 2018 committee members and UPM *Pertanika* journal team that help publish this article.

## REFERENCES

- Berlianta, H. C. (2005). *Knowing foreign exchange*. Yogyakarta, Indonesia: Gadjah Mada University Press.
- Delta, A. A. P. (2016). The effect of Rupiah/US\$ exchange rate inflation and SBI interest rate on composite stock price index (CSPI) in Indonesia



- stock exchange. *International Conference On Education* (pp. 202-214). Malang, Indonesia: International Conference on Education.
- Ebiringa, O. T., & Anyaogu, N. (2014). Exchange rate, inflation and interest rates relationships: An autoregressive distributed lag analysis. *Journal of Economics and Development Studies*, 2(2), 263-279.
- Friedman, M. (1976). *Inflation and unemployment*. Nobel Memorial Lecture, USA. The University of Chicago.
- Hady, H. (2016). *Manajemen keuangan internasional (Edisi 4)* [International Financial Management, 4<sup>th</sup> ed.]. Bogor, Indonesia: Mitra Wacana Media
- Hartati, E. S. and Oktaviani, R. (March 26, 2015). *Elaborating and Taming the Economy Cartel*. Discussion event at the Institute for Development of Economics and Finance office, Jakarta.
- Keown, A. J., Martinet, J. H., Petty, J. W., & Scott, D. F. (2010). *Financial management* (10th ed.). Jakarta, Indonesia: PT Index.
- Kuncoro, M. (2001). *Metode penelitian kuantitatif* [Quantitative research methods]. Yogyakarta, Indonesia: UPP AMP YKPM.
- Latumaerissa, J. R. (2015). *Indonesian economy and global economic dynamics*. Jakarta, Indonesia: Mitra Wacana Media.
- Madura, J. (2006). *Keuangan perusahaan internasional* (Edisi 8) [International corporate finance (8th ed.]. Jakarta, Indonesia: Salemba Empat.
- Mishkin, F. S. (February 2008). *Does stabilizing inflation contribute to stabilizing economic activity?* In *East Carolina University's Beta Gamma Sigma Distinguished Lecture Series, Greenville, North Carolina*. Board of Governors of the Federal Reserve System (U.S.).
- Nanga, M. (2005). *Makro ekonomi: teori, masalah, dan kebijakan* [Macro economics: Theories, problems, and policies]. Jakarta, Indonesia: PT Raja Grafindo Persada.
- Noor, Z. Z. (2011). Pengaruh Inflasi, Suku Bunga, dan Jumlah Uang Beredar terhadap Nilai Tukar [Effects of Inflation, Interest Rates, and Amount of Money Supply on Exchange Rates]. *Trikonomika*, 10(2), 139-147.
- Nugroho, H. (2008). *Analisis pengaruh inflasi, suku bunga, kurs dan jumlah uang beredar terhadap indeks Lq45 (Studi Kasus Pada BEI Periode 2002-2007)* [Analysis of the effect of inflation, interest rates, exchange rates and money supply on the Lq45 index (Case Study on the Indonesia Stock Exchange Period 2002-2007)] (Master's thesis), Universitas Diponegoro, Indonesia.
- Puspitaningrum, R., Suhadak, & Zahroh, Z. A. (2014). Pengaruh tingkat inflasi, tingkat suku bunga SBI, dan pertumbuhan ekonomi terhadap nilai tukar rupiah studi pada Bank Indonesia periode tahun 2003-2012 [Influence of inflation, SBI interest rates, and economic growth on rupiah exchange rate, study at Bank Indonesia for the period 2003-2012]. *Jurnal Administrasi Bisnis (JAB)*, 8(1), 1-9.
- Rahardja, P., & Manurung, M. (2008). *Teori ekonomi makro edisi keempat* [Macroeconomic theory fourth edition]. Jakarta, Indonesia: Lembaga Penerbit FE UI.
- Samuelson, P. A., & Nordhaus, W. D. (2004). *Ilmu makro ekonomi: Edisi Bahasa Indonesia* [Macroeconomics: Indonesian Edition]. Jakarta, Indonesia: PT Media Global Edukasi.
- Sugiyono. (2004). *Metode penelitian bisnis, cetakan keenam* [Business Research Methods, sixth edition]. Bandung, Indonesia: Alfabeta.
- Sunariyah. (2006). *Pengantar pengetahuan pasar modal* [Introduction to capital market]. Yogyakarta, Indonesia: UPP STIM YKPN.
- Sundjaja, R. S., & Barlian, I. (2003). *Manajemen keuangan satu, edisi kelima*. [Financial

- Management 1, fifth edition]. Jakarta, Indonesia: Literata Lintas Media.
- Suryowati, E. (2015). *Coordinating minister for the economy: Rupiah toward fundamental*. Retrieved May 15, 2018, from <http://www.kompas.com>
- Suryowati, E. (2016). *Economic growth in 2015 lowest in the last six years*. Retrieved May 15, 2018, from <http://www.kompas.com>
- Theo, W. and Juwita, R. (2013). *Pengaruh Suku Bunga, Inflasi, Dan Pendapatan Nasional Terhadap Nilai Tukar Rupiah Tahun 2008-2012 [The Influence of Interest Rates, Inflation, and National Revenues on Rupiah Exchange Rates 2008-2012]*. Thesis. Department of Management in STIE (Institute of Economic Science) MDP.
- Tiwari, R. (2003). *Post-crisis exchange rates regimes in Southeast Asia: An empirical survey of the facto policies*. Hamburg, Germany: University of Hamburg.
- Triyono. (2008). Analisis perubahan kurs Rupiah terhadap Dollar Amerika [Analysis of changes in the Rupiah exchange rate against the US Dollar]. *Jurnal Ekonomi Pembangunan*, 9(2), 156-167.
- Ulfia & Aliasuddin. (2011). Revenue relations and exchange rate in Indonesia. *Journal of Economics and Development*, 2(1), 33-44.
- Utami, S. S. (2017). *Sri Mulyani: Last 10 years, Indonesia's economy highest compared to developing countries*. Retrieved May 15, 2018, from <http://metrotvnews.com>



## **The Effect of Banking Efficiency, Earnings Per Share and Price-Earnings Ratio towards the Stock Return of Banking Companies in Indonesia**

**Rahmat Siauwijaya**

*Department of Accounting, Faculty of Economics and Communication, Bina Nusantara University,  
Jl. K.H. Syahdan No. 9, Jakarta Barat 11480, Indonesia*

### **ABSTRACT**

This research made use of 33 samples obtained from various banking industries listed in the Indonesia Stock Exchange (IDX) between 2012 and 2016. The data used in this study was secondary data in the form of annual financial statements and stock prices. Data Envelopment Analysis (DEA) and a quantitative approach were used to calculate the various banking efficiency levels. Multiple linear regression analysis was also used to examine the relationship between the dependent and independent variables. Based on the hypothesis testing results, banking efficiency partially did not influence stock return, however, earnings per share and the price-earnings ratio were shown to have a partial positive influence on stock return. The results of the hypothesis testing simultaneously showed that banking efficiency, earnings per share, and price-earnings ratio influenced stock return.

*Keywords:* Banking efficiency, data envelopment analysis, earnings per share, price-earnings ratio, stock return

### **INTRODUCTION**

Banking plays an essential role in the economic growth of a country. Banks act as a financial institution whose sole responsibility is to collect funds and redistribute them in the form of credit.

Asides collecting funds through their branch offices, banks are also able to obtain them through the capital market by trading its shares. Investors who buy these bank stocks through the capital market expect high returns, and in order to meet the expectations of these investors, the banking industry must be able to maintain its reputation. Banking is the most heavily regulated industry. Every decision made in this industry should be aimed at producing a healthy, strong, and stable banking system. Only when this fact is accepted by the banking

#### **ARTICLE INFO**

*Article history:*

Received: 09 October 2019

Accepted: 03 January 2020

Published: 17 March 2020

*E-mail address:*

rahmat.siauwijaya@binus.ac.id

industry will the bank be able to perform its function as a financial intermediary optimally (Qurniawati, 2013).

Beccalli et al. (2006) provided an insight into the banking industry with regard to factors affecting the stock return. The results indicated that the percentage change in stock prices reflected the percentage change in cost efficiency. This, in turn, suggests that stocks of cost-efficient banks tend to outperform their inefficient counterparts. Vardar's (2013) empirical results reveal that changes in profit efficiency estimates have a positive and significant impact on stock return. Chan and Karim (2014), found that there existed a relationship between banking efficiency in a number of Southeast Asian countries and stock returns. Margaretha and Damayanti's (2008) research results showed that the price earning ratio did affect the stock return. Bukit and Anggono (2013) stated that the price-earnings ratio and earnings per share had a positive and significant effect on stock return in the LQ 45. Cahyaningrum and Antikasari (2017) also provided evidence that earnings per share positively affected the stock return.

Efficiency is essentially a comparison between input and output. A bank is efficient if it uses a lesser number of input units when compared to other banks in generating the same output, or if it uses the same input unit to produce a larger amount of output. More efficient banks will generally outperform less efficient banks. Permono and Darmawan (2000) stated that there were four factors that affected the efficiency of the company, those are efficiency owing to

the economic arbitration, efficiency due to the accuracy of basic asset evaluation, the efficiency owing to the fact that the financial institutions are able to anticipate the risks that will arise, and the efficiency associated with payment mechanisms performed by a financial institution. Siauwijaya's (2016) study concluded that state-owned banks (BUMN) were most efficiently followed by non-foreign exchange national private Banks (BUSN).

An efficient bank is one that is able to generate profits and returns for its larger investors. Efficiency in the banking world is one of the most popular and widely used performance parameters because it is the answer to the various difficulties associated with calculating bank performance measures. Oftentimes, when the calculation of the level of earnings shows good performance, it is not categorized as "healthy" nor does it exceed regulatory standards (Hadad et al., 2003).

According to the Indonesian Banking Regulation No. 6/25/PBI/2004, operational cost and operating income ratio (BOPO) is a measure of efficiency often used to provide an assessment banking efficiency performance. The BOPO ratio compares the operational cost with operating income, and this ratio is used to ease calculation and usage. However, the BOPO ratio is a traditional approach to measure the cost efficiency of a bank. Furthermore, it is unable to describe the actual conditions of a bank, and the results are not easy to interpret. Instead, the cost frontier analysis approach is one that can be used to assess the efficiency of a bank and is more appropriate than

the traditional accounting approach. This approach calculates the maximum amount of costs incurred to produce a financial service product using the same number of output combinations. There are two kinds of frontier approaches used in assessing efficiency namely the non-parametric approach that is Data Envelopment Analysis (DEA), and the parametric approach which makes use of the stochastic frontier analysis (SFA) (Qurniawati, 2013).

This research is the development of previous research that relates financial ratios with a stock return by adding one variable: banking efficiency, which is suspected to influence stock return. Measurement of banking efficiency in this study makes use of a non-parametric approach that is data envelopment analysis (DEA). This approach is tested with multiple linear regression analysis to examine the relationship between the dependent variable and the independent variable. This research has not been found in any literature. The purpose of this research is to determine the effect of bank efficiency, with regards to earnings per share, price-earnings ratio, and stock returns of banking companies. In addition, this research will also provide information for investors and potential investors about the variables studied.

## Literature Review

**Signal Theory.** Signal theory indicates the existence of asymmetry information between the management company and the parties concerned with the information. In that respect, managers need to provide

information to interested parties through the issuance of financial statements. Godfrey et al. (2010) beam that signal theory suggests how a company should “signal” the financial reporter. This signal manifests in the form of information regarding what has been done by the management to realize the desire of the owner.

**Banking Efficiency.** Hadad et al. (2003), stated that the objective of research on banking efficiency was to obtain an accurate frontier, using the parametric approach as well as the DEA approach. Both use different techniques to achieve their goals. The parametric approach produces a stochastic cost frontier while the DEA approach produces a production frontier. Several studies that use DEA to assess banking efficiency include Oral et al. (1992), Golany and Storbeck (1999), Saha and Ravisankar (2000), Sathye (2001), Akhtar (2002), Hadad et al. (2003), and Siauwijaya (2016).

**Earnings Per Share (EPS).** Weygandt et al. (2013) claimed that earnings per share (EPS), defined simply as the earnings obtained per share of the company, was a useful measurement tool for comparing the earnings of an entity from time to time in the event of a change of capital structure.

$$EPS = \frac{\text{Net profit after tax}}{\text{Number of shares outstanding}}$$

**Price-Earnings Ratio (PER).** The price-earnings ratio is a measure of the relative price of a company’s stock. The higher the

growth of the expected revenue, the higher the PER. Theoretically, it is an indicator that can be used to determine whether a particular stock price is overvalued or undervalued. It can also be used to determine when stocks should be bought or sold (Jogiyanto, 2009). According to Weygandt et al. (2013), PER is a comparison between the market price per share with the earnings per share.

$$PER = \frac{\text{Market Price Per Share}}{\text{Earnings Per Share}}$$

**Return.** Return is defined as the result of investment in the form of realized return and expected return (Hardiningsih et al., 2002). Ang (1997) stated that any long-term or short-term investment's main purpose was to obtain returns, either directly or indirectly. According to Darmadji and Fakhrudin (2012), profits obtained by investors by buying or owning stocks include dividends and capital gains. A dividend is a share of the profits that the issuing company provides from the gains generated by the company. Dividends issued by a company can be either cash dividends or stock dividends. Capital gain is the difference between the purchase price and the selling price. Capital gain is obtained by the activity of stock trading in the secondary market.

## METHODS

### Sample

Sample banks used in this study were as many as 33 banks listed on the Indonesia Stock Exchange. Samples were chosen by

using a purposive sampling method where not all of the population are used as samples, a selection must meet certain criteria. The criteria used in this study were banks that have consecutively published their financial statements during the period of 2012-2016.

### Variables

This research used banking efficiency variables namely earnings per share (EPS) and price-earnings ratio (PER) as independent variables; and stock return as the dependent variable.

### Data Collecting Method

Data collection was collected by observing the financial statements obtained from the Indonesia Stock Exchange website. The collected data are financial data which includes: the amount of credit, amount of deposits, operating income, earnings per share, price earning per share and closing stock prices.

### Data Analysis Method

This research used two types of analysis, to conduct estimation and efficiency analysis using data envelopment analysis (DEA), and both statistics tests will use multiple linear regression analysis. The results will be displayed in the form of tables and graphs generated with DEAP 2.1 and E-Views version 9.

### Data Envelopment Analysis (DEA)

DEA is a mathematical program optimization method that measures the efficiency of



a unit's technique of economic activity and compares it relative to other units of economic activity (UEA). DEA was first developed by Farrell (1957) to measure the efficiency of one input and one output technique. Initially, DEA was popularized by Charnes, Cooper, and Rhodes (1978) with the constant return to scale (CRS) method and was developed by Banker et al. (1984) to a become variable return to scale (VRS), which eventually became known as CCR (Charnes Cooper Rhodes) and BCC (Bankers Charnes Cooper).

### Data Panel Regression

According to Ajija et al. (2011), pooled data is a combination of time series data and cross-section data. By combining both information related to cross-section and time-series variables, panel data can substantially reduce the issue of omitted-variables, a model that ignores the relevant variables (Wibisono, 2005). To overcome the intercorrelation among the independent variables that may ultimately lead to an inappropriate appraisal of regression, the panel data method is more appropriate to use (Griffiths, 2001). Regression analysis is used in this research to investigate how big an influence banking efficiency is, its earnings per share (EPS), and its price-earnings ratio (PER). The multiple linear regression analysis equations used in this research is:

$$Y = \beta_0 + \beta_1 X_1 + \beta_2 X_2 + \beta_3 X_3 + \mu$$

Where,

Y = Stock return

$\beta_0$  = Constant

$\beta$  = Regression coefficient of independent variable

$X_1$  = Banking efficiency

$X_2$  = Earnings per share (EPS)

$X_3$  = Price-earnings ratio (PER)

$\mu$  = error term

## RESULTS AND DISCUSSIONS

### Data Envelopment Analysis

The efficiency of this study was calculated using the DEA approach as done by Banker et al. (1984), Effendi et al. (2012), and Siauwijaya (2016), where the DEA model used had variable return to scale with input orientation. Mathematically the DEA model for bank  $i$  and time  $t$  can be written as follows:

$$\text{Min } \delta, \alpha, \delta, \alpha$$

st

$$-q_{it} + Q\alpha \geq 0, -q_{it} + Q\alpha \geq 0,$$

$$\delta x_{it} - X\alpha \geq 0, \delta x_{it} - X\alpha \geq 0,$$

$$II'\alpha = III'\alpha = I$$

$$\alpha \geq 0, \alpha \geq 0$$

Where  $\delta$  denotes technical efficiency with a score of  $0 \leq \delta \leq 10 \leq \delta \leq 1$ ,  $\delta = 1$  indicates the efficiency points on the frontier, and  $II'\alpha = I$  shows the condition of the return to scale variable. An intermediation approach is used to determine the input and outputs in this research based on Law Number 10 Year 1998 regarding banking. The law stipulates that banks in Indonesia functions as an

intermediary institution that collects funds in the form of deposits, and distributes them as credit. Table 1 shows the input and output to calculate technical efficiency.

There are three input variables in this research. Firstly, total deposits, which comprises of demand deposits, savings deposits, time deposits and deposits from other banks. Secondly, personnel expenses, which include salaries and wages. Other administrative expenses include rent and promotion. Thirdly, interest expense and commission paid including all expenses paid by banks in the form of interest expense

in rupiah and foreign currency. This also includes commissions and fees paid by banks in the form of commissions or loan provisions.

There are two output variables in this research. Firstly, the total loans provided, which comprises of the credits granted by banks to debtors. Secondly, interest income and commissions received, which include all bank income in the form of interest in rupiah and foreign currency in its operational activities along with commission income and provisions received in the framework of granting credit.

Table 1  
*Intermediation approach input and output selection*

Code	Variable	Input/Output	Source
$X_1$	Total deposit	Input	Balance sheet
$X_2$	Personnel and administrative expenses	Input	Profit and loss
$X_3$	Interest expense and commission	Input	Profit and loss
$Y_1$	Total credit	Output	Balance sheet
$Y_2$	Interest and commission income	Output	Profit and loss

### Bank Efficiency Calculation Result

Figure 1 and Table 2 shows the results of technical efficiency calculations of 33 banks listed on the Indonesia Stock Exchange along with movement charts from 2012-2016.

Figure 1 shows the technical efficiency improvement of each bank during the study period. It is generally seen that the technical efficiency of each bank is moving dynamically. The increase and decrease in the efficiency level of banks are owing to the higher level of bank competition so that all banks operate with efficiency. This can be

seen in Figure 1, where the efficiency of the bank that was previously inefficient became more efficient. The ability of banks in managing the transformation of inputs into outputs is crucial to how technical efficiency can be driven by each of these banks.

Table 2 shows how the efficiency of each bank moves each year. In general, the technical efficiency of banks is 0.863, 0.903, 0.869, 0.903, 0.920 for 2012, 2013, 2014, 2015 and 2016 respectively. In 2012, 2013, 2014, 2015 and 2016 there are 13, 13, 8, 11, and 14 banks with an efficiency rate of 100%.

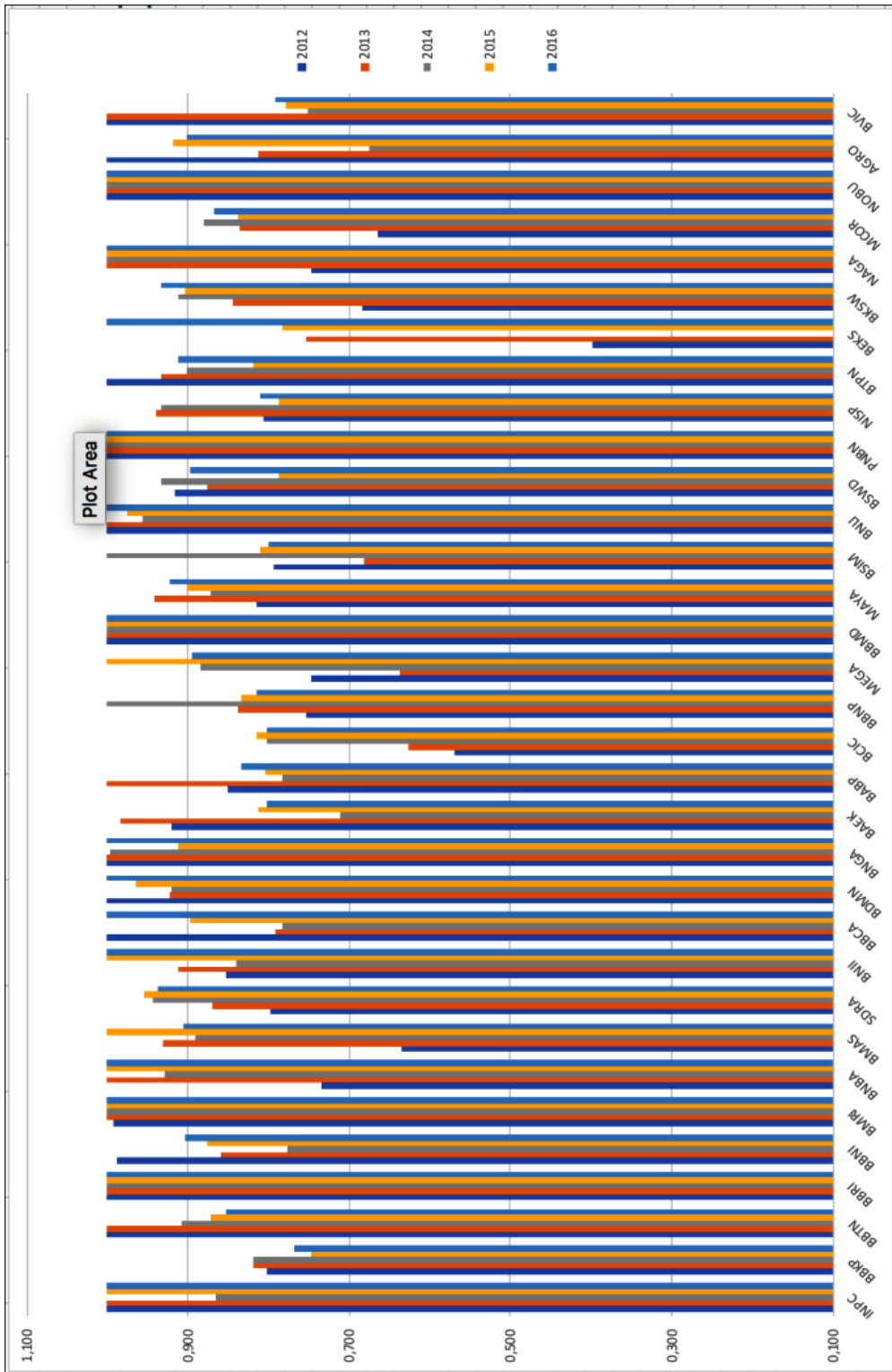

Figure 1. Development of the bank's technical efficiency

Table 2  
*Results of the bank's technical efficiency calculation*

No.	Bank	2012	2013	2014	2015	2016
1	INPC	1.000	1.000	0.866	1.000	1.000
2	BBKP	0.802	0.819	0.818	0.747	0.769
3	BBTN	1.000	1.000	0.907	0.872	0.853
4	BBRI	1.000	1.000	1.000	1.000	1.000
5	BBNI	0.989	0.860	0.777	0.876	0.903
6	BMRI	0.993	1.000	1.000	1.000	1.000
7	BNBA	0.735	1.000	0.928	1.000	1.000
8	BMAS	0.634	0.931	0.890	1.000	0.905
9	SDRA	0.798	0.869	0.943	0.954	0.938
10	BNII	0.852	0.911	0.840	1.000	1.000
11	BBCA	1.000	0.791	0.784	0.897	1.000
12	BDMN	1.000	0.922	0.921	0.964	1.000
13	BNGA	1.000	1.000	0.997	0.911	1.000
14	BAEK	0.921	0.983	0.712	0.812	0.801
15	BABP	0.850	1.000	0.783	0.804	0.834
16	BCIC	0.570	0.626	0.802	0.815	0.802
17	BBNP	0.753	0.837	1.000	0.833	0.815
18	MEGA	0.747	0.638	0.884	1.000	0.895
19	BBMD	1.000	1.000	1.000	1.000	1.000
20	MAYA	0.815	0.941	0.871	0.901	0.923
20	BSIM	0.793	0.682	1.000	0.810	0.800
22	BNLI	1.000	1.000	0.957	0.975	1.000
23	BSWD	0.916	0.875	0.933	0.787	0.897
24	PNBN	1.000	1.000	1.000	1.000	1.000
25	NISP	0.807	0.939	0.933	0.787	0.810
26	BTPN	1.000	0.932	0.901	0.818	0.912
27	BEKS	0.398	0.753	0.651	0.783	1.000
28	BKSW	0.683	0.844	0.912	0.903	0.932
29	NAGA	0.746	1.000	1.000	1.000	1.000
30	MCOR	0.665	0.835	0.880	0.838	0.867
31	NOBU	1.000	1.000	1.000	1.000	1.000
32	AGRO	1.000	0.812	0.675	0.918	0.901
33	BVIC	1.000	1.000	0.752	0.778	0.791
Average		0.863	0.903	0.869	0.903	0.920

### Panel Data Regression Analysis

After calculating the bank's efficiency using DEA, the regression test was conducted to see the effect of banking efficiency, earnings

per share (EPS), the price-earnings ratio (PER) on stock return. Table 3 displays the results of the panel data regression analysis using the pooled least square model.

Table 3  
*Panel data regression analysis results*

Variable	Coefficient	Std. Error	t-Statistic	Prob.
Efficiency	0.093238	0.299391	0.311425	0.7562
Earning Per Share	0.000222	8.94E-05	2.485654	0.0147
Price Earnings Ratio	0.000812	0.000260	3.122932	0.0024
Coefficient	-0.184983	0.274259	-0.674485	0.5016
R-squared		0.149770		
Adjusted R-squared		0.123201		
S.E. of regression		0.207907		
Sum squared resid		4.149648		
Log-likelihood		17.21349		
F-statistic		5.636888		
Prob(F-statistic)		0.001334		
Mean dependent var		-0.037230		
S.D. dependent var		0.222034		
Akaike info criterion		-0.264270		
Schwarz criterion		-0.160063		
Hannan-Quinn criter.		-0.222095		
Durbin-Watson stat		2.309494		

### **The Effect of Banking Efficiency on Stock Return**

Banking efficiency does not have a significant effect on the banking industry, this is because banking efficiency is only presumed to describe the company's ability to manage input variables and output variables, thus not affecting the stock return. Another reason why the calculation of banking efficiency through the DEA method is not published in the financial statements of the company is owing to its specific characteristics and the fact that less attention is paid to investors. This is also supported by the trend of Indonesian investors who are currently only focused on short-term gains or capital gains. This result is in accordance with Maharani (2012)

and Qurniawati (2013) research, which concluded that efficiency did not affect the stock return.

### **The Effect of EPS on Stock Return**

Earning per share (EPS) has a positive effect on stock return. Companies with higher EPS will attract investors as EPS shows the profits that shareholders deserve to get per share owned. Therefore, the higher the value of a company's EPS the greater return on shares. This means that investors pay attention to the ability of the company in generating a net profit on each sheet of stock before making a decision to buy or sell shares. This result is in accordance with the research conducted by Hermawan (2012), and Bukit and Anggono (2013),

stating that earnings per share affect the stock return. Imron (2009) claimed that the bigger the EPS showed the company's better performance because the rate of return was greater.

### **The Effect of Price-Earnings Ratio on Stock Return**

The price-earnings ratio positively affects the stock return. The positive relationship between price-earnings ratio and stock return indicates that if there is an increase in the value of the firm's price-earnings ratio then the stock return will also increase. The increase in price-earnings ratio occurs because of the increase in stock price or decline in the value of earnings per share. This result is in accordance with research by Margaretha and Damayanti (2008), and Aras and Yilmaz (2008), providing evidence that the price-earnings ratio positively influences stock return.

### **The Effect of Banking Efficiency, Earnings per Share and Price-Earnings Ratio Towards a Stock Return**

Based on test results obtained, the F-statistics equals 5.636888 with a p-value of 0.001334, while the value of the F table ( $df_1 = 3$ ,  $df_2 = 96$  dan  $\alpha = 0.05$ ) obtained is 2.699393. It can, therefore, be concluded that  $H_0$  is rejected and  $H_1$  is accepted. This ultimately means that together, the independent variables of banking efficiency, earnings per share and price-earnings ratio affect the dependent variable that is a stock return.

## **CONCLUSIONS**

As identified in the introduction, the purpose of this research is to determine the effect of bank efficiency, with regards to earnings per share, price-earnings ratio, and stock returns of banking companies, and to provide information for investors and potential investors about the variables studied. The more specific conclusions are banking efficiency has no effect on stock return, earnings per share partially have a positive effect on stock return, the price-earnings ratio partially has a positive effect on stock return, banking efficiency, earnings per share and price-earnings ratio simultaneously affect the stock return. These results would be very important in response to international changes and regulations, as well as for the investors to make decisions on their portfolio for investment.

## **ACKNOWLEDGEMENT**

The author wishes to acknowledge and thank all IMHA 2018 committee members and UPM *Pertanika* journal team that help publish this article.

## **REFERENCES**

- Ajija, S. R., Sari, D. W., Setianto, R. H., & Primanti, M. R. (2011). *A smart way to master e-views*. Jakarta, Indonesia: Salemba Empat.
- Akhtar, M. H. (2002). X-efficiency analysis of commercial banks in Pakistan: A preliminary investigation. *The Pakistan Development Review*, 41(4), 567-580.
- Ang, R. (1997). *Buku pintar pasar modal indonesia* [The intelligent guide to Indonesian capital market]. Jakarta, Indonesia: Mediasoft Indonesia.

- Aras, G., & Yilmaz, M. K. (2008). Price earnings ratio, dividend yield and market to book ratio to predict return on stock market: Evidence from the emerging markets. *Journal of Global Business and Technology*, 4(1), 18-30.
- Banker, R. D., Charnes, A., & Cooper, W. W. (1984). Some model for estimating technical and scale inefficiencies in data envelopment analysis. *Management Science*, 30(9), 1078-1092.
- Beccalli, E., Casu, B., & Girardone, C. (2006). Efficiency and stock performance in European banking. *Journal of Business Finance and Accounting*, 33(1-2), 245-262.
- Bukit, I. N. H., & Anggono, A. H. (2013). The effect of price to book value (PBV), dividend payout ratio (DPR), return on equity (ROE), return on assets (ROA) and earning per share (EPS) toward stock return of LQ 45 for the period of 2006-2011. *Review of Integrative Business and Economics Research*, 2(2), 22-43.
- Cahyaningrum, Y. W., & Antikasari, T. W. (2017). Effect of earning per share, price to book value, return on asset, return on equity against stock price financial sector. *Journal Economia*, 13(2), 191-200.
- Chan, S. G., & Karim, M. Z. (2014). Bank efficiency and stock returns in selected ASEAN countries. *Argumenta Oeconomica*, 2(33), 5-20.
- Charnes, A., Cooper, W. W., & Rhodes, E. (1978). Measuring the efficiency of decision-making units. *European Journal of Operational Research*, 2(6), 429-444.
- Darmadji, T., & Fakhruddin, H. (2012). *Capital market in Indonesia a question and answer approach*. Jakarta, Indonesia: Salemba Empat.
- Effendi, N., Setiawan, M., Emvalomatis, G., & Lansik, A. O. (2012). *Banking efficiency and macroeconomic factors: Evidence from Indonesian banking sector* (Working Paper FEB UNPAD No. 35). Bandung, Indonesia: Universitas Padjadjaran.
- Farrell, M. J. (1957). The measurement of productive efficiency. *Journal of the Royal Statistical Society. Series A (General)*, 120(3), 253-290.
- Godfrey, J., Hodgson, A., Tarca, A., Hamilton, J., & Holmes, S. (2010). *Accounting theory*. New York, USA: Wiley.
- Golany B., & Storbeck, J. E. (1999). A data envelopment analysis of the operational efficiency of bank branches. *Interfaces*, 29(3), 14-26.
- Griffiths, W. E. (2001). *Undergraduate econometrics* (2nd ed.). New York, USA: John Willey & Sons, Inc.
- Hadad, M. D., Santoso, W., Ilyas, D., & Mardanugraha, E. (2003). *Analysis of the efficiency of Indonesian banking industry: Use of nonparametric data envelopment analysis (DEA) method* (Working Paper Bank Indonesia), 7(5), 1-28.
- Hardiningsih, P., Suryanto, L. & Chariri, A. (2002). The influence of fundamental and economic risk factors on stock returns in companies in Jakarta stock exchange. *Journal of Business Strategy*, 8(4), 83-96.
- Hermawan, D. A. (2012). Effect of debt to equity ratio, earning per share and net profit margin on stock return. *Management Analysis Journal* 1(5), 1-6.
- Imron, R. (2009). Relationship of financial performance with stock return. *Journal of Accounting and Finance*, 1(1), 180-187.
- Jogiyanto, H. (2009). *Portfolio theory and investment analysis* (6th ed.) Yogyakarta, Indonesia: BPFE UGM.
- Maharani, F. (2012). *Measurement of banking efficiency using data envelopment analysis (DEA) approach and effect of bank efficiency on stock return in a conventional commercial*



- bank listed in Indonesia stock exchange period 2005-2010* (Minor thesis), Faculty of Economics, Management Department, University of Indonesia, Depok, Indonesia.
- Margaretha, F., & Damayanti, I. (2008). Influence of price earning ratio, dividend yield and market to book ratio to stock return at Indonesia stock exchange. *Journal of Business and Accounting*, 10(3), 149-160.
- Oral, M., Kettani, O., & Yolalan, R. (1992). An empirical study on analyzing the productivity of bank branches. *IIE Transaction*, 24(5), 187-203.
- Permono & Darmawan. (2000). Analysis of banking industry in Indonesia (Case study of foreign exchange banks in Indonesia in 1991-1996). *Journal of Economics and Business Indonesia* 15(1), 1-13.
- Qurniawati, R. S. (2013). Banking efficiency in Indonesia and its influence on stock return with data envelopment analysis (DEA) approach. *BENEFIT Jurnal Manajemen dan Bisnis*, 17(1), 27-40.
- Saha, A., & Ravisankar, T. S. (2000). Rating of India commercial banks, a DEA approach. *European journal of operational research*, 124(1), 187-203.
- Sathye, M. (2001). X-Efficiency in Australian banking: An empirical investigation. *Journal of Banking and Finance*, 25(3), 613-630.
- Siauwijaya, R. (2016). The evaluation of bank efficiency in post merger stage in banking industry. *Binus Business Review*, 9(2), 133-139.
- Vardar, G. (2013). Efficiency and stock performance of banks in transition countries: Is there a relationship. *International Journal of Economic and Financial Issues*, 3(2), 355-369.
- Weygandt, J., Kimmel, P., & Kieso, D. (2013). *Financial accounting IFRS edition*. New York, USA: Wiley.
- Wibisono, Y. (2005). *Basic econometrics training module*. Depok, Indonesia: Faculty of Economics, University of Indonesia.

## **Voluntary Disclosure Level and Firm Valuation of Kompas100 Listed Firms**

**Yanthi Hutagaol-Martowidjojo\* and Kevin Richard**

*Department of Accounting, Faculty of Economics and Communication, Bina Nusantara University, Jakarta 11480, Indonesia*

### **ABSTRACT**

This research aims to examine the relationship between voluntary disclosure level and firm valuation as seen from the share price. This study observed non-finance Kompas100 listed firms from 2011 to 2015. Using a set of sampling criteria, a final sample size of 56 firms was determined. The voluntary disclosure level was measured by a modified Botosan index. A content analysis of sample annual reports was undertaken to determine the voluntary disclosure index of the firms under study. The firm valuation was proxied by the firms' share prices. Pooled OLS regression analyses were employed to analyse the data. The result showed that the firms' aggregate voluntary disclosure index (VDI) was valued positively in the market. Consistent results had been generated even after controlling for the firms' size and leverage. Further analysis of individual voluntary disclosure showed that three of seven voluntary disclosure categories were found to be the main value-driven categories, namely, key non-finance statistics, R&D activities and value-added disclosures.

*Keywords:* Firm valuation, IDX, Kompas100, voluntary disclosure, voluntary disclosure score index

### **INTRODUCTION**

All over the world, capital markets, such as the Indonesia Stock Exchange (IDX), regulate listed firms to submit

periodic company reporting (for instance quarterly, annual). There are certain similar requirements, such as audited financial statements, that listed firms should provide in their company reports. However, there are also differences in mandatory items that may be disclosed across markets. As a usual practice, many firms disclose information that may not be mandated but may be useful for the company report users as they make pertinent decisions.

#### **ARTICLE INFO**

*Article history:*

Received: 09 October 2019

Accepted: 03 January 2020

Published: 17 March 2020

*E-mail addresses:*

yhutaol@binus.edu (Yanthi Hutagaol-Martowidjojo)

kevinrchr@gmail.com (Kevin Richard)

\* Corresponding author

According to Healy and Palepu (2001), voluntary disclosure is the result of information asymmetry and agency conflict. They argue that voluntary disclosure is a means to reduce the information gap between firms and shareholders, who, mostly, have no active role in a firm's decision-making process. The voluntary disclosure could be a result of the demand from the shareholders or an initiative from the firms themselves.

There have been many studies conducted to examine the benefits of voluntary disclosure in reducing the cost of equity (Botosan, 1997; Clinch & Verrechia, 2015). Most studies discovered that voluntary disclosure reduced the cost of equity. The main argument is that the commitment of managers to voluntarily disclose information is interpreted as good news by investors who, as a result, lower the price discount, that is the cost of capital (in this case, equity). Therefore, it is expected that there is a negative association between voluntary disclosure and the cost of equity.

Another branch of voluntary disclosure is a discussion of the determinants of company voluntary disclosure (Eng & Mak, 2003; Utama, 2012). There have been many factors, such as corporate governance practice and a firm's characteristics and performance that have been empirically found to determine voluntary disclosure.

Using Indonesian data, several research studies in voluntary disclosure have been identified (Darmadi, 2013; Tandiono & Hutagaol, 2013; Utama, 2012). While Darmadi (2013) investigated information

disclosure of Indonesian family businesses, Tandiono and Hutagaol (2013) specifically explored the profile of voluntary disclosure in family-owned firms listed in the Indonesia Stock Exchange (IDX). Utama (2012) investigated the determinants of firm voluntary disclosure in Indonesia. In particular, she examined the impact of competition as an external factor in a firm's voluntary disclosure.

In this study, the authors investigated the effect of voluntary disclosure on firm valuation. Following Healy and Palepu (2001), this study argued that voluntary disclosure arose from information asymmetry between managers and external shareholders. Managers initiate disclosing more information to signal a firm's true value as described in the Signaling theory. Similar to the studies of Utama (2012) and Tandiono and Hutagaol (2013), this study used the Botosan disclosure index. However, to put this research in the Signaling theory context, this study added future-looking information in the disclosure index as also applied in Sitanggang (2002) as cited by Irma (2013). This future-looking information is perceived as value-added information. This study contributes to the literature of voluntary disclosure in Indonesia by providing empirical evidence of the direct relationship between voluntary disclosure level and market valuation.

The aggregate result showed that the voluntary disclosure index of the research sample firms was positively associated with their market value (share price). Further analysis showed that not all categories of

voluntary disclosure were significantly related to the firms' value. Three of the seven disclosure categories that affected the firms' share price were non-finance key information, R&D activities, and value-added items. However, only the value-added category items serve as an efficient signal to the firms' value.

### Literature Review

There have been several studies investigating voluntary disclosure on firm valuation. Most of these studies define voluntary disclosure on specific non-finance information, mainly on social and environmental information (Harjoto & Jo, 2014; Haggard et al., 2008; Plumlee et al., 2015; Reverte, 2016; Said et al., 2015). However, this study examines more general voluntary disclosures following Botosan (1997) and Irma (2015).

Focusing on voluntary disclosure regarding company risk, Haggard et al. (2008) found that a firm's voluntary disclosure improved stock price informativeness. They argued that a higher voluntary disclosure would stabilize a firm's share price since the investors were more certain about its value. This enables investors to predict the firm's future performance, thus it reduces the risk of investment. Meanwhile, Harjoto and Jo (2016) found that a higher voluntary disclosure on CSR reduced the analyst dispersion of earnings forecast, hence it reduced the volatility of stock returns, cost of capital and increased the firm's value. This implies that more firm disclosures will reduce the number of investors and the risk of an investment that in turn improve

pricing decisions. Furthermore, Haggard et al. (2008) also found that a firm with less voluntary disclosure would likely produce negative returns on their shares. Using different measures of company performance, Said et al. (2015) examined the impact of quality and quantity of sustainability disclosure on Malaysian company performance. Surprisingly, they found that sustainability disclosure had a negative impact on company profitability. Therefore, mixed empirical results have been found in studies that explored the relationship between voluntary disclosure and company performance.

Using different proxies for firm value (that is expected future cash flow, cost of equity) Plumlee et al. (2010) examined the relationship between the quality of a firm's voluntary environmental disclosures and firm value (expected future cash flows and cost of equity) They found a positive correlation between voluntary environmental disclosure quality and future expected cash flow. They also argued that the association between voluntary environmental disclosure quality and firm values was moderated by the type of disclosure.

A recent article by Guay and Verrecchia (2018) analyzed a model of voluntary disclosure and the reaction of investors in discounting the price. They argued that in the absence of mandatory disclosure, rationally, managers had an option to disclose good realizations voluntarily and kept the bad realizations with them. However, they found that firms with conservative reporting (disclose the low realizations as early

as possible) showed their prices being higher on average. Additionally, Guay et al. (2016) found that firms tended to have more voluntary disclosure when the financial reporting environment was more complex. They argued that the complexity of financial reports had a negative effect on investors. Their study showed that firms used voluntary disclosure significantly to mitigate such a negative effect. Besides the direct relationship between voluntary disclosure and firm value, Chung et al. (2015) provided evidence of the role of voluntary disclosure as a moderating variable in executive compensation and firm value relationship. They found that excess executive compensation negatively affected the firm share price. However, the effect was lessened with the presence of voluntary disclosure as it improved the monitoring process within-group firms and governance quality.

In terms of voluntary disclosure items, Guay and Verrecchia (2018) emphasized the importance of elements in conservative reporting, that is to include not only reported earnings but also more broadly any mechanism that committed managers to disclose, such as required footnotes and explanations in corporate filings. Similar to Guay and Verrecchia (2018), this study also includes several categories of voluntary disclosure defined as the modified Botosan index.

In summary, the literature shows that voluntary disclosure influences firm value in several ways. With regard to investment risk, voluntary disclosure stabilizes the

share prices in the market, which results in enhancing stock price informativeness and reducing investment risk, hence increasing firm value. With regard to company reporting, voluntary disclosure moderates the impact of bad news on the firm market values. This study aims to analyze the direct impact of voluntary disclosure on the firm value. Therefore, we hypothesize that voluntary disclosure has a positive impact on the share price of Indonesian listed firms.

## **MATERIALS AND METHODS**

### **Research Sample**

The sample used in this study was drawn from Kompas100 listed firms in 2011. The justification for choosing firms listed in the index as a research sample is that those firms take almost 80% of the IDX market capitalization, therefore, it could be perceived as a representation of the market. A set of criteria was developed to match the research objective. This study excluded finance companies (banks, insurance, financing companies, investment banks). The observed period was between 2011 and 2015. All samples should have a complete set of annual reports during the period. A total of 56 firms fulfilled all the criteria.

### **Data Collection Method and Measurements**

A content analysis of company annual reports was used as a method to collect voluntary disclosure data. Table 1 lists all the categories of voluntary disclosure used in this study. The first six categories were included in the Botosan disclosure index,

Table 1  
*Voluntary disclosure categories*

No.	Disclosure categories	Number of items in each category
1	Background information	6
2	Summary of historical result	5
3	Key-non financial statistics	8
4	Projected information	5
5	Research and development activities	4
6	Employee information	4
7	Value-added information	3
Total		35

while the last category was used to follow Sitanggang's (2012) index. Altogether, there were 35 disclosure items collected from the sample firms' annual reports. The content analysis was conducted by searching the keywords for each item in the annual reports. Each item disclosed was assigned a value of 1, otherwise 0. The measurement for each category was the percentage of items disclosed over the maximum possible disclosures of the category. The Voluntary disclosure index (VDI) was the main independent variable in this study. This study also analysed the individual categories as an independent variable. The measures of individual voluntary disclosure were in the form of a percentage of the number of items disclosed divided by the maximum items disclosed per category. This was applied as different categories had different maximum disclosure items.

The firm value as the dependent variable was collected from Yahoo finance and measured as the closing price for the corresponding year. Two control variables used in this study are the firm's size and

leverage. Plumlee et al. (2010) found that bigger firms tended to disclose more information as a consequence of the analyst following. Prior studies also found a positive relationship between firm size and market valuation. In this study, the firm size was measured by the normal log of market capitalization. Prior studies also found that the presence of debt affected the volume of voluntary disclosure. With debt contracting, it is common for the creditor to request firms to disclose more information. Debt is also found to have a negative effect on the firm's value. In this study, leverage is measured by the debt-to-equity ratio.

### Data Analysis Method

The data was analyzed using a pooled OLS regression model. Firstly, the firm value is regressed by the aggregate VDI and control variables as expressed in the following equation:

$$P_{i,t} = \beta_0 + \beta_1 VDI_{i,t} + \beta_2 Size_{i,t} + \beta_3 Lev_{i,t} + \varepsilon \quad (1)$$

Where  $P_{i,t}$  is the value of firm  $i$  at time  $t$ , measured by the closing share price at the end of a fiscal year,  $VD_{i,t}$  is the number of voluntary information disclosed by a firm  $i$  at time  $t$ ,  $Size_{i,t}$  is the size of the firm  $i$  at time  $t$ , measured by a normal log of market

capitalization, and  $Lev_{i,t}$  is the leverage of firm  $i$  at time  $t$ , measured by debt-to-equity ratio.

To analyze the impact of each category of VD on the firm value, the following equation is employed:

$$P_{i,t} = \alpha_0 + \alpha_1VD1_{i,t} + \alpha_2VD2_{i,t} + \alpha_3VD3_{i,t} + \alpha_4VD4_{i,t} + \alpha_5V5I_{i,t} + \alpha_6VD6_{i,t} + \alpha_7VD7_{i,t} + \alpha_8Size_{i,t} + \alpha_9Lev_{i,t} + \varepsilon \tag{2}$$

All variables defined as in the first equation (1), while  $VD_x$  is the percentage of item disclosure per category in Table 1 as reported in the annual report ( $x = 1, 2, 3, 4, 5, 6, 7$ ) of firm  $i$  at time  $t$ .

average, the sample firms disclosed 14 items voluntarily, with more than half of sample firms reporting 13 items.

The most-reported voluntary disclosure category is VD2 (summary of historical results), which is about 64.1% of the items reported. The least reported category is VD7 (value-added information) in which more than half of sample firms did not report any item related to the category. This indicates that firms do not realize the importance of value-added information to the users or readers of company reports.

## RESULTS AND DISCUSSIONS

### Descriptive Statistics and Univariate Analysis

This section discusses the descriptive statistics of the research variables. Table 2 shows that the aggregate voluntary disclosure index (VDI) shows that, on

Table 2  
Descriptive statistics

Variables	Mean	Median	Std dev	Minimum	Maximum
<i>P</i>	5964	2150	9709	115	62050
<i>VDI</i>	14	13	3	8	20
<i>VD1</i>	0.6351	0.6667	0.1350	0.5000	1.0000
<i>VD2</i>	0.6406	0.6000	0.1649	0.2000	1.0000
<i>VD3</i>	0.3438	0.2500	0.1467	0.1250	0.8750
<i>VD4</i>	0.2486	0.2000	0.1683	0.0000	0.6000
<i>VD5</i>	0.3670	0.2500	0.1756	0.0000	0.7500
<i>VD6</i>	0.3304	0.2500	0.2682	0.0000	0.7500
<i>VD7</i>	0.1214	0.0000	0.2139	0.0000	0.6667
<i>Size</i>	23.6261	23.6085	1.3472	16.2246	26.5465
<i>Lev</i>	2.1471	1.0681	2.7161	0.1536	13.3322



The result further indicates that VD4 is one of the voluntary disclosure categories that are infrequently reported. Some firms did not report any items during the observation period. This notion is against much prior research showing that management forecasts are proven to be an efficient signal to the firm value.

Next is the discussion of the univariate analysis of the research variables. Firstly, Table 3 shows, as expected, that all voluntary

disclosure categories are positively related to firm value (share price). It may be inferred that voluntary disclosure (as an aggregate and as an individual category) is positively related to firm value (share price). Secondly, although there are some categories that are significantly related, the coefficients are not high. It may be inferred that there is no multicollinearity problem in the research data.

Table 3  
Correlation matrix

Variable	<i>P</i>	<i>VDI</i>	<i>VD1</i>	<i>VD2</i>	<i>VD3</i>	<i>VD4</i>	<i>VD5</i>	<i>VD6</i>	<i>VD7</i>	<i>Size</i>
VDI	0.23	1.00								
VD1	0.11	0.55	1.00							
VD2	0.11	0.17	0.02	1.00						
VD3	0.09	0.77	0.50	0.06	1.00					
VD4	0.03	0.22	0.06	-0.10	0.18	1.00				
VD5	0.00	0.42	0.04	0.11	0.12	-0.08	1.00			
VD6	0.03	0.36	0.07	-0.05	0.07	-0.21	-0.06	1.00		
VD7	0.38	0.63	0.10	0.14	0.35	0.00	0.40	0.18	1.00	
Size	0.32	0.14	0.12	0.13	0.06	0.08	-0.02	0.03	0.14	1.00
Lev	-0.12	-0.35	-0.15	-0.14	-0.29	0.01	-0.16	0.00	-0.23	0.03

### Regression Analysis

The results of the regression analyses are presented in Table 4 below. The second and third columns are the analysis results for equation (1) and the third and fourth columns are the analysis results for equation (2). The table shows that both models are valid implying that all independent and control variables are valid to predict share price. Substituting the proxy of voluntary disclosure from aggregate index to the individual category improves the

explanatory power of the models. Table 4 shows that the explanatory power of the models increases from a simple model to more complex models and the models are valid.

Next is the result of the partial testing of the independent and control variables. Column 2 of Table 4 shows that there is a robust positive and significant impact of VDI on the firm value at  $\alpha = 0.01$ . It implies that the more voluntary disclosure item reported, the higher the share price. The result holds even after controlling for

Table 4  
Regression analysis results

Variables	Coefficient ( $\beta$ ) (t-stat)	Coefficient ( $\beta$ ) (t-stat)	Coefficient ( $\alpha$ ) (t-stat)	Coefficient ( $\alpha$ ) (t-stat)
Constant	5136.43* (1.8097)	52793.1932*** (5.4928)	3173.325 (1.0141)	3749.6883*** (3.9958)
VDI	79.4922*** (3.9911)	56.5421*** (2.7555)	-	-
VD1	-	-	98.6687** (2.1634)	72.2184 (1.6265)
VD2	-	-	23.1023 (1.1978)	13.7799 (0.8008)
VD3	-	-	-86.6071* (-1.9167)	-83.63311* (-1.878)
VD4	-	-	15.6180 (0.4694)	25.3642 (0.0793)
VD5	-	-	-107.6600*** (-3.2194)	-98.2857*** (-3.034)
VD6	-	-	-22.7849 (-1.0863)	-23.9881 (-1.1913)
VD7	-	-	22.270*** (7.5463)	20.0404*** (6.9483)
Size	-	2.1763*** (5.3531)	-	1.8601*** (4.7884)
Lev	-	-2.5909 (-1.2175)	-	-2.8001 (-1.4043)
Adj R-Square	0.0508	0.1355	0.1754	0.2338
F-Statistics	15.9291***	15.5819***	9.4636***	10.4638***

the sample firms' size and leverage. The coefficients for both analyses suggest that the more items disclosed voluntarily, the higher the firms' share price. Further, it implies that voluntary disclosure serves as an efficient positive signal to the firm value.

The second analysis employs individual voluntary disclosure on the firms' share price (eq. 2). This study finds that four of the seven disclosure categories significantly affect the share price (column 3). The four significant categories are background information, key non-financial statistics, research and development (R&D) activities,

and value-added information. Background information and value-added information are positively and significantly associated with the share price at  $\alpha=0.05$  and  $\alpha=0.01$ , respectively. Meanwhile, key-non financial statistics and R&D activities appear to be negatively and significantly related to sharing price at  $\alpha=0.1$  and  $\alpha = 0.01$ , respectively.

The results imply that more background information and value-added information reported voluntarily would increase a firm's share price. On the other hand, more R&D activities and key non-financial statistics

disclosed tend to decrease share price. However, after controlling for the firm's size and leverage, the significance of background information disappears (column 4).

As per control variables, all analyses show that size positively and significantly affect share price at  $\alpha = 0.01$ . It infers that bigger firms tend to have a higher valuation in the market, confirming prior studies. However, in all analyses, this study fails to provide evidence for the significant impact of leverage on firm value. Although the result is uncommon, some prior studies also find an insignificant impact of leverage on firm value. For some technical explanation, Table 2 shows a wide range of leverage, indicating the presence of outliers in the data. This might interfere with other statistical results such as regression analysis in this case. However, as leverage is the control variable, the insignificant result does not reduce the test of the main hypothesis.

The findings of the study show that the aggregate voluntary disclosure index (VDI) confirms Healy and Palepu's (2001) argument on the role of voluntary disclosure to reduce information asymmetry among investors. This leads to a more converged opinion about the firm's value resulting in a higher price. Similar to Haggard et al. (2008), this study suggests that voluntary disclosure could mitigate information asymmetry. Moreover, VDI also improves stock price informativeness by stabilizing the share price. Therefore, the more voluntary disclosure items reported, investors are more able to assess their investment risks and influence to stabilize the share price on

the higher price. This study also confirms Guay and Verrecchia's (2018) argument that conservative reporting does not only focus on earnings but on other information, such as value-added information. Moreover, the research sample was taken during a period when the IFRS-converged accounting standard was introduced, which might have resulted in a complex financial reporting environment. Supported by Guay et al.'s (2016) research, this study suggests that the positive association between VDI and firm value is the result of a voluntary disclosure role in mitigating the negative effects of complex financial reporting environment. Additionally, the result also suggests that voluntary disclosure improves the monitoring process within-group firms, which is perceived as a positive value by investors, which translates to a firm's higher share price in the market (Chung et al., 2015).

The disappearance effect of background information on the sample firms' value after controlling for size and leverage implies that background information is perceived as 'common' information across the firms' size and debts that do not add more insights for the investors in assessing firm value. Therefore, its disclosure has no significant impact on firm value. This is in line with the findings by Plumlee et al. (2010), which suggested that the relationship between voluntary disclosure and firm value depended on the type of disclosure.

The negative effect of R&D activities on firm value is unusual. In prior studies, R&D activities were perceived as the

firm's effort to enhance their productivity that would translate into future cash flows, and the firm value, eventually. However, since Indonesian listed firms follow the IFRS-converged accounting standard, most R&D activities are reported in the income statements and are reflected as expenses in their financial statements since they are still in the early stage of R&D. Therefore, the more R&D activities are disclosed in their annual reports, the more they are perceived as incurred expenses that will reduce a firm's net income and decrease the share price.

The negative effect of key non-financial statistics on the share price implies that the market perceives non-financial statistics as irrelevant in terms of valuing the firms. The information items disclosed in this category consist of the number of employees, order backlog, percentage of sales, market share, unit sold, selling price, sales growth. Such information can be depicted from the financial statements and summed up as income information. Therefore, disclosed items in this category are deemed as irrelevant information that leads to lower valuation by the market participants.

Although value-added information is the least disclosed category as reported in the sample firms' annual reports (see Table 2 - Descriptive statistics), it shows a robust positive effect on a firm's value. This finding confirms Zéghal and Maaloul's (2010) study which suggested that value-added information-enabled investors forecast a firm's future cash flow and reduce investment risks. Therefore, the more value-added information disclosed the

more converged investors' opinion on their investment risk, which results in lower price discounts and increased share price (Guay & Verrecchia, 2018). Thus, it could be inferred that value-added information is perceived as an effective signal to a firm's value.

## CONCLUSIONS

This study examines the relationship between voluntary disclosure and firm value. The study finds that overall voluntary disclosure positively affects firm value. The more voluntary disclosure reported, the higher the firm value. The result is robust even after controlling for the firm's size and leverage. This result provides evidence that voluntary disclosure can help to mitigate information asymmetry among market participants. Moreover, this study confirms the effective role of voluntary disclosure as a signal to the firm value.

The results of individual voluntary disclosure categories vary. Three of the seven categories examined significantly affect firm value. However, key non-financial statistics and R&D activities are negatively related to firm value. While the former is perceived as irrelevant, the explanation of the latter is related to the accounting treatment for R&D activities as per accounting standards. Value-added information is positively related to firm value since it helps investors to forecast future cash flows, and reduces the investment risk that in turn will increase the firm value (Irma, 2015).

This study concludes that voluntary disclosure is found to be an effective signal to firm value. However, since the disclosure

is costly, the implication is that firms should carefully choose disclosure items to report as there are categories that are perceived as irrelevant by the market and there are those that are seen to contribute to a reduced firm value.

## ACKNOWLEDGEMENT

The authors wish to acknowledge and thank all IMHA 2018 committee members and UPM *Pertanika* journal team that help publish this article.

## REFERENCES

- Botosan, C. A. (1997). Disclosure level and the cost of equity capital. *Accounting Review*, 72(3), 323-349.
- Chung, H., Li, Y., & Judge, W. Q. (2015). Voluntary disclosure, excess executive compensation and firm value. *Journal of Corporate Finance*, 32(C), 64-90.
- Clinch, G., & Verrecchia, R. E. (2015). Voluntary disclosure and the cost of capital. *Australian Journal of Management*, 40(2), 201-223.
- Darmadi, S., & Sodikin, A. (2013). Information disclosure by family-controlled firms. *Asian Review of Accounting*, 21(3), 223-240.
- Eng, L. L., & Mak, Y. T. (2003). Corporate governance and voluntary disclosure. *Journal of Accounting and Public Policy*, 22(4), 325-345.
- Guay, W. R., Samuels, D., & Taylor, D. J. (2016). Guiding through the fog: Financial statement complexity and voluntary disclosure. *Journal of Accounting and Economics (JAE)*, 62(2-3), 234-269.
- Guay, W., & Verrecchia, R. E. (In Press). Conservative disclosure. *Journal of Financial Reporting*, 3(1), 73-92.
- Haggard, K. S., Martin, X., & Pereira, R. (2008). Does voluntary disclosure improve stock price informativeness? *Financial Management*, 37(4), 747-768.
- Harjoto, M. A., & Jo, H. (2015). Legal vs. normative CSR: Differential impact on analyst dispersion, stock return volatility, cost of capital, and firm value. *Journal of Business Ethics*, 128(1), 1-20.
- Healy, P. M., & Palepu, K. G. (2001). Information asymmetry, corporate disclosure, and the capital markets: A review of the empirical disclosure literature. *Journal of Accounting and Economics*, 31(1), 405-440.
- Irma, I. (2015). Analisis pengaruh tingkat pengungkapan terhadap likuiditas saham [The analysis of the disclosure level impact on stock liquidity]. *Jurnal Organisasi dan Manajemen*, 9(1), 54-72.
- Plumlee, M., Brown, D., Hayes, R. M., & Marshall, R. S. (2015). Voluntary environmental disclosure quality and firm value: Further evidence. *Journal of Accounting and Public Policy*, 34(4), 336-361.
- Reverte, S. (2016). Corporate social responsibility disclosure and market valuation: Evidence from Spanish listed firms. *Review of Managerial Science*, 107(2), 411-435.
- Said, R. M., Theng, L. T., Senik, R., Yusri, Y., & San, O. T. (2015). The state of sustainability disclosure and effects of companies' financial performance. *Pertanika Journal of Social Science and Humanities*, 23(S), 99-117.
- Sitanggang, J. (2002). *Faktor-faktor penentu tingkat pengungkapan sukarela serta pengaruh pengungkapan sukarela terhadap likuiditas dan volatilitas harga saham di bursa efek Jakarta* [The determinants of the level of voluntary disclosure and the effect of voluntary disclosure on liquidity and volatility of stock prices on the Jakarta stock exchange] (Doctoral thesis), University of Indonesia, Indonesia.

- Tandiono, R., & Hutagaol, Y. (2013). Profile of voluntary disclosure of family business in Indonesia: An exploratory study. *The 4<sup>th</sup> Asia-Pacific Business Research Conference*. Singapore.
- Utama, C. A. (2012). Company disclosure in Indonesia: Corporate governance practice, ownership structure, competition and total assets. *Asian Journal of Business and Accounting*, 5(1), 75-108.
- Zéghal, D., & Maaloul, A. (2010). Analysing value-added as an indicator of intellectual capital and its consequences on company performance. *Journal of Intellectual Capital*, 11(1), 39-60.

## **The Effect of Website Quality on e-Trust of Customers: “The Case of ZEN Rooms”**

**Lucina Iswi Hapsari Sulistyo<sup>1\*</sup> and Wenly Pranata<sup>2</sup>**

<sup>1</sup>*Department of Hotel Management, Faculty of Economics & Communications, Bina Nusantara University, Palmerah, Jakarta 11480, Indonesia*

<sup>2</sup>*Business Management Program, Department of Management, BINUS Business School Master Program, Bina Nusantara University, JWC Campus, Senayan Jakarta 11480, Indonesia*

### **ABSTRACT**

The development of technology has made it easier for the traveller to book hotel rooms by the website. The number of online websites that provide services for the hospitality industry is on the rise. Previous studies have focused more on luxury hotels and there is a lack of study to show the perception of guests regarding budget hotels' websites. Therefore the objective of this study is to analyze the connection between a website quality (usability and ease of use) towards online booking with the e-Trust variable on ZEN Rooms. Data were collected through self-administered questionnaires that were distributed using social media and mobile chatting application. The collected data was analyzed with the Multiple Linear Regression method and some descriptive analysis. The findings of the research state that the ease of use variable has a significant impact on online booking intention, same as the e-Trust variable. The result also showed e-Trust could highly be explained by the ease of use of the website and also the usability of a website. Result also depicted there was no significant difference between genders in terms of e-Trust in using websites. A major contribution of this study is its implications for practitioners in the hospitality industry for developing marketing strategies.

*Keywords:* Budget hotel, e-Trust, online booking, website quality, ZEN Rooms

### **ARTICLE INFO**

*Article history:*

Received: 09 October 2019

Accepted: 03 January 2020

Published: 17 March 2020

*E-mail addresses:*

Isulistyo@binus.edu (Lucina Iswi Hapsari Sulistyo)

wenlypranata@gmail.com (Wenly Pranata)

\* Corresponding author

### **INTRODUCTION**

In 2015 the hospitality and tourism industry contributed 4% to the total economy of Indonesia, with 77.1% from international tourists and 22.9% domestic (Indonesia-Investments, 2016). The government targeted to increase the contribution of



hospitality and tourism in Indonesia to 8% by 2019, and have taken steps to achieve this by fixing Indonesia's infrastructure, including the information technology infrastructure and communication, health access and also to improve online promotion abroad as well as improving the superstructure of the country such as roads, airports and hotels to name a few (Indonesia-investments, 2016; World Travel & Tourism Council, 2016).

In the hotel industry, the internet has had a big impact on the evaluation of the distribution channel, which pushed the industry from a traditional operation (offline) to an online operation system (Buhalis & Law, 2008; Guo et al., 2014). The use of the internet has changed the hospitality industry by helping organize, promote and market tourism products and services, as well as helping communication, online transaction, and distribution systems for hoteliers and consumers (Buhalis & Law, 2008). It has given the ease of use, low cost and time efficiency as the main reasons for tourist to plan their trip using e-commerce (Advertorial, 2015). An integrated tourism market through a website connects the tourism industry's information system such as the aviation, cruise, insurance, travel agent, hotel, and tourist attractions' operator to make it easier for tourists to plan and book their trip online. According to Ariff et al. (2014), consumer's behaviour in tourism has always been affected by technology development.

Besides using the hotels' own website, Toh et al. (2011) found that 80% of travellers searched for hotel information using web

tools, with more than half making their bookings through third-party websites which is the Online Travel Agencies (OTAs). According to Quinby and Jain (2012) (which research the OTA market in Australia, China, Japan, India, Indonesia, Malaysia, New Zealand, Singapore and Thailand), the Asia Pacific's online travel booking on 2011 is estimated to be US\$ 1,6 billion/year and predicted to rise 30% to 40% on the next periods (Jamaludin, 2015). Based on the same data, the hotel reservation by OTA in Indonesia itself is estimated to reach US\$ 200 million/year. This showed an opportunity for hotels to actively participate in using OTA that will help increase online hotel booking (Guo et al., 2014). Previous researches have also stated that Online Travel Agent (OTA) gives a bigger chance for the hotel to reach a larger number of future customers (Cheah & Abdul-Rahim, 2018; Choi & Kimes, 2002; Myung et al., 2009).

Previous researches have been focusing more on the international brand hotel and ignored the lower-priced hotels such as budget hotels, which are also big potential in the hotel industry (Ariff et al., 2014; Guo et al., 2014). Budget hotels, which are also called "economic hotel" or "limited service hotels", are different compared to full-service hotels (Senior & Morphey, 1990). Zou (2003) described a budget hotel as a hotel that provides professional service at an affordable price for consumers.

One of the OTA companies in Indonesia that collaborate with budget hotels is ZEN Rooms. ZEN Rooms is a startup that directly

collaborates with hotel owners who do not have a website of its own and receive a commission from every room that customer book through the ZEN Rooms website itself (Wijaya, 2015).

With the growing number of hotels in Indonesia, the number of online websites which offer hotel rooms also increases. Based on the review of previous studies in this area, there is still a lack of study to indicate how travellers think about the purchase of hotel rooms through online websites. Therefore, this study examines the process of online hotel decision making by focusing on the effect of website quality on the customers' e-Trust. The two key issues we wish to examine are: (1) whether customer's perception of the website's usability influenced e-Trust; and (2) whether customer's perception of the website's ease of use influenced their e-Trust.

## Literature Review

The importance of experience in creating competitive advantage is fully discussed by Pine and Gilmore (2014) and other experts. Experience which refers to the new economic value or the fourth offering, after commodity, good, and the service, is the new engine of economic growth for organizations (Pine & Gilmore, 2014). The proper management of customer experience can turn customers into advocates, upon which long-term competitive advantage and profitability can be achieved (Smith & Wheeler, 2002). Various studies in hospitality and tourism settings have attempted to understand the dimensions of

experience. However, most of the previous studies (Hemmington, 2007; Shaw, 2005; Walls, 2013) were based on luxury or full-service hotel settings, or other service settings, and thus might not apply in the budget hotel sector.

Currently, there are over 40,000 budget hotels in Indonesia and they are expected to grow to 30% more in the next 3 years (FP, 2017). Arjun Chopra as CoFounder and CEO of Tinggal.Com stated that tourist's interest in budget hotel was increasing faster compared to the brand hotel (Yustiana, 2016). The director of The Sunan Hotel in Solo, Indonesia also added that the growth of budget hotel was 20% higher than four-stars hotels and 15% higher than five-stars hotels in Indonesia (Slamet, 2015).

Nowadays there are more travellers than ever that search the internet medium for information of the tourist destination and the process of booking the trip, as evidenced by the increase of information access through the search engine and social media and also online hotel booking (Statista Inc., 2017). Approximately 6.5% of web inquiries are related to travel (Jansen et al., 2008), and more than 50% of the sales of major brand hotels were attributed to online marketing channels in 2010 (Pan et al., 2013). Previous studies have shown that the hotel's website quality can positively influence consumer's willingness to do an online booking (Bai et al., 2008; Wang et al., 2015).

A hotel's website is not only an information channel but also a trading form, where it not only provides news and data, creates a brand image but also works

as a sale tool. But this ease does not come without a weakness. Communication by the internet creates uncertainty and risks have become an intrinsic attribute of e-commerce from their complexity and anonymity of online purchase. The hotel's website system usually performs two functions. First, is to provide information to customers to make their purchasing online. The efficiency of the information provided may influence customer satisfaction leading to loyalty towards the website. Second, it facilitates the purchase of products offered (Crnojevac et al., 2010).

Because OTAs are such an important channel for hotel distribution, the industry should pay close attention to the way hotels are presented on OTA web pages. Jeong et al. (2003) explained the concept of website quality for the hotel industry for the first time, saying that a hotel's website quality as the "perfection or effectiveness of a website in providing a message to readers". According to Chang and Chen (2008), website quality becomes the main factor in e-commerce because the perception of the website quality will trigger the customers' purchase intention directly. It presents the importance of customers in judging website performance (Bai et al., 2008).

Loaicono et al. (2002) classified website quality into several dimensions, of which two of them were usability and ease of use. Usability refers to whether a hotel's website can provide sufficient information about the product and the service, while ease of use showed the level of which a hotel's website is easy to navigate and customer-friendly.

The ease of use of an organization's website is a very important success in the context of the internet (Aljukhadar & Senecal, 2015). A good website must be easy to use, understandable, and navigate well (Aziz, 2014). The easiness of using the website's features can influence the customer's interest in using the online service and push their booking intention (Shen & Chiou, 2010; Venkatesh & Agarwal, 2006).

The previous study about website usability has given an understanding of the impact of website usability on consumer's perception and behaviour online. Lee and Kozar (2012) discussed several effects that website quality direct and indirectly affected purchase intention; which were how easy the website is to learn, easy to read, simplicity, relevant context and interactivity. The level of usability of a website will determine whether a user will stay or leave to find another website (Dingli & Caesar, 2014). ZEN Rooms offers a simple booking process and increases the speed of loading the page to give the user great user experience. The ZEN Rooms website effectively delivers information and adopted a good interaction design to make sure consumers can easily navigate the website and find useful information.

Along with the increasing number of online booking websites, there was an increasing issue regarding e-Trust of these websites as well. E-Trust is a concept born from the internet era and presents a new characteristic compared to the traditional market pattern. First, e-Trust includes the hotel's company and website because the

consumers and the business itself are more often communicate by the internet than face-to-face (Wang & Emurian, 2015). According to Chien et al. (2012), e-Trust is the consumer's trust or confidence that the seller will not abuse the consumer's vulnerability.

Even though e-Trust has been done in many researches, but the publication of its implication on the hospitality and tourism industry is limited. Sparks and Browning (2011) found that consumers depended on the easiness of information processing while evaluating a hotel based on online reviews. In the hotel industry, Morgan and Hunt (1994) explained that risk-taking behaviour based on consumer's positive expectations of a hotel's website was called e-Trust. E-Trust plays an important role in online booking because of the risk that comes with online service (Wang & Emurian, 2005).

## **MATERIALS AND METHODS**

To know whether the customer's perception of the website's usability and ease of use influenced their e-Trust, quantitative research was applied. Data were collected by using a questionnaire. The questionnaire was chosen because the research is done on a big population, and the studied data is the data taken from the related population (Sugiyono, 2015). The questionnaire was distributed using social media (Facebook and Instagram) and mobile communication applications (Line and WhatsApp). The questionnaire was developed based on a review of previous literature (Chang & Chen, 2008; Chien et al., 2012; Dingli &

Caesar, 2014; Lee & Kozar, 2012) and was modified by the researcher using a literature review and adjusted for content validity.

The type of research used in this study is descriptive and associative. According to Malhotra (2012), descriptive research is conclusive research with its main goal to describe some characteristic or function of the market. While associative research is to find the connection between two variables or more (Sujarweni, 2015). To answer the gap in previous studies, the current research aimed to find the connection between website quality, e-Trust and online hotel decision.

To ensure the validity and reliability of the questionnaire, a pilot test was conducted using 30 randomly selected hotel guests from different social media. According to Priyanto (2011), the data should be more than 0.6 to be considered as reliable. After running a statistical reliability test of Cronbach's alpha, it was found that the instrument had a reliability factor above 0.6.

Data were collected between July to September 2017. After removing incomplete sets of questionnaires, 100 (83.34%) valid questionnaires were used to analyze guest perception towards website usability and ease of use which affects to e-Trust. In addition to the usual descriptive analysis of means, standard deviations and frequencies, multiple linear regression (MLR) were conducted. Independent sample t-test also was conducted to find out if there are any differences between males and females in terms of e-Trust. All data processing was conducted using SPSS to address the objectives of this study.

**RESULTS AND DISCUSSIONS**

The profile of the respondents indicated that the number of females (61%) was higher than the number of males (39%). The age of respondents indicated that the majority of them were between 18 to 25 years old (93%). Most of the respondents had a bachelor degree (70%) and most of them had a monthly income between 3 million to 6 million Rupiah (53%). Participated respondents were from different nationalities and the majority of them were Indonesian (50%) and followed by South Korean (10%) and Thailand (10%). Most of the respondents mentioned they have the experience of booking rooms from the official website of the hotel (67%) and the rest book through OTA (33%).

The effect of usability of the website and ease of use of the website on e-Trust among participants of this research is elaborated upon in Table 1. The data in this table display the outcomes of a multiple linear regression analysis. This analysis was used to estimate the coefficients of the linear equation involving two factors predicting the e-Trust of customers in Indonesia.

The impact of website quality had with e-Trust was significant [(F2, 103) = 9271,179,  $\rho = 0.000$ ] and contributed 99.4 percent ( $R^2 = 0.994$ ) to the e-Trust of participants. The findings indicate that

“ease of use” of a website ( $\beta = 1.051, \rho = 0.000$ ) had a positive and significant effect on e-Trust of customers while “usability” of a website had not a significant effect ( $\beta = -0.054, \rho = 0.577$ ) e-Trust of customers.

A hotel’s website that has good usability has a significant result on the consumer’s e-Trust. This finding is in line with previous study from Bai et al. (2008) and Wang et al. (2015) which also stated the significant impact between the usability variable towards online booking intention, where the higher a website’s usability was, it automatically affected customer’s e-Trust and willingness to make an online hotel booking. Therefore, hotels should put more focus on their website’s usability to attract more consumers who are in the process of choosing online hotel bookings.

The other variable in this study, which is the ease of use, did not have any significant result on consumer’s e-Trust. This finding is different from previous studies conducted by Shen and Chiou (2010) and Venkatesh and Agarwal (2006) which stated that a website’s ease of use could help consumer’s online booking intention.

Based on the results of Table 2, there was not a significant difference between males and females regarding their e-Trust ( $\chi^2 (2) = 1.044, \rho = 0.309$ ). Findings indicated both females ( $t(0.233) = 0.14814, \rho =$

Table 1  
*Multiple linear regression between usability and ease of use with e-Trust*

Dependent variable	Independent variables	R <sup>2</sup>	Unstandardized	Standardized	Significance
e-Trust	Usability	0.994	1.049	1.051	0.000
	Ease of use		-0.054	-0.054	0.577

0.233) and males ( $t(0.212) = 0.14151$ ,  $\rho = 0.212$ ) had no significant difference towards e-Trust. While the mean of e-Trust among males was a bit higher ( $M = 3.78$ ) compare with females ( $M = 3.60$ ).

There is no significant impact between genders and e-Trust. The findings of this research propose that gender does not play a significant role in the attention of guests toward e-Trust and both genders are highly confident of having online booking purchase of hotel rooms. The findings of this study are supported by previous research which mentioned there is no difference between males and females in terms of online shopping (Hernandez et al., 2011).

Table 2  
*Independent sample T-test between genders and e-Trust*

Gender	F	Sig.	Sig (2-tailed)	Mean
Female	1.044	0.309	0.233	3.6065
Male			0.212	3.7842

## CONCLUSIONS

This study was undertaken to see whether a website's quality, such as its usability and ease of use and its effect on consumer's e-Trust. The importance of having information towards the relationship between a website's usability and consumer's e-Trust is essential to help maintain the attributes of a website's quality to keep consumer's e-Trust of the hotel. The result indicated e-Trust can highly be explained by usability and ease of use of the website. Therefore it is suggested that the website used these factors when

they want to influence the market. It also indicated there was no significant difference between genders in terms of their e-Trust for using the website to reserve rooms in budget hotels. Therefore it is suggested that websites use one specific strategy for the whole market. Since there are no significant differences between genders, these findings can be used by other industries as well in promoting their products. Usability and ease of use affected customers' e-Trust, therefore other industries also can apply these factors in promoting their services. Marketers can also use the findings of this study to develop better marketing strategies and promote the variable of a website quality which has not to make an impact yet. In terms of the theoretical point of view, the findings of this research will enrich the literature for studies related to the influence of a hotel's website quality on consumer's e-Trust.

The current study is not without limitation, such as the scope of the research. Future studies could conduct similar research but through a mobile application instead of the website. The internet keeps developing and there are changing platforms from website to mobile application so the use of mobile in the hotel industry is unsurprising and expected (Wang et al., 2016). Another limitation is that the website used for the research of this study, which is ZEN Rooms, is only one example of other OTAs in Indonesia. Since brand image can affect online booking intention (Aghekyan-Simonian et al., 2012) perhaps the next study could use other OTAs.



## ACKNOWLEDGEMENT

The authors wish to acknowledge and thank all IMHA 2018 committee members and UPM *Pertanika* journal team that help publish this article.

## REFERENCES

- Advertorial. (2015). *Alasan mengapa berbelanja di situs e-commerce lebih hemat* [The reason why shopping on e-commerce sites is more efficient]. Retrieved on September 25, 2017, from <https://news.detik.com/adv-nhl-detikcom/d-3057321/alasan-mengapa-berbelanja-di-situs-e-commerce-lebih-hemat>
- Aghekyan-Simonian, M., Forsythe, S., Kwon, W. S., & Chattaraman, V. (2012). The role of product brand image and online store image on perceived risks and online purchase intentions for apparel. *Journal of Retailing and Consumer Services*, 19(3), 325-331.
- Aljukhadar, M., & Senecal, S. (2015). Determinants of an organization's website ease of use: The moderating role of product tangibility. *Journal of Organizational Computing and Electronic Commerce*, 25(4), 337-359.
- Ariff, M., Yan, N., Zakuan, N., Rahim, K., & Ismail, K. (2014). Online purchasing behaviour of Malaysia's young consumers. In F. L. Gaol, S. Kadry, M. Taylor & P. S. Li (Eds.), *Recent trends in behavioural science* (pp. 167-173). Boca Raton, Florida: CRC Press.
- Aziz, N. S., & Kamaludin, A. (2014). Assessing website usability attributes using partial least squares. *International Journal of Information and Electronics Engineering*, 4(2), 137-144.
- Bai, B., Law, R., & Wen, I. (2008). The impact of website quality on customer satisfaction and purchase intentions: Evidence from Chinese online visitors. *International Journal of Hospitality Management*, 27(3), 391-402.
- Buhalis, D., & Law, R. (2008). Progress in information technology and tourism management: 20 years on and 10 years after the Internet - The state of eTourism research. *Tourism Management*, 29(4), 609-623.
- Chang, H. H., & Chen, S. W. (2008). The impact of online store environment cues on purchase intention: Trust and perceived risk as a mediator. *Online Information Review*, 32(6), 818-841.
- Cheah, C. F., & Abdul-Rahim, A. S. (2018). Relationship between health care and tourism sectors to economic growth: The case of Malaysia, Singapore and Thailand. *Pertanika Journal of Social Sciences and Humanities*, 26(2), 1203-1214.
- Chien, S. H., Chen, Y. H., & Hsu, C. Y. (2012). Exploring the impact of trust and relational embeddedness in e-marketplaces: An empirical study in Taiwan. *Industrial Marketing Management*, 41(3), 460-468.
- Choi, S., & Kimes, S. E. (2002). Electronic distribution channels' effect on hotel revenue management. *Cornell Hotel and Restaurant Administration Quarterly*, 43(3), 23-31.
- Crnojevac, I. H., Gugić, J., & Karlovc̃an, S. (2010). eTourism: A comparison of online and offline bookings and the importance of hotel attributes. *Journal of Information and Organizational Sciences*, 34(1), 41-54.
- FP, E. (2017). *Tinggal.com tawarkan pemesanan hotel bujet online dengan harga mulai Rp 125 ribu* [Tinggal.com offers online budget hotel bookings with prices starting at 125 thousand rupiahs]. Retrieved April 23, 2017, from <https://infokomputer.grid.id/2017/02/berita/berita-reguler/tinggal-com-tawarkan-pemesanan-hotel-bujet-online-dengan-harga-mulai-rp125-ribu/>
- Hemmington, N. (2007). From service to experience: Understanding and defining the hospitality business. *The Service Industries Journal*, 27(6), 747-755.



- Indonesia-investments. (2016). *Industri pariwisata Indonesia* [Indonesia Tourism Industry]. Retrieved March 15, 2017, from <http://www.indonesia-investments.com/id/bisnis/industrisektor/pariwisata/item6051?>
- Jamaludin, F. (2015). *Begini potensi pasar online di Indonesia* [The potential of the online market in Indonesia]. Retrieved April 23, 2017, from <https://www.merdeka.com/teknologi/begini-potensi-pasar-online-travel-di-indonesia.html>
- Jansen, B. J., Ciamacca, C. C., & Spink, A. (2008). An analysis of travel information searching on the web. *Information Technology and Tourism*, 10(2), 1-18.
- Jeong, M., Oh, H., & Gregoire, M. (2003). Conceptualizing web site quality and its consequences in the lodging industry. *International Journal of Hospitality Management*, 22(2), 161-175.
- Kim, D., & Perdue, R. R. (2013). The effects of cognitive, affective, and sensory attributes on hotel choice. *International Journal of Hospitality Management*, 35(1), 246-257.
- Lee, Y., & Kozar, K. A. (2012). Understanding of website usability: Specifying and measuring constructs and their relationships. *Decision Support Systems*, 52(2), 450-463.
- Ling, L., Guo, & Yang, C. (2014). Opening the online marketplace: An examination of hotel pricing and travel agency on-line distribution of rooms. *Tourism Management*, 45, 234-243.
- Lockyer, T. (2005). The perceived importance of price as one hotel selection dimension. *Tourism Management*, 26(4), 529-537.
- Loiacono, E. T., Watson, R. T., & Goodhue, D. L. (2002). Webqual : a measure of website quality. *Marketing Theory and Applications*, 13(3), 432-438.
- Malhotra, N. K. (2012). *Basic marketing research: Implicit measures of attitudes*. Boston, Massachusetts: Pearson.
- Morgan, R. M., & Hunt, S. D. (1994). The commitment-trust theory of relationship marketing. *Journal of Marketing*, 58(3), 20-38.
- Myung, E., Li, L., & Bai, B. (2009). Managing the distribution channel relationship with e-Wholesalers: Hotel operators' perspective. *Journal of Hospitality Marketing and Management*, 18(8), 811-828.
- Pan, B., Xhang, L., & Law, R. (2013). The complex matter of online hotel choice. *Cornell Hospitality Quarterly*, 54(1), 74-83.
- Peng, H., Xu, X., & Chen, W. (2013). Tourist behaviors in online booking: A new research agenda. *Communications in Information Science and Management Engineering*, 3(6), 280-285.
- Quinby, D., & Jain, D. (2012). *PhoCusWright's U.S online travel overviews (Eleventh Edition)*. Retrieved on August 26, 2017, from <https://www.phocuswright.com/Travel-Research/Market-Overview-Sizing/U-S-Online-Travel-Overview-Eleventh-Edition-Market-Data-Sheet>
- Pine, B. J., & Gilmore, J. H. (2014). A leader's guide to innovation in the experience economy. *Strategy and Leadership*, 42(1), 24-29.
- Priyanto, D. (2011). *Buku saku analisis statistik data SPSS* [SPSS data analysis handbook of statistics]. Yogyakarta, Indonesia: Penerbit Mediakom.
- Senior, M., & Morphey, R. (1990). Competitive strategies in the budget hotel sector. *International Journal of Contemporary Hospitality Management*, 2(3), 3-9.
- Shaw, S. (2005). *Tipped off*. Retrieved August 10, 2017, from [https://en.tripadvisor.com.hk/ShowTopic-g60763-i5-k1058414-On\\_Tipping-New\\_York\\_City\\_New\\_York.html](https://en.tripadvisor.com.hk/ShowTopic-g60763-i5-k1058414-On_Tipping-New_York_City_New_York.html)

- Shen, C. C., & Chiou, J. S. (2010). The impact of perceived ease of use on Internet service adoption: The moderating effects of temporal distance and perceived risk. *Computers in Human Behavior*, 26(1), 42-50.
- Slamet, P. (2015). *Pertumbuhan hotel budget di atas 50%* [Budget hotel increase above 50%]. Retrieved August 22, 2017, from <http://id.beritasatu.com/home/pertumbuhan-hotel-budget-di-atas-50/107720>
- Smith, S., & Wheeler, J. (2002). *Managing the customer experience: Turning customers into advocates*. London, England: Prentice Hall Financial Times and Pearson Education Ltd.
- Sparks, B. A., & Browning, V. (2011). The impact of online reviews on hotel booking intentions and perceptions of trust. *Tourism Management*, 32(6), 1310-1323.
- Statista Inc. (2017). *E-commerce share of total retail sales in Indonesia from 2015 to 2017 (in billion US dollars)*. Retrieved September 9 2017, from <https://www.statista.com/statistics/970740/indonesia-e-commerce-share-of-retail-sales/>
- Sujarweni, V. (2015). *Metodologi penelitian bisnis dan ekonomi* [Business and economic research methodology]. Yogyakarta, Indonesia: Pustaka Baru Press.
- Toh, R., Dekay, C., & Raven, P. (2011). Travel planning: Searching for and booking hotels on the Internet. *Cornell Hospitality Quarterly*, 52(4), 388-398.
- TravelClick. (2011). *Hotel bookings by channel*. Retrieved April 11, 2011, from <https://www.travelclick.com/>
- Venkatesh, V., & Agarwal, R. (2006). Turning visitors into customers: A usability centric perspective on purchase behavior in electronic channels. *Management Science*, 52(3), 367-382.
- Walls, A. (2013). A cross-sectional examination of hotel consumer experience and relative effects on consumer values. *International Journal of Hospitality Management*, 32, 179-192.
- Wang Y. S., Li, H. T., Li, C. R., & Zhang, D. Z. (2016). Factors affecting hotels' adoption of mobile reservation systems: A technology-organization-environment framework. *Tourism Management*, 53, 163-172.
- Wang, Y. D., & Emurian, H. H. (2005). An overview of online trust: Concepts, elements, and implications. *Computers in Human Behavior*, 21(1), 105-125.
- Wang, L., Law, R., Guillet, B. D., Hung, K., & Fong, D. K. C. (2015). Impact of hotel website quality on online booking intentions: eTrust as a mediator. *International Journal of Hospitality Management*, 47, 108-115.
- Wijaya, K. K. (2015). *Rocket internet ZEN Rooms pemesanan hotel murah terjangkau* [Rocket ZEN Rooms affordable cheap hotel bookings]. Retrieved November 16, 2016, from <http://id.techniasia.com/rocket/internetZEN-Rooms-pemesanan-hotel-murah-terjangkau>
- World Travel & Tourism Council. (2016). *Economic impact 2017 Asia Pacific*. Retrieved September 17, 2017, from <https://www.wttc.org/-/media/files/reports/economic-impactresearch/regions-2017/asiapacific2017.pdf>
- Yustiana, K. (2016). *Tren pesan hotel via online di Indonesia terus meningkat* [The trend of ordering hotels via online in Indonesia continues to increase]. Retrieved November 21, 2016, from <http://travel.detik.com/read/2016/03/01/155116/3154908/1382/tren-pesan-hotel-viaonline-di-indonesia-terus-meningkat>
- Zou, T. (2003). Critical success factors and operational modes of economy hotels. *Journal of Beijing Foreign Studies University*, 4, 29-32.

## **Control of the Right to Strike Affecting the Productivity of State-Owned Enterprises**

**Christian Orchard Perangin-Angin\* and Bismar Nasution**

*Law Program, Graduate School, University of Sumatera Utara, Jl. Universitas No.19, Padang Bulan, Medan 20155, Indonesia*

### **ABSTRACT**

The existence of manpower is an important part of the production process in state-owned enterprises (SOEs). The involvement of the workforce as the company's leading guard has placed a strike as its basic right to convey any wishes and demands. A strike by labourers/workers is a very detrimental action to the company because it will disturb the production and will eventually impact the people's economy nationally. This research used a normative legal method. The results indicate that the right to strike must meet the provisions of Law Number 13 of 2003 on Manpower (Labor Law). This is further described in the decree of the Minister of Manpower and Transmigration Number 232/MEN/2003 on Legal Effects of Unlawful Strikes (Kepmen 232). In conclusion, both Labor law and Kepmen 232 have sufficiently provided an opportunity for entrepreneurs to anticipate the situation before the strike because it should be notified seven days earlier. Such notification gives the entrepreneurs enough time to prepare a contingency plan so that the production process will not be disturbed.

*Keywords:* Productivity, right to strike, state-owned enterprises

### **INTRODUCTION**

State-owned enterprises (SOEs) are established as a logical consequence of the realization of the state's goal that is to realize

the welfare of the society<sup>1</sup>. This is in line with the mandate of the 1945 Constitution concerning the state's control over the branches of production that are important for the state, and affect the livelihood of the people. Therefore, the purpose, goal

#### **ARTICLE INFO**

*Article history:*

Received: 09 October 2019

Accepted: 03 January 2020

Published: 17 March 2020

*E-mail addresses:*

orchard27christian@gmail.com (Christian Orchard Perangin-Angin)

bismarnasution@gmail.com (Bismar Nasution)

\* Corresponding author

<sup>1</sup> Article 1 Number 1 of Law Number 19 of 2003 on State-Owned Enterprises states that State-Owned Enterprises, hereinafter referred to as SOEs, are business entities wholly or largely owned by the state through a direct participation derived from separated state assets.

and nature of SOEs should be in line with the general purpose of the state that is to improve the public welfare. In addition, the commercial functions of SOEs must go hand in hand with the community functions<sup>2</sup>.

Furthermore, Article 33 of the 1945 Constitution means that the state must maintain what is contained within itself, including safety, economic resilience and state property, from certain group or personal domination, and control the important production branches covering public facilities whose benefits are used for the benefit and welfare of the people (Mahlli, 2015). Therefore, as long as Article 33 of the 1945 Constitution is still listed in the Constitution, the State's involvement in managing the Indonesian economy is still needed (Badan Pembinaan Hukum Nasional [BPHN], 2011).

SOEs as business entities that produce goods or services employ manpower as an integral part of their business activities. Mutual benefit relationships between the employers, in this context, referring to the management of the company, and the workforce will create a conducive situation and a synergistic that will improve the company's performance<sup>3</sup>. The convenience

of working is the main benchmark in creating a conducive company, so it will not be difficult for a company to achieve its goal if the relationships between the workforce and employers run harmoniously.

As Indonesia aims for higher growth rates to spur employment and development, promote national welfare and improve competitiveness, productivity is at the heart of achieving this dream. The production function shows that both capital and labour are experiencing increasing returns offering possibilities for expansion of output and efficient absorption of new inputs. Both labour and capital appear as complementary factors, though labour plays a far more critical role and is experiencing larger expansion than capital. On the other hand, capital has been falling although capital is experiencing saving technological progress, allowing the country to keep output levels with relatively fewer capital inputs. However, the growth of labour requires a higher capital injection to increase output. The time variable indicates positive tech-progress. However, the rapid growth of absolute number of labour requires higher amounts of capital to continue increasing output (Sugiharti, et. al., 2017).

The position of the workforce in an industrial relationship holds the main role because the absence of workforce in a production process will result in the ineffective production process and the company's inability to achieve its goals (Farianto, 2014). However, the existence of a mutual benefit relationship between the employers and the workforce cannot

<sup>2</sup> The number of SOEs between 2015-2017 decreased from 118 to 115, due to the holding of SOEs on Mining on 29 November 2017, namely the transfer of state shares from PT Antam (Persero) Tbk, PT Timah (Persero) Tbk and PT Bukit Asam (Persero) Tbk to PT Inalum Tbk.

<sup>3</sup> Industrial relations that hold on to the values of the nation, in the sense that *Pancasila* is expected to be able to increase the welfare of workers and to maintain calmness in working and running a business that has impacts on the increased production (Sutedi, 2009).

run properly due to the disharmony between them. Each party believes that they have had the greatest contribution to the success of the company. From the workforce side, in expressing their dissatisfaction with the situation and conditions in the company, the workers can use a striking mechanism (Priambodo, 2004).

A strike is usually done by a group of workers as the last alternative to give pressure on the employers for the improvement of a wage system or a working condition (Pardede, 1995). The strength and influence of strike lie in its collective nature to achieve a common goal. This joint action is very important for the workers because without which it would be very difficult for them to deal with the employers who have greater bargaining power positions (Santoso, 2011).

Strikes by SOEs labourers/workers are actions that are very detrimental to the company because the production will be disturbed and will eventually affect the people's economy. As an example of comparison, the data in 2011 recorded 120 cases of strikes involving 40,000 workers and losing 327,355 working hours. In 2012, there was a decline of 51 cases of strikes involving 13,000 workers and losing 28,000 working hours<sup>4</sup>. For workers, a strike will make them lose their working hours, for which they will not get wages. Meanwhile, for society, a massive strike will reduce the national production affecting the rise of

<sup>4</sup> <https://economy.okezone.com/read/2013/07/16/320/837633/duh-mayoritas-buruh-yang-mogok-dari-bumn>, Retrieved April 15, 2018.

the price of goods. In addition, strikes that occur in companies that are experiencing financial difficulties or in small-scale companies will accelerate the bankruptcy of such companies. Such a situation will certainly lead to the increased number of unemployment in society (Widagdo, 2008).

According to Article 33 (2), the Indonesian Constitution 1945 stated that sectors of production which are important for the country and affect the life of the people shall be under the powers of the State. Furthermore, the State implements this article through the establishment of SOEs to run businesses so the profit shall be used to the greatest benefit of the people.

Based on the above conditions, the government regulates the exercise of the right to strike in a Labor Law (UUK). Nevertheless, in its implementation, a strike needs to be controlled in order not to disturb the production process in SOEs (Gunarto, 2010).

### **Formulation of the Problem**

The problem in this research is how to control the right to strike so it will not bring a significant effect on the SOE's productivity.

### **MATERIALS AND METHODS**

This was legal research (Ibrahim, 2006) using a normative method (Soemitro, 1988) in analyzing the material of laws (Soekanto & Mamudji, 2011). Then a literature review was conducted. The data in this paper were secondary data which were library materials

including official documents, library books, legislation, scientific papers, articles and documents relating to research materials (Soekanto & Mamudji, 2011).

## RESULTS AND DISCUSSIONS

### Recognition of a Strike as a Right

Rights are interests that are protected by the law. Rights give pleasure and discretion to individuals in carrying them out (Mertokusumo, 2005). Obligations are positive legal norms that order personal behaviour by prescribing sanctions for the opposite behaviour. The concept of legal obligations is basically related to the concept of sanctions. The subject of legal obligations is an individual whose behaviour can become a condition of imposing sanctions as its consequence (Kelsen, 2006).

Freedom of expressing opinions in public is a human right guaranteed in the 1945 Constitution of the Republic of Indonesia (UUD 1945). This applies to all citizens<sup>5</sup>.

For labourers, the issue of expressing opinions cannot be separated from strike activities. Strikes are one of the issues that can disturb the business world and disrupt employment relations and harmony of the industrial relationships. Besides, the harmonious social life of the community involving various related parties will also be disrupted. On the other hand, for workers involved in a strike, joining a strike is, sometimes, only a compulsion

<sup>5</sup> Article 28 of the 1945 Constitution; further regulated in Law Number 9 of 1998 on Independence of Expressing Opinion in Public

due to the communication deadlock or the absence of good communication between the management and the workers (Van Voss & Tjandra, 2012).

A strike is usually done as the final effort of workers or Labor Union with the purpose of giving pressure to the employers to improve their right and/or the work system which, according to the workers, is still not in compliance with the provisions of their rights (Wijayanti, 2009).

A strike is a tool in achieving goals that initially arise due to the demands of workers. Disputes between the workers and the employers followed by a strike are not an easy phenomenon to avoid in an employment relationship<sup>6</sup>. On the one hand, a strike can result in substantial losses, especially if committed by workers in industries that have a major impact on society, such as trade or public services, but on the other hand, a strike is an internationally recognized right to protect workers.

Although the right to strike is not explicitly stated in the Constitution or in the Philadelphia Declaration, the right to strike is implicitly contained in the ILO Convention Number 87 of 1948 on 'Right to Establish and Become a Member of the Labor Union' and the ILO Convention Number 98 of 1949 on 'Right to Organize and Collective

<sup>6</sup> Industrial relation disputes are disagreements that result in a conflict between the Entrepreneurs or a group of Entrepreneurs with Workers/Laborers or Trade Unions/Labor Unions because of right disputes, interest disputes, work termination disputes and disputes between Trade Unions/Labor Unions in one company (Article 1 Point 1 of Law Number 2 of 2004 on Industrial Relation Settlement). (Kertanegoro, 1999)



Bargaining'. In the discussion report on drafting the ILO Convention Number 87 of 1948, the words "right to strike" were mentioned several times (Werhane, 1985).

At its second meeting held in 1952, the Committee on Freedom of Association had declared that a strike action was a right and had established the basic principles underlying this right, whereby all other rights were acquired at a certain level, and which recognized that the right to strike was one of the means of principle in which workers and their unions could promote and defend their economic and social interests legally. Over the years, in accordance with this principle, the Committee on Freedom of Association has acknowledged that strike action is a right and is not merely a social action (International Labour Organization, 2012). Hence, according to the ILO expert committee, a strike is a labour collective right to stop working with the purpose of meeting their demands. Therefore, a strike is one of the labour union activities corresponding to the ILO Convention Number 87.

In labour law in many countries, including Indonesia, a strike is the right of every worker. The United States has recognized a strike as a right before the Declaration of Human Rights in 1948. Such recognition was made for the protection of its labourers. This situation was marked by the enactment of the Wagner Act in 1935 which changed the concept of the strike as criminal conspiracy or as civil conspiracy into a right (rights to strike). Through the Warner Act, United States has been recorded

as the first country recognizing a strike as a right, even the Warner Act is described as the Magna Charta by US labour (Uwiyono, 2001).

In Indonesia, a strike is a basic right owned by workers/labourers and trade unions/labour unions. Strikes are carried out by workers/labourers and trade unions/labour unions as a result of negotiation failure<sup>7</sup>. The failure to reach an industrial relations dispute resolution agreement may be caused by the employer's reluctance to enter into negotiations even though the trade unions/labour unions have requested in writing to the employer. Labor Law (UUK), in this case, provides a space for labourers and/or labour unions to carry out a strike. Strikes, in labour regulations, are interpreted as labourers' actions which are planned and executed jointly and/or by trade unions/labour unions to stop or slow down their working<sup>8</sup>.

The strikes justified in the Labor Law are those conducted legally, orderly and peacefully and carried out in accordance with the provisions of the Labor Law<sup>9</sup>. Within at least 7 (seven) working days prior notice before the strike is carried out, workers/labourers and trade unions/labour unions shall notify in writing to employers and agencies responsible for the local employment<sup>10</sup>. The notification to employers and agencies responsible for manpower issues shall at least contain 1) the time

<sup>7</sup> See Article 1 Point 23 and Article 137 of Law Number 13 of 2003 on Manpower

<sup>8</sup> Article 1 Point 23 of the Labor Law

<sup>9</sup> Article 137 of the Labor Law

<sup>10</sup> Article 140 Paragraph (1) of the Labor Law



(day, date and time of starting and ending a strike) to strike; 2) the place or location to strike; 3) the reasons motivating to strike; and 4) the signatures of the chairperson and secretary and/or respective chairpersons and secretaries of trade unions/labours unions as the persons in charge of the strikes.

If the strike is carried out without prior notification to the employer and the relevant agencies, then, in order to save the production equipment and assets of the company, the employer and the relevant agencies may take temporary actions such as prohibiting the workers/labourers involved in the strike to be present at the location of production process activities; or where it is deemed necessary, prohibiting the workers/labourers involved in the strike to be present at the company's location.

If the strike is not in accordance with the provisions of Article 139 and Article 140 of the Labor Law, then under the Decree of the Minister of Manpower and Transmigration Number 232 of 2003, the strike is categorized as an illegal strike. The legal effect of unlawful strikes on the striking labourers is qualified as defaulters. To that end, employers may make an appropriate and written summon to work again to those involved in unlawful strikers. If the workers/labourers do not respond to the summon, they are considered to have resigned.

SOEs have to figure out how to resolve the problems on workers' strike so it can mitigate the impact of the strike on productivity. Jeremy Bentham says that all people are self-interested and are motivated

by the desire to avoid pain and find pleasure. Any worker will only work if the reward is big enough or the punishment is sufficiently unpleasant. This metaphor the *carrot and stick* relate of course to the use of rewards and penalties in order to induce the desired behaviour. It comes from the old story that to make a donkey move, one must put a carrot in front of it or dab it with a stick from behind.

Despite all the researches on the theories, reward and punishment are still considered strong motivators. Bentham argues that the problem with this approach is that since carrot refers to money and if one gets it easily, it is thus simple as follows; if a donkey is put in a pen full of carrots and another person stood outside the pen with a carrot in hand, will the donkey be encouraged to come out of the pen? The "stick" in the form of punishment such as loss of income, reduction of bonuses, demotion or some other penalty has continued to be a strong motivator yet it is admittedly not the best kind because it often gives rise to defensive and retaliatory behaviour. Whether managers are first-level managers or executive, the powers of their position to give or withhold rewards or impose penalties of various kinds give them the ability to control to a greater extent, the economic and social wellbeing of their subordinates (Bentham, 2013.)

### **SOEs as the Agent of Development**

Since the first decade of the independence revolution up to the present time, SOEs have contributed enormously to the growth

and development of the national economy. Looking back at the early days of Indonesia's independence, when the private sector had not worked effectively due to the political and economic situation following the unorganized struggle for independence, SOEs became the foundation for the program of providing goods and services and other infrastructure by the government. At that time, it could be said that SOEs served as the pillar for the national economy and development (Yasin, 2012).

In the next period, the role of SOEs remained significant for the development of the national economy (Sulaiman, 2011). Their role included undertaking the development of undeveloped and untouched sectors by private companies. Therefore, many government assignments were handed to SOEs to implement pioneering development projects that gave rise to the term "SOEs as the agent of development" with all its strengths and weaknesses, as well as the various controversies accompanying it (Yasin, 2012).

Such assignments showed the role of SOEs as the agent of development, which did not only think of profit but also served the public interest through the development of projects related to the public interest (Kotter, 1996). At the same time, SOEs were also income sources for the State (Muchayat, 2010), having a considerable amount of assets with varying scales and types of businesses and operating areas scattered throughout Indonesia (Akadun, 2007).

As an organization, SOEs do have unique properties. On the one hand, as the agent of development, it is demanded to shoulder government policies and programs, but on the other hand, it must continue to function as a commercial business unit operating on the basis of sound business rules and principles (Moeljono, 2004). In some ways, the "ambivalence" of the two functions is often less able to walk in harmony, even there is a possibility of confusion of perceptions within the SOEs management. This can result in the difficulty of management in determining strategic and operational measures (Priambodo, 2004).

SOEs are expected to play a role in contributing to the state revenue as well as in providing motivation and innovation for all sectors of the economy. New enterprises, both micro and small-medium scale enterprises, are a mainstay during the economic crisis that can keep the national economic stability expected to grow at the support of SOEs (Muchayat, 2010). Therefore, a concrete concept is needed in order to map and analyze the SOEs after the 1997 economic crisis in order that SOEs will have high competitiveness and can carry out their development role.

SOEs serve as a national economic actor that takes part in determining the direction of Indonesia's economic development in the future, including becoming the main accelerator of the national economic recovery. Therefore, policies relating to SOEs should actually bring values to the extent possible to make the management of SOEs destined for the national interest.

The establishment of state business in the form of state enterprises is motivated by the same single assumption that there is always a sector or field in a country that is considered important for the state, controlling the livelihood of the people and playing a vital or strategic role. Therefore, the management or sustainability of such a sector cannot simply be handed over to private enterprises (Sjahrir & Ikhsan, 1994). Thus the establishment of SOEs is the desire of the state to manage the important sectors or fields that affect the livelihood of the people, which will certainly be returned in the form of public welfare.

At this time, in the implementation of their duties, SOEs require some improvements in their management system to lift their performance. Such improvement devices include creating system controls. The paradigm of SOEs can simultaneously be changed, including changing the mindset of the management and employees and improving their technological systems (Nugraha, 2007).

### **Control of the Right to Strike in SOEs**

The right to strike provided by the labour regulation should be a matter of concern in the effort to make SOEs a locomotive of the national economy. With regard to the function of the state, the government as the state organizer must be able to create legislation in favour of the people (Suhardin, 2007). The actual rule of law will only exist if the rule reflects justice for the associative life of its citizens (Kusnardi & Ibrahim, 1988). Any government policies in the form

of a regulation or legislation will be able to open opportunities for the creation of welfare for society (Halim, 2001).

Jeremy Bentham argued that the role of a law was to create a condition where happiness was always greater than a misery. The law's function is to maintain order and prevent crime. Law becomes a tool for creating conditions where happiness is much more colourful to the lives of more individuals as possible in a society than a misery. In addition, according to Bentham, the law must also act as a balance keeper of various interests (balance of interests). It is in this context that Bentham actually considers a law has to provide a utility to the people. Whether a law is good or bad, fair or unfair depends on whether the law gives happiness to the people (Bentham, 2006).

Rights and obligations are not a collection of rules or regulations but are a balance of power where the individual rights of one party are reflected in the obligations of another party. Rights and obligations are the powers granted to a person by a law (Mertokusumo, 2005). To give rise to rights and obligations needs the occurrence of an event which, by the law, is connected as a cause and an effect. Events that have legal consequences are legal events.

As a legal event that gives rise to legal consequences, the regulation on the rights and obligations of labour and entrepreneurs in strikes is important to be observed because even if the relations of labour and entrepreneurs are interdependent, such an interdependence relationship is always unequal (Rawls, 1971).

A strike is a tool for workers to balance their lower bargaining position compared to entrepreneurs. Thus, the rights and obligations of labour and entrepreneurs in strikes should not be made in such a way that makes the rights to strike which should have served as a balancing bargaining position for workers difficult to implement (Hermawan, 2012).

The problem is different when the employers are the SOEs. As has been previously explained, the status of SOEs is running businesses that affect the livelihood of the people (Hidayat & Soeratin, 2005). In the event of a strike, working hours will be wasted that directly results in declining productivity. The productivity in SOEs do not only produce goods but also services.

For example, PT Jakarta International Container Terminal (JICT) went on a strike on 3-10 August 2017 involving more than 650 workers<sup>11</sup>. This strike certainly caused financial losses. In addition, the large number of goods accumulated in the terminal also caused mistrust from the national and international consumers.

The Labor Law and Kepmen 232 have regulated strikes for employees. For SOEs, it is not difficult to control the strike of their employees because the matters relating to the manner, time and procedure in doing a strike have been regulated in both regulations. Article 140 of the Labor Law states that within at least 7 (seven) working days before the strike is carried out, workers/labourers and trade unions/labour unions shall notify in writing to

<sup>11</sup> <https://megapolitan.kompas.com/read/2017/08/03/14064981/lebih-dari-650-pegawai-jict-mogok-kerja>, Retrieved April 15, 2018.

employers and agencies responsible for the local employment.

Control of strikes may also be made through the labour union. The freedom to establish a labour union and to become or not to become a labour union member is one of the basic rights of workers<sup>12</sup>. Through unions, workers' aspirations can be conveyed democratically for the sake of production sustainability<sup>13</sup>. This means that SOEs should maintain a harmonious relationship with workers through such labour unions<sup>14</sup>.

If strikes are unavoidable, employers should always prepare a contingency plan, so that the service and productivity keep on running optimally. PT JICT, for example, moved the loading and unloading process to another terminal in Tanjung Priok.

## CONCLUSIONS

SOEs run their business on the fields that control the livelihood of the people. SOEs that produce goods or services employ manpower as an integral part of their business activities. Quality relationships between the employers in this context, referring to the management of the company, and the workforce will create a conducive situation and a synergistic that will improve the company's performance. But there will be times when such a relationship does not go as expected, so a strike movement is unavoidable.

<sup>12</sup> Elucidation of Article 104 Paragraph 1 of the Labor Law

<sup>13</sup> Article 10 of the Labor Law

<sup>14</sup> See Article 30 of Law Number 21 of 2000 on Labor Union

Article 140 Paragraph 1 of the Labor Law has provided sufficient opportunities for employers to prepare for a strike. Within at least 7 (seven) working days before the strike is carried out, workers/labourers and trade unions/labour unions shall notify in writing to employers and agencies responsible for the local employment. The settlement through various efforts is still possible to do. In addition, the employers should always prepare a contingency plan, so that service and productivity can still run optimally. For the purpose of effectiveness, several points should be set forth in every internal regulation which is binding on the workers, either in the form of Work Instruction, Standard Operating Procedures or Internal Regulation of the SOEs.

## ACKNOWLEDGEMENT

The authors wish to acknowledge and thank all IMHA 2018 committee members and UPM *Pertanika* journal team that help publish this article.

## REFERENCES

- Akadun. (2007). *Administrasi perusahaan negara* [State company administration]. Bandung, Indonesia: Alfabeta.
- Badan Pembinaan Hukum Nasional. (2011). *Privatisasi perusahaan milik negara ditinjau dari UUD 1945* [Privatization of state-owned companies judging from the 1945 Constitution]. Jakarta, Indonesia: Kementerian Hukum dan Hak Asasi Manusia RI.
- Bentham, J. (2006). *Teori perundang-undangan: prinsip-prinsip legislasi, hukum perdata dan hukum pidana* [Legislation theory: the principles of legislation, civil law and criminal law]. Bandung, Indonesia: Nusamedia dan Nuansa.
- Bentham, J. (2013). *Carrot and stick theory*. Retrieved July 15, 2018, from <http://www.indiagk.net/2013/08/carrotand-stick-theory-by-jeremy.html>
- Farianto, W. (2014). Hak mogok kerja dalam perspektif yuridis dan sosiologis [The right to strike in a juridical and sociological perspective]. *Jurnal Hukum IUS QUIA IUSTUM*, 21(4), 632-654.
- Gunarto, G. (2010). Rekonstruksi konsep kebebasan hak berserikat bagi serikat pekerja pada hubungan industrial berbasis nilai keadilan [Reconstruction of the concept of freedom of association rights for trade unions on industrial relations based on the value of justice]. *Jurnal Dinamika Hukum*, 10(3), 265-276.
- Halim, A. R. (2001). *Pengantar hukum dan pengetahuan ilmu hukum Indonesia* [Reconstruction of the concept of freedom of association rights for trade unions on industrial relations based on the value of justice]. Jakarta, Indonesia: Angky Pelita Studyways.
- Hermawan, A. (2012). Keseimbangan hak dan kewajiban pekerja dan pengusaha dalam mogok kerja [Balance of rights and responsibilities of workers and employers in a strike]. *Jurnal Mimbar Hukum*, 24(30), 418-430.
- Hidayat, H., & Soeratin, H. Z. (2005). *Peranan BUMN dalam kerangka otonomi daerah* [The role of BUMN in the framework of regional autonomy]. Presented at Sosialisasi Peranan BUMN, Universitas Amir Hamzah, Indonesia.
- Ibrahim, J. (2006). *Teori dan metodologi penelitian hukum normatif* [Theory and methodology of normative legal research]. Malang, Indonesia: Bayumedia Publishing.
- International Labour Organization. (2012). *Hak mogok* [Right to strike]. Jakarta, Indonesia: ILO

- Kelsen, H. (2006). *Teori hukum murni: Dasar-dasar ilmu hukum normatif* [Pure legal theory: The basics of normative legal science]. Bandung, Indonesia: Nusamedia dan Nuansa.
- Kertanegoro, S. (1999). *Hubungan industrial-hubungan antara pengusaha pekerja dan pemerintah* [Industrial relations - Relations between employers and the government]. Jakarta, Indonesia: YTKI.
- Kotter, J. (1996). *Leading change: Menjadi pioner perubahan* [Leading change: Being a pioneer of change]. Jakarta, Indonesia: PT Gramedia Pustaka Utama.
- Kusnardi, M., & Ibrahim, H. (1988). *Hukum tata negara Indonesia* [Indonesian constitutional law]. Jakarta, Indonesia: Sinar Bakti
- Mahlli, K. (2015). Negara kesejahteraan dalam konteks pembangunan wilayah [Welfare state in the context of regional development]. *Jurnal Ekonomi*, 18(1), 38-48.
- Mertokusumo, S.(2005). *Mengenal hukum: Suatu pengantar* [An Introduction to Law]. Yogyakarta, Indonesia: Liberty.
- Moeljono, D. (2004). *Reinvensi BUMN: Empat strategi membangun BUMN kelas dunia* [BUMN (state-owned enterprises) Reinvention: Four strategies to build world-class SOEs]. Jakarta, Indonesia: Elex Media Komputindo.
- Muchayat. (2010). *Badan usaha milik negara: Retorika, dinamika, dan realita (menuju BUMN yang berdaya saing)* [State-owned enterprises: Rhetoric, dynamics, and reality (towards competitive SOEs)]. Jakarta, Indonesia: Gagas Bisnis.
- Nugraha, S. (2007). Privatisasi BUMN, antara harapan dan kenyataan [BUMN privatization, between expectations and reality]. *Jurnal Hukum Bisnis*, 26(1), 15-17.
- Pardede, M. (1995). Aspek hukum perlindungan tenaga kerja indonesia dalam era globalisasi [Legal aspects of the protection of Indonesian workers in the era of globalization]. *Science*, 30.
- Priambodo, D. S. (2004). *Perjalanan panjang yang berliku, refleksi BUMN 1993-2003:Sebuah catatan tentang peristiwa, pandangan, dan renungan dalam satu darawarsa* [A long, winding journey, reflection of BUMN 1993-2003: A record of events, views and reflections in a decade]. Yogyakarta, Indonesia: Media Pressindo.
- Rawls, J. (1971). *Atheory of justice*. London, England: Harvard University Press.
- Santoso, B. (2011). Pengaturan mogok kerja dalam perspektif hukum Indonesia dan Malaysia [Arrangement of strikes in Indonesian and Malaysian legal perspectives]. *Jurnal Pandecta*, 6(1), 95-105.
- Soekanto, S., & Mamudji, S.(2011). *Penelitian hukum normatif: Suatu tinjauan singkat* [Normative legal research: A brief review]. Jakarta, Indonesia: Raja Grafindo Persada.
- Sjahrir, & Ikhsan, M. (1994). Mendefinisikan kembali peranan pemerintah dalam pembangunan ekonomi [Redefining the role of government in economic development]. *Majalah Manajemen dan Usahawan Indonesia*, 4(1).
- Sugiharti, L., Purwono, R., Primanthi, M. R., & Padilla, M. A. E. (2017). Indonesian productivity growth: evidence from the manufacturing sector in Indonesia. *Pertanika Journal of Social Sciences and Humanities*, 25(S), 29-44.
- Soemitro, R. H. (1988). *Metodologi penelitian hukum dan jurimetri* [Legal research methods and jurimetry]. Jakarta, Indonesia: Ghalia Indonesia.
- Suhardin, Y. (2007). Peranan hukum dalam mewujudkan kesejahteraan masyarakat [The role of law in realizing community welfare]. *Jurnal Hukum Pro Justitia*, 25(3), 270-282.
- Sulaiman, M. (2011). *Keuangan negara pada badan usaha milik negara dalam perspektif ilmu*

- hukum* [State finance in state-owned enterprises in the perspective of legal science]. Bandung, Indonesia: PT Alumni.
- Sutedi, A. (2009). *Hukum perburuhan* [Law of Labor]. Jakarta, Indonesia: Sinar Grafika.
- Uwiyono, A. (2001). *Hak mogok di Indonesia* [The right to strike in Indonesia]. Jakarta, Indonesia: Program Pasca Sarjana FH-UI.
- van Voss, G. H., & Tjandra, S. (Eds.). (2012). *Bab-bab tentang Hukum Perburuhan Indonesia* [Chapters on Indonesian Labor Law]. Denpasar, Indonesia: Pustaka Larasan.
- Widagdo, B. S. (2008). Hak mogok kerja ditinjau dari konvensi internasional labour organization (ILO) [The right to strike as viewed by the International Labor Organization (ILO) convention]. *Jurnal Ilmu Hukum*, 16(4).
- Werhane, P. H. (1985). *Person, rights and corporation*. New Jersey, USA: Prentice Hall Inc.
- Wijayanti, A. (2009). *Hukum ketenagakerjaan pasca reformasi* [Post-Reformation Labor Law]. Jakarta, Indonesia: Sinar Grafika.
- Yasin, M. (2012). *Membangun BUMN berbudaya* [Building a civilized BUMN (State-owned enterprises)]. Jakarta, Indonesia: Booknesia.



## **Design Thinking Corporate Training Effectiveness and the Attributes of the Trainers**

**Ari Margiono\* and Tubagus Hanafi**

*BINUS Business School Master Program, Bina Nusantara University, Jakarta 11480, Indonesia*

### **ABSTRACT**

This research aims to examine the relationship between perceived trainer attributes and design thinking corporate training effectiveness by analysing the data of 257 participants from a series of corporate training sessions in Indonesia. The research utilized the Ordinary Least Squares (OLS) regression model and relative importance analysis to achieve the objective. This research discovered that perceived trainer personality, perceived trainer knowledge, and perceived trainer participant engagement skills played important roles in design thinking training effectiveness - measured from trainees' perceptions of knowledge improvement, knowledge depth, and knowledge expectations. The relative importance analysis further showed that perceived trainer personality was ranked as the most important factor towards participants' perceptions of knowledge improvement; the research also found that perceived trainer engagement skills were seen as the most important factor in deep learning and satisfaction. The theoretical contributions and limitations are also discussed in the paper.

*Keywords:* Corporate training, design thinking, Indonesia, trainers' attributes, training effectiveness

### **INTRODUCTION**

Design thinking - an 'analytic and creative process that engages a person in opportunities to experiment, create and prototype models, gather feedback, and redesign' (Razzouk & Shute, 2012) - recently has gained new ground in the corporate world. Design thinking allows decision-makers in companies to appropriately approach ill-defined problems; primarily, where the problem tends to be 'wicked', for instance, it

#### **ARTICLE INFO**

*Article history:*

Received: 09 October 2019

Accepted: 03 January 2020

Published: 17 March 2020

*E-mail addresses:*

[mmargiono@binus.edu](mailto:mmargiono@binus.edu) (Ari Margiono)

[thanafi@binus.edu](mailto:thanafi@binus.edu) (Tubagus Hanafi)

\* Corresponding author

is messy and difficult to define and pin-down (Buchanan, 1992). Using experience-based insights, judgements, and intuitions, design thinkers in companies can find solutions through prototyping to ensure that they can learn to fail quickly so that they do not have to waste so many resources focusing on the “best” solution at the first iteration (Brown, 2009; Glen et al., 2014).

To this end, many companies have started to introduce design thinking training programs into their corporate training schemes. As systematic approaches in learning and development aiming to improve the performance of individuals in companies (Goldstein & Ford, 2002), corporate training programs are expected to increase the knowledge, skills, and attitudes of employees. Effective corporate training would also change the mindsets and behaviours of employees and managers by generating cultural awareness to achieve the objectives of the organizations (Schraeder et al., 2005).

Furthermore, much research in design thinking literature indicates that appropriate design thinking training would be able to change the mind-sets of the participants so that they can embrace the design mentality (Goldman et al., 2012) and can contribute to the objectives of the companies. Extant studies in design thinking literature, especially in the management discipline context, focus on issues such as the learning journey of the participants (Goldman et al., 2012).

Despite this, there has been very limited research in design thinking literature

that looks at the effectiveness of design thinking training in corporate training, especially related to the role of trainers, and particularly on the attributes of these trainers. It is known from extant literature that trainers play important roles in the learning process of participants, and their attributes (for instance, personality and knowledge) may influence the learning process of the participants (Varela et al., 2011); but little is known on how this looks in a design thinking training context. Due to the relatively “chaotic” nature of the design thinking approach (Brown, 2009), there might be peculiarities in the ways the attributes of the trainers affect the effectiveness of design thinking training. This is worth investigating.

Using Kirkpatrick’s popular four-level theoretical model of training evaluation (Kirkpatrick, 1996; Kirkpatrick, 1959) and the constructivist view of learning (Palincsar, 1998) as the umbrella theoretical framework, this research’s objective is to fill in this gap in the design thinking literature by examining the relationship between the perceived trainer attributes and training effectiveness from 257 participants of design thinking training programs conducted in state-owned enterprises by an executive education wing of one of the largest private business schools in Indonesia.

## Literature Review

The design thinking approach differs from the traditional, rational-analytic problem-solving approach that many organizations have embraced. Table 1, adapted from Glen

Table 1  
*Rational-analytic and design thinking approaches*

	Rational analytic	Design thinking
Problem formulation	Well-defined goals and constraints	Goals and constraints uncovered in the process
Criteria	Objective definitions of criteria	Objective and subjective definitions of criteria
Method	Planning and analysis	Iterative exploration
Information-processing emphasis	Preference for objective formulations	Preference for visual and spatial representations
Solution process	Based on a rational-logical reasoning process	Evolving solutions, incorporate experience-based, insights, judgements, and intuitions
Rationale	Reduces chances of failure	Rapid prototyping to fail quickly
Outcome	Find the “best” answer	Find a “better” answer

Adapted from Glen et al. (2014)

et al. (2014), summarizes the differences between the traditional rational-analytic and design-thinking approaches.

In contrast to the traditional rational-analytic approach, the design thinking approach embraces an iterative exploration to identify problems and the offered solutions through rapid experimentation and prototyping. This approach becomes useful where the uncertainty is high; it is typical in entrepreneurship and in situations where innovation is sought. As a result, design thinking has recently been adopted in various business and entrepreneurship education programs as well as in many corporate training programs (Garbuio et al., 2018) as a problem-solving method that can offer help to business students and corporate executives to navigate the uncharted waters of the future.

Much design thinking research has captured the journey of the participants of design thinking training programs. For example, one research specifically focuses

on the journey of design thinkers in learning design processes and in shifting mindsets (Goldman et al., 2012); other research focuses on the use of massive online courses to teach design thinking (Taheri et al., 2016), on teaching creativity (Mayseless et al., 2018), and the psychology of designers in training programs (She et al., 2017).

Looking further at the broader education and training literature, much research highlights that the success of training sessions, e.g. corporate training, will depend on whether the participants express positive reactions and learning and on whether there are organizational results emerging from the training. This theoretical framework is outlined in Kirkpatrick’s four-level model of evaluation (Kirkpatrick, 1996). The training effectiveness framework identifies how one can make sense of the effectiveness of a training program through the four levels of assessments. The first level is the most common and the most widely used in many studies: understanding training effectiveness

from the reactions of the participants. Understanding the effectiveness of this point of view means to capture the feelings of the participants in regards to the training (Kirkpatrick, 1959). The second level is evaluating training effectiveness from the actual learning of each trainee. The third level is evaluating the behaviour of the participants after they have finished the training. The fourth level is evaluating training effectiveness in terms of the results that it produces, such as increased profit or reduced costs.

Although the higher the level the more objective the evaluation of the training effectiveness will be, the first level is often still considered useful to evaluate training effectiveness. In previous studies, acceptance of a training program can be expressed in several dimensions, among others the feeling of satisfaction, especially related to the expectations of the training, or what is referred to as “knowledge expectation”; the feeling of comprehension of the subjects presented in the training, or what is considered as “knowledge acquisition”; as well as the feeling that the trainees received in-depth information about the subjects in the training, or what is defined as “knowledge depth”.

Furthermore, much research highlights that there are factors responsible for training effectiveness such as training delivery. Various studies have explored these subjects and much research on training delivery focuses on new approaches to engage learners and focus on specific training methods (Aguinis & Kraiger, 2009). Other

relevant but under-explored attributes associated with training delivery and effectiveness are trainers’ attributes (Varela et al., 2011). Prior research has indicated that trainer attributes play important roles in the success of a training program (Holladay & Quinones, 2008; Liberman et al., 2011). However, much of this research is conducted within a diverse context; and despite extensive research on training effectiveness, studies that investigate the role of trainer attributes in non-diverse issues are still lacking.

Moreover, the relationship between trainers’ attributes and training effectiveness may be best explained by the worldview and theoretical framework presented in the constructivist view of learning (Palinscar, 1998). According to the constructivists’ point of view, learning is a social event (Vygotsky, 1962), and therefore, a learning process is essentially a dialectic between agents participating in social interactions. Consequently, training is also a social event (Kraiger, 2008), where there are interpersonal exchanges between those who are involved in the training to increase a particular understanding of a subject matter. In training, knowledge is transacted among those who are involved in the process (Palinscar, 1998).

Up to this point, there has been very limited research that explores this matter in relation to design thinking training. Thus, this study aims to fill this particular gap in design thinking literature and present a study of training effectiveness, and perceived trainer attributes in design thinking training,

especially related to perceived trainer personality, perceived trainer knowledge, and perceived trainer participant engagement

skills. To this end, the constructed research model can be seen in Figure 1.

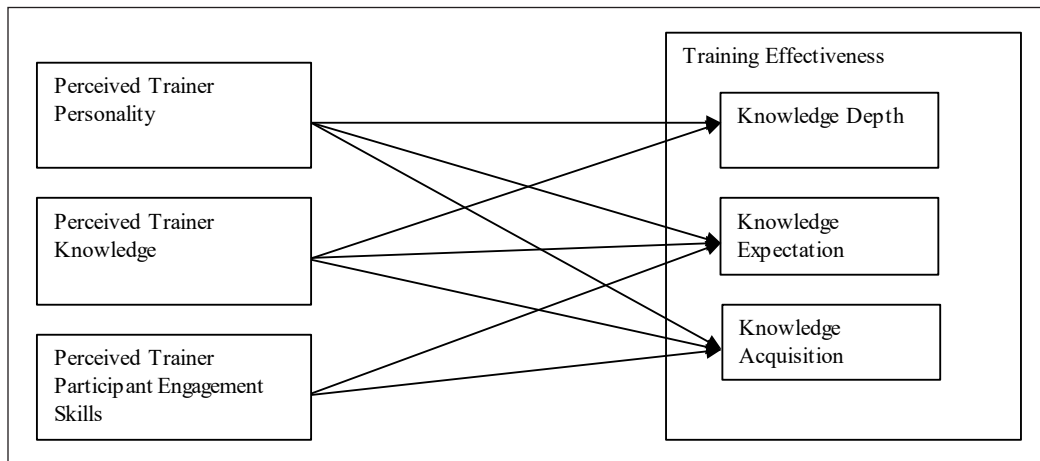

Figure 1. Research model

**Hypotheses Development.** Taking into account Kirkpatrick's four-level theoretical model of evaluation and the constructivist view of a learning framework in explaining the relationship between trainers' attributes and training effectiveness, the following hypotheses were developed.

***Perceived Trainer Personality and Training Effectiveness.*** The perceived personalities of trainers have been known to influence the attitudes and the behaviours of the participants (Banfield et al., 2006; Bernstein-Yamashiro, 2004; Varela et al., 2015). Prior research has shown that positive impressions of a person's personality impact the attitudes and behaviours of others (Varela et al., 2011). The following hypotheses are proposed:

H1a: *Positive perceptions of trainer personality correspond to the feeling that the training sessions meet the expectations of the participants.*

H1b: *Positive perceptions of trainer personality correspond to the feeling that they have learned new knowledge.*

H1c: *Positive perceptions of trainer personality correspond to the feeling that they have in-depth learning of design thinking.*

***Perceived Trainer Knowledge and Training Effectiveness.*** When a person appears knowledgeable, other people tend to believe that the person may have the expertise that he/she shows. For example, in research examining the feedback of book reviews, those who provided negative feedback and therefore looked more knowledgeable were

perceived as more intelligent (Amabile, 1983). Thus, although the participants cannot objectively evaluate the trainer's knowledge, the appearance that the trainer is knowledgeable is important to the learning reactions of the participants. Therefore, it is surmised that:

H2a: *Positive perceptions of a trainer's expert knowledge correspond to the feeling that the training sessions meet the expectations of the participants.*

H2b: *Positive perceptions of a trainer's expert knowledge correspond to the feeling that they have learned new knowledge.*

H2c: *Positive perceptions of a trainer's expert knowledge correspond to the feeling that they have in-depth learning of design thinking.*

***Perceived Trainer Participant Engagement Skills and Training Effectiveness.*** Previous research indicates that a trainer's capability to train is important towards the feeling of learning among the participants (Varela et al., 2011). A trainer's capability to engage with participants, for example, by answering the questions presented by the participants, may help to increase the feeling that the participants have learned the subject matter. Therefore, it is proposed that:

H3a: *Positive perceptions of a trainer's engagement skills correspond to the feeling that the training sessions meet the expectations of the participants.*

H3b: *Positive perceptions of a trainer's engagement skills correspond to the*

*feeling that they have learned new knowledge.*

H3c: *Positive perceptions of a trainer's engagement skills correspond to the feeling that they have in-depth learning of design thinking.*

## **MATERIALS AND METHODS**

### **Participants and Data Collection Procedures**

This research recruited all participants (N = 257) in a population of design thinking training programs that were conducted by a continuing education arm of one of the largest private business schools in Indonesia between 2014-2018. The SOEs involved in this training were mostly operating in banking and service sectors and were approached by the marketing officials of the continuing education unit. The participants of the design thinking training sessions were all middle-managers who underwent capacity building training for their career development. Design thinking was taught as part of the way to increase their skills to enhance a customer-centred approach and utilize innovative solutions. The participants were invited by the learning and development unit of the SOEs and were pre-selected. Therefore, there may be a degree of relative homogeneity in this sample related to the characteristics of the participants. Unfortunately, due to the confidentiality policy, demographic data (age and gender) could not be collected from the participants in this sample.

The training was structured along with the Stanford school design thinking

approach. Depending on the requests of the clients, other business training tools (such as a fishbone analysis, mind-mapping tools, Doblin's Ten Types of Innovation, Business Model Canvas) were used to complement the Stanford d.school tools. All the participants took part in a two-day design thinking training program where they learned to practice the essential steps of design thinking which are empathize, define,

ideate, vote and prototype, and story-tell. Figure 2 outlines the design process that the participants experienced. At the end of the second day of the training, the participants were asked to assess the performance of trainers, including answering questions related to training effectiveness. The participants were asked to respond to a series of statements in a 6-point Likert scale survey of training satisfaction.

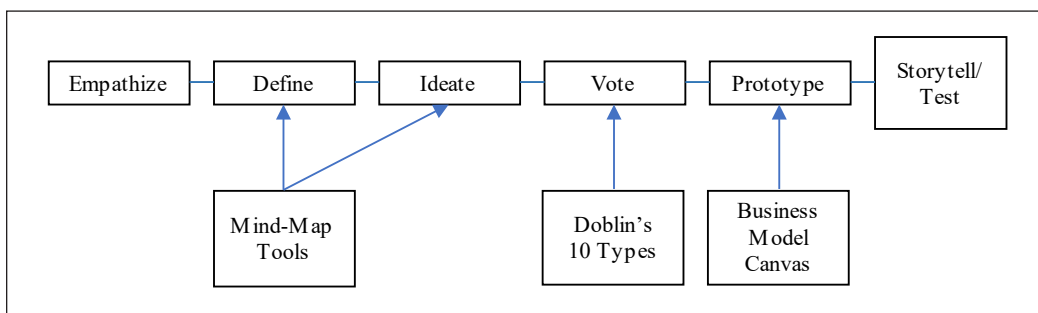

Figure 2. Design process in a design thinking training program

### Measure - Dependent Variable

**Training Effectiveness.** The study's measure of training effectiveness as the dependent variable is the reaction level in Kirkpatrick's four-level model (Kirkpatrick, 1996). Three questions that represent different dimensions of the participants' reactions of the training programs were asked. The questions captured participants' reactions to the extent which they felt that their knowledge was improved to measure their **knowledge acquisition** ("I feel that the subject delivered improved my existing knowledge"), that the training had provided in-depth knowledge in design thinking to measure their **knowledge depth** ("I feel that the subject delivered is deep"), and that

the design thinking subjects delivered in the training programs met their expectations when they started the training sessions on the first day to measure their **knowledge expectations** ("I feel that the training has met my expectations").

### Measure - Independent Variables

**Trainer's Personality.** The trainer's personality was measured using a single-item measure that asked whether the participants felt that the trainer had a pleasant personality according to their perceptions: "How do you rate the personality of the trainer?"

**Trainer's Knowledge.** Similar to personality, this research measured the



trainer's knowledge using a single-item measure that captured the participants' perceptions of the level of knowledge of the trainer: "How do you rate the mastery of the trainer on the subject delivered?"

### **Trainer's Participant Engagement Skills.**

To measure the participant engagement skills, a composite measure was developed that captured the perceptions of participants on the ability of the trainer to engage with them. The composite measure consisted of items that captured the perceptions of the participants on the ability of the trainer to elaborate the subject through a number of examples ("How do you rate the capability of the trainer in giving examples or applied cases?"), on the ability of the trainer to provide clear answers to their questions ("How do you rate the clarity of the answers given by the trainer?"), and on whether they felt that there had been sufficient time allocated to question and answer sessions ("How do you rate the opportunity to engage in question and answer sessions?").

### **Data Analysis**

This research used an Ordinary Least Square (OLS) regression analysis to test the hypotheses in SPSS ver. 23. To further complement the analysis, a relative importance analysis was conducted to understand the relative importance of each independent variable in the analysis (Tonidandel & LeBreton, 2015). This procedure allowed for a further interpretation of the results by ranking the importance

of the independent variables against the dependent variables under investigation. An RWA-WEB tool was used to perform this particular analysis (Tonidandel & LeBreton, 2015).

## **RESULTS AND DISCUSSIONS**

The descriptive statistics of the data, which is outlined in Table 2, shows that all the variables are significantly correlated and they are mostly medium to high correlation ( $0.600 < r < 0.800$ ). The results of the Ordinary Least Square (OLS) regression analysis indicate that the three models show various significant relationships between perceived trainer attributes and training effectiveness variables. Table 3 exhibits the results of the OLS regression analysis of the three models.

Model 1, where the relationship between perceived trainer attributes and the knowledge acquisition was explored, shows a significant relationship between all perceived trainer attributes and knowledge acquisition ( $\beta = 0.417$ ,  $\beta = 0.150$ ,  $\beta = 0.312$ ,  $p < 0.001$ ). In this case, the participants seem to feel that the trainers' attributes contribute to the feeling that they have learned something new. Thus, this finding supports hypotheses 1a, 1b, and 1c.

Model 2, where the relationship between perceived trainer attributes and knowledge depth was explored, conveys a significant relationship between all perceived trainer attributes and training effectiveness ( $\beta = 0.282$ ,  $\beta = 0.438$ ,  $p < 0.001$ ), except between perceived trainer personality and knowledge depth ( $\beta = 0.117$ ,  $p = 0.070$ ).

Thus, this finding only supports hypotheses 2b and 2c. This data seems to show that the feeling of knowledge depth in the training is only attributed to the engagement skills and the knowledge of the trainers, but not the personalities of the trainers.

Model 3, where the relationship between perceived trainer attributes and knowledge expectation was explored, reveals a significant relationship between trainer attributes and training effectiveness ( $\beta =$

0.138,  $\beta = 0.612$ ,  $p < 0.001$ ); the relationship between trainers' knowledge and knowledge expectation is not supported ( $\beta = 0.049$ ,  $p = 0.505$ ). Thus, only hypotheses 3a and 3c are supported. This may indicate that trainers' personalities and skills are responsible to make participants feel that the training meets their expectations. Trainers' knowledge does not seem to contribute to the feeling that the training has met the expectations of the participants.

Table 2  
Descriptive statistics

	M	SD	Knowledge acquisition	Knowledge depth	Knowledge expectations	Trainer's personality	Trainer's knowledge
Knowledge acquisition	5.18	0.653					
Knowledge depth	5.01	0.682	0.741**				
Knowledge expectations	4.97	0.757	0.784**	0.727**			
Trainer's personality	5.21	0.625	0.753**	0.645**	0.614**		
Trainer's knowledge	5.26	0.647	0.707**	0.711**	0.629**	0.753**	
Trainer's engagement skills	5.10	0.634	0.727**	0.741**	0.749**	0.718**	0.777**

Notes: \* $p < 0.05$ ; \*\*  $p < 0.001$

Table 3  
Regression results of the three models (DVs)

	Model 1 Knowledge acquisition	Model 2 Knowledge depth	Model 3 Knowledge expectations
	$\beta$	$\beta$	$\beta$
Trainer's personality	0.416**	0.117	0.138*
Trainer's knowledge	0.150*	0.282**	0.049
Trainer's engagement skills	0.312**	0.438**	0.612**
R-square	0.573**	0.775**	0.804**

Notes: \* $p < 0.05$ ; \*\* $p < 0.001$

### Relative Importance Analysis

A further analysis was conducted to see the relative importance of each independent variable towards the dependent variable in each model. This analysis helped to identify the proportionality of each independent variable towards the variance in the dependent variables. This made it possible to identify the most important contributor to the reactions of the participants in relation to the training effectiveness. Table 4 reports the results of the relative importance analysis. The analysis shows that the trainer's personality is the most important factor (RW = 0.261; RS-RW = 41.53%) that contributes to the feeling that the participants have learned new knowledge or have improved their existing knowledge. This result seems to not only highlight the findings of extant literature that is that personality factors are important in training

programs (Varela et al., 2011), but it also shows that a trainer's personality seems to rank as the top-most factor influencing the reactions of participants in training sessions.

Furthermore, the relative importance analysis shows that the trainers' engagement skills seem to be the most important contributor to the feeling that participants have learned something deep (RW = 0.223; RS-RW = 37.94%) or that the training sessions have met their expectations (RW = 0.260; RS-RW = 47.22%). These findings seem to be consistent with the extant literature. Having a deep understanding, as well as training satisfaction, is closely related to the ability of the trainers in delivering the subject in the training room. Exploring examples and appropriately answering all questions are a few among many skills that may lead to the satisfaction of the participants.

Table 4  
*Relative importance analysis*

	b	$\beta$	RW	CI-L	CI-U	RS-RW(%)
<i>Model 1 - Knowledge Acquisition</i>						
<b>Trainer's Personality</b>	0.434	0.416**	0.261	0.202	0.327	<b>41.53</b>
Trainer's Knowledge	0.152	0.150*	0.193	0.140	0.246	30.74
Trainer's Engagement Skills	0.321	0.312**	0.175	0.124	0.224	27.74
<i>Model 2 - Knowledge Depth</i>						
Trainer's Personality	0.127	0.117	0.155	0.105	0.205	26.31
Trainer's Knowledge	0.297	0.282**	0.219	0.161	0.261	35.74
<b>Trainer's Engagement Skills</b>	0.471	0.438**	0.223	0.170	0.283	<b>37.94</b>
<i>Model 3 - Knowledge Expectations</i>						
Trainer's Personality	0.167	0.138*	0.144	0.095	0.195	26.19
Trainer's Knowledge	0.057	0.049	0.146	0.099	0.191	26.58
<b>Trainer's Engagement Skills</b>	0.730	0.612**	0.260	0.196	0.324	<b>47.22</b>

Notes: DV1 = Knowledge acquisition; DV2 = Knowledge depth; DV3 = Knowledge expectations; RW = Raw relative weight; CI-CL = Confidence interval (lower bound); CI-U = Confidence interval (Upper bound); RS-RW = Rescaled relative weight; \*p < 0.05; \*\* p < 0.001

## CONCLUSIONS

This research aimed to investigate the role of trainers' attributes and the effectiveness of design thinking training programs in companies. Focusing on Kirkpatrick's reaction level of training effectiveness, this research explored the relationship of perceived trainer attributes with knowledge acquisition, knowledge depth, and knowledge expectations of the participants. The data analysis conveyed there were significant relationships between a few variables and supported most of the hypothesized relationships. A further relative importance analysis showed that perceived trainer personality was connected to the impression of learning among the participants, while the trainer's engagement skills were primarily linked to the impression that the training provided depth knowledge and satisfaction, i.e. the training was considered as meeting their expectations.

These analyses seem to reveal two issues specific to design thinking training that are consistent with the extant training literature. These analyses of design thinking training data do not seem to reveal stark differences from the findings or arguments in extant training literature. First, the personalities of trainers seem to also matter in most learning processes. In the social setting of the training programs, pleasant personalities can help "smoothen" relationships and get the social relationship objectives achieved or, in the case of social communications, get the messages delivered. Second, engagement

also seems to be important to ensure deep learning in design thinking. The engagement skills of the trainers are also known to be important contributors to learning success.

Thus, this paper extended the existing design thinking education literature by providing empirical evidence of design thinking training effectiveness in a corporate context. By researching trainers' attributes and focusing on corporate participants as the survey respondents, this paper extends the design thinking literature.

This paper has several limitations. The first drawback is related to the measures of the variables. Single item measures derived from the participants' feedback at the end of every training program were used; there is a risk of bias and of a measurement reliability issue. Second is related to the representativeness of the sample. The population was limited to the SOEs that an executive education unit approached in the past. When the results are generalized to the whole SOE or company population in Indonesia, this may create selection bias. Therefore, more care should be taken in reading and interpreting the results of this research. These findings should be treated as an indication, a 'dip-stick test' of the state of training effectiveness in a few design thinking training programs among SOEs.

## ACKNOWLEDGEMENT

The authors wish to acknowledge and thank all IMHA 2018 committee members and UPM *Pertanika* journal team that help publish this article.

## REFERENCES

- Aguinis, H., & Kraiger, K. (2009). Benefits of training and development for individuals and teams, organizations, and society. *Annual Review of Psychology, 60*, 451-474.
- Amabile, T. M. (1983). Brilliant but cruel: Perceptions of negative evaluators. *Journal of Experimental Social Psychology, 19*(2), 146-156.
- Brown, T. (2009). *Change by design*. New York, USA: HarperCollins Publishers.
- Buchanan, R. (1992). Wicked problems in design thinking. *Design Issues, 8*(2), 5-21.
- Garbuio, M., Dong, A., Lin, N., Tschang, T., & Lovallo, D. (2018). Demystifying the genius of entrepreneurship: How design cognition can help create the next generation of entrepreneurs. *Academy of Management Learning and Education, 17*(1), 41-61.
- Glen, R., Suci, C., & Baughn, C. (2014). The need for design thinking in business schools. *Academy of Management Learning and Education, 13*(4), 653-667.
- Goldman, S., Carroll, M. P., Kabayadondo, Z., Cavagnaro, L. B., Royalty, A. W., Roth, B., ... & Kim, J. (2012). Assessing d. learning: Capturing the journey of becoming a design thinker. In H. Plattner, C. Meinel & L. Leifer (Eds.), *Design Thinking Research* (pp. 13-33). Berlin, Germany: Springer.
- Goldstein, I. L., & Ford, J. K. (2002). *Training in organizations: Needs assessment, development, and evaluation*. Belmont, USA: Wadsworth/Thomson Learning.
- Holladay, C. L., & Quiñones, M. A. (2008). The influence of training focus and trainer characteristics on diversity training effectiveness. *Academy of Management Learning and Education, 7*(3), 343-354.
- Kirkpatrick, D. (1996). Great ideas revisited. *Training and Development, 50*(1), 54-60.
- Kirkpatrick, D. L. (1959). Techniques for evaluation training programs. *Journal of the American Society of Training Directors, 13*(12), 21-26.
- Lieberman, B. E., Block, C. J., & Koch, S. M. (2011). Diversity trainer preconceptions: The effects of trainer race and gender on perceptions of diversity trainer effectiveness. *Basic and Applied Social Psychology, 33*(3), 279-293.
- Mayseless, N., Saggat, M., Hawthorne, G., & Reiss, A. (2018). Creativity in the twenty-first century: The added benefit of training and cooperation. In H. Plattner, C. Meinel & L. Leifer (Eds.), *Design thinking research* (pp. 239-249). Cham, Switzerland: Springer.
- Palincsar, A. S. (1998). Social constructivist perspectives on teaching and learning. *Annual Review of Psychology, 49*(1), 345-375.
- Razzouk, R., & Shute, V. (2012). What is design thinking and why is it important? *Review of Educational Research, 82*(3), 330-348.
- Taheri, M., Unterholzer, T., & Meinel, C. (2016). Design thinking at scale: A report on best practices of online courses. In H. Plattner, C. Meinel & L. Leifer (Eds.), *Design Thinking Research* (pp. 217-235). Cham, Switzerland: Springer.
- Tonidandel, S., & LeBreton, J. M. (2015). RWA web: A free, comprehensive, web-based, and user-friendly tool for relative weight analyses. *Journal of Business and Psychology, 30*(2), 207-216.
- Varela, O. E., Cater III, J. J., & Michel, N. (2015). Learner-instructor similarity: A social attribution approach to learning. *Journal of Management Development, 34*(4), 460-475.
- Varela, O. E., Cater, J. J., & Michel, N. (2011). Similarity attraction in learning contexts: An

- empirical study. *Human Resource Development Quarterly*, 22(1), 49-68.
- Vygotsky, L. S. (1962). Thought and word. In L. Vygotsky, E. Hanfmann & G. Vakar (Eds.), *Studies in communication, thought, and language* (pp. 119 -153). Cambridge, Massachusetts: MIT Pr.





## **Donald Digital Marketing: An Exploratory Study of Digital Political Marketing in Trump Presidential Campaign**

**Irmawan Rahyadi\* and Muhammad Aras**

*Department of Communication, BINUS Graduate Program, Bina Nusantara University,  
Jakarta 11480, Indonesia*

### **ABSTRACT**

Digital marketing harnesses the interactions of individuals through the Internet. Its growing popularity among politicians has potentially important implications for a wide range of digital political marketing activities, such as social media building, constituents' engagement, website development, and digital advertising. This paper explores Trump presidential campaign in 2016 for understanding the digital political marketing implementations and challenges. Four different social media platforms and a website were explored, discussed and compared. The results of the exploratory study were presented based on the digital media used within the 20 months Trump presidential campaign to offer an overview of the relevant evidence in the digital political marketing mechanism. It discusses how this previous work is being extended and combined with insights from detailed data on Trump digital media usage in order to determine which digital marketing strategies are being used in the Trump presidential campaign and how these strategies relate to constituent engagement. Finally, it identifies opportunities that this new area presents for digital political marketing research.

*Keywords:* Digital marketing, digital political marketing, political campaign, social media

### **ARTICLE INFO**

*Article history:*

Received: 09 October 2019

Accepted: 03 January 2020

Published: 17 March 2020

*E-mail addresses:*

[irmawan.rahyadi@binus.ac.id](mailto:irmawan.rahyadi@binus.ac.id) (Irmawan Rahyadi)

[maras@binus.edu](mailto:maras@binus.edu) (Muhammad Aras)

\* Corresponding author

### **INTRODUCTION**

During Trump presidential campaign in 2016, he said to his trusted aid, who was none other than his son-in-law, "I don't want people getting rich off the campaign, and I want to make sure we are watching every dollar just like we would do in business" (Bertoni, 2016). Being a prominent business mogul, Trump has

implemented and mastered most of the marketing strategies known to experts. His political marketing strategies utilized the newest media including digital media.

The development of digital political marketing has been noted since businesses utilized digital marketing and it turns the business strategies into profit. Political sector watched, learnt and practised the strategies into gaining voter supports. Howard Dean was recorded as an early politician employing digital campaign when he competed in the 2004 US presidential election. Roh Moo Hyun won the Korean presidential election and named the “First Internet President” in 2003 (Kim, 2003). The deployment of digital tools has been a political phenomenon since then until the current US presidential election in 2016.

One of the important aspects which marketers should consider when they plan their digital strategies is consumer involvement (Hashim & Ariffin, 2016). Businesses with high consumer involvement will gain positive results in reaching their business goal. People’s presence in the digital world matters since they live and even feel enriched by the platforms in the virtual realms (Thang et al., 2016). These netizens are potential consumers and constituents for business and politicians. The political sector also shares the same condition when the engagement with the constituents is high. It is more likely that their popularity is high. This is one of the reasons why digital marketing has been a trend in the political area in which high level of popularity is essential.

The objective of this study is to explore which digital marketing strategies were used in the Trump presidential campaign and how these strategies relate to constituent engagement. Since all the custom and common strategies of traditional marketing have been challenged by digital marketing, practitioners need to explore a diverse range of digital marketing strategies in maintaining engagement with the target audiences. The digital political marketing has been one of the marketing trends which results in the implementation of marketing strategy in different fields of practice.

### **Literature Review**

Kotler and Levy’s (1969) study as an academic foundation of marketing strategy produced a call to action for future scholars. Their work was heeded and adopted in the digital era by numerous researchers. For example, Parson et al. (1998) underlined the upcoming digital marketing that would have to be developed to win the non-traditional marketing competition. At the time website started to develop as an interactive environment, they called the emerging challenges dealing with new market audiences “digital marketing“. This type of marketing refers to the integrated perspective to manage all types of interactive media for marketing purposes. One of the imperative applications of the elements which marketers rarely apply is engaging users’ interest and participation. The study offered key strategies to manage the “Engage” element by developing creative and valuable contents to achieve interaction and transaction.

The early scholarly works mentioned are also followed by research resulted in studies of consequences within another field. Maarek (2014) used the term of digital political marketing to explain the tools to win political competitions. Even though the method is very helpful in the political campaign, Maarek warned about the inclination of uncontrollable rumour mills production within the digital media. It was claimed that Trumps has successfully utilized targeted communication based on market-oriented metrics to win the 2016 election (Gillies, 2018) even though it was only targeting small fractions of voters. Maarek findings were also noticed by Lilleker (2006) who looked at political marketing as the use of marketing techniques by the political sector in the area of policy development, campaigning, and internal relation.

A variety of specific techniques and strategies have been suggested to address the challenges of overcoming the negative impacts of digital marketing on politics in the campaigning. For example, Knoll et al. (2018) examined social media use as a way to increase political participation. The authors presented a complex form of social media usage as processes that were conditionally interrelated. This approach may not be essential for increasing political participation, but it can be used to develop a complete picture.

The digital media utilization that leads to campaigning and promotion for Trump presidential race has been of great interest to scholars, particularly in the context of

social media performance (Lee & Lim, 2016; Enli, 2017; West, 2017; Wang et al., 2016; Winston, 2016). Since the curiosity to Trump's social media is huge, the public often needs to act on partial information about the particular campaign. Particularly important in the marketing process within new media, given the often used and the reliability of data within the digital world that surround new media, are potential important campaign source for improvement (Hwang, 2016).

Researchers have identified several key digital marketing strategies that lead to a successful marketing campaign in more interactive settings, including the quality of the preparation demonstrated by aspiring digital marketers (Chaffey & Ellis-Chadwick, 2016; Smith, 2011). The presumption is that these strategies reveal the underlying nature of actions and ensure that higher-quality marketing is more likely to achieve success.

The work of Chaffey and Ellis-Chadwick (2016) is worth to refer when one needs to study the digital marketing strategy. The work carefully elaborated the groundwork on strategy, implementation and practice. They highly encouraged that the strategy had to be integrated and structured following the goals and objectives. The strategy was implemented to communicate with the unique digital target audiences at different digital touchpoints (web services, email, social media and mobile phone). The social media application, in particular, is one of the important tactics in digital marketing.

The digital village will only continue to increase in size and diversity. Unfortunately, research into which strategies are used by a particular political actor (in this case Trump's campaign team) has so far been both general and sparse. This is shown by the literature reviewed in this section especially in relation to the core of digital marketing which reflects immaturity. Particularly needed is a way to categorize the strategies used by a particular actor in the digital world and to explore the relation to constituent engagement. In addition, this research is purposely designed to fill in the gaps in describing the relationships between political digital marketing strategies and constituents engagement.

## MATERIALS AND METHODS

As an exploratory empirical study, this paper aims to develop initial evidence about the nature of digital marketing in Trump presidential campaign and its correlation with constituent engagement. This method is appropriate for an evolving topic in the evolving field of digital marketing (Brennan & Croft, 2012; Chi, 2011; Royle & Laing, 2014), as the initial data can be used as a foundation for the next theory development (Eisenhardt, 1989). Thus, rather than formal hypothesis testing, the remainder of the paper will examine key issues around Trump presidential campaign from the perspective of digital political marketing, particularly its links to existing theory on digital marketing strategy and the relation to constituent engagement. To further explore the data, integrated Internet media analysis

and content analysis were performed to the practice of Trump presidential digital campaign.

As the goal of this paper is to provide an additional perspective on digital political marketing, data extracted from Trump's main digital platforms where he conducted his digital marketing activities were used. His website and social media accounts are the largest and dominant operating apparatus. His main website at [www.donaldjtrump.com](http://www.donaldjtrump.com) uses an integrated media model, but it is also the hub for the social media platforms with many of the features written into all of his social media (Shafer, 2017). Thus, website and social media were examined differently in this study because mobile application access to the social media brings digital marketing tactics with a different perspective and is likely to serve as a broadly useful model for examining the digital political marketing efforts.

The official campaign website and social media would be studied from 2015 right after he formed an exploratory committee in preparation for a possible run for president on the Republican Party ticket. Data gathered were limited to the time Trump was elected in November 2016. [Web.archive.org](http://web.archive.org) was used in this study to collect the data on the website within the timeframe<sup>1</sup>. The old data available on the website at the time of the writing of this paper also enriched the data collection. Most of the data from the digital media were not available on the platform

<sup>1</sup> For an archival impression of all the data presented in this study captured in 2018 see <http://web.archive.org> with a specific official media URL, unless otherwise stated.

except Instagram. The method employed for collecting data from Web.archive.org also serves as a validation stage because the owner of the platform could erase the old contents anytime within the time period. There were website content and social media available within the 20 month period to be observed. The goal of the data collection was to see which postings fall in the category of digital political marketing discussed in the literature.

Although Trump used more social media platforms, this study limits the data gathering sources to four official social media accounts. Purposive sampling technique was used to answer the research questions. Datasets were selected from a certain period of time which lies between the election date and the start of the campaign period. The sampling technique as a non-probability sampling is suitable for this study to investigate the presidential campaign period (Tongco, 2007).

The four media are regarded as having the highest role in Trump presidential campaign. The social media management of the campaign focused on four platforms: Twitter, YouTube, Instagram, and Facebook. The twitter account at @realDonaldTrump was created in March 2009. The contents and strategy available in this account from 2015 to 2016 were observed to identify integrated digital political marketing in action. Twitonomy, Allmytweets, TweetStats and Brand 24 are third-party programs used in this study to observe data from Twitter. We also used Twitter Advance Search Engine to categorize tweets within a specific time

range. The reason for the use of the tools is because Twitter only allows nine hundred plus tweets to preview in one account. Considering the official announcement of Trump presidential candidacy on June the 16<sup>th</sup> and the election day on November the 8<sup>th</sup>, we gathered over 9,300 tweets from May 2015 (because campaign-oriented tweets had started a month prior to the campaign launching) to November 2016.

Trump official Facebook for his presidential campaign is @DonaldTrump. It was created since 2009 and it was an important part of his presidential campaign since 2015. Around 1,800 Facebook posts within 20 months of the campaign period were identified and analyzed. The official YouTube account at Donald J. Trump for President was created on March 16, 2015 (Donald J. Trump for President, n. d.). Most of the videos uploaded during the presidential campaign had been deleted from the channel because it was extracted from the actual channel in 2018 which was over two years of the campaign period. Source from web.archive.org was used to locate deleted videos on the channel in order to study the channel. The proportionally missing content from the digital platform, at least in part, an authority of the owner of the platform is an issue of data extraction from the digital site. The issue should not affect our analysis of the integrated digital political marketing and the significance of the variables. 68 videos were identified and analysed within the period of the electoral campaign.

## RESULTS AND DISCUSSIONS

To obtain an understanding of digital political marketing of Trump presidential candidacy, both an empirical description of Trump digital political marketing and an analysis of the factors associated with his digital media management were offered. The areas of social media and webpage utilization were then delved deeper because they are the most important tools in Trump digital political marketing.

Drawing content analysis data from Social Networking Sites (YouTube channel = 68 videos, Twitter account = 9,300 tweets, Instagram account = 912 posts, and Facebook = 1,800 posts) and 200 posts in the official website, the integrated communication was shown as a strategy. From the digital marketing strategies that Trump used, all digital media that he used were important in conveying the message of "Make America Great Again" (MAGA). It started from his website in May 2015 putting the slogan MAGA as the headline of the website which was consistent with all social media.

The number of Instagram posts from May 2015 when the presidential campaign started to the time Trump was elected in November 2016 is 912 posts. This amount of content was the lowest in quantity compared to another social media platform. These posts contained a mix of images, videos, and screenshots of texts. The images showed a humanist side of Trump (Post on Ivana holding his grandchild), his political stance (Post on Obamacare), his support for group/community/locale (Post

on veteran) and his competitiveness (Post on attack video on Hillary). The Instagram posts were part of the whole tools in the integrated digital marketing strategy. Within Instagram, there was a relatively immediate audiences' feedback (Chaffey & Smith, 2013; Tiago & Verssimo, 2014; Wind & Mahajan, 2002) in most of the posts during the campaign period. Cross-posting was found on Instagram the form of screenshots of tweets and uploaded videos from the official YouTube channel.

The official Twitter account had the highest interaction level and usage among all the social media accounts. Screenshots of tweets could be found on the official website, Facebook timeline and Instagram post showing us that Twitter was important for an integral part of the message deliverance. Findings from the texts, videos and image tweets showed that Trump interacted in the form of commenting on current news, issues and word of mouth (Hennig-Thurau et al., 2004). He also showed his humanist side by retweeting the support tweets from his family members. His communication tone was bold and straight forward with the occasional use of cynic words, all-caps words (Kouloumpis et al., 2011), bold and bigger text fonts and sarcastic images. The number of followers of this account had reached three-plus million in 2015 and by the election day of November 9, 2016, his followers were thirteen plus million (Trump, 2016).

The YouTube channel had the lowest interaction level compared to other social media account during the campaign



period even though there were many videos produced and shared across other platforms. It started with twelve plus thousand subscribers in 2015 and reached ninety-nine plus thousand on November 9, 2016 (the election day). Most of the contents at the beginning of the campaign period were campaign advertorials. On the election days, many videos on the debates and TV interviews were uploaded to the channel. MAGA was consistent with another platform as the sub-headline of this channel.

The Facebook account, @DonaldTrump, was created in 2009. It was affiliated with The Trump Organization. It was converted from a personal account to a Facebook Page in 2015. The contents varied from posting originally for Facebook to cross-postings from YouTube and Twitter accounts.

The literature has shown how digital marketing has to be managed. Digital marketing has to be planned in advance and the strategy has to be integrated. Trump presidential campaign showed integrated digital political marketing. His website and social media carried the same message at the presidential campaign since the beginning of 2015. MAGA as the slogan was always deliberately chosen as the headline or sub-headline on the cover page of the digital media.

Trump digital political marketing in the presidential election in 2015-2016 utilized social media and website as the digital marketing tools. Based on our findings, Trump mostly used his Twitter to directly comment, respond and answer to people. The website, Instagram, Facebook, and

YouTube are the types of media mostly managed by his management team. All social media accounts are linked to the official website. Since the domain of the website was created in 1997 and launched in connection with the Trump Organization, it was then acquired to be the official website of Donald Trump presidential campaign. It was launched as a presidential campaign website in 2015 with his integrated digital marketing including slogan and links to the official social media. The website is still active until recently it serves as a current mirror for the official presidential website. One of the interactivity features that the website offers is the "Donate" facility where supporters can complete a donation process as easy as shopping online. The website also underlined the importance of his social media by mentioning the number of followers of social media in the About section of the website. The website was primarily built to create an environment where audiences can interact with the Trump campaign cause. Donate, Get involved, Support form, and Comment features are some of the tools available on the website (Show your support for Donald Trump, 2015).

By comparison, social media accounts successfully nurtured the environment where constituents interact with Trump and with each other. The digital political marketing of Trump presidential campaign has utilized integrated marketing involving digital media management as a tool for interactivity. This study reveals the high interaction between constituents in comment



sections of Facebook posts, Instagram posts and retweets and comments between Twitter followers on particular tweets (Ott, 2017).

Evidently, the more interactions in the comments area, retweets, donation, and likes, the more constituents are engaged, reached and nurtured. The strategy of digital political marketing also employed digital advertising especially Facebook ads. The nature of the political competition in America is not only to compete on some amount of political-aware people who already read Trump social media feeds but also to get the apathy people in the rural areas of the USA. The digital advertising targets the small population of people converts them into Trump supporters (social media followers) and keeps reminding them to show up to vote on the election day.

## CONCLUSIONS

As has been noted, Trump presidential campaign in 2016 utilized digital political marketing. The strategy involves an integrated method employing digital media platforms including websites and social media. The current development of technology and the nature of the audience encourage marketers and politicians to use digital marketing. The real question is how to use digital marketing.

Trump presidential campaign shows us what has been done and which strategy worked for American audiences. The benefit for academic research is an open area of research within digital political marketing, for example;

1. Open an investigation on the design and limitation of digital political marketing strategy. Understand what strategy works and what digital tools should be chosen. Develop a model and prototype of the integrated digital marketing system.
2. Develop effective solutions and tactics on challenges which emerge from the elements of digital marketing. The digital political marketing elements might be slightly modified from the previous findings and theories.
3. Organize a theory-driven experiment that explains the relationship between social media communication and audiences' interaction.
4. Compare the efficiency of digital political marketing across geographical regions. The foundation of the theory might have developed new perspectives by looking at a similar set of the population in different locations.
5. Understand how the personal brand in digital political marketing plays a role in the planning of an integrated strategy.

The power of digital political marketing has its roots in the strategic side of marketing strategy brought about by the increased digital natives as political audiences. Politicians need to create interactivity among the internal organizations, their constituents, their partners, and their competitors. While

digital marketing studies how businesses converting and engaging online audiences, political and marketing theory are the natural foundation for the study and exploration of digital political marketing.

## ACKNOWLEDGEMENT

This study was financially supported by Binus University. All aspects of the study, including study design, sample analysis, and population identification were conducted by the researchers and did not involve other Binus university-affiliated departments. We would like to thank the reviewers for providing some insightful suggestions. There is no conflict of interest in this study.

## REFERENCES

- Bertoni, S. (2016). The son-in-law also rises. *Forbes*, 198(8), 70-76.
- Brennan, R., & Croft, R. (2012). The use of social media in B2B marketing and branding: An exploratory study. *Journal of Customer Behaviour*, 11(2), 101-115.
- Chaffey, D., & Smith, P. R. (2013). *eMarketing eXcellence: Planning and optimizing your digital marketing*. London: Routledge.
- Chaffey, D., & Ellis-Chadwick, F. (2016). *Digital marketing*. Harlow, England: Prentice Hall.
- Chi, H. (2011). Interactive digital advertising vs. virtual brand community: Exploratory study of user motivation and social media marketing responses in Taiwan. *Journal of Interactive Advertising*, 12(1), 44-61.
- Eisenhardt, K. M. (1989). Building theories from case study research. *Academy of Management Review*, 14(4), 532-550.
- Enli, G. (2017). Twitter as arena for the authentic outsider: Exploring the social media campaigns of Trump and Clinton in the 2016 US presidential election. *European Journal of Communication*, 32(1), 50-61.
- Gillies, J. (2018). The US presidential race: Advances and insights for political marketing practice. In *Political Marketing in the 2016 US Presidential Election* (pp. 113-119). Cham, Switzerland: Palgrave Macmillan.
- Hashim, H., & Ariffin, M. F. (2016). Factors influencing electronic word of mouth (eWOM) engagement on social networking sites in Malaysia. *Pertanika Journal of Social Sciences and Humanities*, 24(S), 85-94.
- Hennig-Thurau, T., Gwinner, K. P., Walsh, G., & Gremler, D. D. (2004). Electronic word-of-mouth via consumer-opinion platforms: What motivates consumers to articulate themselves on the Internet? *Journal of Interactive Marketing*, 18(1), 38-52.
- Hwang, A. S. (2016). *Social media and the future of U.S. presidential campaigning*-(CMC Magister Senior Theses), Claremont McKenna College, California.
- Kim, K. (2003). Presidential election and social change in Korea. *Development and Society*, 32(2), 293-314.
- Knoll, J., Matthes, J., & Heiss, R. (2018). The social media political participation model: A goal systems theory perspective. *Convergence: The International Journal of Research into New Media Technologies*, 20(10), 1-22.
- Kouloumpis, E., Wilson, T., & Moore, J. D. (2011). Twitter sentiment analysis: The good the bad and the OMG! In *Proceedings of the Fifth International Conference on Weblogs and Social Media*. (pp. 538-541). Barcelona, Spain: AAAI Press.

- Kotler, P., & Levy, S. J. (1969). Broadening the concept of marketing. *The Journal of Marketing*, 33(1), 10-15.
- Lee, J., & Lim, Y. S. (2016). Gendered campaign tweets: The cases of Hillary Clinton and Donald Trump. *Public Relations Review*, 42(5), 849-855.
- Lilleker, D. G. (2006). *Key concept in political communication*. London, England: Sage.
- Maarek, P. J. (2014). Politics 2.0: New forms of digital political marketing and political communication. *Tripodos*, 1(34), 13-22.
- Ott, B. L. (2017). The age of Twitter: Donald J. Trump and the politics of debasement. *Critical Studies in Media Communication*, 34(1), 59-68.
- Parsons, A., Zeisser, M., & Waitman, R. (1998). Organizing today for the digital marketing of tomorrow. *Journal of Interactive Marketing*, 12(1), 31-46.
- Royle, J., & Laing, A. (2014). The digital marketing skills gap: Developing a Digital Marketer Model for the communication industries. *International Journal of Information Management*, 34(2), 65-73.
- Shafer, J. G. (2017). Donald Trump's 'Political Incorrectness': Neoliberalism as frontstage racism on social media. *Social Media+ Society*, 3(3), 1-10.
- Smith, K. T. (2011). Digital marketing strategies that Millennials find appealing, motivating, or just annoying. *Journal of Strategic Marketing*, 19(6), 489-499.
- Show your support for Donald Trump. (2015). Retrieved July 26, 2017, from <http://web.archive.org/web/20150619034218/https://www.donaldjtrump.com/>
- Thang, S. M., Noor, N. M., Taha, A. M., Ng, L. S., & Aziz, N. B. (2016). Effects of social networking on Malaysian secondary school students: Attitudes, behaviors, and awareness of risks. *Pertanika Journal of Social Sciences and Humanities*, 24(S), 157-168.
- Tiago, M. T. P. M. B., & Veríssimo, J. M. C. (2014). Digital marketing and social media: Why bother? *Business Horizons*, 57(6), 703-708.
- Tongco, M. (2007). Purposive sampling as a tool for informant selection. *Ethnobotany Research and Application*, 5, 147-158.
- Trump, D. J. (2016). *Twitter account*. Retrieved October 5, 2017, from <http://web.archive.org/web/20161109110543/https://twitter.com/realDonaldTrump>
- Trump, D. J. (2015). *Youtube account official*. Retrieved September 27, 2017, from <https://www.youtube.com/channel/UCAq12DyGU2un1Ei2nMYsqOA/about>
- Wang, Y., Luo, J., Niemi, R., Li, Y., & Hu, T. (2016). Catching fire via "Likes": Inferring topic preferences of Trump followers on Twitter. In *International AAAI Conference on Web and Social Media*. (pp. 719-722). Cologne, Germany: ICWSM.
- West, D. M. (2017). *Air wars: Television advertising and social media in election campaigns, 1952-2016*. Los Angeles, USA: CQ Press.
- Wind, J., & Mahajan, V. (2002). Digital marketing. *Symphonya. Emerging Issues in Management*, 1(2002), 43-54.
- Winston, J. (2016). *How the Trump campaign built an identity database and used facebook ads to win the election*. Retrieved October 24, 2017, from <https://medium.com/startup-grind/how-the-trump-campaign-built-an-identity-database-and-used-facebook-ads-to-win-the-election-4ff7d24269ac>

## **Chinese Ethnic Perspective on the Confucius Values of Leadership in West Java Fuqing Organization**

**Mulyani\* and Chyntia Ika Ratnapuri**

*School of Creative Technology, Bina Nusantara University, Kecamatan Andir, Bandung 40181, West Java, Indonesia*

### **ABSTRACT**

Confucius values have been being part of the Chinese culture from generation to generation and become values of relationship and business, including in leadership. Chinese overseas have strong emotional ties with the State of China as their country of origin. In Indonesia, Chinese overseas are called Tionghoa ethnic. They have been living in Indonesia for many generations and believed that they came to Indonesia long before the century. This research was to examine Chinese ethnic perspectives on Confucius values of their leadership in West Java Chinese organization (Fuqing association). This research was conducted at Fuqing association in West Java covering four cities namely Bandung, Bogor, Cianjur, and Sukabumi. The questionnaire was distributed to 121 active members of the Fuqing association. The questionnaire consisted of 31 questions that represent Confucius values. This study used confirmatory factor analysis to test the research model using Smart Partial Least Square version 3.0 (Smart PLS 3.0). The results of this research showed that Confucius values were still practised in Chinese leadership in West Java. Generally, Confucius values in Chinese ethnic leadership are still similar to confusion leadership variables, but the significant variable in Chinese leadership is different. In West Java, the important variables are moral character and lifelong learning.

*Keywords:* Chinese ethnic perspective, Chinese leadership, Confucius values, leadership

### **ARTICLE INFO**

*Article history:*

Received: 09 October 2019

Accepted: 03 January 2020

Published: 17 March 2020

*E-mail addresses:*

mulyani@binus.edu (Mulyani)

chyntia.ratnapuri@binus.ac.id (Chyntia Ika Ratnapuri)

\* Corresponding author

### **INTRODUCTION**

Confucius values are cultural values that have been inherent in Chinese life. Confucius teachings have been passed down from generation to generation and become the root of Chinese culture. Confucian values have been being part of the Chinese culture from generation to generation

and become values in relationship and business, including in leadership. Chinese overseas have strong emotional ties with the State of China as their country of origin. Wherever they are, Chinese overseas identify themselves as Chinese. Many of them still maintain Chinese culture in their daily lives, including Confucius values. This Chinese culture is in line with the research of Chen (2001) finding that many of the Chinese-blooded people continued to identify themselves as Chinese.

Paradoxical facts found related to the existence and identity of Chinese Overseas in Indonesia. Chinese overseas in Indonesia called Tionghoa ethnic, ever through political turmoil and became victims of political interest that no other Chinese overseas ever through (Dawis, 2010). On one side, Chinese ethnic has a strong emotional attachment to their country (China), on the other side, Chinese ethnic has experienced a decade of a forced break with their culture through Presidential Instruction No.14/1967 on Chinese religion, belief, and customs. The Government policy, during Soeharto (the 2<sup>nd</sup> President of Indonesia) regime, prohibited and limited Chinese ethnic to hold their culture and customs. The impact of this policy has not been able to be wiped out until now. This condition led to a lost generation, a generation that did not know its culture and was not able to speak Chinese (Mandarin or another dialect). This paradoxical reality becomes something interesting to research. Previous research results showed that Chinese overseas had strong bonding with their culture (Ahlstrom et al., 2004; Chen,

2001; Lin, 2010; Leung, 1995; Lasserre, 1993; Schwalje, 1996; Wah, 2010), as part of Chinese overseas, based on that fact, it could be assumed that Chinese ethnic had also strong bonding with Chinese culture but paradox fact happened in Indonesia when Chinese ethnic was politically pushed to separate from their original culture. Based on this background, this research would like to investigate whether Confucius values were still implemented by Chinese ethnic. Specifically, this research would examine Chinese ethnic perspectives on Confucius values of their leadership in West Java Chinese organization (Fuqing association).

This research was conducted in Fuqing association. Fuqing association is Chinese overseas association based on the origin of their ancestor in mainland China, Fuqing, a city located in Fujian (one of the provinces in China). This association has a very important meaning for Chinese overseas and Chinese ethnic in Indonesia. This association is identity and recognition. Through this organization, Chinese ethnic is getting closer to each other, keeping communication, knowing each other and establishing a brotherhood.

### **Objectives of the Study**

The main objective of this study was to investigate whether Confucius values is still implemented by Chinese ethnic. The specific objective of the study was to examine Chinese ethnic perspectives on Confucius values of their leadership in West Java Chinese organization (Fuqing association).

## Literature Review

**The Existence of Chinese Ethnic in Indonesia.** Chinese ethnic has been in Indonesia since long ago before the century. Nevertheless, there is no written proof that could explain when the first Chinese come to Indonesia. In Indonesia historical record, the arrival of Chinese in ancient times of Indonesia was in the framework of silk road trade. Although, it is also believed that Chinese has already existed in Indonesia since long before centuries. The era of Chinese, as Chinese overseas (in Indonesia), began during the Ming dynasty, a voyage by Zheng He and his crew at the beginning of the 15<sup>th</sup> century, who later settled in Semarang, Tuban and Lasem. Significant Chinese overseas migration took place around the end of the 19<sup>th</sup> century to a number of areas in Indonesia, especially Java (Lim & Mead, 2011; Schwalje, 1996). Those who migrate mostly came from Southeast China. They left China to seek a better life, where the crisis is engulfing China on agricultural life.

Chinese ethnic is special. It is different from other Chinese overseas in other countries. In the colonial era, Chinese ethnic was classified by the colonial government in two groups, *Totok* and *Peranakan*. The purposes of this classification were to separate and distinguish between Chinese ethnic and local people (Fischer, 2002, Hoadley, 1988; Lim & Mead, 2011; Pekerti, 2008). *Totok* refers to those (adult Chinese ethnic) who migrated to Indonesia used Chinese dialect, Chinese dress and familiar with Chinese culture. Meanwhile,

*Peranakan* refers to the negative stigma that is those who have married with Javanese or local ethnic women, those who are studying the local culture, and those who have converted to Islam. *Peranakan* initially refers to their lineage who have mixed marriage and converted to Islam, however, this term has shifted its meaning that more representing Chinese ethnic who has lived in Indonesia for long times, who has adapted many local cultures and no longer familiar with Chinese cultures, who does not speak Mandarin/other Chinese languages, but still recognizes their origins as Chinese (Fischer, 2002; Lim & Mead, 2011; Pekerti, 2008)

Chinese ethnic in Indonesia has adapted many local cultures, and many of them have married local ethnics, however, living in Indonesia as part of the nation is never be easy. Many incidents happened and become the dark era and experience for them. In Soeharto's era, Chinese ethnic was tried to be eliminated from their identity as Chinese. They have to change their Chinese name to Indonesian, prohibit to speak Chinese, prohibit to celebrate their culture ceremonial through Presidential Instruction. The Presidential Instruction No. 14/1967 on religion, faith and customs of China greatly influenced the existence of Chinese ethnic and their cultures. This Presidential Instruction had caused a lost generation. Chinese generation who was born and grew up in the new order (Soeharto's era) was commonly unable to speak Chinese, either Mandarin or other ethnic languages, and also lost their understanding and knowledge of Chinese culture and customs.



**Confucius Values and Leadership.** As we know, Confucius values as core Chinese culture values implemented in any aspects of Chinese and Chinese overseas (also Chinese ethnic) have been written and agreed by many researchers (Ahlstrom et al., 2004; Chen, 2001; Lin, 2010; Leung, 1995; Lasserre, 1993; Schwalje, 1996; Wah, 2010). In the field of entrepreneurial research, Lasserre (1993) revealed that principles of Confucius become the basis of the philosophy of Chinese overseas entrepreneur and their business philosophy based on the Confucius moral system. In the field of leadership, Chinese overseas leadership is influenced by Confucian values, as the main foundation of Chinese leadership (Ling & Fang, 2003; Ling et al., 2000; Wah, 2010). Wah's (2010) research findings revealed that the basic tenets of Confucius had fused with Chinese leadership styles such as moral character, human-heartedness, human relationship, lifelong learning, and moderation.

As discussed earlier, we have learned that Confucius values as parts of Chinese culture have been rooted and passed on from generation to generation through real implications in various fields, such as leadership. Chinese business value is often an important factor in determining and shaping Chinese business organizational, managerial and leadership practice (Wah, 2010). Based on Wah's (2010) research, there are 5 (five) major dimensions of Confucian values applied in Confucian leadership behaviour, namely moral character, human-heartedness, human relationship, lifelong

learning, and moderation. Firstly, moral character refers to full development of man. Human beings must strengthen their characters, then continuously sharpen through practices. Only through genuine humanitarian practice, humans can be called gentleman (*junzi*). Confucius leaders must have a high moral sense of leadership, built on moral grounds and trained through good and virtuous examples emphasizing moral values and commitment and expecting employees to promote moral. Secondly, human heartedness, in Confucius, the concept of *ren* is very much emphasized in leadership. *Ren* includes humanism and virtue, love and affection, kindness and compassion. Thirdly, human relationship - Confucius teaches people to hold five basic human relationships called *WuLun*: started with self-development, from self-development to family arrangement, from family arrangement into a state setting, and lastly build peace to the world. Confucius focuses on "self" as the centre of a relationship that constantly evolves into a wider network of relationships. The Confucian leader uses *renqing* (which can be interpreted as a sense of humanity or humanitarian sensitivity) to strengthen his decisions related to human interaction and business relationships. Forthly, lifelong learning - Confucian leaders always see themselves as life-long learners and insist that everyone must be proactive in learning by adapting intelligent learning behaviour. Finally, moderation - the principle of *zhongyong*, the principle of balance (mean) focuses on the balance of human thought



and behaviour. In this case, Confucius leader always shows the actions representing their words.

**Fuqing Association in West Java.** Fuqing association is an organization in which the member's ancestors came from the same place that is Fuqing. Fuqing is a city located in Fujian province in Southeast China. Fuqing people are also known as Hokcia people who have their own local language. Many of Fuqing people left their land to seek a better livelihood because the soil was less fertile. One of the destinations chosen by Fuqing people was Indonesia; many of them migrated to Indonesia through Xiamen port (Amoy). Going to a far place to find new hope is called *Xia Nan Yang*. *Xia Nan Yang* is a term used by Chinese people who want to sail toward new hope land throughout Southeast Asia (Iskan 2009). In Indonesia, the number of Fuqing/Hokcia people are less than Hokkian people. Nevertheless, many Hokcia people become successful in their business. Some examples of the successful and well known Hokcia people in Indonesia are Sudono Salim (founder of Salim Group), Sutanto Djuhar (President of RongQiao Group), Tjoa Eng Hoei (founder of Gudang Garam), Kiki Barki (owner of Harum Energy), Lim Haryanto Wijaya Sarwono (owner of Bumitama Agri), Mochtar Riadi (founder Lippo Group), Karmaka Surjaudaja (founder of NISP bank), and Alim Markus (Maspion Group). In the 1980s, businessmen from Fuqing dominated economic growth in Indonesia. One of the most famous businessmen was

Liem Sioe Liong or Sudono Salim who controlled 5% of all domestic products in Indonesia; other businessmen areas Hendry Pribadi (Napan Group), Djuhar Sutanto business associate closest to Liem Sioe Liong, Hendra Rahardja who became rich and known as Yamaha agent, and Rahman Halim (*Gudang Garam Cigarette*) (Shih, 2009).

People from Fuqing generally have traits and characters as hardworking and very concerned about the education of their children. Hokcia people concerning attention on education can be seen from their efforts to establish a school in colonial times. In Bandung, they established a school named *Xin Hua Xiao Xue* in Gardujati. Hardworking is a hallmark of Hokcia people. Their background as people from less fertile areas and living abroad made them the ones who were not afraid to work hard. The successful Hokcia businessmen usually tend to have a foundation to give financial support education for those who are less fortunate. Some of them are dedicating personally to help those who have a passion, a determination to learn but less fortunate.

Another character that stands out from the Hokcia people, especially when we read the story of those who have been successful, is that they are able to change difficulties and broken heart to be motivated to achieve success. To understand the characteristics of the Hokcia people in general, especially in Bandung, it can be observed from the characteristics of a successful business person, Karmaka Surjaudaja, as written in his biography entitled "*Tidak ada yang tidak*

*bisa.*” His book reflects a representation of Hokcia people. He is hardworking, tough, and unyielding.

Hokcia people have a strong business intuition, well-known as an expert in business, even in a difficult situation, they are able to reverse the difficult situation become opportunity. Hokcia people have an inner soul of entrepreneurship and ability to take a risk. According to So, Ridwan, Simamora, and Aryanto (2017), the ability to take risks is one of the important factors as well as entrepreneurial training and learning development opportunities (So et al., 2017). This entrepreneurship soul is in line with their spirit to survive to allow them to succeed in their business. Many Fuqing successful businessmen are derived from a very poor family. Sudono Salim, for example, a very popular conglomerate also comes from less fortunate families.

Hokcia people, like other Chinese overseas, also have a strong attachment to their origin. Those who have succeeded usually have a concern to build his homeland, Fuqing. It is welcomed and facilitated by the provincial government of Fujian with the existence of cooperation woven by Fujian province with cities in Indonesia. Cooperation makes it easy for entrepreneurs including Fuqing entrepreneurs to invest in Fujian especially in Fuqing city.

## MATERIALS AND METHODS

This research was conducted at Fuqing association in West Java covering four cities: Bandung, Bogor, Cianjur, and Sukabumi. The questionnaire was distributed to 121

active members of the Fuqing association. 46 active members of the Fuqing association are in Bandung, 25 active members were from Fuqing association in Bogor, 20 active members were from the Fuqing Association in Cianjur, and 30 active members of the Fuqing association were in Sukabumi. The sample of this research had fulfilled the sampling requirement i.e. at least 10% of the population, where the total number of active members of Fuqing association in West Java was 150 people. Five dimensions of Confucius leadership namely moral character, human heartedness, human relationship, lifelong learning, and moderation are divided into 31 questioner items which describe every dimension.

Moral character in leadership is described as Leadership that builds morale, emphasize moral values and commitment to hold moral values in their words, behaviours, and attitudes. Indicator of this variable is represented in the following characteristics namely trusted, stoic, moral-oriented, become good model, virtuous, rational, insightful, attentive, disciplined and self-control, respecting others, prioritizing employees' welfare, treat their followers like family, and act like a father.

Human heartedness in leadership is described as Leadership that is humanist, full of love and benevolent. Confucius greatly emphasizes the concept of *ren*. *Ren* covers humanism and virtue, love, kindness and compassion. Indicator of this variable is represented in the following characteristics namely fair, humanist, unselfish, benevolence use of power, trust to followers.

Human relationship in leadership is described as Leadership based on a sense of humanity in fostering relationships and treat subordinates, attitudes based on sensitivity to others. This is in accordance with the teachings of Confucius in which Confucian leaders use *renqing* (which can be interpreted as a sense of humanity or humanitarian sensitivity) to strengthen its decisions related to interaction, humanity and business relationships. Indicator of this variable is represented in the following characteristics namely emphasizing *renqing* (humanitarian feeling or humanitarian sensitivity), relying on *guanxi* (kinship).

Lifelong learning in leadership is described as Leadership that always has a passion to keep learning and give priority to education and learning (formal or non-formal), see life as an endless learning process and have space to share knowledge. Indicator of this variable is represented the following characteristics namely lifelong learner and emphasizes proactive behaviour in learning.

Moderation in leadership is described as Leadership that places the principle of harmony, harmony within thought and speech, is able to place themselves and their thinking in a system of harmony in the values of life in dualism antagonistic. Indicator of this variable is represented the following characteristics of leadership that apply the principle of *zhongyong*, the principle of a median that focuses on the balance of human thought and behaviour, harmony between words and deeds.

This research is a descriptive research which seeks to identify and clearly describe how Confucius values influence leadership characteristic in Chinese organizations. The questionnaire in this study used a Likert scale with seven categories of response namely always, often, quite often, maybe, sometimes, almost never, never. The questionnaire consists of 31 questions that represent Confucius values. This research used confirmatory analysis with Smart Partial Least Square version 3.0 (Smart PLS 3.0). The research model is illustrated in Figure 1.

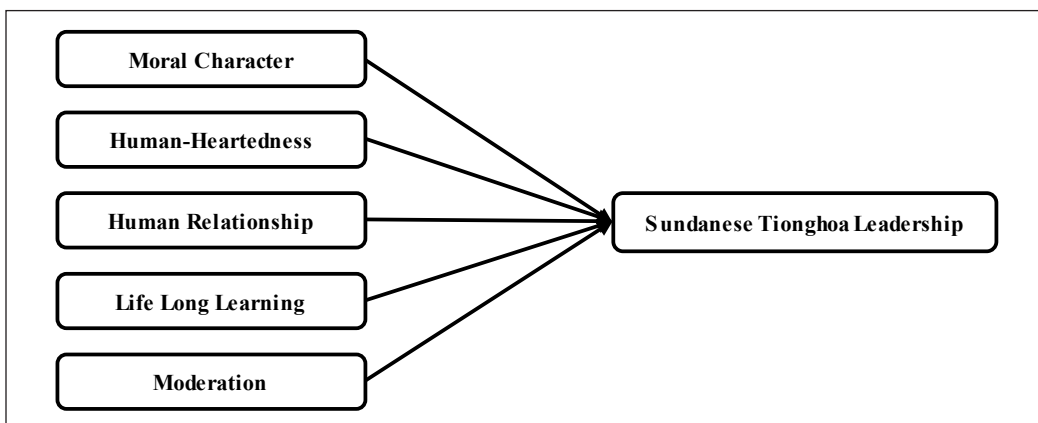

Figure 1. Research model of Chinese leadership

**RESULTS AND DISCUSSIONS**

This study uses confirmatory factor analysis to test the model from the literature review. Confirmatory test for research model uses partial least square that consists of two tests, namely the outer model and inner model. The inner model describes the relationship between one construct with another construct, while the outer model describes the relationship between a construct with its indicators.

The confirmatory test results (Table 1) show that Confucius values are still practised in Chinese leadership in West Java. The results of this research confirm that Chinese ethnic in West Java, who have experienced a dark decade, where their culture and identity were tried to be eliminated politically, still inherent with their core cultural values that is Confucius values. This is proof of the relevance of the Confucius leadership model that five variables are still applied in Chinese ethnic leadership in West Java.

Table 1  
*Result of Chinese leadership model test*

Variables	R	R <sup>2</sup>
Moral character	0.897	0.805
Human heartedness	0.729	0.532
Human relation	0.661	0.436
Lifelong learning	0.990	0.981
Moderation	0.741	0.550

To test the Goodness of Fit Model (GoF) or the suitability of the model, PLS must be done manually as suggested by Tannenhaus (2005) in Wetzels et al. (2009). It can be calculated by the following formula:

$$GoF = \sqrt{AVE} \times \overline{R^2}$$

With the terms of its value according to Wetzels et al. (2009) is as follows: small GoF = 0.1, medium GoF = 0.25, and large GoF = 0.36

$$GoF = \sqrt{0.660 \times 0.383} = 0.409$$

Based on the test results presented above, it is known that the GoF value for this research model is 0.409; it is greater than the cut off value of 0.36. Thus, it can be concluded that this research model has a large GoF which means that the structural model built is robust and accurate. In other words, the model as a whole has a match with the data or is able to reflect the reality and phenomena that exist in the field. Therefore, the results of this study represent the perception of respondents accurately and reliably.

Generally, Confucius values in Chinese ethnic leadership are still similar to confusion leadership variables, but the significant variable in Chinese leadership is different. In West Java, the important variables are moral character and lifelong learning. The other variables (human-heartedness, human relationship, and moderation) have a moderate contribution. Further analysis of this result, why moral character and lifelong learning are very important in Chinese ethnic leadership is presented below.

Chinese ethnic especially Fuqing people (in this research) have strong character and intuition in business. They are very concerned about the importance

of relationship or *Quanxi*. In every relationship, the very important thing is trusting each other. Trust could only be built through strong values of moral. With moral, character relationships can run well. Moral values are very fundamental rules that have to be held. The same thing happened in leadership rules. Chinese ethnic in their leadership always give attention to moral values. A leader has to show attitude and behaviour that reflects the moral quality. He or She must have good characters that could be trusted, could be sympathies by his/her followers. Therefore, he/she could bring comfort and could make his/her followers comfortable, protected and safe.

As described previously, living in Indonesia is not easy for Chinese ethnic. To survive in a new environment, they must have a strong motivation to learn. Learning became the crucial key to make them survive and succeed. As Chinese overseas, Chinese ethnic has to learn everything about their new country fast, learn about culture, learn about local customs and many things to build opportunity for their business, for example, in terms of language, generally Chinese ethnic is very good at learning and adapting local languages. Language has played an important role in communication and Chinese ethnic seems to be very aware of it. To be able to run good leadership, the ability to communicate with followers is very important. This is in line with Hassan and Yong (2008) which revealed that leadership communication practices could contribute towards higher staff commitment in an organization (Hassan & Yong, 2008).

Longlife learning aspect refers to many shapes of the learning process including formal education. It makes sense when the Chinese leader gives much attention to lifelong learning aspect. Lifelong Learning aspect becomes important and significant in the Chinese leadership. This result is reflected in the full support from Chinese leaders to their employees that have the interest to learn or study. Their support could be psychological, time work dispensation and also material support.

## CONCLUSIONS

Chinese Ethnic in Indonesia, especially in West Java, has uniqueness and differences. Long history and lost generation in the decade, in fact, do not eliminate core values of Chinese ethnic. Their culture roots, specifically Confucius values, are still inherent and implemented in their leadership.

This research examined the dimension of Confucius values of leadership namely moral character, human heartedness, human relationship, lifelong learning and moderation. The five dimensions are divided into 31 questioner items and distributed to 121 active members of Fuqing organization. This Research design is to know about the leadership of the Chinese leader through the perception of organization members.

The results show that Confucius values are still implemented by Chinese ethnic, especially in their leadership. The results also show that every dimension of Confucius leadership has a good value of  $< 0.6$ . The perspective on Confucius values of Chinese

ethnic in West Java is different from others, Chinese ethnic in West Java has priority on moral character and lifelong learning in their leadership. The emphasis of moral values as something important, in line with the local cultural values of West Java, where the values of politeness and ethics have a high priority. Learning occupies a high priority in the leadership of Chinese ethnic in West Java, because of their awareness to survive in new places. To survive, grow, be successful, learning is an important thing to do. Learning continuously including learning to adapt to their new environment is important.

Based on this research finding, we could see that environment, place where somebody lives, influences their perception. Our research shows that the importance of some values for Chinese leaders is in line with local cultural values. To be successful, the leader must pay attention to local cultural values in applying his leadership, especially the values adopted by his followers. The difference in cultural values needs to be considered by a leader. Behaviour and attitude of leadership can be perceived differently based on local values. Therefore, it is recommended that a leader is able to adapt local values in his leadership. It is recommended that a leader learns to understand local cultural values. It is to ensure that his leadership can be aligned with local cultural values.

The results of this study indicate that the cultural values that become the core of one's culture are not easy to change or

dammed. As we see from the results of this study that the Confucian values which are the core of Chinese culture remain firmly rooted in Chinese ethnic even though these values have been attempted to be eliminated through various political attempts.

## ACKNOWLEDGEMENT

Praise the Lord for everything. Special thanks to the Fuqing association in West Java for all support. Thanks to Rector BINUS Bandung and Head of Creativepreneurship program for all motivation and support.

## REFERENCES

- Ahlstrom, D., Young, M. N., Chan, E. S., & Bruton, G. D. (2004). Facing constraints to growth? Overseas Chinese entrepreneur and traditional business practices in East Asia. *Asia Pacific Journal of Management*, 21(3), 263.
- Chen, M. J. (2001). *Inside Chinese business, a guide for managers worldwide*. Boston, Massachusetts: Harvard Business School Press.
- Dawis, A. (2010). *Orang Indonesia Chinese mencari identitas* [Chinese Indonesians looking for identity]. Jakarta, Indonesia: Gramedia Pustaka Utama.
- Fischer, C. B. (2002, October 1-11). Chinese Indonesian: Possibilities for civil society. In *Faithful/fateful Encounters: Religions and cultural exchanges between Asia and the West* (pp. 1-11). Beijing, China: Starr King School for the Ministry.
- Hassan, M. S. H., & Aii, C. Y. (2008). Relationships between leadership communication practices and organisational commitment in a selected higher education institution. *Pertanika Journal of Social Sciences and Humanities*, 16(1), 15-29.



- Hoadley, M. C. (1988). Javanese, Peranakan, and Chinese Elites in Cirebon: Changing ethnic boundaries. *The Journal of Asian Studies*, 47(3), 503-517.
- Iskan, D. (2009). *Karmaka Surjaudaja, tidak ada yang tidak bisa* [Karmaka Surjaudaja, nothing can not be]. Surabaya, Indonesia: Jaring Pena.
- Lasserre, P. (1993). *The coming of age of Indonesian-Chinese conglomerates: national, regional or global player?* Euro-Asia Centre Research Series No 13. Fontainebleau, France: INSEAD Euro Asia Centre.
- Leung, F. L. (1995). Overseas Chinese management: Myths and realities. *East Asian Executive Reports*, 17(2), 6-13.
- Lim, H., & Mead, D. (2011). Chinese in Indonesia: A background study. *SIL Electronic Report*, 2011, 1-37.
- Lin, C. (2010). Studying Chinese culture and conflict: A research agenda. *International Journal of Conflict Management*, 21(1), 70-93.
- Ling, W., Chia, R. C., & Fang, L. (2000). Chinese implicit leadership theory. *The Journal of Social Psychology*, 140(6), 729-739.
- Ling, W., & Fang, L. (2003). The Chinese leadership theory. In *Advances in Global Leadership* (pp. 183-204). Bingley, United Kingdom: Emerald Group Publishing Limited.
- Pekerti, A. A. (2008). The interdependent family-centric career: Career perspective of the overseas Chinese in Indonesia. *The Career Development Quarterly*, 56(4), 362-377.
- Schwalje, N. L. (1996). Lords of the Rim: the invisible empire of the overseas Chinese. *Journal of International Affairs*, 49(2), 633-638.
- Shih, L. H. (2009). *The fuqing connection*. Retrieved May 7, 2018, from <http://www.theasiamag.com/archives/2007/the-fuqing-connection>
- So, I. G., Ridwan, A., Simamora, B. H., & Aryanto, R. (2017). Confirming entrepreneurial orientation dimensions and linking it with entrepreneurial intention among business students in Indonesia. *International Journal of Economics and Management*, 11(2), 277-299.
- Wah, S. S. (2010). Confucianism and Chinese leadership. *Chinese Management Studies*, 4(3), 280-285.
- Wetzels, M., Odekerken-Schroder, G., & van Oppen, C. (2009). Using PLS path modelling for assessing hierarchical construct models: Guidelines and empirical illustration. *MIS Quarterly*, 33(1), 177-195.





## **Improving the Intensity of Sales through Digital Banking: The Case of Indonesian Banking Behaviour**

**Janita Sembiring Meliala\* and Puti Sinansari**

*Department of Management, Faculty of Economics and Communication, Bina Nusantara University, Jakarta 11480, Indonesia*

### **ABSTRACT**

The number of banks in Indonesia is increasing as the Indonesian market competes for more in the global economy. Competitive pressure requires the bank to improve its performance. Banking health refers to the state of the bank and its organisational model. This research explored Indonesian banking behaviour based on a sample of 78 banks from which panel data were collected from 2008 to 2017. The panel data regression analysis showed that Indonesian banking behaviour was determined by the intensity of sales (SELL). This is influenced by the number of bank branches or the ability of the bank to reach consumers in Indonesia (SHARE). The coefficient value of 2.16 indicates the positive relationship between SHARE and SELL. The ability to approach consumers all over Indonesia is not only determined by the number of bank branches but also how banks can direct their technology spendings such as interactive websites, applications and electronic banking systems to secure and increase its customer base.

*Keywords:* Banking behaviour, digital era, the intensity of sales

### **INTRODUCTION**

The economic growth of Indonesia from 2008 to 2017 fluctuates between 4% - 6% in line with world economic growth. Although in 2009 Indonesia's economic

growth declined by 2%, the situation quickly recovered. Indonesia as a developing country has a growth rate above the average of other developing countries, indicating that Indonesia is a prominent country

#### **ARTICLE INFO**

##### *Article history:*

Received: 09 October 2019

Accepted: 03 January 2020

Published: 17 March 2020

##### *E-mail addresses:*

janita@binus.ac.id (Janita Sembiring Meliala)

puti.sinansari707@gmail.com (Puti Sinansari)

\* Corresponding author

##### *Current affiliation:*

**Janita Sembiring Meliala**

*Business Creation Program, Management Department,*

*BINUS Business School Undergraduate Program,*

*Bina Nusantara University, Jakarta 11480, Indonesia*

**Puti Sinansari**

*Department of Business Management, Institut Teknologi*

*Sepuluh Nopember, Surabaya 60117, Indonesia*

that should be considered in its economic development.

As the fifth largest country in ASEAN, Indonesia had the largest net interest margin (NIM) of 5.39% in 2016. It indicates that Indonesian banks have better efficiency than other ASEAN countries. However, the role of the financial sector still contributes weakly to Indonesia's economic growth. The contribution of Indonesia's financial sector to Gross Domestic Product (GDP) from 2008 to 2015 was 3% - 4%. This is considered too small for the size of a country as big as Indonesia. The figure is due to more than 64% of business sectors not being served by financial services (Sari, 2016). This did not change much from 2016 to 2017 which recorded a slightly higher contribution to Indonesia's GDP.

The oligopoly of the national banking structure which is controlled by certain players influences the behaviour of the banking industry. A bank that lacks power in the market will die slowly if it does not with several other banks. Indonesia's banking industry consists of private banks, state-owned banks, regional banks and others. They are governed by Bank Indonesia (BI) while the microprudential policy is governed by the Financial Services Authority (OJK) (Tjanjono, 2009).

One instrument that could be used to examine the Indonesian banking industry is the structure, conduct and performance (SCP) theory. The SCP theory introduced by Mason (1939) suggests that the structure of the industry will determine how industry actors behave. The market structure consists

of market share, market concentration and barriers to entry. Market behaviour consists of policies adopted by market players and competitors, especially in terms of price and product characteristics. Behaviour can be seen from the level of competition or collusion between producers. While the performance of the industry is usually severed on three main aspects of efficiency, technological progress and continuity in distribution.

This study examined the behaviour of Indonesian banks operating in a highly competitive environment which had increased due to technology distribution. The collusion in the Indonesian banking industry which is still dominated by several banks makes this study particularly interesting.

Mishra and Sahoo (2012) argued that there was a significant relationship between the intensity of sales, assets, performance and market size. However, no study has discussed how sales intensity will affect the market size, especially in this digitalised era. Digital banking is becoming a common product and it remains uncertain how it will affect market size in Indonesia's banking industry.

Banks provide financial services which they sell to customers. This study focuses on banks' treatment of consumers. The intensity of sales is measured by the number of loans disbursed by banks. The banks' main function is to raise funds from the community and channel them back to the community in the form of loans or credit. Marketing is the spearhead for business because it generates profit. If marketing

can attract consumers to buy a company's products or services, it indicates that the company is valued.

A bank's behaviour in marketing its product includes planning, implementing and controlling activities to collect and channel funds to meet the needs of customers. According to Kasmir (2000), bank behaviour seeks to facilitate or maximise consumption so that customers will buy products repeatedly. It maximises customer satisfaction by providing quality and convenient products and services.

This study analyses the banking behaviour of Indonesian banks. It determines their product selling intensity with the amount of credit offered as the dependent variable. It identifies the independent variables that affect market size most and how internet technology affects its behaviour.

### Literature Review

Behaviour in industrial economics is a pattern of responses and adjustments of various companies in an industry to achieve its goals and face competition. Behaviour can be seen in how the company determines the selling price, product promotion or advertising, coordination of activities in the market and product development (Kuncoro, 2001; Loo, 2018).

This study is based on SCP (structure, conduct and performance) theory. The traditional SCP framework postulates a unidirectional relationship between market structure, conduct/behaviour and performance with the structure of the market

(concentration, and condition of entry) that influences the performance of the firms (profit, growth, and others) via their conduct (behaviour). It is observed that higher market concentration results in higher prices and hence in higher financial return (Mishra & Sahoo, 2012). The modified SCP framework in the context of the banking sector as suggested by Neuberger (1977) is shown below. Here, the basic market conditions include risk, attitude towards risk and principal agent-relationship. These basic conditions affect the market structure, conduct, performance and public policies against market failure.

There are three main topics in SCP theory, but this study will only explain the conduct/behaviour of Indonesia banking. Banks must understand consumer behaviour to know what kind of product must be sold to fulfil consumers' needs. A bank must be able to satisfy consumers so that they have a good impression of the bank. If the consumer recommends its services to others, it is a sign of successful marketing. Banks must also be able to meet the needs of consumers. This is key to securing new markets. Here, the role of marketing a bank's services is vital, especially in after-sales service (Subianto, 2007).

According to Hasibuan (1993), the behaviour is defined as a pattern of responses and adjustments of an industry in the market to achieve its goals. The behaviour of one industry with another is different. One of them is caused by differences in the market structure of industries. The behaviour of a firm in an industry will be interesting to

observe if the firm operates in an imperfect market structure industry. This is because the structure of perfectly competitive markets causes firms to have no power to set market prices.

This study examined the strategic behaviour of Indonesian banks by measuring sales intensity. Sales efforts refer to the bank's expenditure on advertising, service promotion and network service development. According to the annual report data available on each bank, the data that can be used as the embodiment of this variable is the number of bank branches from 2008 to 2017. The number of branches represents the intensity of sales because it is included in the development of service networks and the data is clearly available (Sahoo & Misra, 2012). Neuberger (1997) stated that the behaviour of banking competition could be seen from the density of managed networks, because the more branches scattered in various regions, the easier it was to connect with customers.

Estrella-Ramon et al. (2016) argued that consumer behaviour in banking was shifting from what was only a conventional transaction to internet transaction. Banks with high internet adoption rates have more loyal customers.

## **MATERIALS AND METHODS**

This study used secondary data taken from the active annual reports of Indonesian banks from 2008 to 2017 amounting to 78 banks. Data taken from the banks'

annual report are an asset, branch office growth, return on asset (ROA), and total sales of each bank or credit offered. All of this data was collected for the years 2008 to 2017.

This study used both time series and cross-sectional data because this study wanted to measure the asset, the number of branch offices, ROA and credit offered across nine years and all the banks in Indonesia. The sample consisted of 118 conventional and sharia banks in Indonesia of which only 78 had complete annual report data from 2008 to 2017.

According to Firdaus (2011), the approach with panel data is done by looking at the behaviour of various individuals (cross-section) on a set time (time series). Panel data conducted in this study is to see the effect of predetermined variables on the structure of the Indonesian banking industry from 2008 to 2017. Panel data regression analysis has three models namely Common Effect Model, Fixed Effect Model (FEM), and Random Effect Model (REM).

SELL is a dependent variable that was examined in this research. The bank is a financial services provider that provides many products to its customers. Each bank has a variety of products that cannot be used as a measure to measure these variables. Meanwhile, credit or loan offerings are the main products offered by all banks. Also, the credit offer rate is listed annually in the annual report of each bank. This is the basic parameter for the use of the credit amount offered in the SELL variable.

According to Long and Schiffman (2000), the intensity is related to the tendency of a person to perform an action or behaviour concerning a particular attitude. Meanwhile, the intensity is the tendency to act on objects related to attitude and behaviour. Intensity indicates how far a person has the will to do something. In this study, the intensity of sales is measured through the amount of credit offered because this product will surely be offered continuously and is the core sales of a bank.

According to Sahoo and Misra (2012), the SHARE variable is the market share of a product. Limitations of the data prevent this study using the market share of any bank in Indonesia from 2008 to 2017. Therefore, this research used the number of bank branches as recorded in the bank's annual report. The researchers assume that the greater the number of branches, the more target consumers who want to be approached by the bank, which is an indicator of market share.

The next independent variable is ASSET. The parameter used to measure this variable is an asset owned by a bank. This includes both liquid and non-liquid assets. Assets are included in the measurement because the number of assets owned by a bank will support its behaviour. Banks with large assets tend to have many facilities (such as ATMs and sub-branches). Similarly, in the digital era, banks with large assets will usually have a more stable and responsive digital system that will respond to customer feedback quickly.

Last, is the ROA variable used to measure bank performance. The ROA variable uses the ROA parameter which is the number of assets held by the bank. This is to see how effective and efficient the use of assets owned by banks to support the bank's marketing behaviour. This variable is used to offset asset variables because it would be a waste if the bank has many assets which are not utilised productively. If the existing asset is owned without being productive, then it will burden the bank's finances

Mishra and Sahoo (2012) argued that there was a significant relationship between the intensity of sales, assets, performance and market size. The existence of a relationship between an asset and market size due to the competition will support the structure of the banking industry. In this research, sales intensity will be measured by the amount of credit that is paid, while market share is measured through the number of bank branches. The performance of the bank is measured through ROA and bank assets in accordance with the assets owned by the bank. All of these measurements are conducted within the 2008-2017 period at 78 banks in Indonesia using the following formula:

$$SELL_{it} = f2 (SHARE_{i,t-1}, ASET_{it}, ROA_{i,t-1},)$$

$$SELL_{it} = \alpha + \beta_1 SHARE_{i,t-1} + \beta_2 ASET_{it} + \beta_3 ROA_{i,t-1} + \varepsilon_{it}$$

Where:

SELL = Amount of credit offered

SHARE = : Number of branches

ASSET = Bank assets

ROA = Banking performance

indicates that each increase of one unit of the SELL variable can increase the ROA by 0.003

For ASSET, the regression analysis of panel data indicates that this variable significantly affects the behaviour of the banking industry with a probability of 0.000. There is a positive influence as the value of the coefficient is directly proportional that is if the SELL variable increases by one unit then the ASSET will increase as much as 0.12.

SHARE has a significant influence on the probability of 0.0000. The positive relationship between SHARE and SELL is indicated by the coefficient value of 2.16 which means that every increase of one unit of the SELL variable will affect SHARE increase of 2.16.

The behaviour of the industry is usually determined by the price behaviour of the products of the industry. However, the behaviour of the banking industry is determined by behaviour credit in the form of the amount of credit given to its customers. It takes considerable effort to reach many customers. This is done by opening new branches to facilitate the bank in offering credit (Seelanatha, 2010).

## RESULTS AND DISCUSSIONS

The model of industrial behaviour is a model that measures how the behaviour of the banking industry is reflected in the level of selling intensity. In the annual report of Indonesian banks, the intensity of this sale is viewed from a large number of loans offered by each bank from 2008 to 2017. Based on Table 1, with a probability of 0.05, it seems that SELL significantly and positively affects the value of ROA, ASSETS, and SHARE. This means that the SELL variable is strongly influenced by the independent variables. The increase in each independent variable will affect the increase of the SELL variable.

ROA is a variable for the performance of the banking industry. The result of panel data regression analysis shows that this variable significantly influences the behaviour of the banking industry because it has a probability of 0.0108. The positive influence shown through coefficient 0.003

Table 1  
*Estimation of the behaviour model*

Variables	Coefficient	Std. Error	t-Statistic	Prob.
ROA	0.003592	0.001403	2.560853	0.0108
ASSET	0.121701	0.015028	8.098022	0.0000
SHARE	2.161477	0.539095	4.009451	0.0001
C	0.891414	0.465563	1.914700	0.0563
<i>R-squared</i>	0.999528			
Adjusted R-square	0.999427			



Industry behaviour in this study refers to the intensity of sales and the sales activities undertaken by banks through various branch offices. Banks with various specialisations and offers given to consumers still have to have direction and purpose in marketing to the consumer. Based on the behavioural continuum (Tannenbaum & Schmidt, 1973), the marketing activities of banking products is at level 3. Banking consumers choose a bank based on trust because it involves the funds they save or borrow from a particular bank. Also, the products provided by the bank can be tailored to the needs and capabilities of the consumer such as credit payments adjusted to the capacity of the borrower. The ability of banks to survive in business is high because the bank is a depository institution and offers funds needed by the community. Regional factors, product specificity and consumer segmentation will also affect the way a bank approaches its customers.

### **Research Implications**

In marketing its products and services, the bank is trying to satisfy its customers so they do not to competitors. In the mobile era, customers like to get everything instantly and directly from their phone. It is a challenge for banks to simplify rigid procedures into easy processes available on the mobile phone. Sales intensity is not only supported by the distribution of bank branches but can also be seen from how the bank can reach consumers through technology-based financial applications or information technology (Devi Juwaheer et al., 2012).

According to Krishanan et al. (2016), 75% of conventional transactions take place through conventional branch offices, but that figure drops to 34% due to the innovation of digital banking. While the trend of transactions in digital channels will rise to 35% in the future. Ease of access becomes the main drivers for consumers to choose digital banking as they do not need to waste a lot of time to queue up in conventional branches to make transactions.

Pricewaterhouse Coopers Indonesia (PwC Indonesia) released the Indonesia Banking Survey 2018 stating that technological developments would be a major concern for banks. Most banks direct their technology spending on mobile banking or internet banking. It was noted that mobile and internet for the first time took over the position as the transaction path of the customer. Based on the survey, we argued that banking in Indonesia is transitioning to digital banking which means people do not necessarily have to come to the branch to perform transactions.

### **CONCLUSIONS**

Indonesian banking behaviour is strongly influenced by assets, market share and bank performance. These three issues are very influential for banks to reach their customers. Consumer banking according to marketing continuum is at level 3 that is the selection of products by consumers based on trust. Indonesia geographical conditions support that those with the most assets have a longer reach and are more competitive. The ability to reach consumers is not just about opening

bank branches, but how banks can drive their capital expenditure on technology spending on interactive websites, apps and electronic banking systems to reach consumers. When economic development is fairly evenly distributed in Indonesia, it is not surprising that the assets originally intended to build many branches will be diverted to strengthen safe and convenient technology infrastructure for consumers. However, this study was unable to discuss the effort that banks must make to reach a customer in the digital era and also which marketing strategy will be suitable for digital marketing. Thus, for future research, it will be better to research which variables affect digital marketing in banking.

## ACKNOWLEDGEMENT

The authors wish to acknowledge and thank all IMHA 2018 committee members and UPM *Pertanika* journal team that help publish this article.

## REFERENCES

- Devi Juwaheer, T., Pudaruth, S., & Ramdin, P. (2012). Factors influencing the adoption of internet banking: A case study of commercial banks in Mauritius. *World Journal of Science, Technology and Sustainable Development*, 9(3), 204-234.
- Estrella-Ramon, A., Sánchez-Pérez, M., & Swinnen, G. (2016). How customers' offline experience affects the adoption of online banking. *Internet Research*, 26(5), 1072-1092.
- Firdaus M. (2011). *Aplikasi ekonometrika untuk data panel dan time series* [Econometrics application for panel data and time series]. Bogor, Indonesia: Departemen Ilmu Ekonomi FEM IPB.
- Hasibuan, S. P. M. (1993). *Manajemen sumber daya manusia* [Human Resources Management]. Jakarta, Indonesia: Gunung Agung.
- Kasmir. (2000). *Manajemen perbankan* [Banking management]. Jakarta, Indonesia: Raja Grafindo Persada.
- Krishanan, D., Khin, A. A., Teng, K. L. L., & Chinna, K. (2016). Consumers' perceived interactivity and intention to use mobile banking in structural equation modelling. *International Review of Management and Marketing*, 6(4), 883-890.
- Kuncoro, M. (2001). *Metode kuantitatif, teori dan aplikasi untuk bisnis dan ekonomi* [Quantitative methods, theories and applications for business and economics]. Yogyakarta, Indonesia: UPP AMP YKPN.
- Loo, M. K. L. (2018). A comparative analysis of global competitiveness among BRIC nations: Implications for China. *International Journal of Organizational Business Excellence*, 1(2), 99-120.
- Long, M. M., & Schiffman, L. G. (2000) Consumption values and relationships: Segmenting the market for frequency programs. *Journal of Consumer Marketing*, 17(3), 214-232.
- Mason, E. S. (1939) Price and production policies of large scale enterprises. *The American Economic Review*, 29(1), 61-74.
- Mishra, P., & Sahoo, D. (2012). Structure, conduct and performance of Indian banking sector. *Review of Economic Perspectives*, 12(4), 235-264.
- Neuberger, D. (1977). *Structure, conduct and performance in banking markets* Retrieved May 20, 2018, from [https://www.researchgate.net/publication/24124959\\_Structure\\_Conduct\\_and\\_Performance\\_in\\_Banking\\_Markets](https://www.researchgate.net/publication/24124959_Structure_Conduct_and_Performance_in_Banking_Markets).
- Sari, E. V. (2016). *Kontribusi sektor keuangan terhadap ekonomi masih minim* [The contribution of the financial sector to the economy is still minimal]. Retrieved May

- 25, 2018, from <http://www.cnnindonesia.com/ekonomi/20160509131513-78-129407/kontribusi-sektor-keuangan-terhadap-ekonomi-masih-mini/2016.09.20>
- Seelanatha, S.L. (2010). Determinants of capital structure further evidence from China. *Economics, Management and Financial Markets*, 5(4), 106-126.
- Subianto, T. (2007). Studi perilaku konsumen beserta implikasinya terhadap keputusan pembelian [Study of consumer behaviour and its implications for purchasing decisions]. *Jurnal Ekonomi Modernisasi*, 3(3), 165-182.
- Tannenbaum, R., & Schmidt, W. H. (1973). How to choose a leadership pattern. *Harvard Business Review*, 51, 162-180.
- Tjanjono, E. D. (2009). *Outlook ekonomi Indonesia 2009–2014: Krisis finansial global dan dampaknya terhadap perekonomian Indonesia* [Indonesia economic outlook 2009-2014: Global financial crisis and its impact on the Indonesian economy]. Jakarta, Indonesia: Bank Indonesia.



**REFEREES FOR THE PERTANIKA  
JOURNAL OF SOCIAL SCIENCE AND HUMANITIES**

**VOL. 28 (S1) 2020**

The Editorial Board of the Journal of Social Science and Humanities wishes to thank the following:

Abba Suganda Girsang <i>BINUS, Indonesia</i>	Elia Ardyan <i>STIE Surakarta, Indonesia</i>	Katarzyna Piotrowska <i>Kozminski University, Poland</i>
Adilla Anggraeni <i>BINUS, Indonesia</i>	Elida <i>UNP, Indonesia</i>	Lena N. Sastradinata <i>UPI, Indonesia</i>
Agnes A. Christmastuti <i>Soegijapranata Catholic University, Indonesia</i>	Engkos Achmad Kuncoro <i>BINUS, Indonesia</i>	Lukas S. Tanutama <i>BINUS, Indonesia</i>
Agustinus Dedy Handrimurtjahjo <i>BINUS, Indonesia</i>	Fergyanto Gunawan <i>BINUS, Indonesia</i>	Mahmood A. Momin <i>AUT, New Zealand</i>
Ahmad Nurul Fajar <i>BINUS, Indonesia</i>	Hamdy Hady <i>Persada Indonesia University, Indonesia</i>	Mark Gregory <i>RMIT, Australia</i>
Amalia Maulana <i>BINUS, Indonesia</i>	Hari Mulyadi <i>UPI, Indonesia</i>	Marko Hermawan <i>BINUS, Indonesia</i>
Ana Isabel Jimenez-Zarco <i>UOC, Spain</i>	Harisno <i>BINUS, Indonesia</i>	Noel Scott <i>Griffith University, Australia</i>
Ari Margiono <i>BINUS, Indonesia</i>	Hartoyo <i>Bogor Agricultural University, Indonesia</i>	Nugroho Juli Setiadi <i>BINUS, Indonesia</i>
Arif Zulkarnain <i>BINUS, Indonesia</i>	Haryadi Sarjono <i>BINUS, Indonesia</i>	Opim Sitompul <i>USU, Indonesia</i>
Astari Retnowardhani <i>BINUS, Indonesia</i>	Hasnah Haron <i>UMP, Malaysia</i>	Pradono <i>ITB, Indonesia</i>
Athapol Ruangkanjanases <i>CU, Thailand</i>	Hendi Yogi Prabowo <i>UII, Indonesia</i>	Primidya Soesilo <i>BINUS, Indonesia</i>
Bahtiar Saleh Abbas <i>BINUS, Indonesia</i>	Ignatius Setyawan <i>UNTAR, Indonesia</i>	R. A. Aryanti Puspokusumo <i>BINUS, Indonesia</i>
Bambang Pratama <i>BINUS, Indonesia</i>	Innocentius Bernarto <i>UPH, Indonesia</i>	Rajab Ritonga <i>University of Prof. Dr. Moestopo (Beragama), Indonesia</i>
Dewi Fitriasaki <i>BINUS, Indonesia</i>	Ishak Ismail <i>UMP, Malaysia</i>	Ratih Hurriyati <i>UPI, Indonesia</i>
Dyah Budiastuti <i>BINUS, Indonesia</i>	Jarot Suroso <i>BINUS, Indonesia</i>	Rilla Gantino <i>UEU, Indonesia</i>
Edhie Setiawan <i>Trisakti Institute, Indonesia</i>	Juniati Gunawan <i>Trisakti University, Indonesia</i>	Rinda Hedwig <i>BINUS, Indonesia</i>

Rindang Widuri  
*BINUS, Indonesia*

Shidarta  
*BINUS, Indonesia*

Syamsir Abduh  
*Trisakti University, Indonesia*

Rini Setiowati  
*BINUS, Indonesia*

Sri Vandayuli Riorini  
*Trisakti University, Indonesia*

Taufik Sahroni  
*BINUS, Indonesia*

Rini Sudarmanti  
*Paramadina University, Indonesia*

Sugiarto  
*STIE Wiyatamandala, Indonesia*

Tirta Nugraha Mursitama  
*BINUS, Indonesia*

Rudy Aryanto  
*BINUS, Indonesia*

Sugiharto  
*UBL, Indonesia*

Togar Napitupulu  
*BINUS, Indonesia*

Rudy Harjanto  
*University of Prof. Dr. Moestopo  
(Beragama), Indonesia*

Suharjito  
*BINUS, Indonesia*

Ulf Henning Richter  
*Tongji University, China*

Sani Susanto  
*Parahyangan University, Indonesia*

Suraya Mansur Amin  
*University of Paramadina, Indonesia*

Vitria Ariani  
*BINUS, Indonesia*

Sanjukta Choudhury-Kaul  
*BINUS, Indonesia*

Suryadiputra Liawatimena  
*BINUS, Indonesia*

Yusa Djuyandi  
*UNPAD, Indonesia*

Sevenpri Chandra  
*BINUS, Indonesia*

Suwinto Johan  
*STIE Wiyatamandala, Indonesia*

---

AUT	- Auckland University of Technology
BINUS	- Bina Nusantara University, Indonesia
CU	- Chulalongkorn University
ITB	- Institut Teknologi Bandung
RMIT	- Royal Melbourne Institute of Technology (RMIT),
STIE Surakarta	- Sekolah Tinggi Ilmu Ekonomi Surakarta
STIE Wiyatamandala	- Sekolah Tinggi Ilmu Ekonomi Wiyatamandala
UBL	- Universitas Budi Luhur
UEU	- Universitas Esa Unggul
UII	- Islamic University of Indonesia
UNP	- Universitas Negeri Padang, Indonesia
UNPAD	- Universitas Padjadjaran
UNTAR	- Universitas Tarumanagara
UOC	- Open University of Catalunya
UPH	- University of Pelita Harapan
UPI	- Universitas Pendidikan Indonesia
UPM	- Universiti Malaysia Pahang
USU	- Universitas Sumatera Utara

---

While every effort has been made to include a complete list of referees for the period stated above, however if any name(s) have been omitted unintentionally or spelt incorrectly, please notify the Chief Executive Editor, *Pertanika* Journals at [executive\\_editor.pertanika@upm.edu.my](mailto:executive_editor.pertanika@upm.edu.my)

Any inclusion or exclusion of name(s) on this page does not commit the *Pertanika* Editorial Office, nor the UPM Press or the University to provide any liability for whatsoever reason.

## *Pertanika Journals*

*Our goal is to bring high quality research to the widest possible audience*

### INSTRUCTIONS TO AUTHORS

(SPECIAL ISSUE)

-- Manuscript Preparation & Submission Guide --

*Revised: February 2020*

Please read the Pertanika guidelines and follow these instructions carefully. The Chief Executive Editor reserves the right to return manuscripts that are not prepared in accordance with these guidelines.

#### MANUSCRIPT PREPARATION

*Pertanika* accepts submission of regular article with **≤20%** of similarity index for peer-review.

##### REGULAR ARTICLE

A regular article is full-length original empirical investigations, consisting of introduction, methods, results and discussion. Original work must provide an explanation on research results that contain new and significant findings. Analysis and Discussion must be supported with relevant references.

*Size:* Generally, it is expected **not to exceed 6000 words** (excluding the abstract, references, tables and/or figures), a maximum of **80 references**, and **an abstract of less than 250 words**.

##### Language Accuracy

*Pertanika* **emphasizes** on the linguistic accuracy of every manuscript published. Articles must be in **English** and they must be competently written and argued in clear and concise grammatical English. Contributors are strongly advised to have the manuscript checked by a colleague with ample experience in writing English manuscripts or a competent English language editor.

Author(s) **may be required to provide a certificate** confirming that their manuscripts have been adequately edited. **All editing costs must be borne by the author(s)**.

Linguistically hopeless manuscripts will be rejected straightaway (e.g., when the language is so poor that one cannot be sure of what the authors really mean). This process, taken by authors before submission, will greatly facilitate reviewing, and thus publication if the content is acceptable.

---

#### MANUSCRIPT FORMAT

The paper should be submitted in one column format with at least 4cm margins and 1.5 line spacing throughout. Authors are advised to use Times New Roman 12-point font and *MS Word* format.

##### 1. *Manuscript Structure*

Manuscripts in general should be organised in the following order:

- **Page 1: *Running title***

This page should **only** contain the running title of your paper. The running title is an abbreviated title used as the running head on every page of the manuscript. The running title **should not exceed 60 characters, counting letters and spaces**.

- **Page 2: *Author(s) and Corresponding author's information***

**General information:** This page should contain the **full title** of your paper **not to exceed 25 words**, with name(s) of all the authors, institutions and corresponding author's name, institution and full address (Street address, telephone number (including extension), hand phone number, and e-mail address) for editorial correspondence. **Corresponding authors must be clearly indicated with '\*'.**



**Authors' name:** The names of the authors should be named **in full without academic titles**. For Asian (Chinese, Korean, Japanese, Vietnamese), please write first name and middle name before surname (family name). The last name in the sequence is considered the surname.

**Authors' addresses:** Multiple authors with different addresses must indicate their respective addresses separately by superscript numbers.

**Tables / figures list:** A list of number of **black and white / colour figures and tables** should also be indicated on this page. See "**6. Figures & Photographs**" for details.

*Example (page 2):*

***In vivo* Fecundity Evaluation of *Phaleria macrocarpa* Extract Supplementation in Male Adult Rats**

**Sui Sien Leong<sup>1\*</sup> and Mohamad Aziz Dollah<sup>2</sup>**

<sup>1</sup>*Department of Animal Sciences and Fishery, Universiti Putra Malaysia, 97008 Bintulu, Sarawak, Malaysia*

<sup>2</sup>*Department of Biomedical Sciences, Universiti Putra Malaysia, 43400 Serdang, Malaysia*

leongsuisien@upm.edu.my (Sui Sien Leong), Contact number  
aziddollah@gmail.com (Mohamad Aziz Dollah), Contact number

\*Corresponding author

List of Table / Figure:

Table 1.

Figure 1.

• **Page 3: Abstract**

This page should **repeat** the **full title** of your paper with only the **Abstract**, usually in one paragraph (the abstract should be less than 250 words for a Regular Paper), **and Keywords**.

*Keywords:* **Not more than 8 keywords in alphabetical order** must be provided to describe the contents of the manuscript.

• **Page 4: Text**

Regular Papers should be prepared with the headings *Introduction, Methods, Results and Discussions*. The literature review may be part of or separated from Introduction. A conclusion may be embedded or separated from Results and Discussions.

Title	_____
Abstract	_____
Keywords	_____
<b>(IMRAD)</b>	
Introduction	_____
Methods	_____
Results	_____
And	_____
Discussions	_____
Conclusions	_____
Acknowledgements	_____
References	_____
Supplementary data	_____

**MAKE YOUR ARTICLES AS CONCISE AS POSSIBLE**

Most scientific papers are prepared according to a format called IMRAD. The term represents the first letters of the words Introduction, Materials and Methods, Results, And, Discussion. It indicates a pattern or format rather than a complete list of headings or components of research papers; the missing parts of a paper are: Title, Authors, Keywords, Abstract, Conclusions, and References. Additionally, some papers include Acknowledgments and Appendices.

The Introduction explains the scope and objective of the study in the light of current knowledge on the subject; the Materials and Methods describes how the study was conducted; the Results section reports what was found in the study; and the Discussion section explains meaning and significance of the results and provides suggestions for future directions of research. The manuscript must be prepared according to the Journal's instructions to authors.

## 2. Levels of Heading

Level of heading	Format
1 <sup>st</sup>	<b>LEFT, BOLD, UPPERCASE</b>
2 <sup>nd</sup>	<b>Flush left, Bold, Capitalise each word</b>
3 <sup>rd</sup>	<b>Bold, Capitalise each word, ending with .</b>
4 <sup>th</sup>	<b>Bold italic, Capitalise each word, ending with .</b>

## 4. Equations and Formulae

These must be set up clearly and should be typed double spaced. Numbers identifying equations should be in square brackets and placed on the right margin of the text.

## 5. Tables

- All tables should be prepared in a form consistent with recent issues of Pertanika and should be numbered consecutively with Roman numerals (Table 1, Table 2).
- A brief title should be provided, which should be shown at the top of each table (**APA format**):

Example: Table 1

*PVY infected Nicotiana tabacum plants optical density in ELISA*

- Explanatory material should be given in the table legends and footnotes.
- Each table should be prepared on a new page, embedded in the manuscript.
- Authors are advised to keep backup files of all tables.

**\*\* Please submit all tables in Microsoft word format only - because tables submitted as image data cannot be edited for publication and are usually in low-resolution.**

## 6. Figures & Photographs

- Submit an **original** figure or photograph.
- Line drawings must be clear, with high black and white contrast.
- Each figure or photograph should be prepared on a new page, embedded in the manuscript for reviewing to keep the file of the manuscript under 5 MB.
- These should be numbered consecutively with Roman numerals (Figure 1, Figure 2).
- Provide a brief title, which should be shown at the bottom of each table (**APA format**):

Example: *Figure 1. PVY-infected in vitro callus of Nicotiana tabacum*

- If a Figure has been previously published, acknowledge the original source and submit written permission form the copyright holder to reproduce the material.
- Authors are advised to keep backup files of all figures.

**\*\* Figures or photographs must also be submitted separately as TIFF, JPEG, because figures or photographs submitted in low-resolution embedded in the manuscript cannot be accepted for publication. For electronic figures, create your figures using applications that are capable of preparing high resolution TIFF files.**

## 7. References

References begin on their own page and are listed in alphabetical order by the first author's last name. Only references cited within the text should be included. All references should be in 12-point font and double-spaced.

**NOTE:** When formatting your references, please follow the **Pertanika-APA-reference style** (6<sup>th</sup> Edition) (*refer to examples*). Ensure that the references are strictly in the journal's prescribed style, failing which your article will **not be accepted for peer-review**. You may refer to the *Publication Manual of the American Psychological Association* for further details <https://apastyle.apa.org/>.

Examples of reference style are given below:

**Books**

Books	Insertion in Text	In Reference List
Book with 1-2 authors	<p><b>Information prominent' (the author's name is within parentheses):</b></p> <p>... (Cochrane, 2007) ...</p> <p>Or</p> <p><b>'Author prominent' (the author's name is outside the parentheses):</b></p> <p>Cochrane (2007) ...</p>	<p>Cochrane, A. (2007). <i>Understanding urban policy: A critical approach</i>. Malden, United States: Blackwell Publishing.</p>
Book with 3 or more authors (Pertanika's format)	<p><i>For all in-text references, list only the first author's family name and followed by 'et al.'</i></p> <p><b>Information prominent' (the author's name is within parentheses):</b></p> <p>... (Seeley et al., 2011) ...</p> <p>Or</p> <p><b>'Author prominent' (the author's name is outside the parentheses):</b></p> <p>Seeley et al. (2011) ...</p>	<p>Seeley, R., VanPutte, C., Regan, J., &amp; Russo, A. (2011). <i>Seeley's anatomy &amp; physiology</i>. New York, United States: McGraw-Hill.</p>
Book with 6-7 authors	<p><i>For all in-text references, list only the first author's family name and followed by 'et al.'</i></p> <p><b>Information prominent' (the author's name is within parentheses):</b></p> <p>... (Bulliet et al., 2011) ...</p> <p>Or</p> <p><b>'Author prominent' (the author's name is outside the parentheses):</b></p> <p>Bulliet et al. (2011) ..</p>	<p>Bulliet, R. W., Crossley, P. K., Headrick, D. R., Hirsch, S. W., Johnson, L. L., &amp; Northrup, D. (2011). <i>The earth and its peoples: A global history</i> (5th ed.). Boston, United States: Wadsworth.</p>
Book with more than 8 authors	<p><i>For all in-text references, list only the first author's family name and followed by 'et al.'</i></p> <p>A recent study (Edge et al., 2011) concluded that...</p> <p>Or</p> <p>Edge et al. (2011) concluded that ....</p>	<p>For books with eight or more authors, please follow the guidelines for journal articles with eight or more authors.</p>

Chapter in edited book	<p><b>Information prominent' (the author's name is within parentheses):</b></p> <p>... (Richards, 1997) ...</p> <p>Or</p> <p><b>'Author prominent' (the author's name is outside the parentheses):</b></p> <p>Richards (1997) ...</p>	Richards, K. C. (1997). Views on globalization. In H. L. Vivaldi (Ed.), <i>Australia in a global world</i> (pp. 29-43). Sydney, Australia: Century.
e-book/online book	<p><b>Information prominent' (the author's name is within parentheses):</b></p> <p>... (Niemann et al., 2004) ...</p> <p>Or</p> <p><b>'Author prominent' (the author's name is outside the parentheses):</b></p> <p>Niemann (2004) ...</p>	<p>Niemann, S., Greenstein, D., &amp; David, D. (2004). <i>Helping children who are deaf: Family and community support for children who do not hear well</i>. Retrieved June 1, 2019, from <a href="http://www.hesperian.org/publications_download_deaf.php">http://www.hesperian.org/publications_download_deaf.php</a></p> <p>Schiraldi, G. R. (2001). <i>The post-traumatic stress disorder sourcebook: A guide to healing, recovery, and growth</i> [Adobe Digital Editions version]. doi:10.1036/0071393722</p>
Editor	<p><b>Information prominent' (the author's name is within parentheses):</b></p> <p>... (Zairi, 1999) ...</p> <p>Or</p> <p><b>'Author prominent' (the author's name is outside the parentheses):</b></p> <p>Zairi (1999) ...</p>	Zairi, M. (Ed.). (1999). <i>Best practice: Process innovation management</i> . Oxford, United Kingdom: Butterworth-Heinemann.
Several works by same author in the same year	<p><b>Information prominent' (the author's name is within parentheses):</b></p> <p>... (Fullan, 1996a, 1997b) ...</p> <p>Or</p> <p><b>'Author prominent' (the author's name is outside the parentheses):</b></p> <p>Fullan (1996a, 1996b) ...</p>	<p>Fullan, M. (1996a). Leadership for change. In <i>International handbook for educational leadership and administration</i>. New York, United States: Kluwer Academic.</p> <p>Fullan, M. (1996b). <i>The new meaning of educational change</i>. London, United Kingdom: Casell.</p>
Several authors, different years referred to collectively in your work	<p><b>List sources alphabetically by family name in the in-text reference in the order in which they appear in the Reference List.</b></p> <p>The cyclical process (Carr &amp; Kemmis, 1986; Dick, 2000) suggests...</p>	<p>Carr, W., &amp; Kemmis, S. (1986). <i>Becoming critical: Education knowledge and action research</i>. London, United Kingdom: Falmer Press.</p> <p>Dick, B. (2000). <i>A beginner's guide to action research</i>. Retrieved June 1, 2019, from <a href="http://www.scu.edu.au/schools/gcm/ar/arp/guide.html">http://www.scu.edu.au/schools/gcm/ar/arp/guide.html</a></p>

## Journals

Journals	Insertion in Text	In Reference List
Journal article with 1-2 authors	<p><b>Information prominent' (the author's name is within parentheses):</b> ... (Kramer &amp; Bloggs, 2002)...</p> <p>Or</p> <p><b>'Author prominent' (the author's name is outside the parentheses):</b> Kramer and Bloggs (2002) ...</p>	Kramer, E., & Bloggs, T. (2002). On quality in art and art therapy. <i>American Journal of Art Therapy</i> , 40, 218-231.
Journal article with 3 or more authors (Pertanika's format)	<p><i>For all in-text references, list only the first author's family name and followed by 'et al.'</i></p> <p><b>Information prominent' (the author's name is within parentheses):</b> ... (Erlo et al., 2008) ...</p> <p>Or</p> <p><b>'Author prominent' (the author's name is outside the parentheses):</b> Erlo et al. (2008) ...</p>	Elo, A., Ervasti, J., Kuosma, E., & Mattila, P. (2008). Evaluation of an organizational stress management program in a municipal public works organization. <i>Journal of Occupational Health Psychology</i> , 13(1), 10-23. doi: 10.1037/1076-8998.13.1.10
Journal article with 6 - 7 authors	<p><i>For all in-text references, list only the first author's family name and followed by 'et al.'</i></p> <p><b>Information prominent' (the author's name is within parentheses):</b> ... (Restouin et al., 2009) ...</p> <p>Or</p> <p><b>'Author prominent' (the author's name is outside the parentheses):</b> Restouin et al. (2008) ...</p>	Restouin, A., Aresta, S., Prébet, T., Borg, J., Badache, A., & Collette, Y. (2009). A simplified, 96-well-adapted, ATP luminescence-based motility assay. <i>BioTechniques</i> , 47, 871-875. doi: 10.2144/000113250
Journal article with more than 8 or more authors	<p><b>Information prominent' (the author's name is within parentheses):</b> ... (Steel et al., 2010)..</p> <p>Or</p> <p><b>'Author prominent' (the author's name is outside the parentheses):</b> Steel et al. (2010) ...</p>	Steel, J., Youssef, M., Pfeifer, R., Ramirez, J. M., Probst, C., Sellei, R., ... Pape, H. C. (2010). Health-related quality of life in patients with multiple injuries and traumatic brain injury 10+ years postinjury. <i>Journal of Trauma: Injury, Infection, and Critical Care</i> , 69(3), 523-531. doi: 10.1097/TA.0b013e3181e90c24

Journal article with DOI	<p><b>Information prominent' (the author's name is within parentheses):</b></p> <p>... (Shaw et al., 2005)..</p> <p>Or</p> <p><b>'Author prominent' (the author's name is outside the parentheses):</b></p> <p>Shaw et al. (2005) ...</p>	Shaw, K., O'Rourke, P., Del Mar, C., & Kenardy, J. (2005). Psychological interventions for overweight or obesity. <i>The Cochrane database of systematic reviews</i> (2). doi:10.1002/14651858.CD003818.pub2
--------------------------	---	--

### Newspapers

Newspapers	Insertion in Text	In Reference List
Newspaper article – with an author	... (Waterford, 2007)...	Waterford, J. (2007, May 30). Bill of rights gets it wrong. <i>The Canberra Times</i> , p. 11.
Newspaper article – without an author	... ("Internet pioneer", 2007) ...	Internet pioneer to oversee network redesign. (2007, May 28). <i>The Canberra Times</i> , p. 15.
Article in an newsletter	... ("Australians and the Western Front", 2009) ...	Australians and the Western Front. (2009, November). <i>Ozculture newsletter</i> . Retrieved June 1, 2019, from <a href="http://www.cultureandrecreation.gov.au/newsletter/">http://www.cultureandrecreation.gov.au/newsletter/</a>

### Conference / Seminar Papers

Conference / Seminar Papers	Insertion in Text	In Reference List
<p><b>Print –</b></p> <p><i>If the paper is from a book, use the book chapter citation format. If it is from regularly published proceedings (e.g. annual), use the Journal article citation format.</i></p>	<p>... (Edge, 1996) ...</p> <p>Or</p> <p>Edge (1996) ...</p>	Edge, M. (1996). Lifetime prediction: Fact or fancy? In M. S. Koch, T. Padfield, J. S. Johnsen, & U. B. Kejser (Eds.), <i>Proceedings of the Conference on Research Techniques in Photographic Conservation</i> (pp. 97-100). Copenhagen, Denmark: Royal Danish Academy of Fine Arts.
<p><b>Online</b></p>	<p>... (Tester, 2008) ...</p> <p>Or</p> <p>Tester (2008) ...</p>	Tester, J. W. (2008). The future of geothermal energy as a major global energy supplier. In H. Gurgenci & A. R. Budd (Eds.), <i>Proceedings of the Sir Mark Oliphant International Frontiers of Science and Technology Australian Geothermal Energy Conference</i> , Canberra, Australia: Geoscience Australia. Retrieved June 1, 2019, from <a href="http://www.ga.gov.au/image_cache/GA11825.pdf">http://www.ga.gov.au/image_cache/GA11825.pdf</a>

### Government Publications

Government Publications	Insertion in Text	In Reference List
Government as author	<p><b>First in-text reference: Spell out the full name with the abbreviation of the body.</b></p> <p>... (Department of Finance and Administration [DOFA], 2006) ...</p> <p><b>Subsequent in-text reference/s: Use the abbreviation of the body.</b></p> <p>... (DOFA, 2006)...</p>	<p>Department of Finance and Administration. (2006). <i>Delivering Australian Government services: Managing multiple channels</i>. Canberra, Australia: Author.</p>
Government report - online	<p><b>First in-text reference: Spell out the full name with the abbreviation of the body.</b></p> <p>... (Department of the Prime Minister and Cabinet [PM&amp;C], 2008) ...</p> <p><b>Subsequent in-text reference/s: Use the abbreviation of the body.</b></p> <p>... (PM&amp;C, 2008)...</p>	<p>Department of the Prime Minister and Cabinet. (2008). <i>Families in Australia: 2008</i>. Retrieved June 1, 2019, from <a href="http://www.....">http://www.....</a></p>

### 8. General Guidelines

**Abbreviations:** Define alphabetically, other than abbreviations that can be used without definition. Words or phrases that are abbreviated in the introduction and following text should be written out in full the first time that they appear in the text, with each abbreviated form in parenthesis. Include the common name or scientific name, or both, of animal and plant materials.

**Acknowledgements:** Any individuals and entities who have contributed should be acknowledged appropriately.

**Authors' Affiliation:** The primary affiliation for each author should be the institution where the majority of their work was done. If an author has subsequently moved to another institution, the current address may also be stated in the footer.

**Co-Authors:** The commonly accepted guideline for authorship is that one must have substantially contributed to the development of the paper and share accountability for the results. Researchers should decide who will be an author and what order they will be listed depending upon their order of importance to the study. Other contributions should be cited in the manuscript's Acknowledgements.

**Copyright Permissions:** Authors should seek necessary permissions for quotations, artwork, boxes or tables taken from other publications or from other freely available sources on the Internet before submission to Pertanika. Acknowledgement must be given to the original source in the illustration legend, in a table footnote, or at the end of the quotation.

**Footnotes:** Current addresses of authors if different from heading may be inserted here.

**Page Numbering:** Every page of the manuscript, including the title page, references and tables should be numbered.

**Spelling:** The journal uses American or British spelling and authors may follow the latest edition of the Oxford Advanced Learner's Dictionary for British spellings. Each manuscript should follow one type of spelling only.



## Submission Checklist

### 1. MANUSCRIPT:

Ensure your MS has followed the Pertanika style particularly the first four pages as explained earlier. The article should be written in a good academic style and provide an accurate and succinct description of the contents ensuring that grammar and spelling errors have been corrected before submission. It should also not exceed the suggested length.

### 2. DECLARATION FORM:

Corresponding author has to sign a declaration form. In signing the form, authors declare that the work submitted for publication is original, previously unpublished, and not under consideration for any publication elsewhere.

*Note:*

**COPYRIGHT FORM:** Author will be asked to sign a copyright form when the paper is accepted. In signing the form, it is assumed that authors have obtained permission to use any copyrighted or previously published material. All authors must read and agree to the conditions outlined in the form, and must sign the form or agree that the corresponding author can sign on their behalf. Articles cannot be published until a signed form (*original pen-to-paper signature*) has been received.

Visit our Journal's website for more details at <http://www.pertanika.upm.edu.my/>

## ACCESS TO PUBLISHED MATERIALS

Under the Journal's open access initiative, authors can choose to download free material (via PDF link) from any of the journal issues from Pertanika's website. Under "**Browse Journals**" you will see a link, "*Regular Issue*", "*Special Issue*" or "*Archives*". Here you will get an access to all current and back-issues from 1978 onwards. No hard copy of journals or off prints are printed.

Visit our Journal's website at

[http://www.pertanika.upm.edu.my/regular\\_issues.php](http://www.pertanika.upm.edu.my/regular_issues.php) for "Regular Issue"

[http://www.pertanika.upm.edu.my/cspecial\\_issues.php](http://www.pertanika.upm.edu.my/cspecial_issues.php) for "Special Issue"

[http://www.pertanika.upm.edu.my/journal\\_archives.php](http://www.pertanika.upm.edu.my/journal_archives.php) for "Archives"

---

Any queries may be directed to the **Chief Executive Editor's** office via email to [executive\\_editor.pertanika@upm.edu.my](mailto:executive_editor.pertanika@upm.edu.my)



Control of the Right to Strike Affecting the Productivity of State-Owned Enterprises <i>Christian Orchard Perangin-Angin and Bismar Nasution</i>	311
Design Thinking Corporate Training Effectiveness and the Attributes of the Trainers <i>Ari Margiono and Tubagus Hanafi</i>	323
Donald Digital Marketing: An Exploratory Study of Digital Political Marketing in Trump Presidential Campaign <i>Irmawan Rahyadi and Muhammad Aras</i>	337
Chinese Ethnic Perspective on the Confucius Values of Leadership in West Java Fuqing Organization <i>Mulyani and Chyntia Ika Ratnapuri</i>	347
Improving the Intensity of Sales through Digital Banking: The Case of Indonesian Banking Behaviour <i>Janita Sembiring Meliala and Puti Sinansari</i>	359

Enhancing the Economic Potential of Indigenous People in the Jababeka Industrial Area through Corporate Social Responsibility <i>Ulani Yunus, Triadi Sumbogo, Gayes Mahestu and Wajid Zulqarnain</i>	155
PCAOB Sanction and Client Stock Market Reactions: Evidence from the Case of Ernst & Young Indonesia <i>Gatot Soepriyanto and Arfian Erma Zudana</i>	167
Innovation in Traditional Food Products as Local Wisdom on <i>Dodol Mandai</i> Trias Septyoari Putranto, Tri Wiyana and Sarim	181
@_TNIAU: Case Study on Interactive Public Communication in Indonesia <i>Yuanita Safitri and Mia Angeline</i>	191
Internet of Things (IoT) for Energy Efficiency in Tourism-Related Industry <i>Kasih Cakaputra Komsary, Tati Ernawati, Ade Hodijah and Dian Wardiana</i>	203
Consumer Perceived Value, Attitude, Trust and Purchase Intention of <i>Kuku Bima Ener-G</i> Product <i>Selly Novela, Didiet Gharnaditya, Novita and Patricia Marie Wibisono</i>	215
Training Model for Improving Human Resource Performance and Quality in a Parking Insurance Company <i>Respati Wulandari, Anita Maharani, David Young and Tania Winoto</i>	229
Tobit Regression Analysis on Factors Influencing Dividend Policy of Indonesian Manufacturing Firms <i>Dezie L. Warganegara, Titik Indrawati, Evi Steelyana, Doni S. Warganegara and Mark Kam Loon Loo</i>	243
Factors Affecting Earnings Quality in Companies Listed in Indonesia Stock Exchange <i>Stefanus Ariyanto, Sasya Sabrina and Theresia Lesmana</i>	253
Inflation Effect, Interest Rate of Bank Indonesia Certificates (SBI) and Economic Growth on Rupiah Exchange Rate in Indonesia <i>Darman and Karyana Hutomo</i>	261
The Effect of Banking Efficiency, Earnings Per Share and Price-Earnings Ratio towards the Stock Return of Banking Companies in Indonesia Rahmat Siauwijaya	277
Voluntary Disclosure Level and Firm Valuation of Kompas100 Listed Firms <i>Yanthi Hutagaol-Martowidjojo and Kevin Richard</i>	289
The Effect of Website Quality on e-Trust of Customers: “The Case of ZEN Rooms” <i>Lucina Iswi Hapsari Sulistyono and Wenly Pranata</i>	301

**Perbanka Journal of Social Sciences & Humanities**  
**Vol. 18 (51) 2020**

**Content**

**Sustainability Business Excellence for Sustainability with ICT as an Enabler**

**Indices** 1  
*Richard R. Simanungkalit*

**The Effect of Corporate Governance, E-Readiness and Innovation on Competitive Advantage and Implications on Financial Performance** 1  
*Meliana, Akbar Rizwanul Mahyudin, Priscila Alwangah and Mohamad Fauzan*

**Business Development Analysis in Sustainable Listed Bank Type TB as an Overview of Business Plan Theory in Sustainable Banking Industry in Developing Competitive Advantage** 13  
*Hendjanto Satrio and Agus Setiawan*

**Design and Commercialization Culture of Batik Liris** 29  
*Rita Jenny Setiawan*

**The Survival of Batik Motifs in Digital Era: A Case Study of Small Medium Enterprises (SME) at Batik Motifs Center** 43  
*Alegra, Fit Anayana, Supriadi and Suk Zahir*

**Analysis of Factors Affecting the Consumer Behavior of Indonesian Banking Industry** 59  
*Rahmat Hidayat and Fit Anayana*

**Exploring Employee's Motivation and Performance Factors: Evidence in a 3 Star Hotel in Indonesia by Contrasting Maslow's and Herzberg's Model** 71  
*Dani Setiawan, Ropart Walandari and Denny Khristian*

**The Urgency of Community Participation in the Establishment of a Local Regulation** 87  
*Dani Setiawan, Setiawan and Faisal Akbar Hidarwan*

**Sustainability Report Analysis: Content and Quality-ORION** 100  
*Angi Kusuma, Duan Chandra and Debra Ananta*

**Trend in Representation in Jakarta: An Analysis of Jakarta's City Branding** 110  
*Mitscha, Louis Minkshwan and Pawan Chandra*

**Managerial Effects in Banking Organization Behaviour (Study of Entrepreneur in Indonesia)** 140  
*Rani Kusuma, Susanto, Susanto Indrawati, Lenny and Mandy Hartono*



Perbanka Editorial Office, Journal Division  
Pusat Ekonomi Park  
Jati Rasa, CIBUBUR  
SP4WTEC Technology Center  
Bintaro Jaya Sektor 1  
Jl. Jati Rasa  
Tangerang-Ciandamar  
Majelis

<http://www.perbanka.com>  
Email: [perbanka@perbanka.com](mailto:perbanka@perbanka.com)  
Tel: +62-21-5101111



<http://www.perbanka.com>  
Perbanka  
TANGERANG

