

Available online at [www.sciencedirect.com](http://www.sciencedirect.com)**ScienceDirect**

Energy Procedia 49 (2014) 1165 – 1176

Energy

**Procedia**

SolarPACES 2013

## A systematic comparison on power block efficiencies for CSP plants with direct steam generation

T.Hirsch<sup>a</sup>, A.Khenissi<sup>a</sup><sup>a</sup>*Institute of Solar Research, German Aerospace Center (DLR) Pfaffenwaldring 38-40, 70569 Stuttgart Germany*

---

### Abstract

The increase of the process temperature of concentrating solar power plants above the degradation temperature of thermal oil (400 °C) opens the way for increased power block efficiency and thus reduced cost of electricity production. Direct solar steam generation is one technical option to follow this path. The paper presents different power block designs for direct steam generation parabolic trough and linear Fresnel power plants. Based on a systematic modelling approach, results for efficiency gains are derived and compared against a reference case of an oil-based plant. The results show that different reheat configurations are feasible and that efficiency gains in the range from 4 to 6% can be expected based on today's or near future solar collector technology.

© 2013 The Authors. Published by Elsevier Ltd. This is an open access article under the CC BY-NC-ND license (<http://creativecommons.org/licenses/by-nc-nd/3.0/>).

Selection and peer review by the scientific conference committee of SolarPACES 2013 under responsibility of PSE AG.

Final manuscript published as received without editorial corrections.

**Keywords:** Direct steam generation (DSG), internal reheat, direct reheat, power block, efficiency

---

### 1. Introduction

The majority of existing concentrating solar power plants (CSP) today are operated with thermal oil as heat transfer fluid (HTF). In the parabolic trough technology, oil is heated in linear optical concentrators to a temperature of about 395 °C. The boiler supplied with the heated oil produces steam of about 100 bar/380 °C which is then fed into an industrial steam turbine. The power block makes use of feed water pre-heating in order to increase the solar field inlet temperature to values of about 290 °C. Some of the plants are equipped with a two-tank molten salt storage system that allows about 7 hours of turbine operation without sun. Due to the degradation limit of the oil, the steam temperature for those plants is limited to approx. 380 °C. Typical power block efficiency values are 39%–40% (gross). The span is caused by the efficiencies of the installed heat exchangers, turbines, and the condenser/cooling. Although the technical feasibility is demonstrated by a large number of installations mainly in Spain, the costs of electricity produced by the plants needs to undergo intense reductions.

To further reduce the cost of electricity from CSP plants, engineers are heading for higher cycle parameters (live steam temperature and pressure) with the aim of improving the efficiency. Therefore, alternative HTFs like molten salt or water/steam that allow an increase in solar field temperature are currently investigated. One of the most promising and already demonstrated technologies is the direct steam generation (DSG) in the solar field. In contrast to the oil based parabolic trough plants the DSG system has only one fluid cycle. Sub-cooled water is sent to the solar field, where it is pre-heated, evaporated, and finally superheated. This process can be used in parabolic troughs (TSE 1 in Thailand with 5 MW, 30 bar/330 °C [1]), linear Fresnel (PE-2 in Spain with 30 MW, 55 bar saturated steam [2]), and solar towers (PS10 in Spain with 11 MW, PS20 in Spain with 20 MW, both with saturated steam at 50 bar [3]). While new solar tower plants with direct steam generation are under construction, this paper concentrates on line focusing systems like parabolic troughs or linear Fresnel. The step to higher temperatures has been demonstrated by the research project RealDISS with operation of the essential components at 120 bar/500 °C [4]. Operation at temperatures of 500 °C has also been reported for the linear Fresnel test plant PE-1 [5]. A large number of system studies has been published proving the potential of LCOE reduction with higher temperature [6], [7], [8]. Although the increase in solar field temperature is the main driver for DSG development, there are a number of other benefits compared to the state of the art oil plants like reduction in investment costs by omitting the heat exchangers, electric consumption of the solar field pump is reduced, environmental safety of the heat transfer fluid, or the benefit from about one century experience in the handling of high pressure steam.

A detailed comparison of the state of the art oil and the DSG technology requires a close look on the essential sub-systems like solar field, storage, and power block. The intention of this paper is to work out the systematic technical differences of the power block and their impact on the expected power block efficiency. The major aspect investigated is the possibility to use a reheat in the power cycle. While this is straight-forward for oil plants, there are several technical options for the reheat in the DSG configuration. The options are presented in the paper together with the power block efficiencies for a variety of different steam parameters. The benchmark is a power block of an oil plant with a gross efficiency of 39.5%. The different DSG configurations are compared to this benchmark in terms of possible efficiency gains. In order to retrieve reliable and robust results a rigorous systematic approach for the thermodynamic modeling of the power block has been chosen. The authors note that this study is on the power block only and does not take into account the solar field. Furthermore, auxiliary electric consumption and costs of different installations have not yet been considered. The outcome of the study is a set of reliable technical parameters for the power block that can be used in further studies on system level. In the following, the different DSG power block configurations are presented, the methodology for power block modeling is discussed, and the benchmark configuration is given. The simulation results obtained from these set-ups are then presented and conclusions regarding the possible efficiency gains are derived.

## Nomenclature

$\Delta T_{\text{opt}}$	optimal temperature increase over the preheater
HP	high pressure
LP	low pressure
$P_{\text{Live steam}}$	Live steam pressure
$P_{\text{Reheat}}$	reheat pressure
$T_{\text{Sat}}$	saturation temperature
$T_{\text{Cond}}$	condenser temperature

## 2. Power block configurations for DSG systems

### 2.1. Configuration without reheat

The most simple configuration of a DSG power block is a pure superheating configuration without any reheat. Here, the superheated steam leaving the solar field is directly sent to the turbine where it is expanded successively in the turbine stages, see Fig. 1. Although simple and robust in the set-up, this configuration suffers from moderate efficiencies and strong limitations in the selection of live steam parameters. The wetness in the last turbine stage has to be kept low to avoid damage on the turbine blades due to impinging droplets. Typical values for the tolerated wetness are in the range between 10 to 20% depending on the supplier and the technical layout of the low pressure turbine. A tolerated value of 15% is chosen for this study since turbines for these parameters are definitely available from manufacturers. As shown in the later chapters, steam pressure is strongly limited since too high pressures would move the end of the expansion line deeply into the two-phase region.

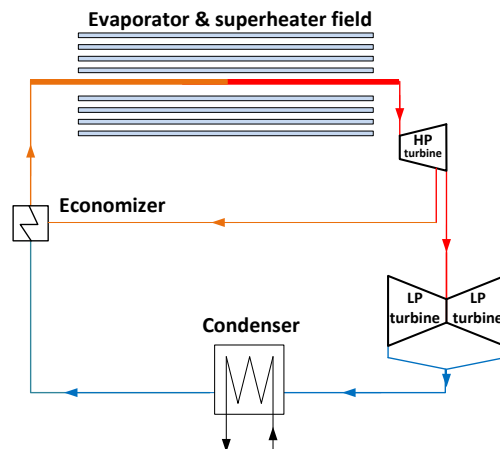

Fig. 1. Configuration without reheat

### 2.2. Configuration with direct reheat

Compared to conventional power plants where steam generator and turbine can be mounted near to each other, DSG plants are characterized by a long distance from heat source to the turbine. This leads to difficulties in the implementation of a reheat system since the steam leaving the high pressure turbine (HP) would have to be sent through a reheat solar field. The low pressure in the range of 20 to 30 bar combined with the high temperatures causes large pressure drops in this reheat line. Nevertheless, this configuration named “direct reheat” is considered as one option in the study, see Fig. 2. The expanded steam leaving the high pressure turbine is directly fed through the reheater solar field where it is superheated, then carried back to the low pressure turbine and expanded. The steam has to travel a long distance from the HP turbine to the solar field, through the reheat field and back to the power block. This is associated with high pressure drop and decrease of the inlet steam pressure in the low pressure turbine. Since the solar field itself is not part of the study the “direct reheat” configuration is analyzed assuming two different pressure drops in the field, namely 5 and 10 bar. The problem with tolerated wetness in the lower pressure turbine is not critical here since reasonable reheat temperatures push the expansion into the low-wetness region.

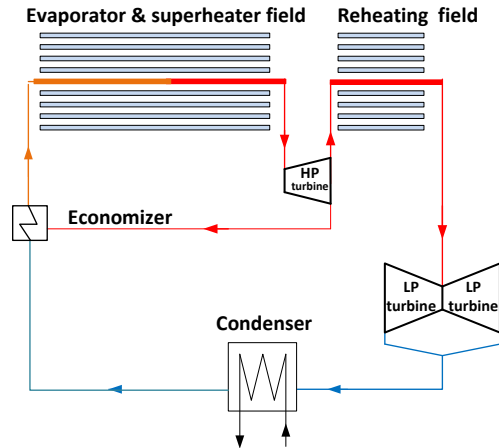

Fig. 2. Direct reheat configuration

### 2.3. Configuration with internal reheat

In order to avoid the pressure drop in the direct reheat configuration, an indirect reheat from the live steam itself can be chosen [9]. A fraction of the live steam is branched off before the HP turbine and used in a heat exchanger to reheat the steam leaving the HP turbine, see Fig. 3. Since the large fraction of enthalpy of the live steam is stored in form of latent heat of evaporation, the heating stream is de-superheated and fully condensed in the reheat heat exchanger. This has large impact on the possible reheat temperature which is now limited by the saturation temperature of the live steam. For 100 bar of live steam, this yields about 310 °C minus the temperature difference of the heat exchanger itself. Compared to the live steam temperatures in the range of 400 °C to 500 °C this is only a marginal reheat. Indeed, the motivation for this reheat solution is not to enhance the turbine efficiency by increasing the medium temperature level of heat supply, but the reduction of wetness in the last turbine stage. Although only small reheat temperatures are achieved, this approach offers much more flexibility in the selection of the steam parameters and, in consequence, the efficiency.

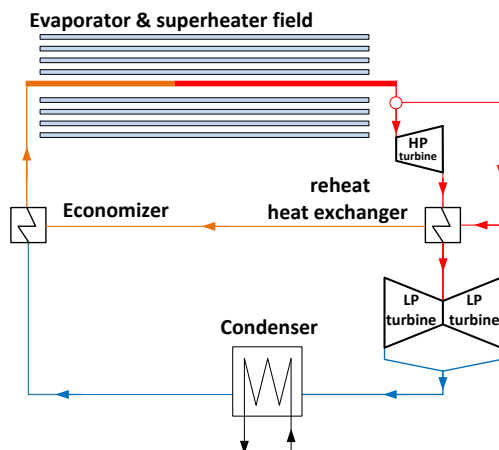

Fig. 3. Indirect reheat configuration

### 3. Systematic approach for power block modeling

Special care is spent on the selection of modelling assumptions in order to allow direct comparison of the different power cycles. Apart from the steam parameters (pressure and live steam), the efficiency of the power block is mainly determined by the isentropic efficiencies of the turbine stages, the chosen condenser pressure, and the design of the feed water pre-heating train. For configurations with reheat the selection of the reheat pressure has additional impact. The following sections will be used to describe those modelling assumptions. The condenser pressure is fixed to 52 mbar for all configurations. This is a value that can be obtained by a wet cooling tower together with an elaborate condenser like it is installed in ANDASOL 3.

The simulations are performed with the power plant simulation program *EpsilonProfessional* without consideration of the solar field. In all three configurations, the live steam mass flow is adapted to provide a constant power of 50 MW (gross). Each power block model, “without reheat”, “direct reheat” and “internal reheat”, is simulated with 11 different live steam pressures ranging from 50 to 150 bar with a step width of 10 bar and 4 different live steam temperatures 400 °C, 450 °C, 500 °C, and 550 °C. Thus, a total of 44 live steam pressure-temperature combinations are obtained. Table 1 recapitulates the most important simulation parameters.

Table 1. Simulation assumption

Assumed power block parameter		
Gross power	[MW]	50
Live steam pressure	[bar]	50, 60, 70, 80, 90, 100, 110, 120, 130, 140, 150
Live steam temperature	[°C]	400, 450, 500, 550
Condenser pressure	[mbar]	52
Min steam fraction	[%]	85
Isentropic efficiency		
First stage	[%]	0,70
Intermediate stage	[%]	0,9
Last stage	[%]	0,75

#### 3.1. Assignment of turbine isentropic efficiencies

The isentropic efficiency of the turbine stages has direct impact on the electric yield since it defines how close the real expansion is to the ideal of an isentropic expansion. For this study, we assume an isentropic efficiency of 90% for all turbine stages except the first and the last stage. In the first stage, additional throttling losses reduce the efficiency and we assume a value of 70%. The last stage of the low pressure turbine suffers from wetness and exhaust losses. We assume also a value of 75% for this stage. Although the isentropic efficiencies will vary slightly depending on the quality of the turbine and the position along the expansion curve, the chosen values appear to be reasonable related to power block configurations provided by manufacturers in various projects.

#### 3.2. Assignment of the turbine pressure levels

Given a certain live steam pressure and temperature, the efficiency of the power block can be improved by feed-water pre-heating. While from a thermodynamic point of view a large number of turbine extractions and corresponding feed water pre-heaters is beneficial, the final design has to take into account the costs of the installation and also turbine stage efficiencies. The assignment of the turbine pressures is thus an optimization problem.

According to different literature sources [10], [11], optimum extraction pressure levels can be chosen based on a homogeneous temperature rise over the pre-heaters. With this approach the exergetic losses in the feed-water pre-heaters are reduced to a minimum. For a system with  $n$  pre-heaters, the temperature rise over each pre-heater can be calculated from the condenser temperature  $T_{cond}$  to the boiling point of the live steam,  $T_{sat}$ , as

$$\Delta T_{opt} = \frac{T_{sat} - T_{cond}}{(n+1)} \quad (1)$$

The feed water outlet temperature  $T_i$  of each pre-heater is then given by

$$T_i = T_{cond} + i * \Delta T_{opt} \quad (2)$$

the pre-heating is mainly done by condensation of the extraction steam the turbine extraction pressures can be chosen based on the pre-heater outlet temperatures plus a temperature difference in the heat exchanger. Fig. 4 shows the chosen pressure distribution over the turbine stages for different live steam pressure. Note, that after the first turbine stage no steam is extracted for feed water pre-heating, thus the first active extraction has the pressure level indicated by the inlet pressure of turbine stage 3. The de-aerator is fed with the extraction steam after stage 5.

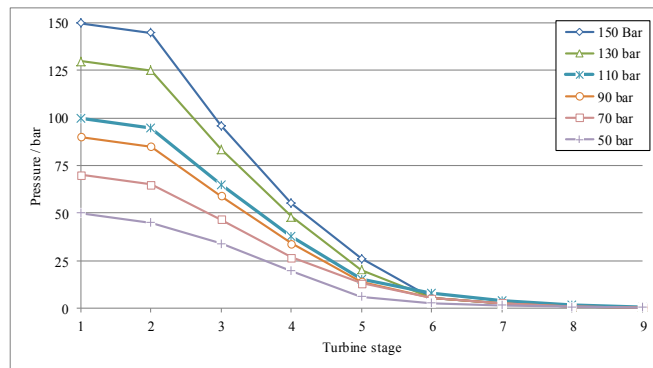

Fig. 4. Inlet pressure of turbine stages for different live steam pressure configurations

The figure shows that the pressure level of the de-aerator is high enough to allow deep part-load operation with a pressure above ambient. A variation of the pressure levels obtained with this approach has shown that the efficiencies are nearly at the optimum and thus the temperature based dimensioning yields reasonable results. Besides the pressure distribution inside the turbine, the approach also defines the final feed water temperature. Thus, the feed water temperature is different for each configuration. From a methodological point of view, this is beneficial since the focus is on the power block and not on the solar field. Thus, the approach gives the maximum efficiency of the power block for a given number of pre-heaters. In our case, the number of pre-heaters for all configurations is chosen as 6 (including the de-aerator).

### 3.3. Assignment of the reheat parameters

Although the approach presented in section 3.2 is applicable to the conventional pre-heaters it is not useful to fix the reheat pressure. The choice of the reheat pressure (if any reheat) is a compromise between power block efficiency and steam fraction in the last turbine stage. Regarding the efficiency, there is an optimum for the reheat pressure in the range between 20 and 25% of the live steam pressure [12]. If the reheat pressure is increased, the fraction of the reheat to the total heat input continuously decreases and thus the positive impact of the reheat is reduced and

converges towards the configuration without reheat for a reheat pressure approaching the live steam pressure. If the reheat pressure is decreased from the optimum point, the efficiency also goes down since the average temperature of the heat supply decreases and the additional heat is provided at low pressures. Besides the efficiency of the power block the choice of the reheat parameters is influenced also by the steam fraction in the last turbine stage. A low reheat pressure yields higher steam fractions. In the simulation, the reheat pressure is chosen in the optimum in terms of efficiency with the boundary condition that the wetness in the turbine should not exceed the tolerated value of 15%. Fig. 5 provides simulation results with a direct reheat power block model at 110 bar/550 °C illustrating the efficiency optimum and the impact on the wetness. In this case, the reheat pressure is chosen as 26% of the live steam pressure. No modification is necessary here since the steam fraction is within the tolerated range.

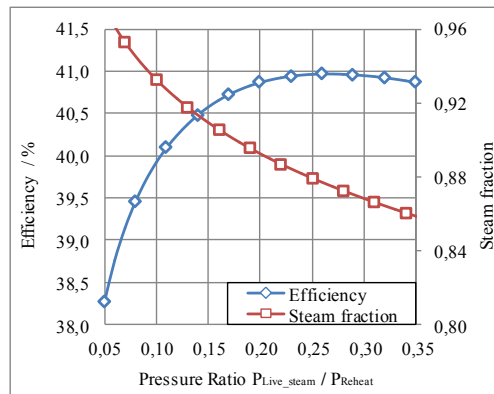

Fig. 5. Power block efficiency and steam fraction as a function of  $p_{reheat}/p_{live\ steam}$  for a direct reheat configuration (110 bar/550

The reheat temperature for the direct reheat configurations is chosen equal to the live steam temperature. For the internal reheat configuration, the reheat temperature is defined by the saturation temperature of the live steam minus 3 K for heat exchanger temperature difference.

#### 4. Reference configuration with oil as HTF

A power block with the characteristics of a conventional CSP plant using thermal oil as HTF (like ANDASOL 3 in Spain) is chosen as reference configuration. The simulation results of the DSG configurations will be compared with this benchmark. The live steam parameters of the reference configuration are set at 380 °C and 100 bars. All other power block parameters are chosen in the same way as described in chapter 3. The turbine pressure levels are chosen according to the feed-water temperature rise as described in the last chapter. The reheat pressure is chosen according to 32,7 bar. The resulting efficiency of the reference plant at the design point (380 °C/100 bar) is 39.5%. Although higher efficiency values are reported for the ANDASOL 3 plant the selection here is a conservative approach. The power block model has been compared to heat flow diagrams of turbine suppliers provided for similar configurations and the agreement is good.

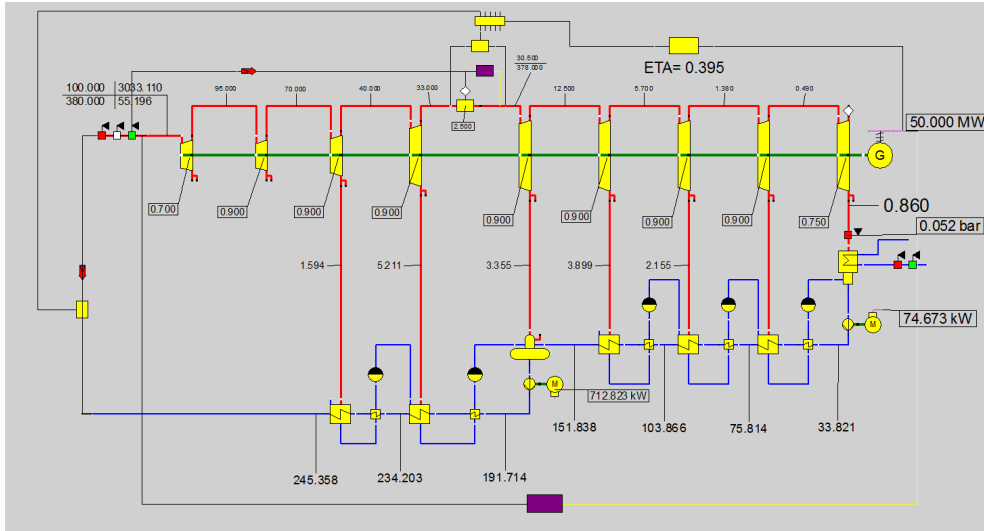

Fig. 6: Heat flow diagram of the oil based reference plant (only steam cycle)

## 5. Simulation results

### 5.1. Power block without reheat

The results from the simulation of the DSG power block without reheat are given in Fig. 7. It is found that the efficiency gain due to an increase in live steam temperature can be quantified as 1% each 75 °C for all live steam pressure. The efficiency gain gradient due to the increase of the live steam pressure is not constant and depends on the live steam pressure. For a 1% point increase in efficiency the live steam pressure has to be increased by ~11 bar at low pressure levels and ~20 bar for high pressure levels.

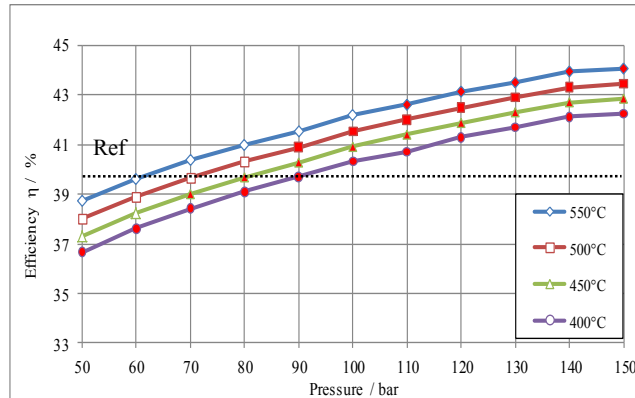

Fig. 7. Power block efficiency for the DSG power block without reheat as a function of live steam pressure and temperature (red filling indicates violation of the wetness limitation).



From a total of 44 live steam pressure-temperature combinations, only 12 meet the requirement on the minimal steam fraction. The valid operating points can be seen in the Fig. 7 on the left hand side while the points with wetness limit violation are marked with filled symbols. Higher temperature and lower pressure are desired to maintain a minimal steam fraction. Without exceeding the permissible wetness fraction, systems without reheat can be operated only with low pressure live steam which then limits the efficiency potential of the power block. To reach a first efficiency target of 41% (3,8% increase compared to the 39,5% of the oil power block) live steam parameters of 80 bar/550 °C are required. For a further increase to 42% live steam parameters have to be set to 110 bar/550 °C. Due to the wetness in the turbine, configurations with 500 °C are restricted to pressures below 90 bar which limits the efficiency to values below 41%. The benefit of the non-reheat configuration is the reduced complexity and investment cost. Together with the other DSG benefits a combination of 90 bar/500 °C can be interesting for a DSG plant.

### 5.2. Power block with internal reheat

In comparison to the configuration without reheat, the internal reheat shows lower efficiency values for the same live steam pressure and temperature. One reason for the difference is that the reheater operates with large exergetic losses. The other reason is the pressure drop in the reheater that reduces the available pressure at the inlet of the low pressure turbine. In the simulation, a pressure drop of 5 bar is assumed for all configurations (equal to the pressure drop in the direct reheat field). Sensitivity analyses on the pressure drop show the large impact on the efficiency. While a 120 bar/500 °C configuration has 41,1% efficiency at 5 bar pressure drop the efficiency is increased to 42,1% for a pressure drop of 0.

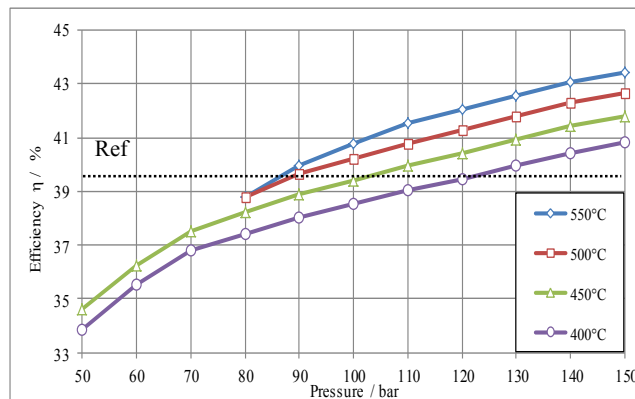

Fig. 8. Power block efficiency for the internal reheat configuration as function of the live steam pressure and temperature

For configurations with low pressure and high live steam temperature the reheat is no longer possible since the condensation temperature of the heating steam is below the steam temperature at the outlet of the turbine. Fig. 9 illustrates the corresponding T-s-diagram. The horizontal line indicates that there is no temperature rise in the reheater but still the pressure drop in the main steam line (which in this extreme case would be close to zero). The points not feasible for reheat are not shown in the diagram but they could well be operated with the non-reheat configuration.

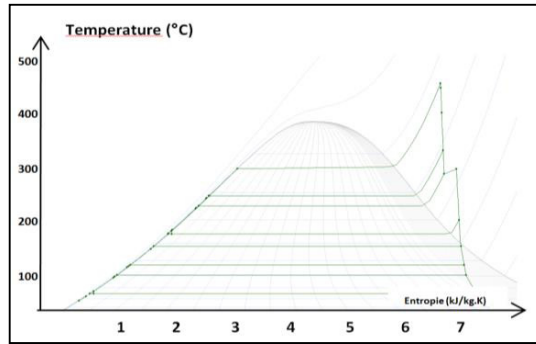

Fig. 9. Border case of internal reheat with saturation temperature equal to the reheat temperature

5.3. Power block with direct reheat

The simulation results for the direct reheat configuration are shown in Fig. 10. The shape of the curve shows similarities with the other configurations. The efficiency gain gradient due to the increase of the live steam pressure is higher for low pressure than for high pressure. All the 44 simulations points fulfill the requirements on the steam fraction. When comparing with the internal reheat curves, the difference of the thermal reheat can be estimated. Both configurations work with a pressure drop of 5 bar in the reheater so the difference between the curves originates from the different reheat temperature. While for the internal reheat a temperature close to the live steam condensation temperatures is reached, the direct reheat assumes the reheat up to live steam temperature. The benefit of the direct reheat configuration is that the live steam parameters can be chosen in order to yield high efficiency values independent of the wetness in the low pressure turbine. Fig. 11 shows the same configuration with a pressure drop of 10 bar in the reheater. In this case, the efficiency values are below those of the internal reheat configuration and one would probably select the internal reheat option. Further studies have to reveal under which conditions low pressure drops of about 5 bar can be realized in a reheater solar field.

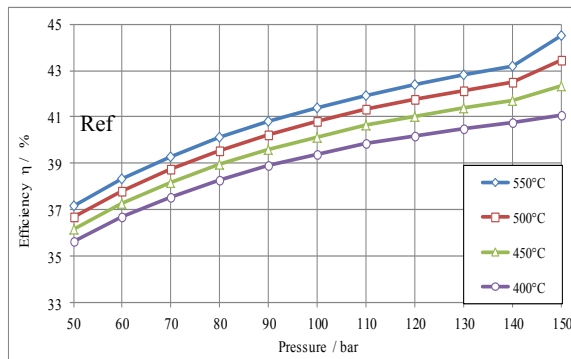

Fig. 10. Power block efficiency for the direct reheat with 5 bar pressure drop as a function of the live steam pressure and temperature

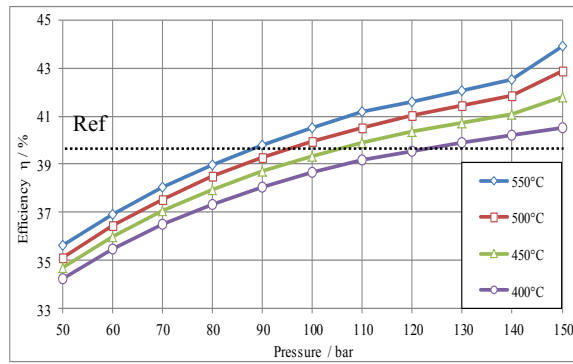

Fig. 11. Power block efficiency for the direct reheat with 10 bar pressure drop as a function of the live steam pressure and temperature

Table 2 summarizes possible DSG live steam parameter combinations for three efficiency targets of 41%, 42%, and 43%. The data clearly show that the non-reheat configuration requires very high steam temperatures of 550 °C in order to reach the efficiency targets of 41% or 42%. In contrast, the internal reheat offers potential to higher efficiencies at moderate steam parameters. Nevertheless, the 43% are only reached with challenging steam parameters of 140 bar/550 °C. The direct reheat configuration with low pressure drop in the reheat field clearly offers the most attractive steam parameters. However, it is doubtful if such low pressure drops can finally be realized. In case the pressure drop increases to 10 bar, similar performance can be obtained with the internal reheat configuration at lower steam parameters.

Table 2. Overview on possible DSG power block configurations

Efficiency target (Increase to ref.)	Without reheat	Internal reheat	Direct reheat	
			ΔP 5 bar	ΔP 10 bar
41% (+3,8%)	80 bar/ 550°C	100 bar/ 550°C	90 bar/ 550°C	110 bar/ 550°C
		115 bar/ 500°C	115 bar/ 500°C	120 bar/ 500°C
		130 bar/ 450°C	120 bar/ 450°C	140 bar/ 450°C
			150 bar/ 400°C	
42% (+6,3%)	100 bar / 550°C	120 bar/ 550°C	110 bar/ 550°C	130 bar/ 550°C
		135 bar/ 500°C	130 bar/ 500°C	145 bar/ 500°C
			145 bar/ 450°C	
43% (+8,9%)		140 bar/ 550°C	140 bar/ 550°C	145 bar/ 550°C
			145 bar/ 500°C	150 bar/ 500°C

Since the presented study is focused on the power block only, the results cannot directly be transferred to the performance of the whole system. Configurations with high steam parameters have elevated heat losses in the field and are more costly in the receiver and piping structure. Nevertheless, the results give valuable information on the selection of appropriate DSG power blocks and the efficiency gains that can be expected compared to the oil reference case. Although the absolute numbers of turbine efficiencies will be adapted for a concrete project, the relative values given in this study will not be affected significantly.

## 6. Conclusion

A systematic study on power block efficiencies for direct steam generation systems is presented. The major difference to a power block of an oil based plant is the implementation of the reheat. A DSG configuration without reheat is strongly limited in the choice of the live steam parameters while the configuration with internal reheat can be applied to a large range of operating conditions. The configuration with a reheat directly in the solar field offers some potential in efficiency in case low pressure drops in the reheat field can be realized. Overall, the results show, that a relative increase of about 4% in gross power block efficiency can be realized with steam parameters that are manageable today. A further increase in efficiency is possible although this requires ambitious steam parameters (either pressures above 120 bar or temperatures above 500 °C). Consecutive studies are required to interpret the results in the context of a whole DSG plant.

## Acknowledgements

The authors would like to thank the German Ministry for the Environment, Nature Conservation and Nuclear Safety for the financial support given to the OPTINEL project under contract No. 0325144B.

## References

- [1] Krüger, D., Krüger, J., Pandian, Y., et al., 2012, "Experiences with Direct Steam Generation at the Kanchanaburi Solar Thermal Power Plant," 18th SolarPACES Conference, Marrakech, Morocco.
- [2] Mertins, M., Link, E., Tschache, M., et al., 2012, "Experiences of operation of 30 MW solarthermal power station based on Fresnel collector technology," SolarPACES 2012 conference, Marrakech, Morocco.
- [3] Osuna, R., Fernández-Quero, V., and Sánchez, M., 2008, "Plataforma Solar Sanlucar la Mayor: The Largest European Solar Power Site," 14th Biennial SolarPACES Symposium, Las Vegas.
- [4] Eck, M., Eickhoff, M., Feldhoff, J. F., et al., 2011, "Direct Steam Generation in parabolic troughs at 500°C - First results of the REAL-DISS project," 17th SolarPACES, Granada, Spain.
- [5] Novatec Solar, 2011, "Press release: Novatec Solar's Fresnel collector generates superheated steam above 500°C," 2011-09-11.
- [6] Feldhoff, J. F., Benitez, D., Eck, M., et al., 2010, "Economic Potential of Solar Thermal Power Plants With Direct Steam Generation Compared With HTF Plants," *Journal of Solar Energy Engineering*, 132 (4), pp. 041001-9.
- [7] Feldhoff, J. F., Schmitz, K., Eck, M., et al., 2012, "Comparative system analysis of direct steam generation and synthetic oil parabolic trough power plants with integrated thermal storage," *Solar Energy*, 86 (1), pp. 520-530.
- [8] Fluri, T. P., Lude, S., Lam, J., et al., 2012, "Optimization of life steam parameters for a Linear Fresnel power plant," SolarPACES 2012 conference, Marrakech, Morocco.
- [9] Birnbaum, J., Eck, M., Fichtner, M., et al., 2010, "A Direct Steam Generation Solar Power Plant With Integrated Thermal Storage," *Journal of Solar Energy Engineering*, 132 (3), pp. 031014-1 - 031014-5.
- [10] Franze, H.G., *Die numerische Berechnung der Dampfkreisläufe von Kernkraftwerken*, Report, Kernforschungszentrum Karlsruhe, Karlsruhe, 1968 (in German)
- [11] Weston K.C, *Energy conversion-The ebook*, <http://www.personal.utulsa.edu/~kenneth-weston/>
- [12] Strauß, K., *Kraftwerkstechnik*, 5<sup>th</sup> edition, Springer, Berlin, 2006 (in German).