



## Gauge/gravity duality beyond the planar limit

Brown, TW

The copyright of this thesis rests with the author and no quotation from it or information derived from it may be published without the prior written consent of the author

For additional information about this publication click this link.

<https://qmro.qmul.ac.uk/jspui/handle/123456789/416>

Information about this research object was correct at the time of download; we occasionally make corrections to records, please therefore check the published record when citing. For more information contact [scholarlycommunications@qmul.ac.uk](mailto:scholarlycommunications@qmul.ac.uk)

# Gauge/Gravity Duality Beyond the Planar Limit

by

**T.W. Brown\***

A report presented for the examination  
for the transfer of status to the degree of  
Doctor of Philosophy of the University of London.

Thesis Supervisor  
Dr. S. Ramgoolam

*Centre for Research in String Theory  
Department of Physics  
Queen Mary, University of London  
Mile End Road, London E1 4NS, UK*

\**t.w.brown@qmul.ac.uk*

# Abstract

One of the most exciting and successful ideas pursued in string theory is gauge/gravity duality. We consider the example of the AdS/CFT correspondence, which maps maximally supersymmetric Yang-Mills ( $\mathcal{N} = 4$  SYM) in four dimensions with gauge group  $U(N)$  to closed strings propagating in a background of Anti de Sitter space crossed with a sphere ( $AdS_5 \times S^5$ ). Much progress has been made understanding this duality in the planar 't Hooft limit, where we fix the coupling of the gauge theory  $\lambda$  and take  $N$  large. On the gravity side the string coupling  $g_s$  is proportional to  $1/N$  for fixed  $\lambda$ , so in this limit we get classical string theory.

In this thesis we use symmetric group methods to study the AdS/CFT correspondence exactly at finite  $N$ , without taking the planar limit. This takes the string theory into the quantum regime and allows us to probe phenomena which are non-perturbative in  $g_s$ .

First we enumerate the spectrum. While the spectrum is non-trivial in the planar limit, it is further complicated at finite  $N$  by the Stringy Exclusion Principle, which truncates the usual trace spectrum. We organise local operators in the gauge theory using representations of the gauge group  $U(N)$ , which for heavy operators are interpreted in terms of giant graviton branes in the bulk. To do this we sort the different fields of the theory into representations of the global superconformal symmetry group using Schur-Weyl duality. We then compute two- and three-point functions of these operators exactly to all orders in  $N$  for the free theory and at one loop. We use these correlation functions to resolve certain transition probabilities for giant gravitons using CFT factorisation.

## Contents

<b>1</b>	<b>Introduction</b>	<b>8</b>
<b>2</b>	<b>Background</b>	<b>11</b>
2.1	The $\mathcal{N} = 4$ supersymmetric Yang-Mills Lagrangian . . . . .	11
2.2	Correlation functions . . . . .	11
2.3	Global symmetry group and classification of multiplets . . . . .	12
2.4	AdS/CFT correspondence . . . . .	13
2.4.1	The planar limit . . . . .	13
2.4.2	Free field theory limit . . . . .	14
2.5	Schur-Weyl duality . . . . .	14
2.6	The half-BPS $U(1)$ sector . . . . .	15
2.6.1	Giant gravitons and the stringy exclusion principle . . . . .	16
2.7	Schur polynomials . . . . .	17
2.7.1	Extremal three-point functions . . . . .	20
2.7.2	Free fermions and geometry . . . . .	20
2.7.3	The dual basis . . . . .	20
2.8	Black holes . . . . .	21
2.9	Quantum deformations of spacetime . . . . .	22
<b>3</b>	<b>Summary</b>	<b>23</b>
<b>4</b>	<b>Free theory spectrum</b>	<b>24</b>
4.1	$U(K)$ . . . . .	24
4.1.1	Covariant operators . . . . .	24
4.1.2	Detail of SW map . . . . .	27
4.1.3	Invariant operators . . . . .	30
4.1.4	Schur polynomials in half-BPS case . . . . .	31
4.1.5	Invertibility . . . . .	31
4.1.6	Diagonality . . . . .	31
4.1.7	Finite $N$ counting . . . . .	33
4.2	Including fermions: $U(K_1 K_2)$ . . . . .	36
4.2.1	Single fermion . . . . .	38
4.3	Schur-Weyl duality for a general group . . . . .	38
4.3.1	$G$ versus $U(\infty)$ . . . . .	40
4.3.2	Properties of Clebsch-Gordan coefficient for general $G$ . . . . .	40
4.3.3	Fields carrying reps of product groups . . . . .	41
4.3.4	Product Clebsch in terms of single group Clebschs . . . . .	41
4.3.5	Invariant operators . . . . .	42
4.3.6	Diagonality . . . . .	43
4.3.7	Finite $N$ counting . . . . .	45

4.4	$SL(2)$ . . . . .	46
4.4.1	Oscillator construction . . . . .	46
4.4.2	$S_n$ action on the oscillators . . . . .	48
4.4.3	Metric and diagonality . . . . .	50
4.4.4	Multiplicity . . . . .	51
4.5	$SO(2, 4)$ . . . . .	52
4.6	$SO(6)$ . . . . .	53
4.7	The higher spin group . . . . .	54
4.8	Matrix models for free theory . . . . .	54
4.9	Worldvolume excitation of giant gravitons . . . . .	55
4.9.1	Worldvolume excitations: review and comments . . . . .	55
4.9.2	Comparison to gauge invariant operators . . . . .	57
4.9.3	Comments . . . . .	59
<b>5</b>	<b>Mixing at one loop</b> . . . . .	<b>61</b>
5.1	The $U(2)$ subsector . . . . .	61
5.2	$U(2)$ Dilatation operator . . . . .	62
5.3	$U(2)$ One-loop correlator . . . . .	64
5.4	Operator mixing . . . . .	65
5.4.1	Dilatation operator . . . . .	69
5.5	Higher loops . . . . .	69
5.6	One-loop mixing for general $\mathcal{N} = 4$ operators . . . . .	70
<b>6</b>	<b>BPS operators</b> . . . . .	<b>73</b>
6.1	Introduction . . . . .	73
6.2	BPS operators from the dual basis . . . . .	75
6.3	The chiral ring and partition algebras . . . . .	76
6.3.1	Counting at finite $N$ . . . . .	77
6.3.2	Check of counting for half-BPS operators . . . . .	79
<b>7</b>	<b>Three-point function and OPE</b> . . . . .	<b>80</b>
7.1	Introduction . . . . .	80
7.2	Extremal three-point function for $U(3)$ . . . . .	80
7.3	‘Basic’ three-point function for $SO(6)$ . . . . .	81
7.4	Non-extremal three-point function for $SO(6)$ . . . . .	82
7.5	Extension to $SO(2, 4)$ . . . . .	84
7.6	At 1-loop . . . . .	84
<b>8</b>	<b>Correlators, topologies and probabilities</b> . . . . .	<b>85</b>
8.1	Introduction . . . . .	85
8.2	Statement of the puzzle . . . . .	86
8.3	From factorization to probability interpretation of correlators . . . . .	87

8.3.1	Factorization on $S^4$ and probabilities . . . . .	87
8.3.2	Higher topology and multi-particle normalization . . . . .	89
8.4	Factorization in the 4D CFT . . . . .	90
8.4.1	Introduction . . . . .	90
8.4.2	Metric . . . . .	91
8.4.3	The genus zero factorization in four dimensions . . . . .	92
8.4.4	The genus one factorization in four dimensions . . . . .	92
8.4.5	The genus one factorization and inequality . . . . .	93
8.4.6	The correlator on $S^3 \times S^1$ . . . . .	94
8.4.7	The Inequality . . . . .	97
8.4.8	Probability interpretation in the large $T$ limit . . . . .	99
8.5	Results for probabilities . . . . .	99
8.5.1	$G = 0$ factorization . . . . .	100
8.5.2	$G = 1$ factorization . . . . .	101
8.5.3	Higher genus factorization . . . . .	103
8.6	Bulk interpretation of the gluing properties of correlators . . . . .	104
8.6.1	Introduction . . . . .	104
8.6.2	Bulk geometries for $\Sigma_4(n - 1)$ boundary from Witten graphs . . . . .	105
<b>9</b>	<b>From <math>U(N)</math> to <math>SU(N)</math> gauge group</b> . . . . .	<b>109</b>
9.1	Introduction . . . . .	109
9.2	$U(N)$ summary . . . . .	110
9.3	$SU(N)$ summary . . . . .	112
9.4	$SU(N)$ details . . . . .	115
9.5	Factorisation and probabilities for $SU(N)$ . . . . .	117
9.6	Diagonalisation by higher Hamiltonians . . . . .	119
<b>10</b>	<b>Conclusion</b> . . . . .	<b>122</b>
<b>A</b>	<b>Key</b> . . . . .	<b>125</b>
<b>B</b>	<b>Symmetric group formulae</b> . . . . .	<b>125</b>
B.1	Conjugacy classes of the symmetric group . . . . .	126
B.2	States and standard Young tableaux . . . . .	127
B.3	Dimensions . . . . .	127
B.4	Representing matrices . . . . .	128
B.5	Characters . . . . .	128
B.6	Tensor products . . . . .	129
B.7	Clebsch-Gordan coefficients . . . . .	129
B.8	The outer product and branching . . . . .	130
B.9	Explicit construction of the orthogonal matrices . . . . .	131
B.9.1	Further analysis of the matrices . . . . .	131

B.10	The natural and hook representations . . . . .	132
B.10.1	The natural representation . . . . .	132
B.10.2	Characters of natural rep . . . . .	133
B.10.3	Tensor products of the natural rep . . . . .	133
<b>C</b>	<b>General linear and unitary group formulae</b>	<b>134</b>
C.1	Semi-standard Young tableaux . . . . .	134
C.2	Dimensions . . . . .	135
C.3	Characters . . . . .	136
C.3.1	Schur polynomials of eigenvalues . . . . .	136
C.4	Tensor products . . . . .	136
C.5	Schur-Weyl duality for $U(2)$ . . . . .	137
C.6	Young symmetrisers and projectors . . . . .	138
<b>D</b>	<b>Diagrammatics</b>	<b>138</b>
<b>E</b>	<b><math>U(2)</math> <math>\Lambda = [2, 2]</math> example operators and two-point functions</b>	<b>139</b>
<b>F</b>	<b>Generating functions for <math>SL(2) \times S_n</math> multiplicity</b>	<b>140</b>
F.1	Examples of symmetric and antisymmetric $S_n$ irreps . . . . .	140
F.2	The generating function for any $SL(2) \times S_n$ irreps . . . . .	141
<b>G</b>	<b><math>U(K)</math> Clebsch-Gordan orthogonality proof</b>	<b>142</b>
<b>H</b>	<b>Calculating branching coefficients</b>	<b>143</b>
H.1	Highest weight case . . . . .	143
H.2	All fields different case . . . . .	143
H.3	$\Lambda = [2, 1]$ . . . . .	143
H.4	$\Lambda = [3, 1]$ . . . . .	144
<b>I</b>	<b>Action on hook basis in detail</b>	<b>144</b>
<b>J</b>	<b>Code</b>	<b>145</b>

**List of Tables**

1	The operators for $n = 4$ and the conjugacy classes of $S_4$ . . . . .	17
2	Key. . . . .	125

**List of Figures**

1	A trace operator in diagrammatic notation. . . . .	18
2	Correlation function of two Schur polynomials. . . . .	19
3	Super-Young tableau. . . . .	37
4	A planar one-loop diagram. . . . .	61
5	The action of part of the dilatation operator on two sites. . . . .	63
6	An extra index gives $N$ enhancement. . . . .	65
7	One-loop correlator. . . . .	65
8	A sphere correlator by gluing two spheres. . . . .	88
9	A torus correlator by gluing two spheres. . . . .	90
10	Graph demonstrating probability inequality. . . . .	99
11	Disconnected graph associated with two insertions on the boundary $S^4$ . . . . .	106
12	Neighborhood of the disconnected graph $G_1$ . . . . .	106
13	Gluing two copies of the $B^5$ with graph neighborhood removed. . . . .	107
14	Connected graph $G_2$ in $B^5$ associated with two insertions on $S^4$ . . . . .	107
15	Neighborhood of the connected graph $G_2$ of topology $B^4 \times I$ . . . . .	108
16	Gluing two copies of the $B^5$ with graph neighborhood removed. . . . .	108
17	The elbow line for the box $(1, 2)$ gives a hook length of 3. . . . .	127
18	A Young diagram with the hook length of each box displayed. . . . .	127
19	Restriction pattern for $S_{n+1} \rightarrow S_n \rightarrow S_{n-1}$ . . . . .	132
20	A Young diagram with the weight of each box displayed. . . . .	135
21	From delta functions to diagrams to permutations. . . . .	138
22	Permutations in series; thick lines represent many strands. . . . .	138
23	Permutations on the upper index. . . . .	139



## 1 Introduction

Two of the most important unsolved problems in theoretical physics are understanding non-perturbative gauge theory and the quantisation of gravity. Gauge/gravity duality intimately connects both of these issues. In its most concrete incarnation, the AdS/CFT correspondence, it maps  $\mathcal{N} = 4$  supersymmetric Yang-Mills ( $\mathcal{N} = 4$  SYM) in four dimensions, a conformal field theory, to closed strings propagating in a background of Anti de Sitter space crossed with a sphere ( $AdS_5 \times S^5$ ). The theory of closed strings is a quantum theory of gravity. This duality is powerful because when the quantum gravity theory is strongly coupled, and hence difficult to calculate with, the gauge theory is weakly coupled and therefore perturbatively accessible. Similarly non-perturbative features of the Yang-Mills theory can be seen from weakly-coupled gravity. The goal of this thesis is to understand the weakly-coupled gauge theory so that we may gain a handle on gravity when it is strongly quantum.

The quantum description of the interactions of elementary particles has culminated in the Standard Model. The electromagnetic and weak forces combine into the electroweak force, which is described by an  $SU(2) \times U(1)$  gauge theory. The Higgs mechanism spontaneously breaks this symmetry down to electromagnetic  $U(1)$  gauge theory at low energies. The strong force is also a gauge theory, called quantum chromodynamics (QCD) with gauge group  $SU(3)$ . The behaviour of this theory is also highly dependent on energy scale: at low energies the theory is strongly coupled, while at high energies the coupling runs to zero. This phenomenon is known as asymptotic freedom. The colour-charged quarks of the theory exhibit confinement: the force between them does not diminish with distance, so they are always bound into colour-neutral hadrons.

Strongly-coupled gauge theories are not easily accessible either perturbatively or analytically; one must discretise spacetime on a lattice and use computers to approximate the path integral, using methods due to Wilson [1]. An alternative approach due to 't Hooft [2] is to allow the number of colours of the gauge group  $SU(N)$  to become large and then to expand in  $\frac{1}{N}$ . The gauge theory simplifies and exhibits string-like behaviour. The Feynman diagrams organise themselves into an expansion in topologies of the two-dimensional surfaces on which the diagrams can be written. The genus expansion is ordered by powers of  $1/N^{2h-2}$  according to the number of handles  $h$  of the 2d surface, just like a string genus expansion.

't Hooft's prescription does not explain how to build the string theory corresponding to the gauge theory expansion. Further developments in string theory were needed.

Bosonic string theory was initially developed to explain the strong force. Instead of point particles and a perturbative expansion of amplitudes in terms of Feynman diagrams, in string theory the fundamental constituents are 1-dimensional and the first-quantised theory is expanded in 2-dimensional worldsheets of different topology, ordered by the string coupling. As a theory of the strong force this model made predictions that

contradicted experiments and it was superseded by QCD. However it was soon noticed that the spectrum of closed strings includes the spin-2 graviton. As a theory of quantum gravity string theory was given a huge boost by the introduction of supersymmetry, which was more consistent than the purely bosonic model and allowed fermions in the spectrum. In fact there are only a few consistent superstring theories: Type I, Type IIA, Type IIB and the heterotic string with  $SO(32)$  or  $E_8 \times E_8$  symmetry.

In the meantime techniques for large  $N$  expansions of gauge theories advanced. Symmetric group techniques for expanding lattice sums in terms of representations of the gauge group were used by Gross to study the expansion of 2d  $U(N)$  Yang-Mills as a string theory [3, 4], see [5] for a review. The symmetric group data appearing in the  $1/N$  expansion were interpreted in terms of branched covers of the original 2d surface.

Further gauge/gravity dualities awaited the Second String Revolution in the mid-Nineties. In 1995 Witten proposed a non-perturbative 11-dimensional theory called M-theory with M2- and M5-brane excitations that reduces to the various superstring theories in certain limits, as well as reducing to 11-dimensional supergravity. Later in the same year it was clarified that open strings can end on extended objects called ‘‘D-branes’’, which are non-perturbative in the string coupling. D-branes have a dual description in terms of closed strings and their low-energy limit gives  $p$ -branes, already studied as the sources for the Ramond-Ramond fields in supergravity [6]. The duality relies on the dual interpretation of the string cylinder diagram, either as an open string loop diagram or as the exchange of a closed string between the branes. This open/closed duality was a prototype for many further examples of gauge/gravity duality.

An important feature of D-brane physics is the appearance of non-Abelian gauge theories on coincident branes. The transverse positions of the branes are given by the matrix-valued scalars (valued in the adjoint of the gauge group), which naturally gives rise to non-commutative geometry. Matrix gauge/gravity dualities soon followed with the appearance of the BFSS model [7], which sought to describe M-theory in terms of the matrix quantum mechanics of a large number of D0-branes. It led to matrix theories for IIA [8] and IIB string theory [9] and the heterotic string [10].

Before these matrix theory results, D-brane constructions had been used to give a microscopic origin for the Bekenstein-Hawking entropy of certain highly symmetric black holes in 5-dimensional spacetime [11]. In studying such constructions of extremal black holes from D-branes, Maldacena made a conjecture that is one of the most celebrated examples of gauge/gravity duality. By examining the low energy limit of a system of  $N$  D3-branes from two different perspectives, he suggested that  $\mathcal{N} = 4$  super Yang-Mills in 4-dimensions, the low energy limit of the worldvolume theory of the D3-branes, was exactly dual to strings on  $AdS_5 \times S^5$ , the near horizon limit of the black branes [12]. The local operators of the gauge theory and their correlation functions map to string states and collision processes in the ‘bulk’  $AdS_5$  [13, 14]. The difference in dimensionalities of the two theories is understood in the framework of holography [15, 16, 17]. The duality is a strong-weak duality because when the ‘t Hooft coupling  $\lambda$  of the gauge

theory is large the string coupling  $\alpha' \sim \frac{1}{\sqrt{\lambda}}$  is small, suppressing string corrections to supergravity. In addition we can take a large number  $N$  of branes so that the string coupling  $g_s \sim \frac{\lambda}{N}$  is suppressed. This gives the weakest form of the Maldacena conjecture: classical supergravity on  $AdS_5 \times S^5$  is dual to large  $N$  strongly-coupled  $\mathcal{N} = 4$  SYM.

In this thesis we apply the symmetric group methods developed in lattice theory and 2-dimensional Yang-Mills to organise local operators and compute their correlation functions in the  $AdS_5/CFT_4$  correspondence when  $N$  is finite. On the bulk side this is equivalent to probing the string theory when the coupling  $g_s$  is non-vanishing. We see non-perturbative objects such as giant graviton branes and this gives us the tools to study black holes and their entropy in the gravity theory. We completely solve the tensionless string [18].

This programme was first carried out by Corley, Jevicki and Ramgoolam in [19] for the half-BPS operators constructed in the gauge theory from a single complex matrix. The new results presented here extend this work to multi-matrix operators constructed from all the fields of  $\mathcal{N} = 4$  SYM. We organise the local operators into representations of the bosonic subgroup  $SO(2, 4) \times SO(6)$  of the global superconformal symmetry group  $PSU(2, 2|4)$  and into representations of the gauge group  $U(N)$ . This simply implements the Stringy Exclusion Principle, which puts bounds on the types of operators one can build in Yang-Mills. We also extend this analysis to  $SU(N)$  gauge group for the half-BPS case.

With the operators organised in terms of symmetry groups and the permutation group, we compute the exact zero-coupling two-point function to all orders in  $N$  and we find it is diagonal, just as it was for the half-BPS sector [19]. The zero-coupling three-point function is expressed very simply in terms of representation fusion coefficients. The mixing at 1-loop, a new feature for the multi-matrix sector, is highly constrained.

These gauge theory results make possible the analysis of non-BPS excitations of giant gravitons. We can also use them to define new types of probability measures for transition processes between giant gravitons, using correlation functions on ‘higher genus’ four-dimensional manifolds.

All these methods are generally applicable to systems with matrix degrees of freedom, so we hope they will be used for much fruitful future research in gauge theories and matrix models. Schur-Weyl duality is an active area of mathematical research, and our techniques should find use not only in the mathematics but also their applications to integrable systems and discrete statistical models.

## 2 Background

### 2.1 The $\mathcal{N} = 4$ supersymmetric Yang-Mills Lagrangian

$\mathcal{N} = 4$  supersymmetric Yang-Mills in 4 spacetime dimensions is a special theory because the  $\beta$ -function vanishes, thus preserving conformal invariance into the quantum regime. The conformal group in a Lorentzian signature is  $SO(2, 4)$ ; in addition there is a global  $R$ -symmetry  $SU(4)_R \cong SO(6)_R$  that rotates the supercharges.

The  $\mathcal{N} = 4$  multiplet consists of a vector boson  $A_\mu$ , 6 real scalar bosons  $\phi^i$  transforming in the fundamental of  $SO(6)_R$  and 4 fermions  $\lambda_a$  transforming in the fundamental of  $SU(4)_R$ . All the fields must transform in the adjoint representation of the gauge group, which we will take initially to be  $U(N)$ .

The Lagrangian for  $\mathcal{N} = 4$  super-Yang Mills theory in four dimensions is unique and given by [20]

$$\begin{aligned} \mathcal{L} = \text{tr} \left\{ & -\frac{1}{2g^2} F_{\mu\nu} F^{\mu\nu} + \frac{\theta_I}{8\pi^2} F_{\mu\nu} \tilde{F}^{\mu\nu} - \sum_a i \bar{\lambda}^a \bar{\sigma}^\mu D_\mu \lambda_a - \sum_i D_\mu \phi^i D^\mu \phi^i \right. \\ & \left. + \sum_{a,b,i} g C_i^{ab} \lambda_a [\phi^i, \lambda_b] + \sum_{a,b,i} g \bar{C}_{iab} \bar{\lambda}^a [\phi^i, \bar{\lambda}^b] + \frac{g^2}{2} \sum_{i,j} [\phi^i, \phi^j]^2 \right\} \end{aligned} \quad (1)$$

where  $g$  is the real coupling and  $\theta_I$  is the real instanton angle. The constants  $C_i^{ab}$  and  $C_{iab}$  are related to the Clifford Dirac matrices for  $SO(6)_R \sim SU(4)_R$ . The covariant derivative is given by  $D_\mu = \partial_\mu - igA_\mu$ ,  $D_\mu \phi^i = \partial_\mu \phi^i - ig[A_\mu, \phi^i]$ ,  $F_{\mu\nu} = \partial_\mu A_\nu - \partial_\nu A_\mu - ig[A_\mu, A_\nu]$ .

The moduli space is found by minimising the scalar potential  $[\phi^i, \phi^j]^2$ . This requires the six matrices to commute and hence the moduli space  $(\mathbb{R}^6)^N / S_N$  is characterised by their eigenvalues up to permutation by  $S_N$ , the remnant of the gauge group  $U(N)$ .

In  $\mathcal{N} = 1$  language the  $\mathcal{N} = 4$  multiplet breaks into one vector multiplet and three chiral multiplets. The six real scalars of  $\mathcal{N} = 4$  combine into three complex scalars

$$X = \phi^1 + i\phi^2 \quad Y = \phi^3 + i\phi^4 \quad Z = \phi^5 + i\phi^6 \quad (2)$$

This splits the fundamental  $\mathbf{6}$  of  $SO(6)$  into a  $\mathbf{3}$  and  $\bar{\mathbf{3}}$  of  $U(3) \subset SU(4)$ .

### 2.2 Correlation functions

One way to get observables from the theory is to compute correlation functions of local operators. Gauge-invariant local operators are constructed by multiplying the normal-ordered products of the field matrices together and taking traces

$$\mathcal{O}(x) = \text{tr}(: W_{m_1}(x) W_{m_2}(x) \cdots W_{m_n}(x) :) \quad (3)$$

Here the  $W_{m_i}$  represent any of the fields of  $\mathcal{N} = 4$ , including their derivatives. We may also take multiple traces at the same spacetime point.

Correlation functions are then computed perturbatively using the Feynman rules derived from the Lagrangian (1). Although we will mostly be concerned with the combinatorics of correlation functions of the free theory, when  $g = 0$ , we will also consider 1-loop corrections to this in Section 5.3. Even though the  $\beta$ -function of  $\mathcal{N} = 4$  vanishes, infinities still arise in correlation functions that require renormalisation. Indeed the dimensions of many operators become anomalous in the quantum theory, and diagonalising the spectrum at higher loops is a major goal of current research.

One simplification in a conformal theory is that the two- and three-point functions are constrained by the conformal symmetry. For Lorentz-invariant operators the two-point function must be of the form

$$\langle \mathcal{O}_A(x) \mathcal{O}_B(y) \rangle \equiv \mathcal{G}_{AB} = \frac{G_{AB}}{|x - y|^{\Delta_A + \Delta_B}} \quad (4)$$

The scaling dimensions  $\Delta$  may be functions of  $g$  and  $N$ .

The three-point function is also determined by conformal invariance

$$\langle \mathcal{O}_A(x) \mathcal{O}_B(y) \mathcal{O}_C(z) \rangle \equiv \mathcal{C}_{ABC} = \frac{C_{ABC}}{|x - y|^{\Delta_A + \Delta_B - \Delta_C} |y - z|^{\Delta_B + \Delta_C - \Delta_A} |z - x|^{\Delta_C + \Delta_A - \Delta_B}} \quad (5)$$

This then allows us to find the operator product expansion (OPE)

$$\mathcal{O}_A(x) \mathcal{O}_B(y) \sim \sum_D C_{AB}^D \mathcal{O}_D(y) |x - y|^{\Delta_D - \Delta_A - \Delta_B} = \sum_D C_{AB}^D \mathcal{O}_D(y) \quad (6)$$

where the OPE coefficients are related to those of the three-point function with the inverse  $\mathcal{G}^{AB}$  of the two-point function propagator  $\mathcal{G}_{AB}$

$$C_{AB}^D = C_{ABC} \mathcal{G}^{CD} \quad (7)$$

Once we have the OPE we can determine the singularity structure of higher-point functions, whose spacetime dependence is not fixed by conformal symmetry.

### 2.3 Global symmetry group and classification of multiplets

The bosonic global symmetries of  $\mathcal{N} = 4$  SYM are the  $R$ -symmetry  $SU(4)_R$  and the conformal symmetry  $SO(2, 4)$  (whose algebra is listed later in equation (151)). In addition there are fermionic symmetries: the Poincaré supersymmetries  $Q_\alpha^a$  and  $\bar{Q}_{\dot{\alpha}a}$  which rotate fermions to bosons, and vice-versa, and the conformal supersymmetries  $S_{\alpha a}$  and  $\bar{S}_{\dot{\alpha}a}$ . These combine into the supergroup  $PSU(2, 2|4)$ .

To build representations the generators of  $psu(2, 2|4)$  divide into a Cartan subalgebra and raising and lowering operators. ‘Highest-weight’ or ‘primary’ states, composed of the fundamental fields of the theory, are annihilated by the raising operators. They are labelled by their quantum numbers under the Cartan subalgebra: the scaling dimension  $\Delta$ , the spins under the Lorentz group  $(j_L, j_R)$  and their  $SU_R(4)$  Dynkin labels  $[k, p, q]$ .

Modules then descend from these primary operators using the lowering operators.

Not all representations are unitary. The unitary representations, which are infinite-dimensional, were classified in [21]. To be unitary the quantum numbers of the highest-weight states (HWS) must satisfy bounds; HWS at these bounds are annihilated by some of the supercharges and thus the representations become short. For example HWS which are Lorentz scalars and have  $SU_R(4)$  labels  $[0, p, 0]$  are annihilated by half the supercharges, and hence called ‘half-BPS’. Lorentz-invariant HWS with  $SU_R(4)$  labels  $[k, p, k]$  are annihilated by at least a quarter of the supercharges, and hence called ‘quarter-BPS’. There are also eighth-BPS and sixteenth-BPS conditions; see for example the study of  $\mathcal{N} = 4$  superconformal characters [22] for more details. Away from these unitarity bounds the generic representations are called ‘long’.

## 2.4 AdS/CFT correspondence

A string theory dual to  $\mathcal{N} = 4$  super Yang-Mills was conjectured by Maldacena in [12] and further details of the correspondence were elucidated in [13, 14]. Maldacena’s idea was to take a system of  $N$  D3-branes in IIB string theory and study the low energy limit from two different points of view: the IIB system and the theory on the branes.

From the point of view of the branes, the massless string excitations give  $\mathcal{N} = 4$  SYM on the branes and IIB supergravity far from the branes. For the bulk perspective, what survives are supergravity modes a long way from the branes and also arbitrary closed string excitations very close to the branes, that get red-shifted as they move out of the gravitational potential well of the branes. In this near-horizon limit the geometry becomes that of  $AdS_5 \times S^5$ .

Thus the dual string theory of  $\mathcal{N} = 4$  SYM is closed type IIB strings on a bosonic background of  $AdS_5 \times S^5$ . The string coupling is related to the number of colours and the ’t Hooft parameter  $\lambda = g_{YM}^2 N$  by  $g_s = \frac{\lambda}{N}$  and the tension of the string (as a unitless ratio of the radius of  $AdS_5 \times S^5$ ) is given by  $T = \sqrt{\lambda}$ . The string coupling, which orders perturbation theory on the worldsheet, is the inverse of the tension  $\alpha' = \frac{1}{T} = \frac{1}{\sqrt{\lambda}}$ .

The strong-weak relations of the coupling constants makes direct verification of the AdS/CFT correspondence all but impossible. For example, checks have been made in BPS sectors, where quantities do not change with the coupling, and sectors close to BPS [23] and in the planar limit.

### 2.4.1 The planar limit

Generically at finite  $N$  there is strong mixing between operators with different trace structures; the combinatorics of even the simplest correlation functions involve complicated expansions in  $N$ . This corresponds to the complicated quantum string expansion in the bulk.

This picture simplifies if we take the ’t Hooft limit by fixing  $\lambda = g_{YM}^2 N$  and taking  $N \rightarrow \infty$ . In this limit we find that mixing between operators with different trace struc-

tures is suppressed in  $1/N$ , so we only keep the single trace operators in the spectrum. In this planar limit the anomalous dimensions of operators can be found using the integrability we gain from an infinite tower of commuting conserved charges. The problem of finding anomalous dimensions reduces to a spin chain solvable by Bethe Ansatz [24, 25].

On the bulk side  $g_s \sim \frac{\lambda}{N}$  so string loops are suppressed. We get only classical string theory, with the topology of sphere, hence the name “planar”.

If we also take the limit of strong coupling in the gauge theory  $\lambda \rightarrow \infty$ , the tension of the string in the bulk  $T = \sqrt{\lambda}$  becomes so strong that there are no longer any internal vibrations in the string and the theory reduces to Type IIB supergravity on  $AdS_5 \times S^5$ . This solution to the supergravity equations was discovered in 1980 [26]. The 5-form self-dual field strength sources the curvature of the metric; there are  $N$  units of 5-form flux through the  $S^5$  sphere of the geometry.<sup>1</sup>

### 2.4.2 Free field theory limit

In the free field theory limit the field theory simplifies considerably. On the bulk side the tension of the string disappears [18].

The global symmetry group  $PSU(2, 2|4)$  is enhanced to the higher spin group  $hs(2, 2|4)$ . When this higher spin symmetry is broken at non-zero coupling, certain short multiplets become anomalous and join long multiplets. In the bulk, this corresponds to a version of the Higgs mechanism called ‘La Grand Bouffe’ [28, 29, 30, 31].

Berkovits has conjectured that the pure spinor string on  $AdS_5 \times S^5$  becomes in the tensionless limit a topological  $G/G$  principal chiral model where  $G = PSU(2, 2|4)$  (see [32, 33] for recent investigations). This would provide a strong-weak duality on the worldsheet and hence considerably ease the proof of the Maldacena conjecture. Similar ideas have been studied in supersphere models [34].

Gopakumar has also looked for a signature of the string diagram moduli space from the free field theory [35].

The approach of this thesis is not directly related to that of Berkovits or Gopakumar, because with the group theory methods we use all non-planar corrections are calculated simultaneously. It is however possible to expand these amplitudes genus by genus, which would then correspond to the string expansion.

## 2.5 Schur-Weyl duality

One of the principle techniques we will use is that of combining the fundamental fields of  $\mathcal{N} = 4$  super Yang-Mills into representations of the global and local symmetry groups of the theory. If we concentrate on the global symmetry  $PSU(2, 2|4)$ , removing gauge indices, then we take tensor products of identical copies of the same representation, the

---

<sup>1</sup>It is also worth mentioning the Eguchi-Kawai reduction [27] in the context of large- $N$  simplification, which states that at  $N = \infty$   $SU(N)$  gauge theory on a  $d$ -dimensional spacetime is equivalent to that at a point.

one containing the fundamental fields of the theory. Because the copies are identical, the tensor product has an additional symmetry under interchange of the copies, which allows us to use permutation group techniques to organise the representations. These techniques form the basis of Schur-Weyl duality.

We give a quick overview of Schur-Weyl duality here. For a familiar example from the composition of spin-half representations of  $SU(2)$  see Appendix Section C.5; there is more detail in subsequent sections.

In the simplest example take the fundamental representation  $V_F$  of the unitary group  $U(K)$  (or the general linear group  $GL(K)$  which has the same representations). For  $U(3)$  the states in  $V_F \cong \mathbb{C}^3$  are given by the fundamental fields  $\{W_m\} = \{X, Y, Z\}$ .

Now consider  $n$  copies of  $V_F$ ,  $V_F^{\otimes n}$ . A state in  $V_F^{\otimes n}$  is

$$W_{m_1} \otimes W_{m_2} \otimes \cdots \otimes W_{m_n}$$

Schur-Weyl duality gives the decomposition of  $V_F^{\otimes n}$  in terms of representations of the two groups which act on  $V_F^{\otimes n}$ :  $U(K)$  which acts on each  $V_F$  and the symmetric group  $S_n$  which permutes the  $n$  elements. Because the actions of these two groups on  $V_F^{\otimes n}$  commute, the space can be simultaneously decomposed in terms of Young diagrams  $\Lambda$  which label both representations of  $U(K)$  and of  $S_n$

$$V_F^{\otimes n} = \bigoplus_{\Lambda \in P(n, K)} V_{\Lambda}^{U(K)} \otimes V_{\Lambda}^{S_n} \quad (8)$$

$\Lambda \in P(n, K)$  means that  $\Lambda$  runs over Young diagrams with  $n$  boxes and at most  $K$  rows. According to (8),  $V_F^{\otimes n}$  has a complete basis of states of the form  $|\Lambda, M_{\Lambda}, a_{\Lambda}\rangle$ , where  $M_{\Lambda}$  label states in the irrep. of  $U(K)$  corresponding to the Young diagram  $\Lambda$  and  $a_{\Lambda}$  label states in the irrep. of  $S_n$  corresponding to the same Young diagram. Knowing the transformation properties of the operator under  $S_n$  is crucial to compute all the permutations of Wick contractions when we find correlation functions later.

## 2.6 The half-BPS $U(1)$ sector

Half-BPS states preserve half of the sixteen supercharges of the theory. On the bulk side the supergravity multiplet is half-BPS. If we Kaluza-Klein reduce supergravity on  $AdS_5 \times S^5$  down to  $AdS_5$  then we can map the spherical harmonics of the supergravity fields on  $S^5$  to symmetric traceless combinations of the six real scalars in  $\mathcal{N} = 4$  [14]

$$\mathcal{O}_k(x) = T_{i_1 \dots i_k} : \text{tr}(X^{i_1}(x) \cdots X^{i_k}(x)) : \quad (9)$$

where  $T_{i_1 \dots i_k}$  is a tensor transforming in the  $[0, k, 0]$  of  $SO(6)$ . The conformal dimension  $\Delta = k$  of  $\mathcal{O}_k$  is protected by the supersymmetry of the operator, so it is not anomalous in the quantum theory. The operator transforms as a scalar under the Lorentz group. We can also choose any multi-trace structure and the operator will remain half-BPS as



long as the operator transforms under this representation of the global symmetry group. Multi-trace local operators correspond to bound states of gravitons in the bulk.

When two- and three-point correlation functions of these half-BPS operators were computed, it was soon realised that many received no corrections [36]. The three-point function was then computed for the supergravity fields in the bulk at tree level, corresponding to strong coupling for the field theory [37]. The result was the same as for the free field theory, so the conclusion was reached that the three-point function is protected from renormalisation at all values of the coupling. This extends to all extremal correlators [38, 39].

If we combine the six real scalars into three complex scalars transforming in the  $U(3) \subset SU(4)_R$ , then we can pick a  $U(3)$  highest weight state in the  $[0, k, 0]$  of  $SO(6)$  by taking the trace of a single complex scalar

$$\mathcal{O}_k^{\text{HWS}}(x) = \text{tr}(X^k(x)) \quad (10)$$

This HWS has charge  $R = k$  under a Cartan  $U(1)$  of  $U(3)$ .

### 2.6.1 Giant gravitons and the stringy exclusion principle

It is clear that when  $N$  is finite, not all powers of the  $N \times N$  matrix fields  $X$  are independent. Just by virtue of the Cayley-Hamilton theorem, the matrix satisfies the polynomial of its eigenvalue equation. This means that traces of powers bigger than  $N$  can always be written in terms of traces of powers  $\leq N$ . This was called the ‘Stringy Exclusion Principle’ in the context of  $AdS_3$  duality [40], [41]. In terms of  $\mathcal{N} = 4$  it was studied in [42].

It was soon asked what this cutoff in the spectrum for  $R > N$  in the field theory corresponded to in the bulk. It was shown [43] that for gravitons with large angular momenta around the  $S^5$ , corresponding to this  $R$ -charge in the field theory, the 5-form field strength inflates the gravitons into a non-commutative  $S^3$  brane due to the Myers effect (see [44] for a review). These supersymmetric branes, named ‘giant’ gravitons, have size proportional to their angular momentum, a typical feature of non-commutative gravity. They can only expand up to the size of the  $S^5$ , beyond which they cease to exist. This is the cutoff which corresponds to the Stringy Exclusion Principle in the boundary gauge theory.

Half-BPS D3-brane solutions were also found expanding in the  $AdS_5$  geometry [45, 46]. Because  $AdS_5$  is non-compact in the radial direction, these giant gravitons can grow to any size.

Local operators in  $\mathcal{N} = 4$  SYM for the sphere giants were initially given in terms of sub-determinants of the complex field  $X$  [47]. Shortly afterwards the gauge theory duals of the AdS giants were also discovered and united with the sphere giants in the framework of the Schur polynomials [19]. This work completely classified all multi-trace half-BPS operators at finite  $N$ .

## 2.7 Schur polynomials

In [19] all multi-trace half-BPS operators of arbitrary size built from a single complex scalar  $X$  at finite  $N$  were classified in terms of Schur polynomials. For operators with  $R \sim N$  this classification gives a very precise map to giant gravitons expanded in the  $S^5$  and the  $AdS_5$ .

For example, at level  $n = \Delta = 4$  we have multi-trace five operators, see the first column in Table 1.

$$\begin{array}{l|l} \text{tr}(X) \text{tr}(X) \text{tr}(X) \text{tr}(X) & (1)(2)(3)(4) \\ \text{tr}(X) \text{tr}(X) \text{tr}(XX) & (1)(2)(34) \\ \text{tr}(X) \text{tr}(XXX) & (1)(234) \\ \text{tr}(XX) \text{tr}(XX) & (12)(34) \\ \text{tr}(XXXX) & (1234) \end{array}$$

Table 1: The operators for  $n = 4$  and representatives of the conjugacy classes of  $S_4$ .

We can write these using the permutations of the symmetric group  $\alpha \in S_4$

$$\text{tr}(\alpha XXXX) = X_{i_{\alpha(1)}}^{i_1} X_{i_{\alpha(2)}}^{i_2} X_{i_{\alpha(3)}}^{i_3} X_{i_{\alpha(4)}}^{i_4} \quad (11)$$

For example the permutation  $\alpha = (12)(34)$  gives us

$$X_{i_2}^{i_1} X_{i_1}^{i_2} X_{i_4}^{i_3} X_{i_3}^{i_4} = \text{tr}(XX) \text{tr}(XX) \quad (12)$$

The trace structure only depends on the cycle structure of the permutations, i.e. only upon the conjugacy classes of  $S_n$ . For example, the permutation  $\alpha = (13)(24)$  gives the same trace structure as  $\alpha = (12)(34)$  in equation (12). The correspondence between multi-trace operators and conjugacy classes for  $n = 4$  is given in Table 1.

Operators may be represented diagrammatically [48], see Figure 1 for the example in (12). Because  $X$  is an  $N \times N$  matrix it acts on the fundamental representation  $V_N$  by the usual matrix multiplication.  $X^{\otimes n}$  is then an automorphism<sup>2</sup> of  $V_N^{\otimes n}$ . In Figure 1 (b) each strand represents a fundamental index  $V_N$ . Reading the diagram from top to bottom (just as we read  $\text{tr}(\alpha X^n)$  from right to left), first  $X^{\otimes n}$  acts on  $V_N^{\otimes n}$ , followed by a permutation  $\alpha$  (Appendix Section D looks at the diagrammatics in more detail), then the diagram is traced connecting the top of the diagram to the bottom. This is drawn more schematically in diagram (c), where the  $n$  strands are bunched together into a single thick strand, and the trace is indicated by horizontal bars at the top and bottom of the diagram.

Now we take a linear combination of these traces that corresponds to the character of  $U(N)$ . This operator is labelled by a representation  $R$  of  $U(N)$  and is called a *Schur polynomial*

$$\mathcal{O}[R] \equiv \chi_R(X) = \frac{1}{n!} \sum_{\alpha \in S_n} \chi_R(\alpha) X_{i_{\alpha(1)}}^{i_1} X_{i_{\alpha(2)}}^{i_2} \cdots X_{i_{\alpha(n)}}^{i_n} \quad (13)$$

<sup>2</sup>An automorphism is a homomorphism from a space to itself that is also an isomorphism.

$$\begin{array}{ccc}
\text{tr}(\alpha X^4) & \equiv & \text{(b)} \\
\text{(a)} & & \text{(c)}
\end{array}$$

Figure 1: The trace for  $\alpha = (12)(34)$ , written using the 4 individual strands, then with all four strands bunched into a thicker strand. The horizontal bars mean that you identify the top bar with the bottom bar, forming a traced loop.

$\chi_R(\alpha)$  is the symmetric group  $S_n$  character of  $\alpha$  in the representation  $R$ .  $R$  corresponds to a Young diagram, a partition of  $n$ . An example operator is

$$\mathcal{O} \left[ R = \begin{array}{|c|c|c|} \hline \square & \square & \square \\ \hline \end{array} \right] = \frac{1}{4!} \left[ 3 \text{tr}(X) \text{tr}(X) \text{tr}(X) \text{tr}(X) + 6 \text{tr}(X) \text{tr}(X) \text{tr}(XX) \right. \\
\left. - 3 \text{tr}(XX) \text{tr}(XX) - 6 \text{tr}(XXXX) \right] \quad (14)$$

It is a linear combination of the operators listed in Table 1.

For  $N \rightarrow \infty$  these partitions are in 1-to-1 correspondence with all partitions of  $n$ , and hence the conjugacy classes of  $S_n$ . But for  $N$  finite, the Young diagram for a representation of  $U(N)$  can have only at most  $N$  rows, so the space of partitions is limited to partitions into at most  $N$  parts. This implements the Stringy Exclusion Principle. The giant gravitons expanding in the compact  $S^5$  of the bulk geometry correspond to Young diagrams with a single column, i.e. row lengths  $[1^n]$  for  $R$ -charge  $n$ . These are the same operators as the sub-determinants from [47], where  $n \leq N$  follows because of the antisymmetry. Giant gravitons expanding in the non-compact  $AdS_5$  are Young diagrams with a single row  $[n]$  and they can become arbitrarily large. Generic Young diagrams correspond to superpositions of these solutions.

We can calculate the two-point function for the Schur polynomials using the scalar propagator

$$\left\langle (X^\dagger)_j^i(x) X_l^k(y) \right\rangle = \delta_l^i \delta_j^k \frac{1}{(x-y)^2} \quad (15)$$

From now on we drop the spacetime dependence and concentrate on the index structure.

In  $V_N^{\otimes n}$  the linear combination of elements of  $S_n$   $P_R = \frac{d_R}{n!} \sum_{\alpha \in S_n} \chi_R(\alpha) \alpha$  is a projector  $P_R P_S = \delta_{RS} P_R$ . We can use this to compute the correlator. Diagrammatically

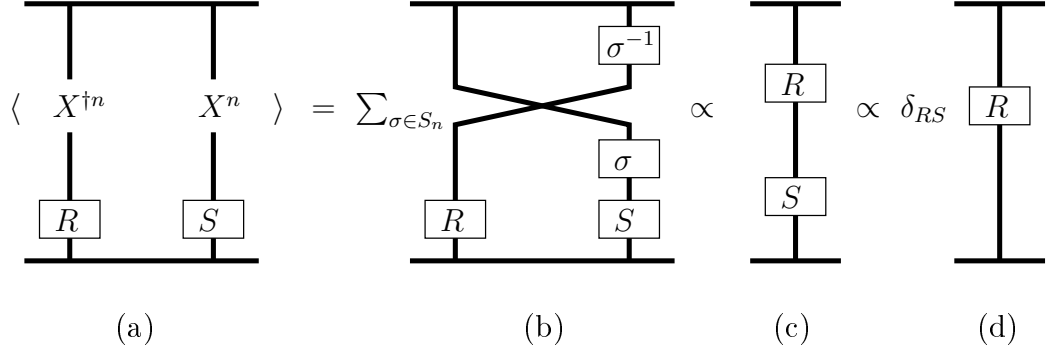

Figure 2: Correlation function of two Schur polynomials.

the correlator is drawn in Figure 2 (a).

$$\begin{aligned}
\langle \mathcal{O}^\dagger[R] \mathcal{O}[S] \rangle &= \frac{1}{(n!)^2} \sum_{\alpha, \beta \in S_n} \chi_R(\alpha) \chi_S(\beta) \langle (X^\dagger)_{i_{\alpha(1)}}^{j_1} \cdots (X^\dagger)_{i_{\alpha(n)}}^{j_n} X_{j_{\beta(1)}}^{i_1} \cdots X_{j_{\beta(n)}}^{i_n} \rangle \\
&= \frac{1}{(n!)^2} \sum_{\alpha, \beta, \sigma \in S_n} \chi_R(\alpha) \chi_S(\beta) \prod_{k=1}^n \langle (X^\dagger)_{i_{\alpha(k)}}^{j_k} X_{j_{\beta\sigma(k)}}^{i_k} \rangle
\end{aligned} \tag{16}$$

In the second line we have summed over permutations of Wick-contracted pairs. Next we use (15)

$$\langle \mathcal{O}^\dagger[R] \mathcal{O}[S] \rangle = \frac{1}{(n!)^2} \sum_{\alpha, \beta, \sigma \in S_n} \chi_R(\alpha) \chi_S(\beta) \prod_{k=1}^n \delta_{j_{\beta\sigma(k)}}^{i_k} \delta_{i_{\alpha(k)}}^{j_{\sigma(k)}} \tag{17}$$

This is Figure 2 (b). We can now contract some of the delta-functions and write them as a trace in  $V_N^{\otimes n}$  of the identity matrix

$$\prod_{k=1}^n \delta_{j_{\beta\sigma(k)}}^{i_k} \delta_{i_{\alpha(k)}}^{j_{\sigma(k)}} = \prod_{k=1}^n \delta_{i_{\alpha\sigma^{-1}\beta\sigma(k)}}^{i_k} = \text{tr}(\alpha \sigma^{-1} \beta \sigma \mathbb{I}_N^n) \tag{18}$$

Because the character is a class function, we can make the substitution  $\beta \rightarrow \sigma \beta \sigma^{-1}$  and hence remove the  $\sigma$  sum to get part (c) of Figure 2

$$\begin{aligned}
\langle \mathcal{O}^\dagger[R] \mathcal{O}[S] \rangle &= \frac{1}{n!} \sum_{\alpha, \beta \in S_n} \chi_R(\alpha) \chi_S(\beta) \text{tr}(\alpha \beta \mathbb{I}_N^n) \\
&= \delta_{RS} \frac{1}{d_R} \sum_{\alpha \in S_n} \chi_R(\alpha) \text{tr}(\alpha \mathbb{I}_N^n) \\
&= \delta_{RS} \frac{n! \text{Dim} R}{d_R} \equiv \delta_{RS} f_R
\end{aligned} \tag{19}$$

In the second line we have used the projector property of  $P_R$ , which makes the two-point

function diagonal. We have used the formula for the  $U(N)$  dimension of  $R$  from identity (495) in the final line.

### 2.7.1 Extremal three-point functions

Schur polynomials are  $U(N)$  characters, so they follow rules for composition of tensor products

$$\chi_R(X)\chi_S(X) = \chi_{R\otimes S}(X) = \sum_T g(R, S; T)\chi_T(X) \quad (20)$$

$R$  has  $n_1$  boxes,  $S$  has  $n_2$  boxes and  $T$  has  $n_1 + n_2$  boxes.  $g(R, S; T)$  is the Littlewood-Richardson coefficient for the number of times  $T$  appears in the  $U(N)$  tensor product  $R \otimes S$ , see Appendix Section C.4 for more details.

This allows to easily compute extremal correlators of half-BPS operators. Extremal correlators [38, 39] have all holomorphic operators (composed of  $X$  rather than  $X^\dagger$ ) at the same spacetime position. Using (20) we find [19, 48]

$$\left\langle \mathcal{O}^\dagger[R](x) \mathcal{O}^\dagger[S](y) \mathcal{O}[T](z) \right\rangle = g(R, S; T) f_T \frac{1}{(x-z)^{2n_1} (y-z)^{2n_2}} \quad (21)$$

### 2.7.2 Free fermions and geometry

In [19] and [49] it was shown that the half-BPS sector may be reduced to a complex matrix model. This in turn can be reduced to a system of the  $N$  eigenvalues in a harmonic oscillator. The eigenvalues become fermionic due to the change in the path integral measure; their excitation levels above the ground state then map to a partition into  $N$  parts, corresponding to the Young diagrams  $R$  for the Schur polynomials. The fermions can be represented as a Fermi droplet in phase space, where a filled circle is the ground state and disturbances of this are excitations. The  $S^5$  giant graviton with Young diagram  $[1^N]$  gives each eigenvalue one excitation, leaving a hole in the filled circle Fermi droplet. The  $AdS^5$  giant  $[N]$  gives the top eigenvalue a large excitation, leaving a small blob separated from the filled Fermi droplet of the ground state.

Approaching from the supergravity side, Lin, Lunin and Maldacena [50] (LLM) searched for all the half-BPS geometries with  $SO(4) \times SO(4) \times \mathbb{R}$  symmetry which are asymptotically  $AdS_5 \times S^5$ . They found smooth solutions determined by a bi-coloured plane, which correspond exactly to the Fermi droplets of the gauge theory matrix model. Geometries with extremely large  $R$  charge are similar to incipient black hole states and can be studied as such [51].

### 2.7.3 The dual basis

Suppose we have a basis of operators  $\mathcal{A}_i$  with two-point function or metric

$$\mathcal{G}_{ij} = \left\langle \mathcal{A}_i^\dagger \mathcal{A}_j \right\rangle \quad (22)$$

We want to find a linear combination of these operators  $\mathcal{B}_i = \mathcal{S}_{ij}\mathcal{A}_j$  which is *dual* to this basis in the sense

$$\langle \mathcal{B}_i^\dagger \mathcal{A}_j \rangle = \delta_{ij} \quad (23)$$

This can be achieved if

$$\mathcal{S}_{ij} = (\mathcal{G}^{-1})_{ij} \quad (24)$$

For the trace basis  $\mathcal{A}_i = \text{tr}(\sigma_i X^n)$ , which is not diagonal, the dual basis takes a particularly simple form

$$\mathcal{B}_i = \frac{||[\sigma_i]||}{n!} \sum_{R \in P(n, N)} \frac{1}{f_R} \chi_R(\sigma_i) \chi_R(X) \quad (25)$$

This basis is useful in the factorisation equations discussed in Section 8 and for reducing the gauge group from  $U(N)$  to  $SU(N)$  in Section 9.

In the large  $N$  limit  $f_R \rightarrow N^n$ , see equation (494), so that the dual basis becomes proportional to the trace basis

$$\mathcal{B}_i \rightarrow \frac{||[\sigma_i]||}{n!} \frac{1}{N^n} \sum_{R \in P(n)} \chi_R(\sigma_i) \chi_R(X) = \frac{||[\sigma_i]||}{n! N^n} \text{tr}(\sigma_i X^n) = \frac{||[\sigma_i]||}{n! N^n} \mathcal{A}_i \quad (26)$$

and (23) just expresses the well-known orthogonality of traces for  $N \rightarrow \infty$ .

## 2.8 Black holes

Schwarzschild black holes are known to exist in  $AdS_5$ . In terms of gauge theory units they have energy  $\Delta \sim N^2$  and their entropy is also  $S \sim N^2$ . Because their energy is so much larger than  $N$ , it is no longer possible to shirk finite  $N$  issues in the gauge theory such as the Stringy Exclusion Principle. New techniques such as those expanded in this thesis are required. It is clear that the  $N^2$  entropy cannot be furnished by just the planar degrees of freedom and that non-planar objects such as multi-trace and determinant operators are needed.

The half-BPS operators cannot furnish this degeneracy of states, because at energy  $N^2$  the number of states is the number of partitions with this many boxes and only  $N$  rows

$$p(N^2, N) \sim e^N \quad (27)$$

The same is true of quarter- and eighth-BPS states, cf. [52].

In fact the only supersymmetric black holes preserve just a sixteenth of the supersymmetry [53], see [54] for a recent study. Finding the dual sixteenth-BPS states in the dual boundary theory is a major goal of current research, see for example [55, 56, 57]. BPS black holes are tractable because direct comparisons can be made between the gauge theory and supergravity because of the protection afforded by supersymmetry; studying generic black holes would be very difficult.

## 2.9 Quantum deformations of spacetime

Truncations of the spectrum such as the Stringy Exclusion Principle are often associated with a deformation of the geometry they describe, see for example fuzzy spheres [58] or the  $q$ -deformed  $AdS_3 \times S^3$  spacetime proposed in [41]. Taking three-point functions in  $AdS_5 \times S^5$  from the planar limit, where they describe spherical harmonic fusion coefficients in the bulk, to finite  $N$  might define a non-commutative deformed geometry.

### 3 Summary

In Section 4 we develop the non-planar spectrum for subsectors of  $\mathcal{N} = 4$  SYM and calculate the free two-point function. The  $U(K)$  spectrum in Section 4.1 is based on a paper with co-authors Paul Heslop and Sanjaye Ramgoolam [59]. In another paper with the same authors [60] we developed the formalism for a general subsector (Section 4.3) and applied it to  $SL(2)$  (Section 4.4). The  $SO(2, 4)$  results in Section 4.5 will appear in a future paper [61].

Section 5 on the one-loop mixing is based on paper [62] for  $U(2)$  and its extension to general groups in [60]. Section 6 contains material on giant gravitons from [59] and unpublished material on the chiral ring and partition algebras in Section 6.3. Additional unpublished material on the three-point function appears in Section 7. The paper ‘Correlators, Topologies and Probabilities’ [63] with co-authors Robert de Mello Koch, Nick Toumbas and Sanjaye Ramgoolam is summarised in Section 8. The  $SU(N)$  study in Section 9 first appeared in [64].

At the start of each section is a summary of the contents and pointers towards the main results. The Appendices give general formulae and other useful equations.



## 4 Free theory spectrum

In this section we extend the non-planar understanding of the half-BPS  $U(1)$  sector of the global symmetry group  $PSU(2, 2|4)$ , explained in Section 2.7 in terms of  $U(N)$  Schur polynomials of a single complex matrix [19], to other sectors. We consider the case of three complex scalars  $U(3) \subset SU(4)_R$  in Section 4.1, three complex scalars and two fermions  $U(3|2)$  in Section 4.2, one derivative  $SU(1, 1) \sim SL(2)$  in Section 4.4, all four derivatives  $SO(4, 2) \sim SU(2, 2)$  in 4.5 and six real scalars  $SO(6)$  in Section 4.6. Other authors have considered a complex scalar and its conjugate  $\{X, X^\dagger\}$  [65]. We use the results to analyse worldvolume excitations of giant gravitons in Section 4.9.

We organise operators into representations of the appropriate global symmetry group (for  $U(K)$  see equation (33) and for general group  $G$  see (111)) and the gauge group  $U(N)$ . This gives us a complete basis that naturally truncates in accordance with the Stringy Exclusion Principle (for  $U(K)$  see equation (67) and  $G$  (132)). This basis counts correctly, see for example Section 4.1.7. The group theoretic properties of these operators allow us to simultaneously compute all  $1/N$  non-planar parts of the free two-point function and we find they diagonalise this correlation function (for  $U(K)$  see equation (71) and  $G$  (135)). We also show in Section 7 that the free three-point function is given simply in terms of group fusion coefficients and in Section 5 that mixing is highly constrained in the one-loop two-point function.

This one-loop work highlights one difference between these larger sectors and the original half-BPS sector: beyond the half-BPS sector our operators and their correlation functions do not generically satisfy non-renormalisation theorems. The operators are no longer eigenstates of the dilatation operator beyond the free theory and mix badly at higher loops. In Section 6 we attempt to isolate the subsets of these operators in certain sectors that remain BPS.

### 4.1 $U(K)$

#### 4.1.1 Covariant operators

In this section we will show how to build the three complex scalars  $X, Y, Z$  of  $\mathcal{N} = 4$  super Yang-Mills into general representations of  $U(3)$ . For simplicity we will drop the adjoint gauge indices from the fields, so that they only transform as the fundamental representation of the global symmetry group  $U(3)$ . We consider tensor products of these basic letters, where we distinguish for example  $X \otimes Z$  from  $Z \otimes X$ .

To keep the discussion general we will take  $U(K)$  instead of  $U(3)$ . Take the fundamental representation of  $U(K)$ ,  $V_F = \{W_m\}$  for  $m = 1, \dots, K$ ,<sup>3</sup> and consider tensor products

$$\hat{\mathcal{O}}[\vec{m}] \equiv W_{m_1} \otimes W_{m_2} \otimes \dots \otimes W_{m_n} \in V_F^{\otimes n} \quad (28)$$

forming words of length  $n$ . There are  $K^n$  such tensor products and they inherit an

---

<sup>3</sup>For  $K = 3$  we would have as the fundamental of  $U(3)$ :  $W_1 = X, W_2 = Y, W_3 = Z$ .

action of  $U(K)$  from the fundamental representation. The hat on  $\hat{\mathcal{O}}$  distinguishes these operators from the gauge-invariant operators we build later, once we have put back in the gauge indices.

As a representation of  $U(K)$  this object is reducible. Our goal is to decompose it into irreducible representations  $\Lambda$  of  $U(K)$ , which are indexed by the set of Young diagrams  $P(n, K)$  with  $n$  boxes and at most  $K$  rows

$$V_F^{\otimes n} = \bigoplus_{\Lambda \in P(n, K)} d_\Lambda V_\Lambda^{U(K)} \quad (29)$$

$d_\Lambda$  is the number of times  $\Lambda$  appears in the decomposition. The first task is to explain this multiplicity  $d_\Lambda$ .

As well as the action of  $U(K)$  on  $V_F^{\otimes n}$ , there is also an action of the permutation group  $\sigma \in S_n$  given by the re-ordering

$$\sigma \cdot W_{m_1} \otimes W_{m_2} \otimes \cdots \otimes W_{m_n} \cdot \sigma^{-1} \equiv W_{m_{\sigma(1)}} \otimes W_{m_{\sigma(2)}} \otimes \cdots \otimes W_{m_{\sigma(n)}} \quad (30)$$

The actions of  $U(K)$  and  $S_n$  are both automorphisms of  $V_F^{\otimes n}$  (i.e. they are isomorphisms that map  $V_F^{\otimes n}$  to itself). The action of the algebra  $\mathbb{C}S_n$  commutes with the action of  $U(K)$  and is in fact the largest algebra in the automorphisms of  $V_F^{\otimes n}$  that commutes with the action of  $U(K)$ . Because of this property we can decompose  $V_F^{\otimes n}$  exactly in terms of representations  $V_\Lambda^{U(K)}$  of  $U(K)$  and the representations  $V_\Lambda^{S_n}$  of  $S_n$  corresponding to the same Young diagram  $\Lambda$

$$V_F^{\otimes n} = \bigoplus_{\Lambda \in P(n, K)} V_\Lambda^{U(K)} \otimes V_\Lambda^{S_n} \quad (31)$$

The Young diagrams  $\Lambda$  correspond to representations both of  $U(K)$  and  $S_n$ . The multiplicity  $d_\Lambda$  in (29) is now explained by the size or dimension of  $V_\Lambda^{S_n}$ ,  $d_\Lambda = \dim V_\Lambda^{S_n}$ . We will always write this dimension as  $d_\Lambda$  to distinguish it from other group representation dimensions.

This result is known as Schur-Weyl duality.

The content of this equation is that there is a linear combination of multi-index tensors from  $V_F^{\otimes n}$  that will form states in the irreducible representation  $V_\Lambda^{U(K)} \otimes V_\Lambda^{S_n}$  of  $U(K) \times S_n$ . We can implement this map using a Clebsch-Gordan coefficient  $C$

$$C : \quad V_F^{\otimes n} \quad \rightarrow \quad V_\Lambda^{U(K)} \otimes V_\Lambda^{S_n} \\ \sum_{\vec{m}} C_{\Lambda, M_\Lambda, a_\Lambda}^{m_1 m_2 \dots m_n} W_{m_1} \otimes W_{m_2} \otimes \cdots \otimes W_{m_n} = |\Lambda, M_\Lambda, a_\Lambda\rangle \quad (32)$$

$C$  is a Clebsch-Gordan coefficient for the map from the tensor product  $V_F^{\otimes n}$  to the  $U(K) \times S_n$  irrep. The  $m_i$  label fundamental fields in  $V_F^{\otimes n}$ ,  $\Lambda$  and  $M_\Lambda$  are the representation and

state of  $U(K)$  and  $\Lambda$  and  $a_\Lambda$  are the representation and state of  $S_n$ . Thus we get operators

$$\hat{\mathcal{O}}[\Lambda, M_\Lambda, a_\Lambda] = \sum_{\vec{m}} C_{\Lambda, M_\Lambda, a_\Lambda}^{\vec{m}} W_{m_1} \otimes W_{m_2} \otimes \cdots \otimes W_{m_n} \quad (33)$$

Under the action of  $\sigma \in S_n$  as in (30) we find

$$\hat{\mathcal{O}}[\Lambda, M, a] \rightarrow D_{ab}^\Lambda(\sigma) \hat{\mathcal{O}}[\Lambda, M, b] \quad (34)$$

where  $D_{ab}^\Lambda(\sigma)$  is the matrix for  $\sigma \in S_n$  in the representation  $\Lambda$ . This implies

$$C_{\Lambda, M, a}^{\vec{m}_\sigma} = D_{ab}^\Lambda(\sigma^{-1}) C_{\Lambda, M, b}^{\vec{m}} \quad (35)$$

where  $\vec{m}_\sigma = (m_{\sigma(1)}, \dots, m_{\sigma(n)})$ .

For  $U \in U(K)$  we get

$$\hat{\mathcal{O}}[\Lambda, M, a] \rightarrow D_{MM'}^\Lambda(U) \hat{\mathcal{O}}[\Lambda, M', a] \quad (36)$$

where  $D_{MM'}^\Lambda(U)$  is the matrix for  $U \in U(K)$  in the representation  $\Lambda$ . See [59] Section 2.5.2 for more details.

The Clebsch-Gordan coefficients are invertible. If we think in terms of bras and kets

$$C_{\Lambda, M_\Lambda, a_\Lambda}^{\vec{m}} = \langle \vec{m} | \Lambda, M_\Lambda, a_\Lambda \rangle \quad (37)$$

then the inverse coefficient is just the hermitian conjugate

$$C_{\vec{m}}^{\Lambda, M_\Lambda, a_\Lambda} \equiv \langle \Lambda, M_\Lambda, a_\Lambda | \vec{m} \rangle = \left( C_{\Lambda, M_\Lambda, a_\Lambda}^{\vec{m}} \right)^* \quad (38)$$

Here the Clebsch-Gordan coefficients are all real so the inverse is the same as the original.

We have two orthogonality relations:

$$\sum_{\vec{m}} C_{\Lambda, M_\Lambda, a_\Lambda}^{\vec{m}} C_{\vec{m}}^{\Lambda', M'_{\Lambda'}, a'_{\Lambda'}} = \delta_{\Lambda \Lambda'} \delta_{M_\Lambda M'_{\Lambda'}} \delta_{a_\Lambda a'_{\Lambda'}} \quad (39)$$

and

$$\sum_{\Lambda, M_\Lambda, a_\Lambda} C_{\Lambda, M_\Lambda, a_\Lambda}^{\vec{m}} C_{\vec{m}'}^{\Lambda, M_\Lambda, a_\Lambda} = \delta_{m_1 m'_1} \cdots \delta_{m_n m'_n} \quad (40)$$

This means that we can recover  $\hat{\mathcal{O}}[\vec{m}]$  from the  $\hat{\mathcal{O}}[\Lambda, M_\Lambda, a_\Lambda]$

$$\hat{\mathcal{O}}[\vec{m}] = \sum_{\Lambda, M_\Lambda, a_\Lambda} C_{\vec{m}}^{\Lambda, M_\Lambda, a_\Lambda} \hat{\mathcal{O}}[\Lambda, M_\Lambda, a_\Lambda] \quad (41)$$

### 4.1.2 Detail of SW map

The exact form of  $C$  depends on how we implement the decomposition in (31), which is in general basis-dependent. Here we will give a method for determining  $C$  and then prove it satisfies the requisite properties. This subsection is technical and not necessary to understand the subsequent discussion; we suggest that the unconcerned reader skips to Section 4.1.3 where the gauge-invariant operators are constructed.

Consider  $\hat{\mathcal{O}}[\vec{m}]$  as in (28) such that the operator contains  $\mu_1$  fields  $W_1$ ,  $\mu_2$  fields  $W_2$ , up to  $\mu_K$  fields  $W_K$ . The vector  $\mu$  describes the ‘field content’ of  $\hat{\mathcal{O}}[\vec{m}]$ . If we choose a canonical order for this field content

$$\mathbf{W}^\mu \equiv \underbrace{W_1 \otimes \cdots \otimes W_1}_{\mu_1} \otimes \underbrace{W_2 \otimes \cdots \otimes W_2}_{\mu_2} \otimes \cdots \otimes \underbrace{W_K \otimes \cdots \otimes W_K}_{\mu_K} \quad (42)$$

then we can write any operator  $\hat{\mathcal{O}}[\vec{m}]$  using a permutation  $\sigma \in S_n$  of this canonical tensor

$$\hat{\mathcal{O}}[\vec{m}] = \hat{\mathcal{O}}[\mu, \sigma] \equiv \sigma \cdot \mathbf{W}^\mu \cdot \sigma^{-1} \quad (43)$$

We can see immediately that  $\sigma$  is not unique because there is a symmetry

$$\sigma \mathbf{W}^\mu \sigma^{-1} \rightarrow \sigma h \mathbf{W}^\mu h^{-1} \sigma^{-1} \quad (44)$$

where the action of  $h \in H_\mu \equiv S_{\mu_1} \times S_{\mu_2} \times \cdots \times S_{\mu_K}$  leaves  $\mathbf{W}^\mu$  unchanged. For  $\hat{\mathcal{O}}[\mu, \sigma]$  this is a symmetry for the action on  $\sigma$  from the right by  $h$

$$\hat{\mathcal{O}}[\mu, \sigma] \rightarrow \hat{\mathcal{O}}[\mu, \sigma h] \quad (45)$$

Thus we should quotient on the right by  $H_\mu$  and choose  $\sigma$  uniquely from the quotient group  $S_n/H_\mu$ . This then gives the correct counting for the number of operators with fixed  $\mu$

$$|S_n/H_\mu| = \frac{|S_n|}{|H_\mu|} = \frac{n!}{\mu_1! \mu_2! \cdots \mu_K!} \quad (46)$$

This is the generalised binomial coefficient for the number of ways of choosing  $n$  objects, with  $\mu_1$  of one kind,  $\mu_2$  of a second kind, and so on up to  $\mu_K$  of the  $k$ 'th kind. Alternatively it is the coefficient of  $x_1^{\mu_1} \cdots x_K^{\mu_K}$  in the polynomial  $(x_1 + \cdots + x_K)^n$ .

Now we want to understand the relation between the choice of  $\mu$  and the Schur-Weyl decomposition (31) into Young diagrams.

To do this we ‘Fourier transform’ the  $\sigma \in S_n$  of  $\mathcal{O}[\mu, \sigma]$  to the space of representing matrices of  $S_n$

$$\hat{\mathcal{O}}[\Lambda, \mu, a, b] \equiv \frac{1}{n!} \sum_{\sigma \in S_n} D_{ab}^\Lambda(\sigma) \hat{\mathcal{O}}[\mu, \sigma] \quad (47)$$

$D_{ab}^\Lambda(\sigma)$  is the orthogonal matrix element in the representation  $\Lambda$  of  $S_n$  for  $\sigma$  (see Appendix Section B.4 for the properties of these matrices). The Peter-Weyl theorem says that these

matrices cover the space of functions on  $S_n$ , implementing the isomorphism

$$\text{functions on } S_n \rightarrow \bigoplus_{\Lambda} V_{\Lambda}^{S_n} \otimes V_{\Lambda}^{S_n} \quad (48)$$

$a, b$  carry the index of this decomposition.

But we must also remember that  $\mathcal{O}[\mu, \sigma]$  is invariant under right action by  $h \in H_{\mu}$ . The irreducible representation  $\Lambda$  of  $S_n$  gives, by restriction, a representation of  $H_{\mu}$ , which is in general reducible. One can then decompose it in terms of irreps of  $H_{\mu}$ . To get invariance under  $H_{\mu}$  we must project the second representation  $V_{\Lambda}^{S_n}$ , whose state is indexed by  $b$ , to the subspace which is invariant under  $H_{\mu}$ , i.e. the trivial representation  $\mathbf{1}$  of  $H_{\mu}$ . To do this we compute the *branching coefficient* for the projection using bra-ket notation

$$\langle \Lambda, b | \Lambda(S_n) \rightarrow \mathbf{1}(H_{\mu}), \beta \rangle \quad (49)$$

The trivial representation  $\mathbf{1}$  of  $H_{\mu}$  will in general appear more than once. The index  $\beta$  runs over an orthonormal basis for this multiplicity. The size of this multiplicity is given by

$$g(\mu; \Lambda) \equiv g([\mu_1], [\mu_2], \dots, [\mu_K]; \Lambda) \quad (50)$$

This is the Littlewood-Richardson coefficient for the appearance of  $\Lambda$  in the tensor product of trivial single-row representations of  $U(K)$   $[\mu_1] \otimes \dots \otimes [\mu_K]$ .

Using the orthonormality of  $\beta$  and inserting a complete set of states we find

$$\begin{aligned} \delta_{\beta_1 \beta_2} &= \langle \Lambda(S_n) \rightarrow \mathbf{1}(H_{\mu}), \beta_1 | \Lambda(S_n) \rightarrow \mathbf{1}(H_{\mu}), \beta_2 \rangle \\ &= \sum_{b=1}^{d_{\Lambda}} \langle \Lambda(S_n) \rightarrow \mathbf{1}(H_{\mu}), \beta_1 | \Lambda, b \rangle \langle \Lambda, b | \Lambda(S_n) \rightarrow \mathbf{1}(H_{\mu}), \beta_2 \rangle \end{aligned} \quad (51)$$

This gives an orthogonality relation for the branching coefficients  $\langle \Lambda(S_n) \rightarrow \mathbf{1}(H_{\mu}), \beta | \Lambda, b \rangle$ . From the reality of the symmetric group irreps.

$$\langle \Lambda, b | \Lambda(S_n) \rightarrow \mathbf{1}(H_{\mu}), \beta \rangle = \langle \Lambda(S_n) \rightarrow \mathbf{1}(H_{\mu}), \beta | \Lambda, b \rangle \quad (52)$$

We can also form a projector from the representation space of  $\Lambda$  onto the subspace which is invariant under  $H_{\mu}$ . The projector  $\Gamma = \frac{1}{|H_{\mu}|} \sum_{h \in H_{\mu}} h$  picks out the trivial irrep  $\mathbf{1}(H_{\mu})$  in this. We can write  $D_{ab}^{\Lambda}(\Gamma) = \langle \Lambda, a | \Gamma | \Lambda, b \rangle$  as

$$\langle \Lambda, a | \Gamma | \Lambda, b \rangle = \sum_{\beta} \langle \Lambda, a | \Lambda(S_n) \rightarrow \mathbf{1}(H_{\mu}); \beta \rangle \langle \Lambda(S_n) \rightarrow \mathbf{1}(H_{\mu}), \beta | \Lambda, b \rangle \quad (53)$$

See [66] and Appendix H for calculations of these branching coefficients. To save space we shall define

$$B_{b\beta} \equiv \langle \Lambda, b | \Lambda(S_n) \rightarrow \mathbf{1}(H_{\mu}), \beta \rangle \quad (54)$$

It should be clear from the context which  $\Lambda$  and  $\mu$  are being used.

Now we use these orthogonality properties to define

$$\hat{O}[\Lambda, \mu, \beta, a] = \sum_b B_{b\beta} \hat{O}[\Lambda, \mu, a, b] \quad (55)$$

Together  $\mu$  and  $\beta$  give us the  $U(K)$  state  $M_\Lambda = [\mu, \beta]$  by labelling a semi-standard tableaux with field content  $\mu$  ( $\beta$  runs over possible semi-standard tableaux; see Appendix Section C.1).

Thus we have the explicit map from  $V_F^{\otimes n}$  to a state in  $V_\Lambda^{U(K)} \otimes V_\Lambda^{S_n}$  for which we have been looking

$$\hat{O}[\Lambda, \mu, \beta, a] = \sum_b B_{b\beta} \frac{1}{n!} \sum_\sigma D_{ab}^\Lambda(\sigma) \sigma \mathbf{X}^\mu \sigma^{-1} \quad (56)$$

To be explicit

$$C_{\Lambda, M, a}^{\vec{m}} = \frac{1}{n!} \sum_{\sigma \in S_n} B_{b\beta} D_{ab}^\Lambda(\sigma) \prod_{k=1}^n \delta_{m_k p_{\sigma^{-1}(k)}} \quad (57)$$

Here  $M = [\mu, \beta]$ . Canonically we choose  $p_1, \dots, p_{\mu_1} = 1, p_{\mu_1+1}, \dots, p_{\mu_1+\mu_2} = 2, \dots$

We can check that  $C$  obeys the right transformation (35) under  $\rho \in S_n$

$$C_{\Lambda, M, a}^{\vec{m}_\rho} = D_{ab}^\Lambda(\rho^{-1}) C_{\Lambda, M, b}^{\vec{m}} \quad (58)$$

We also find the orthogonality equations (39) and (40) we expect, up to a normalisation factor

$$\sum_{\vec{m}} C_{\Lambda, \mu, \beta, a}^{\vec{m}} C_{\Lambda', \mu', \beta', a'}^{\vec{m}} = \delta_{\Lambda \Lambda'} \delta_{\mu \mu'} \delta_{\beta \beta'} \delta_{aa'} \frac{|H_\mu|}{n! d_\Lambda} \quad (59)$$

and

$$\sum_{\Lambda, \mu, \beta, a} \frac{n! d_\Lambda}{|H_\mu|} C_{\Lambda, \mu, \beta, a}^{\vec{m}} C_{\Lambda, \mu, \beta, a}^{\vec{m}'} = \delta_{m_1 m_1'} \cdots \delta_{m_n m_n'} \quad (60)$$

The first of these orthogonality equations follows quickly using orthogonality of the symmetric group representations. See Appendix Section G for proof of the second.

The number of operators with field content  $\mu$  was given in equation (46). To make sure that our operators  $\hat{O}[\Lambda, \mu, \beta, a]$  have the same counting, note that  $a$  runs over the symmetric group irrep dimension  $d_\Lambda$  and  $\beta$  over  $g(\mu; \Lambda)$ , also known as the Kostka number which counts the number of  $U(K)$  states of  $\Lambda$  with field content  $\mu$ . Thus the number of operators with field content  $\mu$  is

$$\sum_\Lambda d_\Lambda g(\mu; \Lambda) \quad (61)$$

Using identity (472) from the Appendix for the Littlewood-Richardson coefficient, we find that this counting is identical to equation (46) as desired.

### 4.1.3 Invariant operators

We have organised  $n$  copies of the fundamental fields in terms of representations of the global symmetry group  $U(K)$ .

$$\hat{\mathcal{O}}[\Lambda, M, a] = C_{\Lambda, M, a}^{\vec{m}} W_{m_1} \otimes W_{m_2} \otimes \cdots \otimes W_{m_n} \quad (62)$$

We now introduce the  $U(N)$  gauge group adjoint indices

$$(W_m)_j^i \quad (63)$$

$i \in V_N$  transforms in the fundamental of  $U(N)$  while  $j \in V_{\bar{N}}$  transforms in the antifundamental. If we take  $n$  of these fields

$$(W_{m_1})_{j_1}^{i_1} (W_{m_2})_{j_2}^{i_2} \cdots (W_{m_n})_{j_n}^{i_n} \quad (64)$$

we see that these are just  $n$  commuting bosons, so they transform in  $\text{Sym}(V_F \otimes V_N \otimes V_{\bar{N}})^{\otimes n}$ . Thus we want our final operator to be an  $S_n$ -invariant.

To form gauge-invariant operators we multiply these matrices together and then take products of traces organised by the symmetric group element  $\alpha \in S_n$ , just as we did in (11) when we only had a single complex matrix

$$\mathcal{O}[\vec{m}, \alpha] = \text{tr}(\alpha W_{m_1} \otimes W_{m_2} \otimes \cdots \otimes W_{m_n}) = (W_{m_1})_{i_{\alpha(1)}}^{i_1} (W_{m_2})_{i_{\alpha(2)}}^{i_2} \cdots (W_{m_n})_{i_{\alpha(n)}}^{i_n} \quad (65)$$

The trace is being taken in  $V_N^{\otimes n}$ . Next Fourier transform from the elements  $\alpha$  of  $S_n$  to the representation matrices  $D_{pq}^R(\alpha)$ , just like we did in equation (48)

$$\frac{1}{n!} \sum_{\alpha \in S_n} D_{pq}^R(\alpha) \text{tr}(\alpha W_{m_1} \otimes W_{m_2} \cdots \otimes W_{m_n}) \quad (66)$$

Because  $\alpha$  is acting on  $U(N)$  indices,  $R$  is also a representation of  $U(N)$ , so  $R$  has at most  $N$  rows (cf. the Schur polynomials (13)).

Finally, reintroducing the  $U(K)$  representation, we combine the free  $S_n$  indices with an  $S_n$  Clebsch-Gordan coefficient<sup>4</sup>  $S^{\hat{\tau}} \begin{smallmatrix} \Lambda & R & R \\ a & p & q \end{smallmatrix}$  because we want our final operator to be  $S_n$ -invariant, as discussed underneath equation (64)

$$\boxed{\mathcal{O}[\Lambda, M, R, \hat{\tau}] = S^{\hat{\tau}} \begin{smallmatrix} \Lambda & R & R \\ a & p & q \end{smallmatrix} C_{\Lambda, M, a}^{\vec{m}} \frac{1}{n!} \sum_{\alpha \in S_n} D_{pq}^R(\alpha) \text{tr}(\alpha W_{m_1} \otimes \cdots \otimes W_{m_n})}$$

$$= S^{\hat{\tau}} \begin{smallmatrix} \Lambda & R & R \\ a & p & q \end{smallmatrix} \frac{1}{n!} \sum_{\alpha \in S_n} D_{pq}^R(\alpha) \text{tr}(\alpha \hat{\mathcal{O}}[\Lambda, M, a]) \quad (67)$$

Note that in these equations we have used implicit Einstein summation over indices and

<sup>4</sup>This Clebsch-Gordan coefficient for  $S_n$  is exactly analogous to the more familiar  $3j$ -symbol used for combining  $SU(2)$  irreps.

$S_n$  states, so that on the right-hand side  $a, p, q$  and  $\vec{m}$  are contracted.

The  $S_n$  tensor product Clebsch-Gordan coefficient  $S^{\hat{\tau}} \Lambda \begin{smallmatrix} R & R \\ a & p & q \end{smallmatrix}$  (see Appendix Sections B.6 and B.7 for details) is only non-zero if the trivial representation with a single row  $[n]$  appears in  $\Lambda \otimes R \otimes R$ , or alternatively if  $\Lambda$  appears in  $R \otimes R$ . The number  $\hat{\tau}$  runs over the  $C(R, R, \Lambda)$  times  $\Lambda$  appears in  $R \otimes R$ . Example operators for the  $U(2)$  representation  $\Lambda = [2, 2]$  are given in Appendix Section E.

We can invert the Clebschs to recover from these operators the basic gauge invariant operators in (65), as demonstrated in Section 4.1.5. This means that our new basis is complete. It also counts correctly at finite  $N$ , as demonstrated in Section 4.1.7.

#### 4.1.4 Schur polynomials in half-BPS case

For the half-BPS operators the  $U(K)$  representation is the trivial totally symmetric one with a single row of length  $n$ ,  $\Lambda = [n]$ .  $[n]$  appears once in the symmetric group tensor product  $R \otimes R$  for every  $R$  and the Clebsch-Gordan coefficient is

$$S^{[n]} \begin{smallmatrix} R & R \\ p & q \end{smallmatrix} = \frac{1}{\sqrt{d_R}} \delta_{pq} \quad (68)$$

For the highest weight state we get the Schur polynomial of Section 2.7

$$\mathcal{O}[\Lambda = [n], \text{HWS}, R] = \frac{1}{\sqrt{d_R}} \chi_R(X) \quad (69)$$

#### 4.1.5 Invertibility

To recover the trace operator (65) from the invariant basis (67)

$$\mathcal{O}[\vec{m}, \alpha] = \sum_{\Lambda, M, R, \hat{\tau}} d_R D_{pq}^R(\alpha) S^{\hat{\tau}} \Lambda \begin{smallmatrix} R & R \\ a & p & q \end{smallmatrix} C_{\Lambda, M, a}^{\vec{m}} \mathcal{O}[\Lambda, M, R, \hat{\tau}] \quad (70)$$

It is easy to prove this using formulae in the group theory appendices; it is done in detail in Section 2.6 of [59].

#### 4.1.6 Diagonality

The transformation properties of these operators under permutations make it extremely easy to compute their correlation functions. In this section we will demonstrate that for the free theory the two-point function is fully diagonal on all their labels

$$\left\langle \mathcal{O}[\Lambda, M, R, \hat{\tau}] \mathcal{O}^\dagger[\Lambda', M', R', \hat{\tau}'] \right\rangle = \delta_{\Lambda\Lambda'} \delta_{MM'} \delta_{RR'} \delta_{\hat{\tau}\hat{\tau}'} \frac{|H_\mu|}{d_R^2} \text{Dim } R \quad (71)$$

To prove this we will need every aspect of the group theoretic decomposition of these operators. There is a tight mesh between the group theoretic decomposition, the com-



pletteness and the diagonality.<sup>5</sup>

To start expand the operators in traces of the fundamental fields

$$\begin{aligned}
& \left\langle \mathcal{O}[\Lambda, M, R, \hat{\tau}] \mathcal{O}^\dagger[\Lambda', M', R', \hat{\tau}'] \right\rangle \\
&= S^{\hat{\tau}} \frac{\Lambda}{a} \frac{R}{p} \frac{R}{q} C_{\Lambda, M, a}^{\bar{m}} \frac{1}{n!} \sum_{\alpha \in S_n} D_{pq}^R(\alpha) S^{\hat{\tau}'} \frac{\Lambda'}{a'} \frac{R'}{p'} \frac{R'}{q'} C_{\Lambda', M', a'}^{\bar{m}'} \frac{1}{n!} \sum_{\alpha' \in S_n} D_{p'q'}^{R'}(\alpha') \\
& \left\langle \text{tr}(\alpha W_{m_1} \otimes \cdots \otimes W_{m_n}) \text{tr}(\alpha' W_{m'_1}^\dagger \otimes \cdots \otimes W_{m'_n}^\dagger) \right\rangle \tag{72}
\end{aligned}$$

For the free two-point function of fundamental fields we just need to sum over the permutations of different Wick-contracted pairs of fields

$$\begin{aligned}
& \left\langle (W_{m_1})_{i_{\alpha(1)}}^{i_1} (W_{m_2})_{i_{\alpha(2)}}^{i_2} \cdots (W_{m_n})_{i_{\alpha(n)}}^{i_n} (W_{m'_1}^\dagger)_{j_{\alpha'(1)}}^{j_1} (W_{m'_2}^\dagger)_{j_{\alpha'(2)}}^{j_2} \cdots (W_{m'_n}^\dagger)_{j_{\alpha'(n)}}^{j_n} \right\rangle \\
&= \sum_{\sigma \in S_n} \prod_{k=1}^n \left\langle (W_{m_k})_{i_{\alpha(k)}}^{i_k} (W_{m'_{\sigma(k)}}^\dagger)_{j_{\alpha'\sigma(k)}}^{j_{\sigma(k)}} \right\rangle \tag{73}
\end{aligned}$$

then use the scalar propagator

$$\left\langle (W_m)_j^i (W_{m'}^\dagger)_l^k \right\rangle = \delta_{mm'} \delta_l^i \delta_j^k \tag{74}$$

For  $U(3)$  this propagator comes from the free  $\mathcal{N} = 4$  action; we have removed the spacetime dependence. We get

$$\begin{aligned}
\sum_{\sigma \in S_n} \prod_{k=1}^n \left\langle (W_{m_k})_{i_{\alpha(k)}}^{i_k} (W_{m'_{\sigma(k)}}^\dagger)_{j_{\alpha'\sigma(k)}}^{j_{\sigma(k)}} \right\rangle &= \sum_{\sigma \in S_n} \prod_{k=1}^n \delta_{m_k m'_{\sigma(k)}} \delta_{j_{\alpha'\sigma(k)}}^{i_k} \delta_{i_{\alpha(k)}}^{j_{\sigma(k)}} \\
&= \sum_{\sigma \in S_n} \prod_{k=1}^n \delta_{m_k m'_{\sigma(k)}} \delta_{i_{\alpha'\sigma\alpha\sigma^{-1}(k)}}^{i_k} \tag{75}
\end{aligned}$$

Finally rewrite the  $U(N)$  index contractions as a trace in  $V_N^{\otimes n}$  and expand the trace in characters

$$\prod_{k=1}^n \delta_{i_{\alpha'\sigma\alpha\sigma^{-1}(k)}}^{i_k} = \text{tr}(\alpha' \sigma \alpha \sigma^{-1}) = \sum_{T \in P(n, N)} \chi_T(\alpha' \sigma \alpha \sigma^{-1}) \text{Dim } T \tag{76}$$

---

<sup>5</sup>Once we develop the more general machinery of Section 4.3 it is possible to derive the diagonality more directly, cf. Section 4.3.6.

$\text{Dim}T$  is the  $U(N)$  dimension of  $T$ . Now insert all this into correlator to get

$$\begin{aligned}
& \left\langle \mathcal{O}[\Lambda, M, R, \hat{\tau}] \mathcal{O}^\dagger[\Lambda', M', R', \hat{\tau}'] \right\rangle \\
&= S^{\hat{\tau}} \begin{matrix} \Lambda & R & R \\ a & p & q \end{matrix} C_{\Lambda, M, a}^{\vec{m}_\sigma} \frac{1}{n!} \sum_{\alpha \in S_n} D_{pq}^R(\alpha) S^{\hat{\tau}'} \begin{matrix} \Lambda' & R' & R' \\ a' & p' & q' \end{matrix} C_{\Lambda', M', a'}^{\vec{m}} \frac{1}{n!} \sum_{\alpha' \in S_n} D_{p'q'}^{R'}(\alpha') \\
&\quad \sum_{\sigma \in S_n} \sum_T \chi_T(\alpha' \sigma \alpha \sigma^{-1}) \text{Dim} T \\
&= \sum_{\sigma \in S_n} S^{\hat{\tau}} \begin{matrix} \Lambda & R & R \\ a & p & q \end{matrix} D_{ba}^\Lambda(\sigma) C_{\Lambda, M, b}^{\vec{m}} \frac{1}{n!} \sum_{\alpha \in S_n} D_{pq}^R(\sigma^{-1} \alpha \sigma) S^{\hat{\tau}'} \begin{matrix} \Lambda' & R' & R' \\ a' & p' & q' \end{matrix} C_{\Lambda', M', a'}^{\vec{m}} \frac{1}{n!} \sum_{\alpha' \in S_n} D_{p'q'}^{R'}(\alpha') \\
&\quad \sum_T \chi_T(\alpha' \alpha) \text{Dim} T \tag{77}
\end{aligned}$$

We have used property (35) for the action of  $S_n$  on the  $U(k)$  Clebsch  $C$ . Using the  $U(K) \times S_n$  Clebsch-Gordan orthogonality (59) we contract the  $\vec{m}$

$$\begin{aligned}
& \delta_{\Lambda\Lambda'} \delta_{MM'} \frac{|H_\mu|}{n! d_\Lambda} \sum_{\sigma \in S_n} S^{\hat{\tau}} \begin{matrix} \Lambda & R & R \\ a & p & q \end{matrix} D_{a'a}^\Lambda(\sigma) \frac{1}{n!} \sum_{\alpha \in S_n} D_{pr}^R(\sigma^{-1}) D_{rs}^R(\alpha) D_{sq}^R(\sigma) S^{\hat{\tau}'} \begin{matrix} \Lambda' & R' & R' \\ a' & p' & q' \end{matrix} \\
&\quad \frac{1}{n!} \sum_{\alpha' \in S_n} D_{p'q'}^{R'}(\alpha') \sum_T D_{tu}^T(\alpha') D_{ut}^T(\alpha) \text{Dim} T \tag{78}
\end{aligned}$$

Property (470) of the  $S_n$  Clebsch-Gordan coefficient  $S$  makes the  $\sigma$  sum trivial, leaving a factor of  $n!$

$$\begin{aligned}
& \delta_{\Lambda\Lambda'} \delta_{MM'} \frac{|H_\mu|}{n! d_\Lambda} n! S^{\hat{\tau}} \begin{matrix} \Lambda & R & R \\ a' & r & s \end{matrix} \frac{1}{n!} \sum_{\alpha \in S_n} D_{rs}^R(\alpha) S^{\hat{\tau}'} \begin{matrix} \Lambda' & R' & R' \\ a' & p' & q' \end{matrix} \frac{1}{n!} \sum_{\alpha' \in S_n} D_{p'q'}^{R'}(\alpha') \\
&\quad \sum_T D_{tu}^T(\alpha') D_{ut}^T(\alpha) \text{Dim} T \tag{79}
\end{aligned}$$

Use the orthogonality of the sums over  $\alpha$  and  $\alpha'$  (456) to get  $R = R' = T$

$$\delta_{\Lambda\Lambda'} \delta_{MM'} \delta_{RR'} \frac{|H_\mu|}{d_\Lambda d_R^2} S^{\hat{\tau}} \begin{matrix} \Lambda & R & R \\ a' & u & t \end{matrix} S^{\hat{\tau}'} \begin{matrix} \Lambda' & R' & R' \\ a' & t & u \end{matrix} \text{Dim} R \tag{80}$$

Finally the sums over  $|R, u\rangle \otimes |R, t\rangle$  give orthogonality for the  $S_n$  CG coefficients  $S$  (466) to get the promised diagonality

$$\left\langle \mathcal{O}[\Lambda, M, R, \hat{\tau}] \mathcal{O}^\dagger[\Lambda', M', R', \hat{\tau}'] \right\rangle = \delta_{\Lambda\Lambda'} \delta_{MM'} \delta_{RR'} \delta_{\hat{\tau}\hat{\tau}'} \frac{|H_\mu|}{d_R^2} \text{Dim} R \tag{81}$$

A demonstration of this diagonality is given for the operators for the  $U(2)$  representation  $\Lambda = [2, 2]$  in Appendix Section E.

#### 4.1.7 Finite $N$ counting

We show here that the operators defined in equation (67) count correctly for finite  $N$ . We know how many gauge-invariant operators there are for a given representation  $\Lambda$  of

$U(K)$  because we can expand the free thermal partition function for the theory on the manifold  $S_1 \times S_3$  and count how many times the character of  $\Lambda$  appears. This finite  $N$  partition function reduces to an integral over a single unitary matrix  $U = e^{i\beta\alpha} \in U(N)$ , where  $\alpha$  is the zero mode of  $A_0$  and  $\beta \equiv 1/T$  [67, 52]. The integral is given in terms of the single letter partition function  $f(\mathbf{x})$ , for bosonic  $\mathbf{x}$ .

$$\mathcal{Z} = \int [dU] \exp \left\{ \sum_{m=1}^{\infty} \frac{1}{m} f(\mathbf{x}^m) \text{tr}(U^\dagger)^m \text{tr} U^m \right\} \quad (82)$$

For the  $U(K)$  subsector  $f(\mathbf{x})$  is just the character of the fundamental representation, which is the trace of the  $U(K)$  matrix

$$f(\mathbf{x}) = \chi_F^{U(K)}(\mathbf{x}) = x_1 + x_2 + \cdots + x_K \quad (83)$$

where  $(x_1, x_2, \dots, x_K)$  are the diagonal entries of the  $U(K)$  matrix. Their power is

$$f(\mathbf{x}^m) = x_1^m + x_2^m + \cdots + x_K^m \quad (84)$$

Now we perform the group integration for  $U(N)$  following [68] (a result first derived in [69]). If we expand out

$$\exp \left\{ \sum_{m=1}^{\infty} \frac{1}{m} f(\mathbf{x}^m) \text{tr}(U^\dagger)^m \text{tr} U^m \right\} \quad (85)$$

and collect the terms we get

$$\sum_n \sum_{C_i \in S_n} \prod_{j=1}^n (f(\mathbf{x}^j))^{i_j} \frac{1}{j^{i_j} i_j!} \text{tr}(C_i U) \text{tr}(C_i U^\dagger) \quad (86)$$

where  $C_i$  is a partition of  $n$  or a conjugacy class of  $S_n$  with  $i_1$  1-cycles,  $i_2$  2-cycles,  $\dots$   $i_n$   $n$ -cycles. In  $\frac{1}{j^{i_j} i_j!}$  the  $j^{i_j}$  comes from the  $\frac{1}{m}$  in (85) and the  $i_j!$  comes from  $\exp(x) = \sum_k \frac{1}{k!} x^k$ .

Using the identity  $\text{tr}(C_i U) = \sum_{R(U(N))} \chi_R(C_i) \chi_R(U)$  and the group integral

$$\int [dU] \chi_R(U) \chi_{R'}(U^\dagger) = \delta_{RR'} \quad (87)$$

we get the finite  $N$  partition function

$$\mathcal{Z} = \sum_n \sum_{R(U(N))} \sum_{C_i \in S_n} \prod_{j=1}^n (f(\mathbf{x}^j))^{i_j} \frac{1}{j^{i_j} i_j!} \chi_R(C_i) \chi_R(C_i) \quad (88)$$

Now we can use the formula for the  $U(K)$  character  $\chi_\Lambda^{U(K)}(\mathbf{x})$  of  $\Lambda$  from (496) to get

$$\prod_{j=1}^n (f(\mathbf{x}^j))^{i_j} = \text{tr}(C_i \mathbf{x}) = \sum_{\Lambda(U(K))} \chi_\Lambda^{S_n}(C_i) \chi_\Lambda^{U(K)}(\mathbf{x}) \quad (89)$$

The partition function becomes

$$\mathcal{Z} = \sum_n \sum_{R(U(N))} \sum_{\Lambda(U(K))} \chi_\Lambda(\mathbf{x}) C(R, R, \Lambda) \quad (90)$$

where  $C(R, R, \Lambda)$  is the number of possible  $\hat{\tau}$  multiplicities in (67), i.e. the number of times  $\Lambda$  appears in the symmetric group tensor product  $R \otimes R$ .<sup>6</sup> As representations of  $U(N)$ , we only sum over Young diagrams  $R$  with at most  $N$  rows. We now see that the operators in (67) provide exactly the correct counting for a given representation  $\Lambda$  of  $U(K)$

$$\sum_{R(U(N))} C(R, R, \Lambda) \quad (91)$$

We can further fine-grain the partition function by using the expansion of the character in terms of polynomials

$$\chi_\Lambda^{U(K)}(\mathbf{x}) = \sum_{\mu} g(\mu; \Lambda) x_1^{\mu_1} x_2^{\mu_2} \dots x_K^{\mu_K} \quad (92)$$

The powers of  $x_i$  indicate the field content  $\mu$ ;  $g(\mu; \Lambda)$  gives us the semi-standard tableaux multiplicity  $\beta$  of the  $U(K)$  states.

By observing the coefficient of  $x_1^{\mu_1} \dots x_K^{\mu_K}$  in the partition function  $\mathcal{Z}$  we can read off the number  $N(\mu_1, \dots, \mu_K)$  of gauge-invariants operators made from fields  $\mu_1$  of  $X_1$ ,  $\mu_2$  of  $X_2$ ,  $\dots$   $\mu_K$  of  $X_K$  at finite  $N$

$$N(\mu_1, \dots, \mu_K) = \sum_{R(U(N))} \sum_{\Lambda(U(K))} C(R, R, \Lambda) g(\mu; \Lambda) \quad (93)$$

For  $N \rightarrow \infty$  the partition function (82) simplifies to

$$\mathcal{Z}_{U(N \rightarrow \infty)}(\mathbf{x}) = \prod_{k=1}^{\infty} \frac{1}{1 - (x_1^k + \dots + x_K^k)} \quad (94)$$

This result can be derived using Pólya theory [70]. In this case, because the sum over  $R$  is no longer restricted by column length, the multiplicity in (91) simplifies to

$$\sum_R C(R, R, \Lambda) = \sum_{C_i \in S_n} \chi_\Lambda(C_i) \quad (95)$$

---

<sup>6</sup> $C(R, S, T) = \frac{1}{n!} \sum_{\sigma \in S_n} \chi_R(\sigma) \chi_S(\sigma) \chi_T(\sigma)$  and  $\prod_{j=1}^n \frac{1}{j^{i_j} i_j!} = \frac{|C_i|}{n!}$  where  $|C_i|$  is the size of the class  $C_i$ .

This result is calculated directly from the polynomial (94) in Section 3.1 of [59].

#### 4.2 Including fermions: $U(K_1|K_2)$

It is interesting to extend these results from the case of Lie groups  $U(K)$  to super Lie groups  $U(K_1|K_2)$ . Indeed the space of eighth BPS operators in  $\mathcal{N}=4$  SYM corresponds to the case  $U(3|2)$ , the three scalar fields  $X, Y, Z$  of the  $U(3)$  sector combining with two fermions,  $\bar{\lambda}^1_2, \bar{\lambda}^1_1$  (in the notation of [22]). The adjoint of the fermions  $\bar{\lambda}^1_a$  is denoted  $\lambda_{1a}$ . The two-point function of the two fermionic fields is then given by

$$\left\langle (\bar{\lambda}^1_a)_j^i (\lambda_{1a})_l^k \right\rangle = \delta_{aa} \delta_l^i \delta_j^k \quad (96)$$

Note that here, as for the bosonic case, we have ignored the  $x$  dependence which is  $(\delta_{a\dot{a}} x_{12}^0 - \sigma_{a\dot{a}}^i x_{12}^i)/x_{12}^4$  where  $x_{12} \equiv x_1 - x_2$ . By taking a limit where separation in time  $x_{12}^0$  dominates the separations in space  $x_{12}^i$ , we have that the two-point function is proportional to  $\delta_{a\dot{a}}$ . We will refer to this later as a Zamolodchikov-type metric; it is also used in [71].

The full set of fundamental fields in the sector is thus denoted  $W_m$  as previously, but where  $W_m$  is bosonic for  $m = 1 \dots K_1$  and fermionic for  $m = K_1 + 1 \dots K_1 + K_2$ . The main difference this makes as far as we are concerned is that we pick up an extra minus sign when two fermionic fields are swapped. So

$$(W_{m_1})_{j_1}^{i_1} (W_{m_2})_{j_2}^{i_2} = (-1)^{\epsilon(W_{m_1})\epsilon(W_{m_2})} (W_{m_2})_{j_2}^{i_2} (W_{m_1})_{j_1}^{i_1} \quad (97)$$

where we have defined the Grassmann parity of  $W_m$  as

$$\begin{aligned} \epsilon(W_m) &= 0 & m &= 1 \dots K_1 \\ \epsilon(W_m) &= 1 & m &= K_1 + 1 \dots K_1 + K_2 \end{aligned} \quad (98)$$

Contrast with (64) where all  $n$  fields are bosonic so transform in  $\text{Sym}(V_F \otimes V_N \otimes V_{\bar{N}})^{\otimes n}$ .

We will also find it useful to define the Grassmann parity of permutations, given a canonical order for the field content  $\mathbf{W}^\mu$ , cf. equation (42). We first define it for transpositions

$$\begin{aligned} \epsilon((ij)) &= 0 & i \text{ or } j &= 1 \dots n_1 \\ \epsilon((ij)) &= 1 & i \text{ and } j &= n_1 + 1 \dots n_1 + n_2 \end{aligned} \quad (99)$$

and extend it to all permutations by insisting that

$$\epsilon(\sigma\tau) = \epsilon(\sigma) + \epsilon(\tau) \pmod{2} \quad (100)$$

Here  $n_1 = \sum_{k=1}^{K_1} \mu_k$  is the total number of bosonic fields, and  $n_2 = \sum_{k=K_1+1}^{K_1+K_2} \mu_k$ , the total number of fermionic fields with  $n = n_1 + n_2$ .

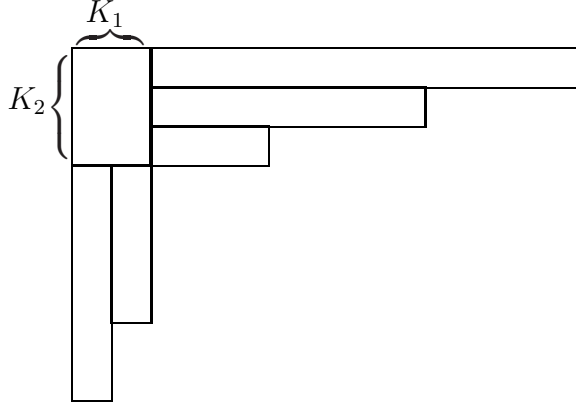

Figure 3: Allowed shape for the Young tableau of the representations  $\Lambda$  of  $U(K_1|K_2)$ .

The gauge covariant operators are defined in analogy to the bosonic case (47)

$$\hat{\mathcal{O}}|\Lambda, \mu, a, b\rangle = \frac{1}{n!} \sum_{\sigma} D_{ab}^{\Lambda}(\sigma) \hat{\mathcal{O}}[\mu, \sigma] \quad (101)$$

The difference comes with the additional minus signs appearing in the symmetry of this operator under conjugation (44). The projector for this symmetry becomes  $\Gamma = \frac{1}{|H_{\mu}|} \sum_{\gamma \in H_{\mu}} (-1)^{\epsilon(\gamma)} \gamma$ . This means that  $D_{ab}^{\Lambda}(\Gamma)$  becomes a projector from the representation space of  $\Lambda$  onto the subspace which is invariant under  $H$  up to a sign. Since it is a projector this can be written in terms of branching coefficients as in equation (53). The Kostka number (defined for  $U(K)$  above equation (61)) becomes equal to the Littlewood-Richardson coefficient for the appearance of  $\Lambda$  in the tensor product of trivial single-row representations and antisymmetric representations  $[\mu_1] \otimes \dots \otimes [\mu_{K_1}] \otimes [1^{\mu_{K_1+1}}] \otimes \dots \otimes [1^{\mu_{K_1+K_2}}]$  and  $\beta$  runs over this number in the final covariant operator. This makes sense given that we are filling up the semi-standard tableaux (see Appendix Section C.1) with  $K_1$  species of commuting bosons and  $K_2$  species of anti-commuting fermions. The final covariant operator is then

$$\hat{\mathcal{O}}|\Lambda, \mu, \beta, a\rangle = \sum_b B_{b\beta} \hat{\mathcal{O}}|\Lambda, \mu, a, b\rangle \quad (102)$$

and its invariant cousin follows exactly as in the purely bosonic case. Furthermore the counting formula will be identical to (93), namely

$$N(\mu_1, \dots, \mu_{K_1+K_2}) = \sum_R \sum_{\Lambda} C(R, R, \Lambda) g(\mu; \Lambda) \quad (103)$$

The only difference is in the definition of the Kostka number and in the allowed representations  $\Lambda$ . The allowed  $U(K_1|K_2)$  representations  $\Lambda$  have the shape as shown in Figure 3. The first  $K_1$  rows are unbounded, but rather more unusually, the first  $K_2$  columns are also unbounded. See for example [72] for more information on representations of supergroups and supertableaux.

### 4.2.1 Single fermion

The simplest example involving fermions is given by  $U(K_1|K_2) = U(0|1)$  corresponding to a single fermion. The allowed representations  $\Lambda$  are the totally antisymmetric reps,  $\Lambda = [1^n]$  and the counting becomes

$$N(n) = \sum_R \sum_{\Lambda} C(R, R, \Lambda) g([1^n]; \Lambda) = \sum_R C(R, R, [1^n]) = \sum_{R=\tilde{R}} 1 \quad (104)$$

where the final sum indicates a sum over self-conjugate representations. This follows from the fact that  $R \otimes [1^n] = \tilde{R}$ , where  $\tilde{R}$  is the partition conjugate to  $R$ , obtained by exchanging the rows and columns of  $R$ .

One can count the allowed operators for  $N > n$  as follows. Single trace operators must have an odd number of fields (otherwise they vanish, for example  $\text{tr}(\psi\psi) = \psi_i^j \psi_j^i = -\psi_j^i \psi_i^j = 0$ ). Multitrace operators are then made of single-trace operators with an odd number of fields in each, with the restriction that you cannot have the same single trace term twice (otherwise it vanishes by anti-symmetry). So all our operators have the form

$$\text{tr}(\psi^{2k_1+1}) \text{tr}(\psi^{2k_2+1}) \dots \text{tr}(\psi^{2k_l+1}) \quad k_1 > k_2 > \dots > k_l \geq 0 \quad (105)$$

The map between these operators and self-conjugate Young-tableaux with  $k_j + j$  boxes in the  $j$ th row and column gives a one-to-one correspondence between multi-trace operators of a single matrix-valued fermion and self-conjugate Young tableaux (cf. discussion on page 65 of Fulton and Harris [73]).

## 4.3 Schur-Weyl duality for a general group

The operators of  $\mathcal{N} = 4$  are organised into representations of the global superconformal symmetry group  $PSU(2, 2|4)$ . To keep the discussion general we will consider subgroups  $G$  of this global symmetry group. Above we have considered the compact group  $G = U(3) \subset SU(4)_R \subset PSU(2, 2|4)$ . Below we will consider  $G = SO(6) \cong SU(4)_R$  and the non-compact groups  $G = SL(2) \sim SU(1, 1) \subset SU(2, 2)$  and  $SO(2, 4) \cong SU(2, 2)$ .

The Lie algebra generators of  $G$  act on  $n$ -fold tensor products of representations  $V_1 \otimes V_2 \dots \otimes V_n$  according to the product rule

$$\Delta_n(J_a) = J_a \otimes 1 \otimes \dots \otimes 1 + 1 \otimes J_a \otimes \dots \otimes 1 + \dots + 1 \otimes \dots \otimes J_a \quad (106)$$

In particular we will be interested in the  $n$ -fold tensor product of the representation  $V_F$  corresponding to the fundamental fields in the sector of the theory given by  $G$ .

The elements  $\mathfrak{a}$  which commute with the action of  $G$  in the space of automorphisms of  $V_F^{\otimes n}$

$$\mathfrak{a} \Delta_n(J_a) = \Delta_n(J_a) \mathfrak{a} \quad (107)$$

form an algebra. We will denote the maximal commuting algebra by  $A$ . The symmetric

group algebra permuting the  $n$  factors in the tensor product will always be a subalgebra of this algebra,  $\mathbb{C}S_n \subset A$ .

We can build representations of  $G$  by taking tensor products of the fundamental fields. All the fundamental fields are contained in the singleton representation  $V_F$ . We write the fundamental fields contained in  $V_F$  as  $\{W_m\} = V_F$ .

We can decompose the  $n$ -tensor product of  $V_F$  into representations  $\Lambda$  of  $G$

$$V_F^{\otimes n} = \bigoplus_{\Lambda} V_{\Lambda}^G \otimes V_{\Lambda}^A \quad (108)$$

Generically the representations  $\Lambda$  of  $G$  appear with a multiplicity, here given by the dimension of the space  $V_{\Lambda}^A$ . This is the representation  $\Lambda$  of the algebra that commutes with  $G$  in the space of automorphisms of  $V_F^{\otimes n}$ . For the general linear and unitary groups this is just the symmetric group algebra  $A = \mathbb{C}S_n$ , which permutes the fundamental fields in  $V_F^{\otimes n}$ . This is known as Schur-Weyl duality. Representations of both  $GL(K)$  and  $S_n$  are labelled by the same Young diagram  $\Lambda$ . For the orthogonal group  $O(K)$   $A$  is the Brauer algebra  $B_n(K)$ . This contains the symmetric group algebra as a subalgebra.

When we consider correlators of operators, we need to act on the operators with permutations to account for all the possible Wick contractions between the fundamental fields. Therefore it is sufficient just to pick out the symmetric group representation  $\lambda$ .

$$V_F^{\otimes n} = \bigoplus_{\Lambda, \lambda} V_{\Lambda}^G \otimes V_{\lambda}^{S_n} \otimes V_{\Lambda, \lambda} \quad (109)$$

The symmetric group algebra is always a subalgebra of  $A$ , just as the  $G$  we consider are always subgroups of  $GL(\mathfrak{N})$  for  $\mathfrak{N} = |V_F| \leq \infty$ . We have decomposed the representation of the algebra  $V_{\Lambda}^A = \bigoplus_{\lambda} V_{\lambda}^{S_n} \otimes V_{\Lambda, \lambda}$ .  $V_{\Lambda, \lambda}$  can be thought of as the representation of the commutant of  $G \times S_n$ ; we will think of it as just a multiplicity space.

The Clebsch-Gordan coefficients for this decomposition are, cf. (32) for the  $U(K)$  case

$$C_{\Lambda, M_{\Lambda}, \lambda, a_{\lambda}, \tau}^{m_1 m_2 \dots m_n} \quad (110)$$

The  $m_i$  label fundamental fields in  $V_F^{\otimes n}$ ,  $\Lambda$  and  $M_{\Lambda}$  are the representation and state of  $G$ ,  $\lambda$  and  $a_{\lambda}$  are the representation and state of  $S_n$  and  $\tau$  labels the multiplicity  $V_{\Lambda, \lambda}$ .

Thus we get operators

$$\boxed{\hat{O}[\Lambda, M, \lambda, a, \tau] = \sum_{\vec{m}} C_{\Lambda, M, \lambda, a, \tau}^{\vec{m}} W_{m_1} \otimes W_{m_2} \otimes \dots \otimes W_{m_n}} \quad (111)$$

which are linear combinations of the fundamental fields. They transform under particular representations  $\Lambda$  of  $G$  and  $\lambda$  of  $S_n$ , in accordance with the decomposition (109).

The decomposition in equation (109) is in general a hard problem. For  $U(K)$  the Young diagram labelling the representation  $\Lambda$  of  $U(K)$  is the same as that for the representation  $\lambda$  of  $S_n$ ,  $\Lambda = \lambda$ , and the multiplicity space  $V_{\Lambda, \lambda}$  is trivial. For multiple deriva-



tives of a complex field in a single direction  $\partial^m X$  we can consider infinite-dimensional representations of the non-compact group  $SL(2)$ . To incorporate all four derivatives we need  $G = SO(2, 4)$ . For the full  $SO(6)$   $R$ -symmetry group we need Brauer algebras [74].

#### 4.3.1 $G$ versus $U(\infty)$

We could have also focused on the  $S_n$  action on  $V_F^{\otimes n}$  and picked out the  $S_n$  representations  $\lambda$

$$V_F^{\otimes n} = \bigoplus_{\lambda} V_{\lambda}^{\text{Com}(S_n)} \otimes V_{\lambda}^{S_n} \quad (112)$$

where  $\text{Com}(S_n)$  is the commutant of  $S_n$  in the space of automorphisms of  $V_F^{\otimes n}$ . Comparing to the  $U(K)$  case we see that  $\text{Com}(S_n) = U(\mathfrak{N})$  where  $\mathfrak{N} = |V_F| \leq \infty$ . We can further subdivide it into representations  $\Lambda$  of  $G$

$$V_{\lambda}^{\text{Com}(S_n)} = \bigoplus_{\Lambda} V_{\Lambda}^G \otimes V_{\Lambda, \lambda} \quad (113)$$

The higher spin group  $hs(2, 2|4)$ , introduced in Section 2.4.2 for the free theory limit, is analogous to  $U(\infty)$  where each derivative of each field is considered as a separate field.

#### 4.3.2 Properties of Clebsch-Gordan coefficient for general $G$

The Clebsch-Gordan coefficient (110) for general  $G$  will satisfy exactly the same properties as those for  $U(K)$  given in equations (34) to (41).

The action under  $\sigma \in S_n$

$$\hat{\mathcal{O}}[\Lambda, M, \lambda, a, \tau] \rightarrow D_{ab}^{\lambda}(\sigma) \hat{\mathcal{O}}[\Lambda, M, \lambda, b, \tau] \quad (114)$$

implies

$$C_{\Lambda, M, \lambda, a, \tau}^{\vec{m}_{\sigma}} = D_{ab}^{\lambda}(\sigma^{-1}) C_{\Lambda, M, \lambda, b, \tau}^{\vec{m}} \quad (115)$$

The Clebsch-Gordan coefficients are invertible. If we think in terms of bras and kets

$$C_{\Lambda, M_{\Lambda}, \lambda, a_{\lambda}, \tau}^{\vec{m}} = \langle \vec{m} | \Lambda, M_{\Lambda}, \lambda, a_{\lambda}, \tau \rangle \quad (116)$$

then the inverse coefficient is just the hermitian conjugate

$$C_{\vec{m}}^{\Lambda, M_{\Lambda}, \lambda, a_{\lambda}, \tau} \equiv \langle \Lambda, M_{\Lambda}, \lambda, a_{\lambda}, \tau | \vec{m} \rangle = \left( C_{\Lambda, M_{\Lambda}, \lambda, a_{\lambda}, \tau}^{\vec{m}} \right)^* \quad (117)$$

and we have both

$$\sum_{\vec{m}} C_{\Lambda, M_{\Lambda}, \lambda, a_{\lambda}, \tau}^{\vec{m}} C_{\vec{m}}^{\Lambda', M'_{\Lambda'}, \lambda', a'_{\lambda'}, \tau'} = \delta_{\Lambda \Lambda'} \delta_{M_{\Lambda} M'_{\Lambda'}} \delta_{\lambda \lambda'} \delta_{a_{\lambda} a'_{\lambda'}} \delta_{\tau \tau'} \quad (118)$$

and

$$\sum_{\Lambda, M_\Lambda, \lambda, a_\lambda, \tau} C_{\Lambda, M_\Lambda, \lambda, a_\lambda, \tau}^{\vec{m}} C_{\vec{m}'}^{\Lambda, M_\Lambda, \lambda, a_\lambda, \tau} = \delta_{m_1 m_1'} \cdots \delta_{m_n m_n'} \quad (119)$$

This means that we can recover  $\hat{\mathcal{O}}[\vec{m}]$  from the  $\hat{\mathcal{O}}[\Lambda, M_\Lambda, \lambda, a_\lambda, \tau]$

$$\hat{\mathcal{O}}[\vec{m}] = \sum_{\Lambda, M_\Lambda, \lambda, a_\lambda, \tau} C_{\vec{m}}^{\Lambda, M_\Lambda, \lambda, a_\lambda, \tau} \hat{\mathcal{O}}[\Lambda, M_\Lambda, \lambda, a_\lambda, \tau] \quad (120)$$

### 4.3.3 Fields carrying reps of product groups

Suppose the global symmetry group has the form  $G_1 \times G_2$ . We consider a field  $\Psi_{k,m}$  where  $k$  is an index transforming under irrep  $V_1$  of  $G_1$  and  $m$  transforms under irrep  $V_2$  of  $G_2$ . Consider the covariant operator

$$\mathcal{O}_{k_1, m_1; k_2, m_2; \dots; k_n, m_n} \equiv \Psi_{k_1, m_1} \otimes \Psi_{k_2, m_2} \otimes \cdots \otimes \Psi_{k_n, m_n} \quad (121)$$

Fields with  $n$  factors transform under the irrep  $(V_1 \otimes V_2)^{\otimes n}$ . With  $\sigma \in S_n$  acting simultaneously on  $V_1$  and  $V_2$ , the commutant of  $G_1 \times G_2$  contains  $S_n$ . The group  $G_1 \times G_2 \times S_n$  acts on the  $n$ -field composites. Correspondingly there is a decomposition of the  $n$ -fold tensor product into irreps. of  $G_1 \times G_2 \times S_n$ . The irreps are related to the product states as

$$|\Lambda_1, M_{\Lambda_1}, \Lambda_2, M_{\Lambda_2}, \lambda, a_\lambda, \tau\rangle = C_{\Lambda_1, M_{\Lambda_1}, \Lambda_2, M_{\Lambda_2}, \lambda, a_\lambda, \tau}^{\vec{k}, \vec{m}} \left| \vec{k}, \vec{m} \right\rangle \quad (122)$$

$\Lambda_1$  is an irrep of  $G_1$ ,  $\Lambda_2$  of  $G_2$  and  $\lambda$  of  $S_n$ . Conversely

$$\left| \vec{k}, \vec{m} \right\rangle = \sum_{\Lambda_1, M_{\Lambda_1}, \Lambda_2, M_{\Lambda_2}, \lambda, a_\lambda, \tau} C_{\vec{k}, \vec{m}}^{\Lambda_1, M_{\Lambda_1}, \Lambda_2, M_{\Lambda_2}, \lambda, a_\lambda, \tau} |\Lambda_1, M_{\Lambda_1}, \Lambda_2, M_{\Lambda_2}, \lambda, a_\lambda, \tau\rangle \quad (123)$$

In terms of vector spaces this decomposition is

$$(V_1 \otimes V_2)^{\otimes n} = \bigoplus_{\Lambda_1, \Lambda_2, \lambda} V_{\Lambda_1}^{G_1} \otimes V_{\Lambda_2}^{G_2} \otimes V_\lambda^{S_n} \otimes V_{\Lambda_1, \Lambda_2, \lambda}^{\text{Com}(G_1 \times G_2 \times S_n)} \quad (124)$$

$\tau$  labels the multiplicity space  $V_{\Lambda_1, \Lambda_2, \lambda}^{\text{Com}(G_1 \times G_2 \times S_n)}$ .

### 4.3.4 Product Clebsch in terms of single group Clebschs

Another way that we could organise  $(V_1 \otimes V_2)^{\otimes n}$ , in contrast to the  $G_1 \times G_2 \times S_n$  decomposition in (124), is in terms of the separate groups

$$\begin{aligned} (V_1 \otimes V_2)^{\otimes n} &= V_1^{\otimes n} \otimes V_2^{\otimes n} \\ &= \left( \bigoplus_{\Lambda_1, \lambda_1} V_{\Lambda_1}^{G_1} \otimes V_{\lambda_1}^{S_n} \otimes V_{\Lambda_1, \lambda_1}^{\text{Com}(G_1 \times S_n)} \right) \otimes \left( \bigoplus_{\Lambda_2, \lambda_2} V_{\Lambda_2}^{G_2} \otimes V_{\lambda_2}^{S_n} \otimes V_{\Lambda_2, \lambda_2}^{\text{Com}(G_2 \times S_n)} \right) \end{aligned}$$

We use the Clebsch  $C_{\vec{k}}^{\Lambda_1, M_{\Lambda_1}, \lambda_1, a_{\lambda_1}, \tau_1}$  for  $G_1$  and  $C_{\vec{m}}^{\Lambda_2, M_{\Lambda_2}, \lambda_2, a_{\lambda_2}, \tau_2}$  for  $G_2$ . Given the simultaneous action of  $S_n$  on  $(V_1 \otimes V_2)^{\otimes n}$ , to connect this decomposition with that in (124) we tensor together the two  $S_n$  irreps  $V_{\lambda_1}^{S_n}$  and  $V_{\lambda_2}^{S_n}$  to get the irrep of the simultaneous  $S_n$  action  $V_{\lambda}^{S_n}$

$$V_{\lambda_1}^{S_n} \otimes V_{\lambda_2}^{S_n} = \bigoplus_{\lambda} V_{\lambda}^{S_n} C(\lambda_1, \lambda_2; \lambda) \quad (125)$$

$C(\lambda_1, \lambda_2; \lambda)$  counts the number of times  $V_{\lambda}^{S_n}$  appears in the  $S_n$  tensor product  $V_{\lambda_1}^{S_n} \otimes V_{\lambda_2}^{S_n}$ . This construction shows us how to write down the relation between the  $G_1 \times G_2 \times S_n$  Clebsch and the  $(G_1 \times S_n) \times (G_2 \times S_n)$  Clebschs

$$C_{\vec{k}, \vec{m}}^{\Lambda_1, M_{\Lambda_1}, \Lambda_2, M_{\Lambda_2}, \lambda, a_{\lambda}, \tau} = C_{\vec{k}}^{\Lambda_1, M_{\Lambda_1}, \lambda_1, a_{\lambda_1}, \tau_1} C_{\vec{m}}^{\Lambda_2, M_{\Lambda_2}, \lambda_2, a_{\lambda_2}, \tau_2} S^{\hat{\tau}' \lambda \begin{smallmatrix} \lambda_1 & \lambda_2 \\ a_{\lambda} & a_{\lambda_1} & a_{\lambda_2} \end{smallmatrix}} \quad (126)$$

The  $S_n$  Clebsch-Gordan coefficient  $S^{\hat{\tau}' \lambda \begin{smallmatrix} \lambda_1 & \lambda_2 \\ a_{\lambda} & a_{\lambda_1} & a_{\lambda_2} \end{smallmatrix}}$  gives the change of basis for the decomposition in (125); it maps the states of the reps in  $V_{\lambda_1}^{S_n} \otimes V_{\lambda_2}^{S_n}$  to those in  $V_{\lambda}^{S_n}$ .  $\hat{\tau}'$  labels the  $C(\lambda_1, \lambda_2; \lambda)$  degeneracy. The  $\tau$  which labels the product group commutant  $V_{\Lambda_1, \Lambda_2, \lambda}^{\text{Com}(G_1 \times G_2 \times S_n)}$  is now a combination of the separate group multiplicities and the  $S_n$  tensor label  $\hat{\tau}'$ :  $\tau = (\tau_1, \tau_2, \hat{\tau}')$ .

$$V_{\Lambda_1, \Lambda_2, \lambda}^{\text{Com}(G_1 \times G_2 \times S_n)} = \bigoplus_{\lambda_1, \lambda_2} V_{\Lambda_1, \lambda_1}^{\text{Com}(G_1 \times S_n)} \otimes V_{\Lambda_2, \lambda_2}^{\text{Com}(G_2 \times S_n)} C(\lambda_1, \lambda_2; \lambda) \quad (127)$$

### 4.3.5 Invariant operators

Now that we have organised the fundamental fields into representations of the global symmetry group  $G$ , we reintroduce the  $U(N)$  gauge group adjoint indices to the fields

$$(W_{m_1})_{j_1}^{i_1} \otimes \cdots \otimes (W_{m_n})_{j_n}^{i_n} \quad (128)$$

Instead of tracing with an element  $\alpha \in S_n$  and then Fourier transforming to an  $S_n$  and  $U(N)$  representation  $R$ , as we did for  $G = U(K)$  in Section 4.1.3, we shall pursue a more abstract and revealing path here.

Treat (128) just as we would for the product group  $G \times U(N) \times U(N)$  in Section 4.3.3. Just as we organised the  $\vec{m}$  into representations of  $G$ , we can organise the fundamental indices  $\vec{i}$  and anti-fundamental indices  $\vec{j}$  into representations of  $U(N)$  to get

$$C_{R, M_R, p}^{\vec{i}} C_{\bar{S}, M_S, q}^{\vec{j}} (W_{m_1})_{j_1}^{i_1} \otimes \cdots \otimes (W_{m_n})_{j_n}^{i_n} \quad (129)$$

We recall that for  $U(N)$  Schur-Weyl duality the same Young diagram  $R$  labels the  $U(N)$  and  $S_n$  representation.  $M_R$  is the  $U(N)$  state of  $R$  and  $p$  is the  $S_n$  state of  $R$ .  $\bar{S}$  is the ‘anti-holomorphic’  $U(N)$  representation made from tensoring together anti-fundamental indices.  $R$  and  $\bar{S}$  transform simultaneously under  $U(N)$ , so it is really a  $U(N)$  tensor product  $R \circ \bar{S}$ . For a complete discussion of  $U(N)$  representations that

include holomorphic and anti-holomorphic parts, see [65].

To get a gauge-invariant operator we must pick out the singlet in the  $U(N)$  tensor product  $R \circ \bar{S}$ . This forces  $S = R$  and we must sum over  $M_R = M_S$

$$\sum_{M_R} C_{R, M_R, p}^{\vec{i}} C_{R, M_R, q}^{\vec{j}} = \frac{1}{n!} \sum_{\alpha \in S_n} D_{pq}^R(\alpha) \delta_{i_{\alpha(1)}}^{j_1} \cdots \delta_{i_{\alpha(n)}}^{j_n} \quad (130)$$

See Appendix Section G for a proof of this formula. Using this we recover the Fourier transform analogous to (66)

$$\frac{1}{n!} \sum_{\alpha \in S_n} D_{pq}^R(\alpha) \text{tr}(\alpha W_{m_1} \otimes W_{m_2} \otimes \cdots \otimes W_{m_n}) \quad (131)$$

Including the Clebsch-Gordan for  $G \times S_n$  we then combine the  $S_n$  representations into the invariant trivial representation  $[n]$ , because the fundamental fields are bosons transforming in  $\text{Sym}(V_F \otimes V_N \otimes V_{\bar{N}})^{\otimes n}$ , to get our final gauge-invariant operator

$$\mathcal{O}[\Lambda, M, \lambda, \tau, R, \hat{\tau}] \equiv S^{\hat{\tau}} \begin{matrix} [n] \\ \lambda \\ a \end{matrix} \begin{matrix} R \\ p \\ q \end{matrix} C_{\Lambda, M, \lambda, a, \tau}^{\vec{m}} C_{R, M_R, p}^{\vec{i}} C_{R, M_R, q}^{\vec{j}} (W_{m_1})_{j_1}^{i_1} \otimes \cdots \otimes (W_{m_n})_{j_n}^{i_n} \quad (132)$$

$\hat{\tau}$  labels the number of times the representation  $[n]$  appears in the symmetric group tensor product  $\lambda \otimes R \otimes R$ , or equivalently the number of times  $\lambda$  appears in  $R \otimes R$ . This can also be written as the trace of the covariant operator (111)

$$\begin{aligned} \mathcal{O}[\Lambda, M, \lambda, \tau, R, \hat{\tau}] &= S^{\hat{\tau}} \begin{matrix} \lambda \\ a \\ p \\ q \end{matrix} \begin{matrix} R \\ R \\ q \end{matrix} \frac{1}{n!} \sum_{\alpha \in S_n} D_{pq}^R(\alpha) \text{tr}(\alpha \hat{\mathcal{O}}[\lambda, M, \lambda, a, \tau]) \\ &= S^{\hat{\tau}} \begin{matrix} \lambda \\ a \\ p \\ q \end{matrix} \begin{matrix} R \\ R \\ q \end{matrix} \frac{1}{n!} \sum_{\alpha \in S_n} D_{pq}^R(\alpha) \sum_{\vec{m}} C_{\Lambda, M, \lambda, a, \tau}^{\vec{m}} \text{tr}(\alpha W_{m_1} \otimes \cdots \otimes W_{m_n}) \end{aligned} \quad (133)$$

Completeness follows just as for the  $U(K)$  case discussed in Section 4.1.5, by inverting all these group theory transformations.

#### 4.3.6 Diagonality

The diagonality of these operators in the free two-point function follows almost immediately from the fact that we have decomposed the space

$$\text{Sym}(V_F \otimes V_N \otimes V_{\bar{N}})^{\otimes n} \quad (134)$$

orthogonally into representations of  $G \times U(N) \times S_n$ . We will find, if we choose appropriate spacetime coordinates,

$$\boxed{\langle \mathcal{O}[\Lambda, M, \lambda, \tau, R, \hat{\tau}] \mathcal{O}[\Lambda', M', \lambda', \tau', R', \hat{\tau}] \rangle = n! d_\lambda \text{Dim} R \delta_{\Lambda\Lambda'} \delta_{MM'} \delta_{\lambda\lambda'} \delta_{\tau\tau'} \delta_{RR'} \delta_{\hat{\tau}\hat{\tau}'}} \quad (135)$$

To see it explicitly, consider the free two-point function of two operators (132) at general positions. Sum over all possible permutations of Wick contractions of the fundamental fields.

$$\begin{aligned} & \left\langle : (W_{m_1})_{j_1}^{i_1}(x) \cdots (W_{m_n})_{j_n}^{i_n}(x) : : (W_{m'_1})_{j'_1}^{i'_1}(x') \cdots (W_{m'_n})_{j'_n}^{i'_n}(x') : \right\rangle \\ &= \sum_{\sigma \in S_n} \prod_{k=1}^n \left\langle (W_{m_k})_{j_k}^{i_k}(x) (W_{m'_{\sigma(k)}})_{j'_{\sigma(k)}}^{i'_{\sigma(k)}}(x') \right\rangle \end{aligned} \quad (136)$$

Now use the  $S_n$  invariance of the operator when we contract the fields with the Clebsch-Gordan coefficients to remove the  $\sigma$  sum

$$\begin{aligned} & \langle \mathcal{O}[\Lambda, M, \lambda, \tau, R, \hat{\tau}](x) \mathcal{O}[\Lambda', M', \lambda', \tau', R', \hat{\tau}](x') \rangle \\ &= S^{\hat{\tau}} \begin{matrix} \lambda & R & R \\ a & p & q \end{matrix} C_{R, M_R, p}^{\vec{i}} C_{R, M_R, q}^{\vec{j}} C_{\Lambda, M, \lambda, a, \tau}^{\vec{m}} S^{\hat{\tau}'} \begin{matrix} \lambda' & R' & R' \\ a' & p' & q' \end{matrix} C_{R', M'_{R'}, p'}^{\vec{i}' } C_{R', M'_{R'}, q'}^{\vec{j}' } C_{\Lambda', M', \lambda', a', \tau'}^{\vec{m}'} \\ & n! \prod_{k=1}^n \left\langle (W_{m_k})_{j_k}^{i_k}(x) (W_{m'_k})_{j'_k}^{i'_k}(x') \right\rangle \end{aligned} \quad (137)$$

Next, if we move the fields to opposite poles of  $S^4$  we can use the Zamolodchikov metric to remove the spacetime dependence of the propagator

$$\left\langle (W_m)_j^i (W_n)_l^k \right\rangle = \delta_{mn} \delta_l^i \delta_j^k \quad (138)$$

For the full operators this gives

$$\begin{aligned} & \langle \mathcal{O}[\Lambda, M, \lambda, \tau, R, \hat{\tau}] \mathcal{O}[\Lambda', M', \lambda', \tau', R', \hat{\tau}] \rangle \\ &= n! S^{\hat{\tau}} \begin{matrix} \lambda & R & R \\ a & p & q \end{matrix} C_{R, M_R, p}^{\vec{i}} C_{R, M_R, q}^{\vec{j}} C_{\Lambda, M, \lambda, a, \tau}^{\vec{m}} S^{\hat{\tau}'} \begin{matrix} \lambda' & R' & R' \\ a' & p' & q' \end{matrix} C_{R', M'_{R'}, p'}^{\vec{i}' } C_{R', M'_{R'}, q'}^{\vec{j}' } C_{\Lambda', M', \lambda', a', \tau'}^{\vec{m}'} \\ &= n! \delta_{\Lambda\Lambda'} \delta_{MM'} \delta_{\lambda\lambda'} \delta_{\tau\tau'} S^{\hat{\tau}} \begin{matrix} \lambda & R & R \\ a & p & q \end{matrix} S^{\hat{\tau}'} \begin{matrix} \lambda' & R' & R' \\ a' & p' & q' \end{matrix} C_{R, M_R, p}^{\vec{i}} C_{R', M'_{R'}, q'}^{\vec{j}' } C_{R, M_R, q}^{\vec{j}} C_{R', M'_{R'}, p'}^{\vec{i}' } \end{aligned} \quad (139)$$

In the final line we have contracted the  $G \times S_n$  Clebsch-Gordan coefficients. Next contract the  $U(N) \times S_n$  coefficients

$$\begin{aligned} & \langle \mathcal{O}[\Lambda, M, \lambda, \tau, R, \hat{\tau}] \mathcal{O}[\Lambda', M', \lambda', \tau', R', \hat{\tau}] \rangle \\ &= n! \delta_{\Lambda\Lambda'} \delta_{MM'} \delta_{\lambda\lambda'} \delta_{\tau\tau'} \delta_{RR'} \delta_{M_R M'_{R'}} \delta_{M_R M'_{R'}} S^{\hat{\tau}} \begin{matrix} \lambda & R & R \\ a & p & q \end{matrix} S^{\hat{\tau}'} \begin{matrix} \lambda' & R' & R' \\ a' & q & p \end{matrix} \\ &= n! \delta_{\Lambda\Lambda'} \delta_{MM'} \delta_{\lambda\lambda'} \delta_{\tau\tau'} \delta_{RR'} \delta_{\hat{\tau}\hat{\tau}'} \delta_{M_R M_R} \delta_{aa} \\ &= n! d_\lambda \text{Dim} R \delta_{\Lambda\Lambda'} \delta_{MM'} \delta_{\lambda\lambda'} \delta_{\tau\tau'} \delta_{RR'} \delta_{\hat{\tau}\hat{\tau}'} \end{aligned} \quad (140)$$

In the first line we have used orthogonality relation (466) for the  $S_n$  Clebsch-Gordan coefficients  $S$ ; in the final line we have used  $\sum_{a_\lambda} = d_\lambda$  and  $\sum_{M_R} = \text{Dim}R$ .

We recover the two-point function at generic spacetime points by translating the operator insertions from the poles of  $S^4$ . Compare this result to the  $U(K)$  diagonalisation (71), which differs only up to a normalisation factor.

### 4.3.7 Finite $N$ counting

To show that these operators count correctly at finite  $N$  we argue exactly as we did for  $G = U(K)$  in Section 4.1.7. We count the appearance of the character  $\chi_\Lambda^G(\mathbf{x})$  in the finite  $N$  partition function

$$\mathcal{Z} = \int [dU] \exp \left\{ \sum_{m=1}^{\infty} \frac{1}{m} f(\mathbf{x}^m) \text{tr}(U^\dagger)^m \text{tr} U^m \right\} \quad (141)$$

$f(\mathbf{x})$  is the character of the fundamental representation  $V_F^G$ . For  $U(K)$  it is

$$f(\mathbf{x}^m) = x_1^m + x_2^m + \cdots + x_K^m \quad (142)$$

and for  $SL(2)$ , as a non-compact example, it is

$$f(q^m) = \frac{q^m}{1 - q^m} \quad (143)$$

(the  $SL(2)$  character and parameter  $q$  are explained in Section 4.4.4).

Performing the same steps as in Section 4.1.7 we find

$$\mathcal{Z} = \sum_n \sum_{R(U(N))} \sum_{C_i \in S_n} \prod_{j=1}^n (f(\mathbf{x}^j))^{i_j} \frac{1}{j^{i_j} i_j!} \chi_R(C_i) \chi_R(C_i) \quad (144)$$

Now if we treat  $\mathbf{x}$  as a diagonal matrix (for  $U(3)$  we have  $(x_1, x_2, x_3)$  on the diagonal, for  $SL(2)$  we have  $(q, q^2, q^3, \dots)$ ) and use

$$\prod_{j=1}^n (f(\mathbf{x}^j))^{i_j} = \text{tr}(C_i \mathbf{x}) = \sum_{\lambda(S_n)} \chi_{\Lambda_1}(C_i) \chi_\lambda(\mathbf{x}) \quad (145)$$

then we get

$$\mathcal{Z} = \sum_n \sum_{R(U(N))} \sum_{\lambda(S_n)} \chi_\lambda(\mathbf{x}) C(R, R, \lambda) \quad (146)$$

where  $C(R, R, \lambda)$  is the number of possible  $\hat{\tau}$  multiplicities, i.e. the number of times  $\lambda$  appears in the symmetric group tensor product  $R \otimes R$ . As representations of  $U(N)$ , we only sum over Young diagrams  $R$  with at most  $N$  rows.

We have treated the global symmetry group here as  $GL(\infty)$ . A further decomposition

into irreps. of  $G$  gives

$$V_\lambda^{GL(\infty)} = \sum_\Lambda V_\Lambda^G \otimes V_{\Lambda,\lambda} \quad (147)$$

When we do this we finally see that the operators in (132) provide this counting

$$\mathcal{Z} = \sum_n \sum_{R(U(N))} \sum_{\Lambda(G)} \sum_{\lambda(S_n)} d_{\Lambda,\lambda} \chi_\Lambda(\mathbf{x}) C(R, R, \lambda) \quad (148)$$

where  $\chi_\Lambda(\mathbf{x})$  is now a  $G$  character and  $d_{\Lambda,\lambda}$  is the dimension of  $V_{\Lambda,\lambda}$  labelled by the  $\tau$  index.

#### 4.4 $SL(2)$

We consider the  $SL(2)$  sector which we can view as a reduction of  $\mathcal{N} = 4$  SYM to a sector with a single light-cone derivative of the complex scalar  $X$ . We choose  $\partial \equiv (\partial_0 + \partial_3)/2$ . The number of fundamental fields is now infinite<sup>7</sup>  $V_F = \{X, \partial X, \partial^2 X, \dots\}$  and we have

$$W_m = \partial^m X \quad (149)$$

for  $m = 0, 1, 2, \dots$

Elements of the tensor product  $V_F^{\otimes n}$  are

$$\partial^{m_1} X \otimes \dots \otimes \partial^{m_n} X \quad (150)$$

We want to organise these into representations of  $SL(2)$  and  $S_n$ , with primaries (lowest weight states) of  $SL(2)$  distinguished from their descendants.

##### 4.4.1 Oscillator construction

The oscillator representation allows an elegant method of constructing primary fields in the  $SL(2)$  sector [75, 76]. By using this representation we can find the Clebsch-Gordan coefficients associated with the  $SL(2) \times S_n$  decomposition. It will turn out that in addition to the groups  $SL(2)$  and  $S_n$  another symmetric group will play an interesting role. It is  $S_k$  where  $k$  is the number of derivatives required to construct the lowest weight state.

The  $SO(4, 2)$  conformal algebra is given by

$$\begin{aligned} [M_{ab}, P_c] &= \eta_{bc} P_a - \eta_{ac} P_b, & [M_{ab}, K_c] &= \eta_{bc} K_a - \eta_{ac} K_b, \\ [M_{ab}, M_{cd}] &= \eta_{bc} M_{ad} - \eta_{ac} M_{bd} + \eta_{ad} M_{bc} - \eta_{bd} M_{ac}, \\ [D, P_a] &= P_a, & [D, K_a] &= -K_a, & [K_a, P_b] &= 2\eta_{ab} D - 2M_{ab} \end{aligned} \quad (151)$$

---

<sup>7</sup>Although these are our fundamental fields, they transform in the spin  $-\frac{1}{2}$  irrep, not the finite fundamental spin  $\frac{1}{2}$  irrep.

The  $SL(2)$  sector in terms of the conformal generators can be chosen as

$$L_+ = \frac{1}{2}(P_0 + P_3) \quad L_- = \frac{1}{2}(K_0 - K_3) \quad L_0 = \frac{1}{2}(D - M_{03}) \quad (152)$$

giving

$$[L_-, L_+] = 2L_0, \quad [L_0, L_\pm] = \pm L_\pm \quad (153)$$

This algebra may be represented using oscillators as

$$L_+ = a^\dagger + a^\dagger a^\dagger a, \quad L_0 = \frac{1}{2} + a^\dagger a, \quad L_- = a \quad (154)$$

where  $[a, a^\dagger] = 1$ . The lowest weight state of the representation  $V_F$  is denoted  $|0\rangle$  and is annihilated by all the lowering oscillators  $L_- = a$ . It can straightforwardly be checked that the raising operators  $L_+$  then act on the lowest weight state as

$$(L_+)^k |0\rangle = k! (a^\dagger)^k |0\rangle \quad \leftrightarrow \quad \partial^k X \quad (155)$$

By the operator-state correspondence, the operator on the RHS above acts on the CFT vacuum at the origin in radial quantization to give a state. Hence we have a map from oscillator states used in the representation theory of  $SL(2)$  to states in radial quantization. Dual states in the oscillator Hilbert space map to states at the dual vacuum (at infinity) in radial quantization.

$$\langle 0|L_-^k = \langle 0|a^k \quad \leftrightarrow \quad \partial^k X^\dagger \quad (156)$$

In a similar way we can represent the tensor product  $V_F^{\otimes n}$  by considering  $n$  independent oscillators  $a_i, i = 1, \dots, n$ . In this space the action of the diagonal  $SL(2)$  is obtained by summing over  $n$ , as in equation (106)

$$\mathbf{L}_+ = \sum_i (a_i^\dagger + a_i^\dagger a_i^\dagger a_i), \quad \mathbf{L}_0 = \frac{1}{2}n + \sum_i a_i^\dagger a_i, \quad \mathbf{L}_- = \sum_i a_i \quad (157)$$

The relation between the oscillator states and the field states is

$$\prod_{l=1}^n (a_l^\dagger)^{k_l} |0\rangle \quad \leftrightarrow \quad \frac{1}{k_1! k_2! \dots k_n!} \partial^{k_1} X \otimes \partial^{k_2} X \otimes \dots \otimes \partial^{k_n} X \quad (158)$$

The lowest weights (primaries) are annihilated by  $\mathbf{L}_- = \sum_i a_i$ . It is an easy exercise with the commutation relation  $[a_i, a_j^\dagger] = \delta_{ij}$  to show that the lowest weight states at level  $L_0 = n + k$  can be generated by  $k$ -oscillator states obtained as products of differences  $(a_i^\dagger - a_j^\dagger)$  acting on the vacuum. The simplest example is at  $n = 2$  where the lowest



weight states are all of the form

$$\mathcal{O}_k = (a_1^\dagger - a_2^\dagger)^k |0\rangle \quad (159)$$

Expanding out the oscillators and using (158) we find the corresponding operators in field space

$$\mathcal{O}_k \sim \sum_{j=0}^k \binom{k}{j}^2 (-1)^{k-j} \partial^j X \otimes \partial^{k-j} X \quad (160)$$

These are conformal higher spin currents, first constructed in [77].

If we exchange  $a_1^\dagger$  and  $a_2^\dagger$  in (159), or correspondingly exchange the operators in the first and second lots in (160), the operator is symmetric for  $k$  even and antisymmetric for  $k$  odd. When  $k$  is even the operator is transforming in the symmetric representation [2] of  $S_2$ , while when  $k$  is odd, it transforms in the antisymmetric [1, 1].

#### 4.4.2 $S_n$ action on the oscillators

The generalisation from  $n = 2$  to arbitrary  $n$  requires some additional knowledge about the transformations under  $S_n$ .

The action of  $\sigma \in S_n$  on  $V_F^{\otimes n}$  is extremely simple for the oscillators, because  $\sigma$  just exchanges the sites on which the oscillators act

$$a_i^\dagger \rightarrow a_{\sigma(i)}^\dagger \quad (161)$$

The  $a_i$  transform in an  $n$ -dimensional representation of  $S_n$  called the ‘natural’ representation, which we write  $V_{\text{nat}}^{S_n}$ . This representation reduces to two irreps of  $S_n$

$$V_{\text{nat}}^{S_n} = V_{[n]}^{S_n} \oplus V_{[n-1,1]}^{S_n} \quad (162)$$

$[n]$  is the trivial representation, given by the sum of all the oscillators which transforms trivially under  $\sigma \in S_n$ :  $\sum_i a_i^\dagger \rightarrow \sum_i a_i^\dagger$ .  $[n-1, 1]$  is the  $(n-1)$ -dimensional ‘hook’ representation, which is a linear combination of the  $n-1$  differences of oscillators  $a_i^\dagger - a_j^\dagger$ . We shall denote the hook representation by  $V_H$  for convenience.

By removing the trivial representation  $[n]$  from every appearance of  $a_i^\dagger$  (corresponding to the action of  $\mathbf{L}_+$ ) we guarantee that we have excluded  $SL(2)$  descendants. The hook representation of oscillators can then be used to build the lowest weight states.

The change of basis from the  $a_i$  to the hook representation is given by

$$A_h^\dagger = \sum_{i=1}^n J_h^i a_i^\dagger \quad (163)$$

where  $J_h^i$  takes us from the natural representation of  $S_n$  on  $n$  objects (labelled by the index  $i$ ) to the  $n-1$  dimensional  $H = [n-1, 1]$  representation for which we will choose the

orthonormal basis (labelled by the index  $h$ ). The matrix  $J$  will thus have the following properties

$$J_h^{\sigma(i)} = D_{hh'}^H(\sigma) J_{h'}^i \quad (164)$$

$$J_h^i J_{h'}^i = \delta_{hh'} \quad (165)$$

where we use the summation convention and  $D_{ab}^H(\sigma)$  is the orthogonal representing matrix for the hook representation of  $S_n$ . Explicitly we find

$$A_h^\dagger = \frac{1}{\sqrt{h(h+1)}} \left( a_1^\dagger + \dots a_h^\dagger - h a_{h+1}^\dagger \right) \quad (166)$$

The details of the  $S_n$  action on  $A_h^\dagger$ , and its relation to the orthogonal representing matrix of the hook representation  $D_{hh'}^H(\sigma)$ , are given in Appendix Section I.

So for  $k$  oscillators (corresponding to  $k$  derivatives) we build primaries using the  $A_h^\dagger$

$$A_{h_1}^\dagger \dots A_{h_k}^\dagger |0\rangle \quad (167)$$

Because the  $a_i^\dagger$  all commute, so do the  $A_h^\dagger$ . This means that the object  $A_{h_1}^\dagger \dots A_{h_k}^\dagger$  transforms in the  $\text{Sym}(V_H^{\otimes k})$  of  $S_n$ . As follows from our usual story of Schur-Weyl diagonality, this is a particular case of the decomposition

$$V_H^{\otimes k} = \bigoplus_{\lambda \vdash n, \kappa \vdash k} V_\lambda^{S_n} \otimes V_\kappa^{S_k} \otimes V_{\lambda, \kappa} \quad (168)$$

The particular case for  $\text{Sym}(V_H^{\otimes k})$  is when the representation of  $S_k$  is trivial, i.e.  $\kappa = [k]$ , the symmetric representation. Note the two different symmetric group actions on  $V_H^{\otimes k}$ :  $S_n$  acting on the separate  $V_H$  (like  $G$  for the general case), while  $S_k$  permutes the separate  $V_H$ .

This means that we can decompose  $\text{Sym}(V_H^{\otimes k})$  into irreps  $\lambda$  of  $S_n$  using the Clebsch-Gordan coefficients for the decomposition in (168)

$$C_{\lambda, a_\lambda, \kappa=[k], \tau}^{h_1 \dots h_k} A_{h_1}^\dagger \dots A_{h_k}^\dagger |0\rangle \quad (169)$$

where  $\tau$  labels the  $V_{\lambda, \kappa}$  multiplicity. Formulae for this multiplicity are given in Section 4.4.4. The basic properties of these Clebsch-Gordan coefficients are outlined here.

Firstly, because they transform in the trivial of  $S_k$ , for  $\rho \in S_k$

$$C_{\lambda, a_\lambda, \kappa=[k], \tau}^{h_{\rho(1)} \dots h_{\rho(k)}} = C_{\lambda, a_\lambda, \kappa=[k], \tau}^{h_1 \dots h_k} \quad (170)$$

Secondly, because it transforms overall as  $\lambda$  under  $\sigma \in S_n$ , this is equivalent to acting on the separate  $V_H$  with  $\sigma \in S_n$

$$C_{\lambda, a, \kappa=[k], \tau}^{h_1 \dots h_k} D_{h_1 h'_1}^H(\sigma) \dots D_{h_k h'_k}^H(\sigma) = D_{aa'}^\lambda(\sigma) C_{\lambda, a', \kappa=[k], \tau}^{h'_1 \dots h'_k} \quad (171)$$

Finally, just like in previous decompositions, we have orthogonality for fixed  $\kappa = [k]$

$$\sum_{\vec{h}} C_{\lambda, a, \kappa=[k], \tau}^{h_1 \dots h_k} C_{h_1 \dots h_k}^{\lambda', a', \kappa=[k], \tau'} = \delta_{\lambda \lambda'} \delta_{a a'} \delta_{\tau \tau'} \quad (172)$$

To get the  $SL(2)$  descendants of these lowest weight operators we have a raising operator  $\mathbf{L}_+$  (see equation (157)) corresponding to a space-time derivative. Acting on the lowest weight state we obtain the descendant operator

$$\mathcal{O}[\Lambda = n + k, M_\Lambda, \lambda, a_\lambda, \tau] = (\mathbf{L}_+)^{M_\Lambda} C_{\lambda, a_\lambda, [k], \tau}^{h_1 \dots h_k} A_{h_1}^\dagger \dots A_{h_k}^\dagger |0\rangle \quad (173)$$

Combined with the identification in (158) this completes our decomposition of  $V_F^{\otimes n}$  into representations of  $SL(2) \times S_n$ .  $M_\Lambda$  runs over the infinite number of descendants of the lowest weight state and  $\tau$  indexes the  $V_{\Lambda, \lambda}$  multiplicity.

#### 4.4.3 Metric and diagonality

The two-point function of fundamental fields in the  $SL(2)$  sector is

$$\langle \partial^{k_1} X_j^{\dagger i}(x) \partial^{k_2} X_l^k(0) \rangle = \frac{(-1)^{k_1} (k_1 + k_2 + 1)!}{x^{2+k_1+k_2}} \delta_l^i \delta_j^k \quad (174)$$

For  $\mathcal{N} = 4$  SYM on  $\mathbb{R}^4$ , taking our two operators to zero and infinity (corresponding to opposite poles of the conformally equivalent  $S^4$ ) gives the metric we need for diagonality (138)

$$\langle \partial^{k_1} X_j^{\dagger i}(x' = 0) \partial^{k_2} X_l^k(x = 0) \rangle = \delta^{k_1 k_2} (k_1!)^2 \delta_l^i \delta_j^k \quad (175)$$

where  $x' = x/x^2$  is the coordinate patch around the north pole and  $x$  around the south. This technique is well known from studies of conformal field theories in two dimensions and the above is known as the Zamolodchikov metric (see [78][79] for a general account and Section 8.4.2 for another application to  $\mathcal{N} = 4$  SYM). Note that this metric on operators is defined using space-time dependent two-point functions but is itself independent of spacetime. Knowing the metric for arbitrary derivatives allows a reconstruction of the spacetime dependence.

Dropping gauge indices and focusing on the  $SL(2)$  indices, the metric (175) agrees with the oscillator inner product

$$\langle 0 | a_i^{k_1} a_j^{\dagger k_2} | 0 \rangle = \delta^{k_1 k_2} \delta_{ij} k_1! \quad (176)$$

once we take into account the normalisation in (155). More directly we can also calculate it using the  $SL(2)$  algebra once we use the fact that  $L_-$  is the hermitian conjugate of  $L_+$  in radial quantization.

To demonstrate the diagonality of the lowest weight states constructed in Section

4.4.2 use the generalisation of the oscillator metric (176)

$$\langle 0 | a_{i_1} a_{i_2} \dots a_{i_k} a_{j_1}^\dagger a_{j_2}^\dagger \dots a_{j_k}^\dagger | 0 \rangle = \sum_{\rho \in S_k} \delta_{i_1 j_{\rho(1)}} \dots \delta_{i_k j_{\rho(k)}} \quad (177)$$

The diagonality follows straightforwardly from the properties of the Clebsch-Gordan coefficient in (170) and (172); see Section 2.3 of [60] for more detail.

#### 4.4.4 Multiplicity

We want to work out the multiplicity of  $SL(2) \times S_n$  representations in the decomposition

$$(V_F^{SL(2)})^{\otimes n} = \bigoplus_{\Lambda, \lambda} V_{\Lambda=n+k}^{SL(2)} \otimes V_\lambda^{S_n} \otimes V_{\Lambda, \lambda} \quad (178)$$

This multiplicity is the dimension of  $\dim V_{\Lambda, \lambda} \equiv d_{\Lambda, \lambda}$ .

We begin by considering the multiplicities of  $SL(2)$  irreps in  $V_F^{\otimes n}$  which includes a sum over  $S_n$  irreps.

$$V_F^{\otimes n} = \bigoplus_{k \geq 0} m(k, n) V_{n+k} \quad (179)$$

where

$$m(k, n) = \sum_{\lambda(S_n)} d_\lambda d_{\Lambda, \lambda} \quad (180)$$

The states  $\partial^l X$  in  $V_F$  have weights  $L_0 = 1 + l$ , with  $l$  going up to infinity. They form a lowest weight discrete series irrep  $V_1 = V_F$ . Similar discrete series irreps exist for any  $k$ , i.e.  $V_k$ . We wish to find the tensor product decomposition of  $V_1^{\otimes n}$  in terms of the irreps.  $V_k$ . This can be derived by characters. The character of the irrep.  $V_k$  is

$$\chi_k(q) := Tr_{V_k}(q^{L_0}) = q^k \sum_{l=0}^{\infty} q^l = \frac{q^k}{(1-q)} \quad (181)$$

For the tensor product  $V_1^{\otimes n}$  we get the character

$$\begin{aligned} (\chi_1(q))^n &= \frac{q^n}{(1-q)} \frac{1}{(1-q)^{n-1}} \\ &= \frac{q^n}{(1-q)} \sum_{k \geq 0} \frac{(n-2+k)!}{k!(n-2)!} q^k \\ &= \sum_{k \geq 0} \chi_{n+k}(q) m(k, n) \end{aligned} \quad (182)$$

where we have defined

$$m(k, n) = \frac{(n-2+k)!}{k!(n-2)!} \quad (183)$$

Now if we want to fine-grain and compute the multiplicity of the  $SL(2) \times S_n$  rep-

representations  $\Lambda \times \lambda$ , by the oscillator construction we must find the multiplicity of  $V_\lambda$  of  $S_n$  in  $\text{Sym}(V_H^{\otimes k})$ . Equivalently this is the multiplicity of the representation  $\lambda \otimes [k]$  of  $S_n \times S_k$  in  $V_H^{\otimes k}$ , where  $[k]$  denotes the Young diagram of  $S_k$  with a single row of length  $k$  which is the symmetric representation. The projectors  $P_\lambda \otimes P_{[k]}$  can be written down using characters of symmetric groups. Hence we have

$$\begin{aligned} d_{\Lambda=n+k,\lambda} &= \frac{1}{d_\lambda d_{[k]}} \text{tr}_{V_H}(P_\lambda \otimes P_{[k]}) \\ &= \frac{1}{n!} \sum_{\sigma \in S_n} \chi_\lambda(\sigma) \frac{1}{k!} \sum_{\tau \in S_k} \chi_{[k]}(\tau) \prod_i (\text{tr}_{V_H}(\sigma^i))^{c_i(\tau)} \end{aligned} \quad (184)$$

$c_i(\tau)$  is the number of cycles in  $\tau$  of length  $i$ . See Appendix Section B.10 for further details on the hook representation and its character. See Appendix Section J for computer code to work out this multiplicity. Generating functions for this multiplicity are given in Appendix Section F.

#### 4.5 $SO(2, 4)$

A Schur-Weyl decomposition for  $SO(2, 4)$  can be carried out using the oscillator construction used above for  $SL(2)$ , details of which will appear in [61]. For  $SO(2, 4)$  we have a scalar field  $X$  with all four spacetime derivatives acting on it. A new complication is that the equations of motion must be enforced.

Generalizing the linear combinations  $A_h^\dagger$  of oscillators which generate the lowest weights in the  $SL(2)$  sector, we now have  $A_{h\mu}^\dagger$  where  $\mu$  is an index in the fundamental of  $SO(4) \subset SO(4, 2)$  and as before  $h$  is in the hook representation  $V_H = [n-1, 1]$  of  $S_n$ . Lowest weights annihilated by  $K_\mu$ , with  $k$  derivatives acting on  $n$ -field composites can be constructed from oscillators of the form

$$A_{h_1\mu_1}^\dagger A_{h_2\mu_2}^\dagger \cdots A_{h_k\mu_k}^\dagger |0\rangle \quad (185)$$

The simplest class of such LWS are those in which the indices  $(\mu_1, \mu_2, \dots, \mu_k)$  are taken to be a symmetric traceless  $SO(4)$  tensor corresponding to the  $SO(4)$  Young diagram  $[k]$ . These states satisfy a type of extremality condition  $L_0 = n + k$ . More generally we will have states of the form (185) which involve contractions of the  $\mu_i$ . In these cases we have to mod out by the equations of motion  $\eta^{\mu_1\mu_2} \partial_{\mu_1} \partial_{\mu_2} X$  on a single field, which leads to a projection of the  $\text{Sym}(V_H \otimes V_H)$  representation of  $\eta^{\mu_1\mu_2} A_{h_1\mu_1}^\dagger A_{h_2\mu_2}^\dagger$  to the  $S_n$  representation  $[n-2, 2]$ . This has dimension  $\frac{n(n-3)}{2}$  which is the number obtained by subtraction of  $n$ , for the equations of motion, from the dimension  $\frac{n(n-1)}{2}$  of  $\text{Sym}(V_H \otimes V_H)$ . Work on a complete solution of the diagonalisation in this sector, using the above facts to give a symmetric group description of the  $SO(4, 2) \times S_n$  Clebsch-Gordans, is in progress [61]. It is clear that the symmetric  $SO(4)$  operators involving the contractions will have  $L_0 > n + k$ . The ‘extremal’ operators mentioned above will be useful in the comparison to excitations of half-BPS giants in Section 4.9.

### 4.6 $SO(6)$

We have 6 hermitian scalar matrices in  $\mathcal{N} = 4$  SYM, transforming in the fundamental of  $SO(6)$ . We know from the general discussion in Section 4.3 that the  $SO(6)$  covariant diagonalisation of free field correlators will be solved once we have solved the Clebsch-Gordan problem for  $SO(6) \times S_n$  in  $V^{\otimes n}$ . Here  $V$  is the fundamental of  $SO(6)$ .

$$\begin{aligned} V^{\otimes n} &= \bigoplus_{\lambda} V_{\lambda}^{GL(6)} \otimes V_{\lambda}^{S_n} \\ &= \bigoplus_{\lambda, \Lambda} V_{\pi(\Lambda)}^{SO(6)} \otimes V_{\lambda, \Lambda} \otimes V_{\lambda}^{S_n} \end{aligned} \quad (186)$$

We first decompose the  $n$ -fold tensor space according to the  $S_n$  symmetry. The Schur-Weyl dual of  $S_n$  is  $GL(6)$  hence the decomposition in the first line. In the second line, we decompose the  $GL(6)$  representations to  $SO(6)$  representations. The dimension of the multiplicity space  $V_{\lambda, \Lambda}$  is given by

$$\text{Dim} V_{\lambda, \Lambda} = \sum_{\delta} g(\Lambda, 2\delta; \lambda) \quad (187)$$

$\lambda$  is a Young diagram with  $n$  boxes,  $2\delta$  is a partition with even parts, i.e. a Young diagram with even row lengths. The sum above includes a sum over  $k \geq 0$ , where  $2k$  is the number of boxes in  $2\delta$  and  $n - 2k$  is the number of boxes in  $\Lambda$ .

The representations of  $GL(6)$  are labelled by Young diagrams with row lengths  $\lambda_1 \geq \lambda_2 \geq \dots \geq \lambda_6 \geq 0$ . The representations of  $SO(6)$  are labelled by  $\lambda_1 \geq \lambda_2 \geq |\lambda_3| \geq 0$ . The last label  $\lambda_3$  can be positive or negative. For  $\lambda_3 = 0$  the irreps are constructed by symmetrising according to the Young diagram and projecting out traces. When  $|\lambda_3| > 0$  the corresponding operation of Young-symmetrising and removing traces leaves us with a reducible representation, which is a direct sum of irreps.  $(\lambda_1, \lambda_2, \lambda_3) \oplus (\lambda_1, \lambda_2, -\lambda_3)$ . The operation  $\pi$  which appears in (186), when it acts on any  $GL(6)$  Young diagram  $\Lambda_1$  gives either zero or a Young diagram obeying the  $SO(6)$  constraints. It is defined in terms of an operation on Young diagrams in [80].

We have arrived above at the  $SO(6) \times S_n$  decomposition by first decomposing into  $GL(6) \times S_n$ , then reducing the  $GL(6)$  to  $SO(6)$ . We can equally start by decomposing in terms of  $SO(6) \times E_6(n)$  where  $E_6(n)$  is the commutant of  $SO(6)$  in  $V^{\otimes n}$  described for example in [74]. A subsequent decomposition of  $E_6(n)$  to  $S_n$  should yield the same result as (186). This follows from general theorems on double commutants which assert that if  $A$  is a subalgebra of  $B$ , and  $\text{End}(B) \subset \text{End}(A)$  are their commutants in some vector space, then the reduction multiplicities for irreps of  $B \rightarrow A$  coincide with those of  $\text{End}(A) \rightarrow \text{End}(B)$  (see [81]). In this case the reduction multiplicities of  $GL(6) \rightarrow SO(6)$  coincide with those of  $E_6(n) \rightarrow S_n$ .

### 4.7 The higher spin group

The free theory of  $\mathcal{N}=4$  SYM is invariant under an infinite dimensional group  $HS(2, 2|4)$  known as the higher spin group. In the interacting theory this is broken to the superconformal group  $SU(2, 2|4)$  but it can nevertheless be useful for some applications (e.g. possible relations via AdS/CFT to a possible ‘tensionless limit’ of string theory) to consider this enlarged group. When restricted to the  $SL(2)$  sector the higher spin group is known as  $HS(1, 1)$ . Operators form lowest weight representations of  $HS(1, 1)$  (which further decompose into an infinite number of lowest weight representations of  $SL(2)$ .) The lowest weight states of these representations were described in [76]. In terms of the oscillators introduced in Section 4.4.1, the higher spin algebra is spanned by the generators

$$J_{p,q} = \sum_i (a_i^\dagger)^p (a_i)^q \quad (188)$$

which contains the  $SL(2)$  algebra (157).

If we have fundamental fields corresponding to the states  $|m\rangle = (a^\dagger)^m |0\rangle$  then the higher spin group is equivalent to  $U(\infty)$ . Therefore the results of the  $U(K)$  Section 4.1 generalise naturally to the higher spin case. Irreducible representations of the higher spin group are specified by Young diagrams,  $\lambda$ , (as observed in [76]). We have

$$V_F^{\otimes n} = \bigoplus_{\lambda \vdash n} V_\lambda^{HS(1,1)} \otimes V_\lambda^{S_n} \quad (189)$$

$$= \bigoplus_{\lambda, \Lambda} V_\Lambda^{SL(2)} \otimes V_{\Lambda, \lambda}^{\text{Com}(SL(2) \times S_n)} \otimes V_\lambda^{(S_n)} \quad (190)$$

The first line is the standard Schur-Weyl duality for  $U(K)$  in the limit  $K \rightarrow \infty$ . Each higher spin representation  $\lambda$  then decomposes further into an  $SL(2)$  irrep  $\Lambda$  and the commutant.

### 4.8 Matrix models for free theory

There is a complex multi-matrix model obtained by reducing the free action for the scalars of 4D  $\mathcal{N} = 4$  SYM on  $S^3 \times R$

$$\int dt \sum_a \text{tr} \partial_t X_a \partial_t X_a^\dagger + \text{tr} X_a X_a^\dagger \quad (191)$$

For a single complex matrix this model was discussed and solved in [19] (see also [82, 83, 84]). For the multi-matrix case it is possible to build up an analogous Hamiltonian and states corresponding to the labels on the gauge-invariant operators constructed above (see Section 7.3 of [59]). Higher conserved charges should be able to distinguish these labels. In [85] the authors used enhanced global non-Abelian symmetries at zero coupling to study this phenomenon further. Generalised Casimirs constructed from the iterated

commutator action of these enhanced symmetries resolve all the multiplicity labels of the bases of matrix operators which diagonalise the two-point function.

#### 4.9 Worldvolume excitation of giant gravitons

In this section we analyse the spectrum of small non-BPS vibrations of giant gravitons, comparing our gauge theory results with those of the bulk analysis in [86]. The properties of standard half-BPS giant gravitons branes were explained in Section 2.6.1.

##### 4.9.1 Worldvolume excitations: review and comments

We review and comment on some results from [86] on the worldvolume excitations of half-BPS giant gravitons. Consider 3-brane giants expanding in the  $AdS_5$ . Use coordinates  $(t, v_1, v_2, v_3, v_4)$  for the  $AdS$  where we have a metric

$$ds^2 = - \left( 1 + \sum_{k=1}^4 v_k^2 \right) dt^2 + L^2 \left( \delta_{ij} + \frac{v_i v_j}{(1 + \sum_k v_k^2)} \right) dv_i dv_j \quad (192)$$

$L$  is the  $AdS_5$  or  $S^5$ -radius. The  $S^5$  can be described in analogous coordinates

$$ds^2 = L^2 \left[ \left( 1 - \sum_{k=1}^4 y_k^2 \right) d\phi^2 + \left( \delta_{ij} + \frac{y_i y_j}{1 - \sum_k y_k^2} \right) dy_i dy_j \right] \quad (193)$$

In global coordinates the AdS metric is

$$ds^2 = - \left( 1 + \frac{r^2}{L^2} \right) dt^2 + \frac{dr^2}{\left( 1 + \frac{r^2}{L^2} \right)} + r^2 d\Omega_3^2 \quad (194)$$

It is also useful to write the  $S^5$  metric as

$$ds^2 = L^2 [d\theta^2 + \cos^2 \theta d\phi^2 + \sin^2 \theta d\Omega_3^2] \quad (195)$$

The  $AdS$  giant graviton  $D3$ -brane solution has

$$\begin{aligned} \phi &= \omega_0 t \\ \omega_0 &= \frac{1}{L} \\ P_\phi &= N \left( \frac{r_0}{L} \right)^2 \end{aligned} \quad (196)$$

and the half-BPS property guarantees the energy is  $E = \frac{P_\phi}{L}$ . The brane worldvolume coordinates are  $\tau, \sigma_1, \sigma_2, \sigma_3$ . The coordinate  $\tau$  is identified with the global time  $t$ . The  $\sigma_1, \sigma_2, \sigma_3$  are identified with angles in  $AdS$ .

The fluctuations are expanded as

$$r = r_0 + \epsilon \delta r(\tau, \sigma_1, \sigma_2, \sigma_3)$$



$$\begin{aligned}\phi &= \omega_0 \tau + \epsilon \delta\phi(\tau, \sigma_1, \sigma_2, \sigma_3) \\ y_k &= \epsilon \delta y_k(\tau, \sigma_1, \sigma_2, \sigma_3)\end{aligned}\tag{197}$$

These perturbations are expanded in spherical harmonics.

$$\begin{aligned}\delta r(\tau, \sigma_i) &= \tilde{\delta}r e^{-i\omega\tau} Y_l(\tau, \sigma_i) \\ \delta\phi(\tau, \sigma_i) &= \tilde{\delta}\phi e^{-i\omega\tau} Y_l(\tau, \sigma_i) \\ \delta y_k &= \tilde{\delta}y_k e^{-i\omega\tau} Y_l(\tau, \sigma_i)\end{aligned}\tag{198}$$

The  $(\phi, y_k)$  are coordinates for the sphere  $S^5$ . The  $Y_l$  are spherical harmonics on  $S^3 \subset AdS_5$ . They are symmetric traceless representations of  $SO(4)$ . They have a quadratic Casimir  $l(l+2)$  for the symmetric traceless representation of dimension  $(l+1)^2$ . The frequencies of these oscillations are calculated from the linearized equations of motion of the brane actions

$$S = S_{DBI} + S_{CS}\tag{199}$$

They lead (after a small simplification of expressions in [86]) to three solutions

$$\begin{aligned}\omega_- &= \frac{l}{L} \\ \omega_+ &= \frac{l+2}{L} \\ \omega &= \frac{l+1}{L}\end{aligned}\tag{200}$$

The modes with frequencies  $\omega_{\pm}$  are related to linear combinations  $\tilde{\delta}r, \tilde{\delta}\phi$ . The frequency  $\omega$  is related to four modes  $\tilde{\delta}y_k$  which transform in the fundamental of  $SO(4)$  in  $SO(6)$ . It is very interesting that these are all integer multiples of the AdS-scale and approach  $\omega = l/L$  in the large  $l$  limit. Note also that  $\omega$  is the frequency for oscillations in  $t$ , the global time of AdS. The energies of the fluctuating giant gravitons are given by  $E = \frac{n}{L} + \omega$  where  $n$  is the angular momentum of the background giant. The energy is related to scaling dimension in the dual CFT [14]. These energy spacings in integer units of  $\frac{1}{L}$  are precisely the sort of spacings we get in free Yang Mills theory. Taking large angular momentum limits as a way to reach a classical regime where strong and weak coupling can be compared directly is familiar from [87].

The  $Y_{l,m}$  are representations of  $SO(4)$ . Specifying the eigenvalues of the Cartan amounts to fixing two spins  $S_1, S_2$ . The  $SL(2)$  sector of gauge theory operators we considered, involving multitraces of  $\partial_{1+i2}^S X^n$  corresponds to rotations in a fixed plane. This means that in each space of spherical harmonics of given  $l$  we are looking at a single state. Now if we consider a second quantization in the field theory of the branes, we would introduce a Fock space generator  $\alpha_l^\dagger$  for each spherical harmonic. This has energy

$l/L$  above the background energy of the brane. General states look like

$$\alpha_1^\dagger{}^{k_1} \alpha_2^\dagger{}^{k_2} \cdots |0\rangle \quad (201)$$

The number of states at excitation energy  $k$  is the number of ways of writing  $k = k_1 + 2k_2 + \cdots = \sum_i ik_i$  which is the number of partitions of  $k$ . When we restore the full  $SO(4)$  we have states of the form

$$\alpha_{l_1, m_1}^\dagger \alpha_{l_2, m_2}^\dagger \cdots |0\rangle \quad (202)$$

In this case it is useful to restrict attention to the symmetric traceless representations  $[k]$  of  $SO(4)$  with excitation energy equal to  $k$ . In this case, the number of excited states of total energy  $L_0 = n + k$  is again given by partitions of  $k$ . In the discussion below we will show that there is an easy way to get these states from the gauge theory. In greater generality we should consider states of the form

$$\alpha_{l_1, m_1, I_1}^\dagger \alpha_{l_2, m_2, I_2}^\dagger \cdots |0\rangle \quad (203)$$

where  $I$ 's are indices running from 1 to 6 which label the six eigenmodes built from (198). Four of these are in the fundamental of  $SO(4) \subset SO(6)$ . The fact that the excitation energies are spaced in units of  $\frac{1}{L}$  (rather than in units of the brane size) was a bit of a surprise, discussed at length in [86]. An important point is that the kind of integer spacing in (200) is exactly what we have in the free Yang Mills limit of the dual CFT. We will see below that this Fock space structure of orthogonal states emerges from the construction of gauge invariant operators in the free dual Yang Mills theory. A connection between excited giant gravitons and the formulae for excitation energies (200) was made in [88]. The unravelling of the Fock space structure of giant graviton worldvolume field theory from gauge invariant operator counting given below is new.

#### 4.9.2 Comparison to gauge invariant operators

We have constructed, in Section 4.4, the lowest weights of the  $SL(2)$  sector by mapping states

$$A_{h_1}^\dagger A_{h_2}^\dagger \cdots A_{h_k}^\dagger |0\rangle \quad (204)$$

in an oscillator construction of  $SL(2)$  to gauge theory operators. The index  $h$  transforms in the hook representation  $[n-1, 1]$  of  $S_n$ . The  $A^\dagger$ 's are bosons so we are looking at the symmetric tensor product of the hook. These were constructed as lowest weight states generated by  $P_{1\bar{1}}$  which forms part of the  $SO(4, 2)$  conformal algebra. These excitations correspond to exciting one spin inside AdS (for more details on the geometry of multiple spins see for example [89] in the context of spinning strings), hence to states of the form (201). After describing how to lift this to more general  $SO(4, 2)$  states, we will show that the counting in the case of single giants agrees with the bulk analysis reviewed above.

Note for now that the above states transform in  $\text{Sym}(V_H^{\otimes k})$  of  $S_n$ .

When we consider the full  $SO(4, 2)$  symmetry, we have additional generators  $K_\mu$  forming the fundamental of  $SO(4)$ . Correspondingly we have  $P_\mu$  transforming in the fundamental of  $SO(4)$ . When we consider lowest weight states annihilated by all the  $K_\mu$ , we have states of the form

$$A_{h_1\mu_1}^\dagger A_{h_2\mu_2}^\dagger \cdots A_{h_k\mu_k}^\dagger |0\rangle \quad (205)$$

Among these LWS are those transforming in the symmetric traceless representation of  $SO(4)$  associated with the symmetric Young diagram  $[k]$  and with energy  $L_0 = n+k$ . As discussed in Section 4.5, these are a simple class of states which do not require projecting out of states due to the equations of motion, which require setting  $P_\mu P_\mu$  to zero.

Since the  $\mu$ 's are symmetrised, and the  $A^\dagger$  are bosons, the indices  $a_1, a_2, \dots, a_k$  are also symmetrised, i.e. we have the symmetric  $k$ -fold tensor power of the hook representation  $[n-1, 1]$  of  $S_n$ . Orthonormal states in this sector are then written as

$$C_{\mu_1 \cdots \mu_k}^{[k], M_{[k]}} C_{h_1 \cdots h_k}^{\lambda, a_\lambda, [k], \tau} A_{h_1\mu_1}^\dagger A_{h_2\mu_2}^\dagger \cdots A_{h_k\mu_k}^\dagger |0\rangle \quad (206)$$

The first Clebsches are for the symmetric traceless of  $SO(4)$  which are precisely the representations we discussed under (202). The second Clebsch have been discussed before in Section 4.4. They decompose the  $\text{Sym}(V_H^{\otimes k})$  into irreps. of  $\lambda$  of  $S_n$ . When we form gauge invariant operators as in Section 4.3.5 there are constraints relating  $\lambda$  to the  $U(N)$  Young diagram  $R$  which organises the traces. This representation  $R$  in the half-BPS case allows a map to the type of giant [19]. Young diagrams with a few (order 1) long (order  $N$  for example) columns map to sphere giants. Those with a few long rows map to AdS giants. Non-abelian worldvolume symmetries emerge when we have rows or columns of equal length. This map also works for open string excitations and there are elegant tests involving the counting of states which are sensitive to the presence of non-abelian symmetries [90, 91, 92, 93].

Consider Young diagrams of the form  $R = [n]$  which correspond to single AdS giants of angular momentum  $n$ . Recall that the gauge invariant operators are labelled by  $R, \Lambda_{n+k}, M, \lambda, \tau, \hat{\tau}$ .  $R$  is a  $U(N)$  irrep.  $\Lambda_{n+k}$  is the lowest weight of the  $SL(2)$  which is completely determined by the excitation energy  $l$ .  $M$  labels states in  $\Lambda_{n+k}$ .  $\lambda$  is an irrep. of  $S_n$ .  $\tau$  runs over the multiplicity of  $\lambda$  in the symmetric tensor product of the hook representation.  $\hat{\tau}$  runs from 1 to  $C(R, R, \lambda)$ . For fixed  $R$  the multiplicity of LWS is

$$\sum_{\lambda} C(R, R, \lambda) \text{Mult}(\text{Sym}(V_H^{\otimes k}), \lambda) \quad (207)$$

By summing over states for fixed  $R$  we can get excited states of a fixed type of giant worldvolume. In particular we are interested in  $R = [n]$ . The inner tensor product of  $R = [n]$  with itself only contains the identity rep.  $\lambda = [n]$ . So the number of lowest weights at level  $k$  is just the multiplicity of  $[n]$  in the symmetric tensor product of the

hook. We have a generating function for this derived in Appendix Section F. The generating function including the descendants is

$$\frac{1}{(1-q)(1-q^2)(1-q^3)\cdots(1-q^n)} \quad (208)$$

The coefficient of  $q^k$  is the number of partitions of  $k$  with no part bigger than  $n$ . Note that  $n$  is the number of boxes in the Young diagram describing the giant. For the semiclassical approximation of giant brane worldvolume to be valid, this is of order  $N^\alpha$  (for  $\alpha$  close to 1),  $k$  is the excitation on the brane worldvolume, which we are treating in a linearized approximation, so we certainly want that to be small compared to  $n$ . When  $k$  is smaller than  $n$ , the above just counts unrestricted partitions of  $k$ . This matches the counting of Fock space states in (206).

Hence, in the regime of interest, where  $k$  is much bigger than one (so we can expect GKP [87] type arguments to be valid) but smaller than the energy of the brane, the above counting of partitions of  $k$  is exactly what we are getting from quantizing a class of vibrations of the AdS giant. Using this emergence of Fock space structures from the counting of states in the tensor product of  $\text{Sym}(V_H^{\otimes k})$  we therefore find the correct counting of gauge theory operators which correspond to states of the form (201) and (202) with energy  $L_0 = n + k$  and with a single spin  $k$  in the case (201) or with  $SO(4)$  representation  $[k]$  for (202).

In fact we can also see where the six different species of oscillations could come from. In the above discussion we have been considering BPS giants built from Schur polynomials of  $X = X_1 + iX_2$  and then perturbed by replacing  $X$  with derivatives  $P_\lambda$  acting on  $X$ , of the form  $P_\lambda^* X$ . We could also consider powers of  $P_\lambda$  acting on  $X_i$  (with  $i = 3, 4, 5, 6$ ) replacing the  $X$ . And finally we can consider powers of  $P_\lambda$  acting on  $X^\dagger$  as the impurities. So in all we have six types of impurities  $P_\lambda^* X, P_\lambda^* X^\dagger, P_\lambda^* X_i$ . These correspond to six sets of gauge invariant operators matching states with the right energies of the form (201), which come, in the spacetime worldvolume analysis to exciting quanta of  $\delta r, \delta y_k, \delta \phi$  excitations. Given the simplicity of  $\omega_-$  we would expect that they correspond to the simplest construction in gauge theory, namely using  $P_\lambda^* X$  impurities, which they match precisely in energy. If we consider the states in (203) and restrict to the case where all the impurities are of the same type and the  $SO(4)$  representation is  $[k]$  with the energy being  $E = n + k$ , then the above discussion extends easily to give the corresponding gauge theory duals. A complete account of the case with mixed impurities will be left for the future.

### 4.9.3 Comments

There are many interesting extensions of the above discussion which could be considered. We have chosen the simplest  $R$  of the form  $[n]$  which correspond to AdS giants. If we consider  $R = [n_1, n_2]$  and sum over  $\lambda$  as in (207) this should correspond to excitations

in spacetime of multiple-giants described by a  $U(2)$  (if  $n_1 = n_2$ ) or  $U(1) \times U(1)$  (if  $n_1 \neq n_2$ ) worldvolume DBI gauge theory. A similar simple counting of states holds true for excitations of S-giants [86]. They will be associated to spherical harmonics of an  $SO(4)$  in the  $SO(6)$ . So we expect that excitations in the gauge theory from the  $SO(6)$  sector should also have this kind of free field counting in an appropriate large angular momentum limit. The  $SO(4) \subset SO(4,2)$  excitations considered in (206) also exist for  $R = [1^n]$ . They should correspond to excitations of sphere giants, but it is not obvious to us how a Fock space structure emerges from considering their motions in the transverse AdS. It will be interesting to clarify this puzzle.

Note that we are making here a comparison between zero coupling in Yang Mills to spacetime calculations dual to strong coupling Yang Mills. This works best for large angular momenta where  $l$  is large so that the frequencies can all be approximated by  $\omega = l$ , but smaller than  $n$  which is the large angular momentum of the giant. This gives a different context of excitations of giant gravitons, where the basic idea of large quantum numbers allowing strong to weak coupling comparisons [87] continues to apply. Here the parameters  $N, k, n$  are all large.

There have been earlier discussions of supersymmetric states obtained from the quantization of moduli spaces of giants and the comparison with gauge theory counting [94, 95, 96, 56]. In the discussion above we have been interested in all the excitations in the free theory of a given half-BPS giant. A subset of these will be supersymmetric but a lot of the states will be non-supersymmetric. We expect that, in analogy with discussions of semiclassical strings [87, 89] appropriate limits of large quantum numbers can be used to compare non-supersymmetric states. The new technical ingredient in the above treatment is the use of a diagonal basis of gauge theory operators at finite  $N$ , where the label  $R$  allows the identification of the giant in question, and additional global symmetry labels help the map to objects in spacetime. The use of symmetric group data in organising the multiplicities of states for fixed  $R$  and fixed global symmetry quantum numbers shows the emergence, in the limit of large  $n$ , of Fock space counting from properties of symmetric group decompositions such as  $\text{Sym}(V_H^{\otimes n})$ . At finite  $n$  we have a cut-off Fock space.

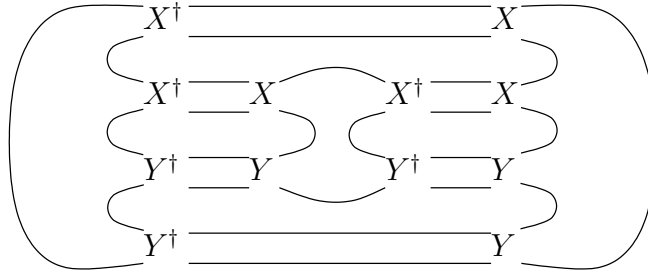

Figure 4: A planar one-loop diagram for a part of the two-point function between  $\text{tr}(XXYY)$  and  $\text{tr}(X^\dagger X^\dagger Y^\dagger Y^\dagger)$  with the  $\text{tr}(YXX^\dagger Y^\dagger)$  effective vertex; note this leading  $N^{4+1}$  behaviour.

## 5 Mixing at one loop

In this section we compute the one-loop mixing of the finite  $N$  basis constructed above, first for the  $U(2)$  subsector then for the full  $PSU(2, 2|4)$  group in Section 5.6. We find that operators only mixing if their  $U(N)$  Young diagrams are related by moving a single box (see equation (236)). A goal of future research is to use these results to find the finite  $N$  eigenstates of the dilatation operator. It is believed that the 16th-BPS operators annihilated by the dilatation operator remain the same at strong coupling [97, 56], so can be compared to black hole solutions in the bulk for  $\Delta \sim N^2$ . It is exactly the non-planar degrees of freedom we discuss here that are needed to furnish the  $N^2$  entropy of these black holes. Planar degrees of freedom are not enough [55].

### 5.1 The $U(2)$ subsector

By re-arranging the multi-trace operators of  $\mathcal{N} = 4$  using representation theory we have shown that the free two-point function becomes diagonal. In this section we will explore how much of this structure survives at one loop. It will turn out that the mixing is highly constrained, with operators only mixing if their  $U(N)$  Young diagrams are related by moving a single box.

For example, suppose we have two operators whose multi-trace structures are organised by the two  $U(N)$  representations with  $n = 4$  boxes  $\begin{array}{|c|c|} \hline \square & \square \\ \hline \square & \square \\ \hline \end{array}$  and  $\begin{array}{|c|c|c|} \hline \square & \square & \square \\ \hline \square & \square & \square \\ \hline \end{array}$  (these would not mix at zero coupling). We can obtain  $\begin{array}{|c|c|c|} \hline \square & \square & \square \\ \hline \square & \square & \square \\ \hline \end{array}$  from  $\begin{array}{|c|c|} \hline \square & \square \\ \hline \square & \square \\ \hline \end{array}$  by moving the box at the bottom right of  $\begin{array}{|c|c|} \hline \square & \square \\ \hline \square & \square \\ \hline \end{array}$  up onto the top row. Furthermore, the  $N$ -dependence of their one-loop mixing matrix is given by the unitary group dimension of  $T = \begin{array}{|c|c|c|} \hline \square & \square & \square \\ \hline \square & \square & \square \\ \hline \end{array}$ , the  $(n + 1)$ -box representation into which both  $\begin{array}{|c|c|} \hline \square & \square \\ \hline \square & \square \\ \hline \end{array}$  and  $\begin{array}{|c|c|c|} \hline \square & \square & \square \\ \hline \square & \square & \square \\ \hline \end{array}$  and fit (see this example in Appendix Section E). For large  $N$  the leading behaviour is  $\text{Dim}T \sim kN^{n+1}$ , which is what we expect for the one-loop result (see for example Figure 4).

To compute the one-loop mixing we must follow permutations and double-line index loops [2] carefully. We make extensive use of the representation theory methods and the diagrammatic techniques introduced in [19] and [48].

In this section we will focus on operators built out of two of the complex scalars of  $\mathcal{N} = 4$  supersymmetric Yang-Mills,  $X$  and  $Y$ , which is a  $U(2) \subset SU(4) \subset PSU(2, 2|4)$  subsector of the full global symmetry group of the theory. This subsector is a useful preliminary case, because it is closed at one-loop.

Following the conventions set in Section 4.1 for  $U(K)$ , for  $U(2)$  the basic multi-trace object built out of  $\mu_1$   $X$ 's and  $\mu_2$   $Y$ 's is

$$\text{tr}(\alpha X^{\mu_1} Y^{\mu_2}) \quad (209)$$

At one loop we get corrections from the self-energy, the scalar four-point vertex and the exchange of a gluon. Cancellations among these corrections mean that the one-loop correlator is given by an effective vertex [98][99]<sup>8</sup> which is just the  $F$ -term scalar vertex

$$\left\langle \text{tr}(\alpha_2 X^{\dagger\mu_1} Y^{\dagger\mu_2}) : \text{tr}([X, Y][X^\dagger, Y^\dagger]) : \text{tr}(\alpha_1 X^{\mu_1} Y^{\mu_2}) \right\rangle \quad (210)$$

For convenience we have dropped a  $-\frac{g_{\text{YM}}^2}{8\pi}$  prefactor and the spacetime dependence  $\log(x\Lambda)^{-2}/x^{2n}$  for some cutoff  $\Lambda$ . The expression between colons  $::$  is normal-ordered so that no contractions within the colons is allowed.

## 5.2 $U(2)$ Dilatation operator

Given that  $\langle X_j^{\dagger i} X_l^k \rangle = \tilde{X}_j^i X_l^k = \delta_l^i \delta_j^k$  where  $\tilde{X}_j^i = \frac{d}{dX_j^i}$  we can get the bare one-loop correlator by first acting on  $\text{tr}(\alpha X^{\mu_1} Y^{\mu_2})$  with the one-loop dilatation operator [99][100][101][104]

$$\Delta^{(1)} = \text{tr}([X, Y][\tilde{X}, \tilde{Y}]) \quad (211)$$

We will break up the action of the dilatation operator on (209) into small pieces.

First consider the action of  $\text{tr}(XY\tilde{X}\tilde{Y})$  on the two-site gauge-covariant object

$$X_{j_1}^{i_1} Y_{j_2}^{i_2} \quad (212)$$

Applying the derivatives

$$\text{tr}(XY\tilde{X}\tilde{Y}) X_{j_1}^{i_1} Y_{j_2}^{i_2} = X_k^{i_2} Y_{j_1}^k \delta_{j_2}^{i_1} \quad (213)$$

The crucial step is to represent this diagrammatically and see that it requires the introduction of a third additional index, two permutations and a trace over one of the indices. See Figure 5. Appendix D briskly introduces the diagrammatic formalism we use; compare to Figures 1 and 2 and the discussion in Section 2.7. If we do this we find

$$\text{tr}(XY\tilde{X}\tilde{Y}) X_{j_1}^{i_1} Y_{j_2}^{i_2} = C_3 [ (132) X Y \mathbb{I}_N (132) ] \quad (214)$$

<sup>8</sup>From here onwards we will drop the spacetime dependence of the correlators and focus on the combinatorial parts. We will use a convention whereby  $\langle \cdot \cdot \cdot \rangle$  means the tree-level correlator.

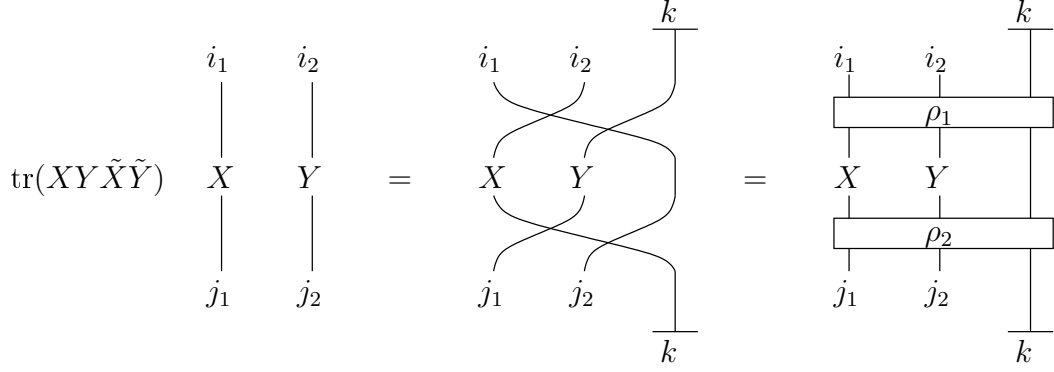

Figure 5: The action of part of the dilatation operator on two sites. The horizontal bars for  $k$  mean that you identify the top and bottom bars to form a closed traced loop.

$\mathbb{I}_N$  is the extra index; (132) is a permutation;  $C_3$  means trace over the third index. For a general tensor  $T_{j_1 j_2 j_3}^{i_1 i_2 i_3}$

$$C_3 \left[ T_{j_1 j_2 j_3}^{i_1 i_2 i_3} \right] = T_{j_1 j_2 k}^{i_1 i_2 k} \quad (215)$$

Now adding the other three parts of the dilatation operator we find similarly

$$\text{tr}([X, Y][\tilde{X}, \tilde{Y}]) X_{j_1}^{i_1} Y_{j_2}^{i_2} = \sum_{\rho_1, \rho_2 \in S_3} f(\rho_1, \rho_2) C_3 [\rho_2 X Y \mathbb{I}_N \rho_1] \quad (216)$$

$f(\rho_1, \rho_2)$  only takes non-zero values on four sets of  $\{\rho_1, \rho_2\}$ , corresponding to the four parts of the dilatation operator

$$\begin{aligned} f((132), (132)) &= 1 \\ f((13), (23)) &= -1 \\ f((23), (13)) &= -1 \\ f((123), (123)) &= 1 \end{aligned} \quad (217)$$

We can write this in a more symmetric fashion that better reflects the commutator structure of the one-loop dilatation operator

$$\begin{aligned} f((13), (23)) &= -1 \\ f((12)(13), (23)(12)) &= 1 \\ f((12)(13)(12), (12)(23)(12)) &= -1 \\ f((13)(12), (12)(23)) &= 1 \end{aligned} \quad (218)$$

This will be useful later.

Now consider the action of the dilatation operator on the general trace operator (209)

$$X_{i_{\alpha(1)}}^{i_1} \cdots X_{i_{\alpha(\mu_1)}}^{i_{\mu_1}} Y_{i_{\alpha(\mu_1+1)}}^{i_{\mu_1+1}} \cdots Y_{i_{\alpha(n)}}^{i_n} \quad (219)$$



Using the product rule we must sum over all the  $\mu_1$   $X$ 's and  $\mu_2$   $Y$ 's on which the derivatives can act. To write this easily, fix the  $X, Y, \mathbb{I}_N$  index on which the  $S_3$  acts to be  $\{\mu_1, n, n+1\}$  instead of  $\{1, 2, 3\}$ . Then sum over the cyclic group  $\mathbb{Z}_{\mu_1} \times \mathbb{Z}_{\mu_2}$  so that we hit all possible pairs of  $X$  and  $Y$

$$\begin{aligned} \text{tr}([X, Y][\tilde{X}, \tilde{Y}]) \text{tr}(\alpha X^{\mu_1} Y^{\mu_2}) = \\ \sum_{\sigma \in \mathbb{Z}_{\mu_1} \times \mathbb{Z}_{\mu_2}} \sum_{\rho_1, \rho_2 \in S_3} f(\rho_1, \rho_2) \text{tr}_{n+1}(\sigma \rho_1 \sigma^{-1} \alpha \sigma \rho_2 \sigma^{-1} X^{\mu_1} Y^{\mu_2} \mathbb{I}_N) \end{aligned} \quad (220)$$

Here we now have

$$\begin{aligned} f((\mu_1, n+1), (n, n+1)) &= -1 \\ f((\mu_1, n), (\mu_1, n+1), (n, n+1), (\mu_1, n)) &= 1 \\ f((\mu_1, n), (\mu_1, n+1), (\mu_1, n), (\mu_1, n), (n, n+1), (\mu_1, n)) &= -1 \\ f((\mu_1, n+1), (\mu_1, n), (\mu_1, n), (n, n+1)) &= 1 \end{aligned} \quad (221)$$

We can cycle around the  $\sigma$  at the front so it kills the last  $\sigma^{-1}$ . Furthermore, since the group  $S_{\mu_1-1} \times S_{\mu_2-1}$  permuting indices  $\{1, \dots, \mu_1-1\}$  and  $\{\mu_1+1, \dots, \mu_1+\mu_2-1\}$  separately commutes with  $\rho_1, \rho_2 \in S_3$ , we can extend the sum over  $\mathbb{Z}_{\mu_1} \times \mathbb{Z}_{\mu_2}$  to a sum over  $S_{\mu_1} \times S_{\mu_2}$  as long as we divide out by the redundancy

$$\frac{\mu_1 \mu_2}{\mu_1! \mu_2!} \sum_{\sigma \in S_{\mu_1} \times S_{\mu_2}} \sum_{\rho_1, \rho_2 \in S_3} f(\rho_1, \rho_2) \text{tr}_{n+1}(\rho_1 \sigma^{-1} \alpha \sigma \rho_2 X^{\mu_1} Y^{\mu_2} \mathbb{I}_N) \quad (222)$$

We can see that this extra index gives an enhancement by a factor of  $N$  when a loop forms, see Figure 6. This happens when  $\sigma^{-1} \alpha_1 \sigma$  maps  $\mu_1 + \mu_2 \mapsto \mu_1$  or  $\mu_1 \mapsto \mu_1 + \mu_2$ , i.e. when  $X$  and  $Y$  are next to each other in a trace  $\text{tr}(\dots XY \dots)$ . This is well-studied in the planar context where this contribution dominates and the model is exactly solvable by the Bethe Ansatz (see for example [24][105][25]). In the non-planar context the trace structure of the operator is still modified when  $\sigma^{-1} \alpha_1 \sigma$  does not satisfy this condition, and traces can split and join (see for example [106]).

### 5.3 $U(2)$ One-loop correlator

To get the one-loop correlator we take the zero-coupling correlator of  $\text{tr}(\alpha_2 X^{\dagger \mu_1} Y^{\dagger \mu_2})$  with the image of  $\text{tr}(\alpha_1 X^{\mu_1} Y^{\mu_2})$  under the one-loop dilatation operator

$$\begin{aligned} \left\langle \text{tr}(\alpha_2 X^{\dagger \mu_1} Y^{\dagger \mu_2}) : \text{tr}([X, Y][X^\dagger, Y^\dagger]) : \text{tr}(\alpha_1 X^{\mu_1} Y^{\mu_2}) \right\rangle \\ = \frac{\mu_1 \mu_2}{\mu_1! \mu_2!} \sum_{\sigma \in S_{\mu_1} \times S_{\mu_2}} \sum_{\rho_1, \rho_2 \in S_3} f(\rho_1, \rho_2) \left\langle \text{tr}(\alpha_2 X^{\dagger \mu_1} Y^{\dagger \mu_2}) \text{tr}_{n+1}(\rho_1 \sigma^{-1} \alpha_1 \sigma \rho_2 X^{\mu_1} Y^{\mu_2} \mathbb{I}_N) \right\rangle \end{aligned}$$

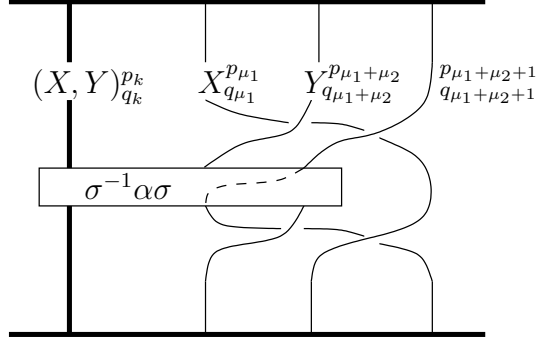

Figure 6: An example of how the extra index allows an index loop to form, giving an  $N$  enhancement.

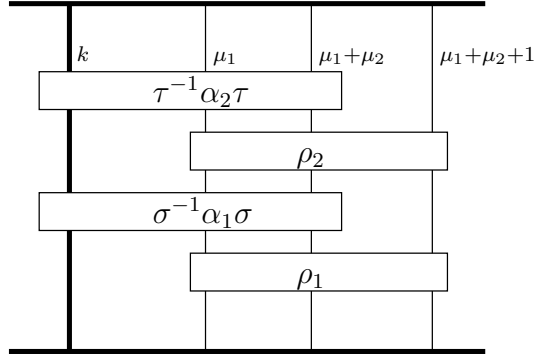

Figure 7: One-loop correlator.

Now Wick contract, permuting with  $\tau \in S_{\mu_1} \times S_{\mu_2}$  for all the possible combinations between the  $X$ 's and  $Y$ 's

$$\frac{\mu_1 \mu_2}{\mu_1! \mu_2!} \sum_{\sigma, \tau \in S_{\mu_1} \times S_{\mu_2}} \sum_{\rho_1, \rho_2 \in S_3} f(\rho_1, \rho_2) \text{tr}(\rho_1 \sigma^{-1} \alpha_1 \sigma \rho_2 \tau^{-1} \alpha_2 \tau \mathbb{I}_N^{n+1}) \quad (223)$$

See Figure 7 for the diagrammatic representation of this trace. We can expand it in characters of  $S_{n+1}$  and dimensions of  $U(N)$   $(n+1)$ -box representations using (495)

$$\begin{aligned} & \left\langle \text{tr}(\alpha_2 X^{\dagger \mu_1} Y^{\dagger \mu_2}) : \text{tr}([X, Y][X^{\dagger}, Y^{\dagger}]) : \text{tr}(\alpha_1 X^{\mu_1} Y^{\mu_2}) \right\rangle \\ &= \frac{\mu_1 \mu_2}{\mu_1! \mu_2!} \sum_{\sigma, \tau \in S_{\mu_1} \times S_{\mu_2}} \sum_{\rho_1, \rho_2 \in S_3} f(\rho_1, \rho_2) \sum_{T \vdash n+1} \chi_T(\rho_1 \sigma^{-1} \alpha_1 \sigma \rho_2 \tau^{-1} \alpha_2 \tau) \text{Dim} T \quad (224) \end{aligned}$$

#### 5.4 Operator mixing

Operator mixing between single- and multi-trace operators at one-loop has been well studied (see for example [107][108][109][110][99]). Here we will consider the mixing of a the basis of operators we have constructed in Section 4.1, which is diagonal at tree level.

We recall from Section 4.1.3 that the basis is given by a linear combination of the

traces

$$\begin{aligned} \mathcal{O}[\Lambda, M, R, \hat{\tau}] &\equiv \frac{1}{(n!)^2} \sum_{\alpha, \sigma \in S_n} B_{b\beta} S_{a \ p \ q}^{\hat{\tau}, \Lambda \ R \ R} D_{ab}^\Lambda(\sigma) D_{pq}^R(\alpha) \text{tr}(\alpha \sigma X^{\mu_1} Y^{\mu_2} \sigma^{-1}) \\ &= \frac{1}{n!} \sum_{\alpha \in S_n} B_{a\beta} S_{a \ p \ q}^{\hat{\tau}, \Lambda \ R \ R} D_{pq}^R(\alpha) \text{tr}(\alpha X^{\mu_1} Y^{\mu_2}) \end{aligned} \quad (225)$$

The equality follows from identity (468). Here  $\Lambda$  labels the  $U(2)$  representation and  $M = [\mu, \beta]$  labels the state within  $\Lambda$ .  $R$  labels the  $U(N)$  representation, which dictates the multi-trace structure of the operator.  $\hat{\tau}$  labels the number of times  $\Lambda$  appears in the symmetric group tensor product  $R \otimes R$  (also called the inner product).  $S_{a \ p \ q}^{\hat{\tau}, \Lambda \ R \ R}$  is the  $S_n$  Clebsch-Gordan coefficient for this tensor product. From the unitary group perspective  $S$  blends the global symmetry  $U(2)$  with the gauge symmetry  $U(N)$ .  $D_{pq}^R(\alpha)$  is the real orthogonal Young-Yamanouchi  $d_R \times d_R$  matrix for the representation  $R$  of the symmetry group  $S_n$ . It is constructed in Chapter 7 of Hamermesh [102] following the presentation by Yamanouchi [103].

At zero coupling these operators are diagonal, see Section 4.1.6.

Now consider the one-loop correlator

$$\left\langle \mathcal{O}^\dagger[\Lambda_2, M_2, R_2, \hat{\tau}_2] : \text{tr}([X, Y][X^\dagger, Y^\dagger]) : \mathcal{O}[\Lambda_1, M_1, R_1, \hat{\tau}_1] \right\rangle \quad (226)$$

*A priori* we know that the one-loop dilatation operator will not mix the  $U(2)$  representations labelled by  $\Lambda$  and the states within those representations labelled by  $[\mu_1, \mu_2, \beta]$  because the one-loop dilatation operator commutes with the classical generators of  $U(2)$  (and indeed of the full classical superconformal group [75])<sup>9</sup>. There is however no reason why the  $U(N)$  representations  $R$  controlling the multi-trace structure shouldn't mix and we will now analyse this using our one-loop result (224).

The first thing we notice is that for a general function of a permutation  $f(\alpha)$  the coefficients in front of the operator can absorb conjugation by  $S_{\mu_1} \times S_{\mu_2}$ , using properties of the Clebsch-Gordan coefficient  $S$  and the branching coefficient  $B$  (described in detail in Section 4.1.2)

$$\frac{1}{n!} \sum_{\alpha \in S_n} B_{a\beta} S_{a \ p \ q}^{\hat{\tau}, \Lambda \ R \ R} D_{pq}^R(\alpha) \sum_{\sigma \in S_{\mu_1} \times S_{\mu_2}} f(\sigma^{-1} \alpha \sigma) = \frac{\mu_1! \mu_2!}{n!} \sum_{\alpha \in S_n} B_{a\beta} S_{a \ p \ q}^{\hat{\tau}, \Lambda \ R \ R} D_{pq}^R(\alpha) f(\alpha) \quad (227)$$

so that for the one-loop correlator (224) we can absorb the  $S_{\mu_1} \times S_{\mu_2}$  sums<sup>10</sup>.

Thus if we concentrate on the  $U(N)$  representation parts of equations (224) and

<sup>9</sup>We thank Sanjaye Ramgoolam for discussions on this point.

<sup>10</sup>Another way of understanding this is that  $\alpha \mapsto \sigma^{-1} \alpha \sigma$  for  $\sigma \in S_{\mu_1} \times S_{\mu_2}$  is a symmetry of the operator  $\text{tr}(\alpha X^{\mu_1} Y^{\mu_2})$ .

(226) we find

$$\sum_{\alpha_1, \alpha_2 \in S_n} D_{p_1 q_1}^{R_1}(\alpha_1) D_{p_2 q_2}^{R_2}(\alpha_2) \sum_{T \vdash n+1} \chi_T(\rho_1 \alpha_1 \rho_2 \alpha_2) \text{Dim} T \quad (228)$$

If we expand the character, which is just a trace of  $S_{n+1}$  representing matrices for  $T$ , we get

$$\sum_{\alpha_1, \alpha_2 \in S_n} D_{p_1 q_1}^{R_1}(\alpha_1) D_{p_2 q_2}^{R_2}(\alpha_2) \sum_{T \vdash n+1} D_{ab}^T(\rho_1) D_{bc}^T(\alpha_1) D_{cd}^T(\rho_2) D_{da}^T(\alpha_2) \text{Dim} T \quad (229)$$

We can pick out the sum over  $\alpha_1$  say

$$\sum_{\alpha_1 \in S_n} D_{p_1 q_1}^{R_1 \vdash n}(\alpha_1) D_{bc}^{T \vdash n+1}(\alpha_1) \quad (230)$$

$\alpha_1$  is in the  $S_n$  subgroup of  $S_{n+1}$ . As a representation of  $S_n$  the representation  $T$  is reducible. It reduces to those  $n$ -box representations of  $S_n$  whose Young diagrams differ by a box from  $T$ . Consider the example used in Chapter 7 of Hamermesh [102]

$$T \left| \begin{array}{c} \text{[Young Diagram of } T \text{]} \\ \hline S_{18} \subset S_{19} \end{array} \right. \rightarrow T_1 \oplus T_3 \oplus T_4 \oplus T_5 \quad (231)$$

The index  $r$  of  $T_r$  labels the row from which the box was removed from  $T$ . This direct product structure is manifest for the representation matrices constructed by Young and Yamanouchi, where the matrix  $D^T$  is block-diagonal for elements of the subgroup  $\sigma \in S_n \subset S_{n+1}$ . For example (231)

$$D^{T \vdash n+1}(\sigma) = \begin{pmatrix} D^{T_1 \vdash n}(\sigma) & & & \\ & D^{T_3 \vdash n}(\sigma) & & \\ & & D^{T_4 \vdash n}(\sigma) & \\ & & & D^{T_5 \vdash n}(\sigma) \end{pmatrix} \quad (232)$$

For a representation  $T_r$  of  $S_n$  we can then apply the identity

$$\sum_{\alpha_1 \in S_n} D_{p_1 q_1}^{R_1 \vdash n}(\alpha_1) D_{bc}^{T_r \vdash n}(\alpha_1) = \frac{n!}{d_{T_r}} \delta^{R_1 T_r} \delta_{p_1 b} \delta_{q_1 c} \quad (233)$$

This identity follows from Schur's lemma and the orthogonality of the representing matrices.

Given the block-diagonal decomposition of  $D^T$  on  $\alpha_1$  and  $\alpha_2$  we find that (229) is only non-zero if  $R_1 = T_r$  and  $R_2 = T_s$  for some  $T$  and for some  $r$  and  $s$  labelling the row from which a box is removed from  $T$ . If there is no  $T$  such that we can remove a single box to reach  $R_1$  and  $R_2$  then the one-loop correlator vanishes. This is the crucial point.

If  $R_1 \neq R_2$  then there is at most one representation  $T$  of  $S_{n+1}$  satisfying this property

and we find that (229) becomes

$$\frac{n!}{d_{T_r}} \frac{n!}{d_{T_s}} D_{q_2 p_1}^T(\rho_1) D_{q_1 p_2}^T(\rho_2) \text{Dim} T \quad (234)$$

The letters underneath the matrix indices indicate the sub-range of the  $d_T$  indices of  $D^T$  over which the index ranges. For example, here  $q_2$  only ranges over the  $d_{T_s}$  indices of  $D^T$  in the appropriate  $s$  sub-row of  $D^T$  and  $p_1$  only ranges over the  $d_{T_r}$  indices in the  $r$  sub-column (see for example the matrix in (232))<sup>11</sup>. Thus for  $D_{q_2 p_1}^T(\rho_1)$   $q_2$  and  $p_1$  label elements in an off-diagonal sub-block of  $D^T$ . This does not vanish because  $\rho_1$  is a generic element of  $S_{n+1}$  not in its  $S_n$  subgroup.

So if there exists a  $T$  for which  $R_1 = T_r$  and  $R_2 = T_s$  and  $R_1 \neq R_2$

$$\begin{aligned} & \left\langle \mathcal{O}^\dagger[\Lambda_2, M_2, T_s, \hat{\tau}_2] : \text{tr}([X, Y][X^\dagger, Y^\dagger]) : \mathcal{O}[\Lambda_1, M_1, T_r, \hat{\tau}_1] \right\rangle \\ &= \frac{\mu_1 \mu_2 \mu_1! \mu_2!}{d_{T_r} d_{T_s}} B_{a_1 \beta_1} S^{\hat{\tau}_1, \Lambda_1} \begin{matrix} T_r & T_r \\ p_1 & q_1 \end{matrix} B_{a_2 \beta_2} S^{\hat{\tau}_2, \Lambda_2} \begin{matrix} T_s & T_s \\ p_2 & q_2 \end{matrix} \sum_{\rho_1, \rho_2 \in S_{n+1}} f(\rho_1, \rho_2) D_{q_2 p_1}^T(\rho_1) D_{q_1 p_2}^T(\rho_2) \text{Dim} T \end{aligned}$$

If we use the more symmetric expression for  $f$  in (221) then we can use identity (468) to get

$$\begin{aligned} & - \frac{\mu_1 \mu_2 \mu_1! \mu_2!}{d_{T_r} d_{T_s}} B_{a_1 \beta_1} S^{\hat{\tau}_1, \Lambda_1} \begin{matrix} T_r & T_r \\ b_1 & p_1 \\ & q_1 \end{matrix} B_{a_2 \beta_2} S^{\hat{\tau}_2, \Lambda_2} \begin{matrix} T_s & T_s \\ & p_2 \\ b_2 & q_2 \end{matrix} \\ & D_{a_1 n_1}^{\Lambda_1} (1 - (\mu_1, n)) D_{a_2 b_2}^{\Lambda_2} (1 - (\mu_1, n)) D_{q_2 p_1}^T((\mu_1, n + 1)) D_{q_1 p_2}^T((n, n + 1)) \text{Dim} T \quad (235) \end{aligned}$$

This expression nicely encodes the vanishing of the one-loop correlator for the half-BPS operators transforming in the symmetric representation of the flavour group (for  $\Lambda = \square \square \square \square$ ,  $D^\Lambda(\sigma) = 1 \ \forall \sigma$ ).

Some hints on how to simplify this expression further, and how one might extract explicitly the orthogonality of  $U(2)$  representations, are given in Appendix Section B.9.1.

If  $R_1 = R_2 \equiv R$  then we must sum over all the representations  $T$  of  $S_{n+1}$  with  $T_r = R$

$$\begin{aligned} & \left\langle \mathcal{O}^\dagger[\Lambda_2, M_2, R, \hat{\tau}_2] : \text{tr}([X, Y][X^\dagger, Y^\dagger]) : \mathcal{O}[\Lambda_1, M_1, R, \hat{\tau}_1] \right\rangle = \sum_{T \text{ s.t. } R=T_r} \frac{\mu_1 \mu_2 \mu_1! \mu_2!}{d_{T_r}^2} \\ & B_{a_1 \beta_1} S^{\hat{\tau}_1, \Lambda_1} \begin{matrix} T_r & T_r \\ p_1 & q_1 \end{matrix} B_{a_2 \beta_2} S^{\hat{\tau}_2, \Lambda_2} \begin{matrix} T_r & T_r \\ p_2 & q_2 \end{matrix} \sum_{\rho_1, \rho_2 \in S_{n+1}} f(\rho_1, \rho_2) D_{q_2 p_1}^T(\rho_1) D_{q_1 p_2}^T(\rho_2) \text{Dim} T \end{aligned}$$

An example of these mixing properties is worked out for  $\Lambda = \square \square$  in Appendix Section E.

Some general comments:

- We can interpret the  $U(N)$  representation  $T \vdash n + 1$  as an intermediate channel through which the operators mix via the ‘overlapping’ of  $R_1 \vdash n$  and  $R_2 \vdash n$  with

<sup>11</sup>To be more sophisticated,  $s$  is the first number in the Yamanouchi symbol for the index of  $T$  and  $q_2$  is the rest of the symbol for  $T_s$ .

$T$ .

- Given that smaller Young diagrams are more likely to be related to each other by moving a box than larger diagrams, mixing at one loop is much more likely for smaller representations than larger ones. Larger ones can be considered practically diagonal at 1-loop (but not at higher loops, see Section 5.5).

#### 5.4.1 Dilatation operator

We can now apply this analysis to the one-loop dilatation operator.

$$\boxed{\Delta^{(1)} \mathcal{O}[\Lambda, M, R, \hat{\tau}] = \sum_{S, \hat{\tau}'} C_{S, \hat{\tau}'}^{R, \hat{\tau}} \mathcal{O}[\Lambda, M, S, \hat{\tau}']} \quad (236)$$

$S$  must be obtainable by removing a box from  $R$  and then putting it back somewhere. We can obtain the matrix  $C_{S, \hat{\tau}'}^{R, \hat{\tau}}$  by reverse-engineering the one-loop mixing (235) using the tree-diagonality of the Clebsch-Gordan basis. We can see for example that for  $R \neq S$  which mix via  $T \vdash n + 1$  we can factor out the  $N$  dependence

$$\begin{aligned} C_{S; \hat{\tau}'}^{R; \hat{\tau}} &= -\mu_1 \mu_2 \frac{d_S \text{Dim} T}{d_R \text{Dim} S} B_{a_1 \beta} S_{b_1}^{\hat{\tau}, \Lambda} R_{p_1} R_{q_1} B_{a_2 \beta} S_{b_2}^{\hat{\tau}', \Lambda} S_{p_2} S_{q_2} \\ &\quad D_{a_1 b_1}^\Lambda (1 - (\mu, n)) D_{a_2 b_2}^\Lambda (1 - (\mu, n)) D_{q_2 p_1}^T ((\mu, n + 1)) D_{q_1 p_2}^T ((n, n + 1)) \\ &\propto \frac{\text{Dim} T}{\text{Dim} S} \propto N - i + j \end{aligned} \quad (237)$$

where  $i$  labels the row coordinate and  $j$  the column coordinate of the box  $R$  has that  $S$  doesn't (see equation (492)).

The kernel of this map provides the  $\frac{1}{4}$ -BPS operators [111][112], but we have no further insight on how to obtain a pleasing group theoretic expression for these operators beyond the hints given in Section 6.2 concerning the dual basis [64][63]. Something like the dual basis seems particularly relevant given that it arose in the  $SU(N)$  context [113][64] from knocking boxes off representations to differentiate Schur polynomials, see Section 9.

## 5.5 Higher loops

If we assume that higher  $\ell$ -loop contributions to the correlator for  $U(2)$  can always be written in terms of an effective vertex like (210) (it works for two loops [105]) then we guess that they can be written in terms of  $S_{n+\ell}$  and  $U(N)$  group theory

$$\sum_{\sigma, \tau \in S_{\mu_1} \times S_{\mu_2}} \sum_{\rho_1, \rho_2 \in S_{n+\ell}} f_\ell(\rho_1, \rho_2) \sum_{T \vdash n+\ell} \chi_T(\rho_1 \sigma^{-1} \alpha_1 \sigma \rho_2 \tau^{-1} \alpha_2 \tau) \text{Dim} T \quad (238)$$

$f_\ell(\rho_1, \rho_2)$  only takes non-zero values on a few permutations of  $\ell+1$  of the  $\{1, \dots, n\}$  indices (where the derivative acts) and the  $n+1, \dots, n+\ell$  indices. The  $\sigma$  and  $\tau$  construction

permutes the  $X$ 's and  $Y$ 's for the product rule.

This guess is informed by the leading planar  $N^{n+\ell}$  contribution to the  $\ell$ -loop term, which is provided by the large  $N$  behaviour of  $\text{Dim}T$  when  $T$  has  $n+\ell$  boxes (see equation (492)).

As a consequence of this structure  $\mathcal{O}[\Lambda_1, M_1, R_1, \hat{\tau}_1]$  and  $\mathcal{O}[\Lambda_2, M_2, R_2, \hat{\tau}_2]$  can only mix at  $\ell$  loops if we can reach the same  $(n+\ell)$ -box Young diagram  $T$  by adding  $\ell$  boxes to each of the  $U(N)$  representations  $R_1$  and  $R_2$ .

An alternative way of saying this is that if two  $U(N)$  representations  $R_1$  and  $R_2$  have  $k$  boxes in the same position then they can first mix at  $n-k$  loops, since we have enough boxes to add to  $R_1$  to reproduce the shape of  $R_2$ .

This means that all operators of length  $n$  can mix at  $n-1$  loops, because all diagrams share the first box in the upper lefthand corner.

This analysis is unlikely to extend beyond  $U(2)$  since for other sectors of the global symmetry group the length of the operator becomes dynamical at higher loops [114].

Finally we point out that another complete basis in the  $U(2)$  sector, the restricted Schur polynomials, have neat tree-level two-point functions and their one-loop properties have been studied [91][92][93][115][116].

## 5.6 One-loop mixing for general $\mathcal{N} = 4$ operators

We have focused here on the  $U(2) \subset SU(4) \subset PSU(2, 2|4)$  sector of the full symmetry group of  $\mathcal{N} = 4$ . These operators only mix if the  $U(N)$  representations specifying their multi-trace structures are related by the repositioning of a single box of the Young diagram. Here we find the same result for the full  $PSU(2, 2|4)$  sector, using our general characterisation of multi-trace operators with arbitrary global symmetry from Section 4.3.

The complete one-loop non-planar dilatation operator is given by [75]

$$D(g) = D_0 - \frac{g_{YM}^2}{8\pi^2} H + \mathcal{O}(g_{YM}^3) \quad (239)$$

where

$$H = \sum_{j=0}^{\infty} h(j) (P_j)_{CD}^{AB} : \text{tr}([W_A, \tilde{W}^C][W_B, \tilde{W}^D]) : \quad (240)$$

$(\tilde{W}^C)_j^i$  is the derivative  $\frac{d}{d(W_C)_i^j}$ .  $h(j) \equiv \sum_{k=1}^j \frac{1}{k}$  are the harmonic numbers and  $P_j$  is the projector for  $V_F \otimes V_F = \oplus_j V_j$ . For  $SL(2)$  and  $PSU(2, 2|4)$   $V_j$  appears with unit multiplicity in  $V_F^{\otimes 2}$  (cf. (183) where  $m(j, 2) = 1$ )<sup>12</sup>. The dilatation operator separates out  $V_F^{\otimes 2}$  in  $V_F^{\otimes n}$  and then projects onto it with the factors in (240).

The action of the dilatation operator has been analysed in the planar limit for single traces using the Bethe Ansatz (see for example [24][25]). In the non-planar limit multi-

<sup>12</sup>In the  $SL(2) \times S_2$  decomposition of  $V_F^{\otimes 2}$ , the symmetric representation  $V_{[2]}^{S_2}$  appears with even  $j$  and the antisymmetric  $V_{[1,1]}^{S_2}$  with odd  $j$ .

trace operators can join and split [106]. We will find that the mixing is neatly constrained if we organise the multi-trace operators using  $U(N)$  representations as we have in (132).

The action of  $H$  on  $\text{tr}(\alpha W_{m_1} \cdots W_{m_n})$  is compactly written by introducing an extra index, tracing in  $V_N^{n+1}$  rather than  $V_N^n$ . The extra index encodes awkward contractions in the action of the dilatation operator. Repeating the  $U(2)$  analysis gives

$$\begin{aligned} & : \text{tr}([W_A, \tilde{W}^C][W_B, \tilde{W}^D]) : \text{tr}(\alpha W_{m_1} \cdots W_{m_n}) = \\ & \frac{1}{(n-2)!} \sum_{\sigma \in S_n} \delta_{m_{\sigma(n-1)}}^C \delta_{m_{\sigma(n)}}^D \sum_{\rho_1, \rho_2 \in S_{n+1}} f(\rho_1, \rho_2) \text{tr}_{n+1} \left( \rho_1 \sigma^{-1} \alpha \sigma \rho_2 W_{m_{\sigma(1)}} \cdots W_{m_{\sigma(n-2)}} W_A W_B \mathbb{I}_N \right) \end{aligned}$$

$\mathbb{I}_N$  is the  $N \times N$  identity matrix.  $f(\rho_1, \rho_2)$  is only non-zero on the  $S_3$  subgroup of  $S_{n+1}$  that permutes the  $n-1$  and  $n$  indices, where the derivatives act, and the new  $n+1$  index. Its non-zero values give the four terms of the commutators in (240).

$$\begin{aligned} f((n-1, n), (n, n+1)) &= 1 \\ f((n-1, n+1), (n, n+1)) &= -1 \\ f((n, n+1), (n-1, n+1)) &= -1 \\ f((n, n+1), (n-1, n)) &= 1 \end{aligned} \tag{241}$$

If we introduce the projector we find

$$\begin{aligned} & \sum_{j=0}^{\infty} h(j) (P_j)_{CD}^{AB} : \text{tr}([W_A, \tilde{W}^C][W_B, \tilde{W}^D]) : \text{tr}(\alpha W_{m_1} \cdots W_{m_n}) = \sum_{\rho_1, \rho_2 \in S_{n+1}} f(\rho_1, \rho_2) \\ & \frac{1}{(n-2)!} \sum_{\sigma \in S_n} \sum_{j=0}^{\infty} h(j) \text{tr}_{n+1} \left( \rho_1 \sigma^{-1} \alpha \sigma \rho_2 W_{m_{\sigma(1)}} \cdots W_{m_{\sigma(n-2)}} P_j \left( W_{m_{\sigma(n-1)}} W_{m_{\sigma(n)}} \right) \mathbb{I}_N \right) \end{aligned}$$

Now consider the action on our gauge-invariant operator (132)

$$\begin{aligned} H\mathcal{O}[\Lambda, M, \lambda, \tau, R, \hat{\tau}] &= \frac{1}{(n-2)!} \sum_{\rho_1, \rho_2 \in S_{n+1}} f(\rho_1, \rho_2) S^{\hat{\tau}} \begin{matrix} \lambda & R & R \\ a & p & q \end{matrix} \sum_{\alpha \in S_n} D_{pq}^R(\alpha) \\ & \sum_{j=0}^{\infty} h(j) C_{\Lambda, M, \lambda, a, \tau}^{\vec{m}} \text{tr}_{n+1} \left( \rho_1 \alpha \rho_2 W_{m_1} \cdots W_{m_{n-2}} P_j \left( W_{m_{n-1}} W_{m_n} \right) \mathbb{I}_N \right) \end{aligned} \tag{242}$$

Here, using properties of our operators, all the  $\sigma$  actions cancel.

To encapsulate the action of the projector we rewrite the covariant decomposition of  $V_F^{\otimes n}$  in terms of  $V_F^{\otimes n-2} \otimes V_F^{\otimes 2}$ . We unclutter the notation by defining  $|\Lambda\rangle \equiv |\Lambda, M, \lambda, a, \tau\rangle$  for the covariant basis.

$$\begin{aligned} |\Lambda\rangle &= \sum_{\vec{m}} C_{\Lambda}^{\vec{m}} \sum_{\Lambda^{n-2}, \Lambda^2} C_{\vec{m}^{n-2}}^{\Lambda^{n-2}} C_{\vec{m}^2}^{\Lambda^2} |\Lambda^{n-2}\rangle \otimes |\Lambda^2\rangle \\ &= \sum_{\Lambda^{n-2}, \Lambda^2} \langle \Lambda^{n-2}, \Lambda^2 | \Lambda \rangle |\Lambda^{n-2}, \Lambda^2\rangle \end{aligned} \tag{243}$$



$|\Lambda^{n-2}\rangle$  lives in  $V_F^{\otimes n-2}$  while  $|\Lambda^2\rangle$  lives in  $V_F^{\otimes 2}$ .  $\vec{m}^{n-2} = (m_1, \dots, m_{n-2})$  and  $\vec{m}^2 = (m_{n-1}, m_n)$ .

The projector  $P_j$  in (242) projects onto  $\Lambda^2 = j$ . The one-loop two-point function is then

$$\begin{aligned} & \left\langle \mathcal{O}^\dagger[\Lambda', M', \lambda', \tau', R', \hat{\tau}'] H \mathcal{O}[\Lambda, M, \lambda, \tau, R, \hat{\tau}] \right\rangle \\ &= \frac{1}{(n-2)!} \sum_{\rho_1, \rho_2 \in S_{n+1}} f(\rho_1, \rho_2) S^{\hat{\tau}} \begin{matrix} \lambda & R & R \\ a & p & q \end{matrix} S^{\hat{\tau}'} \begin{matrix} \lambda' & R' & R' \\ a' & p' & q' \end{matrix} \sum_{\alpha, \alpha' \in S_n} D_{pq}^R(\alpha) D_{p'q'}^{R'}(\alpha') \\ & \sum_{\Lambda^{n-2}, \Lambda^2=j} h(j) \langle \Lambda' | \Lambda^{n-2}, \Lambda^2 \rangle \langle \Lambda^{n-2}, \Lambda^2 | \Lambda \rangle \text{tr}_{n+1} (\rho_1 \alpha \rho_2 \alpha' \mathbb{I}_N^{n+1}) \end{aligned} \quad (244)$$

The trace can be expressed as a sum over  $(n+1)$ -box representations  $T$  of  $S_{n+1}$  and  $U(N)$  with at most  $N$  rows.

$$\text{tr}_{n+1} (\rho_1 \alpha \rho_2 \alpha' \mathbb{I}_N^{n+1}) = \sum_{T \vdash n+1} \chi_T(\rho_1 \alpha \rho_2 \alpha') \text{Dim} T \quad (245)$$

The  $\alpha$  and  $\alpha'$  sums in (244) force  $T$  to reduce to both  $R$  and  $R'$  for the  $S_n$  subgroup of  $S_{n+1}$ . Since  $T$  reduces on its  $S_n$  subgroup to those Young diagrams with a single box removed from  $T$ ,  $R$  and  $R'$  must be related by the repositioning of a single box for this one-loop two-point function not to vanish. This analysis is pursued in more detail for the  $U(2)$  sector above.

The one-loop non-planar mixing of this complete basis of multi-trace operators is therefore highly constrained. Although the operators are not diagonal at one-loop, their very limited mixing suggests they are close to the eigenstates. It would be particularly interesting to find the sixteenth-BPS operators at one loop and gain an understanding of the counting of black hole entropy, along the lines of [55, 56].

## 6 BPS operators

In this section we use two different methods to characterise the  $\frac{1}{4}$ - and  $\frac{1}{8}$ th-BPS operators of  $\mathcal{N} = 4$  which are in the chiral ring of the theory. In Section 6.2 we write the genuine BPS operators at finite  $N$  using their orthogonality to descendants; we also characterise them as functions of eigenvalues of the fields in Section 6.3. On the more difficult topic of the  $\frac{1}{16}$ th-BPS operators, we have nothing to contribute other than the hope that the one-loop analysis of Section 5 might reveal them in the kernel of the non-planar dilatation operator.

### 6.1 Introduction

BPS operators are a special class of local operators in  $\mathcal{N} = 4$  SYM that are annihilated by a subset of the supercharges

$$[Q_\alpha^a, \mathcal{O}] = 0 \tag{246}$$

Their dimensions are protected by supersymmetry and do not receive corrections when we turn on the coupling. As a consequence their two-point functions and certain extremal three-point functions are not renormalised either. Because of their non-renormalisation properties we can compare BPS states directly with those appearing in supergravity.

The number of supersymmetries that an operator preserves depends on its  $PSU(2, 2|4)$  multiplet, see Section 2.3. Highest weight states of half-BPS multiplets are Lorentz singlets and in general built from traceless symmetric  $SO(6)$  tensor combinations of the six real scalars. For convenience a representative of each  $SO(6)$  representation can be picked if we take an operator built only from a single complex scalar  $X$ . Similarly quarter-BPS HWS are also Lorentz scalars but representatives of the  $SO(6)$  tensors now include two complex scalars  $X, Y$ , a  $U(2)$  subsector; eighth-BPS have three scalars  $X, Y, Z$  and two fermions  $\lambda, \bar{\lambda}$ , a  $U(3|2)$  subsector; sixteenth-BPS include an additional fermion and two derivatives to get  $U(3|2, 1)$ :  $\partial_{11}^{n_1} \partial_{12}^{n_2} (X, Y, Z, \lambda_{i1}, \bar{\lambda}_\alpha^1, F_{11})$  for  $i = 2, 3, 4$  with the fermion equation of motion enforced  $\partial_{11} \bar{\lambda}_2^1 = \partial_{12} \bar{\lambda}_1^1$ . Sixteenth-BPS operators with large energy should correspond to BPS black holes in  $AdS_5$ . Because they are annihilated by some supercharges, BPS multiplets become *short*.

However, at weak coupling the global symmetry group quantum numbers of an operator do not guarantee its supersymmetry properties; these also depend on the trace structure of the operator. For example there are  $U(2)$  operators which at weak coupling are part of long multiplets and hence have anomalous dimensions, such as

$$\text{tr}([X, Y][X, Y]) \tag{247}$$

which at weak coupling becomes a descendant of the Konishi operator  $\text{tr}(\phi_i \phi_i)$ .

There is a discontinuous change in the spectrum from zero to weak coupling. Multiplets that were short at zero coupling join long multiplets. There are thus fewer BPS

operators at weak coupling than at zero coupling.<sup>13</sup>

If we concentrate on the  $U(2)$  quarter-BPS sector, the operators which become descendant from zero to weak coupling are those that contain commutators  $[X, Y]$  inside a trace. This is because the action of the supercharge on the fermion gains an additional term at weak coupling

$$Q\lambda \sim F + g[X, Y] \quad (248)$$

To find the operators that remain BPS at weak coupling, it is sufficient then, in the planar limit, to restrict to multitrace operators composed only of symmetrised traces. In a symmetrised trace we sum over all orders of the fields within the trace. This process removes all commutators inside traces, but commutators can still cross between two different traces. These operators built from symmetrised traces are part of the *chiral ring*, which includes  $\frac{1}{4}$ - and  $\frac{1}{8}$ th-BPS operators. For  $\Lambda = \begin{smallmatrix} \square & \square \\ \square & \square \end{smallmatrix}$  there are two such operators,  $\text{tr}(\Phi_r \Phi_s) \text{tr}(\Phi^r) \text{tr}(\Phi^s)$  and  $\text{tr}(\Phi_r \Phi_s) \text{tr}(\Phi^r \Phi^s)$  where  $\Phi^1 = X$ ,  $\Phi^2 = Y$  and  $\Phi_r \Phi^r = \epsilon_{rs} \Phi^r \Phi^s = [X, Y]$ .

In the non-planar limit this does not completely describe the BPS operators. The BPS operators must be annihilated by the dilatation operator and be orthogonal in the two-point function to the descendant operators. This requires  $\frac{1}{N}$  corrections to be added to the operators built from symmetrised traces [111, 112]. For example for the  $\Lambda = \begin{smallmatrix} \square & \square \\ \square & \square \end{smallmatrix}$  case we must add the descendant operator from (247) to  $\text{tr}(\Phi_r \Phi_s) \text{tr}(\Phi^r \Phi^s)$  to get the genuine BPS operator

$$\text{tr}(\Phi_r \Phi_s) \text{tr}(\Phi^r \Phi^s) + \frac{2}{N} \text{tr}(\Phi_r \Phi^r \Phi_s \Phi^s) \quad (249)$$

Capturing these non-planar corrections is one goal of this section.

The physics of eighth-BPS states and their partition functions from both the field theory and the supergravity point of view (where they are product of the half-BPS supergravity multiplet) were studied in [52]. Studies of extensions of giant gravitons from the half-BPS case to quarter- and eighth-BPS are contained in [117, 118, 119, 120, 84, 94, 95, 121, 122, 123]. Giant gravitons with strings attached were considered in [124, 91, 92, 93].

The quarter and eighth-BPS gauge invariant operators should be related to giant gravitons generalizing the analogous connection in the half-BPS case. It has been argued that the physics of the eighth-BPS giants [117] is given by the dynamics of  $N$  particles in a 3D simple harmonic oscillator [118, 94, 95]. States of the harmonic oscillator system are

$$\prod_{i=1}^N a_{n_{i1}, n_{i2}, n_{i3}}^{i \dagger} |0\rangle \quad (250)$$

The index  $i$  labels the particles. The natural numbers  $(n_{i1}, n_{i2}, n_{i3})$  label the excitations

---

<sup>13</sup>However the half-BPS operators remain unchanged regardless of the coupling. This is because the dilatation operator which measure the anomalous dimension (hence the deviation from the BPS condition  $\delta\Delta = 0$ ) only registers antisymmetrisation and  $SO(6)$  traces (e.g. Konishi).

along the  $x, y, z$  direction for the  $i$ 'th particle. When we take an overlap of such a state with excitations  $n_{ia}$  with the conjugate of another state with excitations  $n'_{ia}$  we get an answer proportional to

$$\prod_{ia} \delta(n_{ia}, n'_{ia}) \quad (251)$$

In the leading large  $N$  (planar) limit there is a simple map between the harmonic oscillator states and gauge invariant operators, which preserves the metric. The above SHO states can be associated with

$$\prod_{i=1} \text{Str}(X^{n_{i1}} Y^{n_{i2}} Z^{n_{i3}}) |0\rangle \quad (252)$$

In the leading large  $N$  (planar) limit, it does not actually matter whether we choose symmetrised traces or ordered traces. This is because different trace structures do not mix, and mixings between different orderings within a trace are also subleading in  $1/N$ . With either choice, we have the orthogonality (251) following from correlators of gauge invariant operators. But this does not work at subleading orders in  $1/N$  or at finite  $N$ .

## 6.2 BPS operators from the dual basis

We have an exact formula for the non-planar free two-point function. Thus, given the set of descendant operators, we can use this two-point function to define the space of operators orthogonal to the descendants. This orthogonal subspace will be the genuine BPS operators [111, 112]. To find this dual orthogonal basis we use exactly the mechanism we used for the basis dual to the half-BPS trace basis, see Section 2.7.3.

For example, suppose for the  $\frac{1}{4}$ -BPS operators we choose a  $U(2)$  representation  $\Lambda$ , for which there are  $T$  multi-trace operators in total.  $D$  of these operators are descendants. The descendant operators can easily be characterised as the image of the dilatation operator. For example, for  $\Lambda = \boxplus$  there is only one descendant:  $\text{tr}([X, Y][X, Y])$ . There are then  $T - D$  operators in the chiral ring, which are defined by a single multi-trace structure where each trace is symmetrised. For  $\Lambda = \boxplus$  there are two such operators,  $\text{tr}(\Phi_r \Phi_s) \text{tr}(\Phi^r) \text{tr}(\Phi^s)$  and  $\text{tr}(\Phi_r \Phi_s) \text{tr}(\Phi^r \Phi^s)$  where  $\Phi^1 = X$ ,  $\Phi^2 = Y$  and  $\Phi_r \Phi^r = \epsilon_{rs} \Phi^r \Phi^s = [X, Y]$ .

Write these  $T$  operators as a set  $\{\mathcal{A}_i\}$ , where the first  $D$  are descendant and the remainder are in the chiral ring. The exact free two-point function on this set  $\mathcal{G}_{ij}$ , given in Section 4.1 where the spacetime dependence has been dropped, can be used to define a dual basis  $\mathcal{B}_i = (\mathcal{G}^{-1})_{ij} \mathcal{A}_j$  that is dual in the two-point function

$$\langle \mathcal{B}_i^\dagger \mathcal{A}_j \rangle = \delta_{ij} \quad (253)$$

The last  $D - T$  operators in the dual basis  $\{\mathcal{B}_{D+1}, \dots, \mathcal{B}_T\}$  are now our genuine  $\frac{1}{4}$ -BPS operators because they are orthogonal to the descendants  $\{\mathcal{A}_1, \dots, \mathcal{A}_D\}$ .

Furthermore, because the structure of the metric is the same as for the half-BPS

operators in Section 2.7.3, the genuine  $\frac{1}{4}$ -BPS operators will reduce to the chiral ring operators built from symmetrised traces  $\{\mathcal{A}_{D+1}, \dots, \mathcal{A}_T\}$  in the large  $N$  limit. In other words the genuine BPS operators lead with the chiral ring operators and have  $1/N$  corrections in other operators, just as discovered in the analysis of [111, 112] (see the example in (249)). Verifying that the genuine  $\frac{1}{4}$ -BPS operators defined in this way are annihilated by the non-planar dilatation operator is an important task for the future.

### 6.3 The chiral ring and partition algebras

In this section we characterise the chiral ring of  $\mathcal{N} = 4$  at finite  $N$  in terms of representations of the partition algebra  $P_n(N)$ , the Schur-Weyl dual of  $S_N \subset U(N)$ . The number of these operators matches the finite  $N$  partition functions computed in Dolan [69] and furthermore provides a counting of chiral ring operators for each representation of the global symmetry group  $G$ . For the chiral ring of  $\mathcal{N} = 4$   $G$  is always a subgroup of  $SU(3|2)$ , corresponding to  $\frac{1}{8}$ th-BPS operators, but because these methods are applicable to any eigenvalue system we leave the group general.

In previous work we considered gauge-invariant operators built out of generic matrices transforming in the adjoint of  $U(N)$ . Here we consider the chiral ring, a subset of operators built out of commuting matrices. These are functions only of the eigenvalues, since the matrices are simultaneously diagonalisable. These symmetric functions of eigenvalues are organised by irreps of the  $S_N$  which permutes the eigenvalues and the  $S_n$  which permutes tensor products of fundamental fields.

In Section 4.3 we organised tensor products of the fundamental fields  $V_F^{\otimes n}$  for a global symmetry group  $G$  into representations  $\Lambda \times \lambda$  of  $G \times S_n$

$$\hat{\mathcal{O}}[\Lambda, M, \lambda, a, \tau] = \sum_{\vec{m}} C_{\Lambda, M, \lambda, a, \tau}^{\vec{m}} W_{m_1} \otimes W_{m_2} \otimes \dots \otimes W_{m_n} \quad (254)$$

Now consider the eigenvalues of these fundamental fields  $w_m^e$  where  $e \in \{1, 2, \dots, N\}$ . The subgroup of the gauge group  $U(N)$  which acts on these eigenvalues is  $S_N$ , the symmetric group which permutes the eigenvalues. The eigenvalues are in the *natural representation*  $V_{\text{nat}}^{S_N}$  of  $S_N$ , the  $N$ -dimensional representation where  $S_N$  acts by just permuting the elements, see Section B.10.1.

We can use Schur-Weyl duality on the  $n$ -tensor product of the natural representation of  $S_N$  to decompose it into representations  $K \times \kappa$  of  $S_N \times S_n$

$$\left(V_{\text{nat}}^{S_N}\right)^{\otimes n} = \bigoplus_{K \vdash N, \kappa \vdash n} V_K^{S_N} \otimes V_{\kappa}^{S_n} \otimes V_{K, \kappa} \quad (255)$$

$V_{K, \kappa}$  is treated as a multiplicity for the appearance of  $K \times \kappa$ , which we label with  $\check{\tau}$  in the Clebsch-Gordan coefficient  $C_{K, M_K, \kappa, a_\kappa, \check{\tau}}^{\vec{e}}$  for (255). The full multiplicity-free Schur-Weyl dual of  $S_N$  is the partition algebra  $P_n(N)$ . The symmetric group algebra is a subalgebra of the partition algebra via the Brauer algebra  $B_n(N)$  (which is the Schur-Weyl dual of

$O(N)$ ),  $\mathbb{C}S_n \subset B_n(N) \subset P_n(N)$ , which mirrors the fact that  $U(N) \supset O(N) \supset S_N$ . As the group gets smaller, the commuting algebra grows.

We can thus map the space of eigenvalues  $(V_F^G \otimes V_{\text{nat}}^{S_N})^{\otimes n}$  to the linear combinations

$$C_{\Lambda, M, \lambda, a_\lambda, \tau}^{\vec{m}} C_{K, M_K, \kappa, a_\kappa, \check{\tau}}^{\vec{e}} w_{m_1}^{e_1} w_{m_2}^{e_2} \cdots w_{m_n}^{e_n} \quad (256)$$

For the operators of the chiral ring, we know that they are invariant under the  $S_N$  that permutes the eigenvalues (this is the remnant of the  $U(N)$  gauge invariance that survives for the eigenvalues). This means  $K$  is the trivial representation of  $S_N$ ,  $[N]$ . Furthermore the final operators should be an overall  $S_n$  invariant too, because the eigenvalues are commuting bosons. This forces  $\lambda = \kappa$  and requires us to sum over the  $S_n$  states  $a_\lambda = a_\kappa$ . Thus we get the chiral ring as functions of eigenvalues

$$\mathcal{C}[\Lambda, M, \lambda, \tau, \check{\tau}] = \sum_a C_{\Lambda, M, \lambda, a, \tau}^{\vec{m}} C_{[N], \lambda, a, \check{\tau}}^{\vec{e}} w_{\vec{m}}^{\vec{e}} \quad (257)$$

This means that for a given  $G$  rep  $\Lambda$  we have a multiplicity of operators in the chiral ring

$$\sum_{\lambda(S_n)} \dim V_{\Lambda, \lambda} \dim V_{[N], \lambda} \quad (258)$$

This gives a partition function

$$Z_{U(N)} = \sum_n \sum_{\Lambda(G)} \sum_{\lambda(S_n)} \dim V_{\Lambda, \lambda} \dim V_{[N], \lambda} \chi_\Lambda(\mathbf{x}) \quad (259)$$

Compare this to the counting in (148) for operators built from generic non-commuting matrices.

### 6.3.1 Counting at finite $N$

In this section we verify the counting in the partition function (259) by comparing it to known formulae in Dolan [69]. The multiplicity  $\dim V_{K, \kappa}$  in (255) can be calculating using the same formula we used for  $V_H^{\otimes k}$  at the end of Section 4.4.4 for  $SL(2)$  multiplicities

$$\dim V_{K, \kappa} = \frac{1}{N!} \sum_{\sigma \in S_N} \chi_K(\sigma) \frac{1}{n!} \sum_{\tau \in S_n} \chi_\kappa(\tau) \prod_i (\chi_{\text{nat}}(\sigma^i))^{c_i(\tau)} \quad (260)$$

where  $c_i(\tau)$  is the number of cycles of length  $i$  in  $\tau \in S_n$ .

For the specialisation to  $\kappa = [n]$  we will also use the fact that (derived using similar techniques to those applied for  $V_H^{\otimes k}$  in Appendix Section F)

$$\dim V_{K, [n]}^{S_N \times S_n} = \text{coefficient of } q^n \text{ in } s_K(1, q, q^2, \dots) \quad (261)$$

where  $s_K(1, q, q^2, \dots)$  is the Schur polynomial defined for the partition  $K$  of  $N$  by

$$s_K(1, q, q^2, \dots) = \frac{1}{N!} \sum_{\sigma \in S_N} \chi_K(\sigma) \operatorname{tr} \left( \sigma \begin{pmatrix} 1 & & & \\ & q & & \\ & & q^2 & \\ & & & \ddots \end{pmatrix} \right) \quad (262)$$

Alternatively this can be stated

$$s_K(1, q, q^2, \dots) = \sum_{n=0}^{\infty} \dim V_{K, [n]}^{S_N \times S_n} q^n \quad (263)$$

For representations of  $U(K)$   $\Lambda = \lambda$  so that  $\dim V_{\Lambda, \lambda} = 1$ . Focusing on the  $U(2)$  partition function (259) for  $\frac{1}{4}$ -BPS chiral ring states we get

$$\begin{aligned} Z_{U(N)}(x, y) &= \sum_{\Lambda} \dim V_{[N], \Lambda}^{S_N \times S_n} \chi_{\Lambda}(x, y) \\ &= \sum_{\Lambda} \dim V_{[N], \Lambda}^{S_N \times S_n} \sum_{\mu, \nu} g([\mu], [\nu]; \Lambda) x^{\mu} y^{\nu} \end{aligned} \quad (264)$$

where we've expanded out the Schur polynomial using (499). Next use (260) and the formula for the Littlewood Richardson coefficient  $g$  (472)

$$\begin{aligned} Z_{U(N)}(x, y) &= \sum_{\Lambda} \frac{1}{N!} \sum_{\sigma \in S_N} \frac{1}{n!} \sum_{\tau \in S_n} \chi_{\Lambda}(\tau) \prod_i (\chi_{\text{nat}}(\sigma^i))^{c_i(\tau)} \sum_{\mu, \nu} \frac{1}{\mu! \nu!} \sum_{\rho \in S_{\mu} \times S_{\nu}} \chi_{\Lambda}(\rho) x^{\mu} y^{\nu} \\ &= \sum_{\mu, \nu} \frac{1}{\mu! \nu!} \sum_{\rho \in S_{\mu} \times S_{\nu}} \frac{1}{N!} \sum_{\sigma \in S_N} \prod_i (\chi_{\text{nat}}(\sigma^i))^{c_i(\rho)} x^{\mu} y^{\nu} \end{aligned} \quad (265)$$

We know from [52][125][126] that the generating function for  $Z_{U(N)}(x, y)$  is given by

$$Z(\nu, x, y) = \prod_{n, m=0}^{\infty} \frac{1}{1 - \nu x^n y^m} = \sum_{N=0}^{\infty} \nu^N Z_{U(N)}(x, y) \quad (266)$$

In [69] Dolan showed that

$$Z_{U(N)}(x, y) = \sum_{K \vdash N} s_K(1, x, x^2, \dots) s_K(1, y, y^2, \dots) \quad (267)$$

We will now show that these expressions agree. Working from Dolan's formula we use (263) to get

$$\begin{aligned} Z_{U(N)}(x, y) &= \sum_{K \vdash N} s_K(1, x, x^2, \dots) s_K(1, y, y^2, \dots) \\ &= \sum_{K \vdash N} \sum_{\mu, \nu} \dim V_{K, [\mu]}^{S_N \times S_{\mu}} \dim V_{K, [\nu]}^{S_N \times S_{\nu}} x^{\mu} y^{\nu} \end{aligned} \quad (268)$$

Now use (260) to get

$$\begin{aligned}
Z_{U(N)}(x, y) &= \sum_{K \vdash N} \sum_{\mu, \nu} \frac{1}{N!} \sum_{\sigma_1 \in S_N} \chi_K(\sigma_1) \frac{1}{\mu!} \sum_{\rho_1 \in S_\mu} \prod_i (\chi_{\text{nat}}(\sigma_1^i))^{c_i(\rho_1)} \\
&\quad \frac{1}{N!} \sum_{\sigma_2 \in S_N} \chi_K(\sigma_2) \frac{1}{\nu!} \sum_{\rho_2 \in S_\nu} \prod_j (\chi_{\text{nat}}(\sigma_2^j))^{c_j(\rho_2)} x^\mu y^\nu \\
&= \sum_{\mu, \nu} \frac{1}{N!} \sum_{\sigma \in S_N} \frac{1}{\mu!} \sum_{\rho_1 \in S_\mu} \prod_i (\chi_{\text{nat}}(\sigma^i))^{c_i(\rho_1)} \frac{1}{\nu!} \sum_{\rho_2 \in S_\nu} \prod_j (\chi_{\text{nat}}(\sigma^j))^{c_j(\rho_2)} x^\mu y^\nu \\
&= \sum_{\mu, \nu} \frac{1}{\mu! \nu!} \sum_{\rho \in S_\mu \times S_\nu} \frac{1}{N!} \sum_{\sigma \in S_N} \prod_i (\chi_{\text{nat}}(\sigma^i))^{c_i(\rho)} x^\mu y^\nu \tag{269}
\end{aligned}$$

This is identical to (265) so we are done.

### 6.3.2 Check of counting for half-BPS operators

In the half-BPS case the global symmetry group representation is symmetrised  $\Lambda = \lambda = [n]$  so the counting of the chiral ring gives

$$\dim V_{[N], [n]}^{S_N \times S_n} = p(n, N) \tag{270}$$

$p(n, N)$  is the number of partitions into at most  $N$  parts. This counts the Schur polynomials

$$\chi_R(x_1, x_2, \dots, x_N) \equiv \chi_R(X) \tag{271}$$



## 7 Three-point function and OPE

In this section we compute the three-point function of the operators we have constructed above at tree level and at one loop to all orders in  $N$ . To keep the complexity under control we build up from the extremal case to the non-extremal. We re-use the technology from the free two-point function in Section 4 and build on the ‘cutting’ of operators developed at the end of Section 5 for the one-loop correction. We hope that these correlation functions might be used to define a deformed geometry of quantum spacetime as discussed in Section 2.9.

### 7.1 Introduction

The basic idea is to compute

$$\langle \mathcal{O}_1(x_1) \mathcal{O}_2(x_2) \mathcal{O}_3(x_3) \rangle \quad (272)$$

at order  $\lambda^0$  and  $\lambda^1$  using the techniques developed for the free and one-loop non-planar two-point function.

To do this we will first contract  $\mathcal{O}_1$  and  $\mathcal{O}_2$  in a similar manner to the OPE

$$\mathcal{O}_1(x_1) \mathcal{O}_2(x_2) \sim \sum_{c=0}^{\min(n_1, n_2)} : \mathcal{O}_1(x_1) \mathcal{O}_2(x_2) :_c \frac{1}{|x_1 - x_2|^{2c}} \quad (273)$$

where we sum over the different numbers of contractions between the fields of  $\mathcal{O}_1$  and  $\mathcal{O}_2$ . We then insert this back into the three-point function (272) to compute the final result. To start with we only consider operators that are Lorentz scalars.

Note that (273) is not quite the OPE because the fields on the right-hand side are still at two different points; they would have to be at the same point for the standard OPE. To get the OPE we can simply Taylor expand  $\mathcal{O}_2(x_2)$  about  $x_1$ :

$$\mathcal{O}_1(x_1) \mathcal{O}_2(x_2) \sim \sum_i \mathcal{C}_{12}^i \mathcal{O}_i(x_1) \frac{1}{|x_1 - x_2|^{\Delta_i - \Delta_1 - \Delta_2}} \quad (274)$$

where  $\mathcal{C}_{ijk}$  is the three-point function constant coefficient, and we have raised an index with  $\mathcal{G}^{ij}$ , the inverse of the two-point function  $\mathcal{G}_{ij}$ . A more complete discussion of the conformal structure of the correlation functions of conformal field theories appears in Section 2.2.

### 7.2 Extremal three-point function for $U(3)$

An extremal three-point function for  $U(3)$  has all holomorphic fields  $X, Y, Z$  in a single operator  $\mathcal{O}_3(x_3)$  at a single position. The other two operators  $\mathcal{O}_1(x_1)$  and  $\mathcal{O}_2(x_2)$  must be composed only of antiholomorphic fields  $X^\dagger, Y^\dagger, Z^\dagger$  and their free dimensions must add up to that of  $\mathcal{O}_3$ , i.e.  $\Delta_3 = \Delta_1 + \Delta_2$ . Just as for the extremal three-point functions

of Schur polynomials discussed in Section 2.7.1, the  $U(3)$  extremal case can be expressed using  $U(3)$  and  $U(N)$  group fusion coefficients and the  $U(N)$  dimension of  $\mathcal{O}_3$ . Inserting the the three  $U(3)$  operators (67) we find

$$\begin{aligned} & \left\langle \mathcal{O}_1^\dagger[\Lambda_1, M_1, R_1, \hat{\tau}_1](x_1) \mathcal{O}_2^\dagger[\Lambda_2, M_2, R_2, \hat{\tau}_2](x_2) \mathcal{O}_3[\Lambda_3, M_3, R_3, \hat{\tau}_3](x_3) \right\rangle \\ &= \frac{1}{(x_1 - x_3)^{2\Delta_1}} \frac{1}{(x_2 - x_3)^{2\Delta_2}} \frac{|H_{\mu_3}| \text{Dim } R_3}{d_{R_1} d_{R_2} d_{R_3}} \delta_{\mu_1 + \mu_2 = \mu_3} \\ & \quad B_{a_1 \beta_1} B_{a_2 \beta_2} B_{a_4 \beta_3} D_{a_3 a_4}^\Lambda(\sigma_{12}) S^{\hat{\tau}_1} \begin{matrix} \Lambda_1 & R_1 & R_1 \\ a_1 & p_1 & q_1 \end{matrix} S^{\hat{\tau}_2} \begin{matrix} \Lambda_2 & R_2 & R_2 \\ a_2 & p_2 & q_2 \end{matrix} S^{\hat{\tau}_3} \begin{matrix} \Lambda_3 & R_3 & R_3 \\ a_3 & p_3 & q_3 \end{matrix} \\ & \quad B_{q_3}^{R_3 \rightarrow R_1 \circ R_2; \beta_4} B_{p_3}^{R_3 \rightarrow R_1 \circ R_2; \beta_4} \end{aligned} \quad (275)$$

A new element introduced here is the branching coefficient  $B_{q_3}^{R_3 \rightarrow R_1 \circ R_2; \beta_4}$  for the symmetric group outer product, which corresponds to the  $U(N)$  tensor product of  $R_1$  and  $R_2$ . These coefficients are discussed in Appendix Section B.8.  $\beta_4$  runs over the Littlewood-Richardson coefficient

$$g(R_1, R_2; R_3) > 0 \quad (276)$$

This constraint is the same as that for the extremal three-point function of half-BPS Schur polynomials in (21). The  $N$ -behaviour is the same too, following the  $U(N)$  dimension of  $R_3$ . A full discussion and proof of this result can be found in Section 5 of [59]; because we do the more general non-extremal case below we omit a full description here.

### 7.3 ‘Basic’ three-point function for $SO(6)$

The ‘basic’ three-point function is the extremal three-point function without the holomorphicity constraints, i.e. the conformal dimensions of two of the operators add up exactly to that of the third. This is a necessary stepping-stone for the general non-extremal case.

To reduce the clutter of indices we introduce a composite index  $A$  combining the global and adjoint indices so that each field is written  $W_A \equiv (W_m)_j^i$  and the operator  $\mathcal{O}(x)$  becomes

$$\mathcal{O}(x) = C_{\mathcal{O}}^{A_1 \dots A_n} : W_{A_1}(x) \dots W_{A_n}(x) : \quad (277)$$

This operator lives in  $(V_F \otimes V_N \otimes V_{\bar{N}})^{\otimes n}$  and combines three separate Clebsch-Gordan coefficients

$$C_{\mathcal{O}}^{A_1 \dots A_n} \equiv C_{\Lambda, M, \lambda, a, \tau}^{\vec{m}} C_{R, M_R, p}^{\vec{i}} C_{\bar{S}, M_S, q}^{\vec{j}} \quad (278)$$

We also want the overall operator to transform in the trivial rep of  $S_n$  since each field is a boson, which we achieve with an  $S_n$  Clebsch-Gordan coefficient

$$C_{\mathcal{O}}^{A_1 \dots A_n} = \sum_{a, p, q} S^{\hat{\tau}} [n] \begin{matrix} \lambda & R & S \\ a & p & q \end{matrix} C_{\Lambda, M, \lambda, a, \tau}^{\vec{m}} C_{R, M_R, p}^{\vec{i}} C_{\bar{S}, M_S, q}^{\vec{j}} \quad (279)$$

Now for  $\sigma \in S_n$  the coefficient satisfies

$$C_{\mathcal{O}}^{A_{\sigma(1)} \cdots A_{\sigma(n)}} = C_{\mathcal{O}}^{A_1 \cdots A_n} \quad (280)$$

To get a gauge-invariant operator like that constructed in (132) we force  $R = S$  and sum over the  $U(N)$  states to get a  $U(N)$  singlet. Later we will relax the  $U(N)$ -invariance condition.

Now take the free three-point function of this with two operators  $\mathcal{K}$  of length  $m$  and  $\mathcal{L}$  of length  $n - m$

$$\begin{aligned} \langle \mathcal{O}(x) \mathcal{K}(y) \mathcal{L}(z) \rangle &= C_{\mathcal{O}}^{A_1 \cdots A_n} C_{\mathcal{K}}^{B_1 \cdots B_m} C_{\mathcal{L}}^{B_{m+1} \cdots B_n} \\ &\langle : W_{A_1}(x) \cdots W_{A_n}(x) :: W_{B_1}(y) \cdots W_{B_m}(y) :: W_{B_{m+1}}(z) \cdots W_{B_n}(z) : \rangle \end{aligned} \quad (281)$$

We must contract each allowed pair of fields with the scalar propagator

$$\langle W_{A_1}(x) W_{A_2}(y) \rangle = \delta_{m_1 m_2} \delta_{j_2^{i_1}} \delta_{j_1^{i_2}} \frac{1}{|x - y|^2} = \delta_{A_1 A_2} \frac{1}{|x - y|^2} \quad (282)$$

Using the  $S_n$ -invariance of  $\mathcal{O}$  when we permute the possible pairs we find

$$\langle \mathcal{O}(x) \mathcal{K}(y) \mathcal{L}(z) \rangle \sim \frac{1}{|x - y|^{2m} |x - z|^{2(n-m)}} n! C_{\mathcal{O}}^{A_1 \cdots A_n} C_{\mathcal{K}}^{A_1 \cdots A_m} C_{\mathcal{L}}^{A_{m+1} \cdots A_n} \quad (283)$$

The  $n!$  comes from the redundant sum over  $S_n$ . We have split  $\mathcal{O}$  into two pieces; to make this clear we introduce the following notation for the tensors

$$\langle \mathcal{O} | \mathcal{K} \otimes \mathcal{L} \rangle \equiv C_{\mathcal{O}}^{A_1 \cdots A_n} C_{\mathcal{K}}^{A_1 \cdots A_m} C_{\mathcal{L}}^{A_{m+1} \cdots A_n} \quad (284)$$

The  $N$  dependence is the same as for the extremal three-point function: it appears in the  $U(N)$  dimension of  $\mathcal{O}$ .

#### 7.4 Non-extremal three-point function for $SO(6)$

Here we will use the insertion of complete bases for the separate pieces

$$(V_F \otimes V_N \otimes V_{\bar{N}})^{\otimes n} \rightarrow (V_F \otimes V_N \otimes V_{\bar{N}})^{\otimes c} \otimes (V_F \otimes V_N \otimes V_{\bar{N}})^{\otimes n-c} \quad (285)$$

to cut  $\mathcal{O}(x)$  into two

$$\mathcal{O}(x) = \sum_{\mathcal{K}^{\dagger c}, \mathcal{L}^{\dagger n-c}} \langle \mathcal{K} \otimes \mathcal{L} | \mathcal{O} \rangle \mathcal{K}(x) \mathcal{L}(x) \quad (286)$$

where  $\mathcal{K}, \mathcal{L}$  are not necessarily gauge-invariant. They may now be gauge-covariant  $U(N)$  tensors.

If we contract collections of fundamental fields in the manner of the equation (273)

$$\begin{aligned}
& : W_{A_1^1}(x_1) \cdots W_{A_{n_1}^1}(x_1) : : W_{A_1^2}(x_2) \cdots W_{A_{n_2}^2}(x_2) : \\
&= \sum_{c=0}^{\min(n_1, n_2)} \sum_{\sigma_1 \in S_{n_1}/S_c \times S_{n_1-c}} \sum_{\sigma_2 \in S_{n_2}/S_c \times S_{n_2-c}} \\
& \left\langle : W_{A_{\sigma_1(1)}^1}(x_1) \cdots W_{A_{\sigma_1(c)}^1}(x_1) : : W_{A_{\sigma_2(1)}^2}(x_2) \cdots W_{A_{\sigma_2(c)}^2}(x_2) : \right\rangle \\
& : W_{A_{\sigma_1(c+1)}^1}(x_1) \cdots W_{A_{\sigma_1(n_1)}^1}(x_1) W_{A_{\sigma_2(c+1)}^2}(x_2) \cdots W_{A_{\sigma_2(n_2)}^2}(x_2) : \quad (287)
\end{aligned}$$

Use the  $S_{n_k}$ -invariance of  $\mathcal{O}_1$  and  $\mathcal{O}_2$  and the splitting in (286) to get

$$\begin{aligned}
\mathcal{O}_1(x_1)\mathcal{O}_2(x_2) &= \sum_{c=0}^{\min(n_1, n_2)} \binom{n_1}{c} \binom{n_2}{c} \sum_{\mathcal{K}_1, \mathcal{L}_1} \sum_{\mathcal{K}_2, \mathcal{L}_2} \langle \mathcal{K}_1 \otimes \mathcal{L}_1 | \mathcal{O}_1 \rangle \langle \mathcal{K}_2 \otimes \mathcal{L}_2 | \mathcal{O}_2 \rangle \\
& \langle \mathcal{K}_1(x_1) \mathcal{K}_2(x_2) \rangle : \mathcal{L}_1(x_1) \mathcal{L}_2(x_2) : \quad (288)
\end{aligned}$$

$\mathcal{K}_1, \mathcal{K}_2 \vdash c$ ,  $\mathcal{L}_1 \vdash n_1 - c$ ,  $\mathcal{L}_2 \vdash n_2 - c$ . So looking back to the proper OPE (274) we have for  $\mathcal{O}_i = : \mathcal{L}_1(x_1) \mathcal{L}_2(x_2) :$

$$\mathcal{C}_{12}^i \sim \sum_{\mathcal{K}_1} \sum_{\mathcal{K}_2} \langle \mathcal{K}_1 \otimes \mathcal{L}_1 | \mathcal{O}_1 \rangle \langle \mathcal{K}_2 \otimes \mathcal{L}_2 | \mathcal{O}_2 \rangle \langle \mathcal{K}_1 | \mathcal{K}_2 \rangle \quad (289)$$

where  $\langle \mathcal{K}_1 | \mathcal{K}_2 \rangle$  is the constant factor of the two-point function.

Then when we plug this into the non-extremal three-point function we get

$$\begin{aligned}
\langle \mathcal{O}_1(x_1) \mathcal{O}_2(x_2) \mathcal{O}_3(x_3) \rangle &= \binom{n_1}{c} \binom{n_2}{c} \sum_{\mathcal{K}_1, \mathcal{L}_1} \sum_{\mathcal{K}_2, \mathcal{L}_2} \langle \mathcal{K}_1 \otimes \mathcal{L}_1 | \mathcal{O}_1 \rangle \langle \mathcal{K}_2 \otimes \mathcal{L}_2 | \mathcal{O}_2 \rangle \\
& \langle \mathcal{K}_1(x_1) \mathcal{K}_2(x_2) \rangle \langle \mathcal{L}_1(x_1) \mathcal{L}_2(x_2) \mathcal{O}_3(x_3) \rangle \quad (290)
\end{aligned}$$

$c$  is fixed at  $c = \frac{1}{2}(n_1 + n_2 - n_3)$ . The correlator  $\langle \mathcal{L}_1(x_1) \mathcal{L}_2(x_2) \mathcal{O}_3(x_3) \rangle$  is of the ‘basic’ form studied in Section 7.3 because the dimensions of  $\mathcal{L}_1$  and  $\mathcal{L}_2$  add up to that of  $\mathcal{O}_3$ .

Separating the spacetime and tensor parts of the correlators gives a more symmetric solution

$$\begin{aligned}
\langle \mathcal{O}_1(x_1) \mathcal{O}_2(x_2) \mathcal{O}_3(x_3) \rangle &= \binom{n_1}{c} \binom{n_2}{c} \sum_{\mathcal{K}_1, \mathcal{L}_1} \sum_{\mathcal{K}_2, \mathcal{L}_2} \langle \mathcal{K}_1 \otimes \mathcal{L}_1 | \mathcal{O}_1 \rangle \langle \mathcal{K}_2 \otimes \mathcal{L}_2 | \mathcal{O}_2 \rangle \\
& \frac{\langle \mathcal{K}_1 | \mathcal{K}_2 \rangle}{|x_1 - x_2|^{2c}} \frac{\langle \mathcal{O}_3 | \mathcal{L}_1 \otimes \mathcal{L}_2 \rangle}{|x_1 - x_3|^{2(n_1-c)} |x_2 - x_3|^{2(n_2-c)}} \quad (291)
\end{aligned}$$

To find the  $N$  dependence is made slightly more difficult by the fact that the  $\mathcal{K}_i$  and  $\mathcal{L}_i$  are gauge-covariant. The entire three-point function can be expanded in  $U(N)$  dimensions  $T \in P(\frac{1}{2}(n_1 + n_2 + n_3), N)$ . These must satisfy the following consistency conditions, if we expand out the  $U(N)$  tensors  $R$  for the holomorphic indices from the

composite tensors

$$g(R_{\mathcal{K}_1}, R_{\mathcal{L}_1}, R_{\mathcal{L}_2}; T) > 0 \quad g(R_{\mathcal{K}_2}, R_{\mathcal{L}_1}, R_{\mathcal{L}_2}; T) > 0 \quad (292)$$

Similar conditions hold for the  $U(N)$  tensors  $S$  for the antiholomorphic indices.

### 7.5 Extension to $SO(2, 4)$

With the operators constructed in Section 4.5 it is also possible to extend the non-extremal free three-point function to operators which are not Lorentz scalars. First compute the three-point function for the primary fields. Because we have essentially reduced the three-point function to two two-point function calculations, its general form follows (291), but the spacetime dependence becomes more involved, see for example equation (16) of [127]. For descendants apply the appropriate spacetime derivatives to the three-point function of the primaries.

### 7.6 At 1-loop

When we compute the one-loop correction to the three-point function only F-terms contribute nontrivially [36], just like for the two-point function. This means that we insert the dilatation operator (240) into the three-point function on the condition that fields from  $\{W_A, W_B\}$  and  $\{\tilde{W}^C, \tilde{W}^D\}$  do not contract on the same operator.

There are two generic situations when both of  $\{W_A, W_B\}$  contract with  $\mathcal{O}_1$ :

- $\{\tilde{W}^C, \tilde{W}^D\}$  both contract with  $\mathcal{O}_2$ .
- One of each of  $\{\tilde{W}^C, \tilde{W}^D\}$  contract with  $\mathcal{O}_2$  and  $\mathcal{O}_3$ . This is a genuine three-body interaction.

The three operators will mix via the  $U(N)$  representation

$$T \in P\left(\frac{1}{2}(n_1 + n_2 + n_3) + 1, N\right) \quad (293)$$

When the loop involves fields belonging to only two of the three operators we get the same position dependence as that of the one-loop corrections to two-point functions,  $\ln|x_i - x_j|^2 \Lambda^2$ .

When the four fields belong to three operators then the position dependence is that typical for one-loop corrections to three-point functions

$$\ln \left[ \frac{|x_i - x_j|^2 |x_i - x_k|^2 \Lambda^2}{|x_j - x_k|^2} \right] \quad (294)$$

## 8 Correlators, topologies and probabilities

In this section we compute correlation functions to resolve certain transition probabilities for giant gravitons using CFT factorisation [63]. For a conformal field theory like  $\mathcal{N} = 4$  super Yang-Mills factorisation equations let us write correlators on 4-dimensional surfaces with non-trivial topology in terms of correlators on the 4-sphere, just like factorisation of correlators on Riemann surfaces in two dimensions. Because of positivity properties of the summands in the factorisation equations we can interpret these summands as well-defined probabilities for a large class of processes.

Basic results on giant gravitons and Schur polynomials are summarised in Sections 2.6.1 and 2.7. Section 8.2 states the problem of correctly normalising transition probabilities for giant gravitons, while Section 8.3 gives the outline of our solution to this puzzle. Equation (308) highlights how dividing by correlation functions on ‘genus one’ four-dimensional manifolds can give well-defined probabilities. The resulting correctly normalised results are calculated in Section 8.5 following the general result (365) for the genus one case. In Section 8.6 the bulk manifolds with these higher-genus boundaries and the bulk interpretation of these results are discussed.

### 8.1 Introduction

AdS/CFT duality [12][13][14] provides a framework to study hard questions of quantum gravity, using tractable calculations in gauge theory. The discovery of giant gravitons [43][45][46] and the identification of their dual gauge theory operators [47][19] opened the way to exploring transitions among these brane-like objects, as well as transitions from giant gravitons into small, ordinary gravitons. From the point of view of the bulk gravity theory, these processes are non-perturbative in nature and difficult to analyze quantitatively.

In this section we explain how to calculate the corresponding transition probabilities. These can be obtained by appropriately normalizing the relevant gauge theory correlators describing the bulk interactions. We show that, in general, the normalization factors involve correlators on manifolds of non-trivial topologies. The result is a direct consequence of CFT factorization equations, which relate correlators on manifolds of different topologies<sup>14</sup>. Factorization is expected to be a generic property of conformal field theories, which follows from the operator/state correspondence and sewing properties of path integrals. Here we explore some of its implications for the case of the four dimensional  $\mathcal{N} = 4$  Super Yang Mills theory. We prove explicit inequalities that follow after we discard some intermediate states from the four dimensional factorization equations. As we shall demonstrate with specific examples, factorization relations among correlators on spaces of different topologies constrain the relative growth of the correlators as the number of colors is increased, in a manner consistent with the probability interpretation.

---

<sup>14</sup>The classical study for 2d CFT is Sonoda [128, 129].

These probabilities are the generic observables of string theory in asymptotically  $AdS$  backgrounds.

## 8.2 Statement of the puzzle

We want to work out the normalized amplitudes for the transition from  $AdS$  and sphere giant graviton states either into other giant gravitons or into many Kaluza-Klein gravitons. We make use of two different normalizations: the ‘multi-particle’ normalization and the ‘overlap-of-states’ normalization. For the multi-particle normalization we divide the correlator by the norms of each of the products separately; for the overlap-of-states normalization we divide by the norm of all the outgoing states together. In this section, we ignore the spatial structure of the correlators and only consider the matrix-index structure. In our exact treatment later we cannot ignore the spatial dependencies of the correlators.

The multi-particle-normalized transition from an  $AdS$  giant graviton state with angular momentum  $N$  into several Kaluza-Klein gravitons, all of which have angular momentum  $J$ , is given by

$$\frac{|\langle \chi_{[N]}(X^\dagger) (\text{tr}(X^J))^{N/J} \rangle|^2}{\langle \chi_{[N]}(X^\dagger) \chi_{[N]}(X) \rangle \langle \text{tr}(X^{\dagger J}) \text{tr}(X^J) \rangle^{N/J}} \quad (295)$$

and the overlap-of-states-normalized  $S$  giant transition is given by

$$\frac{|\langle \chi_{[1^N]}(X^\dagger) (\text{tr}(X^J))^{N/J} \rangle|^2}{\langle \chi_{[1^N]}(X^\dagger) \chi_{[1^N]}(X) \rangle \langle (\text{tr}(X^{\dagger J}))^{N/J} (\text{tr}(X^J))^{N/J} \rangle} \quad (296)$$

The first part of the puzzle is that, in general, the multi-particle normalization does not yield well-defined probabilities. For example if we calculate the  $AdS$  giant graviton process (295) for  $J = N/2$ , we get the answer

$$\frac{|\langle \chi_{[N]}(X^\dagger) \text{tr}(X^{\frac{N}{2}}) \text{tr}(X^{\frac{N}{2}}) \rangle|^2}{\langle \chi_{[N]}(X^\dagger) \chi_{[N]}(X) \rangle \langle \text{tr}(X^{\dagger \frac{N}{2}}) \text{tr}(X^{\frac{N}{2}}) \rangle \langle \text{tr}(X^{\dagger \frac{N}{2}}) \text{tr}(X^{\frac{N}{2}}) \rangle} \sim \frac{1}{6\sqrt{2}} \left( \frac{32}{27} \right)^N \quad (297)$$

which is bigger than 1 and therefore does not yield a well-defined probability.

Similarly the multi-particle-normalized transition (295) for  $J \ll N$  is given by

$$\frac{|\langle \chi_{[N]}(X^\dagger) (\text{tr}(X^J))^{N/J} \rangle|^2}{\langle \chi_{[N]}(X^\dagger) \chi_{[N]}(X) \rangle \langle \text{tr}(X^{\dagger J}) \text{tr}(X^J) \rangle^{N/J}} \sim 2^{-\frac{1}{2}} e^{-N+2N \log(2) - (N/J) \log(J)} \quad (298)$$

The factor multiplying  $N$  in the exponential is  $-1/2 + \log(2) - (1/2J) \log(J)$ , which is positive for all  $J$  (because  $\log(2)$  dominates). Thus this amplitude exponentially increases with  $N$  for all  $J$ . This is also inconsistent with a probability interpretation.

When we consider the multi-particle normalized transition from an  $AdS$  giant into

two smaller *AdS* giants, we get similar divergent results

$$\frac{\left| \langle \chi_{[N]}(X^\dagger) \chi_{[\frac{N}{2}]}(X) \chi_{[\frac{N}{2}]}(X) \rangle \right|^2}{\langle \chi_{[N]}(X^\dagger) \chi_{[N]}(X) \rangle \langle \chi_{[\frac{N}{2}]}(X^\dagger) \chi_{[\frac{N}{2}]}(X) \rangle \langle \chi_{[\frac{N}{2}]}(X^\dagger) \chi_{[\frac{N}{2}]}(X) \rangle} \sim \frac{3}{\sqrt{8}} \left( \frac{32}{27} \right)^N \quad (299)$$

Note however that the multi-particle normalization does not always give divergent results. For example the transition from a *sphere* giant state into KK gravitons with  $J \ll N$  is given by

$$\frac{\left| \langle \chi_{[1^N]}(X^\dagger) (\text{tr}(X^J))^{N/J} \rangle \right|^2}{\langle \chi_{[1^N]}(X^\dagger) \chi_{[1^N]}(X) \rangle \langle \text{tr}(X^{\dagger J}) \text{tr}(X^J) \rangle^{N/J}} \sim (2\pi)^{\frac{1}{2}} e^{-N + \frac{1}{2} \log(N) - (N/J) \log(J)} \quad (300)$$

which is exponentially decreasing for all  $J$ .

The second part of the puzzle is that there is no clear way to decide which normalization to use. In this paper we solve both puzzles. We will show that the multi-particle normalization requires us to divide by the two-point function on a ‘higher genus’ 4d manifold. This will yield well-defined probabilities for transitions from a single giant graviton state into a collection of smaller objects. We will also find that different transition probability interpretations require different normalizations.

A final subtlety is that for transitions from a giant state to states described by single trace operators, we cannot just naively take the square of the absolute value of the overlap amplitude of the giant graviton operator with a bunch of traces. Instead we should take the overlap of the giant graviton operator with traces and multiply with the overlap amplitude involving the duals of the trace operators. The dual is defined in terms of the metric on the space of traces:  $\mathcal{G}^{ij} \mathcal{O}_j$ . Section 2.7.3 summarises results for the dual basis.

Details of the calculations presented in this section, as well as several other computations, are given in Appendix A of [63]. The correctly normalized results for the processes discussed here are given in Section 8.5. These are exponentially suppressed in  $N$  as expected.

### 8.3 From factorization to probability interpretation of correlators

#### 8.3.1 Factorization on $S^4$ and probabilities

Factorization in conformal field theory relates  $n$ -point correlators on the sphere to lower point correlators. Consider

$$|\langle A^\dagger(x^*) B(y) \rangle|^2 = \langle A^\dagger(x^*) B(y) \rangle \langle B^\dagger(y^*) A(x) \rangle \quad (301)$$

Factorization implies that we can interpret a normalized version of this as a probability for the state created by the operator  $A$  at  $x$  to evolve into the state created by the operator  $B$  at  $y^*$ . The action of conjugation acts by reversing the sign of the Euclidean



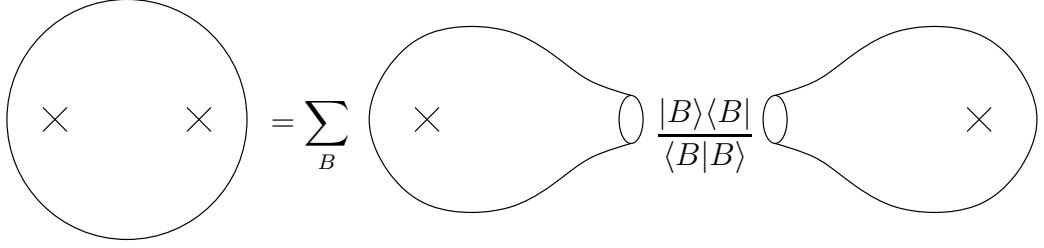

Figure 8: A sphere correlator by gluing two spheres.

time coordinate.<sup>15</sup>

Consider the correlator  $\langle A^\dagger(x^*)A(x) \rangle$  on a sphere. Now cut the sphere in two along a spatial slice  $C$  (a circle  $S^1$  if we are cutting a 2-dimensional sphere  $S^2$ ; if we are cutting an  $S^4$  the slice is an  $S^3$ ), see Figure 8. We sum over a complete set of states  $B$  for the Hilbert space associated with the spatial slice  $C$ . We choose  $B$  to diagonalise the metric on the Hilbert space. The factorisation equations relate the correlator on the original sphere to the cut pieces

$$\langle A^\dagger(x^*)A(x) \rangle = \sum_B \frac{\langle A^\dagger(x^*)B(C) \rangle \langle B^\dagger(C^*)A(x) \rangle}{\langle B^\dagger(C^*)B(C) \rangle} \quad (302)$$

Now use the operator-state correspondence for conformal field theories to relate the state  $B$  at  $C$  to the local operator  $B$  at a point  $y$  on the manifold where we have filled in  $C$ . Dividing by the term on LHS we have

$$1 = \sum_B P(A(x) \rightarrow B(y)) \quad (303)$$

where  $P$  is interpreted as the probability for  $A$  to evolve into  $B$ , given by

$$P(A(x) \rightarrow B(y)) = \frac{\langle A^\dagger(x^*)B(y) \rangle \langle B^\dagger(y^*)A(x) \rangle}{\langle A^\dagger(x^*)A(x) \rangle \langle B^\dagger(y^*)B(y) \rangle} \quad (304)$$

We will describe the detailed factorization equations later on, which follow from conformal invariance and the sewing properties of path integrals. These equations involve sums over all operators. There is a limit of large separations where the factorization can be restricted to BPS states, and gives the combinatoric (position independent) factorization equations in terms of the Littlewood-Richardson coefficients obtained in [48].

If we use the non-diagonal trace basis for the  $B$ 's in (304), we still have a factorization

<sup>15</sup>In Euclidean theories, the proper definition of the adjoint of an operator involves the usual conjugation as well as the reversal of the Euclidean time. This operation guarantees that self-adjoint operators remain self-adjoint under Euclidean time evolution:  $A(\tau) = e^{H\tau}A(0)e^{-H\tau}$ . It also means that for a physical theory  $\langle A^\dagger(-\tau, \theta)A(\tau, \theta) \rangle$  must be positive, a condition called reflection positivity [130]. Thus the RHS of eq. (304) is positive as it must be the case for a proper probability interpretation.

equation. In this basis, the probability is defined by

$$P(A \rightarrow B) = \frac{\langle A^\dagger B \rangle \langle \tilde{B}^\dagger A \rangle}{\langle A^\dagger A \rangle} \quad (305)$$

where  $\tilde{B}$  is the dual operator to  $B$ , with duality being given by the inner product defined by the 2-point function (see Section 2.7.3).

### 8.3.2 Higher topology and multi-particle normalization

We can extend these arguments to derive the probability interpretation for the case of multiple outgoing particles.

We need to consider correlators of higher topology. Take the  $\mathbb{R}^4$  manifold with two  $B^4$ 's cut out and an operator insertion. This gives a manifold with two  $S^3$  boundaries and a puncture. Take a second copy of  $\mathbb{R}^4$  with the  $B^4$ 's cut out and an operator inserted. Glue each  $S^3$  boundary with a corresponding  $S^3$  boundary on the other  $\mathbb{R}^4$ . Call this manifold  $X$  and consider a two-point function on  $X$ :

$$\langle A^\dagger(x^*)A(x) \rangle_{G=1} \quad (306)$$

This procedure is analogous to that of gluing two cylinders in 2d CFT to get a genus one surface with two punctures. Here we are doing the gluing in a 4d CFT, but we have used the notation  $G = 1$  by analogy. We introduce the notation  $\Sigma_4(G)$ , to denote the four dimensional analog of a genus  $G$  surface in two dimensions. It can be obtained by taking two copies of  $S^4$  with  $G + 1$  non-intersecting balls removed, and gluing the two along the  $S^3$  boundaries. To define probabilities for some set of states to go into  $G + 1$  states we need to normalize with correlators on  $\Sigma_4(G)$ .

We can argue for this as follows. By the factorization argument we have

$$\langle A^\dagger(x^*)A(x) \rangle_{G=1} = \sum_{B_1, B_2} \frac{\langle A^\dagger(x^*)B_1(C_1)B_2(C_2) \rangle \langle B_2^\dagger(C_2^*)B_1^\dagger(C_1^*)A(x) \rangle}{\langle B_1^\dagger(C_1^*)B_1(C_1) \rangle \langle B_2^\dagger(C_2^*)B_2(C_2) \rangle} \quad (307)$$

See Figure 9.  $C_1$  and  $C_2$  are circles along which we cut the torus. The operators  $B_i(C_i)$  create states localized on these circles. By scaling, these are related to the more familiar states which, in the operator-state correspondence, are obtained by local operators acting on the vacuum. Hence the equation above can be related to correlation functions of usual local operators. It follows from (307) that

$$1 = \sum_{B_1, B_2} \frac{\langle A^\dagger(x^*)B_1(C_1)B_2(C_2) \rangle \langle B_2^\dagger(C_2^*)B_1^\dagger(C_1^*)A(x) \rangle}{\langle A^\dagger(x^*)A(x) \rangle_{G=1} \langle B_1^\dagger(C_1^*)B_1(C_1) \rangle \langle B_2^\dagger(C_2^*)B_2(C_2) \rangle} \quad (308)$$

Since every summand is real and positive, it can be interpreted as a probability. We conclude that to normalize correlators in order to get a probability for the case of multiple

$$\text{torus correlator} = \sum_{B_1, B_2} \left( \text{sphere}_1 \frac{|B_1\rangle\langle B_1|}{\langle B_1|B_1\rangle} \text{sphere}_2 \right)$$

Figure 9: A torus correlator by gluing two spheres.

outgoing objects we need to divide by factors involving higher genus correlators. This corrects the naive multi-particle prescription used in the previous section.

We conclude this section with some comments:

- Notice that the probabilities we describe are defined subject to the constraint that the number of final states is fixed. Multi-particle states in this context are obtained by the action of products of well separated operators on the vacuum. A brief discussion of conditional probabilities subject to additional conditions, such as fixing one of the outgoing states, is given in Appendix Section B of [63].
- In this paper we focus on Euclidean correlators on  $\mathbb{R}^4$  (or  $S^4$ ) and higher genus spaces. A Lorentzian interpretation can be developed by choosing an appropriate time direction so that the out-states appear at a later time. When the factorization equations are appropriately continued to Lorentzian signature, they still provide relations between correlators. We have not described the normalization procedure in a purely Lorentzian set-up, but we expect that the probabilities continue to be relevant. Certainly in the large distance limits where the probabilities are independent of separations (see section 8.5), this is the case. A more thorough investigation of the Lorentzian picture is desirable, where issues of bulk causality of the results can be explored along the lines of [131].
- We work in a basis where the states are characterized by the action of a local operator on the CFT vacuum. These states are natural to consider from the CFT point of view. In general, such states are linear superpositions of states carrying arbitrary four-momentum. Definite momentum states must be constructed so as to recover the S-matrix of type IIB string theory in the flat space limit, as described in [132][133][134]. It would be interesting to express the factorization equation in the momentum basis and study which features survive in the flat space limit.

## 8.4 Factorization in the 4D CFT

### 8.4.1 Introduction

Factorisation arguments are familiar from two-dimensional conformal field theories; the connection with probabilities and topologies in 2d is studied as a warm-up in Section 4 of

[63]. These discussions extend naturally to conformal field theories in four dimensions. To obtain sphere factorization identities, we glue together two  $S^4$ s around one puncture to produce a single  $S^4$ . To obtain genus-1 factorization identities, we glue together two  $S^4$ s at two punctures to get a genus-1 surface which is conformally equivalent to the  $S^1 \times S^3$  manifold.

#### 8.4.2 Metric

In order to define a positive metric on the space of operators, we choose the scalar 2-point function on  $\mathbb{R}^4$  to satisfy the convention

$$\Delta_x G(x-y) = -\delta^4(x-y) \quad (309)$$

This gives

$$G(x-y) = \frac{1}{4\pi^2|x-y|^2} \quad (310)$$

If we compactify  $\mathbb{R}^4$  to  $S^4$  the metric on the space of Schur polynomials is given by

$$\left\langle R^{\dagger'}(r'=0)S(r=0) \right\rangle \quad (311)$$

in spherical polar coordinates, where  $r' = 1/r$  and the prime on  $R^{\dagger'}$  indicates that the operator is in the primed coordinate frame. We have used heavily truncated notation for the Schur polynomials where  $S \equiv \chi_S(X)$  and  $R^{\dagger} \equiv \chi_R(X^{\dagger})$ . By choosing these coordinate systems and these spacetime points (corresponding to opposite poles of the sphere  $S^4$ ) we can define a metric that is independent of spacetime position (cf. the Zamolodchikov metric in 2d [79]; this kind of metric is also used in the spin bit approach to the planar  $\mathcal{N} = 4$  theory [71]).

To compute the correlator (311), we map  $R^{\dagger'}$  back to the  $r$ -coordinate frame. Under the coordinate transformation  $r' \rightarrow r = 1/r'$ , the metric changes as follows

$$dr'^2 + r'^2 d\Omega^2 \rightarrow \frac{1}{r^4}(dr^2 + r^2 d\Omega^2) \quad (312)$$

and so the primary fields transform as

$$X'(x') \rightarrow \Omega(x)^{-\Delta/2} X(x) = r^{2\Delta} X(x) \quad (313)$$

where  $\Omega(x) = 1/r^4$  is the conformal factor [78]. Thus for the metric element we obtain

$$\begin{aligned} \left\langle R^{\dagger'}(r'=0)S(r=0) \right\rangle &= \lim_{r_0 \rightarrow \infty} r_0^{2\Delta} \left\langle R^{\dagger}(r=r_0)S(r=0) \right\rangle \\ &= \left( \frac{1}{4\pi^2} \right)^{\Delta} f_R \delta_{RS} \end{aligned} \quad (314)$$

We have used the result for the 2-point function of the Schur polynomial given in Section

2.7 where  $f_R \equiv \frac{n! \text{Dim}_N R}{d_R}$ . For ease of notation we will write the diagonal of this metric

$$\langle R^\dagger R \rangle \equiv \langle R^\dagger(r' = 0) R(r = 0) \rangle \quad (315)$$

#### 8.4.3 The genus zero factorization in four dimensions

We start with two 4-spheres, one with coordinates  $(r, \Omega_i)$  and the other with coordinates  $(s, \Omega'_i)$ . Next we cut out a 4-ball of unit radius around the origin in each, and glue them together using  $rs = 1$ . If we have a complete set of local operators  $\{\mathcal{A}_i(x)\}$  the factorization identity implies

$$\langle R^\dagger(s = e^x) R(r = e^x) \rangle = \sum_i \frac{\langle R^\dagger(s = e^x) \mathcal{A}_i(r = 0) \rangle \langle \mathcal{A}_i^\dagger(s = 0) R(r = e^x) \rangle}{\langle \mathcal{A}_i^\dagger \mathcal{A}_i \rangle} \quad (316)$$

where we set  $x > 0$  so that the operator insertion is outside the cut-off region. We have suppressed the angular coordinates of the operator  $R$  in (316), but these can be arbitrary in general. Compare this equation with Figure 8.

If we restrict the sum over local operators  $\mathcal{A}_i$  to the half-BPS Schur polynomials  $S \equiv \chi_S(X)$  then we get an inequality because we've truncated the spectrum of intermediate states

$$\langle R^\dagger(s = e^x) R(r = e^x) \rangle \geq \sum_S \frac{\langle R^\dagger(s = e^x) S(r = 0) \rangle \langle S^\dagger(s = 0) R(r = e^x) \rangle}{\langle S^\dagger S \rangle} \quad (317)$$

#### 8.4.4 The genus one factorization in four dimensions

We parameterize four dimensional flat space  $\mathbb{R}^4$  with spherical coordinates so that the metric is given by

$$ds^2 = dr^2 + r^2 d\Omega_3^2 \quad (318)$$

This metric is conformal to the standard metric on  $S^3 \times \mathbb{R}$  under the coordinate transformation  $r = e^\tau$ :

$$ds^2 = e^{2\tau} (d\tau^2 + d\Omega_3^2) \quad (319)$$

Start with two cylinders  $S^3 \times I$  described by coordinates  $(r, \Omega_i)$  and  $(s, \Omega'_i)$  with the radial variables in the range

$$\begin{aligned} 1 &\leq r \leq e^T \\ 1 &\leq s \leq e^T \end{aligned} \quad (320)$$

In most of the following expressions, we suppress the angular dependence since the angles, in all of the gluings, are identified trivially.

Introduce also the coordinates  $r' = 1/r$  and  $s' = 1/s$ . We now glue the two cylinders  $S^3 \times I$  at the inner ends  $r = 1, s = 1$  with  $rs = 1$ . We then glue the outer ends at  $r = e^T, s = e^T$  with  $r's' = e^{-2T}$  (i.e.  $rs = e^{2T}$ ). The gluing produces an  $S^3 \times S^1$  manifold with

$$\tau \sim \tau + 2T \text{ }^{16}.$$

#### 8.4.5 The genus one factorization and inequality

The argument for the factorization of the correlation functions in the 3 + 1-dimensional CFT follows from a consideration of the path integral. Start with a path integral on the genus-1 surface, expressed in terms of a generic set of fields  $\phi$

$$\langle \mathcal{O}_1(p_1) \mathcal{O}_2(p_2) \rangle_{G=1} = \int [d\phi] e^{-S(\phi)} \mathcal{O}_1(p_1) \mathcal{O}_2(p_2) \quad (321)$$

Now we cut along two  $S^3$  denoted by  $C_1$  and  $C_2$  to get two ‘cylinders’  $S^3 \times I$ , cf. Figure 9. The fields on the two separate cylinders are denoted by  $\phi_L$  and  $\phi_R$ . The boundary values on the two  $S^3$  are written as  $\phi_{b_1}, \phi_{b_2}$ . Hence the correlator can be written as

$$\langle \mathcal{O}_1(p_1) \mathcal{O}_2(p_2) \rangle_{G=1} = \int [d\phi_{b_1}] [d\phi_{b_2}] \int [d\phi_L]_{\phi_{b_1}}^{\phi_{b_2}} e^{-S(\phi_L)} \mathcal{O}_1(p_1) \int [d\phi_R]_{\phi_{b_1}}^{\phi_{b_2}} e^{-S(\phi_R)} \mathcal{O}_2(p_2) \quad (322)$$

The fields  $\phi_L$  and  $\phi_R$  are integrated subject to boundary conditions  $\phi_{b_1}, \phi_{b_2}$  at the 3-spheres  $C_1, C_2$ . Each of the left/right path integrals give rise to wavefunctionals of fields on these circles that are correlated by the insertions of the local operators. Using the correspondence between wavefunctionals and Hilbert space states, the integrals  $\int d\phi_{b_1} \int d\phi_{b_2}$  can be replaced by sums over states. These are the states summed over. These cutting and gluing relations appear in their simplest form in topological field theories, see for example [135][136]. Then use the operator-state correspondence to turn the sum over states to a sum over local operator insertions in correlators.

Consider the correlator on  $\Sigma_4(G = 1)$  which is obtained by gluing two copies of  $S^3 \times I$ , each obtained by cutting out the neighborhoods of two points in an  $S^4$  manifold. We obtain

$$\langle R^\dagger(P_1) R(P_2) \rangle_{G=1} = \sum_{i,j} \frac{\langle R^\dagger(P_1) \mathcal{A}_i^\dagger(C_2^L) \mathcal{A}_k(C_1^L) \rangle \langle \mathcal{A}_k^\dagger(C_1^R) \mathcal{A}_i(C_2^R) R(P_2) \rangle}{\langle \mathcal{A}_i^\dagger(C_2^L) \mathcal{A}_i(C_2^R) \rangle \langle \mathcal{A}_k^\dagger(C_1^L) \mathcal{A}_k(C_1^R) \rangle} \quad (323)$$

$\{\mathcal{A}_i\}$  is a complete set of states; the surfaces  $C_i^L$  and  $C_i^R$  are 3-spheres. Compare this equation with Figure 9.

By scaling, we can express the RHS in terms of correlators of local operators on  $\mathbb{R}^4$

$$\begin{aligned} \langle R^\dagger(r = e^x, \Omega_i) R(s = e^x, \Omega_i) \rangle &= Z_0 \sum_{i,j} e^{-2T\Delta_i} \\ &\frac{\langle R^\dagger(r = e^x, \Omega_i) \mathcal{A}_i^\dagger(r' = 0) \mathcal{A}_k(r = 0) \rangle \langle \mathcal{A}_k^\dagger(s = 0) \mathcal{A}_i(s' = 0) R(s = e^x, \Omega_i) \rangle}{\langle \mathcal{A}_i^\dagger \mathcal{A}_i \rangle \langle \mathcal{A}_k^\dagger \mathcal{A}_k \rangle} \end{aligned} \quad (324)$$

$Z_0$  is the large  $T$  limit of the Euclidean partition function on  $S^3 \times S^1$ . It depends only

<sup>16</sup>In our notation,  $2T$  stands for the inverse temperature with regards to the thermal theory on  $S^3 \times S^1$ . We hope that the notation does not cause confusion to the reader.

on the Casimir energy of the ground state. We will not need it explicitly. In going from a path integral expression to an operator expression, we must specify a time-ordering. We specialize to the case where  $P_2$  and  $P_1$  are related by Euclidean time reversal so that we can expect positivity of the RHS of the equations above. We will further restrict the sum to the case where  $\mathcal{A}_i^\dagger$  and  $\mathcal{A}_k$  are given respectively by the Schur Polynomials  $\chi_{R_1}(X)$  and  $\chi_{R_2}(X)$ . Because we have truncated the intermediate states of (324) we therefore expect an inequality

$$\begin{aligned} & \langle R^\dagger(s = e^x, \Omega_i) R(r = e^x, \Omega_i) \rangle_{G=1} \\ & > Z_0 \sum_{R_1, R_2} e^{-2T\Delta_1} \frac{\langle R^\dagger(r = e^x, \Omega_i) R'_1(r' = 0) R_2(r = 0) \rangle \langle R_2^\dagger(s = 0) R_1'(s' = 0) R(s = e^x, \Omega_i) \rangle}{\langle R_1^\dagger R_1 \rangle \langle R_2^\dagger R_2 \rangle} \end{aligned} \quad (325)$$

It is the goal of the next few sections to demonstrate that this inequality indeed holds, so that we can safely divide both sides by the genus one two-point function and interpret the summand on the RHS as a probability.

We work out the first three-point function to get

$$\begin{aligned} & \langle R^\dagger(r = e^x, \Omega_i) R'_1(r' = 0) R_2(r = 0) \rangle \\ & = \lim_{r_0 \rightarrow \infty} \langle R^\dagger(r = e^x, \Omega_i) r_0^{2\Delta_1} R_1(r = r_0) R_2(r = 0) \rangle \\ & = (4\pi^2)^{-\Delta_1 - \Delta_2} e^{-2x\Delta_2} g(R_1, R_2; R) f_R \end{aligned} \quad (326)$$

Similarly for the second correlator we get

$$\langle R_2^\dagger(s = 0) R_1'(s' = 0) R(s = e^x, \Omega_i) \rangle = (4\pi^2)^{-\Delta_1 - \Delta_2} e^{-2x\Delta_2} g(R_1, R_2; R) f_R \quad (327)$$

Hence the right-hand side of the inequality (325) becomes

$$\sum_{R_1, R_2} (4\pi^2)^{-\Delta_1 - \Delta_2} \frac{g(R_1, R_2; R)^2 f_R^2}{f_{R_1} f_{R_2}} e^{-2T\Delta_1} e^{-4x\Delta_2} \quad (328)$$

Because of charge conservation, the only terms contributing to the RHS are those for which  $\Delta_1 + \Delta_2 = \Delta_R$ , where  $\Delta_R$  is the conformal dimension of the Schur operator  $R$ .

#### 8.4.6 The correlator on $S^3 \times S^1$

Let the metric on  $S^3 \times S^1$  be given by

$$ds^2 = d\tau^2 + d\chi^2 + \sin^2 \chi (d\theta^2 + \sin^2 \theta d\phi^2) \quad (329)$$

where  $\tau \in [0, 2T]$ ,  $\chi, \theta \in [0, \pi]$  and  $\phi \in [0, 2\pi]$ .

If the differential operator  $K$  admits a complete set of eigenvectors  $\Psi_n(x)$  with

$K\Psi_n = \lambda_n\Psi_n$ , then the corresponding Green's function is given by

$$G(x, y) = \sum_{n|\lambda_n \neq 0} \frac{\Psi_n^*(x)\Psi_n(y)}{\lambda_n} \quad (330)$$

and it satisfies

$$\begin{aligned} KG(x, y) &= \sum_{n|\lambda_n \neq 0} \Psi_n^*(x)\Psi_n(y) \\ &= \delta(x - y) - \sum_{n|\lambda_n = 0} \Psi_n^*(x)\Psi_n(y) \end{aligned} \quad (331)$$

For a conformally coupled scalar field in four dimensions, the differential operator  $K$  is given by

$$K = \Delta - \frac{1}{6}R \quad (332)$$

where  $\Delta$  is the Euclidean Laplacian and the second term is the coupling to the 4-dimensional curvature [137]. It is like a mass term and has the same sign as a positive mass term in a Euclidean theory. For  $S^1 \times S^3$  with unit radii, only the curvature of  $S^3$  contributes, giving for the Ricci scalar curvature  $R = 6$ . Thus  $K = \Delta - 1$ .

On  $S^3$  the spherical harmonics are given by [137]

$$\mathcal{Y}_{\mathbf{k}}(\Omega_i) = \Pi_{kJ}(\chi)Y_J^M(\theta, \phi) \quad (333)$$

where  $\mathbf{k} = (k, J, M)$ ,  $Y_J^M$  are spherical harmonics on  $S^2$  and  $\Pi_{kJ}$  is given by

$$\Pi_{kJ} = \left[ \frac{1}{2}\pi k^2(k^2 - 1) \cdots (k^2 - J^2) \right]^{-1/2} \sin^J \chi \left( \frac{d}{d \cos \chi} \right)^{1+J} \cos k\chi \quad (334)$$

The quantum numbers  $k$ ,  $J$  and  $M$  lie in the following ranges

$$\begin{aligned} k &= 1, 2, \dots, \\ J &= 0, 1, \dots, k - 1 \\ M &= -J, -J + 1, \dots, J \end{aligned} \quad (335)$$

The harmonics  $\mathcal{Y}_{\mathbf{k}}(\Omega_i)$  satisfy

$$\Delta_{S^3}\mathcal{Y}_{\mathbf{k}}(\Omega_i) = -(k^2 - 1)\mathcal{Y}_{\mathbf{k}}(\Omega_i) \quad (336)$$

and they are orthonormal. Spherical harmonics on  $S^1$  are given by

$$h_m(\tau) = \mathcal{N}e^{im\pi\tau/T} \quad (337)$$



where  $\mathcal{N} = (2T)^{-\frac{1}{2}}$  is the normalization factor. They satisfy

$$\Delta_{S^1} h_m = - \left( \frac{m\pi}{T} \right)^2 h_m \quad (338)$$

Thus if

$$\Psi_n = h_m(\tau) \mathcal{Y}_{\mathbf{k}}(\Omega_i) \quad (339)$$

where  $n = (m, \mathbf{k})$ , then

$$\Delta_{S^3 \times S^1} \Psi_n = (\Delta_{S^3} + \Delta_{S^1}) \Psi_n = \left[ -(k^2 - 1) - \left( \frac{m\pi}{T} \right)^2 \right] \Psi_n \quad (340)$$

If we add the conformal coupling term as in (332), we get

$$K \Psi_n = (\Delta_{S^3 \times S^1} - 1) \Psi_n = \left[ -k^2 - \left( \frac{m\pi}{T} \right)^2 \right] \Psi_n \quad (341)$$

This eigenvalue problem has no zero-mode solution. In accordance with the  $\mathbb{R}^4$  correlator (309), we actually choose the Green's function to satisfy

$$KG(x, y) = -\delta^4(x - y) \quad (342)$$

so that we get a positive metric on the space of operators. So the desired Green's function is given by

$$\begin{aligned} G(x, y) &= - \sum_n \frac{\Psi_n^*(x) \Psi_n(y)}{\lambda_n} \\ &= \sum_{m, k, J, M} \frac{h_m^*(\tau) \mathcal{Y}_{\mathbf{k}}^*(\Omega_i) h_m(\tau') \mathcal{Y}_{\mathbf{k}}(\Omega'_i)}{k^2 + \left( \frac{m\pi}{T} \right)^2} \end{aligned} \quad (343)$$

where  $k, J$  and  $M$  are in the ranges set out in (335) and  $m$  is an integer.

We want to work out

$$\left\langle R^\dagger(s = e^x) R(r = e^x) \right\rangle_{G=1} \quad (344)$$

where the angular coordinates are fixed to coincide.

If we change coordinates to  $s = e^{-\tau}$ ,  $r = e^\tau$ , we get

$$\begin{aligned} \left\langle X^\dagger(s = e^x) X(r = e^x) \right\rangle_{G=1} &= \frac{1}{rs} \left\langle X^\dagger(\tau = -x) X(\tau = x) \right\rangle_{G=1} \\ &= e^{-2x} \left\langle X^\dagger(\tau = -x) X(\tau = x) \right\rangle_{G=1} \end{aligned} \quad (345)$$

Now insert the Green's function (343) to get

$$Z_{G=1}^{-1} \left\langle X^\dagger(\tau = -x) X(\tau = x) \right\rangle_{G=1} = \sum_{m, k, J, M} \frac{h_m^*(0) \mathcal{Y}_{\mathbf{k}}^*(\Omega_i) h_m(2x) \mathcal{Y}_{\mathbf{k}}(\Omega_i)}{k^2 + \left( \frac{m\pi}{T} \right)^2} \quad (346)$$

where we put each  $S^3$  spherical harmonic at the same point on the  $S^3$  and  $Z_{G=1}$  is the thermal partition function. A choice of the angular point simplifies the sum. Let that point be where  $\chi = 0$  so that  $\Pi_{k,J}$  is zero for  $J > 0$ , since the term  $\sin^J \chi$  at the front of the expression is zero ( $\cos k\chi$  is a polynomial in  $\cos \chi$  so for  $\chi = 0$  the derivatives of  $\cos k\chi$  give a constant). Then the only terms that contribute are those with  $J = M = 0$ . We get

$$\begin{aligned}\Pi_{k0} &= \left[ \frac{1}{2} \pi k^2 \right]^{-1/2} \frac{d}{d \cos \chi} \cos k\chi \Big|_{\chi=0} \\ &= 2^{1/2} \pi^{-1/2} k\end{aligned}\quad (347)$$

Then noting that  $Y_0^0(\theta, \phi) = 2^{-1}(\pi)^{-1/2}$ , we get

$$\begin{aligned}\Gamma(-x, x) &\equiv \frac{\langle X^\dagger(\tau = -x) X(\tau = x) \rangle_{G=1}}{Z_{G=1}} \\ &= \sum_{m \in \mathbb{Z}, k \geq 1} \frac{\mathcal{N}^2 e^{im2\pi x/T} 2^{-1} \pi^{-2} k^2}{k^2 + \left(\frac{m\pi}{T}\right)^2} \\ &= \frac{1}{4\pi^2 T} \sum_{m \in \mathbb{Z}, k \geq 1} \frac{k^2 e^{im2\pi x/T}}{k^2 + \left(\frac{m\pi}{T}\right)^2} \\ &= \frac{1}{4\pi^2 T} \left[ 2 \sum_{m > 0, k \geq 1} \frac{k^2 \cos(m2\pi x/T)}{k^2 + \left(\frac{m\pi}{T}\right)^2} + \sum_{k \geq 1} \frac{k^2}{k^2} \right]\end{aligned}\quad (348)$$

where the second term in the last expression is the  $m = 0$  term. When plotted the truncated sums converge everywhere, except when  $x$  is an integer multiple of  $T$ .

#### 8.4.7 The Inequality

The computations above fill in the details of the inequality in equation (325) and lead to the spacetime inequality

$$\begin{aligned}e^{-2x(\Delta_1 + \Delta_2)} (\Gamma(-x, x))^{\Delta_1 + \Delta_2} f_R Z_{G=1} \\ > Z_0 \left( \frac{1}{4\pi^2} \right)^{\Delta_1 + \Delta_2} \sum_{R_1, R_2} \frac{g(R_1, R_2; R)^2 f_R^2}{f_{R_1} f_{R_2}} e^{-2T\Delta_1} e^{-4x\Delta_2}\end{aligned}\quad (349)$$

or substituting in equation (348)

$$\begin{aligned}\left( \frac{1}{4\pi^2 T} \left[ 2 \sum_{m > 0, k \geq 1} \frac{k^2 \cos(m2\pi x/T)}{k^2 + \left(\frac{m\pi}{T}\right)^2} + \sum_{k \geq 1} 1 \right] \right)^{\Delta_1 + \Delta_2} \\ > \frac{Z_0}{Z_{G=1}} \left( \frac{1}{4\pi^2} \right)^{\Delta_1 + \Delta_2} \sum_{R_1, R_2} \frac{g(R_1, R_2; R)^2 f_R}{f_{R_1} f_{R_2}} e^{-2T\Delta_1 + 2x(\Delta_1 - \Delta_2)}\end{aligned}\quad (350)$$

The  $4\pi^2$  constants cancel. In the large  $T$  limit, the factor  $\frac{Z_0}{Z_{G=1}}$  tends to 1. For the case of the thermal partition function, we have  $\frac{Z_0}{Z_{G=1}} < 1$  in general. If we perform the gluing with periodic boundary conditions for the fermions this factor will be 1<sup>17</sup>. Hence we expect the stronger inequality

$$\left( \frac{1}{T} \left[ 2 \sum_{m>0, k \geq 1} \frac{k^2 \cos(m2\pi x/T)}{k^2 + (\frac{m\pi}{T})^2} + \sum_{k \geq 1} 1 \right] \right)^{\Delta_1 + \Delta_2} > \sum_{R_1, R_2} \frac{g(R_1, R_2; R)^2 f_R}{f_{R_1} f_{R_2}} e^{-2T\Delta_1 + 2x(\Delta_1 - \Delta_2)} \quad (351)$$

to hold.

For  $\Delta_1 = \Delta_2 = \Delta$  the  $x$  dependence of the RHS vanishes, so it is sufficient to check the inequality at the minimum of the LHS. This minimum occurs at  $x = \frac{1}{2}T$ , i.e. where the points are at maximum separation on the  $S_1$ . At this point, we have

$$\begin{aligned} \frac{1}{T} \left[ 2 \sum_{m>0, k \geq 1} \frac{k^2 \cos(m\pi)}{k^2 + (\frac{m\pi}{T})^2} + \sum_{k \geq 1} 1 \right] &= \frac{1}{T} \left[ 2 \sum_{m>0, k \geq 1} \frac{k^2 (-1)^m}{k^2 + (\frac{m\pi}{T})^2} + \sum_{k \geq 1} 1 \right] \\ &= \frac{1}{T} \sum_{k \geq 1} [(-1 + kT \operatorname{cosech}(kT)) + 1] \\ &= \sum_{k \geq 1} k \operatorname{cosech}(kT) \end{aligned} \quad (352)$$

The various sums are convergent. Thus the inequality becomes

$$\left( \sum_{k \geq 1} k \operatorname{cosech}(kT) \right)^{2\Delta} > \sum_{R_1, R_2} \frac{g(R_1, R_2; R)^2 f_R}{f_{R_1} f_{R_2}} e^{-2T\Delta} \quad (353)$$

For small  $T$  the inequality holds because the RHS is constant and the sum in the LHS blows up. For large  $T$  we can approximate the sum (352) by only taking the first term in the sum and noticing that in this limit

$$\operatorname{cosech}(T) \rightarrow 2e^{-T} \quad (354)$$

For  $R = [N]$ ,  $\Delta_1 = \Delta_2 = N/2$ ,  $R_1, R_2 = [N/2]$ , the RHS of (353) is given by

$$\begin{aligned} \frac{f_{[N]}}{f_{[N/2]}^2} e^{-TN} &= \frac{(2N-1)!(N-1)!}{((3N/2-1)!)^2} e^{-TN} \\ &\sim \frac{3}{\sqrt{8}} \left( \frac{32}{27} \right)^N e^{-TN} \end{aligned} \quad (355)$$

---

<sup>17</sup>For a comprehensive discussion of the thermal partition function of the  $\mathcal{N} = 4$  Super Yang Mills theory on  $S^3$  see [67]. For supersymmetric partition sums involving BPS states see [52].

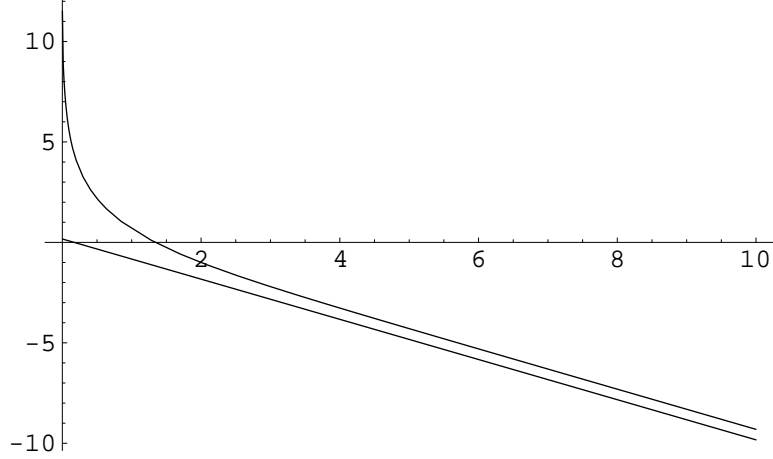

Figure 10: A plot of the logarithms of the LHS of (353) (top) against the RHS of (353) (bottom) against  $T$  for our chosen representations. We have in fact taken the  $N$ th root of each side. We can ignore the  $3/\sqrt{8}$  factor on the RHS because it adds a small constant to the lower graph which does not affect the inequality for any value of  $N$ .

For large  $T$  and our choice of  $R$  the inequality becomes

$$2^N e^{-NT} > \frac{3}{\sqrt{8}} \left(\frac{32}{27}\right)^N e^{-TN} \quad (356)$$

which is satisfied.

In Figure 10, the LHS of (353) is plotted against the RHS of (353), for our choice of Schur polynomials, as a function of  $T$ , to verify that the inequality holds for all  $T$ . For large  $T$ , as expected the graphs are separated by a constant value  $\log(27/16)$ .

#### 8.4.8 Probability interpretation in the large $T$ limit

We can now obtain a well-defined probability for a transition. We take the limit  $T \rightarrow \infty$  and fix  $x = \frac{1}{2}T$  so that the operators are as far apart from each other as they can be.

In this limit we find for general  $R$ ,  $R_1$  and  $R_2$

$$\begin{aligned} P(R \rightarrow R_1, R_2) &= \frac{1}{(2e^{-T})^{\Delta_1 + \Delta_2}} \frac{g(R_1, R_2; R)^2 f_R}{f_{R_1} f_{R_2}} e^{-T(\Delta_1 + \Delta_2)} \\ &= \frac{1}{2^{\Delta_1 + \Delta_2}} \frac{g(R_1, R_2; R)^2 f_R}{f_{R_1} f_{R_2}} \end{aligned} \quad (357)$$

where we have used the approximation (354) for the large  $T$  limit of the genus-1 correlator. This probability is independent both of the spacetime positions of the operators and of  $T$ .

### 8.5 Results for probabilities

The calculations done here are given in the Appendix G of [63].

### 8.5.1 $G = 0$ factorization

For the amplitude of several operators combining into a bigger operator we use genus zero factorization. The correlators are computed on  $\mathbb{R}^4$  and the results for probabilities are invariant under the conformal transformation to  $S^4$ . In a large distance limit, the resulting normalization prescription is equivalent to the overlap of states normalization we naïvely used before. These sphere factorization relations are equivalent to the factorization equations derived in [48]. The gluing procedure is as in Section 8.4.3. For example, the probability for two “in” states to evolve to a single “out” state is given by

$$\begin{aligned} P(R_1(r = e^x, \Omega_i), R_2(r = e^y, \Omega_i) \rightarrow R(r = 0)) \\ = \frac{\left| \langle R_1^\dagger(r = e^x, \Omega_i) R_2^\dagger(r = e^y, \Omega_i) R(r = 0) \rangle \right|^2}{\langle R_2^\dagger(s = e^y, \Omega_i) R_1^\dagger(s = e^x, \Omega_i) R_1(r = e^x, \Omega_i) R_2(r = e^y, \Omega_i) \rangle \langle R^\dagger R \rangle} \end{aligned} \quad (358)$$

In our calculations we put  $R_1$  and  $R_2$  at the same position  $x = y$  so that the normalization factor in the denominator is an extremal correlator. The results will then be valid beyond the zero coupling limit  $g_{YM}^2 = 0$ , where the actual computations are done. If we separate them in spacetime, then we have a non-extremal correlator in the denominator which can be computed at zero coupling, but which will receive non-trivial corrections at finite coupling. We further take the  $x, y \rightarrow \infty$  limit. This maximizes the distance of the operators  $R_1$  and  $R_2$  from  $R$  and gives a probability independent of the spacetime positions of the operators.

For two giants combining into another giant we get

$$\begin{aligned} P(2 \text{ size } N/2 \text{ S giants} \rightarrow 1 \text{ size } N \text{ S giant}) &= \frac{f_{[1^N]}}{\sum_S g([1^{N/2}], [1^{N/2}]; S)^2 f_S} < 1 \\ P(2 \text{ size } N/2 \text{ AdS giants} \rightarrow 1 \text{ size } N \text{ AdS giant}) &= \frac{f_{[N]}}{\sum_S g([N/2], [N/2]; S)^2 f_S} < 1 \end{aligned} \quad (359)$$

For the transition of Kaluza Klein gravitons to a giant we get

$$\begin{aligned} P(N \text{ size } 1 \text{ KK gravitons} \rightarrow \text{one size } N \text{ S giant}) &\sim \frac{1}{N^N} \\ P(N \text{ size } 1 \text{ KK gravitons} \rightarrow \text{one size } N \text{ AdS giant}) &\sim \left( 2^{2N-1} \frac{1}{\sqrt{\pi N}} \right) \frac{1}{N^N} \end{aligned} \quad (360)$$

$$\begin{aligned} P(N/2 \text{ size } 2 \text{ KK gravitons} \rightarrow \text{one size } N \text{ S giant}) &\sim \sqrt{\frac{2}{e}} \frac{1}{(eN)^{N/2}} \\ P(N/2 \text{ size } 2 \text{ KK gravitons} \rightarrow \text{one size } N \text{ AdS giant}) &\sim \left( 2^{2N-1} \frac{1}{\sqrt{\pi N}} \right) \sqrt{\frac{2}{e}} \frac{1}{(eN)^{N/2}} \end{aligned} \quad (361)$$

We see that larger KK gravitons are more likely to evolve into a giant graviton than several smaller ones. It would be interesting to give a proof that this trend continues to hold when KK states of more general small angular momenta are considered. For the case of  $N/k$  angular momenta equal to  $k$ , the obvious guess extrapolating the leading behavior of the above results is  $N^{-N/k}$ . The results of Appendix A.6 of [63] will be useful for the case where only angular momentum 1 and 2 are involved. More generally we will need to establish some general properties of the relevant symmetric group quantities. The information theoretic ideas on overlaps from [138] may be explored as a tool.

Strictly traces can only be interpreted as Kaluza-Klein states when the individual traces involved are small as above. It is of interest, nevertheless, to compute probabilities for extrapolated KK-states where large powers are involved. We find

$$\begin{aligned} P(\text{1 size } N \text{ KK graviton} \rightarrow \text{one size } N \text{ S giant}) &\sim \sqrt{\pi N} \frac{1}{2^{2N}} \\ P(\text{1 size } N \text{ KK graviton} \rightarrow \text{one size } N \text{ AdS giant}) &\sim \left(2^{2N-1} \frac{1}{\sqrt{\pi N}}\right) \sqrt{\pi N} \frac{1}{2^{2N}} = \frac{1}{2} \end{aligned} \quad (362)$$

For transitions to outgoing KK gravitons we must use the basis dual to the trace basis. For the case of a single trace, and an initial giant, we find the same probability whether we have a sphere giant or an AdS giant

$$P(\text{one size } N \text{ giant} \rightarrow \text{one size } N \text{ KK graviton}) = \frac{1}{N} \quad (363)$$

These transitions do not decay exponentially as  $N$  becomes large. Note also the asymmetry between (363) and (362), which is another illustration of the probabilities on the choice of measurement.

### 8.5.2 $G = 1$ factorization

For the amplitude of 1 giant graviton into 2 smaller giants we must use genus-1 factorization. We take two 4-spheres, one with coordinates  $(r, \Omega_i)$ , the other with  $(s, \Omega'_i)$ , cut out two 4-balls at radii 1 and  $e^T$  from the origin in each, and glue the spheres together so that  $rs = 1$  near the first gluing and  $rs = e^{2T}$  near the second. Also introduce a primed coordinate  $r'$  on the first sphere with  $rr' = 1$  and  $s'$  on the second with  $ss' = 1$ .

The probability is then given by

$$\begin{aligned} &P(R(r = e^x, \Omega_i) \rightarrow R'_1(r' = 0)R_2(r = 0)) \\ &= Z_0 e^{-2T\Delta_1} \frac{|\langle R^\dagger(r = e^x, \Omega_i)R'_1(r' = 0)R_2(r = 0) \rangle|^2}{\langle R^\dagger(s = e^x, \Omega_i)R(r = e^x, \Omega_i) \rangle_{G=1} \langle R_1^\dagger R_1 \rangle \langle R_2^\dagger R_2 \rangle} \end{aligned} \quad (364)$$

where  $x \in [0, T]$  so that the operator is outside the cut-off area. We take the limit  $T \rightarrow \infty$ , where the factor  $Z_0 e^{-2T\Delta_1}$  goes to 1 (see discussion in Section 8.4.7). In

addition we fix  $x = \frac{1}{2}T$  so that the operators are far apart from each other, maximizing the distance of the insertion of  $R$  from the two boundaries of the cut  $S^4$ . This procedure will give a probability independent of the spacetime dependencies of the operators, as discussed in Section 8.4.8. In this limit we find

$$\boxed{P(R \rightarrow R_1, R_2) = \frac{1}{2^{\Delta_1 + \Delta_2}} \frac{g(R_1, R_2; R)^2 f_R}{f_{R_1} f_{R_2}}} \quad (365)$$

For the transition of a giant into two smaller giants

$$\begin{aligned} P(1 \text{ size } N \text{ S giant} \rightarrow \text{two size } N/2 \text{ S giants}) &\sim \sqrt{\frac{\pi N}{2}} \left(\frac{1}{2}\right)^{2N} \\ P(1 \text{ size } N \text{ AdS giant} \rightarrow \text{two size } N/2 \text{ AdS giants}) &\sim \frac{3}{\sqrt{8}} \left(\frac{16}{27}\right)^N \end{aligned} \quad (366)$$

These are well-normalized probabilities and demonstrate that (364) with a higher genus correlator in the denominator gives the proper implementation of the multi-particle normalization. In the old multi-particle normalization prescription, we got a divergent result for this transition of *AdS* giants

$$\frac{\left| \langle \chi_{[N]}(X^\dagger) \chi_{[\frac{N}{2}]}(X) \chi_{[\frac{N}{2}]}(X) \rangle \right|^2}{\langle \chi_{[N]}(X^\dagger) \chi_{[N]}(X) \rangle \langle \chi_{[\frac{N}{2}]}(X^\dagger) \chi_{[\frac{N}{2}]}(X) \rangle \langle \chi_{[\frac{N}{2}]}(X^\dagger) \chi_{[\frac{N}{2}]}(X) \rangle} \sim \frac{3}{\sqrt{8}} \left(\frac{32}{27}\right)^N \quad (367)$$

The factor of  $2^{-N}$  from equation (365) provides the correction to (367) to give the correctly normalized result (366).

We can also compute the transition of a giant to two Kaluza-Klein gravitons giving

$$\begin{aligned} P(1 \text{ size } N \text{ S giant} \rightarrow \text{two size } N/2 \text{ KK gravitons}) &\sim \left(\frac{2}{N}\right)^2 \sqrt{\frac{\pi N}{2}} \left(\frac{1}{2}\right)^{2N} \\ P(1 \text{ size } N \text{ AdS giant} \rightarrow \text{two size } N/2 \text{ KK gravitons}) &\sim \left(\frac{2}{N}\right)^2 \frac{3}{\sqrt{8}} \left(\frac{16}{27}\right)^N \end{aligned} \quad (368)$$

These are well-normalized probabilities. In the old multi-particle normalization scheme, we had a diverging result for this transition

$$\frac{\left| \langle \chi_{[N]}(X^\dagger) \text{tr}(X^{\frac{N}{2}}) \text{tr}(X^{\frac{N}{2}}) \rangle \right|^2}{\langle \chi_{[N]}(X^\dagger) \chi_{[N]}(X) \rangle \langle \text{tr}(X^{\frac{N}{2}}) \text{tr}(X^{\frac{N}{2}}) \rangle \langle \text{tr}(X^{\frac{N}{2}}) \text{tr}(X^{\frac{N}{2}}) \rangle} \sim \frac{1}{6\sqrt{2}} \left(\frac{32}{27}\right)^N \quad (369)$$

An interesting question is whether a Schur polynomial operator can only evolve into other Schur polynomials. We might ask whether in the large  $T$  limit

$$\sum_{R_1, R_2} P(R \rightarrow R_1, R_2) \quad (370)$$

adds up to 1. We can calculate this sum when  $R$  is a sphere (or  $AdS$ ) giant because, by the Littlewood Richardson rules, it can only split into other sphere (or  $AdS$ ) giants. We find that this guess does not work

$$\sum_k P([1^N] \rightarrow [1^k], [1^{N-k}]) < 1 \quad (371)$$

which means that the infinite sums over additional outgoing states do contribute a finite amount.

### 8.5.3 Higher genus factorization

For higher genus  $G = n - 1$  factorization, a natural guess for the analogous equation to (365) is

$$P(R \rightarrow R_1, R_2, \dots, R_n) = \frac{1}{k_n^{\Delta_1 + \Delta_2 + \dots + \Delta_n}} \frac{g(R_1, R_2, \dots, R_n; R)^2 f_R}{f_{R_1} f_{R_2} \dots f_{R_n}} \quad (372)$$

where  $k_n$  is a constant. We know  $k_1 = 1$  and  $k_2 = 2$ . We assume that this equation holds in a long-distance limit, when the operators are in a symmetric configuration far apart from each other.

We can work out limits on  $k_n$  by considering the transition of an  $AdS$  giant into  $n$  smaller  $AdS$  giants

$$\begin{aligned} P([N] \rightarrow n \times [N/n]) &= \frac{1}{k_n^N} \frac{f_{[N]}}{f_{[N/n]}^n} \\ &\sim \frac{1}{\sqrt{2}} \left[ \frac{(n+1)}{n} \right]^{\frac{n}{2}} \left[ \frac{4n^{n+1}}{k_n(n+1)^{n+1}} \right]^N \end{aligned} \quad (373)$$

in the large  $N$  limit. Given that  $4n^{n+1}(n+1)^{-n-1}$  tends up to  $4/e$ ,  $k_n > 4/e$  would certainly ensure that the probability is not larger than 1, although this condition is clearly too strong for  $n = 1$ .  $k_n = n$  would satisfy this condition and works for  $n = 1, 2$  but this is no more than a guess.

For the transition of an  $AdS$  giant of  $R$ -charge  $\Delta_R$  to KK gravitons we find

$$P([\Delta_R] \rightarrow \text{tr}(X^{\Delta_1}), \dots, \text{tr}(X^{\Delta_n})) = \frac{1}{k_n^{\Delta_R}} \frac{1}{\Delta_1 \dots \Delta_n} \frac{f_{[\Delta_R]}}{f_{[\Delta_1]} \dots f_{[\Delta_n]}} \quad (374)$$

and for a sphere giant

$$P([1^{\Delta_R}] \rightarrow \text{tr}(X^{\Delta_1}), \dots, \text{tr}(X^{\Delta_n})) = \frac{1}{k_n^{\Delta_R}} \frac{1}{\Delta_1 \dots \Delta_n} \frac{f_{[1^{\Delta_R}]}}{f_{[1^{\Delta_1}]} \dots f_{[1^{\Delta_n}]}} \quad (375)$$



For genus  $G = 2$  we have for the transition of an  $AdS$  giant into KK gravitons

$$\begin{aligned}
 P(1 \text{ size } N \text{ AdS giant} \rightarrow \text{three size } N/3 \text{ KK gravitons}) &= \sqrt{\frac{2}{3}} \frac{36}{N^3} \left( \frac{81}{64k_3} \right)^N \\
 P(1 \text{ size } N \text{ AdS giant} \rightarrow \text{one size } N-2 \text{ and 2 size 1 KKs}) &= \frac{(2N-1)(2N-2)}{(N-2)N^2} \frac{1}{k_3^N}
 \end{aligned}
 \tag{376}$$

which makes it more likely for a giant to evolve into 3 medium-sized KK gravitons than into one large one and two tiny ones.

## 8.6 Bulk interpretation of the gluing properties of correlators

In this section we consider the five-dimensional bulk geometries with boundaries corresponding to the four-dimensional manifolds on which we computed transition properties in the previous section. We give a construction for some of these geometries which involves gluing five-dimensional balls with the neighbourhood of a Witten graph removed.

### 8.6.1 Introduction

The factorization properties of the CFT correlators allow the construction of correlators on a 4-manifold of more complicated topology in terms of correlators on manifolds of simpler topology. For example the theory on  $S^3 \times S^1$  can be reconstructed by starting from correlators on  $S^4$ . As we have emphasized above, these relations imply that to get properly normalized probabilities from correlators on  $S^4$  (or the conformally equivalent  $\mathbb{R}^4$ ) we need, in general, correlators on more complicated topologies.

In the CFT the correlators of local operators can be interpreted in terms of transition amplitudes between states. These states can be identified as wavefunctionals of the fields on  $S^3$  boundaries of four dimensional balls,  $B^4$ , cut out around the local operators. Hence the amplitudes are given by path integrals with boundary conditions on the CFT fields, specified at the  $S^3$  boundaries. Using this CFT interpretation of correlators as transition amplitudes, and the bulk-boundary correspondence of AdS/CFT, it is natural to interpret the correlators as gravitational transition amplitudes, obtained by Euclidean bulk path integrals, subject to boundary conditions for bulk fields that are specified in the neighborhood of the local operator insertions in the boundary CFT. This is indeed compatible with perturbative computations [13, 14, 139, 37] for operators of small  $R$ -charge. The work of LLM [50] relating local operators to bulk geometries suggests that we can interpret correlators of operators with large  $R$  charge in terms of bulk transition amplitudes between geometries (LLM-like in the case of half-BPS operator insertions) defined in the neighborhood of the boundary insertions. Note that although the bulk path integral is over Euclidean metrics, the asymptotic geometries are  $AdS$ -like, and so they admit a Lorentzian continuation. The above bulk spacetime picture of correlators implies, for example, that a three point function of gauge theory operators can be viewed

as a transition from a disjoint union of LLM geometries to a single LLM geometry. This is a topology-changing process.

In this section we will investigate some of the implications of this picture. Some of our discussion will be in terms of the five-dimensional bulk, where the sphere part of  $AdS_5 \times S^5$  is captured through dimensional reduction to gravitational fields on  $AdS_5$  and higher KK modes coming from the five sphere.

One strength of the interpretation of correlators as transition amplitudes computed via bulk Euclidean path integrals is immediately apparent. Since the factorization properties of correlators on the CFT side follow from the path integral implementation of geometrical gluing relations, it is reasonable to expect that a simple bulk-gravitational explanation of these relations among correlators might follow from the postulate that the correlators can also be interpreted as gravitational transition amplitudes defined in terms of path integrals with asymptotic geometries (LLM-like geometries in the case of half-BPS operators of large  $R$  charge). Gluing on the CFT side is then lifted to gluing on the gravity side. In CFT, an important ingredient in relating path integral gluing to relations among correlators of operators is the correspondence between operators and states, viewed as wavefunctionals. Such a connection in gravity is not directly understood.

In addition to SYM correlators on  $S^4$  we will be interested in correlators on manifolds which can be obtained by simple cutting and pasting procedures of copies of  $S^4$ . We can cut out the open four-ball neighborhoods  $B_\circ^4$  of  $n$  points of  $S^4$  and to get a manifold denoted by  $S^4 \setminus \sqcup_{\alpha=1}^n (B_\circ^4)_\alpha$ . This can also be written as  $\overline{S^4 \setminus \sqcup_{\alpha=1}^n (B^4)_\alpha}$ , indicating that we can remove closed balls, and then take the closure<sup>18</sup>. Take two copies of  $S^4 \setminus \sqcup_{\alpha=1}^n (B_\circ^4)_\alpha$  and glue along the  $S^3$  boundaries. The analogous construction in two dimensions gives the genus  $n - 1$  surface. We will denote the corresponding manifold in 4D as  $\Sigma_4(n - 1)$  and refer to it as having genus  $n - 1$  by analogy to the 2D case. The subscript denotes the dimension, and the argument denotes the genus. These manifolds can also be obtained as the boundary in  $\mathbb{R}^5$  of the neighborhood of a graph with  $n - 1$  loops. In the following we will also find it useful to consider neighborhoods of graphs in  $B^5$ , with endpoints of the graph lying on the  $S^4$  boundary of the  $B^5$ . These graphs, denoted as Witten graphs, appear in the perturbative computation of correlators in AdS. They will play a role in understanding how to lift gluings of  $S^4 \setminus \sqcup_{\alpha=1}^n (B_\circ^4)_\alpha$  to the bulk.

### 8.6.2 Bulk geometries for $\Sigma_4(n - 1)$ boundary from Witten graphs

Consider the case of  $S^3 \times S^1 \equiv \Sigma_4(1)$ . Start from 2-point functions on  $S^4$ . Cut out two disjoint copies of  $B_\circ^4$  around the insertion points, obtaining a manifold with topology  $S^3 \times I$ . Using the scaling symmetry on  $S^4$ , we can obtain states at the boundaries of  $S^3 \times I$ . Two copies of  $S^3 \times I$  can be glued to get  $S^3 \times S^1$ . The  $S^4$  is the boundary of Euclidean  $AdS_5$ , which has topology  $B^5$ . We would like to understand how the gluing lifts to the bulk. It is well known that the supergravity partition function for the  $S^3 \times S^1$

<sup>18</sup> $B^k$  will denote closed balls and  $B_\circ^k$  open ones.

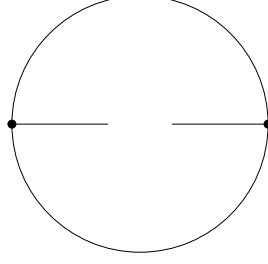

Figure 11: Disconnected graph  $G_1$  in  $B^5$  associated with two insertions on the boundary  $S^4$ .

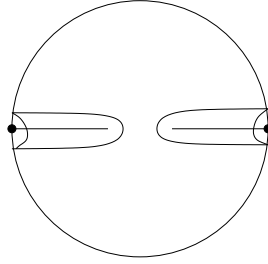

Figure 12: Neighborhood of the disconnected graph  $G_1$ .

manifold receives contributions from two different bulk topologies, namely  $B^4 \times S^1$  and  $S^3 \times B^2$  [14][140]. Hence the procedure for lifting the gluings from boundary to bulk should account for both these possibilities. We will demonstrate that this is accomplished simply by using Witten graphs.

Given two points on  $S^4$  bounding a  $B^5$ , a very simple graph to consider is the disconnected one consisting of two lines, joining points in the bulk to the points on the boundary (see Figure 11). We will denote this disconnected graph  $G_1$ . The neighborhood of each line is a  $B^4$  fibered over an interval and collapsing to zero size at one end. This is homeomorphic to  $B^5$ . Hence the neighborhood of the graph is a disjoint union of two small  $B^5$ 's. Now consider the original  $B^5$  with this neighborhood removed, i.e the complement in  $B^5$  of the neighborhood of the graph. Take the closure. Let us call this  $\overline{B^5 \setminus N(G_1, B^5)}$  where  $N(G_1, B^5)$  indicates a neighborhood<sup>19</sup> in the  $B^5$  of the graph fixed by a small number  $\epsilon$ . The original  $S^4$  boundary now has two  $B^4_\circ$  removed. It has two  $S^3$  boundaries (see Figure 12), exactly the geometry we would consider purely from the point of view of CFT on  $S^4$ . After excising these graph neighborhoods from  $B^5$  (and taking the closure), the original  $S^4$  boundary has become  $S^3 \times I$ . The remaining 5D manifold still has topology  $B^5$ , and its  $S^4$  boundary can be described as

$$B^4 \cup (S^3 \times I) \cup B^4$$

<sup>19</sup>More exactly we write  $N(G, B^5) = \{x \in B^5 : \|G - x\| \leq \epsilon\}$  where we are using the metric inherited from the trivial embedding of  $B^5$  in  $\mathbb{R}^5$ . We do not use the metric of Euclidean AdS in this definition.

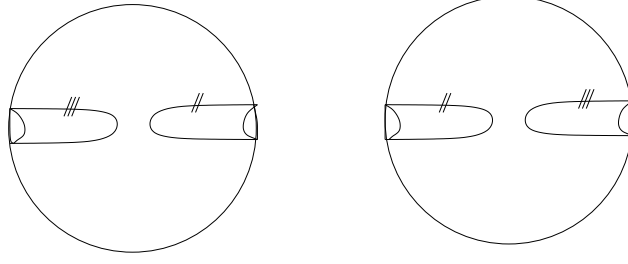
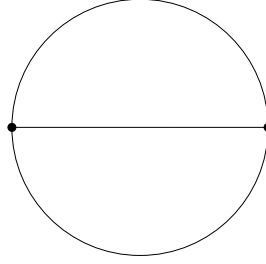
Figure 13: Gluing two copies of the  $B^5$  with graph neighborhood removed.Figure 14: Connected graph  $G_2$  in  $B^5$  associated with two insertions on  $S^4$ .

The two  $B^4$ 's are joined to  $S^3 \times I$  at the two ends of  $I$  on  $S^3$ 's.

Take two copies of this  $\overline{B^5 \setminus N(G_1, B^5)}$  which is topologically the same as  $B^4 \times B^1 \cong B^5$ , and do two gluings (see Figure 13). The outcome is  $B^4 \times S^1$  with boundary  $S^3 \times S^1$ . Thus we have obtained one of the bulk geometries holographically dual to  $S^3 \times S^1$  by lifting to the bulk the CFT gluing of two copies of  $S^3 \times I$ .

Now we want to understand, through the bulk lifting of boundary gluings, the bulk geometry  $S^3 \times B^2$  which also has boundary  $S^3 \times S^1$ . Again we start with two points in the  $S^4$  boundary of  $B^5$ . Now draw the graph which joins the two points and extends through the bulk (see Figure 14). We will call this graph  $G_2$ . The neighborhood of the graph is  $B^4 \times I$ . Excise this neighborhood from the  $B^5$ . The manifold  $\overline{B^5 \setminus N(G_2, B^5)}$  (see Figure 15), has topology  $S^3 \times B^2$ , which has boundary  $S^3 \times S^1$ . The  $S^1$  consists of the interval  $I$  which bounds the excised region, joined to a semicircular interval on the original  $S^4$  boundary. Now take two of these  $\overline{B^5 \setminus N(G_2, B^5)}$ . Glue along the interior  $S^3 \times I$  as indicated in Figure 16. Since  $B^2$  joined to another  $B^2$  along an interval is  $B^2$ , the outcome of this gluing of  $S^3 \times B^2$  to  $S^3 \times B^2$  along  $S^3 \times I$  is  $S^3 \times B^2$ . This is the second topology with boundary  $S^3 \times S^1$  which appears in [14].

In Section 7.2 of [63] we generalise this construction prescription for five-dimensional geometries to all genus boundaries  $\Sigma_4(n-1)$ , following exactly the same procedure. There are now  $p(n)$  such Witten graphs, with the multiplicity given by how many of the boundary points are connected. Excising the neighbourhood of the graph in two copies of  $B^5$  and then gluing them along the exposed boundaries gives a five-dimensional geometry with boundary  $\Sigma_4(n-1)$ . Handlebody decompositions and homology groups of these

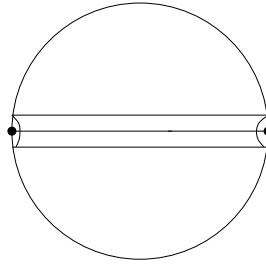

Figure 15: Neighborhood of the connected graph  $G_2$  of topology  $B^4 \times I$ .

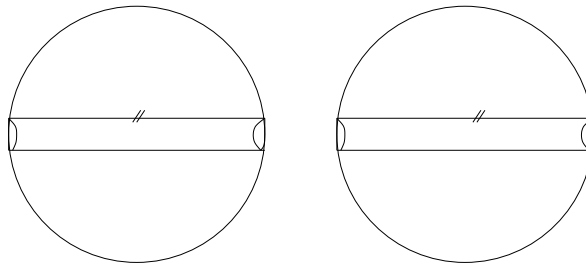

Figure 16: Gluing two copies of the  $B^5$  with graph neighborhood removed.

geometries are given in [63].

## 9 From $U(N)$ to $SU(N)$ gauge group

In this section we study half-BPS operators in  $\mathcal{N} = 4$  super Yang-Mills for gauge group  $SU(N)$  at finite  $N$ . In particular we elaborate on the results of [113], providing an exact formula for the null basis operators algorithmically constructed there (see equations (398) and (410)). This gives us a compact formula for the two-point function (414). For gauge groups  $U(N)$  and  $SU(N)$  we show that this basis is dual to the basis of multi-trace operators with respect to the two point function. We use this to extend the results of Section 8 and paper [63] concerning factorisation and probabilities from  $U(N)$  to  $SU(N)$  in Section 9.5. In Section 9.6 we construct a separate diagonal basis of the  $SU(N)$  operators using the higher Hamiltonians of the complex matrix model reduction of this sector.

### 9.1 Introduction

In  $\mathcal{N} = 4$  SYM half-BPS operators are built from traceless symmetric  $SO(6)$  tensor combinations of the six real scalars  $X_i$ , traced over their gauge indices (the  $X_i$  transform in the adjoint representation of the gauge group). We will be interested in the subset of those operators built from a single complex scalar  $\Phi = X_1 + iX_2$ , invariant under the remaining  $SO(4)$  subgroup of the  $SO(6)$  symmetry. The propagator is

$$\langle \Phi_a^\dagger(x) \Phi_b(y) \rangle = \frac{g_{ab}}{(x-y)^2} \quad (377)$$

where  $a, b$  run over the adjoint representation of the gauge group and  $g_{ab}$  is the inverse of the bilinear invariant form  $g^{ab} = \text{tr}(T^a T^b)$ . From now on we will drop the spacetime dependence of the correlators, because we are only interested in their group-theoretic structure.

For the  $U(N)$  gauge group the adjoint representation of the Lie algebra consists of  $N^2$   $N \times N$  hermitian matrices. If we consider the matrix indices of  $\Phi_j^i = \Phi_a (T^a)_j^i$ , where  $T^a$  is an element of the adjoint representation of the Lie algebra of  $U(N)$ , we find

$$\langle \Phi_j^i \Phi_l^k \rangle = g_{ab} (T^a)_j^i (T^b)_l^k = \delta_l^i \delta_j^k \quad (378)$$

The space of gauge-invariant chiral primary operators of a particular dimension in this  $SO(4)$ -invariant sector is made of products of traces ('multi-traces') of  $\Phi$ . The number of fields  $\Phi$  in the operator gives both the scaling dimension and the R-charge of the operator, which is a typical BPS saturation condition. In [19] the authors showed that linear combinations of the multi-trace operators called Schur polynomials diagonalise this two point function at finite  $N$ .

For dimension  $k \ll N$  mixing between the trace operators is suppressed, so we map  $\text{tr}(\Phi^k)$  to a graviton with angular momentum  $k$  around the the  $X_1 - X_2$  plane of the sphere of  $AdS_5 \times S^5$ . If  $k \sim N$  mixing between trace operators is no longer suppressed so

we must look instead to the diagonal Schur polynomials for the appropriate objects on the gravity side. These correspond to D3 branes spinning in the geometry, called giant gravitons [43, 45, 46, 47, 19]. As a complex matrix model the eigenvalues correspond to fermions in a harmonic potential [19, 49] and there is an exact map between the fermion distribution and the corresponding half-BPS gravity solution with  $\mathbb{R} \times SO(4) \times SO(4)$  symmetry [50].

For the  $SU(N)$  gauge group elements of the Lie algebra are in addition traceless and the correlator receives a correction

$$\langle \Psi_j^{\dagger i} \Psi_l^k \rangle = \delta_l^i \delta_j^k - \frac{1}{N} \delta_j^i \delta_l^k \quad (379)$$

Although at large  $N$  mixing between trace operators is still suppressed, at finite  $N$  this correction to the correlator complicates the combinatorics significantly. The Schur polynomials are no longer diagonal. In [113] a basis of the  $SU(N)$  gauge-invariant operators called the null basis was found, which, while not diagonal, still has extremely nice properties, including a simple correlator. We will clarify the rôle of this basis here.

$U(N)$  is equivalent to  $SU(N) \times U(1)$  up to a  $\mathbb{Z}_N$  identification. In the gauge theory the  $U(1)$  vector multiplet is free, so the corresponding  $AdS$  field must decouple from all other fields living in the bulk, since gravity couples to everything. The field is a singleton field that lives at the boundary of  $AdS$ , corresponding to the centre of mass of the D3 branes [141].

In Section 9.2 we will summarise the known  $U(N)$  results and introduce the dual basis and its properties. Section 9.3 covers the corresponding  $SU(N)$  picture, which is expanded upon in Section 9.4 with detailed proofs. Section 9.5 extends the factorisation results of Section 8 and paper [63] from  $U(N)$  to  $SU(N)$  and Section 9.6 describes the diagonalisation in terms of the higher Hamiltonians of the complex matrix model. There are some useful symmetric group identities in Appendix Section B.

## 9.2 $U(N)$ summary

For  $U(N)$  theories the correlator for the complex scalar is

$$\langle \Phi_j^{\dagger i} \Phi_l^k \rangle = \delta_l^i \delta_j^k \quad (380)$$

We have three bases for the gauge invariant multi-trace polynomials of  $\Phi$ .

1. The **trace basis**, of products of traces of  $\Phi$  such as  $\text{tr}(\Phi\Phi)\text{tr}(\Phi)$ , is the obvious gauge-invariant basis. These multi-traces at level  $n$  are in one-to-one correspondence with the  $p(n)$  conjugacy classes<sup>20</sup> of the permutation group  $S_n$  where  $p(n)$  is the number of partitions of  $n$ . Define a set of elements  $\{\sigma_I\}$  in the permutation group  $S_n$  where each  $\sigma_I$  is an element of a different conjugacy class of  $S_n$ . All the

---

<sup>20</sup>Conjugacy classes of  $S_n$  encode the different cycle structures of permutations.

possible multi-trace operators of dimension  $n$  are given by the  $p(n)$  operators

$$\mathrm{tr}(\sigma_I \Phi) = \sum_{j_1, j_2, \dots, j_n} \Phi_{j_{\sigma_I(1)}}^{j_1} \Phi_{j_{\sigma_I(2)}}^{j_2} \cdots \Phi_{j_{\sigma_I(n)}}^{j_n} \quad (381)$$

For example an element  $\sigma_I$  of  $S_5$  made up of two 1-cycles and a 3-cycle, such as  $\sigma_I = (1)(3)(245)$ , gives an element of the trace basis  $\mathrm{tr}(\sigma_I \Phi) = \mathrm{tr}(\Phi) \mathrm{tr}(\Phi) \mathrm{tr}(\Phi^3)$ .

2. The **Schur polynomial basis** is defined as a sum of these trace operators over the elements  $\sigma$  of  $S_n$ , weighted by the characters of  $\sigma$  in the representation  $R$  of  $S_n$

$$\chi_R(\Phi) = \frac{1}{n!} \sum_{\sigma \in S_n} \chi_R(\sigma) \mathrm{tr}(\sigma \Phi) \quad (382)$$

The representations  $R$  of  $S_n$  can be labelled by Young diagrams with  $n$  boxes, which also correspond to partitions of  $n$ . Thus there are  $p(n)$  Schur polynomials of degree  $n$ .  $R$  also corresponds to a representation of  $U(N)$ .<sup>21</sup>

The correlation function of two Schur polynomials is diagonal for any value of  $N$  [19]

$$\langle \chi_R(\Phi^\dagger) \chi_S(\Phi) \rangle = \delta_{RS} f_R \quad (383)$$

$f_R$  is computed by

$$f_R = \frac{n! \mathrm{Dim}_R}{d_R} = \prod_{i,j} (N - i + j) \quad (384)$$

where  $\mathrm{Dim}_R$  is the dimension of the  $U(N)$  representation  $R$  and  $d_R$  is the dimension of the symmetric group  $S_n$  representation  $R$ . In the product expression we sum over the boxes of the Young diagram for  $R$ ,  $i$  labelling the rows and  $j$  the columns.

We can invert the relation between traces and Schur polynomials using the identities in Section B

$$\mathrm{tr}(\sigma_I \Phi) = \sum_{R(n)} \chi_R(\sigma_I) \chi_R(\Phi) \quad (385)$$

where we sum over representations  $R$  of  $S_n$  with Young diagrams of  $n$  boxes. This gives us a compact formula for the correlation function of two elements of the trace basis

$$\langle \mathrm{tr}(\sigma_I \Phi^\dagger) \mathrm{tr}(\sigma_J \Phi) \rangle = \sum_R f_R \chi_R(\sigma_I) \chi_R(\sigma_J) \quad (386)$$

3. Define the  $p(n)$  elements of the **dual basis** by

$$\xi(\sigma_I, \Phi) := \frac{|\sigma_I|}{n!} \sum_{R(n)} \frac{1}{f_R} \chi_R(\sigma_I) \chi_R(\Phi) \quad (387)$$

<sup>21</sup>For a unitary matrix  $U$  the character of  $U$  in the representation  $R$  is given by  $\chi_R(U)$  defined by this formula. That  $R$  is a representation of both  $S_n$  and  $U(N)$  is a consequence of the fact that  $U(N)$  and  $S_n$  have a commuting action on  $V^{\otimes n}$ , where  $V$  is the fundamental representation of  $U(N)$ .



where  $|\![\sigma_I]\!|$  is the size of the conjugacy class of  $\sigma_I$ . Note that  $\xi(\sigma_I, \Phi)$  is constant on the conjugacy class of  $\sigma_I$ .

This basis is useful because it is dual to the trace basis using the inner product defined in (380), i.e.

$$\langle \xi(\sigma_I, \Phi^\dagger) \text{tr}(\sigma_J \Phi) \rangle = \delta_{IJ} \quad (388)$$

We can show this using the diagonality of the Schur polynomials (383) and the identity (458) in Section B

$$\begin{aligned} \langle \xi(\sigma_I, \Phi^\dagger) \text{tr}(\sigma_J \Phi) \rangle &= \frac{|\![\sigma_I]\!|}{n!} \sum_{R(n)} \frac{1}{f_R} \chi_R(\sigma_I) \sum_{S(n)} \chi_S(\sigma_J) \langle \chi_R(\Phi^\dagger) \chi_S(\Phi) \rangle \\ &= \frac{|\![\sigma_I]\!|}{n!} \sum_{R(n)} \chi_R(\sigma_I) \chi_R(\sigma_J) \\ &= \delta_{IJ} \end{aligned} \quad (389)$$

The correlation function of two elements of the dual basis is given by

$$\langle \xi(\sigma_I, \Phi^\dagger) \xi(\sigma_J, \Phi) \rangle = \frac{|\![\sigma_I]\!|}{n!} \frac{|\![\sigma_J]\!|}{n!} \sum_R \frac{1}{f_R} \chi_R(\sigma_I) \chi_R(\sigma_J) \quad (390)$$

This matrix provides the change of basis from the trace basis to the dual basis

$$\sum_J \langle \xi(\sigma_I, \Phi^\dagger) \xi(\sigma_J, \Phi) \rangle \text{tr}(\sigma_J \Phi) = \xi(\sigma_I, \Phi^\dagger) \quad (391)$$

where we sum  $\sum_J$  over conjugacy classes of  $S_n$ . We have used identity (457) of Section B. It follows that the matrix of correlators of the dual basis (390) is the inverse of the matrix of correlators of the trace basis (386)

$$\sum_J \langle \xi(\sigma_I, \Phi^\dagger) \xi(\sigma_J, \Phi) \rangle \langle \text{tr}(\sigma_J \Phi^\dagger) \text{tr}(\sigma_K \Phi) \rangle = \langle \xi(\sigma_I, \Phi^\dagger) \text{tr}(\sigma_K \Phi) \rangle = \delta_{IK} \quad (392)$$

In the large  $N$  limit we see from equation (384) that  $f_R \rightarrow N^n$  so that the dual basis becomes, up to a factor, the trace basis

$$\xi(\sigma_I, \Phi) = \frac{|\![\sigma_I]\!|}{n!} \sum_{R(n)} \frac{1}{f_R} \chi_R(\sigma_I) \chi_R(\Phi) \rightarrow \frac{|\![\sigma_I]\!|}{N^n n!} \text{tr}(\sigma_I \Phi) \quad (393)$$

In this limit the duality of the two bases in equation (388) is just the well-known orthogonality of traces at large  $N$ .

### 9.3 $SU(N)$ summary

In  $SU(N)$  our complex scalar is traceless. Denote the  $SU(N)$  complex scalar by  $\Psi$  to distinguish it from the  $U(N)$  complex scalar  $\Phi$  which does have a trace. The correlator

for  $\Psi$  is

$$\langle \Psi^{\dagger j} \Psi_l^k \rangle = \delta_l^i \delta_j^k - \frac{1}{N} \delta_j^i \delta_l^k \quad (394)$$

We can relate this to the  $U(N)$  correlator (380) by making the substitution  $\Psi_j^i = \Phi_j^i - \delta_j^i \Phi_k^k / N$ . If we feed this substitution into the  $U(N)$  correlator we get the same result

$$\langle \Psi^{\dagger j} \Psi_l^k \rangle = \langle \left( \Phi_j^{\dagger i} - \delta_j^i \Phi_m^{\dagger m} / N \right) \left( \Phi_l^k - \delta_l^k \Phi_n^n / N \right) \rangle = \delta_l^i \delta_j^k - \frac{1}{N} \delta_j^i \delta_l^k \quad (395)$$

This means that we can use *the same* correlator for both  $U(N)$  and  $SU(N)$ , using operators built from  $\Phi_j^i$  for  $U(N)$  and from  $\Psi_j^i = \Phi_j^i - \delta_j^i \Phi_k^k / N$  for  $SU(N)$ . This ability to move between the  $SU(N)$  and  $U(N)$  correlators using the substitution  $\Psi_j^i = \Phi_j^i - \delta_j^i \Phi_k^k / N$  will be extremely useful in later formulae. In essence this substitution enforces the tracelessness condition.<sup>22</sup>

$\Psi$  is traceless  $\text{tr} \Psi = 0$  so we are going to need to consider elements of  $S_n$  without 1-cycles. Define  $C_n$  to be the subset of  $S_n$  with all the elements with 1-cycles removed. For example

- $C_1 = \emptyset$
- $C_2 = \{(12)\}$
- $C_3 = \{(123), (132)\}$
- $C_4 = \{[(12)(34)], [(1234)]\}$
- $C_5 = \{[(12)(345)], [(12345)]\}$

$[(12)(34)]$  means the conjugacy class of  $(12)(34)$ , which is  $\{(12)(34), (13)(24), (14)(23)\}$ .

Define a set of elements  $\{\tau_i\}$  in  $C_n$  where each  $\tau_i$  is an element of a different conjugacy class. There are  $p(n) - p(n-1)$  conjugacy classes in  $C_n$ , since each element with a 1-cycle can be decomposed into a 1-cycle and an element of  $S_{n-1}$ .

The three bases of dimension  $n$  gauge-invariant polynomials of  $\Psi$  have some different properties to their  $U(N)$  counterparts.

1. The **trace basis** is defined by the  $p(n) - p(n-1)$  conjugacy classes of  $C_n$

$$\text{tr}(\tau_i \Psi) \quad (396)$$

For  $n = 2$  we have  $\text{tr}(\Psi^2)$ , for  $n = 3$  we have  $\text{tr}(\Psi^3)$ , for  $n = 4$  we have  $\text{tr}(\Psi^2) \text{tr}(\Psi^2)$  and  $\text{tr}(\Psi^4)$  and for  $n = 5$  we have  $\text{tr}(\Psi^2) \text{tr}(\Psi^3)$  and  $\text{tr}(\Psi^5)$ .

---

<sup>22</sup>Note that this method can also be applied to  $O(N)$  and  $Sp(2N)$ . Elements of the Lie algebra of  $O(N)$  are antisymmetric real matrices  $\chi = -\chi^T$ . We can obtain the  $O(N)$  correlator by the substitution  $\chi = i(X - X^T)$  where  $X$  is a hermitian generator of  $U(N)$  (cf. [142]). Similarly for  $Sp(2N)$  the real Lie algebra elements  $\Pi$  satisfy  $J\Pi = (J\Pi)^T$  and their correlator can be found with  $\Pi = J(X + X^T)$ .

2. The  $p(n)$  elements of the **Schur polynomial basis**  $\chi_R(\Psi)$  are now neither independent nor diagonal. For each of the  $p(n-1)$  Young diagrams  $T$  with  $n-1$  boxes we have a linear relation between the Schur polynomials of dimension  $n$

$$0 = \text{tr}(\Psi)\chi_T(\Psi) = \chi_{\square}(\Psi)\chi_T(\Psi) = \sum_{R(n)} g(\square, T; R)\chi_R(\Psi) \quad (397)$$

$\square$  is the single box representation  $\chi_{\square}(\Psi) = \text{tr}(\Psi) = 0$  and  $g(\square, T; R)$  is the Littlewood-Richardson coefficient for compositions of representations. It is only non-zero if  $R$  is in  $\square \otimes T$ .

3. The **dual basis** is defined by the  $p(n) - p(n-1)$  conjugacy classes of  $C_n$

$$\xi(\tau_i, \Psi) := \frac{|\tau_i|}{n!} \sum_{R(n)} \frac{1}{f_R} \chi_R(\tau_i) \chi_R(\Psi) \quad (398)$$

It turns out that even for  $SU(N)$  this basis is dual to the trace basis using the inner product defined in (394), i.e.

$$\langle \xi(\tau_i, \Psi^\dagger) \text{tr}(\tau_j \Psi) \rangle = \delta_{ij} \quad (399)$$

We will show that for  $SU(N)$  this dual basis is exactly the null basis constructed algorithmically in [113].

The correlation function of two elements of the dual basis is given by

$$\langle \xi(\tau_i, \Psi^\dagger) \xi(\tau_j, \Psi) \rangle = \frac{|\tau_i|}{n!} \frac{|\tau_j|}{n!} \sum_R \frac{1}{f_R} \chi_R(\tau_i) \chi_R(\tau_j) \quad (400)$$

which is remarkably exactly the same as the  $U(N)$  correlator of the dual basis (390), as proved in [113] for the null basis.

The matrix of correlators of the dual basis provides the change of basis from the trace basis to the dual

$$\sum_j \langle \xi(\tau_i, \Psi^\dagger) \xi(\tau_j, \Psi) \rangle \text{tr}(\tau_j \Psi) = \xi(\tau_i, \Psi^\dagger) \quad (401)$$

where we sum  $\sum_j$  over conjugacy classes of  $C_n$ . To get this result we can use the same argument as for the  $U(N)$  case because we can add into the sum the remaining elements of  $S_n$  with 1-cycles, whose corresponding traces vanish. Thus the matrix of correlators of the dual basis is also the inverse of the matrix of correlators of the trace basis

$$\sum_j \langle \xi(\tau_i, \Psi^\dagger) \xi(\tau_j, \Psi) \rangle \langle \text{tr}(\tau_j \Psi^\dagger) \text{tr}(\tau_k \Psi) \rangle = \langle \xi(\tau_i, \Psi^\dagger) \text{tr}(\tau_k \Psi) \rangle = \delta_{ik} \quad (402)$$

where again we sum  $\sum_j$  over conjugacy classes of  $C_n$ .

#### 9.4 $SU(N)$ details

Following [113] we define a derivative on the Schur polynomials of a general  $N \times N$  matrix  $M_j^i$  by

$$D\chi_R(M) = \sum_{i=1}^M \frac{\partial}{\partial M_i^i} \chi_R(M) = \sum_{T(n-1)} g(\square, T; R) \frac{f_R}{f_T} \chi_T(M) \quad (403)$$

where we have given an exact formula for the derivative. We sum over representations  $T$  with  $(n-1)$  boxes that differ from  $R$  by a ‘legal’ box.  $\square$  is the single-box fundamental representation;  $g(\square, T; R)$  is a Littlewood-Richardson coefficient that is zero if  $R$  is not in  $\square \otimes T$ . The formula for the Littlewood-Richardson coefficient is given in Section B.  $\frac{f_R}{f_T}$  is the weight  $(N-i+j)$  of the box removed from the Young diagram of  $R$  to get  $T$ , where  $i$  labels the row and  $j$  the column of the box in the Young diagram of  $R$ .

Using this we can Taylor expand for a constant  $k$

$$\chi_R(M + k\mathbb{I}) = \sum_{F=0}^n \frac{1}{F!} k^F D^F \chi_R(M) \quad (404)$$

$$= \sum_{F=0}^n \frac{1}{F!} \sum_{T(n-F)} g(\square^F, T; R) \frac{f_R}{f_T} k^F \chi_T(M) \quad (405)$$

Here  $g(\square^F, T; R) = g(\square, \dots, \square, T; R)$  with  $F$   $\square$ 's. It counts the different legal ways we can build the representation  $R$  by adding  $F$  single-box representations  $\square$  to  $T$ .  $T$  has  $(n-F)$  boxes. For example

$$g(\square^2, \square\square; \square\square\square) = 2 \quad (406)$$

because

$$\square \otimes \square \otimes \square\square = \square \otimes (\square\square \oplus \square\square) = 2 \square\square\square \oplus \square\square\square \oplus \square\square\square \oplus \square\square\square \quad (407)$$

We have therefore

$$\chi_R(\Psi) = \chi_R\left(\Phi - \frac{\text{tr } \Phi}{N} \mathbb{I}\right) = \sum_{F=0}^n \frac{1}{F!} \sum_{T(n-F)} g(\square^F, T; R) \frac{f_R}{f_T} \left(-\frac{\text{tr } \Phi}{N}\right)^F \chi_T(\Phi) \quad (408)$$

and conversely

$$\chi_R(\Phi) = \chi_R\left(\Psi + \frac{\text{tr } \Phi}{N} \mathbb{I}\right) = \sum_{F=0}^n \frac{1}{F!} \sum_{T(n-F)} g(\square^F, T; R) \frac{f_R}{f_T} \left(\frac{\text{tr } \Phi}{N}\right)^F \chi_T(\Psi) \quad (409)$$

These two equations are entirely compatible. If we feed the expression for  $\chi_T(\Psi)$  given by (408) into (409) we recover  $\chi_R(\Phi)$ .

In [113] the authors algorithmically constructed a set of operators annihilated by the operator  $D$  which they called the null basis. Because they are annihilated by the operator  $D$  the Taylor expansion (404) is truncated to the  $F = 0$  terms.

Now we will show that that the  $SU(N)$  dual basis  $\xi(\tau_i, \Psi)$  for  $\tau_i \in C_n$  given in (398) is indeed null

$$\boxed{D\xi(\tau_i, \Psi) = 0} \quad (410)$$

and hence, using the substitution  $\Psi = \Phi - \text{tr } \Phi/N$ , we have

$$\xi(\tau_i, \Psi) = \xi(\tau_i, \Phi) \quad (411)$$

This is true because we get only the  $F = 0$  terms in the Taylor expansion.

If we expand  $\xi(\tau_i, \Psi)$

$$\begin{aligned} D\xi(\tau_i, \Psi) &= \frac{[[\tau_i]]}{n!} \sum_{R(n)} \frac{1}{f_R} \chi_R(\tau_i) D\chi_R(\Psi) \\ &= \frac{[[\tau_i]]}{n!} \sum_{R(n)} \chi_R(\tau_i) \sum_{T(n-1)} g(\square, T; R) \frac{1}{f_T} \left( -\frac{\text{tr } \Phi}{N} \right) \chi_T(\Phi) \end{aligned} \quad (412)$$

This looks monstrous but if we extract the sum over  $R$  and use the identity (472) for  $g(\square, T; R)$  from Section B, expanding it in characters of the symmetric group, we see that

$$\begin{aligned} \sum_{R(n)} \chi_R(\tau_i) g(\square, T; R) &= \sum_{R(n)} \chi_R(\tau_i) \frac{1}{(n-1)!} \sum_{\rho \in S_{n-1}} \chi_{\square}(\text{id}) \chi_T(\rho) \chi_R(\text{id} \circ \rho) \\ &= \frac{1}{(n-1)!} \sum_{\rho \in S_{n-1}} \chi_{\square}(\text{id}) \chi_T(\rho) \frac{n!}{[[\tau_i]]} \delta([\tau_i] = [\text{id} \circ \rho]) \end{aligned} \quad (413)$$

where we have used identity (458). Here  $\text{id}$  is the identity permutation made only of 1-cycles. But we know that  $\tau_i$  has no 1-cycles so  $[\tau_i] = [\text{id} \circ \rho]$  is never satisfied. Therefore the  $SU(N)$  dual basis is indeed null  $D\xi(\tau_i, \Psi) = 0$  and thus  $\xi(\tau_i, \Psi) = \xi(\tau_i, \Phi)$  is true.

Note that this only works for the  $SU(N)$  dual basis  $\xi(\tau_i, \Psi)$  with  $\tau_i \in C_n$ . For a general  $\sigma_I \in S_n$  with 1-cycles,  $\sigma_I \notin C_n$ ,  $\xi(\sigma_I, \Psi)$  is not null and we do not have  $\xi(\sigma_I, \Psi) = \xi(\sigma_I, \Phi)$ .

The correlator of two members of the  $SU(N)$  dual basis (400) now follows very quickly because it must be the same as the  $U(N)$  correlator

$$\boxed{\langle \xi(\tau_i, \Psi^\dagger) \xi(\tau_j, \Psi) \rangle = \langle \xi(\tau_i, \Phi^\dagger) \xi(\tau_j, \Phi) \rangle = \frac{[[\tau_i]] [[\tau_j]]}{n! n!} \sum_R \frac{1}{f_R} \chi_R(\tau_i) \chi_R(\tau_j)} \quad (414)$$

Using

$$\langle \Psi^\dagger \text{tr } \Phi \rangle = 0 \quad \Rightarrow \quad \langle \Psi^\dagger \Psi \rangle = \langle \Psi^\dagger \Phi \rangle \quad (415)$$

we can also see that the duality of the multi-trace basis to the null basis follows from

the  $U(N)$  case

$$\langle \xi(\tau_i, \Psi^\dagger) \text{tr}(\tau_j \Psi) \rangle = \langle \xi(\tau_i, \Psi^\dagger) \text{tr}(\tau_j \Phi) \rangle = \langle \xi(\tau_i, \Phi^\dagger) \text{tr}(\tau_j \Phi) \rangle = \delta_{ij} \quad (416)$$

In the first equality we have used property (415) that  $\langle \Psi^\dagger \Psi \rangle = \langle \Psi^\dagger \Phi \rangle$ ; in the second we have used property (411) that  $\xi(\tau_i, \Psi) = \xi(\tau_i, \Phi)$ ; in the final inequality we have used the defining property of the  $U(N)$  dual basis (388).

We would now like to show that the Schur polynomial basis is no longer diagonal for  $SU(N)$ . We can use (409) to see that

$$\begin{aligned} & \langle \chi_R(\Phi^\dagger) \chi_S(\Phi) \rangle \\ &= \sum_{F=0}^n \frac{1}{(F!)^2} \frac{1}{N^{2F}} \sum_{T(n-F)} \sum_{U(n-F)} g(\square^F, T; R) g(\square^F, U; S) \\ & \quad \times \frac{f_R f_S}{f_T f_U} \langle \chi_{\square^F}(\Phi^\dagger) \chi_{\square^F}(\Phi) \rangle \langle \chi_T(\Psi^\dagger) \chi_U(\Psi) \rangle \\ &= \sum_{F=0}^n \frac{1}{(F!)} \frac{1}{N^F} \sum_{T(n-F)} \sum_{U(n-F)} g(\square^F, T; R) g(\square^F, U; S) \frac{f_R f_S}{f_T f_U} \langle \chi_T(\Psi^\dagger) \chi_U(\Psi) \rangle \end{aligned} \quad (417)$$

Separating out the  $F = 0$  term and re-arranging we see that

$$\begin{aligned} \langle \chi_R(\Psi^\dagger) \chi_S(\Psi) \rangle &= \langle \chi_R(\Phi^\dagger) \chi_S(\Phi) \rangle \\ & \quad - \sum_{F=1}^n \frac{1}{(F!)} \frac{1}{N^F} \sum_{T,U} g(\square^F, T; R) g(\square^F, U; S) \frac{f_R f_S}{f_T f_U} \langle \chi_T(\Psi^\dagger) \chi_U(\Psi) \rangle \end{aligned} \quad (418)$$

which when applied recursively gives us

$$\begin{aligned} & \langle \chi_R(\Psi^\dagger) \chi_S(\Psi) \rangle \\ &= \sum_{F=0}^n \frac{1}{(F!)} \left(-\frac{1}{N}\right)^F \sum_{T,U} g(\square^F, T; R) g(\square^F, U; S) \frac{f_R f_S}{f_T f_U} \langle \chi_T(\Phi^\dagger) \chi_U(\Phi) \rangle \\ &= \sum_{F=0}^n \frac{1}{(F!)} \left(-\frac{1}{N}\right)^F \sum_T g(\square^F, T; R) g(\square^F, T; S) \frac{f_R f_S}{f_T} \end{aligned} \quad (419)$$

This agrees with the calculation in equation (10.7) of [48] if we make the identification  $g(\square^F, T; R) = \sum_U d_U g(U, T; R)$ . This identification follows from the identities in Section B and the fact that  $d_U = \chi_U(\text{id}^{\circ F})$ . The formula also agrees with the results from [113].

## 9.5 Factorisation and probabilities for $SU(N)$

Given that we have a basis and its dual we can write down factorisation equations for  $SU(N)$  correlators analogous to those described in Section 8 and paper [63] for  $U(N)$  correlators. For a conformal field theory like  $\mathcal{N} = 4$  super Yang-Mills these factorisation

equations let us write correlators on 4-dimensional surfaces with non-trivial topology in terms of correlators on the 4-sphere, just like factorisation of correlators on Riemann surfaces in two dimensions. Because of positivity properties of the summands in the factorisation equations we can interpret these summands as well-defined probabilities for a large class of processes. Since we are only interested in the combinatorics we will drop the spacetime dependences and any extraneous modular parameters.

If a complete basis for the local operators of our  $SU(N)$  theory is given by  $\{\mathcal{O}_a\}$  and the metric on this basis from the two point function has an inverse  $G^{ab}$ , then for local operators  $\mathcal{A}, \mathcal{B}$  the sphere factorisation is given by a sum of positive quantities [63]

$$\begin{aligned} \langle \mathcal{A}^\dagger \mathcal{B} \rangle &= \sum_{a,b} G^{ab} \langle \mathcal{A}^\dagger \mathcal{O}_a \rangle \langle \mathcal{O}_b^\dagger \mathcal{B} \rangle \\ &> \sum_{i,j} \mathcal{G}^{ij} \langle \mathcal{A}^\dagger \text{tr}(\tau_i \Psi) \rangle \langle \text{tr}(\tau_j \Psi^\dagger) \mathcal{B} \rangle \\ &= \sum_i \langle \mathcal{A}^\dagger \text{tr}(\tau_i \Psi) \rangle \langle \xi(\tau_i, \Psi^\dagger) \mathcal{B} \rangle \end{aligned} \quad (420)$$

We have truncated the sum over operators of the  $SU(N)$  theory to those half-BPS operators made from a single complex scalar  $\Psi$ . In the sum  $i$  and  $j$  range over the conjugacy classes of  $C_n$ . We have used the fact that the inverse of the metric on the trace basis is the correlator of the dual basis  $\mathcal{G}^{ij} = \langle \xi(\tau_i, \Psi^\dagger) \xi(\tau_j, \Psi) \rangle$ , which effects the change of basis from the trace basis to the dual basis (401). If we set  $\mathcal{B} = \mathcal{A}$  and divide both sides of (420) by  $\langle \mathcal{A}^\dagger \mathcal{A} \rangle$  we get a sum of well-defined, positive probabilities

$$P(\mathcal{A} \rightarrow \text{tr}(\tau_i \Psi)) = P(\mathcal{A} \rightarrow \xi(\tau_i, \Psi)) = \frac{\langle \mathcal{A}^\dagger \text{tr}(\tau_i \Psi) \rangle \langle \xi(\tau_i, \Psi^\dagger) \mathcal{A} \rangle}{\langle \mathcal{A}^\dagger \mathcal{A} \rangle} \quad (421)$$

If one of  $\mathcal{A}$  and  $\mathcal{B}$  is a polynomial in  $\Psi$  then we can connect the  $SU(N)$  factorisation (420) to the  $U(N)$  factorisation. The first step is to use  $\xi(\tau_i, \Psi) = \xi(\tau_i, \Phi)$

$$\sum_i \langle \mathcal{A}(\Psi^\dagger) \text{tr}(\tau_i \Psi) \rangle \langle \xi(\tau_i, \Psi^\dagger) \mathcal{B} \rangle = \sum_i \langle \mathcal{A}(\Psi^\dagger) \text{tr}(\tau_i \Psi) \rangle \langle \xi(\tau_i, \Phi^\dagger) \mathcal{B} \rangle \quad (422)$$

Because  $\text{tr}(\Psi) = 0$  we can add back in the conjugacy classes of  $S_n$  with 1-cycles since these terms are zero

$$\sum_i \langle \mathcal{A}(\Psi^\dagger) \text{tr}(\tau_i \Psi) \rangle \langle \xi(\tau_i, \Phi^\dagger) \mathcal{B} \rangle = \sum_I \langle \mathcal{A}(\Psi^\dagger) \text{tr}(\sigma_I \Psi) \rangle \langle \xi(\sigma_I, \Phi^\dagger) \mathcal{B} \rangle \quad (423)$$

Here  $I$  ranges over the conjugacy classes of  $S_n$ . Finally we use  $\langle \Psi^\dagger \Psi \rangle = \langle \Psi^\dagger \Phi \rangle$  to see that  $\langle \mathcal{A}(\Psi^\dagger) \text{tr}(\tau_i \Psi) \rangle = \langle \mathcal{A}(\Psi^\dagger) \text{tr}(\tau_i \Phi) \rangle$  and hence

$$\sum_I \langle \mathcal{A}(\Psi^\dagger) \text{tr}(\sigma_I \Psi) \rangle \langle \xi(\sigma_I, \Phi^\dagger) \mathcal{B} \rangle = \sum_I \langle \mathcal{A}(\Psi^\dagger) \text{tr}(\sigma_I \Phi) \rangle \langle \xi(\sigma_I, \Phi^\dagger) \mathcal{B} \rangle \quad (424)$$

This is now a sum over  $U(N)$  operators, which gives us the  $U(N)$  factorisation. This only works if one of  $\mathcal{A}$  and  $\mathcal{B}$  is a function of  $\Psi$ . If  $\sigma_I$  contains 1-cycles the summand vanishes because  $\langle \Psi^\dagger \text{tr}(\Phi) \rangle = 0$ . So what we are really saying is that if one of  $\mathcal{A}$  and  $\mathcal{B}$  is a polynomial in  $\Psi = \Phi - \text{tr}(\Phi)/N$  we can truncate the  $U(N)$  factorisation (424) to the  $SU(N)$  factorisation (420). If we translate this into probabilities it means that  $P(\mathcal{A}(\Psi) \rightarrow \text{tr}(\tau_i \Psi)) = P(\mathcal{A}(\Psi) \rightarrow \text{tr}(\tau_i \Phi))$ .

Since  $\xi(\tau_j, \Psi) = \xi(\tau_j, \Phi)$  is a polynomial in  $\Psi$  we find the probability

$$P(\xi(\tau_j, \Psi) \rightarrow \text{tr}(\tau_i \Psi)) = \delta_{ij} \quad (425)$$

which is exactly the same as the corresponding  $U(N)$  result  $P(\xi(\tau_j, \Phi) \rightarrow \text{tr}(\tau_i \Phi))$ .

For a transition into two separate states we use the factorisation on a 4-dimensional ‘genus one’ surface

$$\begin{aligned} \langle \mathcal{A}^\dagger \mathcal{B} \rangle_{G=1} &> \sum_{i,j} \sum_{k,l} \mathcal{G}^{ij} \mathcal{G}^{kl} \langle \mathcal{A}^\dagger \text{tr}(\tau_i \Psi) \text{tr}(\tau_k \Psi) \rangle \langle \text{tr}(\tau_l \Psi^\dagger) \text{tr}(\tau_j \Psi^\dagger) \mathcal{B} \rangle \\ &= \sum_i \sum_k \langle \mathcal{A}^\dagger \text{tr}(\tau_i \Psi) \text{tr}(\tau_k \Psi) \rangle \langle \xi(\tau_k, \Psi^\dagger) \xi(\tau_i, \Psi^\dagger) \mathcal{B} \rangle \end{aligned} \quad (426)$$

If one of  $\mathcal{A}$  and  $\mathcal{B}$  is a function of  $\Psi$  then the  $U(N)$  factorisation truncates to this result.

The probability of a transition to KK gravitons is given by

$$P(\mathcal{A} \rightarrow \text{tr}(\tau_i \Psi), \text{tr}(\tau_k \Psi)) = \frac{\langle \mathcal{A}^\dagger \text{tr}(\tau_i \Psi) \text{tr}(\tau_k \Psi) \rangle \langle \xi(\tau_k, \Psi^\dagger) \xi(\tau_i, \Psi^\dagger) \mathcal{A} \rangle}{\langle \mathcal{A}^\dagger \mathcal{A} \rangle_{G=1}} \quad (427)$$

For  $\mathcal{A} = \xi(\tau_m, \Psi)$

$$P(\xi(\tau_m, \Psi) \rightarrow \text{tr}(\tau_i \Psi), \text{tr}(\tau_k \Psi)) \quad (428)$$

$$\begin{aligned} &= \frac{\langle \xi(\tau_m, \Psi^\dagger) \text{tr}(\tau_i \Psi) \text{tr}(\tau_k \Psi) \rangle \langle \xi(\tau_k, \Psi^\dagger) \xi(\tau_i, \Psi^\dagger) \xi(\tau_m, \Psi) \rangle}{\langle \xi(\tau_m, \Psi^\dagger) \xi(\tau_m, \Psi) \rangle_{G=1}} \\ &= \frac{\delta_{[\tau_m]=[\tau_i \circ \tau_k]} \langle \xi(\tau_k, \Psi^\dagger) \xi(\tau_i, \Psi^\dagger) \xi(\tau_m, \Psi) \rangle}{\langle \xi(\tau_m, \Psi^\dagger) \xi(\tau_m, \Psi) \rangle_{G=1}} \end{aligned} \quad (429)$$

So  $\mathcal{A} = \xi(\tau_m, \Psi)$  will decay into two multi-trace operators as long as  $\tau_i \circ \tau_k$  is in the conjugacy class of  $\tau_m$ .

## 9.6 Diagonalisation by higher Hamiltonians

In this section we will find a diagonal basis for the  $SU(N)$  correlator.<sup>23</sup> We can reduce the half-BPS sector of the  $\mathcal{N} = 4$  SYM to matrix quantum mechanics [19, 49]. For gauge group  $U(N)$  the Schur polynomials are eigenstates of commuting higher Hamiltonians (for  $U(N)$  these correspond to the Casimirs of the Lie algebra). Our strategy will be to find eigenstates of the higher Hamiltonians for  $SU(N)$ . These eigenstates are necessarily

<sup>23</sup>This section was done in collaboration with Sanjaye Ramgoolam.



diagonal.

If we do a reduction of the  $\mathcal{N} = 4$  SYM action on  $S^3$  with only the first two real scalars  $X_1$  and  $X_2$  turned on then we get a (0+1)-dimensional matrix model

$$S = \int dt \text{Tr} (\dot{X}_1^2 + \dot{X}_2^2 - X_1^2 - X_2^2). \quad (430)$$

The potential term couples to the curvature of  $S^3$  but we have rescaled the fields appropriately. If we introduce the complex chiral scalar  $Z = X_1 + iX_2$  and find its momentum conjugate  $\Pi$  then we can define harmonic oscillator operators  $A = Z + i\Pi$  and  $B = Z - i\Pi$  and their conjugates  $A^\dagger$  and  $B^\dagger$ . These satisfy standard commutation relations

$$[A_a, A_b^\dagger] = g_{ab} \quad (431)$$

where  $a, b$  run over the adjoint representation of the gauge group and  $g_{ab}$  is the inverse of the bilinear invariant form  $g^{ab} = \text{tr}(T^a T^b)$ .

Our Hamiltonian is

$$H = \text{tr}(A^\dagger A + B^\dagger B) \quad (432)$$

and our angular momentum operator is

$$J = \text{tr}(A^\dagger A - B^\dagger B) \quad (433)$$

For  $\text{tr}((A^\dagger)^n (B^\dagger)^m) |0\rangle$ ,  $E = n+m$ ,  $J = n-m$ . For our highest weight chiral primaries we have  $E = J$  so  $m$  is zero and we restrict to the  $\text{tr}((A^\dagger)^n) |0\rangle$  states. We have higher Hamiltonians

$$H_n = \text{tr}((A^\dagger A)^n) \quad (434)$$

that commute with  $H = \text{tr}(A^\dagger A)$  and each other.

If we concentrate on the  $U(N)$  case we find that in terms of adjoint matrix indices

$$[A_j^i, A_l^\dagger{}^k] = [A_a, A_b^\dagger] (T^a)_j^i (T^b)_l^k = g_{ab} (T^a)_j^i (T^b)_l^k = \delta_l^i \delta_j^k \quad (435)$$

The Schur polynomials are simultaneous eigenstates of these higher Hamiltonians and the different eigenvalues give a complete identification of each Schur polynomial

$$H_n \chi_R(A^\dagger) |0\rangle = C_n^R \chi_R(A^\dagger) |0\rangle \quad (436)$$

For  $U(N)$  these higher Hamiltonians are in fact the Casimirs of the Lie algebra (cf. [143]). In the bulk they can be measured from asymptotic multipole moments of the spacetime [144].

We can show that these Schur polynomials are diagonal in the inner product for this state space, which coincides with the two-point function. Suppose we make no

assumptions about the correlator of the Schur polynomials and define the metric

$$h_{RS} := \langle 0 | \chi_R(A) \chi_S(A^\dagger) | 0 \rangle \quad (437)$$

Now insert a higher Hamiltonian

$$\langle 0 | \chi_R(A) H_n \chi_S(A^\dagger) | 0 \rangle = C_n^S h_{RS} = C_n^R h_{RS} \quad (438)$$

We have acted to the right with  $H_n$  and then to the left. If  $h_{RS} \neq 0$  then we must have  $C_n^R = C_n^S$  for all  $n$ ; otherwise  $h_{RS} = 0$ . We have enough Casimirs to distinguish between the Schur polynomials so if  $R \neq S$  then  $C_n^R \neq C_n^S$  for some  $n$ , so we must have  $h_{RS} = 0$  for  $R \neq S$ .

Now extend this argument to the  $SU(N)$  case for which

$$[A_j^i, A_l^\dagger{}^k] = g_{ab} (T^a)_j^i (T^b)_l^k = \delta_l^i \delta_j^k - \frac{1}{N} \delta_j^i \delta_l^k \quad (439)$$

The higher Hamiltonians no longer have simple eigenvectors or eigenvalues. Also the higher Hamiltonians no longer correspond to the Casimirs of  $SU(N)$ . However they must diagonalise the correlator by the same argument as above.

For example, at level 4 we have two independent gauge-invariant states for which

$$\begin{aligned} H \operatorname{tr}(A^{\dagger 2}) \operatorname{tr}(A^{\dagger 2}) | 0 \rangle &= 4 \operatorname{tr}(A^{\dagger 2}) \operatorname{tr}(A^{\dagger 2}) | 0 \rangle \\ H \operatorname{tr}(A^{\dagger 4}) | 0 \rangle &= 4 \operatorname{tr}(A^{\dagger 4}) | 0 \rangle \\ H_2 \operatorname{tr}(A^{\dagger 2}) \operatorname{tr}(A^{\dagger 2}) | 0 \rangle &= \left[ \left( 4N - \frac{8}{N} \right) \operatorname{tr}(A^{\dagger 2}) \operatorname{tr}(A^{\dagger 2}) + 8 \operatorname{tr}(A^{\dagger 4}) \right] | 0 \rangle \\ H_2 \operatorname{tr}(A^{\dagger 4}) | 0 \rangle &= \left[ \left( 4 + \frac{12}{N^2} \right) \operatorname{tr}(A^{\dagger 2}) \operatorname{tr}(A^{\dagger 2}) + \left( 4N - \frac{28}{N} \right) \operatorname{tr}(A^{\dagger 4}) \right] | 0 \rangle \end{aligned} \quad (440)$$

If we find the eigenvectors of  $H_2$ , we get a diagonal basis

$$\left[ \left( \frac{5}{4N} - \frac{\sqrt{49N^2 + 8N^4}}{4N^2} \right) \operatorname{tr}(A^{\dagger 2}) \operatorname{tr}(A^{\dagger 2}) + \operatorname{tr}(A^{\dagger 4}) \right] | 0 \rangle \quad (441)$$

$$\left[ \left( \frac{5}{4N} + \frac{\sqrt{49N^2 + 8N^4}}{4N^2} \right) \operatorname{tr}(A^{\dagger 2}) \operatorname{tr}(A^{\dagger 2}) + \operatorname{tr}(A^{\dagger 4}) \right] | 0 \rangle. \quad (442)$$

This method of using eigenvectors of higher Hamiltonians to diagonalise the correlator will work at all levels. While it is as complicated as a Gram-Schmidt diagonalisation, it does at least share its derivation from the higher Hamiltonians with the  $U(N)$  matrix model.

## 10 Conclusion

In this thesis we have described a complete solution to free  $\mathcal{N} = 4$  supersymmetric Yang-Mills with a finite number of colours  $N$ . All operators of the theory are arranged into representations of the global bosonic symmetry group  $SO(2, 4) \times SO(6)$  and their trace structure is organised by representations of the gauge group  $U(N)$ , satisfying the Stringy Exclusion Principle. These operators diagonalise the free two-point function and their free three-point functions are given in terms of representation fusion coefficients. This generalises the Schur polynomial construction of the half-BPS operators in [19], where the  $U(N)$  Young diagrams correspond in the bulk to giant graviton branes for  $\Delta \sim N$  and more generally to LLM geometries [49]. At one loop mixing in the two-point function is restricted to those  $U(N)$  representations related by moving a single box of the Young diagram; the three-point function is similarly constrained.

This work gives us the full field theory dual, including non-perturbative degrees of freedom, of the tensionless string, completing the programme of Sundborg [18, 28].

We have also characterised the chiral ring of the theory in two different ways: in terms of a basis dual to the descendants of non-BPS operators and in terms of functions of the eigenvalues of the  $N \times N$  matrices. These operators can be directly compared to BPS giant gravitons in the bulk geometry. Also for operators protected by their large quantum numbers we have found intriguing parallels between non-BPS operators and excitations of giant gravitons.

For transitions between giant graviton states we have defined a new type of probability using correlation functions on ‘higher genus’ four-dimensional manifolds. This procedure resolves paradoxes appearing when trying to calculate the probabilities for these events using naïve normalisations. It also generalises factorisation and sewing from two-dimensional CFT to the four-dimensional setting.

The chief techniques we have used are Schur-Weyl duality and symmetric group manipulations. We have organised tensor products of the fundamental fields  $V_F^{\otimes n}$  into representations of the global symmetry group and the permutation group  $G \times S_n$ . Usually Schur-Weyl duality is applied for the finite-dimensional fundamental representations of a compact group; we have extended its use to infinite-dimensional representations of non-compact groups such as the spin  $-\frac{1}{2}$  representation of  $SL(2)$ .

Representation theory and Schur-Weyl duality played an important part in our understanding of 2d Yang-Mills and its string dual [3][4][5]. We hope that Schur-Weyl duality, and the interplay between the gauge group and the global symmetry group, will provide vital clues for our understanding of  $d = 4, \mathcal{N} = 4$  supersymmetric Yang-Mills and non-perturbative string theory on  $AdS_5 \times S^5$ .

Some considerations for the future:

- The basis of operators constructed here, which is diagonal at tree level, does not remain diagonal at one loop, even though the mixing is constrained. The Brauer algebra  $B_{n,n}(N)$  studied recently in [65] might be useful here, given that it organises covariant representations of  $U(N)$  built out of both fundamental and anti-fundamental representations. There were hints at the end of Section 5 that the dilatation operator projects onto covariant representations of  $U(N)$ . Even better would be to understand the  $SU(N)$  mixing, since the diagonal  $U(1)$  of  $U(N)$  does not participate in one-loop mixing. Diagonalisation of the spectrum at higher loops would allow more direct comparison with the string side of the correspondence.
- A better understanding of the chiral ring could be achieved by further studying systems of eigenvalues organised by the Schur dual of  $S_N$ , the partition algebra  $P_n(N)$ . It would be extremely interesting to elucidate the relation to matrix models and Calogero models.
- The exact finite  $N$  results here could be used to extend the collective field theory of  $\mathcal{N} = 4$  [145]. This would make the connection to string theory more transparent.
- Finite  $N$  three-point functions can be interpreted in the bulk as deformations of the algebra of functions on the  $AdS_5 \times S^5$  spacetime. Understanding exactly how this describes quantum deformations of the geometry, along the lines of our understanding for  $AdS_3$  [41], is an important problem.
- Understanding how the entropy of 16th BPS black holes in the bulk is furnished in the dual field theory is an outstanding problem of the AdS/CFT correspondence. It is clear that the planar sector [55] is not enough to provide the  $N^2$  scaling of the entropy. The non-planar multi-trace and determinant degrees of freedom described here are also needed.
- More directly, recent toy models suggest that finite  $N$  effects prevent information loss during black hole thermalisation [146, 147]. Further investigation should be possible with the technology outlined in this thesis.
- There are wider applications of these finite  $N$  techniques, which apply to general systems with matrix-valued objects. Applications within AdS/CFT would include studying non-local operators, such as Wilson loops and surface operators [148], which play fascinating roles as order parameters for the theory and have connections to number theory.
- Schur-Weyl duality for exotic groups and their algebras is an active area of research in the mathematical community, and the perspective given here can feed back into this subject. Schur-Weyl dual algebras appear everywhere, particularly integrable systems and discrete statistical systems.

### Acknowledgements

I thank James Bedford, David Berman, David Birtles, Andreas Brandhuber, Chong-Sun Chu, Nick Dorey, Dario Duo, Antal Jevicki, Yusuke Kimura, Simon McNamara, Shiraz Minwalla, Adele Nasti, Constantinos Papageorgakis, Thomas Quella, Rodolfo Russo, Volker Schomerus, Andrew Sellers, Bill Spence, Laura Tadrowski, Dan Thompson, Gabriele Travaglini, David Turton, Max Vincon, John Ward and Konstantinos Zoubos for valuable discussions. I also thank Paul Heslop, Robert de Mello Koch and Nick Toumbas for the privilege of collaboration with them on the various parts of this thesis. In particular I thank my supervisor Sanjaye Ramgoolam for his guidance, his collaboration and his patience. I am extremely grateful to STFC for funding through their studentship programme. For my sanity I am indebted to my family and friends for all their support and love, in particular to my parents and Goran Tkalec. Finally I dedicate this work to Sue Willan: the world is a worse place without her.

## A Key

See Table 2.

$S_n$	the permutation or symmetry group of $n$ objects
$\rho, \sigma, \tau, \alpha$	elements of $S_n$
$V_F^{(G)}$	fundamental representation of $G$
$V_H^{(S_n)}$	hook irrep of $S_n$ with Young diagram $[n - 1, 1]$
$\Lambda$	labels representation of global symmetry group $G$
$M_{(\Lambda)}$	labels state within representation $\Lambda$ of global symmetry group $G$
$\lambda$	labels representation of $S_n$
$a_{(\lambda)}, b, c, p, q, r, s$	label states within representations of $S_n$
$R, S, T$	label representations of gauge group $U(N)$
$\tau$	labels multiplicity of representation $\Lambda \otimes \lambda$ of $G \times S_n$ in $V_F^{\otimes n}$
$\hat{\tau}$	labels multiplicity of $\lambda$ in $S_n$ tensor product $R \otimes R$
$\tilde{\tau}$	labels multiplicity of $K \otimes \kappa$ of $S_N \times S_n$ in $(V_{\text{nat}}^{S_N})^{\otimes n}$
$m$	label fundamental fields in $V_F$
$i, j, k, l$	fundamental indices of $U(N)$
$P(n, N)$	set of partitions of $n$ into $\leq N$ parts; label irreps of $U(N)$ and $S_n$
$p(n, N)$	the number of partitions of $n$ into at most $N$ parts $p(n, N) =  P(n, N) $
$\text{Dim}_N R$	the dimension of the $U(N)$ representation $R$
$d_R$	the dimension of the $S_n$ representation $R$
$f_R$	the factor for the 2-point function of the Schur polynomials in (19) $f_R \equiv \frac{n! \text{Dim}_N R}{d_R}$

Table 2: Key.

## B Symmetric group formulae

The symmetric group is the group of permutations of  $n$  objects, written  $S_n$ . The elements of this group are often written in cycle notation, e.g. (123).

The representations of the symmetric group are labelled by Young diagrams with  $n$  boxes.

$$\begin{aligned}
 S_1 &: \square \\
 S_2 &: \square \square \quad \square \\
 S_3 &: \square \square \square \quad \square \square \quad \square \\
 S_4 &: \square \square \square \square \quad \square \square \square \quad \square \square \quad \square \square \quad \square \\
 & \hspace{20em} (443)
 \end{aligned}$$

If  $\lambda$  is a Young diagram and  $\lambda_1 \geq \lambda_2 \geq \dots \lambda_n \geq 0$  are the lengths of its rows, then the row lengths  $\{\lambda_i\}$  are in 1-to-1 correspondence with the possible partitions of  $n$ .

We will often write the Young diagrams as the lengths of its rows between square brackets  $[\lambda_1, \lambda_2, \dots]$ .

Some general representations:

- The *trivial* symmetric representation  $[n]$ , for which the matrix is  $D^{[n]}(\sigma) = 1 \forall \sigma \in S_n$ . It has dimension 1.
- The *antisymmetric* representation  $[1, 1, \dots, 1] = [1^n]$ , for which  $D^{[1^n]}(\sigma) = (-1)^\sigma \forall \sigma \in S_n$ . It has dimension 1.
- The *natural* or *permutation* representation  $V_{\text{nat}}$  which is  $n$ -dimensional, and just corresponds to the permutations of  $n$  objects  $D_{ij}^{\text{nat}}(\sigma) = \delta_{i\sigma(j)}$ . It is reducible

$$V_{\text{nat}} = V_{[n]} \oplus V_{[n-1,1]} \quad (444)$$

- The *regular* representation, for which the carrier space is  $V = \mathbb{C}S_n$ .

### B.1 Conjugacy classes of the symmetric group

The conjugacy class of an element  $\sigma \in S_n$ , written  $[\sigma]$ , is the set of elements in  $S_n$  related to  $\sigma$  by conjugation.

$$[\sigma] = \{\rho \in S_n : \tau\rho\tau^{-1} = \sigma \text{ for some } \tau \in S_n\} \quad (445)$$

Given that conjugation doesn't change the cycle structure of the permutation, the conjugacy class of  $\sigma$  is just the set of all permutations with the same cycle structure as  $\sigma$ . For example, the conjugacy class of  $(12)(34) \in S_4$  is

$$[(12)(34)] = \{(12)(34), (13)(24), (14)(23)\} \quad (446)$$

Cycle structures, and hence conjugacy classes, are in 1-to-1 correspondence with partitions of  $n$ .

Note that the inverse of  $\sigma$ ,  $\sigma^{-1}$  always has the same cycle structure as  $\sigma$ , so  $\sigma^{-1} \in [\sigma]$ .

The symmetry group of  $\sigma \in S_n$ , written  $\text{Sym}(\sigma)$ , is the subgroup of  $S_n$  that preserves  $\sigma$  under conjugation.

$$\text{Sym}(\sigma) = \{\tau \in S_n : \tau\sigma\tau^{-1} = \sigma\} \quad (447)$$

If  $\sigma$  has  $i_1$  1-cycles,  $i_2$  2-cycles,  $\dots$ ,  $i_n$   $n$ -cycles, then the size of the symmetry group  $|\text{Sym}(\sigma)|$  is given by

$$|\text{Sym}(\sigma)| = i_1!1^{i_1} \cdot i_2!2^{i_2} \dots i_n!n^{i_n} \quad (448)$$

The factorial  $i_j!$  factor corresponds to the different ways of ordering  $i_j$   $j$ -cycles, while the  $j$  factor for each  $j$ -cycle corresponds for the  $j$  different ways of writing the same cycle, e.g.  $(123)$ ,  $(231)$  and  $(312)$  are all the same cycle, but there are  $j$  choices of which element to start on.

The size of the conjugacy class  $[[\sigma]]$  is given in terms of the size of the symmetry

group  $|\text{Sym}(\sigma)|$  by

$$|\sigma| = \frac{n!}{|\text{Sym}(\sigma)|} \tag{449}$$

### B.2 States and standard Young tableaux

Standard Young tableaux enumerate the states of representations of  $S_n$ . To get a standard tableau, fill the Young diagram of the representation with numbers  $\{1, \dots, n\}$  strictly increasing in both rows and columns.

There is only one standard Young tableaux for the Young diagram  $\square\square\square$ , reflecting the fact that  $d_{\square\square\square} = 1$ .

$$\begin{array}{|c|c|c|} \hline 1 & 2 & 3 \\ \hline \end{array} \tag{450}$$

There are two standard Young tableaux for the Young diagram  $\begin{array}{|c|c|} \hline \square & \square \\ \hline \square & \\ \hline \end{array}$ , reflecting the fact that  $d_{\begin{array}{|c|c|} \hline \square & \square \\ \hline \square & \\ \hline \end{array}} = 2$ .

$$\begin{array}{|c|c|} \hline 1 & 2 \\ \hline 3 & \\ \hline \end{array} \quad \begin{array}{|c|c|} \hline 1 & 3 \\ \hline 2 & \\ \hline \end{array} \tag{451}$$

### B.3 Dimensions

Let each box of the Young diagram be labelled by  $(i, j)$  where  $i$  is the row coordinate and  $j$  the column coordinate.

The *hook* or *hook length* of a box  $h(i, j)$  is obtained by drawing an ‘elbow line’ or hook through the box and counting how many boxes the elbow line passes through. The elbow line goes vertically up from the bottom of the Young diagram and then turns right going horizontal at the box  $(i, j)$ , see Figure 17. Figure 18 shows a Young diagram with

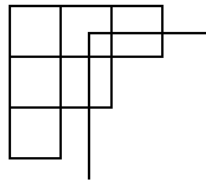

Figure 17: The elbow line for the box  $(1, 2)$  gives a hook length of 3.

all the hook lengths filled in.

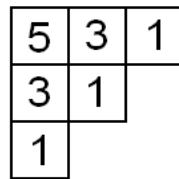

Figure 18: A Young diagram with the hook length of each box displayed.



The symmetric group dimension  $d_R$  of  $R$  is given by  $n!$  divided by the product of all the hooks of all the boxes

$$d_R = \frac{n!}{\prod_{(i,j) \in R} h(i,j)} \quad (452)$$

For the example we have been considering

$$d_{\begin{array}{|c|c|c|} \hline \square & \square & \square \\ \hline \square & \square & \\ \hline \square & & \\ \hline \end{array}} = \frac{6!}{5 \cdot 3 \cdot 3} = 16 \quad (453)$$

### B.4 Representing matrices

There are lots of different ways of constructing representing matrices for the symmetric group: the natural, the seminormal [149], to name but a few. We will exclusively use the orthogonal Young-Yamanouchi matrices, since the orthogonality property

$$D_{ij}^R(\sigma^{-1}) = D_{ji}^R(\sigma) \quad (454)$$

is extremely useful. These matrices are constructed in Section B.9.

The matrices of any representation satisfy the following property, which follows from Schur's Lemma

$$\sum_{\sigma \in S_n} D_{ij}^R(\sigma) D_{lk}^S(\sigma^{-1}) = \frac{n!}{d_R} \delta^{RS} \delta_{ik} \delta_{jl} \quad (455)$$

For orthogonal matrices satisfying (454) equation (455) becomes

$$\sum_{\sigma \in S_n} D_{ij}^R(\sigma) D_{kl}^S(\sigma) = \frac{n!}{d_R} \delta^{RS} \delta_{ik} \delta_{jl} \quad (456)$$

### B.5 Characters

The character of a representation is the trace of its representation matrix. It is constant on conjugacy classes of the group, so is called a *class function*.

There are two basic orthogonality relations for the characters of  $S_n$ .

$$\sum_{\sigma \in S_n} \chi_R(\sigma) \chi_S(\sigma) = n! \delta_{RS} \quad (457)$$

$$\sum_{R \vdash n} \chi_R(\sigma) \chi_R(\tau) = \frac{n!}{|[[\sigma]]|} \delta_{\tau \in [\sigma]} \quad (458)$$

where we have summed over representations of  $S_n$ .

As a special case of (458)

$$\delta(\sigma) \equiv \delta(\sigma = \text{id}) = \frac{1}{n!} \sum_{R \vdash n} d_R \chi_R(\sigma) \quad (459)$$

### B.6 Tensor products

The tensor product of two  $S_n$  representations  $V_R \otimes V_S$  is reducible.

$$V_R \otimes V_S = \bigoplus_{T \vdash n} C(R, S, T) V_T \quad (460)$$

The coefficient  $C(R, S, T)$  counts the number of times  $V_T$  appears in  $V_R \otimes V_S$  and is given by

$$C(R, S, T) = \frac{1}{n!} \sum_{\sigma \in S_n} \chi_R(\sigma) \chi_S(\sigma) \chi_T(\sigma) \quad (461)$$

Some useful examples:

$$\begin{aligned} C(R, R, [n]) &= 1 \quad \forall R \\ C(R, R^c, [1^n]) &= 1 \quad \forall R \end{aligned} \quad (462)$$

$[n]$  is the totally symmetric representation,  $[1^n]$  is the totally anti-symmetric representation and  $R^c$  is the conjugate representation to  $R$  obtained by exchanging the rows for columns.

### B.7 Clebsch-Gordan coefficients

Clebsch-Gordan coefficients for a tensor product like (460) given the exact mapping between states in  $V_R \otimes V_S$  and states in  $V_T$ .

If we label the states  $|R, i; S, j\rangle \equiv |R, i\rangle \otimes |S, j\rangle \in V_R \otimes V_S$  and  $|T, k\rangle \in V_T$  then they are mapped into each other by the Clebsch-Gordan coefficients

$$|R, i; S, j\rangle = S^{\hat{\tau}, T}_{k \ i \ j}{}^R \ S |T, k\rangle \quad (463)$$

where  $\hat{\tau}$  runs over the multiplicity  $C(R, S, T)$  in (460), i.e.

$$S^{\hat{\tau}, T}_{k \ i \ j}{}^R \ S \equiv \langle \hat{\tau}, T, k | R, i; S, j\rangle = \langle R, i; S, j | \hat{\tau}, T, k\rangle \quad (464)$$

Note that everything is real for these representations of  $S_n$ . These are known as  $3j$ -symbols for the more familiar  $G = SU(2)$ .

The Clebsch-Gordan coefficients allow us to write the action of  $\sigma \in S_n$  on the tensor product space  $V_R \otimes V_S$ , such as  $D_{ij}^R(\sigma) D_{kl}^S(\sigma)$ , in terms the action  $D_{ab}^T(\sigma)$  in a single representation  $V_T$ .

$$\begin{aligned} D_{ij}^R(\sigma) D_{kl}^S(\sigma) &= \langle R, i; S, k | \sigma | R, j; S, l\rangle \\ &= \sum_{T, \hat{\tau}} \langle R, i; S, k | \hat{\tau}, T, a\rangle \langle \hat{\tau}, T, a | \sigma | \hat{\tau}, T, b\rangle \langle \hat{\tau}, T, b | R, j; S, l\rangle \\ &= \sum_{T, \hat{\tau}} S^{\hat{\tau}, T}_{a \ i \ k}{}^R \ S D_{ab}^T(\sigma) S^{\hat{\tau}, T}_{b \ j \ l}{}^R \ S \end{aligned} \quad (465)$$

We have inserted two complete sets of states here.

The Clebsch-Gordan coefficients satisfy the following orthogonality relations [102]

$$\sum_{i,j} S^{\hat{\tau}R, R}_{a i} U_j V_j S^{\hat{\tau}S, S}_{b i} U_j V_j = \delta^{RS} \delta^{\hat{\tau}R \hat{\tau}S} \delta_{ab} \quad (466)$$

$$\sum_{\hat{\tau}} \sum_R \sum_a S^{\hat{\tau}, R}_{a i} U_j V_j S^{\hat{\tau}, R}_{a k} U_l V_l = \delta_{ik} \delta_{jl} \quad (467)$$

These follow from the bra-ket notation. From (465) we can then derive

$$\sum_{j,l} D_{ij}^R(\sigma) D_{kl}^S(\sigma) S^{\hat{\tau}, T}_{b j} R_l S_l = \sum_a D_{ab}^T(\sigma) S^{\hat{\tau}, T}_{a i} R_k S_k \quad (468)$$

$$\sum_{\sigma \in S_n} D_{ab}^T(\sigma) D_{ij}^R(\sigma) D_{kl}^S(\sigma) = \frac{n!}{d_T} \sum_{\hat{\tau}} S^{\hat{\tau}, T}_{a i} R_k S_k S^{\hat{\tau}, T}_{b j} R_l S_l \quad (469)$$

Note that, by taking traces in (469) and using (466) we can recover  $C(R, S, T)$  in (461) which comes from the sum over  $\hat{\tau}$ . From (468) we get

$$\sum_{b,j,l} D_{cb}^T(\sigma) D_{ij}^R(\sigma) D_{kl}^S(\sigma) S^{\hat{\tau}, T}_{b j} R_l S_l = S^{\hat{\tau}, T}_{c i} R_k S_k \quad (470)$$

## B.8 The outer product and branching

The outer product is an alternative product for symmetric group representations that mirrors the  $GL(N)$  tensor product C.4. See Chapter 7-12 of Hamermesh [102] for a full discussion of the outer product. For a rep  $R$  of  $S_{n_R}$  and  $S$  of  $S_{n_S}$  we get new reps  $T$  of  $S_{n_R+n_S}$

$$V_R \circ V_S = \bigoplus_T g(R, S; T) V_T \quad (471)$$

$g(R, S; T)$  is the Littlewood-Richardson coefficient given by

$$g(R, S; T) = \frac{1}{n_R! n_S!} \sum_{\rho \in S_{n_R}, \sigma \in S_{n_S}} \chi_R(\rho) \chi_S(\sigma) \chi_T(\rho \circ \sigma) \quad (472)$$

It refines to a mapping coefficient of states called the *branching coefficient*  $B_p^{R \rightarrow R_1 \circ R_2; \beta}$ , where  $\beta$  runs over  $g(R_1, R_2; R)$ . It satisfies the following identities

$$\frac{d_{R_1} d_{R_2}}{\mu_1! \mu_2!} \sum_{\alpha_1 \in S_{\mu_1}} \sum_{\alpha_2 \in S_{\mu_2}} D_{p_1 q_1}^{R_1}(\alpha_1) D_{p_2 q_2}^{R_2}(\alpha_2) D_{pq}^R(\alpha_1 \circ \alpha_2) = \sum_{\beta} B_p^{R \rightarrow R_1 \circ R_2; \beta} B_q^{R \rightarrow R_1 \circ R_2; \beta} \quad (473)$$

$$\sum_p B_p^{R \rightarrow S \circ T; \beta} B_p^{R \rightarrow U \circ V; \beta'} = \delta^{\beta \beta'} \delta^{SU} \delta^{TV} \delta_{p_1 q_1} \delta_{p_2 q_2} \quad (474)$$

Following from these two we get

$$D_{pi}^R(\gamma_1 \circ \gamma_2) B_i^{R \rightarrow S \circ T; \beta} = B_p^{R \rightarrow S \circ T; \beta} D_{qj}^S(\gamma_1) D_{rk}^T(\gamma_2) \quad (475)$$



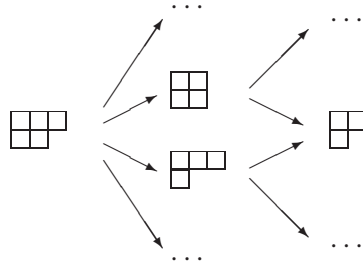

Figure 19: Restriction pattern for  $S_{n+1} \rightarrow S_n \rightarrow S_{n-1}$ .

reduces to Young diagrams with two boxes removed from  $T$ .  $T_{rs} = T_{sr}$  is the common  $S_{n-1}$  Young diagram obtained when boxes are removed both from the  $r$ th and  $s$ th rows (see Figure 19). It is Type II because the boxes can be removed independently. Because  $(n, n + 1)$  commutes with all elements of  $S_{n-1}$ ,  $D_{\frac{q_1 p_2}{r s}}^T((n, n + 1))$  is only non-zero in the case

$$D_{\frac{q_1 p_2}{r s}}^T((n, n + 1)) = \frac{\sqrt{\tau_{rs,rs}^2 - 1}}{|\tau_{rs,rs}|} E_{rs,sr} \tag{477}$$

where  $E_{rs,sr}$  is the identity matrix. If the row lengths of  $T$  are given by  $t_r$  then  $\tau_{rs,rs}$  is<sup>24</sup>

$$\tau_{rs,rs} = (t_r - r) - (t_s - s) \tag{478}$$

Unfortunately we can't work the same magic on  $D_{\frac{q_2 p_1}{s r}}^T((\mu_1, n + 1))$ .

There are also branching-type recursive relations for the Clebsch-Gordan coefficients (see the end of Chapter 7 of Hamermesh [102]).

Given that we know (235) is diagonal in the  $U(2)$  states, this may imply non-trivial identities for these symmetric group reduction formulae.

## B.10 The natural and hook representations

### B.10.1 The natural representation

The permutation or natural representation of  $S_N$  acts by permuting a group of  $N$  objects

$$D^{\text{nat}}((12)) = \begin{pmatrix} 0 & 1 & & & \\ 1 & 0 & & & \\ & & 1 & & \\ & & & \ddots & \\ & & & & 1 \end{pmatrix} \tag{479}$$

---

<sup>24</sup> $\tau_{rs,rs}$  is also known as the *axial distance*.

where

$$V_{\text{nat}} = \begin{pmatrix} x_1 \\ \vdots \\ x_N \end{pmatrix} \quad (480)$$

When acting by conjugation on an  $N \times N$  matrix, it just permutes the eigenvalues  $(x_1, x_2, \dots, x_N)$ .

This representation of  $S_N$  is reducible into the trivial and the ‘hook’ reps

$$V_{\text{nat}} = V_{[N]} \oplus V_{[N-1,1]} \quad (481)$$

where the trivial rep  $[N]$  is just a sum of the eigenvalues

$$V_{[N]} = (x_1 + x_2 + \dots + x_N)$$

$$V_{[N-1,1]} = \begin{pmatrix} x_1 - x_2 \\ x_1 + x_2 - 2x_3 \\ \vdots \\ x_1 + \dots + x_i - ix_{i+1} \\ \vdots \end{pmatrix} \quad (482)$$

### B.10.2 Characters of natural rep

The character of the natural rep is the number of fixed points

$$\chi_{\text{nat}}(\sigma) = \# \text{ 1-cycles} = \chi_{[n]}(\sigma) + \chi_{[n-1,1]}(\sigma) \quad (483)$$

From this we can deduce the character of the hook rep

$$\chi_{[n-1,1]}(\sigma) = \# \text{ 1-cycles} - 1 \quad (484)$$

### B.10.3 Tensor products of the natural rep

The inner product of a representation  $\lambda$  of  $S_n$  with the natural rep is simply

$$V_{\lambda}^{S_n} \otimes V_{\text{nat}}^{S_n} = \bigoplus_{\mu=(\lambda^-)^+} V_{\mu}^{S_n} \quad (485)$$

i.e. knock a box off  $\lambda$  and then add it back somewhere.

$V_{\lambda}^{S_n}$  itself appears with a multiplicity equal to the number of boxes free to remove, e.g. for  $\lambda = [3, 2]$  it appears twice, for  $\lambda = [2, 2, 2]$  it appears once.

## C General linear and unitary group formulae

Irreducible representations of  $GL(N)$  are labelled by Young diagrams with arbitrarily many boxes, but at most  $N$  rows. Representations for its subgroup  $U(N) \subset GL(N)$  are the same and remain irreducible.

Some representations of  $U(2)$  are

$$U(2) : \quad \mathbf{1} \quad \square \quad \square\square \quad \begin{array}{|c|} \hline \square \\ \hline \end{array} \quad \square\square\square \quad \begin{array}{|c|c|} \hline \square & \square \\ \hline \end{array} \quad \square\square\square\square \quad \begin{array}{|c|c|c|} \hline \square & \square & \square \\ \hline \end{array} \quad \begin{array}{|c|c|} \hline \square & \square \\ \hline \square & \square \\ \hline \end{array} \quad \dots \quad (486)$$

(The first representation  $\mathbf{1}$  is the trivial 1-dimensional representation that just maps every element of  $U(2)$  to the same complex number.)

The Young diagram records the symmetry of the tensor under permutation of its indices. Columns represent antisymmetry and rows symmetry.

Some basic representations of  $U(N)$ :

- The *fundamental* is  $N$ -dimensional; let  $v_i$  be a basis

$$v^i \rightarrow U_j^i v^j \quad (487)$$

- The *antifundamental* is also  $N$ -dimensional but transforms contravariantly

$$w_i \rightarrow w_j (U^{-1})_i^j \quad (488)$$

- The *adjoint* is  $N^2$ -dimensional

$$a_{ij} \rightarrow U_{ik} a_{kl} (U^{-1})_{lj} \quad (489)$$

It reduces into a trace  $\sum_i a_{ii}$  and an  $(N^2 - 1)$ -dimensional irrep.

### C.1 Semi-standard Young tableaux

Semi-standard Young tableaux enumerate the states of  $GL(N)$ . To construct a semi-standard tableau, fill the diagram with numbers  $\{1, 2, \dots, N\}$  (or alternatively the fields  $X_1, X_2, \dots, X_N$ ) strictly increasing down columns but only weakly increasing along rows (if they were strictly increasing along the rows too, they would be standard tableaux, cf. Section B.2).

For  $GL(2)$

$$\begin{array}{|c|c|c|} \hline X & X & X \\ \hline \end{array} \quad \begin{array}{|c|c|c|} \hline X & X & Y \\ \hline \end{array} \quad \begin{array}{|c|c|c|} \hline X & Y & Y \\ \hline \end{array} \quad \begin{array}{|c|c|c|} \hline Y & Y & Y \\ \hline \end{array} \quad (490)$$

correspond to the four states in  $V_{\square\square}^{GL(2)}$ .

$$\begin{array}{|c|c|} \hline X & X \\ \hline Y & \\ \hline \end{array} \quad \begin{array}{|c|c|} \hline X & Y \\ \hline Y & \\ \hline \end{array} \quad (491)$$

corresponds to the two states in  $V_{\begin{array}{|c|} \hline \square \\ \hline \end{array}}^{GL(2)}$ .

The reason why they must be strictly increasing down the columns is that columns correspond to antisymmetrisation when we apply the Young symmetriser. If we antisymmetrise a set of objects where some are the same, it will vanish. But when we symmetrise along the rows, it doesn't matter if some are the same, but we must order them so that we don't count the same set twice, hence the requirement that they are only weakly increasing along rows.

### C.2 Dimensions

Let each box of the Young diagram be labelled by  $(i, j)$  where  $i$  is the row coordinate and  $j$  the column coordinate.

The *weight* of each box<sup>25</sup> is  $N - i + j$ . See Figure 20 for the weights assigned to the boxes of a Young diagram. The dimension  $\text{Dim } R$  of the representation  $R$  of  $GL(N)$  is

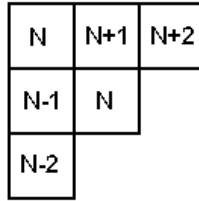

Figure 20: A Young diagram with the weight of each box displayed.

then given by the product of all these weights divided by product of the hook lengths

$$\text{Dim } R = \prod_{(i,j) \in R} \frac{N - i + j}{h_{i,j}} \tag{492}$$

For the example we are considering

$$\text{Dim} \begin{array}{|c|c|c|} \hline \square & \square & \square \\ \hline \square & \square & \\ \hline \square & & \\ \hline \end{array} = \frac{N^2(N^2 - 1)(N^2 - 4)}{5 \cdot 3 \cdot 3} \tag{493}$$

Another useful quantity is the product of the weights by itself, which we denote  $f_R$ .

$$f_R \equiv \prod_{(i,j) \in R} (N - i + j) = \frac{n! \text{Dim } R}{d_R} \tag{494}$$

The hooks and the weights provide an efficient way to encode the combinatorics of tensors with a definite symmetry under swapping indices. For example, the totally antisymmetric tensor with three indices, gives a non-zero result only if all indices take distinct values. Thus, the first index can take any one of  $N$  values, the second index any one of  $N - 1$  values and the third index any one of  $N - 2$  values. These are exactly the value of the weights of the corresponding Young diagram. The division by the hooks

---

<sup>25</sup>Not to be confused with the Dynkin weights of states in the representation.



corrects for the fact that not all elements of this tensor are independent - swapping any two indices only costs a sign.

The dimension is also given in terms of the character of the  $N \times N$  identity matrix  $\mathbb{I}_N$ .

$$\text{Dim } R = \chi_R(\mathbb{I}_N) = \frac{1}{n!} \sum_{\sigma \in S_n} \chi_R(\sigma) \text{tr}(\sigma \mathbb{I}_N^n) = \frac{1}{n!} \sum_{\sigma \in S_n} \chi_R(\sigma) N^{C(\sigma)} \quad (495)$$

where  $C(\sigma)$  is the number of cycles in  $\sigma$ .

### C.3 Characters

The character of  $X \in GL(N)$  is given in terms of the characters  $\chi_R(\sigma)$  of the symmetric group

$$\chi_R(X) = \frac{1}{n!} \sum_{\sigma \in S_n} \chi_R(\sigma) X_{i_{\sigma(1)}}^{i_1} X_{i_{\sigma(2)}}^{i_2} \cdots X_{i_{\sigma(n)}}^{i_n} = \frac{1}{n!} \sum_{\sigma \in S_n} \chi_R(\sigma) \text{tr}(\sigma X) \quad (496)$$

We can recover the trace by summing over  $R$

$$\text{tr}(\sigma X) = \sum_{R \in P(n, N)} \chi_R(\sigma) \chi_R(X) \quad (497)$$

#### C.3.1 Schur polynomials of eigenvalues

If we take the character of a diagonal matrix then we get a symmetric polynomial of the eigenvalues, for example

$$\begin{aligned} \chi_{\square\square} \left( \begin{pmatrix} x & \\ & y \end{pmatrix} \right) &= \frac{1}{2} [(x+y)^2 + (x^2 + y^2)] \\ \chi_{\square} \left( \begin{pmatrix} x & \\ & y \end{pmatrix} \right) &= \frac{1}{2} [(x+y)^2 - (x^2 + y^2)] \end{aligned} \quad (498)$$

These are called Schur polynomials, see the discussion in the Appendix of Fulton and Harris [73]. These kinds of polynomials appear in the indices of  $\mathcal{N} = 4$  [52] [22].

For  $U(K)$  we can expand the polynomial using the Littlewood-Richardson coefficients

$$\chi_\Lambda(\mathbf{x}) = \sum_{\vec{\mu}} g([\mu_1], [\mu_2], \dots, [\mu_K]; \Lambda) x_1^{\mu_1} x_2^{\mu_2} \cdots x_K^{\mu_K} \quad (499)$$

### C.4 Tensor products

The tensor product of two  $GL(N)$  representations  $V_R \otimes V_S$  is reducible.

$$V_R \otimes V_S = \bigoplus_{T \vdash n} g(R, S; T) V_T \quad (500)$$

The coefficient  $g(R, S; T)$  is called the Littlewood-Richardson coefficient and counts the number of times  $V_T$  appears in  $V_R \otimes V_S$ . It is given by

$$g(R, S; T) = \int [dU] \chi_R(U) \chi_S(U) \chi_T(U^\dagger) \quad (501)$$

It is exactly the same as the symmetric group outer product coefficient, which has a simple formula (472). There are graphical rules for computing Littlewood-Richardson coefficients.

### C.5 Schur-Weyl duality for $U(2)$

As an example take  $K = 2$  so that we have fields of  $U(2)$ :  $\{W_m\} = \{X, Y\}$ . This example is very familiar from taking tensor products of  $SU(2)$  spin representations, where  $X \sim |\uparrow\rangle$  and  $Y \sim |\downarrow\rangle$ .

$n = 2 V_F^{\otimes 2}$  contains  $2^2$  states

$$X \otimes X, \quad X \otimes Y, \quad Y \otimes X, \quad Y \otimes Y \quad (502)$$

If we organise them according to representations then we get the ‘spin 1’ symmetric representation

$$V_{\square\square} = \begin{pmatrix} X \otimes X \\ X \otimes Y + Y \otimes X \\ Y \otimes Y \end{pmatrix} \quad (503)$$

and the ‘spin 0’ antisymmetric representation

$$V_{\square} = \begin{pmatrix} X \otimes Y - Y \otimes X \end{pmatrix} \quad (504)$$

$n = 3 V_F^{\otimes 3}$  contains  $2^3$  states

$$X \otimes X \otimes X, \quad X \otimes X \otimes Y, \quad X \otimes Y \otimes X, \quad Y \otimes X \otimes X, \quad X \otimes Y \otimes Y \quad \dots \quad (505)$$

If we organise them according to representations then we get the ‘spin  $\frac{3}{2}$ ’ symmetric representation

$$V_{\square\square\square} = \begin{pmatrix} X \otimes X \otimes X \\ X \otimes X \otimes Y + X \otimes Y \otimes X + Y \otimes X \otimes X \\ X \otimes Y \otimes Y + Y \otimes X \otimes Y + Y \otimes Y \otimes X \\ Y \otimes Y \otimes Y \end{pmatrix} \quad (506)$$

and two copies of the ‘spin  $\frac{1}{2}$ ’ representation

$$V_{\begin{smallmatrix} \square & \square \\ \square & \square \end{smallmatrix},1} = \begin{pmatrix} X \otimes X \otimes Y - X \otimes Y \otimes X \\ Y \otimes X \otimes Y - Y \otimes Y \otimes X \end{pmatrix} \tag{507}$$

$$V_{\begin{smallmatrix} \square & \square \\ \square & \square \end{smallmatrix},2} = \begin{pmatrix} X \otimes X \otimes Y - Y \otimes X \otimes X \\ X \otimes Y \otimes Y - Y \otimes Y \otimes X \end{pmatrix} \tag{508}$$

The number of times these  $U(2)$  representations  $\Lambda$  appear is controlled in (8) by the size of the symmetric group representation  $V_{\Lambda}^{S_n}$ , whose symmetric group dimension we write  $d_{\Lambda}$ . For these cases  $d_{\begin{smallmatrix} \square & \square \\ \square & \square \end{smallmatrix}} = 1$  and  $d_{\begin{smallmatrix} \square & \square \\ \square & \square \end{smallmatrix}} = 2$ .<sup>26</sup>

### C.6 Young symmetrisers and projectors

A more fine-grained projector in  $V_N^{\otimes}$  can be written if we symmetrised according to the individual  $d_R$  standard tableaux, see [150].

## D Diagrammatics

Diagrammatics [48] encode the ‘t Hooft double-line indices. We follow the index lines with delta functions and permutations, see for example Figure 21. We read the permu-

$$\delta_{j_4}^{i_1} \delta_{j_1}^{i_2} \delta_{j_2}^{i_3} \delta_{j_3}^{i_4} = \begin{array}{cccc} i_1 & i_2 & i_3 & i_4 \\ | & | & | & | \\ j_4 & j_1 & j_2 & j_3 \end{array} = \begin{array}{cccc} i_1 & i_2 & i_3 & i_4 \\ \curvearrowright & \curvearrowright & \curvearrowright & \curvearrowright \\ j_1 & j_2 & j_3 & j_4 \end{array} = \begin{array}{cccc} i_1 & i_2 & i_3 & i_4 \\ \boxed{(1432)} \\ j_1 & j_2 & j_3 & j_4 \end{array}$$

Figure 21: From delta functions to diagrams to permutations.

tations in the diagrams from the top down. This is also illustrated in Figure 22, where we remember that in the permutation  $\beta\alpha$  we read from right to left, so that  $\alpha$  acts first followed by  $\beta$ . Also in Figure 22 we clump several strands labelled by  $k$  into a single

$$\delta_{j_{\beta\alpha(k)}}^{i_k} = \begin{array}{c} i_k \\ \downarrow \\ \boxed{\alpha} \\ \downarrow \\ \boxed{\beta} \\ \downarrow \\ j_k \end{array}$$

Figure 22: Permutations in series; thick lines represent many strands.

<sup>26</sup>The way the two representations  $V_{\begin{smallmatrix} \square & \square \\ \square & \square \end{smallmatrix}}$  are chosen is determined by the standard Young tableaux which enumerate the states of the symmetric group representation, see Section B.2.

thick strand, for clarity.

If we write down a series of delta functions we can always alter the order in which we write them down with any  $\sigma \in S_n$ , given that they are just numbers

$$\delta_{j_{\alpha(1)}}^{i_1} \cdots \delta_{j_{\alpha(n)}}^{i_n} = \delta_{j_{\alpha\sigma(1)}}^{i_{\sigma(1)}} \cdots \delta_{j_{\alpha\sigma(n)}}^{i_{\sigma(n)}} \quad (509)$$

This allows us to deal with permutations on the upper index, see Figure 23.

$$\delta_{j_k}^{i_{\beta\alpha(k)}} = \delta_{j_{\alpha^{-1}\beta^{-1}(k)}}^{i_k} = \begin{array}{c} i_k \\ \downarrow \\ \boxed{\beta^{-1}} \\ \downarrow \\ \boxed{\alpha^{-1}} \\ \downarrow \\ j_k \end{array}$$

Figure 23: Permutations on the upper index.

If we have  $\delta_{j_{\beta(k)}}^{i_{\alpha(k)}}$  and we set  $j_k = i_{\sigma(k)}$  then we get

$$\delta_{j_{\beta(k)}}^{i_{\alpha(k)}} \delta_{i_{\sigma(k)}}^{j_k} = \delta_{j_k}^{i_{\alpha\beta^{-1}(k)}} \delta_{i_{\sigma(k)}}^{j_k} = \delta_{i_{\sigma(k)}}^{i_{\alpha\beta^{-1}(k)}} = \delta_{i_{\sigma\beta(k)}}^{i_{\alpha(k)}} \quad (510)$$

## E $U(2)$ $\Lambda = [2, 2]$ example operators and two-point functions

We consider the case with  $U(2)$  representation  $\Lambda = \begin{array}{|c|c|} \hline \square & \square \\ \hline \square & \square \\ \hline \end{array}$  and field content  $XXYY$ . This must be a highest weight state of  $\Lambda$  because the field content matches the rows of  $\Lambda$ . Thus  $\beta$  is unique.

The three allowed  $U(N)$  representations are  $R = \begin{array}{|c|c|} \hline \square & \square \\ \hline \square & \square \\ \hline \end{array}, \begin{array}{|c|c|c|} \hline \square & \square & \square \\ \hline \square & \square & \square \\ \hline \end{array}, \begin{array}{|c|c|} \hline \square & \square \\ \hline \square & \square \\ \hline \end{array}$ , for which  $\Lambda$  only appears once in the symmetric group inner product  $R \otimes R$ .

Here  $\Phi_r \Phi^r = \epsilon_{rs} \Phi^r \Phi^s = [X, Y]$ .

$$\mathcal{O} \left[ \Lambda = \begin{array}{|c|c|} \hline \square & \square \\ \hline \square & \square \\ \hline \end{array}; R = \begin{array}{|c|c|} \hline \square & \square \\ \hline \square & \square \\ \hline \end{array} \right] = \frac{1}{12\sqrt{2}} \left[ \text{tr}(\Phi_r \Phi_s) \text{tr}(\Phi^r) \text{tr}(\Phi^s) + \text{tr}(\Phi_r \Phi^r \Phi_s \Phi^s) \right] \quad (511)$$

$$\mathcal{O} \left[ \Lambda = \begin{array}{|c|c|} \hline \square & \square \\ \hline \square & \square \\ \hline \end{array}; R = \begin{array}{|c|c|c|} \hline \square & \square & \square \\ \hline \square & \square & \square \\ \hline \end{array} \right] = \frac{1}{12\sqrt{6}} \left[ \text{tr}(\Phi_r \Phi_s) \text{tr}(\Phi^r) \text{tr}(\Phi^s) + \text{tr}(\Phi_r \Phi_s) \text{tr}(\Phi^r \Phi^s) - \text{tr}(\Phi_r \Phi^r \Phi_s \Phi^s) \right] \quad (512)$$

$$\mathcal{O} \left[ \Lambda = \begin{array}{|c|c|} \hline \square & \square \\ \hline \square & \square \\ \hline \end{array}; R = \begin{array}{|c|c|} \hline \square & \square \\ \hline \square & \square \\ \hline \end{array} \right] = \frac{1}{12\sqrt{6}} \left[ \text{tr}(\Phi_r \Phi_s) \text{tr}(\Phi^r) \text{tr}(\Phi^s) - \text{tr}(\Phi_r \Phi_s) \text{tr}(\Phi^r \Phi^s) - \text{tr}(\Phi_r \Phi^r \Phi_s \Phi^s) \right] \quad (513)$$

The tree level correlator is diagonal

$$\begin{aligned}
 & \begin{pmatrix} \frac{1}{12}N^2(N^2 - 1) & & \\ & \frac{1}{18}N(N^2 - 1)(N + 2) & \\ & & \frac{1}{18}N(N^2 - 1)(N - 2) \end{pmatrix} \\
 &= \begin{pmatrix} \text{Dim} \begin{array}{|c|c|} \hline \square & \square \\ \hline \end{array} & & \\ & \frac{4}{9}\text{Dim} \begin{array}{|c|c|c|} \hline \square & \square & \square \\ \hline \end{array} & & \\ & & \frac{4}{9}\text{Dim} \begin{array}{|c|c|} \hline \square & \square \\ \hline \end{array} & \end{pmatrix} \quad (514)
 \end{aligned}$$

At one loop everything mixes

$$\begin{aligned}
 & \begin{pmatrix} \frac{1}{4}N^3(1 - N^2) & \frac{1}{4\sqrt{3}}N^2(N^2 - 1)(N + 2) & \frac{1}{4\sqrt{3}}N^2(N^2 - 1)(N - 2) \\ \frac{1}{4\sqrt{3}}N^2(N^2 - 1)(N + 2) & \frac{1}{12}N(1 - N^2)(N + 2)^2 & \frac{1}{12}N(1 - N^2)(N^2 - 4) \\ \frac{1}{4\sqrt{3}}N^2(N^2 - 1)(N - 2) & \frac{1}{12}N(1 - N^2)(N^2 - 4) & \frac{1}{12}N(1 - N^2)(N - 2)^2 \end{pmatrix} \\
 &= \begin{pmatrix} -3N\text{Dim} \begin{array}{|c|c|} \hline \square & \square \\ \hline \end{array} & 2\sqrt{3}\text{Dim} \begin{array}{|c|c|c|} \hline \square & \square & \square \\ \hline \end{array} & 2\sqrt{3}\text{Dim} \begin{array}{|c|c|} \hline \square & \square \\ \hline \end{array} \\ 2\sqrt{3}\text{Dim} \begin{array}{|c|c|c|} \hline \square & \square & \square \\ \hline \end{array} & -\frac{2}{3}(N + 2)\text{Dim} \begin{array}{|c|c|c|} \hline \square & \square & \square \\ \hline \end{array} & -\frac{5}{3}\text{Dim} \begin{array}{|c|c|c|} \hline \square & \square & \square \\ \hline \end{array} \\ 2\sqrt{3}\text{Dim} \begin{array}{|c|c|} \hline \square & \square \\ \hline \end{array} & -\frac{5}{3}\text{Dim} \begin{array}{|c|c|c|} \hline \square & \square & \square \\ \hline \end{array} & -\frac{2}{3}(N - 2)\text{Dim} \begin{array}{|c|c|} \hline \square & \square \\ \hline \end{array} \end{pmatrix} \quad (515)
 \end{aligned}$$

The diagonal terms seem to be the dimension of the irrep. enhanced by the contribution for a specific box, furthest from the top left.

## F Generating functions for $SL(2) \times S_n$ multiplicity

### F.1 Examples of symmetric and antisymmetric $S_n$ irreps

As an example of this method, take  $\lambda = [n]$  the symmetric irrep. We want to calculate  $\frac{1}{a_\lambda} \text{tr}_{\mathcal{W}} P_\lambda q^{L_0}$  where the trace is taken over  $\mathcal{W} = V_1^{\otimes n}$ . This means calculating  $q^{L_0}$  in the symmetrised subspace of  $V_1^{\otimes n}$ . A basis in the symmetrised subspace of  $|m_1, m_2, \dots, m_n\rangle$  is in 1-1 correspondence with natural numbers  $m_1, m_2, \dots, m_n$  obeying

$$0 \leq m_1 \leq m_2 \leq \dots \leq m_n \leq \infty \quad (516)$$

So the character is

$$\begin{aligned} tr_{\mathcal{W}} P_{[n]} q^{L_0} &= q^n \sum_{m_n=0}^{\infty} \sum_{m_{n-1}=0}^{m_n} \cdots \sum_{m_2=0}^{m_3} \sum_{m_1=0}^{m_2} q^{m_1+m_2+\cdots+m_n} \\ &= q^n \prod_{i=1}^n \frac{1}{(1-q^i)} \\ &= \frac{q^n}{(1-q)} \prod_{i=2}^n \frac{1}{(1-q^i)} \end{aligned} \tag{517}$$

The multiplicity of  $V_{\Lambda=n+k}^{SL(2)} \otimes V_{[n]}^{(S_n)}$  is then the coefficient of  $q^k$  in the generating function

$$\prod_{i=2}^n \frac{1}{(1-q^i)} \tag{518}$$

As an example for  $n = 2$ , the multiplicity of  $V_{2+k}$  is the coefficient of  $q^k$  in  $\frac{1}{1-q^2}$ . This tells us that the symmetric irrep. of  $S_n$  only appears for  $k = 0, 2, 4, \dots$  with unit multiplicity.

Similarly, for  $\lambda = [1^n]$  we apply the antisymmetric projector to  $\mathcal{W}$  we have a basis in correspondence with  $(m_1, m_2, \dots, m_n)$  with  $m_1 < m_2 < \dots < m_n$ . So the character is

$$\begin{aligned} tr_{\mathcal{W}} (P_{[1^n]} q^{L_0}) &= q^n \sum_{m_n=n-1}^{\infty} \sum_{m_{n-1}=n-2}^{m_n-1} \cdots \sum_{m_2=1}^{m_3-1} \sum_{m_1=0}^{m_2-1} q^{m_1+m_2+\cdots+m_n} \\ &= q^n q^{\frac{n(n-1)}{2}} \prod_{i=1}^n \frac{1}{1-q^i} \\ &= \frac{q^n}{1-q} q^{\frac{n(n-1)}{2}} \prod_{i=2}^n \frac{1}{1-q^i} \end{aligned} \tag{519}$$

So the number of antisymmetric  $[1^n]$  irreps. of  $S_n$  in the multiplicity space of  $V_{n+k}$  is the coefficient of  $q^k$  in

$$\frac{q^{\frac{n(n-1)}{2}}}{(1-q^2) \cdots (1-q^n)} \tag{520}$$

This multiplicity is zero unless  $k \geq \frac{n(n-1)}{2}$ . This is as it should be because the antisymmetry condition means that we need  $X, \partial X, \dots, \partial^{n-1} X$  which has weight  $n + \frac{n(n-1)}{2}$ .

## F.2 The generating function for any $SL(2) \times S_n$ irreps

In fact it turns out we can write down a compact formula for the generating function for the multiplicities of  $V_{\Lambda=n+k} \otimes V_{\lambda}$  in  $\mathcal{W}$  for any  $\lambda$ . It is given by

$$(1-q) q^{\sum_{i=1}^b \frac{c_i(c_i-1)}{2}} \prod_b \frac{1}{(1-q^{h_b})} \tag{521}$$

The product runs over the boxes of the Young diagram of  $\lambda$  and  $h_b$  is the hook length of the box.  $c_i$  is the column length of the  $i$ 'th column. One can check that this agrees

with (518) and (520) for  $R = [n]$  and  $R = [1^n]$ .

A proof of this generating function, using  $q$ -dimensions of  $GL(\infty)$  can be found in Section 3.2.3 of [60].

## G $U(K)$ Clebsch-Gordan orthogonality proof

In Section 4.1.2 a  $U(K)$  Clebsch-Gordan coefficient was derived

$$C_{\Lambda, M, a}^{\vec{m}} = \frac{1}{n!} \sum_{\sigma \in S_n} B_{b\beta} D_{ab}^\Lambda(\sigma) \prod_{k=1}^n \delta_{m_k p_{\sigma^{-1}(k)}} \quad (522)$$

Here  $M = [\mu, \beta]$ . Canonically we choose  $p_1, \dots, p_{\mu_1} = 1, p_{\mu_1+1}, \dots, p_{\mu_1+\mu_2} = 2, \dots$

We want to prove the orthogonality relation in equation (60)

$$\sum_{\Lambda, \mu, \beta, a_\Lambda} \frac{n! d_\Lambda}{|H_\mu|} C_{\Lambda, M_\Lambda, a_\Lambda}^{\vec{m}} C_{\vec{m}'}^{\Lambda, M_\Lambda, a_\Lambda} = n! \delta_{m_1 m_1'} \cdots \delta_{m_n m_n'} \quad (523)$$

First note that the sum over a vector can be separated into its ‘field content’  $\mu$  and a permutation

$$\sum_{\vec{q}} (q_1, \dots, q_n) = \sum_{\mu} \sum_{\sigma \in S_n / H_\mu} (p_{\sigma(1)}^\mu, \dots, p_{\sigma(n)}^\mu) = \sum_{\mu} \frac{1}{|H_\mu|} \sum_{\sigma \in S_n} (p_{\sigma(1)}^\mu, \dots, p_{\sigma(n)}^\mu) \quad (524)$$

Then using the orthogonality of branching coefficients (53)

$$\begin{aligned} & \sum_M \frac{1}{|H_\mu|} C_{\Lambda, M_\Lambda, a_\Lambda}^{\vec{m}} C_{\vec{m}'}^{\Lambda, M_\Lambda, a_\Lambda'} \\ &= \sum_{\mu, \beta} \frac{1}{|H_\mu|} \frac{1}{(n!)^2} \sum_{\sigma, \sigma' \in S_n} B_{b\beta} B_{b'\beta} D_{ab}^\Lambda(\sigma) D_{a'b'}^\Lambda(\sigma') \prod_{k=1}^n \delta_{m_k p_{\sigma^{-1}(k)}} \delta_{m_k' p_{\sigma'^{-1}(k)}} \\ &= \sum_{\mu} \frac{1}{|H_\mu|} \frac{1}{(n!)^2} \sum_{\sigma, \sigma' \in S_n} \frac{1}{|H_\mu|} \sum_{h \in H_\mu} D_{aa'}^\Lambda(\sigma h \sigma'^{-1}) \prod_{k=1}^n \delta_{m_k p_{\sigma^{-1}(k)}} \delta_{m_k' p_{\sigma'^{-1}(k)}} \\ &= \sum_{\mu} \frac{1}{|H_\mu|} \frac{1}{(n!)^2} \sum_{\sigma', \rho \in S_n} D_{aa'}^\Lambda(\rho) \prod_{k=1}^n \delta_{m_k p_{\sigma'^{-1}\rho^{-1}(k)}} \delta_{m_k' p_{\sigma'^{-1}(k)}} \\ &= \sum_{\mu} \frac{1}{|H_\mu|} \frac{1}{(n!)^2} \sum_{\sigma', \rho \in S_n} D_{aa'}^\Lambda(\rho) \prod_{k=1}^n \delta_{m_{\rho(k)} p_{\sigma'^{-1}(k)}} \delta_{m_k' p_{\sigma'^{-1}(k)}} \\ &= \frac{1}{(n!)^2} \sum_{\rho \in S_n} D_{aa'}^\Lambda(\rho) \prod_{k=1}^n \delta_{m_{\rho(k)} m_k'} \end{aligned} \quad (525)$$

We have used invariance of  $p^\mu$  under  $H_\mu$ , substituted  $\sigma$  for  $\rho = \sigma \sigma'^{-1}$  and then used

(524). Finally

$$\begin{aligned} \sum_{\Lambda, \mu, \beta, a} \frac{n! d_\Lambda}{|H_\mu|} C_{\Lambda, M_\Lambda, a_\Lambda}^{\bar{m}} C_{\bar{m}'}^{\Lambda, M_\Lambda, a_\Lambda} &= \sum_{\Lambda} \frac{1}{n!} \sum_{\rho \in S_n} d_\Lambda \chi_\Lambda(\rho) \prod_{k=1}^n \delta_{m_{\rho(k)} m'_k} \\ &= \prod_{k=1}^n \delta_{m_k m'_k} \end{aligned} \quad (526)$$

## H Calculating branching coefficients

Here the branching coefficients of Section 4.1.2 are calculated.  $D_{ab}^\Lambda(\Gamma)$  projects onto a subspace of the  $S_n$  representation  $\Lambda$  with dimension  $g(\mu; \Lambda)$ ; this subspace is given by the rows/columns of the matrix  $D_{ab}^\Lambda(\Gamma)$ . We want to find the branching coefficients  $B_{a\beta}$  given by

$$D_{ab}^\Lambda(\Gamma) = \sum_{\beta} B_{a\beta} B_{b\beta} \quad (527)$$

We work out some examples below.

### H.1 Highest weight case

For the highest weight state with  $\mu = \Lambda$  (for which  $g(\mu; \Lambda) = 1$ ) Hamermesh's basis works such that

$$D_{ab}^\Lambda(\Gamma) = \delta_{a1} \delta_{b1} \quad (528)$$

Thus the subspace is spanned by a single vector  $B_a = \delta_{a1}$ , which satisfies all the appropriate properties.

### H.2 All fields different case

For  $\mu_1 = 1, \dots, \mu_K = 1$ , i.e. all the fields are different, then  $H = \text{id}$  and  $g(\mu; \Lambda) = d_\Lambda$

$$D_{ab}^\Lambda(\Gamma) = D_{ab}^\Lambda(\text{id}) = \delta_{ab} \quad (529)$$

The most obvious basis satisfying the correct properties is  $B_{a\beta} = \delta_{a\beta}$  (see XYZ example below).

### H.3 $\Lambda = [2, 1]$

$$\begin{aligned} \frac{1}{|H|} D^{\Lambda=[2,1], \mu=XXY}(\Gamma) &= \frac{1}{2} D^{[2,1]}((1)(2)(3) + (12)(3)) = \begin{pmatrix} 1 & 0 \\ 0 & 0 \end{pmatrix} = \begin{pmatrix} 1 \\ 0 \end{pmatrix} \begin{pmatrix} 1 & 0 \end{pmatrix} \\ \frac{1}{|H|} D^{\Lambda=[2,1], \mu=XYX}(\Gamma) &= \begin{pmatrix} \frac{1}{4} & \frac{\sqrt{3}}{4} \\ \frac{\sqrt{3}}{4} & \frac{3}{4} \end{pmatrix} = \begin{pmatrix} \frac{1}{2} \\ \frac{\sqrt{3}}{2} \end{pmatrix} \begin{pmatrix} \frac{1}{2} & \frac{\sqrt{3}}{2} \end{pmatrix} \end{aligned} \quad (530)$$



Note that for this last one the columns/rows of the matrix aren't independent (which concurs with the fact that  $g = 1$ ), so the subspace is spanned by the first column say.

$$\frac{1}{|H|} D^{\Lambda=[2,1], \mu=XYZ}(\Gamma) = \begin{pmatrix} 1 & 0 \\ 0 & 1 \end{pmatrix} = \begin{pmatrix} 1 \\ 0 \end{pmatrix} \begin{pmatrix} 1 & 0 \end{pmatrix} + \begin{pmatrix} 0 \\ 1 \end{pmatrix} \begin{pmatrix} 0 & 1 \end{pmatrix} \quad (531)$$

#### H.4 $\Lambda = [3, 1]$

$$\begin{aligned} \frac{1}{|H|} D^{\Lambda=[3,1], \mu=XXXY}(\Gamma) &= \begin{pmatrix} 1 & 0 & 0 \\ 0 & 0 & 0 \\ 0 & 0 & 0 \end{pmatrix} = \begin{pmatrix} 1 \\ 0 \\ 0 \end{pmatrix} \begin{pmatrix} 1 & 0 & 0 \end{pmatrix} \\ \frac{1}{|H|} D^{\Lambda=[3,1], \mu=XXYY}(\Gamma) &= \begin{pmatrix} \frac{1}{3} & \frac{\sqrt{2}}{3} & 0 \\ \frac{\sqrt{2}}{3} & \frac{2}{3} & 0 \\ 0 & 0 & 0 \end{pmatrix} = \begin{pmatrix} \frac{1}{\sqrt{3}} \\ \frac{\sqrt{2}}{\sqrt{3}} \\ 0 \end{pmatrix} \begin{pmatrix} \frac{1}{\sqrt{3}} & \frac{\sqrt{2}}{\sqrt{3}} & 0 \end{pmatrix} \end{aligned} \quad (532)$$

$$\frac{1}{|H|} D^{\Lambda=[3,1], \mu=XYYY}(\Gamma) = \begin{pmatrix} \frac{1}{9} & \frac{\sqrt{2}}{9} & \frac{\sqrt{6}}{9} \\ \frac{\sqrt{2}}{9} & \frac{2}{9} & \frac{2\sqrt{3}}{9} \\ \frac{\sqrt{6}}{9} & \frac{2\sqrt{3}}{9} & \frac{2}{3} \end{pmatrix} = \begin{pmatrix} \frac{1}{3} \\ \frac{\sqrt{2}}{3} \\ \frac{\sqrt{2}}{\sqrt{3}} \end{pmatrix} \begin{pmatrix} \frac{1}{3} & \frac{\sqrt{2}}{3} & \frac{\sqrt{2}}{\sqrt{3}} \end{pmatrix} \quad (533)$$

$$\begin{aligned} \frac{1}{|H|} D^{\Lambda=[3,1], \mu=XYYZ}(\Gamma) &= \begin{pmatrix} 1 & 0 & 0 \\ 0 & \frac{1}{4} & \frac{\sqrt{3}}{4} \\ 0 & \frac{\sqrt{3}}{4} & \frac{3}{4} \end{pmatrix} = \begin{pmatrix} 1 \\ 0 \\ 0 \end{pmatrix} \begin{pmatrix} 1 & 0 & 0 \end{pmatrix} + \begin{pmatrix} 0 \\ \frac{1}{2} \\ \frac{\sqrt{3}}{2} \end{pmatrix} \begin{pmatrix} 0 & \frac{1}{2} & \frac{\sqrt{3}}{2} \end{pmatrix} \\ \frac{1}{|H|} D^{\Lambda=[3,1], \mu=XYZZ}(\Gamma) &= \begin{pmatrix} \frac{1}{3} & \frac{\sqrt{2}}{3} & 0 \\ \frac{\sqrt{2}}{3} & \frac{2}{3} & 0 \\ 0 & 0 & 1 \end{pmatrix} = \begin{pmatrix} 0 \\ 0 \\ 1 \end{pmatrix} \begin{pmatrix} 0 & 0 & 1 \end{pmatrix} + \begin{pmatrix} \frac{1}{\sqrt{3}} \\ \frac{\sqrt{2}}{\sqrt{3}} \\ 0 \end{pmatrix} \begin{pmatrix} \frac{1}{\sqrt{3}} & \frac{\sqrt{2}}{\sqrt{3}} & 0 \end{pmatrix} \end{aligned}$$

## I Action on hook basis in detail

The orthogonal basis of  $A_h^\dagger$  which we used in Section 4.4 has the property that  $S_n$  acts on it via the standard Young-Yamanouchi orthogonal basis of the  $[n-1, 1]$  hook representation (as given for example in [102]). If  $s_i = (i, i+1)$  are the 2-cycle permutations that generate  $S_n$  then we have

$$\begin{aligned} s_i A_h^\dagger &= A_h^\dagger \quad \text{for } i \leq h-1 \text{ and } i \geq h+2 \\ s_h A_h^\dagger &= \frac{\sqrt{(h-1)(h+1)}}{h} A_{h-1}^\dagger - \frac{1}{h} A_h^\dagger \\ s_{h+1} A_h^\dagger &= \frac{1}{h+1} A_h^\dagger + \frac{\sqrt{h(h+2)}}{h+1} A_{h+1}^\dagger \end{aligned} \quad (534)$$

We can identify the representation of  $S_n$  formed by the  $A_h^\dagger$  using general arguments.

It is easy to see that there is no invariant vector under  $S_n$ , and that there is one invariant vector under  $S_{n-1}$  (namely  $A_{n-1}^\dagger$ ). The only irreducible representations of  $S_n$  which contain the invariant of  $S_{n-1}$  are  $[n]$  and  $[n-1, 1]$ . Having ruled out the symmetric irrep.  $[n]$ , the  $(n-1)$  dimensional representation formed by the  $A_h^\dagger$  can only be the irreducible  $[n-1, 1]$ . More directly we can use the construction of the orthogonal representing matrices given in [102], which uses branching arguments.

## J Code

Code written to calculate the various multiplicities discussed here is available under the GNU General Public Licence at <http://www.nworbmot.org/code/>. It is written in python for use with the SAGE open source computer algebra system. All  $U(2)$  correlators at tree level and one loop can also be checked with the correlator program released on the same site.

## References

- [1] K. G. Wilson, "Confinement of Quarks," *Phys. Rev. D* **10** (1974) 2445.
- [2] G. 't Hooft, "A planar diagram theory for strong interactions," *Nucl. Phys. B* **72** (1974) 461.
- [3] D. J. Gross, "Two-dimensional QCD as a string theory," *Nucl. Phys. B* **400** (1993) 161 [arXiv:hep-th/9212149].
- [4] D. J. Gross and W. Taylor, "Two-dimensional QCD is a string theory," *Nucl. Phys. B* **400** (1993) 181 [arXiv:hep-th/9301068].
- [5] S. Cordes, G. W. Moore and S. Ramgoolam, "Lectures On 2-D Yang-Mills Theory, Equivariant Cohomology And Topological Field Theories," *Nucl. Phys. Proc. Suppl.* **41** (1995) 184 [arXiv:hep-th/9411210].
- [6] J. Polchinski, "Dirichlet-Branes and Ramond-Ramond Charges," *Phys. Rev. Lett.* **75** (1995) 4724 [arXiv:hep-th/9510017].
- [7] T. Banks, W. Fischler, S. H. Shenker and L. Susskind, "M theory as a matrix model: A conjecture," *Phys. Rev. D* **55** (1997) 5112 [arXiv:hep-th/9610043].
- [8] R. Dijkgraaf, E. P. Verlinde and H. L. Verlinde, "Matrix string theory," *Nucl. Phys. B* **500** (1997) 43 [arXiv:hep-th/9703030].
- [9] N. Ishibashi, H. Kawai, Y. Kitazawa and A. Tsuchiya, "A large-N reduced model as superstring," *Nucl. Phys. B* **498** (1997) 467 [arXiv:hep-th/9612115].
- [10] D. A. Lowe, "Heterotic matrix string theory," *Phys. Lett. B* **403** (1997) 243 [arXiv:hep-th/9704041].

- [11] A. Strominger and C. Vafa, “Microscopic Origin of the Bekenstein-Hawking Entropy,” *Phys. Lett. B* **379** (1996) 99 [arXiv:hep-th/9601029].
- [12] J. M. Maldacena, “The large N limit of superconformal field theories and supergravity,” *Adv. Theor. Math. Phys.* **2** (1998) 231 [*Int. J. Theor. Phys.* **38** (1999) 1113] [arXiv:hep-th/9711200].
- [13] S. S. Gubser, I. R. Klebanov and A. M. Polyakov, “Gauge theory correlators from non-critical string theory,” *Phys. Lett. B* **428** (1998) 105 [arXiv:hep-th/9802109].
- [14] E. Witten, “Anti-de Sitter space and holography,” *Adv. Theor. Math. Phys.* **2** (1998) 253 [arXiv:hep-th/9802150].
- [15] G. 't Hooft, “Dimensional reduction in quantum gravity,” arXiv:gr-qc/9310026.
- [16] L. Susskind, “The World As A Hologram,” *J. Math. Phys.* **36** (1995) 6377 [arXiv:hep-th/9409089].
- [17] L. Susskind and E. Witten, “The holographic bound in anti-de Sitter space,” arXiv:hep-th/9805114.
- [18] P. Haggi-Mani and B. Sundborg, “Free large N supersymmetric Yang-Mills theory as a string theory,” *JHEP* **0004** (2000) 031 [arXiv:hep-th/0002189].
- [19] S. Corley, A. Jevicki and S. Ramgoolam, “Exact correlators of giant gravitons from dual N = 4 SYM theory,” *Adv. Theor. Math. Phys.* **5** (2002) 809 [arXiv:hep-th/0111222].
- [20] R. Grimm, M. Sohnius and J. Wess, “Extended Supersymmetry And Gauge Theories,” *Nucl. Phys. B* **133** (1978) 275.
- [21] V. K. Dobrev and V. B. Petkova, “All Positive Energy Unitary Irreducible Representations Of Extended Conformal Supersymmetry,” *Phys. Lett. B* **162** (1985) 127.
- [22] M. Bianchi, F. A. Dolan, P. J. Heslop and H. Osborn, “N = 4 superconformal characters and partition functions,” *Nucl. Phys. B* **767** (2007) 163 [arXiv:hep-th/0609179].
- [23] D. E. Berenstein, J. M. Maldacena and H. S. Nastase, “Strings in flat space and pp waves from N = 4 super Yang Mills,” *JHEP* **0204** (2002) 013 [arXiv:hep-th/0202021].
- [24] J. A. Minahan and K. Zarembo, “The Bethe-ansatz for N = 4 super Yang-Mills,” *JHEP* **0303** (2003) 013 [arXiv:hep-th/0212208].
- [25] N. Beisert and M. Staudacher, “The N=4 SYM Integrable Super Spin Chain,” *Nucl. Phys. B* **670** (2003) 439 [arXiv:hep-th/0307042].

- [26] P. G. O. Freund and M. A. Rubin, “Dynamics Of Dimensional Reduction,” *Phys. Lett. B* **97** (1980) 233.
- [27] T. Eguchi and H. Kawai, “Reduction Of Dynamical Degrees Of Freedom In The Large N Gauge Theory,” *Phys. Rev. Lett.* **48** (1982) 1063.
- [28] B. Sundborg, “Stringy gravity, interacting tensionless strings and massless higher spins,” *Nucl. Phys. Proc. Suppl.* **102** (2001) 113 [arXiv:hep-th/0103247].
- [29] E. Sezgin and P. Sundell, “Massless higher spins and holography,” *Nucl. Phys. B* **644** (2002) 303 [Erratum-ibid. B **660** (2003) 403] [arXiv:hep-th/0205131].
- [30] M. Bianchi, J. F. Morales and H. Samtleben, “On stringy AdS(5) x S\*\*5 and higher spin holography,” *JHEP* **0307** (2003) 062 [arXiv:hep-th/0305052].
- [31] M. Bianchi, P. J. Heslop and F. Riccioni, “More on la grande bouffe,” *JHEP* **0508** (2005) 088 [arXiv:hep-th/0504156].
- [32] N. Berkovits, “Perturbative Super-Yang-Mills from the Topological  $AdS_5 \times S^5$  Sigma Model,” *JHEP* **0809** (2008) 088 [arXiv:0806.1960 [hep-th]].
- [33] N. Berkovits, “Simplifying and Extending the  $AdS_5 \times S^5$  Pure Spinor Formalism,” arXiv:0812.5074 [hep-th].
- [34] V. Mitev, T. Quella and V. Schomerus, “Principal Chiral Model on Superspheres,” *JHEP* **0811** (2008) 086 [arXiv:0809.1046 [hep-th]].
- [35] R. Gopakumar, “From free fields to AdS. III,” *Phys. Rev. D* **72** (2005) 066008 [arXiv:hep-th/0504229].
- [36] E. D’Hoker, D. Z. Freedman and W. Skiba, “Field theory tests for correlators in the AdS/CFT correspondence,” *Phys. Rev. D* **59** (1999) 045008 [arXiv:hep-th/9807098].
- [37] S. Lee, S. Minwalla, M. Rangamani and N. Seiberg, “Three-point functions of chiral operators in D = 4, N = 4 SYM at large N,” *Adv. Theor. Math. Phys.* **2** (1998) 697 [arXiv:hep-th/9806074].
- [38] B. U. Eden, P. S. Howe, A. Pickering, E. Sokatchev and P. C. West, “Four-point functions in N = 2 superconformal field theories,” *Nucl. Phys. B* **581** (2000) 523 [arXiv:hep-th/0001138].
- [39] B. U. Eden, P. S. Howe, E. Sokatchev and P. C. West, “Extremal and next-to-extremal n-point correlators in four-dimensional SCFT,” *Phys. Lett. B* **494** (2000) 141 [arXiv:hep-th/0004102].
- [40] J. M. Maldacena and A. Strominger, “AdS(3) black holes and a stringy exclusion principle,” *JHEP* **9812** (1998) 005 [arXiv:hep-th/9804085].

- [41] A. Jevicki and S. Ramgoolam, “Non-commutative gravity from the AdS/CFT correspondence,” *JHEP* **9904** (1999) 032 [arXiv:hep-th/9902059].
- [42] P. M. Ho, S. Ramgoolam and R. Tatar, “Quantum spacetimes and finite  $N$  effects in 4D super Yang-Mills theories,” *Nucl. Phys. B* **573** (2000) 364 [arXiv:hep-th/9907145].
- [43] J. McGreevy, L. Susskind and N. Toumbas, “Invasion of the giant gravitons from anti-de Sitter space,” *JHEP* **0006** (2000) 008 [arXiv:hep-th/0003075].
- [44] R. C. Myers, “Nonabelian phenomena on D-branes,” *Class. Quant. Grav.* **20** (2003) S347 [arXiv:hep-th/0303072].
- [45] M. T. Grisaru, R. C. Myers and O. Tafjord, “SUSY and Goliath,” *JHEP* **0008** (2000) 040 [arXiv:hep-th/0008015].
- [46] A. Hashimoto, S. Hirano and N. Izhaki, “Large branes in AdS and their field theory dual,” *JHEP* **0008** (2000) 051 [arXiv:hep-th/0008016].
- [47] V. Balasubramanian, M. Berkooz, A. Naqvi and M. J. Strassler, “Giant gravitons in conformal field theory,” *JHEP* **0204** (2002) 034 [arXiv:hep-th/0107119].
- [48] S. Corley and S. Ramgoolam, “Finite factorization equations and sum rules for BPS correlators in  $N = 4$  SYM theory,” *Nucl. Phys. B* **641** (2002) 131 [arXiv:hep-th/0205221].
- [49] D. Berenstein, “A toy model for the AdS/CFT correspondence,” *JHEP* **0407** (2004) 018 [arXiv:hep-th/0403110].
- [50] H. Lin, O. Lunin and J. M. Maldacena, “Bubbling AdS space and 1/2 BPS geometries,” *JHEP* **0410** (2004) 025 [arXiv:hep-th/0409174].
- [51] V. Balasubramanian, J. de Boer, V. Jejjala and J. Simon, “The library of Babel: On the origin of gravitational thermodynamics,” *JHEP* **0512** (2005) 006 [arXiv:hep-th/0508023].
- [52] J. Kinney, J. M. Maldacena, S. Minwalla and S. Raju, “An index for 4 dimensional super conformal theories,” *Commun. Math. Phys.* **275** (2007) 209 [arXiv:hep-th/0510251].
- [53] J. B. Gutowski and H. S. Reall, “General supersymmetric AdS(5) black holes,” *JHEP* **0404** (2004) 048 [arXiv:hep-th/0401129].
- [54] H. K. Kunduri, J. Lucietti and H. S. Reall, “Supersymmetric multi-charge AdS(5) black holes,” *JHEP* **0604** (2006) 036 [arXiv:hep-th/0601156].
- [55] R. A. Janik and M. Trzetrzelewski, “Supergravitons from one loop perturbative  $N=4$  SYM,” *Phys. Rev. D* **77** (2008) 085024 [arXiv:0712.2714 [hep-th]].

- [56] L. Grant, P. A. Grassi, S. Kim and S. Minwalla, “Comments on 1/16 BPS Quantum States and Classical Configurations,” JHEP **0805** (2008) 049 [arXiv:0803.4183 [hep-th]].
- [57] M. Berkooz and D. Reichmann, “Weakly Renormalized Near 1/16 SUSY Fermi Liquid Operators in  $N = 4$  SYM,” JHEP **0810** (2008) 084 [arXiv:0807.0559 [hep-th]].
- [58] S. Ramgoolam, “On spherical harmonics for fuzzy spheres in diverse dimensions,” Nucl. Phys. B **610** (2001) 461 [arXiv:hep-th/0105006].
- [59] T. W. Brown, P. J. Heslop and S. Ramgoolam, “Diagonal multi-matrix correlators and BPS operators in  $N=4$  SYM,” JHEP **0802** (2008) 030 [arXiv:0711.0176 [hep-th]].
- [60] T. W. Brown, P. J. Heslop and S. Ramgoolam, “Diagonal free field matrix correlators, global symmetries and giant gravitons,” JHEP **0904** (2009) 089 [arXiv:0806.1911 [hep-th]].
- [61] T. W. Brown, P. J. Heslop and S. Ramgoolam, to be published.
- [62] T. W. Brown, “Permutations and the Loop,” JHEP **0806** (2008) 008 [arXiv:0801.2094 [hep-th]].
- [63] T. W. Brown, R. de Mello Koch, S. Ramgoolam and N. Toumbas, “Correlators, probabilities and topologies in  $N = 4$  SYM,” JHEP **0703** (2007) 072 [arXiv:hep-th/0611290].
- [64] T. W. Brown, “Half-BPS  $SU(N)$  correlators in  $N = 4$  SYM,” JHEP **0807** (2008) 044 [arXiv:hep-th/0703202].
- [65] Y. Kimura and S. Ramgoolam, “Branes, Anti-Branes and Brauer Algebras in Gauge-Gravity duality,” JHEP **0711** (2007) 078 [arXiv:0709.2158 [hep-th]].
- [66] L.J. Somers, “Analysis of the outer product for the symmetric group,” Journal of Mathematical Physics, Volume 24, Issue 4, April 1983, pp.772-778.
- [67] O. Aharony, J. Marsano, S. Minwalla, K. Papadodimas and M. Van Raamsdonk, “The Hagedorn / deconfinement phase transition in weakly coupled large  $N$  gauge theories,” Adv. Theor. Math. Phys. **8** (2004) 603 [arXiv:hep-th/0310285].
- [68] S. Dutta and R. Gopakumar, “Free Fermions and Thermal AdS/CFT,” JHEP **0803** (2008) 011 [arXiv:0711.0133 [hep-th]].
- [69] F. A. Dolan, “Counting BPS operators in  $N=4$  SYM,” Nucl. Phys. B **790** (2008) 432 [arXiv:0704.1038 [hep-th]].

- [70] B. Sundborg, “The Hagedorn Transition, Deconfinement and N=4 SYM Theory,” Nucl. Phys. B **573** (2000) 349 [arXiv:hep-th/9908001].
- [71] L. F. Alday, J. R. David, E. Gava and K. S. Narain, “Towards a string bit formulation of N = 4 super Yang-Mills,” JHEP **0604** (2006) 014 [arXiv:hep-th/0510264].
- [72] I. Bars, B. Morel and H. Ruegg, “Kac-Dynkin Diagrams And Supertableaux,” J. Math. Phys. **24** (1983) 2253.
- [73] W. Fulton and J. Harris, “Representation Theory: A First Course,” Springer, 1991.
- [74] C. Grood, “Brauer algebras and Centralizer algebras for  $SO(2n, \mathbb{C})$ ,” Journal of Algebra **222**, 678-707 (1999).
- [75] N. Beisert, “The complete one-loop dilatation operator of N = 4 super Yang-Mills theory,” Nucl. Phys. B **676** (2004) 3 [arXiv:hep-th/0307015].
- [76] N. Beisert, M. Bianchi, J. F. Morales and H. Samtleben, “Higher spin symmetry and N = 4 SYM,” JHEP **0407** (2004) 058 [arXiv:hep-th/0405057].
- [77] S. E. Konstein, M. A. Vasiliev and V. N. Zaikin, “Conformal higher spin currents in any dimension and AdS/CFT correspondence,” JHEP **0012** (2000) 018 [arXiv:hep-th/0010239].
- [78] P. H. Ginsparg, “Applied Conformal Field Theory,” arXiv:hep-th/9108028.
- [79] J. Polchinski, “String theory. Vol. 1: An introduction to the bosonic string,” CUP (1998).
- [80] Koike and Terada, “Young Diagrammatic methods for the representation theory of the classical groups of type  $B_n, C_n, D_n$ ,” Jour. of Algebra. **107**, 466.
- [81] T. Halverson, “Characters of the centralizer algebras of mixed tensor representations of  $GL(r, \mathbb{C})$  and the quantum group  $U_q(GL(r, \mathbb{C}))$ ,” Pacific Journal of Mathematics, Vol. 174, No. 2 , 1996.
- [82] Y. Takayama and A. Tsuchiya, “Complex matrix model and fermion phase space for bubbling AdS geometries,” JHEP **0510** (2005) 004 [arXiv:hep-th/0507070].
- [83] A. Donos, A. Jevicki and J. P. Rodrigues, “Matrix Model Maps in AdS/CFT,” Phys. Rev. D **72** (2005) 125009 [arXiv:hep-th/0507124].
- [84] D. Berenstein, “Large N BPS states and emergent quantum gravity,” JHEP **0601** (2006) 125 [arXiv:hep-th/0507203].
- [85] Y. Kimura and S. Ramgoolam, “Enhanced symmetries of gauge theory and resolving the spectrum of local operators,” Phys. Rev. D **78** (2008) 126003 [arXiv:0807.3696 [hep-th]].

- [86] S. R. Das, A. Jevicki and S. D. Mathur, “Vibration modes of giant gravitons,” *Phys. Rev. D* **63** (2001) 024013 [arXiv:hep-th/0009019].
- [87] S. S. Gubser, I. R. Klebanov and A. M. Polyakov, “A semi-classical limit of the gauge/string correspondence,” *Nucl. Phys. B* **636** (2002) 99 [arXiv:hep-th/0204051].
- [88] V. Balasubramanian, M. x. Huang, T. S. Levi and A. Naqvi, “Open strings from  $N = 4$  super Yang-Mills,” *JHEP* **0208** (2002) 037 [arXiv:hep-th/0204196].
- [89] B. . J. Stefanski and A. A. Tseytlin, “Large spin limits of AdS/CFT and generalized Landau-Lifshitz equations,” *JHEP* **0405** (2004) 042 [arXiv:hep-th/0404133].
- [90] V. Balasubramanian, D. Berenstein, B. Feng and M. x. Huang, “D-branes in Yang-Mills theory and emergent gauge symmetry,” *JHEP* **0503** (2005) 006 [arXiv:hep-th/0411205].
- [91] R. de Mello Koch, J. Smolic and M. Smolic, “Giant Gravitons - with Strings Attached (I),” *JHEP* **0706** (2007) 074 [arXiv:hep-th/0701066].
- [92] R. de Mello Koch, J. Smolic and M. Smolic, “Giant Gravitons - with Strings Attached (II),” *JHEP* **0709** (2007) 049 [arXiv:hep-th/0701067].
- [93] D. Bekker, R. de Mello Koch and M. Stephanou, “Giant Gravitons - with Strings Attached (III),” *JHEP* **0802** (2008) 029 [arXiv:0710.5372 [hep-th]].
- [94] I. Biswas, D. Gaiotto, S. Lahiri and S. Minwalla, “Supersymmetric states of  $N = 4$  Yang-Mills from giant gravitons,” *JHEP* **0712** (2007) 006 [arXiv:hep-th/0606087].
- [95] G. Mandal and N. V. Suryanarayana, “Counting 1/8-BPS dual-giants,” *JHEP* **0703** (2007) 031 [arXiv:hep-th/0606088].
- [96] M. M. Caldarelli and P. J. Silva, “Multi giant graviton systems, SUSY breaking and CFT,” *JHEP* **0402** (2004) 052 [arXiv:hep-th/0401213].
- [97] M. Berkooz, D. Reichmann and J. Simon, “A Fermi surface model for large supersymmetric AdS(5) black holes,” *JHEP* **0701** (2007) 048 [arXiv:hep-th/0604023].
- [98] N. R. Constable, D. Z. Freedman, M. Headrick, S. Minwalla, L. Motl, A. Postnikov and W. Skiba, “PP-wave string interactions from perturbative Yang-Mills theory,” *JHEP* **0207** (2002) 017 [arXiv:hep-th/0205089].
- [99] N. Beisert, C. Kristjansen, J. Plefka, G. W. Semenoff and M. Staudacher, “BMN correlators and operator mixing in  $N = 4$  super Yang-Mills theory,” *Nucl. Phys. B* **650** (2003) 125 [arXiv:hep-th/0208178].
- [100] D. J. Gross, A. Mikhailov and R. Roiban, “A calculation of the plane wave string Hamiltonian from  $N = 4$  super-Yang-Mills theory,” *JHEP* **0305** (2003) 025 [arXiv:hep-th/0208231].



- [101] R. A. Janik, “BMN operators and string field theory,” *Phys. Lett. B* **549** (2002) 237 [arXiv:hep-th/0209263].
- [102] M. Hamermesh, “Group Theory and its Applications to Physical Problems,” Addison-Wesley Publishing Company, 1962.
- [103] T. Yamanouchi, *Proc. Phys. Math. Soc. Japan* **19** (1937) 436.
- [104] N. Beisert, C. Kristjansen, J. Plefka and M. Staudacher, “BMN gauge theory as a quantum mechanical system,” *Phys. Lett. B* **558** (2003) 229 [arXiv:hep-th/0212269].
- [105] N. Beisert, C. Kristjansen and M. Staudacher, “The dilatation operator of  $N = 4$  super Yang-Mills theory,” *Nucl. Phys. B* **664** (2003) 131 [arXiv:hep-th/0303060].
- [106] S. Bellucci, P. Y. Casteill, J. F. Morales and C. Sochichiu, “Spin bit models from non-planar  $N = 4$  SYM,” *Nucl. Phys. B* **699** (2004) 151 [arXiv:hep-th/0404066].
- [107] G. Arutyunov and S. Frolov, “On the correspondence between gravity fields and CFT operators,” *JHEP* **0004** (2000) 017 [arXiv:hep-th/0003038].
- [108] G. Arutyunov, S. Penati, A. C. Petkou, A. Santambrogio and E. Sokatchev, “Non-protected operators in  $N = 4$  SYM and multiparticle states of AdS(5) SUGRA,” *Nucl. Phys. B* **643** (2002) 49 [arXiv:hep-th/0206020].
- [109] S. Mukohyama, “Non-locality as an essential feature of brane worlds,” *Prog. Theor. Phys. Suppl.* **148** (2003) 121 [arXiv:hep-th/0205231].
- [110] N. R. Constable, D. Z. Freedman, M. Headrick and S. Minwalla, “Operator mixing and the BMN correspondence,” *JHEP* **0210** (2002) 068 [arXiv:hep-th/0209002].
- [111] A. V. Ryzhov, “Quarter BPS operators in  $N = 4$  SYM,” *JHEP* **0111** (2001) 046 [arXiv:hep-th/0109064].
- [112] E. D’Hoker, P. Heslop, P. Howe and A. V. Ryzhov, “Systematics of quarter BPS operators in  $N = 4$  SYM,” *JHEP* **0304** (2003) 038 [arXiv:hep-th/0301104].
- [113] R. de Mello Koch and R. Gwyn, “Giant graviton correlators from dual  $SU(N)$  super Yang-Mills theory,” *JHEP* **0411** (2004) 081 [arXiv:hep-th/0410236].
- [114] N. Beisert, “The  $su(2-3)$  dynamic spin chain,” *Nucl. Phys. B* **682** (2004) 487 [arXiv:hep-th/0310252].
- [115] R. Bhattacharyya, S. Collins and R. d. M. Koch, “Exact Multi-Matrix Correlators,” *JHEP* **0803** (2008) 044 [arXiv:0801.2061 [hep-th]].
- [116] S. Collins, “Restricted Schur Polynomials and Finite  $N$  Counting,” *Phys. Rev. D* **79** (2009) 026002 [arXiv:0810.4217 [hep-th]].

- [117] A. Mikhailov, “Giant gravitons from holomorphic surfaces,” JHEP **0011** (2000) 027 [arXiv:hep-th/0010206].
- [118] C. E. Beasley, “BPS branes from baryons,” JHEP **0211** (2002) 015 [arXiv:hep-th/0207125].
- [119] P. J. Heslop and P. S. Howe, “OPEs and 3-point correlators of protected operators in  $N = 4$  SYM,” Nucl. Phys. B **626** (2002) 265 [arXiv:hep-th/0107212].
- [120] P. J. Heslop and P. S. Howe, “Aspects of  $N = 4$  SYM,” JHEP **0401** (2004) 058 [arXiv:hep-th/0307210].
- [121] E. Gava, G. Milanesi, K. S. Narain and M. O’Loughlin, “1/8 BPS states in AdS/CFT,” JHEP **0705** (2007) 030 [arXiv:hep-th/0611065].
- [122] B. Chen *et al.*, “Bubbling AdS and droplet descriptions of BPS geometries in IIB supergravity,” JHEP **0710** (2007) 003 [arXiv:0704.2233 [hep-th]].
- [123] K. Skenderis and M. Taylor, “Anatomy of bubbling solutions,” JHEP **0709** (2007) 019 [arXiv:0706.0216 [hep-th]].
- [124] D. Berenstein, D. H. Correa and S. E. Vazquez, “A study of open strings ending on giant gravitons, spin chains and integrability,” JHEP **0609** (2006) 065 [arXiv:hep-th/0604123].
- [125] S. Benvenuti, B. Feng, A. Hanany and Y. H. He, “Counting BPS operators in gauge theories: Quivers, syzygies and plethystics,” JHEP **0711** (2007) 050 [arXiv:hep-th/0608050].
- [126] B. Feng, A. Hanany and Y. H. He, “Counting Gauge Invariants: the Plethystic Program,” JHEP **0703** (2007) 090 [arXiv:hep-th/0701063].
- [127] H. Osborn, “Implications of conformal invariance for quantum field theories in  $d \geq 2$ ,” arXiv:hep-th/9312176.
- [128] H. Sonoda, “Sewing Conformal Field Theories,” Nucl. Phys. B **311** (1988) 401.
- [129] H. Sonoda, “Sewing Conformal Field Theories 2,” Nucl. Phys. B **311** (1988) 417.
- [130] K. Osterwalder and R. Schrader, “Axioms for Euclidean Green’s Functions,” Commun. Math. Phys. **31** (1973) 83.
- [131] J. Polchinski, L. Susskind and N. Toumbas, “Negative energy, superluminality and holography,” Phys. Rev. D **60** (1999) 084006 [arXiv:hep-th/9903228].
- [132] L. Susskind, “Holography in the flat space limit,” arXiv:hep-th/9901079.
- [133] S. Fernando and F. Mansouri, “Black holes and super black holes as Chern Simons theories in 2+1 dimensions,” arXiv:hep-th/9901066.

- [134] S. B. Giddings, “The boundary S-matrix and the AdS to CFT dictionary,” *Phys. Rev. Lett.* **83** (1999) 2707 [arXiv:hep-th/9903048].
- [135] E. Witten, “On the Structure of the Topological Phase of Two-Dimensional Gravity,” *Nucl. Phys. B* **340** (1990) 281.
- [136] R. Dijkgraaf, “Fields, strings and duality,” arXiv:hep-th/9703136.
- [137] N. D. Birrell and P. C. W. Davies, “Quantum Fields In Curved Space,” CUP (1982).
- [138] V. Balasubramanian, V. Jejjala and J. Simon, “The library of Babel,” *Int. J. Mod. Phys. D* **14** (2005) 2181 [arXiv:hep-th/0505123].
- [139] D. Z. Freedman, S. D. Mathur, A. Matusis and L. Rastelli, “Correlation functions in the CFT( $d$ )/AdS( $d + 1$ ) correspondence,” *Nucl. Phys. B* **546** (1999) 96 [arXiv:hep-th/9804058].
- [140] E. Witten, “Anti-de Sitter space, thermal phase transition, and confinement in gauge theories,” *Adv. Theor. Math. Phys.* **2** (1998) 505 [arXiv:hep-th/9803131].
- [141] M. Flato, C. Fronsdal and D. Sternheimer, “Singleton physics,” arXiv:hep-th/9901043.
- [142] O. Aharony, Y. E. Antebi, M. Berkooz and R. Fishman, “‘Holey sheets’: Pfaffians and subdeterminants as D-brane operators in large N gauge theories,” *JHEP* **0212** (2002) 069 [arXiv:hep-th/0211152].
- [143] A. O. Barut and R. Raczka, “Theory Of Group Representations And Applications,” *Singapore: World Scientific (1986)*.
- [144] V. Balasubramanian, B. Czech, K. Larjo and J. Simon, “Integrability vs. information loss: A simple example,” *JHEP* **0611** (2006) 001 [arXiv:hep-th/0602263].
- [145] R. de Mello Koch, A. Jevicki and J. P. Rodrigues, “Collective string field theory of matrix models in the BMN limit,” *Int. J. Mod. Phys. A* **19** (2004) 1747 [arXiv:hep-th/0209155].
- [146] N. Iizuka and J. Polchinski, “A Matrix Model for Black Hole Thermalization,” *JHEP* **0810** (2008) 028 [arXiv:0801.3657 [hep-th]].
- [147] N. Iizuka, T. Okuda and J. Polchinski, “Matrix Models for the Black Hole Information Paradox,” arXiv:0808.0530 [hep-th].
- [148] S. Gukov and E. Witten, “Gauge theory, ramification, and the geometric langlands program,” arXiv:hep-th/0612073.

- [149] W. Wu and Q. Zhang, "The Orthogonal and the Natural Representation for Symmetric Groups," *Int. Journal of Quantum Chemistry* **50** (1994) 55-67.
- [150] H. Elvang, P. Cvitanovic and A. D. Kennedy, "Diagrammatic Young Projection Operators for  $U(n)$ ," arXiv:hep-th/0307186.