

ReM-AM: Reflective Middleware for Acoustic Management in Intelligent Environments

Gabriela Santiago¹, Jose Aguilar^{1,2,*}, Danilo Chávez²

¹CEMISID, Dpto. de Computación, Facultad de Ingeniería, Universidad de Los Andes, Mérida – Venezuela

²Escuela Politécnica Nacional, Quito, Ecuador

gabrielas@ula.ve, aguilar@ula.ve, danilo.chavez@epn.edu.ec

*Prometeo researcher, Escuela Politécnica Nacional, Universidad Técnica Particular de Loja, Ecuador

Abstract—This paper presents the architecture of a Reflective Middleware for Acoustic Management that will improve the interaction between users and agents in Intelligent Environments, using the Multiagent System paradigm. The middleware manages the acoustic services, from the identification and recognition of the acoustic signals, until the interpretation, processing and analysis of them. In this paper are detailed the architecture bases, the middleware components, and case studies where this Middleware can be used. Acoustic signals and vibrations will generate the connection between agents, but it will also include the sounds that are provided by the users of the Intelligent Environment, making it an interactive and immersive experience.

Index Terms—Acoustic Management, Intelligent Environment, Reflective Middleware, Multiagent System

I. INTRODUCTION

AN Intelligent Environment (AmI) uses computational technology in order to operate automatically, improving the experience of the user in terms of comfort, safety and efficiency [1]. The automation integrates multiple factors that interact with each other, and in this work the proposal is that all these factors be modeled using Multiagent Systems (MAS) connected with acoustic elements, as sound frequencies and vibrations.

We extend the AmICL architecture with acoustic software and hardware components. AmICL is a reflective Middleware based in Cloud Learning, for Intelligent Learning Environments [4, 21]. The middleware is defined using MAS, and propose academic services on the cloud based on the current context. Our extension allows observing, modifying and interacting in every state of the AmI from the acoustics.

The architecture bases are proposed considering the unpredictable situations with sounds and vibrations in an AmI, in order to propose the specification of the Reflective Middleware for Acoustic Management (ReM-AM), for the recognition of acoustic signals, going through processing, analyzing and responding.

The case studies include the Smart Classroom (SaCI) [2, 24], mainly for noise reduction, speech intelligibility and hearing aid for disabled students; the Ambient Assisted Living (AAL) [3], for anticipating the needs of older and disabled people and providing assistance while maintaining their safety and comfort at home; the smart concert halls and auditoriums,

for interaction between lightning agents, acoustic panels movements and audience; and finally, the outdoor places that require any kind of acoustic isolation.

ReM-AM aims to be able to describe the capabilities of an AmI in terms of acoustic uses, rather than just functionality. This paper is organized in the next way: first we present the theoretical framework that includes AmICL and the automatization of the sound management; section 3 presents the architecture bases, and the next section introduces the ReM-AM specifications; finally are presented the case studies and the conclusions of this work.

II. THEORETICAL FRAMEWORK

A. AmI for C-Learning (AmICL)

As explained in [4, 21], the C-Learning uses the digital resources from the Internet for improving the training process of students around the world. It incorporates the tools and services in the cloud to make affordable the fact that the students and the teachers can interact while they are not physically in the same room. This model can be extended with the acoustic management, in order to use acoustic services and tools to integrate the sound in the devices and smart objects in their tasks.

Specifically, AmICL combines educational services available in the cloud with intelligent or non-intelligent objects, to adapt the learning process to the student's preference. This allows the user to choose the right moment for the learning-teaching process, and for performing other activities.

The integration of objects with educational services in the cloud is a way to adjust the behavior of the objects to the requirements of the users and the context of the AmI. As is shown in Figure 1, the architecture of AmICL is a Multilayer architecture [4, 21]:

- Physical Layer (PL)
- MAS Management Layer (MMAL)
- Services Management Layer (SML)
- AmI Logical Management Layer (ILL)
- AmI Physical Management Layer (IPL).

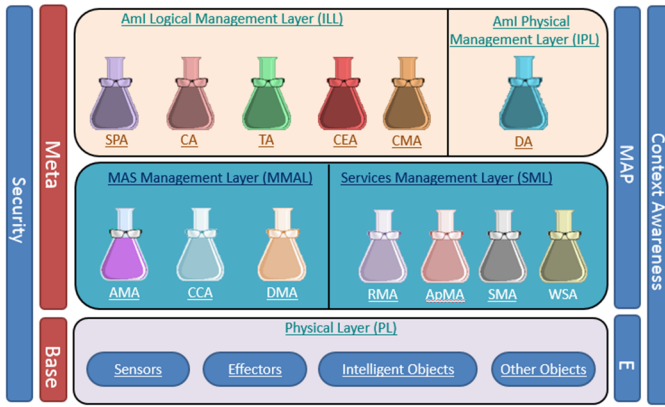

Figure 1. AmICL, proposed in [4]

B. Sound in AmI

In [12] is explained that the acoustic sensors are ones of the main factors to consider for the interaction in an AmI, since it can send information about acoustic events, as complement for image, temperature, motion, among other sensors. It is a source for communication between users and system, and generates *knowledge* about the activities that are developed in an AmI. In [25] is proposed the design of a smart room based on the acoustic detection and voice recognition. This design includes the analysis of sound frequencies and emotions recognition, and its main benefits are adaptability and invisibility.

In [3] is established that the acoustic sensors and actuators can analyze the room when it is quiet, and then identify the acoustic changes generated by random events, for the decision-making that will take place after. The advantage of acoustic sensors is the real-time processing [26], where an acoustic software uses voice and sounds from the performers to project magnified images in the background, combining abstract communication with graphic design and music composition. The interaction between users and acoustic agents has been used also in interactive platforms as in [27, 28].

These works show the development of sound processing in AmI to improve the experience of the users, regardless of its purpose (academic, entertainment, health).

III. ARCHITECTURE BASES

A. Generalities

An important task of a middleware is to make more affordable the interoperability in a system, when devices and networks need to understand each other and converge into a representation that can be understood by the system architecture in upper levels [9].

The proposal of ReM-AM is to incorporate every acoustic signal to describe the behaviors in an AmI, using a generic architecture, considering the random acoustic sources, mainly from the users (voices, motion). The architecture needs to be aware of the context [10] and also needs to reason on it [11].

ReM-AM is a Reflective Middleware Architecture, being the reflection the ability to supervise, monitor and modify its own behavior and its implementation, so ReM-AM can be sensitive to its environment in terms of acoustic signals. Its

dynamic and adaptive behavior allows it to manage programs that are in constant change.

This proposal is compatible with the processes of introspection and intersection already explained, included in AmICL, now with the extension in order to allow the management of the acoustic in the software and hardware components in the AmI.

The ReM-AM will include services to have an overall sight of the acoustic events, and they will be used by the two levels of a classic reflective middleware.

Additionally, by incorporating acoustic sensors and actuators, the system is able to collect details of the events in the AmI. This middleware uses these distributed resources to manage the sound in the entire system by identifying acoustic signals and sources, recognize them, make an interpretation, process and analyze them, and then responding accordingly.

B. Architectural Model

ReM-AM's multilayer architecture is defined by the same layers that conform AmICL [4, 21]:

- **Physical Layer (PL):** This layer contains the physical and virtual AmI components linked to the sound, such as acoustic sensors, intelligent and non-intelligent sound objects, and acoustic software objects. In ReM-AM, the interaction among the *users* and its new components is very important in this layer.
- **MAS Management Layer (MMAL):** This layer was adapted from FIPA standard [5] and it defines the rules and agents that allow the existence, operation and management of the MAS.
- **Services Management Layer (SML):** This layer is for the management of the educational services (when in SaCI) physically or in the cloud, to take advantage of it and adapt the AmI to the users' requirements.
- **AmI Logical Management Layer (ILL):** This layer is in charge of providing intelligence. All the applications and people are characterized by agents that contain metadata that define their properties. In our case, in this layer are specifically defined all the software components that allow an intelligent management of the sound in an AmI, for preprocessing, identification, analysis, and interpretation tasks, among others. For example, here will be the algorithms of sound filtering, recognition and learning of acoustic signals, among other mechanisms required for an intelligent sound management. The main component is the *smart speaker*, described in the next section.
- **AmI Physical Management Layer (IPL):** The physical elements of the environment are characterized in this layer, to make its use and communication easier. Every physical device's properties are characterized by an agent that contains metadata, and some of them are smart devices, being characterized by the properties of learning, reasoning and autonomy.

ReM-AM is an extension to AmICL, with a new layer in the meta level of AmICL called Audio Management Layer (AML), next to MMAL and SML. This layer will be in charge

of collecting and processing the audio information that is generated by the interaction between the system, the users and the agents, just in terms of acoustic signals that can provide important data to the system for the decision-making. It is composed of three components:

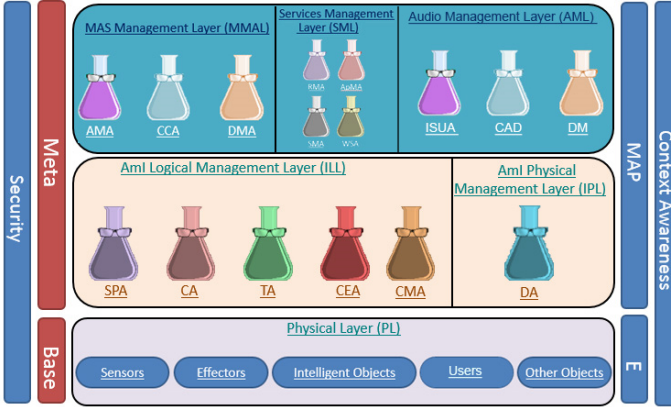

Figure 2. Extension to AmICL for the acoustic management.

- The *interaction system-user-agent (ISUA)* component will make the recognition and analysis tasks of the acoustic events in the environment, in order to identify the source. This layer will use the algorithms provided by the services in the cloud for the audio filtering and recognition, using the SML layer. This recognition and analysis will be made in terms of pitch, loudness and sound tone, among other audio information.
- The *collecting audio data (CAD)* component will be in charge of creating the new metadata that is required by the system from the random acoustic events in the AmI. The audio will be categorized by spectral analysis, among other techniques. CAD will interact with IPL in order to define the properties of physical devices that act as acoustic sources, etc.
- The *decision-making (DM)* is the component that will send the acoustic events detected and analyzed to the other layers of the system, especially to the ILL agents. One of the main elements is the *smart speaker* (that is part of ILL), which will have an audio output that is adapted to the requirements of the users. The answer of this module will act after deciding which is the receiver, i.e. the people, the system's mechanisms involved, or the environmental features.

These components define an autonomic cycle for the acoustic management in AmICL, based on the concept of autonomic cycles as services proposed in [32, 33]. This autonomic cycle establishes the relationship between the components in order to allow the self-management acoustics in an AmI.

IV. REM-AM SPECIFICATIONS

A. Description

Ones of the main elements that integrate the ReM-AM are the sensors and actuators [12]. Every AmI has a variety of

distributed sensors to understand the current status of the environment (See Figure 3). The data flow in ReM-AM is connected to the main system using a wireless network, and ReM-AM merges in real-time all the influx of information, detects corrupt or incomplete information, and sends it to other high decision-making modules of the system. The ReM-AM will get the data from acoustic sensors, and will make it useful for every layer of the architecture.

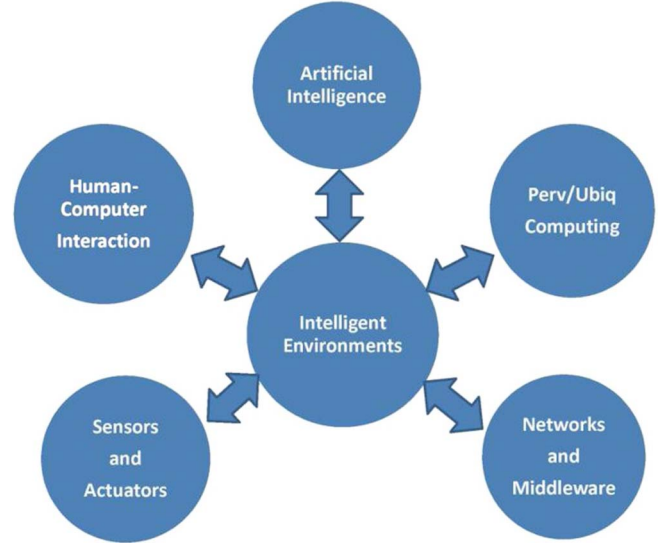

Figure 3. Data flow in AmI for the sound management [12]

There is a wide range of sensors in an AmI with varying capabilities [13] [14] including sensors of pressure, position, direction, distance, motion, light, radiation, temperature, among others, for the information identification like biometric data, images, and of course, sounds. These sensors provide different values to the system, from a simple on/off value, to numerical ranges or richer data.

In ReM-AM, these sensors are combined to suit an acoustic application. That means, the sensors will receive the acoustic signal, which will be processed by the components of ReM-AM to identify the signal, recognized them, and make an interpretation of the sound source and of the signal itself, analyzed them, and finally, give an answer. Auxiliary tools are also implemented, such as spectrum analysis, duration analysis of acoustic events, an auralization system, and a database of audio files for recognition tasks [15].

The sensors and actuators must allow the interaction between acoustic and non-acoustic agents. An acoustic agent can perceive a signal and depending on the classification of the acoustic signal that is made in the process of identification and analysis, the acoustic agent can decide if it is necessary to send the information on the Cloud or to another agent for decision-making, in response to an event in the AmI.

Another aspect to be considered by ReM-AM is that the auditory fields for sound perception in the sensors are defined in a wide range of frequencies, not just in the human audible range (Figure 4), so infrasounds and ultrasounds must be included.

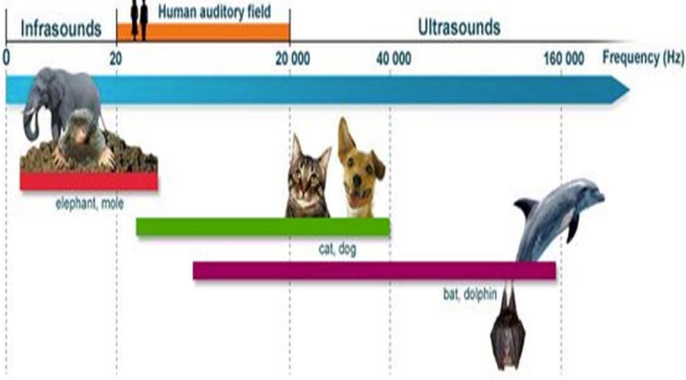

Figure 4. Sonic Spectrum Hz for hearing. [16]

The next step is to provide this information to each agent of Aml, in order to react precisely, and interact with other agents if necessary.

B. The smart speaker

The main smart agent that is proposed for ReM-AM is called *smart speaker*, which is composed by sensors that perceive the acoustic signals in terms of frequencies, levels and pitch, as show in Figure 5.

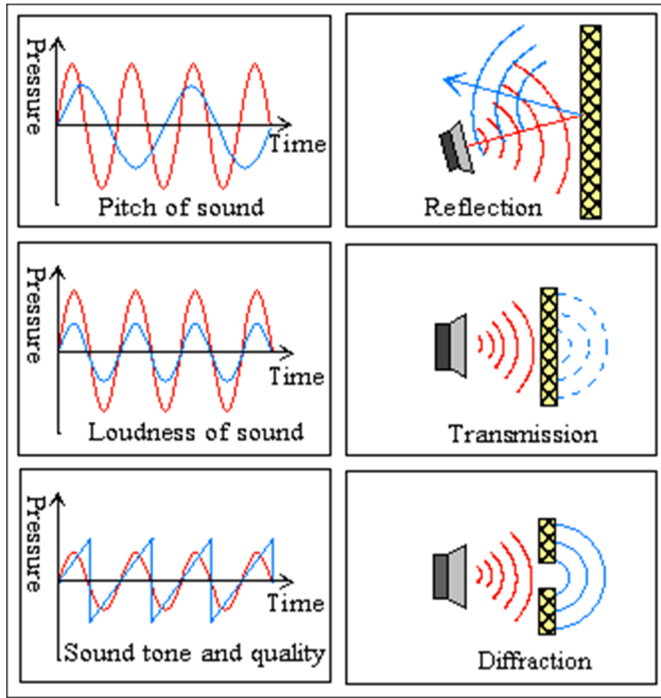

Figure 5. Factors affecting sound waves. [17]

All these factors are determined not just by the sources, but also by the materials and shapes that are surrounding the agent. As seen in Figure 6, if a surface is hard and concave around the smart speaker and the acoustic wave is being reflected, the acoustic pressure perceived by the sensor will be high, while if the surfaces are soft, convex and with pores, the wave will be reflected in a different direction.

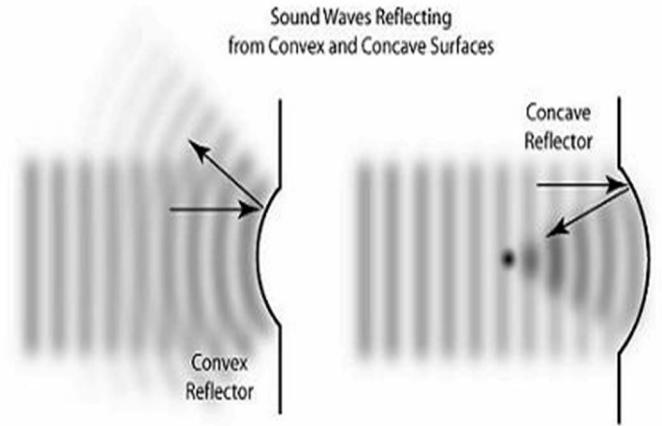

Figure 6. Sound waves reflections. [18]

The *smart speaker* will perceive the signals from the sensors and will adapt its behavior to it. In a conversation between two people, the *smart speaker* will be able to perceive the pitch, loudness and tone of the voices, and if it is playing music, will adapt its output level and even change the playlist if necessary.

To keep the output signal focalized in the audience, an echo-noise canceller, as presented in [19], will be incorporated to the smart speaker system. This will solve the problem of the double-talk that tends to make the adaptive filter diverge, by estimating the misalignment in closed-loop based on a gradient adaptive approach (see Figure 7).

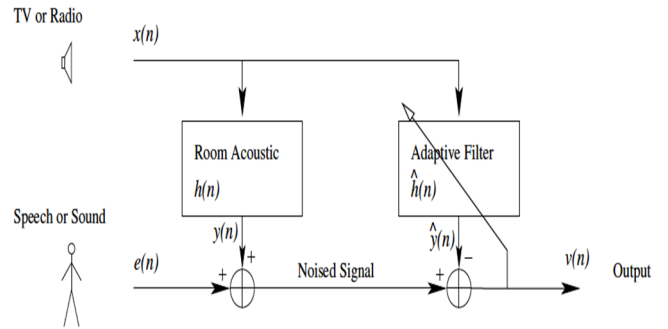

Figure 7. Block diagram of an echo cancellation system. [3]

Nevertheless, this echo cancellation does let some residual noise that can be attenuated by a post-filter, as presented in [20], which is a psycho-acoustical approach with randomly distributed time-variant spectral peaks in the noise as spectral subtraction.

V. CASE STUDIES

In order to show the performance of the ReM-AM architecture, its application is studied in different Intelligent Environments.

A. Smart Classroom (SaCI)

This case of study is proposed in [2, 21], when a teacher is giving class and proposes some practical activities that students have to develop in the classroom. Even though a

Smart Classroom should be able to act proactively to help user with their needs, and assuming that there is a smart board, student board, computers, among other smart agents, there should be a self-management system for improving the intelligibility of the teacher's speech, helping the hearing disabled student, solving the problem of the student sitting at the end of the classroom that cannot hear well, controlling the excessive noise that can be from an external source, or from the students in the classroom themselves.

ReM-AM offers an individual system to improve the hearing experience of every student in the classroom, by the acting of the layers SML and the ISUA and DM components of AML, analyzing the acoustic signals required in a given moment by the students and educational services. Every student board should have an acoustic sensor that perceives the pitch, loudness and tone of the teacher's speech and the sound system (for example, *smart speakers*, or *ear smart systems*) must regulate and adapt the sound features to make the voice cleaner, louder or even slower. The noise inside the classroom will be controlled by using a double-ceiling structure (see Figure 8), which incorporates smart speakers that will analyze the noise frequencies to reproduce the same range and cancel the phases of the waves.

ReM-AM will recognize the signal (considering that will be mainly noise from the students), process the gain and level, and then reproduce the same filtered signal to cancel the phases and make the place less noisy.

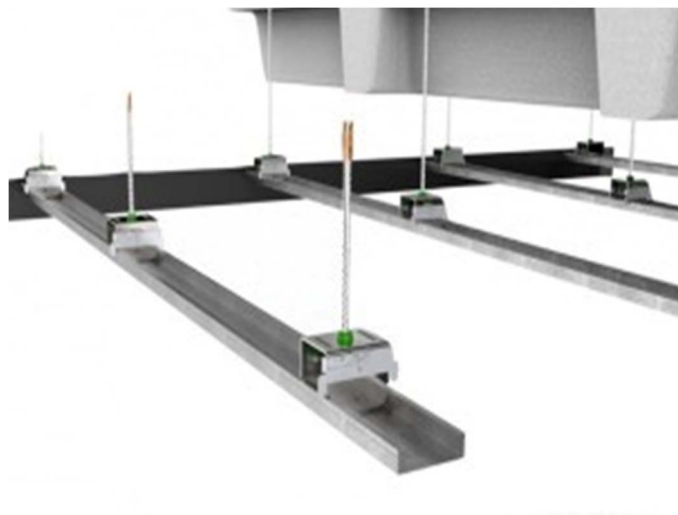

Figure 8. Double-ceiling structure proposed for noise control. [29]

B. Ambient Assisted Living (AAL)

Older and disable people are always in the need to enhance the quality of life, and nowadays technology offers many features, but most of the assistant systems are related to sound in terms of voice recognition or command. When a person cannot speak, then the system is not useful as expected. ReM-AM is proposing a perception system that includes not just voice, but the capability of identify noises that are not common in the Aml for assisted living.

The layers that act in smart homes are mainly the Physical Layer that contains physical and virtual components, as

acoustic sensors and software, and the CAD component of our AML to create the new metadata from acoustic events.

In this case, if a person cannot talk but is making noises that are not frequent, and the system identifies it as an unknown signal, then it is possible to find a situation derived since his/her own actions, to make an emergency call with other agents to provide help to the person.

The first step is to monitor the person that acts without autonomy through sensor measurements, to find his/her status by compensating the disabilities through home automation. The interaction between agents is high in this case, because the system has to ensure the security by detecting distress situations, and different agents can be part of the solution if a problem is presented.

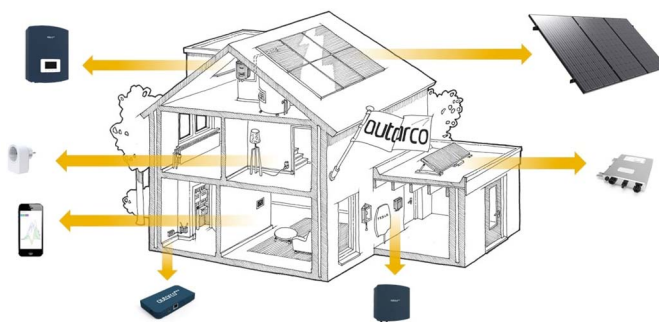

Figure 9. Sensors for monitoring in a Smart Home. [31]

Smart homes are equipped with sensors (Figure 9) for location, furniture usage, temperature, among others, but ReM-AM proposes that acoustic sensors can deliver highly informative data, even though it is a task with numerous challenges [22]. These sensors will recognize the signal altering the environmental soundscape to filter the difference and identify if the sound is anthropogenic, natural or from the system, and then will make the decision to alarm the system or the person in charge of taking care of the patient.

C. Smart Concert Halls and Auditoriums

Rem-Am can incorporate the acoustic signal for the decision-making tasks. In a concert hall, right before the orchestra is tuning the instruments for starting the concert (usually in A 440Hz, or A 432Hz), the lightning agents can receive that acoustic information to turn off the lights gradually before the first musical piece begins. Also, as is shown in Figure 10, the acoustic sensors can be incorporated to the default acoustic reflectors, and allow the equitable distribution of sound waves to all the seating levels of the concert hall with the system of the smart speaker. In this case, the main component to act will be ISUA, for the interaction that will take place in this kind of enclosures between the audience and the physical elements of the hall.

The system will recognize the noise from the public, cancel it, and give the order to act to the systems in charge of lights, using audio signals to communicate.

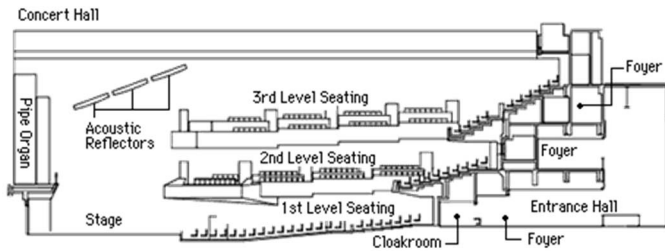

Figure 10. Concert Hall Sectional view. [30]

If the situation is a theater play or any other entertainment show, the sounds generated by the performers and players can be the commands for changing the colors, the movements can be the motion control for the spotlight, and the voices can also send relevant information to other agents.

D. Outdoor Places

Some places need acoustic treatments even when they are open. If a music band is giving a concert in an outdoor place, the location of the speaker lines and the distribution of the signals have to be designed having in account the locations around the place where the event will be done.

New technologies as Funktion-One [23] are used to work with speakers to increase the direction of sound propagation (See Figure 11). This system can be incorporated to ReM-AM with the echo-noise cancelled system, to improve the experience in the concert and also to make less dangerous the high noise exposition of the audience that can result in hearing fatigue. The main layer acting in outdoor places is IPL to facilitate the communication between the physical elements of the natural environment and the elements of the virtual system. From AML, the main component interacting is ISUA, considering that the events in outdoor places always include big crowds.

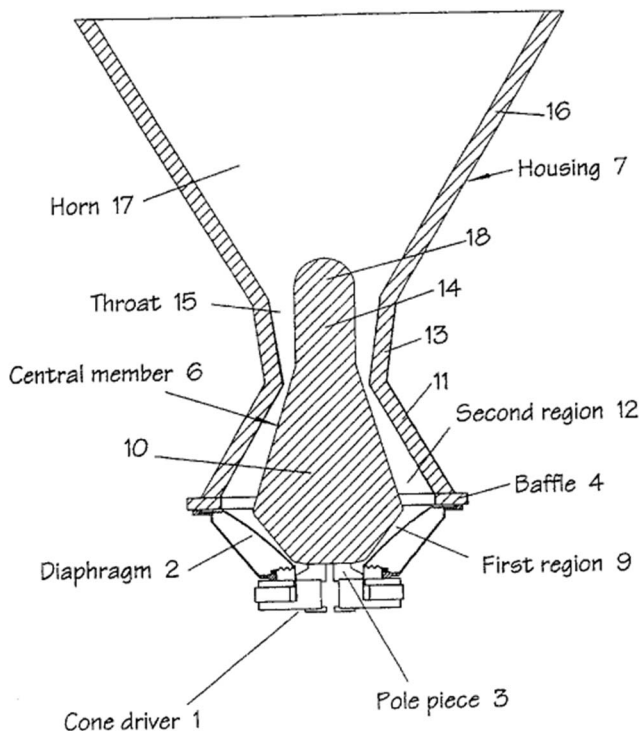

Figure 11. Funktion One Loudspeaker. [23]

Also, when in an indoor place an animal is not welcome; because there could be a conference inside the place, it could be a recording studio, or simply a place that is required to be quiet; ReM-AM can be also used outside the buildings to perceive the presence of an animal and generate an output frequency (in infrasounds or ultrasounds, depending on the animal) that will not result in any damage to animals, but can help to keep them far from the place, without interfering with the activity inside.

ACKNOWLEDGMENTS

Dr. Aguilar has been partially supported by the Prometeo Project of the Ministry of Higher Education, Science, Technology and Innovation of the Republic of Ecuador.

VI. CONCLUSIONS

In this paper is proposed a reflective middleware architecture for acoustic management, designed for use in different AmIs. The architecture uses the AmICL model expanded to allow a self-management system of the sound.

Different works as the echo-noise cancellation system are added in order to facilitate some of the features of ReM-AM. The main idea is to mix the benefits and capabilities of an AmI, such as reflective, autonomous and context awareness, with the acoustic management, to provide a better use of the physical, virtual or hybrid resources and services. The reflective and contextual awareness capabilities of the system allow improving and adapting to the needs of the environment and the users, acting intelligently for every event that arises.

Its application is not only for academic needs, but also for health, entertainment, among other environments. ReM-AM exploits the intelligent capabilities related to reflection and analysis of the context for the acoustic events in the environment.

From this point, the specific services and components of ReM-AM need to be developed. Also, the design of the ontologies that describe the knowledge inside ReM-AM is another task. The future works will also develop the mechanisms to define the system itself (of reasoning, learning, etc.) and to use it.

REFERENCES

- [1] H. Hagra, V. Callaghan y M. Cooley, «A Hierarchical Fuzzy Genetic Multi-Agent Architecture for Intelligent Buildings Sensing and Control.» de *Developments in Soft Computing*, 2001.
- [2] J. Aguilar, P. Cordero; L. Chamba-Eras, "Specification of a Smart Classroom Based on Agent Communities", *New Advances in Information Systems and Technologies* (A. Rocha, M., Correia, H., Adeli, P. Reis, M. Mendonca, Eds.), Springer, pp. 1003—1012, 2016.
- [3] M. Vacher, F. Portet, A. Fleury, and N. Noury, "Development of Audio Sensing Technology for Ambient Assisted Living: Applications and Challenges," in *Digital Advances in Medicine, E-Health, and Communication Technologies*. United States: Medical Information Sciences Reference, p. 148-167, 2013.
- [4] M. Sánchez, J. Aguilar, J. Cordero, P. Valdiviezo, "A Smart Learning Environment based on Cloud Learning", *International Journal of Advanced Information Science and [1]Technology*, vol. 39, no. 39, pp.39-52, 2015.

- [5] J. Aguilar, A. Ríos, F. Hidrobo y M. Cerrada, *Sistemas MultiAgentes y sus aplicaciones en Automatización Industrial*, Mérida, Universidad de Los Andes, 2013.
- [6] M. Mendoça, J. Aguilar y N. Perozo, «Middleware Reflexivo Semántico para Ambientes Inteligentes», de CoNCISA 2014, Caracas, 2014.
- [7] M. Jerez, J. Aguilar E. Exposito, T. Viellemur “CARMiCLOC: Context Awareness Middleware in CLOud Computing”, *Proceeding of the XLI Conferencia Latinoamericana en Informática (CLEI 2015)*, Arequipa, Peru, pp. 532-541, 2015
- [8] J. Vizcarrondo, J. Aguilar, E. Exposito y A. Subias, «ARMISCOM: Autonomic Reflective MIddleware for management Services COMposition», de *GIIS 2012*, Choroni, Venezuela, 2012.
- [9] G. Schiele, M. Handte, and C. Becker, “Pervasive computing middleware”, *Handbook of Ambiente Intelligence and Smart Environments*, pp.201-221, 2010.
- [10] T. G. Stavropoulos, D. Vrakas, D. Vlachava, and N. Bassiliades, “BOnSAI: a smart building ontology for ambient intelligence”, *Proc. of the 2nd International Conference on Web Intelligence, Mining and Semantics*, pp. 30-41, 2012.
- [11] D. Gregor, “Desarrollo de un Servicio Middleware de Ontologías Cooperativas aplicado a Sistemas Embebidos de Transportes Inteligentes”, *Tesis Doctoral*, Universidad de Sevilla, Sevilla, 2013.
- [12] J. Augusto, V. Callaghan, D. Cook, A. Kameas, and I. Satoh, “Intelligent Environments: a manifesto,” *Human-centric Computing and Information Sciences*, vol. 3, no. 12, p. 18, 2013.
- [13] D. Cook and W. Song, “Ambient intelligence and wearable computing: Sensors on the body, in the home, and beyond”, *Journal of ambient intelligence and smart environments*, vol. 1, no. 2, pp-83-86, 2009.
- [14] J. Delsing and P. Lindgren, “Sensor communication technology towards ambient intelligent”, *Measurement Science and Technology*, vol. 16, no. 4, p. 37, 2005.
- [15] E. Accolti, “Generación automática de paisajes sonoros realistas con espectro, distribución de duraciones y categorías semánticas especificados”, *Informe Técnico*, Facultad de Ciencias Exactas, Ingeniería y Agrimensura, Universidad Nacional de Rosario, Argentina, 2015.
- [16] <http://positivr.fr/quel-age-on-vos-oreilles-test/>
- [17] <http://www.askiitians.com/iit-jee-wave-motion/velocity-of-wave/>
- [18] <http://www.ctgclean.com/tech-blog/ultrasonics-understanding-sound-waves-1>
- [19] J-M- Valin and I. B. Collings, “A new robust frequency domain echo canceller with closed-loop learning rate adaptation”, in *Proceedings of the IEEE International Conference on Acoustics, Speech and Signal Processing (ICASSP 2007)*, pp.1-93-1-96, 2007.
- [20] S. Gustafsson, R. Martin, P. Jax and P. Vary, “A psychoacoustic approach to combined acoustic echo cancellation and noise reduction”, in *IEEE Transactions on Speech and Audio Processing*, vol. 10, no. 5, pp. 245-256, 2004.
- [21] M. Sánchez, J. Aguilar, J. Cordero, P. Valdiviezo, “Basic features of a reflective middleware for intelligent learning environments in the cloud (IECL)”, in *Asia-Pacific Conference on Computer Aided System Engineering (APCASE)*, pp.1-6, 2015.
- [22] M. Vacher, F. Portet, A. Fleury and N. Noury, “Challenges in the processing of audio channels for ambient assisted living”, in *Proceedings of IEEE HealthCom*, pp.33-337, 2010.
- [23] A. Andrews, T. Hunt and J. Newsham, “Loudspeaker. Funktion-One (GB)”, *Patent US6,650,760*, 2010.
- [24] P. Valdiviezo, J. Cordero, J. Aguilar, M. Sanchez "Conceptual Design of a Smart Classroom Based on Multi agent Systems", *published Proceeding International Conference on Artificial Intelligence (ICAI'15)*, 2015.
- [25] M. Navarro, "Inteligencia ambiental: entornos inteligentes ante el desafío de los procesos inferenciales," *Eidos: Revista de Filosofía de la Universidad del Norte*, no. 15, pp. 184-205, 2011.
- [26] <http://www.tmema.org/messa/messa.html>
- [27] <http://www.student.uni-ak.ac.at/nicole.weniger/info-text-probst.html>
- [28] M. Droumeva and R. Wakkary, “Understanding Aural Fluency in Auditory Display Design for Ambient Intelligent Environments,” *Proc. 14th International Conference on Auditory Display*, 2008.
- [29] <http://comoinsonorizar.com/sistemas-aislamiento-acustico/insonorizar-un-techo/>
- [30] http://ongakudo.jp/e/e_concert
- [31] <https://www.autarco.com/int/products/smart-home/>
- [32] J. Vizcarrondo, J. Aguilar, E. Exposito, A. Subias "MAPE-K as a Service-oriented Architecture", *Revista IEEE Latinoamericana Transactions*, Vol. 15, No. 6, pp. 1163-1175, 2017.
- [33] O. Buendia, J. Cordero, J. Aguilar, “Specification of the Autonomic Cycles of Learning Analytic Tasks for a Smart Classroom”, *Journal of Educational Computing Research*, 2017