

Instituut voor Biologisch en Scheikundig onderzoek
van landbouwgewassen
Wageningen

Verslagen
nr. 49 1968

The "Ruiglandzaamachine" (triple disc seeder)
in photographs

W.A.P. Bakermans
and
L. ten Holte

The "Ruiglandzaaimachine" (triple disc seeder) in photographs

To investigate the problems involved in arable cropping when soil cultivation is replaced by chemical weed control, in 1963 an investigation was started into the possibilities of arable cropping with a permanent sodlike cover. In this investigation all soil tilling is completely omitted.

Weeds and any other undesired plant growth is controlled by chemicals. Chemical weed control is supported by ecological methods, by intercropping with soil covering crops and leaving the remains of this crop as mulch on the soil. A weed free soil by spraying will more easily remain so in this way. We also consider green manuring and soil covering necessary to obtain natural recovery of the structure and to keep the soil fertile.

To sow in unploughed land on which the remains of the preceding crop, harvested or not, are still present, the Ruiglandzaaimachine (triple disc seeder) was developed in co-operation with the Office of Joint Services (B. G. D.), Institute of Agricultural Engineering and Rationalisation (I. L. R.) and the Ede Welding Industry (E. L. I.). Since uncultivated land before seeding is often covered by long more or less wiry plant remains, collecting of the material occurs almost immediately in using a usual seeder with fixed sowing cutters. It is therefore necessary to use disc cutters.

Figs. 1, 2 and 3 show the first design of the triple disc seeder of 1963. The machine cuts with disc cutters through the plant remains and makes slits into the soil in which the seed is sown by a pair of seed discs mounted in V-shape.

Adjusting the depth and closing the drilling slits takes place by rollers which can be additionally loaded, as shown in Fig. 3. Furthermore, the front carrying bar on which the seeding units have been mounted can be adjusted to depth by a spindle (Fig. 2).

With this machine most crops can be sown reasonably well. However, especially on uneven land and on clay soil seeding is rather irregular.

Because the front cutter, seeding unit and roller are mounted lengthwise on the same bar (Fig. 1), the depth adjustment is insufficient when the soil is very uneven across the moving direction. Furthermore, especially the front cutters are too close to the cross bar on which all the seeding units are mounted. When the land is uneven in the moving direction, e. g. by the presence of tracks, certain rows will be sown too deep and others too shallow.

In the improved seeder an attempt was made to solve this problem by giving all parts their own fastening, depth adjustment and load, independent of each other. The elements crawl more or less like a caterpillar over the land. Figs. 4 and 5 show that this heavy machine is fitted with low-pressure tires preventing the formation of deep tracks, also in weak soil. The depth adjustment of the front cutter discs takes place by an iron wheel screwed against the cutter disc (Figs. 8 and 18), in which the size of the wheel determines the cutting depth of the disc. In this way an ideal depth adjustment is obtained, independent of the unevenness of the soil.

The double drilling discs are suspended by means of a parallelogram and the depth is adjusted by an adjustable following wheel (Figs. 4, 5 and 6). Furthermore, convex disc-harrow discs follow to close the seeding groove (Fig. 6). The depth of these is also adjusted by a following wheel.

In testing this four-wheeled seeder it was found that it was very difficult to handle. In the latest design, therefore, the pivot on the front wheels was shifted directly to the tractor (Fig. 7), which made the seeder into a very manageable two-wheeled cart (Figs. 9 and 10). Furthermore, the depth adjustment of the seeding discs and the closing discs by the following wheels to be seen in Figs. 4, 5 and 6, was not satisfactory. On uneven land the depth adjustment is insufficient and on wet clay soil the following wheels get blocked by soil clods (Fig. 6). In the last design the depth adjustment of these discs is also solved by wheels screwed against the disc (Figs. 8, 10, 11, 12, 19 and 20). A choice of wheels with different diameters opens the possibility to seed at various depths. To keep clean the seeding discs and wheels scrapers have been mounted (Figs. 12 and 14).

By means of weights all parts can be loaded with the desired pressure

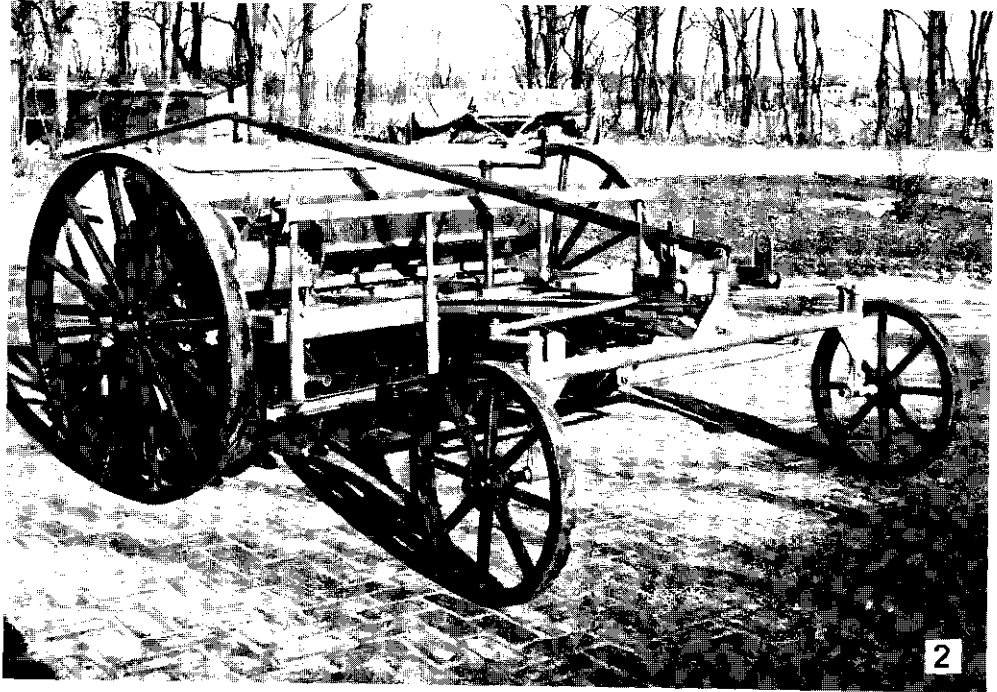
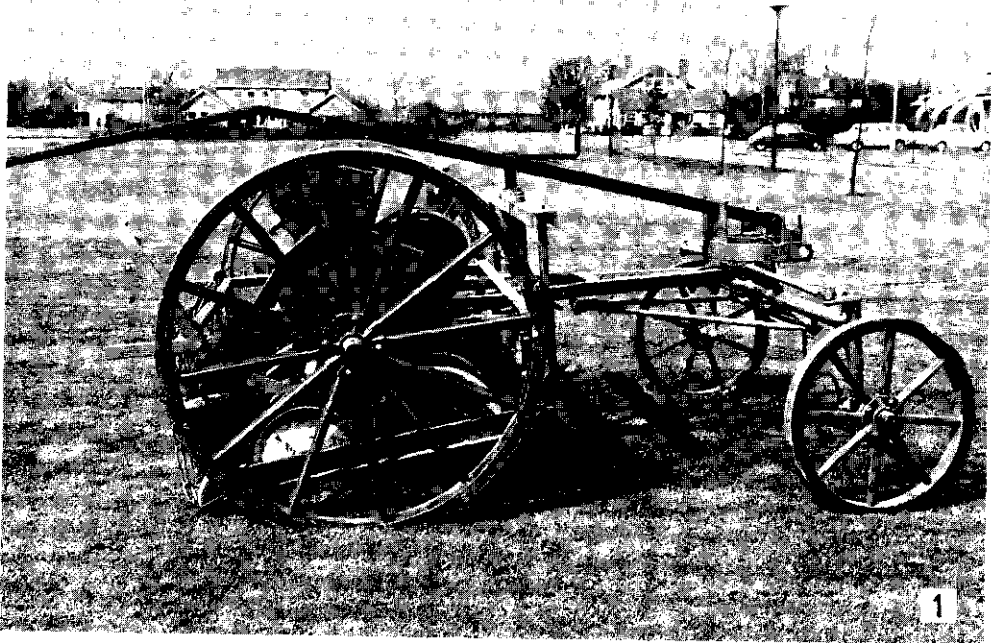

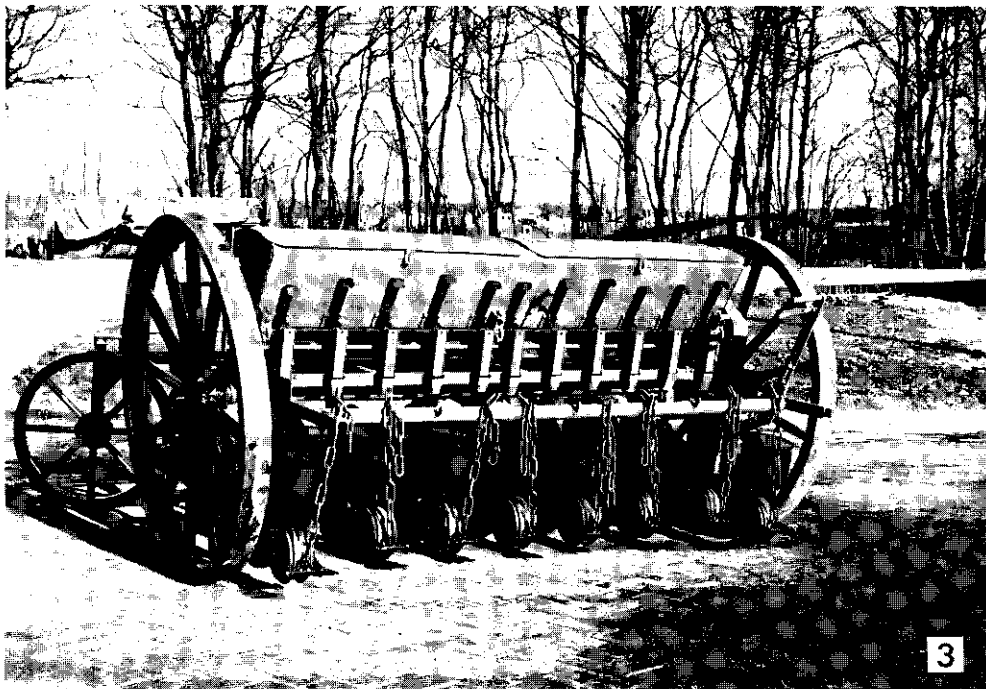

(Figs. 8, 13 and 15).

Figs. 18, 19 and 20 show the technical details of the construction of:

1. cutter discs with wheel (Fig. 18);
2. double seeding discs with wheel (Fig. 19);
3. closing discs (Fig. 20).

In 1968 excellent results were obtained with this machine on several soils and with various crops. Figs. 16 and 17 show this.

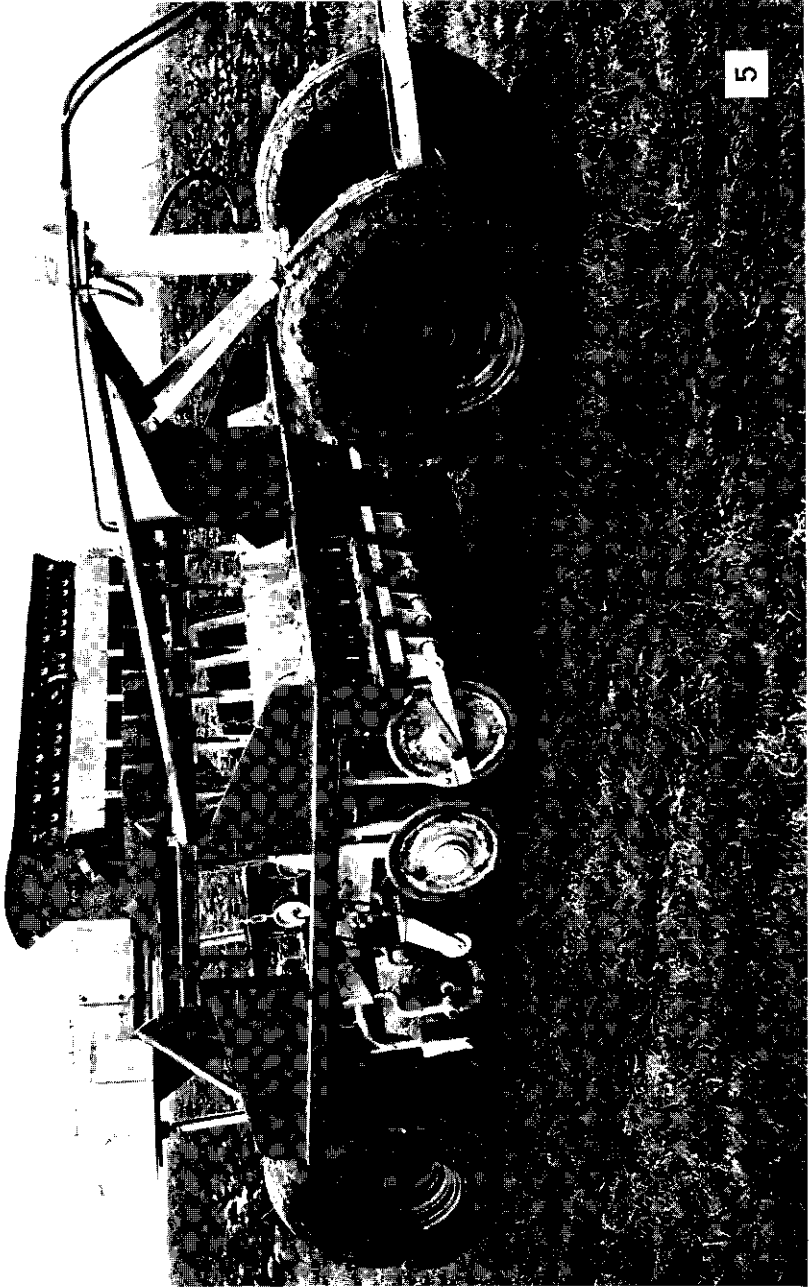

5

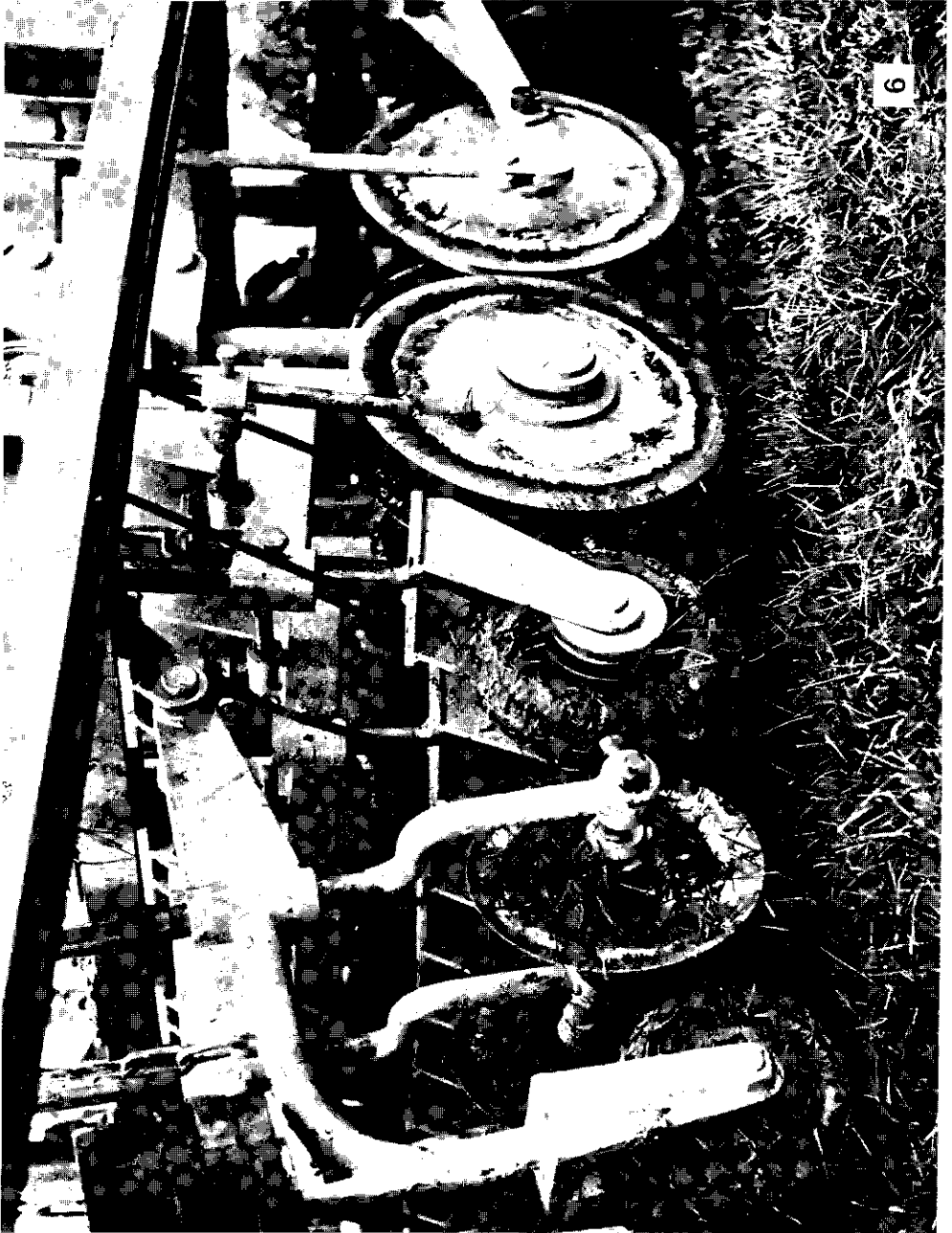



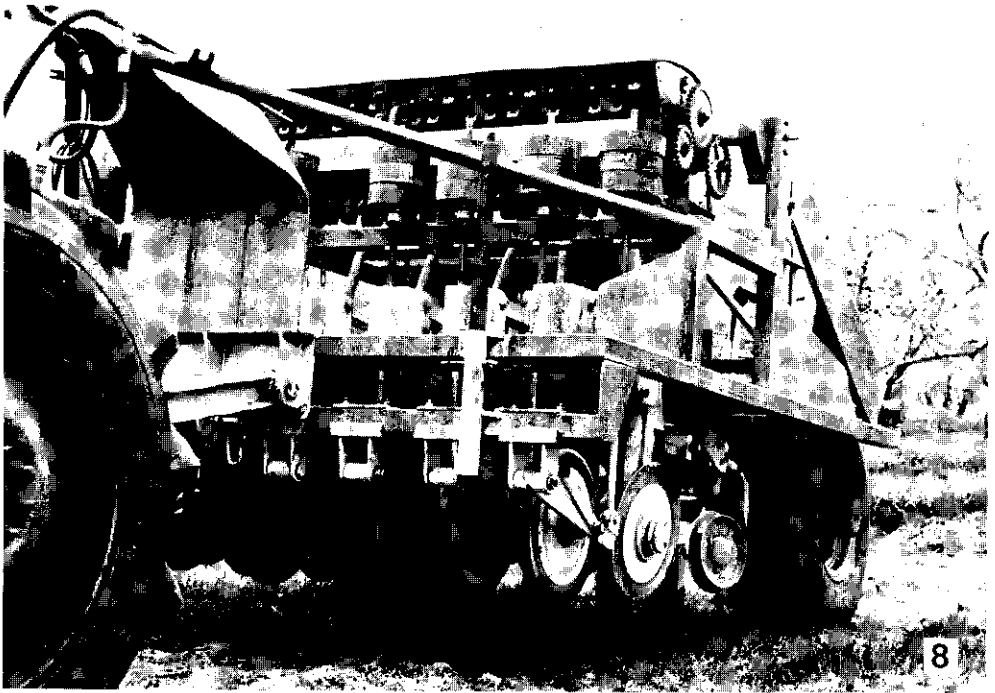

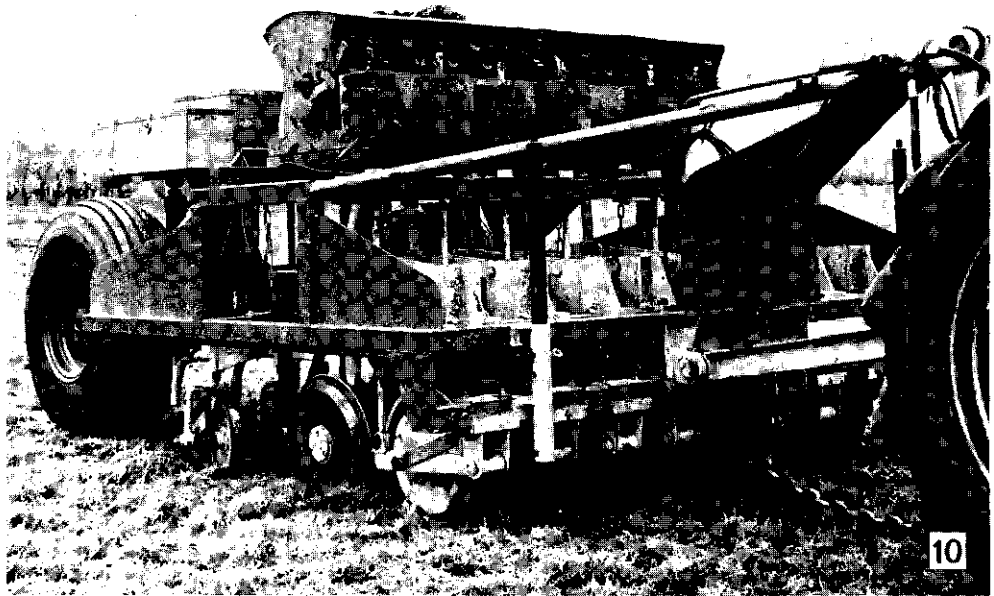

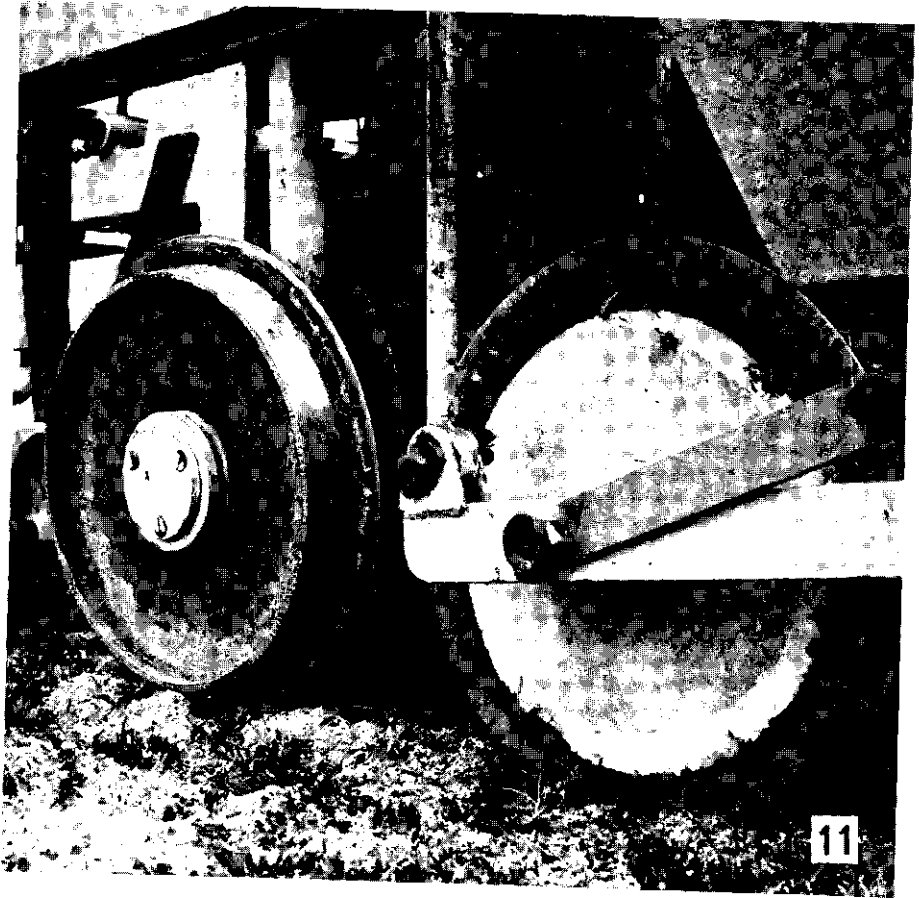

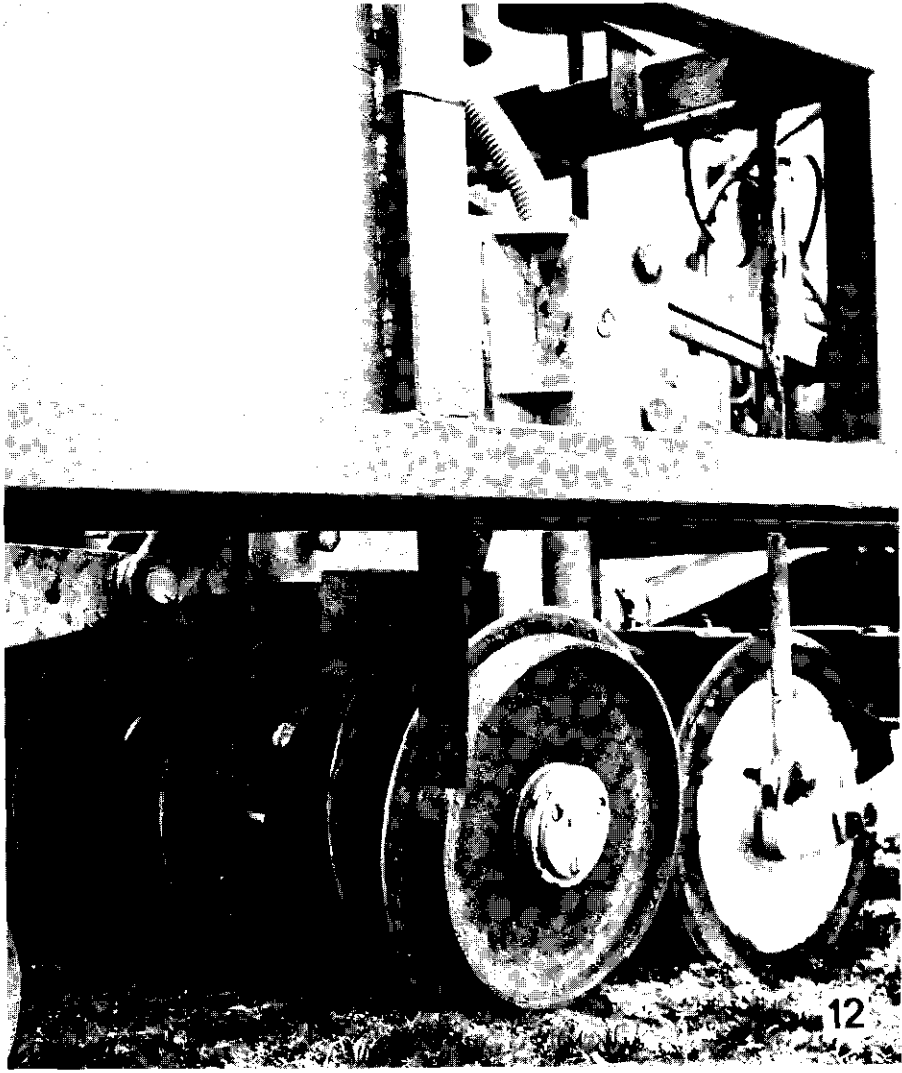

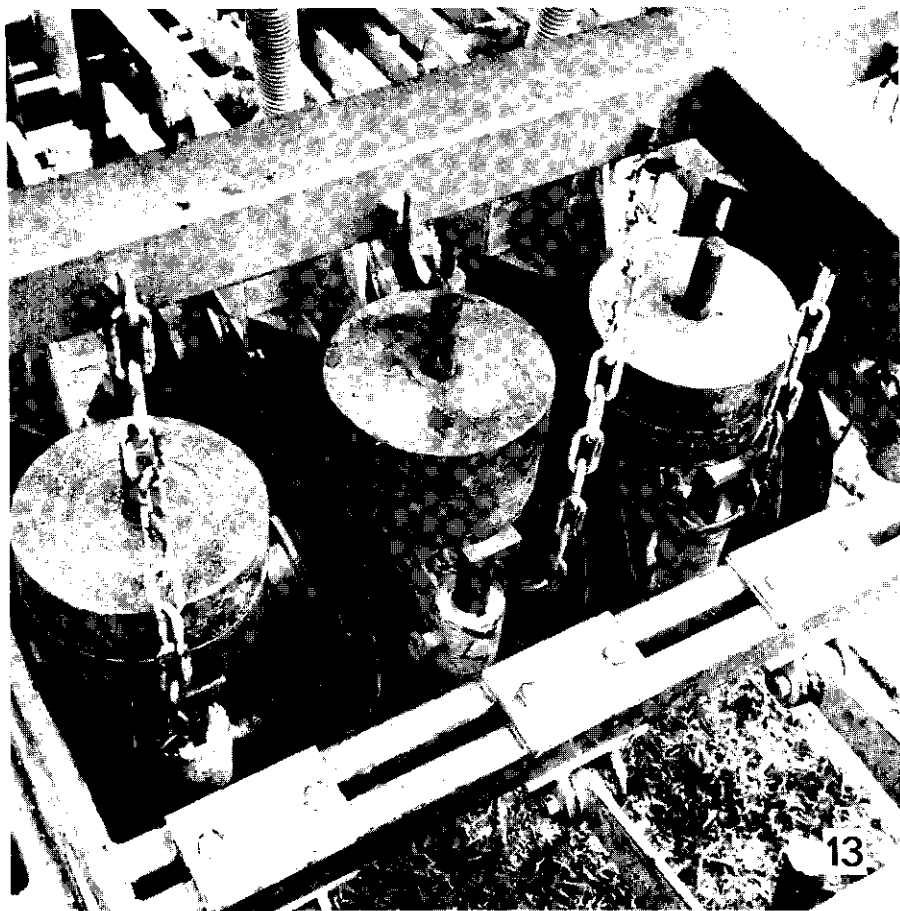

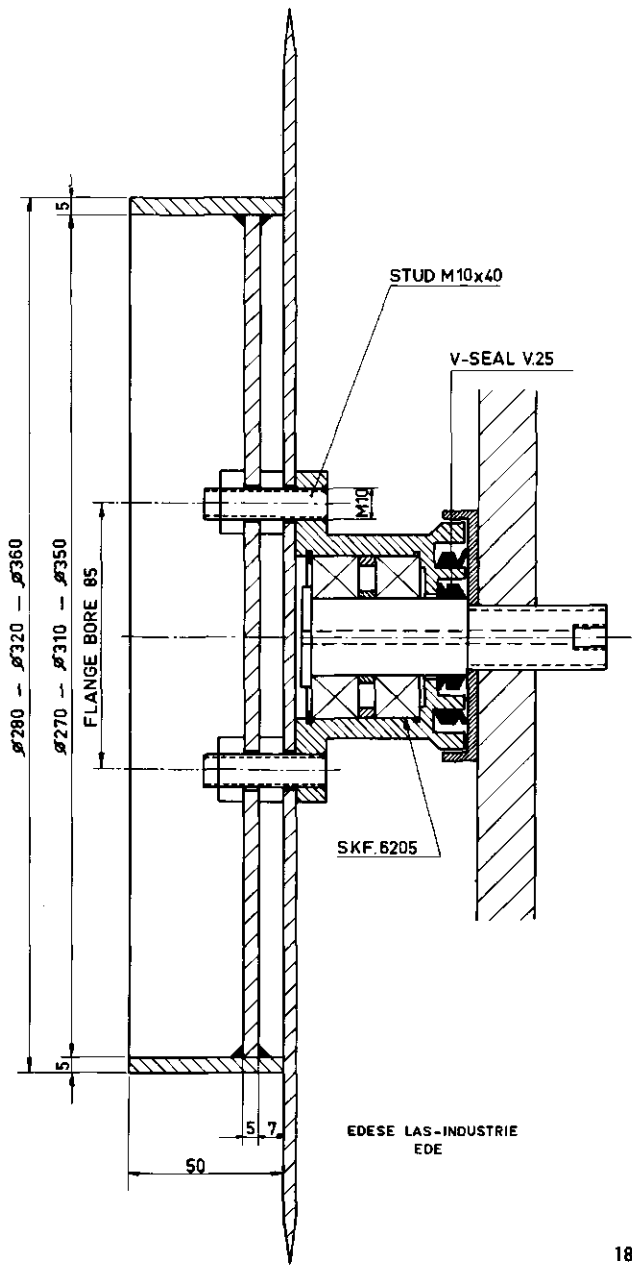

EDESE LAS-INDUSTRIE
 EOE

EDESE LAS-INDUSTRIE
EDE

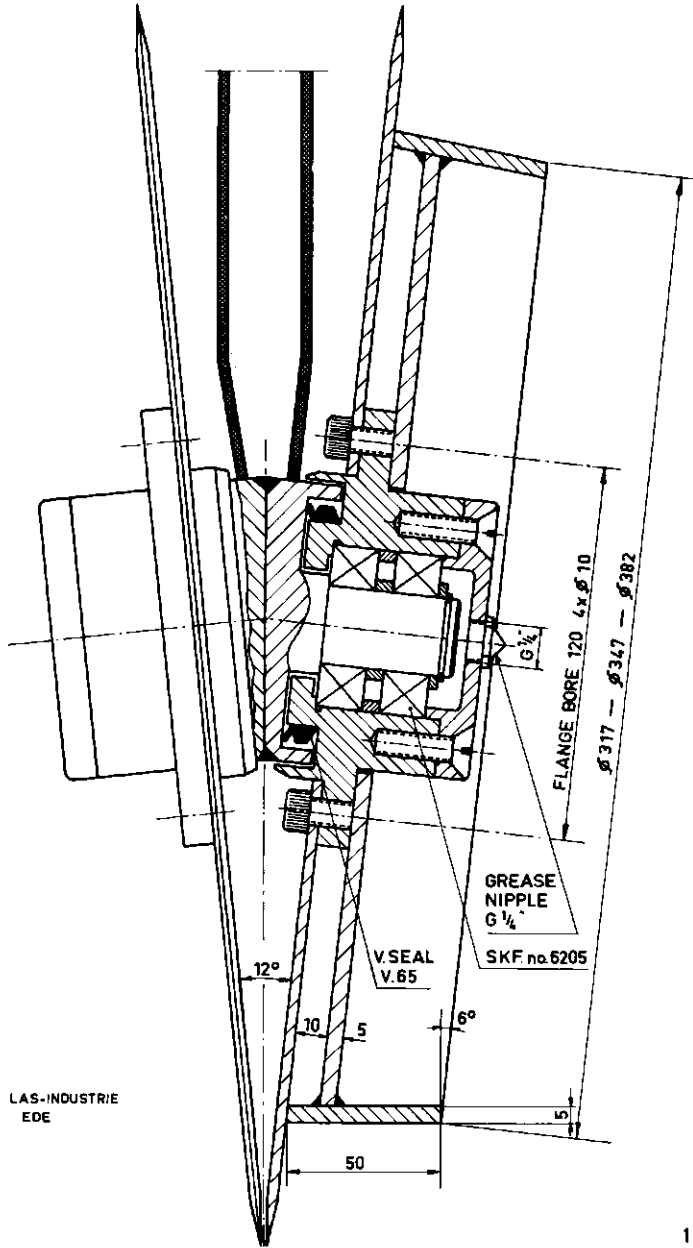

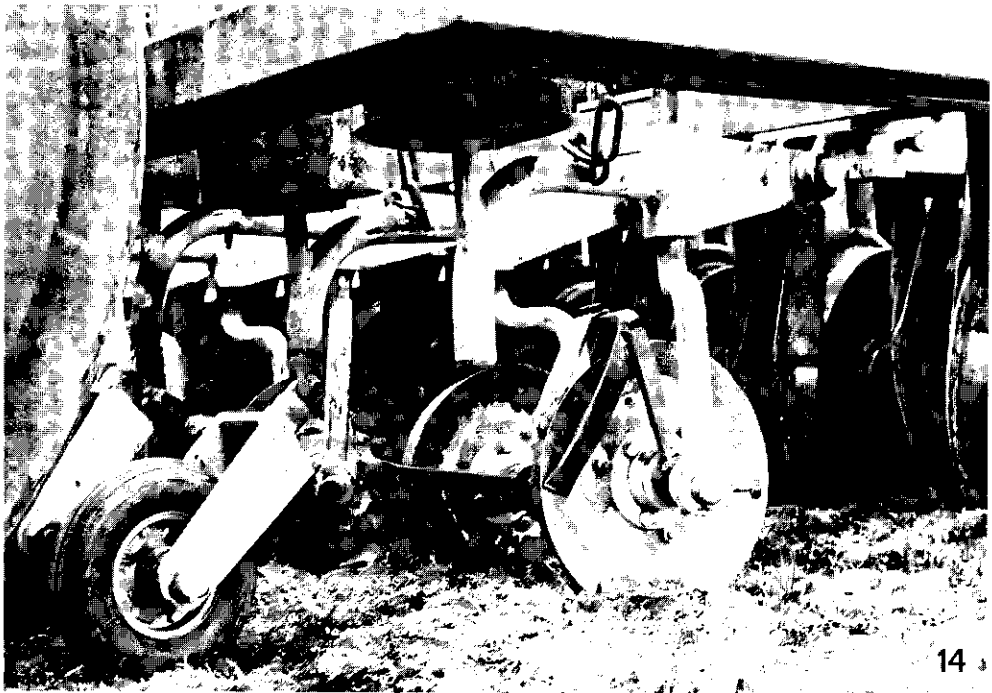

14

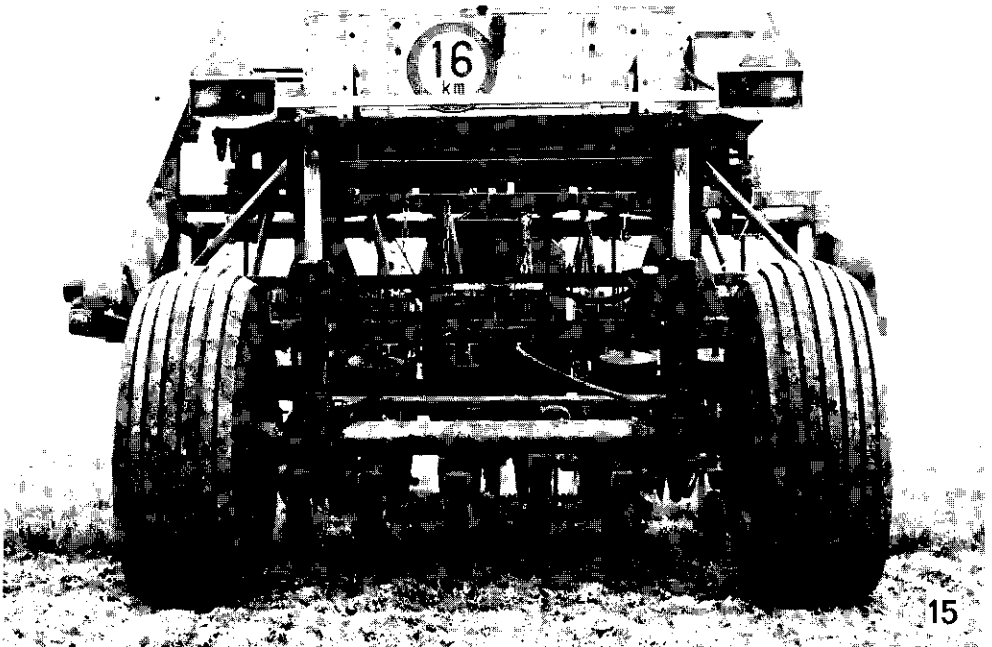

15



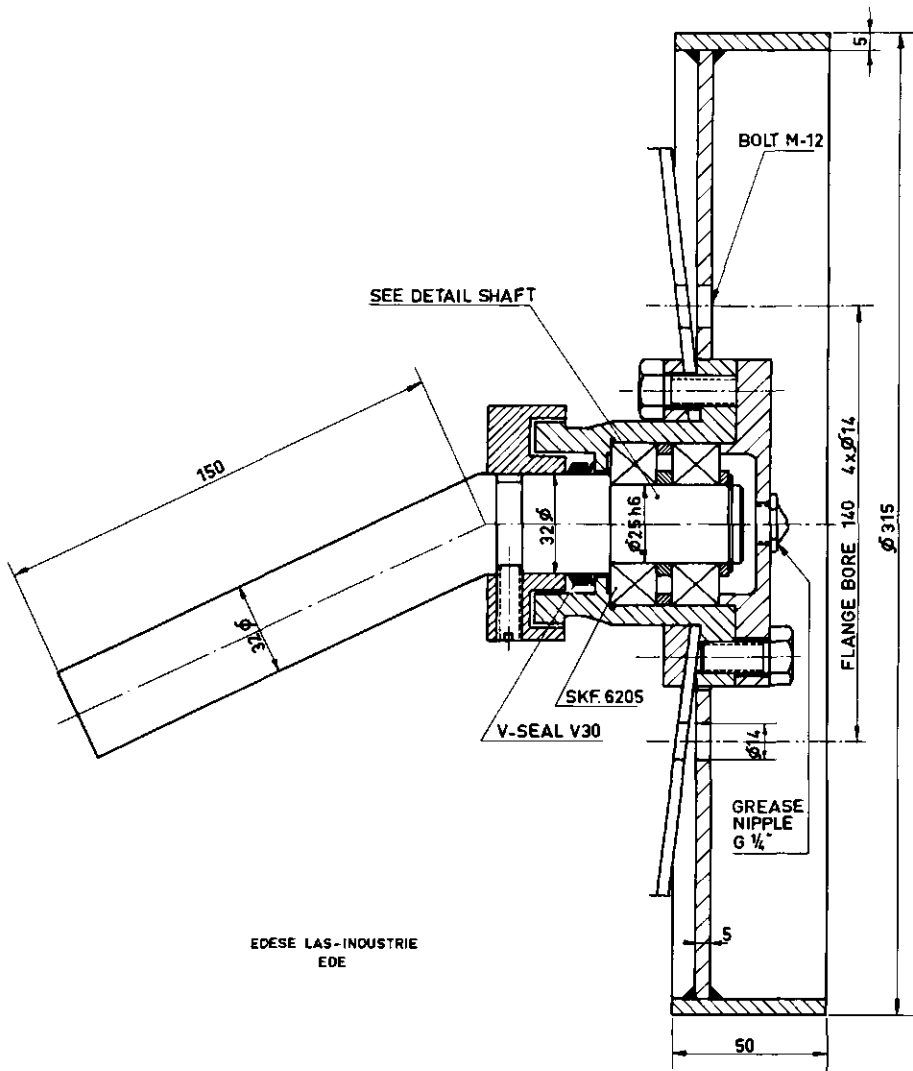

EDESE LAS-INDUSTRIE
 EDE