

Effect of leaking natural gas on soil and vegetation in urban areas

BIBLIOTHEEK
DER
LANDBOUWHOOGESCHOOL
GEN. FOULKEWEG 1a
WAGENINGEN

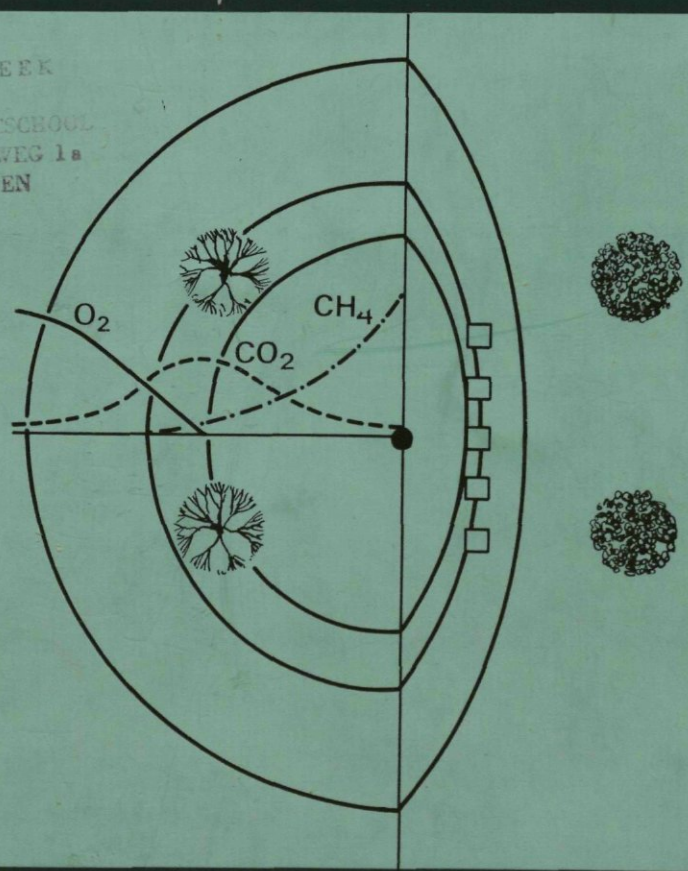

NN08201.524

J. Hoeks

Effect of leaking natural gas on soil and vegetation in urban areas

Proefschrift

ter verkrijging van de graad van
doctor in de landbouwwetenschappen,
op gezag van de rector magnificus, prof. dr. ir. H. A. Leniger,
hoogleraar in de technologie,
in het openbaar te verdedigen
op vrijdag 22 september 1972 te 16.00 uur
in de aula van de Landbouwhogeschool te Wageningen



Centre for Agricultural Publishing and Documentation

Wageningen - 1972

Abstract

HOEKS, J. (1972) Effect of leaking natural gas on soil and vegetation in urban areas. Doctoral thesis, Wageningen, ISBN 90 220 402 3, (viii) + 120 p., 20 tabs, 40 figs, 138 refs, Eng. and Dutch summaries. Also: Agric. Res. Rep. (Versl. landbouwk. Onderz.) 778.

Leakage of natural gas from the gas distribution system affects the physical, chemical and biological processes in the soil. Particularly the microbial oxidation of methane is then of predominant importance for the composition of the soil gas phase. The rate of methane oxidation was measured under varying conditions of gas phase composition, temperature and nutrient supply. Computation models were evolved with which it is possible to calculate the effect of these and other factors on the distribution of methane, oxygen and carbon dioxide around a leak. Experiments with actual and artificial leaks as well as the calculations showed that the extent of the gas zone largely depends on the leakage rate, the depth of the groundwater table, the soil moisture content and the extent of the pavement. The soil temperature also proved to have a significant influence by its effect on the microbial methane oxidation. At low temperatures this microbial process is limited and consequently the anaerobic zone, which is invariably present in summer, may then disappear completely, thus making the probability of injury to vegetation negligible in winter. After repair of the leak the poor aeration conditions in the soil may persist for quite a long time. This is caused by the high consumption rate of oxygen required for the oxidation of organic substances and reduced anorganic compounds accumulated in the soil during gas leakage. The oxygen overdemand and the oxidation rate were determined for various gassed soils. Measures can be taken to accelerate soil recovery processes and to improve conditions for regeneration of injured trees and before planting new trees. Both experiments and calculations with computation models proved that installation of open ventilation channels is very effective, even if the leak cannot be immediately repaired. So ventilation channels can also be installed as preventive measure.

UDC 631.433:622.324:518.5.001.572:631.461.62:632.122.2:712.4

ISBN 90 220 0402 3

This thesis will also be published as Agricultural Research Reports 778.

© Centre for Agricultural Publishing and Documentation, Wageningen, 1972.

Niets uit deze uitgave mag worden verveelvoudigd en/of openbaar gemaakt door middel van druk, fotocopie, microfilm of op welke andere wijze ook zonder voorafgaande schriftelijke toestemming van de uitgever.

No part of this book may be reproduced and/or published in any form, by print, photoprint, microfilm or any other means without written permission from the publishers.

Stellingen – Propositions

1

Het injecteren van lucht ter verbetering van de bodemventilatie bij straatbomen, bijvoorbeeld met een compressor, moet worden ontraden.

Dit proefschrift

Forcing air into the soil to improve soil aeration around street trees, as for instance with a compressor, is not to be recommended.

2

Indien een gaslekzoekmeter berustend op dichtheidsbepaling (bijv. een Gasophon-meter) aangeeft dat het gasmengsel in de bodem zwaarder is dan lucht, mag niet worden geconcludeerd dat aardgaslekage afwezig is.

Dit proefschrift

If a leak detection apparatus based on density determination (e.g. a Gasophon-apparatus) indicates that the gas mixture in the soil is heavier than air, this is not proof of absence of natural-gas leakage.

3

Bij aanplant van straatbomen dient men voorzichtig te zijn met toediening van gemakkelijk te oxyderen organische meststoffen.

Dit proefschrift

In planting street trees, one should be cautious when adding easily decomposable organic fertilizers.

4

Binnen de bebouwde kom moet asfaltering van klinkerwegen met boombeplanting worden tegengegaan, tenzij speciale maatregelen worden getroffen.

Dit proefschrift

Inside urban areas asphaltting of brick roads lined with street trees must be avoided unless special measures are taken.

5

Na aardgaslekage is de vruchtbaarheid van de grond verhoogd.

D. R. Johnson et al. (1969) Agron. J. 61: 371-373

Dit proefschrift

After leakage of natural gas the fertility of the soil has been increased.

6

De bepaling van kritieke bodemzuurstofgehalten voor een gewas enkel uit metingen van de bodemluchtsamenstelling en de daaraan gecorreleerde opbrengstgegevens is weinig zinvol.

G. Geisler (1969) Bayer, Landw. Jb. 46: 259-278

E. R. Lemon (1962) Agron. J. 54: 167-170

Determining critical soil oxygen concentrations for a crop solely from measurements of the soil gas phase composition and correlated crop yields, is of small value.

7

De redoxpotentiaal van een bodemoplossing geeft weinig informatie over de werkelijke verhouding van de activiteiten van de aanwezige gereduceerde en geoxydeerde ionen.

H. L. Bohn (1971) Soil Sci. 112: 39-45

Redox potentials of a soil solution do not yield much information on the actual ratio between the activities of reduced and oxidized ions present.

8

De produktie van eiwit uit methaan door micro-organismen zal in poreuze media bij hoge CO₂-concentraties waarschijnlijk efficiënter zijn dan in de tot op heden gebruikte vloeistofcultures.

J. F. Wilkinson (1971) In: Microbes and biological productivity (Ed. D. E. Hughes and A. H. Rose) p. 15-46

P. S. Vary and M. J. Johnson (1967) Appl. Microbiol. 15: 1473-1478

J. C. Mueller (1969) Can. J. Microbiol. 15: 1047-1050

Dit proefschrift

The production of single-cell protein from methane will probably be much more efficient if the microbial process proceeds in porous media at high CO₂-concentrations, than in liquid systems.

9

Voor een billijke vaststelling van heffingen voor het lozen van afvalwater is het nodig dat bij de definiëring van het begrip inwonerequivalent rekening wordt gehouden met de biochemische oxydatiesnelheid van de zuurstofbindende stoffen.

Wet verontreiniging oppervlaktewateren (1970) art. 19 en toelichting (B-2): 90-99

In order to fairly fix levies for discharging waste water the definition of the term 'inhabitant-equivalent' should also take into account the rate of biochemical oxidation of the oxygen-consuming substances.

10

De experimenten van Barrs geven geen doorslaggevend bewijs voor zijn stelling dat de wet van Darcy niet zou gelden voor het watertransport in de plant.

H. D. Barrs (1970) Symposium on plant response to climatic factors, Uppsala, Sweden

The experiments of Barrs are not conclusive as to his proposition that Darcy's law does not hold for transport of water in plants.

11

De benaming 'tweede woning' voor een verblijfsaccommodatie die uitsluitend bestemd is voor recreatief gebruik is misleidend en dient te worden vervangen door de benaming 'recreatieverblijf'.

F. L. G. Slooff (1971) *Bouw* 26: 168-171

J. Heester (1971) *Jaarverslag ICW 1970*: 94-97

The name 'second home' for a living accommodation only intended for recreative use is misleading and should be superseded by the name 'recreative dwelling'.

12

Vuilstortplaatsen moeten met het oog op mogelijke verontreiniging van bodem en grondwater worden gesitueerd in kwelgebieden.

Sanitary landfills should be situated in areas of positive net subsurface inflow in view of possible pollution of soil and groundwater.

13

Het laat zich aanzien, dat houten funderingspalen onder gebouwen bij verlaagde grondwaterstanden kunnen worden beschermd tegen aantasting door softrot schimmels door een gedeelte van de bodematmosfeer te vervangen door een mengsel van stikstof en aardgas.

In the case of lowered groundwater levels wooden foundation piles below buildings may be protected from attack by softrot fungi by replacing part of the soil atmosphere by a mixture of nitrogen and natural gas.

14

Uit oogpunt van beheerskosten van natuurgebieden verdient het aanbeveling de randgebieden uit te breiden ten koste van de kernen.

Studiegroep Volthe-De Lutte (1971). *De landinrichting van het gebied Volthe-De Lutte, verkenning analyse en modellen*. Wageningen, 107 pp.

J. W. Righolt (1971) *Jaarverslag ICW 1970*: 107-111

To reduce management costs of nature conservancies it is recommended to extend the border areas at the expense of kernel areas.

Preface

At the finish of the here presented research it is with particular pleasure that I take the opportunity to thank all who have contributed to its completion.

I am greatly indebted to Prof. Dr. Ir. G. H. Bolt for the stimulating discussions in the course of this study. His lectures on transport processes in soil have been of great help to describe mathematically the transport of gases in soil near a gas leakage.

My sincere appreciation is due to the Committee for Study of the Influence of Natural Gas on Vegetation (SIAB) who provided me with the subject of the present investigation and especially to the members of the Steering Committee under whose aegis the research was conducted. The Vereniging van Exploitanten van Gasbedrijven (VEG) and the N.V. Nederlandse Gasunie generously undertook to bear the direct costs of the research, while the Wageningen Agricultural University placed her computer facilities at my disposal.

I am most grateful to Dr. Ir. C. van den Berg, Director of the Institute for Land and Water Management Research, for offering me the privilege to work in his Institute, the use of its facilities and, as my present employer, for allowing me to prepare the manuscript.

I express my gratitude to Ir. J. W. Bakker for the many fruitful discussions, his knowledge of soil aeration has been of great value for the research and the preparation of the manuscript. I gratefully remember the support given by Ir. B. Vrijhof and Ir. G. Gaikhorst, they kept me in close touch with the problems of natural-gas leakage encountered by park departments and gas companies and made valuable suggestions regarding parts of the manuscript.

I greatly appreciate the thoroughness with which Ir. E. W. Schierbeek MSF has gone through the manuscript, our fruitful discussions and his valuable remarks on its contents and his brilliant polishing of the English text. Valuable advice when preparing the manuscript was also given by Dr. Ir. R. A. Feddes, Dr. Ir. P. E. Rijtema and Ir. Ph. Th. Stol.

Thanks are due to Prof. Dr. Ir. E. G. Mulder for granting the facilities for research on the microbial aspects of natural-gas leakage, and to Dr. Ir. A. D. Adamse who made valuable remarks on parts of the manuscript and supervised the microbial research which was carried out by Mr. J. de Bont and Mr. J. F. van Kessel. Their contributions are gratefully acknowledged.

Thanks are also due to Prof. Dr. Ir. J. F. Bierhuizen for reading part of the manuscript and for stimulating a research on the growth of plants on gassed soils. The

cooperation of Mr. J. Leegwater in this research and of Mr. J. J. Asjee in an earlier stage of my research is much appreciated.

For the performance of field experiments, urban experimental sites were generously placed at my disposal by the Park Departments of Amsterdam, The Hague, Rotterdam, Utrecht, Wageningen and Zwolle, they also offered assistance in performing measurements and collecting soil samples. In this respect the assistance given by Mr. K. Pors and Mr. H. van Roomen is in particular to be mentioned. Much information was gained from measurements at an experimental field generously offered by the Forest Research Station and I wish to acknowledge the pleasant cooperation with several members of its staff.

I am very indebted to Mrs. M. J. van Dijk for the cheerfulness with which she faultlessly typed the drafts and the final manuscript. Thanks are due to Mr. A. L. N. Rietveld who, under the supervision of Mr. T. Klaassen, made the drawings. Measurements of some physical and chemical soil characteristics were performed by Miss G. A. Valk and Mr. G. Veerman, while some of the calculations were made by Miss M. G. van Steenbergen with assistance of Mrs. W. M. Hovestad and Miss G. Buitenhuis, for which I am duly grateful.

I wish to thank the Centre for Agricultural Publishing and Documentation for publishing the manuscript in its series 'Agricultural Research Reports'.

It almost goes without saying that without the patience and understanding of my wife Guus it would have been impossible to complete this study.

Curriculum vitae

Na zijn studie in de bodemkunde en bemestingsleer aan de Landbouwhogeschool te Wageningen gedurende 1962-1969 werd de auteur, als wetenschappelijk medewerker van de Studiecommissie Invloed Aardgas op Beplantingen, door de Landbouwhogeschool gedetacheerd op het Instituut voor Cultuurtechniek en Waterhuishouding te Wageningen. Sinds 1 januari 1972 is hij verbonden aan dit Instituut.

Contents

1 Introduction	1
2 Experimental sites and field measurements	5
2.1 Urban experimental sites	5
2.2 Non-urban experimental site	5
2.3 Measurements	7
2.3.1 Sampling of the soil gas phase	7
2.3.2 Methods to detect gases	8
2.3.3 Other measurements	11
3 Composition of the soil gas phase	12
3.1 General	12
3.2 Transport of gases in soil	12
3.2.1 Flow equation	12
3.2.2 Diffusion of gases	16
3.2.3 Bulk flow of gases	18
3.2.4 Influence of biological processes	19
3.3 Solution of the flow equation	19
3.3.1 Analytical solutions	19
3.3.2 Numerical solutions	23
3.4 Oxidation-reduction status of the soil	24
4 Processes near a leakage of natural gas	27
4.1 Microbial oxidation of methane	27
4.1.1 General	27
4.1.2 Laboratory experiments	28
4.1.3 Effect of composition of the soil gas phase	29
4.1.4 Effect of temperature and nutrients	32
4.2 Distribution of gases around gas leakages	35
4.3 Mathematical description of the distribution	38
4.3.1 Calculation of production terms	38
4.3.2 Coordinate geometry of the model	41
4.3.3 Steady state solutions	44
4.3.4 Non-steady state solutions	49
4.4 Computed and measured concentration distributions	50
4.4.1 Effect of leakage rate	50
4.4.2 Effect of temperature	53

4.4.3	Effect of soil fertility, moisture content and depth of groundwater	55
4.5	Reduction processes in the soil	57
5	Processes after repair of a gas leakage	60
5.1	General	60
5.2	Laboratory experiments	60
5.3	Effect of changing composition of the soil gas phase on microorganisms	62
5.4	Oxidation of reduced compounds	64
5.5	Oxygen overdemand of gassed soil	64
5.6	Changes in the soil gas phase	70
6	Causes of gas injury to vegetation	73
6.1	General	73
6.2	Metabolic activity of roots	73
6.2.1	Oxygen supply to roots	74
6.2.2	Effect of carbon dioxide	75
6.2.3	Root growth	76
6.2.4	Uptake of water and nutrients	76
6.3	Plant injury near gas leakages	77
6.4	Sensitivity of plants	79
6.5	Aftereffects and replanting	80
7	Measures to improve soil aeration	83
7.1	General	83
7.2	Curative measures	83
7.2.1	Technical aspects	84
7.2.2	Ventilation channels	84
7.2.3	Compressor treatments	93
7.3	Preventive measures	95
7.4.	Conclusions and recommendations	96
	Summary	98
	Samenvatting	104
	References	110
	List of used symbols	115
	Appendix I	
	Computer program for steady state distribution of gases around a leak	118
	Appendix II	
	Computer program for non-steady state distribution of gases around a leak	119
	Appendix III	
	Computer program for non-steady state distribution of oxygen around ventilation channels after leak repair	120

1 Introduction

Urban vegetation has several important functional tasks. Apart from the esthetic value by making a stony desert more attractive, vegetation also has a favourable effect on the urban microclimate. Temperature fluctuations are levelled and trees can catch considerable amounts of dust from the air. Furthermore the urban vegetation, particularly in parks, has an important recreative function as it may counterbalance the incessant hurry of daily life. Usually townsmen appreciate the urban vegetation as a pleasant element in their environment. Thus it is not surprising that people became worried about sudden deteriorations of urban vegetation as it was to be observed in the Netherlands some five to six years ago, just after the changeover from town gas to natural gas. Since such a changeover a considerable number of street trees and shrubs has been injured by leakage of natural gas from the gas distribution system in towns and villages in the Netherlands as also in other West-European countries.

As a consequence the Netherlands Association of Municipal Park Superintendents instituted the Committee for Study of the Influence of Natural Gas on Vegetation (SIAB). The committee was instructed to investigate the extent of the gas injury in the Netherlands, to study the processes in the soil near natural-gas leakages and to find measures to control and, if possible, to prevent the damage. Results of the Committee's work were published in a number of reports (SIAB, 1968a, b, 1969, 1970; Hoeks, 1971; Adamse et al., 1972a; Hoeks & Leegwater, 1972).

After the changeover from town gas to natural gas the number of leaks strongly increased from a mean of 6 to about 20 leaks per kilometer of cast iron mains. The leak size of the presently occurring leaks is on the average of the order of 40 l per hour (Gaikhorst, 1971). The increase in the number of leaks was caused by several factors (SIAB, 1968). The gas pressure in the low pressure distribution system was raised from 0.0065 to 0.025 ato (in parts of the low pressure network in some cities it has recently been raised to middle pressure, about 0.1 ato). In the second place, and this is also an important factor, the natural gas is often distributed through gas mains formerly used for the distribution of town gas. In 60% of this older distribution system (in the Netherlands about 13000 km) the cast iron pipes are jointed by the so-called lead-oakum joints. The oakum in these joints serves to provide a gastight connection. As the town gas was almost saturated with water vapour, the oakum absorbed water from the gas and swelled, thus forming a gastight joint. The natural gas, however, is extremely dry and this has a desiccating effect on the oakum. Consequently the oakum shrinks and the joint starts leaking. Gas mains with this older

type of joints are situated for the larger part in older town sections. In newer sections new gas mains have been installed in which modern joint techniques are used (Gaikhorst, 1971), as yet giving no problems. A third factor is the increase in traffic intensity, which causes more and more loose joints.

Low and middle pressure distribution networks are situated by necessity in urban surroundings. Accordingly leakages of natural gas will occur specifically in such areas and will there affect the vegetation, i.e. street trees and shrubs. In the first and fourth SIAB report (1968, 1970) some data are given on the extent of the damage. These data were collected from inquiries and some of the results are listed in table 1.

In these cases no information was available about the position of the tree with respect to the gas network, the age of the mains, the quality of the joints and the extent and nature of the pavement. Therefore it is not justifiable to draw conclusions with relation to the susceptibility of the different tree species and their age groups.

From these data it appears that 50 to 70% of the recently observed dead street trees have died as a result from leakage of natural gas. As the total number of street trees and also the total number of dead trees include trees in new town sections, where leakage of natural gas occurs only occasionally, the damage percentage will be higher if only the trees in the older sections would have been taken into account. The latter was done for three large cities (The Hague, Rotterdam, Zwolle). Here all the trees in the older sections are potential gas-trees, because these trees can be assumed to be in the near vicinity of an old gas main and thus may be affected by leakage. As here more information was available about the position of the tree, the percentage of damage caused by natural gas, as calculated from these figures, is more reliable (table 2).

This table shows that during the last four to five years about 5 to 20% of the street trees in the older town sections presumably died as a result of leakage of natural gas. This appeared to be 60 to 90% of the total mortality of street trees.

Damage to vegetation by underground leakage of natural gas has also been described in literature (Bray, 1958; Riva, 1961; Braverman et al., 1962; Kühne & Köster, 1967). The symptoms of the injuries are described as: yellowing and premature fall of the leaves, failure to bud, death of branches and a bluish-violet colouring of the

Table 1. Extent of mortality of street trees caused by leakage of natural gas (after SIAB, 1970). 'Gas-trees' are trees killed by leakage of natural gas.

	Growth stage of the trees		
	young	half-grown	full-grown
Total number of street trees	71,979	105,836	96,134
Total number of dead trees	2,010	2,774	1,906
Total mortality in %	2.8	2.6	2.0
Number of gas-trees	984	1,967	1,309
Gas mortality in % of total mortality	49	71	69

Table 2. Total mortality of street trees caused by natural-gas leakage, in older town sections up to the end of 1969 (after SIAB, 1970).

	The Hague	Rotterdam	Zwolle
Change-over to natural gas in	1967	1968	1965
Number of street trees	29,333	33,377	10,037
Number of potential gas-trees	16,618	10,014	3,031
Total number of dead gas-trees	760	1,370	569
Gas mortality as % of potential gas-trees	4.1	13.7	18.8

roots, accompanied by a typical smell of gas and organic acids. Until recently the natural gas in itself was assumed to be non-toxic (Gaikhorst & van Zijl, 1964). The hydrocarbons are almost all in a saturated state (table 3) and toxic components as CO, HCN and C₂H₄, which were the toxic components of town gas, should not be present. Recent research, however, as described by Adamse et al. (1972a) and Hoeks & Leegwater (1972), has given evidence about the presence of ethylene in natural gas in a concentration of about 2 to 3 ppm. Concerning the possible toxicity of the odor additive THT (tetrahydrothiophene) there is as yet little information. Pirone (1960) concluded from his experiments that the odorant mercaptan can be regarded as non-toxic.

The aerial contact of plants with natural gas has no or hardly any harmful effect (Solheim & Ames, 1941; Gustafson, 1944, 1950). Damage by underground leakage is ascribed by several authors to a lack of oxygen (Braverman et al., 1962; Kuhne & Köster, 1967). Other causes of damage are mentioned in literature as being partly a consequence of this lack of oxygen, like the occurrence of toxic, reduced components in the soil. Schollenberger (1930) found an increase of exchangeable Mn²⁺ up to 18% of the exchangeable cations. Strongly increased Mn²⁺ and Fe²⁺ contents were also found by Adams & Ellis (1960) and Kühne & Köster (1967).

Aside from the lack of oxygen, changes in bacterial processes are reported to take place (Harper, 1939), resulting in N-fixation, cellulose conversion and denitrification (Kaserer, 1905; Balks & Wehrmann-Ebsdorf, 1944). Schollenberger (1930) and later Adams & Ellis (1960) found an increase in organic matter content and an increase in

Table 3. Composition of natural gas in the Netherlands.

CO ₂	0.90%	C ₂ H ₆	2.7%	C ₆ H ₁₄	0.03%
O ₂	0.01%	C ₃ H ₈	0.37%	C ₇ H ₁₆	0.01%
N ₂	14.2%	C ₄ H ₁₀	0.16%	C ₈ H ₁₈	0.01%
CH ₄	81.6%	C ₅ H ₁₂	0.02%	C ₆ H ₆	0.01%

Odorant: THT (tetrahydrothiophene) about 20 mg per m³ natural gas at 15 °C and 1 atm.

Density: 0.82 g · l⁻¹ at 0 °C and 1 atm.

water retention of the soil. The desiccating effect of natural gas on the soil has also been mentioned as a possible cause of damage (Bray, 1958). With regard to the composition of the soil gas phase near leaks very few experimental data are available. Accordingly a closer examination of the processes occurring in soil near gas leakages appeared to be necessary.

The present investigations, performed on request of and in close cooperation with the SIAB-Committee already mentioned, were intended to gain an insight into the processes in the soil around a natural-gas leakage with the purpose to find measures for controlling and preventing damage to vegetation.

Subjects discussed in this study are: the composition of the soil gas phase as a result of gas transport processes and biological processes, changes in physical and (bio)chemical processes, as well during leakage of natural gas as after repair of the leak, and their influence on plant growth. Especially the rate of recovery of the soil environment is important in this respect, both for the survival of trees and for successful replanting of new trees. Finally the effects of some measures (curative and preventive) on soil aeration will be discussed.

The investigations consisted in part of the observation of the changes in composition of the soil gas phase at selected sites in urban regions where the presence of a gas leakage had been established. In addition a controlled experiment was set up at the Forest Research Station in Wageningen, where a controlled gas 'leakage' was induced between poplars and willows growing on an experimental field sealed with plastic sheeting. This latter experiment proved to be of great importance as it allowed precise observations of all processes taking place in the soil right from the start of a gas leakage.

The observed effects could be described mathematically and the formulae evolved could be used to predict the influence of leakage of natural gas on the composition of the soil gas phase as well as to predict the effect of certain control measures. In many cases such calculated predictions could be compared with experimental data.

2 Experimental sites and field measurements

2.1 Urban experimental sites

At various sites where accidental leakages of natural gas occurred in streets lined with trees (in the towns of Amsterdam, The Hague, Rotterdam, Utrecht, Wageningen and Zwolle) measurements were taken. The experimental measurements mainly consisted of analyses of the soil gas phase. In addition the effects of curative measures were studied from the ensuing change in the soil gas phase composition. The measurements were taken during one or two years and this appeared to be too short a period to study the whole process of recovery of the tree after repair of the leak. An injured tree mostly needs several growing seasons for its regeneration processes. More prolonged research would be necessary to ascertain which tree species have a good capability for recovery.

For the interpretation of some obtained results, especially concerning the effect of measures, the relative position of the leak, of the sampling points, of the ventilation channels present, etc. are very important. Therefore a layout of five experimental sites is given in fig. 1.

Some additional facts on soil texture, depth of groundwater and soil pH, which may be important for the processes in the soil near the leaks given in fig. 1 are:

fig. 1A, B and C, experimental sites in The Hague: fine sand poor in humus (dune sand); bulk density 1.3 to 1.4 $\text{g} \cdot \text{cm}^{-3}$ (pore volume 45 to 50%); pH-KCl 6.9 to 7.6; groundwater table about 1.20 to 1.50 m below soil surface;

fig. 1D, experimental site in Wageningen: humic sand (man-made 'plaggen' soil in pleistocene colian sand); bulk density 1.5 to 1.6 $\text{g} \cdot \text{cm}^{-3}$ (pore volume 40 to 45%); pH-KCl 6.5 to 7.0; groundwater table deeper than 2.00 m below soil surface;

fig. 1E, experimental site in Rotterdam: fine sand poor in humus (river sand); bulk density 1.3 to 1.4 $\text{g} \cdot \text{cm}^{-3}$ (pore volume 45 to 50%); pH-KCl 7.6 to 8.0; groundwater table about 1.25 to 1.50 m below soil surface.

2.2 Non-urban experimental site

The experimental field at the Forest Research Station in Wageningen has a soil profile of coarse sand with gravel, classified as Holt podzol on the soil map of the Netherlands (de Bakker and Schelling, 1966). The top soil (0-20 cm) is a dark humic layer with an organic matter content of 4%, a bulk density of 1.3 to 1.4 $\text{g} \cdot \text{cm}^{-3}$ soil (pore volume 45 to 50%) and a pH-KCl of 3.7 to 4.1. The subsoil (below 20 cm)

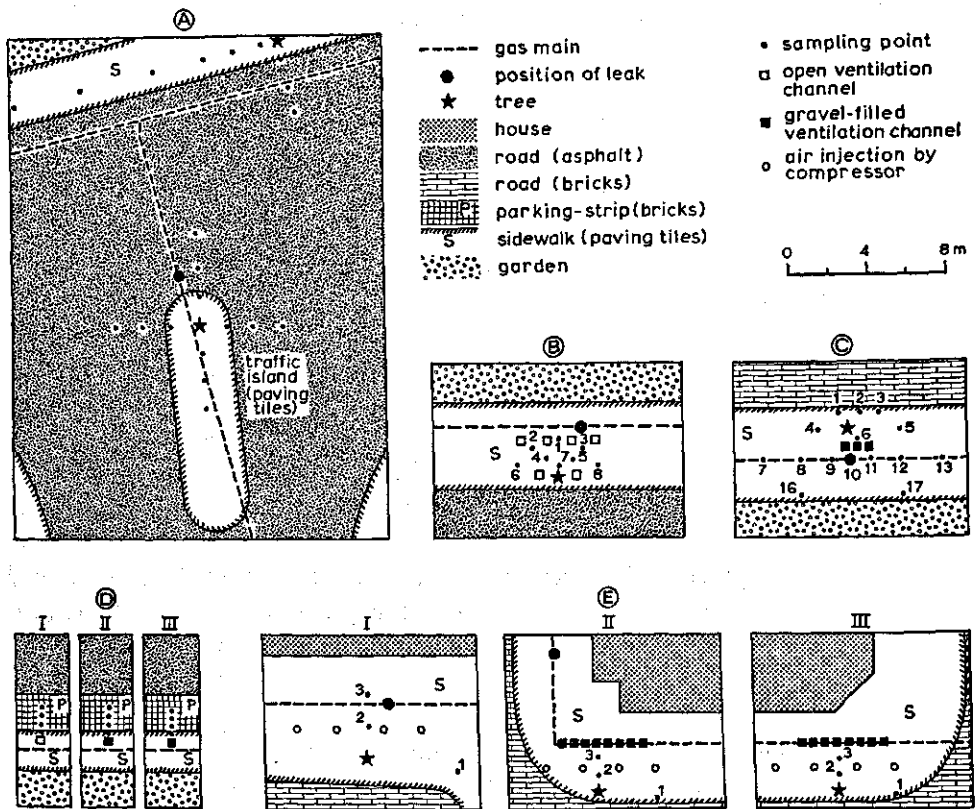

Fig. 1. Layout of some of the urban experimental sites. A: Prinsenvinkenpark, The Hague, measurements during and after leakage; B: Goudenregenstraat, The Hague, measurements after leakage starting from installation ventilation channels (12-VII-1971); C: Oostduinlaan, The Hague, measurements during leakage before and after installation ventilation channels (8-VII-1969); D: Geertjesweg, Wageningen, three separate leaks (I, II, III), measurements after leakages starting from installation ventilation channels (17-IX-1969); E: Pieter de Hooghstraat, Rotterdam, three separate leaks (I, II, III), measurements of I during leakage and air injection, II the same after installation ventilation channels, III after leakage and after installation ventilation channels.

is a redish-brown layer 50 cm thick with an organic matter content of 1%, a bulk density of 1.5 to $1.6 \text{ g} \cdot \text{cm}^{-3}$ soil (pore volume 40 to 45%) and a pH-KCl of 4.2 to 4.9, overlying sandy pleistocene deposits. The depth of the groundwater table is about 20 meter below soil surface.

An artificial leak was installed by means of inserting a piece of iron tubing reaching to a depth of 80 cm below soil surface (this being the most common depth of gas mains in the Netherlands) and bleeding natural gas at a controlled rate, varying between 5 and 250 liter per hour, as checked with a flow meter.

In the experiments the soil surface was covered with a plastic sheeting in order to simulate the effect of pavement. The oxygen diffusion coefficient of the plastic sheeting was determined according to the method of Bakker & Hidding (1970). The diffusion

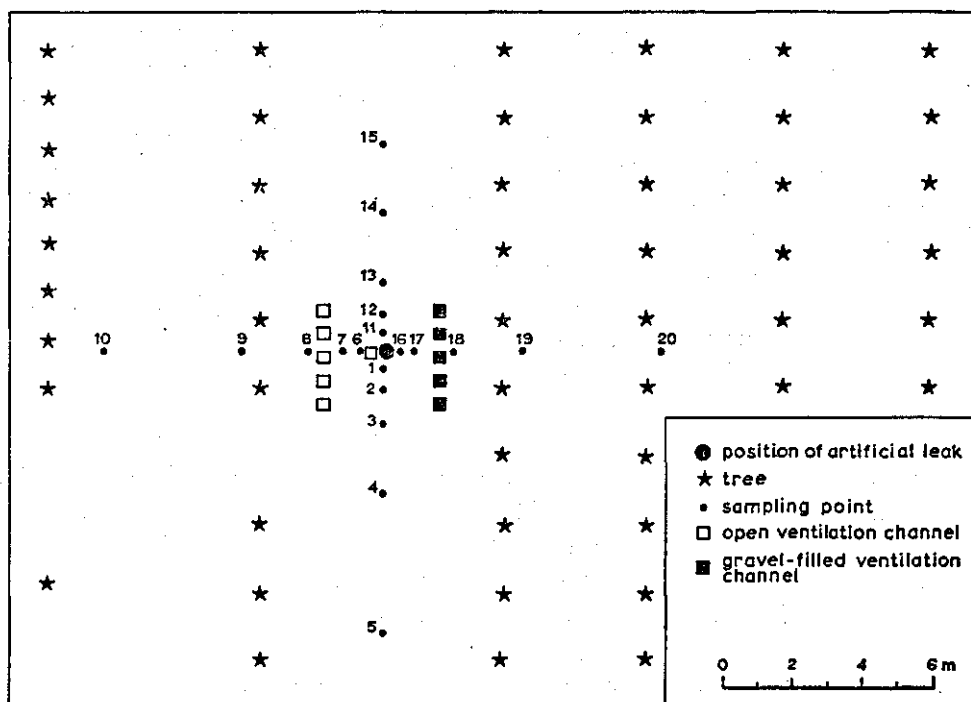

Fig. 2. Layout of the non-urban experimental site, Forest Research Station, Wageningen; measurements from the start of leakage before and after installation ventilation channels (the two rows on 5-VIII-1970; channel near leak on 11-IX-1970).

resistance (thickness of sheeting over diffusion coefficient) was more than $10^5 \text{ s} \cdot \text{cm}^{-1}$, which is comparable with the values for an asphalt pavement 5 cm thick. The plastic sheeting was fitted as closely as possible to the trunk of the trees growing on the field, thus limiting the escape of gas to the atmosphere to a minimum.

At first the processes from the start of the leakage were examined without ventilation channels. In a later stage their effect was also studied. The layout of the experimental field is given in fig. 2.

2.3 Measurements

2.3.1 Sampling of the soil gas phase

Most of the measurements concerned analyses of the soil gas phase. The most important gas components near leaks of natural gas are methane (CH_4), oxygen (O_2) and carbon dioxide (CO_2). The concentration of these gases in per cent of volume was measured periodically. In a few cases the concentration of ethane (C_2H_6), propane (C_3H_8) and butane (C_4H_{10}) in the soil gas phase was also determined.

Various lengths of copper tubing (inner diameter 1 mm) were installed into the

soil as permanent sampling points (see fig. 2). At the top, these were connected to nylon tubing, from which samples of soil air could be sucked. After taking a sample, the nylon tubing was closed with a nail, thus preventing gas exchange between soil and atmosphere. The samples were either analyzed in the field (with portable instruments) or transported to the laboratory in specially made small bags of aluminium-coated cellophane. At the urban experimental sites most samples were taken at a depth of 50 cm below the pavement unless mentioned otherwise. On the experimental field at each sampling point the sampling depths were 20, 50 and 80 cm, while at a distance of 50 cm from the leak samples were also taken at a depth of 120, 150 and 180 cm below soil surface, all via separate copper pipes.

2.3.2 Methods to detect gases

For detection of gas components in a mixture of gases several methods are available, for which various instruments available on the market can be applied (cf. Janse, 1969). This does not mean, however, that each method of detection is equally convenient for analysis of the soil gas phase around a leak.

The methods for the detection of gases are mostly based on:

a. Heat conductance: if the heat conductivity of the gas component in question clearly differs from the conductivity of all the other components of the mixture, then this method can be used for detection. However, in the case of the detection of methane in a soil air sample, complications arise. From table 4 it appears that not

Table 4. Some properties of a number of gases.

Gas	Density at 0 °C, 1 atm ($g \cdot l^{-1}$)	Heat conductivity at 0 °C, 1 atm ($\times 10^{-3}$ $cal \cdot cm^{-1} \cdot$ $s^{-1} \cdot ^\circ K^{-1}$)	Solubility in water at 20 °C, 1 atm ($g \cdot l^{-1}$)	Diffusion coefficient in air at 20 °C, 1 atm ($cm^2 \cdot s^{-1}$)	Sound velocity at 0 °C, 1 atm ($m \cdot s^{-1}$)	Viscosity at 20 °C, 1 atm ($\times 10^{-4}$ $dyne \cdot$ $cm^{-2} \cdot s$)	Specific magnetic susceptibility at 20 °C, 1 atm ($\times 10^{-6}$)
Air	1.29	5.66	0.024	—	331	1.81	—
O ₂	1.43	5.70	0.044	0.20	316	2.03	+106.2
N ₂	1.25	5.66	0.019	—	334	1.75	-0.342
CO ₂	1.97	3.37	1.73	0.158	259	1.46	-0.423
CH ₄	0.71	7.15	0.024	0.189*	430	1.09	-2.5
C ₂ H ₆	1.34	4.26	—	—	308**	—	—
H ₂	0.09	39.7	0.002	0.720	1284	—	-1.97
H ₂ O-vapour	0.80	4.29	—	0.258	401	—	—
SO ₂	2.86	1.95	110	—	213	—	—
NO	1.34	5.65	—	—	324**	—	+48.66

* Calculated with eq. (9).

** at 10 °C.

only methane but also carbon dioxide has quite a different heat conductivity from oxygen, nitrogen and air. Therefore high concentrations of carbon dioxide in the sample, as is common in soil air samples, greatly disturb the methane determination. Only when the methane concentration is very high, as is the case close to a leak, this determination will be more or less reliable, particularly because in that case the concentration of carbon dioxide is generally low.

b. Propagation of sound waves: each gas has its own characteristics with respect to the propagation of sound waves. Again methane and carbon dioxide show characteristics clearly different from the other components of air. Accordingly, this principle is not convenient for analysis of the soil gas phase near leaks of natural gas.

Apparatuses, based on this method, are used by several gas companies in the Netherlands for the detection of gas leaks. Because of the interference by carbon dioxide the readings are not accurate and only the larger leaks can be detected. From measurements of Förch (1970) it became clear that near leaks the methane concentration must be higher than 10 to 20% before the meter gives readings indicating the presence of this gas.

c. Combustion of gases: this method can be used for the detection of combustible gases. The sample flows along a glowing platinum wire and the burning gas raises the temperature of the wire, resulting in a change of the electric resistance of the wire. The rise in temperature of the wire is dependent on the amount and the heat of combustion of the gas burnt. The wire temperature will also depend on the heat conductivity of the surrounding gas mixture and here carbon dioxide may interfere again. The temperature rise is only little affected by it, however.

This method gives good results in the detection of leaks, particularly when the concentration of natural gas is low. When the gas concentration is higher than the Lower Explosive Level (LEL), the sample has to be diluted with air for a reading to be realized. In most cases the degree of dilution in the apparatus used is not constant enough and therefore the determination of methane concentrations higher than LEL is not very accurate.

d. Flame ionization: this method is convenient for the detection of hydrocarbons. In a hydrogen flame the hydrocarbons are ionized and this process changes the electric conductivity of the flame. Even very small concentrations (parts per million) can be detected in this way.

e. Infrared absorption: hetero-atomic gas components have characteristic absorption spectra in the infrared zone. The method is useful for gases as CH_4 and CO_2 , but not for homo-atomic gases as N_2 , H_2 and O_2 . With the aid of filters it is possible to eliminate the effect of interfering gases. Very low concentrations (parts per million) can be detected.

f. Chemical absorption in liquids: this method is very convenient for the volumetric determination of oxygen (absorption in pyrogallol) and carbon dioxide (absorption in potassium hydroxide). Particularly the absorption of oxygen in pyrogallol takes some time. Some new absorption liquids for the oxygen determination have been developed, however, in which the absorption proceeds at a faster rate.

The absorbing liquids are specific for the various gases, so interference by other components is negligible. The method is sometimes used to calibrate apparatuses based on other methods.

g. Polarography: this electrochemical method can be used for the determination of oxygen, because of the unique feature of this gas to reduce at a cathode when a certain difference in potential (-0.7 V) is created between cathode and anode. As anode a Ag or Zn-electrode and as cathode a Au or C-electrode is used, the electrodes placed in a saturated KCl-solution. Then the following reactions occur

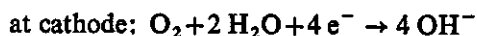

When the anode is a Zn-electrode, the difference in potential required for the reaction given above is self-generated. When it is a Ag-electrode then the voltage between the two electrodes must be maintained at 0.7 V. The KCl-liquid in the cell may become poisoned when brought into contact with high carbon dioxide concentrations. Normally the sample is in the apparatus for a short time only and afterwards atmospheric air is sucked into it to calibrate it again. In this way the poisoning effect of carbon dioxide appears to be no problem.

h. Paramagnetic behaviour: only a small number of gases have a significant specific magnetic susceptibility, e.g. O_2 , NO and NO_2 . In soil air nitrogen oxides are not present or only in a very low concentration. Therefore this method can be used for the determination of oxygen in soil air samples. The oxygen is brought into a magnetic field affecting the magnetic field strength. The change in position of a magnet in that field is electrically compensated, the force of the compensating current is proportional to the oxygen concentration.

Summarizing, the methods based on heat conductance (*a*) and propagation of sound waves (*b*) are not satisfactory for the determination of methane and carbon dioxide in soil air samples. The methane concentration may be determined with methods based on combustion (*c*), flame ionization (*d*) or infrared absorption (*e*), the carbon dioxide concentration with methods based on infrared absorption (*e*) or chemical absorption in potassium hydroxide (*f*) and the oxygen concentration with methods based on absorption in pyrogallol (*f*), polarography (*g*) or specific magnetic susceptibility (*h*).

For measurements in the field portable apparatuses were mostly used. The methane concentration was determined with a Johnson-Williams Combustible Gas Detector (Sniffer model C), based on combustion of methane. The oxygen concentration was determined with a Johnson-Williams Oxygen Indicator (model K), based on the polarographic method (Zn and Au-electrode); in some cases an Orsat-apparatus (chemical absorption in pyrogallol) was used. The carbon dioxide concentration was also determined with this Orsat-apparatus (absorption in potassium hydroxide).

Laboratory analyses were in some cases performed with other types of instruments. Thus the concentration of methane and carbon dioxide was determined with the aid of an URAS-apparatus, based on absorption of infrared light. In some cases a total analysis of the gas sample was made with a gaschromatograph. In a column filled with Porapak R the constituents of the gas mixture were separated and the concentration was determined with a flame ionization-detector.

2.3.3 *Other measurements*

Aside from analyses of the soil gas phase a few other characteristics of the soil were determined. These were the pH-KCl, the redox potential as measured with a Pt-calomel electrode couple, the organic matter content, moisture content, the soil moisture characteristic (moisture content as a function of moisture tension) and gas-filled pore space. Soil temperatures at three depths (20, 50 and 80 cm below soil surface) were read with the aid of thermistors at the time the soil gas phase composition was measured.

3 Composition of the soil gas phase

3.1 General

The gas phase of the soil contains a number of components of which nitrogen, oxygen and carbon dioxide are quantitatively the most important ones. As nitrogen usually behaves as an inert gas (except in nitrogen fixation processes) oxygen and carbon dioxide deserve most attention, particularly because they affect biological and physico-chemical processes in the soil and, specifically, the growth of its vegetative cover. Under special circumstances, as in the case of leakage of natural gas from underground gas mains, also other gas components may be important, for instance methane.

The composition of the soil gas phase is determined by the combined result of two processes, namely the process of transport of gases, from atmosphere to soil as well as within the soil, and the biological c.q. chemical processes. The transport of gases in soil may be impeded by excessively wet soil conditions or by dense structures under moist conditions, or both when the top soil is in puddled condition (Domy & Kohnke, 1956; Bakker & Hidding, 1970). Tillage of the soil may favourably influence the exchange of gases between atmosphere and soil (van Duin, 1956).

Considering the situation in a soil under a pavement, the moisture content of the commonly sandy soil is usually rather low because the larger part of the rain water flows directly into the sewage system. So the moisture conditions will hardly offer any problems for the transport of gases. As the pavement is rather impervious, however, the exchange of gases with the atmosphere is restricted, especially when it concerns asphalt, which constitutes an almost perfect seal.

In this chapter the general aspects of the transport processes determining the composition of the soil gas phase and the effect of this composition on soil processes will be discussed.

3.2 Transport of gases in soil

3.2.1 Flow equation

Gas transport in soil is mainly governed by diffusion but in some cases also bulk flow may be important. The general flux equation, taking into account both processes, is

$$F_m = -D_m \nabla \rho_m + v \rho_m \quad (\text{mg} \cdot \text{cm}^{-2} \cdot \text{s}^{-1}) \quad (1)$$

where $F_m(\text{mg} \cdot \text{cm}^{-2} \cdot \text{s}^{-1})$ is the flux of gas component m in the soil, $\rho_m(\text{mg} \cdot \text{cm}^{-3})$ is the concentration of that component in the soil gas phase, $v(\text{cm} \cdot \text{s}^{-1})$ is the apparent flow velocity of the gas mixture through the soil (i.e. the volume of gas passing through unit area of soil in unit time) and $D_m(\text{cm}^2 \cdot \text{s}^{-1})$ is the diffusion coefficient of the component in the soil. The concentration gradient, being the driving force for the diffusion process, is represented by $\nabla\rho_m$.

Introducing in eq. (1) the equation for continuity

$$\frac{\partial H_m}{\partial t} = -(\nabla \cdot F_m) + A_m \quad (2)$$

one finds the flow equation

$$\frac{\partial H_m}{\partial t} = (\nabla \cdot D_m \nabla \rho_m) - (\nabla \cdot v \rho_m) + A_m \quad (\text{mg} \cdot \text{cm}^{-3} \cdot \text{s}^{-1}) \quad (3)$$

where $H_m(\text{mg} \cdot \text{cm}^{-3})$ is the total amount of component m per unit volume of soil and $A_m(\text{mg} \cdot \text{cm}^{-3} \cdot \text{s}^{-1})$ is the rate of production of component m per unit volume of soil in unit time (negative if the component is consumed). If ε_g is the gas-filled pore space of the soil then $H_m = \varepsilon_g \rho_m$. The operator ∇ applied to a vector field v is defined (Timman, 1966) as

$$(\nabla \cdot v) = \lim_{V \rightarrow 0} \frac{\iint_S (v \cdot n) dS}{V} \quad (4)$$

where n is the unit vector directed along the normal to the surface $S(\text{cm}^2)$. The integration proceeds over the whole surface S enclosing the volume $V(\text{cm}^3)$. This limit is known as the divergence of the vector field v and expresses the net rate of influx per unit volume.

Assuming that ε_g and D_m are constant and that for practical purposes the density of the gas mixture is also constant (i.e. pressure gradients and temperature gradients are ignored, and the gas phase behaves like an incompressible fluid), equation (3) yields

$$\varepsilon_g \frac{\partial \rho_m}{\partial t} = D_m \nabla^2 \rho_m - (v \cdot \nabla \rho_m) + A_m \quad (\text{mg} \cdot \text{cm}^{-3} \cdot \text{s}^{-1}) \quad (5)$$

because in this case $(\nabla \cdot v) = 0$. The operator ∇^2 is defined in accordance with the particular coordinate system chosen.

Solution of equation (5) depends, of course, on the boundary conditions. In the procedure, as discussed in chapter 4, several coordinate systems were employed, yielding eq. (5S) for spherical symmetry at short distances to a natural-gas leakage, eq. (5C) for cylindrical symmetry at large distances and eq. (5R) for a two-dimensional rectangular system for the situation with more than one ventilation channel (chapter 7)

$$\varepsilon_g \frac{\partial \rho_m}{\partial t} = D_m \left(\frac{1}{r^2} \frac{\partial}{\partial r} \left(r^2 \frac{\partial \rho_m}{\partial r} \right) \right) - v_r \frac{\partial \rho_m}{\partial r} + A_m \quad (5S)$$

$$\epsilon_g \frac{\partial \rho_m}{\partial t} = D_m \left(\frac{1}{r} \frac{\partial}{\partial r} \left(r \frac{\partial \rho_m}{\partial r} \right) \right) - v_r \frac{\partial \rho_m}{\partial r} + A_m \quad (5C)$$

$$\epsilon_g \frac{\partial \rho_m}{\partial t} = D_m \left(\frac{\partial^2 \rho_m}{\partial x^2} + \frac{\partial^2 \rho_m}{\partial y^2} \right) - v_x \frac{\partial \rho_m}{\partial x} - v_y \frac{\partial \rho_m}{\partial y} + A_m \quad (5R)$$

Within the range of temperature gradients found in the soil under the conditions studied, the effect of these gradients on diffusion processes is rather small and accordingly the calculations were based on isothermal conditions. In that case ρ_m is directly proportional to the partial pressure.

In addition, the intrinsic permeability of the soil for gases is sufficiently high to warrant neglectance of gradients of the total gas pressure (arising as a result of bulk flow of gases), even in connection with gas leakages of considerable magnitude.

Taking the flux equation to be $v = -K(\partial p/\partial t)$, the flow equation expressed in spherical coordinates is

$$\epsilon_g \frac{\partial p}{\partial t} = K \left(\frac{1}{r^2} \frac{\partial}{\partial r} \left(r^2 \frac{\partial p}{\partial r} \right) \right) \quad (\text{cm}^3 \cdot \text{cm}^{-3} \cdot \text{s}^{-1})$$

In the steady state ($\partial p/\partial t = 0$), employing the boundary condition $-K(dp/dr) = Q_i(4\pi r^2)^{-1}$ and $p(r \rightarrow \infty) = p_a$, the distribution of the total pressure can be described by $p = p_a + Q_i(4\pi r K)^{-1}$, where $K = 1.013 \times 10^6 K_i \eta^{-1}$, K_i being the intrinsic permeability of soil, p_a the atmospheric pressure, η the viscosity of gas (see table 4). For a dune sand ($\epsilon_g = 0.20$ to 0.40 , bulk density $1.64 \text{ g} \cdot \text{cm}^{-3}$) with $K_i = 1$ to $3 \times 10^{-7} \text{ cm}^2$ (Bakker, personal communication), some calculated results are given in fig. 3.

Thus neglecting pressure gradients, the concentration of gas component m is directly proportional to the volume fraction of m in the gas mixture. As the experimental data were usually acquired as per cents of volume of the different gases, concentrations in tables and figures in the next chapters are expressed in terms of volume fractions (C_m). Conversion of C_m to ρ_m occurs according to

$$\rho_m = \rho_{om} C_m \quad (\text{mg} \cdot \text{cm}^{-3}) \quad (6)$$

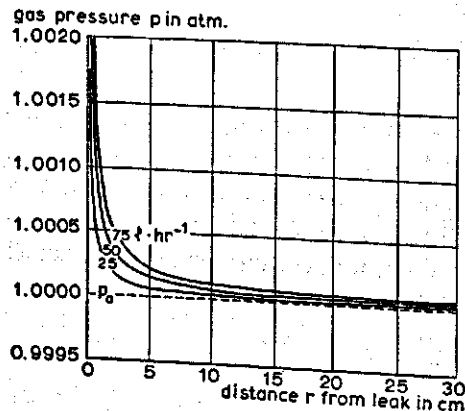

Fig. 3. Pressure distribution in the soil gas phase around a gas leak at three leakage rates Q_i ($1 \cdot \text{hr}^{-1}$) in a dune sand soil ($\epsilon_g = 0.30 \text{ cm}^3 \cdot \text{cm}^{-3}$; $K = 1.52 \times 10^3 \text{ cm}^2 \cdot \text{atm}^{-1} \cdot \text{s}^{-1}$; bulk density $1.64 \text{ g} \cdot \text{cm}^{-3}$).

where $\rho_{om} = pM_m (22.4)^{-1} 273T^{-1}$ (= density of the pure gas component m), p being the total pressure of the gas mixture (atm) and M_m the molecular weight ($\text{g} \cdot \text{mol}^{-1}$) of component m . The values of the factor ρ_{om} for the gases O_2 , CO_2 and CH_4 are given in table 5 as a function of T ($^\circ\text{K}$) at a total gas pressure of 1 atm.

For the situation considered, viz. $(\nabla \cdot v) = 0$, the velocity v of bulk flow, due to leakage of natural gas and to loss in volume as a result of biological processes, may be expressed for instance in terms of cylindrical coordinates

$$v = \frac{Q}{2\pi d_g r} \quad (\text{cm} \cdot \text{s}^{-1}) \quad (7)$$

where

$$Q = Q_i - 2\pi d_g \int_0^r \beta r \, dr \quad (\text{cm}^3 \cdot \text{s}^{-1}) \quad (7a)$$

and d_g the height of the cylinder, here equal to groundwater depth; Q_i being the rate of

Table 5. Factor $\rho_{om}(\text{mg} \cdot \text{cm}^{-3})$ for conversion of the volume fraction $C_m(\text{cm}^3 \cdot \text{cm}^{-3})$ to the gas concentration $\rho_m(\text{mg} \cdot \text{cm}^{-3})$ and of $\alpha_m(\text{cm}^3 \cdot \text{cm}^{-3} \cdot \text{s}^{-1})$ to $A_m(\text{mg} \cdot \text{cm}^{-3} \cdot \text{s}^{-1})$; $p_a = 1$ atm.

Temperature ($^\circ\text{K}$)	ρ_{om} for gas component		
	CH_4	CO_2	O_2
273	0.714	1.964	1.429
274	0.712	1.957	1.423
275	0.709	1.950	1.418
276	0.707	1.943	1.413
277	0.704	1.936	1.408
278	0.701	1.929	1.403
279	0.699	1.922	1.398
280	0.696	1.915	1.393
281	0.694	1.908	1.388
282	0.691	1.902	1.383
283	0.689	1.895	1.378
284	0.687	1.888	1.373
285	0.684	1.882	1.368
286	0.682	1.875	1.363
287	0.679	1.868	1.359
288	0.677	1.862	1.354
289	0.675	1.856	1.349
290	0.672	1.849	1.345
291	0.670	1.843	1.340
292	0.668	1.836	1.336
293	0.666	1.830	1.331
294	0.663	1.824	1.327
295	0.661	1.818	1.322
296	0.659	1.812	1.318
297	0.657	1.806	1.313
298	0.654	1.799	1.309

gas leakage ($\text{cm}^3 \cdot \text{s}^{-1}$) and β the loss in gas volume per cm^3 of soil ($\text{cm}^3 \cdot \text{cm}^{-3} \cdot \text{s}^{-1}$). The second term on the right hand side of eq. (7a) represents the total loss in volume in a cylinder with radius r and height d_g .

3.2.2 Diffusion of gases

The diffusion flux, given by Fick's first law, is dependent on the diffusion coefficient D_m in the soil. The soil factors influencing the diffusion coefficient (e.g. porosity and tortuosity factors) are commonly expressed in terms of the ratio D_m/D_{ma} , where D_m is the diffusion coefficient of a gas in soil and D_{ma} the diffusion coefficient of the same gas in air. The advantage of using this ratio is its independence of the nature of the gas or vapour. The ratio is related to the gas-filled pore space ε_g ($\text{cm}^3 \cdot \text{cm}^{-3}$) of the soil, according to Currie (1960)

$$D_m/D_{ma} = a\varepsilon_g^b \quad (8)$$

The coefficients a and b are related to the complexity of the pore system and to the degree of aggregation of the soil particles, so these coefficients will vary for different soils with different structure. Several authors have published data concerning the order of magnitude of the coefficients a and b (Currie, 1960 and 1961; Grable & Siemer, 1968; Bakker & Hidding, 1970). Many authors (see van Duin, 1956; Wesseling, 1957, 1962) found a linear relationship between D_m/D_{ma} and ε_g given by

$$D_m/D_{ma} = a(\varepsilon_g - b) \quad (9)$$

Data from literature concerning both relationships are summarized by Bakker & Hidding (1970). Millington & Shearer (1971) give a relation for D_m/D_{ma} taking into account the effect of aggregation in the soil. As the upper layers of the soil profile below a pavement are mostly sandy (single grain structure) and the gas-filled pore space is rather high (0.20 to 0.40 cm^3 per cm^3 of soil) because of low moisture contents, equation (9) will be used here, as this linear equation gives a good approximation of the relation between D_m/D_{ma} and ε_g for sandy soils at high values of ε_g . According to Call (1957) the coefficient a was taken 0.66 and b 0.10, this being in close agreement with data of Currie (1960 and 1961) as also of Penman (1940) and van Bavel (1952b) although the latter authors took b equal to zero.

The diffusion coefficient in air (D_{ma}) has to be known for a calculation of D_m . The diffusion coefficients of oxygen and carbon dioxide are known from experiments described in literature. For the component methane, which is important near leaks of natural gas, no experimental data were found. It is possible, however, to estimate the diffusion coefficient of methane in air with a formula based on molecular gas theory. Several authors (Wilke & Lee, 1955 and as cited by Reid & Sherwood, 1966; Slattery & Bird, 1958; Chen & Othmer, 1962; Othmer & Chen, 1962; Fuller, Schettler & Giddings, 1965) have proposed formulae derived from the theoretical one, introducing one or more empirical constants. Reid & Sherwood (1966) have tested these formulae with a large number of experimental data. It appeared that the theoretical formula

gave quite good results (mean deviation 7.5%), even better than some of the formulae improved with empirical constants.

The theoretical formula for calculation of diffusion coefficients in a mixture of two gases, which is based on the Chapman-Enskog kinetic theory (Bird et al., 1960), reads

$$D_{12} = 1.8583 \times 10^{-3} \frac{\sqrt{T^3 \left(\frac{1}{M_1} + \frac{1}{M_2} \right)}}{p \sigma_{12}^2 \Omega_D} \quad (\text{cm}^2 \cdot \text{s}^{-1}) \quad (10)$$

where

D_{12} = diffusion coefficient in a binary gas mixture ($\text{cm}^2 \cdot \text{s}^{-1}$),

σ_{12} = factor related to the dimensions of the molecules of components 1 and 2 (Å) and

Ω_D = factor indicating the probability of collision of the molecules, depending on the temperature as well as the potential field between the molecules of components 1 and 2.

The values for σ_1 and σ_2 [$\sigma_{12} = \frac{1}{2}(\sigma_1 + \sigma_2)$] and Ω_D have been tabulated for many gases by Hirschfelder et al. (1949, 1954).

The effect of temperature and pressure on the diffusion coefficient may be calculated with eq. (10), but because the coefficient Ω_D also depends on temperature it is easier to calculate these effects with the relation given by Slattery & Bird (1958)

$$D_m = D_{m0} \left(\frac{T}{T_0} \right)^{1.823} \left(\frac{p_0}{p} \right) \quad (\text{cm}^2 \cdot \text{s}^{-1}) \quad (11)$$

where D_{m0} is the diffusion coefficient at temperature T_0 and pressure p_0 .

Calculation of the diffusion coefficient of methane in air with eq. (10) yields a value of $0.166 \text{ cm}^2 \cdot \text{s}^{-1}$ at $273 \text{ }^\circ\text{K}$ and 1 atm. The calculated values for oxygen and carbon dioxide are respectively 0.175 and 0.129, which are in rather good agreement with the experimental data, being respectively 0.178 and $0.139 \text{ cm}^2 \cdot \text{s}^{-1}$ (Handbook of Chemistry and Physics, 1965/1966).

The gas phase of the soil is, however, a multicomponent heterogeneous mixture of gases and therefore the above equation is not entirely correct. Reid & Sherwood (1966) gave the following equation for the diffusion coefficient of component 1 (D_{1m}), diffusing in a homogeneous mixture of m components

$$D_{1m} = \frac{(1 - y_1)}{\sum_{j=2}^n (y_j / D_{1j})} \quad (\text{cm}^2 \cdot \text{s}^{-1}) \quad (12)$$

where y_1 is the mole fraction of the diffusing component, y_j the mole fraction of component j , and D_{1j} the diffusion coefficient for a binary mixture of component 1 and j (calculated with eq. 10). Calculations showed that for the composition of the soil gas phase near leaks (CH_4 : 0 to 25%; CO_2 : 1.5 to 10%; O_2 : 0 to 15%) the diffusion coefficients calculated with eq. (12) deviated less than 5% from the coeffi-

icients calculated with eq. (10). Therefore the effect of a change in composition of the soil gas phase on the coefficient of diffusion is further ignored. Changes in diffusion coefficients with position are neglected too because of the single grain structure of the sandy soil usually found beneath a pavement. Differences in pore space with depth may occur, but are ignored in the present calculations.

3.2.3 Bulk flow of gases

Transport of gases by bulk flow, i.e. flow of a medium in bulk, will occur as a consequence of gradients in total pressure. Such gradients may be caused by several factors (Bouyoucos, 1915, as cited by Grable, 1966; Keen, 1931; Romell, 1935, cited by Russell, 1952). The diurnal temperature wave, mostly restricted to rather shallow depths in the soil, creates gradients in density and pressure. The effect, however, is small (Russell, 1952), just as the effect of changes in barometric pressure (Grable, 1966). Bulk flow may also result from pressure gradients brought about by wind blowing over the soil surface and the pumping effect of infiltrating rain water. Kimball & Lemon (1971) found that at a depth of 8 cm below soil surface the effect of atmospheric turbulence on evaporation of hexane had decreased with 91 % in comparison with the effect at 1 cm depth. Gas transport in the soil due to these causes appears to contribute little to soil aeration as seen against diffusive transport (Russell, 1952).

Other processes which may cause bulk flow are biological processes. As a result of respiration of plant roots, microorganisms, etc. oxygen is consumed while carbon dioxide, and in some cases also methane and hydrogen, are produced. When the amount of gases consumed does not equal the amount of gases produced, a gradient in pressure will be built up, resulting in bulk flow. Under normal aerobic conditions the amount of oxygen consumed is approximately equal to the amount of carbon dioxide produced. Under wet circumstances, when the soil is poorly aerated, the production of gases may be in excess of the consumption (Black, 1957). Penningsfield (1950) stated that the oxygen consumption in the soil after a period of anaerobiosis is higher than the production of carbon dioxide. In all these cases oxygen is required for the oxidation of a reductant, mostly a solid organic compound.

In the special case to be discussed here the reductant is a gas itself, i.e. CH_4 in the soil, so the oxidation process is accompanied by a decrease in volume, as the formed H_2O is converted almost completely to the liquid phase. Accordingly the bulk flow induced by this process (and directed towards the oxidation zone) must be taken into account.

Finally the outflow of natural gas from a leak constitutes a significant bulk-flow term in the transport equation for gases. Obviously the magnitude of this term tends to diminish rather rapidly with increasing distance from the leak, especially in the case of spherical symmetry. Although the bulk-flow term is thus an important term in the transport equation to be solved, the earlier statement to the effect that gradients of total gas pressure can be ignored, remains valid because of the relatively high permeability of soil for gases.

3.2.4 Influence of biological processes

The composition of the soil gas phase is closely related to the biological activity of plant roots and micro- and macroorganisms (respiration processes). The marked diurnal and seasonal variations in oxygen and carbon dioxide concentrations in the soil reflect the effect of temperature on biological activity. Increase of this activity brought about by a raise of temperature, addition of nutrients and/or organic matter, involves an increase in oxygen consumption and carbon dioxide production. In the case of leakage of natural gas the microbial oxidation of methane and also of higher hydrocarbons is very important for the composition of the soil gas phase around a leak. Calculation of changes in concentration in the gas phase with a mathematical model requires some knowledge on the factors influencing this microbial process. In chapter 4 laboratory experiments will be discussed, showing the extent of the microbial methane oxidation as influenced by a number of such factors.

3.3 Solution of the flow equation

In many cases the flow under consideration is rather complex and analytical solutions are not possible, unless far-reaching simplifications are made. Such solutions can be given for several steady state problems and to a lesser extent for certain non-steady state problems. Below examples of solutions of some transport problems are given.

For the more complex systems numerical methods may give a good approximation of the real solution. Some general remarks will be presented on the use of numerical methods with regard to the problems of leakage of natural gas.

3.3.1 Analytical solutions

Steady state problems are easier to solve than non-steady state problems because one independent variable (t) is lacking, as $\partial C_m / \partial t = 0$. In one-dimensional systems the partial differential equation will then change into an ordinary differential equation.

Most analytical solutions known from literature solely concern the transport by diffusion. As mass diffusion and heat conduction are analogous in this respect, existing solutions are generally applicable to both phenomena. Many analytical solutions for different boundary conditions have been given by Carslaw & Jaeger (1959) and Crank (1956).

For non-steady state situations analytical solutions of the flow equation are available for systems with rather simple geometry, provided the initial and boundary conditions are not too involved.

Crank (1956) describes the following methods for solution of the flow equation in the non-steady state:

Reflection and superposition; this method can be used in the case of instantaneous

sources in an infinite, semi-infinite or finite system. The source may be a plane source, a line source or a point source and there may be reflection at an impermeable boundary. A certain amount of substance is injected at a certain time and position. The concentration distribution is then found to be expressible in terms of Gauss distribution functions. This method is particularly convenient for calculating the concentration distribution in the early stages of diffusion.

Separation of variables; this method yields series of trigonometric functions, which are because of a more rapid convergence more convenient for the middle and later stages of diffusion than the solutions of the above mentioned method.

Laplace transformation; this method can be used for various problems. The time variable of the partial differential equation is temporarily removed from the equation, thus leaving an ordinary differential equation to solve which is eventually translated back into a time dependent solution.

As soon as the problem is somewhat complicated, the given solutions for non-steady state cases are often too cumbersome for practical use. Complicated integrals often occur in the final equation, which have to be evaluated by numerical approximations.

For steady state problems analytical solutions are more readily available. Specific solutions concerning the aeration of the soil were given by for example van Bavel (1951, 1952a) and Lemon (1962). Van Bavel (1951) considers one-dimensional diffusion of oxygen in soil, taking into account consumption of oxygen in an active layer overlying or underlying an inactive layer, combined with a difference in diffusion coefficients for the layers if required. Aeration of the soil under a pavement can be treated in this way. The pavement will affect the soil gas phase composition in a similar way as a dense inactive topsoil layer, as discussed by van Duin (1956). The pavement has thickness d_p , overlying an active soil layer of thickness $(L-d_p)$, in which oxygen is consumed. The boundary conditions of this system are

$$z = 0 \quad C = C_a$$

$$z = L \quad \frac{dC}{dz} = 0$$

$$z = d_p \quad D_p \frac{dC}{dz} = D \frac{dC}{dz}$$

where D_p is the diffusion coefficient in the pavement and D is the diffusion coefficient in the soil.

With the condition that the concentration C is continuous at the boundary d_p between two layers, the solutions are:

for $0 < z < d_p$

$$C = -\frac{\alpha}{D_p}(d_p - L)z + C_a \quad (\text{cm}^3 \cdot \text{cm}^{-3}) \quad (13a)$$

for $d_p < z < L$

$$C = -\frac{\alpha}{2D}(z^2 - d_p^2) + \frac{\alpha L}{D}(z - d_p) + \frac{\alpha d_p}{D}(L - d_p) + C_a \quad (\text{cm}^3 \cdot \text{cm}^{-3}) \quad (13b)$$

where $-\alpha$ is the rate of consumption of oxygen expressed in volume units per unit volume of soil ($\text{cm}^3 \cdot \text{cm}^{-3} \cdot \text{s}^{-1}$); α may be converted to A ($\text{mg} \cdot \text{cm}^{-3} \cdot \text{s}^{-1}$) with the factor ρ_{om} (see table 5).

The value D_p is known for an asphalt pavement from experiments carried out by Bakker according to the method described by Bakker & Hidding (1970). Values of D_p for other kinds of pavements were estimated as

$$D_p = \epsilon_p D \quad (\text{cm}^2 \cdot \text{s}^{-1}) \quad (14)$$

where ϵ_p is the area fraction of the road surface which is non-sealed (open soil between the elements as bricks or tiles), expressed as cm^2 open soil per cm^2 pavement. Diffusion through bricks and tiles was neglected. The calculated data for oxygen diffusion coefficients are

asphalt pavement	$5 \times 10^{-5} \text{ cm}^2 \cdot \text{s}^{-1}$
tile pavement	$5 \times 10^{-4} \text{ cm}^2 \cdot \text{s}^{-1}$
brick pavement	$1.4 \times 10^{-3} \text{ cm}^2 \cdot \text{s}^{-1}$
soil	$3.8 \times 10^{-2} \text{ cm}^2 \cdot \text{s}^{-1}$

The rate of O_2 -consumption ($-\alpha$) in the active layer has been estimated here as $2 \times 10^{-7} \text{ cm}^3 \text{ O}_2$ per cm^3 of soil per second.

Some results of calculations with these values are given in fig. 4. For the chosen value of α the diffusion flux through the asphalt pavement is too small to supply

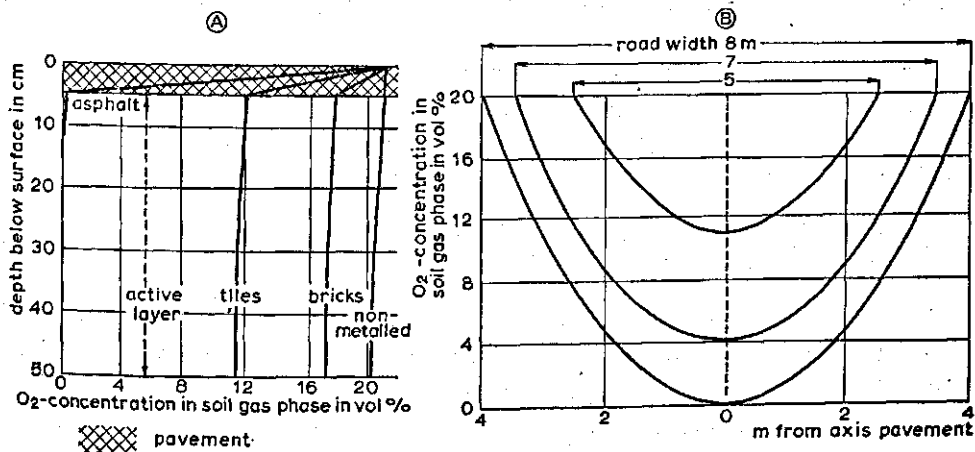

Fig. 4. Calculated O_2 -concentration in the soil gas phase under a pavement. A: under various infinite pavements compared with non-metalled soil for an oxygen consumption rate in the active layer of $2 \times 10^{-7} \text{ cm}^3 \cdot \text{cm}^{-3} \cdot \text{s}^{-1}$; B: under asphalt roads of various widths lined with grass borders for a 1 m thick active layer with an oxygen consumption rate of $1 \times 10^{-7} \text{ cm}^3 \cdot \text{cm}^{-3} \cdot \text{s}^{-1}$.

the whole active layer (here $L = 50$ cm) with oxygen; the oxygen flux is just enough to support biological activities in an active layer of about 10 cm. If other sources of oxygen supply, e.g. via non-metalled borders, soil around a tree or ventilation channels, are lacking root growth is hardly possible under an asphalt pavement. It is clear from fig. 4A that also the tile pavement may inhibit the aeration of the soil to a large extent once the consumption rate increases above the value chosen in fig. 4. From the non-metalled borders along an asphalt road oxygen enters beneath the pavement, so the oxygen concentration in the soil will depend on the width of the road (fig. 4B).

Diffusion of oxygen from a ventilation channel (see chapter 7) may be described in the steady state as

$$D\nabla^2 C = -\alpha \quad (15a)$$

In a cylindrically symmetric system this yields, if D is constant

$$\frac{D}{r} \frac{d}{dr} \left(r \frac{dC}{dr} \right) = -\alpha \quad (15b)$$

With the boundary conditions

$$r = r_v \quad C = C_v$$

$$r = L \quad \frac{dC}{dr} = 0$$

where r_v is the inner radius of the ventilation channel, the solution of this differential equation is

$$C = C_v - \frac{\alpha}{4D} (r^2 - r_v^2) + \frac{\alpha L^2}{2D} (\ln r - \ln r_v) \quad (\text{cm}^3 \cdot \text{cm}^{-3}) \quad (16a)$$

For the particular case that the ventilation channel is the only source of oxygen (other sources and diffusion through the pavement being negligible) there is an additional condition, namely $C = 0$ at $r = L$. Introducing this condition into eq. (16a) yields an equation in L according to

$$-\left(\frac{\alpha}{4D} + \frac{\alpha \ln r_v}{2D} \right) L^2 + \frac{\alpha}{2D} L^2 \ln L + \frac{\alpha r_v^2}{4D} + C_v = 0 \quad (16b)$$

The value of L , satisfying the above equation, may be approximated by the method of Newton-Raphson or with the regula falsi (iterative methods, cf. Kosten, 1966). Concentration distributions calculated according to eq. (16a) and (16b) for different values of α are given in chapter 7.

3.3.2 Numerical solutions

Solution of partial differential equations by numerical methods is based on the approximation of differentials by finite differences in the following way

$$\frac{dC_m}{dt} \approx \frac{C_m^{i,k+1} - C_m^{i,k}}{\Delta t} \quad (17a)$$

Furthermore

$$\frac{d^2C_m}{dx^2} \approx \frac{1}{\Delta x} \left[\frac{C_m^{i+1,k} - C_m^{i,k}}{\Delta x} - \frac{C_m^{i,k} - C_m^{i-1,k}}{\Delta x} \right] \quad (17b)$$

$$\frac{dC_m}{dx} \approx \frac{1}{2} \left[\frac{C_m^{i+1,k} - C_m^{i,k}}{\Delta x} + \frac{C_m^{i,k} - C_m^{i-1,k}}{\Delta x} \right] \quad (17c)$$

where $C_m^{i,k}$ represents the concentration at position $x = i\Delta x$ and at time $t = k\Delta t$. Combining eq. (17a), (17b) and (17c) yields an equation expressing $C_m^{i,k+1}$ explicitly as a function of the three known concentrations at time t , namely $C_m^{i-1,k}$, $C_m^{i,k}$ and $C_m^{i+1,k}$. This method is known as the explicit or Schmidt-method (cf. Crank, 1956).

Strictly speaking eq. (17a) gives the first derivative with respect to t at time $(t + \frac{1}{2}\Delta t)$, while eq. (17b) and (17c) approach the derivatives with respect to x at time t . In the Crank-Nicolson method (Crank & Nicolson, 1947, cited by Crank (1956)) the derivatives with respect to distance are therefore approximated for time $(t + \frac{1}{2}\Delta t)$ as follows

$$\begin{aligned} \frac{d^2C_m}{dx^2} \approx \frac{1}{2\Delta x} \left[\left(\frac{C_m^{i+1,k+1} - C_m^{i,k+1}}{\Delta x} + \frac{C_m^{i+1,k} - C_m^{i,k}}{\Delta x} \right) + \right. \\ \left. - \left(\frac{C_m^{i,k+1} - C_m^{i-1,k+1}}{\Delta x} + \frac{C_m^{i,k} - C_m^{i-1,k}}{\Delta x} \right) \right] \quad (18a) \end{aligned}$$

$$\begin{aligned} \frac{dC_m}{dx} \approx \frac{1}{4} \left[\left(\frac{C_m^{i+1,k+1} - C_m^{i,k+1}}{\Delta x} + \frac{C_m^{i,k+1} - C_m^{i-1,k+1}}{\Delta x} \right) + \right. \\ \left. + \left(\frac{C_m^{i+1,k} - C_m^{i,k}}{\Delta x} + \frac{C_m^{i,k} - C_m^{i-1,k}}{\Delta x} \right) \right] \quad (18b) \end{aligned}$$

Combining eq. (17a), (18a) and (18b) yields an implicit equation, in which the three unknown terms $C_m^{i-1,k+1}$, $C_m^{i,k+1}$ and $C_m^{i+1,k+1}$ are expressed in three known terms $C_m^{i-1,k}$, $C_m^{i,k}$ and $C_m^{i+1,k}$. The process yields n equations with n unknown concentrations which can be solved.

The explicit method is subject to the stability criterion, which means that the time interval Δt has to be related to the distance interval Δx . In order to prevent exponential growth of the errors inherent to the method, the relation has to satisfy $D_m^* \Delta t / \Delta x^2 \leq 0.5$ ($D_m^* = D_m / \epsilon_g$). This relation holds for the case of one dimensional linear diffusion.

The numerical method is used here for transport (diffusion and bulk flow) in cylindrical and spherical systems, however. In this case stability was secured when the relation satisfied $D_m^* \Delta t / \Delta r^2 \leq 0.45$, as found empirically. The distance interval Δr in numerical calculation of the composition of the soil gas phase around a gas leakage was taken at 20 cm. For D_m^* appearing in the stability relation, the highest diffusion coefficient of the three gas components under consideration (CH_4 , O_2 and CO_2) was taken, thus yielding Δt equal to 0.6 hour. Calculating the effect of ventilation channels, the distance interval Δr was taken 10 cm. A change of Δr from 5 to 25 cm appeared to give only slight differences in the calculated oxygen concentration (less than 0.5 vol. %). The discrepancies became smaller for larger distances and larger times.

With the implicit Crank-Nicolson method Δx and Δt can be chosen independently from each other and be relatively large compared with the explicit method, because this computation process is in principle stable. However, it requires a considerable amount of computation time when a concentration-dependent production function is taken into account, as then time-consuming iterative procedures have to be employed. Production functions can be accounted for much easier by using the explicit method, as this method does not present any difficulties when production (or consumption) varies with time and position. As a varying production function is characteristic for the soil around a gas leakage, the explicit method was employed in the present study.

3.4 Oxidation-reduction status of the soil

A considerable amount of research on the oxidation-reduction processes in the soil has been done on paddy soils (rice culture). During the period of inundation the soil is completely anaerobic, thus oxygen is absent from the gas phase. The oxygen molecule is acting in redox reactions as an electron acceptor. Electrons are released with the oxidation of for example Fe^{2+} , according to

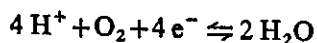
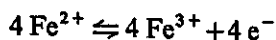

The Fe^{2+} -ion acts as an electron donor and the electron is transferred to an electron acceptor, here O_2 . Other electron donors in soil are Mn^{2+} and organic compounds, the latter often present in large quantities. If O_2 is practically absent, NO_3^- , Fe^{3+} , Mn^{4+} or SO_4^{2-} will act as electron acceptor.

A well-known reduction reaction is the reduction of nitrate (denitrification), proceeding in the following way (Laskowski & Moraghan, 1967)

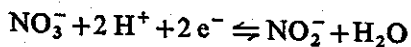

The NO_2^- will eventually be reduced to N_2O and N_2 . The loss of nitrogen, as N_2O and N_2 , is often observed within a couple of days after the onset of the anaerobic period. As soon as almost all of the NO_3^- has been reduced, the other electron ac-

ceptors Mn^{4+} , Fe^{3+} and SO_4^{2-} will successively be reduced

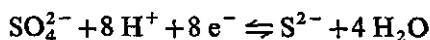
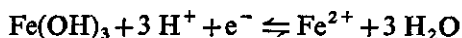
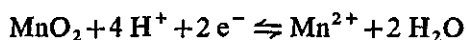

Electron donors, e.g. organic compounds, are required for these reduction reactions. Addition of easily decomposable organic matter is found to accelerate the reduction processes (Aomine, 1962; McKeague, 1965; Gotoh & Yamashita, 1966; Harmsen, 1971). The oxidation-reduction processes are related to the rate of microbial activity (Kamura et al., 1963; Parr, 1969).

The reduction processes cited above may be brought about by facultative anaerobic bacteria, except the reduction of sulphate which is accomplished by strictly anaerobic sulphate-reducing bacteria.

If the soil has been reduced to a large degree, organic compounds may be fermented by anaerobic microorganisms to gases as CH_4 , H_2 and CO_2 . So acetic acid can for example be reduced to methane

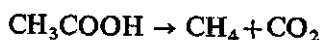

by methane-producing bacteria.

As electrons are involved in these redox reactions, measurements of electron activity in soil (redox potential measurements) will indicate the degree of reduction or oxidation in the soil. The redox potential for the redox reaction, $\text{Ox} + n\text{e}^- + a\text{H}^+ \rightleftharpoons \text{Red}$, can be expressed by the Nernst equation

$$E_h = E_0 + \frac{RT}{nF} \ln \frac{(\text{Ox})(\text{H}^+)^a}{(\text{Red})} \quad (\text{V}) \quad (19)$$

where

E_h = redox potential (V)

E_0 = standard potential at 25 °C (V)

R = gas constant (8.31 J.K⁻¹ · mol⁻¹)

T = absolute temperature (°K)

F = Faraday (96 500 C. eq⁻¹)

(Ox), (Red), (H^+) = activity of respectively oxidized component, reduced component and H^+ -ions (eq. l⁻¹)

n , resp. a = number of electrons resp. H^+ -ions involved in the reaction

Eq. (19) applied to the Fe^{2+} - $\text{Fe}(\text{OH})_3$ system yields at a temperature of 298 °K ($n = 1$)

$$E_h = 1.06 - 0.059 \log \text{Fe}^{2+} - 0.177 \text{pH} \quad (\text{V}) \quad (20)$$

In soil, however, the redox systems rarely reach an equilibrium state, because of a continuous, but often rather slow, oxidation of electron donors, i.e. oxidizable organic compounds (Bohn, 1971). Furthermore there will often be several redox couples

Table 6. Successive stages in the reduction processes in soil after Takai & Kamura (1966).

Reduction stage	Process	Redox pot. (V)	Microorganisms	Formation of organic acids
First stage	disappearance of O ₂	+0.60 to +0.50	aerobes	none
	disappearance of NO ₃ ⁻	+0.50 to +0.20	facultative	slight accumulation after addition of organic matter
	formation of Mn ²⁺	+0.40 to +0.20	anaerobes	
	formation of Fe ²⁺	+0.30 to +0.10		
Second stage	formation of S ²⁻	0 to -0.15	obligate anaerobes	rapid accumulation
	formation of H ₂	-0.15 to -0.22		rapid decrease
	formation of CH ₄	-0.15 to -0.22		

present in the soil, so at non-equilibrium the measured redox potential E_h will be a 'mixed potential' (Bohn, 1968 and 1971). The relation of such mixed potentials to the various activities of the oxidized and reduced components is as yet unsolvable. Because of non-equilibrium situations and also differences in experimental methods it is not surprising that the E_h -values mentioned in literature for the various redox reactions in soil vary rather much. A very precise measurement of E_h is of little use therefore (cf. also Jeffery, 1961b).

Nevertheless, measurements of redox potentials are useful in supplying a general picture of the intensity of the oxidation-reduction conditions in the soil. A rough estimation of the different E_h -levels, at which the mentioned reactions may be expected to occur, was given by Takai & Kamura, 1966 (table 6).

As H⁺-ions are involved in the reduction processes, the pH of the soil will change (Starkey, 1966; Ponnampertuma et al., 1966; Gotoh & Yamashita, 1966; Mukhopadhyay et al., 1967). In acid soils the process of reduction proceeds more rapidly than in alkali soils, as more H⁺-ions are available. Reversely, the process of oxidation proceeds more rapidly in an alkali soil (Greene, 1963).

During the stage of reduction the pH of an acid soil increases, because H⁺-ions are fixed. Here the drop in E_h and the rise in pH are likely to be determined by the Fe(OH)₃-Fe²⁺ system. In an alkali soil, however, the pH may decrease during the period of reduction (Adams & Ellis, 1960; Mukhopadhyay et al., 1967). Here different systems as the carbonate-carbon dioxide equilibrium may determine the decrease in pH (Ponnampertuma et al., 1966). In a flooded soil (and also near a gas leakage) CO₂ produced by bacterial action is accumulated in rather high amounts and this will affect the pH of the soil. Thus the increase in pH by reduction processes may be smaller than the decrease in pH by a raised CO₂-concentration.

Ponnampertuma stated that the pH of a soil should shift towards pH 7 during an anaerobic period. After aeration of the soil the pH shifts back towards the original value.

4 Processes near a leakage of natural gas

4.1 Microbial oxidation of methane*

4.1.1 General

From literature it is known that a number of microorganisms can grow in a medium with gaseous hydrocarbons as the only carbon-source. The hydrocarbons are then oxidized, yielding eventually CO_2 as the end product. The energy liberated in the oxidation process, may be used for the synthesis of cell material (assimilation of hydrocarbons).

Since natural gas consists of hydrocarbons to about 85% by volume, these microbial oxidation processes may be expected to occur in soil near gas leakages. Considering the composition of natural gas, particularly the oxidation of methane, ethane and propane should be important.

Methane-oxidizing microorganisms have been described by several authors (Kaserer, 1906; Söhngen, 1906; Harper, 1939; Leadbetter & Foster, 1960; Brown et al., 1964; Nyns & Wiaux, 1969). The organisms mentioned in literature are for example *Bacillus methanicus* (Söhngen, 1906), *Methanomonas methanooxidans* (Brown et al., 1964), *Methylococcus capsulatus* (Foster & Davis, 1966) and *Pseudomonas methanica* (Dworkin & Foster, 1956; Leadbetter & Foster, 1958).

The majority of investigations reported in literature concern the microbial oxidation of methane in water; only few authors investigated methane oxidation in soil near leakages of natural gas. Davis et al. (1964) and Coty (1967) reported an increased nitrogen content in soil near leaks. They isolated methane-oxidizing bacteria capable of fixing atmospheric nitrogen. Earlier Schollenberger (1930) and Harper (1939) already found accumulation of nitrogen in 'gassed soils'. Harper attributed this phenomenon to nitrogen fixation by *Clostridium* spp. under anaerobic conditions.

According to Brown et al. (1964) the oxidation of methane proceeds via a number of intermediates. Ribbons et al. (1970) calculated the change in free energy ($\text{kcal} \cdot \text{mol}^{-1}$) for each oxidation step in the course of methane oxidation



* Most of the material presented in this part has also been treated in Hoeks (1972).

Formaldehyde is likely to be a key compound for synthesis of cell material by methane-oxidizing microorganisms (Johnson & Quayle, 1964; Kemp & Quayle, 1967; Wilkinson, 1971). The chemical combustion reactions indicate the maximum relative amounts of oxygen and carbon dioxide which may be involved

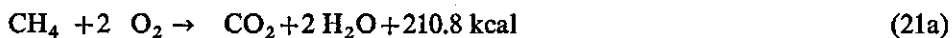

As in soil the oxidation is brought about by microorganisms using part of the hydrocarbons for the synthesis of cell material, the O₂-consumption and CO₂-production per unit volume of oxidized hydrocarbon will be lower than the relative amounts given above. Data from measurements with suspensions of methane-oxidizing bacteria yielded divergent values for the relation between the CH₄-consumption, O₂-consumption and CO₂-production (Söhngen, 1906; Dostalek, 1954; Dworkin & Foster, 1958; Brown et al., 1964; Whittenbury et al., 1970a; Naguib, 1971). Per unit volume of oxidized CH₄ the O₂-consumption ranged from 0.2 to 1.8 and the CO₂-production from 0.2 to 0.9 volume units. The large differences may in part have been due to additional oxidation of higher hydrocarbons (e.g. C₂H₆), which appeared to be present in a number of cases. Furthermore the growth stage of the microbial population should be of importance. In an early stage the number of bacteria will strongly increase and then the assimilation of CH₄ must be higher than in a later stage when the number of microorganisms remains almost constant (stationary phase).

Microorganisms using CH₄ as a source of carbon under anaerobic conditions are not reported in the literature.

4.1.2 Laboratory experiments

The rate of CH₄-oxidation and the resulting O₂-consumption and CO₂-production was investigated for dune sand soil from the town of The Hague. Soil samples were taken at a depth of 30 to 50 cm below the pavement. Two types of samples were distinguished, namely of:

Gassed soil: during the year before the experiment this soil in the neighbourhood of a leaking gas main, was saturated with natural gas; the O₂-concentration in the soil was almost 0%, the CO₂-concentration varied from 6 to 8% by volume. Other data: pH-KCl 7.8, organic matter 2.6%, moisture content 6.6% by weight.

Normal soil: this soil was sampled at the same site, but outside the zone of influence of the leak; the O₂-concentration was 17 to 19% throughout the year before the experiment, the CO₂-concentration 2 to 4% by volume. Other data: pH-KCl 8.1, organic matter 1.0%, moisture content 5.6% by weight.

The differences in pH, organic matter and moisture content between the two types

of soil may have resulted from local differences (heterogeneous soil). Nevertheless, such effects on pH, organic matter and moisture content resulting from gas leakage, have been reported by Harper (1939) and Adams & Ellis (1960).

The soil samples were transferred to metal pots (diameter 15.5 cm, height 23 cm), which were gastight, except for inlet and outlet through which a gas mixture (air, nitrogen, carbon dioxide and natural gas) was introduced and collected after passage through the soil (cf. also Dasberg & Bakker, 1970). By determining the influent and effluent amounts of a gas component, so the product of its concentration and of the flow velocity of the gas mixture, the rate of consumption or production of that gas component in the soil can be calculated.

Flow velocity was measured both at inlet and at outlet, with a flow meter. Considering the chemical combustion reaction (eq. 21a), the flow velocity is likely to be lower at the outlet than at the inlet, as only 1 mol CO₂ is produced while 1 mol CH₄ plus 2 mol O₂ are consumed. The formation of H₂O may be disregarded as it converts to the liquid phase.

The O₂-concentration was measured with a Johnson Williams Oxygen Indicator, Model K 525. For continuous measurements a Beckman Oxygen Analyser (nr. 777) was used. The CH₄ and CO₂-concentrations were measured with an Infrared Analyser (URAS) which was adapted to the different gases by changing the detector.

To obtain the rate of CH₄-oxidation in the soil, the rates of consumption of CH₄ and O₂ and the rate of production of CO₂, were determined at three constant temperature levels, viz. 20.5, 17.0 and 13.5 °C (within 0.2 °C). The effect of the composition of the gas mixture introduced into the soil, was investigated by varying the concentrations of the components concerned (CH₄: 0, 2.5, 5%; O₂: 0, 1, 2, 4, 7, 12, 21%; CO₂: 0, 8%) and by varying the flow velocity of the gas mixture (10 and 25 cm³ · min⁻¹).

During the experiments small soil samples were taken from the pots. At the Laboratory for Microbiology of the Agricultural University at Wageningen methane and ethane-oxidizing bacteria were isolated from the soil samples and the number of bacteria per gram of soil was counted. Results of microbiologic investigations are discussed in detail by Adamse et al. (1972b).

4.1.3 *Effect of composition of the soil gas phase*

When excess CH₄ and O₂ were supplied to the gassed soil, the rate of microbial oxidation of methane in the soil was found to be very high, resulting in high rates of O₂-consumption and CO₂-production. Values for the rate of O₂-consumption were found to be 50 to 100 times higher than those found in normal soil (table 7).

The ratio between the rate of consumption and the rate of production of the three components concerned approximated the ratio derived from the chemical reaction. From fig. 5 this relation could be calculated for the here presented case as

$$\alpha_{\text{CH}_4} : \alpha_{\text{O}_2} : \alpha_{\text{CO}_2} = -1 : -2.02 : +0.98$$

Table 7. Rate of O₂-consumption and CO₂-production (both in cm³ · s⁻¹ per cm³ of soil at about 20 °C) in a gassed soil, compared with normal soils.

Soil type	Particulars	O ₂ -consumption (×10 ⁻⁷)	CO ₂ -production (×10 ⁻⁷)
Dune sand	normal soil	0.5— 1.0	0.5— 1.0
Dune sand	normal soil with plant	2.7— 4.1	2.7— 4.1
Silt loam	normal soil with plant*	2.5— 5.8	2.5— 5.8
Dune sand	gassed soil during leakage of natural gas	190 —275	65 —95

* Derived from data of Dasberg & Bakker (1970).

It has to be mentioned that besides the oxidation of methane, also oxidation of ethane is likely to contribute to the O₂-consumption and CO₂-production. Considering the composition of natural gas, however, this effect will be relatively small. From the above relation it may be concluded that the CH₄-assimilation rate was low, indicating a more or less steady microbial population.

The rate of CH₄-oxidation depends on the density and the metabolic activity of the microbial population. In this respect factors as nutrient conditions (supply of inorganic nutrients, methane and oxygen), pH and temperature are most important.

The effect of the composition of the soil gas phase will be important with respect to the supply of O₂ and CH₄ to the methane-oxidizing microorganisms. From fig. 6 it becomes clear that the rate of CH₄-oxidation, as found in these experiments, did not correspond with the maximum attainable rate. Microbial activity was limited by a lack of oxygen as soon as the rate of O₂-supply was lower than 0.4 cm³ · min⁻¹. If the O₂-supply exceeded 0.4 cm³ · min⁻¹ the microbial activity was rather constant and the rate of CH₄-consumption was as high as the rate of CH₄-supply, being 0.18 cm³ · min⁻¹. Thus, in these experiments the microbial activity was either limited by the rate of O₂-supply or by the rate of CH₄-supply.

In order to find the maximum attainable rate of oxidation the rate of O₂ and CH₄-supply had to be increased. This was realized by raising the flow velocity of the gas mixture. Only in the case of low O₂-concentrations in the gas mixture the rate of O₂-supply still remained too low and appeared to be a limiting factor for microbial CH₄-oxidation. The fact that at very low O₂-concentrations of 0.6% all the oxygen supplied was consumed in the soil, leads to the conclusion that the activity of the methane-oxidizing microorganisms is, although dependent on the rate of supply of O₂, practically independent of the O₂-level in the gas phase.

After increasing the rate of O₂ and CH₄-supply, the relation between consumption and production terms changed a little [$\alpha_{\text{CH}_4}:\alpha_{\text{O}_2}:\alpha_{\text{CO}_2} = -1:(-1.8 \text{ to } -2.1):(+0.7 \text{ to } +0.8)$, at about 20 °C]. The relative decrease in CO₂-production may indicate a rise in CH₄-assimilation. Possibly the microbial population was growing during these experiments.

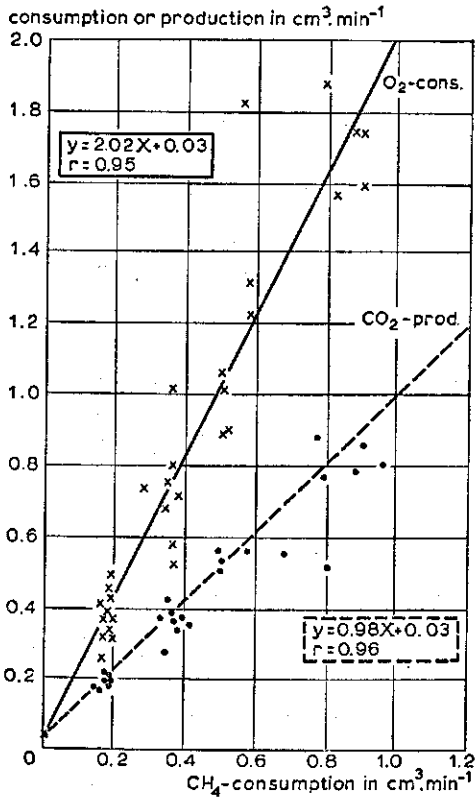

Fig. 5. Relation between the O_2 -consumption rate, resp. the CO_2 -production rate, and the CH_4 -consumption rate in a pot with dune sand soil at about 20°C .

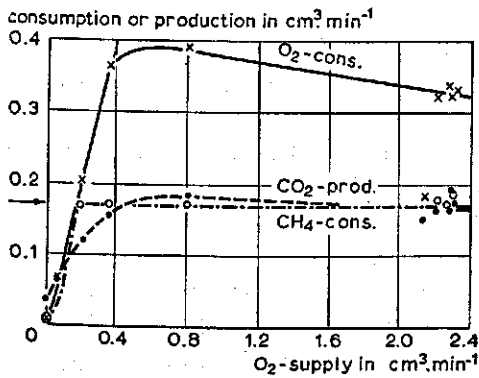

Fig. 6. Effect of the O_2 -supply on the microbial CH_4 -oxidation rate at a constant CH_4 -supply ($0.18 \text{ cm}^3 \cdot \text{min}^{-1}$) and about 20°C , measured as the consumption rates of O_2 and CH_4 and the production rate of CO_2 .

Data about the rate of CH_4 -oxidation are summarized in table 8. Here only data have been given concerning experiments in which the supply of both O_2 and CH_4 was not a limiting factor for microbial activity. So other factors as temperature, soil fertility and soil acidity will have determined the activity of the microorganisms.

Raising the CH_4 -concentration from 2.5 to 5% by volume did not increase the CH_4 -consumption rate, so the activity of the methane-oxidizing microorganisms,

Table 8. Rate of microbial CH₄-oxidation at 17 °C, as influenced by composition of the gas mixture.

Pot	Composition of gas mixture in vol.%			Temp. (°C)	Production in cm ³ · s ⁻¹ per cm ³ soil (× 10 ⁻⁵)			α _{O₂} : α _{CH₄} : α _{CO₂}
	CH ₄	CO ₂	O ₂		O ₂	CH ₄	CO ₂	
G-8	2.5	<0.1	7.7	17.0	-1.14	-0.61	+0.47	-1.9 : -1 : +0.8
	2.7	<0.1	11.4	17.4	-1.22	-0.69	+0.50	-1.8 : -1 : +0.7
	2.6	<0.1	20.2	17.0	-1.17	-0.58	+0.39	-2.0 : -1 : +0.7
G-9	4.7	<0.1	7.5	17.0	-1.92	-0.64	+0.67	-3.0 : -1 : +1.0
	4.9	<0.1	11.0	17.4	-1.86	-0.75	+0.72	-2.5 : -1 : +1.0
	4.6	<0.1	19.7	17.0	-1.78	-0.61	+0.64	-2.9 : -1 : +1.0
G-19	2.5	8.1	7.5	17.4	-2.25	-0.94	+0.64	-2.4 : -1 : +0.7
	2.4	8.4	11.5	17.0	-1.92	-0.89	+0.61	-2.2 : -1 : +0.7
	2.3	7.8	18.8	17.6	-1.81	-0.86	+0.50	-2.1 : -1 : +0.6
G-20	5.3	7.9	7.5	17.4	-2.81	-0.94	+0.78	-3.0 : -1 : +0.8
	5.4	8.5	11.4	17.0	-2.67	-1.06	+0.81	-2.5 : -1 : +0.8
	5.0	7.7	18.3	17.6	-1.78	-0.69	+0.58	-2.6 : -1 : +0.8

although dependent on the rate of CH₄-supply, is not influenced by the CH₄-level. The O₂-consumption rate and the CO₂-production rate did increase, however. Gas-chromatographic analyses (carried out at the Laboratory of Microbiology, Agricultural University at Wageningen) showed also ethane and propane being oxidized in the soil by bacteria (Adamse et al., 1971). Because of the low concentrations of these components in natural gas the rate of C₂H₆-supply and of C₃H₈-supply will have been limiting the activity of ethane and propane-oxidizing microorganisms. A two-fold CH₄-concentration by raising the amount of natural gas supplied, implies a two-fold C₂H₆ and C₃H₈-concentration. Therefore the consumption rates of C₂H₆ and C₃H₈ will have increased with a factor 2. This may at least partly explain the relative rise in O₂-consumption and CO₂-production at the highest CH₄-concentration in the gas mixture.

The presence of CO₂ in the gas mixture was found to stimulate the activity of the methane-oxidizing microorganisms, possibly resulting from a pH-effect. The rate of CH₄-oxidation was clearly augmented as appeared from the increased CH₄ and O₂-consumption and CO₂-production data. The production of CO₂ slightly reduced in proportion to the consumption of O₂ and CH₄ as reflected in the relation α_{CH₄} : α_{O₂} : α_{CO₂}. This might indicate that under these conditions the microbial population increased (higher CH₄-assimilation rate) and/or the CH₄-oxidation proceeded less completely, yielding incompletely oxidized intermediates.

4.1.4 Effect of temperature and nutrients

The metabolic activity of the methane-oxidizing microorganisms was strongly influenced by temperature. At the Laboratory of Microbiology at least two types of

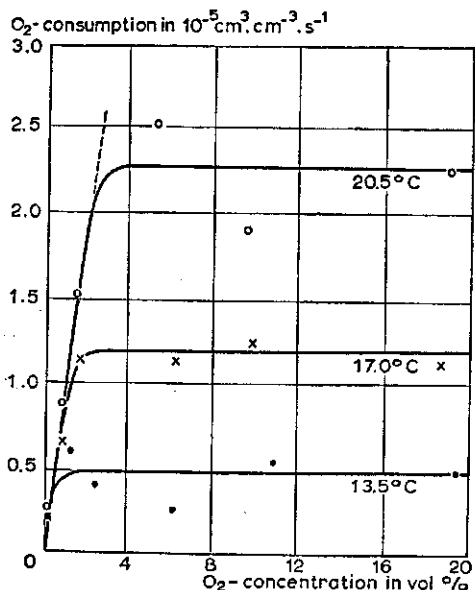

Fig. 7. O₂-consumption rate as a function of temperature in a dune sand soil through which a natural gas-air mixture (CH₄-concentration about 2.5 vol.%) was lead.

methane-oxidizing bacteria have been isolated from the dune sand, used in the experiments described here (Adamse et al., 1971), viz. *Pseudomonas methanica* and a bacterium probably identical to *Methylosinus trichosporium*, as it was described by Whittenbury et al. (1970a). The optimum temperature for growth of both bacteria is about 30 °C. Furthermore methane and ethane-oxidizing mixotrophic fungi were isolated from the dune sand soil (Adamse et al., 1972b).

The O₂-consumption in a gassed soil increased with a factor of 4 to 5 when the temperature was raised from 13.5 °C to 20.5 °C (fig. 7). This means a very strong dependence on temperature, since for growth processes of higher plants as a mean a factor of 2 to 3 is found with a temperature raise of 10 °C. At different temperatures the relation between consumption and production terms was

$$20.5 \text{ } ^\circ\text{C} \quad \alpha_{\text{CH}_4} : \alpha_{\text{O}_2} : \alpha_{\text{CO}_2} = -1 : (-1.8 \text{ to } -2.1) : (+0.7 \text{ to } +0.8)$$

$$17.0 \text{ } ^\circ\text{C} \quad \alpha_{\text{CH}_4} : \alpha_{\text{O}_2} : \alpha_{\text{CO}_2} = -1 : (-1.9 \text{ to } -2.8) : (+0.7 \text{ to } +1.0)$$

$$13.5 \text{ } ^\circ\text{C} \quad \alpha_{\text{CH}_4} : \alpha_{\text{O}_2} : \alpha_{\text{CO}_2} = -1 : (-3.9 \text{ to } -4.5) : (+2.0 \text{ to } +2.5)$$

At lower temperatures the O₂-consumption and CO₂-production increased relative to the CH₄-consumption. Perhaps the oxidation of methane is reduced to a larger extent than are the other biological processes in soil.

The fertility of the soil will also influence the growth rate and the activity of the microorganisms. The methane-oxidizing bacteria are more akin to autotrophs than to heterotrophs, since they can only use C-sources as CH₄ and CH₃OH (Ribbons et al., 1970). Davies & Whittenbury (1970) called them obligate heterotrophs. Anorganic nutrients, as for example nitrates, are necessary, however, for growth of the bacteria, preventing uptake by the plant.

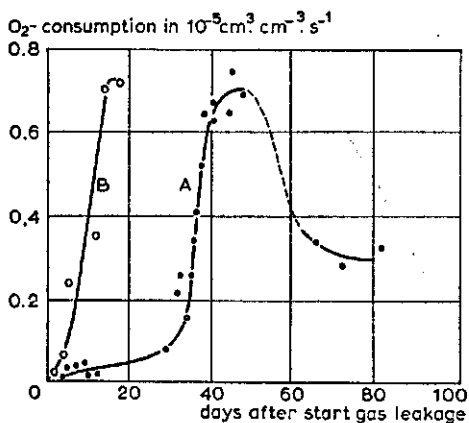

Fig. 8. Changes in microbial activity in a dune sand soil after the start of gas leakage, as reflected in the O_2 -consumption rate at about $20^\circ C$. A: without adding a nutrient solution to the soil; B: when adding at the start of gas leakage 150 cm^3 of a nutrient solution (for composition see table 9) to the soil.

The effect of nutrient conditions is demonstrated in fig. 8. Here a mixture of natural gas and air was supplied to a normal soil. Oxidation of methane, as expressed in the O_2 -consumption, started only after an extensive lag phase of 30 days. During this phase the microorganisms get adapted to changed environmental conditions. The slight increase in O_2 -consumption during this period was found to be the result of oxidation of ethane and propane. The lag phase for ethane and propane-oxidizing microorganisms was relatively short in comparison with the lag phase of methane-oxidizing microorganisms (Adamse et al., 1972b).

After addition of a nutrient solution (for its composition see table 9), the lag phase became very short and oxidation of methane started practically at once. The phase of exponential growth lasted in both cases about 15 days. In the next period the O_2 -consumption dropped and (at least temporarily) stabilized at a considerably lower level. This back-sliding might have been caused by shortage of nutrients and/or accumulation of toxic metabolic excretates due to the intensive microbial activity.

The methane-oxidizing bacteria isolated from dune sand were found to grow at optimum rate at pH 7.0, while growth was possible within a pH-range of 5.5 to 8.0 (Adamse et al., 1971). Therefore soil acidity is an important factor for the metabolic activity of the bacteria. The pH of the dune sand was 7.8 to 8.0, so within the above mentioned range. The pH of the soil at the experimental field, however, was about 4. Thus microbial activity should be low in this soil (table 10). Nevertheless the rate of

Table 9. Composition of the nutrient solution after Leadbetter & Foster (1960). Amounts in g per liter de-ionized water.

$NaNO_3$	2	KCl	0.04	H_3BO_3	10×10^{-6}
$MgSO_4$	0.2	$CaCl_2$	0.015	$MnSO_4$	10×10^{-6}
Na_2HPO_4	0.2	$FeSO_4$	0.001	$ZnSO_4$	70×10^{-6}
NaH_2PO_4	0.09	$CuSO_4$	5×10^{-6}		

Table 10. Number of bacteria per g of soil at the experimental field and in the used dune sand (after Adamse et al., 1972b).

Samples from	Particulars	Number of bacteria
Experimental field with 6-month leakage (pH 4)	0.5 m from leak	4.89×10^6 (n=5)
	1 m from leak	1.95×10^6 (n=5)
	10 m from leak	1.01×10^6 (n=5)
Pots with dune sand (pH 8)	normal soil	3.8×10^6 (n=3)
	gassed soil after a 7-week leakage	122×10^6 (n=3)
	gassed soil after a 3-week aeration	68.2×10^6 (n=3)

methane oxidation was still high enough to create a practically anaerobic zone around the leak (see section 4 of this chapter). It is not unlikely, however, that at low pH-values other methane-oxidizing microorganisms, more adapted to acid conditions as fungi or yeasts, are active in the soil. Isolations were made in a medium of pH 7, being perhaps less favourable for such microorganisms.

4.2 Distribution of gases around gas leakages

From measurements at experimental sites in urban regions and later on from measurements at the experimental field it has become clear that the composition of the soil gas phase around a leakage of natural gas shows the same characteristic picture in all cases, in spite of differences in soil type. In fig. 9 an example is given of the distribution of O_2 and CO_2 around a leak. This leak, influencing the soil gas phase up to a distance of more than 16 m, was a very large one. There exists a completely anaerobic zone up to 11 m from the leak. Natural gas was found to be present in the

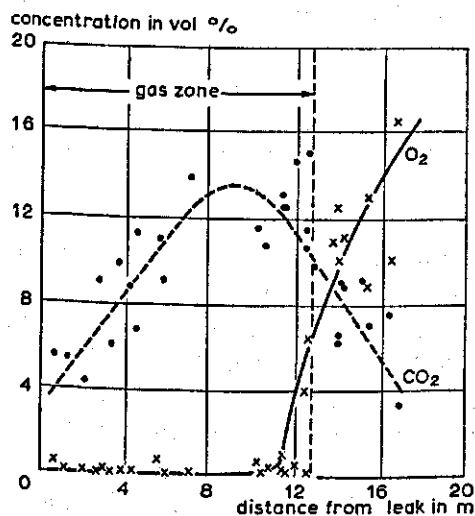

Fig. 9. Distribution of O_2 and CO_2 in the soil gas phase near a gas leakage in the Prinsenvinkenpark at The Hague (see also fig. 1A).

soil gas phase up to 13 m. The CO_2 -concentration can be rather high, in the example given here 4 to 14 per cent by volume dependent on the distance from the leak.

From a large number of measurements, later on confirmed by calculations, a general picture of the situation around a gas leakage can be given. This situation is drawn in fig. 10.

The microbial oxidation of CH_4 , as discussed in the previous section, requires both CH_4 and O_2 . As a consequence CH_4 -oxidation cannot occur in the anaerobic zone. It appeared that there is only a relatively narrow zone where both CH_4 and O_2 are present and where CH_4 -oxidation might occur. This zone is defined as the *methane oxidation zone*. Here CH_4 is supplied from the leak and O_2 is supplied from the opposite direction, viz. from the *unaffected normal soil* via a zone with lower O_2 and higher CO_2 content, the *oxygen transit zone*. The methane oxidation zone, being the only zone where both O_2 and CH_4 are found together, is rather narrow. The data of Bravermann et al. (1962) are therefore dubious. They report CH_4 -concentrations of 13 to 45 vol. % together with O_2 -concentrations of 4.8 to 14 vol. %. This is only possible during the winter period or just after the start of gas leakage when methane oxidation is limited, but it is most unlikely to occur in the summer period.

Because of the production of CO_2 in the oxidation zone, high CO_2 -concentrations are found here. In principle the highest CO_2 -concentration is found at the inner side of the oxidation zone at the boundary with the anaerobic zone ($r = r_a$). Going towards the leak the concentration decreases because the CO_2 is pushed away by the flow of natural gas (bulk flow). In the steady state all the CH_4 released by the leak is oxidized in the oxidation zone. At the same time all O_2 , transported to this oxidation zone is consumed here. Thus the concentrations of O_2 and CH_4 are known at two distances viz. $C_{\text{O}_2} = 0$ at $r = r_a$ and $C_{\text{CH}_4} = 0$ at $r = r_b$. Furthermore the concentrations of the three components (O_2 , CO_2 and CH_4) are given at the distance r_c (with C_{CH_4} always equalling zero). These conditions are used as boundary conditions in the mathematical solutions for calculation of the composition of the soil gas phase in the steady state.

The extent of the *gas zone* i.e. the region where methane is present in the soil gas phase is defined in terms of its horizontal radius, be it cylindrical or spherical. In reality the leak influence extends to a larger distance, for also in a part of the oxygen transit zone the soil gas phase composition is unfavourable for plant growth. The above defined gas zone, however, will be used as a measure for the leak influence as it is easy to determine. In urban regions the radii of the gas zones of the majority of gas leakages are found to vary between 2 and 6 m.

Because of the difference in density between natural gas ($0.82 \text{ mg} \cdot \text{cm}^{-3}$) and air ($1.29 \text{ mg} \cdot \text{cm}^{-3}$) one might suppose that the gas should be transported preferentially in an upward direction (Kelsey, 1964; Eynon, 1967). From the measurements at the experimental field this effect appeared to be negligible. The natural gas and the soil gas phase are apparently mixed rather intensively by diffusion of the different gas components, resulting in an only gradual increase in density from the leak to the unaffected normal soil.

The iso-concentration surfaces are almost spherically distributed around the leak.

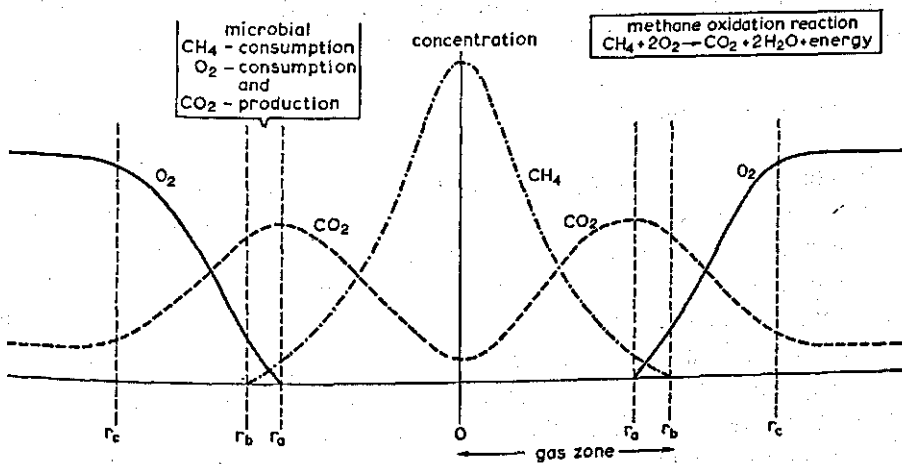
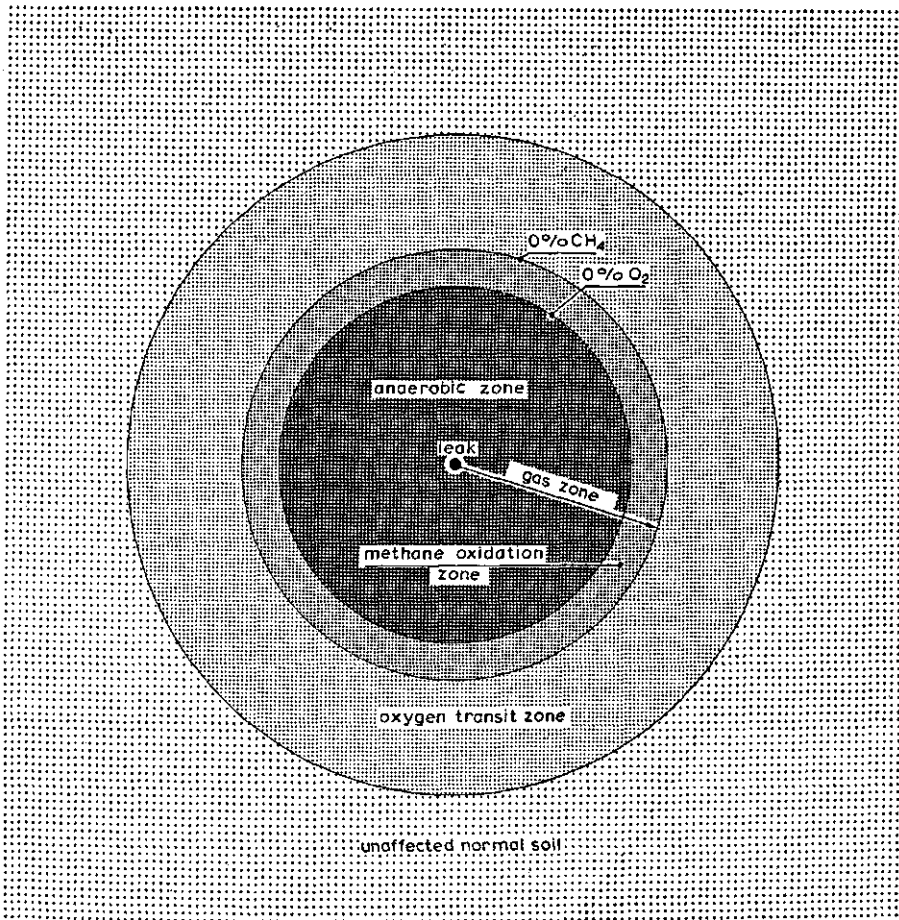

Fig. 10. Schematic representation of the composition of the soil gas phase around a leakage of natural gas in soil.

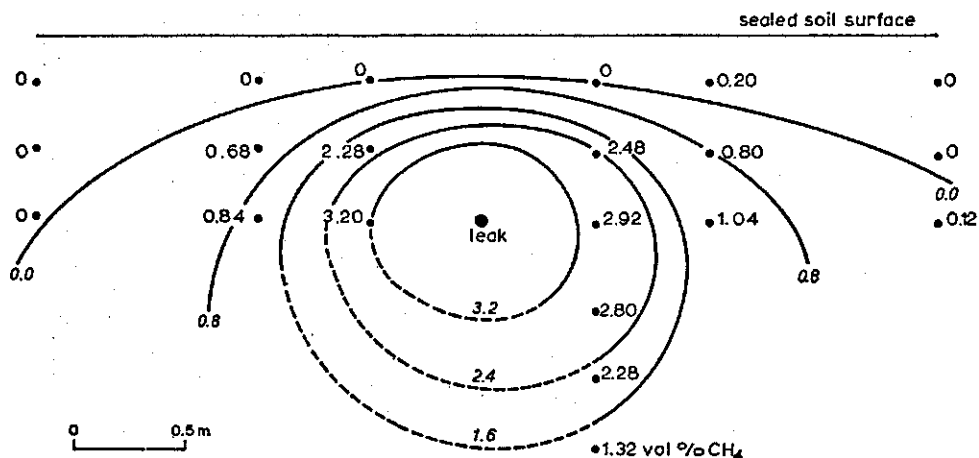

Fig. 11. Distribution pattern of natural gas around an artificial leak ($5 \text{ l} \cdot \text{hr}^{-1}$), as reflected in the CH_4 -concentration (vol.%) in the soil.

A cross-section is shown in fig. 11 for a relatively small leak (5 l of natural gas per hour). In this case the spherical distribution is somewhat flattened at the top, as the microbial activity (oxidation of CH_4) is higher in the topsoil than in the subsoil. This is probably due to more favourable nutrient conditions in the topsoil.

4.3 Mathematical description of the distribution

The distribution of gases around a gas leakage, as discussed in the previous section, can be described mathematically. To this purpose the flow equation (3) must be solved while taking into account the appropriate boundary conditions. The production terms for the different components of the gas phase were derived from the laboratory experiments on the rate of microbial CH_4 -oxidation discussed in section 4.1.

4.3.1 Calculation of production terms

In the situation under concern the production terms of the three components CH_4 , O_2 and CO_2 should include the aerobic dissimilation processes in the oxygen transit zone, the microbial CH_4 -oxidation in the oxidation zone, and the processes of anaerobic dissimilation in the anaerobic zone. Fortunately the production rates following from the microbial oxidation of CH_4 are extremely high and consequently the production rates due to the other two processes may be neglected (cf. table 7). This assumption leads to the situation where production (or consumption) of gases is limited to the region of the methane oxidation zone.

The rate of microbial CH_4 -oxidation was found to be influenced by the CO_2 -level in the soil gas phase, while it was practically independent of the O_2 and CH_4 -level within rather wide limits. Also important for the rate of microbial CH_4 -oxidation is

the influence of temperature and specifically the existence of an initial period before the microbial population reaches its maximum size.

The ratio of the production rates of the dominant gas components accompanying the microbial oxidation process was empirically determined. In the oxidation zone the CO_2 -level is always high, about 10 to 15% by volume. According to the CO_2 -effect as given in table 8, the ratio of the three production terms in the methane oxidation zone was estimated to be

$$\alpha_{\text{CH}_4} : \alpha_{\text{O}_2} : \alpha_{\text{CO}_2} = -1 : -2 : +0.6 \quad (22)$$

Once α_{CH_4} is known the other production rates were calculated in accordance with this relation.

The effect of temperature on the production terms was, for lack of more information, approximated by application of the Arrhenius equation to the experimental data given in section 4.1, as being

$$\alpha_m = k e^{-\mu/2.3RT} \quad (23)$$

By plotting the natural logarithm of the O_2 -consumption rates (given in fig. 7) versus T^{-1} (cf. fig. 12) one finds for the value of μ (i.e. energy of activation) $3.41 \times 10^5 \text{ J} \cdot \text{mol}^{-1}$. Using the given rate of CH_4 -consumption at temperature T_0 as a reference (for computations T_0 was taken 293 °K), the rate at any temperature T was calculated with the equation

$$\alpha_m = \alpha_m\{T_0\} e^{-1.784 \times 10^4 (T^{-1} - T_0^{-1})} \quad (\text{cm}^3 \cdot \text{cm}^{-3} \cdot \text{s}^{-1}) \quad (24)$$

It should be pointed out that this equation was derived from data in the temperature range from 13.5 to 20.5 °C. The use of the equation outside this range remains somewhat doubtful, because it does not account for a minimum and a maximum temperature for microbial activity.

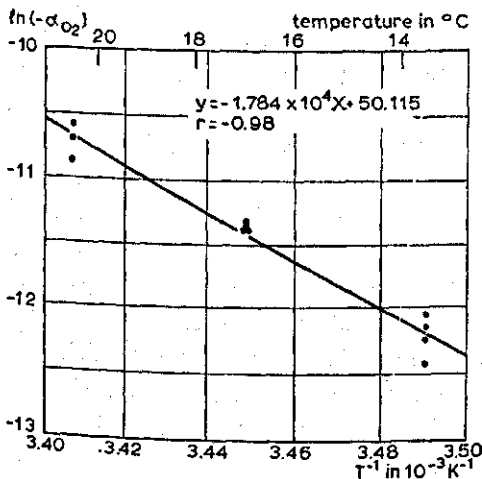

Fig. 12. The natural logarithm of the O_2 -consumption rate $-\alpha_{\text{O}_2}$ in $\text{cm}^3 \cdot \text{cm}^{-3} \cdot \text{s}^{-1}$ for microbial methane oxidation as a function of the reciprocal of temperature at the 2.5 vol.% CH_4 -level.

As mentioned above another complication in applying the experimentally determined production rates to the situation around a gas leakage, is the existence of an initial period during which the microbial population has not yet reached its maximum size. It was assumed that during this initial period the microbial population is in a phase of exponential growth changing abruptly into a stationary phase after this period, being expressible as

$$\frac{dB}{dt} = \lambda B \quad \text{for } t \leq t_1$$

and

$$\frac{dB}{dt} = 0 \quad \text{for } t > t_1 \quad (25)$$

These conditions yield

$$B = B_1 e^{\lambda(t-t_1)} \quad \text{for } t \leq t_1$$

and

$$B = B_1 \quad \text{for } t > t_1 \quad (26)$$

in which B is the number of microorganisms in the population and t_1 is the moment when the population has reached its stationary size B_1 .

As the production term α_m is likely to be directly proportional to the number of bacteria, eq. (26) can be converted to

$$\alpha_m = \alpha_m\{t_1\} e^{\lambda(t-t_1)} \quad (\text{cm}^3 \cdot \text{cm}^{-3} \cdot \text{s}^{-1}) \quad (27)$$

where $\alpha_m\{t_1\}$ is the rate of production at time t_1 , when the microbial population is in a stationary phase. Data of the O_2 -consumption rates after the start of gas leakage in a normal soil were given in fig. 8. In this figure the O_2 -consumption rate fell back to a lower level after the period of exponential increase. This back-sliding is as yet unexplained; it might be a shortage of nutrients or an accumulation of toxic microbial excreted, but it seems reasonable to assume that eventually there must set in a stationary phase at whatever level. For the computations in this chapter this phenomenon is of small importance as the level of the eventual O_2 -consumption rate will be varied for checking its effects on the soil gas phase composition near a gas leakage.

As far as the phase of exponential growth of the bacteria population is concerned, the natural logarithms of the O_2 -consumption rates were plotted versus time (cf. fig. 13). From this figure the growth rate coefficient λ was calculated as being $1.86 \times 10^{-6} \text{ s}^{-1}$. Of course the value of λ will also depend on temperature. No data were available on this effect, however, so it was not taken into account. The above value of λ is only valid at about 20°C , since it was derived from experiments which were carried out at room temperature. Under extreme conditions, for instance during the winter period, the growth rate of the microbial population may be extremely low to practically zero.

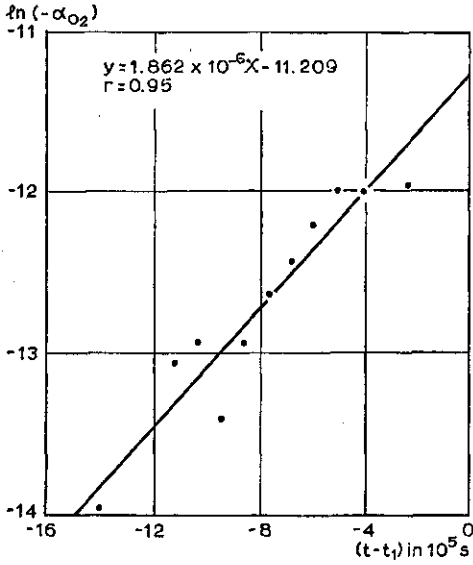

Fig. 13. The natural logarithm of the O_2 -consumption rate $-\alpha_{O_2}$ in $cm^3 \cdot cm^{-3} \cdot s^{-1}$ for microbial methane oxidation as a function of time at the 4 vol.% CH_4 -level.

Combining eq. (24) and (27) the production term in the initial period ($t \leq t_1$) was taken as

$$\alpha_m = \alpha_m\{T_0, t_1\} e^{-1.784 \times 10^4(T^{-1} - T_0^{-1}) + 1.86 \times 10^{-6}(t-t_1)} \quad (cm^3 \cdot cm^{-3} \cdot s^{-1}) \quad (28)$$

The fertility status of the soil was found to affect the duration of the lag phase of the methane-oxidizing microorganisms after the start of gas leakage. This effect can be expressed in t_1 . For the dune sand used in the laboratory experiments the lag phase lasted about 30 days, while the phase of exponential growth lasted some 15 days, so a total period of 45 days, i.e. t_1 equals 3.888×10^6 s. After adding a nutrient solution this period decreased to 15 days yielding a t_1 -value of 1.296×10^6 s.

If $\alpha_m\{T_0, t_1\}$ and t_1 are known, the production rates in the initial period ($t \leq t_1$) at temperature T can be calculated with eq. (28). For $t > t_1$ the microbial population is thought to be in a stationary phase and the production rates remain constant, so eq. (24) supersedes eq. (28) where $\alpha_m\{T_0\}$ equals $\alpha_m\{T_0, t_1\}$.

4.3.2 Coordinate geometry of the model

From fig. 11 it became clear that the transport of gases at short distances to the leak can be considered as spherically symmetric transport from a point source. However, because of the existence of a practically gastight pavement at the top and possibly a groundwater table acting as an impervious boundary at the bottom of the soil layer under consideration, the flow lines of the gases are deflected at larger distances (fig. 14A). At even farther distances the transport can be treated as cylindrically symmetric transport. Between the regions of spherical and cylindrical transport there is a transition region where the transport somewhat resembles hemi-

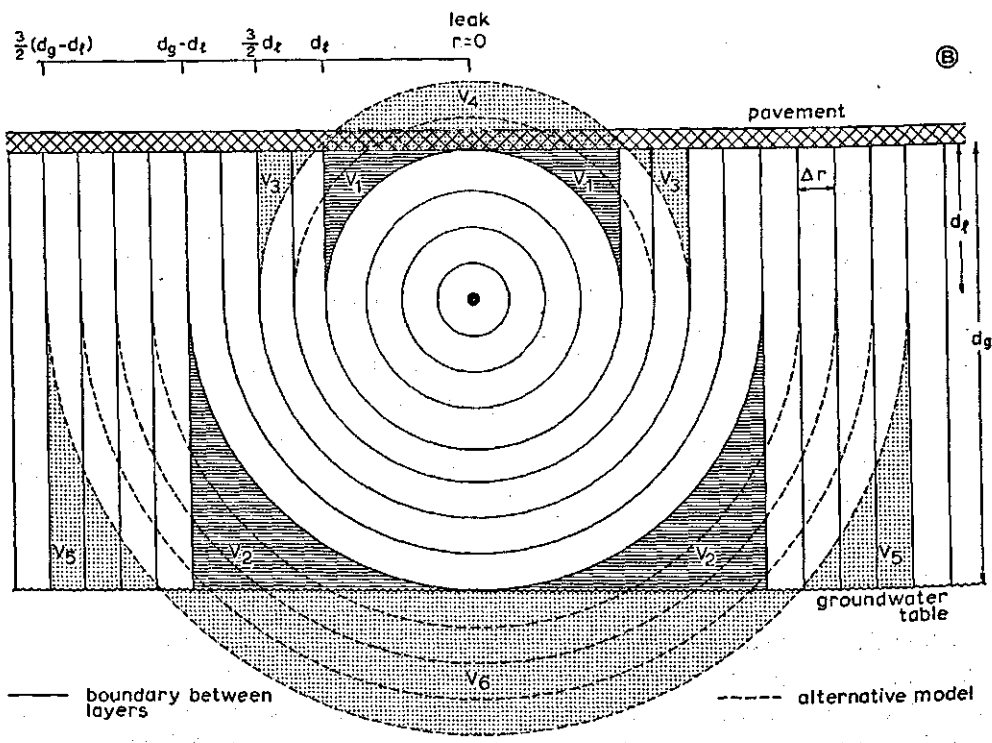
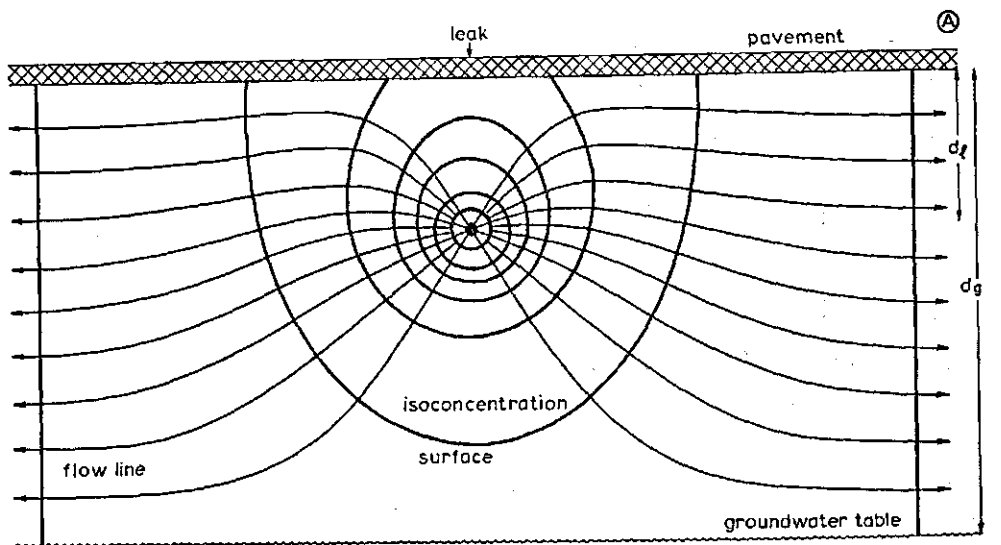

Fig. 14. Schematic representation of flow lines and isoconcentration surfaces near a gas leakage (A) and the ensuing subdivision of the space around the leak in layers approximately perpendicular to the flow lines for the numerical computations (B). See text for the symbols used.

spherical transport.

Although in principle the distribution of gases in the different zones is amenable to computation with a generalized equation in three-dimensional Cartesian coordinates, the time needed for such computations appears to be hardly warranted in view of uncertainties in the model description. Therefore a schematic model as illustrated in fig. 14B was chosen. If the leak is situated at a depth d_l under a gastight pavement, while a groundwater table is found at d_g , the geometry of the model can be described for the case of $(d_g - d_l) > d_l$ (road surface nearer to the leak than groundwater table) as

0	$< r < d_l$	spherical symmetry
d_l	$< r < d_g - d_l$	mixed symmetry
$d_g - d_l$	$< r$	cylindrical symmetry

The mixed symmetry assumed for the transition zone between spherical and cylindrical symmetry consists here of a cylinder with radius r and length d_l plus at the bottom a hemisphere with radius r .

Transformation of spherical to mixed symmetry takes place at the impervious boundary nearest to the leak, be it the pavement or the groundwater table, so either at $r = d_l$ (cf. above and fig. 14B) or at $r = d_g - d_l$. In the latter case the mixed symmetry consists of a cylinder with radius r and length $d_g - d_l$ plus at the top a hemisphere with radius r . The transformation of mixed to cylindrical symmetry then takes place at $r = d_l$, being the boundary remotest from the leak.

The error introduced when changing over from the spherical distribution pattern to the mixed pattern at the distance $r = d_l$ amounts to the introduction of an instantaneous jump in the distribution pattern, i.e. once a certain concentration reaches the distance d_l it is assumed that the rotational volume indicated by V_1 (fig. 14B) is suddenly filled with gas at that particular concentration. Obviously the result must be a slight exaggeration of the spreading velocity of the gas, so the actual concentration should be slightly less than predicted. In order to check the magnitude of the error introduced in this manner, the calculations were repeated with a change from spherical to mixed symmetry at $r = \frac{2}{3} d_l$. In that case the approximation solely involves a sudden redistribution of the gas present in the hypothetical volume V_4 above the pavement over the rotational volume V_3 (equal to V_4), under the pavement. In this case the real situation should be approximated very closely indeed. As the differences in concentration computed with both alternatives were negligible (cf. table 11), further calculations were done for a distance of transformation equal to d_l . A similar reasoning holds for the second transformation, i.e. from mixed to cylindrical symmetry.

On the experimental field the groundwater table was that deep that there was no need for using cylindrical symmetry, so only spherical and mixed symmetry were used.

The direction of flow given in fig. 14A holds for transport of CH_4 and CO_2 , trans-

Table 11. Composition of the soil gas phase (vol.%), calculated with a mathematical distribution model, based on a spherical distribution pattern at short distances from a leak and on a mixed (hemispherical and cylindrical) pattern at larger distances. The transformation of one pattern to the other was taken at respectively 80 cm (= d_1) and 120 cm (= $\frac{3}{2}d_1$) from the leak. Rate of gas leakage: $51 \cdot \text{hr}^{-1}$ ($Q_1 = 1.389 \text{ cm}^3 \cdot \text{s}^{-1}$); CH_4 -consumption rate (α_{CH_4} {293 °K, t_1): $2.22 \times 10^{-7} \text{ cm}^3 \cdot \text{cm}^{-3} \cdot \text{s}^{-1}$; temperature 18 °C ($T = 291 \text{ °K}$); maximum rate of CH_4 -oxidation reached after 25 days ($t_1 = 2.16 \times 10^6 \text{ s}$).

Time (hr)	Distance to the leak (cm)	Boundary between spherical model and mixed model					
		80 cm (= d_1)			120 cm (= $\frac{3}{2}d_1$)		
		% CH_4	% O_2	% CO_2	% CH_4	% O_2	% CO_2
48	30	9.8	15.9	2.7	9.7	15.9	2.8
	110	2.1	17.5	3.0	2.0	17.5	3.0
	190	0.6	17.8	3.0	0.6	17.8	3.0
	270	0.2	17.9	3.0	0.2	17.9	3.0
168	30	10.6	15.2	2.9	10.5	15.2	2.9
	110	2.8	16.7	3.2	2.7	16.8	3.2
	190	1.2	17.1	3.2	1.2	17.1	3.2
	270	0.5	17.3	3.2	0.5	17.3	3.2
Steady state	30	7.4	7.8	6.7	7.5	8.1	6.5
	110	0.0	10.9	6.3	0.0	11.0	6.2
	190	0	14.0	4.9	0	14.0	4.9
	270	0	15.4	4.2	0	15.4	4.2

port of O_2 occurs in the opposite direction, i.e. towards the leak, coming from the unaffected normal soil where at non-metalled sites O_2 diffuses into the soil.

4.3.3 Steady state solutions

From the equation for continuity (2)* the differential equation for the cylindrically symmetric transport in the steady state ($\partial C_m / \partial t = 0$) can be derived as

$$\frac{1}{r} \frac{d}{dr} \left[r \left(-D_m \frac{dC_m}{dr} + vC_m \right) \right] = \alpha_m \quad (29)$$

The term between parentheses represents the total flux f_m , multiplied by the distance r . Since α_m is assumed to be zero in the anaerobic zone and in the oxygen transit zone (fig. 15), the term between square brackets rf_m , must be constant in these zones. The flux f_m is the volume of the gas component m which is transported through a unit area of soil per unit time; for the case of cylindrical transport, f_m may be expressed as $Q_m / 2\pi r d_g$, where Q_m is the total amount of gas transported through the surface of a cylinder with radius r and height d_g . Consequently Q_m must be constant

* In eq. (2) F_m , ρ_m and A_m can be replaced by f_m , C_m and α_m respectively, because $F_m = \rho_{om} f_m$, $\rho_m = \rho_{om} C_m$ and $A_m = \rho_{om} \alpha_m$ (the conversion factor ρ_{om} is given in table 5, chapter 3). The bulk flow term v is used for flow in the r -direction.

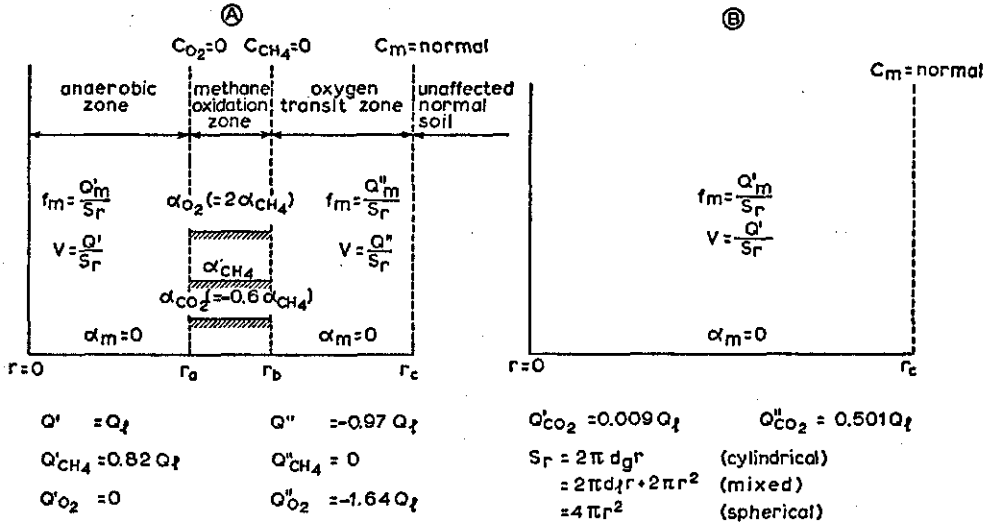

Fig. 15. Data used in the steady state eqs. (36C, 36S and 36M) for two situations of gas flow from a leak at $r = 0$. A: with a methane oxidation zone (normal situation during summer); B: without a methane oxidation zone (situation in winter at low temperatures).

in the anaerobic zone ($= Q'_m$) as well as in the oxygen transit zone ($= Q''_m$). Considering the transport of CH_4 it is clear that Q_{CH_4} will be zero at any distance beyond the methane oxidation zone ($Q'_{CH_4} = 0$), while at any distance within the oxidation zone Q_{CH_4} will equal the amount of CH_4 released from the leak ($Q'_{CH_4} = 0.82 Q_l$, where Q_l is the rate of leakage of natural gas and 0.82 represents the volume fraction of CH_4 in it). So eq. (29) can be integrated as

$$\int_{0.82 Q_l / 2\pi d_g}^0 d \left[r \left(-D_{CH_4} \frac{dC_{CH_4}}{dr} + v C_{CH_4} \right) \right] = \int_0^\infty \alpha_{CH_4} r dr \quad (30)$$

Because α_{CH_4} was assumed to be a discontinuous function of distance (constant and finite in the oxidation zone, zero elsewhere), this equation can be written as

$$-\frac{0.82 Q_l}{2\pi d_g} = \int_{r_a}^{r_b} \alpha_{CH_4} r dr = \frac{\alpha_{CH_4}}{2} (r_b^2 - r_a^2) \quad (31)$$

Thus the volume of the methane oxidation zone, $\pi d_g (r_b^2 - r_a^2)$, equals

$$\pi d_g (r_b^2 - r_a^2) = -\frac{0.82 Q_l}{\alpha_{CH_4}} \quad (cm^3) \quad (32)$$

dependent on the rate of gas leakage Q_l and on the microbial activity (expressed in α_{CH_4}).

Inside the oxidation zone Q_{O_2} equals zero for the steady state, so $Q'_{O_2} = 0$. With eq. (30) the value of Q''_{O_2} outside the oxidation zone can be calculated as

$$Q''_{O_2} = 2\pi d_g \int_{r_a}^{r_b} \alpha_{O_2} r dr \quad (cm^3 \cdot s^{-1}) \quad (33)$$

which, with $\alpha_{O_2} = 2\alpha_{CH_4}$ and with eq. (31), yields $Q''_{O_2} = -1.64 Q_i$. In a similar way Q''_{CO_2} can be calculated as $0.501 Q_i$, since Q'_{CO_2} equals the amount of CO_2 released from the leak, being $0.009 Q_i$ (natural gas contains 0.9% CO_2).

The bulk flow term v may be expressed as $Q/2\pi r d_g$, according to eq. (7). The loss in volume β , mentioned in eq. (7a) can be replaced by $-2.4 \alpha_{CH_4}$, so yielding

$$Q = Q_i - 2\pi d_g \int_0^r 2.4 \alpha_{CH_4} r dr \quad (\text{cm}^3 \cdot \text{s}^{-1}) \quad (34)$$

In the anaerobic zone ($r < r_a$) the integral in this equation cancels out, so $Q' = Q_i$. In the oxygen transit zone ($r > r_b$) the integral is a constant, which can be solved with eq. (31), yielding $Q'' = -0.97 Q_i$. These constant values of Q_m and Q are given, together with other boundary conditions, in fig. 15.

Considering the flux equation

$$f_m = -D_m \frac{dC_m}{dr} + v C_m \quad (\text{cm}^3 \cdot \text{cm}^{-2} \cdot \text{s}^{-1}) \quad (35a)$$

where f_m and v can be expressed in terms of Q_m and Q , its solution can be obtained for those regions where Q_m and Q are constants. Rearranging eq. (35a) as

$$\frac{dC_m}{Q_m - Q C_m} = - \frac{dr}{2\pi D_m d_g r} \quad (35b)$$

one finds after integration, with the boundary condition $C_m = C_{mr_1}$ at distance $r = r_1$

$$\ln \left[\frac{Q_m - Q C_m}{Q_m - Q C_{mr_1}} \right] = \frac{Q}{2\pi D_m d_g} \ln \left[\frac{r}{r_1} \right] \quad (36C)$$

In a similar way the general solutions for a spherical distribution pattern and for a mixed pattern can be obtained

$$\text{spherical} \quad \ln \left[\frac{Q_m - Q C_m}{Q_m - Q C_{mr_1}} \right] = \frac{Q}{4\pi D_m} \left[\frac{1}{r_1} - \frac{1}{r} \right] \quad (36S)$$

$$\text{mixed} \quad \ln \left[\frac{Q_m - Q C_m}{Q_m - Q C_{mr_1}} \right] = \frac{Q}{2\pi D_m d_i} \ln \left[\frac{1 + d_i/r_1}{1 + d_i/r} \right] \quad (36M)$$

From these equations C_m can be solved for any distance r , provided C_{mr_1} at $r = r_1$ is known. For calculation of the concentration distribution in the *oxygen transit zone* the known concentration C_{mr_e} was used as a boundary condition ($C_{mr_1} = C_{mr_e}$, $r_1 = r_e$). For calculation of the concentration distribution in the *anaerobic zone*, however, no information is available with respect to the concentration at any partic-

* $\beta = -(\alpha_{CH_4} + \alpha_{O_2} + \alpha_{CO_2})$, and according to eq. (22) $\alpha_{O_2} = 2\alpha_{CH_4}$ and $\alpha_{CO_2} = -0.6 \alpha_{CH_4}$, thus yielding $\beta = -2.4 \alpha_{CH_4}$.

ular location. Thus one must first attempt to calculate the concentration distribution in the *oxidation zone*, making use of the value of the concentration at its outer boundary, which must equal the concentration obtained from the distribution in the oxygen transit zone. In the oxidation zone Q_m and Q are not constant, so an analytical solution of eq. (35a) is not possible. Therefore the flux equation pertaining to this zone was solved numerically, according to fig. 16A as

$$f_m^i = D_m \frac{C_m^{i+1} - C_m^i}{\Delta r} + v_i \frac{C_m^{i+1} + C_m^i}{2} \quad (37)$$

where

$$f_m^i = f_m^{i-1} \left(\frac{r_{i-1}}{r_i} \right) + \frac{\alpha_m}{2r_i} (r_i^2 - r_{i-1}^2)$$

$$v_i = v_{i-1} \left(\frac{r_{i-1}}{r_i} \right) + \frac{2.4\alpha_{\text{CH}_4}}{2r_i} (r_i^2 - r_{i-1}^2)$$

$$r_i = r_b - i\Delta r$$

Because the starting point of the calculation scheme is the value of C_m at the boundary r_b of the oxygen transit zone, the index i is numbered in backwards direction, i.e. in the direction of decreasing r .

The remaining difficulty is now that the value of r_b is not yet known. This problem was solved by means of successive approximations, consisting of the following steps:

1. For extremely high values of α_m in the methane oxidation zone, the thickness of this zone approaches zero and it is situated at the distance where the O_2 -concentration reaches its zero value. This distance can be calculated from the equations (36) holding for the O_2 -distribution in the oxygen transit zone.
2. For a finite value of α_m , the oxidation zone has a certain thickness and is situated around the distance calculated in step 1. The volume of the oxidation zone is known from eq. (32) and as a first approximation it was assumed that half of this volume is situated on either side of the distance mentioned above, yielding a first approximation of r_a and r_b , namely r_a^i and r_b^i .
3. Substituting the value r_b^i in eq. (36) one thus finds the starting concentration to insert in eq. (37). Then the concentration in the oxidation zone is computed yielding the value of C_{O_2} at $r = r_a^i$.
4. The first approximation as derived in step 2 implies that the computed C_{O_2} at $r = r_a^i$ will be negative. So the value of r_b^i and consequently r_a^i must be raised. In the computer programme r_b^i was increased to

$$r_b^{i+1} = r_b^i + \left(\frac{r_a^i}{r_b^i} \right)^2 \Delta r$$

where Δr equaled 2.5 cm. With this second approximation of r_b (and r_a) step 3 and 4 were repeated. Raising the approximated value of r_b was continued until $C_{\text{O}_2} \geq 0$

calculation of the concentration distribution in the anaerobic zone with eq. (36). The computer program used for steady state calculations is presented in Appendix I.

Only in two extreme situations, either when the oxidation zone is infinitely small ($\alpha_m = \infty$) or when the oxidation zone is absent ($\alpha_m = 0$), the concentration distribution in the region between $r = 0$ and $r = r_c$ can be calculated entirely with analytical solutions of the type (36). The real situation will vary between these two extremes.

4.3.4 Non-steady state solutions

For the non-steady state the equation for continuity (2) is valid and this equation converts for the case of cylindrical symmetry to

$$\varepsilon_g \frac{\partial C_m}{\partial t} = -\frac{1}{r} \frac{\partial}{\partial r} (r f_m) + \alpha_m \quad (\text{cm}^3 \cdot \text{cm}^{-3} \cdot \text{s}^{-1}) \quad (38)$$

This equation was solved with finite difference methods. The gas leakage was treated as leakage from a volume source with radius r_l instead of leakage from a point source, because this assumption permits larger intervals Δr and Δt . The region r_l to r_c around the leak was divided into n layers of equal thickness Δr (cf. fig. 16B) and the time into intervals Δt . The concentration in the i^{th} layer at time $t = k\Delta t$ is represented by $C_m^{i,k}$, the inner radius of this layer by r_{i-1} , the outer radius by r_i and the centre of the layer by $\frac{1}{2}(r_{i-1} + r_i)$. The distance r_i was calculated as $r_i = r_l + i\Delta r$. Then equation (38) was approximated by the finite difference equation

$$C_m^{i,k+1} = C_m^{i,k} + \frac{\Delta t}{\frac{1}{2}\varepsilon_g(r_{i-1} + r_i)} \left[\frac{r_{i-1}f_m^{i-1,k} - r_i f_m^{i,k}}{\Delta r} \right] + \frac{\alpha_m \Delta t}{\varepsilon_g} \quad (39a)$$

where

$$f_m^{i,k} = -D_m \left[\frac{C_m^{i+1,k} - C_m^{i,k}}{\Delta r} \right] + v_i \left[\frac{C_m^{i+1,k} + C_m^{i,k}}{2} \right] \quad (39b)$$

and

$$v_i = v_{i-1} \left[\frac{r_{i-1}}{r_i} \right] + 2.4 \alpha_{\text{CH}_4} \left[\frac{(r_i^2 - r_{i-1}^2)}{2r_i} \right] \quad (39c)$$

These equations were solved employing the boundary conditions

$$\begin{aligned} k = 0 \quad i > 0 \quad C_m^{i,0} &= C_{mr_c} && \text{(constant initial concentration in all layers)} \\ k > 0 \quad i = n \quad C_m^{n,k} &= C_{mr_c} && \text{(fixed concentration in } n^{\text{th}} \text{ layer)} \\ i = 1 \quad f_m^{0,k} &= Q_{mr_l} / 2\pi d_g r_l && \text{(known flux from the leak into the first layer,} \\ &&& Q_{mr_l} = C_{mg} Q_l) \end{aligned}$$

The production term α_m is zero as soon as either C_{CH_4} or C_{O_2} equals zero. When both CH_4 and O_2 are present α_m is calculated from the given value of $\alpha_{\text{CH}_4}\{T_0, t_1\}$ taking into account the effects of temperature and growth rate of the microbial

population according eq. (22) and (28) (cf. computer program in Appendix II).

The solutions thus obtained for the non-steady state were checked in some cases by continuing the calculations until the steady state was reached, and by comparing these results with steady state solutions (discussed in section 4.3.3).

For spherical and mixed symmetry the differential equation (38) changes into

$$\text{spherical} \quad \varepsilon_g \frac{\partial C_m}{\partial t} = - \frac{1}{r^2} \frac{\partial}{\partial r} (r^2 f_m) + \alpha_m \quad (40)$$

$$\text{mixed} \quad \varepsilon_g \frac{\partial C_m}{\partial t} = - \frac{1}{(rd_1 + r^2)} \frac{\partial}{\partial r} [(rd_1 + r^2) f_m] + \alpha_m \quad (41)$$

These equations were numerically solved in the same way as presented above for the case of cylindrical symmetry.

4.4 Computed and measured concentration distributions

Results of the calculations described in the previous section have been compared with measured values obtained from the experimental field. The start and the rate of the gas leakage were known in this case. At the urban experimental sites these data were always missing, thus making it difficult to compare those experimental results with computed data.

The transport of gases just after the establishment of a leak must be treated as transport under transient conditions. After a certain period the composition of the soil gas phase around the leak will reach an approximately steady state. When comparing computed data with experimental results it must be born in mind, however, that field conditions, particularly with regard to temperature, are not fixed, resulting in periodic deviations from the steady state.

The gas zone of a leak will depend, among other factors, on the rate of leakage and on temperature. Both factors were investigated at the experimental field and results could be compared with computed data. Other important factors are the extent and the nature of the pavement, soil fertility, soil moisture content and depth of the groundwater table (see fig. 14A). The influence of these factors could not be established at the experimental sites, but was estimated from the calculations.

Installation of ventilation channels will also affect the extent of the gas zone. This effect will be discussed in chapter 7.

4.4.1 Effect of leakage rate

At the experimental field the rate of leakage was increased from 5 to 25 and ultimately to 250 l · hr⁻¹. The measured distribution of the gases in the soil, presented in fig. 17, may be considered as a steady state distribution. In the case given in fig. 17C, it probably must be assumed that the measured soil gas phase composition does not yet represent the steady state.

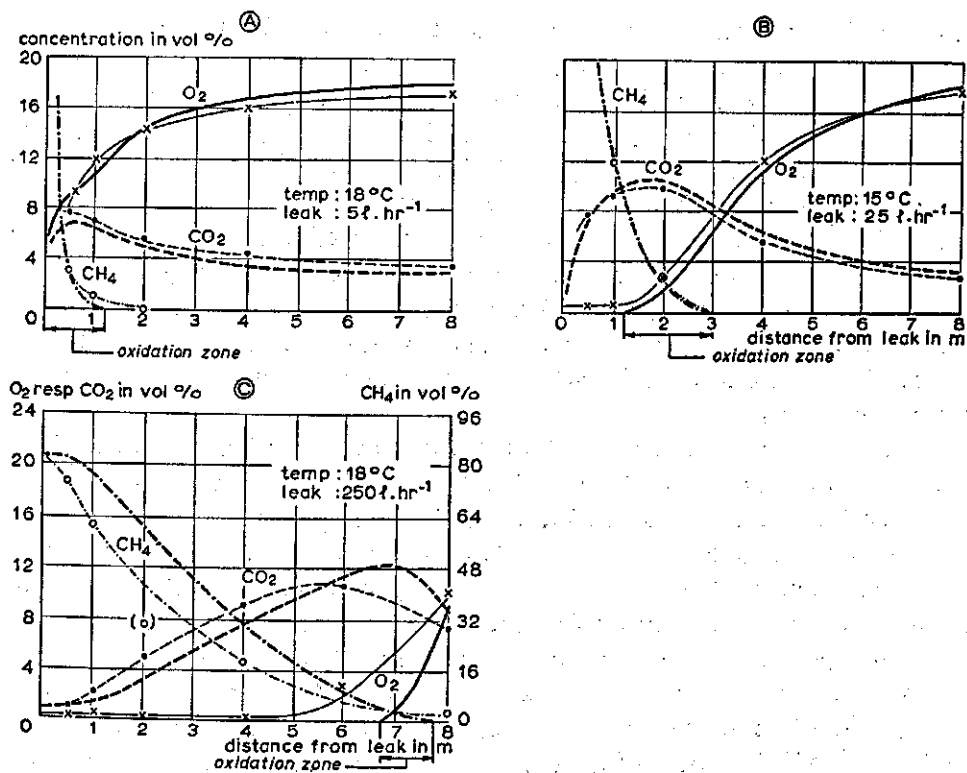

Fig. 17. Calculated (thick lines) and measured (thin lines) distribution of CH₄, O₂ and CO₂ around a leak at the non-urban experimental site (with sealed soil surface) for a leak of 5 l · hr⁻¹ two months after the start of the leakage (A), of 25 l · hr⁻¹ about eight months after establishment of this rate (B) and of 250 l · hr⁻¹ about one month after establishment of that rate (C).

Considering the measured data it appears that the methane oxidation zone is rather wide, indicating a low bacterial activity (α_{CH_4} is low, according to eq. 32). Since here no information was available on the occurring rate of CH₄-oxidation the best fit between experimental and calculated data (steady state) was determined using the production term as a variable, resulting in a CH₄-consumption rate at 20 °C of $2.22 \times 10^{-7} \text{ cm}^3 \cdot \text{cm}^{-3} \cdot \text{s}^{-1}$. This value is about 80 to 100 times lower than the values found for dune sand. The low pH-value at the experimental field (pH 4 to 4.5) is likely to be less favourable for microbial activity. The number of bacteria in both types of soil, given in table 10, confirms this.

When the leak is small (here 5 l per hour) the oxidation-zone is situated direct around the leak and the anaerobic zone, occurring with larger leaks, is missing here.

At the experimental field the soil was covered with a plastic sheeting to 8 or 9 m from the leak. If the plastic cover should extend to only 4 m (so the distance between the leak and the open soil r_c becomes smaller), the flux of oxygen to the leak will be larger, resulting in a smaller gas zone (table 12). For practical cases this means that the area affected by a gas leakage will be very much dependent on the extent of the

pavement. In the calculations it was assumed that at the distance r_c the aeration of the soil is that favourable that the O_2 -concentration is not influenced by the leakage of natural gas. Only in fig. 17C the oxygen and carbon dioxide concentrations at r_c were apparently influenced by the leakage and the boundary conditions here, i.e. $C_{O_2} = 0.100 \text{ cm}^3 \cdot \text{cm}^{-3}$ (10.0 vol. %) and $C_{CO_2} = 0.075 \text{ cm}^3 \cdot \text{cm}^{-3}$ (7.5 vol. %) at $r = r_c$, were taken from the measured concentration distributions.

It took quite a long time before the steady state was reached (several weeks to some months). Transient conditions may arise just after the start of leakage or when the temperature of the soil changes considerably as is common in autumn and in spring. Since furthermore microorganisms need time to adapt to such changed conditions, the transient stage is more prolonged than it might be expected on the base of transport processes only.

Just after the start of leakage the rate of CH_4 -oxidation is negligibly small, resulting in a rapid spreading of the natural gas into the soil. The measurements given in fig. 18A show that in spite of the small rate of leakage the gas zone extended in 9 days to a distance of more than 4 m from the leak. In the successive period the microbial activity increased, the CH_4 -oxidation started to influence the composition of the soil gas phase and the gas zone finally decreased to about 2 m in the steady state.

This change in composition of the soil gas phase in the early stages was also calculated numerically with non-steady state solutions (fig. 18B). The production terms were obtained from the previously calculated CH_4 -consumption rate of $2.22 \times 10^{-7} \text{ cm}^3 \cdot \text{cm}^{-3} \cdot \text{s}^{-1}$. The value of t_1 depending on the duration of the lag phase, was not known, so it was used as a variable. The best fit between measured and calculated data was found when t_1 equaled $2.16 \times 10^6 \text{ s}$ (25 days). This value is quite acceptable

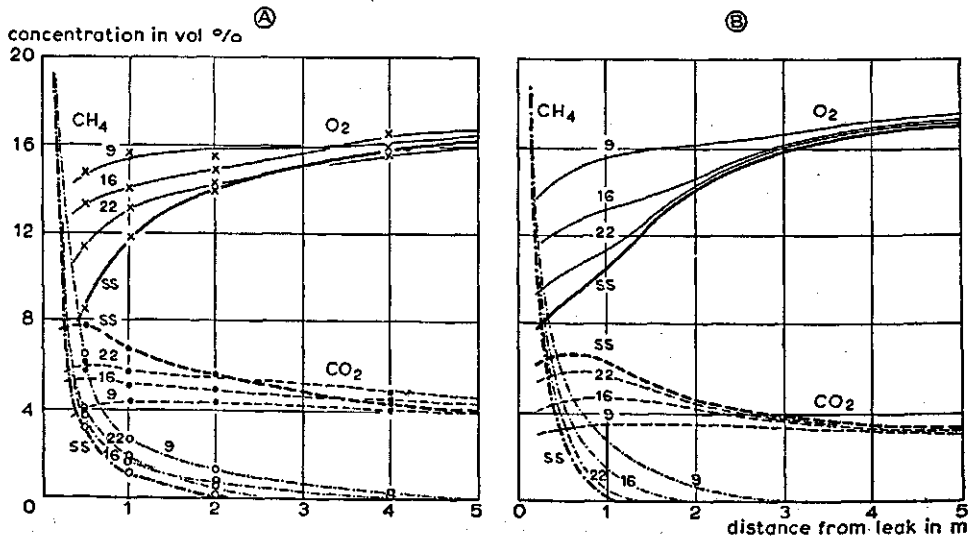

Fig. 18. Composition of the soil gas phase after different periods (9, 16 resp. 22 days; ss = steady state) of gas leakage (rate $5 \text{ l} \cdot \text{hr}^{-1}$). A: data from the non-urban experimental site; B: calculated results at $291 \text{ }^\circ\text{K}$, with $\alpha_{CH_4}(T_0, t_1) = -2.22 \times 10^{-7} \text{ cm}^3 \cdot \text{cm}^{-3} \cdot \text{s}^{-1}$; $T_0 = 293 \text{ }^\circ\text{K}$; $t_1 = 2.16 \times 10^6 \text{ s}$.

especially in view of observations at the experimental field indicating that the CH_4 -oxidation started about 9 days after the start of the gas leakage (see fig. 22) while, according to the laboratory experiments (section 4.1), the period of exponential growth of the microbial population lasts about 15 days, the latter being rather unaffected by soil fertility differences. The differences between calculated and experimental data are rather small, justifying the conclusion that with the given mathematical description the effect of leakage of natural gas on the soil gas phase can be predicted with satisfying accuracy.

4.4.2 Effect of temperature

At falling temperatures the microbial activity decreases. This effect is mathematically described by eq. (28). Because the CH_4 -consumption rate ($-\alpha_{\text{CH}_4}$) decreases, the oxidation zone has to become wider (eq. 32), i.e. the inner boundary r_a of this zone will shift towards the leak and the outer boundary r_b outwards. So the gas zone will extend and the O_2 -front will move towards the leak. This may continue until the anaerobic zone has completely disappeared ($r_a = 0$), this being a normal situation during the winter period. In fig. 19 the composition of the soil gas phase around a leak of $25 \text{ l} \cdot \text{hr}^{-1}$ is given for the summer and winter period. Some conclusions can be drawn from this figure. First, considering the problem of leakage of natural gas mainly as an aeration problem, it may be stated that the probability of injury to vegetation is negligibly small during the winter period, also in view of the low activity of plant roots. A second conclusion concerns the transport mechanism. The slight lowering of the O_2 -concentration in winter, which then is solely the result of bulk flow, indicates that the extreme low O_2 -concentrations during the summer period must be mainly caused by the then high O_2 -consumption rate in the methane oxida-

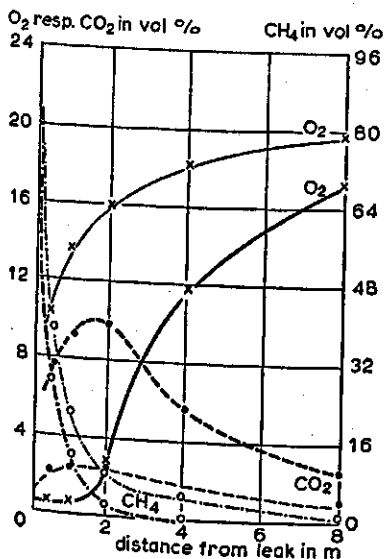

Fig. 19. Distribution of the three main components of the soil gas phase around an artificial leak (rate $25 \text{ l} \cdot \text{hr}^{-1}$) at the non-urban experimental field in summer (thick lines) and in winter (thin lines).

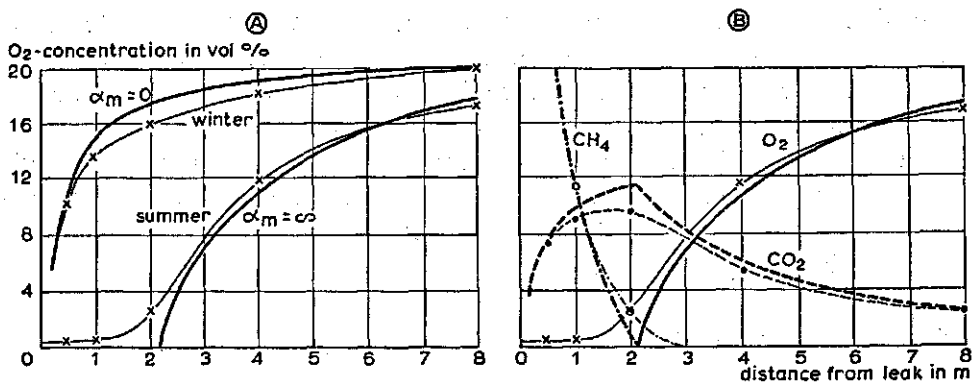

Fig. 20. A: O₂-distributions around an artificial leak (rate 25 l · hr⁻¹) calculated analytically (thick lines) for $\alpha_m = \infty$ and $\alpha_m = 0$, and as measured (thin lines) in summer and in winter; B: distributions of the three main components of the soil gas phase around the same leak, calculated analytically (thick lines) for $\alpha_m = \infty$ and as measured (thin lines) in summer.

tion zone. With analytical solutions for the two extreme situations ($-\alpha_{\text{CH}_4}$ either infinitely high or zero in the oxidation zone), the boundaries between which the real situation is to be found, can be calculated. These calculations can be performed without the use of a computer (with equations of the type 36). In fig. 20A these two extreme situations (only for the O₂-distribution) are compared with experimental data. The O₂-distribution during the summer period was found to be in close agreement with the calculated distribution for an infinite consumption rate and the distribution during the winter period with the calculated one for zero consumption. So simple analytical solutions can be used with success to give a fairly close prediction of the effect of a certain leakage rate on the soil gas phase. In fig. 20B such solutions for all three components (note the infinitely small oxidation zone at about 2 m from the leak) are compared with the measured data for the summer period.

Obviously the soil gas phase must change in composition in autumn. Soil temperature had to be rather low (less than about 5 °C), however, before the effect of the falling temperature became noticeable in the soil gas phase composition.

This insensitivity of the distribution pattern of gases around a leak in the temperature range between 5 and 20 °C is caused by the fact that the level of microbial activity is less important for the distribution (cf. section 4.4.3) unless it becomes very low as in winter. Steady state calculations, however, showed a stronger temperature effect (table 12). Then, using the previously calculated value of $2.22 \times 10^{-7} \text{ cm}^3 \cdot \text{cm}^{-3} \cdot \text{s}^{-1}$ for the rate of CH₄-consumption at 20 °C, the distribution pattern was already markedly influenced after a lowering of temperature to 10 °C, a pattern which does not correspond with the experimental data. This may have been caused by deriving the exponential temperature dependence for the range of 13.5 to 20.5 °C, and extrapolating it to lower temperature ranges. Furthermore the composition of the soil gas phase is not in a steady state in periods of falling temperature, so it does not pertain to the actual soil temperature.

4.4.3 Effect of soil fertility, moisture content and depth of groundwater

As was pointed out in section 4.1, the fertility status of the soil affects the microbial CH_4 -oxidation in two ways. In the first place the duration of the lag phase of the microorganisms is influenced. This was established at the experimental field in the initial period just after the start of the gas leakage (fig. 21). In the topsoil microbial CH_4 -oxidation started at an earlier date than in the subsoil. After 9 days of leakage the CH_4 -concentration decreased because of the increasing CH_4 -consumption rate. The course of the O_2 and CO_2 -concentration also indicates higher microbial activity in the topsoil, where probably the nutrient conditions are more favourable for the microorganisms (cf. also Hoeks, 1970).

Secondly, the size of the microbial population, and accordingly the rate of CH_4 -oxidation, in the stationary phase will be the higher the more fertile the soil. It appears likely that in general the microbial activity in soil near gas leakages will considerably exceed the activity calculated for the soil at the experimental field ($\alpha_{\text{CH}_4}\{293^\circ\text{K}\} = -2.22 \times 10^{-7} \text{ cm}^3 \cdot \text{cm}^{-3} \cdot \text{s}^{-1}$), as the latter soil was rather acid (pH 4) and poor in nutrients. The microbial activity in the dune sand soil was much higher ($\alpha_{\text{CH}_4}\{293^\circ\text{K}\} = -60 \text{ to } -100 \times 10^{-7} \text{ cm}^3 \cdot \text{cm}^{-3} \cdot \text{s}^{-1}$). In spite of these large differences in α , however, the distribution of gases in the soil gas phase in the steady state differs only slightly for the various α -values (fig. 22). The computations show convincingly that in the range of CH_4 -consumption rates between ∞ and $0.83 \times 10^{-7} \text{ cm}^3 \cdot \text{cm}^{-3} \cdot \text{s}^{-1}$ the influence of α (via the width of the oxidation zone)

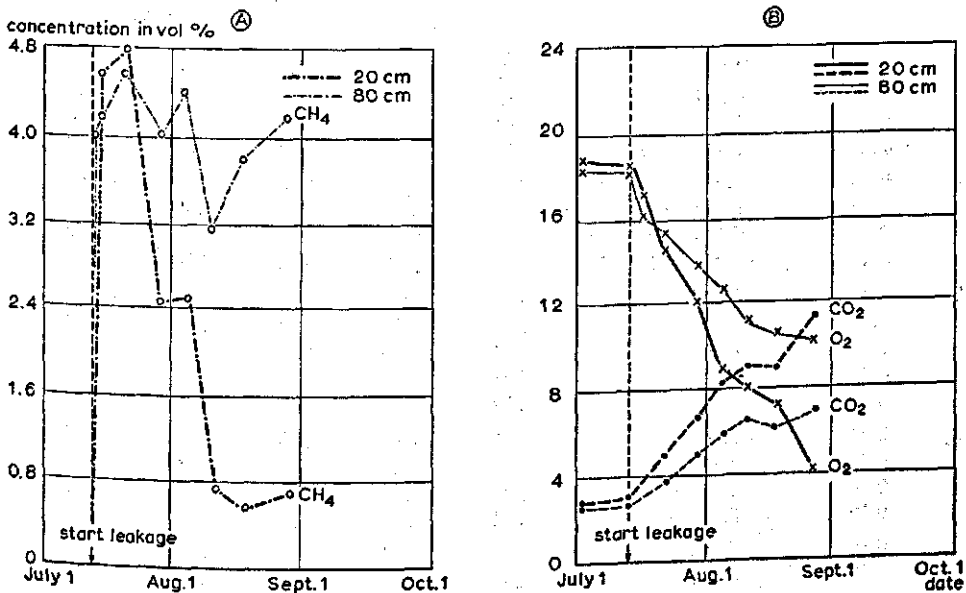

Fig. 21. Changes in the CH_4 -concentration (A) and the O_2 and CO_2 -concentrations (B) at 50 cm from an artificial leak (rate $5 \text{ l} \cdot \text{hr}^{-1}$) measured at a depth of 20 and 80 cm below a sealed soil surface.

is negligible for practical purposes.

This then leads to the important conclusion that at 'summer temperatures' the fertility status of the soil is of little concern with regard to the steady state distribu-

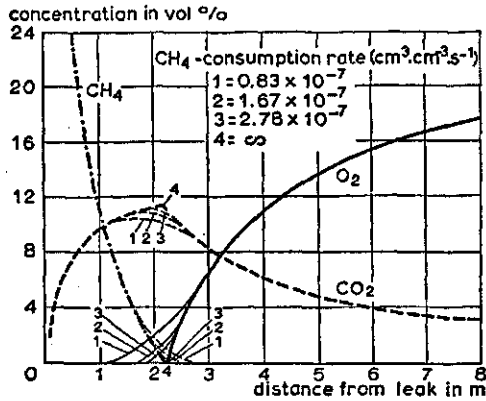

Fig. 22. Computed effect of the microbial CH_4 -oxidation rate, as dependent on soil fertility (1 and 2 = very low, 3 and 4 = medium to very high fertility status), on the composition of the soil gas phase around an artificial leak (rate $25 \text{ l} \cdot \text{hr}^{-1}$).

Table 12. Effect of gas filled pore space (ϵ_g), rate of leakage (Q_l), temperature (T), depth of groundwater (d_g) and distance to open soil (r_c) on the extent of the gas zone. Calculations were made with analytical solutions for infinitely high microbial activity in the oxidation zone except for the effect of T , where numerical solutions were used for finite microbial activity $\alpha_{\text{CH}_4} \{293^\circ\text{K}\} = -2.22 \times 10^{-7} \text{ cm}^3 \cdot \text{cm}^{-3} \cdot \text{s}^{-1}$.

Effect of	ϵ_g ($\text{cm}^3 \cdot \text{cm}^{-3}$)	Q_l ($\text{cm}^3 \cdot \text{s}^{-1}$)	T ($^\circ\text{K}$)	d_g (cm)	r_c (cm)	Radius of anaerobic zone (cm)	Radius of gas zone (cm)
ϵ_g	0.20	6.944	293	2000	800	349	349
	0.25	6.944	293	2000	800	267	267
	0.30	6.944	293	2000	800	214	214
	0.35	6.944	293	2000	800	177	177
Q_l	0.30	1.389 (= 5 l.hr ⁻¹)	293	2000	800	40	40
	0.30	6.944 (= 25 l.hr ⁻¹)	293	2000	800	214	214
	0.30	27.778 (=100 l.hr ⁻¹)	293	2000	800	492	492
	0.30	69.444 (=250 l.hr ⁻¹)	293	2000	800	642	642
T	0.30	6.944	293	2000	800	182	247
	0.30	6.944	288	2000	800	120	303
	0.30	6.944	283	2000	800	0	438
	0.30	6.944	278	2000	800	0	653
	0.30	6.944	273	2000	800	0	800
d_g	0.30	6.944	293	∞	800	214	214
	0.30	6.944	293	2000	800	214	214
	0.30	6.944	293	240	800	411	411
	0.30	6.944	293	160	800	513	513
r_c	0.30	6.944	293	2000	800	214	214
	0.30	6.944	293	2000	600	193	193
	0.30	6.944	293	2000	400	161	161
	0.30	6.944	293	2000	200	107	107

tion of gases around a leak. This is in accordance with the observation that the distribution of gases around a gas leakage always shows a similar characteristic picture whatever the soil fertility status. Only if the CH_4 -consumption rate sinks considerably below $1 \times 10^{-7} \text{ cm}^3 \cdot \text{cm}^{-3} \cdot \text{s}^{-1}$ it does influence the distribution. Such extremely low consumption rates are only found during winter.

In contrast, see table 12, the effect of soil moisture and depth of the groundwater table on the gas distribution is usually considerable. A change in moisture content affects the gas-filled pore space ϵ_g , and accordingly the diffusion coefficient (eq. 9). The gas zone becomes much larger upon increase of the moisture content (ϵ_g smaller). The chosen range of ϵ_g between 0.20 and 0.40 corresponds to the one commonly found under pavements. The depth of the groundwater table d_g determines the for gas transport available part of the profile and consequently the extent of the gas zone. Obviously the effect is considerable as long as d_g is in the same order of magnitude or smaller than the gas zone.

Summarizing, it may be stated that for temperatures above about 5°C the steady state distribution of gases is typically flux-dominated, and thus the factors affecting the flux, as soil moisture content and impervious boundaries as a pavement or a groundwater table, have a very significant influence on the extent of the gas zone. At very low temperatures in winter the metabolic activity of the methane-oxidizing microbes will also be of importance.

4.5 Reduction processes in the soil

Measurements of the redox potential showed that the soil in the anaerobic zone is in a state of strong reduction (E_h in the range of -0.15 to -0.20 V, cf. fig. 23). According to the stages (see table 6) distinguished by Takai and Kamura (1966), this would mean that the components NO_3^- , Mn^{4+} , Fe^{3+} and SO_4^{2-} become reduced for the larger part and also organic compounds (acids) may be broken down to CO_2 ,

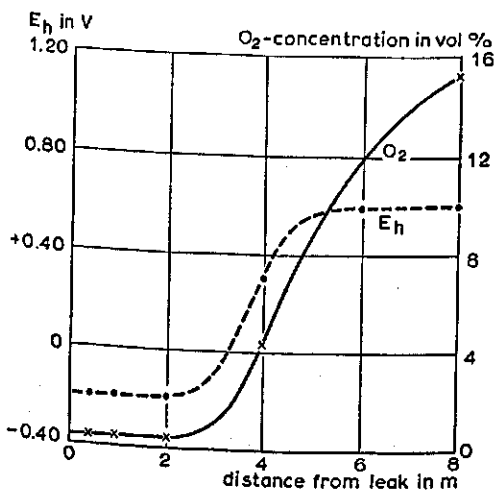

Fig. 23. Redox potential (E_h) and O_2 -concentration in the soil gas phase around an artificial leak (rate $250 \text{ l} \cdot \text{hr}^{-1}$; with ventilation channels).

H₂ and CH₄ by anaerobic fermentation processes. The presence of large amounts of reduced components as Fe²⁺ and Mn²⁺ in gassed soils was reported by Adams & Ellis (1960) and Kühne & Köster (1967). In all soil samples of our experiments the colour of the gassed soils was darker than of the accompanying normal soils, which might indicate formation of FeS (cf. Gotoh & Yamashita, 1966; Starkey, 1966).

The low redox potential of less than +0.30 V in the methane oxidation zone and part of the oxygen transit zone (3 to 4 m from the leak) is remarkable. Here the soil is aerobic and therefore a redox potential of about +0.50 to +0.60 V should be expected to occur, as in theory even a lowering of the O₂-concentration of 20 to 0.2 vol. % brings about a lowering of the redox potential of only 0.03 V. The effect found here indicates a lack of equilibrium between the gas phase (characterized by the O₂-concentration) and the liquid phase (characterized by the redox potential). This lack of equilibrium means that there is a gradient in *E_h* from high at the liquid-gas interface to low in the liquid phase. So the O₂-concentration in the liquid phase must be practically zero. This may occur in strongly aggregated soils, where the inner part of water-saturated structure elements can be in a reduced state, while the outer part is in an oxidized state. In the soil under concern (the sandy soil of the experimental field) structure elements of considerable size are absent, however, so the low oxygen status in the liquid phase can only be explained by assuming a very high rate of O₂-consumption in a thin liquid layer near the liquid-gas interface. In the methane oxidation zone high O₂-consumption rates are common. In the oxygen transit zone, however, high O₂-consumption rates are unlikely, unless it is a remnant of a previous event, as is probable in the case presented. Because of a drop in temperature during the winter period the gas zone extends, i.e. CH₄ is introduced into the initial oxygen transit zone. In spring at rising temperatures CH₄ will here be oxidized again and the gas zone decreases to its initial extent. Thus CH₄-oxidation will occur in the oxygen transit zone during some weeks in spring and some weeks in autumn.

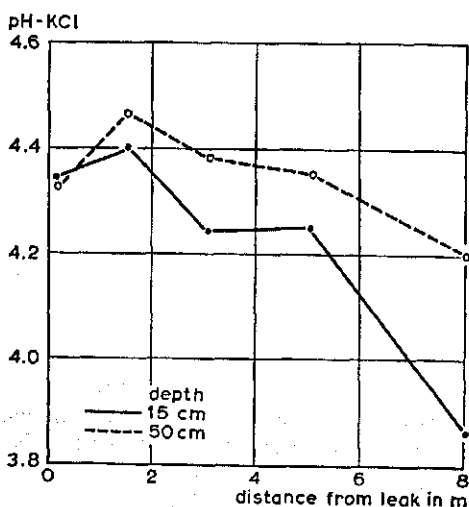

Fig. 24. The pH-KCl as rising (due to reduction processes) from the unaffected normal soil towards the same leak as in fig. 23 in the layers at 15 and 50 cm depth.

Furthermore the extent of the gas zone of the particular gas leakage of fig. 23 was earlier much larger, but it decreased after installation of ventilation channels. So high O_2 -consumption rates in part of the oxygen transit zone may be a remnant of both events mentioned above. If this explanation is correct then the aftereffects of such events on the O_2 -consumption rate should persist for several months, as the ventilation channels were installed 8 months before collection of the data and 2 months after the start of methane oxidation in spring (see also chapter 5).

Reduction processes in acid soils are commonly accompanied by a raise in pH (see section 3.4). This was also established for the anaerobic zone around the leak at the experimental field (fig. 24). In the calcareous dune sand soil used in laboratory experiments, however, the pH of the gassed soil samples was lower than of normal soil samples (7.3 against 7.7) accompanied by a lower carbonate content (0.1% as against 1.1%). Similar shifts in pH resulting from gas leakage in acid soils and in alkali and calcareous soils were reported by Adams & Ellis (1960). An explanation of such shifts in soil pH under anaerobic conditions was given in section 3.4.

5 Processes after repair of a gas leakage

5.1 General

The first step towards improvement of the composition of the soil gas phase at leakage sites is obviously repair of the leak. Since leakage is in most cases induced by desiccation of the lead-oakum joints (see chapter 1), addition of water to natural gas will bring a certain improvement. Application of this method is usually not of practical value as expensive wetting installations are required and as difficulties may arise during frost periods. Other liquids, which may be introduced into gas mains and which are acting more effectively than water are a mixture of water and diethylene-glycol (90%), an emulsion of water and bitumen (1:1) or an emulsion of water and rubber (1:1). These methods of repair are known as internal sealing methods (Gaikhorst, 1971). External sealing methods are more commonly used, however. Techniques employed are: fixing of leak clamps around the joint, pouring a sealing compound on bitumen or rubber-basis around the joint, or introducing di-ethylene-glycol into the desiccated joint from the outside.

After repair of the leak the composition of the soil gas phase changes and therefore the environmental conditions for microorganisms. This results in shifts within the microbial population. The oxidation-reduction conditions in the soil are also altered and reduced compounds will be oxidized. It is important to know how much time is involved with these processes and what the consequences will be for the composition of the soil gas phase.

The changes in O_2 -consumption rate after repair of a gas leakage were determined in laboratory experiments. Measurements of the redox potential at the experimental field gave more information on the rate of oxidation of reduced compounds in the anaerobic zone near a leak. Simultaneously the changes in soil gas phase composition were measured.

5.2 Laboratory experiments

In pot experiments, performed according to the procedure described in section 4.1.2, repair of the leak was imitated by cutting off the supply of natural gas. Thus air was the only component passing through the soil. Although differences between the rates of O_2 -consumption and CO_2 -production are to be expected, particularly immediately after stopping the natural-gas supply, differences in flow velocity in inlet and outlet appeared to be within the limits of measurement. Therefore in later

Table 13. Description of the soil samples used for determination of the O₂-overdemand of gassed soils.

Number of sample	Description	Pretreated (see table 14)	Radius gas zone (m)	Distance from leak (m)	Period of leakage (months)	Composition of soil gas phase at sampling date		Date of leak repair	Sampling date	Start of the experiment
						% O ₂	% CH ₄			
1A	dune sand, The Hague	+	5	2.5	10	< 1	20-25	not	5- I-70	29- I-70
1B	dune sand, The Hague	+	5	2.5	10	< 1	20-25	not	5- I-70	20- X-70
1C	dune sand, The Hague (fig. 1C)	+	1	0.5	6	0.8	15	not	23-III-71	6-IV-71
2A	sand, exp. field	-	4	1	20	10.5	16	1- III-71	2-III-71	3-III-71
2B	sand, exp. field	-	4	2	20	15.7	5	1- III-71	2-III-71	3-III-71
2C	sand, exp. field (fig. 2)	-	4	4	20	13.7	2	1- III-71	2-III-71	3-III-71
3A	sand, Amsterdam	-	4	<0.5	1	0	0	18- I-71	29- I-71	2- II-71
3B	sand, Amsterdam	-	3	<0.5	1	2	0	18- I-71	29- I-71	2- II-71
4A	dune sand, The Hague	-	7	0.8	>12	3.2	>50	18-XII-70	27- I-71	29- I-71
4B	dune sand, The Hague	-	4	0.6	>12	2.7	25	18-XII-70	27- I-71	29- I-71
5A	sand, Rotterdam	-	6	1	6	< 2	0	15- I-71	9- II-71	12- II-71
5B	sand, Rotterdam	-	5	1.5	3	< 1	15	not	9- II-71	12- II-71
6A	sand, Zwolle	-	3	<0.5	> 6	4	42	16- II-71	17- II-71	12-III-71
6B	sand, Zwolle	-	2.5	<0.5	> 6	6	28	16- II-71	17- II-71	12-III-71
7	clay, Wageningen	-	3-4	<0.5	?	-	-	18- I-71	18- I-71	19- I-71

Table 14. Pretreatment of soil samples in the laboratory.

Number of sample	Aerobic period			Anaerobic period
	CH ₄ -consumption ($\times 10^{-5} \text{ cm}^3 \cdot \text{cm}^{-3} \cdot \text{s}^{-1}$)	O ₂ -consumption ($\times 10^{-5} \text{ cm}^3 \cdot \text{cm}^{-3} \cdot \text{s}^{-1}$)	duration (days)	duration (days)
1A1*	0.2 to 2.0	0.4 to 4.2	33	0
1A2*	0.1 to 1.1	0.2 to 2.2	33	0
1B1	n.d.	0.47	21	0
1B2	n.d.	0.69	56	29
1C1	n.d.	0.22	29	0
1C2	n.d.	0.25	19	10
1C3	n.d.	0.22	10	19
1C4	—	—	0	29

* The O₂-concentration in and the flow velocity of the mixture varied during the aerobic period (cf. section 4.1.2), thus causing large differences in CH₄ and O₂-consumption rates.

cases only the flow velocity of the influent gas mixture was measured.

All soils used had been affected by natural gas either during a pretreatment in the laboratory or during leakage at urban experimental sites. Pretreatments were of different duration and either aerobic, during which air and natural gas were introduced (sometimes at varying rates) into the soil so CH₄-oxidation could occur, or anaerobic during which natural gas was the sole gas introduced into the soil (no CH₄-oxidation, possibly reduction processes), or aerobic followed by anaerobic. A description of the soil samples is presented in table 13 and the various treatments in table 14.

The rate of O₂-consumption in the gassed soils was measured at set times until it finally equaled the consumption rate in the corresponding normal soils taken at the same sites but outside the gas zone. All experiments were carried out at room temperature.

Shifts within the microbial population after repair of the leak were studied in the soil samples 1B1 and 1B2. Results of this microbiologic research were described in detail by Adamse et al. (1972a, b). Here some of the results will be discussed, as these microbial shifts are responsible for biological decay processes which play an important role in the recovery rate of the soil.

5.3 Effect of changing composition of the soil gas phase on microorganisms

After repair of the leak, methane-oxidizing microorganisms will remain active as long as natural gas is present in the soil. Of course the same holds for ethane and propane-oxidizing microorganisms. So the decrease in amount of natural gas in the soil is due to continued consumption of hydrocarbons. Furthermore part of the gas can be removed from the soil with the aid of ventilation channels or with compressor treatments (see chapter 7).

Adamse et al. (1972b) studied the shifts within the microbial population in a dune sand soil by counting the number of bacteria per g of soil with respect to methane and ethane-oxidizing bacteria and heterotrophic bacteria. With the disappearance of methane from the soil gas phase the methane-oxidizing microorganisms will become inactive and will finally die or sporulate. The number of viable methane-oxidizing bacteria decreased only very slowly, however, as is demonstrated in fig. 25. Whittenbury (1970b) reported formation of exospores respectively cysts by the bacteria *Methylosinus trichosporium* and *Methylocystus parvus*. Perhaps this spore and cyst formation is one of the reasons of the slow decrease of the number of viable methane-oxidizing bacteria in an infected culture medium.

In soil many heterotrophic microorganisms are present which play an important role in plant nutrition. They decompose organic substances and mobilize plant nutrients. After addition of organic matter (especially easily decomposable compounds) to the soil, the number of heterotrophic microorganisms (bacteria, actinomycetes and fungi) generally increases considerably (Gaur et al., 1971).

In the methane oxidation zone around a gas leakage organic substances are accumulating. These may be for instance intermediates of the CH_4 -oxidation process (as methanol) or other excreted of methane-oxidizing microorganisms and, of course, dead bacterial cells. Already during the leakage period this accumulation resulted in a slight increase in the number of heterotrophic organisms.

After repair of the leak the number of methane-oxidizing bacteria decreased, indicating an accelerated dying-off of bacterial cells. The lysis of these cells will result in a release of non-living organic matter. The ensuing increase in the number of heterotrophic bacteria during a 5-day period is clearly demonstrated in fig. 25. The ethane-oxidizing bacterial population also extended, since they are able to use organic compounds other than ethane for their metabolic processes.

In the anaerobic zone around the leak shifts within the microbial population are also to be expected. As soon as oxygen is introduced into this zone the anaerobic

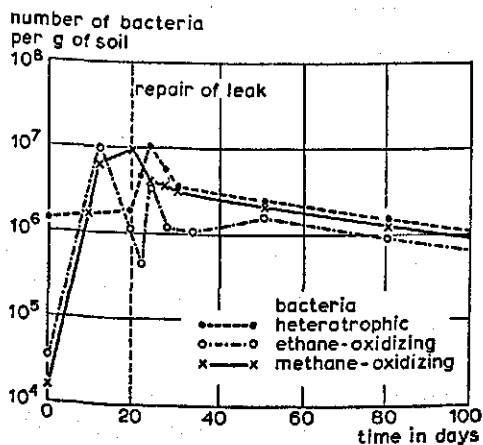

Fig. 25. Number of microorganisms per g of a dune sand soil (1B of table 13) in a pot experiment during and after leakage of natural gas (after Adamse et al., 1972b).

microbes will die or sporulate. The aerobic microbes will then develop after a more or less prolonged lag phase.

5.4 Oxidation of reduced compounds

In chapter 4 some data were given concerning the redox potential in the anaerobic zone around a leak. These data confirmed that reduced components, like Mn^{2+} , Fe^{2+} and S^{2-} , and organic acids may be present in this zone. After repair of a leak the oxygen content of the soil will increase and consequently reduced substances will be oxidized. In soils with low contents of reduceable components, the redox potential then will often increase to a normal level within some days. Theoretically the redox potential should reach a normal level (+0.50 to +0.60 V) as soon as the O_2 -concentration in the soil gas phase is measurable. Literature reports concerning the increase in redox potential after an anaerobic period (mostly a period of inundation) are scarce, while data about a simultaneous increase in O_2 -concentration are lacking.

From data collected at the experimental field and presented in fig. 26 it became clear that the redox potential in the liquid phase was not in equilibrium with the O_2 -concentration in the soil gas phase. Within 30 days after repair of the leak the O_2 -concentration reached a level of 10 to 12 vol. % (case A1), but nevertheless the soil remained in a reduced state (in case A2: $E_h = 0$ to -0.15 V). In all probability here the same reasoning holds as given in section 4.5, i.e. the rate of O_2 -consumption at the liquid-gas interface must be that high that the O_2 -concentration in the liquid phase remains extremely low. A rise in redox potential started near the methane oxidation zone (see case B2). After some time the redox potential at shorter distances from the leak (see case A2) also increased.

The oxidation of reduced components in soil can be a purely chemical process, in many cases, however, microbes are involved in the oxidation reactions (Russell, 1952). After reintroduction of O_2 into an anaerobic soil the aerobic microorganisms responsible for such oxidation reactions have to adapt themselves to the changed environmental conditions. During this lag phase the metabolic activity of microbes and therefore the rate of oxidation will be low. Furthermore the oxidation process in an acid soil (as in fig. 26) proceeds at a slower rate than in an alkali soil.

5.5 Oxygen overdemand of gassed soil

Oxygen is required for the decomposition by heterotrophic microorganisms of accumulated organic substances and for the oxidation of reduced components. In laboratory experiments the rate of O_2 -consumption in gassed soils was measured and compared with the rate in normal soils. First some experimental results will be discussed and afterwards it will be shown that in view of these results the rate of O_2 -consumption after leak repair may be described in terms of a first order reaction.

After repair of the leak, in the laboratory imitated by stopping the supply of natural gas but continuing the air supply, the O_2 -consumption rate initially decreased rather

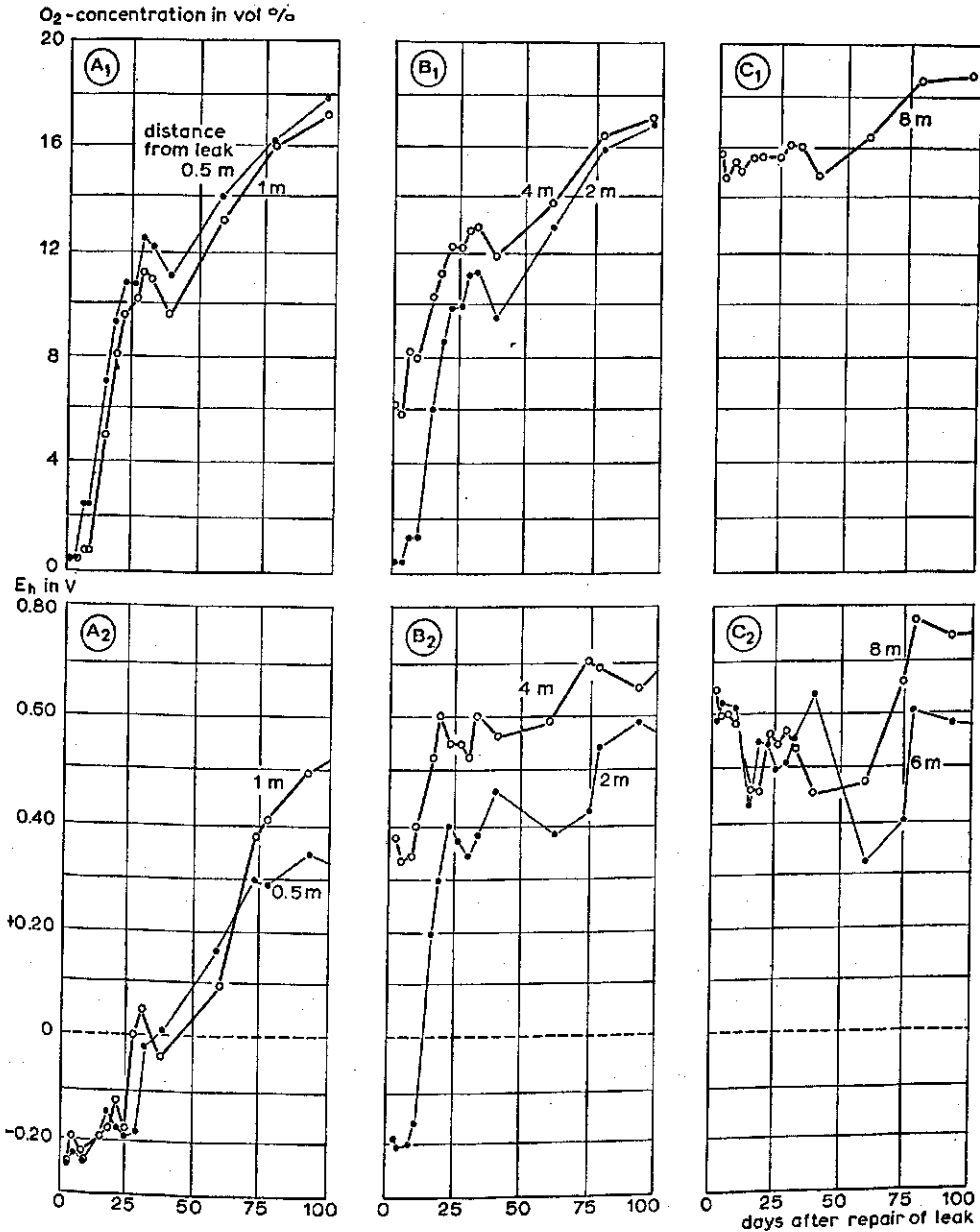

Fig. 26. Increase in O₂-concentration and redox potential E_h with time after repair of an artificial leak (rate 250 l · hr⁻¹; with ventilation channels) at various distances from the former leak.

rapidly, but still remained high during a considerable time. Only after a period of 60 to 80 days the O₂-consumption rate reached the normal level of $1 \times 10^{-7} \text{ cm}^3 \cdot \text{cm}^{-3} \cdot \text{s}^{-1}$ (fig. 27A). This period will be called the *soil recovery period*. In this case the O₂-consumption in the soil was not limited by an inadequate O₂-supply as the

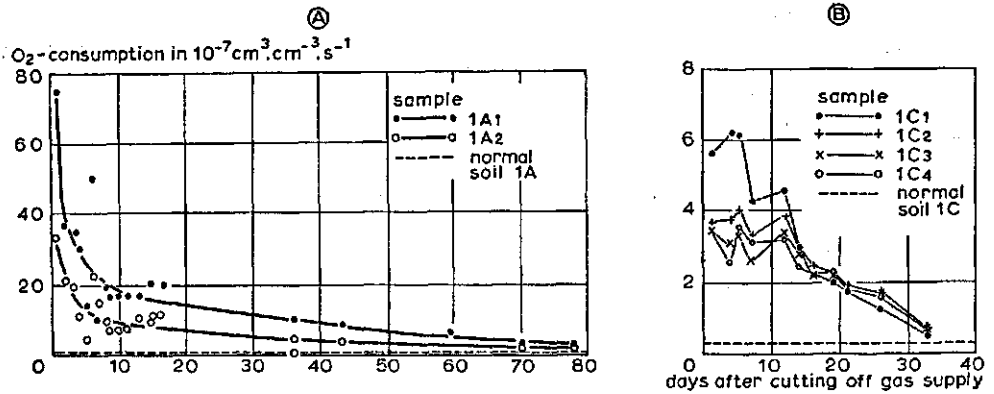

Fig. 27. O₂-consumption rates during the soil recovery period as influenced by the conditions during gas leakage for two soils (1A and 1C) and six different treatments (see table 14).

O₂-concentration in the soil gas phase during the recovery period never dropped below 16 to 18 vol. %. This is not to be expected in soils under a pavement, however.

The rate of O₂-consumption was found to be related to the conditions during the previous gas leakage. In sample 1A1 the rate of CH₄-oxidation during leakage was about two times as high as in sample 1A2 (see table 14). During the pretreatment these soils were never anaerobic, so the raised O₂-consumption can only result from decomposition of (probably organic) substances accumulated in the soil during the aerobic pretreatment when microbial oxidation of methane, ethane and propane could occur. In the field such a situation is found in the methane oxidation zone near a leak. The O₂-consumption rate during the recovery period was the higher the longer the microbial oxidation of methane continued (cf. fig. 27B).

In the anaerobic period during the pretreatment of gassed dune sand soil the redox potential dropped rather quickly to between +0.035 and -0.200 V. After reintroduction of oxygen into the soil the redox potential reached a level of +0.40 to +0.60 V within one day. These rapid changes indicate probably that only small amounts of reduced compounds were present in this soil. Therefore the raised O₂-consumption rates in the recovery period here have to be attributed mainly to decomposition of accumulated organic compounds.

In the non-pretreated soil samples collected in the immediate vicinity of a leak the O₂-consumption rate was found to decrease in a similar way after repair of the leak. In fig. 28 this is demonstrated for a clay soil.

The amount of oxygen consumed in a gassed soil during the recovery period minus the amount consumed in a normal soil, will here be defined as the O₂-overdemand of the gassed soil, which may be described mathematically as

$$P_0 = - \int_0^{\infty} (\alpha - \alpha_n) dt \quad (\text{cm}^3 \cdot \text{cm}^{-3}) \quad (42)$$

where P_0 (cm³ · cm⁻³) is the O₂-overdemand at $t = 0$, i.e. the moment when the

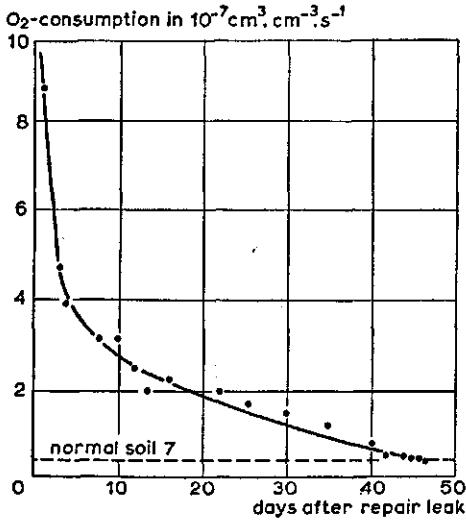

Fig. 28. O₂-consumption rate during the soil recovery period in a gassed clay soil (sample 7, table 13).

natural gas is removed from and oxygen is introduced into the soil; $-\alpha$ is the O₂-consumption rate at time t , and $-\alpha_n$ is the constant consumption rate in a normal soil (both in $\text{cm}^3 \cdot \text{cm}^{-3} \cdot \text{s}^{-1}$). The O₂-overdemand of a gassed soil, in a way comparable with the BOD (Biochemical Oxygen Demand)-value of waste water depends on the amount of accumulated organic and reduced compounds, and will, together with the oxidation rate coefficient, determine the duration of the recovery period. In this respect the rate and duration of the gas leakage will be important factors.

For lack of precise information as to the nature of the oxidizable compounds present in a gassed soil it was checked whether the observed O₂-consumption rate could be expressed in terms of a first order reaction. In that case the O₂-overconsumption at a given moment is proportional to the O₂-overdemand at that moment, according to

$$-(\alpha - \alpha_n) = \omega P \quad (\text{cm}^3 \cdot \text{cm}^{-3} \cdot \text{s}^{-1}) \quad (43)$$

where $P = \text{O}_2$ -overdemand of the soil at time t ($\text{cm}^3 \cdot \text{cm}^{-3}$)

$$\omega = \text{oxidation rate coefficient (s}^{-1}\text{)}$$

The decrease in P per unit time equals in principle the O₂-overconsumption rate, so

$$(dP/dt) = (\alpha - \alpha_n) \quad (44)$$

Combination of eqs. (43) and (44) yields the differential equation

$$(dP/dt) = -\omega P \quad (45)$$

With a boundary condition, e.g. $P = P_0$ at time $t = 0$, the solution of eq. (45) becomes

$$P = P_0 e^{-\omega t} \quad (\text{cm}^3 \cdot \text{cm}^{-3}) \quad (46)$$

With eqs. (43) and (46) the following linear relationship between the natural logarithm of the O₂-overconsumption rate and time can be derived

$$\ln [-(\alpha - \alpha_n)] = \ln \omega P_0 - \omega t \quad (47)$$

In fig. 29 $\ln [-(\alpha - \alpha_n)]$ is plotted against t for a number of pretreated and non-pretreated soils. The calculated values of P_0 and ω are given for each soil sample. The correlation coefficients are rather satisfying (r often higher than 0.80), so it is taken that O₂-overconsumption rate in a gassed soil after repair of a leak can be described with satisfactory accuracy as an exponential function of time. The P_0 and ω -values for the soils mentioned in table 13 and 14 are listed in table 15. Most of these soil samples were collected at short distances from a leak (usually from within the anaerobic zone) and this may be one of the reasons for the lower P_0 -values in

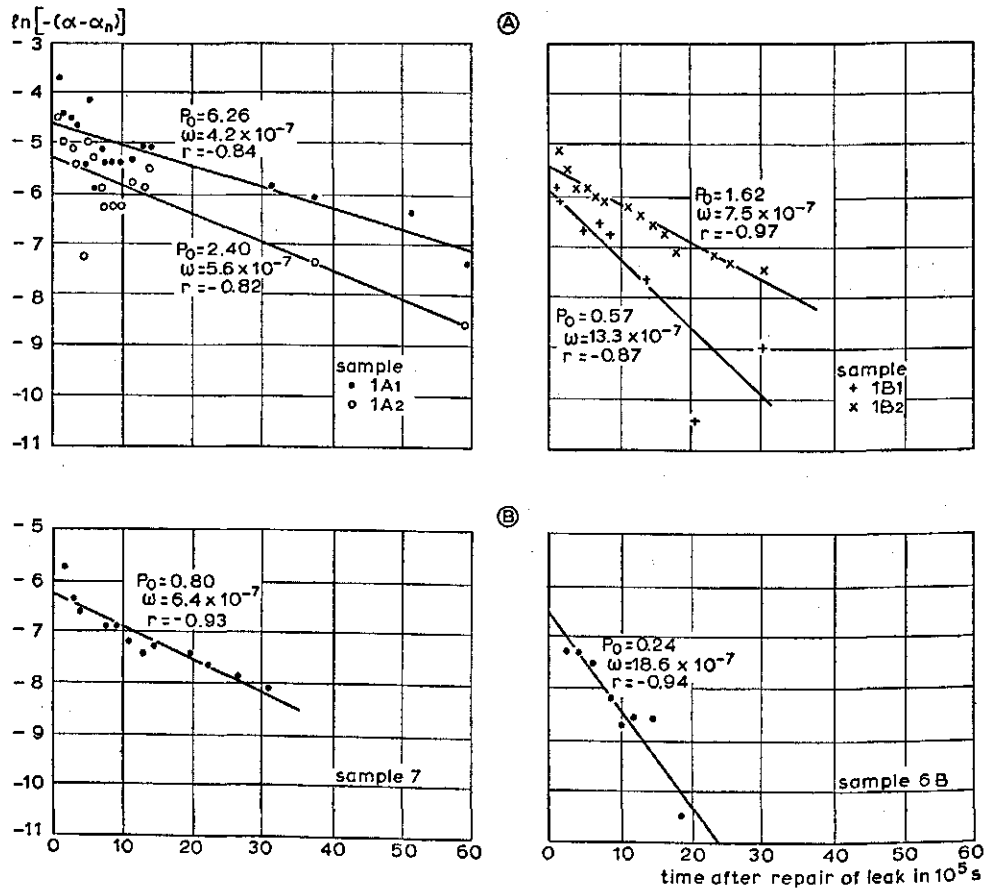

Fig. 29. The natural logarithm of the O₂-overconsumption rate ($\text{cm}^3 \cdot \text{cm}^{-3} \cdot \text{s}^{-1}$) against time (s) in pretreated (A) and non-pretreated (B) gassed soils (see tables 13 and 14) during the soil recovery period. The O₂-overdemand P_0 ($\text{cm}^3 \cdot \text{cm}^{-3}$) and the oxidation rate coefficient ω (s^{-1}) were calculated from the regression line.

Table 15. O₂-overdemand P_0 and oxidation rate coefficient ω for various gassed soils (see tables 13 and 14).

Soil sample	P_0 (cm ³ · cm ⁻³)	ω (×10 ⁻⁷ · s ⁻¹)	Corr. coeff.
1A1	6.26	4.2	-0.84
1A2	2.40	5.6	-0.82
1B1	0.57	13.3	-0.87
1B2	1.62	7.5	-0.97
1C1	0.80	10.9	-0.96
1C2	0.72	7.1	-0.89
1C3	0.67	6.2	-0.87
1C4	0.67	6.2	-0.86
2A	0.49	6.7	-0.81
2B	0.39	10.3	-0.80
2C	0.73	2.8	-0.77
3A	0.27	16.4	-0.92
3B	0.49	10.6	-0.88
4A	0.43	8.1	-0.87
4B	0.46	7.5	-0.55
5A	0.15	32.5	-0.95
5B	0.19	19.4	-0.97
6A	0.22	20.5	-0.94
6B	0.24	18.6	-0.94
7	0.80	6.4	-0.93

the non-pretreated soil samples. From the data found in pretreated samples (1A1 through 1C4) it could be derived that the highest values for the O₂-overdemand P_0 are to be expected in the methane oxidation zone. This was confirmed by the P_0 -value of sample 2C, which was collected close to the oxidation zone. For other soils with high contents of reduced components the P_0 -values within the anaerobic zone may be high also. The high P_0 -value found for the clay soil (sample 7) might be indicative.

The oxidation rate coefficient ω will depend on the nature of the accumulated organic and reduced anorganic substances. The varying values of ω for the different samples are not surprising therefore, since many compounds of different nature will be present in the soil. The simultaneous presence of a number n of oxidizable compounds with different oxidation rate coefficients would mean, when the decomposition of these compounds is assumed to be a first order reaction, that

$$P = \sum_{i=1}^n P_i \quad (\text{cm}^3 \cdot \text{cm}^{-3}) \quad (48)$$

$$\omega = \sum_{i=1}^n (P_i/P)\omega_i \quad (\text{s}^{-1}) \quad (49)$$

where P_i is the O_2 -demand of compound i contributing to the O_2 -overdemand and ω_i the oxidation rate coefficient for this compound. So the overall oxidation rate coefficient ω is the fraction-weighted mean value of ω_i , but it is not a constant, as the fractions of the compounds i change with time. Easily decomposable compounds with high oxidation rate coefficients will rapidly disappear, while the more resistant compounds with low coefficients are left, so the overall value of ω will decrease with time. As was indicated above, however, the available data fitted the first order reaction (ω is constant) rather well, so for the present purpose, i.e. calculating O_2 -consumption rates during the recovery period, the possibility of the simultaneous presence of compounds with rather different oxidation rates was left out of consideration. The above may serve as a warning, however, that the overall value of ω may be estimated too high if data are collected in an early stage of the recovery period only. In this context it should also be mentioned that the oxidation process is mainly a microbial one, so ω will undoubtedly depend on temperature and soil characteristics as pH, moisture content, fertility status. Differences in ω might also be expected for the different zones around a gas leakage. From the data in table 15, however, such differences could not be established unambiguously.

There is a tendency in the data presented that the lower ω the higher P_0 . A possible explanation might be that the higher values of P_0 will usually be found near the methane oxidation zone, mainly resulting from accumulation of organic compounds, while the lower P_0 -values will be found in the anaerobic zone, mainly resulting from accumulation of reduced anorganic compounds. The oxidation rate coefficient is likely to be lower for organic compounds than for reduced anorganic compounds. This would mean that the rate of the recovery process of a gassed soil is fairly certain to be limited in the methane oxidation zone rather than in the anaerobic zone. Obviously more research will be necessary to clarify this point.

Since biological determinations of the O_2 -overdemand, as done in the here presented research, are rather time-consuming it should perhaps be considered to try to develop a laboratory procedure in order to establish rapidly the O_2 -demand of the soil, for instance with a chemical oxidant, compare COD (Chemical Oxygen Demand)-determinations in waste water.

5.6 Changes in the soil gas phase

After repair of a leak the composition of the soil gas phase changes in a way as demonstrated in fig. 30 pertaining to the leak on the experimental field (cf. fig. 2).

That at a distance of 0.5 m from the former leak the O_2 -concentration is higher than at 1 or 2 m, is a result of a ventilation channel installed in this case next to the leak. The almost steady state distribution of gases existing during gas leakage, is represented by the thick lines. The CH_4 -concentration dropped, particularly due to the ventilation channel, to zero per cent within 6 days.

The O_2 -front proceeded towards the former leak and after about one month the O_2 -concentration in the whole area around the former leak was higher than 11 vol. %.

Table 16. Data concerning the duration of the recovery process after repair of gas leakages at a number of urban experimental sites (data after Hoeks, 1971).

Experimental site	Soil	Pavement (sidewalk+road)	Radius gas zone (m)	Distance tree to leak (m)	Measures	Months after leak repair necessary to achieve		
						% CH ₄ = 0	% O ₂ > 10	% O ₂ > 15
1. Prinsenvinkenpark, (The Hague) cf. fig. 1A	sand	bricks+asphalt	13	2	V(5)	2-4	9-11	11-13
2. Rusthoekstraat (The Hague)	sand	tiles+bricks	10	8	V(5)	3	11-12	—
3. Van Alkemadeaan (The Hague)	sand	tiles+asphalt	4	3	V(5)	‡	1‡-2	2-3
4. Parklaan (Rotterdam)	sand	tiles+bricks	4	3	V(8), C(9)	—	2‡-4	4-7
5. Sophiakade (Rotterdam)	clay	bricks	—	—	V(11), C(9)	3-3‡	4-5	6-7
6. Italiaansestraat (Rotterdam)	sand	tiles+bricks	4	3	no	‡-1	2	7
7. P. de Hooghstraat (Rotterdam) cf. fig. 1E	sand	tiles+bricks	2	2	C(3)	‡	1	2
	sand	tiles+bricks	6	6	V(8), C(3)	—	‡	1
	sand	tiles+bricks	6	2	V(8)	1	7	9
8. Geertjesweg (Wageningen) cf. fig. 1D	sand	tiles+bricks	4	3	V(1) ^o	‡	1	2
	sand	tiles+bricks	4	3	V(2)	‡	3	—

V = ventilation channels, filled with gravel (between parentheses the number of channels); ^o open ventilation channel.

C = compressor (between parentheses the number of treatments).

Installation of ventilation channels: at site 1, 2, 3 in a circle around the tree, at site 4, 5, 6, 7 in a row between tree and gas main.

Position of measuring points: several within a radius of 2 m from the tree; sampling depth 50 cm.

Duration of gas leakage: not known, leak already present when measurements started; repair within 1 to 2 months. For object 7 it is known that leaks were present for more than 6 months.

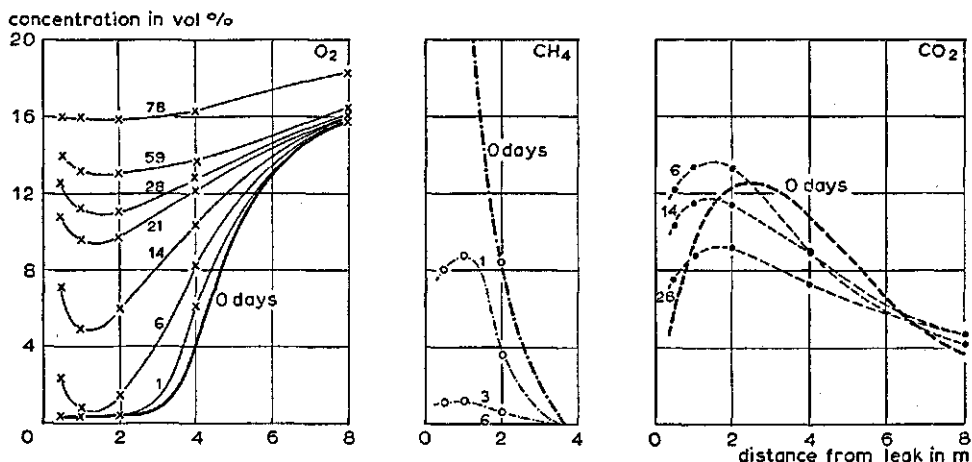

Fig. 30. Changes in soil gas phase composition at successive times (0, 1, 3, 6, 14, 21, 28, 59 and 78 days) after repair of an artificial leak (data from the measuring points 1 through 5 of fig. 2).

At short distances from the former leak the CO₂-concentration initially increased because CO₂ now was not pushed away by leaking gas. As soon as the methane was consumed or removed from the soil, the CO₂-concentration decreased in the whole area. The increase in redox potential was already described in section 5.4.

The recovery processes after repair of a leak were also investigated at urban experimental sites. The composition of the soil gas phase was always found to change in the way described above. Often the process took more time, because either no measures were taken to improve soil ventilation or because the measures were more or less ineffective. The effectiveness of measures in various situations will be discussed in detail in chapter 7. In table 16 some data are presented on the course of recovery after repair of leaks at 8 urban experimental sites.

In spite of the measures applied the recovery process up to a normal O₂-concentration in the soil gas phase often took several months to one year. In comparison with these data the O₂-concentration at the experimental field (cf. fig. 30) increased rather quickly. This was particularly due to the there present open ventilation channels.

6 Causes of gas injury to vegetation

6.1 General

As was shown in chapter 4 and 5 leakage of natural gas in soil strongly affects the composition of the soil gas phase, giving rise to practically zero O₂-concentrations, to high CO₂-concentrations, and to high concentrations of natural gas in the gas zone. Aside from the direct influence of natural gas, the very low O₂-concentrations and also the high CO₂-concentrations must lead to serious aeration problems for growing plants. The latter is to be considered as an indirect effect of gas leakage comparable to aeration problems also accompanying for example prolonged inundation of soils. The effect of the soil gas phase composition on plant growth has been extensively studied. Literature reviews were given, amongst others, by Russell (1952), Black (1957) and Grable (1966). Some aspects will be treated here in order to formulate conclusions concerning the cause of injury to plants by natural-gas leakage.

In addition to the above indirect effect, the aeration effect, natural gas might have a direct toxic influence on plant growth, especially since ethylene was found to be present in the gas (Adamse et al., 1972a; Hoeks & Leegwater, 1972).

The aftereffects of gas leakage may persist for a considerable period. First a lack of oxygen during part of the period following leak repair may cause injury to plants. Secondly toxic components may be left in the soil as reduced inorganic substances (e.g. Fe²⁺, Mn²⁺, S²⁻) or organic acids (e.g. propionic and butyric acid). These aftereffects are important in view of the regeneration of injured street trees and replanting of young trees at leakage sites where a dead tree has been pulled up. Check measurements are to be done before replanting.

6.2 Metabolic activity of roots

In the soil, oxygen is consumed in respiration processes of plant roots, microorganisms, etc. The supply of oxygen from the atmosphere into the soil takes place through the gas phase and mainly by diffusion. Plant roots and microorganisms are surrounded by a water-saturated zone, so in last resort the oxygen has to be transported through the liquid phase. At the liquid-gas interface oxygen dissolves into the water, but the solubility is small (8 mg O₂ per l at 25 °C and a partial pressure of 0.21 atm; in comparison the O₂-concentration in air at that partial pressure is 275 mg per l at 25 °C). Furthermore the diffusion coefficient of oxygen in water is about 10⁴ times as low as in air ($D_w = 2.60 \times 10^{-5} \text{ cm}^2 \cdot \text{s}^{-1}$, $D_a = 0.226 \text{ cm}^2 \cdot \text{s}^{-1}$,

both at 25 °C). Therefore transport through the water-saturated zone is very slow. Under wet soil conditions this zone is relatively thick, so the transport of oxygen to the root may then become a limiting factor in root respiration. High CO₂-concentrations can also reduce root respiration. As the respiration processes in the root liberate the energy required for root growth and uptake of nutrients and water, these latter processes will be indirectly affected by the aeration conditions.

6.2.1 Oxygen supply to roots

According to Lemon (1962) the O₂-concentration inside the root (ρ_i) is related to the O₂-consumption rate inside the root (A_i) and the concentration at the liquid-gas interface (ρ_{i0}), i.e. at the external boundary of the water-saturated zone around the root, expressed as

$$\rho_i = \rho_{i0} - \frac{A_i r_r^2}{2 D_e} \ln(r_r/r_{i0}) + \frac{A_i}{4 D_i} (r_r^2 - r^2) \quad (\text{mg} \cdot \text{cm}^{-3}) \quad (50)$$

where D_i and D_e are the diffusion coefficients respectively in the root and in the water-saturated zone outside the root, r_r is the radius of the root and r_{i0} the radius of the root plus water-saturated zone.

In this model the thickness of the water-saturated zone equals $(r_{i0} - r_r)$ cm. Consumption of oxygen outside the root is neglected and the rate of consumption in the root tissue is assumed to be independent of the O₂-concentration. Other research workers also found the activity of roots and bacteria to be unaffected by the O₂-level, even at levels less than 1 to 2 vol. % (Hopkins et al., 1950; Longmuir, 1954; Michael & Bergmann, 1954; Harris & van Bavel, 1957c; Greenwood, 1968; McCauley & Griffin, 1969; Wood & Greenwood, 1971). The activity of methane-oxidizing microorganisms was also found to be independent of the O₂-level over a rather wide range (cf. section 4.1.3). This assumption means that the rate of supply of oxygen to the root can be a limiting factor, while the concentration level at which it is supplied to the root system is of minor importance between rather wide limits.

The O₂-concentration at the liquid-gas interface becomes critical when the rate of supply to the root is at its minimum, i.e. when the O₂-concentration in the root centre (at $r = 0$) just equals zero. This critical O₂-concentration can be calculated from eq. (50) as

$$\rho_{i0}^* = \frac{A_i r_r^2}{2 D_e} \ln(r_r/r_{i0}) - \frac{A_i r_r^2}{4 D_i} \quad (\text{mg} \cdot \text{cm}^{-3}) \quad (51)$$

The critical O₂-level at the liquid-gas interface (ρ_{i0}^*) is directly proportional to the critical O₂-level in the soil gas phase via the solubility of O₂ in water, depending on (cf. Lemon and Wiegand, 1962) the O₂-consumption rate in the root tissue and the root diameter (varies with plant species) and on the thickness of the water-saturated zone (varies with soil structure and soil moisture content). The rate of O₂-consumption increases with rising temperatures, resulting in a higher critical

O₂-level. Thus it is clear that no single value for the critical O₂-level in the soil gas phase can be given, because various parameters are involved. Generally the water-saturated zone is thick under wet conditions and then plants may suffer from a lack of oxygen although the O₂-level in the soil gas phase is rather high.

Thus a sole measurement of the soil gas phase composition does not always give sufficient information about the aeration status of a soil. Supplementary measurements of the oxygen diffusion rate to a platinum electrode (ODR-measurements, Lemon & Erickson, 1952; Bakker, 1971) may complete the picture. According to Letey et al. (1961, 1962b, c) root growth stops when the oxygen supplied to the electrode is less than $15 \text{ to } 20 \times 10^{-8} \text{ g} \cdot \text{cm}^{-2} \cdot \text{min}^{-1}$. When this value is about $30 \text{ to } 40 \times 10^{-8} \text{ g} \cdot \text{cm}^{-2} \cdot \text{min}^{-1}$ root growth commonly is not hampered. Correlations between ODR-measurements and crop yield were found to be satisfactory. For one soil type with changing moisture content and bulk density, measurements of the gas-filled porosity in the soil gave also satisfying correlations with crop yield (Dasberg & Bakker, 1970).

6.2.2 *Effect of carbon dioxide*

The data in literature about the effect of CO₂ on the metabolic activity of roots are somewhat confusing. Usually some toxic action of CO₂ has been found, but the mentioned critical concentration levels vary widely. It has to be kept in mind that here again the CO₂-concentration at the root surface is a function of the CO₂-concentration in the soil gas phase, the CO₂-production rate in the root, the root diameter and the thickness of the water-saturated zone around the root (cf. eq. 51).

Low CO₂-concentrations in the root zone (1 to 4 vol.%) seem to stimulate plant growth (Grable, 1966; Geisler, 1969). Injury was observed by Geisler with CO₂-concentrations of 8 vol.%, while Leonard & Pinckard (1946) did not observe any injury up to a CO₂-level of 15 vol.%. Norris et al. (1959) found a reduction in root respiration of onion in the order of 30 to 50% with a CO₂-concentration of 10 vol.%. Harris & van Bavel (1957c) showed, however, that in spite of a reduced CO₂-production of roots, crop yields were not depressed when 5 vol.% CO₂ was present in the soil gas phase. They only found depressions in crop yield if the CO₂-concentration exceeded the O₂-concentration, so possibly there is some interaction between both gas components. Michael & Bergmann (1954) found an increase in root growth of 10 to 70%, when CO₂ was removed from the soil by absorption to active coal.

Summarizing, high CO₂-concentrations are likely to reduce root respiration. A critical CO₂-level in the soil gas phase, though different for each case, may be expected to be of the order of about 5 to 15 vol.%. Usually the CO₂-concentration in the soil will not reach a lethal level, this being in the order of about 20 vol.% or more. In contrast the O₂-concentration can reach a lethal level. In situations where the O₂-concentration in the gas phase is zero this is obvious. In addition it might occur that due to high O₂-consumption rates in the liquid phase, as after gas leakage, the supply to the root will be negligible even at finite O₂-concentrations in the gas phase.

6.2.3 *Root growth*

Under anaerobic conditions root growth was found to stop immediately (Visser et al., 1971). Most research workers observed dying of roots within some days to one week after the onset of anaerobic conditions. Segeren & Visser (1971) report that there are large differences in susceptibility of the root system to anaerobic conditions during the different periods of the year. In winter even 6 weeks of inundation did not injure the root system of apple trees. In summer, however, roots were dying after 3 days of inundation. Kramer & Jackson (1954) also found injury to roots after 2 to 6 days of anaerobiosis.

A lack of oxygen is especially detrimental in early growth stages just after germination (Letey et al., 1962a). Particularly the process of cell elongation would be affected (Harris & van Bavel, 1957a). Because the plant has to form new roots in springtime, poor aeration conditions are probably most detrimental in this period (van 't Woudt & Hagan, 1957).

6.2.4 *Uptake of water and nutrients*

Under poor aeration conditions absorption of water as well as transpiration are reduced (Kramer, 1951; Kramer & Jackson, 1954). In the initial stage of the anaerobic situation the uptake of water is reduced due to a decrease in permeability of the root tissue, especially the endodermis (Bierhuizen, 1969). Kramer (1940) states that this would be caused by the low O₂-concentration, while others (Seifriz, 1942; Chang & Loomis, 1945) attribute this phenomenon to a specific role of CO₂. The acidity, the viscosity and also the permeability of cell protoplasm would be influenced at high CO₂-concentrations (see also Russell, 1952).

The reduction in water uptake will also affect the uptake of nutrient ions, because the ions are partly transported into the roots with the bulk flow of water. The real contribution of bulk flow to the overall supply of ions to the roots is, however, uncertain because the water uptake and ion uptake may be effected by different sections of the root system (cf. Bolt, 1966). Therefore it is not simple to predict how the reduction in water uptake will affect the uptake of nutrient ions.

Furthermore root respiration is depressed at poor aeration conditions and thus the active uptake of nutrients will be reduced. The effect is not the same, however, for the various nutrient ions as the relation between active and passive uptake is different for each ion. Chang & Loomis (1945) reported a decreasing effect in the order K > N > P > Ca > Mg. Harris & van Bavel (1957b) found almost the same order except for the effect on Mg-uptake, being slightly higher than on Ca-uptake.

Labanouskas et al. (1971) stated lower contents of N, P, K, Ca, Mg, Zn and Fe in the plant under poor aeration conditions. On the other hand the contents of Na, Cl, Ca and B appeared to be higher than normal. Under normal aerobic conditions these ions are partly excluded by the plant. As this exclusion process requires energy, it may be disturbed under poor aeration conditions (Letey et al., 1961 and 1962b).

6.3 Plant injury near gas leakages

Injury to vegetation near leaks of natural gas might be ascribed to a direct toxic effect or to an indirect effect of the natural gas. Until recently a direct effect, as it was found for leakage of town gas, was not expected here since toxic constituents were not found in the gas. Recent experiments, however, have thrown some doubt upon this point. Both gaschromatographic analyses of the gas and a so-called 'triple response test' with germinating peas showed that in all probability ethylene is present in the natural gas in a concentration of about 2 to 3 ppm (Adamse et al., 1972a; Hoeks & Leegwater, 1972). Up till now symptoms of injury to trees near leaks have not pointed to ethylene as the injurious agent. The injury proceeds slowly and the first symptoms are only observed some time after the establishing of anaerobic conditions in the soil, mostly 1 to 3 months after the start of gas leakage. In contrast, injury by town gas usually proceeds rather rapidly (Fenner, 1951; Haller, 1959). Here ethylene was thought to be one of the toxic agents. Symptoms of injury by town gas or natural gas, however, are not quite characteristic but resemble the symptoms due to other factors affecting the root system, as for instance a lack of water or a lack of oxygen. In general, symptoms of injury by natural-gas leakage are: yellowing and premature fall of leaves, death of branches, failure to bud in spring and premature blossoming or fructification, eventually followed by death.

An indirect effect is to be expected in view of the data of the previous chapters. The problem of injury by natural-gas leakage there was shown to be mainly an aeration problem. The O_2 -concentration in the soil is rather low in the methane oxidation zone and in part of the oxygen transit zone, while in the anaerobic zone there is no oxygen at all.

In rather dry sandy soils, as usually found under pavements, the critical O_2 -concentration is rather low (4 to 8 vol. %). The O_2 -concentration near leaks, however, is that low that in the oxidation zone and part of the oxygen transit zone the metabolic activity of plant roots will be depressed, if it has not ceased completely due to high O_2 -consumption rates at the liquid-gas interface (cf. section 4.5). The high CO_2 -concentrations in these zones may also reduce root respiration and accordingly the uptake of water and nutrients. In the anaerobic zone root growth will be stopped and eventually the roots will die, unless O_2 can be supplied to the roots from the aerial parts of the plant via intercellular spaces or air cavities in the stem (cf. section 6.5). Furthermore toxic substances as Fe^{2+} , Mn^{2+} , S^{2-} and organic acids can be expected to occur in this zone, but the effects on plant growth will depend on the concentrations reached.

The disturbed process of uptake of water and nutrients involves an increased susceptibility to plant diseases. McNew (cited by Black, 1957) states that the decreased resistance would result from a toxic action of organic compounds as salicylic aldehyde, which may be formed from anaerobic decomposition of organic matter. Under anaerobic conditions microorganisms can also produce ethylene in the soil and this may be a significant factor in causing injury to plants under waterlogged

conditions (Smith et al., 1971). Some kinds of pathogenic aerobes are less inhibited by poor aeration conditions than are most other aerobic organisms. Consequently the pathogenic microbes are comparatively favoured, since the antagonistic action of other microbes is decreased (Russell, 1952). Moreover, injured roots are more susceptible to infection than uninjured roots.

The changes in pH due to reduction processes in the soil affect the availability of plant nutrients (Jeffery, 1961a; Starkey, 1966). Adams & Ellis (1960) reported an increased amount of available P when the pH increased during gas leakage, which is undoubtedly related to the change in solubility of iron. If the pH decreased, the amount of available P decreased too.

In several papers describing injury by natural gas, desiccation of the soil is mentioned as one of the possible causes of injury. At the experimental field the desiccating effect of the gas was only observed up to some 10 cm around the leak, so it is negligible with respect to plant injury. Even after two years of gas leakage the soil moisture content within the gas zone was rather high (moisture tension 100 to 50 cm H₂O, so pF-values of 2.0 to 1.7), which was even slightly higher than outside the gas zone. This is not surprising, remembering the formation of water vapour with the microbial CH₄-oxidation.

Another aspect of the microbial activity near leaks is the production of organic matter (intermediates of the CH₄-oxidation process, dead bacterial cells), as can be inferred from the increase in the number of heterotrophic microorganisms (cf. section 5.3). This organic material will be partly broken down, but the more resistant constituents will be left in the soil, causing an increase in the organic matter content. To estimate this increase it is assumed that 40% of the CH₄ consumed by microorganisms is converted to bacterial cell material, for simplicity sake taken to be (CH₂O)_n. At a low CH₄-consumption rate of $2.22 \times 10^{-7} \text{ cm}^3 \cdot \text{cm}^{-3} \cdot \text{s}^{-1}$, estimated for the experimental field, the accumulation of organic matter if decomposition is ignored will amount to $1.19 \times 10^{-7} \text{ mg} \cdot \text{cm}^{-3} \cdot \text{s}^{-1}$, which means at a bulk density of the soil of $1.4 \text{ g} \cdot \text{cm}^{-3}$ an absolute increase in organic matter of 0.022% by weight per month. For comparison it can be mentioned that at the experimental field the organic matter content at a depth of 15 cm increased with 0.6% (from 3.5 to 4.1%) and at 50 cm with 0.4% (from 1.0 to 1.4%) during the two-year experiment. Outside the gas zone the organic matter content decreased with 0 to 0.5%.

Adams & Ellis (1960) observed in gassed soils a much more pronounced increase in organic matter. In a gassed soil the organic matter content was found to be up to three times as high as in the normal soil. This increase was clearly reflected in the change in the moisture retention curves. The distinct effects, particularly in the upper 6 inches of the soil, may have been caused by a number of factors. The pH of the soils was rather favourable for microbial activity (pH 5.6 to 7.6). Their research concerned gas leakages in cultivated areas, so a pavement was missing and consequently the O₂-supply to the soil will have been rather high. Furthermore the soil will probably have been rather fertile. All these facts favour a high microbial CH₄-oxidation rate, especially in the topsoil, which may have been many times higher

than at the present author's experimental field. The period of gas leakage in the experiments of Adams and Ellis was moreover extremely long. Two samples were taken at sites where methane was spontaneously produced in the subsoil (gas wells); 'leakage' was supposed to occur here for at least 9 respectively 25 years. Such strong effects, however, are not likely to be found in soil under a pavement.

6.4 Sensitivity of plants

Some plants, for instance rice, can survive anaerobic situations in the soil because they possess specific features with respect to the supply of oxygen to the roots. Every plant is more or less able to adapt to poor aeration conditions, for example in the following ways:

Development of specialized structures in the plant (air cavities) which serve to supply oxygen to the roots (Russell, 1952). The existence of air-conducting tissues in rice can explain why the roots of this crop are able to grow in an anaerobic environment. O₂-supply from the aerial parts of the plant reduces after stem elongation, possibly due to an increased diffusion resistance (Alberda, 1953).

Development of adventitious roots (Kramer, 1951). These roots are developed at or above the soil surface, where aeration is most favourable. The absorbed oxygen can be transported to the roots in the anaerobic subsoil (Alberda, 1953). According to Kramer (1951) particularly the rate of development of adventitious roots would determine whether the plant will survive an anaerobic period or not.

A few plants are able to respire anaerobically, because they possess special enzymes for this process (Alberda, 1953).

As dying of roots was often observed within one week after the onset of the anaerobic conditions, the plant may only survive a prolonged anaerobic period if it has adapted itself to the situation within a relatively short time. Obviously a plant is more sensitive to anaerobic conditions during the growing season than during the winter period when the metabolic activity of the roots is low.

Considering the situation under a pavement, the development of adventitious roots near the soil surface is hardly possible, because here the aeration conditions are mostly as bad as in the subsoil, unless the soil is non-metalled. Therefore only different internal structures and differently developed root systems may result in differences in sensitivity to poor aeration conditions between the various tree species. This means that bottomland tree species will be more tolerant to poor aeration conditions than are upland species. Van Camp (1970) reports that tree species normally associated with flood plains and lowlands appear to show better survival, better growth rates and a better condition when planted along city streets and in parks than do upland species.

It is most likely, however, that in view of the anaerobic conditions near a gas leakage all tree species will eventually die, unless only a small part of the root system

is affected. Therefore the possibility of survival of a tree will mainly depend on the duration of the anaerobic situation and on the root-regeneration capacity of the tree.

6.5 Aftereffects and replanting

In the period following leak repair some aftereffects can be expected in view of the persisting low O₂-contents and high CO₂-contents and the possible presence of reduced toxic substances in the soil. Replanting of young trees at sites where a tree has died because of natural-gas leakage, has been performed with varying success.

In table 17 some data obtained from inquiries are given. Because the poor aeration conditions may persist during a considerable time after leak repair (cf. table 16), the results of replanting were considered with respect to the period between leak repair and replanting. After one growing season 115 trees were dying or wilting, being 27% of the total number of newly planted trees. In most cases data on the O₂- and CH₄-concentration in the soil were missing, but from the few data available it could be assumed that in many cases a lack of O₂ had caused the injury, especially when replanting took place within 4 months. By measuring the O₂ and CH₄-concentration in the soil before replanting it is possible to select only those sites, which are suitable from the point of view of soil aeration. When doing so, replanting will be more successful. In two cities, The Hague and Rotterdam, this procedure has been applied. In The Hague 19% of the sites initially recommended for replanting were found to be unsuitable because of bad aeration conditions in the soil or because additional gas leakages were found. At the remaining sites trees were planted. After one growing season about 10% of these trees were dying or did show symptoms of injury. As regards Rotterdam, after carefully selecting the sites for replanting the observed damage among the planted trees was reduced to 12%.

Nevertheless this percentage of damage is higher than that found when replanting

Table 17. Results of replanting after natural-gas leakage related to the period between leak repair and replanting (data after SIAB, 1970).

Period between leak repair and replanting	Number of planted trees	Results after one growing season	
		healthy	dying or wilting
2 months	18	—	18
3 months	38	—	38
4 months	33	33	—
5 months	62	58	4
6 months	10	10	—
7 months	193	165	28
1 year	54	39	15
1½ year	14	5	9
2 years	8	5	3
Total	430	315	115

under normal conditions. This may be due to the following causes. First, replanting is done during the winter period (November to February). Oxygen-measurements to select sites for replanting are mostly carried out in autumn, when temperature is already rather low. Under these conditions the biological activity in the soil will also be low, resulting in low O₂-consumption and consequently high O₂-concentrations in the soil. At some sites the O₂-concentration may just exceed the required level; for safety purposes a level of 12 to 14% oxygen is recommended (SIAB, 1970). In spring when temperature is on the rise, the O₂-concentration may again drop to a level which is injurious to the newly planted trees. Secondly, toxic components arising from former anaerobic conditions might be left in a gassed soil, as reduced substances and organic acids, or perhaps toxic components from the natural gas itself (as for example ethylene).

In pot experiments these aspects were investigated (Hoeks & Leegwater, 1972). Bean seedlings (*Phaseolus vulgaris* L. c.v. 'Vroege Wagenaar') were planted in gassed dune sand soil under optimum aeration conditions. Growth of the beans on this gassed soil was not inhibited in any way and was even better than on the normal soil. Analyses of soil and crop samples showed that the nitrogen content in the gassed soil was higher than it was in the normal soil. The smaller number of root nodules confirmed this nitrogen effect (in the gassed soil hardly any root nodules were found). Accumulation of nitrogen in gassed soils may be due to nitrogen fixation (absolute increase of N-content) by anaerobic *Clostridium* spp. (in the anaerobic zone), as reported by Harper (1939), or by methane-oxidizing microorganisms, as reported by Davis et al. (1964). However, for the methane-oxidizing bacteria, isolated from the dune sand soil used here, Adamse et al. (1971) could not establish any nitrogen fixation. It is also possible that the N-content is only relatively increased as a result from decomposition of dead bacterial cells.

As pointed out earlier the amount of reduced compounds was rather low in this dune sand soil. Therefore the results are not directly transferable to other soils. More research with different soil types would be required in this respect. It seems to be a justified conclusion, however, that the natural gas itself did not leave toxic components in the soil, at least not in injurious concentrations.

Therefore it can be stated that in soils with low contents of reduceable compounds, replanting in gassed soils may be performed as soon as the aeration conditions have become favourable again. An additional check on the soil O₂-content in spring time is to be recommended and if necessary measures are then to be taken to improving soil aeration (cf. chapter 7).

Of course the soil conditions will also be important with respect to regeneration of injured trees. Furthermore, the rate of regeneration varies with plant species and also with the season. The later in the season, the slower the regeneration rate and the smaller the chance of survival (Sutton, 1969). Root regeneration can be stimulated by adding fertilizers and water to the soil near the root system.

The effect of root injury on root and shoot growth depends on the extent of the damage. It is known that removal of rather extensive parts of the root system of

trees has little effect on the growth rate of the roots. The growth rate of the shoots generally decreases, however. A tentative conclusion is therefore that even with rather extensive injury to the root system, a tree may survive because root growth is probably not seriously affected. In such cases it deserves recommendation, however, to restrict transpiration of the tree by pruning the crown to such a degree as is needed to compensate for the loss in roots (Bray, 1958).

7 Measures to improve soil aeration

7.1 General

Poor aeration conditions in the soil may result from impeded exchange between the soil gas phase and the atmosphere (e.g. due to a pavement) or from exceptionally high biological activity in the soil (e.g. resulting from gas leakage). Near underground leaks of natural gas in urban regions both facts are responsible for the unfavourable aeration status of the soil. Obviously the situation can improve as soon as the leak is sealed. From chapter 5 it became clear, however, that poor aeration conditions in the soil may persist quite a long time after leak repair. For regeneration of injured trees and for replanting of young trees at short notice it is therefore necessary to take measures to improve soil aeration and to accelerate the recovery process of the soil.

Except for aeration measures, other measures as pruning of the tree and addition of water and nutrients to the roots in order to stimulate formation of new roots are to be mentioned, but these are outside the scope of the present research.

In many instances the gas leakages cannot be repaired until some weeks or even some months after detection. This will be due to a variety of reasons, like arrears in the repair of leaks, a bad accessibility of the leak, or planned replacement of old gas mains by new ones in the near future. Consequently measures are to be taken to protect trees in such situations. The effectiveness of such measures will at the same time give information on the effects which are to be expected of preventive measures taken at sites with valuable street trees where gas leakage is more or less likely to occur.

7.2 Curative measures

The SIAB (Committee for Study of the Influence of Natural Gas on Vegetation) proposed three measures (SIAB, 1969), viz. (1) the installation of ventilation channels, (2) removal of unfavourable gas mixtures by forcing air into the soil and (3) removal of unfavourable gas mixtures by sucking them from the soil. The latter method has found no acceptance in practice, as a risk of formation of explosive gas mixtures in the apparatus exists.

The research reported here concerns the effects of ventilation channels and compressor treatments in various situations. The purpose of these measures is to introduce oxygen into the soil, so the effects will depend on the rate of O_2 -consumption in the soil and thus on all factors influencing this rate.

7.2.1 Technical aspects

Ventilation channels A ventilation channel usually consists of an auger hole to a depth of 70 cm below the pavement surface with a diameter of 20 to 25 cm. The hole may be filled with gravel (*gravel-filled ventilation channel*), or it may be left unfilled (*open ventilation channel*). In both cases the channel is covered with a ventilation tile either with holes or slits (see fig. 31). Oxygen diffuses from the channel into the soil, while methane and carbon dioxide diffuse from the soil into the channel and finally into the atmosphere. The gas exchange between channel and atmosphere will have to be rapid. As this left much to be desired in the gravel-filled channels initially designed, the open ventilation channels were then introduced. In practice such open channels collapse if no provisions are made to prevent this. To that purpose a perforated pvc-tube with a wall perforation of 25% or more is used as a mantle for the ventilation channel. Of course, any material with a sufficient rigidity and an adequate perforation may be used.

The pvc-tube is covered with a nylon sleeve, while the tube may be bedded in a few centimeters of gravel in order to prevent clogging of the perforations in the tube wall. An additional advantage of open channels is the considerably reduced risk of clogging of the openings in the ventilation tile. The tiles on top of gravel-filled channels are usually clogged with dust and litter within two months, which seriously limits their effect. In open channels dust and litter fall through the openings in the tile and accumulate on the bottom of the channel. Then, even after two years no clogging was observed.

Clogging of the ventilation tiles and the slow gas exchange in a gravel-filled channel may explain the excessively long recovery periods which were observed at a number of urban experimental sites where gravel-filled channels were installed (cf. table 16).

Compressor treatments A very rapid improvement of the soil gas phase composition is achieved by forcing air into the soil with a compressor (see fig. 32). Generally a compressor is used with a capacity of about 3 m³ per minute. Air is forced into the soil through 4 to 6 injectors at 6 ato. The treatment may last from 20 minutes to one hour, depending on the capacity of the compressor. There is no point in continuing the treatment over more prolonged periods. Since oxygen is consumed in the soil, the treatment has obviously a transient effect and has to be repeated after some time.

7.2.2 Ventilation channels

The effect of a ventilation channel on the composition of the soil gas phase depends on the biological activity in the soil. If cylindrical symmetry is assumed, the effect of the O₂-consumption rate on the steady state distribution of oxygen around the channel can be calculated with eq. (16a) and (16b) of chapter 3 (cf. fig. 33). It should be noted that the geometric assumption made is permissible only if the soil surface is covered with an impervious pavement and if the bottom of the ventilation channel

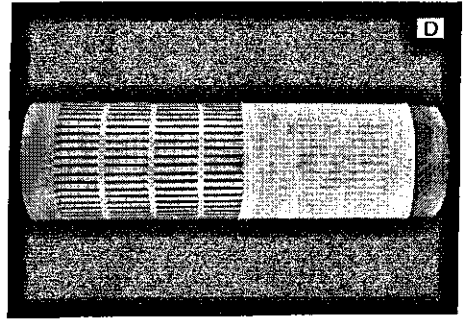
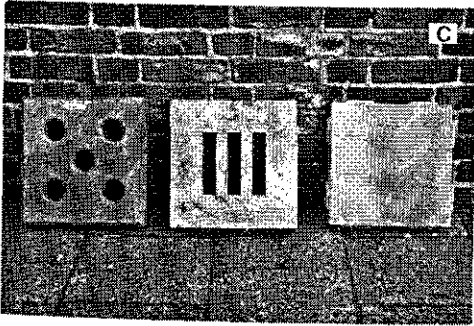
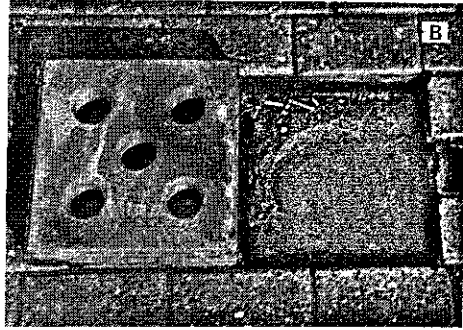
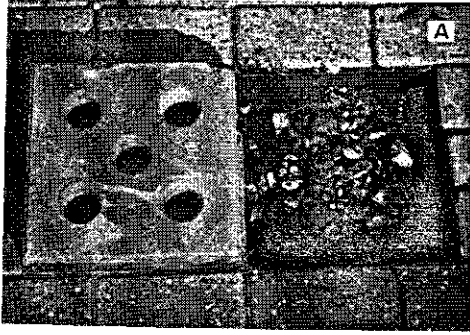

Fig. 31. Ventilation channels and tiles. A: gravel-filled channel with hole-vented tile; B: open channel with hole-vented tile; C: l. to r. hole-vented tile, slit-vented tile, studded tile (a special paving tile not to be used to cover ventilation channels, however); D: slitted pvc-tube used as mantle of an open channel, with part of the nylon sleeve to prevent clogging of the perforations.



Fig. 32. Compressor treatment near a tree affected by gas leakage (photograph VEG-Gasinstituut, Rijswijk).

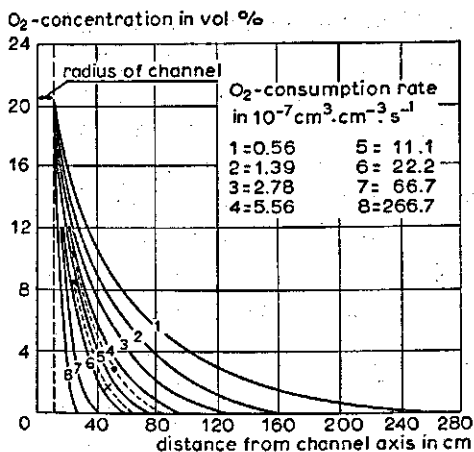

Fig. 33. Calculated steady state distributions (—) of oxygen around a ventilation channel (in which an O₂-concentration of 21 vol.% is maintained) as a function of the O₂-consumption rate. Added, the O₂-distribution as measured respectively 5 (×) and 9 (·) days after installation of an open ventilation channel at the experimental site Geertjesweg at Wageningen (cf. fig. 1D).

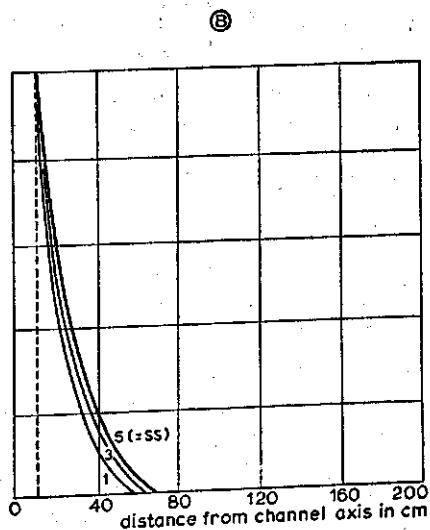
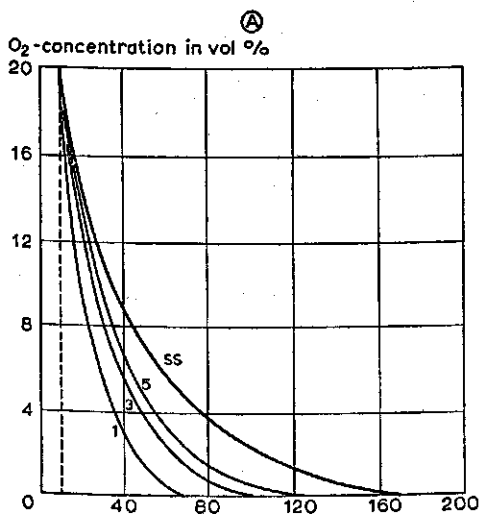

Fig. 34. Calculated O₂-distribution at respectively 1, 3 and 5 hours after installation of a ventilation channel compared with the steady state distribution (ss) reached after respectively about 30 hours (A: O₂-consumption rate $1.39 \times 10^{-7} \text{ cm}^3 \cdot \text{cm}^{-3} \cdot \text{s}^{-1}$) and 5 hours (B: O₂-consumption rate $13.9 \times 10^{-7} \text{ cm}^3 \cdot \text{cm}^{-3} \cdot \text{s}^{-1}$).

reaches into the groundwater.

For the O₂-consumption rates as found in a gassed soil the steady state is reached within a few hours to one day (fig. 34). The steady state is reached the more rapidly, the higher the O₂-consumption rate. Before repair of the leak the O₂-consumption rate is much higher than after leak repair. Therefore the results of experiments with ventilation channels will be discussed for these two cases separately.

Effect before leak repair Near a gas leakage the O₂-consumption rate in the soil is very high if both CH₄ and O₂ are present. According to table 7 it may range from

190 to $275 \times 10^{-7} \text{ cm}^3 \cdot \text{cm}^{-3} \cdot \text{s}^{-1}$. With such high consumption rates the zone of influence of the ventilation channel is negligibly small; the soil becomes only aerobic within a radius of about 25 cm from the axis of the channel (cf. fig. 33). Nevertheless ventilation channels can be quite effective near a leak, because the hydrocarbons of the gas are oxidized near the channel, while at the same time natural gas can escape via the channel into the atmosphere. In fact the effectiveness of the channel as to consumption of methane is inversely related to its zone of influence, since the consumption is governed by the total influx of oxygen by diffusion into the soil. This flux increases with increasing gradient in the O_2 -concentration and thus with decreasing extent of the zone of influence.

The following calculation may illustrate the oxidation effect. The total amount of oxygen transported from a channel (with radius r_v and depth d_v) into the soil equals

$$Q_{\text{O}_2} = -2\pi r_v d_v D \left(\frac{dC}{dr} \right)_{r_v} \quad (\text{cm}^3 \cdot \text{s}^{-1}) \quad (52)$$

The concentration gradient at distance $r = r_v$ can be solved from the differential equation for the steady state (eq. 15b), yielding

$$Q_{\text{O}_2} = -\pi d_v \alpha (L^2 - r_v^2) \quad (\text{cm}^3 \cdot \text{s}^{-1}) \quad (53)$$

where L is the distance where both the concentration and the concentration gradient equal zero. With data for d_v (70 cm), r_v (10 cm), α (e.g. $-267 \times 10^{-7} \text{ cm}^3 \cdot \text{cm}^{-3} \cdot \text{s}^{-1}$) and L (25 cm at the chosen value of α , cf. fig. 33), the amount of oxygen transported into the soil equals 3.08 cm^3 per second, i.e. 11.1 l per hour. With this amount of oxygen about 5 to 6 l CH_4 can be oxidized per hour. Furthermore the amount of natural gas escaping into the atmosphere can be considerable when there are large concentration gradients in the soil near the channel, i.e. when the channel is installed close to the leak. The effect of both processes, the oxidation and the escape of natural gas, will resemble the effect of a decreased leakage rate.

This effect could be established both at urban experimental sites and at the experimental field. At the experimental site Oostduinlaan at The Hague (cf. fig. 1C) three gravel-filled channels were installed right beside the leaking gas main. The effect was only slight as can be seen in fig. 35 (situation b). Because the zone of influence of these channels was negligibly small, the effect was only measurable near the outer boundary of the gas zone (sampling points 7, 13, 16, 17 of fig. 1C) as a decrease in the natural-gas concentration and as an increase in the O_2 -concentration. The CO_2 -concentration increased within the whole area of the gas zone. The next year the three gravel-filled channels were replaced by five open channels. Consequently the radius of the gas zone decreased from about 5 to 3.5 m accompanied by a distinct increase in the O_2 -concentration in the region between 3 and 8 m from the leak. The success of such measures will, however, depend on the position of the tree with respect to the leaking gas main, for the conditions for plant growth are not really improved for a tree situated at for instance 2 m from the gas main. A decrease in the radius of the

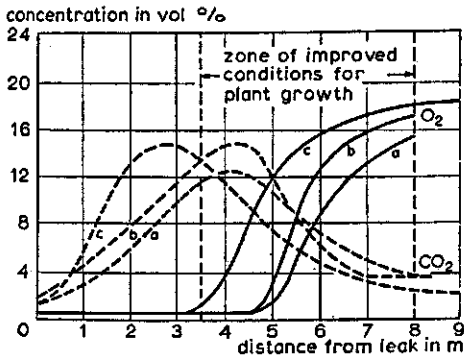

Fig. 35. Distribution of O_2 and CO_2 in the soil gas phase at the experimental site Oostduinlaan at The Hague (cf. fig. 1C) before (a), 5 weeks after installation of gravel-filled ventilation channels (b) and 5 weeks after replacing these channels by 5 open ones (c).

gas zone from 5 to 3.5 m would mean, in view of results from the experimental field, an apparent decrease in the rate of leakage from about 120 to 60 l per hour. So 60 l natural gas per hour disappeared due to the installation of the five ventilation channels, i.e. as a mean 12 l per hour per channel.

At the experimental field, the radius of the gas zone of the artificial leak (rate 250 l per hour) decreased considerably after installation of ventilation channels (fig. 36), viz. from initially 8 m to finally 1.80 m at the side with the open channels and to about 3.20 m at the side with the gravel-filled channels. Especially the open channel installed right beside the leak in a later stage, was quite effective as large amounts of natural gas could escape here into the atmosphere due to high concentration gradients near the channel. Comparing again the limits of the gas zone before and after installation of the ventilation channels, one would in this case estimate the combined effect of removal of gas by oxidation and escape at at least 15 l per hour per channel as a mean, i.e. for the open channels it will be higher while for the gravel-

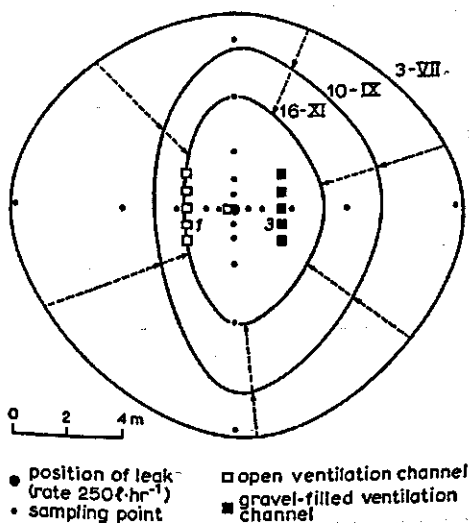

Fig. 36. Extent of the gas zone near an artificial leak (rate $250 \text{ l} \cdot \text{hr}^{-1}$) before (July 3) installation of ventilation channels, 5 weeks after (September 10) the installation of 5 open channels and 5 gravel-filled channels, and another 9 weeks after (November 16) the installation of one open channel right beside the leak.

filled channels it will be lower. For the one open channel right beside the leak the total amount of removed gas may be estimated at at least 40 l per hour, possibly even more since after the installation of this channel the amount of gas removed by the other channels will have decreased.

The open channels were much more effective than the gravel-filled ones because the gas exchange with the atmosphere was considerably increased by air turbulences in them. This could be established from data concerning the gas composition in the channels (cf. table 18, gravel-filled channels: 0.2 to 5.8 vol. % O₂, 10 to 22 vol. % CH₄; open channels: 17 to 21 vol. % O₂, 0.7 to 8 vol. % CH₄) and from the effect of the wind velocity on the gas composition in the open channels. The O₂-concentration is the higher and the natural-gas concentration the lower, the higher the wind velocity.

Near a leak open channels may give some problems, since the gas mixture in the channel may become explosive. Ignition of this explosive mixture is hardly dangerous, however, since the channel is open towards the atmosphere, but in practice such

Table 18. Composition of the gas mixture in ventilation channels in the vicinity of a gas leakage (the position of the channels with regard to the leak is shown in fig. 36).

Date	Description	Wind velocity	Gas concentration in parts of LEL*		Oxygen concentration in vol. %	
			open channel 1	gravel-filled channel 3	open channel 1	gravel-filled channel 3
22-VII	installation of 2 open channels		expl**		19.2	
23-VII	installation of 2 gravel-filled channels		expl		18.4	
24-VII			expl			
27-VII			0.70			
28-VII			0.95		19.0	5.8
29-VII			0.54	expl		
3-VIII			0.85	expl	19.2	0.9
5-VIII	installation of another 3 open channels and 3 gravel-filled channels					
7-VIII		+	0.90	expl	18.2	0.8
13-VIII		+	0.65	expl	19.0	0.9
17-VIII		+	expl	expl	17.6	0.9
18-VIII		++++	0.17	expl	20.1	1.1
18-VIII		++	0.57			
21-VIII		+++	0.20		19.8	
24-VIII		++	0.63			
10-IX		++++	0.18	expl	20.3	0.2

* Lower Explosive Level
 ** expl is >1.00 LEL, i.e. >4% CH₄
 + light
 ++ light to moderate
 +++ moderate to strong
 ++++ strong

situations are perhaps preferably to be avoided. Explosive gas mixtures can be expected just after the installation of the channels. In most cases, however, the natural-gas concentration will decrease to below the explosive level within some days. Only when the rate of leakage is high and the channel is situated close to the leak, the gas mixture in the channel may remain persistently explosive. At the experimental field this was the case with the channel at 10 cm from the leak (rate of 250 l per hour). The CH_4 -concentration in this channel varied between 6 and 10 vol. % (Lower Explosive Level is 4 vol. % CH_4 in air). The transient explosive situation will be more common, but this situation can be completely avoided by a single air injection into the soil with a compressor just after installation of the channels.

Effect after leak repair After leak repair the O_2 -consumption rate in a gassed soil is much lower and decreases with time from about 20×10^{-7} to eventually 1×10^{-7} $\text{cm}^3 \cdot \text{cm}^{-3} \cdot \text{s}^{-1}$, the latter being the rate in a normal soil. This means that the effect of a ventilation channel (cf. fig. 33) is then measureable within a radius of about 0.6 m to finally 2 m from the channel axis. Data collected at the experimental site Geertjesweg at Wageningen showed (fig. 33) that in view of the distribution of oxygen around the open channel the O_2 -consumption rate in the soil amounted to approximately 15×10^{-7} $\text{cm}^3 \cdot \text{cm}^{-3} \cdot \text{s}^{-1}$ at the 5th day after installation of the channel and to about 8×10^{-7} $\text{cm}^3 \cdot \text{cm}^{-3} \cdot \text{s}^{-1}$ at the 9th day after installation. At this experimental site the effect of the open channel could be compared with that of the gravel-filled ones, because the starting situations were comparable, viz. the leaks were repaired at the same moment (two weeks before installation of the channels) and the starting composition of the soil gas phase was also comparable, 0 to 1.6 vol. % O_2 , 11.0 to 13.9 vol. % CO_2 while natural gas was absent. Six weeks after installation of

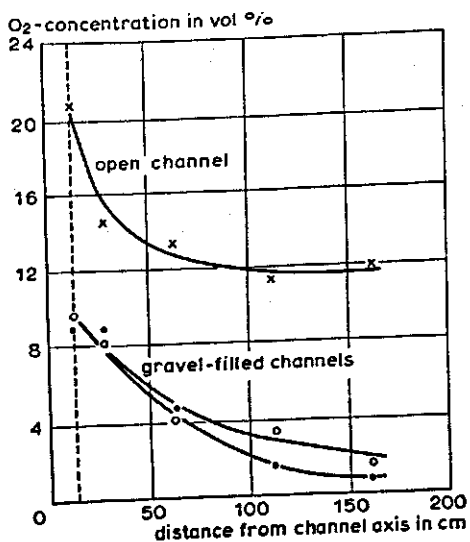

Fig. 37. Measured O_2 -distribution around either an open or a gravel-filled ventilation channel six weeks after installation at the experimental site Geertjesweg at Wageningen (cf. fig. 1D).

the channels the O₂-distribution around the open channel was considerably more favourable than around the two gravel-filled channels (fig. 37). Again the gas exchange in the open channel appeared to be much better (20.8 vol. % O₂) than in the gravel-filled channels (9.3 to 9.6 vol. % O₂).

When several ventilation channels are interacting, transport can be described in two-dimensional Cartesian coordinates (if vertical transport is ignored). This means that eq. (5R) can be used for the present case where diffusion is assumed to be the only process contributing to the transport, this equation converts, if concentration and consumption rate are expressed in volume units, to

$$\varepsilon_g \frac{\partial C_m}{\partial t} = D_m \frac{\partial^2 C_m}{\partial x^2} + D_m \frac{\partial^2 C_m}{\partial y^2} + \alpha_m \quad (\text{cm}^3 \cdot \text{cm}^{-3} \cdot \text{s}^{-1}) \quad (54)$$

This differential equation is approximated by the explicit finite difference equation

$$\begin{aligned} C_m^{i,j,k+1} = & C_m^{i,j,k} + \frac{D_m \Delta t}{\varepsilon_g \Delta x^2} (C_m^{i+1,j,k} - 2 C_m^{i,j,k} + C_m^{i-1,j,k}) + \\ & + \frac{D_m \Delta t}{\varepsilon_g \Delta y^2} (C_m^{i,j,k+1} - 2 C_m^{i,j,k} + C_m^{i,j,k-1}) + \frac{\alpha_m \Delta t}{\varepsilon_g} \end{aligned} \quad (55)$$

where $C_m^{i,j,k}$ represents the concentration of a gas component at location $x = i\Delta x$, $y = j\Delta y$ and at time $t = k\Delta t$. Computer calculations were run for the situation as presented in fig. 38: in the sidewalk six ventilation channels are installed, four along the gas main and two near the tree. The soil surface next to the sidewalk is non-metalled. Calculations can be restricted to region I, since region II is the reflection of I. A grid is laid over region I where the distance between the grid points is Δx in the x -direction and Δy in the y -direction (here $\Delta x = \Delta y = 20$ cm). Eq. (55) was now used to calculate the O₂-concentration in the soil as a function of location and time, making use of the following boundary conditions (cf. Appendix III): (a) the initial O₂-concentration in the soil is zero ($C = 0$ if $x > 0$, $y \geq 0$, $t = 0$), (b) the O₂-concentration in the non-metalled soil next to the sidewalk was fixed at 18 vol. % ($C = 0.18$ if $x = 0$, $y \geq 0$, $t \geq 0$), (c) no oxygen is transported through the symmetry planes ($dC/dx = 0$ if $x = x_n$, $y \geq 0$, $t \geq 0$, and $dC/dy = 0$ if $x \geq 0$, $y = 0$, $t \geq 0$ or if $x \geq 0$, $y = y_n$, $t \geq 0$), (d) the O₂-concentration in the ventilation channels was fixed at 21 vol. % ($C = 0.21$ if $x = x_1$, $y = y_1$, $t \geq 0$, if $x = x_2$, $y = y_2$, $t \geq 0$, etc). The O₂-consumption rate was calculated from the oxygen overdemand P with the oxidation rate coefficient ω (see section 5.5), so

$$-\alpha_{i,j,k} = \omega P_{i,j,k} - \alpha_n \quad (\text{cm}^3 \cdot \text{cm}^{-3} \cdot \text{s}^{-1}) \quad (56)$$

where

$$P_{i,j,k} = P_{i,j,k-1} + (\alpha_{i,j,k-1} - \alpha_n) \Delta t \quad (\text{cm}^3 \cdot \text{cm}^{-3}) \quad (57)$$

Calculations were made for an initial oxygen overdemand P_0 of 0.50 and 0.25 $\text{cm}^3 \cdot \text{cm}^{-3}$ and an oxidation rate coefficient ω of respectively 10×10^{-7} and 15×10^{-7}

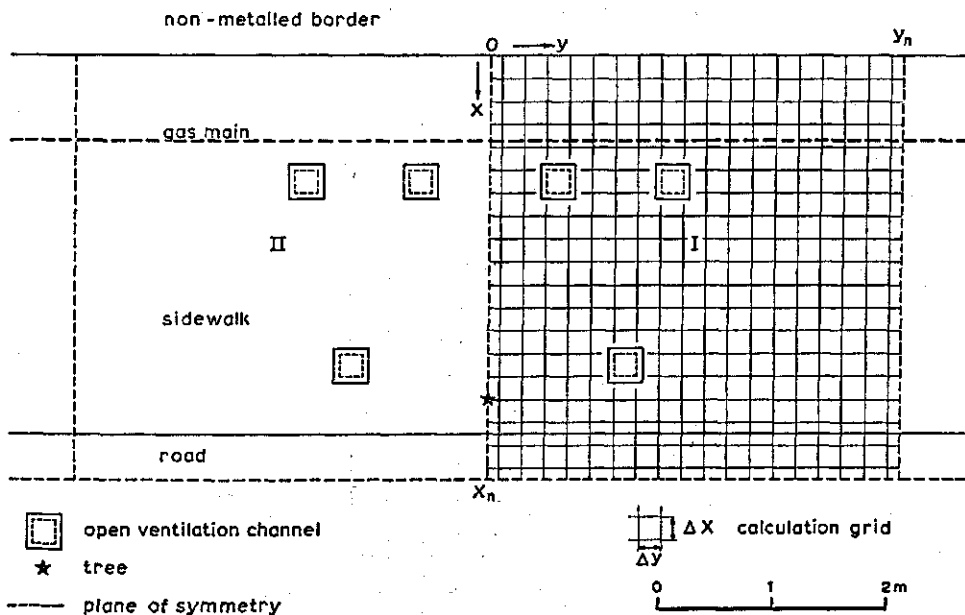

Fig. 38. Schematic representation of the situation used to calculate the effect of ventilation channels (see also fig. 39).

s^{-1} . Results are presented in fig. 39. It can be seen that even within two days the O_2 -concentration in a large part of the root zone of the tree is already higher than 5 vol.%, in spite of the still rather high P -values. So in gassed soils, even in those with a rather high oxygen overdemand, the installation of six ventilation channels around the tree can already considerably improve the aeration conditions within some days to one week.

The above calculations were confirmed by data from the experimental site Goudenregenstraat at The Hague. Five days after leak repair six open ventilation channels were installed here (cf. fig. 1B). The soil gas phase was sampled and analyzed at 8 measuring points situated in the region between the channels. Initially natural gas was still present in the soil, but it disappeared within two days (table 19). The O_2 -concentration, which ranged from 0.2 to 1.4 vol.%, increased during the first day after installation of the channels to a level of 0.6 to 5.3 vol.%, while after two days already a level of 1.0 to 9.9% was reached. One week after the installation the O_2 -concentration exceeded 7 vol.% in the whole region between the channels. At the experimental field it took about one week after leak repair before all natural gas was removed from the soil. After another week the O_2 -concentration exceeded 5 vol.% in the whole region around the former leak.

Leak repair during the winter period will usually result in a very rapid rise in the O_2 -concentration, first because the starting O_2 -concentration in the gas zone is already rather high in this period and secondly because the O_2 -consumption rate during the recovery period is very low. It should be mentioned that in such cases substances

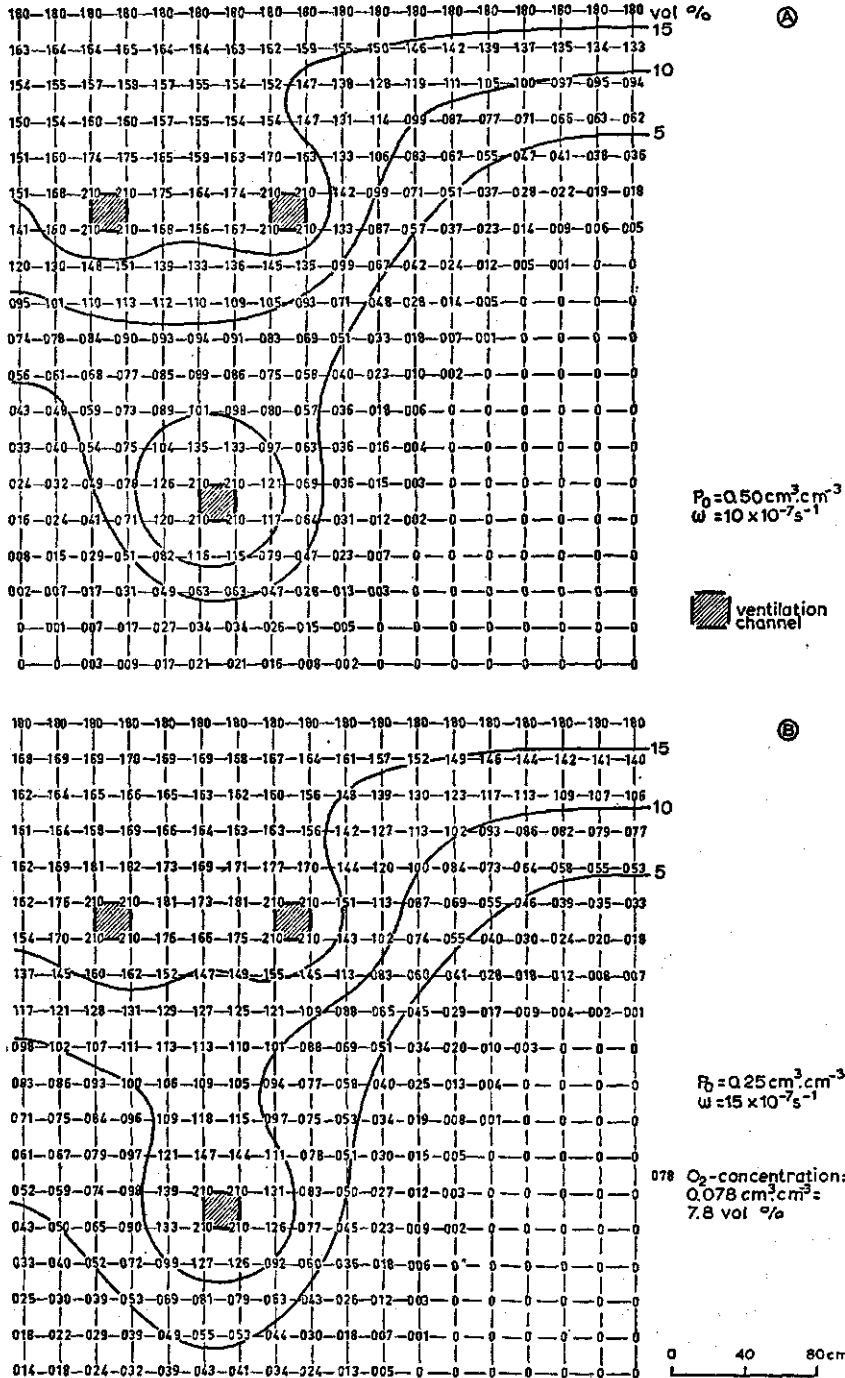

Fig. 39. Calculated O_2 -distribution around the ventilation channels of fig. 38 two days after installation, for an O_2 -overdemand P_0 of $0.50 \text{ cm}^3 \cdot \text{cm}^{-3}$ and an oxidation rate coefficient ω of $10 \times 10^{-7} \text{ s}^{-1}$ (A) and for $P_0 = 0.25 \text{ cm}^3 \cdot \text{cm}^{-3}$ and $\omega = 15 \times 10^{-7} \text{ s}^{-1}$ (B).

Table 19. Composition of the soil gas phase before (12-VII) and after installation (on 12-VII) of open ventilation channels (Goudenregenstraat, The Hague; for layout see fig. 1B). Soil air sampled at a depth of 55 cm; date of repair of gas leak: 7-VII-71; duration of gas leakage: about 8 months.

Sampling point	12-VII-71		13-VII-71		15-VII-71	19-VII-71
	% O ₂	% CH ₄	% O ₂	% CH ₄	% O ₂	% O ₂
1	0.3	1.6	4.9	0	9.8	13.0
2	0.2	1.8	5.3	0	9.9	13.2
3	0.2	2.0	2.6	0	7.5	11.0
4	0.3	0.8	1.7	0	6.6	11.1
5	0.2	0.8	1.1	0.4	6.2	11.5
6	1.4	1.4	1.9	0	5.4	9.0
7	0.6	1.2	0.6	0.6	1.0	7.4
8	0.3	2.0	0.8	0	4.0	8.5

accumulated during the gas leakage remain in the soil. In spring, at higher temperatures, the oxidation of these substances will set in causing at that time a temporary drop in the O₂-concentration.

7.2.3 Compressor treatments

A quick but only transient improvement of the soil gas phase composition is obtained by forcing air into the soil with a compressor. The following example may illustrate this short-duration effect. During the treatment the O₂-concentration in the soil gas phase may be raised to a maximum of 21 vol. %. So in a soil with a gas-filled pore space of 30% the applied amount of oxygen per cm³ of soil is 0.063 cm³. Just after repair of a gas leakage the O₂-consumption rate in a gassed soil may be in the order of $15 \times 10^{-7} \text{ cm}^3 \cdot \text{cm}^{-3} \cdot \text{s}^{-1}$. In that case the oxygen supplied will be consumed in 11 to 12 hours. Before leak repair the O₂-consumption rate is even considerably higher, so the effect will then last only a few hours. Therefore this measure will not solve the problem, since the effect is only very temporary.

Experiments at a number of urban experimental sites also indicated the short duration of the effect. In table 20 data have been summarized from the experimental site Pieter de Hooghstraat at Rotterdam (layout in fig. 1E). During the compressor treatment lasting 20 minutes, the O₂-concentration was raised to a level of 17.3 to 21.0 vol. %, except at sampling point I1, where the O₂-concentration decreased. This latter effect is likely to be attributable to the distance of this point to the injectors (2.80 m). The gas mixture with low O₂-content initially present near the injectors was blown towards this sampling point, causing here a lowering of the O₂-concentration. It must be concluded therefore that the effective radius of action of the injectors was here about 2 m. In situation I the favourable effect of the treatment disappeared within five hours. The O₂-consumption rate at the sampling points I2 and I3 was likely to be high due to microbial methane oxidation (short distance to

Table 20. Short-duration effects of air compressor treatments (duration 20 minutes) on the soil gas phase composition (at 50 cm depth) before (situation I and II) and after (situation III) repair of a gas leakage at the urban experimental site Pieter de Hooghstraat at Rotterdam (cf. fig. 1E). J.W. (gas): measurements of combustible gases; reading > 1.00 corresponds with an explosive gas mixture (expl) i.e. with >4 vol.% CH₄.

Situation	Measuring point	Measurement	Before treatment	Time (hours) after compressor treatment				
				0	2	5	10	25
I. gas leakage, without ventilation channels	I 1	J.W. (gas)	0	0	0	0	0	0
		% CO ₂	4.5	5.4	—	4.9	—	4.4
		% O ₂	17.0	13.7	16	16.3	17.3	17.5
	I 2	J.W. (gas)	0.67	0	0	0.07	expl	expl
		% CO ₂	12.4	2.9	—	8.4	—	11.9
		% O ₂	3.5	17.5	7.5	1.2	0.4	0.0
	I 3	J.W. (gas)	0.45	0	0	0.15	expl	expl
		% CO ₂	13.3	1.9	—	13.2	—	14.6
		% O ₂	2.9	17.3	8.0	1.3	0.4	1.0
II. gas leakage, with ventilation channels	II 1	J.W. (gas)	0	0	0	0	0	0
		% CO ₂	6.1	2.3	2.3	2.9	—	3.4
		% O ₂	15.3	20.3	20.5	19.2	17.9	16.6
	II 2	J.W. (gas)	0	0	0	0	0	0
		% CO ₂	11.3	0.9	1.9	2.6	—	4.9
		% O ₂	7.6	20.9	20.2	17.5	14.5	11.6
	II 3	J.W. (gas)	0.24	0	0	0	0	0
		% CO ₂	14.6	5.3	5.4	6.1	—	10.6
		% O ₂	1.3	18.2	14.2	9.4	7.2	4.3
III. leak repaired, with ventilation channels	III 1	J.W. (gas)	0	0	0	0	0	0
		% CO ₂	—	1.7	1.9	3.1	—	3.8
		% O ₂	17	20.9	20.5	19.5	19.0	16.4
	III 2	J.W. (gas)	0	0	0	0	0	0
		% CO ₂	—	0.8	1.4	1.8	—	2.0
		% O ₂	9.5	21.0	20.9	20.2	19.6	18.0
	III 3	J.W. (gas)	0	0	0	0	0	0
		% CO ₂	—	0.9	2.9	2.9	—	3.6
		% O ₂	10.0	21.0	19.4	18.4	18.2	16.4

the leak). In situation II the sampling points II2 and II3 were farther away from the leak than in situation I. Moreover here 8 ventilation channels were present between the leak and these points, thus acting as an intercepting screen. Therefore the supply of methane will have been small initially even none, resulting in lower O₂-consumption rates and consequently a more prolonged effect (one day or more). In situation III the leak was repaired about half a year before the experiments started. Nevertheless the O₂-concentration was still somewhat low at the points III2 and III3 (about 10 vol. %). During the compressor treatment the O₂-concentration was raised to 21 vol. %. The drop in O₂-concentration afterwards was much slower than in situations I

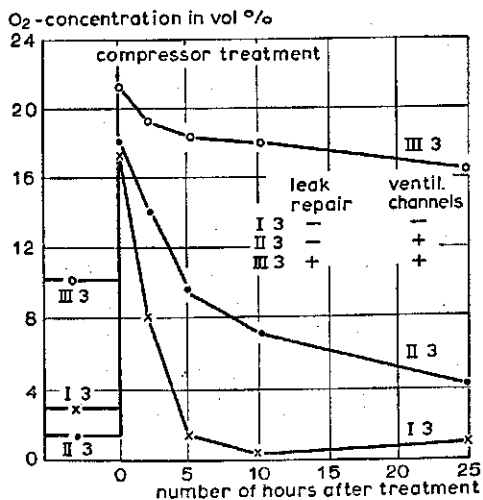

Fig. 40. Effect of air compressor treatments (duration 20 minutes) on the O₂-concentration in the soil gas phase as measured at the experimental site Pieter de Hooghstraat at Rotterdam (cf. fig. 1E) at the sampling points I3, II3 and III3.

and II because the rate of O₂-consumption in situation III was considerably lower. However, in this case again the effect was of rather short duration (some days). The decrease in the O₂-concentration as measured at the sampling points I3, II3 and III3 is demonstrated in fig. 40.

7.3 Preventive measures

Preventive measures are to be taken at those sites where sooner or later gas leakages may be expected and where valuable street trees are threatened. As a matter of course, the gas companies are expected to do all that is possible to improve the gas distribution system. This may imply timely replacement of old gas mains and service pipes by new ones in which modern jointing techniques are applied or taking measures to prevent the desiccation process in the oakum joints of the older distribution systems (internal sealing with liquids).

Aside from these gas-technical measures to prevent leakage other action should be taken to protect valuable trees for the possible case of leakage in the future. From the above discussed effects of curative measures before leak repair it can be concluded that as an effective preventive measure ventilation channels can be installed between the gas main and the tree, thus acting as an intercepting screen when the gas main starts leaking. Due to oxidation and escape of the gas, the extent of the gas zone will then remain small. As furthermore the leakage rate of a starting leak will be low, time will be gained to mend the leak as the ventilation channels will protect the tree for a sufficiently long period. At these sites supplementary checks on leaks in the gas mains are to be done periodically. To this purpose the gas mixture in the channels (near the bottom, since the natural-gas concentration will be the highest there) can be sampled and analyzed. When natural gas is found to be present (concentrations in open channels are commonly low, often less than 5 vol.%) the leak

must be located and repaired as soon as possible. With control measurements executed twice a year leaks detected are likely to be still rather small ones and in most cases anaerobic conditions in the root zone of the tree may be completely avoided.

7.4 Conclusions and recommendations

Effective restriction and prevention of leakage of natural gas as well as the ensuing injury to street trees, can only be realized if there is a good cooperation between the (municipal) gas companies and park departments. To this purpose the SIAB (Committee for Study of the Influence of Natural Gas on Vegetation) designed a gas-tree form (SIAB, 1969), on which a layout (mains, leaks, kind of pavements, ornamental vegetation, measuring points, etc.) of the leakage site and data of measurements can be noted. These forms facilitate the exchange of data between both services.

The park department, watching the state of health of street trees, should be equipped to perform routine measurements concerning oxygen and natural-gas (and if wanted also carbon dioxide) content in the soil near suspected trees. The gas-trees detected should be reported to the gas company, on the other hand the gas company should report to the park department those leaks which are found near street trees. Then curative measures should be taken.

The gas company, in consultation with the park department, may draft an urgency programme for repair of leaks taking into account their location and size and the value of the threatened trees. The value of a tree is hard to estimate, but a table as presented by Raad (1970) may be helpful. This table accounts for the location of the tree (in the town centre the value is much higher than in outskirts), its state of health, the species and particularly the age of the tree.

Open ventilation channels are to be installed at all leakage sites even if the leak cannot yet be repaired, since one channel can per hour remove 5 to even 40 l of gas from the soil. Per tree four channels are preferably to be installed close along the gas main (spacing approximately 1 m) while two additional channels are to be installed in the tree-line, one on each side of the tree. If the leak has not yet been repaired, one treatment with a compressor is recommended to avoid explosive gas mixtures in the channels. One or two days later the composition of the gas mixture in the channels has to be checked. If the mixture is still explosive (which is there hardly dangerous, however) it means the leak is very large and must be repaired immediately.

The use of gravel-filled ventilation channels must be disadvised since the gas exchange between channel and atmosphere is poor as air turbulences in the channel are absent, while moreover the ventilating tile is soon clogged. Also treatments with a compressor, other than the one application mentioned above, are of little or no use because of the short-duration effect.

Open channels are to be protected against collapse by inserting a perforated pvc-tube (diameter 20 cm or more, to obtain adequate air turbulences in the channel; perforation of the tube wall 25% or more). Other materials with sufficient rigidity

and adequate perforation may also be used (e.g. plastic-coated or corrosion-resistant wire netting). The tube is to be covered with a nylon sleeve and surrounded by some centimeters of gravel to prevent clogging of the wall perforations.

Preventive measures should be taken at sites where, in view of the age of the gas mains and the quality of the joints, leaks may be expected sooner or later and where valuable trees can then be injured. First of all the gas company should do all that is possible to prevent leakage (especially by substituting new gas mains for old ones). Secondly the gas company and the park department together may select the sites where ventilation channels will be installed to protect valuable trees (four channels per tree installed along the gas main). Together with periodical control measurements on possible leaks at these sites (for example twice a year), injury to trees will thus largely be prevented.

It is also recommendable to install open ventilation channels at sites where the oxygen concentration in the soil is low due to impervious road surfaces only. In order to avoid failures when replanting young trees in gassed soils but also in non-gassed soils, the soil oxygen status should be checked before (re)planting (as a safe limit the O₂-concentration must be higher than 12 to 14 vol. %). From this it will be clear that an oxygen analyzer is an indispensable tool for park departments, while it may be very efficient to have also a gas detection apparatus (or a combined oxygen-combustible gas analyzer) available for establishing whether low oxygen concentrations are due to gas leakage or not. The exact location of leaks is, of course, to be done by the gas company.

For the planning of measurements an intensive contact between gas company and park department is a prerequisite. Only in this way the knowledge and skill of both services can be used to solve problems related to the leakage of natural gas.

Summary

Urban vegetation has several important functions as for instance esthetic, climatic and recreative ones. The value of these functions is more and more recognized since people are becoming concerned about environmental conditions. From this point of view the Netherlands Association of Municipal Park Superintendents instituted the Committee for Study of the Influence of Natural Gas on Vegetation (SIAB) in September 1967, when sudden deteriorations of urban vegetation were observed following the change-over from town gas to natural gas. In the Netherlands a considerable number of street trees and shrubs has been injured by gas leakage which strongly increased after this change-over. The causes of this were the increase in gas pressure from 6.5 to 25 mbar, the desiccation of lead-oakum joints in the older cast iron mains and the vibrations caused by the increasing traffic. The majority of the leaks are found in town centres, because here the older gas mains with oakum joints are still present. In these areas about 5 to 20% of the tree population died from gas leakage in the last four to five years. As a mean, 60 to 90% of the total mortality among street trees has been caused by leakage of natural gas.

The aim of this study was to investigate the processes in the soil near a natural-gas leakage and to find the most efficient measures for control and prevention of injury to urban vegetation.

Experiments were carried out on request of and in close cooperation with the SIAB-Committee already mentioned, both at urban experimental sites and at a non-urban experimental site, i.e. at an experimental field which was sealed with a plastic sheeting to simulate the effect of a pavement and where an artificial gas leakage was induced. The effect of the leakage on the soil gas phase composition was established by measuring the concentration of methane, oxygen and carbon dioxide in the soil gas phase. Several methods of detection of these gases are available, although not all of them were equally convenient for the present purpose. The suitability of several methods is discussed in chapter 2 and a description of the experimental sites is given there.

Transport of gases in the soil gas phase is mainly governed by diffusion. Bulk flow resulting from temperature gradients, changes in barometric pressure or wind may usually be ignored under normal conditions. Near a gas leakage, however, bulk flow constitutes a significant term in the transport of gases due to the outflow of natural gas, especially at short distances from the leak. Furthermore biological processes

may induce bulk flow when the amount of gases consumed does not equal the amount produced. This is particular true for the microbial process of methane oxidation near a gas leakage. In chapter 3 the general aspects of gas transport in soil by diffusion and bulk flow are discussed and some analytical solutions of the transport equation are presented to calculate the oxygen concentration in soil under various kinds of pavement and the oxygen concentration around a ventilation channel. For non-steady state situations often numerical procedures have to be used. The application of such procedures is discussed.

The oxidation-reduction status of the soil is closely related to the soil gas phase composition. Under anaerobic conditions nitrates (NO_3^-), iron (Fe^{3+}), manganese (Mn^{4+}) and sulfates (SO_4^{2-}) can be reduced and these reduced compounds are more or less toxic for plant growth. Measurements of the redox potential may give information on the oxidation-reduction status of the soil, but data should be interpreted with caution. Reduction and oxidation processes in soil are commonly accompanied by a change in pH. In acid soils usually a rise in pH is observed during a reductive stage, while in alkaline and calcareous soils often a decrease is found. Two processes, viz. the fact that H^+ -ions are involved in the oxidation-reduction processes and the fact that carbon dioxide has a distinct effect on pH at alkaline levels, are responsible for these shifts in pH. Since oxidation-reduction processes are likely to be of importance near a natural-gas leakage the general aspects of these processes are also discussed in chapter 3.

The most important process near a leakage of natural gas is the microbial oxidation of hydrocarbons present in the gas. In this oxidation process, mainly oxidation of methane as 95% of the hydrocarbons in natural gas is methane, oxygen is consumed while carbon dioxide is produced. The metabolic activity of the methane-oxidizing microbes is influenced by the supply of both CH_4 and O_2 , the CO_2 -level in the soil gas phase, the temperature and the fertility status of the soil. At excess supply of CH_4 and O_2 the metabolic activity of the microbes is independent of the CH_4 and O_2 -concentration in the soil gas phase. High CO_2 -concentrations of 8 vol.% were found to stimulate the activity. The temperature dependence is strong, a raise from 13.5 °C to 20.5 °C raised the consumption of oxygen in the soil with a factor 4 to 5. The most important effect of the fertility status was its influence on the duration of the lag phase, i.e. the period following the start of gas leakage during which the bacterial activity is still low. In dune sand soil this lag phase was found to last about 30 days, but it was absent when a nutrient solution was added to the soil.

Near a leakage of natural gas a number of different zones are to be distinguished (fig. 10). The inner part of the gas zone, i.e. the zone where natural gas is present in the soil gas phase, is anaerobic and accordingly it was termed the anaerobic zone. In the outer part of the gas zone microbial oxidation of methane can occur because here both oxygen and methane are present. This zone was termed the methane oxidation zone. Outside the gas zone the oxygen transit zone is found, through which oxygen is transported from the normal soil to the methane oxidation zone. The

released natural gas flows approximately spherically from the leak. Near impervious boundaries as the pavement and the groundwater table the flow is deflected and thus at larger distances from the leak the flow becomes approximately cylindrical. The coordinate system used for calculations of the concentration of gases around a leak was chosen in the following way (fig. 14): at short distances a spherically symmetric system was used, which converted via a transitional system, being a combination of a cylindrically symmetric system and a hemispherical system, to a cylindrically symmetric system at larger distances from the leak. The distances at which transition from one system to the following system takes place, depend on the distance between leak and pavement and between leak and groundwater table. Simple analytic solutions for the steady state were found to represent rather well the real situation around a leak. With numerical solutions it appeared to be possible to calculate quite satisfactorily the change in the soil gas phase composition after establishing of a gas leakage.

The distribution of gases around a leak was found to be typically flux-dominated, i.e. except for the rate of leakage, factors affecting the flux, like the soil moisture content, the depth of the groundwater table and the extent and the nature of a pavement, have a significant influence on the extent of the gas zone. Daily temperature fluctuations and the soil fertility status, both factors which influence the microbial activity in the soil, appeared to be of little concern. Only at very low temperatures in winter the distribution pattern is markedly influenced and the anaerobic zone may then disappear completely. Thus the probability of injury to vegetation is negligibly small during the winter period, also in view of the low activity of plant roots in this period.

In the anaerobic zone around the leak the redox potential was found to be very low indicating the reductive conditions in this zone, so toxic, reduced, substances may be present in this zone. During the two-year leakage at the experimental field the pH in the anaerobic zone increased from 3.8 to 4.3 as a result of these reduction processes. The details of the processes near a natural-gas leakage, the description of the mathematical distribution model and the results of calculations and experiments are discussed in chapter 4.

Chapter 5 deals with the processes in the soil following the repair of a leakage of natural gas. With the disappearance of methane from the soil gas phase the methane-oxidizing bacteria will become inactive and will finally die or sporulate. Due to accumulation of organic substances, such as intermediates of the CH_4 -oxidation process, excreted of bacteria and dead bacterial cells, the number of heterotrophic microorganisms which decompose organic substances was found to increase after repair of the leak. Furthermore oxygen is reintroduced into the anaerobic zone causing shifts within the microbial population and oxidation of reduced substances. The two processes, decomposition of organic substances and oxidation of reduced compounds, require oxygen and explain the high rate of O_2 -consumption in a gassed soil. This consumption rate decreases with time but even at optimum aeration con-

ditions it may take one to two months until the O_2 -consumption rate of the gassed soil reaches a level as low as that of the normal soil. This period was called the soil recovery period. The amount of oxygen consumed in a gassed soil during this recovery period minus the amount consumed in a normal soil was defined as the oxygen overdemand of the gassed soil, which is in a way comparable with the Biochemical Oxygen Demand (BOD) of waste water. The actual rate of O_2 -consumption in a gassed soil was related to the oxygen overdemand at that moment by a first order equation, which was found to give rather satisfactory correlations with the measured data. The oxygen overdemand depends on the amount and nature of the accumulated organic and reduced anorganic substances, while the rate of oxidation depends on the decomposability of the compounds and on the microbial activity in the soil. The changes in the soil gas phase composition following the repair of a leakage of natural gas are largely dependent on the rate of these oxidation processes and on the rate of oxygen supply towards the former gas zone. The highest values of the oxygen overdemand, which were usually accompanied by the lowest oxidation rate coefficients, are likely to be found in the former methane oxidation zone, so the rate of the recovery process of a gassed soil is fairly certain to be limited in the methane oxidation zone rather than in the anaerobic zone. At a number of urban experimental sites the whole recovery process took some months to even more than a year, which was often due to inefficient measures or to the omitting of measures.

Leakage of natural gas in soil may affect plant growth directly or indirectly. Since ethylene was found to be present in the gas in a concentration of 2 to 3 ppm a direct effect is not unlikely. The gas injury to trees, however, has not pointed to ethylene as the injurious agent. The injury proceeds slowly while the first symptoms are only observed some time after establishing of anaerobic conditions in the soil. In contrast the injury by town gas is ascribed to toxic compounds in the gas, ethylene being one of them and in this case the injury usually proceeds rather rapidly.

The indirect effect of natural gas leakage on urban vegetation is obvious, since the soil gas phase composition near a leak is unfavourable for plant growth. Within the gas zone the oxygen concentration is very low to zero, while the carbon dioxide concentration is high. Consequently root growth is stopped while root respiration and so uptake of water and nutrients are reduced. Eventually the tree will die, unless oxygen can be supplied to the roots from the aerial parts of the tree or from adventitious roots. The formation of adventitious roots is supposed to be most important for survival, but will hardly be of use for street trees because of the impermeability for gas of the pavement. Therefore without countermeasures the possibility of survival of a street tree near a gas leakage is slight, unless only a smaller part of the root zone is affected. After repair of the leak poor aeration conditions may persist for several months. Whether a tree will overcome the injury will depend on the degree of injury and on the regeneration capability of the tree. These aspects of bad aeration conditions and plant growth are discussed in chapter 6.

For regeneration of injured trees and when replanting young trees at short notice after leak repair, measures are to be taken to improve the soil aeration. Furthermore measures are to be taken to protect trees in situations where leaks cannot be repaired immediately after detection. The technical aspects and the effectiveness of the measures in different situations are discussed in chapter 7. Apart from measures to improve soil aeration it should be mentioned that other action is to be taken to accelerate the regeneration of injured trees, e.g. by pruning the tree and by adding nutrients and water to stimulate formation of new roots.

Discussed measures to improve soil aeration are the installation of ventilation channels and the use of an air compressor. Both measures are intended to supply oxygen to the soil. Two types of ventilation channels are discussed (fig. 31), viz. gravel-filled channels and open channels. Experiments both at urban experimental sites and at the experimental field showed that the installation of gravel-filled channels must be disadvised because the gas exchange between channel and atmosphere is poor. Moreover the ventilation tile over the channel will often clog within two to three months after installation. In open channels, on the other hand, the gas exchange with the atmosphere is favourable due to air turbulences in the channel, while dust and litter does not clog the ventilation tile but accumulates at the bottom of the channel.

Even when the leak has not yet been repaired the installation of ventilation channels in a row along the leaking gas main appeared to be very effective (fig. 36). Due to escape and oxidation of the natural gas, the extent of the gas zone was strongly reduced. It could be estimated that one channel may account for the disappearance of 10 to 40 l natural gas per hour. As was already mentioned the rate of soil recovery following leak repair will depend on the amount of the substances accumulated in the soil during gas leakage (being proportional to the oxygen overdemand of the gassed soil) and their oxidation rate. Calculations as well as experiments showed, that the oxygen concentration in a large part of the former gas zone can be raised to more than 5% within two weeks after leak repair when six ventilation channels are installed (figs 38 and 39), even at rather high values of the oxygen overdemand.

Forcing air into the soil by means of a compressor has little or no effect, because of its short duration. In most cases the amount of oxygen forced into the soil is consumed within some hours to some days. In one case the air compressor may be of use. Treatment with a compressor after installation of ventilation channels near a leak is quite effective to avoid the possible formation of an explosive gas mixture in the channels, which is hardly dangerous, however.

Preventive measures are to be taken at sites where gas leakages are to be expected in the future and valuable trees can be threatened. Of course the gas company should do all that is possible to improve the gas distribution system. Aside from these gas-technical measures, such trees can be protected by the installation of four to five ventilation channels in a row along the suspected gas main. For an effective restriction and prevention of gas injury to street trees a good cooperation between gas company and park department is a prerequisite. Urgency programmes for repair

of leaks as well as for curative and preventive measures should preferably be drafted in consult of both services. Also for the control measurements an intensive contact is recommended, since only then the knowledge and skill of both services can be used to solve the problem of leakage of natural gas.

Samenvatting

De invloed van aardgaslekage op bodem en beplantingen in stedelijke gebieden

Stedelijke beplantingen zijn vanuit meerdere gezichtspunten, zoals bijvoorbeeld esthetische, klimatologische en recreatieve, belangrijk voor het stedelijke leefklimaat. Sinds het leefmilieu meer in de belangstelling is gekomen, worden ook deze waardevolle functies van de stedelijke beplanting duidelijker onderkend. Toen, direct na de overschakeling van stadsgas op aardgas, plotselinge sterfte onder de stedelijke beplanting was geconstateerd heeft de Nederlandse Vereniging van Hoofden van Gemeentelijke Beplantingen dan ook in september 1967 de Studiecommissie Invloed Aardgas op Beplantingen (SIAB) geïnstalleerd. Sinds de overschakeling van stadsgas op aardgas is in Nederland een groot aantal straatbomen door aardgaslekages gesneuveld. De sterke toename van het aantal gaslekken was het gevolg van de verhoging van de gasdruk van 6,5 naar 25 mbar, de uitdroging van loodstriktouwverbindingen in de oudere gietijzeren leidingen en de trillingen tengevolge van het steeds toenemende verkeer. Het merendeel van de gaslekken blijkt voor te komen in de oudere stadswijken, omdat vooral hier de oudere gasleidingen met de loodstriktouwverbindingen voorkomen. In deze oudere stadswijken is in de laatste vier à vijf jaar ongeveer 5 à 20% van het straatboombestand uitgevallen tengevolge van aardgaslekage. Gemiddeld blijkt ongeveer 60 à 90% van alle bij straatbomen geconstateerde schade een gevolg te zijn van gaslekage.

Het doel van dit onderzoek was na te gaan welke processen er plaatsvinden in de bodem rond een gaslek en welke maatregelen het meest efficiënt zouden zijn voor bestrijding en voorkoming van schade aan stedelijke beplantingen.

De experimenten werden uitgevoerd op verzoek van en in nauwe samenwerking met de reeds genoemde SIAB-commissie en vonden plaats op proefobjecten in stedelijke gebieden en op een proefveld met een kunstmatig gaslek, waar de bodem werd afgedekt met plastic folie om het effect van een wegdek na te bootsen. Het effect van gaslekage op de samenstelling van de bodemlucht werd vastgesteld via meting van de concentraties van methaan, zuurstof en koolzuur in de gasfase in de bodem. Er zijn verscheidene methoden bekend voor de detectie van deze gassen. Niet alle methoden zijn echter even goed bruikbaar voor het hier gestelde doel. Daarom is in hoofdstuk 2 de geschiktheid van de verschillende methoden besproken, terwijl in dit zelfde hoofdstuk ook een beschrijving is gegeven van de proefobjecten.

Het transport van gassen in de bodemgasfase vindt voornamelijk plaats via diffusie. Massastroming als gevolg van temperatuurgradiënten, van veranderingen in lucht-

druk of van wind is onder normale omstandigheden verwaarloosbaar. Bij gaslekage geeft de massastroming echter een belangrijke bijdrage aan het transport van gassen, vooral op korte afstand van het lek. Ook biologische processen kunnen aanleiding zijn tot massastroming als het verbruikte gasvolume niet gelijk is aan het geproduceerde gasvolume. Dit is met name het geval voor de microbiologische methaanoxidatie zoals die bij een gaslek optreedt. In hoofdstuk 3 zijn de algemene aspecten van gastransport door diffusie en massastroming besproken, terwijl tevens enkele analytische oplossingen van de transportvergelijking zijn gegeven, namelijk voor de berekening van het zuurstofgehalte in de bodem onder verschillende typen wegdek en voor de berekening van het zuurstofgehalte rond een ventilatiekanaal. Voor niet-stationaire situaties moeten veelal numerische methoden worden gebruikt. De toepassing van dergelijke methoden is besproken.

De oxidatie-reductie toestand van de grond hangt ten nauwste samen met de samenstelling van de bodemgasfase. Onder anaerobe omstandigheden kunnen nitraten (NO_3^-), ijzer (Fe^{3+}), mangaan (Mn^{4+}) en sulfaten (SO_4^{2-}) worden gereduceerd en deze gereduceerde verbindingen zijn in meer of mindere mate giftig voor de plantengroei. Metingen van de redoxpotentiaal kunnen enige informatie verschaffen over de oxidatie-reductie toestand van de grond, hoewel de meetgegevens met voorzichtigheid moeten worden gehanteerd. De oxidatie en reductieprocessen in de bodem gaan gewoonlijk gepaard met wijzigingen in de pH. In zure gronden wordt over het algemeen een pH-stijging waargenomen tijdens reductie, terwijl in dit geval in alkalische en kalkhoudende gronden vaak een pH-daling wordt gevonden. Twee processen zijn verantwoordelijk voor deze pH-verschuivingen, namelijk enerzijds de deelname van H^+ -ionen in de oxidatie-reductie reacties en anderzijds de duidelijke invloed van CO_2 op de pH bij hoger pH-waarden. Deze oxidatie-reductie processen zijn belangrijk bij gaslekage en daarom zijn enige algemene aspecten behandeld in hoofdstuk 3.

Het meest belangrijke proces bij een gaslek is de microbiologische oxidatie van koolwaterstoffen. Aangezien de koolwaterstoffen in aardgas voor 95% bestaan uit methaan is methaanoxidatie verreweg het belangrijkste. Bij dit oxidatieproces wordt zuurstof verbruikt, terwijl koolzuur wordt geproduceerd. De metabolische activiteit van methaanoxiderende microorganismen wordt beïnvloed door de toevoer van CH_4 en O_2 , door de CO_2 -concentratie in de bodemgasfase, door de temperatuur en door de voedingsomstandigheden in de grond. Bij een overmatige toevoer van CH_4 en O_2 blijkt de activiteit van de microorganismen onafhankelijk te zijn van de CH_4 - en O_2 -concentratie. Hoge CO_2 -concentraties van 8 vol. % bleken de activiteit te stimuleren. De temperatuurafhankelijkheid is sterk: een temperatuursverhoging van 13,5 naar 20,5 °C deed de zuurstofconsumptie toenemen met een factor 4 à 5. De voedingsomstandigheden in de grond bleken vooral invloed te hebben op de duur van de 'lag' fase, dat is de periode direct na het ontstaan van een gaslek tijdens welke de bacterie-activiteit nog gering is. In duinzandgrond bleek deze fase ongeveer 30 dagen te duren, maar na toevoeging van een voedingsoplossing was zij geheel afwezig.

Rond een gaslek kunnen een aantal verschillende zones in de bodem worden onder-

scheiden (fig. 10). Het binnenste deel van de gas zone, dit is de zone waar aardgas aanwezig is in de bodemgasfase, is anaeroob en is daarom de anaerobe zone genoemd. In het buitenste deel van de gas zone kan microbiologische oxidatie van methaan plaatsvinden, omdat hier naast methaan ook zuurstof aanwezig is. Deze zone is de methaanoxidatie zone genoemd. Buiten de gas zone bevindt zich de zuurstofdoorvoer zone, zo genoemd omdat de zuurstof via deze zone wordt aangevoerd naar de methaanoxidatie zone vanuit de normale grond. Het aardgas stroomt ongeveer sferisch uit het lek. Bij de ondoorlatende grenzen, zoals het wegdek en de grondwaterspiegel, wordt de stroming afgebogen in horizontale richting, zodat op grote afstand van het lek de stroming praktisch cilindrisch verloopt. Het coördinatensysteem voor de berekening van de concentraties van gassen rondom het lek werd als volgt gekozen (fig. 14): op korte afstand van het lek werd een sferisch-symmetrisch systeem gebruikt dat via een overgangssysteem, bestaande uit een cilindrisch-symmetrisch en een half-sferisch systeem, op grotere afstand overging in een cilindrisch-symmetrisch systeem. De afstanden waarop moet worden overgegaan van het ene systeem op het volgende, worden bepaald door de afstand tussen het lek en het wegdek en door de afstand tussen het lek en de grondwaterspiegel. Eenvoudige analytische oplossingen voor de stationaire toestand bleken de werkelijke situatie rond een lek vrij goed weer te geven. Met numerische oplossingen bleek het goed mogelijk om de veranderingen in de bodemgasfase na het ontstaan van het gaslek te berekenen.

De distributie van gassen rond een lek bleek vooral bepaald te worden door die factoren die direct de flux beïnvloeden, hetgeen betekent dat behalve de lekgrootte, factoren als het vochtgehalte van de grond, de diepte van de grondwaterstand en de aard en de uitgestrektheid van het wegdek, de uitbreiding van de gas zone bepalen. De dagelijkse temperatuurschommelingen en de vruchtbaarheid van de grond, twee factoren die de microbiologische activiteit in de grond beïnvloeden, bleken slechts van geringe betekenis te zijn. Alleen bij zeer lage temperaturen in de winter wordt het distributiepatroon duidelijk beïnvloed en de anaerobe zone kan dan geheel verdwijnen. De kans op schade aan beplantingen is dan ook verwaarloosbaar klein in de winter, mede gezien de geringe wortelactiviteit in dit jaargetijde.

In de anaerobe zone rond het lek bleek de redoxpotentiaal zeer laag te zijn ($-0,15$ à $-0,20$ V), hetgeen wijst op reducerende omstandigheden en op de mogelijkheid van vorming van giftige gereduceerde verbindingen in deze zone. Tijdens de twee jaar durende gaslekkage op het proefveld nam de pH in de anaerobe zone toe van 3,8 tot 4,3 als gevolg van deze reductieprocessen. Nadere gegevens over de processen bij gaslekkage, een beschrijving van het wiskundige distributiemodel en de resultaten van berekeningen en experimenten zijn besproken in hoofdstuk 4.

Hoofdstuk 5 beschrijft de processen zoals die in de bodem optreden na de reparatie van het gaslek. De verdwijning van methaan uit de bodemgasfase heeft tot gevolg dat de methaanoxiderende bacteriën inactief worden en uiteindelijk zullen afsterven of overgaan in sporevorm. Het aantal heterotrofe organismen welke verantwoordelijk zijn voor de afbraak van organische stoffen in de grond, bleek toe te nemen na de

lekreparatie hetgeen wijst op de aanwezigheid van opgehoopt organisch materiaal in de grond, zeer waarschijnlijk tussenprodukten van de CH_4 -oxidatie, uitscheidingsprodukten van bacteriën en dode bacteriecellen. Bovendien neemt het zuurstofgehalte in de anaerobe zone weer toe na de lekreparatie en dit veroorzaakt hier verschuivingen in de microbiologische populatie en oxidatie van gereduceerde verbindingen. Voor beide processen, de afbraak van organische stoffen en de oxidatie van gereduceerde verbindingen, is zuurstof nodig en dit verklaart het hoge zuurstofverbruik in een gasgrond. Dit verbruik neemt af met de tijd maar zelfs als de aeratie van de grond optimaal is, duurt het nog een à twee maanden voordat het zuurstofverbruik van de gasgrond gelijk geworden is aan het zuurstofverbruik van een normale grond. Deze periode is de herstelperiode van de bodem genoemd. De totale hoeveelheid zuurstof in de gasgrond verbruikt tijdens de herstelperiode verminderd met de hoeveelheid zuurstof die in dezelfde tijd in een normale grond wordt verbruikt, is aangeduid als de extra zuurstofbehoefte van de gasgrond, hetgeen enigszins vergelijkbaar is met de 'Biochemical Oxygen Demand' (BOD) van afvalwater. De werkelijke zuurstofconsumptie in een gasgrond is afhankelijk gesteld van de extra zuurstofbehoefte op dat moment en wel volgens een vergelijking van de eerste orde. Dit bleek redelijk bevredigende correlaties op te leveren met de meetgegevens. De extra zuurstofbehoefte van een gasgrond hangt af van de hoeveelheid en de aard van de opgehoopte organische en gereduceerde stoffen, terwijl de oxidatiesnelheid afhangt van de stabiliteit van de verbindingen en van de microbiologische activiteit in de grond. De veranderingen in de samenstelling van de bodemgasfase na de lekreparatie worden grotendeels bepaald door de snelheid waarmee de oxidatieprocessen zich voltrekken en door de snelheid waarmee zuurstof kan worden aangevoerd in de oorspronkelijke gas zone. De hoogste waarden voor de extra zuurstofbehoefte, die gewoonlijk samen bleken te gaan met de laagste oxidatiesnelheidscoëfficiënten, treden zeer waarschijnlijk op in de oorspronkelijke methaanoxidatie zone. Dit betekent dat de snelheid van het herstelproces van een gasgrond veeleer gelimiteerd zou worden in de methaanoxidatie zone dan in de anaerobe zone. Op een aantal proefplekken in stedelijke gebieden bleek het gehele herstelproces enkele maanden tot zelfs meer dan een jaar te duren. Dit was echter in veel gevallen het gevolg van inefficiënte maatregelen of van het geheel achterwege blijven van maatregelen.

Aardgaslekage in de bodem zou de plantegroei op twee manieren kunnen beïnvloeden, namelijk direct dan wel indirect. Sinds kort is bekend geworden dat aardgas, waarin tot dan toe geen giftige verbindingen waren aangetoond, het giftige ethyleen bevat in een concentratie van 2 à 3 delen per miljoen. De gasschade aan straatbomen wijst echter niet op ethyleenschade. Zij voltrekt zich langzaam, terwijl de eerste symptomen pas worden waargenomen enige tijd na het optreden van een anaerobe situatie in de bodem. Daarentegen voltrekt de schade bij stadsgaslekage, waarbij ethyleen een van de giftige verbindingen in het gas is, zich over het algemeen tamelijk snel.

Het indirecte effect van aardgaslekage op stedelijke beplantingen is voor de hand liggend, gezien de zeer ongunstige samenstelling van de bodemgasfase. In de gas zone

is het zuurstofgehalte zeer laag tot nihil, terwijl het koolzuurgehalte hoog is, met gevolg dat de wortelgroei ophoudt en de wortelademhaling en daarmee de opname van water en voedingszouten wordt geremd. Uiteindelijk zal de boom dood gaan, tenzij de wortels zuurstof aangevoerd krijgen vanuit de bovengrondse delen van de boom of vanuit adventiefwortels. De vorming van adventiefwortels wordt zeer belangrijk geacht voor de overleving, maar een straatboom is nauwelijks in staat van deze wortels gebruik te maken gezien de aanwezigheid van een wegdek. De overlevingskans van een straatboom bij een gaslek is daarom klein, tenzij slechts een klein gedeelte van het wortelstelsel wordt beïnvloed door de gaslekkeg. Na de reparatie van het lek houden de ongunstige aeratie-omstandigheden nog gedurende verscheidene maanden aan. Of een boom de schade te boven zal komen zal afhangen van de omvang van de schade en van de regeneratiecapaciteit van de boom. Enkele algemene aspecten van plantegroei in verband met slechte aeratie-omstandigheden zijn behandeld in hoofdstuk 6, waaruit enkele conclusies zijn afgeleid ten aanzien van de aardgasschade.

Voor regeneratie van beschadigde bomen en ook voor herinplant van jonge bomen op korte termijn is het noodzakelijk dat maatregelen getroffen worden om de bodemaeratie te verbeteren. In vele gevallen blijken de gaslekken niet onmiddellijk na de opsporing te kunnen worden gerepareerd. In dergelijke gevallen zullen dus maatregelen nodig zijn om de bomen te beschermen. De technische aspecten en de effectiviteit van een aantal maatregelen zijn besproken in hoofdstuk 7. Naast maatregelen ter verbetering van de bodemaeratie dient nog te worden vermeld dat er ook teeltkundige maatregelen genomen moeten worden om de regeneratie van beschadigde bomen zo veel mogelijk te versnellen, zoals bijvoorbeeld door het snoeien van de boom en door toevoeging van voedingsstoffen en water om de vorming van nieuwe wortels te bevorderen.

De maatregelen die hier zijn besproken, betreffen de aanleg van ventilatiekanalen en de toepassing van een luchtcompressor. Beide maatregelen beogen een verhoging van het zuurstofgehalte in de grond. Twee typen ventilatiekanalen zijn beproefd (fig. 31), namelijk grindgevulde kanalen en open kanalen. Experimenten op proefplekken in de stad en ook op het proefveld hebben aangetoond dat de aanleg van grindkanalen moet worden afgeraden wegens de gebrekkige gasuitwisseling tussen het kanaal en de atmosfeer. Bovendien blijkt de ventilatietegel die het kanaal afdekt vaak binnen twee of drie maanden na de aanleg te zijn verstopt. In open kanalen daarentegen is de gasuitwisseling met de atmosfeer gunstig dankzij luchtwervelingen in het kanaal, terwijl verder stof en bladafval de ventilatietegel hier niet verstopen omdat ze op de bodem van het kanaal terecht komen.

Zelfs als het gaslek nog niet is gerepareerd blijkt de installatie van ventilatiekanalen in een rij langs de lekkende gasleiding zeer effectief te zijn (fig. 36). Dankzij het ontsnappen en de oxidatie van het gas neemt de omvang van de gas zone sterk af. Uit schattingen kan worden afgeleid dat 1 ventilatiekanaal goed is voor de verdwijning van 10 tot 40 l aardgas per uur.

Zoals reeds gezegd is de snelheid van het herstel van de bodem na de lekreparatie afhankelijk van de hoeveelheid stoffen opgehoopt tijdens de gaslekkage (en dus van de extra zuurstofbehoefte van de gasgrond) en van de oxidatiesnelheid van deze stoffen. Zowel de berekeningen als de experimenten toonden aan dat de zuurstofconcentratie in een groot deel van de wortelzone binnen twee weken kan stijgen tot boven 5% als er een zestal ventilatiekanalen is aangelegd rond de boom (fig. 38 en 39), zelfs wanneer de extra zuurstofbehoefte van de gasgrond tamelijk hoog is.

De toepassing van een luchtcompressor heeft weinig of geen zin vanwege het kortdurende effect. In de meeste gevallen is reeds binnen enkele uren tot enkele dagen de toegediende zuurstof weer volledig verbruikt (fig. 40). In één geval kan de compressor van nut zijn. Onmiddellijk na de aanleg van ventilatiekanalen bij een open lek blijkt een eenmalige compressorbehandeling zeer effectief te zijn om de, overigens nauwelijks gevaarlijke, vorming van explosieve gasmengsels in de ventilatiekanalen te voorkomen.

Preventieve maatregelen dienen te worden genomen op die plaatsen waar in de toekomst gaslekken kunnen worden verwacht en waar waardevolle straatbomen worden bedreigd. Vanzelfsprekend behoort het gasbedrijf al het mogelijke te doen ter verbetering van het distributienet. Behalve door deze gastechnische maatregelen kan de boom worden beschermd door de aanleg van vier of vijf ventilatiekanalen in een rij langs de gasleiding.

Teneinde een effectieve bestrijding en voorkoming van aardgasschade aan beplantingen te verwezenlijken is een goede samenwerking tussen gasbedrijf en plantsoendienst een eerste vereiste. Urgentieprogramma's zowel voor de reparatie van lekken als voor curatieve en preventieve maatregelen dienen bij voorkeur te worden opgesteld in overleg tussen beide diensten. Ook voor de uit te voeren metingen is een intensief contact aan te bevelen, omdat dit de enige manier is om zo efficiënt mogelijk gebruik te maken van de kennis en ervaring van beide diensten bij het oplossen van problemen samenhangende met aardgaslekkage.

References

- Adams, R. S. & R. Ellis, 1960. Some physical and chemical changes in the soil brought about by saturation with natural gas. *Proc. Soil Sci. Soc. Amer.* 24: 41-44.
- Adamse, A. D., J. Hoeks & J. A. M. de Bont, 1971. Microbial activities in soil near natural gas leaks. *Antonie van Leeuwenhoek* 37: 251-252.
- Adamse, A. D., J. Hoeks, J. A. M. de Bont & J. F. van Kessel, 1972a. De microbiologische activiteit in de grond rondom een aardgaslek. SIAB-report 6, P.O. Box 1240, The Hague, 15 pp.
- Adamse, A. D., J. Hoeks, J. A. M. de Bont & J. F. van Kessel, 1972b. Microbial activities in soil near natural gas leaks. *Arch. Mikrobiol.* 83: 32-51.
- Alberda, Th., 1953. Growth and root development of lowland rice and its relation to oxygen supply. *Plant Soil* 5: 1-28.
- Aomine, S., 1962. A review of research on redox potentials of paddy soils in Japan. *Soil Sci.* 94: 6-13.
- Bakker, J. W., 1971. Luchthuishouding van bodem en plant; overzicht processen en kenmerkende grootheden. Nota 610, ICW, Wageningen, 9 pp.
- Bakker, J. W. & A. P. Hidding, 1970. The influence of soil structure and air content on gas diffusion in soils. *Neth. J. Agric. Sci.* 18: 37-48.
- Bakker, H. de & J. Schelling, 1966. Systeem van bodemclassificatie voor Nederland. De hogere niveaus. Pudoc, Wageningen, 217 pp.
- Balks, R. & C. Wehrmann-Ebsdorf, 1944. Schädigungen der Kulturpflanzen durch Grubengas? *Forschungsdienst* 17: 133-138.
- Bavel, C. H. M. van, 1951. A soil aeration theory based on diffusion. *Soil Sci.* 72: 33-46.
- Bavel, C. H. M. van, 1952a. A theory on the soil atmosphere in and around a hemisphere in which soil gases are used and released. *Proc. Soil Sci. Soc. Amer.* 16: 150-153.
- Bavel, C. H. M. van, 1952b. Gaseous diffusion and porosity in porous media. *Soil Sci.* 73: 91-96.
- Bierhuizen, J. F., 1969. Het transport door de plant. Meded. 128, ICW, Wageningen, 4 pp.
- Bird, R. B., W. E. Stewart & E. N. Lightfoot, 1960. *Transport Phenomena*. John Wiley & Sons, Inc., London, New York, 780 pp.
- Black, C. A., 1957. *Soil-Plant Relationships*. John Wiley & Sons, Inc., New York, p. 88-101.
- Bohn, H. L., 1968. Electromotive force of inert electrodes in soil suspensions. *Proc. Soil Sci. Soc. Amer.* 32: 211-215.
- Bohn, H. L., 1971. Redox potentials. *Soil Sci.* 112: 39-45.
- Bolt, G. H., 1966. Soil physical processes as boundary conditions to ion uptake. *Techn. Rep. Ser. Intern. Atomic Energy Agency* 65: 57-65.
- Braverman, M. M., I. Ettinger & M. B. Jacobs, 1962. Determining the cause of death of vegetation by analysis of soil gases. *Gas Age* 129: 23-26.
- Bray, D. F., 1958. Gas injury to shade trees. *Sci. Tree Topics* 2: 19-22.
- Brown, L. R., R. I. Strawinsky & C. S. McClesky, 1964. The isolation and characterization of *Methanomonas methanooxidans* Brown and Strawinsky. *Can. J. Microbiol.* 10: 791-799.
- Call, F., 1957. Soil fumigation. V. Diffusion of ethylene dibromide through soils. *J. Sci. Food Agric.* 8: 143-150.
- Camp, J. van, 1970. Protecting trees from physical damage on construction sites. *Arborist's News* 35: 129-132.
- Carslaw, H. S. & J. C. Jaeger, 1959. *Conduction of heat in solids*. 2nd ed. Oxford Univ. Press, London, 509 pp.
- Chang, H. T. & W. E. Loomis, 1945. Effect of carbon dioxide on absorption of water and nutrients by roots. *Plant Physiol.* 20: 221-232.

- Coty, V. F., 1967. Atmospheric nitrogen fixation by hydrocarbon-oxidizing bacteria. *Biotechn. Bioeng.* IX: 25.
- Crank, J., 1956. The mathematics of diffusion. Oxford Univ. Press, London, 347 pp.
- Currie, J. A., 1960. Gaseous diffusion in porous media. I. A non-steady state method. *Br. J. Appl. Phys.* 11: 314-324.
- Currie, J. A., 1961. Gaseous diffusion in the aeration of aggregated soils. *Soil Sci.* 92: 40-45.
- Dasberg, S. & J. W. Bakker, 1970. Characterizing soil aeration under changing moisture conditions for bean growth. *Agron. J.* 62: 689-693.
- Davies, S. L. & R. Whittenbury, 1970. Fine structure of methane and other hydrocarbon-utilizing bacteria. *J. Gen. Microbiol.* 61: 227-232.
- Davis, J. B., V. F. Coty & J. P. Stanley, 1964. Atmospheric nitrogen fixation by methane-oxidizing bacteria. *J. Bact.* 88: 468-472.
- Domby, C. W. & H. Kohnke, 1956. The influence of soil crusts on gaseous diffusion. *Proc. Soil Sci. Soc. Amer.* 20: 1-5.
- Dostalek, M., 1954. Wachstumscharakteristiken von Kohlenwasserstoffbakterien. *Čs. Biol.* 3: 173.
- Duin, R. H. A. van, 1956. On the influence of tillage on conduction of heat, diffusion of air and infiltration of water in soil (Dutch). *Versl. Landbouwk. Onderz.* 62-7, Pudoc, Wageningen, 82 pp.
- Dworkin, M. & J. W. Foster, 1956. Studies on *Pseudomonas methanica* (Söhngen) *nov. comb.* *J. Bacteriol.* 72: 646-659.
- Dworkin, M. & J. W. Foster, 1958. Experiments with some microorganisms which utilize ethane and hydrogen. *J. Bacteriol.* 75: 592-603.
- Ellis, R. & R. S. Adams, 1961. Contamination of soils by petroleum hydrocarbons. *Adv. Agron.* 13: 197-216.
- Eynon, S. B., 1967. Current vegetation leakage survey techniques. *Gas Age* 134: 38-41.
- Fenner, C. G., 1951. Gas injury to trees and shrubs. *Arborist's News* 16: 44-51.
- Förch, J. H., 1970. Unpublished data of Gas Industry, Amsterdam.
- Foster, J. W. & R. H. Davis, 1966. A methane-dependent coccus with notes on classification and nomenclature on obligate methane-utilizing bacteria. *J. Bacteriol.* 91: 1924-1931.
- Gaikhhorst, G., 1971. Gaslekken en lekbestrijding. In: *Verslag Studieconferentie 'Belagers van het groeimilieu van onze stedelijke beplantingen'*, Helmond, p. 19-27.
- Gaikhhorst, G. & Th. G. van Zijl, 1964. De invloed van gas op planten. *Het Gas* 5: 95-101.
- Gaur, A. C., K. V. Sadasivam, O. P. Vimal & R. S. Mathur, 1971. A study on the decomposition of organic matter in an alluvial soil: CO₂ evolution, microbiological and chemical transformations. *Plant Soil* 34: 17-28.
- Geisler, G., 1969. Die Wirkung der Sauerstoff und Kohlensäure Konzentration in der Bodenluft auf Spross- und Wurzelwachstum von Wintergerste, Mais und Erbsen. *Bayer. landw. Jb.* 46: 259-278.
- Gotoh, S. & K. Yamashita, 1966. Oxidation - reduction potential of a paddy soil in situ with special reference to the production of ferrous iron, manganous manganese and sulfide. *Soil Sci. Plant Nutr.* 12: 230-238.
- Grable, A. R., 1966. Soil aeration and plant growth. *Adv. Agron.* 18: 57-106.
- Grable, A. R. & E. G. Siemer, 1968. Effects of bulk density, aggregate size and soil water suction on oxygen diffusion, redox potentials and elongation of corn roots. *Proc. Soil Sci. Soc. Amer.* 32: 180-186.
- Greene, H., 1963. Prospects in Soil Science. *J. Soil Sci.* 14: 1-11.
- Greenwood, D. J., 1968. Microbial metabolism. In: *The ecology of soil bacteria* (Ed. T.R.G. Gray & D. Parkinson), Liverpool Univ. Press, p. 138-157.
- Gustafson, F. G., 1944. Is natural gas injurious to flowering plants? *Plant Physiol.* 19: 551-558.
- Gustafson, F. G., 1950. Is the American elm (*Ulmus americana*) injured by natural gas? *Plant Physiol.* 25: 433-440.
- Haller, J. M., 1959. Illuminating gas injury. *Tree Care*, Mac.Millan Comp., New York, p. 190-191.
- Harmsen, G. W., 1971. Förderung des Reduktionsgrades im Boden durch Verspülung. *Plant & Soil* 34: 237-240.
- Harper, H. J., 1939. The effect of natural gas on the growth of microorganisms and the accumulation of nitrogen and organic matter in the soil. *Soil Sci.* 48: 461-468.

- Harris, D. G. & C. H. M. van Bavel, 1957a. Growth, yield and water absorption of tobacco plants as affected by the composition of the root atmosphere. *Agron. J.* 49: 11-14.
- Harris, D. G. & C. H. M. van Bavel, 1957b. Nutrient uptake and chemical composition of tobacco plants as affected by the composition of the root atmosphere. *Agron. J.* 49: 176-181.
- Harris, D. G. & C. H. M. van Bavel, 1957c. Root respiration of tobacco, corn and cotton plants. *Agron. J.* 49: 182-184.
- Hirschfelder, J. O., R. B. Bird & E. L. Spatz, 1949. *Chem. Revs.* 44: 205-231.
- Hirschfelder, J. O., C. F. Curtiss & R. B. Bird, 1954. *Molecular theory of gases and liquids.* John Wiley & Sons, Inc., New York, p. 1110-1112.
- Hoeks, J., 1970. De samenstelling van de bodemlucht bij een gaslek en de invloed daarop van het dichten van het lek. In: SIAB-report 4, P.O. Box 1240, The Hague, p. 8-10.
- Hoeks, J., 1971. De verbetering van de bodemluchtsamenstelling bij straatbomen. SIAB-report 5, P.O. Box 1240, The Hague, 19 pp.
- Hoeks, J., 1972. Changes in composition of soil air near leaks in natural gas mains. *Soil Sci.* 113: 46-54.
- Hoeks, J. & J. Leegwater, 1972. Groei van planten op gasgrond. SIAB-report 7, P.O. Box 1240, The Hague (in press).
- Hopkins, H. T., A. W. Specht & S. B. Hendricks, 1950. Growth and nutrient accumulation as controlled by oxygen supply to plant roots. *Plant Physiol.* 25: 193-209.
- Janse, A. R. P. Aardgasschade aan beplantingen. *Med. Rijksfac. Landb. Wetensch. Gent XXXIV:* 305-315.
- Jeffery, J. W. O., 1961a. Defining the state of reduction of a paddy soil. *J. Soil Sci.* 12: 172-179.
- Jeffery, J. W. O., 1961b. Measuring the state of reduction of a waterlogged soil. *J. Soil Sci.* 12: 317-325.
- Johnson, P. A. & J. R. Quayle, 1964. Microbial growth on C_1 compounds of oxidation of methanol, formaldehyde and formate by methanol-grown *Pseudomonas* AM 1. *Biochem. J.* 93: 281.
- Kamura, T., Y. Takai & K. Ishikawa, 1963. Microbial reduction mechanism of ferric iron in paddy soils (part 1). *Soil Sci. Plant Nutr.* 9: 171-175.
- Kaserer, H., 1906. Ueber die Oxidation des Wasserstoffes und des Methans durch Mikroorganismen. *Zentralbl. Bakteriol.* 15: 573-576.
- Keen, B. A., 1931. *The physical properties of the soil.* Longmans, Green and Co., London.
- Kelsey, M. C., 1964. Locating leaks with leak-search records. *Gas*: 94-102.
- Kemp, M. B. & J. R. Quayle, 1967. Microbial growth on C_1 compounds. Uptake of (^{14}C) formaldehyde and (^{14}C) formate by methane grown *Pseudomonas methanica* and determination of the hexose labelling pattern after brief incubation with (^{14}C) methanol. *Biochem. J.* 102: 94-102.
- Kimball, B. A. & E. R. Lemon, 1971. Air turbulence effects upon soil gas exchange. *Proc. Soil Sci. Soc. Amer.* 35: 16-21.
- Kosten, L., 1966. Numerieke analyse. In: *Handboek der Wiskunde* (Ed. L. Kuipers & R. Timman), Scheltema & Holkema N.V., Amsterdam, p. 561-681.
- Kramer, P. J., 1940. Causes of decreased absorption of water by plants in poorly aerated media. *Amer. J. Bot.* 27: 216-220.
- Kramer, P. J., 1951. Causes of injury to plants resulting from flooding the soil. *Plant Physiol.* 26: 722-736.
- Kramer, P. J. & W. T. Jackson, 1954. Causes of injury to flooded tobacco plants. *Plant Physiol.* 29: 241-245.
- Kühne, H. & P. Köster, 1967. Erdgasschäden an Strassenbäumen. *Nachrichtenbl. Deut. Pflanzenschutzdienst* 19: 121-122.
- Labanauskas, C. K., L. H. Stolzy, L. J. Klotz & T. A. de Wolfe, 1971. Soil oxygen diffusion rates and mineral accumulations in citrus seedlings. *Soil Sci.* 111: 386-392.
- Laskowski, D. & J. T. Moraghan, 1967. The effect of nitrate and nitrous oxide on hydrogen and methane accumulation in anaerobically-incubated soils. *Plant Soil* 27: 357-368.
- Leadbetter, E. R. & J. W. Foster, 1958. Studies on some methane-utilizing bacteria. *Arch. Mikrobiol.* 30: 91-118.
- Leadbetter, E. R. & J. W. Foster, 1960. Bacterial oxidation of gaseous alkanes. *Arch. Mikrobiol.* 35: 92-104.
- Lemon, E. R., 1962. Soil aeration and plant root relations. I. Theory. *Agron. J.* 54: 167-170.
- Lemon, E. R. & A. E. Erickson, 1952. The measurement of oxygen diffusion in the soil with a platinum microelectrode. *Proc. Soil Sci. Soc. Amer.* 16: 160-163.

- Lemon, E. R. & C. L. Wiegand, 1962. Soil aeration and plant root relations. II. Root respiration. *Agron. J.* 54: 171-175.
- Leonard, O. A. & J. A. Pinckard, 1946. Effect of various oxygen and carbon dioxide concentrations on cotton root development. *Plant Physiol.* 21: 18-36.
- Letey, J., L. H. Stolzy & G. B. Blank, 1962a. Effect of duration and timing of low soil oxygen content on shoot and root growth. *Agron. J.* 54: 34-37.
- Letey, J., L. H. Stolzy, G. B. Blank & O. R. Lunt, 1961. Effect of temperature on oxygen - diffusion rates and subsequent shoot growth, root growth and mineral content of two plant species. *Soil Sci.* 92: 314-321.
- Letey, J., L. H. Stolzy, N. Valoras & T. E. Szuszkiewicz, 1962b. Influence of oxygen diffusion rate on sunflower growth at various soil and air temperatures. *Agron. J.* 54: 316-319.
- Letey, J., L. H. Stolzy, N. Valoras & T. E. Szuszkiewicz, 1962c. Influence of soil oxygen on growth and mineral concentration of barley. *Agron. J.* 54: 538-540.
- Longmuir, I. S., 1954. Respiration rate of bacteria as a function of oxygen concentration. *Biochem. J.* 57: 81-87.
- McCaughey, B. J. & D. M. Griffin, 1969. Effects of carbon dioxide and oxygen on the activity of some soil fungi. *Trans. Brit. Mycol. Soc.* 53: 53-62.
- McKeague, J. A., 1965. A laboratory study of gleying. *Can. J. Soil Sci.* 45: 199-206.
- Michael, G. & W. Bergmann, 1954. Bodenkohlensäure und Wurzelwachstum. *Z. Pflanzenern. Düng. Bodenk.* 65: 180-194.
- Millington, R. J. & R. C. Shearer, 1971. Diffusion in aggregated porous media. *Soil Sci.* 111: 372-378.
- Mukhopadhyay, A., T. R. Fischer & G. E. Smith, 1967. Submergence and liming effects on soil. I. Changes in pH, E_h and manganese uptake by rice plants. *Soil Sci.* 104: 107-112.
- Naguib, M., 1971. On methane-oxidizing bacteria in fresh waters. III. The capacity of methane utilization by methane-oxidizing enrichment cultures as revealed by gas chromatographic analyses. *Z. Allg. Mikrobiol.* 11: 39-47.
- Norris, W. E., J. D. Wiegand & L. Johanson, 1959. Effect of carbon dioxide on respiration of excised onion root tips in high-oxygen atmospheres. *Soil Sci.* 88: 144-149.
- Nyns, E. J. & A. L. Wiaux, 1969. Biologie des hydrocarbures. *Agricultura* 17: 3-56.
- Parr, J. F., 1969. Nature and significance of inorganic transformations in tile-drained soils. *Soils and Fertilizers* 32: 411-415.
- Penman, H. L., 1940. Gas and vapour movement in the soil. I. The diffusion of vapours through porous solids. *J. Agric. Sci. Camb.* 30: 438-462.
- Penningsfield, F., 1950. Ueber Atmungsuntersuchungen an einige Bodenprofilen. *Z. Pflanzenern. Düng. Bodenk.* 50: 135-164.
- Pirone, P. P., 1960. Natural gas and odorants do not harm shade trees. *Gas Age* 125: 31-33.
- Ponnamperuma, F. N., E. Martinez & T. Loy, 1966. Influence of redox potential and partial pressure of carbon dioxide on pH values and the suspension effect of flooded soils. *Soil Sci.* 101: 421-431.
- Raad, A., 1970. Proeve van een waardebepaling van straat- en parkbomen. *Groen* 26: 78-83.
- Reid, C. & T. K. Sherwood, 1966. The properties of gases and liquids. *Mc. Graw Hill Book Comp.*, New York, 646 pp.
- Ribbons, D. W., J. E. Harrison & A. M. Wadzinski, 1970. Metabolism of single carbon compounds. *A. Rev. Microbiol.* 24: 135-158.
- Riva, A., 1961. Le filtrazioni metanifere nei terreni irrigati del Lodigiano (with English summary). *Boll. Soc. Geografica Ital.* 2: 449-465.
- Russell, M. B., 1952. Soil aeration and plant growth. In: *Soil physical conditions and plant growth* (Ed. B. T. Shaw). *Agron.* 2: 253-301.
- Schollenberger, C. J., 1930. Effect of leaking natural gas upon the soil. *Soil Sci.* 29: 260-266.
- Segeren, W. A. & J. Visser, 1971. Nieuwe normen voor de ontwatering van appelboomgaarden. *Van Zee tot Land* 49: 103-126.
- Seifriz, W., 1942. Some physical properties of protoplasm and their bearing on structure. In: *The structure of protoplasm*. Iowa State College Press, Ames, Iowa, p. 245-264.
- SIAB, 1968a. SIAB-report 1, P.O. Box 1240, The Hague, 22 pp.
- SIAB, 1968b. Samenvatting literatuuronderzoek Pudoc, SIAB-report 2, The Hague, 6 pp.
- SIAB, 1969. Methoden ter verbetering van de samenstelling van de bodemlucht bij straatbomen. SIAB-report 3, The Hague, 24 pp.
- SIAB, 1970. Bestrijding en voorkoming van aardgasschade aan stedelijke beplantingen. SIAB-report 4, The Hague, 16 pp.

- Smith, K. A. & S. W. F. Restall, 1971. The occurrence of ethylene in anaerobic soil. *J. Soil Sci.* 22: 430-443.
- Söhngen, N. L., 1906. Ueber Bakterien, welche Methan als Kohlenstoffnahrung Energiequelle gebrauchen. *Zentralbl. Bakteriologie* 15: 513-517.
- Solheim, W. G. & R. W. Ames, 1941. The effect of some natural gases upon plants. *J. Colorado - Wyoming Acad. Sci.* 3: 38.
- Starkey, R. L., 1966. Oxidation and reduction of sulfur compounds in soils. *Soil Sci.* 101: 297-306.
- Sutton, R. F., 1969. Form and development of conifer root systems. Commonwealth Agric. Bur., Farnham Royal, Bucks., England, 131 pp.
- Takai, Y. & T. Kamura, 1966. The mechanism of reduction in waterlogged paddy soil. *Folia Microbiol.* 11: 304-313.
- Timman, R., 1966. Vectoranalyse. In: *Handboek der Wiskunde* (Ed. L. Kuipers & R. Timman), Scheltema & Holkema N.V., Amsterdam, p. 443-501.
- Visser, J., J. Th. Locher & R. Brouwer, 1971. Effects of aeration and mineral supply on growth and mineral content of shoots and roots of apple trees (var. Golden Delicious on M IX). *Neth. J. Agric. Sci.* 19: 125-137.
- Wesseling, J., 1957. Some aspects of the water government in agricultural soils (Dutch). *Versl. landbouwk. Onderz.* 63.5, Pudoc, Wageningen, 90 pp.
- Wesseling, J., 1962. Some solutions of the steady state diffusion of carbon dioxide through soils. *Neth. J. Agric. Sci.* 10: 109-117. *Techn. Bull.* 26, ICW, Wageningen.
- Whittenbury, R., K. C. Philips & J. F. Wilkinson, 1970a. Enrichment, isolation and some properties of methane-utilizing bacteria. *J. Gen. Microbiol.* 61: 205-218.
- Whittenbury, R., S. L. Davies & J. F. Davy, 1970b. Exospores and cysts formed by methane-utilizing bacteria. *J. Gen. Microbiol.* 61: 219-226.
- Wilke, C. R. & C. Y. Lee, 1955. Estimation of diffusion coefficients for gases and vapors. *Ind. Eng. Chem.* 47: 1253-1257.
- Wilkinson, J. F., 1971. Hydrocarbons as a source of single-cell protein. In: *Microbes and biological productivity* (Ed. D. E. Hughes & H. A. Rose), Cambridge Univ. Press, London, p. 15-46.
- Wood, J. T. & D. J. Greenwood, 1971. Distribution of carbon dioxide and oxygen in the gas phase of aerobic soils. *J. Soil Sci.* 22: 281-288.
- Woudt, B. D. van 't & R. M. Hagan, 1957. Crop responses at excessively high soil moisture levels. In: *Drainage of agricultural lands* (Ed. J. N. Luthin). Am. Soc. Agron., Madison, Wisconsin, p. 514-579.

List of used symbols

The subscript m refers to the gas component m , which in this paper is either CH_4 , O_2 or CO_2 . When only one of these gases is meant, its chemical formula is used as subscript. When it is clear from the text which component is meant this subscript is omitted.

Symbol	Interpretation	Units
A_m	rate of production in weight units per cm^3 soil	$\text{mg} \cdot \text{cm}^{-3} \cdot \text{s}^{-1}$
A_{mi}	rate of production per cm^3 root tissue	$\text{mg} \cdot \text{cm}^{-3} \cdot \text{s}^{-1}$
B	number of bacteria per cm^3 soil	
C_m	concentration in soil gas phase (volume per volume)	$\text{cm}^3 \cdot \text{cm}^{-3}$
C_{ma}	concentration in atmosphere	$\text{cm}^3 \cdot \text{cm}^{-3}$
C_{mg}	concentration in natural gas	$\text{cm}^3 \cdot \text{cm}^{-3}$
C_{mr_a}	concentration at distance r_a	$\text{cm}^3 \cdot \text{cm}^{-3}$
C_{mv}	concentration in ventilation channel	$\text{cm}^3 \cdot \text{cm}^{-3}$
D_m	diffusion coefficient in soil	$\text{cm}^2 \cdot \text{s}^{-1}$
D_{ma}	diffusion coefficient in air	$\text{cm}^2 \cdot \text{s}^{-1}$
D_{me}	diffusion coefficient in the water-saturated zone around the root	$\text{cm}^2 \cdot \text{s}^{-1}$
D_{mi}	diffusion coefficient in the root tissue	$\text{cm}^2 \cdot \text{s}^{-1}$
D_{m0}	diffusion coefficient in soil at temperature T_0 and pressure p_0	$\text{cm}^2 \cdot \text{s}^{-1}$
D_{mp}	diffusion coefficient in pavement	$\text{cm}^2 \cdot \text{s}^{-1}$
D_{mw}	diffusion coefficient in water	$\text{cm}^2 \cdot \text{s}^{-1}$
E_h	redox potential	V
E_0	redox potential at 25°C	V
F_m	weight flux per cm^2 soil	$\text{mg} \cdot \text{cm}^{-2} \cdot \text{s}^{-1}$
H_m	weight of gas per cm^3 soil	$\text{mg} \cdot \text{cm}^{-3}$
K	permeability of soil for gases ($K = 1.013 \times 10^6 K_f/\eta$)	$\text{cm}^2 \cdot \text{atm}^{-1} \cdot \text{s}^{-1}$
K_i	intrinsic permeability of soil for gases	cm^2
L	distance where flux equals zero (i.e. $\nabla C_m = 0$)	cm
M_m	molecular weight	$\text{g} \cdot \text{mol}^{-1}$
P	oxygen overdemand of gassed soil per cm^3 soil	$\text{cm}^3 \cdot \text{cm}^{-3}$

P_i	oxygen demand of compound i contributing to the oxygen overdemand of the soil	$\text{cm}^3 \cdot \text{cm}^{-3}$
P_0	oxygen overdemand at $t = 0$	$\text{cm}^3 \cdot \text{cm}^{-3}$
Q	transported volume of soil gas phase	$\text{cm}^3 \cdot \text{s}^{-1}$
Q'	constant value of Q in the anaerobic zone	$\text{cm}^3 \cdot \text{s}^{-1}$
Q''	constant value of Q in the oxygen transit zone	$\text{cm}^3 \cdot \text{s}^{-1}$
Q_l	rate of gas leakage	$\text{cm}^3 \cdot \text{s}^{-1}$
Q_m	transported volume of gas component m	$\text{cm}^3 \cdot \text{s}^{-1}$
Q'_m	constant value of Q_m in the anaerobic zone	$\text{cm}^3 \cdot \text{s}^{-1}$
Q''_m	constant value of Q_m in the oxygen transit zone	$\text{cm}^3 \cdot \text{s}^{-1}$
S	area through which flow passes	cm^2
S_r	area of flow at distance r	cm^2
T	temperature	$^\circ\text{K}$
d_g	depth of groundwater below soil or road surface	cm
d_l	depth of leaking gas main below soil or road surface	cm
d_p	thickness of pavement	cm
d_v	depth of ventilation channel below ventilation tile	cm
f_m	volume flux per cm^2 of soil	$\text{cm}^3 \cdot \text{cm}^{-2} \cdot \text{s}^{-1}$
i, j, k	superscripts to C_m and f_m , and subscripts to v , P and α used in numerical calculations to refer to a location (i, j) and a time (k)	
m	subscript referring to gas component m in a gas mixture	
p	gas pressure	atm
P_a	atmospheric pressure ($= 1 \text{ atm} = 760 \text{ mm Hg} = 1.013 \text{ bar}$)	atm
r	radial distance in cylindrical and spherical coordinate systems	cm
r_a, r_b	inner and outer radius of methane oxidation zone	cm
r_c	radial distance of boundary between oxygen transit zone and normal soil	cm
r_{lg}	radius of root plus water-saturated zone	cm
r_r	radius of root	cm
r_v	inner radius of ventilation channel	cm
Δr	distance interval in numerical calculations	cm
t	time	s
t_1	time required for growth of bacterial population to maximum density	s
Δt	time interval in numerical calculations	s
v	apparent flow velocity of the gas phase in the soil, i.e. the volume of gas passing through 1 cm^2 soil per unit time	$\text{cm} \cdot \text{s}^{-1}$
x, y	distances in Cartesian coordinate systems	cm

$\Delta x, \Delta y$	distance intervals in numerical calculations	cm
z	depth below soil or road surface	cm
α_m	rate of production in gassed soils in volume units per cm^3 soil	$\text{cm}^3 \cdot \text{cm}^{-3} \cdot \text{s}^{-1}$
$\alpha_m\{T_0, t_1\}$	rate of production at temperature T_0 and time t_1	$\text{cm}^3 \cdot \text{cm}^{-3} \cdot \text{s}^{-1}$
α_{mn}	rate of production under normal soil conditions	$\text{cm}^3 \cdot \text{cm}^{-3} \cdot \text{s}^{-1}$
β	loss in gas volume due to biological processes per cm^3 soil per unit time	$\text{cm}^3 \cdot \text{cm}^{-3} \cdot \text{s}^{-1}$
ϵ_g	gas-filled pore space per cm^3 soil	$\text{cm}^3 \cdot \text{cm}^{-3}$
ϵ_p	area fraction of the road surface which is non-sealed	$\text{cm}^2 \cdot \text{cm}^{-2}$
η	viscosity of a gas	$\text{dyne} \cdot \text{cm}^{-2} \cdot \text{s}$
λ	growth rate coefficient of bacterial population	s^{-1}
μ	energy of activation	$\text{J} \cdot \text{mol}^{-1}$
ρ_m	concentration in soil gas phase (weight per volume)	$\text{mg} \cdot \text{cm}^{-3}$
ρ_{mi}	concentration in root	$\text{mg} \cdot \text{cm}^{-3}$
ρ_{mlg}	concentration in liquid phase at the liquid-gas interface	$\text{mg} \cdot \text{cm}^{-3}$
ρ_{om}	density of gas component m (used as conversion factor: $\rho_m = \rho_{om} C_m, F_m = \rho_{om} f_m, A_m = \rho_{om} \alpha_m$)	$\text{mg} \cdot \text{cm}^{-3}$
ω	oxidation rate coefficient of oxidizable substances in a gassed soil	s^{-1}
∇	differential operator; when applied to a scalar as C_m it is the gradient of C_m (∇C_m), when applied to a vector as v it is the divergence of v ($\nabla \cdot v$).	

Appendix I

Computer program for steady state distribution of gases around a leak

```
PROGRAM LEAK 1
C *****SOIL GAS PHASE COMPOSITION NEAR A LEAK (STEADY STATE)*****
C
C DIMENSION R(2), CH(2), CO(2), CC(2)
C ***FILLED PORE SPACE
POR=0.3
C ***DIFFUSION COEFFICIENTS IN AIR (M=CH4, O=O2, C=CO2)
DM=0.2
DO=0.2
CO=0.1
C ***CH4 AND CO2(C)-CONCENTRATION IN NATURAL GAS
CHN4=0.82
COG=0.82
C ***FIXED CONCENTRATIONS IN NON-METALLED NORMAL SOIL (AT DISTANCE DIST)
DIST=1.0
CH1=0.
CO1=0.18
CC1=0.03
C ***RELATION BETWEEN CONSUMPTION/PRODUCTION TERMS (P1=O2/CH4, P2=CO2/CH4)
P1=0.0
P2=0.0
C ***DISTANCE STEP FOR COMPUTATION (DR) AND FOR PRINTING OF RESULTS (RPRINT)
DR=0.5
RPRINT=2.
C ***DATA OF LEAK RATE (LEAK) = CH4-CONSUMPTION RATE AT 20 DEGREES CELSIUS
C ***CHN4(20) = TEMPERATURE IN DEGREES CELSIUS (TEMP)
1 READ 10, LEAK, CHN4(20), TEMP
IF (LEAK.GE.0.99999) STOP
PRINT 95, LEAK, CHN4(20), TEMP
C ***DIFFUSION COEFFICIENTS IN SOIL (M=CH4, O=O2, C=CO2)
TFACOR=(TEMP-273.)/273.
DIFM=1.66E-09*(POR=0.3)/TFACOR**1.823
DIFC=1.66E-09*(POR=0.3)/TFACOR**1.823
DIFO=1.66E-09*(POR=0.3)/TFACOR**1.823
C ***VOLUME OF METHANE OXIDATION ZONE (TCNT)
TCNT=TEMP-273.
CHN4T=CHN4(20)*EXP(17844.*((1./293.)-1./TK))
VOL=LEAK*CHN4T
VOLCH4=VOL*POR
IF (CHN4T-0.0) VOL=0.5*VOL/CHN4T
TCNT=VOL/P2
C *****CALCULATION OF LOCATION OF METHANE OXIDATION ZONE*****
C
R=0.
R1=0.
IF (CHN4T.EQ.0.) GO TO 41
R(1)=DIST
CO(1)=CC1N
C
10 R(2)=R(1)+DR
IF (R(2).LE.R1) GO TO 43
RS=R(2)+0.5*DR
RS=CONTENT(RS)
C ***BULK FLOW (LEAK) CORRECTED FOR VOLUME LOSS (TOTVSHR)
IF (RS.LT.R0.AND.RS.GT.R1) RFACT=1+1/TCNT
IF (RS.GE.R0.OR.RS.GT.R1) RFACT=1.
IF (RS.LE.R1.OR.RFACT.LT.0.) RFACT=0.
TOTVSHR=RFACT*(1+P1-P2)*VOLM
LEAK=LEAK-TOTVSHR
C ***COMPUTATION OF O2-CONCENTRATION (CO)
COEF=O2/PO*SURFACE(RS)/DR
CO(2)=(1-P1)*VOLM*RFACT/(COEF-LEAK)/Z+1*CO(1)/(COEF+LEAK)/Z+1
IF (CO(2).LT.0.) GO TO 39
CO(1)=CO(2)
R1=R(2)
GO TO 10
C
C ***BOUNDARIES OF METHANE OXIDATION ZONE, OUTER RADIUS (RO), INNER RADIUS (RI)
C
38 IF (RO.GT.0.) GO TO 39
O2=CONTENT(R(2))
IF (O2.LE.VOL) PRINT*,VOL
IF (O2.LT.VOL) PRINT*,VOL-CNT
X=R(2)
38 IX=DR
SOILVOL=CONTENT(IX)-CNT
IF (SOILVOL.LT.FRIMPL) GO TO 35
RO=1
IF (O2.LT.VOL) GO TO 42
GO TO 38
39 IF (R(2).LT.20.) GO TO 43
RO=RO-DR*(R(2)/RO)**2
X=RO
39 CNT=CONTENT(RO)
40 IX=DR
SOILVOL=CNT-CONTENT(IX)
IF (SOILVOL.LT.TCNT) GO TO 44
R1=2
GO TO 42
41 R1=0.
RO=DIST
42 DRIMPL=RO-RI
RIMPL=RO
A=CONTENT(RI)
GO TO 8
C
C ***PRINTING OF LOCATION AND WIDTH OF METHANE OXIDATION ZONE
43 PRINT 100, R1PL, DRIMPL
PRINT 105
C
C *****COMPUTATION OF THE SOIL GAS PHASE COMPOSITION IN=CH4, O=O2, C=CO2*****
C
NUMBER=0
PRINT*,RPRINT/DR
CH(1)=CH1
CO(1)=CO1N
CC(1)=CC1N
R(1)=R1
A=CONTENT(RI)
B=CONTENT(RO)-A
C
45 NUMBER=NUMBER+1
R(2)=R(1)+DR
IF (R(2).LT.RO) GO TO 1
R=RO
IF (R(2).LT.RO) GO TO 1
COEFM=O2/PO*SURFACE(RS)/DR
COEFO=O2/PO*SURFACE(RS)/DR
COEFCH4=O2/PO*SURFACE(RS)/DR
RS=CONTENT(RS)
C ***CALCULATION OF BULK FLOW TERM
IF (RS.LT.R0.AND.RS.GT.R1) RFACT=1+1/TCNT
IF (RS.GE.R0.OR.RS.GT.R1) RFACT=1.
IF (RS.LE.R1.OR.RFACT.LT.0.) RFACT=0.
TOTVSHR=RFACT*(1+P1-P2)*VOLM
LEAK=LEAK-TOTVSHR
C ***METHANE CONCENTRATION (CH)
IF (R(2).GT.RO) GO TO 38
CO(2)=VOLM*(1-RFACT)/(COEFM-LEAK)/Z+1*CO(1)/(COEFM+LEAK)/Z+1
38 CH(2)=0.
C ***OXYGEN CONCENTRATION (CO)
55 IF (R(2).LT.R1) GO TO 40
CO(2)=(1-P1)*VOLM*RFACT/(COEFO-LEAK)/Z+1*CO(1)/(COEFO+LEAK)/Z+1
GO TO 45
60 CO(2)=0.
C ***CARBON DIOXIDE CONCENTRATION (CC)
65 CC(2)=VOLM*(P2+VOLM*RFACT)/(COEFC-LEAK)/Z+1*CC(1)/(COEFC+LEAK)/Z+1
C
C ***PRINTING OF RESULTS
IF (NUMBER.NPRINT) GO TO 70
PRINT 110, R(2), CH(2), CO(2), CC(2)
NUMBER=0
75 R(1)=R(2)
CH(1)=CH(2)
CO(1)=CO(2)
CC(1)=CC(2)
GO TO 45
C
90 FORMAT (2E1.10, /F7.4F5.1)
95 FORMAT (2E1.5E4, LEAK=1.0E-5, CHN4(20)=F7.4, F5.1, STEMP=F5.1)
100 FORMAT (3E1.5, RIMPL=F6.0, F3.0, X=7, DRIMPL=F6.1)
105 FORMAT (3E1.5, RFACT=0.3, BNDCH=CH4.3, BNDCO=CO2.3, BNDCC=CC(2)
110 FORMAT (2E1.7, O2=3E7, CH4=3E3, F7.3, F5.3)
END
C
C *****FUNCTIONS FOR CALCULATION OF SURFACE AND CONTENT*****
C
FUNCTION SURFACE (R)
R1=3.14
C ***DEPTH OF LEAK (DLEAK) AND GROUNDWATER (DGRWT)
DLEAK=0.
DGRWT=2000.
C ***DISTANCES (D) AND (DP) OF TRANSFORMATION OF MODELS
DEPT=DGRWT-DLEAK
DL=1.5*DLEAK
DP=1.5*DEPT
IF (D=0) D=0.3
C ***SPHERICAL SYMMETRY
2 SURFACE=4.*PI*X**2
GO TO 6
3 IF (D=DP) A=5+5
C ***CYLINDRICAL SYMMETRY
4 SURFACE =2.*PI*X*DLEAK+2.*PI*X**2
GO TO 6
C ***CYLINDRICAL SYMMETRY
5 SURFACE =2.*PI*X*DGRWT
6 RETURN
END
C
FUNCTION CONTENT (R)
R1=3.14
C ***DEPTH OF LEAK (DLEAK) AND GROUNDWATER (DGRWT)
DLEAK=0.
DGRWT=2000.
C ***DISTANCES (D) AND (DP) OF TRANSFORMATION OF MODELS
DEPT=DGRWT-DLEAK
DL=1.5*DLEAK
DP=1.5*DEPT
IF (D=0) D=0.3
C ***SPHERICAL SYMMETRY
7 CONTENT=1+0.333*PI*X**3
GO TO 9
8 IF (D=DP) T=8+8
C ***CYLINDRICAL SYMMETRY
7 CONTENT =PI*X**2*DLEAK+2.*PI*X**3/3.
GO TO 9
C ***CYLINDRICAL SYMMETRY
8 CONTENT =PI*X**2*DGRWT
9 RETURN
END
```

Appendix III

Computer program for non-steady state distribution of oxygen around ventilation channels after leak repair

```
PROGRAM CHANNELS
C *****EFFECT OF VENTILATION CHANNELS ON O2-CONCENTRATION (NON-STEADY STATE)**
C
C *****DIMENSION C(20*20*2), T(2), P(20*20)
C *****FILLED PORE SPACE
POR=0
C *****TEMPERATURE IN DEGREES CELSIUS
TEMP=20
C *****DIFFUSION COEFFICIENT IN AIR (D) AND IN SOIL (DIF)
IFACTOR=(TEMP+273.1/273)
D=0.15
DIF=0.65*POR*(1-POR)+TFACTOR*.025
C *****INITIAL CONCENTRATION IN SOIL
C(0)=0
C *****FIXED CONCENTRATION IN VENTILATION CHANNEL
CKAN=0.21
C *****FIXED CONCENTRATION IN NON-METALLED BORDER
C(0,0)=0
C *****OXYGEN OVERDEMAND OF THE GASED SOIL AT TIME T=0
POR=0.25
C *****OXIDATION RATE COEFFICIENT
RATE=0.0054
C *****O2-CONSUMPTION RATE IN NORMAL SOIL
CONSP=0.0036
C *****TIME INDICATIONS FOR PRINTING OF RESULTS
TFIN=0.05
DPRINT=12.00
TPRINT=11.99
C *****DISTANCE STEP
DX=20
C
C *****INITIAL SECTION*****
C
N=10
M=10
T(1)=0
DO 5 I=2,N
DO 5 J=1,M
P(I,J)=0
5 C(I,J)=C(1)
C
DO T J=1,M
C(1,0,2)=C(0)
7 C(1,1,1)=C(0)
C
C *****POSITION OF VENTILATION CHANNELS
C(6,4)=CKAN
C(9,5)=CKAN
C(7,4)=CKAN
C(7,5)=CKAN
C(8,9)=CKAN
C(6,10)=CKAN
C(7, 8)=CKAN
C(7,10)=CKAN
C(14,7)=CKAN
C(14,8)=CKAN
C(15,7)=CKAN
C(15,8)=CKAN
C *****CALCULATION OF TIME STEP (DT)
DT=0.45*POR*DX**2/(12.*DIF)
MP=DT*PRINT/DT*1.
DI=DI*PRINT/MP
C
C *****DYNAMIC SECTION*****
C
PX=0/POR*(1-POR+DX**2)
10 T(2)=T(1)+DT
DO 20 I=2,N
C(I,1)=C(I,2)
C(1,20)=C(1,19)
I=1
J=1
DO 20 J=2,M
IF (I.EQ.6.AND.J.PQ.4) GO TO 15
IF (I.EQ. 8.AND.J.EQ. 5) GO TO 15
IF (I.EQ. 7.AND.J.EQ. 4) GO TO 15
IF (I.EQ. 7.AND.J.EQ. 8) GO TO 15
IF (I.EQ.6.AND.J.EQ. 9) GO TO 15
IF (I.EQ. 6.AND.J.EQ.10) GO TO 15
IF (I.EQ. 7.AND.J.EQ. 9) GO TO 15
IF (I.EQ. 7.AND.J.EQ.10) GO TO 15
IF (I.EQ.4.AND.J.EQ.7) GO TO 15
IF (I.EQ.4.AND.J.EQ. 8) GO TO 15
IF (I.EQ.10.AND.J.EQ. 7) GO TO 15
IF (I.EQ.10.AND.J.EQ. 8) GO TO 15
C *****CALCULATION OF O2-OVERCONSUMPTION RATE (CONSP) FROM O2-OVERDEMAND (P(I,J))
CONSP=RATE*(I,J)
J=J+1
J=J+1
C(20,J)=C(19,J)
AMP=C(I,1)*J-2.*C(I,J)+C(I,J+1)+PX*(C(I,J+1)-
6 2.*C(I,J)+C(I,J-1)+C(I,J))
B=CONSP*DT/POR
IF (B.GT.A) CONSP=APOR/DT
P(I,J)=P(I,J)-DT*CONSP
C *****CALCULATION OF O2-CONSUMPTION RATE (CONSP) AND O2-CONCENTRATION (C(I,J))
CONSP=CONSP+CONSP
C(I,J,2)=A-CONSP*DT/POR
GO TO 20
15 C(I,J,2)=CKAN
P(I,J)=0
20 CONTINUE
C
C *****PRINTING OF O2-CONCENTRATION
IF (T(2).LT.TPRINT) GO TO 22
PRINT 90, T(2)
DO 21 I=1,M
21 PRINT 100, C(I,J,2)+J*2*M)
TPRINT=TPRINT+DT*PRINT
C
22 DO 25 I=2,N
DO 25 J=2,M
25 C(I,J)=C(I,J,2)
T(1)=T(2)
IF (T(2).LT.TFIN) GO TO 10
C
C *****PRINTING OF OXYGEN OVERDEMAND AT TIME T=TFIN
PRINT 80
DO 30 I=2,N
30 PRINT 100, (P(I,J), J=2,M)
STOP
C
80 FORMAT (//20X,20HOXYGEN OVERDEMAND (CH3,CH-3)**)
90 FORMAT (//20X,5HTIME,PT-2,1,3MU//)
100 FORMAT (//2X,20F6,3)
END
```