

Modeling and (adaptive) control of greenhouse climates



Promotoren: ir. J. J. van Dixhoorn
hoogleraar in de regeltechniek aan de
Technische Hogeschool Twente

dr. ir. J. Schenk
hoogleraar in de technische natuurkunde

A. J. Udink ten Cate

Modeling and (adaptive) control of greenhouse climates

Proefschrift

ter verkrijging van de graad van
doctor in de landbouwwetenschappen,
op gezag van de rector magnificus,
dr. C. C. Oosterlee,
hoogleraar in de veeteeltwetenschap,
in het openbaar te verdedigen
op vrijdag 7 januari 1983
des namiddags te vier uur in de aula
van de Landbouwhogeschool te Wageningen.

BIBLIOTHEEK
DER
LANDBOUWHOGESCHOOL
WAGENINGEN

ISBN = 178280-02

Des HEREN werk is wijs

Jesaja 28: 23-29

voor Floris
en voor Jasper

Stellingen

1. De huidige generatie kasklimaatmodellen is gebaseerd op drastische vereenvoudigingen, zoals de veronderstelde uniformiteit van fysische grootheden in de kas. Het is onaannemelijk dat -uitgaande van deze vereenvoudigingen- een klimaatmodel kan worden samengesteld via bekende fysische relaties uit de warmteleer. Een aanpak waarmee de nauwkeurigheid van de modellen wordt verbeterd, zonder hun complexiteit te vergroten, is dat de (fysische) relaties per geval geschat worden uit meetgegevens.

Dit proefschrift, hoofdstukken 2, 3, 7 en 9.

2. Eenvoudige dynamische modellen, die op een "personal" computer kunnen worden gesimuleerd, kunnen een wezenlijke bijdrage leveren aan de verbetering van kasklimaatregelingen in de praktijk.

Dit proefschrift, hoofdstukken 3, 7 en 9.

3. Het is fundamenteel onjuist het momentane kasklimaat te optimaliseren op basis van (productie) modellen die zijn verkregen uit lange-termijnproefnemingen.

Dit proefschrift, hoofdstuk 8.

4. Het aantonen van de verbeteringen die worden bereikt met een kasklimaatregeling die gebaseerd is op metingen aan planten (zie b.v. Takakura et al. 1978), door op traditionele wijze de opbrengst van een teelt te bepalen, stuit op dezelfde problemen als die waarvoor indertijd een dergelijke manier van regelen is aanbevolen (Germing, 1969). Significante uitkomsten zijn dan ook niet te verwachten.

T. Takakura, G. Ohara, en Y. Nakamura. 1978. Direct digital control of plant growth III. Analysis of the growth and development of tomato plants. Acta Hort. 87: 257-264.

G.H. Germing. 1969. Recente ontwikkelingen bij de regeling en beheersing van het kasklimaat. Tuinbouwmeded. 32(7/8): 344-353.

A.J. Udink ten Cate
Modeling and (adaptive) control of greenhouse climates
Wageningen, 7 januari 1983

BOEKHOEF
DER
LANDBOUWHOGESCHOOL
WAGENINGEN

5. De aanpak van de modelvorming van Otto et al. (1982) is niet juist omdat een dynamisch (hoogfrequent) model -zoals in de regeltechniek wordt toegepast- wordt gebruikt om een verschijnsel (het temperatuurverloop in een kas) te beschrijven dat vooral laagfrequente componenten bevat.

P. Otto, K. Sokollik, J. Wernstedt, en M. Diezemann. 1982. Ein Innentemperaturmodell zur Mikrorechnersteuerung der Heizungssysteme von Gewächshäusern. Arch. Gartenbau 30(3): 139-146.

6. Bij de discussies rondom de zogenaamde 1%-*vuistregel*, die het effect van lichtvermindering op de opbrengst beschrijft, wordt er ten onrechte van uitgegaan dat het zinvol is het genoemde percentage nauwkeurig te bepalen.

7. Binnen de daarvoor geldende marges, draagt fossiele energietoevoer nauwelijks bij tot de produktiesnelheid van winterkomkommers in Nederland.

8. Ten onrechte wordt in het handboek van Godman en Payne (1979) het "muizeval-effect" voor straling aangewezen als bepalend voor het kasklimaat. Reeds in 1909 is door Wood en in 1910 is door Van Gulik aangetoond dat dit effect lang niet het belangrijkste is (Businger, 1963).

A. Godman, en E.M.F. Payne. 1979. Longman dictionary of scientific usage. Longman Group, Harlow, Engeland. (2e druk). p. 407-408.

J.A. Businger. 1963. The glasshouse (greenhouse) climate. In: W.R. van Wijk [ed]. Physics of plant environment. North-Holland Publ. Co., Amsterdam. p. 277-318.

9. Bij het beschrijven van algoritmen voor discrete "model reference adaptive systems" gaat Landau (1979) ten onrechte voorbij aan de problematiek hoe de parameters van het discrete proces aangepast moeten worden.

Y.D. Landau. 1979. Adaptive control, the model reference approach. Marcel Dekker Publ. Co., New York. 406 p.

10. Programmeertalen komen, programmeertalen gaan, maar FORTRAN blijft altijd bestaan.

11. In discussies over verbetering van de volksgezondheid wordt vaak beweerd, dat een centraal gegevensbestand met informatie over patiënten en hun gezinssituaties voor de arts van groot nut is. Deze bewering komt voort uit de fundamenteel onjuiste opvatting dat meer gedetailleerde informatie tot betere beslissingen leidt. Een gebrekkig gegevensbestand met informatie over artsen, dat ter beschikking staat van patiënten, zou wellicht een veel wezenlijker bijdrage tot de volksgezondheid leveren.

Voorwoord

Het in dit proefschrift beschreven onderzoek is beïnvloed door talloze kontakten met mede-onderzoekers. Daarnaast verleenden velen hun medewerking. Ik zou hiervoor mijn erkentelijkheid willen uitspreken.

Mijn promotor prof. ir. J.J. van Dixhoorn zou ik willen bedanken voor zijn aanmoediging, vooral tijdens de beginfase van het onderzoek in 1976. Het streven om regeltechnische karakteristieken van het kasklimaat te vertalen naar fysische eigenschappen, kan gezien worden als een uitvloeisel van zijn inzichten.

Mijn promotor prof. dr. ir. J. Schenk heeft vooral gedurende het laatste deel van het onderzoek het eigenlijke schrijven van dit proefschrift intensief begeleid. Daarbij fungeerde hij als klankbord voor het begripsmatige deel van het proefschrift en -uiteraard- bij de fysische interpretatie van de meetgegevens. Ik zou hem hiervoor willen bedanken, en daarnaast ook voor zijn streven naar nauwkeurige formuleringen, waardoor in een aantal gevallen een extra dimensie aan de inzichten kon worden toegevoegd.

Het onderzoek dat aan dit proefschrift ten grondslag ligt, is gedragen door een informele werkgroep "Optimalisering kasklimaat ten behoeve van de teelt van kasgewassen", bestaande uit ir. G.P.A. Bot (LH, Natuur- en Weerkunde), dr. ir. H. Challa (CABO), dr. ir. J. van de Vooren (Proefstation Naaldwijk) en ikzelf, waarbij zich in een later stadium dr. ir. A.H.C.M. Schapendonk (CABO) voegde. Mijn inzichten en opvattingen zijn sterk beïnvloed door de vele onderlinge gesprekken en door het vele gezamenlijke onderzoek. Dit multidisciplinaire aspect van het werk behoort tot mijn meest plezierige en stimulerende ervaringen.

Het leeuwedeel van het onderzoek is uitgevoerd bij het Proefstation voor Tuinbouw onder Glas te Naaldwijk, in een hechte samenwerking met dr. ir. J. van de Vooren. Deze heeft op de onderliggende inzichten veel invloed uitgeoefend, en heeft daarnaast vele proefnemingen uitgevoerd. Vanaf deze plaats wil ik hem daarvoor zéér hartelijk dankzeggen.

De werkzaamheden in Naaldwijk vonden plaats in het kader van een samenwerkingsovereenkomst tussen het Proefstation en de Landbouwhogeschool

(vakgroep Natuur- en Weerkunde). Ik zou het Proefstation in de persoon van zijn directeur ir. E. Kooistra willen bedanken voor de verleende mogelijkheden en voor de ontvangen aanmoediging. Op het Proefstation verleenden velen hun medewerking of waren bereid hun inzichten te verklaren. Ik ben hen daarvoor erkentelijk, immers voor een toegepast onderzoek is zoiets van onschatbare waarde. De nuchtere inzichten van Th. Strijbosch verdienen hier apart gememoreerd te worden.

De gescheiden bereik (split-range) regeling in hoofdstuk 4 is onderzocht op het Proefstation voor de Bloemisterij in Nederland te Aalsmeer, in een plezierige samenwerking met ing. J. Valentin.

De publikatie, die in hoofdstuk 5 is opgenomen, werd geschreven met prof. ir. H.B. Verbruggen, TH Delft. Ik zou hem voor deze samenwerking willen bedanken.

Binnen de vakgroep Natuur- en Weerkunde hebben vele van de collega's direkt of indirekt aan het onderzoek bijgedragen. Hen zou ik willen bedanken voor de stimulerende werksfeer. Graag wil ik de hechte samenwerking met ir. G.P.A. Bot noemen, die mij wat vertrouwder wist te maken met de fysica van het kas-klimaat. Ir. J.G. Lengkeek is in de beginfase van het onderzoek actief geweest en heeft de eerste kontakten geëntameerd. J. van Zeeland heeft veel bijgedragen met name op het gebied van de gescheiden bereik regelingen (hoofdstuk 4). Prof. ir. O.H. Bosgra zou ik willen danken voor zijn aanmoediging en het bekritisieren van hoofdstuk 5. Tenslotte hebben vele studenten op de een of andere wijze aan dit proefschrift meegewerkt. Ik zou hen voor hun entoesiasme willen danken.

De medewerkers van het elektronica ontwikkelings laboratorium van de vakgroep, ing. C.J. van Asselt, G. Lenters en P. Jansen worden bedankt voor het animo waarmee zij hun deskundigheid inbrachten, hetgeen ook geldt voor de mechanische werkplaats: A.E. Jansen, T. Jansen en W. Hillen.

Mijn naaste collega's, ing. D. van den Akker, ing. W.F.M. Driessen, ing. B. Lammers, mej. C. Pitlo en dr. ir. G.A. van Zee zou ik willen bedanken voor hun hulp en hun inbreng. Daarenboven hebben zij in het laatste jaar de mogelijkheden geschapen om de tijd vrij te maken die voor een onderzoek in de eindfase nodig is.

Voor een proefschrift is uiteraard de vormgeving van groot belang.

Mevr. L.M.A. van der Zel-Kriek verrichtte op uiterst voortvarende wijze het type-werk. P. van Espelo verzorgde de tekeningen en gaf vele nuttige adviezen met betrekking tot de uitvoering. J. van de Brink verzorgde het fotomateriaal. De omslag is een ontwerp van Wiert Douglas, illustrator. Mijn hartelijke dank gaat naar hun vakkundige inbreng uit.

Tenslotte zou ik een woord van dank willen uitspreken aan mijn gezin. Lieve Ellen, bedankt voor je steun. Aan onze zoons Floris en Jasper, die de toekomst nog in zich bergen, draag ik gaarne dit proefschrift op.

Rhenen, 6 november 1982.

Contents

List of frequently used symbols

1	Introduction	1
2	A description of the control problem	7
2.1	Terminology	7
2.1.1	Local, spatial average and crop canopy climate	7
2.1.2	Environmental and climate control	8
2.1.3	Plant and crop responses	10
2.2	Crop growth as a hierarchical system	10
2.3	Control of the climate subsystem	13
2.4	Review of climate control methods	14
2.4.1	Methods	14
2.4.2	Control with a "speaking plant"	16
2.4.3	Operation of control equipment	17
2.4.4	Control loop dynamics	18
2.5	Review of greenhouse models	19
2.5.1	Greenhouse models	19
2.5.2	Applicability of greenhouse models	20
2.5.3	Modern control	22
3	Models for temperature control	23
3.1	Introduction	23
3.2	A simple thermal model	25
3.2.1	Incremental variables	25
3.2.2	Heating	28
3.2.3	Ventilation	29
3.2.4	Radiation	30
3.3	Actuator processes	32
3.3.1	Mixing valve	32
3.3.2	Ventilation windows	33

3.4	<i>Experiments</i>	35
3.4.1	<i>Experimental set up</i>	35
3.4.2	<i>Signal conditioning</i>	36
3.4.3	<i>Actuator processes</i>	38
3.4.4	<i>Heating process</i>	40
3.4.5	<i>Non-linearity of the heating system</i>	42
3.4.6	<i>Relation with thermal parameters</i>	45
3.4.7	<i>Ventilation</i>	49
3.4.8	<i>Radiation</i>	51
3.5	<i>Discussion</i>	53
4	<i>Temperature control</i>	55
4.1	<i>Desired performance characteristics</i>	55
4.2	<i>Heating system control</i>	57
4.2.1	<i>Control scheme</i>	57
4.2.2	<i>Discrete time algorithms</i>	58
4.2.3	<i>Typical performance</i>	60
4.3	<i>Dog-lead algorithm</i>	63
4.3.1	<i>The algorithm</i>	63
4.3.2	<i>Proportional kick</i>	64
4.3.3	<i>Performance of the PI algorithms</i>	66
4.4	<i>Split-range heating system control</i>	71
4.5	<i>Ventilation control</i>	74
5	<i>Least-squares like gradient methods for on-line parameter estimation</i>	76
5.1	<i>Introduction</i>	76
5.2	<i>Continuous gradients</i>	77
5.3	<i>A least-squares like gradient method for discrete process identification (reprint Int. J. Control 28(6): 933-952, (1978))</i>	83
	1 <i>Introduction</i>	83
	2 <i>Least-squares like gradient method (LSLG)</i>	84
	3 <i>Slowly time-varying parameters</i>	88
	4 <i>Comparison with the least-squares method</i>	89
	5 <i>Extensions of the algorithm</i>	91
	6 <i>Selection of the parameters of the algorithm</i>	93
	7 <i>Conclusions</i>	99

6	Adaptive control of the heating system	103
6.1	<i>Introduction</i>	103
6.2	<i>The adaptive problem</i>	104
6.3	<i>The adaptive algorithm</i>	106
6.4	<i>Results</i>	108
6.4.1	<i>Modified PI</i>	108
6.4.2	<i>Dog-lead PI</i>	111
6.5	<i>Discussion</i>	112
7	Improved models	114
7.1	<i>Introduction</i>	114
7.2	<i>Steady-state calculations</i>	115
7.3	<i>Quasi-static modeling</i>	118
7.4	<i>Discussion</i>	123
8	Optimal control of plant growth	125
8.1	<i>The hierarchical system description</i>	125
8.2	<i>Growth models for control</i>	128
8.3	<i>Speaking plant approach</i>	130
8.4	<i>Optimal crop growth</i>	132
8.5	<i>Discussion</i>	133
9	Final discussion and suggestions	136
	Summary	141
	Samenvatting	146
	References	152
	Curriculum vitae	159

List of frequently used symbols

	<i>Symbols</i>	Introduced in section
A	area [m^2]	3.2.2
a_0, a_1	constants (of ventilation rate formula)	3.3.2
b, b_1	constants (of heating system heat transfer)	3.4.6, 3.4.5
C	heat capacity [$J K^{-1}$]	3.2.1
C_0, C_1	constants	4.4, 6.3
c_p	specific heat at constant pressure [$J kg^{-1} K^{-1}$]	3.1
E	quadratic error criterion	3.4.4
e	error signal	3.4.4, 4.2.2
f	non-linear transfer function	3.3.1
GCFC	greenhouse climate feedback/feedforward control	2.1.2
H	transfer function	3.2.1
H_r, H_p	transfer function of controller process	4.2.2
h	height [m]	3.2.2
h_h	constant related to heat transfer of the heating system	3.4.6
K	gain	3.4.1
K_r	gain of controller	4.2.2
k	heat transfer coefficient [$W m^{-2} K^{-1}$]	3.2.2
L	limit	4.2.2
l	length [m]	3.4.1
q_v	exchange rate [$m^3 s^{-1}$]	3.1
R	thermal resistance [$K W^{-1}$]	3.2.1
r	position, aperture [-], %	3.1
S_v	ventilation rate [h^{-1}]	3.1
T	period [h^{-1}]	3.4.4
T_s	sample time [min]	3.4.4
t	time [s]	
u	setpoint	3.4.4
V	volume [m^3]	3.1
v_w	wind velocity [$m^3 s^{-1}$]	3.1

x	humidity [g kg^{-1}]	3.1
y	calculated response	3.4.4
ζ	constant [$\text{W h m}^{-3}\text{K}^{-1}$] (related with k_v^*)	3.2.2
η	fraction (related with ϕ_s)	3.2.1
θ	temperature [$^{\circ}\text{C}$]	3.1
ρ	density [kg m^{-3}]	3.2.2
τ	time constant [s, min]	3.2.1
τ_d	dead time [s, min]	3.2.1
ϕ_s, ϕ_e	shortwave, longwave radiation flux [W]	3.1
ϕ''	radiation flux density [W m^{-2}]	3.2.4

Subscripts

a	ambient (outside)
f	feed, e.g. θ_f ; filtered e.g. $\tilde{\theta}_{g,f}$
g	greenhouse
h	heating system (heating pipes)
i	integral
l	lower, longwave
m	mixing valve
p	proportional
r	roof
s	shortwave
ss	steady-state
t	total
u	upper
v	ventilation
w	window

Note: combined subscripts e.g. $\theta_{hg} = \theta_h - \theta_g$

Superscripts

*	normalized per unit greenhouse area, e.g. $C_g^* = C_g/A_g$
-	average value, e.g. $\bar{\theta}$
~	increment, e.g. $\tilde{\theta}$
^	estimated value

1 Introduction

In the Netherlands, the popularity of mini- and microcomputers for the control of greenhouses is steadily growing. At present approximately 2500 *greenhouse computers* are in operation at commercial holdings, with units ranging from central minicomputers with extensive user facilities to straightforward functional replacements of conventional equipment. In this development the control algorithms in the computer usually perform the same functions as conventional controllers. In a computer system, however, more sophisticated control methods could be applied. Because improved methods not necessarily require more extensive computer hardware, this means that the potentials of computers are not fully exploited.

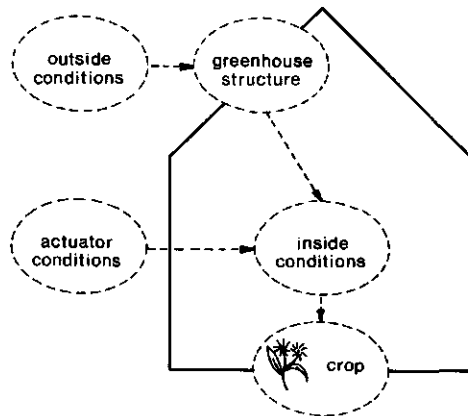

Fig. 1.1 The greenhouse control situation.

In fig. 1.1 the greenhouse control situation is depicted schematically (after Seginer, 1980). The crop that is grown in the greenhouse, is influenced by the *conditions* -insofar relevant for growth and development- *inside* the greenhouse. The conditions inside result from *actuator conditions* (which can be varied by the grower) and from *outside conditions*, which act upon the inside via the *greenhouse structure*. Examples of the structure are: covering-material (single or double-layered glas or plastic), dimensions of the greenhouse, thermal screens. Examples of actuators: heating system, ventilators, water supply, artificial lighting. The outside conditions are composed by the weather. A subset of the inside conditions is referred to as the *greenhouse climate*.

Greenhouse computers are used for a wide variety of tasks. Control of the inside conditions is computerized, but also data-logging and alarming tasks are performed. Boiler control and load-scheduling are other options. *Climate control* is only one of the activities of a greenhouse computer system.

The computer fits well into the development of automation in greenhouses. Automation made a hesitating start in the late fifties (Vijverberg and Strijbosch, 1968) by the introduction of thermostats for heating control. Later analogue electronic controllers were introduced. At first performing similar functions as thermostats, but later with growing capabilities (Winspear and Morris, 1965, Winspear, 1968), such as the automation of ventilation windows (Strijbosch and Bol, 1965, Strijbosch, 1966). Also functions like irrigation were automated with irrigation dependent on the daily global radiation sum (De Graaf and Van den Ende, 1981) as advanced feature.

With the increasing level of automation, an increasing quantity of equipment has been employed. Especially when control actions are based upon time-varying outside weather conditions, like outside air temperature or irradiation, the analogue electronic equipment becomes quite complex. Under these conditions the costs of a computer system compare favourably, which explains the rapid increase of computer systems in greenhouse control (Gieling, 1980).

The greenhouse computer can perform all the control functions of the conventional analogue electronic climate controllers, with the additional feature that those functions can be more flexible because they are no longer physically related to electronic circuits. The supplier of the greenhouse computer can easily extend the software with new control methods and make them operational on existing computers. This facilitates to follow the newest trends in control methods and the individual wishes of growers, without the necessity for considerable investments for additional equipment. This explains why most greenhouse computer suppliers in this country update the software regularly, which is done for limited extra costs.

An interesting aspect of the development in recent decades is that the underlying philosophy in control with greenhouse computers conforms to an *operator* making use of the various actuators. Instead that the grower is adjusting his actuators by himself when walking around in his greenhouse, the same task is

now performed by a controller (Vijverberg and Strijbosch, 1968). Using external information and measurements, and applying time clocks it is possible to translate this operator approach into *procedures* which are carried out by the controller (be it a conventional analogue electronic one or a computer). In a greenhouse computer these procedures are easily transferred into software; in a conventional controller this requires complex hardware.

It is stated here that also the grower's perception with reference to greenhouse control is essentially that of an operator. The climate controller is designed as to facilitate this task. In the greenhouse computer industry most research activities are focused on improving the computer performance by translating established operator methods into control procedures and subsequently include these in the software. As a result, in industry an everlasting effort is put into the upgrading of software since the established control procedures are permanently changing (new types of greenhouses, new varieties, higher fuel costs).

The rapid introduction of computers in the Netherlands contrasts with developments in other countries. The difference can be explained from the level of automation in greenhouse control. Under the permanently changing weather conditions in this country in greenhouses many actuators are in use. Because of the amount of actuators and because of the size of an average commercial holding, a high level of automation is essential to save a considerable amount of labour. When also control procedures become widely accepted, which is an other way of describing a general high level of expertise of the growers, the required analogue electronic equipment becomes so expensive that a computer system is economically justified.

When, conversely, the outside climatic conditions are generally steady (as they are in Japan, Israel, Southern France), heating and ventilation control can be performed with thermostats with a satisfactory degree of accuracy. When also the holdings are of a small size and the outside climatic conditions, the level of expertise, or the way the crop is grown are such that control procedures are not applied, a greenhouse computer system of the type that is presently in vogue is too expensive. This will change when very low-cost systems will be marketed that can compete with the thermostatic controls and with the time switches that are presently used in low-cost solutions for greenhouse control.

Permitting a glimpse into the future, with the advance of low-cost single chip microcomputers (containing a microprocessor, memory, real-time clock, analog and logical input/output channels) this breakthrough can be expected within a few years. The greenhouse control will be performed by a decentralized computer network, where the main tasks will be performed by decentral computers which are connected with a central computer system (carrying out alarm, data-logging and central operation tasks). Using far more expensive hardware, in the Netherlands decentralized systems have already been realized at the IMAG in Wageningen (Van Meurs, 1980) and at the Experiment Stations in Aalsmeer and Naaldwijk.

The operators attitude of the grower has also consequences for the generally accepted approach to greenhouse control. Because in growers procedures actuator signals (like ventilation window aperture or heating system temperature) are directly related to the (assumed) reactions of the crop, in practice most control procedures are formulated along these lines. Typically in practice control procedures are improved by adding operator knowledge in terms of conditional compensations or logical decisions. The dynamical nature of the process under control is generally not analyzed. As a result, in practically oriented research on control as it is done in horticultural experiments, the research is aimed at improvement of procedures.

The research on climate control reflects this practice and little attention is paid to climate control as such. Because of this in the field of greenhouse climate control relatively few studies have been published which deal with the dynamical aspects of the climate control loops (O'Flaherty, 1973, Tantau, 1979, Udink ten Cate and Van de Vooren, 1977, 1981). The prevailing interest in climate control procedures, where the interrelation between climate control and the related crop response is regarded as one aggregated problem, does not motivate research to new climate control methods very much. A methodological restriction is that an eventual improved performance cannot be demonstrated in the traditional field trials (Germing, 1969a,b, Germing and Van Drenth, 1971). Also the development of models of the greenhouse climate, that are suitable for computer simulation and can be used for the design of new algorithms, has received little attention.

Because of the energy crisis much research is devoted to new greenhouse

structures, heating systems etc. in order to reduce the heating costs. In these new greenhouses the climate differs from the traditional ones (e.g. higher humidities occur in better insulated glasshouses). A better understanding of the control of the climate might lead to quicker results than the traditional research for climate control procedures by lengthy and costly field trials.

Quite another aspect is the application of computerized optimization methods in order to maximize economic results. Much academic research is performed in this field of *optimal plant growth* and it is felt that the feasibility of these methods depends on the accuracy of the climate control. Also the application of explicit growth models in the control algorithms requires an accurate climate control.

As indicated above, the greenhouse climate can be described from various points of view using disciplines like horticulture, physics or control science. Although it could be argued that in the end all approaches amount to the same thing, in reality this is not so true.

Emphasizing the archetypes, in *horticulture* the climate is in fact the climate regime, its relation with growers' procedures and its influence on crop growth and development. Much attention is given to avoid extreme climatic conditions that may damage the crop (including damage by diseases). In *physics* the research is mainly concerned with the impact in climatic terms of structural aspects of greenhouses (heating systems, thermal screens, double glazed roofs etc.), thereby giving a detailed description of the climate factors as they occur in the greenhouse. *Control science* focuses on the dynamical nature of the controlled processes of which the climate is the basic one -which itself is strongly related to the crop growth and development processes. In control the stability and accuracy of the resulting control loops is of interest.

The crucial question is whether control science will contribute solutions for the above-mentioned developments with respect to greenhouse control, new types of greenhouses and optimal control of plant growth. Therefore in this thesis much effort is given in formulating the problem in adequate terms and to describe possible approaches. A *system approach* is followed where greenhouse climate control, plant growth and crop development are described as

coupled subsystems. In Chapter 2 such a description is presented, stressing the point that climate control cannot be regarded as a problem in its own right, but is embedded in requirements stemming from the other subsystems. The approach permits reflection on the feasibility of optimal plant growth via climate control (Chapter 8).

Simple dynamical models are essential in the design and analysis of controllers. In Chapter 3 models are presented that describe the dynamics (high frequency behaviour) of the greenhouse air temperature. Methods for its control are presented in Chapter 4. Because outside weather conditions have a strong influence on the dynamics of the temperature control loop, an *adaptive* (or: self-adjusting) heating system control algorithm has been proposed. The theory is treated in Chapter 5 where a reprint is presented of a publication that was written jointly with prof. ir. H.B. Verbruggen (Delft University of Technology). The greenhouse application is discussed in Chapter 6.

Models that describe both the dynamical (high frequency) behaviour and the statical (low frequency) behaviour of the greenhouse climate yield the absolute values of the greenhouse climate (dynamical models usually only describe the variations accurately). These models can be used to assess the heating requirements of new greenhouse structures or can be applied in optimal procedures with respect to plant growth. For the greenhouse air temperature such models are presented in Chapter 7. Conclusions are presented in the final Chapter 9.

2 A description of the control problem

2.1 TERMINOLOGY

In greenhouse climate control the terminology is not defined very well, so that various authors do not use the same concepts. Consequently, special care is taken to formulate precisely the terminology that is adopted in this thesis. This formulation is outlined below.

2.1.1 *Local, spatial average and crop canopy climate*

As is depicted in fig. 1.1 the conditions inside a greenhouse influence the growth and development of a crop. Relevant conditions are e.g. air temperature, air humidity, CO₂ content, long wave radiation, short wave radiation, air movement, artificial light, water supply, fertilizers, nursing methods. The first three conditions (air temperature, humidity and CO₂ content) are associated with the *greenhouse atmosphere* and are usually of concern in air-conditioning studies.

A comprehensive treatment of the relevant conditions can be found in texts on greenhouse operation, like von Zabeltitz (1978), Kanthak (1973), Seemann (1974) or Hanan, Holley and Goldsberry (1978). A subset of these inside conditions can be referred to as *climate*. The term climate is not very strictly defined, but conditions or factors that obviously form the greenhouse climate are air temperature, humidity and radiation. Seemann (1974) uses the term *meteorological growth factors* to denote a set of relevant climate factors, including long and short wave radiation, air temperature, CO₂ content and humidity.

Inside the greenhouse the climate can be described in space. Of interest for the individual plant is its surrounding *local climate*. The greenhouse can also be looked upon as having uniformly distributed values of the climate factors, which can be approximated using the notion of *spatial average climate*.

When using the term spatial average climate it should be realized that in

a greenhouse large gradients can occur both vertically and horizontally. Another drawback of the term spatial average climate is that it is restricted to the climate factors of the greenhouse atmosphere (air temperature, humidity and CO₂ content). It is for example not so obvious to include inside air movement or local radiation (like long wave radiation from the heating system) in the concept. Therefore, the term *crop canopy climate* is introduced to refer to the spatial average climate inside the crop canopy, which itself is the ensemble result of the local climates surrounding the individual plants. In the term crop canopy climate, factors like local radiation balances and air movement are also considered.

To distinguish between *spatial average climate* and *crop canopy climate* is of importance for research, since a change in the greenhouse structure can have a different impact on both climates. A thermal screen, another type of heating system (air heating instead of heating pipes) can result in the same spatial average climate (in terms of the greenhouse atmosphere), whereas other factors of the crop canopy climate -notably the long wave radiation and air movement- will be quite different.

2.1.2 *Environmental and climate control*

In control the terminology can be refined too. In *environmental control* the interest is focused on all measures that influence the inside conditions in the greenhouse. Examples of environmental control are: heating by heating pipes or by air heaters, ventilation by natural or by forced ventilation, screening, shading, spraying of water, fan and pad cooling, artificial lighting; in short the use of the whole range of installations and devices in a greenhouse that are employed in order to accommodate a beneficial crop environment.

The term control is used in a *broad sense* here. In a *more strict sense* in control only the *dynamical aspects* are of interest. This is not so in environmental control, where the attention is mainly focused on the effects on the inside conditions and subsequently on the crop. The only dynamical notion is that the magnitude of the environmental control actions can be varied.

Climate control restricts itself to the control of the spatial average climate factors in the greenhouse and can be regarded as a sub-class of

environmental control. The term control can be used in the broad sense, when the attention is directed to the effects on climate factors.

In the more strict sense the dynamical behaviour is of primary interest. A *climate process* is controlled of which the relevant climate factors (the climate) are the *output variables*. The *input variables* of the climate process are the *climate control actions* that are applied to regulate the climate. These control actions serve as *driving variables* or *actuator signals* for the input of the climate process. Other factors that influence the output, but are not controllable (outside weather conditions) act as *disturbances*.

The driving variables have to be more or less continuous in time, which excludes actuator signals like the drawing of a thermal screen or other actions that cause an abrupt change in the inside conditions. These phenomena can be seen to change the properties of the climate process, or can be modelled as disturbances. Naturally the distinction between admissible and non-admissible input variables is not very sharp.

In control -or more precisely in *feedback* control- the process output variables are measured. Via the controller an actuator is regulated which generates an input signal for the process. The dynamics of the process and the feedback loop determine the control scheme that is employed, where *accuracy* and *stability* are important criteria. When the dynamics of the process are known a-priori also a form of *feedforward* control can be applied in order to compensate for fast disturbances.

To emphasize the fact that in climate control in the more strict sense, the dynamical nature of the climate process is of interest and that a form of feedback is essential, the term *Greenhouse Climate Feedback/Feedforward Control* (GCFC) is used throughout this thesis in order to distinguish from the term climate control in the broad sense and from the term environmental control.

Because of the fact that the controlled climate process output variables have to be measured and that the number of variables has to be kept as small as possible in order to avoid complex control schemes, in the practice of growing only spatial average climate factors of the greenhouse atmosphere are measured and controlled. The most important factors are air temperature and humidity, which -in the usual greenhouse in the Netherlands- are regulated by the actuators heating system and ventilation windows.

It is noted that -because of its direct relation to the crop- it is more natural to control the crop canopy climate instead of the spatial average climate. That this is not done, might be explained from the relative difficulty to measure crop canopy climate factors in practical horticulture.

2.1.3 *Plant and crop responses*

The responses of the plants on the internal conditions in a greenhouse can be described both in time and in space, leading to notions similar to that in the case of the climate.

The responses of a plant can be evaluated from a relatively *short time scale* (up to one day because of the diurnal periodicity) to a *long time scale* (plant development, production of fruits). In most cases it is not practical to regard every plant individually so that is referred to *the crop* as the ensemble of plants. It is seen that the response of a crop is the ensemble of responses of individual plants to their local climates.

On a short time scale the response of the crop is referred to as *over-all plant response*. It is assumed that the over-all plant response can be described adequately as the response on the (average) crop canopy climate.

On a long time scale the over-all plant response is denoted as *crop response* in order to distinguish between both time scales. It is seen that the crop response is the result of the crop canopy climate over a long time scale -which is usually referred to as the crop canopy *climate regime*. With respect to the over-all plant response and to the crop response, it can be assumed that there exists a strong coherence between the climate regime of the spatial average greenhouse climate and that of the crop canopy climate.

2.2 CROP GROWTH AS A HIERARCHICAL SYSTEM

In greenhouses the ultimate goal is to accomodate conditions as to stimulate crop growth. *Crop growth and development* are the result from the inside conditions over a long time scale. In this thesis the attention is restricted to these inside conditions as they are controlled by GCFC. However, because of the ultimate interest, a qualitative analysis is presented of the relation between climate control and crop growth and development.

The control of crop growth and development is very complex because the inside

conditions can be influenced in many ways. When we restrict ourselves to climate conditions, the crop canopy climate is the relevant set of inside conditions. There are many ways to influence the crop canopy climate and also crop growth and development can be described by many processes. This leads to a large family of relevant input and output variables, so that some restriction is essential in order to describe the system conveniently. In the case at hand, the problem is how to control crop growth and development by imposing a climate in the greenhouse. Therefore, the system is described as a *hierarchical system*, consisting of three levels, where the higher level controls the lower levels (fig. 2.1).

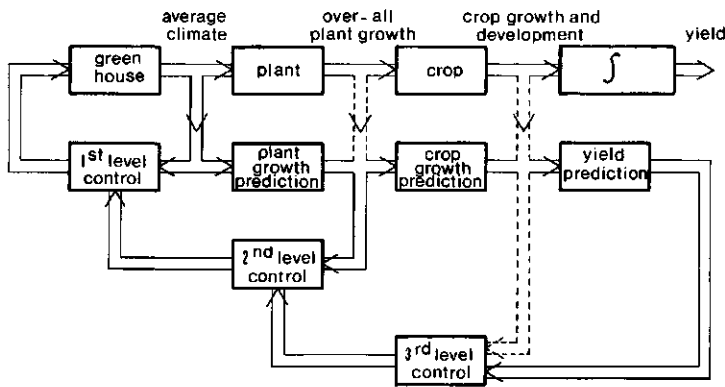

Fig. 2.1 Crop growth as a hierarchical system.

The control of the average climate is the *first level* of the hierarchical system of fig. 2.1. Other environmental control actions are not considered here but could be included if desired. The greenhouse structure determines the properties of the climate process. The output of the first level is the spatial average climate, but for the coupling with the second level subsystem the crop canopy climate is required. Since the spatial average climate is described by a subset of the family of variables describing the crop canopy climate, a certain ambiguity is introduced.

On the *second level* the short term over-all plant responses are described in relation to the imposed crop canopy climate. The crop canopy climate is not completely controllable; factors like solar radiation for example, are mainly the result of outside climatic conditions and act as a disturbance in our

description. Factors like irrigation, application of fertilizers, the occurrence of pests etc. are of course very important in plant growth, but are omitted in our description.

There are various control strategies that can be followed on this level. The most straightforward approach is to measure fundamental processes that determine plant growth. This *speaking plant* approach (terminology from Bot, Van Dixhoorn and Udink ten Cate, 1978a, Udink ten Cate, Bot and Van Dixhoorn, 1978) is rather cumbersome because the measurements are difficult to perform and only give local information. In the practice of growing not the actual or instantaneous over-all plant growth is of interest, but what one from experience expects the "over-all" plants to do in a given situation over a limited time span (minutes to several hours). Therefore the time scale of the process on level two is from minutes to one day, thus describing the diurnal course of the plant. It incorporates several plant growth subsystems which are discussed in more detail later. A number of cultivation methods, as they are incorporated in GCFC methods and in control procedures, can be put on the second level. In the hierarchical system the control of level two sets the desired values for the GCFC on level one. The first level control will then attempt to realize these values.

On the *third level* crop growth and development are of interest, with a time unit of one day. The integrated effects over the whole cropping period are yield quality and time of harvesting (earliness) which determine the economic value.

A mechanism that controls the output of this system on the basis of measurements cannot be established because the result is only known after the harvesting. Decisive here is the expected economic result, the expectation of which is based on *blue prints* of cultivation methods and the growers observation of the growth stage, in addition to experience, intuition and spirit of enterprising. The expectations lead to actions on the second (and subsequently the first) level.

The separation between the second level system describing over-all plant growth and the third level system describing crop growth and development is mainly based on the time scale: a time span of one day describes the diurnal course of the plant growth processes, so that one day is the time unit of crop growth. However, it also reflects the way of modelling that is used to describe the phenomena. On level two causal relations are used whereas on

level three empirical (Van Wijk, 1963) models are employed. In the hierarchical system level two and level three are coupled, but because of the way of modelling, the set of output variables of level two is not very much apt to resemble the set of input variables of level three.

The hierarchical system description has been introduced by Bot et al. (1978a) and by Udink ten Cate et al. (1978) and was later adopted by other authors. Carlsson, Christensen and Nilsson (1979) observe a similarity between their approach for an economical model of crop growth and the above model. Hashimoto et al. (1980, 1981 a,b) use the idea of speaking plant approach in describing their research; Copet and Videau (1980) use a hierarchical system description in the presentation of an adaptive control scheme.

2.3 CONTROL OF THE CLIMATE SUBSYSTEM

The first level of the hierarchical system describes the spatial average greenhouse climate and its control. In this section some general aspects will be reflected.

For crop growth the crop canopy climate is of interest. As said before (see 2.1.1 and 2.1.2) the factors that determine the spatial average climate are measurable and basically controllable. Conversely, factors of the crop canopy climate, like air movement, are neither readily measured nor controlled. Since GCFC restricts itself formally to spatial average climate factors, the crop canopy climate is controlled implicitly via limitations and minimal or maximal values of control actions, of which the values are based on practical experience.

There is no reason why one should restrict oneself to the control of climate factors of the greenhouse atmosphere. Suppose, for example, that more knowledge becomes available of the ventilation process in greenhouses which describes the relation between window aperture and the air change rate. Then the water vapour flow from the greenhouse can be calculated using data from inside and outside humidity and of condensation on the roof using roof temperature measurements (Van de Vooren, personal communication). By controlling the ventilation, the vapour flow from the crop and the greenhouse soil can be controlled. It might well turn out that this approach is more relevant to the crop canopy climate and the over-all plant responses than -for example- control of the humidity.

One of the main problems in GCFC is that control cannot be very accurate. This is partly due to the strong influences of the outside climate conditions which act as disturbances in the control loop. Another reason is that the crop itself influences the greenhouse average climate by evapotranspiration (evaporation from the soil and transpiration from the plants combined together). As a result disturbances are not rejected very well. In general only a lower and an upper limit of the controlled variables can be kept.

As discussed above, the control of the crop canopy climate with the usual GCFC actuators (heating system, ventilation windows) is not established. This does not mean that no relations could be formulated. It is felt that the use of the crop canopy climate concept in research will facilitate the application of experimental results obtained in phytotrons. In horticultural research crop canopy climate factors could be measured explicitly. This is not done in the usual approach towards research on climate control procedures. Consequently, the relations between actuator signals and the crop canopy climate are only included implicitly.

Take for example research that is conducted towards a direct relation between crop growth and the aperture of the ventilation windows. There is no reason to see why it is impossible to define air movement in the greenhouse and subsequently the boundary layer resistance of leaves in relation to growth. Research results on the relation between air movement and over-all plant growth as obtained in phytotrons could be used here, instead of experimentally establish in field trials a relation between crop growth and minimum aperture of ventilation windows or minimum heating pipe temperature.

2.4 REVIEW OF CLIMATE CONTROL METHODS

In this section existing methods in greenhouse climate control are reviewed briefly. The hierarchical system description presented in the foregoing sections is used as a framework. The climate control equipment is discussed as well.

2.4.1 *Methods*

In applied research on climate control in greenhouses, the attitude of the grower is adopted. This means that the relation between control procedures

and the crop responses is investigated. The effects of climate control actuators on the crop canopy climate lead to control procedures where the objective is to avoid extreme situations that may damage plant growth.

The following researches illustrate the approach to avoid extremes. Groenewegen (1962) describes a comparison between commercial holdings where tomato crops are grown. A significant difference is found in humidity between heated and unheated greenhouses. In order to avoid high humidities -which also occur in heated greenhouses during dull days in winter- research has been carried out by Strijbosch and Bol (1965) and Strijbosch (1966); for an overview see Vijverberg and Strijbosch (1968). The problem can be solved by concurrent heating and ventilation and by situating the heating pipes just above the ground between the crop. A disadvantage of this approach is that once the extreme situations are avoided, the solution can be less optimal with respect to other criteria, such as fuel consumption.

A logical suite of the avoidance of extreme situations is climate control that is based on knowledge of plant reactions. An example is the *light-dependent temperature control* (Bowman and Weaving, 1970, Bokhorst, Van Drenth and Van Holsteyn, 1972), which is based on the assumption that when more photosynthetic active radiation becomes available, a higher crop temperature increases photosynthesis and subsequently plant growth. Depending on the amount of solar radiation an increment is added to the normal value of the desired greenhouse air temperature. Apart from the fact that the assumption of increasing photosynthesis is not generally valid, the beneficial effect of this strategy is hard to establish, because in winter-time a higher air temperature demands a higher fuel consumption. The higher yields have to pay off the higher fuel costs, so that an economic optimization problem is considered (Hand and Soffe, 1971, Calvert and Slack, 1975, 1980). This makes it difficult to assess a significant outcome, which can be regarded as a fundamental problem in this type of climate research (Germin, 1969a,b, Germin and Van Drenth, 1971).

In practical horticulture the strategy is followed only when the temperature increase is realized by solar radiation, so that the effect is that no "free" heat is wasted and some air exchange is maintained. This can be realized by extra criteria for setpoints in the controller (Bokhorst et al., 1972). The *same effect* can also be achieved by founding the aperture of the ventilation windows on outside weather conditions (Van de Vooren and

Strijbosch, 1980).

Another strategy that is based on a-priori assumptions on evapotranspiration in the greenhouse in relation to solar radiation is the *delta-X control* (Heijna, 1975). It is used for simultaneous heating and ventilation.

In the above strategies, a form of control on the second level of the hierarchical system is realized, since the strategies perform essentially setpoint control of the first level. The widely accepted use of different day and night temperatures can also be understood in this way.

It is noted that in the mentioned strategies no explicit measurement of plant growth is realized.

2.4.2 Control with a "speaking plant"

In the research on climate control, second level relations are hard to assess in the traditional field trials. Germing (1969 a,b;) (Germing and Van Drenth, 1971) suggests that plant responses can be monitored in the research and eventually used in a feedback control loop. The latter is essentially what was called the *speaking plant* approach, of which the drawbacks were already mentioned in section 2.2. Some specific research in this field has been reported. Takakura et al. (1974) present the control of photosynthesis via atmospheric climate factors, where the photosynthesis is indirectly determined by measuring the CO₂ uptake in a closed system. Results on a tomato crop have been reported (Takakura, Ohara, Nakamura, 1978). Control of leaf temperature was investigated by Matsui and Eguchi (1977b) for a phytotron and by Mackroth (1974) for a greenhouse. None of these experiments seems to be very decisive, partly because only a single variable was measured and partly because positive results could also be explained from "average" influences (higher temperatures, CO₂ enrichment), thus leaving an economical optimization problem to be solved.

Whereas the *speaking plant* approach in the previous alinea has not produced new methods, the approach to *avoid extreme situations* and the practical use of methods like light-dependent temperature control or *delta-X control*, have been markedly succesful. In the Netherlands improved climate (or better environmental) control has been considered a *cheap means* of improving crop quality and yield (Vijverberg and Strijbosch, 1968). In most commercial

controllers methods like light-dependent temperature control or delta-X control have been incorporated, with a number of conditional settings to obtain the desired results.

2.4.3 Operation of control equipment

The control methods discussed above lead to rather complex controllers. In the relevant literature these controllers are explained, but the interest is focused on the sensor types and the conditional settings (of setpoints of the first level climate control). Not so much attention is paid to the dynamics of the climate processes themselves, and in many texts only environmental control is treated in *statical* (equilibrium) situations.

Winspear and Morris (1965) and Winspear (1968) discuss the early potentialities of environmental and climate control. Bokhorst et al. (1972) discuss the setpoint conditions of the light-dependent climate control in some commercial controllers and Heijna (1970) does so for delta-X control.

The use of controllers in practical horticulture is among others discussed by Van der Meer (1977) and by Strijbosch (1974). A comprehensive overview of sensors and commercial controllers is given by Taveirne (1972) and by Heijnen, Buitelaar and De Kroon (1979). Gieling and Van Meurs (1977) present a survey of commercial equipment for greenhouse control, which indicates the complexity as well as the prices of analogue electronic controllers.

In the books of Kanthak (1973) and Seemann (1974) much attention is paid to environmental control. In the book of von Zabeltitz (1978) a detailed treatment is given on environmental control, the thermal properties of greenhouse structures and some dynamical aspects of GCFC. In Hanan et al. (1978) the environmental control is discussed in terms of practical use.

In recent years, in the literature some attention is given to greenhouse computers. Although much of the literature is not open (since most research is performed by commercial firms) some descriptions of computer systems have been published. Van de Vooren (1975) and Van de Vooren and Koppe (1975) discuss the computer control of the multifactoral climate glasshouse at the Naaldwijk Horticultural Experiment Station (with a Siemens 330 minicomputer). A twin system was installed at the Aalsmeer Floricultural Experiment Station in 1977. Weaving and Hoxey (1980) describe a Texas Instruments TMS 990/10

system developed at the National Institute of Agricultural Engineering (England). Tantau (1981b) deals with the developments at Hannover University (Germany). Van Meurs (1980) describes a decentralized computer system at the IMAG (Wageningen) using a central DEC PDP 11/34 mini. Saffell (1981) reports a system with a PDP 11/05 datalogger at Nottingham University (England). In Japan computer installations are found at Shimane University (YEW YODAC/200 system), at Tokyo University (Takakura, Taniwaki and Shimaji, 1980) and recently at Ehime University (Matsuyama) (Mitsubishi MELCOM minicomputer).

Because industrial type systems employ expensive hardware, also low-cost solutions are considered and developed. White and Olsen (1978) discuss a low-cost system with a programmable HP 9810 calculator. Killeen et al. (1980) describe a system employing a low-cost KIM 1 microcomputer. Willits, Karnoski and McClure (1981) discuss a system based on an Intel 8080 microprocessor.

The emphasis of the cited references is focused on hardware and the by far more interesting software that is employed is only vaguely described. Also no data of reliability is available. In contradiction to what the low number of references suggest, the commercial applications are widespread (Gieling, 1980).

2.4.4 *Control loop dynamics*

Because of the prevailing approach in greenhouse climate control, studies that are concerned with modeling and analysis of the dynamical behaviour of the GCFC control loops are relatively few. The most extensive studies were carried out by Tantau (1979), who uses classical control methods to model the GCFC dynamics in the frequency domain. The results are then used for analyzing the behaviour of PID (three term) controllers. The studies are carried out for various types of heating and ventilation systems. O'Flaherty, Gaffney and Walsh (1973) analyze the dynamical behaviour of a temperature control loop in the time domain and apply the resulting model in a (analogue-computer) simulation.

In the *modern* applications of computer control, that are discussed in the following section, the dynamics of the control loops are modelled and used in design and simulation. As for a digital implementation of continuous time methods, results have been reported by Udink ten Cate and Van de Vooren (1977, 1981) for the control of a heating system, by Udink ten Cate and

Van Zeeland (1981) for a *dog-lead* algorithm for an improved heating system control and by Udink ten Cate, Van Zeeland and Valentin (1979) for a split-range temperature control. These results will be reviewed in Chapter 4.

2.5 REVIEW OF GREENHOUSE MODELS

2.5.1 *Greenhouse models*

In contrast to the limited availability of models for GCFC, models of the (spatial) average greenhouse climate that are based on the physical phenomena of heat and mass transfer are widely used. Typically in these models the average climate is calculated with the outside weather and the environmental control actions as time-varying boundary conditions, which enter as *input variables* into the model. The thermal properties of the greenhouse structure, the soil and the crop can be established using known physical relations and enter into the model as *parameters*. The obvious advantage of this approach is that the effect of changes in the structural aspects of the greenhouse (e.g. thermal screens, other covering materials) on the average climate can be calculated straightforwardly.

In the sixties methods based on the steady-state *energy budget* have been suggested e.g. by Businger (1963). Here the energy balances are calculated from the input variables using *algebraic relations*. In the greenhouse no energy storage elements are modelled, because doing so would lead to simultaneous differential equations which at the time were not easy to solve for arbitrary time-varying input variables. Because the crop and the soil influence the average climate very much -mainly by latent heat transfer- the radiation balances are of importance in the modeling. This leads to quite complex models. The energy balance method was used e.g. by Kimball (1973) for shading and evaporative cooling in a greenhouse; by Garzoli and Blackwell (1973) for greenhouses under Australian summer conditions; by Maher and O'Flaherty (1973) for evaporative cooling with polythene as cladding material; and by Heijna (1970) to investigate the influence of delta-X control. Seginer and Levav (1971) present a modeling approach where energy balances are used in combination with laboratory size scale models which are used in controlled experiments for model validation.

The energy balance models are essentially steady state models and do not account for *energy storage* in the greenhouse. For the basic diurnal periodicity of the outside weather, the energy stored in the soil is of interest. For rapidly varying weather conditions during the day, also other energy storage elements, like the inside air, the structure, or the heating and irrigation system are of importance. As a result, the agreement of these models with measurements is satisfactory only in steady weather conditions.

These objections have motivated modeling which at least can account for diurnal periodicity. Takakura, Jordan and Boyd (1971) presented such a model where the input signals were decomposed using Fourier series expansion of low harmonics. Froehlich et al. (1979) present a model using steady-periodic input signals. Kindelan (1980) describes a model in which small energy storage elements are neglected as to describe the diurnal course. Bot, Van Dixhoorn and Udink ten Cate (1978b) describe a dynamical model employing all energy storage elements that are considered relevant. This model could be used for arbitrary input variables, but only diurnal basic periodic results are presented.

2.5.2 *Applicability of greenhouse models*

The models based on energy storage elements give qualitatively good results when idealized input signals are applied. For low-frequent inputs in a real-world greenhouse also satisfactory agreement is claimed. No results are reported with arbitrary rapidly time-varying weather conditions. A problem with these models is that the greenhouse is approximated as a *perfectly stirred tank*, resulting in a single homogeneous inside air temperature etc. This type of approximation is not very realistic, since in the greenhouse atmosphere large temperature gradients occur both vertically and horizontally. An accurate modeling of the greenhouse atmosphere with more than one perfectly stirred tank results in models with small time constants, which are computationally untractable.

In the modeling the phenomena are described using known physical relations. These relations usually determine the parameters of the model. Because the known relations are used together with assumptions on uniform distributions and because not all the relations are linear, some errors are introduced. Added to that, some of the thermal phenomena are rather unpredictable (e.g. reflectivity of dusty cladding material) or even unmeasurable (e.g.

condensation on the roof). This leads to inaccuracies in the parametrization of the model. For example, Garzoli and Blackwell (1981) find a poor agreement between calculated and measured values of heat-loss during the night.

Studies on the greenhouse average climate which involve measurements (Stanhill et al., 1973, Jimenez and Casas-Vazquez, 1978) indicate that the "average" values of the variables are not readily determined. This makes detailed validation of the models cumbersome. As a result, these models are used in essentially the same way as the energy balance models (containing no energy storage elements) for the same classes of idealized input signals. For example, Van Bavel, Damagnez and Sadler (1981) use this approach of modeling to assess the properties of a new "fluid roof" type of greenhouse.

Because the physical phenomena enter into the model as parameters, it seems straightforward that a form of *parameter estimation* can be used for the fitting of measured data with the model responses - both for steady-state and for dynamical models. Hitherto some attempts have been reported with the dynamical model of Bot et al. (1978b) by Oosterhuis (1979) and by Jacobs (1981), for a greenhouse without a crop (only sensible heat fluxes), and for a limited amount of parameters. The rather large amount of parameters in the greenhouse models makes this approach rather cumbersome.

The attractiveness for GCFC of greenhouse (spatial) average climate models is that they can be used for the design and evaluation of control systems. For this purpose -as a rule- only dynamical models can be applied. However, when dynamical average climate models are based on a stirred tank approximation, the distributed nature of the greenhouse climate is not modelled. This distributed nature leads to transport times in the greenhouse with respect to the relation between control actuators and controlled climate factors. When these characteristics are neglected, the controller will perform not so well in a real-world greenhouse (Udink ten Cate, 1980b). In fact these problems can be seen as the result of the *relevant time scale* in the spatial average climate models (hours to days) and GCFC modeling (minutes). An approach to circumvent this problem is to use in GCFC simple black-box models. These models are defined for a working point (a steady-state situation) which is the result of all the variables acting upon the spatial average climate. Recently, results have been reported by Otto et al. (1982), where parameters of a black-box model are validated.

2.5.3 *Modern control*

Because of the lack of dynamical models that can be used in controller synthesis and evaluation not many applications of *modern control* science (using state space variables) are reported in the literature. Potentially, using more detailed information of the climate process, with modern control concepts an improved control performance could be achieved. Hoenink (1978) gives a simulation example of a state-regulator based on the model of Bot et al. (1978b). An optimal controller for soil temperature is reported by Hara and Sugi (1981).

Because in the greenhouse climate process some parameters can vary in an unpredictable way, it is possible to estimate on-line certain process characteristics that are relevant for the control behaviour of the GCFC loops. This leads to *adaptive* control. A reliable GCFC model is essential here in order to establish the performance of the controller in simulation. Adaptive control is reported by Copet and Videau (1981) for heating and ventilation according to Richalet and Rault's method of model predictive heuristic control (Richalet et al., 1978).

As a general comment it can be said that most of the designs are rather "academic" and are not well tested in field trials. In Chapter 6 of this thesis an adaptive control algorithm of the heating system is described, which has been in operation in GCFC over several years.

A completely distinct approach is to use *fuzzy set* theory as introduced by Zadeh (1973), see also Gupta, Saridis and Gaines (1977). Here the operator's approach is formalized into procedures using the linguistic relations that growers use themselves. A study on the ventilation of a greenhouse has been reported by Van Steekelenburg (1982).

3 Models for temperature control

3.1 INTRODUCTION

In the field of GCFC most research has been attributed to the control of the greenhouse inside air temperature. This can be explained because traditionally the temperature is considered the most important climate factor. Though other factors are of importance too, in this thesis the general trend will be followed so that the main attention is focused on temperature control. For control the dynamical nature of the GCFC loops has to be modelled.

In this chapter some models will be discussed. The parameters of the models are estimated experimentally and the relations between the parameters and the thermal characteristics of the greenhouse are investigated using a simple mathematical model.

Fig. 3.1 Greenhouse climate control.

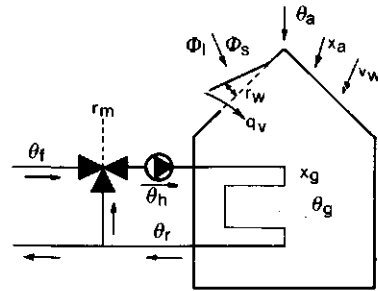

In fig. 3.1 a greenhouse is depicted with the actuators that are commonly in use in GCFC in the Netherlands. Inside the greenhouse the climate factors *air temperature* θ_g [$^{\circ}\text{C}$] and the *absolute[†] humidity* x_g [g kg^{-1}] are regulated by heating and ventilation and depend on the outside weather conditions as *ambient air temperature* θ_a [$^{\circ}\text{C}$], *ambient absolute humidity* x_a [g kg^{-1}], *wind velocity* v_w [m s^{-1}] and *direction*, *shortwave (solar) radiation* ϕ_s [W] and *longwave radiation* ϕ_l [W].

The greenhouse heating system consists of steel pipes in which water is circulated with *inlet temperature* θ_h [$^{\circ}\text{C}$]. The temperature of the *outlet*

[†] In this thesis the *absolute* humidity is employed instead of the commonly used *relative* humidity, because it is more meaningful in describing the climate process and the related transport phenomena.

(return) water is θ_r [$^{\circ}\text{C}$] and this water is mixed with feedwater from the main boiler with temperature θ_f [$^{\circ}\text{C}$]. This is performed by a mixing valve of which the position is denoted by $r_m \in [0, 100\%]$. Ventilation is achieved by opening ventilation windows which are situated in the roof. The aperture of the windows is $r_w \in [0, 100\%]$ and leads to an air exchange rate q_v [m^3s^{-1}]. More details on the lay-out of the system as well as design criteria can be found in the relevant literature (Heijnen et al., 1979, Taveirne, 1972, von Zabeltitz, 1978).

Fig. 3.2 A block diagram of the greenhouse climate.

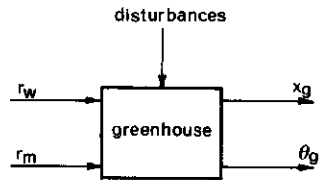

The system of fig. 3.1 can be represented as a black-box with inputs $r_w(t)$ and $r_m(t)$, and outputs $x_g(t)$ and $\theta_g(t)$ (fig. 3.2). The variables are a function of time. The outside weather conditions act as disturbances on this system and have a significant influence on the relationship between input and output of the system. Because $r_w(t)$ and $r_m(t)$ control the ventilation and heating processes respectively, these can be shown separately (fig. 3.3). As will be discussed later in this chapter, $q_v(t)$ is dependent on $r_w(t)$ as well as on $v_w(t)$, while $\theta_h(t)$ depends on $r_m(t)$ and $\theta_f(t)$.

Fig. 3.3 A block diagram with the actuator processes shown separately.

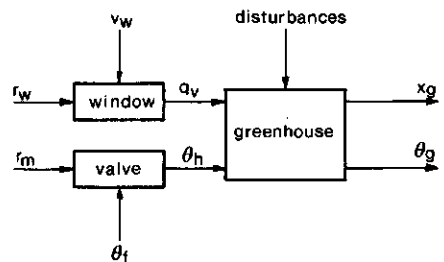

In the greenhouse system of fig. 3.3 the output variables [$\theta_g(t)$, $x_g(t)$] have the same order of magnitude, which also holds for the input variables [$r_w(t)$, $r_m(t)$] and the intervariable $\theta_h(t)$. As a result no scaling has to be carried out. The intervariable $q_v(t)$ is usually replaced by the ventilation rate (air change rate) $S_v(t)$; the (theoretical) arithmetic number of times

the greenhouse air is completely refreshed per hour

$$S_v(t) \cong \frac{q_v(t) 3600}{V_g} \quad [h^{-1}] \quad (3.1)$$

where V_g is the greenhouse air volume [m^3]. In an average greenhouse in winter conditions r_w and $r_m \in [0, 100\%]$, $S_v \in [0.5, 10 h^{-1}]$, $\theta_h \in [20, 100 ^\circ C]$, $x_g \in [10, 20 g kg^{-1}]$ and $\theta_g \in [10, 35 ^\circ C]$. In summer conditions S_v can be considerably more important $S_v \in [0.5, 100 h^{-1}]$. With the above described range of the variables the greenhouse system of fig. 3.3 is sufficiently scaled.

It is noted here that the measurement of the system variables introduces some ambiguity. In fig. 3.3 a uniform distribution of the values of the variables in the greenhouse is suggested. In reality this is not the case. In control the variables are measured at a single point which leads to a behaviour somewhat different from what one should expect using a simple physical model.

Such a simple model is reviewed in the following sections for temperature control. It is demonstrated that this model, which is based on simple thermal analysis, can be adequately used for the prediction of the control characteristics. Experiments are reported in which the parameters of the control models are determined. Methods of temperature GCFC are described in Chapter 4.

3.2 A SIMPLE THERMAL MODEL

3.2.1 Incremental variables

The block diagram of fig. 3.3 does not represent the dynamical behaviour of the GCFC loops in a convenient way. This is accomplished in fig. 3.4 where the GCFC process is defined in terms of increments. For example, the increment $\tilde{\theta}(t)$ of the temperature $\theta(t)$ is defined as

$$\tilde{\theta}(t) \cong \theta(t) - \bar{\theta} \quad (3.2)$$

The average $\bar{\theta}$ describes a *working point* (also called: equilibrium situation, stationary situation).

Fig. 3.4 The GCFC process.

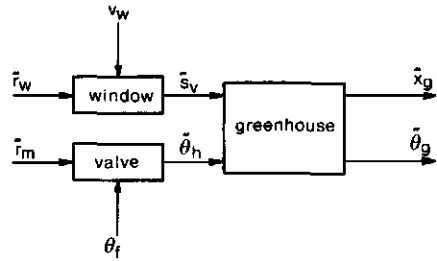

In this chapter our attention is restricted to the inside air temperature $\theta_g(t)$. The relation of each of the input variables or the disturbances with $\tilde{\theta}_g(t)$ can be investigated separately. In fig. 3.5 the heating process of the greenhouse is shown, where the transfer function $H_{g,h}$ relates $\tilde{\theta}_h(t)$ with $\tilde{\theta}_g(t)$.

Fig. 3.5 The heating process.

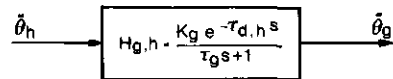

In a first approximation the process is described by a first order system with a dead time (transport time). Taking the Laplace transform

$$H_{g,h}(s) \cong \frac{\tilde{\theta}_g(s)}{\tilde{\theta}_h(s)} = \frac{K_g e^{-\tau_{d,h}s}}{\tau_g s + 1} \quad (3.3)$$

where s the Laplace operator, K_g is a *gain*, $\tau_{d,h}$ is a *dead time* and τ_g is the dominant *time constant* of the greenhouse. The values of τ_g and $\tau_{d,h}$ are usually expressed in *minutes*. The approximation of eqn. (3.3) is usual in thermal systems with distributed parameters.

The temperature $\theta_g(t)$ is measured at one point in the greenhouse. In the heating system $\theta_h(t)$ is assumed to be uniform. As a rule the inlet temperature of the water in the heating pipes is measured and taken as $\theta_h(t)$ which is acceptable when $\theta_h - \theta_r \ll \theta_h$ a condition that is usually satisfied since the temperature loss of the water in the heating pipe network of the greenhouse is not large.

The model of eqn. (3.3) is presented *without specific knowledge* of the process characteristics in physical (thermal) terms, and is essentially a *black-box model*. Related models are presented in eqns. (3.10) and (3.15) for the ventilation and the radiation processes. Because much data of the thermal properties of greenhouses are available -which are applied in design and construction- it seems worthwhile to investigate the process of eqn. (3.3) in more detail. To do so, an *idealized* approximation is employed, where in the greenhouse the variables are assumed to be uniform in a *perfectly stirred tank* approximation (fig. 3.6) leading to a *simple thermal model*. The relation of the parameters of the black-box models with the simple thermal model is presented in sections 3.2.2, 3.2.3 and 3.2.4. Experimental results on the black-box models as well as on the simple thermal models will be given in section 3.4.

Fig. 3.6 The greenhouse as a perfectly stirred tank.

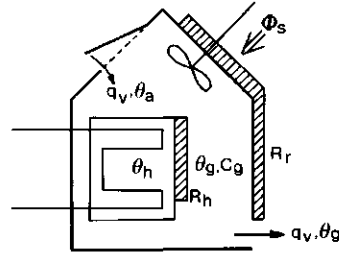

The dead time $\tau_{d,h}$ will not be present in the perfectly stirred tank model because it represents the *non-uniform* characteristics of the greenhouse in relation to *single point measurements*. However, when single point measurements are applied in the experimental validation of the perfectly stirred tank model, dead times must be introduced again.

Consider the greenhouse of fig. 3.6 where uniform variables are assumed. Summing the (sensible) heat fluxes leads to the equation

$$C_g \frac{d\theta_g}{dt} = q_v(t) c_{p,air} \rho_{air} (\theta_a(t) - \theta_g(t)) + \frac{1}{R_h} (\theta_h(t) - \theta_g(t)) + \frac{1}{R_r} (\theta_a(t) - \theta_g(t)) + \eta \phi_s(t) \quad (3.4)$$

where C_g is the greenhouse heat capacity [$J K^{-1}$], $c_{p,air}$ is the specific heat of dry air at constant pressure [$J kg^{-1} K^{-1}$], ρ_{air} [$kg m^{-3}$] is the density;

R_h, R_r [$K W^{-1}$] are the thermal resistances of the heating system and of the roof and sidewalls; ϕ_s is the incoming short-wave radiation and η is a fraction $\eta \in [0,1]$. Note that only sensible heat fluxes are represented in eqn. (3.4) and that the longwave radiation and the latent heat are not taken into account. This is motivated because in the two thermal resistances already latent heat and longwave radiation are incorporated in the way they are obtained. The fraction η indicates the fraction of shortwave radiation that is effective for the sensible heat flux; the other part of ϕ_s is reflected or transferred into latent heat by evapotranspiration.

3.2.2 Heating

To investigate the transfer function associated with the heating process of fig. 3.5 from eqn. (3.4) a relation in *increments* has to be derived. Linearizing around a working point (an equilibrium) and assuming that q_v, θ_a and ϕ_s are constant from eqns. (3.2) and (3.4) the relation follows

$$C_g \frac{d\tilde{\theta}_g}{dt} = - (\bar{q}_v c_{p,air} \rho_{air} + \frac{1}{R_h} + \frac{1}{R_r}) \tilde{\theta}_g(t) + \frac{1}{R_h} \tilde{\theta}_h(t) \quad (3.5)$$

To normalize this equation, (3.5) is expressed in terms of *units of ground area* of the greenhouse. The greenhouse ground area is A_g [m^2], so that the normalized parameters are $C_g^* \triangleq C_g/A_g$ [$J K^{-1} m^{-2}$], $\bar{q}_v^* \triangleq \bar{q}_v/A_g$ [$m s^{-1}$], $k_h^* \triangleq 1/(R_h A_g)$ [$W m^{-2} K^{-1}$] and $k_r^* \triangleq 1/(R_r A_g)$ [$W m^{-2} K^{-1}$]. This yields

$$C_g^* \frac{d\tilde{\theta}_g}{dt} = - (\bar{q}_v^* c_{p,air} \rho_{air} + k_h^* + k_r^*) \tilde{\theta}_g(t) + k_h^* \tilde{\theta}_h(t) \quad (3.6)$$

The greenhouse air volume $V_g = A_g \bar{h}_g$ where \bar{h}_g is the average height, $\bar{q}_v^* \triangleq \bar{q}_v/A_g = \bar{q}_v \bar{h}_g / V_g$. In analogy with the other k-factors a factor k_v^* is introduced:

$$k_v^* \triangleq c_{p,air} \rho_{air} \bar{q}_v \bar{h}_g / V_g \quad (3.7)$$

This k_v^* will be expressed in term of the ventilation rate S_v . With $c_{p,air} = 10^3$ [$J kg^{-1} K^{-1}$], $\rho_{air} = 1.2$ [$kg m^{-3}$] and with eqn. (3.1):

$$k_v^* = \zeta \bar{h}_g \bar{S}_v \quad [W m^{-2} K^{-1}] \quad (3.8)$$

where $\zeta = c_{p,air} \rho_{air} / 3600 \approx 1/3 [W h m^{-3} K^{-1}]$.

Substituting in eqn. (3.6) and taking the Laplace transform yields a first order transfer function

$$H'_{g,h} = \frac{K'_g}{s \tau'_g + 1} \quad (3.9a)$$

$$\tau'_g = C_g^* / (k_v^* + k_h^* + k_r^*) \quad [s] \quad (3.9b)$$

$$K'_g = k_h^* / (k_v^* + k_h^* + k_r^*) \quad [-] \quad (3.9c)$$

Comparing this result with eqn. (3.3) the transfer function is similar with the exception of the dead time, which has vanished because of the approximation employed in eqn. (3.4).

3.2.3 Ventilation

The relation between ventilation rate and greenhouse temperature can be described as a black-box model (fig. 3.7).

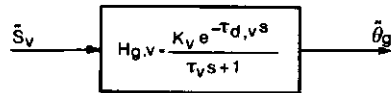

Fig. 3.7 The ventilation process.

In accordance with eqn. (3.3) the transfer function $H_{g,v}$ is approximated by

$$H_{g,v}(s) \cong \frac{\tilde{\theta}_g(s)}{\tilde{S}_v(s)} = \frac{K_v e^{-\tau_{d,v}s}}{\tau_v s + 1} \quad (3.10)$$

with $\tau_{d,v}$ and τ_v expressed in minutes.

In order to express the parameters of eqn. (3.10) in terms of the simple thermal model of eqn. (3.4) a linearization around the working point is carried out with in this case θ_a , θ_h and ϕ_s constant. When the product $\tilde{q}_v(t)\tilde{\theta}_g(t)$ is neglected because it is comparatively small a model results:

$$C_g \frac{d\tilde{\theta}_g}{dt} = - (\bar{q}_v c_{p,air} \rho_{air} + \frac{1}{R_h} + \frac{1}{R_r}) \tilde{\theta}_g(t) + c_{p,air} \rho_{air} (\bar{\theta}_a - \bar{\theta}_g) \tilde{q}_v(t) \quad (3.11)$$

Normalizing this equation by dividing by A_g and using eqn. (3.8) gives

$$C_g^* \frac{d\tilde{\theta}_g}{dt} = - (k_v^* + k_h^* + k_r^*) \tilde{\theta}_g(t) + \zeta \bar{h}_g (\bar{\theta}_a - \bar{\theta}_g) \tilde{S}_v(t) \quad (3.12)$$

where the factor k_v^* is given by eqn. (3.8):

$$k_v^* = \zeta \bar{h}_g \bar{S}_v \quad [W m^{-2} K^{-1}] \quad (3.13)$$

with $\zeta = 1/3 [W h m^{-3} K^{-1}]$.

Taking the Laplace transform gives a first order transfer function

$$H'_{g,v} = \frac{K'_v}{\tau'_v s + 1} \quad (3.14a)$$

$$\tau'_v = C_g^* / (k_v^* + k_h^* + k_r^*) \quad [s] \quad (3.14b)$$

$$K'_v = \zeta \bar{h}_g (\bar{\theta}_a - \bar{\theta}_g) / (k_v^* + k_h^* + k_r^*) \quad [K h] \quad (3.14c)$$

K'_v is a *negative* gain. Comparing the τ'_v of eqn. (3.14b) with τ'_g of eqn. (3.9b) it appears that the time constants for heating and ventilation are described by the same relation.

3.2.4 Radiation

In fig. 3.8 the relation between radiation flux density $\tilde{\phi}_g [W m^{-2}]$ and the greenhouse temperature $\tilde{\theta}_g$ is depicted.

Fig. 3.8 The radiation process.

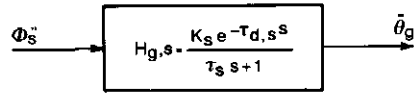

The transfer function can be approximated by

$$H_{g,s}(s) \cong \frac{\tilde{\theta}_g(s)}{\tilde{\phi}_s''(s)} = \frac{K_s e^{-\tau_{d,s}s}}{\tau_s s + 1} \quad (3.15)$$

with $\tau_{d,s}$ and τ_s in minutes. Linearizing around the working point and normalizing of eqn. (3.4) yields:

$$C_g^* \frac{d \tilde{\theta}_g}{dt} = - (k_v^* + k_h^* + k_r^*) \tilde{\theta}_g(t) + \eta \tilde{\phi}_s''(t) \quad (3.16)$$

Taking the Laplace transform gives

$$H'_{g,s} = \frac{K'_s}{\tau'_s s + 1} \quad (3.17a)$$

$$\tau'_s = C_g^* / (k_v^* + k_h^* + k_r^*) \quad [s] \quad (3.17b)$$

$$K'_s = \eta / (k_v^* + k_h^* + k_r^*) \quad [K m^2 W^{-1}] \quad (3.17c)$$

Here again the time constant is described by the same relation as the time constants of the heating and ventilation transfer functions.

In this section, the heating, ventilation and radiation transfer functions $H_{g,h}$, $H_{g,v}$ and $H_{g,s}$ respectively are presented in eqns. (3.3), (3.10) and (3.15) in a black-box manner. The relation of the parameters of these black-box models with a simple thermal model is given in eqns. (3.9), (3.14) and (3.17). A relation between $\tilde{\theta}_a$ and $\tilde{\theta}_g$ is not presented as such because the variations in θ_a -which are caused by outside weather conditions- are so slow that they can be regarded as a slowly time-varying working point.

The transfer functions presented in this section are of the single-input single-output type. When more than one input is active, the combined result on $\tilde{\theta}_g$ is assumed to be additive, leading to the model of fig. 3.9.

Fig. 3.9 The GCFC temperature process.

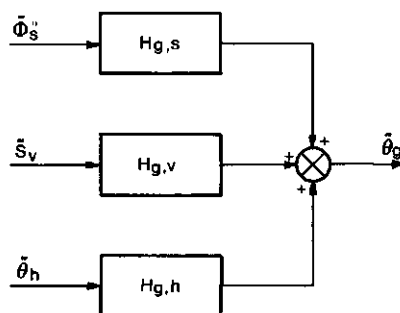

3.3 ACTUATOR PROCESSES

3.3.1 *Mixing valve*

The transfer function $f_{m,h}$ that is associated with the mixing valve behaviour (fig. 3.10) is non-linear.

Fig. 3.10 The mixing valve process.

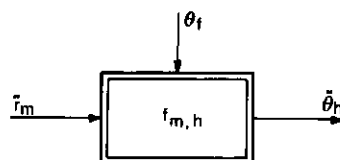

The relation between the input and the output can be described as

$$\theta_h(t) = \left[1 - \frac{r_m(t)}{100}\right] \theta_r(t) + \frac{r_m(t)}{100} \theta_f(t); \quad r_m \in [0, 100\%] \quad (3.18)$$

Here $\theta_r(t)$ is the temperature of the return water and $\theta_f(t)$ is the temperature of the feedwater from the main boiler. In most lay-outs $(\theta_h - \theta_g) \gg (\theta_h - \theta_r)$.

The value of θ_r depends on the surface conditions of the heating pipe network and on the circulation rate of the heating water. An approximation of

θ_r is made with

$$\theta_r(s) = \frac{e^{-\tau_{d,m}s}}{s\tau_m + 1} [\theta_h(s) - K_m \{\theta_h(s) - \theta_g(s)\}] \quad (3.19)$$

with τ_m in the order of one or two minutes, $\tau_{d,m}$ depends on the flow rate of the heating water and $K_m \in [0.02, 0.1]$ depends on the temperature decrease of the water in the heating pipe network. Because of the ranges of the variables it is not useful to describe the relations in terms of increments.

In control, the responses of eqns. (3.18) and (3.19) are fast compared to the responses of $H_{g,h}$, $H_{g,v}$ and $H_{g,s}$ as long as the changes in $r_m(t)$ are not (on purpose) constrained. In general this holds for increasing θ_h . When θ_h has to decrease, a complication arises because the heat-loss from the heating pipe network into the greenhouse is relatively small and $\theta_r \approx \theta_h$. Consequently r_m is put to its minimum value when a decrease of more than some tenths of a degree is desired.

The mixing valve is usually controlled by a separate feedback loop of which the behaviour is *saturated* for large upward steps of the desired value of θ_h and also saturated for small and large downward steps of θ_h . The behaviour is only linear in regulator situations (θ_h has to be kept on a constant value). More on the characteristics of mixing valves can be found in e.g. von Zabeltitz (1978).

3.3.2 Ventilation windows

In the usual type of greenhouse in the Netherlands -the Venlo type glasshouse- the ventilation windows are situated in the roof. When the windows are opened natural ventilation occurs. To induce the low rates of air exchange which are kept under winter conditions, the ventilation windows on the *lee-side* of the prevailing wind direction are opened.

Fig. 3.11 The ventilation windows process.

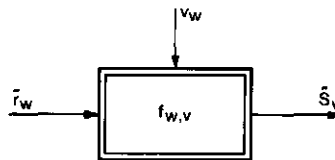

The relation $f_{w,v}$ between aperture of the ventilation windows $r_w(t)$ and the ventilation rate $S_v(t)$ (fig. 3.11) is not well established and $S_v(t)$ is also not measurable in a commercial greenhouse in contrast to θ_h . For a greenhouse with ventilation windows in the roof, relations are presented by Businger (1963) and by Whittle and Lawrence (1960). For the climate glasshouse at the Naaldwijk Experimental Station -where the experiments reported in this chapter were performed- Bot (1982) has established a relation for *lee-side* ventilation:

$$\bar{S}_v = (a_0 + \bar{r}_w) a_1 \bar{v}_w \quad (3.20)$$

where a_0 and a_1 are constants, $r_w \in [0, 30 \text{ \%}]$ and $v_w \in [1, 10 \text{ m s}^{-1}]$. The relation was found with experiments using CO_2 as tracer gas in empty glasshouses and was calculated from steady-state situations. Nederhoff (1982) found the same relation for the same glasshouses, now with a cucumber crop and measuring the decay-rate of a high CO_2 concentration. The uptake of CO_2 by the crop was accounted for in the data-processing.

Businger (1963) suggests also a term containing $\bar{\theta}_g - \bar{\theta}_a$ in relation (3.20), but in the studies of Bot and Nederhoff this was not found to be significant. These latter results agree with those of Whittle and Lawrence, who investigated the leakage of greenhouses. The relation of eqn. (3.20) is based on fixed values of r_w and the validity of the eqn. for changes (increments) $\tilde{r}_w(t)$ has not been verified -as far as the author knows. Because the relations of eqns. (3.10) and (3.14) are expressed in terms of increments, eqn. (3.20) is linearized around a working point, leading to

$$\tilde{S}_v(t) = a_1 \bar{v}_w \tilde{r}_w(t) + a_1 \bar{r}_w \tilde{v}_w(t) \quad (3.21)$$

where fluctuations in wind velocity as well as changes of $r_w(t)$ are taken into account. The product $a_1 \tilde{r}_w(t) \tilde{v}_w(t)$ is assumed sufficiently small to be neglected. In accordance with eqn. (3.20) this relation can only be expected to be valid by *lee-side roof ventilation* and for small apertures $r_w \in [0, 30 \text{ \%}]$ and $v_w \in [1, 10 \text{ m s}^{-1}]$.

3.4 EXPERIMENTS

3.4.1 Experimental set up

The experiments described in this section have been performed in the *Naaldwijk multifactoral glasshouse* (Van de Vooren and Koppe, 1975) situated at the Horticultural Experiment Station, Naaldwijk, The Netherlands. In the glasshouse a (Siemens 300) minicomputer regulates 24 identical compartments independently. The size of the compartments is 56 m². Details of the computer programs are found in Van de Vooren (1975). The glasshouse is of the Venlo type. The general lay-out is depicted in fig. 3.12. Fig. 3.13 shows one compartment. Table 3.1 summarizes some characteristics.

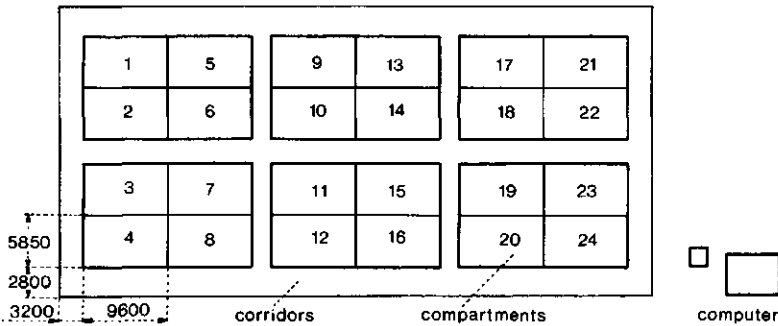

Fig. 3.12 The Naaldwijk multifactoral glasshouse (after Van de Vooren and Koppe, 1975).

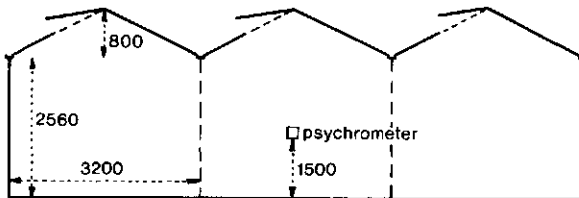

Fig. 3.13 Dimensions of one compartment.

ground surface	A_g	=	55.7	m^2
air volume	V_g	=	163.0	m^3
average height	$\bar{h}_g = V_g/A_g$	=	2.93	m
sidewalls surface	A_s	=	85.2	m^2
roof surface	A_r	=	63.0	m^2
heating pipes length (active)	l_h	=	110.0	m (diam. 51 mm)
heating pipes surface	A_h	=	17.6	m^2
heating pipes volume	V_h	=	0.216	m^3

Table 3.1 Glasshouse characteristics.

The measurements were carried out by the computer system. Temperatures are measured with copper-constantan thermocouples with electronic zero-junction compensation. The resolution of the computer system is 0.125°C and the absolute accuracy can be assumed not better than 0.5°C (Van der Wel and Van de Vooren, 1981). Temperature and relative humidity are measured by aspirated psychrometers (one in every compartment). Outside shortwave radiation is measured using a Kipp solarimeter. Details on the instrumentation can be found in Van de Vooren and Koppe (1975).

The crop that was grown during the experiments was *Chrysanthemum*. The plants were grown in beds parallel with the gutters, with 3 beds in every compartment. The average height of the crop at the time the measurements were made was 1 m. Most of the experiments described here have been made in compartments no. 1 - 8 of the glasshouse.

3.4.2 *Signal conditioning*

In order to estimate the parameters of the transfer functions, *test signals* were imposed on the process input. Because the transfer functions are formulated in terms of increments, a *working point* has to be defined.

The disturbances acting upon the glasshouse are time-varying to such extent that an equilibrium situation over a longer period of time (2 - 12 hours) is not maintained. This means that a working point is gradually changing. As a result, step responses -which are frequently used for determining the parameters of a first order transfer function- do not give reliable results.

The unreliability of step responses is illustrated with results obtained in the Naaldwijk glasshouse. Here step responses were measured in order to estimate the parameters of $H_{g,h}$. A step wise change of θ_h is applied and the result on θ_g is measured, assuming that no other disturbances are present. For this reason the step responses were measured at night ($\phi_s'' \equiv 0$). It was found that with closed windows ($r_w \equiv 0$) $K_g \in [0.18, 0.25]$, $\tau_g \in [22, 36 \text{ min.}]$ and $\tau_{d,h} \in [6, 10 \text{ min.}]$ under various weather conditions, which led to the conclusion that the characteristics of $H_{g,h}$ *strongly* depend on outside weather condition. However, the variations in the results can also be explained from disturbances acting upon the measurements. Once this was realized, it was decided to carry out a new series of experiments, which have been performed in the spring of 1982. Here the time-varying nature of the working point is taken into account.

The working point is subject to slow variations, which can be described as *trend* and *low frequency* disturbances. In a linear system the input and output signals are in the same frequency range. The output frequency components that depend on the input can be discriminated from the disturbances by *filtering*, provided the input frequencies are in a *suitable (high) frequency* range. For this reason for the estimation of e.g. $H_{g,h}$ the input signal $\tilde{\theta}_h(t)$ was selected to be a block signal with a period of 2 hours, so that the basic harmonic is much higher than the disturbances and also in the range of the process cut-off frequency. The dead time was found from step responses.

For a set of measurement data this estimation procedure is illustrated. The analysis and the filtering have been carried out using an interactive software package (Van Zee and Van den Akker, 1983). The data set contains 720 points of θ_h and θ_g of compartment no. 1 (from 1982-03-01:19.00 to 03-02:7.00 hrs.; sample time $T_s = 1$ minute). The data are first corrected for linear trend and then transformed using a FFT (Fast Fourier Transform) routine with a rectangular window and zero's added to the data set in order to obtain $2^{10} = 1024$ points. The frequencies are defined on 1024 data points. It is seen that $\theta_g(\omega)$ contains low frequencies that are not a result from $\theta_h(\omega)$ (fig. 3.14). Using filtering techniques, in the frequency domain these components can be removed. After an inverse transformation a filtered signal in the time domain is obtained. The procedure is shown in fig. 3.15 on time series, where fig. 3.15a shows the "raw" data and fig. 3.15b the processed

data using linear trend correction, FFT, removing the first harmonics by a bandstop filter (minimum cut-off frequency 0, maximum 3; harmonics defined on 1024 data points), and inverse transformation. Of the filtered time series a part is selected for estimation.

Fig. 3.14 Frequency contents of data set.

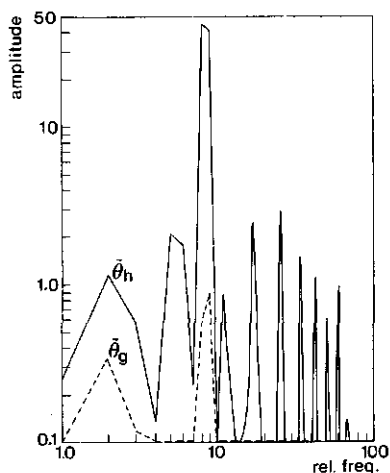

3.4.3 Actuator processes

Before investigating the dynamics of the GCFC process (mixing valve process and ventilation window process), the actuator processes are treated.

The *mixing valve process* $f_{m,h}$ (fig. 3.10) is not of interest in the parameter estimation, because its output is measurable. The mixing valve behaviour is used in simulation and for the analysis of control algorithms. The parameters of eqn. (3.19) have been determined from step responses in the Naaldwijk glasshouse. A reasonable accuracy was obtained with $\tau_{d,m} = 6$ min., $\tau_m = 2$ min. and $K_m = 0.05$.

For the *ventilation windows process* $f_{w,v}$ (fig. 3.11) in the Naaldwijk glasshouse, results have been obtained by Bot (1982) and by Nederhoff (1982) starting from the relation of eqn. (3.20). In eqn. (3.20) $a_0 = 1$ represents the leakage. According to Bot $a_1 = 0.072$ and to Nederhoff $a_1 = 0.064$. Because the measurements of Bot are based on equilibrium (steady-state) situations and since those of Nederhoff on the decay-rate under slowly-varying wind velocities, the value $a_1 = 0.064$ is preferred. This value was established for $\bar{r}_w \in [2, 18 \%$], $\bar{v}_w \approx 4 \text{ m s}^{-1}$ or $\bar{r}_w \in [0, 5 \%$], $\bar{v}_w \approx 7.5 \text{ m s}^{-1}$ (Nederhoff, 1982).

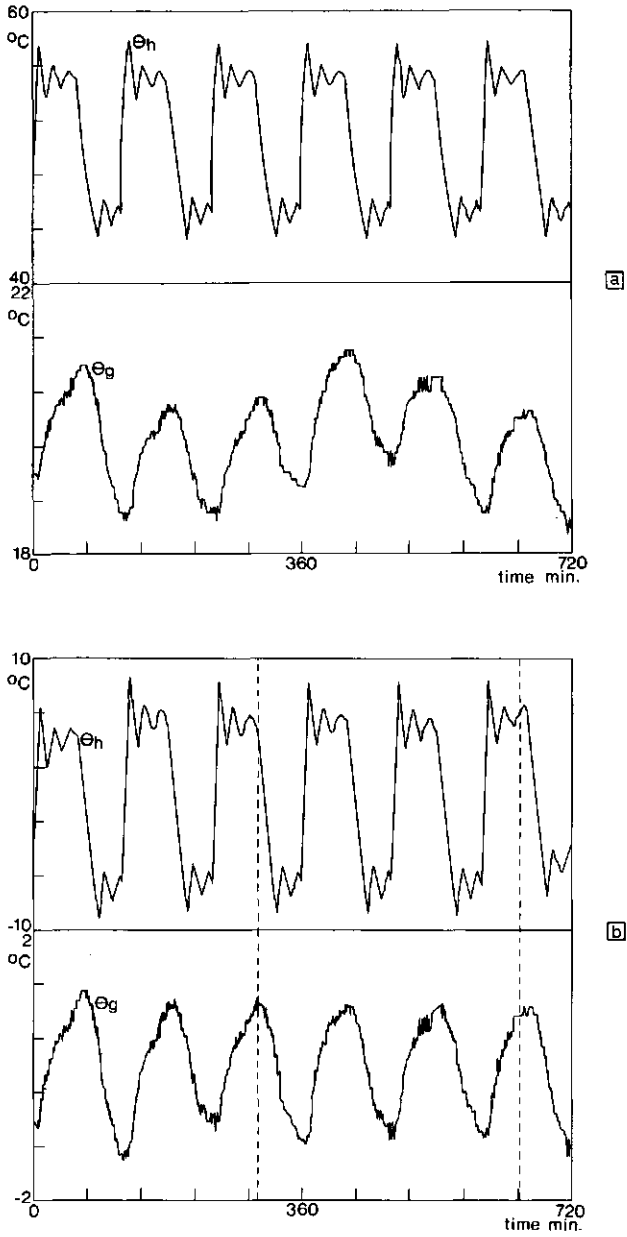

Fig. 3.15 Filtering of set of measurement data; "raw" data (a) and filtered data (b).

3.4.4 Heating process

To estimate the parameters of $H_{g,h}$ test signals were applied by varying $\theta_h(t)$ and by keeping the ventilation windows closed ($r_w \equiv 0$). The signals were applied to the compartments no. 1 - 8. A block signal was obtained for $\tilde{\theta}_h(t)$ by imposing a desired value u_h to the control loop that regulates $\theta_h(t)$. The test signal was $u_h(k) = \bar{u}_h \pm 5 \text{ }^\circ\text{C}$; where $u_h(k)$ is a piece-wise constant signal, $t = k T_s$ and T_s is the sampling interval (1 minute). The output signal as well as the realized input signal were filtered in order to remove trend and low frequency disturbances. For compartment no. 1 the filtered signals $\tilde{\theta}_{h,f}$ and $\tilde{\theta}_{g,f}$ are shown in fig. 3.15b. A part of the time series was selected and by optimization techniques a best fit is obtained for the parameters of a calculated response and the actual response. The response was calculated numerically with a system input $x(k) = \tilde{\theta}_{h,f}(k)$; $t = k T_s$, and the calculated system output is $y(k)$. Adams-Bashfort 2nd order integration is used with a step size equal to T_s (1 minute). The response $y(k)$ is fitted to $\tilde{\theta}_{g,f}(k)$ by minimizing a quadratic error criterion

$$E = \sum_{k=1}^N e^2(k) \quad (3.22)$$

with $e(k) \hat{=} y(k) - \tilde{\theta}_{g,f}(k)$. The optimization was carried out by Powell's conjugate gradient method using a software package described by Birta (1977).

The dead time in $H_{g,h}$ was selected as a multiple of the sampling time T_s , its value following from step responses as well as from the best fit. The test signals are concurrently employed in 7 compartments, which means that the external disturbances have the same influence. Because of the mixing valve process characteristics, the (desired) $u_h \approx \theta_h$ for $\bar{u}_h = 50, 60 \text{ }^\circ\text{C}$. For lower values of \bar{u}_h , $u_h(k)$ was not so closely followed as is depicted in fig. 3.16.

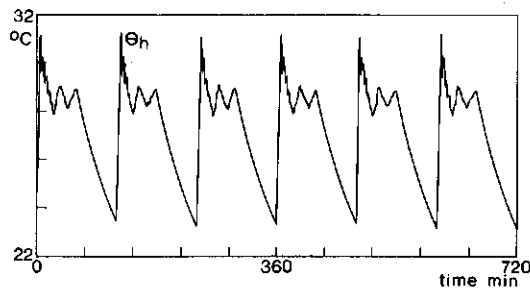

Fig. 3.16 Test signal θ_h for low value of \bar{u}_h ($= 25 \text{ }^\circ\text{C}$).

Because the compartments are similar with respect to the lay-out, the external disturbances are comparable so that significant differences in the parameter estimation are due to thermal characteristics and not to these external disturbances. Table 3.2 summarizes some results for the compartments no. 1 - 7. The error criterion E is defined in eqn. (3.22).

comp.	\bar{u}_h	$\bar{\theta}_h$	$\tau_{d,h} = 6 \text{ min.}$			$\tau_{d,h} = 7 \text{ min.}$			$\tau_{d,h} = 8 \text{ min.}$		
			K_g	τ_g	E	K_g	τ_g	E	K_g	τ_g	E
1	50	50.7	0.187	20.7	3.54	0.176	18.6	3.62	0.167	16.7	3.90
2	60	60.2	0.228	20.3	4.04	0.216	18.3	3.98	-	-	-
3	30	32.2	0.149	21.3	3.23	0.145	19.7	3.16	0.138	17.9	3.29
4	25	27.8	0.147	21.6	3.34	0.144	20.8	3.21	0.141	19.9	3.29
5	30	32.3	0.160	23.1	3.98	0.157	21.0	3.85	0.154	20.2	3.89
6	60	60.2	0.227	22.1	4.38	0.215	19.9	4.34	0.210	18.9	4.62
7	50	50.7	-	-	-	0.190	20.9	3.51	0.187	20.1	3.34

$\theta_h = \bar{u}_h \pm 5 \text{ }^\circ\text{C}$	$\bar{\theta}_a = 5.5 \text{ }^\circ\text{C}$	filtered results 820302: 0.00 - 5.50 hrs.
$r_w = 0$	$\bar{v}_w = 5.7 \text{ m s}^{-1}$	$T_s = 1 \text{ min.}$

Table 3.2 Results from measurements (March 1 19.00 hrs. - March 2 7.00 hrs., 1982).

A best fit for compartment no. 1 is shown in fig. 3.17.

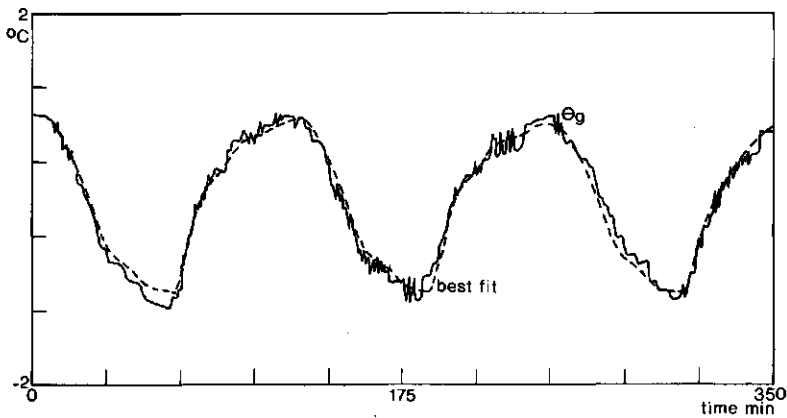

Fig. 3.17 Best fit of the model in compartment no. 1.

From the results of table 3.2 it can be concluded that a value of $\tau_{d,h} = 7$ min. gives a relatively good fit. This corresponds with step response measurements performed in other experiments where $\tau_{d,h} \in [6, 10]$. The average of $\bar{\tau}_g = 19.9$ min. (or better 20 min.).

The values of K_g seem to depend on $\bar{\theta}_h$. A linear regression is made

$$K_{g, \text{regr}} = 8.12 \cdot 10^{-2} + 0.214 \cdot 10^{-2} \bar{\theta}_h \quad (3.23)$$

with regression coefficient $r = 0.97$. Because of the filtering, only regression with the average values $\bar{\theta}_h$ is meaningful.

3.4.5 Non-linearity of the heating system

In eqn. (3.23) only a regression is carried out, indicating a non-linear behaviour of the heating system. In order to obtain understanding of this result, it is interpreted in terms of the idealized model of eqn. (3.6). It is assumed that of eqns. (3.9) the values τ'_g and K'_g are equal to τ_g and K_g of $H_{g,h}$ of eqn. (3.3), which means that in eqn. (3.6) $\tilde{\theta}_h(t)$ is replaced by $\tilde{\theta}_h(t - \tau_{d,h})$. From eqn. (3.23) it is anticipated that the heating system k-factor k_h^* is non-linear. The following ratio's are introduced

$$a_g = k_h^* / (k_r^* + k_v^*) \quad (3.24a)$$

$$c_g = C_g^* / (k_r^* + k_v^*) \quad (3.24b)$$

Eqn. (3.6) can be written as:

$$C_g^* \frac{d\tilde{\theta}_g}{dt} = - \{k_r^* + k_v^*\} \tilde{\theta}_g(t) + k_h^* \{ \tilde{\theta}_h(t - \tau_{d,s}) - \tilde{\theta}_g(t) \} \quad (3.25a)$$

With eqns. (3.24) this leads to

$$\frac{d\tilde{\theta}_g}{dt} = \frac{1}{c_g} [- \tilde{\theta}_g(t) + a_g \{ \tilde{\theta}_h(t - \tau_{d,s}) - \tilde{\theta}_g(t) \}] \quad (3.25b)$$

From eqn. (3.9) it follows that $a_g = K_g / (1 - K_g)$ and $c_g = \tau_g / (1 - K_g)$ since it is assumed that $K_g = K'_g$ and $\tau_g = \tau'_g$. It was checked that a_g and c_g calculated

this way from table 3.2 yield the same results as optimization using eqn. (3.25b). The calculated results are presented in table 3.3.

Compartment	$\bar{\theta}_{hg}$	a_g	c_g
1	31.0	0.214	22.6
2	37.1	0.275	23.3
3	17.6	0.169	23.0
4	14.8	0.168	24.3
5	16.7	0.186	25.0
6	37.3	0.273	25.4
7	31.7	0.234	25.7

Table 3.3 Calculated values of a_g and c_g from table 3.2 for $\tau_{d,h} = 7$ min.

Calculating the regression from $\bar{\theta}_{hg} \cong \bar{\theta}_h - \bar{\theta}_g$ gives

$$a_{g, \text{regr}} = 9.95 \cdot 10^{-2} + 0.441 \cdot 10^{-2} \bar{\theta}_{hg} \quad (3.26)$$

with regression coefficient $r = 0.96$. The results of table 3.3 indicate that a_g depends upon $\bar{\theta}_{hg}$ and that c_g is the same for all compartments. Averaging c_g for all compartments yields $\bar{c}_g = 24.17$ min. ($r = 0.97$, $\sigma = 1.14$). A model can be fitted where $c_g = \bar{c}_g$ for all compartments and a_g is fitted. The results are presented in table 3.4.

Compartment	a_g	E
1	0.223	3.77
2	0.282	4.05
3	0.175	3.19
4	0.167	3.22
5	0.182	3.94
6	0.265	4.43
7	0.223	<u>3.99</u>
		$\Sigma E = 26.59$

Table 3.4 Estimated values of a_g with $c_g = \bar{c}_g$.

Calculating the regression from a_g of table 3.4 with $\bar{\theta}_{hg}$ from table 3.3 it results

$$a_{g, \text{regr}} = 10.1 \cdot 10^{-2} + 0.437 \cdot 10^{-2} \bar{\theta}_{hg} \quad (3.27)$$

with regression coefficient $r = 0.96$. This form is quite similar to eqn. (3.26) and indicates that the results of the optimization procedure are reliable in that no sub-optima are found.

In the results presented in table 3.4 all the optimizations are carried out separately for fixed $c_g = \bar{c}_g$ and the data are fitted by eqn. (3.27). It is also possible to perform concurrent optimization of all 7 compartments. The process is now described by

$$\dot{\hat{\theta}}_g = \frac{1}{c_g} \tilde{\theta}_g + (a_0 \underline{1} + b_0 \bar{\theta}_{hg}) (\tilde{\theta}_h - \tilde{\theta}_g) \quad (3.28)$$

with $\hat{\theta}_g^T = [\frac{d\theta}{dt}]_g$, $\tilde{\theta}_g^T = [\tilde{\theta}_{g,i}]$, $\bar{\theta}_{hg}^T = [\bar{\theta}_{hg,i}]$ and $\tilde{\theta}_h^T = [\tilde{\theta}_{h,i}]$; i denoting the i^{th} compartment and element of the vector, and the superscript T means transpose. The vector $\underline{1}$ is the unity vector: all vectors $\in R^7$. The parameters \bar{c}_g , a_0 and b_0 in eqn. (3.28) are estimated yielding

$$a_{g, \text{optim}} = 9.97 \cdot 10^{-2} + 0.437 \cdot 10^{-2} \bar{\theta}_{hg} \quad (3.29)$$

and $\bar{c}_g = 24.18$ with $E_t = \Sigma E_i = 28.46$.

The results of eqns. (3.27) and (3.29) suggest that the ensemble average of the time series equals the time average so that the estimated values of the parameters explain the process output over the whole data set used for the estimation and that eqns. (3.29) and (3.27) describe a physical phenomenon.

The relations in eqns. (3.27) and (3.29) can be investigated somewhat further. Because the ventilation windows are closed and the windspeed does not vary very much, k_r^* and k_v^* can be assumed constant, so that k_h^* will cause the non-linearities. Theoretically, the convective heat transfer from a pipe in still air can be described by $Q_h = \alpha_c \theta_{hg}^{1.25}$ where $\theta_{hg} \hat{=} \theta_h - \theta_g$.

Linearizing this relation yields

$$\tilde{Q}(t) = \frac{\partial Q}{\partial \bar{\theta}_{hg}} \bigg|_{\bar{\theta}_{hg}} \tilde{\theta}_{hg} = \alpha_g \tilde{\theta}_{hg} \quad , \quad \alpha_g = 1.25 \alpha_c \bar{\theta}_{hg}^{0.25} \quad (3.30)$$

From eqn. (3.4), its linearized version eqn. (3.5), and its linearized and normalized version eqn. (3.6) we know that k_h^* is *proportional* to α_g . Since k_r^* and k_v^* are constant; from eqn. (3.24a) it follows that also a_g is proportional to α_g . Consequently we may assume that

$$a_g = a_1 \bar{\theta}_{hg}^{b_1} \quad (3.31)$$

where $b_1 = 0.25$. By regression with a_g from table 3.4 with $\bar{\theta}_{hg}$ from table 3.3 it is found that $a_1 = 4.41 \cdot 10^{-2}$ and $b_1 = 0.49$. It is remarked here that for b_1 a higher value is found than 0.25, which suggests that the heat transfer from the heating system is not adequately modeled from well-known natural convection heat transfer relations.

3.4.6 Relation with thermal parameters

With the relations following eqns. (3.9) and (3.24) only the *quotients* of the thermal parameters of the simple thermal model of eqn. (3.6) are obtained. Now experiments are presented that facilitate to calculate the thermal parameters themselves. The results are then compared with data found in the literature.

For the ventilation k-value k_v^* , in the Naaldwijk multifactorial glasshouse it is found from eqn. (3.7) with an average height $\bar{h} \approx 3$ m. (table 3.1) and $\zeta \approx 1/3$ [$W h m^{-3} K^{-1}$] that

$$k_v^* \approx \zeta' \bar{S}_v \quad , \quad \zeta' \approx 1.0 \quad [W h m^{-2} K^{-1}] \quad (3.32)$$

The k_h^* of the heating system is calculated from the following experiment. The mixing valve is closed so that no heat is supplied to the heating system. The pumps are running, so that θ_h decreases only because of heat transfer from the heating pipe network into the glasshouse in a normal operating condition. Approximating the heating pipes as a cylinder of water with uniform tempera-

ture the heat balance reads

$$C_h^* \frac{d\theta_h(t-\tau_{d,h})}{dt} = h_h^* \{\theta_h(t-\tau_{d,h}) - \theta_g(t)\}^b \quad (3.33)$$

The parameters C_h^* and h_h^* are defined per unit ground area. The time shift $\tau_{d,h} = 7$ min. follows from eqn. (3.25). The data are fitted with a model with calculated output $y(k)$; $y(0) = \theta_h(0)$. In fig. 3.18 a best fit is presented for the interval $\theta_{hg} \in [3, 20^\circ\text{C}]$, where the fit cannot be distinguished from the measurements.

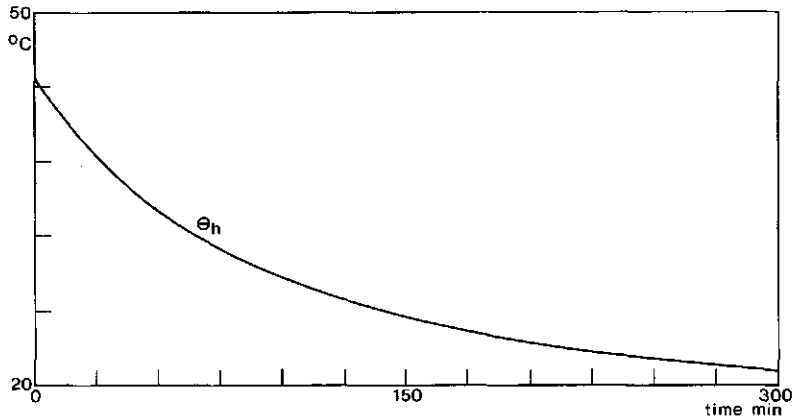

Fig. 3.18 Measurements and best fit for measurements at May 26, 1982 from 0.00 hrs. to 5.00 hrs. in compartment no. 1.

Compartment	a_h	h_h^*	b	E
1	$6.18 \cdot 10^{-5}$	1.00	1.452	7.81
5	$6.15 \cdot 10^{-5}$	0.998	1.457	5.47
$r_m = 0$ $\bar{\theta}_a = 13.5$ results 820526: 0.00 - 5.00 hrs. $r_w = 0$ $\bar{v}_w = 0.55$ $T_s = 1$ min.				

Table 3.5 Results from measurements (May 25 19.00 hrs. - May 26 7.00 hrs., 1982).

Results are given in table 3.5. Here $a_h \approx h_h^* / C_h^*$. The value of $h_h^* = a_h C_h^*$ can be calculated. From table 3.1 $V_h = 0.216$ and $A_g = 55.7$; since

$C_h^* = c_{\text{water}} \rho_{\text{water}} V_h / A_g = 4.187 \cdot 10^3 \cdot 0.216 / 55.7 = 16.24 \text{ kJ K}^{-1} \text{m}^{-2}$, h_h^* can be found. From table 3.5 values are selected $h_h^* = 1.0$ and $b = 1.46$, so that ϕ_h^* , the heating pipe network heat loss per unit ground area is

$$\phi_h^* = 1.0 \theta_{hg}^{1.46} \quad (3.34)$$

By linearizing (compare eqn. 3.30) it is found that

$$k_h^* = 1.46 \bar{\theta}_{hg}^{0.46} \quad (3.35)$$

When k_h^* is known, the other thermal parameters of eqn. (3.6) can be calculated, as is done in table 3.6.

Compartment	$\frac{k_h^*}{k_r^* + k_v^*}$	$\bar{\theta}_{hg}$	k_h^*	$k_r^* + k_v^*$	C_g^*	C_g^*/C_{air}^*
1	0.223	31.0	7.1	31.8	$46.1 \cdot 10^3$	11.8
2	0.282	37.1	7.7	27.3	$39.6 \cdot 10^3$	10.1
3	0.175	17.6	5.5	31.2	$45.3 \cdot 10^3$	11.6
4	0.167	14.8	5.0	30.2	$43.8 \cdot 10^3$	11.2
5	0.182	16.7	5.3	29.3	$42.5 \cdot 10^3$	10.9
6	0.265	37.3	7.7	29.1	$42.2 \cdot 10^3$	10.8
7	0.223	31.7	7.2	<u>32.1</u>	<u>$46.6 \cdot 10^3$</u>	<u>11.9</u>
			average:	30.1	$43.7 \cdot 10^3$	11.2

Table 3.6 Calculated parameters of the simple thermal model.

The result of eqn. (3.35) can be compared with eqn. (3.31). The exponents are 0.46 and 0.49 respectively, and the factor $1.46/(k_v^* + k_r^*) = 1.46/30.1 = 4.85 \cdot 10^{-2}$ corresponds with $a_1 = 4.41 \cdot 10^{-2}$.

With $C_{\text{air}}^* = c_{p,\text{air}} \rho_{\text{air}} V_g / A_g \approx 3.9 \text{ [J K}^{-1} \text{m}^{-2}]$, in table 3.6 the ratio C_g^*/C_{air}^* is calculated. Its value 11.2 is much higher than one should expect at first sight. It means that the parallel thermal capacities are much higher than the capacity of the air alone. In Jacobs (1981) a ratio 7.5 was calculated for the same glasshouse for a detailed physical model.

The results of table 3.6 can be compared with data from the literature. It is recalled that the parameters originate from linearization around a working point. When non-linearities occur this leads to other parameters than in a simple heating-load analysis. For example, for k_h^* in eqn. (3.35) in heating load calculations the (exact) value

$$k_{h,ss}^* = 1.0 \bar{\theta}_{hg}^{-0.46} \quad (3.36)$$

is used. The suffix ss indicates here a steady-state or statical relationship.

From the literature k-values are available from studies for energy consumption (Okada and Takakura, 1973, Okada and Hayashi, 1978, von Zabeltitz, 1978, Tantau, 1981a), where only the steady-state part of eqn. (3.4) is evaluated. The analysis implicitly includes the latent heat transfer. In von Zabeltitz (1978; p. 151) the heating requirement of a greenhouse with closed ventilation windows and $\bar{v}_w = 4[\text{m s}^{-1}]$ is

$$\bar{\phi}^* = 7.56 \frac{A_r}{A_g} (\bar{\theta}_g - \bar{\theta}_a) \quad [\text{W m}^{-2}] \quad (3.37)$$

so that $(k_{r,ss}^* + k_{v,ss}^*) = 7.56 A_r / A_g$. However, in the Naaldwijk glasshouse compartments, also the sidewalls have to be taken into account (although they are not important for the heating-load) leading to $(k_{r,ss}^* + k_{v,ss}^*) = 7.56 (A_r + A_s) / A_g = 20$. From table 3.6: $k_v^* + k_r^* = 30$.

In the factor $k_{v,ss}^*$ also the latent heat loss is included. Okada and Takakura give values of $k_{v,ss}^*$ depending on outside weather conditions. A worst case value is $k_{v,ss}^* = 2.5 A_r / A_g = 2.8$ for $\bar{v}_w = 4[\text{m s}^{-1}]$ and $\bar{s}_v \approx 1.2$ so that $k_{v,ss}^* \approx 2.3 k_v^*$ and small compared to $k_{r,ss}^*$ resp. k_r^* .

The results of table 3.6 depend upon the initial accuracy of k_h^* in eqn. (3.35). This eqn. is compared with data from von Zabeltitz (p. 166, tab. 42) who gives for the heating system the dissipated heat per m heating pipe of 51 mm. external diameter. With a $\bar{\theta}_h = 40^\circ\text{C}$ and $\bar{\theta}_g = 20^\circ\text{C}$ the dissipated heat is 44 W. In the glasshouse $l_h / A_g = 110/55.7 \approx 2$ m (table 3.1) so that $\bar{\phi}_h^* = 88$ W. Because

$$\bar{\phi}_h^* = k_{h,ss}^* \bar{\theta}_{hg} \quad [\text{W m}^{-2}] \quad (3.38)$$

it follows that $k_{h,ss}^* = 4.4$. Using eqn. (3.36) $k_{h,ss}^* = 20^{0.46} = 4.0$, so that the outcomes are quite comparable. In Chapter 7 it is demonstrated that when $k_{r,ss}^*$ is calculated from steady-state conditions "acceptable" values are obtained, which indicates that eqn. (3.36) is not unrealistic.

It can be concluded that the parameters of $H_{g,h}$ can be approximately calculated from heating load data, but that because of linearizations and other simplifications the parameters tend to be too low so that some care has to be excersized. For a rough estimate, the inaccuracy will be smaller than a factor two.

3.4.7 Ventilation

The parameters of the transfer function $H_{g,v}$ have also been estimated. Here a test signal was established by changing r_w stepwise around a working point $r_w = \bar{r}_w \pm 2.8\%$ so that with eqn. (3.21) and $\tilde{S}_v = 0.064 \cdot 3.5 \tilde{r}_w = 0.22 \tilde{r}_w$. Because in the initial experimental set-up the value of τ_v was expected to be small, a test signal period of 30 min. was selected. The heating system was set at a constant $\theta_h = \bar{\theta}_h = 60^\circ\text{C}$. Table 3.7 summarizes the results.

Comp.	$\bar{r}_w = \bar{u}_w$	K_v $\tau_{d,v=0}$	τ_v [min]	E	\bar{S}_v	$\bar{\theta}_{ag}$	K_v/τ_v τ_v [s]	C_g^*
1	2.8	-0.92	7.12	4.18	0.86	-17.2	$2.1 \cdot 10^{-3}$	$8.0 \cdot 10^3$
2	8.7	-0.88	9.65	5.17	2.2	-15.9	$1.52 \cdot 10^{-3}$	$10.4 \cdot 10^3$
3	14.7	-0.57	6.31	5.86	3.5	-13.5	$1.50 \cdot 10^{-3}$	$9.0 \cdot 10^3$
4	26.7	-0.76	12.1	4.42	6.2	-11.2	$1.05 \cdot 10^{-3}$	$10.6 \cdot 10^3$
5	26.7	-0.71	13.9	13.5	6.2	-11.4	$0.85 \cdot 10^{-3}$	$13.4 \cdot 10^3$
6	14.6	-0.54	4.90	4.22	3.5	-13.9	$1.84 \cdot 10^{-3}$	$7.5 \cdot 10^3$
7	8.9	-1.0	10.4	4.38	2.2	-15.3	$1.66 \cdot 10^{-3}$	$9.2 \cdot 10^3$
8	2.8	-0.89	6.08	4.76	0.85	-16.7	$2.45 \cdot 10^{-3}$	$6.8 \cdot 10^3$

$r_w = \bar{r}_w \pm 2.8\%$ $\bar{\theta}_a = 4.6^\circ\text{C}$ filtered results 820331: 22.50-0104: 05.00 hrs.
 $\theta_h = 60^\circ\text{C}$ $\bar{v}_w = 3.5 \text{ m s}^{-1}$ $T_s = 1 \text{ min}$ $\tilde{S}_v = 0.22 \tilde{r}_w$

Table 3.7 Results and calculations from measurements (March 31 19.00 hrs. to April 1 7.00 hrs., 1982).

The values for τ_v do not correspond to the results from table 3.2. When from the ratio $K_v/\tau_v = \zeta \bar{h}_g \bar{\theta}_{ag} / C_g^*$ (see eqns. 3.14) the value of C_g^* is calculated, the results also do not agree with table 3.6. Note that C_g^* is calculated without knowledge of k_h^* .

The incorrect value of τ_v can be explained from the fact that the test signal period was too small. Because only the ventilation windows are controlled and not the ventilation rate S_v , one might well expect that only the first harmonic of the test signal is supplied to the process. Because $H_{g,v}$ is a first order transfer function, using harmonic input signals any combination of K_v and τ_v can be found, as long as the ratio K_v/τ_v is constant. Clearly the applied test signal is not suitable in this case and should contain more distinct frequencies.

The results of table 3.7 might suggest that the approach using thermal characteristics is not completely correct. Therefore, in table 3.8 results are presented for $H_{g,h}$, but with the ventilation windows opened at fixed apertures \bar{r}_w .

comp.	\bar{r}_w	K_h	τ_h	E	$\bar{\theta}_{hg}$	k_h^*	$\bar{S}_v = k_v^*$	k_r^*	C_g^*
			$\tau_{d,h} = 7$						
1	0	0.201	20.2	2.15	30.4	7.0	0.23	27.6	$42.2 \cdot 10^3$
2	5.6	0.215	21.9	7.04	31.2	7.1	1.5	24.4	$37.9 \cdot 10^3$
3	11.6	0.186	22.1	4.95	33.2	7.3	2.9	29.0	$51.7 \cdot 10^3$
4	23.6	0.167	21.3	8.44	35.3	7.5	5.6	<u>32.0</u>	<u>$57.6 \cdot 10^3$</u>
							average: 28.3		$47.4 \cdot 10^3$
$u_h = 50 \pm 5 \text{ }^\circ\text{C}$ $\bar{\theta}_a = 4.8 \text{ }^\circ\text{C}$ filtered results 820330: 20.40-0331: 02.50 hrs. $\bar{v}_w = 3.6 \text{ m s}^{-1}$ $T_s = 1 \text{ min}$									

Table 3.8 Results and calculations from measurements (March 30 19.00 hrs. to March 31 07.00 hrs., 1982).

Here \bar{S}_v is calculated with eqn. (3.20) and k_h^* using eqn. (3.35). The average value of $k_r^* = 28.3$ is close to that from table 3.6; where $(k_r^* + k_v^*) = 30.1$ and with $k_v^* = 0.36$ it follows that $k_r^* = 29.6$. The average of C_g^* is $47.4 \cdot 10^3$

and agrees with $43.7 \cdot 10^3$ from table 3.6.

From the results presented in table 3.8 it might be concluded that a static (steady-state) ventilation rate \bar{S}_v does comply with the approach using thermal data. From table 3.7 it can be seen that in the mechanism describing \bar{S}_v in relation to \tilde{r}_w some unknown influences are present.

3.4.8 Radiation

The parameters of the transfer function $H_{g,s}$ (eqn. 3.15) have been estimated from measurements. Because on ϕ_s'' no test signal can be superimposed, one has to wait for suitable experimental conditions. Also the estimation can be less efficient in that the input signal does not contain sufficient distinct frequencies (recall the problems associated with the experiments from table 3.7). In table 3.9 results are presented. In the experiment $\theta_h = \bar{\theta}_h$ was kept constant and the windows are closed.

Compartment	K_s	τ_s [min] $\tau_{d,s} = 1$	E	$\bar{\theta}_h$
1	0.0278	27.6	17.7	35.0
2	0.0310	28.7	21.1	30.0
3	0.0248	27.5	38.6	25.1
4	0.0239	26.6	65.2	21.0

$\bar{\theta}_a = 6.4 \text{ } ^\circ\text{C}$ filtered results 820330: 08.00 - 15.00 hrs.
 $r_w = 0$ $\bar{v}_w = 4.5 \text{ m s}^{-1}$ $T_s = 1 \text{ min}$

Table 3.9 Results from measurements (March 30 08.00 hrs. - 16.00 hrs.).

In table 3.9 the value of τ_s is higher than results presented in tables 3.2 and 3.8 but should be similar (eqn. 3.17b). However, the dead times represent several small time constants and might be added to the measured time constants. In that case the results of tables 3.2, 3.8 and 3.9 agree. For compartment no. 1 the "raw" data are shown (fig. 3.19a) as well as the best fit (fig. 3.19b).

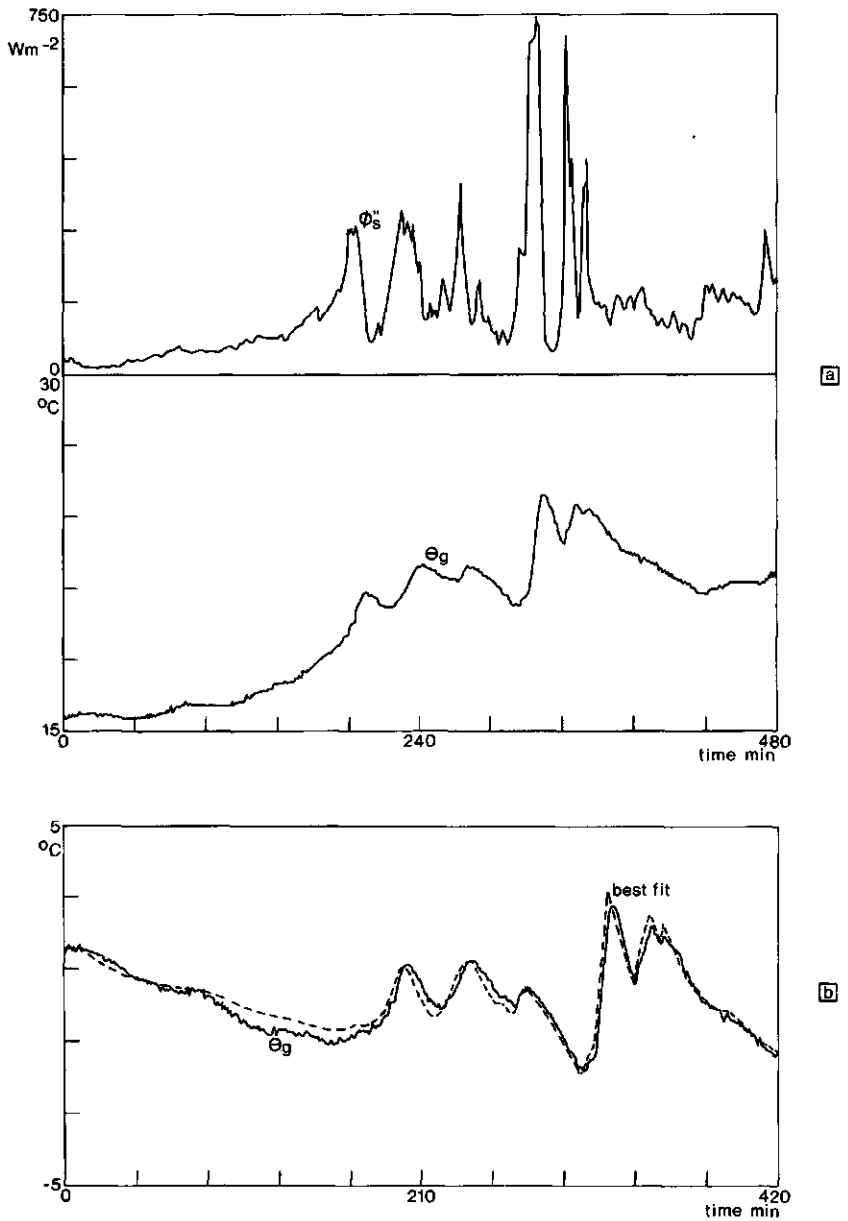

Fig. 3.19 Measurements and estimation results for compartment no. 1 at March 30 08.00 hrs. - 16.00 hrs. Measured radiation and greenhouse air temperature (a), filtered air temperature and best fit (b).

The values of $(k_r^* + k_v^*)$ and η can be calculated from eqns. (3.17) with k_h^* according to eqn. (3.35). In table 3.10 the average results of experiments on three days are presented including their relative variance. In all cases the windows are closed and θ_h is kept as the same constant levels in the same compartments.

experiment	$\bar{\theta}_a$	\bar{v}_w	$\bar{\phi}_s''$	$\bar{\eta}$	$\frac{\sigma\eta}{\bar{\eta}}$	$k_r^* + k_v^*$	$\frac{\sigma k}{\bar{k}}$
820330: 08.00 - 0330: 16.00	6.5	4.5	133	0.71	0.026	22.1	0.045
820407: 07.00 - 0407: 18.59	11.7	7.6	136	0.58	0.045	16.4	0.045
820409: 07.00 - 0409: 18.59	4.9	5.3	234	0.72	0.073	19.9	0.079

Table 3.10 Averages of calculated results of three experiments.

Comparing the calculated values of $k_r^* + k_v^*$ with the results obtained in sections 3.4.6 and 3.4.7 a satisfactory agreement can be claimed. The values are somewhat lower which might be caused by the fact that the corridors are heated by radiation too, which makes the experiments different from those discussed in the previous sections.

3.5 DISCUSSION

The results presented in this chapter indicate that the modeling of the dynamical behaviour of the greenhouse temperature control loops can be performed with a satisfactory degree of accuracy. Although the measurements were carried out in one type of greenhouse, it is felt that this conclusion also holds for greenhouses in general.

In addition to the determination of transfer functions, the results of the parameter estimation are related to the parameters of a simple thermal model. This facilitates to explain the relations in terms of heating-load coefficients or *thermal parameters*.

The results suggest that the estimated thermal parameters are constant or

have distinct non-linearities. The processes are deterministic by nature i.e. that no phenomena occur that have to be modelled by their statistical properties -if any. However, the parameter estimation is based on selected periods of time so that no statements can be made on the eventual occurrence of bursts of sudden disturbances.

It is recalled that these results are based on four key features. The first is that the non-linear actuator processes are *separated* from the climate process. The second is that the climate process is *linearized* around a working point and that the variables are formulated in terms of increments. This draws the attention on the disturbances acting upon the working point. The third feature is that experiments are set up such that the disturbances on the working point can be *filtered out* (in the frequency domain) using time series analysis techniques. The fourth feature is that the experiments have been performed *concurrently* in *identical* greenhouses, which provides the opportunity to investigate non-linearities that occur with respect to the working point.

The results are markedly different from what is found in the literature on this subject (Tantau, 1979, von Zabeltitz, 1978, O'Flaherty et al., 1973). In the work of Tantau, which is the most elaborate study available as yet, only approximate results are obtained (p. 93, table 6-1). Tantau has described the greenhouse properties by directly measuring frequency diagrams using sinusoidal input signals -a common approach in air-conditioning research. When this method is applied in greenhouses, the discrimination of disturbances that act on the working point is unsatisfactory. By nature the curves are not interpretable in terms of thermal parameters. It is felt that parametric modeling in relation to a simple thermal model as presented in this chapter has profound advantages over the direct measurement of frequency diagrams.

4 Temperature control

4.1 DESIRED PERFORMANCE CHARACTERISTICS

In GCFC, the control of the inside air temperature has received most attention. Temperature control is achieved by heating -when the temperature would drop too low- and by ventilation -in case the temperature would rise too high. Concurrent heating and ventilation is only employed when a certain air change rate is considered to be beneficial for the crop. The control of the heating system has received most interest, which is reflected in the existing literature on GCFC (Heijnen et al., 1979, von Zabeltitz, 1978, Tantau, 1979). This preference is understandable, since the energy consumption of a greenhouse is mainly associated with heating.

With respect to the required ventilation, the prevailing opinion is that with the existing *blue print* temperatures, in winter conditions a high temperature is beneficial for crop growth. This means that the air change rate is kept at a low level as to maintain a minimum level of CO₂ (when no CO₂ enrichment is applied) and to avoid diseases by lowering the relative humidity. Higher ventilation rates will preferably be employed only when the greenhouse temperature is rising too high. The topic is discussed in section 4.5.

The requirements that are put upon the performance of the heating system control are not formulated straightforwardly, because of the special way GCFC is performed in the practice of growing. Many control actions are formulated in terms of *manipulating control actuators* (see Chapter 1), and the controls should allow such manipulations. As an example, due to horticultural requirements, limits are put upon the values of the heating pipe temperature, constraining both the maximum and the minimum. It is also accepted practice to raise the heating pipe temperature a few hours before sunrise, in order to avoid condensation on the crop.

The setpoint of the GCFC loop is time-varying too. As a rule at night a lower temperature is kept and during the day the setpoint is varied when for example light-dependent temperature control is applied.

In some cases only a *minimum temperature* is controlled. When the weather conditions cause a rise in temperature, e.g. when the radiation drives the temperature over the setpoint, this extra rise is not thought to be a disadvantage as long as the heating can be turned off. To drop under the setpoint is on the contrary not desirable since the setpoint represents a minimum admissable value. As a result the following requirements can be formulated for GCFC heating system control, with the greenhouse air temperature as *controlled variable*:

1. The temperature should not drop significantly (a few degrees) *under* the setpoint at daytime when disturbances act upon the greenhouse or when the setpoint is time-varying.
2. The setpoint should be followed *accurately* at night. Typically at night the setpoint is constant and no significant disturbances act upon the greenhouse.
3. The temperature should not *exceed* the setpoint due to *energy input via the heating system* (if the energy is "free" this requirement does not apply).
4. Changes in the setpoint should be followed reasonably accurate (in order to create an optimal plant growth situation).

The order of the requirements formulated above reflects their relative importance in existing practice. In *commercial GCFC equipment*, the first requirement is difficult to cope with and is not usually satisfied. The second is quite reasonably fulfilled in practice (and is a typical selling argument), and also the third is satisfied. The fourth requirement is not recognized to be of importance.

When the hierarchical system description of fig. 2.1 is recalled, in fact the fourth requirement summarizes the three others. When control schemes have to be employed which are formulated on the second level -for example when control is based on plant responses- a close tracking of the setpoint becomes essential. For this reason the fourth requirement is formulated explicitly here.

In most commercial controllers the limits on the heating pipe temperatures -which are formulated because of horticultural reasons- are used to improve the control behaviour, for example by linking the minimum pipe temperature with the outside air temperature. The result is satisfactory in steady-state situations, but in transients induced by setpoint changes or high-frequency disturbances the performance is such that the requirements are not satisfied.

4.2 HEATING SYSTEM CONTROL

4.2.1 Control scheme

In GCFC the control of the heating system is usually carried out using a master-slave (or cascade) configuration. The slave loop controls the heating pipe temperature θ_h . The master regulates the greenhouse inside air temperature θ_g by imposing a desired value of θ_g , a signal referred to as u_h , on the slave. In fig. 4.1 a master-slave configuration is depicted. In this case the control algorithms are incorporated in a greenhouse climate computer.

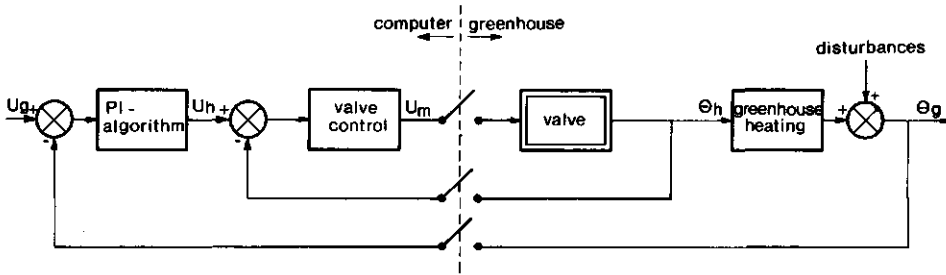

Fig. 4.1 Master-slave control of the greenhouse air temperature.

The application of the slave-loop is motivated by fluctuations that occur in the feedwater temperature θ_f and subsequently in the return water temperature θ_r (see fig. 3.1). The dynamical behaviour of the slave is fast compared to the master. The relation between the position of the mixing valve r_m and θ_h is such that the valve behaves linearly for increasing u_h . For decreasing u_h the heat loss in the greenhouse is so small that $\theta_r > u_h$, so that r_m is put in fully closed position. In terms of dynamic behaviour this is a *constraint* (or: saturation). The decrease of θ_h is in this case determined by the heat transfer from the heating pipes into the greenhouse. This leads to an asymmetric behaviour of the mixing valve control, with a small time constant for increasing u_h and a large one for decreasing u_h . For small changes in u_h , as will occur when a constant θ_g is kept and the disturbances are small, the valve process will behave linearly. The slave control algorithm is usually of the proportional type, where in computer control a time-proportional algorithm is employed.

The master controller is usually of the PI (proportional plus integral) type. The transfer function of the controller is given by

$$H_R(s) = K_R \left(1 + \frac{1}{\tau_i s} \right) \quad (4.1)$$

The parameters of eqn. (4.1) -the controller settings- are selected using estimated values of the parameters of the greenhouse heating transfer function $H_{g,h}(s)$. The slave loop is considered transparent ($H_{m,h}(s) \equiv 1$), so that in fact only a design is made for upward transients of u_h and for steady state regulation. For downward steps -or equivalent disturbances- the controller behaviour is not so satisfactory and some tricks have to be applied in order to establish an acceptable performance.

For the *Naaldwijk multifactoral glasshouse* using the model of eqn. (3.3), for the design of a controller a transfer function is used

$$H_{g,h} = \frac{0.25 e^{-8 s}}{20 s + 1} \quad (4.2)$$

with a worst-case value for K_g . The dead time includes the dead time introduced by the actuator circuit of the digital control ($\frac{1}{2}T_s$; $T_s = 1$ min.). The actual dead time $\tau_{d,h} \in [7, 8$ min.]. Although the computer dictates the application of discrete time algorithms, the sample time T_s is sufficiently small to allow a continuous time domain analysis for the selection of the controller settings. Using Bode-diagrams, it is seen that a choice of $\tau_i = 30$ min. and $K_R = 10$ would satisfy stability criteria. Because this K_R would lead to overshoot for upward transients usually a lower $K_R = 8$ is selected. By limiting the valve motor actuating signal u_m a satisfactory behaviour can be achieved in upward transient situations, at the expense of disturbance reduction capability.

4.2.2 Discrete time algorithms

In discrete time a PI control algorithm can be formulated (Verbruggen, Peperstraete and Debruyne, 1975):

$$u'(k) = k_p e(k) \quad (4.3a)$$

$$u''(k) = k_i \sum_{j=0}^{k-1} e(k-j) = u''(k-1) + k_i e(k) \quad (4.3b)$$

$$u(k) = u'(k) + u''(k) \quad (4.3c)$$

Here $u(k) = u(t)$ at time $t = kT_s$. In eqns. (4.3) the controller output $u(k) \equiv u_h(k)$ and the error $e(k) = u_g(k) - \theta_g(k)$. The signal $u'(k)$ represents the proportional action and $u''(k)$ the integral action. Compared to eqn. (4.1) $k_i = K_r T_s / \tau_i$ and $k_p = K_r$.

The algorithm of eqns. (4.3) can be written in a more compact form as a *modified PI* algorithm

$$u(k) = u(k-1) + K_p \{e(k) - e(k-1) + K_i e(k)\} \quad (4.4)$$

with $K_p = k_p$ and $K_i K_p = k_i$. The PI algorithm of eqns. (4.3) and the modified PI of eqn. (4.4) are equivalent in linear behaviour. When constraints are present in the control loop, the integral part of the controller (eqn. 4.3b) can grow to large values (windup) and is therefore limited in an anti-windup procedure. In eqn. (4.3b) limits are imposed $L_{\min} \leq u''(k) \leq L_{\max}$ with $L_{\min} < L_{\max}$ arbitrary scalars, and also $L_{\min} \leq u(k) \leq L_{\max}$ where $[L_{\min}, L_{\max}]$ is the operating range of the controller. In eqn. (4.4) only $u(k) \in [L_{\min}, L_{\max}]$ which gives a better damped response when the limits are effective.

This is demonstrated by simulation of a process with transfer function

$$H_p(s) \triangleq \frac{y(s)}{u(s)} = \frac{0.2 e^{-5s}}{(10s + 1)(30s + 1)} \quad (4.5)$$

which is controlled by a PI algorithm according to eqns. (4.3) and one according to eqn. (4.4). Also a PID type algorithm is used which is formulated like eqns. (4.3) and where a four-point difference was applied (Takahashi, Rabins and Auslander, 1970). Fig. 4.2a shows the simulated responses. In all cases the controller gains are selected $K_r = 10$, $\tau_i = 33$ and in the PID controller $\tau_d = .10$. The system is linear where zero represents an arbitrary working point. The setpoint is varied from 0.5 and backwards and the limits $L_{\max} = 10$ and $L_{\min} = -5$ act upon $u(k)$.

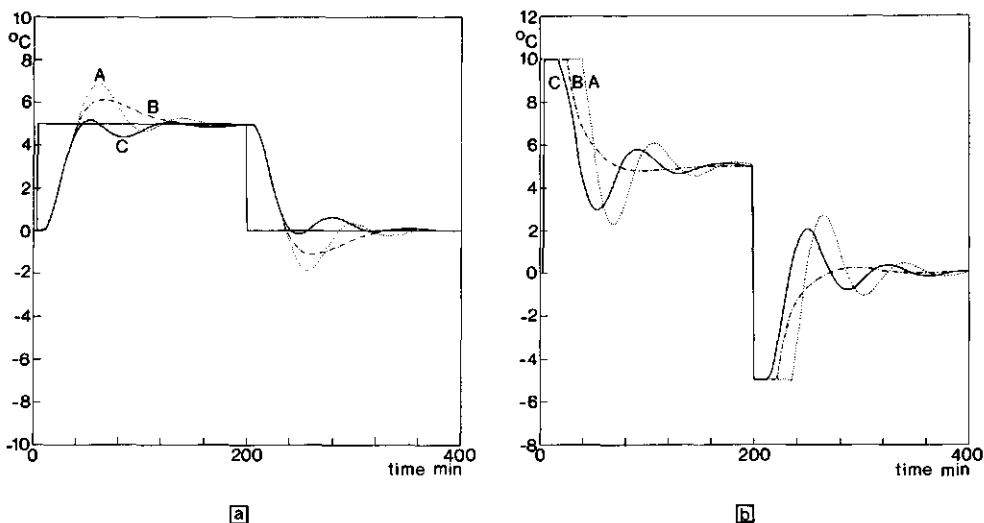

Fig. 4.2 Effect of anti-windup procedure in PI algorithm (A), modified PI (B) and PID algorithm (C). Shown are output of the system (a) and actuator signals (b).

In fig. 4.2b the signal $u(k)$ from the controller is shown, indicating that the modified PI is quicker coming out of its saturation, resulting in an improved response. This is explained because $u''(k)$ of eqn. (4.3b) comes out of its saturation when $e(k)$ changes sign, whereas in eqn. (4.4) a trade-off between $e(k) - e(k-1)$ and $K_i e(k)$ is made. The response of the PID control is also shown indicating that the modified PI adds an extra damping in a saturated situation.

Eqn. (4.4) is liable to setpoint changes because the proportional gain factor K_p leads to *proportional kick* (Verbruggen et al., 1975). There are situations where this is not desirable. In section 4.3.2 this is discussed in more detail.

4.2.3 Typical performance

The modified PI has been implemented in the computer control of the Naaldwijk multifactoral glasshouse since 1977, in several forms -including an adaptive one as is presented in Chapter 6. Although the performance is better than the usual PI of eqns. (4.3), some notorious problems remain. This is illustrated

in fig. 4.3 showing u_g , θ_g as well as u_h and θ_h on a bright winter day with relatively strong radiation during the day and a cold night (Jan. 5, 1980).

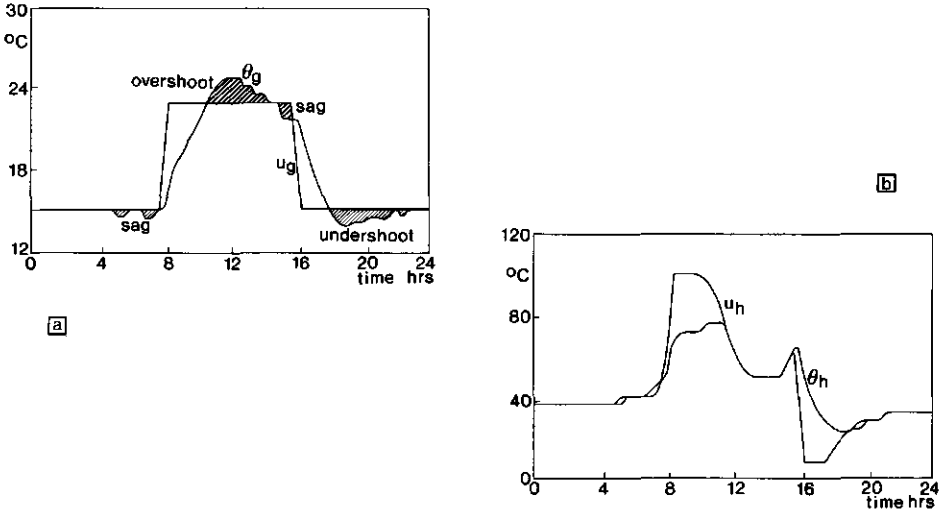

Fig. 4.3 Typical performance of GCFC temperature control.

The responses demonstrate exemplarily the problems associated with GCFC heating control. In the morning the setpoint u_g rises, and subsequently u_h and θ_h rise. Because of the limited capacity of the main boiler (note the response of θ_h between 8.00 hrs. and 10.00 hrs.), u_h and θ_h diverge and u_h is clamped to L_{max} (100°C). When θ_g approaches u_g , u_h decreases but because of the divergence between θ_h and u_h this has no immediate effect. As a result a large *overshoot* (3 °C) of θ_g occurs, partly due to the incoming radiation. In the afternoon the radiation decreases, causing a *sag* at 15.00 hrs., the effect of which is hidden by the decrease of u_g . At the end of the afternoon -when u_g is put on its night value- an *undershoot* occurs caused by a similar divergence between u_h and θ_h as in case of the overshoot discussed above. This leads to an undershoot for about 4 hrs. which can be considered to be the most detrimental of the undesired effects, since the night temperature is usually a minimal acceptable value (in winter) and the temperature should not drop under its desired value. It is seen that the steady-state behaviour during the night is satisfactory.

The responses in fig. 4.3 are better than those which would be obtained with a PI algorithm according to eqns. (4.3), which can be argued from the fact that $u_h(k)$ comes out of its saturation before $e(k)$ changes sign. Naturally, the responses in fig. 4.3 could be improved by the selection of better values for L_{\min} and L_{\max} ; a choice 30, 80 °C would much improve the controller performance. However, "good" values of L_{\min} and L_{\max} depend on the outside disturbances (the weather conditions) and cannot in general be calculated from measurements, so that this kind of solution is either inadequate or requires day to day tuning by the grower.

Of the responses the overshoot is exceptionally large because of the large setpoint change and the favourable bright weather. The sag and the undershoot will also occur for small setpoint changes. The sag because it is the result of outside disturbances. The undershoot is caused by the large time constant associated with the decrease of θ_h and will nearly always be present. It is only less severe in the rare occasion that the weather conditions are such that the value of L_{\min} is close to the value which is necessary to maintain the required night temperature.

In the foregoing discussion the tuning of the slave loop has not received any attention because it was assumed that the slave was properly tuned. However, an important parameter in the slave loop is the gearing mechanism that relates the valve motor to mixing valve position. This mechanism differs for various makes so that the slave is adjusted on-line in an ad-hoc fashion.

An often encountered problem is that the proportional gain in the slave loop is put to a *too low value* and causes stability problems in the main master loop. For the Naaldwijk glasshouse such a situation is shown in fig. 4.4, leading to slow oscillations in θ_h with a period of time of 25 min. These oscillations are also present in the response of θ_g . Often, in such a situation the solution is sought in *decreasing* the slave loop gain, believing that the slave loop is *too fast*. The correct solution is to *increase* the loop gain (Udink ten Cate, 1980). The responses were obtained at Jan. 6, 1980.

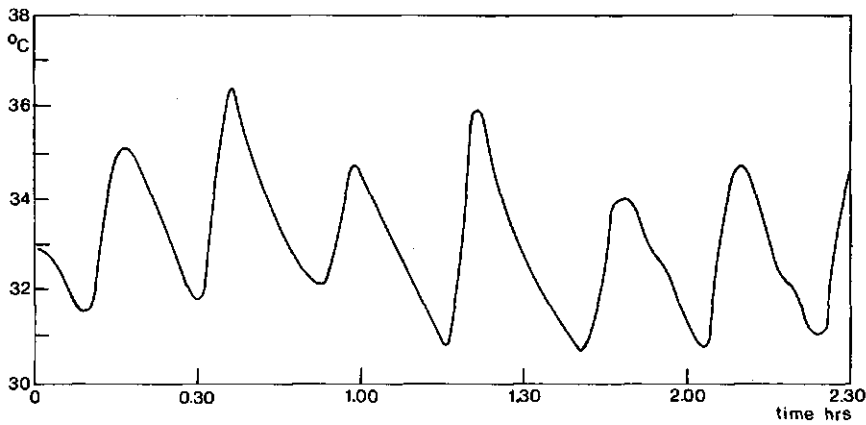

Fig. 4.4 Responses of $\theta_h(t)$ for a too slow mixing valve actuation.

4.3 DOG-LEAD ALGORITHM

4.3.1 The algorithm

In the discussion on fig. 4.3, the poor performance of the PI control with respect to undershoot, sag and overshoot, was explained because the actual θ_h deviates from its desired value u_h . It seems straightforward to develop a PI algorithm where this is not the case. By Udink ten Cate and Van Zeeland (1981) such an algorithm is presented, which is called the *dog-lead* algorithm. This algorithm is described here. The method was inspired by a paper of Hanus (1980).

The PI algorithm of eqn. (4.4) can be rewritten as

$$u(k) = u(k-1) + \Delta u(k) \quad (4.6a)$$

$$\Delta u(k) = K_p \{(e(k) - e(k-1)) + K_i e(k)\} \quad (4.6b)$$

which follows directly from eqn. (4.4). Because of saturations in the actuator $u(k)$ can *diverge* from its realized value. Hanus (1980) suggests to use instead of eqn. (4.6a) the algorithm

$$u(k) = u_r(k-1) + \Delta u(k) \quad (4.7)$$

where $u_r(k-1)$ is the *realized* actuator output. This implies that the saturation occurs in the actuator circuit and that its output is measurable. Because $\Delta u(k)$ is not bounded, the instantaneous behaviour of the controller still remains of the PI type, but the value of $u(k)$ is prevented from diverging from its realized value $u_r(k)$.

In the greenhouse heating system $\theta_h(t)$ is the actuating variable for the GCFC heating process. The mixing-valve circuit contains the dominant saturations of the control loop, so that $u_r \equiv \theta_h$ agrees with the requirements concerning eqn. (4.7). A complication arises because θ_h itself is controlled by the slave controller and by using eqn. (4.7) fluctuations in θ_h are not reduced, but instead used to generate a new master controller output $u_h(k)$, causing a drift in θ_h and subsequently poor control. In order to suppress fluctuations an *essential modification* leads to the algorithm

$$u(k) = u_r'(k-1) + \Delta u(k) \quad (4.8a)$$

$$u_r(k-1) - R_1 \leq u_r'(k-1) \leq u_r(k-1) + R_2 \quad (4.8b)$$

R_1 and R_2 are constants. In the GCFC loop $u_r \equiv \theta_h$ and $u \equiv u_h$. The term $\Delta u(k)$ is defined in eqn. (4.6b). Eqns. (4.8) state that the output $u_h(k)$ of the master controller is free to move between limits imposed by $u_r(k)$; reason to call this concept the *dog-lead* method. The values of R_1 and R_2 are selected such that in steady-state control a ripple on $u_r (\equiv \theta_h)$ falls within the range spanned by eqn. (4.8b). In this respect, the values of R_1 and R_2 depend on the accuracy of the slave loop. In the Naaldwijk glasshouse by trial and error $R_1 = R_2 = 5$ °C.

4.3.2 Proportional kick

The algorithms of eqns. (4.4) and (4.7) are sensitive to *proportional kick*. When a setpoint change occurs, the value of $u(k)$ is changed. In a saturated situation this can cause undesirable behaviour as is depicted in fig. 4.5, which is the result of a computer simulation described in section 4.3.3.

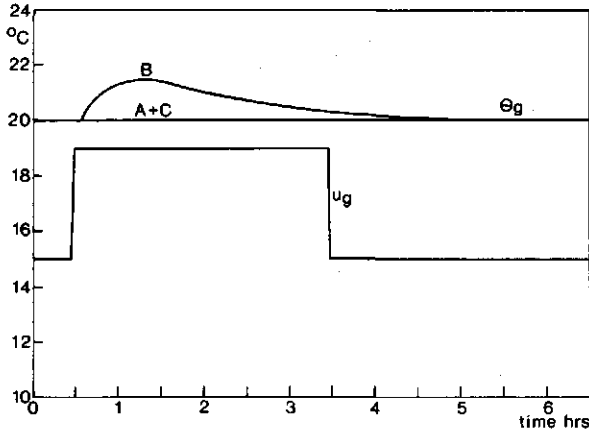

Fig. 4.5 Proportional kick. (A) Conventional PI algorithm (4.3), modified PI and dog-lead PI, without (B) and with (C) proportional kick suppression.

In this fig. $u_g < \theta_g$ as can be the case on a summer day. When u_g changes upward, in the control algorithm this is equivalent to a negative change in θ_g , which results in the increase of u_h and thus the mixing valve will be opened. This happens regardless of the fact whether the new setpoint is above or below the actual θ_g . In a linear operating condition this behaviour is correct, but in the saturated case of fig. 4.5 this is not so. It is seen that the conventional algorithm of eqns. (4.3) does not exhibit this sensitivity because the kick is suppressed by the saturated integral action of eqn. (4.3b). The proportional kick sensitivity of the modified algorithms is reduced by including conditional (IF) statements in the algorithm. This is represented in fig. 4.6 where eqn. (4.6b) is rewritten with $e(k) = x(k) - y(k)$:

$$\begin{aligned}
 u(k) &= K_1\{x(k) - y(k)\} + K_p\{(x(k) - x(k-1)) - (y(k) - y(k-1))\} \\
 &= K_1\{x(k) - y(k)\} + K_p\{\Delta x(k; k-1) - \Delta y(k; k-1)\}
 \end{aligned}
 \tag{4.9}$$

By putting $\Delta x(k; k-1) \cong x(k) - x(k-1)$ to the values as indicated in fig. 4.6, the proportional kick is suppressed in undesired situations, as is shown in the simulation results of fig. 4.5.

Fig. 4.6 Conditional suppression of undesired proportional kick.

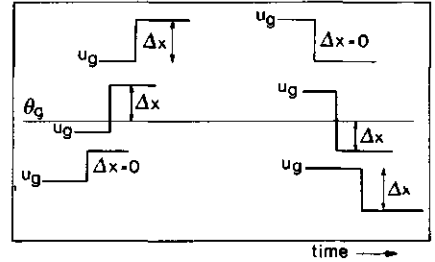

4.3.3 Performance of the PI algorithms

In order to compare the dog-lead algorithm of eqns. (4.8) and (4.9) with the conventional type of eqns. (4.3) simulation is carried out. The greenhouse heating process is simulated by a transfer function

$$H_{g,h}(s) = \frac{\tilde{\theta}_g(s)}{\tilde{\theta}_h(s)} = \frac{0.25 e^{-5 s}}{20 s + 1} \quad (4.10)$$

The working point is defined by $\bar{\theta}_h = 30 \text{ }^\circ\text{C}$ and $\bar{\theta}_g = 15 \text{ }^\circ\text{C}$. The mixing valve is described according to eqn. (3.18) with $\theta_f = 50 \text{ }^\circ\text{C}$ and the parameters of eqn. (3.19) are selected $\tau_{d,m} = 6$, $\tau_m = 2 \text{ min.}$, $K_m = 0.05$. The slave circuit is controlled by a time-proportional controller: $u_m(k)$ (the actuating signal for $r_m(t) \in [-15, 15 \text{ sec.}]$). In the master controller $K_r = 6$ and $\tau_i = 30$; $T_s = 1 \text{ min.}$ The range of $u_h(k) \in [10, 80 \text{ }^\circ\text{C}]$. In fig. 4.7a the responses are simulated when a stepwise disturbance occurs on θ_h of $10 \text{ }^\circ\text{C}$ for $t \in [90, 210 \text{ min.}]$. The boiler feedwater temperature is rather low so that windup will occur.

The results of fig. 7a clearly show the improvements obtained by the dog-lead method. In fig. 7b and 7c the $u_h(k)$ and $\theta_h(t)$ for both algorithms are shown, demonstrating the effectiveness of the dog-lead anti-windup procedure when saturations occur in the control loop.

Apart from simulation, the dog-lead PI and the modified PI algorithms -both with kick reduction according to eqn. (4.9)- have been compared in field trials. In January 1981 extensive experiments have been performed in the Naaldwijk multifactoral glasshouse (see section 3.4.1), in order to obtain a good tuning of the controller settings for a stepwise upward setpoint change in the early morning, as well as for steady-state behaviour. For the modified

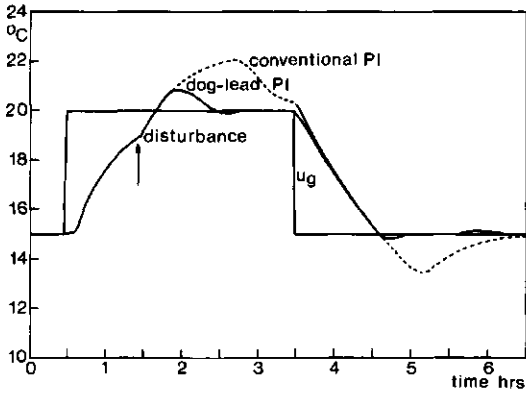

a

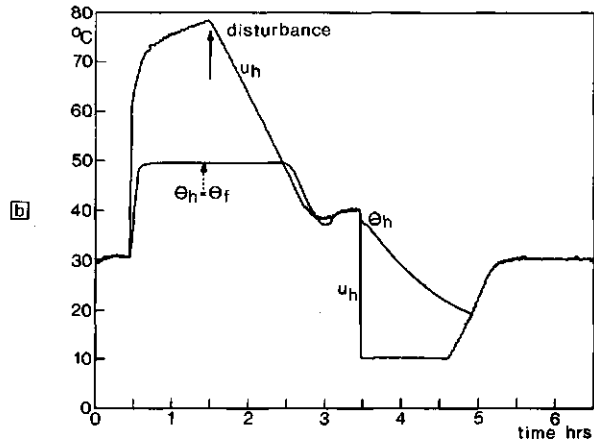

b

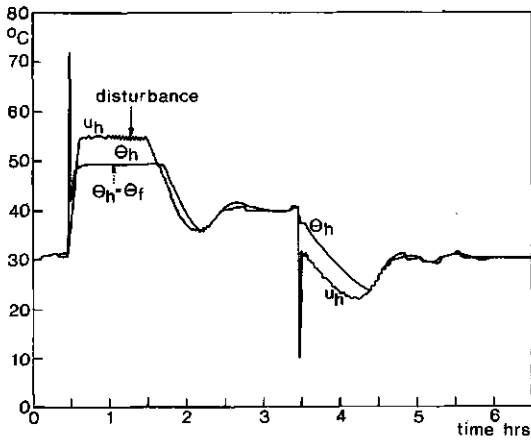

c

Fig. 4.7 Comparison of conventional and dog-lead PI in simulation.

Shown are: greenhouse temperatures (a); heating system responses for conventional PI (b) and dog-lead PI (c).

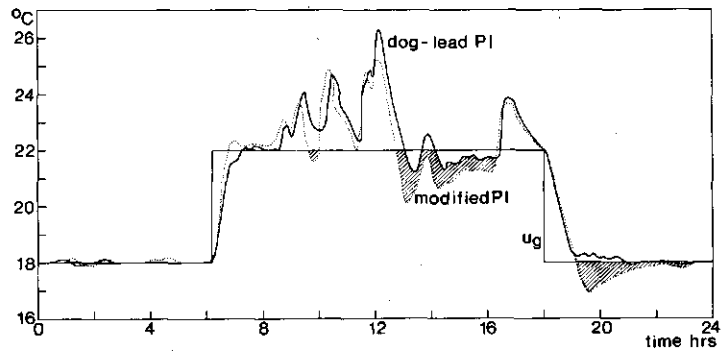

(a)

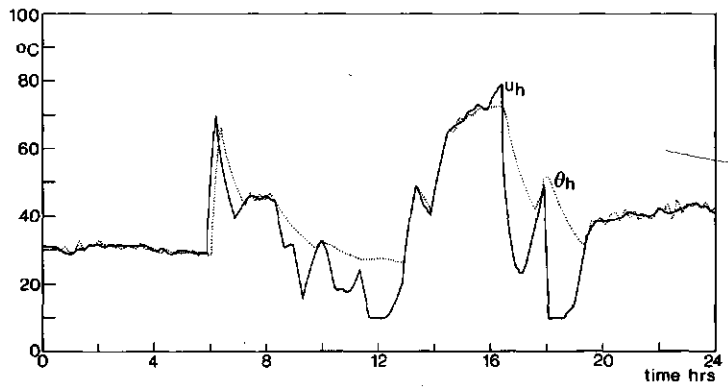

(b)

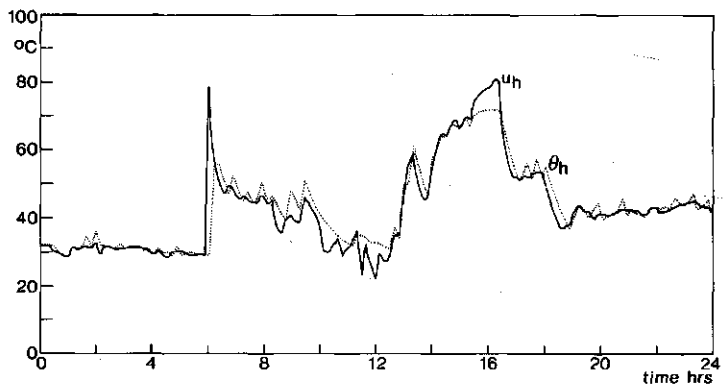

(c)

Fig. 4.8 Comparison of dog-lead PI and modified PI on March 22, 1981. Shown are greenhouse temperatures (a), u_h and θ_h for modified PI (b) and for dog-lead PI (c).

PI $K_p = 8$ and $K_i = 0.033$. The choice of K_p is rather low as to reduce overshoot as much as possible. For the dog-lead algorithm $K_p = 12$ and $K_i = 0.04$ was selected.

In fig. 4.8a responses are shown of θ_g for both algorithms, on a relative warm day in March (March 22, 1981), $\bar{\theta}_a = 10.2$ °C, with alternating sun and clouds, causing strong disturbances. The dog-lead PI responses are obtained in compartment no. 5; the modified PI responses in compartment no. 3.

The performance of the algorithms is evaluated in terms of *overshoot*, *sag* and *undershoot* of θ_g . Other differences between u_g and θ_g are not relevant as was discussed in section 4.1. Differences between θ_g of both algorithms as they occur from 8.00 - 16.00 hrs. are caused by the glasshouse structure and not of importance here. The relevant areas in fig. 4.8a are *shaded*. The superior performance of the dog-lead algorithm in this situation is clearly demonstrated and can be explained from the responses of $u_h(k)$ and $\theta_h(t)$ of the two algorithms as are shown in fig. 4.8b (modified PI) and fig. 4.8c (dog-lead PI).

In fig. 4.9 also responses of other days are presented. In fig. 4.9a the responses of $\theta_g(t)$ are shown on March 17, 1981: a cold day, $\bar{\theta}_a = 4.8$ °C. In fig. 4.9b a warmer day is shown $\bar{\theta}_a = 7.4$ °C (April 21, 1981).

The performance of the dog-lead and modified PI was also compared using daily experimental results between January 28 and May 24, 1981. The responses were compared in terms of overshoot, sag and undershoot, on a 5-point scale. In fig. 4.10 the results are presented, in cumulative values of the available evaluations. Note that not every day an evaluation could be made because of the outside weather conditions; or because of missing or incomplete data.

It is seen that the dog-lead PI algorithm according to eqns. (4.8) and (4.9) performs significantly better than the modified PI of eqns. (4.4) and (4.9). It was observed that the upward step responses is somewhat slower. The improvement originates from the fact that in a saturated situation the dog-lead method reacts quicker than the modified PI does. Such a saturated situation occurs regularly in the controller, so that the dog-lead algorithm can be considered to be of *great practical interest*.

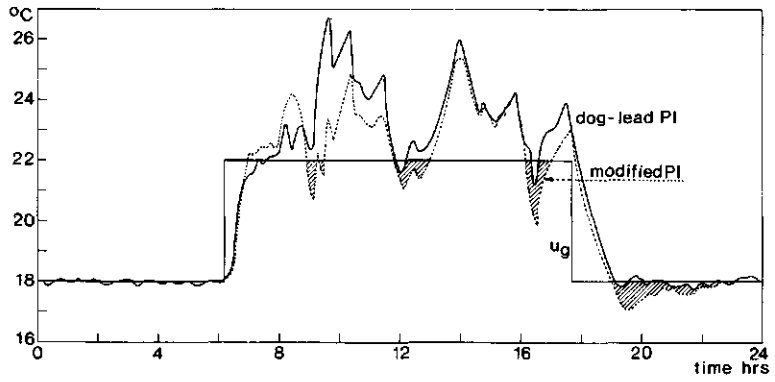

[a]

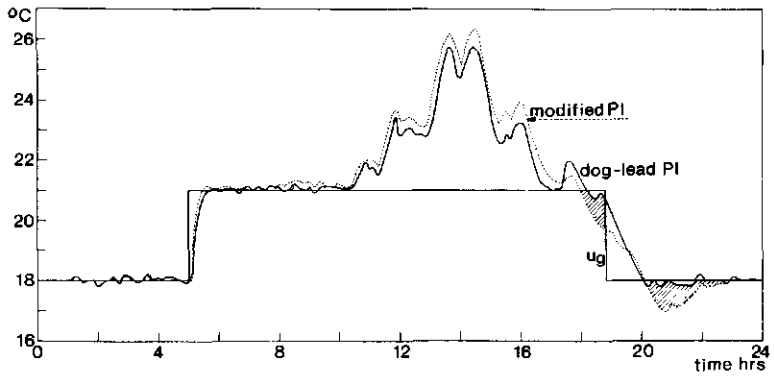

[b]

Fig. 4.9 Comparison of dog-lead PI and modified PI. Greenhouse temperatures on a cold day (a); and on a warmer day (b).

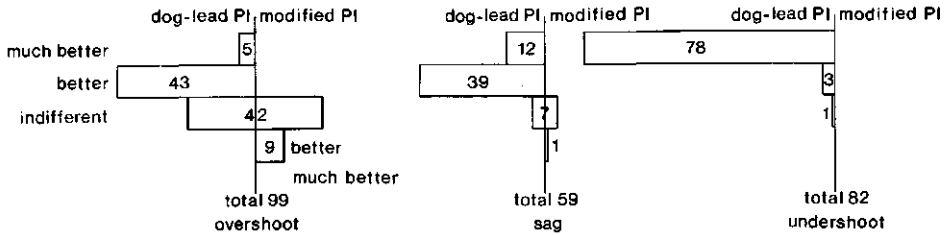

Fig. 4.10 Results from field trials between January 28 - May 24, 1981.

4.4 SPLIT-RANGE HEATING SYSTEM CONTROL

In the foregoing sections the heating system is constructed of one heating pipe network, situated just over the ground. In many greenhouses in the Netherlands a *lower* and an *upper* heating pipe network is used, each with a separately controlled temperature. The lower network is used to meet the primary heating load. It is situated in the crop, so that the maximum admissible temperature can be 40 - 50 °C. When the lower network cannot supply the required heat, the upper network is used (which is situated over the crop). The limited capacity of the lower pipe network makes it necessary to use the upper network in transient situations as well in steady-state situations with a large heating demand. In fig. 4.11 a greenhouse with two heating systems is depicted.

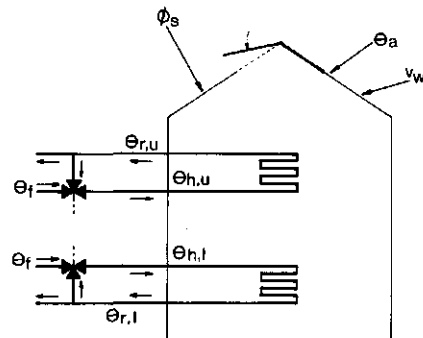

Fig. 4.11 A greenhouse with two heating pipe networks.

In practice there are various methods to operate the pipe networks. A popular approach is to use two separate master-slave controllers and decide logically which pipe network has to be turned on. Especially in transient situations this can lead to oscillatory behaviour.

Such a situation did exist in the computer controlled glasshouses of the Research Station for Floriculture at Aalsmeer, the Netherlands. To improve the control, a split-range control algorithm was designed, where one master algorithm controls the lower and the upper pipe network by imposing a desired water temperature to two separate slave controllers (Udink ten Cate, Van Zeeland and Valentin, 1979, Valentin and Van Zeeland, 1980).

A simple transfer function is established for the transfer functions of the lower and of the upper pipe network respectively. Using the same model as presented in eqn. (3.3):

$$H_{g,h,l}(s) = \frac{\tilde{\theta}_g}{\tilde{\theta}_{h,l}} = \frac{K_{g,l} e^{-\tau_{d,h,l}}}{\tau_{g,l} s + 1} \quad (4.11a)$$

$$H_{g,h,u}(s) = \frac{\tilde{\theta}_g}{\tilde{\theta}_{h,u}} = \frac{K_{g,u} e^{-\tau_{d,h,u}}}{\tau_{g,u} s + 1} \quad (4.11b)$$

Here the suffix l means lower; u means upper. From step responses the parameters in eqns. (4.11) were obtained as $\tau_{g,l} \approx \tau_{g,u} = 30 \text{ min.}$, $\tau_{d,h,l} \approx \tau_{d,h,u} = 5 \text{ min.}$, $K_{g,l} = 0.15$ and $K_{g,u} = 0.12$. The similarity between the values of $\tau_{g,l}$ and $\tau_{g,u}$ can be explained from the simple model parameter of eqn. (3.8b), where the normalized k_h^* is equal for heating with a heating pipe and for heating up cold heating pipes (disregarding the temperature dependance of k_h^* to $\bar{\theta}_{hg}$). Equal time constants could be expected this way. The dead times $\tau_{d,h,l}$ and $\tau_{d,h,u}$ depend partly on the water flow through the pipe networks as well as on the length and could be unequal in another construction. The same holds for $K_{g,l}$ and $K_{g,u}$.

For a wide-span glasshouse a *split-range* control system has been designed as is shown in fig. 4.12. The master algorithm is of the modified PI type. The split-range operates first on the lower pipe network and then on the upper one, although this could be reversed easily. The decision procedure is

defined by the algorithm

$$u_{h,l}(k) = u_h(k) \quad \text{if } \theta_{h,l} < \theta_{h,l,\max}$$

$$\text{else } u_{h,u}(k) = u_h(k) - \theta_{h,l,\max} + C_0 \quad (4.12)$$

where C_0 is an offset, usually $C_0 = \theta_{h,u,\min}$. The suffixes max and min denote a maximum or minimum value respectively (and can be compared to L_{\min} , L_{\max} in eqn. 4.4).

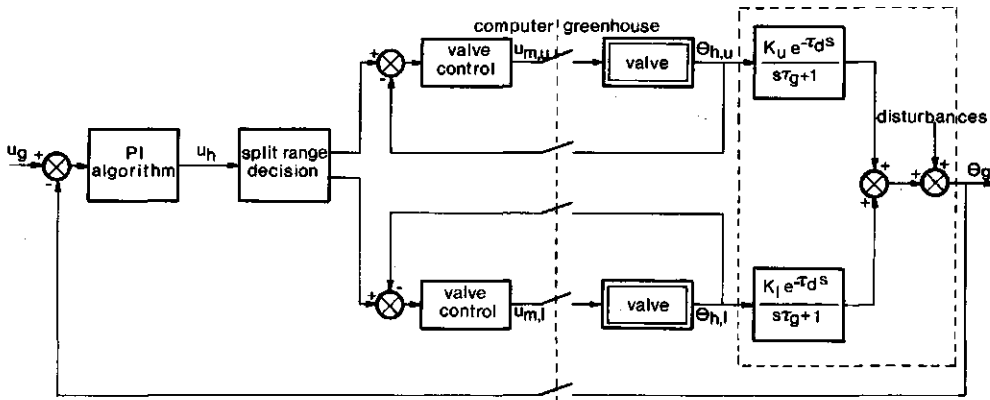
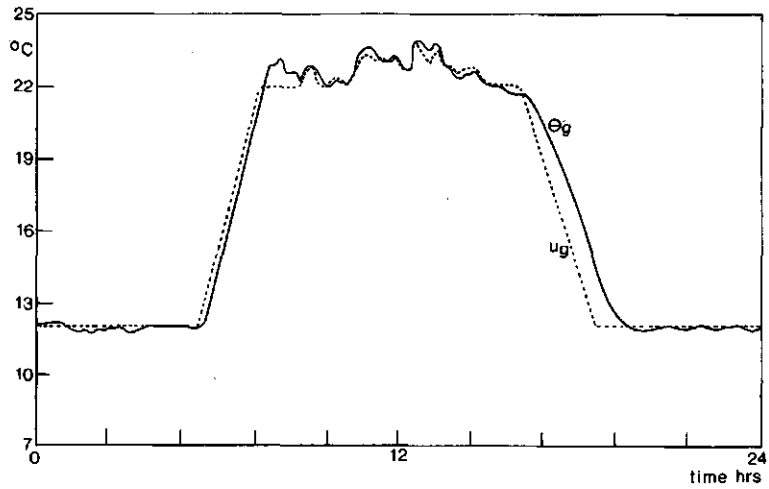

Fig. 4.12 A split-range heating control system.

When the master switches from lower to upper pipe network, K_p and K_i can be changed without disturbing the output $u_h(k)$. The lower limit of $u(k)$ in eqn. (4.4) is given by $\theta_{h,l,\min}$; the upper limit by $\theta_{h,u,\max} + \theta_{h,l,\max} - C_0$. In fig. 4.13 a response is presented for a large setpoint change of 10°C (Valentin and Van Zeeland, 1980). At daytime the setpoint is varied according to the amount of light.

The response is acceptable -which also can be explained because the setpoint takes two hours to go from night to day level. Some sag and undershoot can be observed. It is seen that the take-over from the upper and the lower pipe network is satisfactory.



(a)

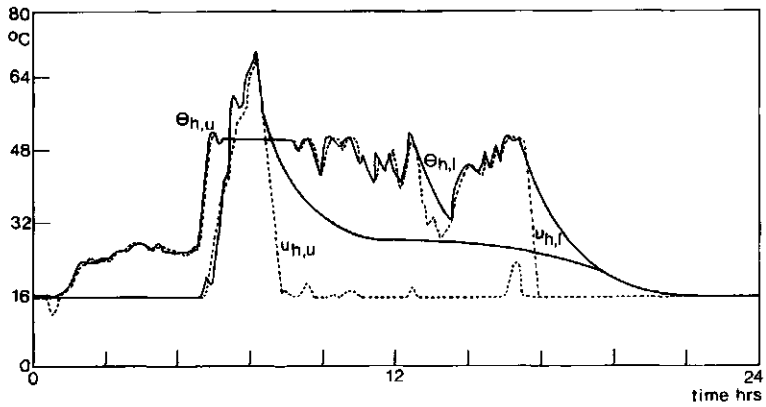

(b)

Fig. 4.13 Responses of split-range temperature control. Greenhouse temperature (a). Heating pipe temperatures (b).

4.5 VENTILATION CONTROL

Ventilation control in GCFC is not only performed in order to maintain a specified temperature level. It is also done to provide a minimum amount of air exchange, lowering the air humidity inside the greenhouse and otherwise thought to be beneficial for the crop. By ventilation CO_2 can be provided when no enrichment is applied. This has motivated various strategies. Usually a minimum air change rate is maintained using heuristic criteria derived from outside weather conditions. Above a certain level temperature is controlled

(Van de Vooren and Strijbosch, 1980, Strijbosch, 1973, Albers, 1971). Heijna (1975) suggests for the delta-X control to ventilate according to the inside air humidity and the expected transpiration of the crop.

Regardless of the research strategy, one of the main problems of ventilation control is that the air change rate S_v is *not measurable*. An experimental relation as presented in eqns. (3.20) and (3.21) is not known to be valid for an arbitrary greenhouse. An additional requirement is that the number of times the motor is actuated, has to be as low as possible in order to avoid wear and tear of the ventilation mechanism.

A typical control layout -as it is realized in the computer control of the Naaldwijk multifactoral glasshouse- is given in fig. 4.14. The lee-side windows are opened first. The reason that r_w is measured is explained because in some ventilation strategies the value of r_w is controlled.

When the temperature is controlled, a process with two inputs and one output is regulated. Because the time constants of the heating and the ventilation process are of the same value, dynamically any combination of admissible inputs can give the desired output. An additional criterion is that a minimum of heating energy should be used. In a practical situation this is realized by putting the setpoint of the ventilation at least 1-2 °C over that of the heating.

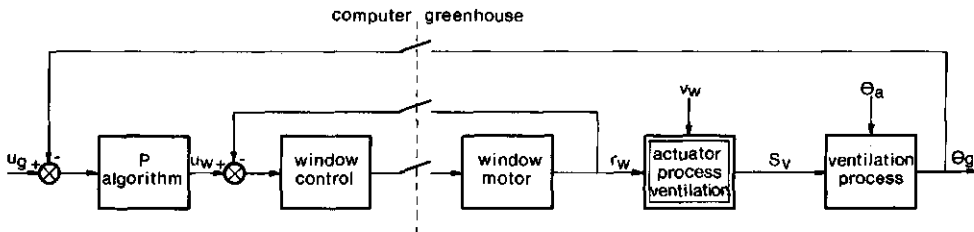

Fig. 4.14 Ventilation control system.

5 Least-squares like gradient methods for on-line parameter estimation

5.1 INTRODUCTION

In this chapter parameter estimation techniques are treated that can be used in adaptive control. As indicated in Chapter 4, in GCFC the temperature control loop is subject to disturbances and non-linearities which change the parameters of the transfer function. To compensate for these parameter variations an adaptive temperature control method is presented in Chapter 6. The applied parameter estimation technique is treated here.

The parameters of the transfer function of a process can be estimated by methods that minimize the difference between the parameters associated with the process and those of a corresponding model. This parameter difference can be expressed in several criteria (Bykhoff, 1974, Young, 1981). In this treatment the *equation error* formulation is used. A gradient algorithm minimizes an *instantaneous* error function based on the equation error.

In the present study a stability approach to on-line gradient methods is described. The parameter estimation problem is formulated as a gradient minimization of which the convergence is investigated by stability methods. This results in *least-squares like gradient* (LSLG) algorithms that resemble the algorithms of the well known recursive *least-squares* methods which originate from a statistical point of view. The approach facilitates a detailed investigation of the convergence properties of the proposed algorithms. The algorithms are described both in continuous time and in discrete time. In discrete time LSLG algorithms have been reported earlier in the literature by Udink ten Cate and Verbruggen (1978), a reprint of which is presented in section 5.3. The method has been applied for adaptive GCFC by Udink ten Cate and Van de Vooren (1977, 1981). An application to discrete model reference adaptive control systems was presented by Udink ten Cate (1979). The results for the continuous time domain have not been reported earlier and serve as an introduction to the method. A related algorithm for continuous time is described by Young and Jakeman (1980).

The application of stability methods to investigate the convergence of gradient algorithms has been described by Lion (1967) for a simple continuous time gradient algorithm. For discrete time the approach has been used among others by Mendel (1973). Both authors use Liapunov's second method to investigate the stability properties. Using hyperstability methods Landau (1976) and Landau and B  thoux (1975) described related algorithms in discrete time.

5.2 CONTINUOUS GRADIENTS

A linear univariate process can be represented by the differential equation

$$g^{(n)} + a_{n-1}g^{(n-1)} + \dots + a_0g^{(0)} = b_m f^{(m)} + b_{m-1}f^{(m-1)} + \dots + b_0f^{(0)} \quad (5.1)$$

where $g^{(k)} = \frac{d^k g(t)}{dt^k}$; $g(t)$ is the process output signal and $f(t)$ is the process input. The parameters a_i and b_j ($i = 0(1)n-1$; $j = 0(1)m$) are unknown and time invariant or slowly time varying. A more convenient notation for eqn. (5.1) is obtained with $g^{(n)}(t) = y(t)$ and

$$\underline{\theta}^T = (b_0, b_1, \dots, b_m, -a_0, -a_1, \dots, -a_{n-1})$$

$$\underline{u}^T(t) = (f^{(0)}, f^{(1)}, \dots, f^{(m)}, g^{(0)}, g^{(1)}, \dots, g^{(n-1)})$$

$\underline{\theta}, \underline{u} \in R^{n+m+1}$. The superscript T denotes the transpose. Eqn. (5.1) can be rewritten as

$$y(t) = \underline{\theta}^T \underline{u}(t) \quad (5.2)$$

Note that $y(t)$ is not the output of the process output $g(t)$, but merely a short-hand notation. The estimation of the unknown parameter vector $\underline{\theta}$ is carried out by a model of the process of corresponding dimensions. The model contains the estimates $\hat{\underline{\theta}}(t)$ of the process parameters. Assuming that $\underline{u}(t)$ is deterministic -which means that $\underline{u}(t)$ is measurable without error- the model is described by

$$\hat{y}(t) = \hat{\underline{\theta}}^T(t) \underline{u}(t) \quad (5.3)$$

where $\hat{y}(t)$ is the estimate of $y(t)$. The parameter difference is denoted $\underline{\delta}(t) \hat{=} \underline{\hat{\theta}} - \hat{\theta}(t)$. As a measure of $\underline{\delta}(t)$ the *equation error* is introduced $\epsilon(t) \hat{=} y(t) - \hat{y}(t)$ (Eykhoff, 1974, Lion 1967, Young, 1981). From eqns. (5.2) and (5.3):

$$\epsilon(t) = \underline{\delta}^T(t) \underline{u}(t) \quad (5.4)$$

In gradient techniques a criterion function $J(\underline{\delta}; t)$ is established, that is minimized by adjusting $\hat{\theta}(t)$ according to a gradient mechanism (Lion, 1967, Eykhoff, 1974). Selecting $J(\underline{\delta}; t) = \frac{1}{2}\epsilon^2(t)$ the gradient is

$$\text{grad}_{\underline{\delta}} J(\underline{\delta}; t) = \frac{\partial J}{\partial \underline{\delta}} = \frac{\partial \epsilon}{\partial \underline{\delta}} \epsilon(t) = \underline{u}(t) \epsilon(t) \quad (5.5a)$$

This leads to the adjustment law

$$\frac{d\underline{\hat{\theta}}(t)}{dt} = -\Lambda \text{grad } J(\underline{\delta}; t) = -\Lambda \underline{u}(t) \epsilon(t) \quad (5.5b)$$

where the gain matrix $\Lambda = \text{diag}[\lambda_i]$, the constants $\lambda_i > 0$ and $\Lambda \in \mathbb{R}^{(n+m+1) \times (n+m+1)}$. Since $\frac{d\underline{\hat{\theta}}(t)}{dt} = -\frac{d\underline{\hat{\theta}}(t)}{dt}$ eqns. (5.5) can be rewritten:

$$\frac{d\underline{\hat{\theta}}(t)}{dt} = \Lambda \underline{u}(t) \epsilon(t) \quad (5.6)$$

With eqn. (5.6) an adjustment law is given for the model parameters. The gain matrix Λ is usually diagonal and constant. It is used to scale the adjustments of the various model parameters. The values of λ_i follow from trial and error.

In this section a time-varying gain matrix is presented. Conditions are established for an arbitrary time-varying gain matrix.

When a matrix is selected that is related to the inverse of the process covariance matrix, a continuous version of the well known least-squares method is obtained. Consider instead of eqn. (5.6) a gradient algorithm

$$\frac{d\underline{\hat{\theta}}(t)}{dt} = -c(t) P(t) \underline{u}(t) \epsilon(t) \quad (5.7)$$

where $c(t)$ is a time variant *scalar* and $P(t)$ is a time variant matrix of appropriate dimensions: $P \in \mathbb{R}^{(n+m+1) \times (n+m+1)}$. It is assumed that $P(t)$ is

positive definite: $P(t) > 0$.

The convergence of the parameter difference vector $\underline{\delta}(t)$ towards the origin after an initial disturbance can be investigated using stability methods.

When the second method of Liapunov is applied, a Liapunov function is selected for the parameter difference $\underline{\delta}(t)$. The norm $\|\underline{\delta}(t)\|$ will then be shown to converge to zero if eqns. (5.6) or (5.7) are satisfied and the process input is sufficiently excited. For eqn. (5.6) Lion (1967) demonstrates this for Λ being a single constant. Udink ten Cate (1974) uses a diagonal constant matrix for a modified form of eqn. (5.6).

For eqn. (5.7) the convergence will be demonstrated below. To do so, for a process with bounded input signals a positive definite Liapunov function $V(t)$ is selected

$$V(t) = \underline{\delta}^T(t) P^{-1}(t) \underline{\delta}(t) \quad (5.8)$$

where $V(t)$ is a scalar, $P^{-1}(t) > 0$, symmetrical and P^{-1} is a bounded matrix of which the norm $\|P^{-1}(t)\| < L$; L being a positive scalar $L \in (0, \infty)$. The time derivative of $V(t)$ is obtained as

$$\frac{dV(t)}{dt} = 2\underline{\delta}^T(t) P^{-1}(t) \frac{d\underline{\delta}(t)}{dt} + \underline{\delta}^T(t) \frac{d P^{-1}(t)}{dt} \underline{\delta}(t) \quad (5.9)$$

With eqns. (5.7) and (5.4) it follows that

$$\frac{dV(t)}{dt} = -\underline{\delta}^T(t) (2 c(t) \underline{u}(t) \underline{u}^T(t) - \frac{d P^{-1}(t)}{dt}) \underline{\delta}(t) \quad (5.10)$$

From Liapunov theory, it follows that the convergence is ensured if the form (5.10) is negative definite. Therefore the form

$$D(t) \hat{=} 2 c(t) \underline{u}(t) \underline{u}^T(t) - \frac{d P^{-1}(t)}{dt} \quad (5.11)$$

has to be evaluated.

There are several selections of $P(t)$ and $c(t)$ that lead to the desired result. For instance, in the gradient law of eqn. (5.6) $P(t) = \Lambda$ and time invariant, so that $\frac{d P^{-1}(t)}{dt} = 0$. With $c(t)$ being unity this yields

$$D(t) = 2 \underline{u}(t) \underline{u}^T(t) \quad (5.12a)$$

and

$$\frac{dV(t)}{dt} = - 2\delta^T(t) \underline{u}(t) \underline{u}^T(t) \delta(t) = - 2\epsilon^2(t) \quad (5.12b)$$

which is a negative definite form provided $\delta(t)$ and $\underline{u}(t)$ are non-orthogonal.

Another choice is $P(t) = \Lambda$ and $c(t) > 0$ is a time-varying term, for example $c(t) = \frac{1}{t} + \xi$ ($\xi > 0$ an arbitrary small constant). Then

$$D(t) = 2 c(t) \underline{u}(t) \underline{u}^T(t) \quad , c(t) > 0 \quad (5.13a)$$

and

$$\frac{dV(t)}{dt} = - 2 c(t) \epsilon^2(t) \quad (5.13b)$$

which is again a negative definite form.

A selection leading to a continuous least-squares algorithm is

$$\frac{d P^{-1}(t)}{dt} = - \eta(t) P^{-1}(t) + \gamma(t) \underline{u}(t) \underline{u}^T(t) \quad , P^{-1}(0) > 0 \quad (5.14a)$$

so that

$$D(t) = 2 c(t) \underline{u}(t) \underline{u}^T(t) + \eta(t) P^{-1}(t) - \gamma(t) \underline{u}(t) \underline{u}^T(t) \quad (5.14b)$$

and

$$\begin{aligned} \frac{dV(t)}{dt} &= - \eta(t) \delta^T(t) P^{-1}(t) \delta(t) - \{2 c(t) - \gamma(t)\} \epsilon^2(t) = \\ &= - \eta(t) V(t) - \{2 c(t) - \gamma(t)\} \epsilon^2(t) \end{aligned} \quad (5.14c)$$

With $\eta(t) \geq 0$ and $\gamma(t) < 2c(t)$ this yields a negative definite form.

The positive definiteness of $P^{-1}(t)$ in eqn. (5.14a) can be demonstrated following a theorem on linear matrix equations found e.g. in Brockett (1970; p.59) stating that the solution of a linear matrix equation of the form

$$\frac{dX(t)}{dt} = A_1(t) X(t) + X(t) A_2(t) + F(t) \quad (5.15a)$$

with $A_1(t)$, $A_2(t)$ and $F(t)$ known is given by

$$X(t) = \Phi_1(t, t_0) X(t_0) \Phi_2^T(t, t_0) + \int_{t_0}^t \Phi_1(t, \sigma) F(\sigma) \Phi_2^T(t, \sigma) d\sigma \quad (5.15b)$$

where $\phi_1(t, t_0)$ is the transition matrix of $\frac{d\mathbf{x}(t)}{dt} = A_1(t)\mathbf{x}(t)$ with solution $\mathbf{x}(t) = \phi_1(t, t_0)\mathbf{x}(t_0)$ and $\phi_2(t, t_0)$ is the same for $\frac{d\mathbf{x}(t)}{dt} = A_2(t)\mathbf{x}(t)$.

X_0 is the initial value of $X(t)$ and σ is a dummy variable.

Rewriting eqn. (5.14b) with $X(t) = P^{-1}(t)$, $A_1(t) = A_2(t) = -\frac{1}{2}\eta(t)I - I$ being the unity matrix- and $F(t) = \gamma(t)\underline{u}(t)\underline{u}^T(t)$ it is seen that because $P^{-1}(t_0) > 0$ and because $\phi_1(t, t_0) = \phi_2(t, t_0)$ the first term of the right hand side of eqn. (5.16) is a decaying matrix which is positive semi-definite. The second term is positive definite since $\int \underline{u}(t)\underline{u}^T(t)$ is related to the process signal covariance matrix.

The selections of $P^{-1}(t)$ and $c(t)$ in eqns. (5.12-5.14) lead to negative definite forms for $\frac{dV(t)}{dt}$ provided $\hat{\delta}(t)$ and $\underline{u}(t)$ are non-orthogonal, and non-zero. This is the case when the process input signal is non-zero and contains sufficient distinct frequencies (Lion, 1967, Anderson, 1974). The expression $\frac{dV(t)}{dt}$ will then be negative definite with respect to $\|\hat{\delta}(t)\|$ so that asymptotic stability in the sense of Liapunov is ensured. This means that after an initial disturbance $\|\hat{\delta}(t)\|$ will converge to zero for $t \rightarrow \infty$.

The selections of $P(t)$ and $c(t)$ lead to various adjustment laws. The law that is related to eqns. (5.12) was given in eqn. (5.6). The adjustment law related to eqns. (5.13) is written:

$$\frac{d\hat{\delta}(t)}{dt} = c(t) \wedge \underline{u}(t) \varepsilon(t) \quad , c(t) > 0 \quad (5.16)$$

With for example $c(t) = \frac{1}{t} + \xi$ ($\xi > 0$), a time-decreasing gain factor results of the type that is also found in stochastic approximation schemes (Young and Jakeman, 1980). Related to eqns. (5.14) the adjustment law is formulated

$$\frac{d\hat{\delta}(t)}{dt} = c(t) P(t) \underline{u}(t) \varepsilon(t) \quad , c(t) > 0 \quad (5.17a)$$

$$\begin{aligned} \frac{dP(t)}{dt} &= \eta(t) P(t) - \gamma(t) P(t) \underline{u}(t) \underline{u}^T(t) P(t) \\ & \quad , \eta(t) \geq 0 \\ & \quad \gamma(t) < 2c(t) \end{aligned} \quad (5.17b)$$

Eqn. (5.17b) follows from eqn. (5.14a) using the relation for an arbitrary non singular matrix $A(t)$ that

$$\frac{dA^{-1}(t)}{dt} = -A^{-1}(t) \frac{dA(t)}{dt} A^{-1}(t)$$

which follows from $A^{-1}(t)A(t) = I$. The result of eqns. (5.17) is the *continuous* least-squares algorithm because of the similarity with the recursive least-squares *algorithm* in discrete time. In Young (1981) a related algorithm is described where $\eta(t) = 0$, $c(t) = 1$ and $\gamma(t) = 1$ and which is not motivated from a stability point of view.

It is noted that the vector $\underline{u}(t)$ and $\varepsilon(t)$ requires the generation of n derivative signals for a n^{th} order process. This can be accomplished by *state variable filters* (Kohr, 1967). Some experience with these methods (Udink ten Cate and Verstoep, 1974) indicates that high order derivatives are susceptible to errors, limiting the feasibility of the method to 1st or 2nd order processes.

Because of the complexity associated with the adjustment laws (5.17) in a practical situation a computer is applied using numerical integration-differentiation on sampled data of the process. Another approach is to estimate the parameters of a discrete model of the process, leading to the discrete gradient method that is described in the following section.

5.3 A least-squares like gradient method for discrete process identification *

A. J. UDINK TEN CATE† and H. B. VERBRUGGEN‡

A new deterministic 'least-squares-like gradient' method is presented for the identification of discrete processes. The method is gradient-based and physically similar to the recursive least-squares method. The novel gradient method is based on a stability concept (Liapunov's second method) yielding new views on the estimation procedure and more degrees of freedom compared with least-squares methods. The method can be applied for linear and a class of non-linear (multivariable) processes with slowly time-varying unknown parameters.

1. Introduction

In control theory, recursive least-squares techniques have found widespread acceptance for the identification of dynamic processes. The least-squares (LS) technique originates from a statistical approach. In most texts on the subject reference is made to the presumable similarity between gradient-like techniques and LS (Eykhoff 1974, Young 1969). This motivated the authors to investigate this similarity in some detail, since, compared with the LS method, the usual discrete gradient techniques suffer from poor performance.

In gradient methods, the study of the convergence of the parameter estimates to their true values is of interest (Graupe and Fogel 1976), see also Åström *et al.* (1977) for the self-adjusting controller. In deterministic discrete gradient methods the second method of Liapunov is applied for this purpose (Mendel 1973, 1974). In this paper a novel gradient method is introduced in which the so-called 'gain' matrix is the inverse of the signal covariance matrix, which results in a technique that bears close resemblance to the LS method and therefore is called the 'least-squares-like gradient' (LSLG) technique. Because of the similarity, the two methods are compared throughout this paper. The convergence of the LSLG method is investigated by Liapunov's second method. The attention is focused on the convergence, yielding interesting new views on the estimation procedure and more degrees of freedom compared with LS. The additional degrees of freedom could be used to accelerate convergence.

In this paper the emphasis is put on the investigation of limitations in the choice of the parameters of the estimation procedure which are compared with the ones used in good engineering practice in LS techniques but are not justified theoretically. The new technique is an *a-priori* identifier (and not an *a-posteriori*, like LS) which makes the LSLG applicable to a class of

Received 14 November 1977.

† Department of Physics and Meteorology, Agricultural University, Wageningen, The Netherlands.

‡ Control Engineering Laboratory, Department of Electrical Engineering, Delft University of Technology, Delft, The Netherlands.

CON.

6 H

* Reprinted with permission of the publisher.

problems where LS is not, and vice versa. This, and the fact that the LSLG is based on a stability concept, makes the new technique promising for adaptive control applications.

In our approach Liapunov's second method is used. Readers familiar with the results of Popov's hyperstability theory in this field (Landau 1976, Landau and Béthoux 1975) will observe similarities. And differences too, because Liapunov theory concentrates on the convergence of the estimation, whereas hyperstability concentrates on the stability of the estimation scheme.

The authors recall the recent discussion between Bierman (1976) and Mendel on the subject of identification methods. The former advocates an approach of rigorously numerical mathematics, the latter defends the opinion that it might be valuable to look into the problem from a control (= stability) point of view. We feel that our study is in favour of Mendel's arguments.

In this paper the LSLG technique is presented for processes with time-invariant, or slowly time-varying parameters (§§ 2 and 3). In § 4 a comparison is made with the recursive LS technique. Extensions of the LSLG and the multivariable identification problem are treated in § 5. Finally, the choice of the parameters of the estimation procedure is discussed and results are presented of the identification of analogously simulated systems comparing the LS and LSLG methods.

2. Least-squares-like gradient method (LSLG)

Consider a single-input, single-output, linear process with unknown time-invariant parameters, described by the difference equation

$$\sum_{i=0}^N a_i y(kT_s - iT_s) = \sum_{j=0}^M b_j x(kT_s - jT_s), \quad a_0 = 1 \quad (1)$$

where $y(iT_s)$ and $x(jT_s)$ are the sampled process output and input signals respectively, and T_s is the sampling interval. In most cases b_0 will be zero. Define $y(iT_s)$ as $y(i)$ and $x(jT_s) = x(j)$ and the vectors $\theta^T = (b_0, b_1, \dots, b_M, -a_1, -a_2, \dots, -a_N)$ and $\mathbf{u}^T(k) = (x(k), x(k-1), \dots, x(k-M), y(k-1), \dots, y(k-N))$ with $\theta, \mathbf{u} \in R^{N+M+1}$. The superscript T denotes the transpose. Equation (1) can be written as

$$y(k) = \theta^T \mathbf{u}(k) \quad (2)$$

The parameters of the process are estimated by a model of similar structure and dimension, described by

$$\hat{y}(k) = \hat{\theta}^T(k) \mathbf{u}(k) \quad (3)$$

where $\hat{\theta}(k)$ denotes the estimated values of θ at time kT_s and

$$\hat{\theta}^T(k) = (\hat{b}_0(k), \hat{b}_1(k), \dots, \hat{b}_M(k), -\hat{a}_1(k), -\hat{a}_2(k), \dots, -\hat{a}_N(k))$$

The parameter difference between the model and the process is defined by the vector $\delta(k) \triangleq \hat{\theta}(k) - \theta$. Assuming that noise-free measurements $\mathbf{u}(k)$ are available, the difference can be measured indirectly by the 'generalized error model' (Eykhoff 1974) or the 'equation error' (Mendel 1973): $e(k) \triangleq \hat{y}(k) - y(k)$, which yields eqn. (4):

$$e(k) \triangleq \hat{y}(k) - y(k) = \hat{\theta}^T(k) \mathbf{u}(k) - \theta^T \mathbf{u}(k) = \delta^T(k) \mathbf{u}(k) \quad (4)$$

In the deterministic gradient method (Mendel 1973), a criterion function $J(\boldsymbol{\delta}(k)) = \frac{1}{2}w(k)e^2(k)$ is defined, which is an instantaneous function of the parameter difference; $w(k) > 0$ is an instantaneous weighting factor.

The sequential algorithm is described generally by

$$\hat{\boldsymbol{\theta}}(k+1) = \hat{\boldsymbol{\theta}}(k) - \Lambda(k) \frac{\partial J(\boldsymbol{\delta}(k))}{\partial \hat{\boldsymbol{\theta}}(k)} \quad (5)$$

where $\Lambda(k)$ is an $(M+N+1) \times (M+N+1)$ matrix weighting the various gradients and is referred to as the 'gain' matrix. Usually $\Lambda(k)$ is a time-invariant and diagonal matrix and $w(k)$ is chosen unity.

If $\boldsymbol{\theta}$ is time-invariant, the gradient follows from

$$\frac{\partial J(\boldsymbol{\delta}(k))}{\partial \hat{\boldsymbol{\theta}}(k)} = \frac{\partial J(\boldsymbol{\delta}(k))}{\partial \boldsymbol{\delta}(k)} = w(k)e(k)\mathbf{u}(k) \quad (6)$$

which yields eqn. (7):

$$\hat{\boldsymbol{\theta}}(k+1) = \hat{\boldsymbol{\theta}}(k) - w(k)\Lambda(k)e(k)\mathbf{u}(k) \quad (7)$$

Note that $\hat{\boldsymbol{\theta}}(k+1)$ can be calculated as soon as the information $\mathbf{u}(k)$ is available, thus at time $t = kT_s + \epsilon$ (ϵ : computing time).

The problem is the choice of $\Lambda(k)$. Moreover, the parameters $\hat{\boldsymbol{\theta}}$ converge slowly to the parameters $\boldsymbol{\theta}$, especially when $\Lambda(k)$ is chosen constant. However, the algorithm is computationally simple.

In the following a weighted gradient method is presented with the interesting feature:

$\Lambda(k)$ is chosen time-dependent and non-diagonal, leading to a better convergence at the cost of more computing time for each step of the sequential algorithm. $\Lambda(k)$ is automatically updated and indirectly related to the signals $\mathbf{u}(k)$.

The algorithm to be presented shows a close resemblance to the least-squares method (LS) and therefore is called the LS-like gradient (LSLG) method. The convergence of the parameter difference will be demonstrated by Liapunov's second method (Mendel 1973).

The LSLG algorithm is in its basic form described by

$$\boldsymbol{\delta}(k+1) = \boldsymbol{\delta}(k) - \alpha(k)w(k)P(k)e(k)\mathbf{u}(k), \quad \alpha(k) > 0 \quad (8a)$$

$$P^{-1}(k+1) = P^{-1}(k) + w(k)\mathbf{u}(k)\mathbf{u}^T(k) \quad (8b)$$

The algorithm of eqn. (8a) can be compared to the one defined in eqn. (7), with $\boldsymbol{\delta}(k+1) - \boldsymbol{\delta}(k) = \hat{\boldsymbol{\theta}}(k+1) - \hat{\boldsymbol{\theta}}(k)$, and $P(k)$ is a time-varying gain matrix comparable with Λ in eqn. (7). The scalar $\alpha(k) > 0$ follows from stability analysis, as is shown later. The gain matrix $P(k)$ is updated by the algorithm like the one of eqn. (8b). Instead of the inverse matrix $P^{-1}(k)$, also the matrix $P(k)$ can be calculated recursively as is shown in Appendix C.

Now it will be shown that this procedure guarantees convergence of the difference vector to zero under very ample conditions by applying Liapunov's stability method. Choose the following Liapunov function :

$$V(k) = \delta^T(k)P^{-1}(k)\delta(k) \quad (9)$$

with $P^{-1}(k)$ as a positive definite symmetrical matrix, denoted by $P^{-1}(k) > 0$. In Appendix A it is shown that $P^{-1}(k+1) > 0$ and is also symmetrical, using eqn. (8 b). The convergence of the parameter difference vector is investigated by evaluating

$$\Delta V(k) \triangleq V(k+1) - V(k) \quad (10)$$

which has to be negative definite to guarantee asymptotic stability of the equilibrium $\delta(k) = \mathbf{0}$ of the set of equations (Mendel 1973).

The scalar $\alpha(k) > 0$ is selected as follows :

$$\alpha(k) = [\mu(k) + w(k)\mathbf{u}^T(k)P(k)\mathbf{u}(k)]^{-1}, \quad \mu(k) \geq 0 \quad (11 a)$$

A criterion for the choice of $\mu(k)$ will be discussed later.

In Appendix B it is shown that after substitution of eqn. (9) in eqn. (10), using eqns. (8) and (3) the following equation results :

$$\Delta V(k) = -w(k)\alpha^2(k)e^2(k)(-\mu^2(k) + 2\mu(k) + w(k)\mathbf{u}^T(k)P(k)\mathbf{u}(k)) \quad (11 b)$$

This expression is non-positive definite if the following conditions are fulfilled :

$$w(k) > 0, \quad 0 \leq \mu(k) < 2 \quad (12)$$

Then $\Delta V(k) = 0$ for $e(k) = 0$. This is the case, see eqn. (4), if $\delta(k) = \mathbf{0}$, $\mathbf{u}(k) = \mathbf{0}$ or $\delta(k)$ and $\mathbf{u}(k)$ are orthogonal.

Excluding the case $\mathbf{u}(k) = \mathbf{0}$ (the system is not excited), the special case is left that $\delta(k)$ and $\mathbf{u}(k)$ are orthogonal. In Mendel (1973, 1974) it is stated, following Lion (1967), that if the process input is a periodic one and contains sufficient distinct frequencies, a gradient algorithm of the form of eqn. (7) is asymptotically stable in the large according to Liapunov's second method. This theorem obviously holds for eqn. (8), so that after an initial disturbance the Euclidean norm $\|\delta(k)\|$ will converge to zero for $k \rightarrow \infty$.

Remark 1

The rate of convergence of $\|\delta(k)\|$ depends on $\Delta V(k)/V(k)$, a relative measure, while the convergence of $\|\delta(k)\|$ depends on $\Delta V(k)$, an absolute measure. For a given $V(k)$ the value of $\Delta V(k)$ is a measure for the convergence. An optimal value of $\Delta V(k)$ is obtained by minimizing ΔV for the parameter $\mu(k)$ which can still be chosen within the above-mentioned limits.

By evaluating $\partial \Delta V(k)/\partial \mu(k) = 0$ the optimum value $\mu(k) = 0$ is found. For a discussion on the validity of this approach for a similar problem the reader is referred to Mendel (1974), Bransby (1976) and finally to Graupe and Fogel (1976).

From eqns. (11 a) and (11 b) with the condition $\mu(k) = 0$ it can be seen that $\Delta V(k) = -[\mathbf{u}^T(k)P(k)\mathbf{u}(k)]^{-1}e^2(k)$, thus $w(k)$ can be chosen arbitrarily, for instance $w(k) = 1$.

In a practical implementation however the scalar $\alpha(k)$ in eqn. (11 a) can go to infinity for small values of \mathbf{u} . This problem can be overcome by choosing $w(k)$ very large or by putting $\mu(k)$ to a value $\mu(k) = \epsilon$, if $\alpha(k)$ exceeds an upper limit. Since $\mu(k)$ appears in the expression of $\alpha(k)$ only, one might as well limit $\alpha(k)$ directly to a maximum value. If $\mu(k)$ is chosen $\mu(k) = 1$, from eqns. (11) it can be seen that $\Delta V(k) = -w(k)\alpha(k)e^2(k)$ with $\alpha(k) = [1 + w(k)\mathbf{u}^T(k)P(k)\mathbf{u}(k)]^{-1}$.

This is an interesting case which can be compared to the results of the LS method (§ 4).

Remark 2

From eqn. (8 b) the influence of the magnitude of the input-output signal vector \mathbf{u} can be demonstrated. Large values of \mathbf{u} cause a relatively large increase of $\|P^{-1}(k+1)\|$. Because of the validity of the above approach, using Liapunov's theory, $\Delta V(k+1)$ will be negative definite, so that $V(k+1)$ will decrease. Therefore $\|\delta(k+1)\|$ decreases faster than $\|P^{-1}(k+1)\|$ increases. This is in accordance with the experience that the convergence of the estimation is accelerated by increasing the magnitude of the signal vector \mathbf{u} .

Remark 3

From eqn. (8 b) the influence of the magnitude of $\|P^{-1}(0)\|$ can be demonstrated. A small value of $\|P^{-1}(0)\|$ yields a small value of $V(0)$ and accordingly $\Delta V(k)$ will decrease very slow; a large value of $\|P^{-1}(0)\|$ yields a large value of $V(0)$ and $\Delta V(k)$ will decrease very fast (see Fig. 1 for a one-dimensional case). The convergence of $\hat{\theta}(k)$ to θ is however determined by $\Delta V/V$.

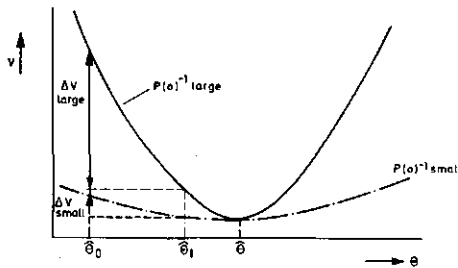

Figure 1. Influence of $P(k)$ on the Liapunov function $V(k)$ for $k=0$.

The LSLG algorithm of eqn. (8) can be rewritten, with eqn. (11 a) and the results of Appendix C, and since $\delta(k+1) - \delta(k) = \hat{\theta}(k+1) - \hat{\theta}(k)$ as

$$\hat{\theta}(k+1) = \hat{\theta}(k) - \alpha(k)w(k)e(k)P(k)\mathbf{u}(k), \quad w(k) > 0 \quad (13 a)$$

$$\alpha(k) = [\mu(k) + w(k)\mathbf{u}^T(k)P(k)\mathbf{u}(k)]^{-1}, \quad 0 \leq \mu(k) < 2 \quad (13 b)$$

$$P(k+1) = P(k) - w(k)P(k)\mathbf{u}(k)[1 + w(k)\mathbf{u}^T(k)P(k)\mathbf{u}(k)]^{-1}\mathbf{u}^T(k)P(k) \quad (13 c)$$

This algorithm can be applied for the parameter estimation of time-invariant processes. In the next section the method is extended to time-varying systems.

3. Slowly time-varying parameters

In the preceding section the process and the parameters were assumed to be time-invariant. In the algorithm of eqn. (8) the norm $\|P^{-1}(k)\|$ will gradually increase as new measurements of \mathbf{u} become available, so that $\|P(k)\|$ will decrease. This means that new process measurements give rise to smaller adjustments in the estimation of $\hat{\theta}(k)$. See also Young (1969) for a similar discussion in LS identification. When θ is slowly time-varying, which means that θ can be considered time-invariant during a sampling interval, old measurements have to be forgotten gradually in order to be able to track the parameter variations. This can be accomplished by changing eqn. (8 b) into

$$P^{-1}(k+1) = \beta(k)P^{-1}(k) + \gamma(k)w(k)\mathbf{u}(k)\mathbf{u}^T(k) \quad (14)$$

where the 'fading memory' or 'exponential weighting' factor $\beta(k)$ (Eykhoff 1974) and $\gamma(k) \geq 0$ are factors related to the rate of change of the process parameters; $0 < \beta(k) \leq 1$. It can be seen that for $\beta(k) < 1$ old data are forgotten in an exponential way. By taking $\gamma(k) > 1$ the influence of the last measured data can be enlarged. In eqn. (8 b) $P^{-1}(k+1)$ will always increase for $w(k) \neq 0$. According to eqn. (14), however, $P^{-1}(k+1)$ will increase or decrease. In Appendix A it is proved that $P^{-1}(k+1) > 0$ if $P^{-1}(0) > 0$.

Choosing the Liapunov function of eqn. (9) it is demonstrated in Appendix B that after substitution of eqn. (9) in eqn. (10), using eqns. (8 a), (14) and (3), we obtain

$$\Delta V(k) = (\beta(k) - 1)V(k) + w(k)e^2(k)A \quad (15)$$

with

$$A = \alpha^2(k)[\gamma(k)\mu^2(k) - 2\mu(k)\beta(k) - \beta(k)w(k)\mathbf{u}^T(k)P(k)\mathbf{u}(k)] \quad (16)$$

If $\mu(k) = 0$ or if $\mu(k) > 0$ and $\gamma(k)\mu(k) < 2\beta(k)$ we get the scalar expression $A < 0$. Note that for $0 < \beta(k) < 1$ the expression $\Delta V(k)$ is negative definite with respect to $\delta(k)$, which is not the case in eqn. (11 b) with eqn. (12).

This theoretical result would indicate that the parameter difference will always converge to zero and that there are not restrictions on \mathbf{u} , as discussed in § 2. However, if $0 < \beta < 1$, $P^{-1}(k) \rightarrow 0$ in the limit if the matrix, summing the sequence $\gamma(k)w(k)\mathbf{u}(k)\mathbf{u}^T(k)$, is singular or zero (Appendix A). This will not be so if the process input signal is persistently excited (Åström and Bohlin 1966). This remark adds to the conception of Liapunov stability for processes with periodic (Lion 1967) or almost-periodic (Anderson 1977) input signals. The authors do not wish to investigate this matter in detail here.

Remark 4

As described in Remark 1, an optimal value of $\mu(k)$ can be obtained in this case too by evaluating the partial derivative of $\Delta V(k)$ with respect to $\mu(k)$, which yields the optimal value $\mu(k) = 0$.

Remark 5

In § 2 it is demonstrated that ΔV is non-positive definite in spite of the fact that $P^{-1}(k+1)$ is increasing in eqn. (9), see eqn. (8 b). Thus the parameter vector will decrease strongly. In this section it is demonstrated that ΔV is negative definite ; moreover $P^{-1}(k+1)$ can as well increase as decrease, see eqn. (14). Therefore, the parameter vector might decrease in a very slow manner. To avoid this it is possible to increase \mathbf{u} or to increase $\gamma(k)$. By choosing $\gamma(k)=0$ a constant value of $\|P^{-1}(k+1)\|$ is found, whereas $\hat{\boldsymbol{\theta}}(k+1)$ will still be adjusted.

4. Comparison with the least-squares method

In this section the proposed LSLG algorithm is compared with that of the weighted LS method. The LSLG algorithm can be written as

$$\hat{\boldsymbol{\theta}}(k+1) = \hat{\boldsymbol{\theta}}(k) - \alpha(k)w(k)e(k)P(k)\mathbf{u}(k) \tag{17 a}$$

$$\alpha(k) = [\mu(k) + w(k)\mathbf{u}^T(k)P(k)\mathbf{u}(k)]^{-1} \tag{17 b}$$

$$P(k+1) = \frac{1}{\beta(k)} P(k) - \frac{\gamma(k)}{\beta(k)} w(k)P(k)\mathbf{u}(k) \times [\beta(k) + \gamma(k)w(k)\mathbf{u}^T(k)P(k)\mathbf{u}(k)]^{-1}\mathbf{u}^T(k)P(k) \tag{17 c}$$

where $w(k) > 0$; $0 < \beta(k) \leq 1$, $\gamma(k) \geq 0$ and

$$\{\mu(k) = 0\} \cup \{\mu(k) > 0 \cap \mu(k)\gamma(k) \leq 2\beta(k)\} \tag{17 d}$$

Expression (17 c) follows from eqn. (14), as is demonstrated in Appendix C. When $\beta(k) = \gamma(k) = 1$ the algorithm of eqn. (17) is identical to eqn. (11) for time-invariant parameters.

The weighted LS algorithm (Mendel 1973, Young 1969) is written in a similar notation :

$$\hat{\boldsymbol{\theta}}(k+1) = \hat{\boldsymbol{\theta}}(k) - a(k+1)w(k+1) \times \{\hat{\boldsymbol{\theta}}^T(k)\mathbf{u}(k+1) - y(k+1)\}P(k)\mathbf{u}(k+1) \tag{18 a}$$

$$P(k+1) = \frac{1}{\lambda(k+1)} P(k) - \frac{a(k+1)}{\lambda(k+1)} w(k+1)P(k)\mathbf{u}(k+1)\mathbf{u}^T(k+1)P(k) \tag{18 b}$$

$$a(k+1) = [\lambda(k+1) + w(k+1)\mathbf{u}^T(k+1)P(k)\mathbf{u}(k+1)]^{-1} \tag{18 c}$$

In eqn. (18) $\lambda(k)$ is the exponential weighting factor $0 < \lambda(k+1) \leq 1$.

Usually eqns. (18) are written in a different form with the matrix $P(k+1)$ appearing in eqn. (18 a). The equivalence of the set of eqns. (18) with those of the usual notation is readily demonstrated (Eykhoff 1974). Comparing the eqns. (17) and (18), the similarity between the two algorithms is striking, especially if we choose $\beta(k) = \mu(k) = \lambda(k+1)$ and $\gamma(k) = 1$.

Now the difference between the two algorithms is that the LS algorithm calculates the value of $\hat{\boldsymbol{\theta}}(k+1)$ at time $t = (k+1)T_s$ (*a-posteriori* identification) and the LSLG algorithm calculates a trial value of $\hat{\boldsymbol{\theta}}(k+1)$ at time $t = kT_s$ (*a-priori* identification) (Mendel 1973). As a result the error $e(k)$ in eqn. (17 a) differs slightly from the predicted error $(\hat{\boldsymbol{\theta}}^T(k)\mathbf{u}(k+1) - y(k+1))$ in

eqn. (18 a). In a practical situation, however, there is little difference between both algorithms.

The difference is mainly caused by the number of parameters which can be selected in the algorithm and which is two in the LS-algorithm instead of four in the LSLG algorithm. Moreover, the LSLG algorithm is based on the Liapunov approach, which guarantees asymptotic stability of the parameter difference for deterministic measurements. The LS algorithm is based on a statistical approach which guarantees under certain circumstances an unbiased and convergent estimate of θ for measurements contaminated with noise.

Remark 6

In the LSLG algorithm the optimal value $\mu(k)=0$ can be chosen, whereas in the LS algorithm $\mu(k)=1$.

Remark 7

In the literature on LS methods (Eykhoff 1974, Young 1969), the starting matrix $P(0)$ of $P(k)$ is usually chosen as a diagonal matrix with elements of a high value to satisfy theoretical requirements, originating from the fact that the recursive algorithm is derived from a batch procedure. Theoretically the starting matrix $P(0)=\eta I$ with a large value of η ($> 10^5$) leads to a good parameter convergence; however, in practice, due to small measurement errors, erroneous results are found for the first computations (Scheurer 1975). For this reason usually a smaller value of η is chosen.

In the LSLG method $P(0)$ can be set to any value provided $P^{-1}(0) > 0$, which is also established in practical experience with the method. In practice, however, $P(0)$ should not be chosen too small.

Remark 8

In the LSLG method $\gamma(k)$ can be set to zero, which means that $P(k)$ is not updated. In practice $P(k)$ will tend to quasi-stationary values after an initial disturbance, so that setting $\gamma(k)=0$ for some k can be advantageous by reducing computing time without influencing the performance of the method.

Remark 9

It is noted that the algorithms of eqns. (17 b) and (18 b) for evaluating $P(k+1)$ are sensitive to small measurement and computational errors. Therefore it is recommended to evaluate either the upper triangular part of the symmetric matrix $P(k+1)$ or to use an algorithm proposed by Mendel (1973) for the LS method, which is less sensitive.

Concluding this section it has been shown that in comparison to the LS method, the LSLG method has more flexibility, resulting in an improved convergence or a more 'robust' version of the LS algorithm with guaranteed stability of the method. Nevertheless, more parameters ($\beta(k)$, $\gamma(k)$, $\mu(k)$ and $w(k)$) have to be chosen than in the LS case where only two parameters $w(k)$ and $\lambda(k)$ have to be chosen. At a first glance the choice of the parameters might seem to be not always obvious, and there is an interaction of the influences of the various parameters. In § 6 some rules are given for the selection of these parameters.

Remark 10

As was mentioned already, the difference between the LSLG method and the conventional discrete gradient method is caused by the gain matrix $P(k)$. It was seen that $P(k)$ usually decreases after the start of the identification procedure. In order to improve convergence in gradient methods a decreasing gain matrix can also be applied (Mendel 1973). The difference with the LSLG is that the (decreasing or increasing, see Remark 5) LSLG gain matrix is based on the inverse signal covariance matrix, which leads to the observed similarity with the LS method. From the practical point of view and disregarding the small difference between *a-priori* and *a-posteriori* type of identification, the conventional discrete gradient method can be regarded as a special case of stochastic approximation, of which the convergence proofs can follow from stability methods (Albert and Gardner 1967). These results can, however, not be extended to LS methods (Graupe and Fogel 1976). A stochastic version of the LSLG may generalize the deterministic results into the framework of stochastic approximation.

Remark 11

The recent results of Åström *et al.* (1977) on the convergence of self-tuning regulators—where LS methods are applied—are to be mentioned here. Following a stability approach, the results in the regulator problem for LS methods are obtained by writing the discrete algorithms as differential equations in the continuous-time domain. It is noticed that the results for the LSLG are obtained in discrete time and are so far only valid for deterministic signals.

5. Extensions of the algorithm

5.1. A class of time-varying parameters

The LSLG algorithm can also be applied to a process with time-varying process parameters $\theta(k)$, described by

$$\theta(k) = R(k)\phi \tag{19}$$

where $\phi \in R^L$ are constant or slowly time-varying process parameters (see § 3) and $R(k) \in R^{M \times L}$ is an *a-priori* known time-varying matrix (Mendel 1973). According to eqn. (4) the equation error can be written with eqn. (19) :

$$e(k) = (\hat{\theta}(k) - \theta(k))^T \mathbf{u}(k) = (\hat{\phi}(k) - \phi)^T R^T(k) \mathbf{u}(k) \tag{20}$$

As the Liapunov function is selected, according to eqn. (9) :

$$V(k) = (\hat{\phi}(k) - \phi)^T P^{*-1}(k) (\hat{\phi}(k) - \phi) \tag{21}$$

Following the same reasoning as in § 2 it is readily verified that asymptotic convergence of $\hat{\phi}(k) - \phi$ is guaranteed and a slightly modified algorithm is found substituting $R^T(k)\mathbf{u}(k)$ for $\mathbf{u}(k)$, $P^*(k)$ for $P(k)$ and $\hat{\phi}(k)$ for $\hat{\theta}(k)$ in eqns. (17).

The matrix $R(k)$ could also contain known time-invariant quantities, in order to reduce the number of process parameters to be identified, for instance, in a closed-loop identification. Hang (1974) and Udink ten Cate (1976) have followed this approach in the design of multivariable continuous adaptive systems.

It is noted that the LSLG method, which is an *a-priori* identifier, can be applied using the *a-priori* knowledge of $R(k)$, while the *a-posteriori* LS identifier cannot be used in this way for this class of systems.

5.2. Multivariable processes

In this section the LSLG method will be formulated for a multivariable process. The approach outlined in this section is equivalent to that of Udink ten Cate (1975) for a conventional discrete gradient technique; see also Kudva and Narendra (1974). The process with unknown, time-variant or slowly time-varying parameters is described by

$$\mathbf{y}(k+1) = A\mathbf{y}(k) + B\mathbf{x}(k) \quad (22)$$

where the process state vector $\mathbf{y} \in R^N$, the input vector $\mathbf{x} \in R^M$ and consequently $A \in R^{N \times N}$, $B \in R^{N \times M}$. A more convenient notation is obtained:

$$\mathbf{y}(k+1) = \Phi \mathbf{z}(k) \quad (23 a)$$

$$\Phi = [A; B], \quad \mathbf{z}^T(k) = [\mathbf{y}^T(k); \mathbf{x}^T(k)] \quad (23 b)$$

where $\Phi = |\theta_{ij}|$. The corresponding model is written as

$$\hat{\mathbf{y}}(k+1) = \hat{\Phi}(k+1)\mathbf{z}(k) \quad (24)$$

In this multivariable identification problem a vector equation error is defined as $\mathbf{e}(k) \triangleq \hat{\mathbf{y}}(k) - \mathbf{y}(k)$. By defining $D(k) \triangleq \hat{\Phi}(k+1) - \Phi(k+1)$, and for convenience (in order to get the same structure as given in eqn. (4)) a vector $\mathbf{u}(k)$ is introduced defined by $\mathbf{u}(k) \triangleq \mathbf{z}(k-1)$. The following equation error vector is found:

$$\mathbf{e}(k) = D(k)\mathbf{u}(k) \quad (25)$$

The i th row of the matrix $D(k)$ is denoted $\mathbf{d}_i(k)$. If the process parameter matrix Φ contains slowly time-varying quantities, the LSLG algorithm becomes in its basic form

$$\mathbf{d}_i(k+1) = \mathbf{d}_i(k) - \alpha_i(k)w_i(k)e_i(k)P_i(k)\mathbf{u}(k) \quad (26 a)$$

$$P_i^{-1}(k+1) = \beta_i(k)P_i^{-1}(k) + \gamma_i(k)w_i(k)\mathbf{u}(k)\mathbf{u}^T(k) \quad (26 b)$$

Note the similarity with the univariate formulation as presented in eqns. (8). A Liapunov function is selected, cf. eqn. (9):

$$V(k) = \sum_{i=1}^N \mathbf{d}_i^T(k)P_i^{-1}(k)\mathbf{d}_i(k) \quad (27)$$

Because of the equivalence of the single terms of the sum in eqn. (27) with the univariate identification problem, it is stated without proof that the LSLG algorithm of eqn. (26) yields a negative definite form $\Delta V(k) \triangleq V(k+1) - V(k)$.

Therefore, the algorithm is asymptotically stable with respect to the parameter difference. From eqns. (26) the LSLG algorithm can be written for a multivariable process ; with $\hat{\theta}_i(k)$ denoting the i th row of $\hat{\Phi}(k)$:

$$\hat{\theta}_i(k+1) = \hat{\theta}_i(k) - \alpha_i(k)w_i(k)e_i(k)P_i(k)\mathbf{u}(k) \tag{28 a}$$

$$\alpha_i(k) = [\mu_i(k) + w_i(k)\mathbf{u}^T(k)P_i(k)\mathbf{u}(k)]^{-1} \tag{28 b}$$

$$P_i(k+1) = \beta_i^{-1}(k)(P_i(k) - \alpha_i^*(k)\gamma_i(k)w_i(k)P_i(k)\mathbf{u}(k)\mathbf{u}^T(k)P_i(k)) \tag{28 c}$$

$$\alpha_i^*(k) = [\beta_i(k) + \gamma_i(k)w_i(k)\mathbf{u}^T(k)P_i(k)\mathbf{u}(k)]^{-1} \tag{28 d}$$

with $w_i(k) > 0$, $0 < \beta_i(k) \leq 1$, $\gamma_i(k) \geq 0$ and

$$\{\mu_i(k) = 0\} \cup \{\mu_i(k) > 0 \cap \mu_i(k)\gamma_i(k) \leq 2\beta_i(k)\} \tag{28 e}$$

The eqns. (28) present the LSLG algorithm for the identification of a multi-variable process. Regarding the similarity of the terms of the sum of the Liapunov function in eqn. (27), and the Liapunov function selected in eqn. (9) for the single-input, single-output process, the observations and remarks made in the preceding sections will also hold for the algorithm of eqn. (28). This means that criteria are present for the selection of the scalars $\beta_i(k)$, $\gamma_i(k)$, $w_i(k)$, $\mu_i(k)$ and the starting values $P_i(0)$.

5.3. Other extensions

The LSLG method can also be applied to identify a class of non-linear processes, where the process parameters enter linearly into the equation error (Mendel 1973). This is analogous to continuous gradient methods (Lion 1967) and the LS method.

In most identification problems part of the process parameters are known beforehand. This might be used to simplify considerably the identification algorithm by identifying the unknown parameters only or alternatively to check the proper operation of the algorithm by estimating the known parameters too. It is readily demonstrated that the LSLG can include known parameters.

So far it was assumed both for the LS and the LSLG method that the process signals were exactly measurable. When $\mathbf{u}(k)$ is contaminated, even by zero mean noise, the estimation of the parameters will be biased except for the case $\alpha_i = 0$ for $i = 1, \dots, N$, and for the case when the noise is white and coloured by an auto-regression filter of the same transfer function as the denominator of the process transfer function. A biased estimation occurs even with a relatively low noise level. When the frequency band of the noise can be separated from the frequency band of the process signals, the noise influence can be reduced by prefiltering the process input and output (Mendel 1973, Lion 1967).

6. Selection of the parameters of the algorithm

As is shown in the previous sections, a number of parameters has to be set before the LSLG algorithm can be applied. The results presented in this

section, are related to the estimation of various second-order systems (see Table 1), simulated both inside and outside the computer. As a test-signal a block-signal is used with a period of 20 s, a maximum value of 2 V and a minimum value of 0 V.

	Continuous system					Discrete system			
	$H(s) = \frac{d_1 s + d_2}{c_0 s^2 + c_1 s + c_2}$					$H_0 H(z) = \frac{a_1 z^{-1} + a_2 z^{-2}}{1 + b_1 z^{-1} + b_2 z^{-2}}$			
						$T_s = 1$			
	d_1	d_2	c_0	c_1	c_2	a_1	a_2	b_1	b_2
1. Overdamped	0	2	20	9	1	0.043	0.037	-1.598	0.638
2. Damped	0	10	20	9	11	0.207	0.178	-1.214	0.637
3. Non-min. phase	-3	1	5	6	1	-0.270	0.384	-1.187	0.301

Table 1.

6.1. The factor $w(k)$

When the identification procedure begins, during the first iterations the influence of a time-invariant parameter value of $w(k) = w$ is similar to the influence of η in the diagonal matrix $P(0) = \eta I$ if $\eta w \gg \|\mathbf{u}(0)\mathbf{u}^T(0)\|$. In that case (see eqn. (8 b)) it follows with $\gamma(k) = \beta(k) = 1$:

$$\frac{P^{-1}(1)}{w} = \frac{P^{-1}(0)}{w} + \mathbf{u}(0)\mathbf{u}^T(0) = \frac{1}{\eta w} + \mathbf{u}(0)\mathbf{u}^T(0) \simeq \mathbf{u}(0)\mathbf{u}^T(0) \quad (29)$$

Substituting $P^{*-1}(k)$ for $(1/w)P^{-1}(k)$ or $P^*(k)$ for $wP(k)$ yields with eqns. (13) and (13 b):

$$\hat{\boldsymbol{\theta}}(k+1) = \hat{\boldsymbol{\theta}}(k) - \alpha(k)e(k)P^*(k)\mathbf{u}(k) \quad (30 a)$$

$$\alpha(k) = [\boldsymbol{\mu}(k) + \mathbf{u}^T(k)P^*(k)\mathbf{u}(k)]^{-1} \quad (30 b)$$

In experiments identical results were obtained for parameter estimation runs with the following settings: $P(0) = 10^3 I$, $w = 1$; $P(0) = I$, $w = 10^3$ and $P(0) = 10^6 I$, $w = 10^{-3}$.

It can also be shown that the influence on the convergence $\Delta V(k)/V(k)$ (see next section) is equivalent to the influence of η for

$$\frac{\Delta V(k)}{V(k)} = \frac{-e^2(k)\alpha^2(k)[- \mu^2(k) + 2\boldsymbol{\mu}(k) + \mathbf{u}^T(k)P^*(k)\mathbf{u}(k)]}{\boldsymbol{\delta}^T(k)P^{*-1}(k)\boldsymbol{\delta}(k)} \quad (31)$$

with

$$\alpha(k) = [\boldsymbol{\mu}(k) + \mathbf{u}^T(k)P^*(k)\mathbf{u}(k)]^{-1}$$

6.2. The factor η of $P(0)$

The choice of the starting matrix $P(0)$, usually a diagonal matrix $P(0) = \eta I$, is very important; see also Remarks 7 and 9. Moreover, there is a dependence with the amplitude of the measurement signals (Remark 2). In this

section the discussion is restricted to the choice of the parameter η which should be chosen very high in order to satisfy theoretical requirements (Schreuder 1975, Young 1969). The choice of η was related to the relative convergence $\Delta V/V$ (see Remark 1).

A large value of $\eta w(k)$ ($\eta w(k) > 10^5$) yields a fast increase of $\|P^{-1}(k+1)\|$, leading to a decrease of $\|\delta(k+1)\|$. Small values of $\eta w(k)$ ($1 < \eta w(k) < 10^2$) yield a relatively small increase of $\|P^{-1}(k+1)\|$. The decrease of $\|\delta(k+1)\|$ is significantly less than in the previous case. There is clear agreement with the convergence criterion

$$\sum_{k=0}^N \frac{\Delta V(k)}{V(k)}$$

given in Fig. 2 for various values of η ($w(k)$ is set to 1) for a process simulated in the computer. There is no advantage in choosing $\eta > 10^5$; moreover, for

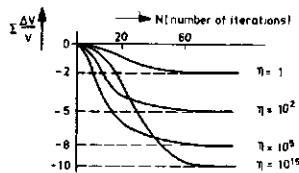

Figure 2. Influence of starting matrix on the convergence; simulated process.

larger values of η , the criterion remains very small for small values of N . The criterion is also calculated for a process outside the computer. The results are shown in Fig. 3, and indicate that a maximum convergence is obtained for $\eta = 10^2$, and that both for smaller and larger values of η the convergence deteriorates. The reasons for small values of η are the same as outlined before; however, for larger values of η there will be considerable parameter misalignments caused by small offset values.

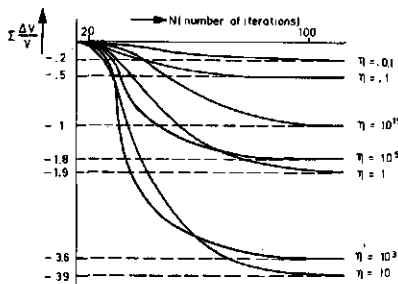

Figure 3. As Fig. 2; real process.

A starting matrix $10I < P(0) < 10^3I$ will be a good choice in most cases. It is noted that this choice is theoretically justified and is not subject to the requirement that $P(0)$ has to be very large. In engineering practice in the LS method a relatively low value of $P(0)$ is already applied.

6.3. The variable $\alpha(k)$

The variable $\alpha(k)$ determines to a great extent the adjustment of the parameters (see eqns. (13 a) and (17 a)). On the one hand, $\alpha(k)$ is influenced by $\mu(k)$ and on the other hand by $P(k)$, since

$$\alpha(k) = [\mu(k) + w(k)\mathbf{u}^T(k)P(k)\mathbf{u}(k)]^{-1} \quad (32)$$

For values of $\eta > 10^3$ the behaviour of $\alpha(k)$ as a function of k is shown in Fig. 4.

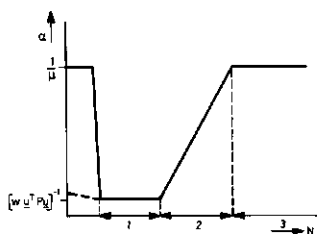

Figure 4. Influence of starting matrix on $\alpha(k)$; large starting values.

Starting with $\mathbf{u}(0) = \mathbf{0}$, $\alpha(0) = 1/\mu(0)$ and independently of η . The values of $\alpha(k)$ will decrease very rapidly to a value $\alpha(k) \approx [w(k)\mathbf{u}^T(k)P(k)\mathbf{u}(k)]^{-1}$, which is in the range of $P^{-1}(0)$ (see part 1, Fig. 4). Next the value of $\|P^{-1}(k+1)\|$ will increase according to eqn. (29 a), causing a decrease of $w(k)\mathbf{u}^T(k)P(k)\mathbf{u}(k)$. Thus the value of $\alpha(k)$ will increase after 10 to 25 iterations, depending on the value of η (see part 2, Fig. 4). Finally the term $w(k)\mathbf{u}^T(k)P(k)\mathbf{u}(k)$ will be obscured again by $\mu(k)$, yielding $\alpha(k) \approx 1/\mu(k)$ (see part 3, Fig. 4).

For values of $\eta < 10$ the behaviour of $\alpha(k)$ as function of k is shown in Fig. 5. In that case $w(k)\mathbf{u}^T(k)P(k)\mathbf{u}(k)$ is already in the order of magnitude of $\mu(k)$ right after starting the procedure. For very small values of η ($\eta < 0.01$), the value of $\alpha(k) \approx 1/\mu(k)$ for all values of k . If $\mathbf{u}(0) \neq \mathbf{0}$, the starting value of $\alpha(0)$ will be very small and in the range of $P^{-1}(0)$ (see dotted curves in Figs. 4 and 5).

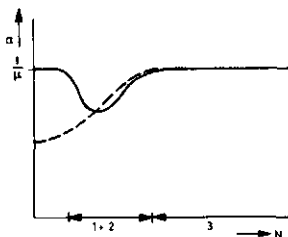

Figure 5. As Fig. 4; small starting values.

The behaviour of $\alpha(k)$ as shown in Fig. 4 is most preferable with a small part 1 and a relative large part 2, which is the case for $10I < P(0) < 10^3I$. In Fig. 6 the results are shown for $P(0) = 10^2I$ (solid lines) and $P(0) = 0.1I$ (dotted lines) respectively.

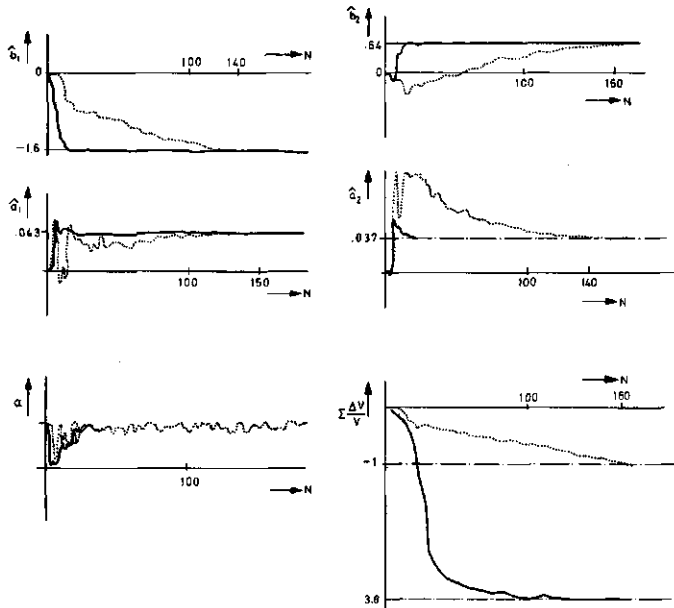

Figure 6. Influence of starting matrix on estimation results : $\eta = 10^2$ (solid lines) ; $\eta = 0.1$ (dotted lines).

6.4. The factor $\mu(k)$

Using the LSLG method one has the possibility of choosing $0 \leq \mu(k) \leq 2$ ($\gamma(k) = 1$), while in the LS method this parameter is fixed : $\mu(k) = 1$. As shown in the previous section the value of $\mu(k)$ influences the behaviour of $\alpha(k)$, which influences in turn the behaviour of the parameter convergence.

By choosing $\mu(k)$ small, for instance 0.01, the parts 1 and 2 of Fig. 4 are extended, causing a better convergence of the parameters. Moreover, it can be shown by differentiating $\Delta V(k)$ with respect to $\mu(k)$ that an optimal choice of $\mu(k)$ would be zero. However, choosing $\mu(k) = 0$ will cause very high values of $\alpha(k)$ which will influence the parameter behaviour too much when noise influences are present.

A possibility is to choose $u(k)$ as a function of $u^T(k)P(k)u(k)$ as follows :

$$\mu(k) = \rho w(k) u^T(k) P(k) u(k) \tag{33}$$

In practical experiments the value $\rho = 0.5$ yields a fast parameter convergence and a diminished influence of the noise. In Fig. 7 the results are shown for

$P(0) = 10^3 I$, $\mu = 0.1$ (solid line) and $P(0) = 10^3 I$, $\mu(k) = 0.5 \mathbf{u}^T(k) P(k) \mathbf{u}(k)$ (dotted line).

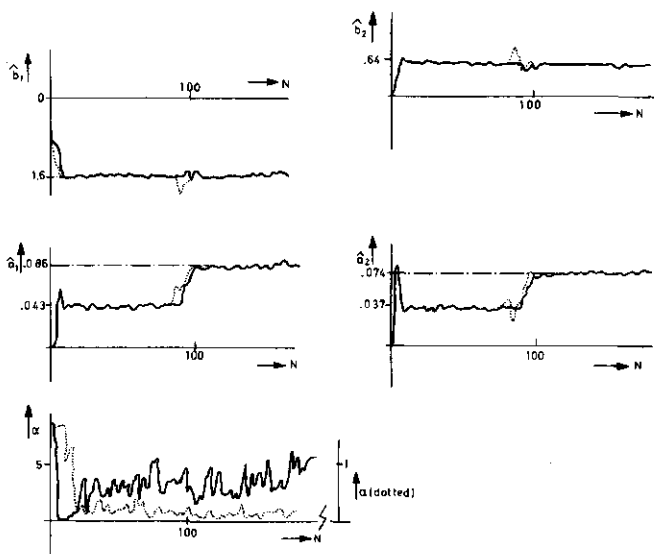

Figure 7. Influence of $\mu(k)$ on estimation results.

6.5. The factors $\beta(k)$ and $\gamma(k)$

The factors $\beta(k)$ and $\gamma(k)$ are introduced in order to track the parameters of a time-varying process.

Recalling eqn. (14) and eqns. (17) it is clear that these factors influence the gain matrix $P(k)$ directly and the updating of $\alpha(k)$ and $\hat{\theta}(k)$ indirectly. The choice of the values of $\beta(k)$ and the $\gamma(k)$ is discussed referring to eqn.(14): $P^{-1}(k+1) = \beta(k)P^{-1}(k) + \gamma(k)w(k)\mathbf{u}(k)\mathbf{u}^T(k)$ or with $\beta(k) = \beta$ and $\gamma(k) = \gamma$:

$$P^{-1}(k+1) = \beta^{k+1}P^{-1}(0) + \sum_{i=0}^k \beta^{k-i}\gamma w(i)\mathbf{u}(i)\mathbf{u}^T(i) \tag{34}$$

An element of the gain matrix is adjusted according to

$$p_{mn}^{-1}(k+1) = \beta^{k+1}p_{mn}^{-1}(0) + \sum_{i=0}^k \beta^{k-i}\gamma w(i)u_m(i)u_n(i) \tag{35}$$

where $p_{mn}^{-1}(k+1)$ is the mn element of $P^{-1}(k+1)$. This equation is equivalent to that of an exponential smoothing filter with a gain of $\gamma/1-\beta$ and an exponential weighting factor β .

By selecting a small value of β old data are forgotten relatively fast (see Fig. 8) while by selecting $\gamma > 1$ the influence of most recent information is enlarged. This can also be accomplished by taking a large value for $w(k)$.

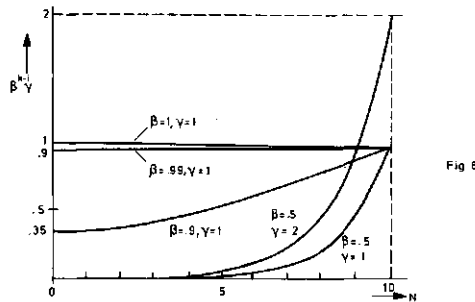

Figure 8. Exponential weighting of old data.

Theoretically the fastest convergence of $\Delta V(k)$ is found for very small values of β . The quasi-stationary value of $P^{-1}(k+1)$ will be obtained after a long period if a value of $\beta < 0.9$ is chosen. Moreover, for these values of β the parameter estimation is very sensitive to the influence of even a small amount of noise.

In practice a value of $0.95 \leq \beta \leq 0.99$ would be a good choice. The influence of β as a function of k is given in Table 2 ($\gamma=1, N$ is the value of k for which $\beta^{N+1} \leq 0.1$).

β	N
0.99	225
0.98	113
0.97	75
0.96	56
0.95	45

Table 2. $\beta^{N+1} \leq 0.1$.

7. Conclusions

A deterministic 'least-squares-like gradient' (LSLG) identification method was presented that bears close resemblance to the well-known recursive least-squares (LS) method. The interesting feature of the LSLG method is that it is based on a stability concept (Liapunov's second method) guaranteeing the convergence of the estimates to their true-values. Following this approach, it was demonstrated that the LSLG method has more degrees of freedom in comparison with the LS method, which could be used to make the method more suitable for a special problem.

Because of the different types of estimators (LSLG : *a priori* versus LS : *a-posteriori*) both methods complement each other in certain applications. The stability concept combined with the *a-priori* type of estimator makes the LSLG method interesting for adaptive control. Present research is being performed on discrete and continuous model reference adaptive systems.

ACKNOWLEDGMENTS

The authors wish to acknowledge ir. P. G. F. J. Ligtoet. The material in § 6 is based on his thesis.

Appendix A

Theorem

If the matrix $P^{-1}(k+1)$ is calculated from

$$P^{-1}(k+1) = \beta(k)P^{-1}(k) + \gamma(k)w(k)\mathbf{u}(k)\mathbf{u}(k)^T \quad (\text{A } 1)$$

with $\beta(k) > 0$, $\gamma(k) \geq 0$, $w(k) > 0$ and if $P^{-1}(k)$ is positive definite, then $P^{-1}(k+1)$ is also positive definite.

Proof

By definition a matrix Q is positive definite, denoted $Q > 0$ if $\mathbf{x}^T Q \mathbf{x}$ is positive definite.

Pre-multiplying and post-multiplying the terms of eqn. (A 1) with \mathbf{x}^T resp. \mathbf{x} , yields

$$\mathbf{x}^T P^{-1}(k+1) \mathbf{x} = \beta(k) \mathbf{x}^T P^{-1}(k) \mathbf{x} + \gamma(k) w(k) \mathbf{x}^T \mathbf{u}(k) \mathbf{u}(k)^T \mathbf{x} \quad (\text{A } 2)$$

For $\beta(k) > 0$ the first term on the right-hand side of eqn. (A 2) is positive definite, since $P^{-1}(k)$ is positive definite. For $\gamma(k) \geq 0$ and $w(k) > 0$ the second term on the right-hand side of eqn. (A 2) is non-negative; therefore $P^{-1}(k+1) > 0$.

Corollary

If the starting matrix $P^{-1}(0) > 0$ and is symmetric, then $P^{-1}(k+1) > 0$ and $P^{-1}(k+1)$ is symmetric.

Proof

If $\gamma(k) \geq 0$ and $w(k) > 0$ for all k the second term of (A 2) will be symmetric and $\mathbf{u}(k)\mathbf{u}(k)^T \geq 0$. Thus $P^{-1}(1) > 0$ and is symmetric, because the sum of two symmetric matrices is again a symmetric matrix. Evaluating $P^{-1}(2)$, etc. yields again positive definite symmetric matrices.

Remark

If $0 < \beta(k) < 1$ and the matrix

$$Q = \sum_{k=0}^{\infty} \gamma(k) w(k) \mathbf{u}(k) \mathbf{u}(k)^T \quad (\text{A } 3)$$

is singular or zero, then $P^{-1}(k)$ will be singular or zero respectively for $k \rightarrow \infty$. The matrix $Q > 0$ and is non-zero if \mathbf{u} satisfies the conditions of persistent excitation (Åström and Bohlin 1966).

Appendix B

The asymptotic stability of the LSLG identification scheme is demonstrated by Liapunov's second method (Mendel 1973). Consider the positive

definite Liapunov function

$$V(k) = \delta^T(k)P^{-1}(k)\delta(k) \quad (B\ 1)$$

with $P(k) > 0$ and symmetric. The LSLG technique is based on the algorithms

$$\delta(k+1) = \delta(k) - \alpha(k)w(k)e(k)P(k)u(k) \quad (B\ 2\ a)$$

$$P^{-1}(k+1) = \beta(k)P^{-1}(k) + \gamma(k)w(k)u(k)u^T(k) \quad (B\ 2\ b)$$

with the scalars $\alpha(k), w(k) > 0$; $\gamma(k) \geq 0$ and $0 < \beta(k) \leq 1$. Also, the equation error is recalled :

$$e(k) = \delta^T(k)u(k) \quad (B\ 3)$$

To investigate the stability the form $\Delta V(k) \triangleq V(k+1) - V(k)$ is evaluated ; for notational convenience $c(k) \triangleq u^T(k)P(k)u(k)$:

$$\begin{aligned} \Delta V(k) &= \delta^T(k+1)P^{-1}(k+1)\delta(k+1) - \delta^T(k)P^{-1}(k)\delta(k) \\ &= (\beta(k) - 1)V(k) + w(k)e^2(k) \\ &\quad \times [\gamma(k) - 2\alpha(k)\beta(k) - 2\alpha(k)\gamma(k)w(k)c(k) \\ &\quad + \alpha^2(k)\beta(k)w(k)c(k) + \alpha^2(k)\gamma(k)w^2(k)c^2(k)] \end{aligned} \quad (B\ 4)$$

When the scalar $\alpha(k) > 0$ is selected as follows :

$$\alpha(k) = [\mu(k) + w(k)u^T(k)P(k)u(k)]^{-1} \quad (B\ 5)$$

with $\mu(k) \geq 0$ and bearing in mind that $c(k) = u^T(k)P(k)u(k)$, eqn. (B 4) can be written

$$\Delta V(k) = (\beta(k) - 1)V(k) + w(k)e^2(k)A \quad (B\ 6\ a)$$

with

$$A = \alpha^2(k)[\gamma(k)\mu^2(k) - 2\beta(k)\mu(k) - \beta(k)w(k)u^T(k)P(k)u(k)] \quad (B\ 6\ b)$$

From eqn. (B 6 b) it can be seen, since $u^T(k)P(k)u(k) \geq 0$, that sufficient requirements for the condition $A \leq 0$ are fulfilled by requiring $0 < \beta(k) \leq 1$, $w(k) > 0$, $\gamma(k) \geq 0$ and

$$\{\mu(k) = 0\} \cup \{\mu(k) > 0 \cap \gamma(k)\mu(k) < 2\beta(k)\} \quad (B\ 7)$$

With condition (B 7) the expression for $\Delta V(k)$ of eqn. (B 6) is non-positive definite for $\beta(k) = 1$ and negative definite for $0 < \beta(k) < 1$.

Appendix C

An algorithm is derived to evaluate the matrix $P(k)$ from its inverse $P^{-1}(k)$, given by

$$P^{-1}(k+1) = \beta(k)P^{-1}(k) + \gamma(k)w(k)u(k)u^T(k) \quad (C\ 1)$$

when the scalars $\gamma(k) \geq 0$, $w(k) > 0$, $0 < \beta(k) \leq 1$. Using standard methods (Young 1969), pre-multiplying and post-multiplying with $P(k+1)$ and $P(k)$ respectively yields

$$P(k) = \beta(k)P(k+1) + \gamma(k)w(k)P(k+1)u(k)u^T(k)P(k) \quad (C\ 2)$$

The scalar $\alpha^*(k)$ is introduced :

$$\alpha^*(k) = [\beta(k) + \gamma(k)w(k)\mathbf{u}^T(k)P(k)\mathbf{u}(k)]^{-1} \quad (\text{C } 3)$$

Post-multiplying of (C 2) with $\alpha^*(k)\gamma(k)w(k)\mathbf{u}(k)\mathbf{u}^T(k)P(k)$:

$$\alpha^*(k)\gamma(k)w(k)P(k)\mathbf{u}(k)\mathbf{u}^T(k)P(k) = \gamma(k)w(k)P(k+1)\mathbf{u}(k)\mathbf{u}^T(k)P(k) \quad (\text{C } 4)$$

Substitution of the right-hand side of eqn. (C 4) with eqn. (C 2) yields the recursive form :

$$P(k+1) = \beta^{-1}(k)P(k) - \alpha^*(k)\gamma(k)w(k)P(k)\mathbf{u}(k)\mathbf{u}^T(k)P(k) \quad (\text{C } 5)$$

where $\alpha^*(k)$ is given by eqn. (3). From eqns. (C 3) and (C 5) it is seen that the matrix $P(k)$ is symmetric provided the initial value $P(0)$ is symmetric.

REFERENCES

- ALBERT, A. E., and GARDNER, L. A., 1967, *Stochastic Approximation and Nonlinear Regression* (Cambridge, Massachusetts : M.I.T. Press).
- ANDERSON, B. D. O., 1977, *I.E.E.E. Trans. autom. Control*, **22**, 83.
- ÅSTRÖM, K. J., and BOHLIN, T., 1966, *Proceedings of the IFAC Symposium on the Theory of Self-adaptive Control Systems* (New York : Plenum).
- ÅSTRÖM, K. J., BORISSON, U., LJUNG, L., and WITTENMARK, B., 1977, *Automatica*, **13**, 457.
- BIERMAN, G. J., 1976, *I.E.E.E. Trans. autom. Control*, **21**, 883.
- BRANSBY, M. L., 1976, *I.E.E.E. Trans. autom. Control*, **21**, 139.
- EYKHOFF, P., 1974, *System Identification* (London : Wiley).
- GRAUPE, D., and FOGEL, E., 1976, *Automatica*, **12**, 53.
- HANG, C. C., 1974, *Int. J. Control*, **19**, 365.
- KUDVA, P., and NARENDRA, K. S., 1974, *I.E.E.E. Trans. autom. Control*, **19**, 549.
- LANDAU, I. D., 1976, *I.E.E.E. Trans. autom. Control*, **21**, 194.
- LANDAU, I. D., and BÉTHOUX, 1975, *Proceedings of the 6th IFAC World Congress*, Paper 58.4.
- LION, P. M., 1967, *A.I.A. Aerospace J.*, **5**, 1835.
- MENDEL, J. M., 1973, *Discrete Techniques of Parameter Estimation* (New York : Dekker); 1974, *I.E.E.E. Trans. autom. Control*, **19**, 820.
- SCHURER, H. G., 1975, *Regelungstechnik*, **12**, 427.
- UDINK TEN CATE, A. J., 1975, *Electronics Lett.*, **11**, 98; 1976, *Ibid.*, **12**, 359.
- YOUNG, P. J., 1969, *Control Engng*, **16**, No. 10, 119.

6 Adaptive control of the heating system

6.1 INTRODUCTION

In this chapter an *adaptive control* application will be described. Adaptive control has received much attention over the last two decades. The basic idea is that the controlled process contains time-varying parameters which vary to such an extent that the controller has to be adjusted in order to retain an acceptable performance.

The adjustment can be based on a-priori knowledge of the process. An example is the gain of the greenhouse heating transfer function, which depends on the heating pipe temperature according to eqn. (3.22). This relation can be used to compensate the variations by adjusting the gain of the heating system controller. When a-priori knowledge is used for compensation this method is called *gain scheduling* (Åström, 1981), a type of adaptive control that is widely used in practice.

In other cases there is no a-priori knowledge available because the process parameters change in an unpredictable way, or because the process itself is not well identified. In such cases the relevant process parameters are estimated by an on-line procedure. The controller is adjusted according to some decision mechanism. When a form of on-line parameter estimation is applied, the method is usually referred to as *adaptive, self-adaptive, self-adjusting* or *self-tuning* control.

The estimation procedure has to fulfil several criteria, because it is applied on-line. The most important criterion is that it must lead to a stable control scheme. In adaptive control much research has been focused on the stability of the control and adjustment mechanism. In the early developments in the field of adaptive control, the parameter estimation was performed combined with the adjustment of the controller, where the controlled process has to follow a fixed model. Much research has been performed on the stability properties of these *model reference adaptive systems*. Examples of this approach are found in the book of Landau (1979). The main results are established for the continuous time domain, for processes of which the order

is exactly known and for deterministic (noise free) signals. When in a practical situation measurement noise is present, the deterministic parameter estimation methods give rise to biased results (Eykhoff, 1974). This causes stability problems even when in a practical situation filters are used to reduce the noise level (Udink ten Cate and Verstoep, 1974).

Arguing that stability of the whole scheme follows naturally when the on-line estimation is ensured to converge to the true parameter values, much research in the seventies deals with stochastic estimation procedures. Because of the more complex nature of the algorithms, the main interest is in discrete time representation. A summary of on-line estimation has been given by Young (1981). A typical problem in estimation is that the process input signal has to be sufficiently excited. In adaptive systems this is not always permitted.

As a result of the problems associated with the application of adaptive control, not so many applications have been reported for practical problems (Åström, 1981). The adaptive greenhouse heating system control reflects the difficulties, in that care has been taken to *circumvent* the problems in the design stage.

In this chapter the adaptive problem is formulated and then the algorithms are presented, which are the result of several years on-line evaluation. The performance is demonstrated from field trials.

6.2 THE ADAPTIVE PROBLEM

As discussed in Chapter 3, a simple relation between the heating pipe temperature and the greenhouse inside air temperature is given by the transfer function

$$H_{g,h} \triangleq \frac{\tilde{\theta}_g(s)}{\tilde{\theta}_h(s)} = \frac{K_g e^{-\tau_{d,h} s}}{\tau_g s + 1} \quad (6.1)$$

where the variables are formulated in terms of increments with respect to a working point. In the simple relation the parameters K_g and τ_g vary due to physical phenomena and external influences, as well because of inaccuracies in the modeling. The relation $H_{g,h}$ is the basis for the adaptive control.

In eqn. (6.1) the input signal is $\tilde{\theta}_h(t)$ which is not a driving signal directly from the controller, but the output of the mixing valve process. As discussed in section 3.3.1 the mixing valve process is asymmetrical: a small time constant for rising θ_h ; a large one for decreasing θ_h . The small time constant is much smaller than τ_g . The usual greenhouse heating system controller consists of a master-slave configuration as depicted in fig. 4.1. The use of eqn. (6.1) in the adaptive control means that the attention is focused on the behaviour of the master loop.

In eqn. (6.1) two parameters are present. It is assumed that by changing K_g and τ_g the time varying characteristics of $H_{g,h}$ can be described adequately. The most straightforward adaptive approach is to estimate both parameters in an on-line procedure. In order to get an accurate result, the input signal θ_h has to be time-varying. Since this is not the case under normal conditions, a test signal has to be applied. The resolution of the measurements in a greenhouse is in the order of 0.1°C so that a ripple on θ_g of $0.5 - 1^\circ\text{C}$ as a result of the test signal is necessary. This is not acceptable, and no test signals can be used. In this case only the gain factor K_g can be estimated.

As discussed in the previous chapter, the estimation of τ_g with the LSLG method (or by related methods) may lead to biased results, which is not so for K_g .

The time varying nature of the parameters in eqn. (6.1) is assumed to be represented by a time varying K_g and fixed values for τ_g and $\tau_{d,h}$. The master loop of the heating control is designed for a constant value of K_g , and changes will be compensated in the adaptive controller. This approach was adopted by Udink ten Cate and Van de Vooren (1977, 1978, 1981) for tuning a modified PI controller (eqn. 4.4). In the next sections these results are presented.

A choice in the adaptive design has been to apply a PI controller of which the settings are changed, instead of applying another control scheme. This is motivated because the adaptive controller has to be understood and accepted by potential users. The relation between climate and plant growth is very strong and often control procedures take the place of GCFC. A solution that can be added to the existing methods (and computer software) and is easy to override, seems attractive in such a situation. Existing knowledge of the

performance of conventional control methods could be evaluated in the design and eventually included. The adaptive PI algorithm fits well into these criteria.

6.3 THE ADAPTIVE ALGORITHM

The adaptive algorithm is discussed, that has been applied in the adaptive heating system control of the multifactoral glasshouse at Naaldwijk. In the model of eqn. (6.1) under various conditions $\tau_{d,h} = 7$ min, $\tau_g = 20$ min and $K_g = 0.16 - 0.22$. Like in conventional control the heating system is controlled by a master-slave algorithm. In the slave a time-proportional velocity algorithm is applied with respect to the valve position. In the master a PI algorithm is used. The idea of the adaptive approach is to compensate for variations in K_g by adjusting the gain of the controller, so that the PI algorithm is always tuned correctly.

A problem is that the model of eqn. (6.1) is linearized around a working point. This is strongly influenced by the outside conditions, so that it is time-varying and not a-priori known. This causes serious difficulties in the estimation procedure because an incorrect calculation of the working point might lead to severe errors in the estimate of K_g , e.g. a negative value could be obtained. A solution to this problem is to use a high-pass filter for the signals used in the estimation. This method was not considered applicable in the greenhouse problem because only very low harmonics have to be rejected (see Chapter 3) which is not obtained by a simple filter. Otherwise, using a simple filter, high frequent signal components remain which have only a low magnitude compared to the noise introduced by discretizing the measured climate process signals. So a less elegant solution is considered by assuming a working point at zero, which means that a significant offset is introduced. The estimate of K_g will in this case never give a completely wrong result by yielding negative values. In the adaptive method the introduced offset is lumped together with the dynamic and time-varying gain K_g , producing a new time-variant gain K'_g . In the Naaldwijk glasshouse $K'_g = 0.2 - 1.0$. The drawback of this approach is that variations in the dynamic gain K_g are estimated as variations in K'_g which will be relatively of a smaller magnitude. Although in principle it is possible to estimate the offset separately, this is not considered because it would introduce an extra unknown parameter.

The gain K'_g is estimated on-line by a *least-squares like gradient* (LSLG) algorithm as presented in the previous chapter. To estimate the time-varying K'_g , a discrete time estimation model of eqn. (6.1) is formulated using a backward difference operator

$$\hat{\theta}_g(k) = a_1 \theta_g(k-1) + \hat{K}'_g(k) a_2 \theta_h(k-d_{d,h}) \quad (6.2)$$

where $\hat{\theta}_g(k)$ and $\hat{K}'_g(k)$ are the estimates of $\theta_g(k)$ and $K'_g(k)$ respectively at the k -th sampling interval; $a_2 = T_s/(1+\tau_g)$, $a_1 = 1-a_2$, $\tau_g = 30$, $d_{d,h} = 6 = \tau_{d,h}/T_s$, $T_s = 1$ min. The values of θ_g and θ_h are in $^{\circ}\text{C}$ with (the working point) zero as reference. The simple difference operator is justified by the high sampling rate with respect to the process dominant time constant.

The values of τ_g and $d_{d,h}$ were obtained from large step responses, with $\theta_h = 20 \rightarrow 70$ $^{\circ}\text{C}$ and $\theta_g = 15 \rightarrow 25$ $^{\circ}\text{C}$. These values *differ* from those used in eqn. (4.2) (20 min. and 8 respectively), the latter being obtained from better defined experiments. The values applied in eqn. (6.2) are however not unrealistic. The result will be that more variations in \hat{K}'_g will occur in order to explain variations in the process signals. Conform the theory \hat{K}'_g is updated as

$$\hat{K}'_g(k+1) = \hat{K}'_g(k) - \alpha(k) \{ \hat{\theta}_g(k) - \theta_g(k) \} P(k) \theta_h(k-d_{d,h})/a_2 \quad (6.3a)$$

$$\alpha(k) = [1 + P(k) \theta_h^2(k-d_{d,h})]^{-1} \quad (6.3b)$$

$$P^{-1}(k+1) = \beta(k) P^{-1}(k) + \gamma(k) \theta_h^2(k-d_{d,h}) \quad (6.3c)$$

$P(k)$ is a scalar here, $\beta(k) = 0.95$ and $\gamma(k)$ is used as a switch to limit $P(k)$ (and 0 or 1), $10^{-8} \leq P(k) \leq 1$ and also $0.2 \leq \hat{K}'_g \leq 2.0$. The factor $\beta(k)$ is chosen relatively small because \hat{K}'_g has to track variations in K'_g that might occur in a relatively short time interval (30 min.).

The estimate resulting from eqn. (6.3a) is used to tune a discrete PI algorithm of the modified type (eqn. 4.4) or a dog-lead algorithm (fig. 6.1). In both cases:

$$K_p(k) = C_1 / \hat{K}'_g(k) \quad (6.4)$$

From the *decision procedure* of eqn. (6.4) it can be seen that the product $K_p(k) \hat{K}'_g(k) = C_1$ is kept constant, where C_1 has to be tuned on-line. It is recalled that $\hat{K}'_g(k)$ in eqn. (6.4) is not the dynamic gain K_g of eqn. (6.1), so that keeping $\hat{K}'_g(k) K_p(k)$ constant does not imply a constant gain in the control loop and a corresponding dynamical behaviour.

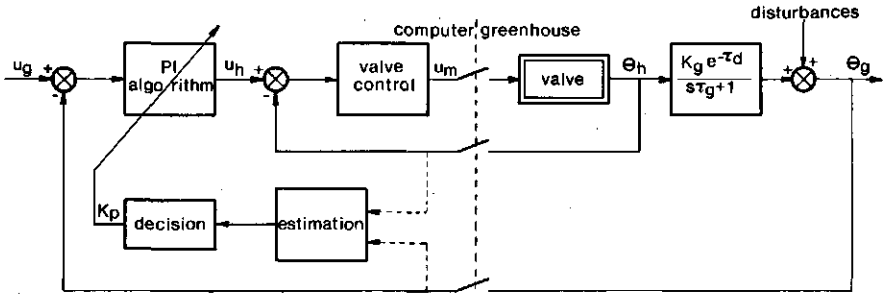

Fig. 6.1 Adaptive control of greenhouse heating system.

6.4 RESULTS

To investigate the performance of the adaptive control, comparative field trials have been performed in winter/spring 1981, in the multifactoral glass-house of the Naaldwijk Experiment Station. The trials were run concurrently with those already described in section 4.3. A comparison is made between *adaptive* and *non-adaptive* versions of the *modified PI* and the *dog-lead PI* algorithms. The criteria used to evaluate the performance are *overshoot*, *sag* and *undershoot*; the same criteria used in section 4.3. The comparison has been carried out after the settings of the controller gains had been made as good as possible for winter conditions.

6.4.1 Modified PI

The performance of the adaptive/non-adaptive modified PI algorithm is examined first. After experiments with stepwise changes of the setpoint, a best setting was selected with $K_i = 0.033$, $K_p = 8$ (non-adaptive; compartment no. 3) and $C_1 = 5$ (adaptive; compartment no. 6). As in section 4.3, the responses of the adaptive and the non-adaptive controller are compared in terms of a 5 point-scale. Data is evaluated as obtained between January 21 and May 24, 1981. The cumulative results are presented in fig. 6.2.

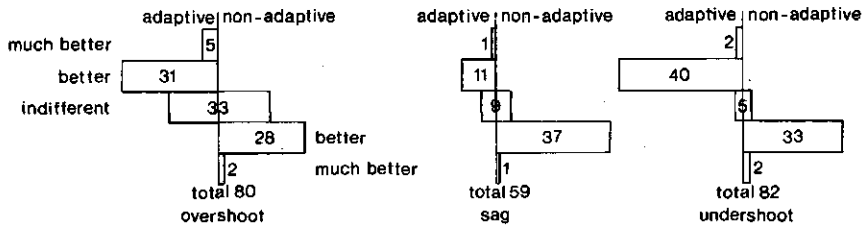

Fig. 6.2 Results from field trials of modified PI algorithms.

From fig. 6.2 it is seen that the performance of the adaptive PI is slightly better for overshoot and undershoot, but that sag is not so well reduced.

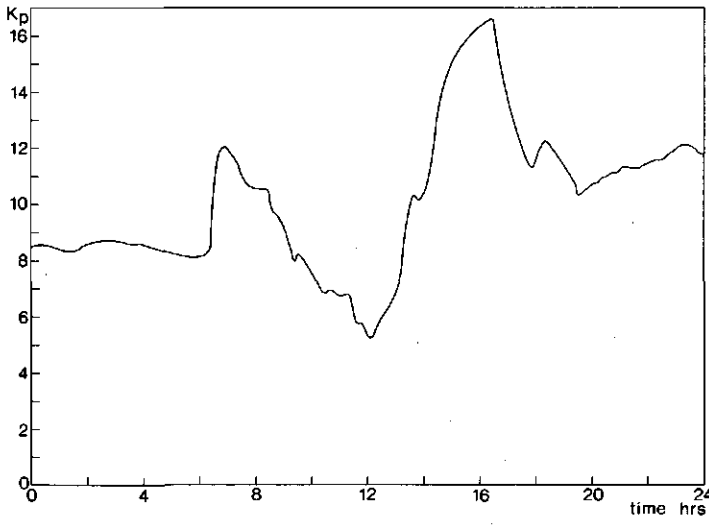

Fig. 6.3 Response of controller gain K_p for adaptive modified PI algorithm.

The performance of the adaptive controller can be understood by evaluating the effect of the time-varying adaptive gain K_p (fig. 6.3).

When the estimation result is examined it is seen that for higher values of θ_h the controller gain K_p is higher. With eqn. (3.22) or (3.35) as a-priori information, a lower value of K_p would be expected to compensate for a higher value of K_g in eqn. (6.1). This is not so because the offset on the working point obscures this phenomenon. It can only be expected that for large

setpoint changes this result will produce favourable effects. In this case a higher value of $\beta(k)$ could be motivated ($\beta(k) = 0.98$), leading to a slower adjustment of K_p . However, the estimated \hat{K}_g' rises to a high value (≈ 1.0) during the day when strong disturbances (radiation) are present. This gives a low value of $K_p(k)$, which will be less effective to reduce sag. Therefore $\beta(k)$ cannot be made much larger than the selected value ($\beta(k) = 0.95$).

Responses of θ_g and u_g are presented in order to illustrate the behaviour of the controllers (fig. 6.4). Shown are the responses on of March 2, 1981 ($\bar{\theta}_a = 8.4$ °C) and March 22, 1981 ($\bar{\theta} = 10.2$ °C). March 2 is a dull day; March 22 is a day with a high level of radiation and alternating sun and clouds.

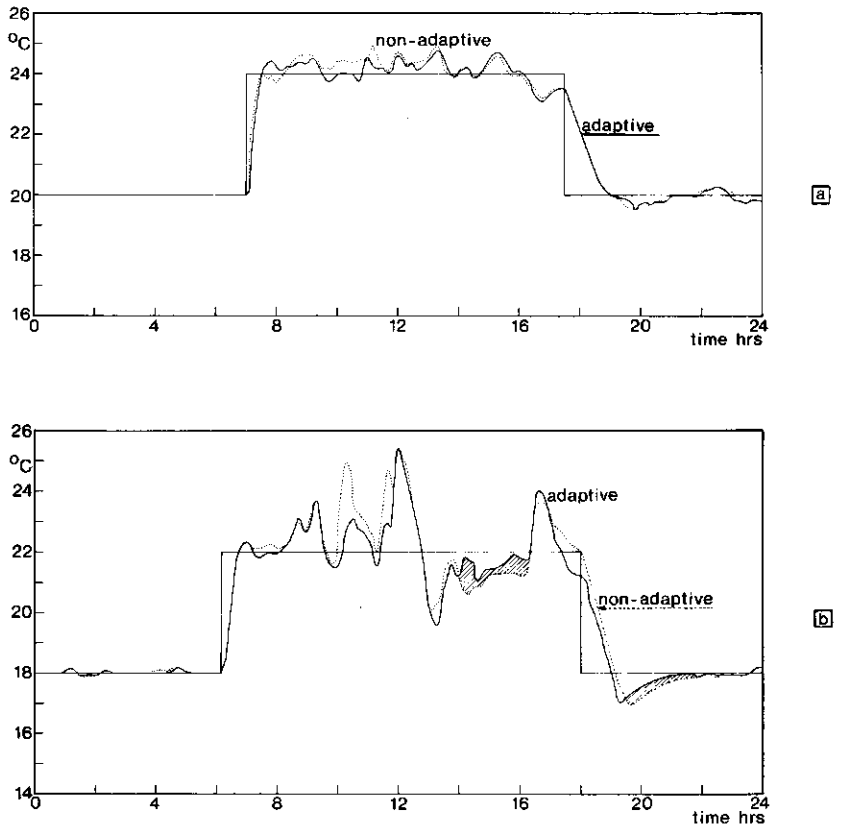

Fig. 6.4 Responses of greenhouse temperatures using modified PI algorithms. Shown are March 2, 1981 (a) and March 22, 1981 (b).

6.4.2 Dog-lead PI

When the adaptive/non-adaptive dog-lead PI algorithms are compared the performance of the adaptive controller comes out poorer than the non-adaptive one. In fig. 6.5 data are evaluated obtained between Feb. 26 and May 24, 1981. The controller settings were $K_i = 0.04$, $K_p = 12$ (non-adaptive; compartment no. 5) and $C_1 = 5$ (adaptive; compartment no. 1). Also the responses of θ_g and u_g are presented on March 2 and March 22, 1981 (fig. 6.6).

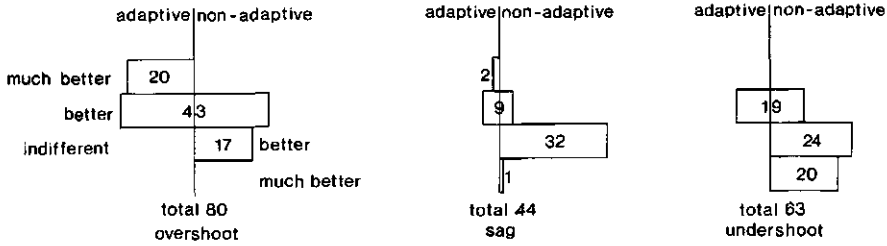
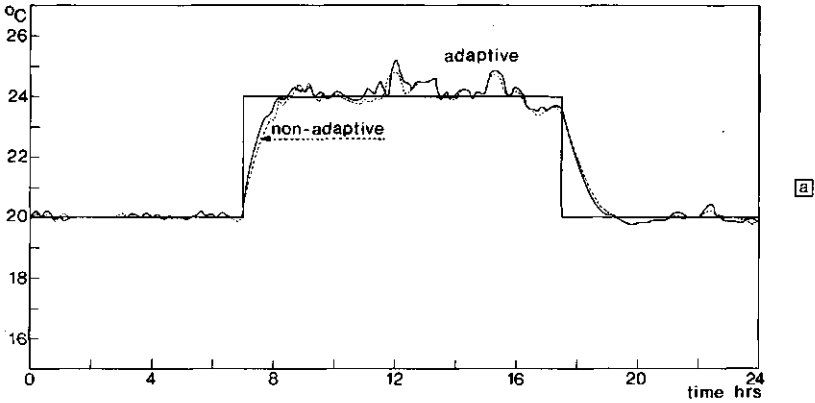

Fig. 6.5 Results from field trials of dog-lead PI algorithms.



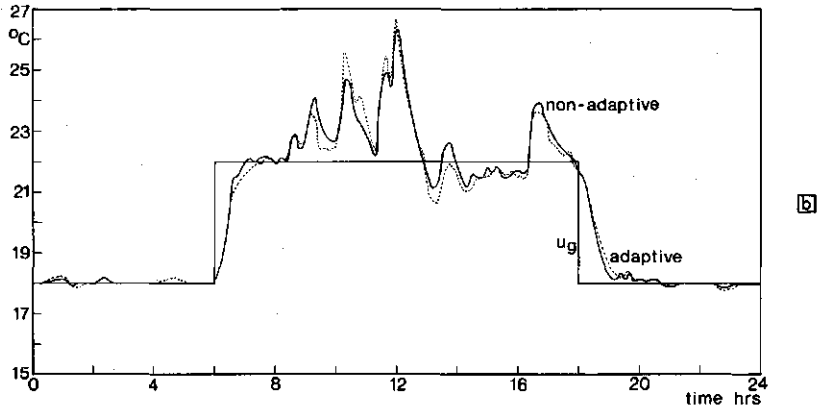

Fig. 6.6 Responses of greenhouse temperatures using dog-lead PI algorithms on March 2, 1981 (a) and on March 22, 1981 (b).

6.5 DISCUSSION

Considering fig. 6.2 and fig. 6.5 the field trials provide results that are disappointing for the adaptive control. With the modified PI controller the performance is somewhat improved for overshoot and undershoot; for sag the performance deteriorates. With the dog-lead PI controller only the overshoot is somewhat improved, but sag and undershoot are significantly poorer.

This outcome can be understood, because of the most striking phenomena indicating improper controller behaviour (overshoot, sag, undershoot) only *overshoot* could be reduced by a better tuned (adaptive) controller. Sag and undershoot are caused by windup in the controller, and adaptive control is *not* a solution for this. The dog-lead method reduces the windup effects much more effectively.

The adaptive tuning is not working properly at daytime because of the disturbances (radiation) that act upon the greenhouse heating process $H_{g,h}$. Also, the selection of the working point at zero introduces errors in the estimate of K_g . Consequently, the adaptive controller is not well adjusted at daytime and sag and undershoot is not reduced well, which is more striking for the dog-lead than for the modified PI algorithm.

The adaptive control as presented in this chapter does not improve the controller behaviour. The phenomena that cause poor controller performance are not adequately compensated by a better tuning of the controller gains.

Although in some cases the performance is better, the total result over a long period of time (99 observed days) is insignificant (modified PI) or even worse (dog-lead PI).

When the relative complexity of the adaptive algorithms is also taken into account, it can be concluded that adaptive methods will not improve greenhouse air temperature control -even when design problems like the definition of the working point are solved.

Other methods are more likely to lead to better temperature control performance. The dog-lead method reduces undershoot and to some extent the sag. The sag might further be reduced by feedforward control using radiation measurements. Realizing the deterministic character of the greenhouse climate process -as discussed in Chapter 3- improvements could be obtained using a-priori knowledge of the climate process in *gain-scheduling* procedures. Also a type of adaptation called *self-tuning* is feasible, where self-tuning means that automatically a test program is carried out on-line and the process parameters are estimated. When the estimation procedure complies with the procedures presented in this thesis, it is felt that this is realizable. This self-tuning procedure can be carried out when the control installation is put into operation for the first time, and occasionally during the growing period.

7 Improved models

7.1 INTRODUCTION

In Chapter 3 dynamical models have been presented. The models were formulated in terms of increments (eqn. 3.2), which are defined for a fixed working point. A fixed working point is associated with an equilibrium situation. In reality, such an equilibrium situation seldom occurs. The actual behaviour can be modeled as *disturbances* that act upon the *steady-state* (static) situation. Another approach is to allow the working point to vary slowly in time, in a *quasi-static* way. Conceptually both ways of representing the working point do not differ very much. The steady-state representation is more easily calculated. The quasi-static representation can be applied in a wider range of conditions.

The quasi-static behaviour of the working point can be modeled by writing the relevant variables, e.g. the greenhouse inside air temperature $\theta_g(t)$ as:

$$\theta_g(t) = \theta_{g,ss}(t) + \tilde{\theta}_g(t) \quad (7.1)$$

where the suffix *ss* means that $\theta_{g,ss}(t)$ is *quasi-static*[†], containing steady-state, trend and low frequency components of $\theta_g(t)$, and $\tilde{\theta}_g(t)$ contains the high frequency components of $\theta_g(t)$. It is remarked that -although eqn. (7.1) seems to differ from eqn. (3.2)- in terms of the followed parameter estimation procedure in Chapter 3 implicitly eqn. (7.1) was used when the average, the trend and the low frequency components of the process signals were filtered out. When the low frequency components are considered not as disturbances but as slow variations of the working point, the modeling can be carried out according to eqn. (7.1).

[†] The meaning of this term "quasi-static" agrees with the thermodynamic definition, where during a quasi-static process the system is at all times infinitesimally near to equilibrium. However, here "quasi-static" is associated with the time behaviour of the variables, whereas in thermodynamics a process characteristic is meant.

Another reason to use eqn. (7.1) is that the models presented in Chapter 3 only bear a relation to the reality in a dynamical sense, which means that they are not easily interpretable for an arbitrary behaviour of a greenhouse since only a -high frequency- part of the observations is modeled. Adding the quasi-static behaviour to the dynamical models facilitates the description of the actual behaviour of the greenhouses in recognizable values of the relevant variables. Now the models are *greenhouse climate models* of the type discussed in section 2.5.

Based on the same experiments that are described in Chapter 3, in this chapter the working point will be investigated. Firstly a simple steady-state approach will be presented in order to calculate the working point. Secondly, the slowly time-varying nature of the working point is modeled.

As in Chapter 3 the parameters are expressed as *thermal parameters*. It is shown that the values of the thermal parameters describing low frequency phenomena (of the working point) *differ* from similar parameters describing the high frequency phenomena (of the dynamical models).

7.2 STEADY-STATE CALCULATIONS

Steady-state calculations of the working point are carried out using *average* values of the variables constituting the *average* heat balance of a greenhouse

$$k_{h,ss}^* \bar{\theta}_{hg} - (k_{r,ss}^* + k_{v,ss}^*) \bar{\theta}_{ga} + \eta_{ss} \bar{\phi}_s'' = 0 \quad (7.2)$$

with $\theta_{hg} \hat{=} \theta_h - \theta_g$, $\theta_{ga} \hat{=} \theta_g - \theta_a$ and the suffix ss denoting the steady-state (static) values of the variables, which follow from steady-state relations.

Eqn. (7.2) follows from eqn. (3.4) for an equilibrium situation, with the k-values defined as in eqn. (3.6) and eqn. (3.7). In the eqn. (7.2) θ_h is the heating pipe temperature, θ_a is the outside air temperature, ϕ_s'' is the radiation flux density and the star * indicates that the relation is normalized per m² ground area of the greenhouse.

Eqn. (7.2) is only solvable when one of the terms is assumed to be known: here $k_{h,ss}^*$ is assumed to be known according to eqn. (3.36).

It is noted that although in eqn. (7.2) the (shortwave) radiation $\bar{\phi}_s''$ is present, with respect to the calculation of the working point this term is not correct. The calculation is carried out with average values of the

variables, where the actual values do not differ too much from the average. This is not the case with the radiation, where a diurnal periodic course is made. This means that the working point is only defined according to eqn. (7.2) in periods with absence of (shortwave) radiation (at night) or at periods with low radiation intensity.

The procedure that is carried out to calculate the working point is outlined below. When the term containing $\bar{\phi}_s''$ is neglected, eqn. (7.2) can be rewritten with $\bar{\phi}_h^* = k_{h,ss}^* \bar{\theta}_{hg}$ as

$$\bar{\phi}_h^* = (k_{r,ss}^* + k_{v,ss}^*) \bar{\theta}_{ga} \quad (7.3a)$$

In this formula $\bar{\phi}_h^*$ is calculated from eqn. (3.36) as

$$\bar{\phi}_h^* = k_{h,ss}^* \bar{\theta}_{hg} = 1.0 \bar{\theta}_{hg}^{1.46} \quad (7.3b)$$

A value for $k_{v,ss}^*$ is calculated with eqns. (3.8) and (3.20) as

$$k_{v,ss}^* = \zeta'_{ss} \bar{S}_v, \quad (\zeta'_{ss} = \zeta \bar{h} \approx 1/3 \cdot 3 = 1.0) \quad (7.4a)$$

$$\bar{S}_v = (1 + \bar{r}_w) \cdot 0.064 \cdot \bar{v}_w \quad (7.4b)$$

where $\bar{h} = 3$ [m] follows from table 3.1. As $\bar{\theta}_{ga}$ and $\bar{\theta}_{hg}$ are known from measurements, $(k_{r,ss}^* + k_{v,ss}^*)$ can be calculated from eqns. (7.3). With $k_{v,ss}^*$ according to eqns. (7.4) the values of $k_{r,ss}^*$ are found. For the same experiment that constitutes the results summarized in table 3.2 in table 7.1 the values of the relevant variables are presented for the various compartments. In fig. 7.1 the best fit in the least-squares sense is depicted for $(k_{r,ss}^* + k_{v,ss}^*)$. Note that the line expressing this relation according to eqn. (7.3a) crosses the origin by necessity (and is *not* a linear regression). The best fit is $k_{r,ss}^* + k_{v,ss}^* = 10.4$.

The values of $\bar{\phi}_h^*$ in table 7.1 and fig. 7.1 follow from eqn. (7.3b) (and eqn. 3.36) and are not all within the range $\bar{\theta}_{hg} \in [3, 20 \text{ } ^\circ\text{C}]$ for which that eqn. is valid. This is done because also in Chapter 3 eqn. (3.36) has been used outside its validity range to perform the calculations e.g. for table 3.6.

compartment	$\bar{\theta}_{hg}$	$\bar{\phi}_h^*$	$\bar{\theta}_{ga}$
1	31.0	150.4	14.2
2	37.1	195.6	17.6
3	17.6	65.8	9.1
4	14.8	51.1	7.5
5	16.7	61.0	10.1
6	37.3	197.1	17.4
7	31.7	155.4	13.5

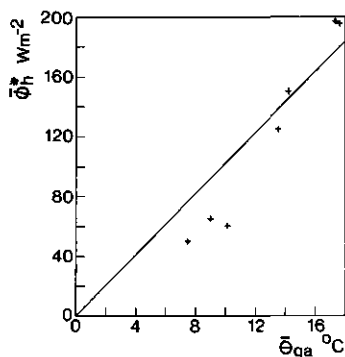

Table 7.1 Steady-state calculations
(for table 3.2)

Fig. 7.1 Best fit for table 7.1.

The same results can of course be obtained by fitting in fig. 7.1 $\bar{\phi}_h^* - k_{v,ss}^* \bar{\theta}_{ga}$ with $\bar{\theta}_{ga}$. Because $k_{v,ss}^*$ is the same in all compartments this is not necessary, but in case \bar{r}_w is different for the various compartments, this procedure has to be followed. This means that also for the experiment described in table 3.8 a value of $k_{r,ss}^*$ can be calculated.

For various experiments the value of $k_{r,ss}^*$ has been evaluated (table 7.2). For convenience also the calculated leakage $\bar{S}_v(\bar{r}_w = 0)$ is presented.

experiment	$\bar{\theta}_a$	\bar{v}_w	$\bar{S}_v(\bar{r}_w = 0)$	$k_{r,ss}^*$	remarks
820301: 19.00 - 0302: 07.00	5.5	5.7	0.36	9.9	$r_w = 0$
820330: 19.00 - 0331: 07.00	4.8	3.6	0.22	9.8	various r_w
820331: 24.00 - 0401: 07.00	4.5	3.6	0.23	9.4	various r_w
820525: 19.00 - 0506: 07.00	13.4	0.55	0.03	7.0	$r_w = 0$

Table 7.2 Steady-state calculations.

The steady-state results indicate that it is possible to calculate the working point for night conditions ($\bar{\phi}_s'' \equiv 0$). In the calculations it was confirmed that the values of $k_{r,ss}^*$ are reasonably consistent for the various compartments, although fig. 7.1 indicates that the assumptions on the value of $\bar{\phi}_h^*$ might not hold for larger values of $\bar{\theta}_{hg}$. The table 7.2 summarizes the available experimental material; no outlayers are omitted, with the exception

of an experiment with a varying \tilde{r}_w (table 3.7) for which a value of $k_{r,ss}^* = 12.6$ was obtained.

Apart from the possibility to calculate the working point, table 7.2 also leads to values of $k_{r,ss}^*$ that comply with values found in practice. In eqn. (3.37) a value is presented for $(k_{r,ss}^* + k_{v,ss}^*) = 7.56 A_r/A_g =$ (table 3.1) $= 8.55$; $\bar{v}_w = 4[m s^{-1}]$. With $k_{v,ss}^*$ according to eqns. (7.4) this would lead to $k_{v,ss}^* = 0.25$ ($\bar{r}_w = 0$) and $k_{r,ss}^* = 8.3$. This value of $k_{r,ss}^*$ is similar to the results presented in table 7.2.

This indicates that the assumptions made on $k_{h,ss}^*$ (and on k_h^*) are not unreasonable and that the relation found for $k_{h,ss}^*$ (and k_h^*) is realistic. This being true, it can be observed that the same parameter of the perfectly stirred tank model of eqn. (3.4) has *different values* for the dynamical models presented in Chapter 3 and for the steady-state case.

7.3 QUASI-STATIC MODELING

In this section the feasibility of low frequency modeling will be discussed. The model that is used is given by

$$C_{g,ss}^* \frac{d \theta_{g,ss}}{dt} = k_{h,ss}^* \{ \theta_{h,ss}(t - \tau_{d,h}) - \theta_{g,ss}(t) \} - \{ k_{r,ss}^* + \zeta_{ss}' S_{v,ss}(t) \} \{ \theta_{g,ss}(t) - \theta_{a,ss}(t) \} + \eta_{ss} \phi_{s,ss}''(t) \quad (7.5)$$

which is the perfectly stirred tank model of eqn. (3.4) for the quasi-static case. The dead time $\tau_{d,h}$ is introduced in order to use the model of eqn. (7.5) for parameter estimation, following the same arguments as in case of eqns. (3.25). Note that not $k_{v,ss}^*$ is used here, but the term $\zeta_{ss}' S_{v,ss}(t)$ in order to allow more explicitly for slowly time-varying values of the ventilation rate. The introduction of the multiplicative term leads to a *bilinear system* albeit in a quasi-static form. $S_{v,ss}(t)$ is calculated according to eqns. (7.4).

In eqn. (7.5) a longwave radiation term, representing the longwave radiation balance with the sky is not present. This can be considered to be an omission when low-frequency behaviour is of interest. For dynamical

modeling (and also for steady-state calculations) this radiation term is modeled with the shortwave radiation at daytime, and seen as a disturbance at nighttime.

The storage term $C_{g,ss}^* \frac{d\theta_{g,ss}}{dt}$ is present in eqn. (7.5) in order to facilitate the model to dampen sudden peaks (numerical inaccuracies) that may occur in the generation of the time responses of the quasi-static variables. The effect is mainly cosmetic, and for its value $C_{g,ss}^* = C_g^*$ (table 3.6) is selected.

The model of eqn. (7.5) will be validated on experimental data. Like in eqn. (7.2), the quasi-static variables in eqn. (7.5) do not contain sufficient distinct frequencies as to facilitate a complete parameter estimation. This means that the value of one of the terms should be known. Again, $k_{h,ss}^*$ is taken according to eqns. (3.36) and (7.3).

In fig. 7.2 the measured value of $\theta_{g,ss}$ and the best fit with quasi-static variables is shown, according to eqn. (7.5). The estimation is carried out for the same experiment as depicted in fig. 3.17 (a nightly experiment $\phi_{s,ss}'' = 0$ in compartment no. 1). The result of that experiment in terms of thermal variables is given in table 3.6.

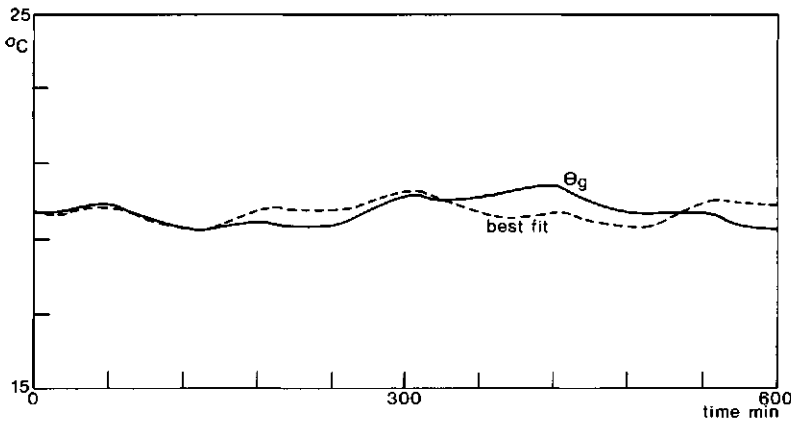

Fig. 7.2 Quasi-static modeling for experiment of fig. 3.17.

In the quasi-static case the best fit is obtained for $k_{r,ss}^*$ and ζ_{ss}' , where ζ_{ss}' contains a correction term representing the influence of the wind on $k_{r,ss}^*$ as well as incorrect calculation of the leakage. The result is $\zeta_{ss}' = 0.42$ and $k_{r,ss}^* = 8.2$. Of the available 720 datapoints 600 were used.

The quasi-static signals are obtained by subtracting in the time domain a filtered signal (see Chapter 3) from the original signal. This is a very straightforward method, introducing numerical inaccuracies. Also filtering can be used.

The ultimate interest of the quasi-static models is to use them to describe the observed variable(s) according to eqn. (7.1), where the greenhouse air temperature is formulated as the sum of a quasi-static and a incremental (dynamical) variable. By adding the response of $\tilde{\theta}_g$ of fig. 3.17 (obtained for the observed data set of 600 points) to the response of $\theta_{g,ss}$ of fig. 7.2, the total response of $\theta_g = \theta_{g,ss} + \tilde{\theta}_g$ is obtained (fig. 7.3a). In fig. 7.3b the response is depicted when the working point is calculated according to eqn. (7.2) so that here $\theta_g = \bar{\theta}_g + \tilde{\theta}_g$. It is seen that in this nightly situation the two responses are quite similar, with the error criterion (eqn. 3.22) $E = 91$ for the case of the quasi-static response (fig. 7.3a) and $E = 106$ for the steady-state working point calculation of fig. 7.3b.

The same procedure is carried out for the case that radiation is present. Now the experiment depicted in fig. 3.19 (for compartment no. 1; see also table 3.9) is treated. Fig. 7.4a and fig. 7.4b show the original signal of radiation ϕ_s'' and air temperature θ_g as well as their low frequent components $\phi_{s,ss}''$ and $\theta_{g,ss}$ (obtained by filtering the first three harmonics and not only one harmonic as was done in section 3.4.8). Here 420 data points are used out of a set of 480.

The estimation according to eqn. (7.5) yields a best fit with a value of $k_{r,ss}^* = 7.7$ and $\eta_{ss} = 0.45$; the influence of the wind in terms of variations was neglectable, so for $\zeta'_{ss} = 0.064$ was set. In fig. 7.5 the response of the actual value of θ_g is compared with a simulated response of a dynamical model with a quasi-static working point. As discussed in section 7.2 for daytime conditions steady-state calculations are not well defined, so no simulation could be carried out for that case.

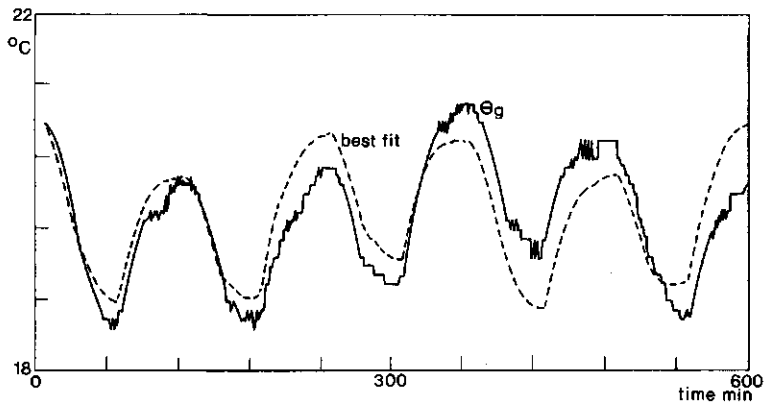

a

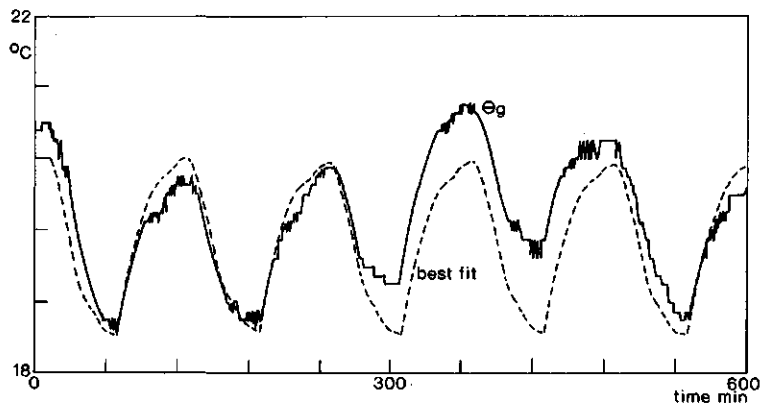

b

Fig. 7.3 Actual and simulated responses of the greenhouse air temperature. Simulation with quasi-static working point (a); with steady-state working point (b).

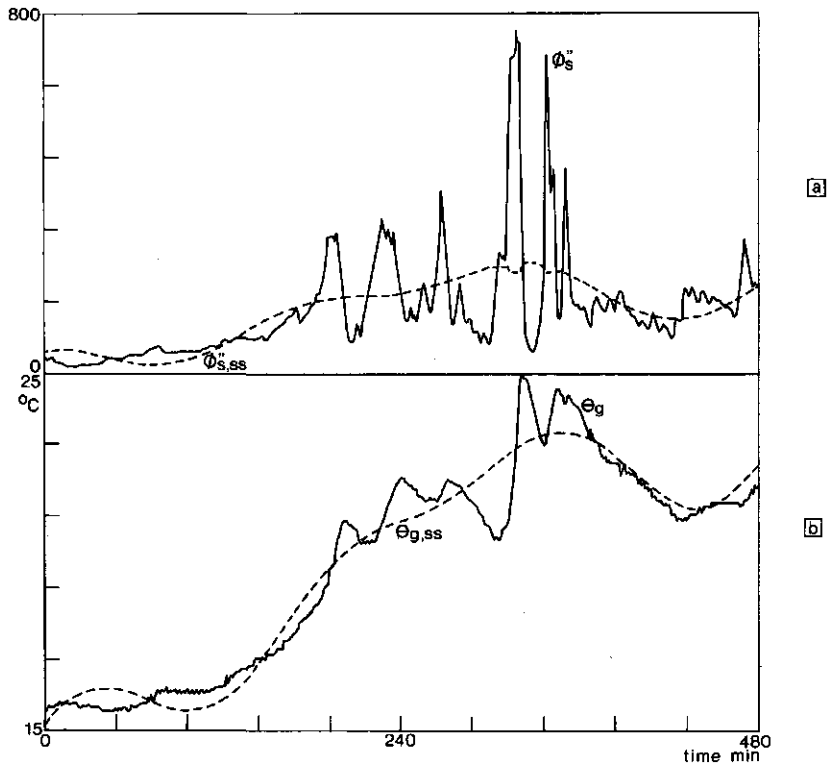

Fig. 7.4 Responses of the original signal and its quasi-static component; for the radiation (a); for the greenhouse air temperature (b).

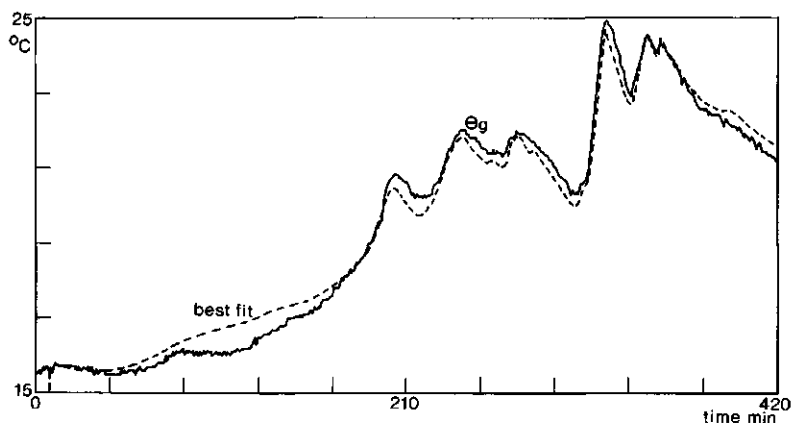

Fig. 7.5 Actual and simulated responses of greenhouse air temperature. Simulation with quasi-static working point.

7.4 DISCUSSION

In this chapter a method is described to calculate the working point of a dynamical model -of the type presented in Chapter 3. In a *steady-state* situation the working point can be computed from the *average* values of the relevant variables. When the variables constituting the working point tend to deviate too much from their average, the working point is described by a *quasi-static* model, where the average, trend and low frequency components of the relevant variables are used to model the slowly time-varying working point. For two cases it is demonstrated that this leads to quite *acceptable* results.

The calculations of the working point are based upon a simple thermal model. This model is applied for the dynamical modeling in Chapter 3, and is sufficiently accurate there. However for the modeling of the working point, more heat transfer terms should be included, notably a term representing the longwave radiation to the outside atmosphere (the sky temperature). Also terms describing the heat fluxes to and from the greenhouse soil and latent heat fluxes could be incorporated. It appears that for an accurate modeling of the working point detailed physical climate models of the type discussed in section 2.5 become of interest.

In terms of harmonics, the distinction between high frequency signals (applied in dynamical models) and low frequency signals is ≥ 5 or ≤ 3 harmonics defined on 1024 data points, or between harmonics of a period $\leq 3\frac{1}{2}$ or ≥ 6 hours. The applied test signals have a period of 2 hours in case of the determination of the heating transfer function $H_{g,h}$ of eqn. (3.3).

With respect to the working point the applied test signals are of a low frequency, and the distinction between test signals and the quasi-static signal components is rather abrupt. This means that the filtering techniques that are applied are critical.

When the working point is calculated, a-priori known values of the normalized k-value of the heating system k_h^* are used. The values of k_h^* are of crucial importance, since the accuracy of other thermal parameters (see Chapter 3) relies on the accuracy of k_h^* . Therefore, in Chapter 3, k_h^* was estimated from a dynamical experiment (fig. 3.18) and checked against steady-state results (eqns. 3.35 and 3.31). Also k_h^* has been compared with data from literature (eqn. 3.38). This leads to values of the normalized roof k-value k_r^* that are higher than could be explained. However, when in section 7.2 values of $k_{r,ss}^*$ are calculated based on a-priori known values of $k_{h,ss}^*$ which follow from the same measurements as in Chapter 3, much lower values of $k_{r,ss}^*$ result that do agree with results from literature (table 7.3). This stresses the point that using the same simple thermal model, the values of the (thermal) parameters found in the dynamic case and in the steady-state (quasi-static) case do *not* necessarily possess the same values.

experiment	$k_{r,ss}^*$	k_r^*	remarks
820301: 19.00 - 0302: 07.00	9.9	29.7	table 7.2/table 3.6 with $k_v^*=0.4$
820330: 19.00 - 0331: 07.00	9.8	28.3	table 7.2/table 3.8
820330: 08.00 - 0330: 16.00	7.7	21.8	comp.no.1/table 3.10 with $k_v^*=0.3$

Table 7.3 Comparison of results for steady-state (quasi-static) and dynamical models.

8 Optimal control of plant growth

8.1 THE HIERARCHICAL SYSTEM DESCRIPTION

Plant growth was described as a hierarchical system in Chapter 2 (fig. 2.1). In this description three levels are distinguished. The use of these levels will be motivated in this section.

Plant growth can be considered as a complex system. In protected cultivation, the *output variables* of this system are usually related to the economical output at the time of harvesting of the crop; with variables like yield, quality, earliness. The *input variables* are all the factors that attribute to growth, like planting material, application of fertilizers, pest control, nursing methods, labour, climate (inside and outside the greenhouse), greenhouse structure. Plant growth is a development in time, which means that especially the time course of the input and output variables is of interest.

In a very complex system, it is useful to *reduce* the complexity by focusing on certain relations. A common approach is to isolate families of input variables. Relevant to this thesis are the set of input variables associated with the greenhouse climate and structure; in general the environment of the crop in terms of *environmental physics*. After this first restriction, still a very complex system remains, relating environmental physics inside a greenhouse with the ultimate output variables at the time of harvesting. A next step can be made by realizing that the output variables at the time of harvesting are the resultant of the system over a period of time (the whole growing period) and therefore associated with an integral action. These *integral variables* represent the final outcome of the processes described by the system. Consequently their relation to time differs from that of the input variables. Therefore, a second restriction can be made in that the integral output variables are distinguished from output variables that are *time-varying* (although the time units that are used may be up to weeks).

After these preliminary restrictions the plant growth system itself is

considered. When the eventual purpose of the control actions is to obtain "*optimal plant growth*" in terms of considered input and (integral) output variables, a *hierarchical system* description can be useful. Here the idea is to break the complex system down into subsystems. Preferably the input/output variables of the subsystems are formulated such that the output of one subsystem can be considered as the input of another subsystem. The subsystems are arranged in a hierarchy where the *lower* level generates the inputs of the *higher* level. Control of the system is formulated such that the higher level operates on the controls of the lower level.

When optimality is pursued, this is obtained by optimizing the *higher* levels in terms of output variables of the lower levels, and to optimize each of the levels *within* these limits set by the higher levels. This approach facilitates to reduce the complexity of the optimization, although it might be less optimal than optimizing the whole system.

The hierarchical system description presumes that subsystems can be formulated meaningfully, that the inputs and the outputs of the subsystems are measurable and that the feedback from the higher to the lower levels (other than via control on purpose) can be neglected. The first two assumptions are obvious, the last one can be used as a criterion, requiring the absence of interaction. In reality, however, some (weak) interaction is always present. Because the interaction criterion alone does not reduce the complexity of the system sufficiently, another criterion is formulated. It is assumed that a distinction can be made on the relevant time scale of the process that is described.

As for the plant growth system, on the basis of weak interaction the climate subsystem can be isolated from the plant. This subsystem constitutes the first level of the hierarchical system. The output of this climate subsystem is in principle measurable, and its input is (partially) controllable, so that it forms a sound basis for future optimization.

Regarding the plant, a distinction can be made using the time scale criterion. Plant processes that operate on a short time scale and processes which operate on a long time scale can be distinguished. What is done in the hierarchical system of fig. 2.1 is to define a border at the diurnal course of the plant. Plant processes that fall within this time scale are situated on the second level; processes operating on a longer time scale are placed

on level three. The requirement of the absence of interaction is not necessarily satisfied here and also with respect to the measurement of the input and output variables -and even to the identification of what the relevant variables are- some questions remain.

With respect to the formulation of level two and three of the hierarchical system it is recalled that the purpose of the system is to facilitate optimal control of plant growth. Therefore it is tried to split the complex plant growth system into meaningful subsystems. From a scientific point of view this might seem unsatisfactory, because seemingly this approach obscures potential relations between the levels, and denies the idea that "everything is related to everything". This approach is justified because it is followed in order to reduce the complexity of the system, in relation with the purpose to control the growth of plants optimally via a distinct (hierarchical) strategy.

The ideas on the hierarchical system description as outlined above, will be reflected on research on optimal control of plant growth as it is found in the literature.

In section 2.4.2 it was pointed out that some knowledge on level two and level three processes is already incorporated in existing climate controllers in an implicit way. Here explicit strategies are discussed.

In the strategies a distinction can be made between the *knowledge* that is used in optimal control procedures, and the *approaches* that are followed -although these two are related to each other.

With respect to the available knowledge, on level two diurnal plant growth is considered and the plant responses (see section 2.1.3) fall into two classes of models: *transpiration models* and *structural dry matter increase models*. On level three the crop responses can be described by *crop growth and development models*. The three models differ in terms of input and output variables and can be formulated independently.

The models represent subsystems of the hierarchical system, and can be regarded as processes when input/output relations are considered. Some of the variables of the processes can be measured, using techniques that as a rule originate from plantphysiological research.

The (optimal) control strategy can operate on the second or on the third level of the hierarchical system. When on level two over-all plant response measurements are involved, we will say that the *speaking plant* approach is followed. When on level three the crop growth is considered, *optimal crop growth* is envisaged over the whole cropping period, with the objective to maximize the yield-earnings/running-costs ratio.

In the literature several attempts are described where over-all plant responses or crop responses are related to space average climate control on level one. Some of the studies are based on phytotron experiments, others are carried out in greenhouses under experimental conditions. In the next section, models of plant and crop reactions -as they are used in control- are treated. Then, control strategies based on these models are described and their feasibility in the practice of growing is discussed.

8.2 GROWTH MODELS FOR CONTROL

Plant growth on the second level of the hierarchical system of fig. 2.1 can be described by two classes of subsystems, one using transpiration models and the other using structural dry matter increase models. Both subsystems represent plant physiological phenomena.

Transpiration models deal with plant-water relations. The plant responses are described by causal relationships. In relation with control, a model of this type has been described by Hashimoto and co-workers (Hashimoto, Morimoto and Funada, 1981a, Hashimoto et al., 1981b). The model has stomatal aperture and leaf temperature as output variables (facilitating to determine CO₂ uptake). Inputs are the crop canopy climate and water uptake by the roots. Inter-variables are the water content of the stem and of the leaves. The parameters from the model describing the relations between these variables are estimated from experiments in phytotrons, where the input variables are varied in order to induce test signals into the system (Hashimoto et al., 1981b, Hashimoto, Morimoto and Funada, 1982a, b). A similar approach to describe causal relationships is suggested by Hopmans (1981), who relates temperature, transpiration rate and water potential in leaves.

Structural dry matter increase models are concerned with photosynthesis,

respiration and translocation processes in plants. Takatsuji, Kaneko and Tsuruoka (1979) describe such a model as a basis of an optimal control method. Challa (1976) established a relation for cucumber plants, that was used in a blue-print approach for varying night temperatures (Van de Vooren, De Lint and Challa, 1978).

Crop growth and development models are -in a control context- presented by Matsui and Eguchi (1976, 1977a, 1978). Also more elaborate crop growth models (De Wit et al., 1978) have been employed for control purposes (Soribe and Curry, 1973, Krug and Liebig, 1979). A problem with elaborate crop growth and development models is that they are not readily validated.

The output variables of crop growth and development models are based on the time unit of these models which is one day. Of interest is the integrated result of these variables over the time span of the whole cropping period. In traditional horticultural research the growth and development is evaluated by describing the status of the crop (number of leaves, tross formation) in time. The main interest is focused on the integrated or integral result with integral variables like yield, quality, earliness which can be related with auction prices in order to assess the economical output. It is seen that these integral variables are not the same as the output variables of the crop growth and development process, although they are related. For this reason in the hierarchical system of fig. 2.1 an integral block relates crop growth and development and the yield (including all integral variables). In research, using explicit models the outlook on the final result can be adopted, where the interest is focused on one integral variable, or on a scalar function which represents a weighted sum of all integral variables leading to *production models*. Challa and Van de Vooren (1980) have investigated the relation between earliness of a winter crop of cucumbers and the temperature regime. Seginer(1980) uses a scalar function for growth which is the derivative of a scalar function of integral variables.

Comparing the three types of growth models, the transpiration models are seen to be based on *causal* relations, the described processes are *reproducible* and subsequently the parameters of the models can be estimated from test-signal experiments. This situation conforms to that of the greenhouse climate modeling as presented in this thesis. Conversely, crop growth and development models are based on *empirical* relations (Van Wijk, 1963), the processes are

not generally reproducible so that test-signals give no useful information. Structural dry matter increase models fall somewhat between these two extremes. By the way the three models are formulated (the methodology of the observed relations) and because of the variables that are relevant to the models, it is obvious that there is no unambiguous relation between the models. This means that it is -in principle- not possible to control explicitly one of the growth subsystems via another one.

In practice, the result is that the control strategies are focused on one of the subsystems. However, the control actions operate via other subsystems (on the lower levels of the hierarchical system). This means that the other subsystems influence the effective control of the relevant subsystem. Because the other subsystems operate on another time scale, it seems possible to reduce their influence in an average sense. This (implicitly) leads to restrictions with respect to the time behaviour of the control signals.

8.3 SPEAKING PLANT APPROACH

Control of the greenhouse climate can be based partially on the measurement of plant processes associated with transpiration or structural dry matter increase. This is called the *speaking plant* approach, where the purpose is to create a "comfortable" environment for the plants. This is conceptually similar to the "comfort" criteria for air-conditioning in buildings.

In the literature, the speaking plant approach has been formulated by several authors (albeit not under this name). It can be considered as a quantitative sequel on the research for control procedures of the greenhouse climate. As such this approach has been suggested in order to overcome the problem that "improved" climate control cannot be demonstrated to give higher yields in the traditional field trials (Germing, 1969a,b, Germing and Van Drenth, 1971). In the "Green energy program" of the Japanese Ministry of Agriculture this approach is advocated in a strategy for saving heating costs (Agric. Res. Council, 1980).

When the speaking plant approach is used in research, the relation can be established between extreme situations that may damage the plants in terms of the spatial average climate or the crop canopy climate. This knowledge, added to the already existing practical knowledge and experience with respect to

over-all plant behaviour, can be applied in controllers and in control procedures. The knowledge could also be used by incorporating an explicit strategy in the control algorithm e.g. using predictive control methods. In this way models of the plant response become important, because prediction assumes a correct knowledge of the actual plant status.

Transpiration and structural dry matter increase models are based upon many fundamental processes, leaving a large number of variables to be measured. Because this is hardly practical, only a limited number is measured.

Measurements can be made *directly* -which means that the sensors are attached to a single plant- or *indirectly* (for example CO₂ uptake indicating the rate of net-photosynthesis). The indirect measurements are usually tedious because other processes influence the measured variable (as is the case with CO₂).

The direct measurements have to be performed on living matter, which makes them rather cumbersome. Also the representativeness is questionable. In the first place the measurements are taken locally within the crop while a crop shows a significant variation between the individual plants. In the second place the sensors have to make contact with the plant. Research indicates that plants which are regularly stirred have lower yields compared with unstirred plants (Klapwijk, 1976, Mitchell et al., 1975). According to Mitchell et al. this raises questions on the representativeness when in routine measurements the sensors continuously make contact with the plant.

The complexity of the problem has motivated research to control methods, where only one or two variables related to transpiration or structural dry matter increase are measured. By closing a control loop around the variables it is expected that at least some improvement could be obtained. This was done by e.g. Takakura et al. (1974) who determined photosynthesis by measuring CO₂ uptake in a closed system. The same type of measurements has been described by Hand and Bowman (1969) and Hand (1973). Results on a tomato crop have been reported (Takakura, Ohara, Nakamura, 1978).

Also the control of leaf temperature has received some attention (Mackroth, 1974) with the objective to control this variable instead of the greenhouse air temperature. Matsui and Eguchi (1977b) and Hashimoto (1980) studied the control of the leaf temperature via climate control in phytotrons. The last two studies are mainly concerned with the control of the transpira-

tion processes. A discussion on the control of leaf temperature can be found in the book of Hanan et al. (1978).

The results of the approach using a limited number of measurements have not been very decisive with respect to the eventual yield. In the few cases that an improvement could be demonstrated, the results could also be explained from phenomena like the occurrence of CO₂ depletion or extreme humidities, which occurred by the crop that was grown according to the standard treatment. In a good "blue-print" climate regime, these extremities are also avoided, which means that the speaking plant approach in fact is *not* compared to a standard treatment. *Without* the plant measurements required for the speaking plant approach the same result could be obtained. The comparisons should be carried out with "good" blue-prints, leaving an economical optimization problem to solve.

An approach in which structural dry matter increase information is used is presented by Takatsuji, Kaneko and Tsuruoka (1979). Here the relevant variables are measured and controlled in growth chamber experiments. The obtained data are expected to lead to a model on which control of optimal plant growth can be based.

Another approach is the application of *detailed models*. In the case of transpiration processes Hashimoto et al. (1981b) suggest the use of models as a basis for control. It is not obvious how in this case information has to be obtained in a practical application, but the studies suggest a form of prediction with models and on-line correction of the predicted variables.

8.4 OPTIMAL CROP GROWTH

Crop growth is associated with level three of the hierarchical system. The relevant time span is the whole cropping period, with one day as a unit. The relevant output variables are associated with the growth over one day (fresh weight, length, dry weight, leaf area). One is, however, interested in the final result of these variables integrated over the cropping period with integral variables like yield, earliness, quality.

Matsui and Eguchi (1976, 1977a, 1978)(Eguchi and Matsui, 1977, 1978) use pattern recognition techniques in order to determine fresh weight increase,

leaf growth and plant elongation. These measurements facilitate to evaluate crop growth on a daily basis. The measured variables are then led along trajectories (which are assumed to be known) in order to obtain an optimal result (Eguchi, personal communication). Since here growth chamber experiments are discussed, it is not clear if and how actual outside weather conditions fit into this approach.

When the integral variables are of interest, in fact the economic result is considered. This opens a possibility to apply optimization procedures which are related to the economic results. Using a production model Krug and Liebig (1979) propose to calculate the economic result/running-cost ratio's for various crops, planting dates and auction prices under average weather conditions. Gal, Angel and Seginer (1981) present a similar approach, but suggest to calculate a set of trajectories in order to be able to account for the actual weather conditions (over a longer period). Also, Seginer and Albright (1980) and Seginer (1980) use a production model in order to calculate the effect of early closing of thermal screens in terms of production delay versus energy conservation.

Challa and Van de Vooren (1980) related a production model (with earliness of a cucumber crop versus temperature regime) to rate of leaf formation. This enables to relate actual variables (on a time scale of a few hours) and actual energy consumption to earliness and economic output. An on-line optimization can be carried out. This was done experimentally for a cucumber crop (Challa et al., 1980) yielding a small difference between the optimal and a standard treatment in terms of economical benefits.

8.5 DISCUSSION

With respect to optimal control of plant growth, it is obvious that the result are not encouraging when it comes to the traditional horticultural criteria of economic output (in integral variables). This can be explained because improvement of the second level control is not directly related to the final output.

On the third level the production models have to compete with existing knowledge and expertise from which the application is partly based on observations of the grower during the growing process. In production models these observations are not readily included, which stresses the point that

the production models do not so much relate input variables to output variables, but originate from relating output to input by mathematical differentiation. Apart from their scientific merits, they are not seen to improve the economics of growing an individual crop by a grower under specific weather conditions.

From the discussion on the various models it is seen that it is important to use the proper variables for the control of the individual subsystems. This means that the proper input variables have to be actuated, based on measurements of the proper output variables. For example, when envisaging the final result (integral variables: yield, earliness, quality), the related variables are the output of the crop growth process, namely fresh weight, length, dry weight, leaf area, and *not* temperature sums, radiation sums, or air humidity sums over one day -as is usually done. Using these latter crop canopy climate factors in integral form (of one day) assumes that their effects on dry matter increase (on a diurnal base) are mutually independent. This assumption might hold in an average sense, but it is surely not possible to base decisions for *actual* control actions (time basis of minutes) on these type of models.

Considering the time scale on which the subsystems operate, it is seen that the transpiration process operates on a minute basis. Because it seems possible to measure the output variables of this process, it opens the feasibility to control the transpiration behaviour of the crop. However, in a greenhouse the disturbances (solar radiation) can be much faster than the control system can respond, so that no tight control can be achieved. Also, the desired state of the output variables of the transpiration process is not sufficiently known so that only the *avoidance of stress situations* can be the strategy.

The time scale of the structural dry matter increase model is in the order of hours. The time response of the control system can effectively regulate these processes, so that a tight control can be achieved. Measurement of the process output variables is not so well defined, but for example CO₂ uptake can be measured. Combined with a model, the output variables could be estimated and used in the control loop. Because also the observations of the grower are based on a longer time scale than hours -which explains the

application of control procedures in GCFC- improvements in this field are potentially obtainable.

In the discussion above, the merits of the optimal control of each of the subsystems have been reflected. In the hierarchical system description in section 8.1 it was stated that optimal control of each level leads to an over-all optimal behaviour. Summarizing the potentials with respect to the subsystems that are used in the hierarchical system description leads to the following points of view. With respect to the second level, *transpiration* is not easily controllable because of the relevant time constants, but is otherwise directly related to the first level (the climate), and the variables are relatively easily measurable. However, transpiration is not seen to lead to optimal behaviour of level two. *Structural dry matter increase* is more related to optimal results, is controllable in terms of dominant time constants, but the associated variables are not easily measured. On level three *plant growth and development* optimization has already been carried out in practice by the growers. Optimal procedures on this level have to compete with existing expertise and are for that reason not readily seen to accomplish very much. However, when other factors are considered, such as labour management in relation with crop development, some improvements might be achieved on level three.

9 Final discussion and suggestions

In the introduction of Chapter 1, the question has been posed whether *control science* would contribute solutions with respect to a better understanding of greenhouse control, new types of greenhouses and optimal control of plant growth. In this final chapter it is examined which answers are tentatively provided for these questions and suggestions are made for future research.

Generally speaking, in this thesis two lines of thinking are followed. The first one is a heuristic *engineer's approach* with a high esteem of the achievements obtained in horticultural practice. Since in practice control procedures are followed by the grower, the emphasis is laid on improving these control procedures by improving the effectiveness of GCFC methods (GCFC = greenhouse climate feedforward/feedback control).

The second line of thinking is a *system approach*, where the question is how to incorporate more (scientific) knowledge in climate control. Here the concept of the hierarchical system is introduced, where the first level (the greenhouse climate) is investigated in more detail. This results in a novel approach to greenhouse climate modeling (employing high-frequency and low-frequency models).

The two lines of thinking do not naturally exclude each other, but indicate the target-groups for which the results might be of interest. The engineer's approach and related results may appeal to the grower, traditional horticulture and greenhouse computer manufacturers. The system approach is concerned with more fundamental issues and is related to plant physiology and environmental physics.

Models of the greenhouse climate constitute the basis of both lines of thinking. For control, models that are formulated in terms of incremental variables are of interest. In this thesis a basis is laid for the formulation of such models in terms of the spatial average climate (Chapter 3). This is done by demonstrating how these models, which are formulated in a black-box fashion, are estimated from experimental data. The models are established for *sensible heat fluxes* only. An important contribution of this thesis is that

the black-box models are reformulated in terms of thermal parameters (heating-load coefficients) for a simple thermal model. By this way of modeling the behaviour of the greenhouse climate dynamics can be predicted from heating-load coefficients which are widely available. This opens a wide range of applications. Using simple thermal models in design, control procedures as well as control methods can be improved. Simulation of the proposed control algorithms could assess the relative merits. In the greenhouse computer industry, by this approach the reliability of GCFC can be significantly improved.

A related result holds for new types of greenhouses which are in the drawing-table stage, but of which the heating-load characteristics are known. Also the lay-out of the heating and ventilation systems can be based on these thermal models.

Because the models are quite simple, for simulation a low-cost personal computer will do the job, so that *suggestion 1* is to develop software packages for greenhouse climate models and for control on a suitable personal computer.

For the individual greenhouse, the parameter estimation method of the black-box models as presented in Chapter 3 can be applied in order to determine the relevant characteristics of the GCFC dynamics as well as the heating system non-linearity. This facilitates the tuning of the controller algorithms of a newly installed greenhouse computer by employing analytical tools and/or off-line simulation. This might speed up the tuning of the greenhouse computer controller settings considerably.

The models of Chapter 3 can be improved by modeling the working point, as is suggested in Chapter 7. As a result, the dynamical (high frequency) models get a more realistic appearance which makes the actual values of the variables more easily interpretable. Another result is that, employing these improved models in individual greenhouses, the occurrence of e.g. heat-leaks can be determined.

The models as described in this thesis are not complete. Air humidity is not modelled, which leads to *suggestion 2*: to establish models that include *latent heat fluxes* (air humidity).

The *ventilation* phenomena in greenhouses are not well known, so that *suggestion 3* is to investigate the relation between ventilation rate and

window aperture (also in the dynamical sense). This being clarified, opportunities emerge for *humidity control*. With more reliable sensors becoming available (than the aspirated psychrometers presently used) humidity -or a related variable, see section 2.3- can be controlled. In the control algorithm a trade-off can be made between the lowering of the humidity and its associated heat-loss.

In the greenhouse, the heating system is not modelled in sufficient detail, so that *suggestion 4* is to model the dynamical behaviour of the mixing valve in relation to the heating system temperature (section 3.3.1).

With respect to the frequency dependency of the estimated parameters of the simple thermal model, some intriguing issues arise. The results in this thesis are obtained for a simple thermal model based on the assumption of a perfectly stirred tank which accounts for one energy storage element only. In more detailed physical climate models, more variables are employed -for example roof temperature, plant temperature, soil temperature- where each of the variables is related to an energy storage element. Frequency dependency can be anticipated when these energy storage elements are not modelled separately, but lumped into one element - as is the case with the simple thermal model. However, does the simplified modeling employed in this thesis account for the observed frequency dependency, or is the frequency dependency also apparent in more detailed climate models? If this were true, this might explain the not very reliable results of the available greenhouse climate models found in the literature (Chapter 2). *Suggestion 5* is to investigate this intriguing matter in detail.

It is recalled that the climate models represent the *spatial average climate*. In Chapter 2 it has been suggested to use the *crop canopy climate* as family of climate factors. *Suggestion 6* is to formulate models in terms of the crop canopy climate. This offers potential advantages. In terms of optimal control of plant growth, the crop canopy climate is more closely related to the overall plant responses than the spatial average climate. Added to that, the concept of crop canopy climate might make it possible to simulate the greenhouse climate in phytotrons, thus making phytotronic results link with practice in greenhouses. This might facilitate research to extreme climate situations in a greenhouse. It also illustrates the need to improve the dynamics of the existing climate control in phytotrons.

Returning our attention to control, in Chapter 4 performance criteria are formulated for temperature control. The behaviour of controllers, as it most frequently occurs in practice is analyzed, leading to the terms *overshoot*, *sag* and *undershoot*. These terms can be used to evaluate controller performance, which is done in Chapter 4 in a comparison between various control algorithms. A new *dog-lead* algorithm is introduced and is seen to be of *great practical interest*. For greenhouses with upper and lower heating pipe networks a *split-range* control method was presented. *Suggestion 7* is to investigate the characteristics and to evaluate the performance of split-range control methods in more detail.

Adaptive temperature control is presented in Chapters 5 and 6. The relevant theory is treated in Chapter 5. From the appearance of the presented gradient algorithms, resemblance to the well-known "least-squares" methods is claimed. This claim is done on purpose, since least-squares methods are known for their nice statistical properties. An algorithm that is based on gradient minimization, that is stable (according to Liapunov's method) and of which the statistical properties are well established, is naturally attractive for on-line parameter estimation and adaptive control. However, the claim of resemblance just by looking to the resulting algorithms is somewhat meagre, and is not likely to convince a sceptical reader. Therefore, *suggestion 8* is to establish more firmly the least-squares likeliness of the stable gradient methods.

Employing a simple algorithm from the theory, in Chapter 6 an adaptive temperature control algorithm is presented. The problems associated with the design of the proposed adaptive PI control algorithm are outlined. The adaptive algorithms are compared with their non-adaptive variants in a full-scale trial spanning 99 days of observation. It turns out that the adaptive algorithms do not lead to an improvement. However, realizing the deterministic nature of the dynamical models, adaptation can be employed in the form of *gain-scheduling*. *Suggestion 9* is to investigate gain-scheduling schemes e.g. for the non-linear heating system gain or in order to reduce the effect of measurable disturbances like radiation. The problem here is to find an easy way to separate on-line, high and low frequency components of the disturbance signals. *Suggestion 10* is to develop a self-tuning procedure in which the GCFC dynamics are estimated by an on-line estimation procedure.

Using the hierarchical system description, optimal control of plant growth is discussed in Chapter 8. The central theme here is that control is an order more complicated than describing or explaining empirical or causal relations. As this chapter is speculative by nature, many suggestions could be formulated. Two will be mentioned here. *Suggestion 11* is to establish a clear distinction between optimal control and the blue-print approach. This is seen to be of importance in order to clarify whether computer systems are essential to carry out the control. *Suggestion 12* is to formulate optimality in terms other than growth and its associated direct (energy) costs; for example by introducing labour management aspects in order to constitute a sub-optimum.

A final word should be said on the issue whether (in the future) advanced computer systems could "replace" the grower. The ideas outlined in Chapter 8 on optimal control of plant growth, indicate that the scientific knowledge is not sufficiently coherent to be able to regulate plant growth in a closed loop. At best one can hope that more information can be made available to the grower so that he can make better motivated decisions. It is recalled that a computer is basically an information processing device, and easy achievements can only be obtained for processes that are characterized by streams of readily available information. Because of this in Chapter 8 labour management has been suggested as a potential area for optimization.

It can be concluded that the replacement of the grower by the computer, which from an ethical point of view is regarded to be undesirable, from a heuristic point of view is seen to be untractable. Both points of departure arrive at the same conclusion, indicating that ethical and heuristic thinking do not necessarily exclude each other and most surely agree on the statement that the availability of a computer system does not offer the researcher a short-cut from science to relevance.

Summary

The material presented in this thesis can be grouped around four themes, system concepts, modeling, control and adaptive control. In this summary these themes will be treated separately.

System concepts

In Chapters 1 and 2 an overview of the problem formulation is presented. It is suggested that there is some ambiguity with respect to what exactly control is since in practical horticulture *control procedures* are used. This has motivated to introduce the term *GCFC* (greenhouse climate feedback/feedforward control) where control in the strict sense is meant. It is ascertained that -despite much research in the field of control procedures- in the field of *GCFC* little results have been reported in the literature.

It is argued that climate control (or more strictly *GCFC*) in practice restricts itself to climate factors with respect to the greenhouse atmosphere (air temperature and humidity, CO_2 contents). It is suggested to formulate *GCFC* in terms of the *crop canopy climate* in that notably the radiative part of the control actuators is considered as a controlled variable too.

The existing control methods for greenhouse climates are described using the concept of a *hierarchical system formulation*. Here the problem of creating a beneficial environment for the plants is described as a system with *three levels*. On the first level *GCFC* is found, on level two plant growth on a diurnal basis, and on level three crop growth and development. It is argued that the control procedures as they are employed in the practice of horticulture, can be seen as a combination of the levels one and two, whereas *GCFC* restricts itself to level one. It is suggested that the control procedures can be improved by solving the *GCFC* problem adequately and formulate the procedures as setpoint control of level one.

Also, in Chapter 2 an overview of existing literature is presented, both on control in greenhouses and on models of the greenhouse climate.

Another conceptual part is presented in Chapter 8, where the *optimal control of plant growth* is treated. Here the idea of the hierarchical system is employed to describe the optimal control problem. The system is broken down into less complex subsystems (levels in the hierarchical system) and each of the higher levels is optimized in terms of output variables of the lower levels. This assumes that the variables that are used in the optimization correspond with the relevant level.

These ideas are reflected against the literature. It is ascertained that measurements on plants can be performed (the speaking plant approach) and that potentially plant transpiration can be regulated -at least in an experimental situation. However, the measurements have to be made in relation with specific knowledge of the plant processes under control. The measurement of single variables like leaf temperature, evapotranspiration etc. alone is not seen to lead to significant results.

Although the material in Chapter 8 is speculative by nature, the basic ideas are well established. Scientific knowledge alone does not imply more opportunities of (optimal) control, and for optimal control the approach should be aimed at reducing the complexity of the problem by focusing on variables (and relations between variables) that comply with the level of the hierarchical system.

Modeling

The second theme of this thesis concerns the *modeling*. In Chapter 3 a new approach to the modeling of dynamical greenhouse climate processes is presented. The approach incorporates a sequence of key features which differ from the usual one.

The first feature is that the greenhouse climate process -in our case restricted to the temperature- and the actuator processes (mixing valve process and ventilation window process) are described separately. For the mixing valve process that regulates the temperature of the heating pipe network, this is quite natural since the output of the mixing valve process (the heating pipe temperature) can be measured. For the ventilation windows process this is less natural, because the output of this process is the air change rate, which is not directly measurable. However, by the proposed way of description the main non-linearities are removed from the climate process.

The following steps follow logically when dynamical systems are of

interest: the climate (temperature) process is formulated in terms of *incremental* variables and a *working point* is defined. Essential in greenhouses is that the working point is *slowly time-varying*. By supplying (relatively) high frequency signals as inputs of the system, the low frequency variations of the working point can be rejected using *filter techniques*. Then *parameter estimation* is carried out in the time domain, using optimization techniques in order to determine the parameters of a simple model.

In this thesis, for the filtering of the signals frequency domain techniques have been used, but filtering in the time domain (with finite impulse response filters) could be used as well. For the test signal, a block signal was applied, because some frequency dependency of the parameters was anticipated. This test signal performs well for the mixing valve as actuator of the process, but for the ventilation windows a test signal spanning a wider frequency range must be used.

Up to this point, the traditional goal of control engineering is satisfied, since the process is sufficiently described. However, from the results some dependencies on physical phenomena could be guessed (section 3.4.5). Therefore it was tried to interpret the results in terms of physical parameters. Because a *detailed* physical model does not comply with the simple dynamical model, an approach was followed using heating-load coefficients (k-values), where the heating-load coefficients enter as the parameters into the simple thermal model.

To carry out the interpretation (section 3.4.6), at least one heating-load parameter has to be known. For this, the parameter describing the heat flow from the heating pipe network into the greenhouse is used. This parameter was determined from one type of experiment, and was found to be non-linear. Because the parameter estimation of the dynamical models was carried out on various temperature levels, the non-linearity of the heating system could be checked and was found to comply in both types of experiments.

From the parameter of the heating system, the other parameters could be calculated. The values that are found are consistent, as they are confirmed in several different experiments under different outside weather conditions. The value of the heating system parameter was found to agree with values from literature. However, the values found from parameter estimation differ roughly

a factor two from the corresponding values found in literature.

This latter result could be caused by a defective value of the heating system parameter. Therefore, in Chapter 7 a steady-state analysis is carried out to determine the parameters, where again the heating system parameter is assumed to be known. This time the parameters agree with results found in the literature, so that it may be concluded that the parameters of the dynamical (control) models and the static heating-load models *differ*, and that the first ones are *frequency dependent*.

For a few cases in Chapter 7 it is also demonstrated, that it is possible to model the slowly time-varying working point, using a quasi-static model. The absence of a long-wave radiation term from the sky in the model can be seen as an omission here. It was suggested that at daytime a quasi-static model should be employed, and that at nighttime a (more simple) steady-state (static) model can be used. When the responses of the working point are combined with the responses of the dynamical model, the "real" climate responses can be calculated so that a model of the greenhouse climate is obtained. This model is quite accurate in predicting the momentaneous behaviour of the greenhouse climate process.

Control

The control of greenhouse climates in terms of GCFC is discussed in Chapter 4. Here the attention is focused on temperature control.

By analyzing the behaviour of the control loop, performance criteria are formulated, where the attention is focused on the behaviour of the controller when saturations occur caused by the influences of the outside weather conditions. In this respect the control differs from the usual ones. This leads to the formulation of the performance of the GCFC control in terms of overshoot, sag, and undershoot.

The performance of a conventional type PI controller is compared with a new *dog-lead* PI algorithm -which is easily implemented in a computer- in terms of the performance criteria. It is seen that the dog-lead algorithm is by far superior in performance with respect to undershoot, better with respect to sag, and similar with respect to overshoot. Since undershoot is the most

severe phenomena with respect to poor performance, it is suggested that the dog-lead algorithm is of *great practical interest*.

Also a *split-range* algorithm is described, which can be used in greenhouses with an upper and a lower heating pipe network.

Adaptive control

An adaptive control method of GCFC of the greenhouse temperature is presented in Chapter 6, and the relevant theory is treated in Chapter 5.

The theory is concerned with a novel approach to the estimation of parameters of a dynamical process. The algorithm is based on stability criteria and is formulated as a gradient optimization. From the appearance of the resulting algorithm in the discrete time domain, resemblance to the well known least-squares method is claimed. In the continuous time domain similar algorithms are presented.

Adaptive control is presented in Chapter 6. After an outline of the problems associated with the design, results are given of a field test that concludes several years experience with the adaptive method. It is claimed that for the comparison made in the field test, the "best" tuned algorithms were compared, so that *within* the design criteria no further improvement can be obtained.

By comparing the adaptive algorithms with the non-adaptive variants it was clearly demonstrated that the adaptation does not bring significant improvement when the behaviour over a longer period of time is evaluated. In case of the adaptive dog-lead method the results even deteriorate by using adaptation. It was suggested that this is mainly caused by the saturated behaviour of the controller. This not very encouraging result can be seen as an illustration that adaptation of a process does not come in the place of detailed knowledge of that process.

Final discussion

In Chapter 9 a final discussion is presented and suggestions are made for future research.

Samenvatting

De onderwerpen die in dit proefschrift aan de orde komen, kunnen in vier categorieën worden ingedeeld: systeembegrippen, modelvorming, klimaatregeling en adaptieve klimaatregeling. In deze samenvatting zal elk van de categorieën afzonderlijk worden behandeld.

Systeembegrippen

In de hoofdstukken 1 en 2 wordt een overzicht gegeven van de probleemstelling. Gesteld wordt dat enige onduidelijkheid bestaat over wat nu precies "regelen" is, omdat in de tuinbouw meestal *regelprocedures* worden toegepast. Dit geeft aanleiding om de term GCFC (greenhouse climate feedback/feedforward control) te introduceren, waarmee klimaatregeling wordt onderscheiden van het meer algemene begrip klimaatbeheersing. Ondanks veel onderzoek op het gebied van regelprocedures, valt te constateren dat op het gebied van kasklimaatregeling (GCFC) zelf slechts weinig resultaten in de literatuur bekend zijn.

Kasklimaatregeling (GCFC) beperkt zich in de praktijk tot klimaatfactoren die verband houden met de kaslucht (luchttemperatuur, luchtvochtigheid, CO₂ gehalte). Voorgesteld wordt om kasklimaatregeling te beschrijven in termen van *gewasklimaat*, waarbij vooral het stralingsaandeel van de regelorganen als een geregelde variabele wordt beschouwd.

In hoofdstuk 2 wordt de regeling van het kasklimaat beschreven als een *hierarchisch systeem*. Het probleem om een gunstige omgeving te scheppen voor de plant wordt beschreven als een systeem dat is opgebouwd uit *drie niveau's*. Op het eerste niveau vindt men de eigenlijke kasklimaatregeling (GCFC). Op het tweede niveau treft men de dagelijkse plantengroei aan en op niveau drie gewasgroei en ontwikkeling. Regelprocedures zoals die in de praktijk worden aangewend, kunnen worden gezien als een combinatie van de niveau's één en twee, terwijl kasklimaatregeling zich beperkt tot het eerste niveau. Er wordt voor gepleit de regelprocedures te verbeteren, door de kasklimaatregeling als probleem op zich adequaat op te lossen en om vervolgens de procedures te

formulieren als setpoint (gewenste waarde) sturingen van het eerste niveau.

Daarnaast wordt in hoofdstuk 2 een overzicht gegeven van de bestaande literatuur, zowel voor de regeling en beheersing van het klimaat in kassen als voor modellen van het kasklimaat.

Een volgend begripsmatig gedeelte is te vinden in hoofdstuk 8, waar de *optimale regeling van plantengroei* wordt behandeld. Hier wordt de benadering van het hiërarchische systeem gebruikt om het optimale regelprobleem te beschrijven. Het totale systeem wordt opgedeeld in subsystemen van een geringere complexiteit (de niveau's van het hiërarchische systeem) en elk van de niveau's wordt geoptimaliseerd. Verondersteld wordt hierbij dat de variabelen die gebruikt worden in de optimalisatie inderdaad bij het desbetreffende niveau gedefinieerd kunnen worden.

Deze gedachten worden getoetst aan bestaande literatuur. Gesteld kan worden dat het meten aan planten, dat voor zo'n optimalisatie nodig is, in principe uitvoerbaar is (de "sprekende plant" benadering). Op deze wijze kan de transpiratie van planten worden beheerst -tenminste in een experimentele omgeving. De metingen dienen echter gerelateerd te zijn aan specifieke kennis van de te beheersen processen in de plant. Het meten van enkelvoudige variabelen als bladtemperatuur, evapotranspiratie etc. lijkt derhalve niet tot gunstige resultaten te leiden.

Hoewel de stof in hoofdstuk 8 verkennend van aard is, zijn de grondgedachten tamelijk uitgesproken. Wetenschappelijke kennis alleen impliceert niet de aanwezigheid van meer mogelijkheden voor (optimaal) regelen. Daarnaast dient bij optimaal regelen de aandacht gericht te zijn op het reduceren van de complexiteit van het probleem door de variabelen te beschouwen (en de relatie tussen variabelen) die overeenstemmen met het niveau van het hiërarchische systeem waarop de optimalisatie wordt uitgevoerd.

Modelvorming

Een tweede reeks onderwerpen in dit proefschrift, heeft betrekking op *modelvorming*. In hoofdstuk 3 wordt een nieuwe benadering van de modellering van het dynamische kasklimaat proces beschreven. Deze nieuwe benadering bezit een aantal kenmerkende eigenschappen waarmee hij zich onderscheidt van het algemeen gangbare.

Het eerste kenmerk is dat het kasklimaat proces -in ons geval beperkt tot

een proces met één uitgang, de luchttemperatuur- en de processen die direkt te maken hebben met de regelorganen (mengklep en luchtramen) afzonderlijk worden beschreven. Voor de mengklep, die de temperatuur van de verwarmingsbuizen reguleert, is dit nogal vanzelfsprekend omdat de uitgang van het mengproces (de temperatuur van de verwarmingsbuizen) eenvoudig kan worden gemeten. Voor de luchtramen is dit minder vanzelfsprekend, omdat deze ingrijpen op het ventilatievoud -dat nu eenmaal niet direkt te meten is. Met de voorgestelde wijze van beschrijven is het echter mogelijk de belangrijkste niet-lineariiteiten van het klimaat proces te isoleren.

De volgende kenmerken zijn een logisch uitvloeisel van het formuleren van dynamische systemen. Het klimaat (temperatuur) proces wordt beschreven in termen van *incrementele* variabelen en een *werkpunt* wordt gedefinieerd. In een kas zal het werkpunt slechts *langzaam* in de *tijd variëren*. Door (relatief) hoogfrequente signalen aan de ingangen van het klimaat proces toe te voeren, kunnen de laagfrequente variaties van het werkpunt geëlimineerd worden door toepassing van *filter technieken*. Vervolgens wordt in het tijddomein een *parameter schatting* uitgevoerd, waarbij optimaliseringstechnieken worden gebruikt om de parameters van een eenvoudig model te bepalen.

Voor het filteren worden in dit proefschrift technieken in het frequentie domein aangewend, maar evengoed kunnen technieken in het tijddomein worden toegepast (met name filters met een eindige impulsresponsie). Als testsignaal is een blokvormig signaal gebruikt omdat het vermoeden bestond dat de parameters enigszins frequentie afhankelijk zouden zijn. Dit testsignaal voldoet goed wanneer de mengklep als procesingang fungeert maar bij de luchtramen dient een testsignaal met een groter frequentiebereik te worden gebruikt.

Op dit punt is de traditionele doelstelling van de regeltechniek gerealiseerd, immers het proces ligt nu voldoende vast. Uit de verkregen resultaten kon echter afhankelijkheid van fysische verschijnselen worden verondersteld (§ 3.4.5). Als gevolg hiervan is geprobeerd om de resultaten te interpreteren in termen van parameters die op de fysica gebaseerd zijn. Omdat een *gedetailleerd* fysisch model niet overeenstemt met de aanpak die leidt tot een eenvoudig dynamisch (regeltechnisch) model, is een benadering gevolgd waarin voor de modellering warmtetechnische kentallen (k-waarden) zijn gebruikt. Deze warmtetechnische kentallen vormen de parameters in het dynamische model.

Om de interpretatie uit te kunnen voeren (§ 3.4.6) moet tenminste één

warmtetechnisch kental bekend zijn. Hiervoor is het kental gebruikt dat het warmtetransport van de verwarmingsbuizen naar de kas representeert. Het kental is verkregen uit één type experiment. Het bleek niet-lineair te zijn. Omdat de parameter schatting van de dynamische modellen is uitgevoerd op verschillende temperatuur niveau's, is het mogelijk ook op deze wijze de niet-lineariteit van het verwarmingssysteem na te gaan. Het blijkt dat beide typen van experimenten t.a.v. de niet-lineariteit hetzelfde resultaat opleveren.

Met het warmtetechnische kental van het verwarmingssysteem kunnen de andere kentallen worden berekend. De uitkomsten zijn betrouwbaar, daar ze meerdere malen werden verkregen voor verschillende experimenten onder verschillende weersituaties. Ook stemt de waarde van het kental van het verwarmingssysteem overeen met literatuurgegevens. De waarden die resulteerden uit de parameter schatting verschillen ruwweg een factor twee van overeenkomstige waarden uit de literatuur.

Dit laatste resultaat zou het gevolg kunnen zijn van een foutieve waarde van het warmtetechnische kental van het verwarmingssysteem. Daarom is in hoofdstuk 7 een evenwichtsanalyse uitgevoerd om opnieuw de kentallen te bepalen, waarbij het kental van het verwarmingssysteem wederom bekend is verondersteld. Dit maal komen de berekende kentallen wél overeen met gegevens uit de literatuur, zodat verondersteld kan worden dat overeenkomstige parameters van de dynamische en van de statische modellen *verschillen* en dat ze *frequentie-afhankelijk* zijn.

Voor een paar gevallen wordt in hoofdstuk 7 aangetoond dat het mogelijk is het langzaam tijd-variërende werkpunt te beschrijven met een quasi-statisch model. Uiteraard is het ook mogelijk het werkpunt te beschrijven met een volledig statisch model. Voorgesteld wordt om voor de dag een quasi-statisch model te gebruiken en voor de nacht een (eenvoudiger) statisch (evenwichts) model. Wanneer de responsies van het werkpunt model gecombineerd worden met responsies van het dynamische model, kunnen "echte" klimaat responsies worden berekend. Hiermee wordt een kasklimaat model verkregen dat vrij nauwkeurig het momentane gedrag van het klimaat in de kas (de luchttemperatuur) voorspelt.

Klimaatregeling

In hoofdstuk 4 wordt de regeling van het kasklimaat in termen van GCFC besproken. De aandacht is hier gericht op temperatuurregeling.

Door het gedrag van de regeling nader te analyseren worden criteria geformuleerd om de prestaties te bepalen. Hierbij is het vooral van belang hoe de regelaar zich gedraagt wanneer door de invloed van de weersomstandigheden, verzuivingen optreden in de regellus. Hiermee wijkt de klimaatregeling af van wat normaal in regelingen gebruikelijk is. Dit leidt tot het formuleren van criteria ten aanzien van de prestaties van de kasklimaatregeling in termen van doorschot naar boven, doorzakking en doorschot naar beneden.

De prestaties van een conventionele PI regelaar worden vergeleken met die van een nieuw *honderiem* PI algoritme -dat gemakkelijk in een computer geïmplementeerd kan worden. Vastgesteld wordt dat het honderiem algoritme aanmerkelijk beter werkt bij het optreden van doorschot naar beneden (in feite wordt dat tot nul gereduceerd), beter werkt ten aanzien van doorzakking en vergelijkbaar is bij doorschot naar boven. Aangezien doorschot naar beneden de ernstigste tekortkoming van de regeling is, kan gesteld worden dat het honderiem algoritme van *groot praktisch nut* is.

Tenslotte wordt in § 4.4 een *gescheiden bereik* algoritme beschreven dat kan worden gebruikt in kassen met een boven- en een ondernet.

Adaptieve klimaatregeling

Een adaptieve methode voor de regeling van de kasluchttemperatuur wordt beschreven in hoofdstuk 6, terwijl de bijbehorende theorie is gegeven in hoofdstuk 5.

De theorie behelst een nieuwe aanpak van de schatting van de parameters van een dynamisch proces. Het schattings algoritme is gebaseerd op stabiliteits criteria (de methode van Liapunov) en wordt geformuleerd als een gradient optimalisatie. Afgaande op de vorm van het schattings algoritme in het discrete tijddomein wordt overeenkomst gesignaleerd met de bekende "kleinste kwadraten" methode. In het continue tijddomein wordt een overeenkomstig algoritme afgeleid.

De adaptieve klimaatregelingen worden beschreven in hoofdstuk 6. Na een

exposé van de problemen die met het ontwerp samenhangen, worden de resultaten gegeven van een proefneming die een periode van meerdere jaren ervaring met een adaptieve klimaatregeling afsluit. Voor de vergelijking die in de proefneming wordt gemaakt, geldt dat de "best" ingestelde algoritmen zijn vergeleken. Hierdoor kunnen *binnen* de ontwerpeisen geen verdere verbeteringen worden verkregen.

Door adaptieve algoritmen te vergelijken met hun niet-adaptieve varianten, wordt duidelijk aangetoond dat adaptatie géén significante verbeteringen geeft als de werking over een langere tijdsperiode wordt beschouwd. Bij de honderiem methode verslechteren de prestaties zelfs door het toepassen van adaptatie. Er wordt vastgesteld dat de slechte resultaten vooral veroorzaakt worden door de verzadigingen die in de regellus optreden.

De weinig bemoedigende resultaten kunnen worden gezien als illustratie van het feit dat adaptatie van een proces niet de plaats kan innemen van gedetailleerde kennis over een proces.

Slotbeschouwing

In hoofdstuk 9 wordt een slotbeschouwing gehouden en worden suggesties gedaan voor toekomstig onderzoek.

References

- Agric. Res. Council. 1980. Effective control of greenhouse environment. Ch. III, p. 75-80. In: Agric. Forest. Fish. Res. Council Secr. Green energy program. Min. Agric., Tokyo, Japan. 110 p.
- Albers, R.B. 1971. Heating and ventilation control systems in glasshouses: automatic climate control "system Meerel". Acta Hort. 22: 49-54.
- Anderson, B.D.O. 1974. Multivariable adaptive identification. Univ. of Newcastle. Techn. Rep. EE7402, Newcastle, Australia. Approx. 50 p.
- Åström, K.J. 1981. Theory and applications of adaptive control. In: Preprints 8th IFAC World Congress, Kyoto, Japan (Aug. 1981). P.S: 28-39.
- Birta, L.G. 1977. A parameter optimization module for CSSL-based simulation software. Simulation (April): 113-121.
- Bokhorst, D., A. van Drenth, and G.P.A. van Holsteyn. 1972. Lichtafhankelijke klimaatregeling voor kassen [in Dutch]. Instit. Tuinbouwtechniek, Publik. No. 74. Wageningen, The Netherlands. 80 p.
- Bot, G.P.A., J.J. van Dixhoorn, and A.J. Udink ten Cate. 1978a. Beheersing van de teelt in kassen met behulp van de computer [in Dutch]. Bedrijfsontwikkeling 9(10): 729-731.
- Bot, G.P.A., J.J. van Dixhoorn, and A.J. Udink ten Cate. 1978b. Dynamic modelling of glasshouse climate and the application to glasshouse control. Phytotron Newsletter 18: 70-80. (Also in: Preprints ICHMT Int. Seminar on "Heat transfer in buildings", Dubrovnik, Yugoslavia, Aug. 29 - Sep. 2, 1977).
- Bot, G.P.A. 1982. Ventilation in glasshouses. Report, Dept. Physics and Meteorol., Agric. Univ., Wageningen, The Netherlands. Subm. for publication.
- Bowman, G.E., and G.S. Weaving. 1970. A light-modulated greenhouse control system. J. Agric. Eng. Res. 15(3): 255-264.
- Brockett, R.W. 1970. Finite dimensional linear systems. John Wiley Publ. Inc., New York. 244 p.
- Businger, J.A. 1963. The glasshouse (greenhouse) climate. In: W.R. van Wijk [ed.] Physics of plant environment. North-Holland Publ. Co., Amsterdam. p. 277-318.
- Calvert, A., and G. Slack. 1975. Light-dependent control of day temperature for early tomato crops. Acta Hort. 51: 163-168.
- Calvert, A., and G. Slack. 1980. Effects of light-dependent control of day temperature on the yields of early-sown tomatoes. J. of Hort. Sc. 55(1): 7-13.
- Carlsson, M., I. Christensen, and A.C. Nilsson. 1979. BET analysis (Biologic Economic, Technical) in Swedish horticultural firms. Acta Hort. 97: 1-11.
- Challa, H. 1976. An analysis of the diurnal course of growth, carbon dioxide exchange and carbohydrate reserve content of cucumber. Agric. Res. Report No. 861. Pudoc, Wageningen, The Netherlands. 88 p.
- Challa, H., and J. van de Vooren. 1980. A strategy for climate control in greenhouses in early winter production. Acta Hort. 106: 159-164.
- Challa, H., J.C. Bakker, G.P.A. Bot, A.J. Udink ten Cate, and J. van de Vooren. 1980. Economical optimization of energy consumption in an early cucumber crop. Acta Hort. 118: 191-199.
- Copet, B., and J.A. Videau. 1981. Digital control system for greenhouses. Acta Hort. 115 (2 Volumes) (1): 327-334.

- Eguchi, H., and T. Matsui. 1977. Computer control of plant growth by image processing. II. Pattern recognition of growth in on-line system. *Environ. Control in Biol.* 15: 37-45.
- Eguchi, H., and T. Matsui. 1978. Computer control of plant growth by image processing. III. Image processing for evaluation of plant growth in practical cultivation. *Environ. Control in Biol.* 16: 47-55.
- Eykhoff, P. 1974. System identification -parameter and state estimation. John Wiley Publ. Co., London. 585 p.
- Froelich, D.P., L.D. Albright, N.R. Scott, and P. Chandra. 1979. Steady-periodic analysis of glasshouse thermal environment. *Trans. ASAE* 22: 387-399.
- Gal, S., A. Angel, and I. Seginer. 1981. Optimal control of greenhouse climate: methodology. IBM Israel Sci. Center Rep. No. 106. Haifa, Israel. 29 p.
- Garzoli, K.V., and J. Blackwell. 1973. The response of a glasshouse to high solar radiation and ambient temperature. *J. Agric. Eng. Res.* 18: 205-216.
- Garzoli, K.V., and J. Blackwell. 1981. An analysis of the nocturnal heat loss from a single skin plastic greenhouse. *J. Agric. Eng. Res.* 26(39): 203-214.
- Germing, G.H. 1969a. Recente ontwikkelingen bij de regeling en beheersing van het kasklimaat [in Dutch]. *Tuinbouwmeded.* 32(7/8): 344-353.
- Germing, G.H. 1969b. Regeling en beheersing van het kasklimaat [in Dutch, English summary]. *Instit. Tuinbouwtechniek, Publik. No. 46. Wageningen, The Netherlands.* 14 p.
- Germing, G.H., and A. van Drenth. 1971. Developments in the control of the glasshouse climate. *Acta Hort.* 22: 44-48.
- Gielsing, Th.H., and W.Th.M. van Meurs. 1977. Leidraad bij het aanschaffen van klimaatregelaars voor kassen [in Dutch]. *Instit. Mech., Arbeid en Gebouwen, Publik. No. 78. Wageningen, The Netherlands.* 39 p.
- Gielsing, Th.H. 1980. Commercial greenhouse computersystems: inventarisation of implemented research, carried out by commercial firms. *Acta Hort.* 106: 59-66.
- Graaf, J. de, and J. van den Ende. 1981. Transpiration and evapotranspiration of the glasshouse crops. *Acta Hort.* 119: 147-158.
- Groenewegen, J.H. 1962. De tomaat en het kasklimaat [in Dutch]. *Meded. Dir. Tuinb. (juni 1962):* 351-355.
- Gupta, M.M., G.N. Saridis, and B.R. Gaines. 1977. Fuzzy automata and decision processes. North-Holland publ. Co., Amsterdam. 496 p.
- Hanan, J.J., W.D. Holley, and K.L. Goldsberry. 1978. *Greenhouse management.* Springer Verlag, Berlin. 530 p.
- Hand, D.W., and G.E. Bowman. 1969. Carbon dioxide assimilation measurement in a controlled environment glasshouse. *J. Agric. Eng. Res.* 14(1): 92-99.
- Hand, D.W., and D.W. Soffe. 1971. Light-modulated temperature control and the response of greenhouse tomatoes to different CO₂ regimes. *J. Hort. Sci.* 46: 381-396.
- Hand, D.W. 1973. A null balance method for measuring crop photosynthesis in an airtight daylight controlled-environment cabinet. *Agric. Meteorol.* 12: 259-270.
- Hanus, R. 1980. A new technique for preventing control windup. *J.A.* 21(1): 15-20.
- Hara, M., and J. Sugi. 1981. Optimal control of soil-water system in greenhouse. Iwate Univ., Fac. Agric. Report. Morioka, Japan. 15 p.
- Hashimoto, Y. 1980. Computer control of short term plant growth by monitoring leaf temperature. *Acta Hort.* 106: 139-146.

- Hashimoto, Y., T. Morimoto, and S. Funada. 1981a. Computer processing of speaking plant for climate control and computer aided plantation (Computer aided cultivation). *Acta Hort.* 115 (2 Volumes) I: 317-325.
- Hashimoto, Y., T. Morimoto, S. Funada, and J. Sugi. 1981b. Optimal control of greenhouse climate by the identification of water deficit and photosynthesis in short term plant growth. In: Preprints 8th IFAC World Congress, Kyoto, Japan (Aug. 1981). XV: 5-10.
- Hashimoto, Y., T. Morimoto, and S. Funada. 1982a. Image processing of plant information in the relation between leaf temperature and stomatal aperture. In: Preprints 9th IMEKO World Congress. Berlin, Germany (May 1982). V/III.
- Hashimoto, Y., T. Morimoto, S. Funada. 1982b. Identification of water deficiency and photosynthesis in short term plant growth under random variation of the environment. In: Preprints 6th IFAC Symp. on "Identif. and System Parameter Estimation". Arlington, Virginia, USA (June 1982). Vol. 2.
- Heijna, B.J. 1970. Berekening van het kasklimaat [in Dutch, English summary]. *Instit. Tuinbouwtechniek. Publik. No. 55. Wageningen, The Netherlands.* 36 p.
- Heijna, B.J. 1975. Delta X - a new control system. *Acta Hort.* 46: 13-19.
- Heijnen, J.G., Th. Buitelaar, and H. de Kroon. 1979. Kasklimaat-regeling [in Dutch]. *CST (Centrale School voor Tuinbouwtechniek en Technologie), Ede, The Netherlands.* 246 p.
- Hoenink, G. 1978. Quasi-optimal regulator for greenhouse climate. M.Sc. Thesis, Dept. Elec. Eng., Twente Univ. of Techn., Enschede, The Netherlands. Approx. 90 p.
- Hopmans, P.A.M. 1981. In situ plant water relations monitoring for greenhouse climate control with computers. *Acta Hort.* 119: 137-145.
- Jacobs, W.A.M. 1981. Simulatie van het kasklimaat in CSMP [in Dutch]. M.Sc. Thesis, Dept. Physics and Meteorol., Agric. Univ., Wageningen, The Netherlands. 92 p.
- Jiménez, J.I., and J. Casas-Vázquez. 1978. An experimental study of micro-meteorological modifications in a glasshouse during summer. *Agric. Meteorol.* 19: 337-348.
- Kanthak, P. 1973. Klima und Klimatisierung von Gewächshäusern [in German]. *Verlag Paul Parey, Berlin.* 142 p.
- Killeen, N., C. Twomey, H.H. Power, and T. O'Flaherty. 1980. A first step in microcomputer control of greenhouse environment. *Acta Hort.* 106: 91-108.
- Kindelan, M. 1980. Dynamic modeling of greenhouse environment. *Trans. ASAE* 23: 1232-1239.
- Kimball, B.A. 1973. Simulation of the energy balance of a greenhouse. *Agric. Meteorol.* 11(2): 243-260.
- Klapwijk, D. 1976. Schudden voor het gebruik? I [in Dutch]. *De tuinderij* 16(16): 32-33. *ibid.* II. *ibid.* 16(17): 36-37. *ibid.* III. *ibid.* 16(18): 38-39. *ibid.* IV. *ibid.* 16(20): 28-29.
- Kohr, R.H. 1963. A method for the determination of a differential equation model for simple nonlinear systems. *IEEE Trans. Electron. computers* 12(4): 394-400.
- Krug, H., and H.P. Liebig. 1979. Analyse, Kontrolle und Programmierung der Pflanzenproduktion in Gewächshäusern mit Hilfe beschreibender Modelle I. Das Produktionsmodell [in German, English summary]. *Gartenbauwissenschaft* 44(4): 145-164.
- Landau, I.D. 1976. Unbiased recursive identification using model reference adaptive techniques. *IEEE Trans. Autom. Control* 21: 194-202.

- Landau, Y.D. 1979. Adaptive control, the model reference approach. Marcel Dekker Publ. Co., New York. 406 p.
- Lion, P.M. 1967. Rapid identification of linear and non-linear systems. AIAA J. 5(10): 1835-1842.
- Mackroth, K. 1974. Die Blattemperatur zur Regelung des Gewächshausklima's. I. Luft und Blattemperatur bei verschiedenen Klimatisierungs-verfahren [in German, English summary]. Gartenbauwissenschaft 39(2): 105-134. Ibid. II. Die mit Thermoelementen gemessene Blattemperatur im Vergleich zu den Temperaturen verschiedenen Modellkörper und den Messergebnissen eines Radiometers. Ibid. 39(3): 259-287.
- Maher, M.J., and T. O'Flaherty. 1973. An analysis of greenhouse climate. J. Agric. Eng. Res. 18: 197-203.
- Matsui, T., and H. Eguchi. 1976. Computer control of plant growth by image processing. I. Mathematical representation of relation between growth and pattern area taken in photographs of plants. Environ. Control in Biol. 14: 1-7.
- Matsui, T., and H. Eguchi. 1977a. ibid. II. Pattern recognition of growth in on-line system. ibid. 15: 37-45.
- Matsui, T., and H. Eguchi. 1977b. Feedback control of leaf temperature. Phytotronic Newslett. 16: 6-12.
- Matsui, T., and H. Eguchi. 1978. Image processing of plants for evaluation of growth in relation to environment control. Acta Hort. 87: 283-290.
- Meer, Th.J.M. van der. 1977. Klimaatregeling [in Dutch]. Proefstat. Groenten- en Fruitteelt onder Glas. Informatiereeks No. 38. Naaldwijk, The Netherlands. 121 p.
- Mendel, J.M. 1973. Discrete techniques of parameter estimation: the equation error formulation. Marcel Dekker Publ. New York. 385 p.
- Meurs, W.Th.M. van. 1980. The climate control computersystem at the IMAG, Wageningen. Acta Hort. 106: 77-83.
- Mitchell, C.A., C.J. Severson, J.A. Wott, and P.A. Hammer. 1975. Seismomorphogenetic regulation of plant growth. J. Am. Soc. Hort. Sci. 100(2): 161-165.
- Nederhoff, E.M. 1982. Meting ventilatievoud in kassen onder praktijkomstandigheden [in Dutch]. M.Sc. Thesis, Dept. Physics and Meteorol., Agric. Univ., Wageningen, The Netherlands. 81 p.
- O'Flaherty, T., B.J. Gaffney, and J.A. Walsh. 1973. Analysis of the temperature control characteristics of heated glasshouses using an analogue computer. J. Agric. Eng. Res. 18: 117-132.
- Okada, M., and T. Takakura. 1973. Guide and data for greenhouse air conditioning. (3) Heat loss due to air infiltration of heated greenhouse. J. Agric. Meteorol. 28(4): 11-18.
- Okada, M., and M. Hayashi. 1978. Reducing greenhouse heat consumption by curtain insulation systems. Acta Hort. 87: 103-110.
- Oosterhuis, J.G. 1979. Modelvorming van het kasklimaat en het schatten van parameters uit meetgegevens [in Dutch, English summary]. M.Sc. Thesis, Dept. Electr. Eng., Twente Univ. of Techn. Rep. No. 1241.79.13. Enschede, The Netherlands. 61 p.
- Otto, P., K. Sokollik, J. Wernstedt, and M. Diezemann. 1982. Ein Innentemperaturmodell zur Mikrorechnersteuerung der Heizungssysteme von Gewächshäusern [in German, English summary]. Arch. Gartenbau 30(3): 139-146.
- Richalet, J., A. Rault, J.L. Testud, and J. Papau. 1978. Model predictive heuristic control -applications to industrial processes. Automatica 14: 413-428.
- Saffell, R.A. 1981. Instrumentation and computer control of the environment

- in experimental glasshouses. ODA Micrometeorology Unit, Univ. of Nottingham, School of Agriculture, Report No. 6.
- Seginer, I., and N. Levav. 1971. Models as tools in greenhouse climate design. Technion Research and Development Foundation Research No. 150-085. First Annual Report. Haifa, Israel. 80 p.
- Seginer, I. 1980. Optimizing greenhouse operation for best aerial environment. *Acta Hort.* 106: 169-178.
- Seginer, I., and L.D. Albright. 1980. Rational operation of greenhouse thermal-curtains. *Trans. ASAE* 23(5): 1240-1245.
- Seemann, J. 1974. Climate under glass. WMO Technical Note No. 131. Geneva. 40 p. (also WMO Rep. No. 373).
- Soribe, F.I., and R.B. Curry. 1973. Simulation of lettuce growth in an air-supported plastic greenhouse. *J. Agric. Eng. Res.* 18: 133-140.
- Stanhill, G., M. Fuchs, J. Bakker, and S. Moreshet. 1973. The radiation balance of a glasshouse rose crop. *Agric. Meteorol.* 11: 385-404.
- Steekelenburg, G. van. 1982. Een ventilatieregelaar voor tuinbouwkassen op basis van weertypering [in Dutch]. M.Sc. Thesis, Dept. Elec. Eng., Delft Univ. of Techn., Rep. CCA-7.810-A82.005(281). Delft, The Netherlands. 194 p.
- Strijbosch, Th., and L. Bol. 1965. De regeling van verwarming en ventilatie in tomatenkassen [in Dutch]. *Meded. Dir. Tuinb.* 25(10): 517-521.
- Strijbosch, Th. 1966. Ventilatie en verwarming van tomatenkassen. [in Dutch, English summary]. *Meded. Dir. Tuinb.* 29(9): 364-371. (Also: Proefstat. Groenten- en Fruitteelt onder Glas, Publik. No. 123. Naaldwijk, The Netherlands. 8 p.).
- Strijbosch, Th. 1973. Regeling van de ventilatie in de klimaatregeling in kassen [in Dutch]. *Bedrijfsontwikkeling* 4(5): 515-518.
- Strijbosch, Th. 1974. Beter overweg met de klimaatregeling [in Dutch]. Proefstat. Groenten- en Fruitteelt onder Glas. Informatiereeks No. 25. Naaldwijk, The Netherlands. 16 p.
- Takahashi, Y., M.J. Rabins, and D.M. Auslander. 1970. Control and dynamic systems. Addison-Wesley Publ. Co., Reading Mass. 800 p.
- Takakura, T., K.A. Jordan, and L.L. Boyd. 1971. Dynamic simulation of plant growth and environment in the greenhouse. *Trans. ASAE* 14(5): 964-971.
- Takakura, T., T. Kozai, K. Tachibana, and K.A. Jordan. 1974. Direct digital control of plant growth- I. Design and operation of the system. *Trans. ASAE* 17(6): 1150-1154.
- Takakura, T., G. Ohara, and Y. Nakamura. 1978. Direct digital control of plant growth III. Analysis of the growth and development of tomato plants. *Acta Hort.* 87: 257-264.
- Takakura, T., K. Tanikawi, and H. Shimaji. 1980. Microcomputer systems for multivariable control of greenhouses and for measurement and control in the field experiment [in Japanese, English summary]. Dept. Agric. Eng., Univ. of Tokyo. Techn. Rep. No. 101. Tokyo, Japan. 242 p.
- Takatsuji, M., T. Kaneko, and H. Tsuruoka. 1979. Measurement and control of optimum plant growth. In: Preprints Symp. Am. Chem. Soc., Honolulu (April 1979).
- Tantau, H.-J. 1979. Analyse des Regelverhaltens klimatisierter Gewächshäuser als Grundlage zur Auswahl und Entwicklung geeigneter Regler [in German]. *Instit. Technik in Gartenbau und Landwirtschaft, Univ. Hannover. Gartenbautechnische Informationen Heft 7. Hannover, Germany.* 146 p.
- Tantau, H.-J. 1981a. Inventory of more significant parameters which can be useful to characterize energy requirements for heating. *Acta Hort.* 107: 99-102.
- Tantau, H.-J. 1981b. The ITG digital greenhouse climate control system for

- energy conservation. In: Preprints 8th IFAC World Congress, Kyoto, Japan (August 1981). XV: 1-4.
- Taveirne, W. 1972. Temperatuurregeling bij kasverwarming [in Dutch]. Rijksstation voor Landbouwtechniek. Merelbeke, België. 591 p.
- Udink ten Cate, A.J. 1974. Improvement of continuous-gradient identification techniques by Lyapunov's second method. *Electron. Lett.* 10(23): 474-475.
- Udink ten Cate, A.J., and N.D.L. Verstoep. 1974. Improvement of Liapunov model reference adaptive control systems in a noisy environment. *Int. J. Control* 20(6): 977-996.
- Udink ten Cate, A.J., and J. van de Vooren. 1977. Digital adaptive control of a glasshouse heating system. In: H.R. Van Nauta Lemke [ed.] *Digital computer applications to process control.* (Proc. IFAC/IFIP Int. Conf. The Hague, The Netherlands, June 1977) North-Holland Publ., Amsterdam. p. 502-512.
- Udink ten Cate, A.J., and J. van de Vooren. 1978. Adaptive control of a glasshouse heating system. *Acta Hort.* 76: 121-125.
- Udink ten Cate, A.J., G.P.A. Bot, and J.J. van Dixhoorn. 1978. Computer control of greenhouse climates. *Acta Hort.* 87: 265-272.
- Udink ten Cate, A.J., and H.B. Verbruggen. 1978. A least-squares like gradient method for discrete process identification. *Int. J. Control* 28(6): 933-952.
- Udink ten Cate, A.J. 1979. A least-squares like gradient algorithm for discrete model reference adaptive systems. In: Preprints IFAC Symp. on "Computer aided design of control systems", Zurich, Switzerland (Aug. 1979).
- Udink ten Cate, A.J., J. van Zeeland and J. Valentin. 1979. Adaptive control of glasshouse climates. In: Proc. 3rd. IEE Conf. on "Trends in on-line computer control systems", Sheffield, England (March, 1979).
- Udink ten Cate, A.J. 1980a. Opmerkingen bij kasklimaatregelingen [in Dutch]. *Bedrijfsontwikkeling* 11(7/8): 741-744.
- Udink ten Cate, A.J. 1980b. Remarks on greenhouse climate control models. *Acta Hort.* 106: 43-48.
- Udink ten Cate, A.J., and J. van Zeeland. 1981. A modified PI-algorithm for a glasshouse heating system. *Acta Hort.* 115 (2 Volumes) (I): 351-358.
- Udink ten Cate, A.J., and J. van de Vooren. 1981. Adaptive systems in greenhouse climate control. In: Preprints 8th IFAC World Congress, Kyoto, Japan (Aug. 1981). Late papers. p. 9-15.
- Valentin J., and J. van Zeeland. 1980. Adaptive split-range control of a glasshouse heating system. *Acta Hort.* 106: 109-115.
- Van Bavel, C.H.M., J. Damagnez, and E.J. Sadler. 1981. The fluid-roof solar greenhouse: energy budget analysis by simulation. *Agric. Meteorol.* 23: 61-76.
- Verbruggen, H.B., J.A. Peperstraete, and H.P. Debruyn. 1975. Digital controllers and digital control algorithms. *J. A.* 16(2): 53-67.
- Vooren, J. van de. 1975. A computer for crop research and climate control in glasshouses. *Acta Hort.* 51: 169-174.
- Vooren, J. van de, and R. Koppe. 1975. The climate glasshouse at Naaldwijk. *Neth. J. Agric. Sci.* 23: 238-247.
- Vooren, J. van de, P.J.A.L. de Lint, and H. Challa. 1978. Influence of varying night temperatures on a cucumber crop. *Acta Hort.* 87: 249-255.
- Vooren, J. van de, and Th. Strijbosch. 1980. Glasshouse ventilation control. *Acta Hort.* 106: 117-124.
- Vijverberg, A.J., and Th. Strijbosch. 1968. Ontwikkelingen in de klimaatregeling bij tomaat en sla [in Dutch]. *Meded. Dir. Tuinb.* 31(12): 472-475.

- Weaving, G.S., and R.P. Hoxey. 1980. Monitoring and control of greenhouse environment utilising a Texas Instruments TMS 990/10 minicomputer. *Acta Hort.* 106: 67-75.
- Wel, G. van der, and J. van de Vooren. 1981. IJken van thermokoppels in de klimaatkas op het Proefstation voor Tuinbouw onder Glas, Naaldwijk [in Dutch]. Internal Rep., Naaldwijk Hort. Exp. Sta., Naaldwijk, The Netherlands. 7 p.
- White, R.A.J., and B.G. Olsen. 1978. Programmable calculator control of greenhouse environments. *Acta Hort.* 87: 273-281.
- Whittle, R.M., and W.J.C. Lawrence. 1960. The climatology of glasshouses.II. Ventilation. *J. Agric. Eng. Res.* 5: 36-41.
- Wijk, W.R. van. 1963. Introduction, the physical method. In: W.R. van Wijk [ed.] *Physics of plant environment*. North-Holland Publ. Co., Amsterdam. p. 1-16.
- Willits, D.H., T.K. Karnoski, and W.F. McClure. 1980. A micro-processor-based control system for greenhouse research: Part I Hardware. *Trans ASAE* 23(3): 688-692. Ibid. Part II Software. Ibid. : 693-698.
- Winspear, K.W., and L.G. Morris. 1965. Automation and control in glasshouses. *Acta Hort.* 2: 61-71.
- Winspear, K.W. 1968. Control of heating and ventilation in glasshouses. *Acta Hort.* 6: 62-78.
- Wit, C.T. de, et al. 1978. Simulation of assimilation, respiration and transpiration of crops. *Simulation Monographs*, PUDOC, Wageningen, The Netherlands. 141 p.
- Young, P., and A. Jakeman. 1980. Refined instrumental variable methods of recursive time-series analysis. Part III. Extensions. *Int. J. Control* 31(4): 741-764.
- Young, P. 1981. Parameter estimation for continuous-time models -a survey. *Automatica* 17(1): 23-39.
- Zabeltitz, C. von. 1978. *Gewächshäuser - Planung und Bau* [in German]. Verlag Eugen Ulmer. Stuttgart, Germany. 267 p.
- Zadeh, L.A. 1973. Outline of a new approach to the analysis of complex systems and decision processes. *Trans. IEEE Syst., Man and Cybern.* 3(1): 28-44.
- Zee, G.A. van, and D. van den Akker. 1983. *TSAPACK users guide*. Dept. Physics and Meteorol., Agric. Univ. Rep. LH-NW-MRS-83-1. Wageningen, The Netherlands. To be published.

Curriculum vitae

Alexander John Udink ten Cate werd geboren op 25 november 1947 te Enschede.

In 1964 behaalde hij het diploma HBS-B aan het Gemeentelijk Lyceum te Enschede. Daarna werd het tweede leerjaar gevolgd van de Hogere Technische School te Enschede, richting elektrotechniek.

In 1965 werd een studie aangevangen bij de afdeling der elektrotechniek van de Technische Hogeschool te Delft. Als na-kandidaats richting werd gekozen voor een studiepakket in de informatietechnologie. Het afstudeer-onderzoek werd verricht bij de vakgroep Regeltechniek (prof. ir. H.R. van Nauta Lemke) met als onderwerp "Ontwerp van een adaptieve stuurautomaat voor een schip met de methode van Liapunov" (mentoren: lector ir. G. Honderd en ir. H.B. Verbruggen). Het diploma van elektrotechnisch ingenieur werd behaald in november 1972, waarbij tevens onderwijsbevoegdheid in de wis- en natuurkunde werd verkregen.

In het kader van een wederzijdse uitwisseling werden in 1973 een zestal maanden doorgebracht bij het Department of Electrical and Electronic Engineering van het Queen Mary College te Londen. Hierna volgde de militaire dienst, die werd vervuld in de functie van studiebegeleider bij het laboratorium voor Regeltechniek van de Koninklijke Militaire Academie te Breda. In 1975 volgde een aanstelling als wetenschappelijk medewerker bij de vakgroep Natuur- en Weerkunde van de Landbouwhogeschool te Wageningen. Binnen het taakgebied van de sectie Meet-, Regel- en Systeemtechniek wordt bijgedragen aan onderwijs en onderzoek.