

**Immunological and biochemical characterization of  
extracellular polysaccharides of mucoralean moulds**

Gerhard A. de Ruiter



ISBN 579307

**BIBLIOTHEEK  
LANDBOUWUNIVERSITEIT  
WAGENINGEN**

Promotoren:     dr ir F.M. Rombouts  
  
                  hoogleraar in de levensmiddelenhygiëne en -microbiologie  
  
                  Landbouwniversiteit Wageningen

                  dr J.H. van Boom  
  
                  hoogleraar in de bio-organische chemie  
  
                  Rijksuniversiteit Leiden

NN03201, 1625

Gerhard A. de Ruiter

**Immunological and biochemical characterization of  
extracellular polysaccharides of mucoralean moulds**

**Proefschrift**

ter verkrijging van de graad van doctor  
in de landbouw- en milieuwetenschappen  
op gezag van de rector magnificus,  
dr H.C. van der Plas,  
in het openbaar te verdedigen  
op vrijdag 14 mei 1993  
des namiddags te vier uur in de Aula  
van de Landbouwuniversiteit te Wageningen.

157 579307

CIP-GEGEVENS KONINKLIJKE BIBLIOTHEEK, DEN HAAG

Ruiter, Gerhard A. de

Immunological and biochemical characterization of  
extracellular polysaccharides of mucoralean moulds

Gerhard A. de Ruiter. [S.l : s.n]

Proefschrift Wageningen. Met lit. opg.

Met samenvatting in het Nederlands.

ISBN 90-5485-086-8

Trefw.: microbiologie

Cover design: Sylvia Josso & Arie Bergwerff

The research described in this thesis was performed at the laboratory of Food Chemistry and Food Microbiology at the department of Food Science, Wageningen Agricultural University, the Netherlands, and was supported by the Netherlands' Foundation for Chemical Research (SON) with financial aid from the Netherlands' Technology Foundation (STW).

Those parts of this thesis which have been published elsewhere have been reproduced with the permission of both publishers and authors.

## STELLINGEN

1. De methode van Banks en Cox om hyfen van schimmels aan een ELISA-plaat te binden voor het testen van antilichamen die tegen de hyfen zijn opgewekt, is onvoldoende onderbouwd.  
J.N. Banks, and S.J. Cox (1992) *Mycopathologia* 120:79-85.
2. Het is niet aannemelijk dat de toename van (1-2)-gebonden rhamnose eenheden na inwerking van het enzym endo-arabinanase op de geïsoleerde 500 mM DEAE fractie, zoals Will en Dietrich hebben vastgesteld, inderdaad is veroorzaakt door dit enzym. De conclusie dat lineaire ketens van (1-5)-gebonden arabinose eenheden aan het C<sub>4</sub>-aatom van (1-2)-rhamnose eenheden gebonden zijn, is dan ook niet gerechtvaardigd.  
J.F. Will, and H. Dietrich (1992) *Carbohydrate Polymers* 18:109-117.
3. Het is onwaarschijnlijk dat de door Robertson en Patel gebruikte methode voor de bereiding van polyclonale antilichamen, waarbij een konijn wordt geïmmuniseerd met een mengsel van verschillende schimmels, leidt tot een mengsel van antilichamen dat met al die schimmels in ongeveer gelijke mate reageert.  
A. Robertson, and N. Patel (1989) *Food and Agricultural Immunology* 1:73-81.
4. De door Kesselmans *et al.* beschreven hydroborering van (1 $\alpha$ ,4 $\alpha\beta$ ,8 $\alpha\beta$ )-(±)-decahydro-7-ethylidene-1,4a-dimethyl-1-naphthalenol wordt ten onrechte aangeduid als stereospecifiek.  
R.P.W. Kesselmans, J.B.P.A. Wijnberg, A.J. Minnaard, R.E. Walinga, and Æ. de Groot (1991) *Journal of Organic Chemistry* 56:7237-7244.
5. Het volgen van de aantallen thermofiele campylobacters in het influent en effluent van rioolwaterzuiveringsinstallaties gedurende een periode van slechts één jaar geeft geen betrouwbare informatie over het optreden van seizoensinvloeden.  
S. Stampi, O. Varoli, G. De Luca, and F. Zanetti (1992) *Zentralblatt für Hygiene und Umweltmedizin* 193:199-210.
6. Het is onwaarschijnlijk dat het voorkomen van een esterase en glucosidase enzym uniek is voor pathovars van *Fusarium oxysporum* die als ziekteverwekker kunnen voorkomen in cyclamen en anjers. Het gebruik van bepalingsmethoden voor de detectie van deze plant-pathogene species, die op dit principe gebaseerd zijn, lijkt dan ook voorbarig.  
A. Keressies, A. Everink, en H.J. van Telgen (1992) *Vakblad voor de Bloemisterij* 33:46-47.

7. De dwingend voorgeschreven, vaste tarieven van notarissen dragen in hoge mate bij aan hun negatieve imago.  
*De Volkskrant 17 oktober 1992.*
8. Als minister Ritzen de kwaliteit van de Nederlandse universiteiten werkelijk wil verhogen, verdient het aanbeveling een flexibeler personeelsbeleid voor wetenschappelijk medewerkers mogelijk te maken.
9. Overdreven aandacht voor veiligheid in een laboratorium dient het doel niet.
10. Wat oud-minister Lely op 4 maart 1904 aan zijn promoverende zoon schreef: 'Veel gewicht hecht ik aan die nieuwigheid niet, ik vrees zelfs, dat die proefschriften voor het meerendeel vrij onbeduidend zullen zijn en dat in het algemeen voor den practischen ingenieur het beter is zich in de practijk te bekwamen dan zijn tijd aan het schrijven van zulk een boekje te besteden', geldt niet voor (bio)chemici.  
*K. Jansma (1948) Lely: De bedwinger der Zuiderzee, H.J. Paris, Amsterdam.*
11. De omschrijving van het begrip *levensmiddelen* in de jongste editie van de 'van Dale' - al wat dient om de stoffelijke mens in stand te houden - geeft een heldere kijk op de kwaliteiten van een levensmiddelentechnoloog.
12. Sinds John Garner, acht jaar vice-president van de Verenigde Staten onder Franklin Delano Roosevelt, zijn functie omschreef als 'een warme bak spuug' houden we voor Al Gore (geronnen bloed) ons hart vast.  
*De Volkskrant 25 januari 1992.*
13. Zolang Japanse politici geen kennis hebben gemaakt met Wageningse ingenieurs, zullen zij buitenlanders lui blijven noemen.  
*NRC Handelsblad 15 december 1992.*

Gerhard A. de Ruiter, Wageningen 14 mei 1993.

Stellingen behorende bij het proefschrift 'Immunological and biochemical characterization of extracellular polysaccharides of mucoralean moulds'.

CONTENTS

Chapter	Title	Page
1.	General introduction	1
2.	Formation of antigenic extracellular polysaccharides by moulds belonging to Mucorales and preparation of rabbit IgG antibodies. <b>Antonie van Leeuwenhoek</b> (1992) 62:189-199.	21
3.	High-performance size-exclusion chromatography and ELISA detection of extracellular polysaccharides from Mucorales. <b>Carbohydrate Research</b> (1991) 215:47-57.	35
4.	Carbohydrate analysis of water-soluble uronic acid containing polysaccharides with HPAEC using methanolysis combined with TFA hydrolysis is superior to four other methods. <b>Analytical Biochemistry</b> (1992) 207:176-185.	47
5.	Detection of fungal carbohydrate antigens by high-performance immunoaffinity chromatography using a protein A column with covalently linked IgG. <b>Journal of Chromatography</b> (1992) 584:69-76.	65
6.	Isolation and characterization of $\beta(1-4)$ -linked D-glucuronans from extracellular polysaccharides of moulds belonging to Mucorales <b>Carbohydrate Polymers</b> (1992) 18:1-7.	75
7.	2-O-methyl mannose is a constituent of the epitopes of mucoralean extracellular polysaccharides <b>Journal of Bacteriology</b> submitted.	85
8.	Characterization of 2-O-methyl-mannose containing epitopes of antigenic polysaccharides from <i>Mucor racemosus</i> <b>Carbohydrate Research</b> to be submitted.	103
9.	The value of antigenic extracellular polysaccharides for the classification of the <i>Mortierella isabellina</i> group (Mucorales). <b>Mycological Research</b> (1993) 97:in press.	119
10.	The production and partial characterization of a monoclonal IgG antibody specific for moulds belonging to the order of Mucorales <b>Journal of General Microbiology</b> (1993) in press.	133

<b>11. General discussion</b>	<b>147</b>
<b>Summary</b>	<b>159</b>
<b>Samenvatting</b>	<b>162</b>
<b>Nawoord</b>	<b>165</b>
<b>Curriculum vitae</b>	<b>167</b>
<b>List of publications</b>	<b>168</b>



## General introduction<sup>1</sup>

### 1. Occurrence and properties of Mucorales

#### *Moulds belonging to Mucorales*

Moulds belonging to the class of the Zygomycetes are relatively primitive fungi characterized by coenocytic mycelium and by the production of solitary sexual spores, called zygospores (4). The most important genera of the class of the Zygomycetes which commonly are found in foods, are confined to a single order, the Mucorales, previously called Mucorineen or Mucorinées. Species of six main genera are of significance in food spoilage, some of them are also important as a cause of mucormycosis in humans. The genera *Mucor*, *Rhizopus*, *Rhizomucor* and *Absidia* are classified in the family of the *Mucoraceae*, the genus *Syncephalastrum* belongs to the family of the *Syncephalastraceae* and the genus *Thamnidium* is classified in the *Thamnidiaceae*. These genera are closely

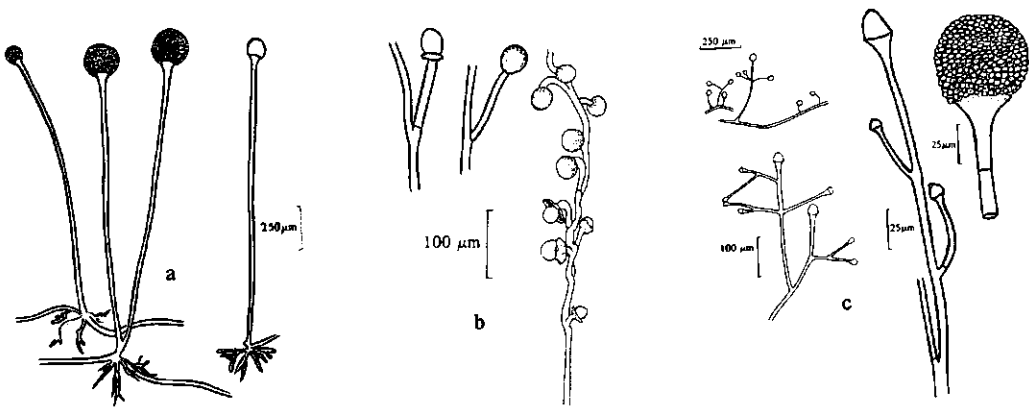

**Fig. 1.** Morphological structures of the mould species *Rhizopus stolonifer* (a), *Mucor hiemalis* (b) and *Absidia corymbifera* (c) belonging to the order of Mucorales (74).

<sup>1</sup>Partly published as Chapter 13 in *Fungal Cell Wall and Immune Response 1991* (Eds. J.-P. Latgé and D. Boucias), p. 169-180, NATO ASI Ser. H. 53, Springer Verlag, Berlin. Authors: G.A. De Ruiter, P. Smid, A.W. Van der Lugt, J.H. Van Boom, S.H.W. Notermans, and F.M. Rombouts.

related and in this thesis the order name Mucorales or the description 'mucoralean group' is used to embrace the species belonging to the above mentioned families.

In Fig. 1, typical morphological structures of some mucoralean species are shown. The main difference in generic separation is based on the structure of the sporangia and the sporangiophores. Furthermore, *Rhizopus* species possess characteristic rhizoids, short root-like structures, which are less regularly formed in *Absidia* species, and are absent in the genus *Mucor* (72,77).

### *Mucorales species in foods*

The FAO (Food and Agriculture Organisation) of the United Nations have estimated that approximately 25% of all food production worldwide is lost after harvesting due to mould contamination (31). Many species of Mucorales are widely distributed on food products, particularly on stored grain, fruits and vegetables and cause many cases of food spoilage (72,77). *Rhizopus stolonifer*, often nicknamed as 'bread mould', is the most commonly occurring species and is frequently the cause of post-harvest deterioration of fruits, vegetables and cereals. The genus *Mucor* (e.g. *M. racemosus*, *M. hiemalis* and *M. circinelloides*) has a world-wide distribution and species are isolated very often on a broad range of foods. *Absidia corymbifera* has a world-wide distribution and is isolated frequently from cereals, cereal products and decaying fruits and vegetables. Due to the high optimum temperature of growth (approx. 38 °C) this species commonly occurs at elevated temperatures. *Syncephalastrum racemosum* has also a relatively high optimum temperature of growth and is found mainly in tropical regions. *Thamnidium elegans* is a psychrophilic mould traditionally associated with cold stored meat. Some species of Mucorales are important for use in fermented foods, e.g. *Rhizopus oligosporus* in tempe production (28,70). The only mycotoxin ever reported of mucoralean moulds is Rhizonin A, a cyclic heptapeptide produced by *Rhizopus microsporus* (80).

Methods commonly used for detection of moulds in food products have many disadvantages (34,38,94). The microscopic methods detecting mycelium, such as the Howard Mould Count (HMC), lack precision and the chemical methods are particularly laborious and also lack precision (e.g. 69). Plating techniques (mould colony count) are based on enumeration of viable propagules, including asexual and/or sexual spores. Mycelium, even when present in large amounts, usually leads to low mould colony counts. Heating or filtration leads to inactivation or removal of viable mould parts, leaving uncertainty about the mycological quality and safety of the products.

Therefore, methods which are able to recognize moulds under all circumstances in food may allow for a reduction of the number of mycotoxin analyses mainly produced by species of the genera *Penicillium*, *Aspergillus* and *Fusarium* (19). As a consequence, there is a continuous need to improve existing methods and to develop new methods for the detection of fungal contamination in food (38,75,94).

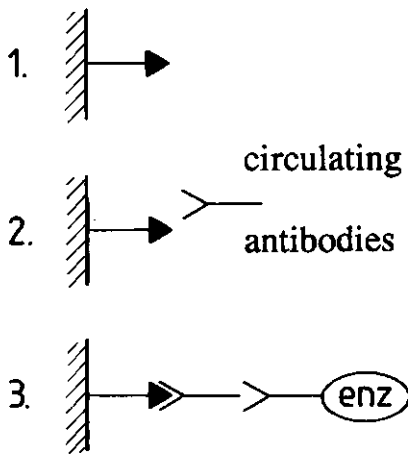

**Fig. 2.** Principle of the ELISA to detect circulating antibodies in serum from patients suffering from mucormycosis. 1. Purified antigenic polysaccharides from mucoralean moulds are coated to the wall of a microtitre plate. 2. If circulating antibodies are present in diluted human serum, their paratopes will bind to epitopes of the coated polysaccharides. 3. The presence of these human antibodies can be visualised by using an anti-human antibody conjugated to an enzyme (e.g. peroxidase) which can convert a suitable substrate into a colour which can be measured spectrophotometrically.

### *Mucormycosis*

Mucormycosis is a serious mycotic infection in man caused by several fungi belonging to the order of Mucorales, for the first time reported by Paltauf (71). The term mucormycosis is accepted by many clinicians and mycologists, but other names such as zygomycosis and phycomycosis are also used (8,83). Mucormycoses are usually caused by fungi of the genera *Rhizomucor*, *Rhizopus* and *Absidia*, and occasionally by species of *Mucor*. They cause opportunistic infections which have been recognized mainly in patients suffering from diabetes mellitus, chronic or acute leukaemia and immunosuppression resulting from drugs or disease. Mucormycosis is diagnosed rarely in otherwise healthy people (47,73). The clinical picture of this worldwide increasing infection, includes the craniofacial form, the pulmonary form and the gastrointestinal form (8). Mucormycosis is often a rapidly fatal infection, therefore accurate and rapid diagnosis is important. Diagnosis is usually achieved postmortem by histological examination of tissue specimens. However, investigation of biopsy tissue is complicated and culturing, particularly of swabs, often leads to negative laboratory findings. Also, culture determination cannot be conclusive as a result of the ubiquitous presence of Mucorales.

Progress in diagnosis was made by the development of methods based on immunochemical detection of circulating antibodies of which the principle is given in Fig. 2.

(35,42,95). An antibody ELISA (enzyme-linked immunosorbent assay) based on the carbohydrate antigens isolated from *Rhizopus arrhizus* (= *R. oryzae*) and *Rhizomucor pusillus* has been developed recently (42). With this assay, utilizing a 1:400 serum dilution as a minimally positive ELISA titre, 77% of proven cases of mucormycosis could be diagnosed. However, circulating antibodies are not always present in immunocompromised patients whereas they are quite often present in normal individuals (92). Therefore diagnosis in individual patients depends on changes in antibody titres in paired serum samples.

Other methods for detection of mucormycoses should be developed. A new approach for immunological detection is based on the detection of circulating antigens or IgG-antigen complexes as recently described for disseminated aspergillosis (74,76), candidosis (44,94) and for many other fungal pathogens (41). Although mucoralean infections in humans occur usually very localized and limited amounts of antigens circulate, the determination of carbohydrate antigens in serum or cerebrospinal fluid of patients suffering from mucormycosis may serve as an additional diagnostic tool.

## 2. Polysaccharides from Mucorales

### *The cell wall of mucoralean moulds*

Bartnicki-Garcia (1) proposed a classification of various taxonomic groups of moulds according to the cell-wall polysaccharide composition, a feature which is important because polysaccharides are the main part of cell walls. The moulds belonging to the order of Mucorales have been classified in the group of the chitosan-chitin cell wall polysaccharides (1). The hyphal walls of these moulds are mainly composed of uronic acids, neutral sugars, hexosamines and proteins. Several studies have been carried out on polysaccharide fractions isolated from mycelium of Mucorales species. Both glucuronic acid (GlcA) and fucose (Fuc) are components of the cell walls of *Mucor* species (2,12,15). They are also present in the mycelium of species of *Rhizopus* and *Absidia* (51,53). Heteropolysaccharides composed of glucuronic acid, fucose, mannose (Man) and some other minor neutral sugars are typical for members of Mucorales.

A heteropolysaccharide called 'mucoran' was extracted from the mycelium of *Mucor rouxii*. It is mainly composed of glucuronic acid, fucose and mannose (2,3). Datema and coworkers (12) demonstrated that a similar fraction could be obtained from the hyphal cell wall of *M. mucedo* using different extraction procedures, indicating that it is a genuine component of the cell walls and not the result of modification or degradation during extraction. Likewise, mucoran can be considered as characteristic for cell walls of mucoralean moulds, besides several other components including hexosamine containing

polymers like chitin and chitosan (84), proteins and polyphosphates (12).

Mucoran was partly characterized by Bartnicki-Garcia and Lindberg (3). It could be eluted from an anion-exchange column as a single sharp peak and was also found to be homogeneous when analysed by size-exclusion chromatography. The apparent molecular mass was around 100 kDa. They proposed an alternating sequence of GlcA and Man residues as a major feature of mucoran. However, a considerable part of the GlcA remained in their acid resistant fraction (3).

Mucoric acid, a homopolymer consisting of glucuronic acid only, could be isolated after acid treatment of mucoran (12,16,86). Tsuchihashi and coworkers (86) studied mucoric acid polymers derived from the mucoran fraction of *Absidia cylindrospora*, *Mucor mucedo* and *Rhizopus nigricans* (= *R. stolonifer*), by nuclear magnetic resonance (NMR) and showed that these polymers are constituted of  $\beta(1-4)$ -linked D-glucuronic acid residues.

### *Extracellular polysaccharides*

Filamentous fungi are able to excrete a large variety of extracellular substances (21,23,30,48). Among these, water-soluble extracellular polymers are thought to play various roles in fungal biology which probably can be compared with their function in bacteria (46). In bacteria, these polysaccharides are either an integral part of the cell wall, as this is known to be the case with the somatic lipopolysaccharides of some Enterobacteriaceae, or may form extracellular capsules like those of *Pneumococcus*, *Klebsiella* and many *Escherichia coli* strains (33). Some of the excreted polymers may act as reserve nutrients, as adhesin or as moisture regulatory compound (18). Other polymers seemingly have no function in the organism, and may be by-products of the metabolism of the bacteria (46). The exact function of the excreted material of moulds is currently unknown.

The extracellular polymers of Mucorales consist mainly of carbohydrates (50 to 90 %) and protein (10 to 50%) and are therefore often referred to as extracellular polymers or polysaccharides (EPSs). It would perhaps be desirable to call them proteoglycans or peptidoglycans, but in this thesis the term extracellular polysaccharides (EPSs) is maintained throughout. The presence of fucose, galactose (Gal), mannose and glucose (Glc) residues has been established (2,48). The EPSs of *Rhizopus stolonifer*, *Mucor mucedo* and *Absidia cylindrospora* were partly characterized by Miyazaki and Irino (52,54). They established the presence of a main fraction composed of Fuc, Man, Glc, Gal, *N*-acetyl glucosamine (GlcNAc) and *N*-acetyl galactosamine (GalNAc) with molar ratios as listed in Table 1. Minor polysaccharide fractions obtained from these EPS preparations were composed of Fuc, Gal and GlcA.

**Table 1.** Sugar composition of the main EPS fractions of *R. stolonifer*, *M. mucedo* and *A. cylindrospora* in molar percentages.

Mould species	Sugar residues					
	Fuc	Man	Glc	Gal	GlcNAc	GalNAc
<i>R. stolonifer</i>	2	55	10	13	10	10
<i>M. mucedo</i>	21	54	4	8	9	4
<i>A. cylindrospora</i>	23	57	9	5	4	2

Data derived from Miyazaki and Irino (52,54).

### *Antigenic properties of these polysaccharides*

Microbial polysaccharides are often located on the cell surface and are, therefore, of importance in recognition and immune response of higher organisms to microbial infection (33). The scientific interest in fungal polysaccharides has increased considerably after the discovery that these polysaccharides possess immunogenic and antigenic properties. Immunogenicity and antigenicity of a molecule are defined by the International Union of Pure and Applied Chemistry (IUPAC) as 'the ability to stimulate the immune system to produce a set of specific antibodies', in addition, the term antigenicity also includes 'the ability to combine with the resulting antibodies through a specific binding site or epitope' (22,58). The latter phenomenon solely is sometimes also described as 'immunoreactivity'. In principle, macromolecules such as polysaccharides may contain many different epitopes, which are defined as those parts which act as antigenic determinants (22,58). The corresponding specific binding sites of the antibodies are called the paratopes.

The antigenic properties of the cell walls of Mucorales have been described by the group of Miyazaki (24,25,53,55-57,87,88). Antigenic substances of *A. cylindrospora* (55) were found mainly in the supernatant from disrupted cells and could only be isolated in low yields from purified mycelium. Therefore, it was suggested that the antigenic substances of the cell walls of Mucorales species may be loosely bound to the surface of the mycelium and easily released from the surface (26,27,55).

Antibodies against cell walls have been raised in rabbits after immunisation with more or less purified fractions of cell walls of species of Mucorales (57). It has been established that the immunological reaction is indeed based on the integrity of sugar residues. Periodate treated cell walls did not react with antibodies raised against cell walls while treatment with protein degrading enzymes such as pronase and trypsin did not affect the immunological reaction (24,57). Several fractions isolated from the mycelium of species of Mucorales containing Man, Fuc and protein were found to be antigenic. It was

demonstrated that antigenicity is expected in the mannose and fucose containing fractions and that the uronic acid containing fractions are immunologically not reactive with rabbit IgG (27,55,88).

Two antigenic fractions were further studied by Yamada *et al.* (88), one of them was a fucomannopeptide containing a minor amount of uronic acid and a second fraction was a mannoprotein. The mannose glycosidic linkages present in these fractions were heterogeneous and mainly  $\alpha(1-6)$  and  $\alpha(1-2)$  (87).

The immunochemistry of the extracellular polysaccharides from *A. cylindrospora*, *M. hiemalis* and *R. stolonifer* was studied by the same group (56,89). They isolated  $\alpha(1-6)$ -linked mannose oligomers from the EPS of *A. cylindrospora* which were able to inhibit the immunoprecipitation assay for 60%. This assay was performed with antibodies raised in rabbits against extracellular material of *A. cylindrospora* and with antigens isolated from the mycelium of both *A. cylindrospora*, *M. hiemalis* and *R. stolonifer*. They postulated an important role for  $\alpha(1-6)$ -linked mannopyranosyl oligomers as a common antigenic determinant of Mucorales (56,57).

Also, a mannoprotein and a fucomannan could be isolated from the EPS of *A. cylindrospora*, similar as previously obtained from the mycelium of this mould (87,88). From these fractions, antigenic mannans could be isolated with the lectin concanavalin A. One of them was found to be rich in  $\alpha(1-2)$ -linkages, another contained also  $\alpha(1-6)$ -linked mannose residues together with terminal  $\alpha$ -fucose residues.

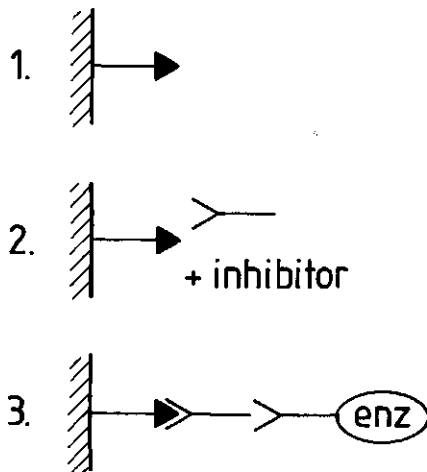

**Fig. 3.** Principle of the inhibition ELISA to test oligosaccharides on their inhibitory capacity. This immunoassay is similar to the ELISA shown in Fig. 2, except for the second step in which the oligosaccharides are added as inhibitor of the IgG antibodies which are raised against the EPS which is coated to the wall. In step 3, goat anti-rabbit IgG conjugated to an enzyme (e.g. peroxidase) is used (65).

Therefore, they concluded that also the  $\alpha(1-2)$ -linked mannose residues might play an important role in the epitopes of Mucorales (89). However, all studies on the immunochemistry of intra- and extracellular polysaccharides of moulds belonging to this order, did not show any cross-reactivity of the antibodies used with mannans obtained from the yeasts *Candida albicans* and *Saccharomyces cerevisiae* which are composed of  $\alpha(1-2)$ - and  $\alpha(1-6)$ -linked mannose residues mainly.

Clinical investigations revealed an immunological cross-reactivity of *R. oryzae* and *R. arrhizus* with *A. corymbifera* and *Rhizomucor* species as opposed to the antigenic dissimilarity between *M. racemosus* and *Rhizomucor* species (29,92). Immunochemical investigation of allergens from cell wall extracts of *R. stolonifer* revealed several glycoprotein fractions with both allergenic and antigenic potency. However, in this study no attention was given to the role of the sugars in these glycoproteins (79).

#### *Structural elucidation of carbohydrate epitopes.*

Different approaches can be used to elucidate the structure of the epitopes of fungal polysaccharides. In addition to the conventionally used methods for carbohydrate analysis of the total EPS and analysis of the glycosidic linkages of the sugar units involved (5,9,78), more detailed information should be obtained regarding the antigenicity. A commonly used method, is a hapten-inhibition experiment in which oligomers, obtained either by partial hydrolysis of the total EPS or by synthesis, are tested with the inhibition ELISA which principle is shown in Fig. 3. In this assay format, the inhibitory capacity is expressed as the concentration of the oligomer which is able to inhibit the reaction between antigen (EPS) and antibody for 50%. This approach was used to identify the capacity of differently  $\beta$ -D-galactofuranose oligomers to inhibit the reaction between EPSs of *Penicillium* and *Aspergillus* moulds and antibodies raised against these EPSs (65). Hapten inhibition studies were also used to test the immunoreactivity of oligosaccharides obtained after partial hydrolysis of EPS from Mucorales (56). However, the results of hapten-inhibition experiments should be used carefully since the method itself is an indirect method. Specially if milligram quantities of monomers or oligomers are necessary to obtain any inhibition, these results can only be considered as indicative.

A promising approach was recently described by Van Bruggen-van der Lugt and coworkers (90), who used purified enzymes to degrade specifically the carbohydrate epitopes of EPS preparations of *Penicillium* and *Aspergillus*. The sophisticated use of a purified exo- $\beta$ -D-galactofuranosidase unequivocally confirmed the above mentioned inhibition experiments that sequences of  $\beta(1-5)$ -linked D-galactofuranose are uniquely responsible for the antigenic properties of these EPSs. Furthermore, the combined use with the reductive-cleavage technique resulted in a new structural model for the antigenic galactofuranose residues of *Penicillium* species as shown in Fig. 4. (50,90).



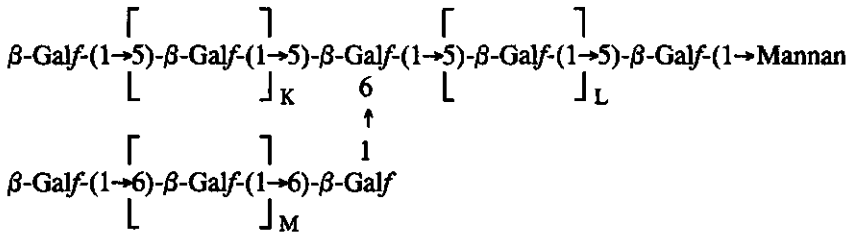

**Fig. 4.** New structural model for the antigenic galactofuranose side chains of the extracellular polysaccharides of *Penicillium* species according to Van Bruggen-Van der Lugt *et al.* (50,90). The values for K, L and M may vary from zero to eight residues.

### 3. Development and practical use of immunoassays for detection of moulds in food

#### *Development of a sandwich ELISA and a latex agglutination assay*

It was proposed to use the antigenic properties of fungal polysaccharides for immunological detection of moulds in foods (36,38,45,60,61,64) or for diagnosis of mucormycosis in man (35,42). It was demonstrated that EPS of *Penicillium* and *Aspergillus* species contain sequences of  $\beta(1-5)$ -linked D-galactofuranose residues which are uniquely responsible for their antigenic properties (65,90).

Many polyclonal antibodies were raised in rabbits against intracellular or extracellular polysaccharides of moulds (10,27,37,63). These antibodies are mainly raised in rabbits by immunizing them with water-soluble EPSs. Polyclonal antibodies which can differ from batch to batch in their affinity. Recently, the development of monoclonal antibodies against several fungal polysaccharides was described (6,14,20,32,81,82). These antibodies can be produced by hybridoma cells originating from one cell obtained after fusion of a spleen cell of an immunized mouse (or rat) with a myeloma cell. Using this method, monospecific antibodies can be obtained which can be produced *in vitro* in indefinite amounts without the requirement of more animals.

Using IgG antibodies raised against EPS preparations of different moulds, various formats of immunoassays have been developed. Sandwich ELISAs have been used for detection of the mould species belonging to the genera *Penicillium* and *Aspergillus*, *Mucor* and *Rhizopus*, *Botrytis* and *Monascus*, *Fusarium*, *Cladosporium* and *Alternaria* (10,11,43,45,63,66).

A mould latex agglutination assay (MLA) with antibodies specific for *Penicillium* and *Aspergillus* species was described by Kamphuis *et al.* (36). This assay format, which principle is shown in Fig. 5, is very convenient for practical use in food industry as agglutination can be observed visually without any expensive laboratory equipment as

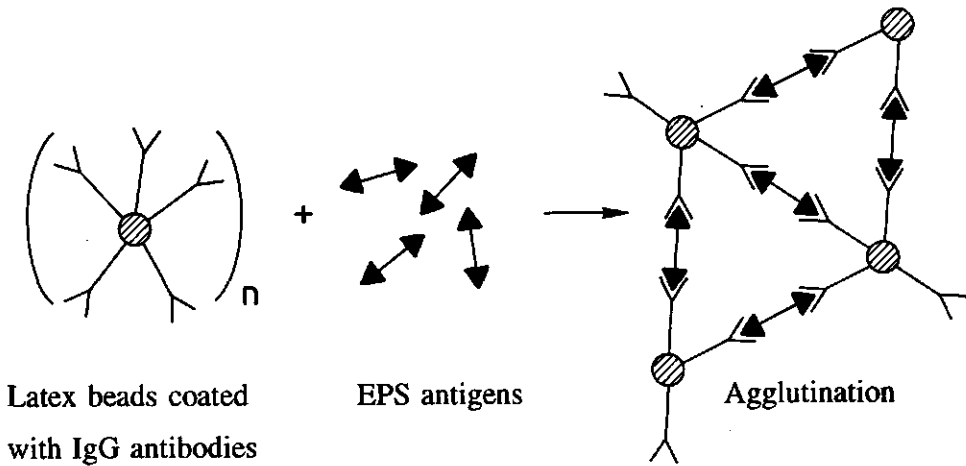
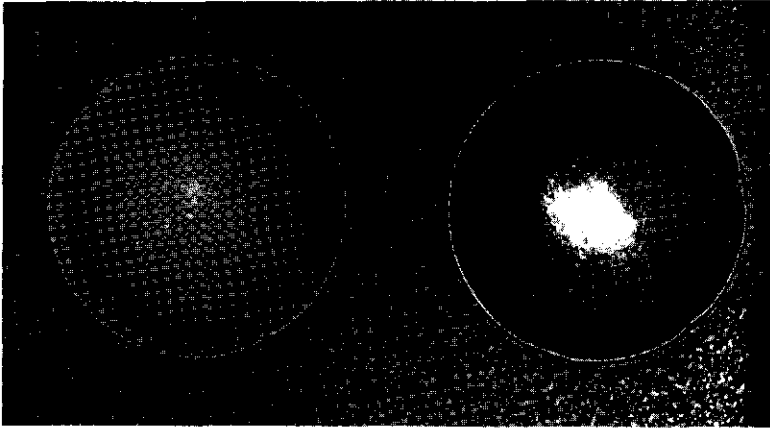

**Fig. 5.** Schematic principle of the mould latex agglutination assay (MLA). The assay is based on the recognition of extracellular polysaccharide antigens by specific IgG antibodies coated to latex beads resulting in a visible agglutination (36).

shown in Fig. 6. The latex agglutination assay is slightly less sensitive than the sandwich ELISA but satisfactory results can be obtained within 10 to 20 minutes.

*Specificity of antibodies used in immunoassays*

A successful use of immunoassays for the detection of moulds in food requires antibodies, either polyclonal or monoclonal, with specificity for a certain group of related genera. Many antibodies are reported for this purpose as previously reviewed (13,38). However, some antibodies give cross-reactions with mould species belonging to other non-related genera. Most users will consider these as inappropriate for reliable use. In general, antibodies raised against EPS from *Penicillium* species are specific for nearly all species belonging to the genus *Penicillium* and the related genus *Aspergillus*, due to their common  $\beta(1-5)$ -galactofuranose epitopes. Similar results have been obtained for mould species of the related genera *Botrytis* and *Monascus*. A promising approach to obtain specific antibodies was proposed by Kamphuis *et al.* (37). They raised antibodies towards synthetic epitopes (tetramers of  $\beta(1-5)$ -linked D-galactofuranosides) by coupling them to a protein. Such an approach is only possible if the structure of the epitopes of the extracellular polysaccharides from different mould genera are known in detail.



**Fig. 6.** Latex agglutination assay of a blank (1) and a nutmeg sample (2) for the detection of *Penicillium* and *Aspergillus* as developed by Kamphuis *et al.* (36).

#### *Recognition of false-positive and false-negative results of immunoassays*

The practical use of immunoassays in food analysis requires an easy test format. However, all immunoassays are susceptible to non-specific reactions of food components as a result of the often very complex composition of foodstuffs. False-positive reactions are often caused through binding of the antibodies not based on an immunological reaction by compounds present in food as e.g. lysozyme and tannins (17,59).

False-negative results may be caused by irreversibly binding of the antigenic EPSs to certain food components or by the presence of enzymes in the food sample tested which are able to degrade the epitopes recognized by the antibodies used (68). These can be recognized easily by the addition to the test sample of purified EPS derived from moulds involved. As a result of this, a negative result will be converted into a positive one and a false-negative sample remains negative.

The recognition of false-positive reactions is more difficult. These reactions can be recognized by the additional use of anti-idiotypic antibodies (67). Another possibility to recognize such reactions is the addition of a synthetic epitope to a test sample which prevents a reaction between EPS and the IgG molecule. Due to this specific inhibition a positive result should be converted into a negative by specifically blocking the immunological binding sites (paratopes) of the antibodies used, as schematically shown for an ELISA in Fig. 7. This principle for recognition of false-positive results can be used both in the ELISA and in the MLA. For this latter approach, it is necessary to identify the epitopes of the antigenic extracellular polysaccharides as recently shown for

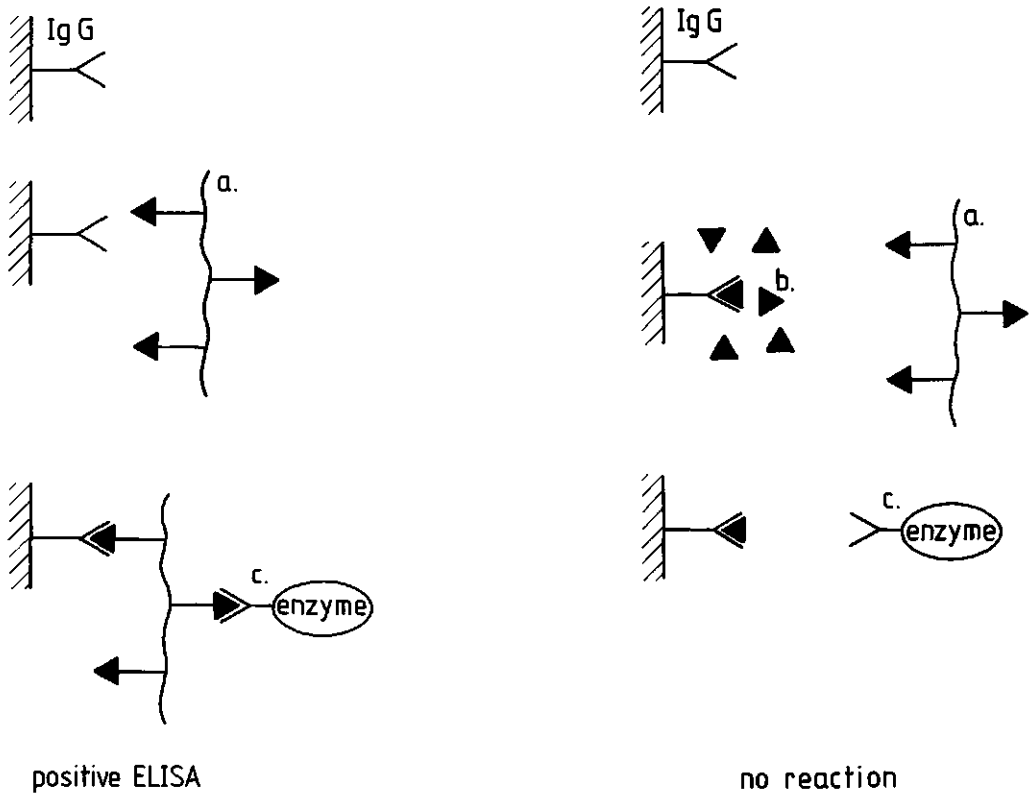

**Fig. 7.** Recognition of false-positive ELISA reactions by the addition of synthesized epitopes to the test sample, converting a positive result into a negative. IgG: immunoglobulin G coated to the wall of a microtitre plate; a: Antigenic extracellular polysaccharides; b: Synthetic epitopes; c: Peroxidase enzyme conjugated to IgG antibodies.

*Aspergillus* and *Penicillium* species (38). Samples of walnuts are very sensitive for both false-positive and false-negative reactions using the ELISA or mould latex agglutination assay (66,68). This phenomenon is observed in many reports, and not limited to immunoassays for *Penicillium* and *Aspergillus*. These findings underline the need for testing for false-positive results in food analysis with immunoassays.

*Analysis of fungal contamination of foods with immunoassays*

Laboratory analysis of foods on contamination of *Penicillium* and *Aspergillus* species by immunoassays has been reported repeatedly (7,13,39,40,66,68,91). These analyses are mainly based on the mould latex agglutination assay (MLA) as developed by Kamphuis *et*

al. (36). Samples to be tested with immunoassays have to aqueous solutions. As the immunoreactive EPSs from moulds are water-soluble, the pre-treatment of food products prior to immunoanalysis is very simple. From solid foods, an aqueous extract has to be prepared. Routinely, 10 gram of a food product is diluted with 90 ml of phosphate-buffered saline (70 mM sodium phosphate, pH 7.2, 150 mM NaCl) or peptone-physiological saline (PPS; 1 g/l peptone, pH 7.2, 150 mM NaCl) and homogenised with the stomacher for 1 minute. The supernatants after centrifugation are used in the immunoassays. Citrate buffer (pH 7.2) is reported to be superior for dairy products, especially cheese, due to its high content of calcium caseinate and fat (85). Citrate complexes with  $\text{Ca}^{2+}$ -ions resulting in the complete solubilization of caseinate. For many products such as spices, cereals and related products, fruit juices, dried products, animal feed, cheese, coffee and cocoa, these immunoassays are successfully used to estimate fungal contamination with *Aspergillus* and *Penicillium* species. However, a good correlation with the mould colony count, based on detection of viable propagules, is not always observed. The basic principles of both methods are completely different. It can be expected that the immunoassay gives a better indication for the (previous) presence of moulds in most samples than plating techniques, as many food products are heat treated, filtered or gamma-irradiated. Additionally, especially in dried products the use of immunoassays reduces the analysis time considerably.

An important public health aspect of foods contaminated with moulds is the possible presence of mycotoxins. Many assays, either chemical or immunochemical, are available for the detection of various mycotoxins in food. Since there are more than 100 known mycotoxins this is a very laborious approach. It is more feasible to detect the (previous) presence of the moulds itself that are able to produce mycotoxins as proposed by Notermans *et al.* (62). The immunoassays can be used to assess the quality of the food and identify those samples that need to be tested further on mycotoxins. As shown by the studies of Notermans *et al.* (62) and Braendlin and Cox (7) this approach is promising as in most samples high amounts of aflatoxins correlate with high titres of the *Aspergillus* immunoassay. However, more fundamental research on this correlation is needed to establish the level of antigenic EPS which signals the possible presence of different mycotoxins in food.

#### *Analysis of fungal contamination with commercially available immunoassays*

The past three years test-kits for the detection of *Penicillium* and *Aspergillus* moulds have been introduced into the market by the companies Holland Biotechnology b.v. (Leiden, The Netherlands) and Sanofi Diagnostics Pasteur (formerly Eco-Bio; Genk, Belgium). Both are based on the recognition of fungal antigens (EPS) by specific antibodies using the latex-agglutination format. Despite of their high sensitivity and reliability, the first experiences with immunological tests for the detection of moulds in

food revealed that commercialization is hampered by many factors (49). As the principles of immunoassays are completely different from those of the frequently used plating techniques, many industrial laboratories have a lack of experience with immunoassays. Also, validation of immunoassays for routine analysis of fungal contamination of food is not easy. As there are no clearly defined widely applicable standards, each user has to define the antigen concentration which corresponds to an unacceptable level of moulds in his own situation.

However, the most important problem for implementation of immunoassays in food analysis is the more or less conservative attitude towards new detection methods and the lack of adequate legislation. The severe drawbacks of the plating methods are inherently accepted, probably because these methods are so widely used. A poor correlation between the methods often leads to an extensive discussion about the negative points of the new method, without considering the relevance of the drawbacks of the traditional plating techniques. Furthermore, the legislation in most countries is limited to the maximum amount of aflatoxins which is permitted in foods and does not contain rules for fungal contamination. Therefore, the use of these immunoassays often results only from the own motivation or quality assurance policy of the industrial laboratories. Nevertheless, the immunological detection of moulds could be of great value to control raw materials, semi-manufactured products and end products in food industry. Also, routine testing on mould contamination to assess the mycological quality could be a valuable tool in selection for high quality raw materials.

Widespread implementation of these techniques requires a change in attitude of industrial control laboratories and food inspection services. The introduction of law-enforced guidelines for the quality of food products might change this attitude in future. The availability of test kits covering all important fungal food contaminants would make antigen detection more attractive. Also, potential customers will be convinced more easily when more published data will be available on the practical application of these immunoassays.

#### **4. Scope of this thesis**

Aim of the investigations described in this thesis, was to identify and characterize the antigenic determinants (epitopes) of the extracellular polysaccharides from moulds belonging to the order of Mucorales. Knowledge of the structure of the epitopes of Mucorales should allow the development of specific and reliable immunoassays, either a sandwich ELISA or mould latex agglutination assay, to detect mould species belonging to Mucorales in food rapidly.

For this purpose, several prerequisites should be met. First of all, it should be established if antigenic EPSs are always excreted by Mucorales moulds. In **Chapter 2**, the excretion of antigenic EPS by mucoralean moulds is studied using some growth conditions of these moulds. Furthermore, the specificity of polyclonal IgG antibodies raised against EPS of *Mucor racemosus* is established in this chapter. For an accurate analysis of the antigenic polysaccharides, new methods should be developed. In **Chapter 3**, a method to detect the antigenic parts of the EPS preparations is described. High-performance size-exclusion chromatography was combined with ELISA detection of the respective fractions, which allows a rapid and unequivocal determination of the apparent molecular mass of the immunoreactive fractions. An accurate and reproducible method for the analysis of the carbohydrate composition of the uronic acid containing EPSs using methanolysis followed by TFA-hydrolysis of the polysaccharides is described in **Chapter 4**. With the use of high-performance anion-exchange chromatography with pulsed-amperometric detection it was possible to analyse 20  $\mu\text{g}$  of polysaccharide accurately without the need for derivatisation. In **Chapter 5**, the analysis of antigenic carbohydrates by high-performance immunoaffinity chromatography is described. The immunoaffinity column was prepared from IgG antibodies raised against the EPS of *M. racemosus*, and were covalently linked to Sepharose beads using protein A and dimethyl pimelidate. The isolation and characterization of a common  $\beta(1-4)$ -linked D-glucuronic acid polymer from the EPS preparations of the moulds belonging to Mucorales, is described in **Chapter 6**. In **Chapter 7**, the purification and characterization of an exo- $\alpha$ -D-mannanase enzyme is described which is able to degrade the epitopes of EPSs of Mucorales specifically. Analysis of the reaction products, using different chromatographic methods, revealed the presence of 2-O-methyl-mannose residues. Their importance in the antigenicity of these EPSs is discussed. In **Chapter 8**, the structure of the epitopes of mucoralean moulds is revealed with 2-O-methyl-mannose residues always present on the non-reducing terminal. This was proved by using specific enzymatic degradation of the EPS preparations combined with structural characterization of highly antigenic fractions isolated from the EPSs. Furthermore, hapten inhibition experiments with synthesized epitopes were carried out. The taxonomic value and immunochemical behaviour of extracellular polysaccharides is described in **Chapter 9**. In this chapter, the EPS preparations of species belonging to the *Mortierella isabellina* group were analysed immunochemically and chemically. Finally, in **Chapter 10**, the production and characterization of monoclonal mouse-IgG antibodies against EPS of *Mucor racemosus* is described. Also, the development of a DOT-BLOT assay for detection of these moulds in food using these monoclonal antibodies is described.

## References

1. Bartnicki-Garcia, S. 1968. Cell wall chemistry, morphogenesis, and taxonomy of fungi. *Ann. Rev. Microbiol.* 22:87-108.
2. Bartnicki-Garcia, S., and Reyes, E. 1968. Polyuronides in the cell wall of *Mucor rouxii*. *Biochim. Biophys. Acta* 170:54-62.
3. Bartnicki-Garcia, S., and Lindberg, B. 1972. Partial characterization of mucoran: the glucuronomannan component. *Carbohydr. Res.* 23:75-85.
4. Benjamin, R.K. 1979. Zygomycetes and their spores, p. 573-621. In B. Kendrick (Ed.), *The whole fungus*, vol. 2. Nat. Museum Natural Sc. Ottawa.
5. Biermann, C.J. 1988. Hydrolysis and other cleavages of glycosidic linkages in polysaccharides. *Adv. Carbohydr. Chem. Biochem.* 46:251-271.
6. Bossi, R., and Dewey, F.M. 1992. Development of a monoclonal antibody-based immunodetection assay for *Botrytis cinerea*. *Plant Pathol.* 41:472-482.
7. Braendlin, N., and Cox, L. 1992. Immunoagglutination assay for rapid detection of *Aspergillus* and *Penicillium* contamination in food, p. 233-240. In R.A. Samson, A.D. Hocking, J.I. Pitt, and A.D. King (Eds.), *Modern Methods in Food Mycology*. Elsevier Publishers, Amsterdam.
8. Chandler, F.W., Watts, J.C., Kaplan, W., Hendry, A.T., McGinnis, M.R., and Ajello, L. 1985. Zygomycosis, report of four cases with formation of Chlamydoconidia in tissue. *Am. J. Clin. Pathol.* 84:99-103.
9. Churms, S.C. 1990. Recent developments in the chromatographic analysis of carbohydrates. *J. Chromatogr.* 500:555-583.
10. Cousin, M.A., Dufrenne, J., Rombouts, F.M., and Notermans, S. 1990. Immunological detection of *Botrytis* and *Monascus* species in food. *Food Microbiol.* 7:227-235.
11. Cousin, M.A. 1990. Development of the enzyme-linked immunosorbent assay for detection of molds in foods: a review, p. 157-163. In G.E. Pierce (Ed.), *Developments in Industrial Microbiology* vol. 31.
12. Datema, R., Van den Ende, H., and Wessels, J.G.H. 1977. The hyphal wall of *Mucor mucedo* 1. Polyanionic polymers. *Eur. J. Biochem.* 80:611-619.
13. De Ruiter, G.A., Kamphuis, H.J., Notermans, S.H.W., Van Boom, J.H., and Rombouts, F.M. 1993. The development of immunoassays for the rapid detection of moulds. In D.H. Vuijk, J.J. Dekkers, H.C. Van der Plas (Eds.), *Developing Agricultural Biotechnology in the Netherlands*. Pudoc, Wageningen (In press).
14. Dewey, F.M., MacDonald, M.M., Philips, S.I., and Priestley, R.A. 1990. Development of monoclonal-antibody-ELISA and -DIP-stick immunoassay for *Penicillium islandicum* in rice grains. *J. Gen. Microbiol.* 136:753-760.
15. Dow, J.M., and Rubery, P.H. 1977. Chemical fractionation of the cell walls of mycelial and yeast-like forms of *Mucor rouxii*: A comparative study of the polysaccharide and glycoprotein components. *J. Gen. Microbiol.* 99:29-41.
16. Dow, J.M., Darnall, D.W., and Villa, V.D. 1983. Two distinct classes of polyuronides from the cell walls of a dimorphic fungus, *Mucor rouxii*. *J. Bacteriol.* 155:1088-1093.
17. Essink, A.W.G., Arkesteijn, S.J.M.W. and Notermans, S. 1985. Interference of lysozyme in the sandwich enzyme-linked immunosorbent assay (ELISA). *J. Immunol. Meths.* 80:91-96.
18. Fett, W.F., Osman, S.F., and Dunn, M.F. 1989. Characterization of exopolysaccharides produced by plant-associated fluorescent Pseudomonads. *Appl. Environ. Microbiol.* 55:579-583.



19. Frisvad, J.C., and Samson, R.A. 1991. Filamentous fungi in foods and feeds: Ecology, spoilage, and mycotoxin production, p. 31-68. In D.K. Arora, K.G. Mukerji, and E.H. Marth (Eds.), *Handbook of Applied Mycology*. Vol. 3: *Foods and Feeds*. Marcel Dekker Inc., New York.
20. Fuhrmann, B., Lebreton, V., Van Hoegaerden, M., Kamphuis, H.J., and Strosberg, A.D. 1992. A monoclonal antibody specific for conidia and mycelium wall layer of *Penicillium* and *Aspergillus*. *Microbiol. Immunol.* 36:1-12.
21. Gander, J.E. 1974. Fungal cell wall glycoproteins and peptido-polysaccharides. *Ann. Rev. Microbiol.* 28:103-119.
22. Goodman, J.W. 1989. Modelling determinants for recognition by B cells and T cells, p. 1-22. In E. Sercarz (Ed.), *Antigenic determinants and immune regulation*. vol. 46. Chem. Immunol. Basel.
23. Gorin, P.A.J., and Barreto-Bergter, E. 1983. The chemistry of polysaccharides of fungi and lichens, p. 365-408. In G.O. Aspinall (Ed.), *The Polysaccharides*, vol. 2. Academic Press, New York.
24. Hayashi, O., Yamada H., Yadomae T., and Miyazaki T. 1978. Purification and partial characterization of the serologically active substance from *Absidia cylindrospora*. *J. Gen. Microbiol.* 106:289-295.
25. Hayashi, O., Yadomae T., Yamada H., and Miyazaki T. 1978. Cross-reactivity of antiserum to *Absidia cylindrospora* among some Mucorales and other fungi. *J. Gen. Microbiol.* 108:345-347.
26. Hayashi, O., Yadomae, T., and Miyazaki, T. 1979. Distribution of antigenic substances among *Absidia cylindrospora*, *Mucor hiemalis*, and *Rhizopus nigricans*. *Jpn. J. Med. Mycol.* 20:181-185.
27. Hearn, V.M., and Mackenzie, D.W.R. 1980. The preparation and partial purification of fractions from mycelial fungi with antigenic activity. *Mol. Immunol.* 17:1097-1103.
28. Hesseltine, C.W. 1983. Microbiology of oriental fermented foods. *Ann. Rev. Microbiol.* 37:575-601.
29. Hessian, P.A., and Smith, J.M.B. 1982. Antigenic characterization of some potentially pathogenic mucoraceous fungi. *Sabouraudia* 20:209-216.
30. Hough, L., and Perry, M.B. 1955. An extracellular polysaccharide from *Mucor racemosus*. *Biochem. J.* 61:viii-ix.
31. IAEA. 1989. Food processing by irradiation: World facts and trends. *International Atomic Energy Agency News Feature*, No. 5, Vienna.
32. Ianelli, D., Capparelli, R., Marziano, F., Scala, F., and Noviello, C. 1983. Production of hybridomas secreting monoclonal antibodies to the genus *Fusarium*. *Mycotaxon.* 17:523-532.
33. Jann, K., and Westphal, O. 1975. Microbial polysaccharides, p. 1-125. In M. Sela (Ed.), *The antigens*, vol. III. Academic Press, New York.
34. Jarvis, B., Seiler, D.A.L., Ould, A.J.L., and Williams, A.P. 1983. Observations on the enumeration of moulds in food and feedingstuffs. *J. Appl. Bacteriol.* 55:325-336.
35. Jones, K.W., and Kaufman, L. 1978. Development and evaluation of an immunodiffusion test for diagnosis of systemic zygomycosis (mucormycosis): preliminary report. *J. Clin. Microbiol.* 7:97-103.
36. Kamphuis, H.J., Notermans, S., Veeneman, G.H., Van Boom, J.H., and Rombouts F.M. 1989. A rapid and reliable method for detection of molds in food: using the Latex Agglutination Assay. *J. Food Prot.* 52:244-247.
37. Kamphuis, H.J., Veeneman, G.H., Rombouts, F.M., Van Boom, J.H., and Notermans, S. 1989. Antibodies against synthetic oligosaccharide antigens reactive with extracellular polysaccharides produced by moulds. *Food Agric. Immunol.* 1:235-242.
38. Kamphuis, H.J. 1992. Extracellular polysaccharides as target compounds for the immunological detection of *Aspergillus* and *Penicillium* in food. PhD-thesis, Wageningen Agricultural University.
39. Kamphuis, H.J., Van der Horst, M.I., Samson, R.A., Rombouts, F.M., and Notermans, S. 1992. Mycological condition of maize products. *Int. J. Food Microbiol.* 16:237-245.

40. Karman, H., and Samson, R.A. 1992. Evaluation of an immunological mould latex detection test: A collaborative study, p. 229-232. In R.A. Samson, A.D. Hocking, J.I. Pitt, and A.D. King (Eds.), *Modern Methods in Food Mycology*. Elsevier Publishers, Amsterdam.
41. Kaufman, L., and Standard, P.G. 1987. Specific and rapid identification of medically important fungi by exoantigen detection. *Ann. Rev. Microbiol.* 41:209-225.
42. Kaufman, L., Turner L.F., and McLaughlin D.W. 1989. Indirect ELISA for Zygomycosis. *J. Clin. Microbiol.* 27:1979-1982.
43. Kitagawa, T., Sakamoto, Y., Furumi, K., and Ogura, H. 1989. Novel enzyme immunoassays for specific detection of *Fusarium oxysporum* f.sp. *cucumerinum* and for general detection of various *Fusarium* species. *Phytopathol.* 79:162-165.
44. Lemieux, C., St-Germain, G., Vincelette, J., Kaufman, L., and De Repentigny, L. 1990. Collaborative evaluation of antigen detection by a commercial latex agglutination test and enzyme immunoassay in the diagnosis of invasive candidiasis. *J. Clin. Microbiol.* 28:249-253.
45. Lin, H.H., and Cousin, M.A. 1987. Evaluation of Enzyme-linked immunosorbent assay for detection of molds in foods. *J. Food Sci.* 52:1089-1094,1096.
46. Longbottom, J.L., and Austwick, P.K.C. 1986. Fungal antigens, p. 7.1-7.11. In D.M. Weir (Ed.), *Immunochemistry: Handbook of Experimental Immunology*, Vol 1. Blackwell Scientific Publications, Oxford.
47. Marchevsky, A.M., Bottone, E.J., Geller, S.A., and Giger, D.K. 1980. The changing spectrum of disease, etiology, and diagnosis of mucormycosis. *Human. Path.* 11:457-464.
48. Martin, S.M., and Adams, G.A. 1956. A survey of fungal polysaccharides. *Can. J. Microbiol.* 34:715-721.
49. Miller, S.A., Rittenburg, J.H., Petersen, F.P., and Grothaus, G.D. 1992. From the research bench to the market place: development of diagnostic kits, p. 208-220. In J.M. Duncan, and L. Torrance (Eds.), *Techniques for the rapid detection of plant pathogens*. Blackwell Scientific Publishers, Oxford.
50. Mischnick, P., and De Ruiter, G.A. 1993. Investigation of the structure of the antigenic polysaccharides of *Aspergillus* and *Penicillium* species using reductive cleavage. *Carbohydr. Res.* (submitted).
51. Miyazaki, T., and Irino, T. 1970. Acidic polysaccharides from the cell wall of *Absidia cylindrospora*, *Mucor mucedo*, and *Rhizopus nigricans*. *Chem. Pharm. Bull.* 18:1930-1931.
52. Miyazaki, T., and Irino, T. 1971. Studies on fungal polysaccharides. VIII. Extracellular heteroglycans of *Rhizopus nigricans*. *Chem. Pharm. Bull.* 19:1450-1454.
53. Miyazaki, T., and Irino, T. 1971. Studies on fungal polysaccharides. IX. The acidic polysaccharide from the cell wall of *Rhizopus nigricans*. *Chem. Pharm. Bull.* 19:2545-2550.
54. Miyazaki, T., and Irino, T. 1972. Studies on fungal polysaccharides X. Extracellular heteroglycans of *Absidia cylindrospora* and *Mucor mucedo*. *Chem. Pharm. Bull.* 20:330-335.
55. Miyazaki, T., Suzuki, I., Yamada, H., Yadomae, T., Kumazawa, Y., and Mizunoe, K. 1977. Serologically active substance(s) from *Absidia cylindrospora*. *Kitasato Arch. Exp. Med.* 50:1-11.
56. Miyazaki, T., Hayashi, O., Ohshima, Y., and Yadomae, T. 1979. Studies on fungal polysaccharides: The immunological determinant of the serologically active substances from *Absidia cylindrospora*, *Mucor hiemalis* and *Rhizopus nigricans*. *J. Gen. Microbiol.* 111:417-422.
57. Miyazaki, T., Yadomae, T., Yamada, H., Hayashi, O., Suzuki, I., and Ohshima, Y. 1980. Immunochemical examination of the polysaccharides of Mucorales, p. 81-94. In P.A. Sandford and Matsuda K. (Eds.), *Fungal Polysaccharides*. ACS Symposium Series, vol 126, Washington.
58. Nagel, B., Dellweg, H., and Gierash, L.M. 1992. Glossary for chemists of terms used in biotechnology (IUPAC Recommendations 1992). *Pure Appl. Chem.* 64:143-168.

59. Notermans, S., Timmermans, P., and Nagel, J. 1982. Interaction of staphylococcal protein A in enzyme-linked immunosorbent assays for staphylococcal antigens. *J. Immunol. Meths.* 55:35-41.
60. Notermans, S., and Heuvelman, C.J. 1985. Immunological detection of moulds in food by using the enzyme-linked immunosorbent assay (ELISA); preparation of antigens. *Int. J. Food Microbiol.* 2:247-258.
61. Notermans, S., Heuvelman, C.J., Beumer, R.R., and Maas, R. 1986. Immunological detection of moulds in food: relation between antigen production and growth. *Int. J. Food Microbiol.* 3:253-261.
62. Notermans, S., Heuvelman, C.J., Van Egmond, H.P., Paulsch, W.E., and Besling, J.R. 1986. Detection of mold in food by enzyme-linked immunosorbent assay. *J. Food Protect.* 49:786-791.
63. Notermans, S., and Soentoro, P.S.S. 1986. Immunological relationship of extracellular polysaccharide antigens produced by different mould species. *Antonie van Leeuwenhoek* 52:393-401.
64. Notermans, S., Wieten, G., Engel, H.W.B., Rombouts, F.M., Hoogerhout, P., and Van Boom, J.H. 1987. Purification and properties of extracellular polysaccharide (EPS) antigens produced by different mould species. *J. Appl. Bacteriol.* 62:157-166.
65. Notermans, S., Veeneman, G.H., Van Zuylen, C.W.E.M., Hoogerhout, P., and Van Boom, J.H. 1988. (1→5)-linked  $\beta$ -D-galactofuranosides are immunodominant in extracellular polysaccharides of *Penicillium* and *Aspergillus* species. *Mol. Immunol.* 25:975-979.
66. Notermans, S., Dufrenne, J., and Soentoro, P.S. 1988. Detection of molds in nuts and spices: The mold colony count versus the enzyme linked immunosorbent assay (ELISA). *J. Food Sci.* 53: 1831-1833,1843.
67. Notermans, S., Alber, G., Sailer-Kramer, B., and Hammer, D.K. 1989. The use of an anti-idiotypic monoclonal antibody for reliable detection of staphylococcal enterotoxins. *Food Agric. Immunol.* 1:11-17.
68. Notermans, S., and Kamphuis, H. 1990. Detection of moulds in food by latex agglutination: a collaborative study. *Food Agric. Immunol.* 2:37-46.
69. Nout, M.J.R., Bonants-van Laarhoven, T.M.G., de Jongh, P., and de Koster, P.G. 1987. Ergosterol content of *Rhizopus oligosporus* NRRL 5905 grown in liquid and solid substrates. *Appl. Microbiol. Biotechnol.* 26:456-461.
70. Nout, M.J.R., and Rombouts, F.M. 1990. A review: Recent developments in tempe research. *J. Appl. Bacteriol.* 69:609-633.
71. Paltauf, A. 1885. Mycosis mucorina. *Virchows Arch. Path. Anat.* 102:543.
72. Pitt, J.I., and Hocking, A.D. 1985. *Fungi and Food Spoilage*. Academic Press, Sydney, New York 409 pp.
73. Prevoo, R.L.M.A., Starink, T.M., and De Haan, P. 1991. Primary cutaneous mucormycosis in a healthy young girl: Report of a case caused by *Mucor hiemalis* Wehmer. *J. Am. Acad. Dermatol.* 24:882-885.
74. Repentigny, L. de, Boushira, M., Ste-Marie, L., and Bosisio, G. 1987. Detection of galactomannan antigenemia by enzyme-assay in aspergillosis. *J. Clin. Microbiol.* 25:863-867.
75. Rose, S.A., and Stringer, M.F. 1989. Immunological methods, p. 121-167. In M.R. Adams and C.F.A. Hope (Eds.), *Rapid methods in food microbiology*, Vol 26. Elsevier, Amsterdam.
76. Sabetta, J.R., Minster, P., and Andriole, V.T. 1985. The diagnosis of invasive aspergillosis by an enzyme linked immunosorbent assay for circulating antigen. *J. Infect. Dis.* 152:946-953.
77. Samson, R.A., and Van Reenen-Hoekstra, E.S. 1988. *Introduction to food-borne fungi*. Centraalbureau voor Schimmelcultures (CBS), Baarn, 299 p.
78. Selvendran, R.R., and Ryden, P. 1990. Isolation and analysis of plant cell walls, pp. 549-579. In P.M. Dey (Ed.), *Methods in Plant Biochemistry. 2. Carbohydrates*. Academic Press, London.

79. Sridhara, S., Gangal, S.V., and Joshi, A.P. 1990. Immunochemical investigation of allergens from *Rhizopus nigricans*. *Allergy* 45:577-586.
80. Steyn, P.S., Tuinman, A.A., Van Heerden, F.R., Van Rooyen, P.H., Wessels, P.L., and Rabie, C.J. 1983. The isolation, structure, and absolute configuration of the mycotoxin, Rhizonin A, a novel cyclic heptapeptide containing *N*-methyl-3-(3-furyl)alanine, produced by *Rhizopus microsporus*. *J. Chem. Soc. Chem. Commun.* 47-49.
81. Stynen, D., Meulemans, L., Goris, A., Braendlin, N., and Symons, N. 1992. Characteristics of a latex agglutination test based on monoclonal antibodies for the detection of fungal antigens in food, p. 213-219. In R.A. Samson, A.D. Hocking, J.I. Pitt, and A.D. King (Eds.), *Modern Methods in Food Mycology*. Elsevier Publishers, Amsterdam.
82. Stynen, D., Sarfati, J., Goris, A., Prévost, M.-C., Lesourd, M., Kamphuis, H., Darras, V., and Latgé, J.-P. 1992. Rat monoclonal antibodies against *Aspergillus galactomannan*. *Infect. Immun.* 60:2237-2245.
83. Sugar, A.M. 1992. Mucormycosis. *Clin. Infect. Dis.* 14(Suppl 1):S126-129
84. Tominaga, Y., and Tsujisaka, Y. 1981. Investigations of the structure of *Rhizopus* cell wall with lytic enzymes. *Agric. Biol. Chem.* 45:1569-1575.
85. Tsai, G.-J., and Cousin, M.A. 1990. Enzyme-linked immunosorbent assay for detection of molds in cheese and yogurt. *J. Dairy Sci.* 73:3366-3378.
86. Tsuchihashi, H., Yadomae, T., and Miyazaki, T. 1983. Structural analysis of the cell-wall D-glucuronans from the fungi *Absidia cylindrospora*, *Mucor mucedo*, and *Rhizopus nigricans*. *Carbohydr. Res.* 111:330-335.
87. Yamada, H., Ohshima, Y., and Miyazaki, T. 1982. Characterisation of fucomannopeptide and mannoprotein from *Absidia cylindrospora*. *Carbohydr. Res.* 110:113-126.
88. Yamada, H., Ohshima, Y., and Miyazaki, T. 1982. Heterogeneity and antigenic properties of mannoheteroglycan from *Absidia cylindrospora*. *J. Gen. Microbiol.* 128:189-197.
89. Yamada, H., Ohshima, Y., and Miyazaki, T. 1982. Characterization of extracellular mannoheteroglycans from *Absidia cylindrospora*. *Chem. Pharm. Bull.* 30:1784-1791.
90. Van Bruggen-Van der Lugt, A.W., Kamphuis, H.J., De Ruiter, G.A., Mischnick, P., Van Boom, J.H., and Rombouts, F.M. 1992. New structural features of the antigenic extracellular polysaccharides of *Penicillium* and *Aspergillus* species revealed with exo- $\beta$ -D-galactofuranosidase. *J. Bacteriol.* 174:6096-6102
91. Van der Horst, M., Samson, R.A., and Karman, H. 1992. Comparison of two commercial kits to detect moulds by latex agglutination, p. 241-245. In R.A. Samson, A.D. Hocking, J.I. Pitt, and A.D. King (Eds.), *Modern Methods in Food Mycology*. Elsevier Publishers, Amsterdam.
92. Waldorf, A.R., Halde, C., and Vedros, N.A. 1983. Immunodiffusion and complement fixation assays with sera from mucormycotic-infected mice. *Mycopathol.* 83:157-160.
93. Weiner, M.H., and Yount, W.J. 1976. Mannan antigenemia in the diagnosis of invasive *Candida* infections. *J. Clin. Invest.* 58:1045-1053.
94. Williams, A.P. 1989. Fungi in foods - rapid detection methods, p. 255-272. In M.R. Adams and C.F.A. Hope (Eds.), *Rapid methods in food microbiology*, Vol 26. Elsevier, Amsterdam.
95. Wysong, D.R., and Waldorf, A.R. 1987. Electrophoretic and immunoblot analyses of *Rhizopus arrhizus* antigens. *J. Clin. Microbiol.* 25:358-363.

## Formation of antigenic extracellular polysaccharides by moulds belonging to Mucorales and preparation of rabbit IgG antibodies

*Antonie van Leeuwenhoek*<sup>1</sup> (1992) 62:189-199.

Polyclonal IgG antibodies were raised in rabbits against extracellular polysaccharides (EPSs) of *Mucor racemosus* and characterized as almost specific for moulds belonging to the order of Mucorales. Cross-reactivity in the ELISA could be observed only towards the yeast *Pichia membranaefaciens*. EPSs were isolated from various cultures of *M. hiemalis* growing on six different carbon sources and two nitrogen sources, with ratios varying from 0.13 to 0.44 relative to the amount of biomass. Other strains including *Mucor* spp., *Rhizopus* spp., *Rhizomucor* spp., *Absidia corymbifera* and *Syncephalastrum racemosum* also excreted EPS, with ratios varying from 0.05 to 0.23. In all cases, the EPS had similar antigenic properties as determined by ELISA. No enzymatic degradation of the antigenic parts of the polysaccharides could be observed upon prolonged incubation. Considering that all tested strains formed similar amounts of antigenic EPS there might be scope for the specific detection of biomass of mucoralean moulds using ELISA techniques, for example in food.

### Introduction

Moulds are able to excrete a large variety of extracellular substances (11,12,18). Among these, water-soluble extracellular polymers are thought to play various roles in fungal biology which probably can be compared with their function in bacteria (17). Some of the excreted polymers may act as reserve nutrients, as adhesin or as moisture regulatory compound (10). Other polymers seemingly have no function in the organism, and may be by-products of the metabolism of the mould (17).

The extracellular polymers of Mucorales (Zygomycetes) mainly consist of carbohydrates (50 to 90 %) and protein (10 to 50 %) and are therefore often referred to

---

<sup>1</sup>Authors: G.A. De Ruiter, A.W. Van Bruggen-van der Lugt, M.J.R. Nout, W.J. Middelhoven, P.S.S. Soentoro, S.H.W. Notermans, and F.M. Rombouts.

as extracellular polymers or polysaccharides (EPS). The presence of fucose, galactose, mannose and glucose residues has been established (3,6,7,18). Also,  $\beta$ -D-(1-4)-linked glucuronic acid polymers have been described as an important structural entity of these EPS (8). A part of these EPS from species of the order of Mucorales possess antigenic properties (24-28). As demonstrated recently, the EPS preparations of various species belonging to Mucorales did give a clear immunological reaction with the IgG antibodies raised against EPS of *M. racemosus* and contain one common antigenic fraction (6). The sugar constituents of these EPS were found to be immunodominant. However, until now no detailed information is available about the exact composition of these carbohydrate epitopes.

It was proposed to use these antigenic properties for immunological detection of moulds in food (9,26,27) or for diagnosis of mucormycosis in man (13,15). The IgG antibodies used in this study were raised against EPS of *M. racemosus* and were more specific than those used by Notermans and Soentoro (28).

Before antibodies could be used for the detection or quantification of biomass of a fungal order, e.g. Mucorales in foods, several prerequisites must be met. First the specificity of the antibodies must be significant. In addition, it must be established that the target fungi produce the antigenic compound when growing on various saccharides occurring in foods. For quantitative purposes the antigenic activity per unit biomass must be predictable (7).

In this study, the formation of antigenic activity of the EPS is assessed in the presence of several saccharides and lactate, and related to biomass production. In addition, the specificity of polyclonal IgG antibodies raised against EPS of *M. racemosus* is established by testing 39 strains of yeasts and 18 strains of moulds, many of them often occurring in food, on their ability to react with these antibodies.

## Materials and methods

### *Organisms*

The strain of *Mucor hiemalis* CBS 201.28 used in this study was grown on Malt Extract Agar (Oxoid CM 59) plates (14 cm diameter) at 22 °C. After incubation for about one week, the spores were harvested by adding 30 ml sterile NaCl solution (9 g/l containing 0.05% Tween 20) and the surface growth was rubbed with a sterile Drigalski spatula. The spores were collected by centrifugation (1000 g, 5 min), washed with sterile distilled water and resuspended in a physiological NaCl solution and stored at -20 °C. A density of  $10^7$  spores/ml was established by counting in a Bürker-Türk haemocytometer and appropriate dilution. Other moulds used in this study were *M. circinelloides* M 40,

*M. racemosus* H473-R5, *Rhizopus oryzae* LU 581, *R. stolonifer* CBS 609.82, *Rhizomucor miehei* CBS 371.71, *Rhizomucor pusillus* CBS 432.78, *Absidia corymbifera* LU 017 and *Syncephalastrum racemosum* CBS 443.59 grown under the same culture conditions.

Various yeasts and moulds commonly found in food (listed in Table 1) were tested on their activity towards IgG antibodies raised against EPS of *M. racemosus*. The yeast strains were obtained from the culture collection of the Laboratory of Microbiology, Wageningen Agricultural University. Yeast species known to occur in foods (1) were represented by strains isolated from foods or silage if available.

### Inoculation

In order to eliminate variability due to asynchronous spore germination, inoculation was carried out either with spore-suspensions or with germinated spores. In the time experiments cultures were inoculated with spore suspensions: 0.2 ml ( $10^7$  spores per ml) per 400 ml medium in an Erlenmeyer flask of 1 l. In the other experiments micro-colonies of previously germinated spores (2,31) were used as an inoculum. These were prepared by making pour plates (14.5 cm diameter) of several dilutions of spore suspensions in 20 ml of a solution of 1.5% (w/v) malt extract (Oxoid L 39) and 0.25% (w/v) agar (Oxoid L 13), which were incubated at 25 °C till the germinated spores had grown out to micro-colonies with a diameter of 2-5 mm and could be harvested with a small sterile spatula. From plates with 20-50 well isolated micro-colonies, five micro-colonies were transferred to 1 l Erlenmeyer flasks containing 200 ml of culture medium.

### Culture media

Yeast nitrogen base (YNB) and yeast carbon base (YCB) (Difco Labs, Detroit, U.S.A.) served as basal medium with concentrations of 6.7 g/l and 11.7 g/l, respectively. Both media are composed of defined quantities of minerals, some amino acids, vitamins and some trace elements. In addition YNB contains ammonium sulphate (5 g/l) as nitrogen source but no carbon source while YCB contains glucose (10 g/l) as carbon source but no nitrogen source. Six different carbon sources (30 g/l), viz. glucose monohydrate (Merck), saccharose (Merck), lactose (Difco), maltose monohydrate (Merck), mannose (Merck) and lactate (CCA Biochem, Gorinchem, The Netherlands) were used. Two nitrogen sources, viz. ammonium sulphate (Merck) (5 g/l) and urea (Merck) (2.25 g/l) containing the same amount of nitrogen, were used in YCB. Solutions of ten-fold concentrated basal media were filter-sterilised (0.45  $\mu$ m) and added to autoclaved solutions of nitrogen and carbon sources. Incubation was performed at 22 °C, on a rotary shaker at 100 rpm (Gallenkamp Ltd, Loughborough, UK), except with *A. corymbifera* and *S. racemosum* which were incubated at 37 °C.

**Table 1.** Perfect and imperfect ascomycetous and basidiomycetous yeast species and mould species of nine genera often found in food, screened for the reactivity towards rabbit IgG antibodies raised against EPS of *Mucor racemosus*.

**Species**

**ascomycetous yeasts**

- Arxula adeninivorans* (Middelhoven, Hoogkamer-te Niet et Kruger-van Rij) Van der Walt, M. Th. Smith et Yamada M13-11  
*Candida famata* (Harrison) Meyer et Yarrow D 74e (ref. 22)  
*Candida glabrata* (Anderson) Meyer et Yarrow CBS 138  
*Candida holmii* (Jørgensen) Meyer et Yarrow D 17f (ref. 22)  
*Candida krusei* (Castellani) Berkhout D 4a (ref. 22)  
*Candida lambica* (Lindner et Genoud) Van Uden et Buckley PB 1 B (ref. 19)  
*Candida magnoliae* (Lodder et Kruger-van Rij) Meyer et Yarrow CBS 166  
*Candida milleri* Yarrow PB 32 (ref. 19)  
*Candida parapsilosis* (Ashford) Langeron et Talice CBS 604t  
*Candida sake* (Saito et Ota) Van Uden et Buckley CBS 159  
*Candida tropicalis* (Castellani) Berkhout CBS 94t  
*Candida utilis* (Henneberg) Lodder et Kreger-van Rij CBS 621  
*Candida vini* (Vallot ex Desmazières) Van Uden et Buckley CBS 639t  
*Citeromyces matritensis* (Santa Maria) Santa Maria CBS 2764t  
*Debaryomyces hansenii* (Zopf) Lodder et Kreger-van Rij G 815  
*Geotrichum candidum* Link D 74b (ref. 22)  
*Hanseniaspora vineae* Van der Walt et Tscheuschner CBS 2171t  
*Hansenula anomala* (Hansen) H. et P. Sydow D 25a (ref. 22)  
*Hansenula capsulata* Wickerham CBS 1993t  
*Hansenula holstii* Wickerham CBS 2028  
*Kluyveromyces marxianus* (Hansen) Van der Walt var. *marxianus* Van der Walt CBS 1555  
*Metschnikowia pulcherrima* Pitt et Miller CBS 5833t  
*Pichia guilliermondii* Wickerham G 26 (ref. 23)  
*Pichia membranaefaciens* (Hansen) Hansen CBS 107t  
*Saccharomyces cerevisiae* Meyen ex Hansen K 1502  
*Saccharomyces dairensis* Naganishi WM 1K (ref. 19)  
*Saccharomyces exiguus* Reess ex Hansen WM 5 (ref. 19)  
*Saccharomyces unisporus* Jørgensen CBS 398t  
*Schizosaccharomyces pombe* Lindner CBS 356t  
*Stephanosascus cijferii* Smith, Van der Walt et Johannsen P2-25 (ref. 23)  
*Torulaspora delbrueckii* (Lindner) Lindner CBS 1146t  
*Yarrowia lipolytica* (Wickerham et al.) Van der Walt et Von Arx CBS 6124t  
*Zygosaccharomyces bailii* (Lindner) Guillaumond Na  
*Zygosaccharomyces rouxii* (Boutroux) Yarrow CBS 732t

**basidiomycetous yeasts**

- Cryptococcus laurentii* (Kufferath) Skinner CBS 7140  
*Leucosporidium scottii* Fell, Statzell, Hunter et Phaff M 1  
*Rhodosporella toruloides* Banno CBS 14t  
*Rhodotorula minuta* (Saito) Harrison K2-7 (ref. 23)  
*Trichosporon cutaneum* (De Beurmana, Gougerot et Vaucher) Ota B1-301 (ref. 23)

**Mould species**

- Aspergillus fumigatus* Fres. RIVM M3  
*Cladosporium cladosporioides* (Fres.) de Vries CBS 143.65  
*Cladosporium herbarum* (Pers.) Link CBS 673.69  
*Fusarium oxysporum* Schlecht. RIVM M28  
*Fusarium sambucinum* Fuckel CBS 291.91  
*Fusarium poae* (Peck) Wollenweber CBS 446.67  
*Mortierella polycephala* Coemans CBS 327.72  
*Mortierella reticulata* van Tieghem CBS 452.74  
*Mortierella hyalina* (Harz) W. Gams CBS 654.68  
*Paecilomyces variotii* Bain. RIVM M113  
*Penicillium funiculosum* Thom RIVM M50  
*Penicillium digitatum* Sacc. RIVM M58  
*Penicillium tardum* Thom RIVM M59  
*Penicillium aurantiogriseum* Dierckx CBS 342.51  
*Penicillium chartesii* G. Smith NRRL 1887  
*Talaromyces flavus* (Klöckner) Stolk & Samson RIVM M86  
*Trichothecium roseum* (Pers.; Fr.) Link RIVM M34  
*Wallemia sebi* v. Arx RIVM M114



### *Isolation of mycelium and water-soluble extracellular polymers*

The culture fluid (200 ml) was separated from the mycelium by filtration through pre-dried and pre-weighed filter paper (589 Schwarzband, Schleicher and Schüll, Dassel, Germany) on a Büchner funnel. The mycelial dry weight was measured after oven-drying the mycelium residue at 80 °C for 24 h.

The filtrates of two flasks were combined (400 ml) and concentrated five-fold with a vacuum rotary evaporator in a water bath at 40 °C, and heated for 5 min at 100 °C to inactivate cellulase enzymes damaging dialysis bags. The filtrate was poured into a dialysis bag (pre-boiled with distilled water), dialysed overnight against running tap water and subsequently against distilled water for 24 h. The solution was concentrated five times with a rotary evaporator and lyophilized. The solid was dissolved in 20 ml of distilled water and any water-insoluble material was removed by centrifugation (15 min, 19600 g). Finally, the water-soluble material supposed to consist of the extracellular polymers (EPS) was freeze-dried and weighed.

### *Chemical analyses of the extracellular polymers*

The glucuronic acid content of the mixture of extracellular polymers was measured using the automated *m*-hydroxy diphenyl assay (33) slightly modified by the addition of 0.0125 M sodium tetraborate to the sulphuric acid as described by Blumenkrantz and Asboe-Hansen (4), with glucuronic acid as the standard. Neutral sugars were determined using the automated orcinol method (34), using glucose as the standard. Corrections in the latter analysis were made for interference from glucuronic acid.

### *HPLC detection of the glucose level in the culture medium*

The amount of residual glucose was measured using the HPLC method according to Voragen *et al.* (35). Samples of the culture filtrates (1 ml) were treated with 50  $\mu$ l of a 1 M solution of lead nitrate. The mixture was stored for at least 1 hour in the freezer (-20 °C) and centrifuged (1000 g; 10 min). An aliquot of 20  $\mu$ l of the supernatant was injected into an SP 8800 HPLC-system (Spectra Physics, San Jose, CA U.S.A.). The system was equipped with a Merck Polyspher CH PB HPLC-column (85 °C) and a guard column (20 °C) packed with a mixture of equivalent amounts of dried AG50W-X4 (H<sup>+</sup>, 400 mesh) and AG3-X4A (OH<sup>-</sup>, 200-400 mesh) (Bio-Rad Labs., Richmond, CA U.S.A.). Distilled water filtered in a Millipore system (Millipore Corp., Bedford, MA U.S.A) was used as eluent at a flow rate of 0.5 ml/min. Sugars were detected with a Shodex RI SE-61 (Showa Denko, Tokyo, Japan) Refractive Index detector. Standard solutions of glucose, saccharose, mannose, lactose and maltose were used for calibration in the respective experiments.

### *Sandwich ELISA for the detection of antigenic EPS*

Polyclonal IgG antibodies 1000/1201 were obtained by immunization of rabbits with EPS isolated from *Mucor racemosus* as described by Notermans and Heuvelman (26). The IgG fraction of the serum was purified using selective precipitation with octanoic acid as described (32). The sandwich ELISA was carried out as described earlier (6,26) in wells of polyvinyl chloride microtitre plates (Dynatech, Chantilly, VA U.S.A.). The substrate solution was 3,3',5,5'-tetramethylbenzidine in dimethyl sulphoxide containing H<sub>2</sub>O<sub>2</sub> prepared according to Bos *et al.* (5). The horse-radish peroxidase reaction was stopped by adding 50  $\mu$ l of 2 M H<sub>2</sub>SO<sub>4</sub> to each well. The absorbance of the yellow colour was measured spectrophotometrically at 450 nm. The ELISA reactivity was expressed as the titre of the isolated EPS, defined as the reciprocal dilution of a solution of 10  $\mu$ g/ml EPS in distilled water just giving a positive reaction, i.e. an absorption  $\geq$  0.1 above that of a blank containing no antigenic EPS.

## **Results**

### *Specificity of the polyclonal IgG antibodies used in this study*

The polyclonal IgG antibodies (1000/1201) raised in rabbits against the EPS of *M. racemosus* were further tested on their specificity. A sandwich ELISA based on these antibodies was used to test EPS of different strains of yeasts and moulds, of which many often occur in foods. The yeast strains tested belonged to ascomycetous and basidiomycetous species (Table 1). The EPS of (imperfect) ascomycetous yeasts are almost species-specific (20), therefore a large variety of ascomycetous species were tested. Moreover, 18 strains of moulds, belonging to nine different genera were tested. No cross-reactivity with the strains of yeasts and moulds tested could be observed, except with the yeast *Pichia membranaefaciens* (Hansen) Hansen. This strain gave a clear positive reaction with the polyclonal IgG antibodies raised against EPS of *M. racemosus*. Therefore, EPS from *P. membranaefaciens* was isolated and purified. Its ELISA titre determined on a 10  $\mu$ g/ml preparation of EPS in distilled water was 200. A similar ELISA reactivity was obtained for EPS of *M. racemosus* and *Rhizopus stolonifer*.

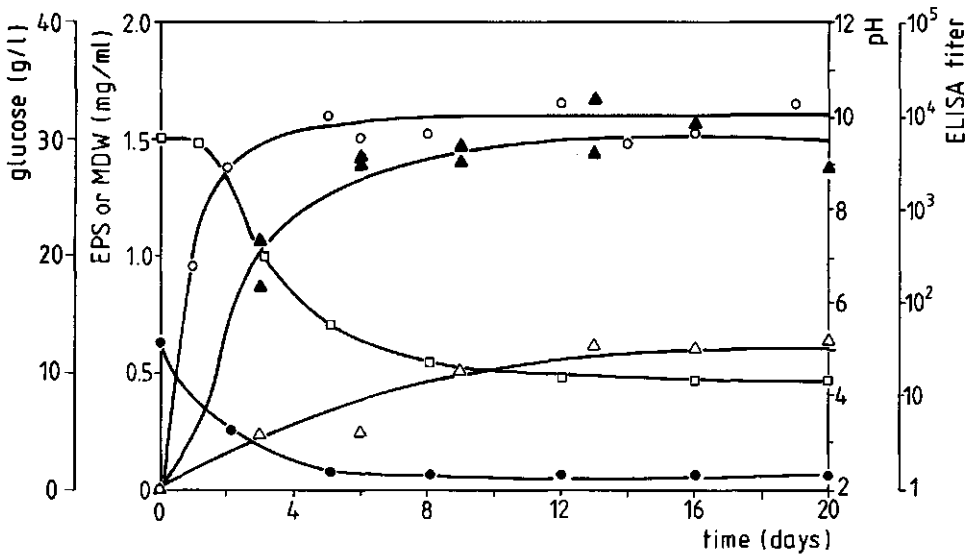

**Fig. 1.** Growth and production of antigenic extracellular polysaccharides of *Mucor hiemalis* with glucose as the carbon source and ammonium sulphate as the nitrogen source. Symbols:  $\blacktriangle$ - $\blacktriangle$ -, Mycelial dry weight;  $\triangle$ - $\triangle$ -, yield of EPS;  $\circ$ - $\circ$ -, sandwich ELISA titre;  $\bullet$ - $\bullet$ -, pH;  $\square$ - $\square$ -, glucose consumption.

### Time experiments

The production of extracellular polymers by *Mucor hiemalis* and its content of antigenic EPS was tested as a function of growth. The yield of extracellular polymers and the mycelial dry weight as function of the age of the culture using ammonium sulphate as the nitrogen source are shown in Fig. 1. After removing the mycelial pellets by filtration, fractions of the culture medium were examined with the sandwich ELISA also shown in Fig. 1. Mycelial growth and production of antigenic EPS followed similar trends stabilizing after 6 days. The production of total EPS was more gradual and stabilized after 12 days. The initial pH (5.1) dropped to 2.3, while the amount of glucose was only consumed partially after 20 days of incubation as indicated. Apparently, the low pH limited further growth and substrate assimilation. In similar experiments with urea as sole source of nitrogen, the initial pH of 5.9 increased to 8.8 after 21 days of incubation. The use of equal amounts of urea and ammonium calculated on N-weight, resulted in a decrease of the pH from 6.5 to 4.7 during the first nine days followed by an increase to 7.4 after 21 days of incubation. Under these circumstances the amount of glucose was consumed completely after 8 days. Also, the mycelial dry weight and antigenic EPS increased during six days, while no significant decrease of the titre of the culture medium could be observed during the stationary phase.

**Table 2.** Mycelial dry weight, yield and ELISA reactivity of excreted EPS of *M. hiemalis* using different glucose concentrations in the liquid culture medium of YNB with ammonium sulphate (5 g/l) as nitrogen source after 8 days of incubation<sup>a</sup>.

Glucose		Mycelial dry weight (mg/l)	Excreted EPS			Ratio <sup>c</sup>	ELISA titre <sup>d</sup>
initial (g/l)	final (g/l)		weight (mg/l)	% n.s. <sup>b</sup> (wt/wt)	% glcA <sup>b</sup> (wt/wt)		
5	0	1395 ± 50	330 ± 5	34 ± 1	23 ± 0	0.13	++
10	0	1515 ± 30	445 ± 25	35 ± 0	25 ± 1	0.18	++
20	4	1655 ± 65	600 ± 20	34 ± 1	24 ± 0	0.21	++
30	12	1560 ± 45	610 ± 40	35 ± 2	23 ± 1	0.23	++
50	25	1510 ± 25	650 ± 5	34 ± 1	21 ± 1	0.24	++

<sup>a</sup> Average of four replications ± SD.

<sup>b</sup> Neutral sugar and glucuronic acid content respectively.

<sup>c</sup> Calculated by taking the saccharide content (neutral sugars + glcA) of the EPS and the mycelial weight.

<sup>d</sup> ELISA titre of the isolated EPS fractions as determined on 10 µg/ml solutions in distilled water:

-, titre ≤ 10; +, 10 < titre ≤ 100; ++, 100 < titre ≤ 1000; +++, titre > 1000.

### *Inoculation using micro-colonies*

During the above-mentioned growth experiments (Fig. 1), inoculation with spore suspensions caused rather large standard deviation, variation coefficient 19.1 %, of mycelial dry weight. It was attempted to reduce this variability by inoculation with pre-germinated spores. The reproducibility was tested in 12 replications. In nearly all cases every single micro-colony grew out into one mycelial pellet under shaking conditions. The average of the biomass produced per Erlenmeyer flask was  $281.2 \pm 13.6$  mg (variation coefficient 4.8 % with confidence limit 95%; Student's *t* test). Consequently, in the experiments reported in Tables 2, 3 and 4 micro-colonies were used as inoculum.

### *Growth and production of EPS as a function of the glucose concentration*

The effect of glucose concentration on mycelial dry weight and production of EPS of *M. hiemalis* was assessed using ammonium as the N-source. As the sugar constituents of the EPS were found to be immunodominant (7,25), the ratio between the amounts of EPS and mycelial dry weight of the moulds was calculated based on the total sugar content of the EPS. As shown in Table 2, production of EPS of *M. hiemalis* occurred at all glucose concentrations tested. The chemical composition of the respective EPS was similar,

**Table 3.** Mycelial dry weight, yield and ELISA reactivity of excreted EPS of *M. hiemalis* using different carbon and nitrogen sources after 8 days of incubation<sup>a</sup>

Carbon source <sup>e</sup>	Nitrogen source <sup>f</sup>	Mycelium dry weight (mg/l)	Excreted EPS			Ratio <sup>e</sup>	ELISA titre <sup>d</sup>
			weight (mg/l)	% n.s. <sup>b</sup> (wt/wt)	% glcA <sup>b</sup> (wt/wt)		
Glucose	(NH <sub>4</sub> ) <sub>2</sub> SO <sub>4</sub>	1605 ± 60	710 ± 15	36 ± 2	22 ± 1	0.26	++
Mannose	(NH <sub>4</sub> ) <sub>2</sub> SO <sub>4</sub>	1865 ± 15	765 ± 15	39 ± 2	21 ± 1	0.25	++
Saccharose	(NH <sub>4</sub> ) <sub>2</sub> SO <sub>4</sub>	1945 ± 55	600 ± 30	32 ± 1	27 ± 2	0.18	++
Maltose	(NH <sub>4</sub> ) <sub>2</sub> SO <sub>4</sub>	765 ± 25	665 ± 5	44 ± 1	7 ± 0	0.44	+
Glucose	urea	1285 ± 90	240 ± 25	24 ± 2	7 ± 2	0.06	++
Glucose	(NH <sub>4</sub> ) <sub>2</sub> SO <sub>4</sub> /urea	1755 ± 15	130 ± 5	30 ± 1	17 ± 1	0.03	++

<sup>a</sup>, <sup>b</sup>, <sup>c</sup> and <sup>d</sup> as in Table 2.

<sup>e</sup> Concentration of the sugars was 30 g/l.

<sup>f</sup> Concentration of the nitrogen source was 1.06 g N/l.

as can be judged from the percentages of neutral sugars and glucuronic acid (Table 2). After 8 days of growth, glucose was exhausted in the media initially containing 5 and 10 g/l of glucose. An increase of the initial glucose concentration to 20-50 g/l resulted in higher amounts of carbon source consumed, approximately the same amount of mycelium produced and significantly higher ratios between excreted amounts of EPS and mycelial dry weight of the mould. The antigenicity of the EPS isolated from culture media with increasing amounts of glucose as carbon source was similar as could be revealed from their ELISA reactivity in Table 2. In all cases between 10 and 100 ng per ml of the isolated EPS could be detected. Under all conditions, the initial pH of 5.1 dropped to 2.6 within three days, probably as a result of ammonia utilization and production of organic acids (30).

#### *Effect of the nutrients*

To investigate the effect of different carbon sources, glucose was replaced by 30 g/l of a monosaccharide (mannose), disaccharides (saccharose, maltose and lactose) and lactate in YNB, using ammonium sulphate as the nitrogen source (Table 3). Replacement by mannose did not have significant influence on production of mycelium and EPS. Also, the antigenicity of the isolated EPS, tested in the ELISA, was similar to that of glucose-grown *M. hiemalis*. With disaccharides (saccharose and maltose) as carbon source, these features changed somewhat more as shown in Table 3. Growth of *M. hiemalis* on maltose

**Table 4.** Mycelial dry weight, yield and ELISA reactivity of excreted EPS of various strains belonging to Mucorales after 8 days of incubation at their optimum temperature<sup>a</sup>.

Mould species	Mycelium dry weight (mg/l)	Excreted EPS			Ratio <sup>c</sup>	ELISA titre <sup>d</sup>
		weight (mg/l)	% n.s. <sup>b</sup> (wt/wt)	% glcA <sup>b</sup> (wt/wt)		
<i>Mucor hiemalis</i>	1560 ± 45	610 ± 40	35 ± 2	23 ± 1	0.23	++
<i>Mucor circinelloides</i>	1455 ± 100	410 ± 25	30 ± 1	14 ± 0	0.12	++
<i>Mucor racemosus</i>	1170	190	34	16	0.08	++
<i>Rhizopus oryzae</i>	1405 ± 145	290 ± 5	30 ± 2	22 ± 1	0.11	++
<i>Rhizopus stolonifer</i>	1885	300	33	21	0.09	++
<i>Rhizomucor miehei</i>	2270	325	28	22	0.07	++
<i>Rhizomucor pusillus</i>	1555	220	19	15	0.05	++
<i>Absidia corymbifera</i>	1250 ± 80	175 ± 20	37 ± 2	9 ± 1	0.06	+
<i>Syncephalastrum racemosum</i>	1125 ± 90	140 ± 10	35 ± 2	13 ± 1	0.06	++

<sup>a</sup> Glucose (30 g/l) was used as the carbon source and ammonium sulphate as the nitrogen source (5 g/l), average of four replications ± SD. If no SD is given, the values are the average of two experiments.

<sup>b</sup>, <sup>c</sup> and <sup>d</sup> as in Table 2.

as sole carbon source resulted in an EPS preparation with a relatively high neutral sugar content, low glucuronic acid content and a low antigenicity. The initial pH (5.1) of the culture media with various carbon sources dropped to a final value of 2.4 (mannose and saccharose) or 2.9 (maltose). On lactose and lactate, no growth occurred and consequently no EPS could be detected.

If ammonia was replaced entirely or partly by urea, the amount of EPS was significantly lower (Table 3). If urea was used as the only nitrogen source the initial pH of 7.1 increased to a value of 8.0, and the ratio between the sugar part of the EPS and biomass was as low as 0.06, which is approximately four times less than with ammonium as nitrogen source. The combined use of urea and ammonium had a stabilizing effect on the pH (final value 4.7), enabling rapid growth. However, the amount of EPS was even lower as shown in Table 3. The change in nitrogen source did not have a significant influence on the antigenicity of the respective EPS (Table 3).

## Growth and production of extracellular polymers and antigenic EPS of various species belonging to Mucorales

In order to assess growth and formation of antigenic EPS of species of the Mucorales other than *M. hiemalis*, a number of strains of major genera were grown under the same conditions at their optimum temperature for growth. Strains tested belonged to species of the genera of *Mucor*, *Rhizopus* and *Rhizomucor* as well as the species *Absidia corymbifera* and *Syncephalastrum racemosum*. As shown in Table 4, all species belonging to five different genera excreted EPS, containing neutral sugars and glucuronic acid. However, the proportion of EPS to biomass was significantly lower than for *M. hiemalis*. The EPS produced by *Absidia corymbifera* contained much more glucose compared to the EPS of the other Mucorales strains tested (6). The antigenicity of the EPS of *A. corymbifera* as tested in the sandwich ELISA was lower compared to the other EPS which showed similar antigenicity as EPS from *M. hiemalis* as shown in Table 4.

## Discussion

The polyclonal IgG antibodies raised against EPS of *M. racemosus* used in this study were found to be specific for moulds belonging to Mucorales. Only the yeast *Pichia membranaefaciens* (Hansen) Hansen did cross-react with these antibodies. This yeast often has been isolated from soil and is frequently found in foods such as various beverages, yoghurt and yeast cake (16). No cross-reaction of the IgG antibodies was observed with different strains of moulds other than those belonging to Mucorales. Hence, these polyclonal antibodies are more specific than those described by Notermans and Soentoro (28) which cross-reacted with some other mould genera. Therefore, our IgG antibodies can be considered as almost mono-specific for mucoralean moulds, enabling specific detection of these moulds.

The time experiment in this study showed that growth and carbohydrate assimilation of *M. hiemalis* is limited by the decreased pH. However, more carbohydrate may have been incorporated into the EPS under these conditions. It is shown that using selected carbon and nitrogen sources, often found in foods, significant amounts of EPS are excreted if growth of Mucorales moulds occurs. The chemical composition of these EPS, previously established consisting of neutral sugars (19–37%), glucuronic acid (14–42%) and protein (11–40%) is similar under all growth conditions tested, except using maltose as carbon source and if *Absidia corymbifera* is inoculated. In these cases EPS is produced with a much higher neutral sugar content, due to the presence of glucans, not reactive in this

sandwich ELISA (6).

The antigenic polysaccharides constitute only a minor part of the total amount of EPS excreted by different moulds under various growth conditions and evidently, their production only occurs if biomass is formed. The increase of the ELISA titre in the growth experiment follows the growth curve of the mould closely, indicating that at all stages of growth the antigenicity of the EPS is of the same order of magnitude. This agrees with results of Middelhoven *et al.* (21) who demonstrated that the amount of EPS excreted by the yeasts *Hansenula wickerhamii* and *Stephanoascus ciferri* was proportional to the amount of biomass under a great variety of culture conditions. However, in cultures of *Saccharomyces cerevisiae* antigenic EPS excretion occurred in the stationary growth phase (21). In Mucorales species and in yeasts under various conditions no enzymes are produced that degrade the antigenic part of the EPS. This phenomenon is important in view of practical application of the ELISA. However, as shown for growth experiments with selected culture liquids, a quantification of the amount of biomass based on ELISA titre is inaccurate. This is due to the variations of the excreted amounts of EPS related to biomass, and to the relative amount of antigenic polysaccharides in the EPS.

Hence, our results allow the conclusion that the use of the sandwich ELISA developed by Notermans and coworkers (6,9,26,27) for the detection of *Mucor* and *Rhizopus* species is almost specific for moulds belonging to Mucorales including species belonging to the genera *Rhizomucor*, *Absidia* and *Syncephalastrum*. However, as shown in this study, quantification of these moulds in liquid cultures with the ELISA may only be indicative as a result of variations in the excretion and composition of the EPS due to differences in growth conditions as well as the reproducibility of the ELISA system.

The use of the sandwich ELISA method in complex samples such as food, characterized by complex matrices of various components, requires the detection of false-positive immunological reactions in order to enhance the reliability of the assay. This can be accomplished by the use of synthetic epitopes in control assays as clearly shown by Notermans and coworkers (14,29). Detailed knowledge about the structure of the epitopes is necessary to make their synthesis possible. A general application of this sandwich ELISA requires also more detailed information about the excretion of antigenic polysaccharides during growth of these moulds on solid substrates.

## References

1. Barnett J.A., Payne R.W., and Yarrow D. (1991) *Yeasts; Characteristics and Identification* (2<sup>nd</sup> ed.). Cambridge University Press, Cambridge.



2. Bartnicki-Garcia S., and Nickerson W.J. (1962) Nutrition, growth, and morphogenesis of *Mucor rouxii*. *J. Bacteriol.* 84:841-858.
3. Bartnicki-Garcia S., and Reyes E. (1968) Polyuronides in the cell walls of *Mucor rouxii*. *Biochim. Biophys. Acta* 170:54-62.
4. Blumenkrantz N., and Asboe-Hansen G. (1973) New Method for Quantitative Determination of Uronic Acids. *Anal. Biochem.* 54:484-489.
5. Bos E.S., Van der Doelen A.A., Van Rooy N., and Schuur A.H.W.M. (1981) 3,3',5,5'-tetramethylbenzidine as an Ames test negative chromogen for horse-radish peroxidase in enzyme-immunoassay. *J. Immunoassay* 2:187-203.
6. De Ruiter G.A., Van der Lugt A.W., Voragen A.G.J., Rombouts F.M., and Notermans S.H.W. (1991) High-performance size-exclusion chromatography and ELISA detection of extracellular polysaccharides from Mucorales. *Carbohydr. Res.* 215:47-57.
7. De Ruiter G.A., Smid P., Van der Lugt A.W., Van Boom J.H., Notermans S.H.W., and Rombouts F.M. (1991) Immunogenic extracellular polysaccharides of Mucorales. In: Latgé J.P., and Boucias D. (Eds) *Fungal Cell Wall and Immune Response*, vol. H 53 (pp. 169-180). NATO ASI Series, Springer Verlag Berlin Heidelberg.
8. De Ruiter G.A., Josso S.L., Colquhoun I.J., Voragen A.G.J., and Rombouts F.M. (1992) Isolation and characterization of  $\beta(1-4)$ -D-glucuronans from extracellular polysaccharides of moulds belonging to Mucorales. *Carbohydr. Polym.* 18:1-7.
9. De Ruiter G.A., Hoopman T., Van der Lugt A.W., Notermans S.H.W., and Nout M.J.R. (1992) Immunochemical detection of Mucorales species in food. In: Samson R.A., Hocking A.D., Pitt J.I., and King A.D. (Eds) *Modern Methods in Food Mycology* (pp. 221-227). Elsevier Publishers, Amsterdam.
10. Fett W.F., Osman S.F., and Dunn M.F. (1989) Characterization of exopolysaccharides produced by plant-associated fluorescent Pseudomonads. *Appl. Environ. Microbiol.* 55:579-583.
11. Goatley J.L. (1968) Production of exocellular polysaccharides by *Alternaria solani*. *Can. J. Microbiol.* 14:1063-1068.
12. Graham D.C.W., Steinkraus K.H., and Hackler L.R. (1976) Factors affecting production of mold mycelium and protein in synthetic media. *Appl. Environ. Microbiol.* 32:381-387.
13. Jones K.W., and Kaufman L. (1978) Development and evaluation of an immunodiffusion test for diagnosis of systemic Zygomycosis (Mucormycosis) Preliminary report. *J. Clin. Microbiol.* 7:97-103.
14. Kamphuis H.J., Notermans S., Veeneman G.H., Van Boom J.H., and Rombouts F.M. (1989) A rapid and reliable method for the detection of molds in foods: using the Latex Agglutination assay. *J. Food Prot.* 52:244-247.
15. Kaufman L., Turner L.F., and McLaughlin D.W. (1989) Indirect Enzyme-linked Immunosorbent Assay for Zygomycosis. *J. Clin. Microbiol.* 27:1979-1982.
16. Kreger-Van Rij N.J.W. (Ed) (1984) *The yeasts, a Taxonomic Study*. 3<sup>rd</sup> edn Elsevier, Amsterdam.
17. Longbottom J.L., and Austwick P.K.C. (1986) Fungal antigens. In: Weir D.M. (Ed) *Immunochemistry. Handbook of Experimental Immunology*, Vol 1 (pp 7.1-7.11). Blackwell Scientific Publications, Oxford.
18. Martin S.M., and Adams G.A. (1956) A survey of fungal polysaccharides. *Can. J. Microbiol.* 34:715-721.
19. Middelhoven W.J., and Franzen M.M. (1986) The Yeast Flora of Ensiled Whole-crop Maize. *J. Sci. Food Agric.* 37:855-861.

20. Middelhoven W.J., and Notermans S. (1988) Species-specific extracellular antigen production by ascomycetous yeasts detected by ELISA. *J. Gen. Appl. Microbiol.* 34:15-26 .
21. Middelhoven W.J., Slingerland R.J., and Notermans S. (1988) The effect of growth conditions on production and excretion of extracellular antigens by three ascomycetous yeasts. *Antonie van Leeuwenhoek* 54:235-244.
22. Middelhoven W.J., and Van Baalen A.H.M. (1988) Development of the Yeast Flora of Whole-crop Maize during Ensiling and during Subsequent Aerobiosis. *J. Sci. Food Agric.* 42:199-207.
23. Middelhoven W.J., De Jong I.M., and De Winter M. (1990) Yeasts and fungi occurring in ensiled whole-crop maize and other ensiled vegetable crops. *Antonie van Leeuwenhoek* 57:153-158.
24. Miyazaki T., and Irino T. (1972) Studies on fungal polysaccharides. X. Extracellular heteroglycans of *Absidia cylindrospora* and *Mucor mucedo*. *Chem. Pharm. Bull.* 20:330-335.
25. Miyazaki T., Yadomae T., Yamada H., Hayashi O., Suzuki I., and Ohshima Y. (1980) Immunochemical Examination of the polysaccharides of Mucorales. In: Sandford P.A., and Matsuda K. (Eds) *Fungal Polysaccharides*, ACS Symposium Series 126 (pp 81-94). American Chemical Society, Washington DC.
26. Notermans S., and Heuvelman C.J. (1985) Immunological detection of moulds in food by using the enzyme-linked immunosorbent assay (ELISA); preparation of antigens. *Int. J. Food Microbiol.* 2:247-258.
27. Notermans S., Heuvelman C.J., Beumer R.R., and Maas R. (1986) Immunological detection of moulds in food: relation between antigen production and growth. *Int. J. Food Microbiol.* 3:253-261.
28. Notermans S., and Soentoro P.S.S. (1986) Immunological relationship of extra-cellular polysaccharide antigens produced by different mould species. *Antonie van Leeuwenhoek* 52:393-401.
29. Notermans S., Veeneman G.H., Van Zuylen C.W.E.M., Hoogerhout P., Van Boom J.H. (1988) (1→5)-linked  $\beta$ -D-galactofuranosides are immunodominant in extracellular polysaccharides of *Penicillium* and *Aspergillus* species. *Mol. Immunol.* 25:975-979.
30. Slaughter J.C. (1988) Nitrogen metabolism. In: Berry D.R. (Ed) *Physiology of industrial fungi* (pp 58-76). Blackwell Scientific Publications, Oxford.
31. Solomons G.L. (1975) Submerged culture production of mycelial biomass. In: Smith J.E., and Berry D.R. (Eds) *The filamentous fungi*, vol. 1 *Industrial Mycology* (pp 249-264). Edward Arnold Publ., London.
32. Steinbuch M., and Audran R. (1969) The isolation of IgG from mammalian sera with the aid of caprylic acid. *Arch. Biochem. Biophys.* 134:279-284.
33. Thibault J.-F. (1979) Automatisation du Dosage des Substances Pectiques par la Méthode au Méta-hydroxydiphényl. *Lebensm. Wiss. Technol.* 12:247-251.
34. Tollier M.T., and Robin J.-P. (1979) Adaptation de la méthode à l'orcino-sulfurique au dosage automatique des glucides neutres totaux: conditions d'application aux extraits d'origine végétale. *Ann. Technol. Agric.* 28:1-15.
35. Voragen A.G.J., Schols H.A., Searle-van Leeuwen M.F., Beldman G., and Rombouts F.M. (1986) Analysis of oligomeric and monomeric saccharides from enzymatically degraded polysaccharides by high-performance liquid chromatography. *J. Chromatogr.* 370:113-120.

## High-performance size-exclusion chromatography and ELISA detection of extracellular polysaccharides from Mucorales

*Carbohydrate Research*<sup>1</sup> (1991) 215:47-57.

High-performance size-exclusion chromatography and ELISA detection were used to study the extracellular polysaccharides excreted by mould species belonging to Mucorales. EPS preparations from different species were heterogeneous as detected by refractive index measurements. ELISA detection of fractions collected after high-performance size-exclusion chromatography revealed reactivity of antibodies with a limited number of polysaccharides with a retention time of 27 to 29 min in EPS preparations of all species tested. In addition to the antigenic polysaccharide fraction, other polysaccharides were present, depending on species and carbon source used for growth. The method employed allowed one to fractionate EPS preparations and to discriminate between antigenic and non-antigenic components. All Mucorales tested produced polysaccharides reactive with polyclonal IgG antibodies raised against EPS from *Mucor racemosus*.

### Introduction

The chemistry and immunochemical properties of polysaccharides excreted by fungi belonging to the family of the Mucoraceae of the order of Mucorales of the class of Zygomycetes have been previously studied (10,13-16). Recently, immunological detection of moulds based on the immunochemical properties of the excreted polysaccharides, was proposed by Notermans and associates (17,18) using an enzyme-linked immunosorbent assay (ELISA). Reactivity of the extracellular polysaccharides (EPSs) of *Mucor* and *Rhizopus* species with antibodies raised against EPS of *Mucor racemosus*, was found, indicating similar immunodominant structures (19).

Until now, no detailed information was available about the composition and molecular weight distribution of the mixture of polysaccharides excreted by Mucorales and its relation to their immunochemical properties. High-performance size-exclusion chromatography was

---

<sup>1</sup>Authors: G.A. De Ruiter, A.W. van der Lugt, A.G.J. Voragen, F.M. Rombouts, and S.H.W. Notermans.

used to study the composition of the glucuronic acid-containing EPSs. This method was previously applied for galacturonic acid-containing pectins (1,6,9) and a fungal EPS scleroglucan (11). The combined use of high-performance liquid chromatography and immunochemical assays for screening glycoproteins on their immunological properties was recently proposed (12).

In this study, the behaviour of EPSs of mucoralean moulds in high-performance size-exclusion chromatography and ion-exchange chromatography is presented. The IgG fraction of rabbit polyclonal antibodies raised against EPS of *M. racemosus*, was used in a sandwich ELISA to study immunochemical reactivity of fractions of EPSs of various moulds species separated by size-exclusion chromatography.

## Materials and methods

### Moulds

The strains of *Mucor hiemalis* CBS 201.28, *M. racemosus* H473-R5, *M. circinelloides* RIVM M 40, *Rhizopus stolonifer* CBS 609.82, *R. oryzae* RIVM S 40, *Rhizomucor miehei* CBS 371.71, *Rhm. pusillus* CBS 432.78, *Absidia corymbifera* LU 017, *Syncephalastrum racemosum* CBS 443.59 and *Thamnidium elegans* CBS 342.55 used in this study were grown on a Yeast Nitrogen Base (YNB, Difco Labs, Detroit, USA) synthetic culture medium supplemented with D-glucose (Merck) as carbon source in a concentration of 30 g/l. Incubation was performed at 30 °C on a rotary shaker at 100 r.p.m. (Gallenkamp Ltd, Loughborough, UK), except with *M. hiemalis*, *R. stolonifer* and *T. elegans* which were incubated at 25 °C and *A. corymbifera* and *S. racemosum* which were incubated at 37 °C.

### Isolation of the extracellular polysaccharides

The culture liquid (200 ml) was separated from the mycelium by filtration with pre-weighed filter paper (55 mm, 589 black ribbon; Schleicher & Schüll, Dassel, Germany) on a Büchner funnel. The filtrate was concentrated five-fold with a vacuum rotary evaporator in a water bath at 40 °C, and heated for 5 min at 100 °C to inactivate enzymes which might have been present. The filtrate was poured into a dialysis bag (preboiled with distilled water), dialysed against running tap water overnight and then against distilled water for 24 h. The solution was further concentrated under reduced pressure and lyophilized. The residue was dissolved in 20 ml of distilled water and any water-insoluble material was removed by centrifugation. Finally, the EPS-containing water fraction was poured into five volumes of ethanol (96%) and stored for 16 h at 4 °C. The precipitate was separated by centrifugation (30 min, 19600 g), and dissolved in 20 ml of distilled water and precipitated for a second

time. This process was repeated once more, and the precipitate was dissolved in 10 ml of distilled water, freeze-dried and weighed. This constituted the water-soluble EPSs.

#### *Sugar analysis of the EPS*

The neutral sugar composition of the EPS was determined as alditol acetates using GLC. Neutral sugars were released by pre-treatment with 12 M H<sub>2</sub>SO<sub>4</sub> for 1 h at 30 °C followed by hydrolysis with 1 M H<sub>2</sub>SO<sub>4</sub> for 3 h at 100 °C. Next, sugars were converted to their alditol acetates as described (8) and analysed by GLC using inositol as the internal standard.

#### *Molecular weight distribution*

The molecular weight distribution was studied using high-performance size-exclusion chromatography, which was performed on a SP8800 HPLC system (Spectra Physics, San Jose, CA U.S.A.) equipped with three Bio-Gel TSK columns in series (40XL, 30XL, 20XL; 300x7.5 mm; Bio-Rad Labs, Richmond, CA U.S.A.) in combination with a TSK-XL guard column (40 x 6 mm) at 30 °C. An aliquot of 20 µl of a solution of EPS in distilled water (1 mg/ml) was injected into the system and 0.4 M acetic acid/sodium acetate (pH 3.0) was used as eluent with a flow rate of 0.8 ml/min. The effluent was monitored using a Shodex SE-61 refractive index detector. To estimate the apparent molecular masses, calibration of the this system was performed by analysing dextran standards (10 to 500kDa; Pharmacia, Uppsala, Sweden) using software obtained from Spectra-Physics.

The effluent was partitioned in fractions of 0.4 ml (0.5 min) using a Bio-Rad 2110 fraction collector. After adding 0.14 ml of a 1 M solution of NaOH for neutralisation, the samples were diluted by adding 1.06 ml of distilled water. These samples were examined by the sandwich ELISA and further diluted (2 to 8 times) on microtitre plates. The optimal dilution was determined by comparing the ELISA absorbance with those of a dilution curve of a standard EPS derived from *Mucor hiemalis*.

#### *Sandwich ELISA for the detection of EPS*

The sandwich ELISA was carried out as described (17), in wells of polyvinyl chloride microtitre plates (Dynatech, Chantilly, VA U.S.A.). An IgG fraction (1000/1201) of polyclonal antibodies was obtained by immunization of rabbits with EPS produced by *M. racemosus* as described (19). An aliquot (100 µl) containing 10 µg/ml of rabbit IgG anti *M. racemosus* EPS in 0.07 M phosphate-buffered saline (pH 7.2) containing 0.15 M NaCl (PBS), was added to each well and incubated overnight at room temperature. After rinsing with PBS containing 0.05% Tween 20 (PBST) 100 µl portions of samples diluted in PBST were added and incubated for 90 min at room temperature. After another rinse with PBST the wells were incubated with IgG (anti *M. racemosus* EPS), conjugated to horse radish

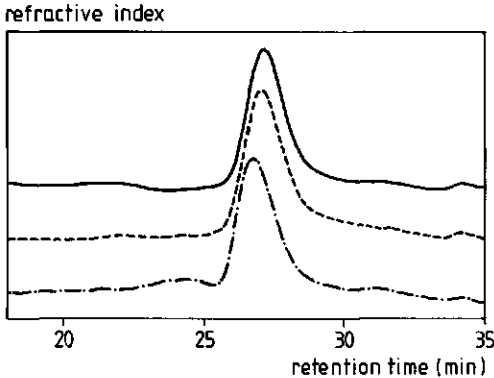

**Fig. 1.** High-performance size-exclusion chromatograms of EPS from *Mucor* species with refractive index (RI) detection. *M. racemosus*, —; *M. circinelloides*, ---; *M. hiemalis*, -•-•-.

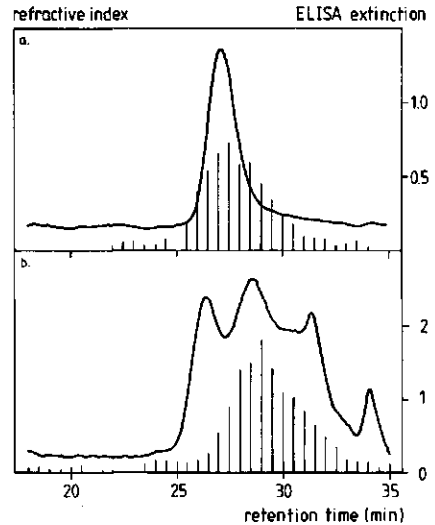

**Fig. 2.** High-performance size-exclusion chromatograms with ELISA detection of EPS of *M. racemosus* grown with glucose (a) and *M. hiemalis* with maltose as carbon source (b). RI-detection, —; ELISA detection, bars.

peroxidase, for 90 min. Finally, the rinsed wells were incubated at room temperature for 30 min with 100  $\mu$ l of a substrate solution. The substrate solution was 3,3',5,5' tetramethyl benzidine in DMSO containing  $H_2O_2$  prepared according to Bos *et al.* (5). A stock solution of 42 mM 3,3',5,5' tetra methyl benzidine in DMSO was prepared and 1 ml of the solution was added dropwise under gentle shaking to 100 ml of 0.1 M sodium acetate-citric acid buffer, pH 6.0. Just before use, 7  $\mu$ l of 30%  $H_2O_2$  was added to the 100 ml buffer solution. The enzyme reaction was stopped by adding 50  $\mu$ l of 2 M  $H_2SO_4$  to each well. The absorbance of the yellow colour was measured at 450 nm.

#### *Preparative anion-exchange chromatography*

Anion-exchange chromatography was performed (21) on a column (12 x 1.6 cm) of DEAE-Sepharose CL-6B (Pharmacia, Uppsala, Sweden), equilibrated with 0.05 M sodium acetate buffer (pH 5.0). After loading of the sample of EPS (4 ml of a 2.5 mg/ml solution), the column was washed with 25 ml of buffer and then eluted at 30 ml/h with a linear gradient (100 ml) of 0.05-1 M sodium acetate buffer, followed by 50 ml of 1 M buffer. Fractions (3 ml) were assayed for glucuronic acid and neutral sugars.

**Table 1.** Sugar composition of EPS preparations of various mould species belonging to Mucorales, grown on culture media with D-glucose as carbon source determined after sulphuric acid hydrolysis<sup>a</sup>.

Mould species	Sugar composition (mol%) <sup>b</sup>				
	Fuc	Man	Gal	Glc	GlcA
<i>Mucor hiemalis</i>	18	17	13	4	48
<i>Mucor hiemalis</i> <sup>c</sup>	7	9	4	60	20
<i>Mucor racemosus</i>	13	23	9	8	47
<i>Mucor circinelloides</i>	13	27	8	11	41
<i>Rhizopus oryzae</i>	15	13	4	13	55
<i>Rhizopus stolonifer</i>	13	9	11	23	44
<i>Rhizomucor miehei</i>	25	15	7	-	53
<i>Rhizomucor pusillus</i>	19	21	8	3	49
<i>Absidia corymbifera</i>	11	11	7	39	32
<i>Syncephalastrum racemosum</i>	22	30	6	-	42
<i>Thamnidium elegans</i>	9	8	6	27	50

<sup>a</sup> In this chapter sulphuric acid hydrolysis is used. However, as shown in Chapter 4, methanolysis followed by TFA hydrolysis provides more accurate data on the sugar composition (cf. Table 5, p. 58).

<sup>b</sup> Values are the average of duplicate experiments; the sugar content of the EPS preparations varied between 40 to 60% (w/w).

<sup>c</sup> Grown on a culture medium with maltose as carbon source.

### Analytical methods

The contents of glucuronic acid of the fractions were determined with the automated *m*-hydroxydiphenyl (*m*-hdp) method (22) slightly modified by the addition of 0.0125 M sodium tetraborate to the sulphuric acid, using glucuronic acid as standard. Neutral sugars in the eluted fractions were determined with the automated orcinol method (23), using D-glucose as the standard. Corrections in the latter analysis were made for interference from glucuronic acid.

## Results

### Determination of the molecular weight distribution of Mucor-EPSs

The molecular weight distribution of the EPSs excreted by *M. hiemalis*, *M. racemosus* and *M. circinelloides* were found to be similar as revealed in Fig. 1. The EPSs derived from these species had an unimodal molecular weight distribution, and a retention time between

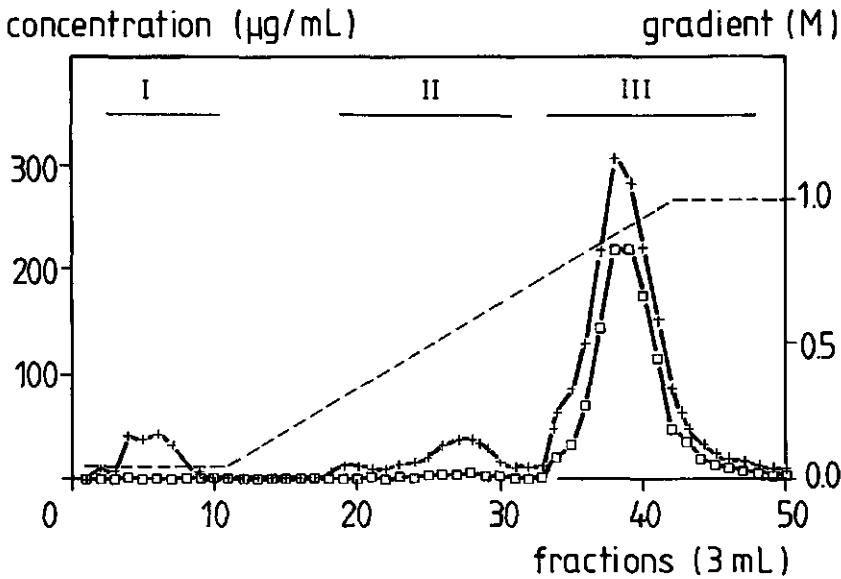

**Fig. 3.** Chromatography of crude EPS from *M. hiemalis* on DEAE-Sepharose CL-6B with sodium acetate buffer (pH 5.0) gradient (see Experimental). Glucuronic acid,  $-\square-\square-$ ; neutral sugars,  $-+-+-$ ; gradient,  $-----$ .

27 and 29 min on this size-exclusion chromatography system using refractive index (RI) detection. Calibration of the system with dextrans indicated that this peak corresponded to an apparent molecular mass ranging from 10 to 30 kDa. The peak widths of these EPSs were found to be similar to that of the dextrans used for calibration of the system.

The EPS of *M. racemosus* was used to raise polyclonal antibodies in rabbits. A sandwich ELISA using the IgG fraction of these antibodies was used to characterize the EPS immunochemically after chromatographic separation. To this end, the chromatography system was connected to a fraction collector and fractions of 0.4 ml were collected. After neutralization and dilution the sandwich ELISA was performed on these fractions. The ELISA extinctions of the fractions are shown in Fig. 2a, in which figure they can be compared with the results of RI-detection. Very similar graphs (not shown) were obtained using the EPS of *M. hiemalis* and *M. circinelloides* (cf. Fig. 1). The sugar composition of EPS of *M. racemosus* resembled that of both other *Mucor* species as shown in Table 1.

If D-glucose in the growth and EPS-production medium was replaced by maltose, a more complex EPS was excreted by the mould as indicated by the differences in sugar composition (Table 1) and by the size-exclusion chromatogram as given in Fig. 2b.

The composition of the EPSs excreted by D-glucose-grown *M. racemosus* was studied further by using preparative anion-exchange chromatography. Fig. 3 shows the elution



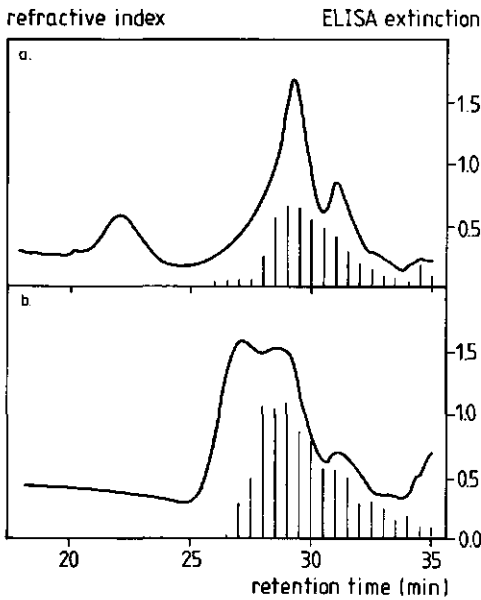

**Fig. 4.** High-performance size-exclusion chromatograms with ELISA-detection of EPS of *R. oryzae* (a) and *R. stolonifer* (b). RI-detection, —; ELISA detection, bars.

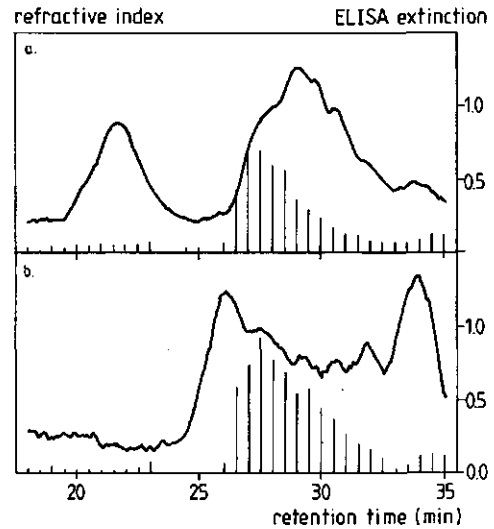

**Fig. 5.** High-performance size-exclusion chromatograms with ELISA-detection of EPS of *Rhizomucor pusillus* (a) and *Rhm. miehei* (b). RI-detection, —; ELISA detection, bars.

pattern using a DEAE anion-exchange column with a linear gradient of a sodium acetate buffer (pH 5.0). Analysis of the collected fractions with the orcinol assay and the *m*-hdp assay revealed one major fraction (III) and two minor fractions (I and II). The ELISA reactivity with these polyclonal rabbit-IgG antibodies was found in fractions I and II and not in fraction III.

#### *EPSs of Rhizopus and Rhizomucor species*

The EPS preparations of different D-glucose-grown *Rhizopus* and *Rhizomucor* species were found to be much more heterogeneous than the EPS excreted by the *Mucor* species, as revealed by sugar analysis (Table 1) and size-exclusion chromatography (Figs. 4 and 5). In each of these EPS preparations a broad peak with a retention time of 27–29 min, containing antigens reactive with the antibodies raised against *M. racemosus* EPS, could be detected.

Anion-exchange chromatography was performed on EPS of *R. oryzae* which resulted in a similar elution pattern as for *M. hiemalis* (not shown). The ELISA positive part of the EPS of *R. oryzae* was found to be present in fraction I, which did not bind to the anion-exchange column.

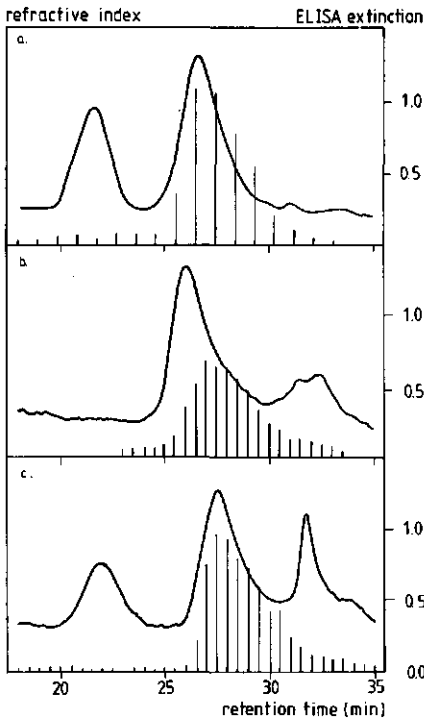

**Fig. 6.** High-performance size-exclusion chromatograms with ELISA-detection of EPS derived from *Absidia corymbifera* (a), *Syncephalastrum racemosum* (b) and *Thamnidium elegans* (c). RI-detection, —; ELISA detection, bars.

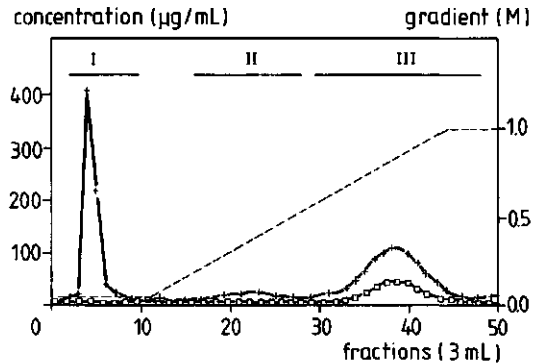

**Fig. 7.** Separation of the crude EPS from *Absidia corymbifera* with DEAE anion-exchange chromatography with sodium acetate buffer (pH 5.0) gradient. GlcA, -□-□-; neutral sugars, +-+-; Gradient, ---.

### Determination of the EPS of other species belonging to the Mucorales

The multimodal molecular weight distribution chromatograms of D-glucose-grown *Absidia corymbifera*, *Syncephalastrum racemosum* and *Thamnidium elegans* EPS preparations are shown in Fig. 6. Fig. 6a reveals a bimodal molecular weight distribution. The high molecular mass peak (500 to  $2 \times 10^3$  kDa) did not react with the antibodies raised against *M. racemosus* EPS.

The second peak, reactive in the ELISA, had a retention time of 27 - 29 min, similar to the antigenic peak of the other Mucorales. Separation of the EPS derived from *Absidia corymbifera* by anion-exchange chromatography as shown in Fig. 7 revealed three peaks (I-III) as indicated in the figure.

The EPS derived from *Syncephalastrum racemosum* (Fig. 6b) was found to be composed of a broad range of fractions with different hydrodynamic volumes. The epitope-containing part could be detected with the size-exclusion chromatography system with ELISA detection as revealed in the figure. Its molecular weight distribution was similar to that of the ELISA positive fraction of *Absidia corymbifera*. The molecular weight distribution of *Thamnidium elegans* EPS (Fig. 6c) was again different from that of *Absidia corymbifera* and that of *Syncephalastrum racemosum*. However, also in this case a similar fraction was determined to be antigenic. The sugar composition of the EPS preparations from these three species differed markedly as shown in Table 1.

## Discussion

High-performance size-exclusion chromatography and anion-exchange chromatography were combined with ELISA-detection to study the EPS excreted by species of Mucorales. Each of the EPS preparations of the mould species belonging to this order tested contained a 27–29 min size-exclusion chromatography fraction, reactive with the antibodies raised against EPS of *M. racemosus*. In the EPS preparations derived from *Mucor* species, only small portions of neutral polysaccharides were found, if species were grown on D-glucose as carbon source. In addition to the 27–29 min reactive material, EPS preparations derived from species belonging to the genera *Rhizopus*, *Rhizomucor*, *Absidia*, *Syncephalastrum* and *Thamnidium* also produce polysaccharides with a high molecular mass which are not reactive with the antibodies. In these EPS preparations the shape of the peak of the antigenic material differs slightly.

Notwithstanding the fact that the low pH of the eluent in the system minimised the number of ionized glucuronic acid residues, it cannot be excluded that the molecular weight distribution has to be corrected for possible differences in hydrodynamic volume due to charge effects, as reported for galacturonic acid containing polymers (6). Determination of the exact molecular masses of this fraction requires additional methods, such as laser light scattering or ultracentrifugation. Furthermore, the unimodal molecular weight distribution of the antigenic fraction of EPS preparations tested does not necessarily corresponds to a monodispersed hydrodynamic volume distribution. However, it can be concluded that the fraction contains polysaccharide antigens which appear common to all representatives of Mucorales tested. Therefore the use of the sandwich ELISA previously proposed for the determination of *Mucor* and *Rhizopus* (19), can be extended to more genera of Mucorales.

The sugar composition of D-glucose-grown *Mucor* species (Table 1) indicates that the antigenic fraction may be similar or identical to mucoran, the cell-wall associated polysaccharide of members of Mucorales as described by Bartnicki-Garcia's group (3,4). Chemical and biochemical properties of cell wall polysaccharides of fungi have been

proposed as important features in fungal taxonomy (2). As shown in this paper, EPSs may also be useful for this purpose. The use of high-performance size-exclusion chromatography with ELISA-detection is an elegant method to study these polysaccharides.

The method was found to be very sensitive and reproducible. Sandwich ELISA detection was 10 times more sensitive than refractive index detection. A disadvantage of the system is the necessity to apply the ELISA batchwise on collected fractions instead of measuring continuously.

No detailed information is available about the composition of the epitopes of the EPS of Mucorales (16). As demonstrated for *Penicillium* and *Aspergillus* species by Notermans and associates (20), the reliable ELISA detection of fungi in food or medical samples requires synthetic epitopes to eliminate false-positive ELISA reactions. Therefore it will be desirable to reveal the structure of the epitopes to develop specific diagnostic assays enabling rapid and reliable detection and identification of the medically and agriculturally important mould species of the Mucorales.

Preliminary hapten-inhibition studies have been recently performed (7), indicating an important role for mannose residues. Further research is in progress to reveal the structure of the EPS preparations of species of Mucorales in general and the immunodominant structures in the 27-29 min fraction in particular.

## References

1. Barth H.G. 1980. High-performance gel permeation chromatography of pectins. *J. Liq. Chromatogr.* 3:1481-1496.
2. Bartnicki-Garcia S. 1968. Cell wall chemistry, morphogenesis, and taxonomy of fungi. *Ann. Rev. Microbiol.* 22:87-108.
3. Bartnicki-Garcia S., and B. Lindberg. 1972. Partial characterization of mucoran: the glucuronomannan component. *Carbohydr. Res.* 23:75-85.
4. Bartnicki-Garcia S., and E. Reyes. 1968. Polyuronides in the cell wall of *Mucor rouxii*. *Biochim. Biophys. Acta.* 170:54-62.
5. Bos E.S., A.A. van der Doelen, N. van Rooy, and A.H.W.M. Schuurs. 1981. 3,3',5,5'-tetramethylbenzidine as an Ames test negative chromogen for horse-radish peroxidase in enzyme-immunoassay. *J. Immunoassay* 2:187-204.
6. Deckers H.A., C. Olieman, F.M. Rombouts, and W. Pilnik. 1986. Calibration and application of high-performance columns for molecular weight distribution of pectins. *Carbohydr. Polym.* 6:361-378.
7. De Ruiter G.A., P. Smid, A.W. van der Lugt, J.H. van Boom, S.H.W. Notermans, and F.M. Rombouts. 1991. Immunogenic extracellular polysaccharides of Mucorales, p. 169-180. In J.-P. Latgé and D. Boucias (Ed). *Fungal cell wall and immune response*. NATO ASI Ser. H 53. Springer Verlag, Berlin.
8. Englyst H.N., and J.H. Cummings. 1984. Simplified method for the measurement of total non-starch polysaccharides by gas-liquid chromatography of constituent sugars as alditol acetates. *Analyst* 109:937-942.

9. Fishman M.L., P.E. Pfeffer, R.A. Barford, and L. W. Doner. 1984. Studies of pectin solution properties by high-performance size-exclusion chromatography. *J. Agric. Food Chem.* 32:372-378.
10. Hough L., and M.B. Perry. 1955. An extracellular polysaccharide from *Mucor racemosus*. *Biochem. J.* 61: viii-ix.
11. Lecacheux D., Y. Mustiere, R. Panaras, and G. Brigand. 1986. Molecular weight of scleroglucan and other microbial polysaccharides by size-exclusion chromatography and low angle laser light scattering. *Carbohydr. Polym.* 6:477-492.
12. MacDonald M.M., R.H. Dunstan, and F.M. Dewey. 1989. Detection of low-M<sub>r</sub> glycoproteins in surface washes of some fungal cultures by gel-filtration HPLC and by monoclonal antibodies. *J. Gen. Microbiol.* 135:375-383.
13. Martin S.M., and G.A. Adams. 1956. A survey of fungal polysaccharides. *Can. J. Microbiol.* 34:715-721.
14. Miyazaki T., O. Hayashi, Y. Ohshima, and T. Yadomae. 1979. Studies on fungal polysaccharides: The immunological determinant of the serologically active substances from *Absidia cylindrospora*, *Mucor hiemalis* and *Rhizopus nigricans*. *J. Gen. Microbiol.* 111:417-422.
15. Miyazaki T., and T. Irino. 1972. Studies on fungal polysaccharides. X. Extracellular heteroglycans of *Absidia cylindrospora* and *Mucor mucedo*. *Chem. Pharm. Bull.* 20:330-335.
16. Miyazaki T., T. Yadomae, H. Yamada, O. Hayashi, I. Suzuki, and Y. Ohshima. 1980. Immunochemical Examination of the polysaccharides of Mucorales, p. 81-94. In P.A. Sandford and K. Matsuda (Eds.), *Fungal Polysaccharides*. ACS Symposium Series 126, American Chemical Society, Washington, D.C.
17. Notermans S., and C.J. Heuvelman. 1985. Immunological detection of moulds in food by using the enzyme-linked immunosorbent assay (ELISA); preparation of antigens. *Int. J. Food Microbiol.* 2:247-258.
18. Notermans S., C.J. Heuvelman, R.R. Beumer, and R. Maas. 1986. Immunological detection of moulds in food: relation between antigen production and growth. *Int. J. Food Microbiol.* 3:253-261.
19. Notermans S., and P.S.S. Soentoro. 1986. Immunological relationship of extracellular polysaccharide antigens produced by different mould species. *Antonie van Leeuwenhoek* 52:393-401.
20. Notermans S., G.H. Veeneman, C.W.E.M. van Zuylen, P. Hoogerhout, and J.H. van Boom. 1988. (1→5)-linked β-D-galactofuranosides are immunodominant in extracellular polysaccharides of *Penicillium* and *Aspergillus* species. *Mol. Immunol.* 25:975-979.
21. Rombouts F.M., and J.-F. Thibault. 1986. Feruloylated pectic substances from sugar-beet pulp. *Carbohydr. Res.* 154:177-187.
22. Thibault J.-F. 1979. Automatisation du Dosage des Substances Pectiques par la Méthode au Méta-hydroxy-diphényl. *Lebensm. Wiss. Technol.* 12:247-251.
23. Tollier M.T., and J.-P. Robin. 1979. Adaptation de la méthode à l'orcinol-sulfurique au dosage automatique des glucides neutres totaux: conditions d'application aux extraits d'origine végétale. *Ann. Technol. Agric.* 28:1-15.



## **Carbohydrate analysis of water-soluble uronic acid containing polysaccharides with HPAEC using methanolysis combined with TFA hydrolysis is superior to four other methods**

*Analytical Biochemistry*<sup>1</sup> (1992) 207:176-185.

Sulphuric acid hydrolysis according to the Saeman procedure, TFA hydrolysis and methanolysis combined with TFA hydrolysis were compared for the hydrolysis of water-soluble uronic acid containing polysaccharides originating from fungi, plants and animals. The constituent sugar residues released were subsequently analysed by either conventional GLC analysis of alditol acetates or by high-performance anion-exchange chromatography (HPAEC) with pulsed-amperometric detection. It was shown that TFA hydrolysis solely is not sufficient for the complete hydrolysis. Sulphuric acid hydrolysis of these polysaccharides resulted in low recoveries of 6-deoxy-sugar residues. Best results were obtained by methanolysis combined with TFA hydrolysis. Methanolysis with 2 M HCl prior to TFA hydrolysis resulted in complete liberation of monosaccharides from pectic material and from most fungal and animal polysaccharides tested. Any incomplete hydrolysis could be assessed easily by HPAEC, by the detection of characteristic oligomeric products, which is difficult using alternative methods currently in use. Methanolysis followed by TFA hydrolysis of 20  $\mu$ g water-soluble uronic acid containing polysaccharides and subsequent analysis of the liberated sugar residues by HPAEC allowed us to determine the carbohydrate composition of these polysaccharides rapidly and accurately in one assay without the need for derivatisation.

### **Introduction**

Uronic acid containing polysaccharides are widely distributed in nature and have been found in plants (1), animals (2), algae (3), bacteria (4) and fungi (5). Their exact carbohydrate content is often an important feature in the study of their functional or

---

<sup>1</sup>Authors: G.A. De Ruiter, H.A. Schols, A.G.J. Voragen, and F.M. Rombouts. © Academic Press Inc.

biological properties. Recently, we studied the (immuno)chemical properties of extracellular polysaccharides from moulds belonging to the order of Mucorales (6,7). Difficulties were observed in complete hydrolysis of these polysaccharides, due to the presence of  $\beta(1-4)$ -glucuronans which are found to be very resistant towards hydrolysis with sulphuric acid (8).

Methods available for carbohydrate analysis of complex polysaccharides are mainly based on determination of their constituent sugar residues obtained after chemical hydrolysis of the native polymers. These are composed of various sugar residues interlinked by many different glycosidic linkages, either  $\alpha$  or  $\beta$ , which can differ considerably in their susceptibility towards acid hydrolysis (9,10). Uronic acids are often involved in very acid-resistant glycosidic linkages, particularly in the aldobiuronic acid type of linkages.

Procedures commonly applied for quantification of the liberated monosaccharides have disadvantages, mainly originating from the necessity for derivatisation of the monosaccharides to alditol acetates (11,12) and trimethyl silyl ethers (12,13), or inadequate separation by HPLC of the monosaccharides (14,15). Also, the effectiveness of the hydrolysis method applied cannot be assessed after derivatisation, as oligomers resulting from incomplete hydrolysis often escape detection. A considerable improvement in the sensitivity of analysis of monosaccharides was obtained by the development of high-performance anion-exchange chromatography (HPAEC) using pellicular resins and pulsed-amperometric detection (PAD) (16-20). With this method carbohydrates can be analysed accurately without any derivatisation with a sensitivity of 0.1 nmol per injected amount.

Quantification of uronic acids is often obtained by the colorimetric assay described first in 1947 by Dische (21), modified considerably by Blumenkrantz and Asboe-Hansen (22) who introduced the use of *m*-hydroxy diphenyl and sodium tetraborate and automated by Thibault (23).

Several procedures, differing in the nature and the concentration of the acid and in time and temperature used, are available for hydrolysis of polysaccharides (10,24). The most commonly used hydrolytic agents are sulphuric acid (25,26), trifluoroacetic acid (TFA; 11), hydrochloric acid (13,14) or sulphuric acid in absolute methanol (27), hydrofluoric acid (28) and various chemicals used in reductive cleavage (29). The major disadvantage of  $H_2SO_4$  is its inability to hydrolyse the  $\beta(1-4)$ -linkages in polyglucuronic acid completely and the difficulty of removing the acid after hydrolysis (8,10). Hydrolysis with TFA (2 M, 1 h, 121 °C), which can be readily removed by evaporation after hydrolysis, is reported to be insufficient for hydrolysis of  $\beta(1-4)$ -linked cellulose polymers (30), mucins (31), capsular polysaccharides from *Haemophilus influenzae* (28) and glycosaminoglycans (32). Methanolysis is reported to be more convenient for this purpose, but each sugar residue resulted in as many as four peaks of their methylglycosides together with a small amount of the free sugar residue. The reaction products can be analysed by GLC after derivatisation to the corresponding silyl



derivatives (13,33), or directly by HPLC with pulsed-amperometric detection (34). This often results in complex chromatograms with overlapping peaks which makes quantification difficult (12). The reductive-cleavage technique is also of limited value for accurate analysis of uronic acid containing polysaccharides, as often severe ring contraction is observed during reductive cleavage of uronic acids (35,36).

Therefore, the hydrolysis of the glycosidic linkages of uronic acid residues in polysaccharides can be considered as the major limitation of accurate sugar analysis of these polysaccharides. Next to the hydrolysis conditions, accurate carbohydrate analysis should preferably be possible on micro-gram quantities of polysaccharides without the need for derivatisation.

In this study, a survey of methods available for the accurate carbohydrate analysis of water-soluble uronic acid containing polysaccharides, originating from fungi, plants and animals, is carried out. Commonly used methods for the hydrolysis of uronic acid containing polysaccharides are compared with the use of methanolysis followed by TFA hydrolysis. Furthermore, the advantages of HPAEC-PAD technology for sensitive analysis of the released products over alternatives currently in use are presented.

## Materials and methods

### *Uronic acid containing water-soluble polysaccharides*

Glucuronic acid (GlcA) containing fungal extracellular polysaccharides (EPSs) of the strains of *Mucor racemosus* CBS 222.81, *M. hiemalis* CBS 201.28, *M. circinelloides* RIVM M 40, *Rhizopus stolonifer* CBS 609.82, *R. oryzae* LU 581, *Rhizomucor miehei* CBS 371.71, *Rhm. pusillus* CBS 432.78, *Absidia corymbifera* LU 017, *Syncephalastrum racemosum* CBS 443.59 and *Thamnidium elegans* CBS 342.55, *Mortierella isabellina* CBS 560.63, *Fusarium oxysporum* CBS 254.52, *F. verticillioides* CBS 167.87 and *F. solani* CBS 165.87 used in this study were isolated and purified as described (6).

Galacturonic acid (GalA) containing pectic materials used in this study were citrus pectin (37) and modified hairy regions (MHR) isolated from apple pectin (38).

Iduronic acid (IdoA) and GlcA containing glycosaminoglycans isolated from animal connective tissues were kindly provided by Dr. G. van Dedem (Diosynth bv, Oss, The Netherlands) and were isolated by various methods as described (39). Dermatan sulphate was isolated from pig mucosal tissues, chondroitin 6-sulphate (Ch-6S) and chondroitin 4-sulphate (Ch-4S) were isolated from the cranial cartilage of the river sturgeon *S. platorhynchus*, heparan sulphate was obtained from beef lung, heparin was isolated from pig mucosal and hyaluronic acid (HA) was isolated out of cockscombs.

**Table 1.** Comparison of five different methods for carbohydrate analysis of uronic acid containing polysaccharides originating from fungi, plants and animals.

Method	Acid	Hydrolysis conditions			Derivatisation	Method of analysis	
		Molarity (M)	Temperature (°C)	Time (h)		neutral sugars	uronic acids
1	H <sub>2</sub> SO <sub>4</sub>	12	30	1			
		1	100	3	yes	GLC	<i>m</i> -HDP <sup>a</sup>
2	TFA	2	121	1	yes	GLC	<i>m</i> -HDP
3	HCl in methanol	2	80	16			
		2	121	1	yes	GLC	<i>m</i> -HDP
4	TFA	2	121	1	no	HPAEC <sup>b</sup>	HPAEC
5	HCl in methanol	2	80	16			
		2	121	1	no	HPAEC	HPAEC

<sup>a</sup> Colorimetric method using *m*-hydroxy diphenyl reagent (22,23).

<sup>b</sup> High-performance anion-exchange chromatography combined with pulsed-amperometric detection (PAD).

### Hydrolysis procedures

As summarised in Table 1, H<sub>2</sub>SO<sub>4</sub>-hydrolysis (method 1), TFA hydrolysis (methods 2 and 4) and methanolysis combined with TFA hydrolysis (methods 3 and 5) were compared. Analysis was carried out by either derivatisation of the neutral sugars to alditol acetates and subsequent GLC separation and colorimetric determination of the uronic acid content (methods 1 to 3) or by high-performance anion-exchange chromatography (HPAEC) with pulsed-amperometric detection (methods 4 and 5).

With the first hydrolysis procedure according to Saeman *et al.* (25; method 1) the sugars were released by treatment of 2 mg sample, to which 250 µg *myo*-inositol was added as internal standard, with 225 µl 12 M H<sub>2</sub>SO<sub>4</sub> (72 % w/w) for 1 h at 30 °C. Then, distilled water was added giving 1 M H<sub>2</sub>SO<sub>4</sub> and the mixture was further hydrolysed for 3 h at 100 °C. Hydrolysis with trifluoroacetic acid (TFA) (methods 2 and 4) according to Albersheim and coworkers (11) was performed on 2 mg of polysaccharide with 250 µg *myo*-inositol as internal standard in method 2 and on 20 µg in method 4. A solution of 2 M TFA (0.5 ml) was added and heated in a closed screw-cap test tube for 1 h at 121 °C. The third hydrolysis procedure was a combination of methanolysis according to Chambers and Clamp (13) and the TFA hydrolysis (methods 3 and 5). In method 3, 2 mg of polysaccharide with 250 µg *myo*-inositol added as internal standard was heated for 16 h at 80 °C with 0.5 ml of anhydrous 2 M HCl in absolute methanol in a closed screw-cap test tube. The anhydrous HCl in methanol was prepared by flushing HCl-gas through dry

CH<sub>3</sub>OH. After cooling, the liquid was evaporated by a stream of air at 25 °C and the remaining carbohydrates were hydrolysed further with 2 M TFA as described above.

Polysaccharides to be analysed with HPAEC-PAD using methanolysis combined with TFA hydrolysis (method 5) were first dissolved in distilled water (1 mg/ml). An aliquot of 20 µl of this solution was dried in a screw-cap test tube by a stream of air (25 °C) followed by the methanolysis with 0.5 ml anhydrous 2 M HCl in absolute methanol and TFA hydrolysis as described above. In separate tubes, aliquots of 100 µl of two standard mixtures of known amounts of sugars (approx. 100 nmol/ml for neutral sugars and hexosamines and 200 nmol/ml for uronic acids) were treated identically each time and were used for quantification. The first standard mixture contained L-fucose (Fluka AG, Buchs, Switzerland), L-rhamnose (Merck, Darmstadt, Germany), L-arabinose (Merck), D-glucosamine hydrochloride (Merck), D-glucose (Merck), D-xylose (Merck), D-galacturonic acid (Merck) and D-glucuronic acid (Sigma, St. Louis, MO U.S.A.). The second one contained L-fucose, L-rhamnose, D-galactosamine hydrochloride (Merck), D-galactose (Merck), D-mannose (Merck), D-galacturonic acid and D-glucuronic acid.

#### *Derivatisation to alditol acetates*

After hydrolysis the liberated monosaccharides were converted to alditol acetates in methods 1, 2 and 3, according to the procedure of Englyst and Cummings (26). After reduction, acetylation and purification the samples were dried in a screw-cap tube by a stream of air. Finally, 200 µl acetone was added and the solution was transferred to a GLC vial and sealed. Gas-liquid chromatography was performed on a Carlo Erba 2300 system (Milan, Italy), equipped with a Carlo Erba AS 570 autosampler. Separation of the different alditol acetates was performed on a column (3m × 2mm, i.d.) of 3% OV-275 on Chromosorb W HP 80/100 mesh (Chrompack, Middelburg, The Netherlands). Routinely, 1.5 µl samples were injected into the system and separated isothermally at 210 °C. A standard mixture (125 µl) of known amounts of sugars (approx. 2 mg/ml) were treated identically. The uronic acid content of the samples was determined by the colorimetric *m*-hydroxy diphenyl procedure as described below.

#### *Colorimetric uronic acid determination*

Determination of the uronic acids in the hydrolysed samples as prepared with methods 1, 2 and 3, was performed by the automated *m*-hydroxy diphenyl method (23), slightly modified by the addition of 0.0125 M sodium tetraborate to the sulphuric acid (22). Determination of the uronic acid content of citrus pectin and MHR was preceded by deesterification of the galacturonic acid residues by alkali treatment (1 h, pH 12) at room temperature. Glucuronic acid or galacturonic acid was used as the standard, depending on the samples analysed.

**Table 2.** Relative response factors of various monosaccharides towards pulsed-amperometric detection before and after hydrolysis

Sugar residue	Retention time <sup>a</sup> (min)	Relative response factor <sup>b</sup>	Relative response factors after hydrolysis <sup>c</sup>		
			Untreated	TFA	methanolysis/TFA
L-Fucose (Fuc)	4.2 ± 0.1	83 ± 3	100	88 ± 4	93 ± 3
L-Rhamnose (Rha)	7.5 ± 0.1	62 ± 1	100	93 ± 3	83 ± 8
D-Arabinose (Ara)	9.0 ± 0.3	86 ± 2	100	93 ± 2	83 ± 9
D-Galactosamine (GalN) <sup>d</sup>	9.1 ± 0.1	105 ± 1	100	84 ± 5	83 ± 6
D-Glucosamine (GlcN) <sup>d</sup>	11.2 ± 0.2	113 ± 4	100	96 ± 4	91 ± 7
D-Galactose (Gal)	12.4 ± 0.3	100 ± 4	100	90 ± 3	86 ± 8
D-Glucose (Glc)	13.8 ± 0.2	96 ± 3	100	94 ± 6	94 ± 4
D-Mannose (Man)	15.2 ± 0.3	86 ± 3	100	81 ± 5	89 ± 2
D-Xylose (Xyl)	16.0 ± 0.1	81 ± 1	100	100 ± 2	91 ± 9
D-Galacturonic acid (GalA)	59.9 ± 0.4	52 ± 3	100	77 ± 7	71 ± 3
D-Glucuronic acid (GlcA)	62.0 ± 0.3	69 ± 3	100	71 ± 8	63 ± 4

<sup>a</sup> Average of six injections ± SD, retention times may shift with slight variations in the concentration of NaOH or sodium acetate in different batches of eluents.

<sup>b</sup> Expressed in molar percentages relative to galactose 1.922 nmol (100), average of 5 experiments ± SD.

<sup>c</sup> Expressed in molar percentages relative to the response factor (100) when the hydrolysis steps are omitted. Average of five experiments ± SD.

<sup>d</sup> Galactosamine, 2-amino-2-deoxy-D-galactose; Glucosamine, 2-amino-2-deoxy-D-glucose.

#### *Analysis by high-performance anion-exchange chromatography (HPAEC)*

After hydrolysis according to methods 4 and 5, analysis of the liberated products was performed using HPAEC with pulsed-amperometric detection (PAD). To this end, the samples were dried and 100 µl distilled water was added to the tubes, mixed vigorously, and finally transferred to an HPLC sample vial.

Chromatography of the samples was performed using a Dionex Bio-LC system (Sunnyvale, CA U.S.A.) coupled to an SP 8880 autosampler (Spectra-Physics, San Jose, CA U.S.A.). The HPLC system was equipped with a CarboPac PA 1 column (4 × 250 mm) in combination with a CarboPac guard column and run at 20 °C. Separation was performed with a flow rate of 1 ml/min using a combined gradient of three eluents prepared from distilled water filtered in a Nanopure II system (Sybron/Barnstead, Boston, MA U.S.A.). Eluent A: 0.1 M NaOH prepared from a 50 % solution of NaOH (Baker, 7067) to minimise the carbonate content in the final eluent. Eluent B: 1 M sodium acetate (Merck, Darmstadt, Germany) in 0.1 M NaOH prepared accordingly. Eluent C: distilled water. The eluents were degassed by flushing helium and pressurized continuously with

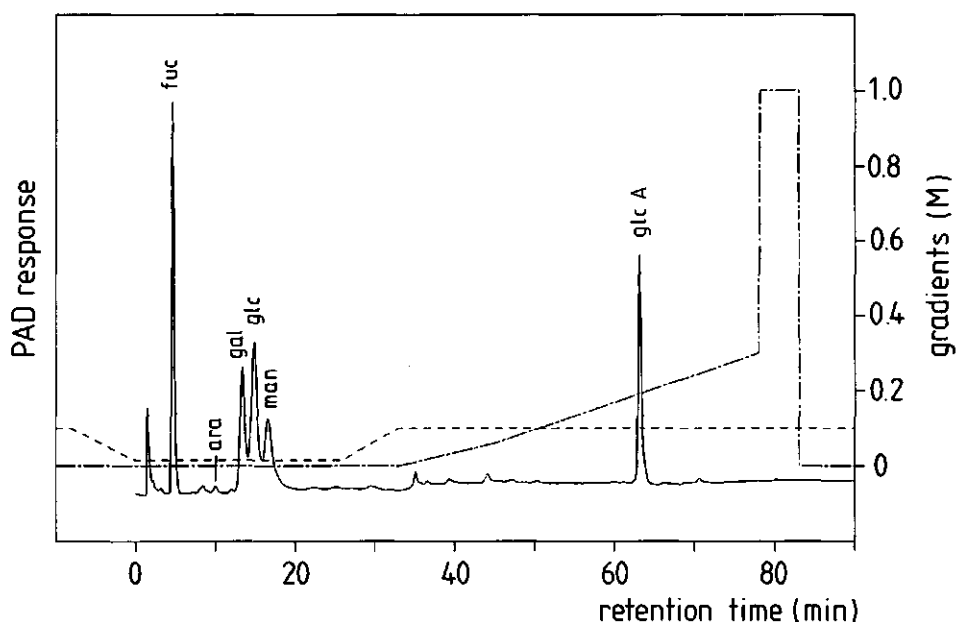

**Fig. 1.** HPAEC-PAD of an EPS preparation of *Rhizopus stolonifer* after methanolysis and TFA hydrolysis using gradients of NaOH (-----) and sodium acetate (-•-•-) for separation of the constituent sugar residues.

the eluent degas module of Dionex. Both gradients of NaOH and NaAc were used simultaneously to elute the monosaccharides by mixing the three eluents. This resulted in the following gradient of NaOH: 0–26 min, 15 mM; 26–33 min, 15–100 mM; 33–91 min, 100 mM; 91–99 min, 100–15 mM. The simultaneous gradient of NaAc was: 0–33 min, 0 mM; 33–45 min, 0–60 mM; 45–78 min, 60–300 mM; 78–81 min, 300–1000 mM; 81–86 min, 1000 mM; 86–99 min, 0 mM. Samples (20  $\mu$ l) were injected at 99 min starting a new gradient cycle using a Spectra Physics SP8880 autosampler. The effluent was monitored using a pulsed-electrochemical detector in the pulsed-amperometric mode (PAD) with a gold working electrode and an Ag/AgCl reference electrode (Dionex, Sunnyvale, CA U.S.A.) to which potentials of E1 0.1 V, E2 0.6 V and E3 -0.6 V were applied for duration times T1 0.50 s, T2 0.09 s and T3 0.06 s at a sensitivity of 3  $\mu$ C. Chromatograms were recorded and integrated using a Spectra Physics Winner system with the attenuation set at 128. Quantification of the samples was performed using the response factors calculated from the peak areas of the mixed standard solutions as described.

**Table 3.** Comparison of five different methods for carbohydrate analysis of water-soluble glucuronic acid containing fungal polysaccharides from *Mucor racemosus* and *Rhizopus stolonifer*<sup>a</sup>.

Polysaccharide derived from	Method <sup>b</sup>	Sugar composition (mol %)					Total sugar (w/w %)
		Fuc	Man	Gal	Glc	GlcA	
<i>M. racemosus</i>	1	14	20	7	2	57	33
	2	14	21	7	3	55	35
	3	18	18	6	7	51	37
	4	28	27	7	4	34	20
	5	21	20	7	7	45	37
<i>R. stolonifer</i>	1	16	11	13	24	36	43
	2	16	11	12	25	36	43
	3	19	11	12	23	35	44
	4	20	16	15	34	15	40
	5	15	10	11	26	38	55

<sup>a</sup> Average of duplicate experiments.<sup>b</sup> From Table 1.

## Results

### *Detector responses of carbohydrate residues after different hydrolysis procedures*

HPAEC analysis of the constituent sugar residues in acid digests of uronic acid containing polysaccharides requires knowledge about the detector responses and the stability of carbohydrate residues under conditions of the hydrolysis used. Analysis of standard mixtures of known amounts of monosaccharides with HPAEC and PAD, before and after hydrolysis, revealed linear responses for the sugar residues tested in the range from 0.1 - 10 nmol. Furthermore, their relative molar responses are listed in Table 2, expressed relative to D-galactose which was not treated with acid. Differences in responses were found between the various sugar residues. D-GalA, L-Rha and D-GlcA gave a lower response compared to the other sugars. After methanolysis combined with TFA hydrolysis, the neutral sugars and hexosamines could be recovered with yields between 83 and 94% relative to the response of the sugars not treated with acid. The uronic acids tested were found to be more sensitive towards these hydrolysis procedures as they could be recovered with 63 and 71 % yield.

To obtain maximum hydrolysis with a minimum of decomposition of the liberated monosaccharides 2 M methanolic HCl was used at 80 °C for 16 h (9,14) followed by hydrolysis of the carbohydrates by 2 M TFA (1 h, 121 °C). The latter procedure also

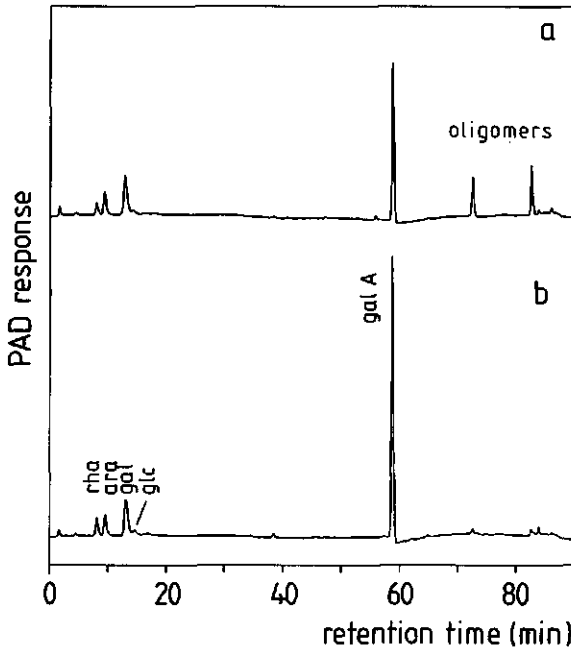

**Fig. 2.** HPAEC analysis with pulsed-amperometric detection of citrus pectin after TFA hydrolysis solely (a), and methanolysis combined with TFA hydrolysis (b). Identical gradients for NaOH and NaAc were used as in Fig. 1.

converts the methyl-glycosides obtained after methanolysis into the corresponding monosaccharide residues.

Quantification of the amount of sugar residues released by sulphuric acid hydrolysis according to the Saeman procedure was only possible after subsequent derivatisation and GLC analysis as described in method 1 (Table 1). HPAEC analysis of the sugars in the  $H_2SO_4$ -hydrolysate was not possible as the mineral acid could not be removed selectively. Neither the use of ion-exchange columns nor neutralization with  $Ba(OH)_2$ , resulting in precipitation of  $BaSO_4$ , was successful due to the presence of negatively charged uronic acids and their simultaneous removal, respectively (results not shown).

#### *Glucuronic acid containing fungal polysaccharides*

The water-soluble glucuronic acid containing extracellular polysaccharides derived from the moulds *Mucor racemosus* and *Rhizopus stolonifer* were examined for their carbohydrate composition using the five methods outlined in Table 1. As shown in Table 3, differences in the total amount of carbohydrates liberated were obtained, depending both on the hydrolysis procedure used as well as the method employed for determination

**Table 4.** Comparison of five different methods for carbohydrate analysis of water-soluble galacturonic acid containing citrus pectin and the modified hairy regions (MHR) of apple pectin<sup>a</sup>.

Pectic material	Method <sup>b</sup>	Sugar composition (mol %)						Total sugar (w/w %)
		Rha	Ara	Xyl	Gal	Glc	GalA	
Citrus pectin	1	1	3	0	6	0	90	70
	2	2	4	0	7	1	86	69
	3	3	4	0	8	1	84	70
	4	4	5	0	9	1	81	46
	5	4	3	0	6	1	86	85
MHR <sup>c</sup>	1	5	52	8	10	0	25	83
	2	10	49	8	10	1	22	83
	3	13	47	7	10	1	22	84
	4	12	46	9	13	2	18	79
	5	14	39	8	12	1	26	90

<sup>a</sup> Average of duplicate experiments.

<sup>b</sup> From Table 1.

<sup>c</sup> Modified hairy regions (MHR) from apple pectin (38).

of the glucuronic acid.

TFA hydrolysis solely was insufficient to hydrolyse these fungal polysaccharides completely as dimers could be determined using HPAEC analysis (results not shown). TFA hydrolysis with subsequent GLC analysis of neutral sugars and colorimetric determination of the uronic acids (method 2) resulted in a significantly higher amount of GlcA compared to TFA hydrolysis combined with HPAEC analysis (method 4). As a result of this, the relative molar amounts of the other carbohydrate residues present in these polysaccharides are too high in method 4 (Table 3).

TFA hydrolysis preceded by methanolysis (method 5) resulted in complete hydrolysis as can be derived from Fig. 1, in which only characteristic peaks for monosaccharides can be detected. Using this combination of methanolysis and TFA hydrolysis resulted in similar proportions of the sugar residues compared to the sulphuric acid hydrolysis (method 1). The amount of fucose in the EPS from *Mucor racemosus* using method 5 was slightly higher than with the use of H<sub>2</sub>SO<sub>4</sub>-hydrolysis in method 1. The total amounts of carbohydrates liberated with this combined method 5 were significantly higher than the total amounts determined by the commonly used sulphuric acid hydrolysis procedure.

#### *Galacturonic acid containing water-soluble pectic material*

Galacturonic acid containing citrus pectin and the highly branched hairy regions of



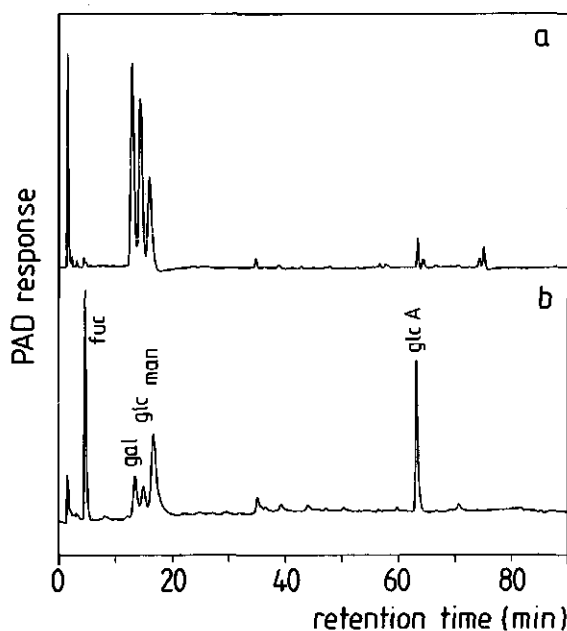

**Fig. 3.** HPAEC after methanolysis and TFA hydrolysis of water-soluble EPSs of *Fusarium oxysporum* (a) and *Mucor racemosus* (b). Identical gradients for NaOH and NaAc were used as in Fig. 1.

apple pectin (MHR) were examined using the five different methods for carbohydrate analysis (Table 4). As with the glucuronic acid containing fungal polysaccharides, TFA hydrolysis alone was insufficient to cleave all the glycosidic linkages. This is illustrated in Fig. 2, in which both TFA hydrolysis and TFA hydrolysis preceded by methanolysis were compared using HPAEC analysis. The latter procedure showed peaks corresponding to only monosaccharides, whereas hydrolysis with TFA only, also resulted in oligomers in the hydrolysate. The amount of rhamnose determined after the  $H_2SO_4$ -hydrolysis (method 1) was significantly lower than that analysed with methods 4 and 5 for both samples of pectic material. The results of the colorimetric *m*-hydroxy diphenyl assay in methods 1 to 3 were influenced by the amount of methyl esters of the GalA residues. The samples were saponified with alkali prior to this assay, this resulted in significantly higher values (up to 15 %) for the GalA content compared to analysis in which prior saponification was omitted (results not shown).

#### *Extracellular polysaccharides derived from various moulds*

Extracellular polysaccharides (EPSs) derived from eight different species of various genera belonging to the order of Mucorales were analysed together with a polysaccharide

**Table 5.** Sugar composition of different extracellular fungal polysaccharides using methanolysis followed by TFA hydrolysis and high-performance anion-exchange chromatography analysis<sup>a</sup>.

Polysaccharides derived from	Sugar composition (mol %) <sup>b</sup>							Total sugar (w/w %)
	Rha	Fuc	Ara	Man	Gal	Glc	GlcA	
<i>Mucor hiemalis</i>	-	28	0	18	15	2	37	50
<i>Mucor circinelloides</i>	-	22	2	30	8	4	34	66
<i>Rhizopus oryzae</i>	-	22	0	17	4	15	42	52
<i>Rhizomucor miehei</i>	-	42	1	22	12	2	21	39
<i>Rhizomucor pusillus</i>	-	36	1	31	13	5	14	28
<i>Absidia corymbifera</i>	-	13	1	10	8	52	16	44
<i>Syncephalastrum racemosum</i>	-	35	0	32	9	3	21	37
<i>Thamnidium elegans</i>	-	16	0	14	9	32	29	35
<i>Mortierella isabellina</i>	-	46	0	14	12	1	27	45
<i>Fusarium solani</i>	2	2	0	25	34	30	7	50
<i>Fusarium oxysporum</i>	0	1	0	23	34	36	6	63
<i>Fusarium verticillioides</i>	0	1	0	43	21	29	6	39

<sup>a</sup> Average of duplicate experiments.<sup>b</sup> -, not detected; 0, present but less than 0.5 %.

preparation from *Mortierella* and three from *Fusarium* species using methanolysis combined with TFA hydrolysis followed by analysis with HPAEC according to method 5. The data listed for the preparations derived from Mucorales species (Table 5) can be compared with the results obtained using H<sub>2</sub>SO<sub>4</sub>-hydrolysis (method 1) as described previously (6). Much more fucose residues could be liberated with the use of methanolysis/TFA compared to method 1. The amount of GlcA which could be determined after methanolysis and TFA hydrolysis (method 5) was lower than with sulphuric acid. However, the hydrolysis of the EPSs from Mucorales and *Mortierella* were considered to be complete as no dimers or trimers could be determined in their digests after HPAE chromatography. These oligomeric products resulting from incomplete hydrolysis are released from the anion-exchange column with characteristic retention times of higher than 65 min, using the gradients as described for method 5. Complete liberation of monosaccharides could not be obtained for EPSs from *Fusarium* using methanolysis combined with TFA hydrolysis as minor amounts of dimers were detectable as shown in Fig. 3. These dimers were also obtained after sulphuric acid hydrolysis and were identified as aldobiuronic acids according to the recently described method for HPAEC combined with mass-spectrometry (40; results not shown).

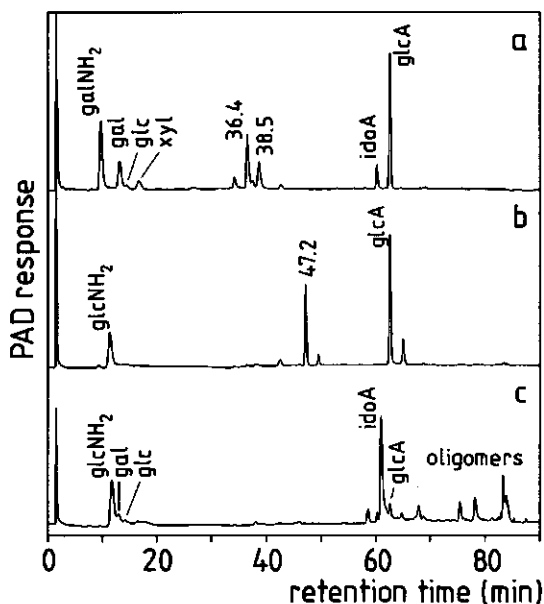

**Fig. 4.** HPAEC after methanolysis and subsequent TFA hydrolysis of the glycosamino-glycans isolated from animal connective tissues: chondroitin 4-sulphate (a), hyaluronic acid (b), and heparin (c). Identical gradients for NaOH and NaAc were used as in Fig. 1.

#### *Iduronic acid and glucuronic acid containing glycosaminoglycans*

Glycosaminoglycans from animal origin, both containing IdoA, GlcA and hexosamines which are partially acetylated and sulphated are known to be acid resistant (2,39). Six different glycosaminoglycans varying in type and amount of uronic acid were hydrolysed with TFA (method 4) and with methanolysis combined with TFA (method 5) and analysed subsequently by HPAEC. In all samples tested, the use of TFA solely was insufficient to hydrolyse these polysaccharides completely; only minor amount of liberated monouronic acids and hexosamines could be detected (results not shown). Complete hydrolysis could be obtained for chondroitin 6-sulphate, chondroitin 4-sulphate, dermatan sulphate and hyaluronic acid with methanolysis followed by TFA hydrolysis, giving characteristic peaks for the respective hexosamines, uronic acids and minor amounts of neutral sugars (Fig. 4). Galactose and xylose originate from the carbohydrate-protein linkage structure, common for all glycosaminoglycans (41). As illustrated in Fig. 4a and Fig. 4b, some

unknown peaks with retention times between 30 and 40 min (Ch-4S, Ch-6S) and 47.2 min (HA) could be observed in most of these samples, but no peaks of oligomers characteristic for incomplete hydrolysis, normally released from the column after 65 min, could be observed. The N- and O-sulphated glycosaminoglycans heparin (containing L-IdoA) and heparan sulphate (containing D-GlcA) could not be hydrolysed completely to monosaccharide residues with methanolysis and TFA hydrolysis. Oligomeric peaks probably containing uronic acids were determined with method 5, as illustrated for heparin in Fig. 4c. No attempts were made to quantify the glycosaminoglycans tested as no IdoA standard was available and the unknown peaks with retention times between 30 and 50 min were not further characterised.

## Discussion

In this study, five different methods of carbohydrate analysis, varying in both hydrolysis conditions and analysis methods of the liberated sugar residues, are compared for water-soluble uronic acid containing polysaccharides originating from fungi, plants and animals.

Pulsed-amperometric detection (PAD) gave lower responses towards uronic acids and rhamnose than to neutral sugars, as also previously reported (20). The use of TFA as hydrolytic agent resulted in some decomposition of sugar residues, especially for uronic acids, which is similar to the findings of Biermann (10). Methanolysis with 2 M HCl in methanol prior to TFA hydrolysis, resulted in most cases in no significant extra decomposition of the sugar residues (13). To be able to quantify sugars with HPAEC with PAD the exact molar responses for the sugar residues involved were determined, by subjecting various mixtures of reference monosaccharides to identical conditions used for the hydrolysis of the polysaccharide preparations.

A disadvantage of this CarboPac PA 1 column with the gradients used for HPAEC in this study, is the incomplete separation of xylose and mannose. This separation can be improved by the use of the recently available CarboPac PA 100 column or the use of lower amounts of NaOH in the first part of the gradient combined with post-column addition of NaOH. As in our preparations this combination of monosaccharides was not present, no attempts were made to optimize this separation.

The use of sulphuric acid for hydrolysis of uronic acid containing polysaccharides according to method 1 resulted in low recoveries of 6-deoxy-sugar residues. Both the amount of rhamnose (Rha, 6-deoxy-mannose) in pectic material and fucose (Fuc, 6-deoxy-galactose) in fungal polysaccharides were significantly lower compared to the other methods tested. Probably, this is due to incomplete hydrolysis of the glycosidic linkage of aldobiuronic acids, in which the 6-deoxy-residues serve as aglycon, which are

known to be very acid resistant (9,42,43). Another disadvantage of the sulphuric acid hydrolysis is the necessity to use relatively high amounts of polysaccharide material to perform a pre-hydrolysis accurately. Also, it is necessary to analyse the neutral sugars by GLC after derivatisation as the mineral acid cannot be removed adequately prior to the alternative HPAEC analysis.

In most of the samples, the use of TFA hydrolysis solely is not sufficient for the complete hydrolysis. Both in GalA-containing pectic material and in GlcA-containing fungal polysaccharides oligomeric material could often be detected by HPAEC after TFA hydrolysis. TFA hydrolysis of glycosaminoglycans from animal connective tissues liberated oligomers mainly and only minor amounts of monosaccharide residues could be detected as reported previously (32). However, the amount of uronic acids determined after TFA hydrolysis with the colorimetric *m*-hydroxy diphenyl assay is similar compared to sulphuric acid hydrolysis. It can be assumed that this can be attributed to the extra hydrolysis step (concentrated H<sub>2</sub>SO<sub>4</sub>, 100 °C, 5 min) performed in the *m*-hydroxy diphenyl assay rather than to TFA hydrolysis itself.

This study allows the conclusion that methanolysis with 2 M HCl prior to TFA hydrolysis results in complete hydrolysis of pectic material, most fungal polysaccharides and most glycosaminoglycans tested, giving higher recovery of sugars. Probably, the unknown peaks revealed after chromatography of the glycosaminoglycan samples originate from partially sulphated monosaccharides, which can be expected in this area.

This two-step hydrolysis procedure is in most cases found to be as good as or superior to the generally used sulphuric acid hydrolysis, which is often described as the superior hydrolytic procedure (10,17,24,42). As both 2 M HCl in methanol and 2 M aqueous TFA can be removed by evaporation with a stream of air, accurate and reproducible analysis with HPAEC and PAD can be performed on only 20 µg of polysaccharide using only one test-tube. In addition, HPAEC-PAD technology enables direct and sensitive detection of neutral sugars, hexosamines and uronic acids in one analysis without any derivatisation, each giving one characteristic peak. Incomplete hydrolysis can be assessed easily by HPAEC determination of oligomeric products in the acid digests, as shown in this study for extracellular polysaccharides of *Fusarium* spp. and for heparin. This is impossible with the conventional sulphuric acid hydrolysis and subsequent analysis of the alditol acetates or with methanolysis followed by derivatisation to silyl derivatives.

Obviously, methanolysis is more effective to cleave the glycosidic linkages of aldobiuronic acids resulting in higher relative amounts of rhamnose in both citrus pectin (37) and MHR (38) and higher proportions of sugar residues in extracellular polysaccharides from Mucorales (6,7,44,45) compared to sulphuric acid hydrolysis. Also, the use of this method for analysis of glycosaminoglycans of animal origin provides a useful alternative to other methods, enabling rapid determination of the IdoA and GlcA ratio of these polymers. More research is in progress to reveal the influence of the sulphate groups of the glycosaminoglycans towards methanolysis and TFA hydrolysis, and

the formation of peaks with retention times between 30 and 50 min as a result thereof.

In conclusion, analysis of water-soluble uronic acid containing polysaccharides by methanolysis followed by hydrolysis with TFA combined with HPAEC-PAD technology can be considered as superior to the four other methods tested.

## References

1. Pilnik, W., and Voragen, A.G.J. 1970. Pectic substances and other uronides. *in* The biochemistry of fruits and their products (Hulme, A.C., Ed.), Vol I., pp. 53-87, Academic Press, London.
2. Casu, B. 1985. Structural and biological activity of heparin. *Adv. Carbohydr. Chem. Biochem.* **43**, 51-134.
3. Sime, W.J. 1990. Alginates. *in* Food Gels (Harris, P., Ed.), pp. 53-78, Elsevier Appl. Sc., London.
4. Lindberg, B. 1990. Components of bacterial polysaccharides. *Adv. Carbohydr. Chem. Biochem.* **48**, 279-318.
5. Barreto-Bergter, E., and Gorin, P.A.J. 1983. Structural chemistry of polysaccharides from fungi and lichens. *Adv. Carbohydr. Chem. Biochem.* **41**, 67-103.
6. De Ruiter, G.A., Van der Lugt, A.W., Voragen, A.G.J., Rombouts, F.M., and Notermans, S.H.W. 1991. High-performance size-exclusion chromatography and ELISA detection of extracellular polysaccharides from Mucorales. *Carbohydr. Res.* **215**, 47-57 (this thesis, Chapter 3).
7. De Ruiter, G.A., Smid P., Van der Lugt, A.W., Van Boom, J.H., Notermans, S.H.W., and Rombouts, F.M. 1991. Immunogenic extracellular polysaccharides of Mucorales. *in* Fungal Cell Wall and Immune Response (Latgé, J.-P. and Boucias, D., Eds.), NATO ASI Ser. H 53, pp. 169-180, Springer Verlag, Berlin.
8. De Ruiter, G.A., Josso, S.L., Colquhoun, I.J., Voragen, A.G.J., and Rombouts, F.M. 1992. Isolation and characterization of  $\beta(1-4)$ -D-glucuronans from extracellular polysaccharides of moulds belonging to Mucorales. *Carbohydr. Polym.* **18**, 1-7 (this thesis, Chapter 6).
9. BeMiller, J.N. 1967. Acid-catalyzed hydrolysis of glycosides. *Adv. Carbohydr. Chem.* **22**, 25-108.
10. Biermann, C.J. 1988. Hydrolysis and other cleavages of glycosidic linkages in polysaccharides. *Adv. Carbohydr. Chem. Biochem.* **46**, 251-271.
11. Albersheim, P., Nevins D.J., English P.D., and Karr A. 1967. A method for the analysis of sugars in plant cell-wall polysaccharides by gas-liquid chromatography. *Carbohydr. Res.* **5**, 340-345.
12. Churms, S.C. 1990. Recent developments in the chromatographic analysis of carbohydrates. *J. Chromatogr.* **500**, 555-583.
13. Chambers, R.E., and Clamp, J.R. 1971. An assessment of methanolysis and other factors used in the analysis of carbohydrate-containing materials. *Biochem. J.* **125**, 1009-1018.
14. Cheetham, N.W.H., and Sirimanne, P. 1983. Methanolysis studies of carbohydrates, using H.P.L.C. *Carbohydr. Res.* **112**, 1-10.
15. Hicks, K.B. 1988. High-performance chromatography of carbohydrates. *Adv. Carbohydr. Chem. Biochem.* **46**, 17-72.
16. Rocklin, R.D., and Pohl, C.A. 1983. Determination of carbohydrates by anion exchange chromatography with pulsed amperometric detection. *J. Liq. Chromatogr.* **6**, 1577-1590.

17. Garleb, K.A., Bourquin, L.D., and Fahey, G.C. 1989. Neutral monosaccharide composition of various fibrous substrates: A comparison of hydrolytic procedures and use of anion-exchange high-performance liquid chromatography with pulsed amperometric detection of monosaccharides. *J. Agric. Food Chem.* **37**, 1287-1293.
18. Martens, D.A., and Frankenberger, W.T. 1990. Determination of glycuronic acids by high-performance anion chromatography with pulsed amperometric detection. *Chromatographia* **30**, 651-656.
19. Lee, Y.C. 1990. High-performance anion-exchange chromatography for carbohydrate analysis. *Anal. Biochem.* **189**, 151-162.
20. Clarke, A.J., Sarabia, V., Keenleyside, W., MacLachlan, P.R., and Whitfield, C. 1991. The compositional analysis of bacterial extracellular polysaccharides by high-performance anion-exchange chromatography. *Anal. Biochem.* **199**, 68-74.
21. Dische, Z. 1947. A new specific color reaction of hexuronic acids. *J. Biol. Chem.* **167**, 189-198.
22. Blumenkrantz, N., and Asboe-Hansen, G. 1973. New method for quantitative determination of uronic acids. *Anal. Biochem.* **54**, 484-489.
23. Thibault, J.-F. 1979. Automatisation du dosage des substances pectiques par la méthode au méta-hydroxydiphenyl. *Lebensm. Wiss. Technol.* **12**, 247-251.
24. Dutton, G.G.S. 1973. Applications of gas-liquid chromatography to carbohydrates: part 1. *Adv. Carbohydr. Chem. Biochem.* **28**, 11-160.
25. Saeman, J.F., Moore, W.E., Mitchell, R.L., and Millett, M.A. 1954. Techniques for the determination of pulp constituents by quantitative paper chromatography. *TAPPI* **37**, 336-343.
26. Englyst, H.N., and Cummings, J.H. 1984. Simplified method for the measurement of total non-starch polysaccharides by gas-liquid chromatography of constituent sugars as alditol acetates. *Analyst* **109**, 937-942.
27. Roberts, E.J., Godshall, M.A., Clarke, M.A., Tsang, W.S.C., and Parrish, F.W. 1987. Methanolysis of polysaccharides: a new method. *Carbohydr. Res.* **168**, 103-109.
28. Ip, C.C.Y., Manam, V., Hepler, R., and Hennessey, J.P. 1992. Carbohydrates composition analysis of bacterial polysaccharides: optimized acid hydrolysis conditions for HPAEC-PAD analysis. *Anal. Biochem.* **201**, 343-349.
29. Rolf, D., and Gray, G.R. 1982. Reductive cleavage of glycosides. *J. Am. Chem. Soc.*, **104**, 3539-3541.
30. Selvendran, R.R., March, J.F., and Ring S.G. 1979. Determination of aldoses and uronic acid content of vegetable fiber. *Anal. Biochem.* **96**, 282-292.
31. Griggs, L.J., Post, A., White, E.R., Finkelstein, J.A., Moeckel, W.E., Holden, K.G., Zarembo, J.E., and Weisbach, J.A. 1971. Identification and quantification of alditol acetates of neutral and amino sugars from mucins by automated gas-liquid chromatography. *Anal. Biochem.* **43**, 369-381.
32. Höök, M., Lindahl, U., and Iverius, P.-H. 1974. Distribution of sulphate and iduronic acid residues in heparin and heparan sulphate. *Biochem. J.* **137**, 33-43.
33. Inoue, S., and Miyawaki, M. 1975. Quantitative analysis of iduronic acid and glucuronic acid in sulfated galactosaminoglycuronans by gas chromatography. *Anal. Biochem.* **65**, 164-174.
34. Lampio, A., and Finne, J. 1991. Sugar analysis of glycoproteins and glycolipids after methanolysis by high-performance liquid chromatography with pulsed-amperometric detection. *Anal. Biochem.* **197**, 132-136.
35. Vodonik, S.A., and Gray, G.R. 1988. Analysis by the reductive-cleavage method of linkage positions in a polysaccharide containing 4-linked D-glucopyranosyluronic residues. *Carbohydr. Res.* **175**, 93-102.

36. Zeller, S.G., and Gray, G.R. 1992. Analysis of *Macrocystis pyrifera* and *Pseudomonas aeruginosa* alginic acids by the reductive-cleavage method. *Carbohydr. Res.* **226**, 313-326.
37. Kravtchenko, T.P., Voragen, A.G.J., and Pilnik, W. 1992. Analytical comparison of three industrial pectin preparations. *Carbohydr. Polym.* **18**, 17-25.
38. Schols, H.A., Posthumus, M.A., and Voragen A.G.J. 1990. Structural features of hairy regions of pectins isolated from apple juice produced by the liquefaction process. *Carbohydr. Res.* **206**, 117-129.
39. Rodén, L., Baker, J.R., Cifonelli, J.A., and Mathews, M.B. 1972. Isolation and characterization of connective tissue polysaccharides. *Methods Enzymol.* **28**, 73-140.
40. Niessen, W.M.A., Van der Hoeven, R.A.M., Van der Greef, J, Schols, H.A., Lucas-Lokhorst, G., Voragen, A.G.J., and Bruggink, C. 1992. High-performance anion-exchange chromatography/thermospray mass spectrometry in the analysis of oligosaccharides. *Rap. Comm. Mass Spectrom.* **6**, 474-478.
41. Sugahara, K., Ohi, Y., Harada, T., De Waard, P., and Vliegenthart, J.F.G. 1992. Structural studies on sulfated oligosaccharides derived from the carbohydrate-protein linkage region of chondroitin 6-sulfate proteoglycans of shark cartilage. *J. Biol. Chem.* **267**, 6027-6035.
42. Selvendran, R.R., and Ryden, P. 1990. Isolation and analysis of plant cell walls. *in Methods in Plant Biochemistry 2. Carbohydrates* (Dey, P.M., Ed.), pp. 549-579, Academic Press, London.
43. Garleb, K.A., Bourquin, L.D., and Fahey, G.C. 1991. Galacturonate in pectic substances from fruits and vegetables: comparison of anion exchange HPLC with pulsed amperometric detection to standard colorimetric procedure. *J. Food Sc.* **56**, 423-426.
44. Miyazaki, T., Yadomae, T., Yamada, H., Hayashi, O., Suzuki, I., and Ohshima, Y. 1980. Immunochemical examination of the polysaccharides of Mucorales. *in Fungal Polysaccharides* (Sandford, P.A., and Matsuda, K., Eds.), ACS Symp. Ser. 126, pp. 81-94, American Chemical Society, Washington.
45. Yamada, H., Ohshima, Y., and Miyazaki, T. 1982. Characterisation of extracellular mannoheteroglycans from *Absidia cylindrospora*. *Chem. Pharm. Bull.* **30**, 1784-1791.



## Detection of fungal carbohydrate antigens by high-performance immunoaffinity chromatography using a protein A column with covalently linked immunoglobulin G

*Journal of Chromatography*<sup>1</sup> (1992) 584:69-76.

Fungal carbohydrate antigens were analysed by high-performance immunoaffinity chromatography with IgG antibodies raised against extracellular polysaccharides of *Mucor racemosus*. The protein A-IgG complex was covalently bound with dimethyl pimelimidate which enabled the use of strong acidic buffers to release the tightly bound antigens from the column. Prior to pulsed-amperometric detection, an anion-micromembrane suppressor was used to raise the pH of the effluent to above 12 without dilution. The HPIAC system provides a sophisticated method for the rapid and sensitive detection of antigenic oligomeric carbohydrates in biological samples and is proposed as an alternative for quantitative ELISA techniques.

### Introduction

Antibodies are widely used for affinity separation of mixtures of oligosaccharides or polysaccharides containing the target antigen (1-6). Conventional methods for immobilizing IgG antibodies as ligands on solid matrices usually employ non-specific antibody-protein coupling to activated Sepharose or macroporous silica. This binding reduces the efficiency of the antibody-antigen interaction because of the multisite attachment and orientation of the immunoglobulin molecule (7,8). The introduction of the complex of *Staphylococcus* protein A coupled to Sepharose beads, which specifically binds non-covalently to the Fc-fragment of IgG molecules, allows optimal spatial orientation of the paratopes of the IgG and therefore maximum antigen-binding efficiency (9).

The combined use of immunoaffinity chromatography and high-performance liquid chromatography (HPLC) technology has been proposed by Ohlson *et al.* (7), and is known as high-performance immunoaffinity chromatography (HPIAC) as a further refinement of the more general high-performance liquid affinity chromatography (HPLAC) (10,11). Potentially, this approach can be used in developing biosensors for rapid chromatographic monitoring of

---

<sup>1</sup>Authors: G.A. De Ruiter, P. Smid, H.A. Schols, J.H. Van Boom, and F.M. Rombouts.

bioprocesses such as downstream processing and fermentations (12). Many antigenic oligosaccharides can be separated and detected successfully with immunoaffinity columns of antibodies coupled to tresyl-activated silica combined with HPLC (13,14). Improvement in sensitivity was obtained by Wang *et al.* (15) who introduced the use of pulsed-amperometric detection (PAD) to this system, which allows detection of 10 ng of oligosaccharides separated with these immunoaffinity columns.

Moulds belonging to different genera of the order of Mucorales are distributed worldwide and are important in foods causing many cases of food spoilage (16). Medically, some species are able to cause mucormycosis in man (16). These mucoralean moulds excrete mixtures of polysaccharides with a common antigenic carbohydrate determinant (17,18). Antigenic activity of fungal polysaccharides is often based on the presence of carbohydrate epitopes of three to six sugar residues linked to extracellular polysaccharides (EPSs), as demonstrated recently for EPSs from *Penicillium* and *Aspergillus* species (19,20). To elucidate the structure of the epitopes of the EPSs produced by species belonging to the order of Mucorales, many polysaccharide and oligosaccharide fractions, either isolated or synthesized, had to be tested on their immunochemical activity towards IgG antibodies raised against the EPSs of *Mucor racemosus*. To this end, series of  $\alpha$ -linked fucose and mannose oligomers and combinations thereof were synthesized (21,22). As a sandwich enzyme-linked immunosorbent assay (ELISA) requires the presence of at least two epitopes on one molecule, this is an inappropriate assay for testing oligosaccharides and small polysaccharides. With other ELISA techniques it is difficult to test microgram quantities of carbohydrates on their immunological properties. Therefore, other, more sensitive other methods are necessary to test these fractions immunochemically.

In this study, the preparation of an high-performance immunoaffinity chromatography (HPIAC) column from polyclonal IgG antibodies raised against EPSs of *Mucor racemosus* is described. The Fc-fragments of the IgG antibodies were coupled to a HiTrap protein A-column recently available from Pharmacia (Uppsala, Sweden). The complex of the IgG and protein A was linked covalently using dimethyl pimelimidate (DMP). This enables the use of strong acidic buffers to elute the tightly bound antigens from the HPIAC column without eluting the IgG antibodies. The oligosaccharides eluted from this column were detected with pulsed-amperometric detection.

## Materials and methods

### *Extracellular polysaccharides*

EPSs of the strains *Mucor racemosus* CBS 222.81, *Mucor circinelloides* RIVM M 40, *Rhizopus oryzae* LU 581, *Rhizomucor pusillus* CBS 432.78, *Absidia corymbifera* LU 017 and

*Syncephalastrum racemosum* CBS 443.59 used in this study, were produced, isolated and purified by ethanol precipitation as previously described (17).

#### *Preparation of the protein A immunoaffinity column*

A HiTrap protein A column (Pharmacia LKB, Uppsala, Sweden) containing 1 ml Sepharose high-performance beads with approximately 3 mg of protein A (derived from *Staphylococcus aureus*) was washed with 20 ml of 0.1 M sodium borate buffer (pH 8.2) using a pump with a flow of approximately 0.3 ml/min at 4 °C. Lyophilized polyclonal rabbit antibodies (4.3 mg; IgG 1000/1201) raised against EPSs of *Mucor racemosus* (18) were dissolved in 1 ml of 0.1 M sodium borate buffer (pH 8.2) and pumped slowly through the column in 1 h, after which the column was washed with an excess (10 ml) of sodium borate buffer. The effluent was collected in fractions of 1 ml which were all tested for protein content with the Sedmak assay (23) to determine any unbound IgG. Only 65 µg protein could be detected in the first fraction, corresponding to 1.5% of the IgG protein applied to the column. The column was rinsed with 10 ml 0.2 M triethanolamine (pH 8.2). The IgG was covalently bound to the column by rinsing the column with 20 ml (0.3 ml/min) of 50 mM DMP.2HCl (dimethyl ester of heptane diimidic acid; Pierce, Rockford, IL, U.S.A.) freshly made up in 0.2 M triethanolamine with the pH readjusted to pH 8.2 (9). The column was rinsed with 10 ml 50 mM ethanolamine (pH 8.2) and finally with 10 ml of 0.1 M sodium borate buffer of the same pH. The column was tested several times by rinsing with 20 ml 0.1 M sodium citrate-sodium hydroxide buffer pH 2.0. Only after the first washing was a minor amount (60 µg) protein released from the column. The HPIAC column was stored in 0.1 M sodium borate buffer (pH 8.2) supplemented with 0.02% sodium azide as an antimicrobial agent.

#### *High-performance immunoaffinity chromatography system (HPIAC)*

HPIAC was carried out using a Dionex Bio-LC HPLC system (Sunnyvale, CA, U.S.A.) with a pulsed-amperometric detector equipped with a gold working electrode and an Ag/AgCl reference electrode. The system was run at 20 °C with a flow-rate of 0.2 ml/min using 50 mM sodium borate buffer (pH 8.0) and 50 mM sodium citrate-sodium hydroxide buffer (pH 2.0) as eluents, prepared from distilled water filtered in a Nanopure II system (Sybron/Barnstead, Boston, MA, U.S.A.). In order to decrease the pulse noise from the HPLC pump, a restrictor was connected between the pump and the injection valve, providing a working pressure of 40-50 bar. After automatic injection of 20 µl of a saccharide sample (1 mg/ml) using an SP 8880 autosampler (Spectra-Physics, San Jose, CA, U.S.A.), elution was performed with 4 ml of sodium borate buffer (pH 8.2) followed by 4 ml of sodium citrate buffer (pH 2.0) and then another 4 ml of sodium borate buffer. Prior to pulsed-amperometric detection, a solution of 1.5 M NaOH was used to increase the pH of the

effluent above 12 by means of an anion-micromembrane suppressor (AMMS II; Dionex) at a flow-rate of 4.0 ml/min using a separate pump (24).

### *Sandwich ELISA for the detection of EPSs*

To determine the ELISA activity of the various fractions obtained after separation with the HPIAC column, the effluent was partitioned in fractions of 0.2 ml (1 min) in a separate experiment using a Bio-Rad 2110 fraction collector after disconnecting the PAD detector. The antigenic activity of these fractions was determined using the sandwich ELISA as previously described (17), in wells of polyvinyl chloride microtitre plates (Dynatech, Chantilly, VA, U.S.A.). The IgG fraction (1000/1201) used for the preparation of the HPIAC column was also used in this ELISA. An aliquot (100  $\mu$ l) containing 10  $\mu$ g/ml of rabbit IgG anti *M. racemosus* EPSs in 0.07 M sodium phosphate buffer (pH 7.2) containing 0.15 M NaCl (phosphate-buffered saline; PBS) was added to each well and incubated overnight at room temperature. After rinsing with PBS containing 0.05% Tween 20 (PBST), 60- $\mu$ l portions of samples diluted with 40  $\mu$ l 0.15 M PBST (pH 7.5) were added and incubated for 90 min at room temperature. After another rinse with PBST the wells were incubated with rabbit IgG (anti *M. racemosus* EPS), conjugated to horse-radish peroxidase, for 90 min. Finally, the rinsed wells were incubated at room temperature for 30 min with 100  $\mu$ l of a substrate solution. The substrate solution was 3,3',5,5' tetramethylbenzidine in dimethyl sulphoxide (DMSO), prepared according to Bos *et al.* (25). Just before use, 7  $\mu$ l of 30% H<sub>2</sub>O<sub>2</sub> were added to 100 ml of the substrate solution. The enzyme reaction was stopped by adding 50  $\mu$ l of 2 M H<sub>2</sub>SO<sub>4</sub> to each well. The absorption of the yellow colour was measured at 450 nm using an EAR 400 spectrophotometer (SLT, Groedig, Austria).

## Results

### *Preparation and analysis conditions of the HPIAC column*

The IgG antibodies were bound covalently to the protein A column with the use of DMP with a yield of more than 95%. Only the first washing after the covalent coupling with a strong acidic buffer released some IgG protein from the HPIAC column representing 1.4% of the initial amount. Further elution of the column with sodium citrate buffer (pH 2.0) did not release any protein.

The binding and the subsequent release of the antigenic compounds from the HPIAC column in relation to the pH and the flow-rate of the eluents were studied by ELISA detection of the effluent. Complete binding of the antigenic components of the EPSs of *M. racemosus* could be achieved with a flow-rate of 0.2 ml/min of the sodium borate buffer (pH

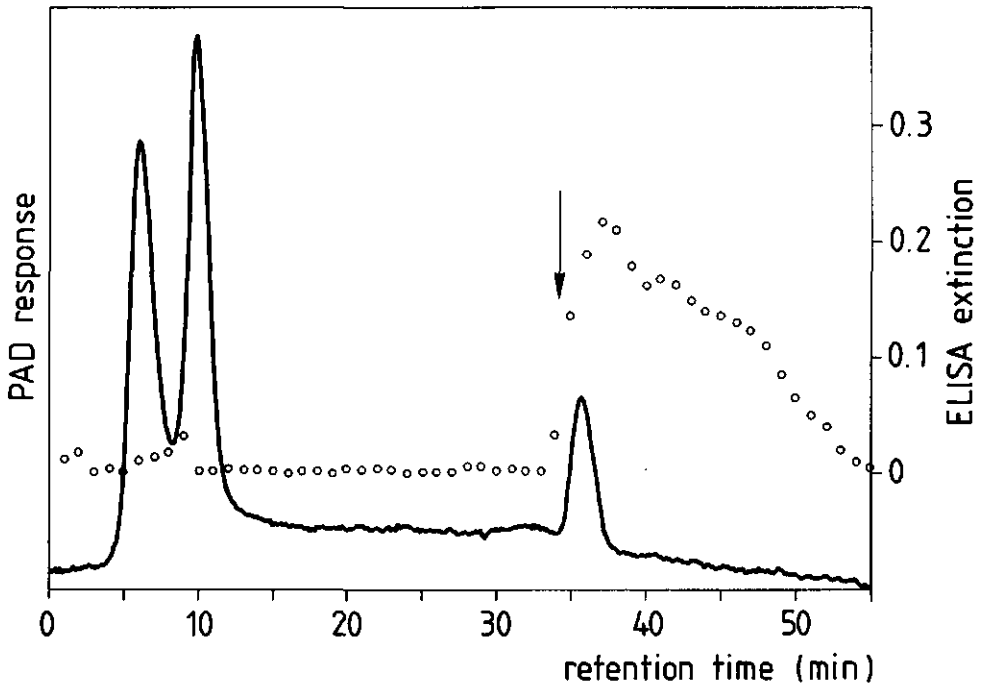

**Fig. 1.** High-performance immunoaffinity chromatogram of 20  $\mu\text{g}$  of a preparation of extracellular polysaccharides derived from the mould *Mucor racemosus*. The binding antigenic fraction was eluted from the column with 50 mM sodium citrate buffer pH 2 (arrow). —, response of the pulsed-amperometric detector; o, ELISA extinction of the different fractions at 450 nm.

8.2), as no antigenic material could be detected by ELISA in the non-binding fraction (Fig. 1). Higher flow-rates also resulted in the presence of antigenic material in the effluent at the initial pH, indicating incomplete binding of the antigenic material. The influence of the enlarged size of the immobilized ligand as a result of cross-linking, which is likely to increasingly invoke steric hindrance, was not studied in detail.

Release of antigenic material could only be obtained by lowering the pH of the eluent with at least 2 pH units, which was determined by the use of different buffers with various pH values in the range of 8 to 2 (results not shown). An optimal release of the binding antigenic material in this HPIAC system was obtained by using a sodium citrate-sodium hydroxide buffer pH 2. As shown in Fig. 1, in which the start of the elution with this buffer is indicated with an arrow, the antigenic material could be released completely from the column in 4 ml of this buffer. Lower pH values were not tested to prevent any damage to the IgG antibodies covalently linked to the HPIAC column. Successful PAD detection of the carbohydrate material in the effluent of the HPIAC column requires a pH of more than 12.

This was obtained by post-column addition of OH<sup>-</sup>-ions by the use of an anion-micromembrane suppressor (24). As the capacity of the suppressor was limited, the maximum flow-rate of the 50 mM sodium citrate buffer (pH 2) was 0.2 ml/min. However, exact quantification of the antigenically active material was difficult because of the unknown responses of the PAD detector towards these polysaccharides. Using these elution conditions the column exhibited negligible loss of performance after analysis of more than 200 samples during a period of one year.

#### *Detection of fungal antigenic extracellular polysaccharides*

Preparations of EPSs derived from various moulds species of five different genera belonging to the order of Mucorales were analysed with HPIAC with IgG antibodies raised against the EPSs of *M. racemosus*. As illustrated in Figs. 1 and 2, the preparations tested contained an antigenic fraction which was able to bind to this column. ELISA reactivity (tested in separate experiments as described; results not shown) could only be determined in the peaks with a retention time of around 36 min, representing the HPIAC-binding fractions. The non-binding material eluted in two fractions from the HPIAC column after rinsing with sodium borate buffer (pH 8.2). This column, prepared from 4.3 mg IgG, showed a linear relationship between peak area and the amount of injected antigenic polysaccharides between 50 and 1000 ng. Based on the peak areas after pulsed-amperometric detection, the binding fractions represent 10 to 15 % of the total amount of EPSs.

#### *HPIAC analysis of oligosaccharides*

The characteristics of the HPIAC column used in this study were carefully determined with antigenic polysaccharides and subsequent ELISA detection as described above. Assuming a similar performance of this HPIAC column towards antigenic oligosaccharides, many synthesized carbohydrate oligomers were tested immunochemically with this column.

Oligomers of  $\alpha(1-2)$ -,  $\alpha(1-3)$ - and  $\alpha(1-4)$ -linked L-fucose residues were synthesized using the iodonium ion-assisted stereospecific glycosylation procedure as recently described (21). Also,  $\alpha(1-6)$ - and  $\alpha(1-2)$ -linked D-mannopyranoside oligomers,  $\alpha$ -D-man-(1-4)- $\alpha$ -L-fuc-O-Me and  $\alpha$ -L-fuc-(1-2)- $\alpha$ -D-man-O-Me were synthesized using the same procedure (22). As shown in Fig. 3, the  $\alpha(1-2)$ -tetramer of D-mannopyranoside was able to bind partly to this column. The binding capacity of the other oligomers tested in this study was negligible.

### **Discussion**

An high-performance immunoaffinity chromatography column was prepared from a

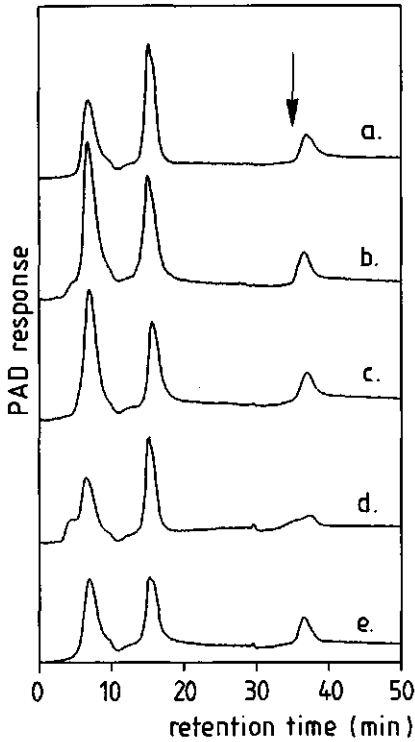

**Fig. 2.** High-performance immunoaffinity chromatograms of 20  $\mu\text{g}$  of preparations from extracellular polysaccharides from the mucoralean moulds: *Mucor circinelloides* (a), *Rhizopus oryzae* (b), *Rhizomucor pusillus* (c), *Absidia corymbifera* (d) and *Syncephalastrum racemosum* (e). The arrow indicates the start of the elution with the sodium citrate buffer (pH 2).

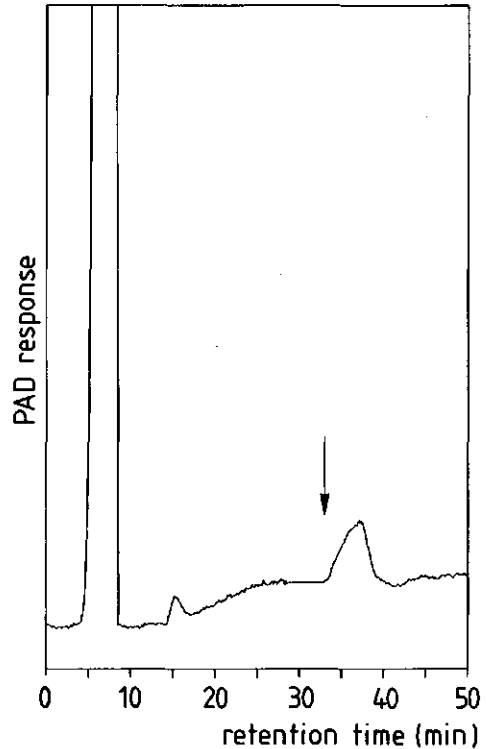

**Fig. 3.** High-performance immunoaffinity chromatogram of 20  $\mu\text{g}$  of  $\alpha(1-2)$ -tetramer of D-mannopyranoside. The binding fraction was eluted from the column with 50 mM sodium citrate buffer pH 2 (arrow).

protein A column with IgG antibodies raised against extracellular polysaccharides of *Mucor racemosus*. As the binding between the paratopes of the antibodies and the epitopes of the antigenic polymers was found to be very strong, covalent binding of the IgG-protein A complex of the column was necessary to be able to use strong acidic buffers to release the antigens from the column after binding. Stabilization of the complex of protein A and the Fc fragment of the IgG through covalent binding with DMP was possible with an efficiency of more than 95%. The resulting HPIAC column with optimal spatial orientation of the IgG paratopes could be used to separate the antigenic polysaccharides completely. Repeated experiments revealed reproducible peak areas of the binding fraction. However, there is no evidence that these circumstances provide a maximized stoichiometry of the interaction between antibody and antigen. This HPIAC column can easily be incorporated into any

HPLC system, providing considerable improvements compared with HPIAC columns described previously (11,15).

Electrochemical detection of the effluent using a pulsed-amperometric detector requires alkalization of the effluent prior to detection. Previously, this was performed by the addition of a solution of NaOH to the effluent (15), which resulted in a two-fold greater dilution of the effluent. To avoid this problem, an anion-micromembrane suppressor was introduced, enabling alkalization of the effluent without dilution (24). The sensitivity and reproducibility of the HPIAC system was increased considerably as a result of this.

The use of Sepharose beads as a matrix of this HPIAC column resulted also in partial separation of the non-binding fractions (Figs. 1 and 2). As the molecular mass of these polysaccharides is known to be lower than 100 kDa (17), the doublet near the void cannot originate from size-exclusion effects of this Sepharose-based column. It is known that the EPSs of Mucorales consist of a mixture of neutral polysaccharides and negatively charged polysaccharides containing glucuronic acid (17). Therefore, this phenomenon can probably be explained by assuming some weak interaction with the glucuronic acid containing polysaccharides present in these preparations.

The analysis of several EPSs preparations of various moulds belonging to Mucorales revealed a similar antigenic fraction. This fraction, representing 10 to 15% of the initial polysaccharides, could be separated reproducibly from the non-antigenic material. This strongly suggests that the epitopes of Mucorales are not randomly distributed among the excreted polysaccharides, but are located only on specific polysaccharides that are a minor fraction of the total amount excreted. Previously, it was established that these antigenic polysaccharides of Mucorales have a unimodal molecular weight distribution with an average molecular mass of 30 kDa (17).

Immunochemical analysis of oligomers was possible on microgram quantities, which is approximately ten times less than the amounts needed for testing these oligomers with conventional ELISA techniques (16,19). The range of sensitivity of this column can be improved by increasing the amount of IgG coupled to the column. As the  $\alpha$ -L-fucose oligomers, the dimer of  $\alpha$ (1-6)-linked mannopyranose,  $\alpha$ -D-man-(1-4)- $\alpha$ -L-fuc-O-Me and  $\alpha$ -L-fuc-(1-2)- $\alpha$ -D-man-O-Me did not bind to this column, it can be assumed that these configurations play no role in the antigenicity of the EPSs of Mucorales.

Miyazaki *et al.* (26) suggested that  $\alpha$ (1-6)-mannose residues are the antigenic determinants of mucoralean polysaccharides, but our results do not confirm this suggestion. Some binding of the  $\alpha$ (1-2)-linked D-mannopyranoside tetramers was found with this HPIAC system, indicating a role of these mannose residues in the epitopes of EPSs of Mucorales. However, the binding was incomplete and it is therefore unlikely that the mucoralean epitopes are composed of nothing else than  $\alpha$ (1-2)-linked D-mannopyranoside sequences as suggested by Yamada *et al.* (27).

In conclusion, the HPIAC column described in this study can be considered as an important improvement of the HPIAC of carbohydrate oligomeric antigens, and can be used



as an alternative to ELISA techniques, allowing tenfold lower concentrations of antigens to be detected. Potentially, such immunochromatographic biosensor systems can be used to monitor the level of almost any carbohydrate against which a suitable antibody can be raised (12,28).

## References

1. J. Dakour, G.C. Hansson, A. Lundblad, and D. Zopf, 1986. Separation and partial sequence analysis of blood group A-active oligosaccharides by affinity chromatography using monoclonal antibodies. *Arch. Biochem. Biophys.* 248:677-683.
2. P.A. Prieto, and D.F. Smith, 1986. A new ganglioside in human meconium detected with antiserum against human milk sialyltetrasaccharide a. *Arch. Biochem. Biophys.* 249:243-253.
3. D. Zopf, K. Schroer, G. Hansson, J. Dakour, and A. Lundblad, 1987. Affinity purification of oligosaccharides using monoclonal antibodies. *Methods Enzymol.* 138:307-313.
4. S. Mårtensson, C. Due, P. Pahlsson, B. Nilsson, H. Eriksson, D. Zopf, L. Olsson, and A. Lundblad, 1988. A carbohydrate epitope associated with human squamous lung cancer. *Cancer Res.* 48:2125-2131.
5. S. Ohlson, A. Lundblad, and D. Zopf, 1988. Novel approach to affinity chromatography using "weak" monoclonal antibodies. *Anal. Biochem.*, 169:204-208.
6. H. Sabharwal, S. Sjöblad, and A. Lundblad, 1991. Affinity chromatographic identification and quantitation of blood group A-active oligosaccharides in human milk and feces of breast-fed infants. *J. Pediatr. Gastroenterol. Nutr.* 12:474-479.
7. S. Ohlson, L. Hansson, P.-O. Larsson, and K. Mosbach, 1978. High performance liquid affinity chromatography (HPLAC) and its application to the separation of enzymes and antigens. *FEBS Lett.*, 93: 5-9.
8. J. Dakour, A. Lundblad, and D. Zopf, 1988. Detection and isolation of oligosaccharides with Le<sup>a</sup> and Le<sup>b</sup> blood group activities by affinity chromatography using monoclonal antibodies. *Arch. Biochem. Biophys.* 264:203-213.
9. C. Schneider, R.A. Newman, D.R. Sutherland, U. Asser, and M.F. Greaves, 1982. A one-step purification of membrane proteins using a high efficiency immunomatrix. *J. Biol. Chem.* 257:10766-10769.
10. T.M. Phillips, 1989. High-performance immunoaffinity chromatography. *Adv. Chromatogr.*, 29:133-173.
11. J. Alhama, J. López-Barea, F. Toribio, and J.M. Roldán, 1992. Purification and determination of glutamine synthetase by high-performance immunoaffinity chromatography. *J. Chromatogr.* 589:121-126.
12. H.A. Chase, 1986. Rapid chromatographic monitoring of bioprocesses. *Biosensors*, 2:269-286.
13. J. Dakour, A. Lundblad, and D. Zopf, 1987. Separation of blood group A-active oligosaccharides by high-pressure liquid affinity chromatography using a monoclonal antibody bound to concanavalin A silica. *Anal. Biochem.* 161:140-143.
14. D. Zopf, S. Ohlson, J. Dakour, W. Wang, and A. Lundblad, 1989. Analysis and purification of oligosaccharides by high-performance liquid affinity chromatography. *Methods Enzymol.* 179:55-64.
15. W.T. Wang, J. Kumlien, S. Ohlson, A. Lundblad, and D. Zopf, 1989. Analysis of a glucose-containing tetrasaccharide by high-performance liquid affinity chromatography. *Anal. Biochem.* 182:48-53.

16. G.A. De Ruiter, P. Smid, A.W. Van der Lugt, J.H. Van Boom, S.H.W. Notermans, and F.M. Rombouts, 1991. Immunogenic extracellular polysaccharides of Mucorales, p. 169-180. In J.P. Latgé and D. Boucias (Editors), *Fungal Cell Wall and Immune Response*, Springer-Verlag, Berlin.
17. G.A. De Ruiter, A.W. Van der Lugt, A.G.J. Voragen, F.M. Rombouts, and S.H.W. Notermans, 1991. High-performance size-exclusion chromatography and ELISA detection of extracellular polysaccharides from Mucorales. *Carbohydr. Res.* 215:47-57 (this thesis, Chapter 3).
18. G.A. De Ruiter, A.W. Van Bruggen-van der Lugt, M.J.R. Nout, W.J. Middelhoven, P.S.S. Soentoro, S.H.W. Notermans, and F.M. Rombouts, 1992. Formation of antigenic extracellular polysaccharides by selected strains of *Mucor* spp., *Rhizopus* spp., *Rhizomucor* spp., *Absidia corymbifera* and *Syncephalastrum racemosum*. *Antonie van Leeuwenhoek* 62:189-199 (this thesis, Chapter 2).
19. S. Notermans, G.H. Veeneman, C.W.E.M. Van Zuylen, P. Hoogerhout, and J.H. van Boom, 1988. (1→5)-linked  $\beta$ -D-galactofuranosides are immunodominant in extracellular polysaccharides of *Penicillium* and *Aspergillus* species. *Mol. Immunol.* 25:975-979.
20. A.W. Van Bruggen-van der Lugt, H.J. Kamphuis, G.A. De Ruiter, P. Mischnick, J.H. Van Boom, and F.M. Rombouts, 1992. New structural features of the antigenic extracellular polysaccharides of *Penicillium* and *Aspergillus* species revealed with exo- $\beta$ -D-galactofuranosidase. *J. Bacteriol.* 174:6096-6102.
21. P. Smid, G.A. De Ruiter, G.A. Van der Marel, F.M. Rombouts, and J.H. Van Boom, 1991. Iodonium ion assisted stereospecific glycosylation: synthesis of oligosaccharides containing  $\alpha$ (1-4)-linked L-fucopyranosyl units. *J. Carbohydr. Chem.* 10:833-849.
22. P. Smid, 1993. *Use of monosaccharides in the preparation of biologically active compounds*. PhD-thesis, State University Leiden.
23. J.J. Sedmak, and S.E. Grossberg, 1977. A rapid, sensitive, and versatile assay for protein using Coomassie Brilliant blue G250. *Anal. Biochem.* 79:544-552.
24. J. Haginaka, Y. Nishimura, J. Wakai, H. Yasuda, K. Koizumi, and T. Nomura, 1989. Determination of cyclodextrins and branched cyclodextrins by reversed-phase chromatography with pulsed amperometric detection and a membrane reactor. *Anal. Biochem.* 179:336-340.
25. E.S. Bos, A.A. Van der Doelen, N. Van Rooy, and A.H.W.M. Schuurs, 1981. 3,3',5,5'-tetramethylbenzidine as an Ames test negative chromogen for horse-radish peroxidase in enzyme-immunoassay. *J. Immunoassay* 2:187-204.
26. T. Miyazaki, O. Hayashi, Y. Ohshima, and T. Yadomae, 1979. Studies on fungal polysaccharides: The immunological determinant of the serologically active substances from *Absidia cylindrospora*, *Mucor hiemalis* and *Rhizopus nigricans*. *J. Gen. Microbiol.* 111:417-422.
27. H. Yamada, Y. Ohshima, and T. Miyazaki, 1982. Characterization of extracellular mannoheteroglycans from *Absidia cylindrospora*. *Chem. Pharm. Bull.*, 30:1784-1791.
28. R.F. Taylor, 1991. Immobilized antibody- and receptor-based biosensors, p. 263-303. In R.F. Taylor (Ed.), *Protein immobilization, fundamentals and applications*. Marcel Dekker Inc., New York.

## Isolation and characterization of $\beta(1-4)$ -linked D-glucuronans from extracellular polysaccharides of moulds belonging to Mucorales

*Carbohydrate Polymers*<sup>1</sup> (1992) 18:1-7.

Glucuronic acid polymers were isolated after acid treatment (2 M HCl, 100° C, 4 h) of antigenic extracellular polysaccharides from various moulds belonging to the order of Mucorales. NMR methods have been used to elucidate their structure. It was found that the polymers, which are mainly composed of  $\beta(1-4)$ -linked D-glucuronic acid, can be considered as characteristic fragments of extracellular polysaccharides of all mucoralean moulds. However, it is unlikely that the glucuronic acid residues play an important role in the immunodominant part of these polysaccharides since no positive ELISA reaction with these polyuronides was found with antibodies raised against the native extracellular polysaccharides of *M. racemosus*.

### Introduction

Polyuronides occur fairly abundantly in nature as important components of carbohydrate polymers. Pectin, a plant cell wall polymer, contains  $\alpha$ -D-(1-4)-galacturonic acid residues as a major constituent (22). Alginate, a polysaccharide derived from brown marine algae, is composed of linear chains of  $\beta$ -D-(1-4)-mannuronic acid and  $\alpha$ -L-(1-4)-guluronic acid (27). Fungal polyuronides are isolated from the fruiting bodies of fungi belonging to the taxon Phallales. These contain  $\alpha$ -L-(1-4)-iduronic acid and  $\beta$ -D-(1-4)-glucuronic acid (31). Mucoric acid, a homopolymer consisting of  $\beta$ -D-glucuronic acid is present in a fraction isolated from the cell walls of moulds belonging to the order of Mucorales (2,6,11,30). Mucoric acid has been described as an acceptor for transferase enzymes in the biosynthesis of glucuronic acid containing cell wall compounds of *Mucor rouxii* (5,10). Sequences of three  $\beta(1-4)$ -linked D-glucuronic acid residues are found in extracellular polysaccharides (EPSs) of the bacterium *Rhizobium* (17).

Recently, we studied the immunochemical and high-performance size-exclusion chromatographic properties of EPSs of a number of mould species belonging to the order of

<sup>1</sup>Authors: G.A. De Ruiter, S.L. Josso, I.J. Colquhoun, A.G.J. Voragen, and F.M. Rombouts.

Mucorales (8). The immunological properties of these EPSs can be used for the detection of these moulds by immunoassay (7,20). Mould species belonging to the order of Mucorales (class of the Zygomycetes) are important fungi which are distributed worldwide and are the causes of many cases of food spoilage (23). Certain *Rhizopus* and *Mucor* species are essential in the solid-state fermentation of soya beans to produce tempe (21). Medically, some members are significant as a result of their ability to cause mucormycosis in man (9). In previous studies of EPSs derived from various species of Mucorales the presence of fucose (11–25 mol%), mannose (9–30 mol%), galactose (4–13 mol%), glucose (0–39 mol%) and glucuronic acid (32–55 mol%) was established (2,9,14,16,18).

In this study,  $\beta$ -D-(1–4)-glcA polymers are described as a structural entity of these extracellular polysaccharides. These polyuronides, which are found to be common and characteristic for extracellular polysaccharides of Mucorales, are compared with the previously reported mucoric acids of fungal cell wall origin. Furthermore, the role of these polyglucuronides and their relation to the immunochemistry of the initial extracellular polysaccharides of these moulds are examined.

## Materials and methods

### *Extracellular polysaccharides of moulds*

EPSs of the strains of *Mucor hiemalis* CBS 201.28, *Mucor circinelloides* RIVM M 40, *Rhizopus stolonifer* CBS 609.82, *Rhizopus oryzae* LU 581, *Rhizomucor miehei* CBS 371.71, *Absidia corymbifera* LU 017 and *Syncephalastrum racemosum* CBS 443.59 used in this study were isolated and purified as described (8).

### *Preparation of polyglucuronic acid*

Polyglucuronic acid was isolated from EPS by a slight modification of the method according to Bartnicki-Garcia and Reyes (2) and Tsuchihashi *et al.* (30). The EPS preparation (200 mg) was dissolved completely in 10 ml of 2 M HCl and heated for 4 h at 100 °C. The polyglucuronic acid containing precipitate was isolated by decanting the supernatant after centrifugation (15 min, 2000 g). The precipitate was extracted twice with 1 M NaOH (3 ml) at room temperature. A minor amount (3.5 mg) of alkali-insoluble residue remained. The combined extracts were dialysed against running tap water (24 h) and distilled water (48 h) followed by lyophilization.

### *Purification of $\beta(1-4)$ -D-polyglucuronic acid*

Polyglucuronic acid was isolated and purified from the lyophilized preparation using an anion-exchange column (15 x 1.7 cm) of DEAE-Sephacel (Pharmacia, Uppsala, Sweden) (8,24), which was equilibrated with 0.05 M sodium acetate buffer (pH 5.0). After loading of the sample (15 mg in 4 ml 0.05 M buffer, pH 5.0) the column was washed with 25 ml of buffer and then eluted at 30 ml/h with a linear gradient (100 ml) of 0.05–1 M sodium acetate buffer, followed by 25 ml of 1 M buffer. Fractions (1.7 ml) were assayed for glucuronic acid by the automated *m*-hydroxydiphenyl method (29) slightly modified by the addition of 0.0125 M sodium tetraborate to the sulphuric acid (4). Glucuronic acid was used as the standard. Finally, the glucuronic acid containing fractions were combined, dialysed and lyophilized yielding purified  $\beta(1-4)$ -D-polyglucuronic acid as a white powder.

### *Chemical analysis*

Neutral sugars were released by pre-treatment with 12 M  $H_2SO_4$  for 1 h at 25 °C followed by hydrolysis with 1 M  $H_2SO_4$  for 3 h at 100 °C. Next, sugars were converted to their alditol acetates as described (12) and analyzed by gas chromatography. Inositol was used as the internal standard. Methylation analysis was performed using dimethyl sulphinylium anion (13). Reduction of glucuronic acid was performed using the slightly modified (26) method of Taylor and Conrad (28). Protein was measured using coomassie brilliant blue (25) with bovine serum albumin as standard. The uronic acids in the supernatant after 2 M HCl hydrolysis, were determined using a high-performance anion-exchange chromatography (HPAEC) system of Dionex (Sunnyvale, CA U.S.A.) with pulsed-amperometric detection as described (15). Circular dichroism was performed on a JASCO J-600 spectropolarimeter.

### *Sandwich ELISA*

Immunochemical examination of the polyglucuronic acid preparations was performed using a sandwich enzyme-linked immunosorbent assay (ELISA) as described (8) with polyclonal IgG antibodies (1000/1201) raised against EPSs from *Mucor racemosus*.

### *Molecular weight distribution*

The molecular weight distribution was studied using high-performance size-exclusion chromatography, which was performed on an SP8800 HPLC system (Spectra Physics, San Jose, CA U.S.A.) equipped with three Bio-Gel TSK columns in series (40XL, 30XL, 20XL; 300x7.5 mm; Bio-Rad Labs, Richmond, CA U.S.A.) in combination with a TSK-XL guard column (40 x 6 mm) at 30 °C using 0.4 M acetic acid/sodium acetate (pH 3.0) as eluent with a flow rate of 0.8 ml/min (8).

**Table 1.** Properties of glucuronic acid polymers isolated from EPSs of various mould species belonging to Mucorales.

Species	Yield related to		GlcA content <sup>c</sup>	Molecular mass <sup>d</sup>
	EPS <sup>a</sup>	GlcA <sup>b</sup>		
<i>Mucor hiemalis</i>	8	28	86	5.5
<i>Mucor circinelloides</i>	8	25	86	5.5
<i>Rhizopus stolonifer</i>	5	15	79	6.5
<i>Rhizopus oryzae</i>	5	14	80	5.5
<i>Absidia corymbifera</i>	5	20	86	6.0
<i>Rhizomucor miehei</i>	10	37	88	10.0
<i>Syncephalastrum racemosum</i>	16	52	78	9.0

<sup>a</sup> Expressed as percentage (w/w) of initial amount of EPS.

<sup>b</sup> Expressed as percentage (w/w) of initial amount of glcA in EPS.

<sup>c</sup> Determined by the automated *m*-hdp method using glcA as standard.

<sup>d</sup> in kilo Dalton; calibration with dextran standards.

### NMR experiments

The <sup>13</sup>C-(100.4 MHz) and <sup>1</sup>H-NMR spectra (399.65 MHz) were obtained with a JEOL GX-400 spectrometer on a solution of polyglucuronic acid derived from *M. hiemalis* in D<sub>2</sub>O (10 mg/0.5 ml; pD 5) and for the polyglucuronic acid preparations from the other moulds with a Bruker AC200E spectrometer (200 MHz) in 5 mm tubes at 25 °C. The chemical shifts for the methyl group of internal acetone were taken to be 2.217 (<sup>1</sup>H) and 31.07 p.p.m. (<sup>13</sup>C) with respect to the signals for Me<sub>4</sub>Si.

## Results

### Preparation and purification

EPSs of mould species belonging to the order of Mucorales are composed of glucuronic acid, mannose, fucose, galactose and glucose (8). Treatment of these EPSs was performed with 2 M HCl, 100 °C, 4 h. After alkali extraction of the precipitate a polyglucuronic acid fraction was isolated from the alkali-soluble material by anion-exchange chromatography from all species tested, belonging to five different genera within this order. As can be seen in Table 1, the yield varied from 5 to 16% relative to the initial amount of EPS. After hydrolysis, a considerable part of the initial amount of glucuronic acid was found in the

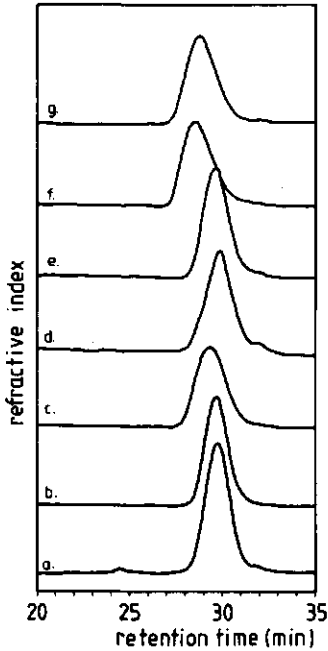

**Fig. 1.** High-performance size-exclusion chromatograms of polyglucuronic acid fractions derived by acid hydrolysis of EPSs from (a) *M. hiemalis*, (b) *M. circinelloides*, (c) *R. stolonifer*, (d) *R. oryzae*, (e) *A. corymbifera*, (f) *Rhm. miehei*, (g) *S. racemosum*.

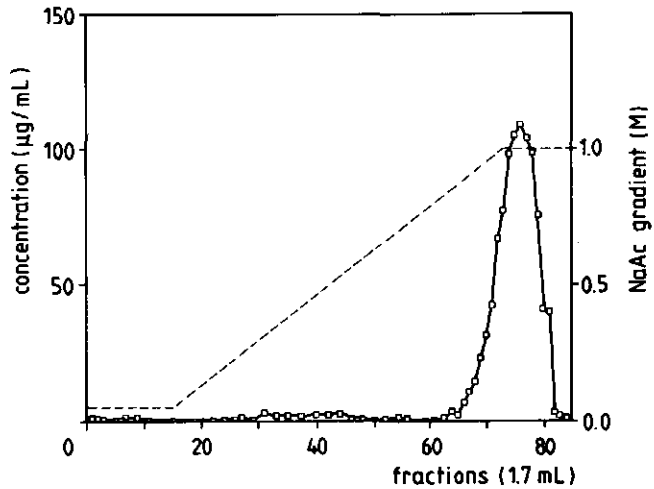

**Fig. 2.** Anion-exchange chromatogram of the polyglucuronic acid fraction derived from extracellular polysaccharides of *Mucor hiemalis*, using DEAE-Sephacel with a sodium acetate buffer (pH 5.0) gradient. Glucuronic acid,  $\square$ - $\square$ -; Gradient, -----.

polymeric acid-insoluble fraction, varying from 14-15% for species belonging to the genus *Rhizopus* and 25-28% for *Mucor* species to more than 50% for *Syncephalastrum racemosum*. Determination of the acid-soluble compounds in the supernatant revealed a non-binding DEAE-fraction, composed mainly of monomeric neutral sugars and a fraction binding to an anion-exchange column. The latter could be released using 0.1 M NaAc buffer (pH 5.0) as eluent, and was characterized as monomeric glucuronic acid by high-performance anion-exchange chromatography. No oligomers or polymers of glucuronic acids could be determined in the supernatant. The minor fraction of insoluble residue after NaOH extraction did not contain neutral or acidic sugars but turned blue after addition of Sedmak reagent (25).

#### Chromatographic homogeneity

The polyglucuronic acid fraction isolated from various preparations of EPSs showed a

**Table 2.** Chemical shifts and coupling constants for  $^1\text{H-NMR}$  resonances of the  $\beta(1-4)$ -D-linked glucuronic acid polymer derived from EPS of *M. hiemalis*.

	Glucuronic acid atom				
	H-1	H-2	H-3	H-4	H-5
Chemical shift <sup>a</sup> (p.p.m.)	4.52	3.37	3.63	3.68	3.87
$J_{\text{H,H}+1}$ (Hz)		7.9	9.2	8.6	9.1

<sup>a</sup>  $\pm 0.01$  p.p.m.

homogeneous molecular weight distribution in high-performance size-exclusion chromatography (Fig. 1). The molecular mass of the fractions varied from 5.5 kD to 6 kD for the species belonging to the genera *Mucor*, *Rhizopus* and *Absidia* whereas *Rhizomucor* and *Syncephalastrum* polyglucuronic acids had a higher molecular mass (9 to 10 kD) as determined by calibration with dextran standards.

Polyglucuronic acid was isolated in a yield of 60% from the acid-insoluble precipitate from EPS derived from *Mucor hiemalis*. Elution from a DEAE anion-exchange column revealed a single peak (Fig. 2) using 1 M NaAc buffer as eluent. Polyglucuronides from other mould species tested, were isolated from the acid-insoluble precipitates in yields varying from 51 to 82%, and eluted similarly from the anion-exchange column (patterns not shown).

#### Chemical characterization

The glucuronic acid content in the polyglucuronic acid fractions varied from 78 to 88% for the different preparations (Table 1). Neutral sugar analysis revealed traces of fucose (less than 2%) in most of the preparations. No protein could be detected. Methylation analysis of the polyglucuronic acid preparations was not successful as degradation of the polymers took place after treatment with dimethyl sulphanyl anion. Complete reduction of the polymers by the method of Taylor and Conrad (26,28) could not be achieved. After three reduction steps the polymer still contained about 40% of the original *m*-hdp positive material.

#### NMR spectroscopy

The data of the  $^1\text{H-NMR}$  spectrum from the polyuronic acid fraction derived from *M. hiemalis* are summarized in Table 2. A chemical shift of the anomeric proton of 4.52 p.p.m. with a coupling constant ( $J_{1,2}$ ) of 7.9 Hz, indicates a  $\beta$ -linkage. Assignment of the remaining resonances was obtained by homonuclear decoupling experiments. Some minor peaks (data not given) could be assigned as differently linked  $\beta$ -glucuronic acid residues and as traces



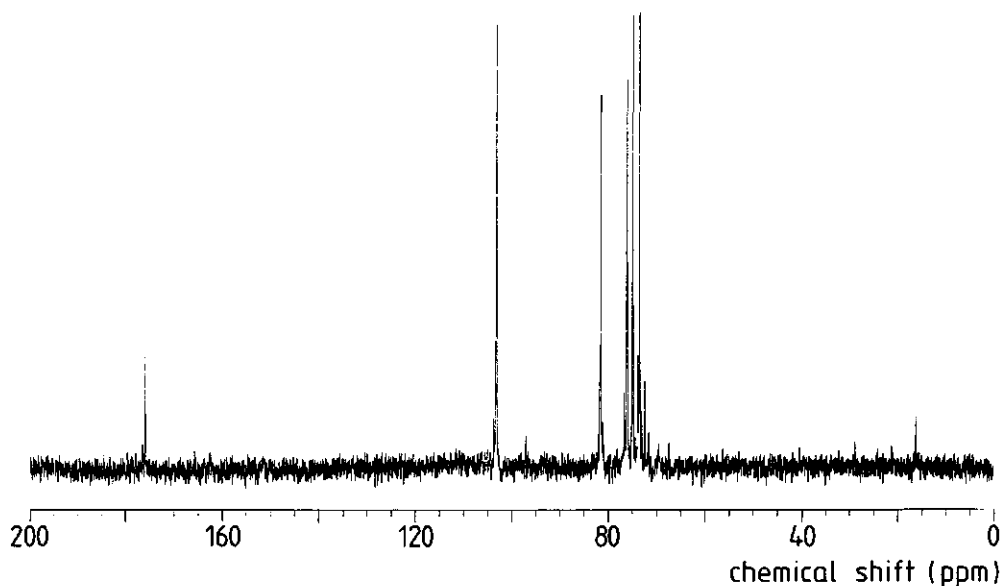

**Fig. 3.**  $^{13}\text{C}$ -NMR spectrum (100.4 MHz) of  $\beta(1-4)$ -linked D-polyglucuronic acid from *Mucor hiemalis*.

of L-fucose. The  $^{13}\text{C}$ -NMR spectrum of polyglucuronic acid as given in Fig. 3 showed six main peaks, which could be assigned to a  $\beta(1-4)$ -D-glucuronic acid (30). The  $^{13}\text{C}$ -NMR data of polyglucuronic acid are listed in Table 3. Polyglucuronic acid preparations from other moulds belonging to the order of Mucorales, including the species *Mucor circinelloides*, *Rhizopus stolonifer*, *Rhizopus oryzae*, *Rhizomucor miehei*, *Absidia corymbifera* and *Syncephalastrum racemosum* gave similar NMR spectra (not shown).

#### *Other properties*

Immunochemical characterization of these polyglucuronic acid preparations by an ELISA, showed no reactivity with antibodies raised against EPSs of *M. racemosus*. The water-soluble  $\beta(1-4)$ -glucuronic acid polymers were very stable towards acid hydrolysis as incomplete hydrolysis was obtained under conditions of the Saeman hydrolysis (12 M  $\text{H}_2\text{SO}_4$ , 1 h, 25 °C followed by 1 M, 3 h, 100 °C). Circular dichroism measurement of the polyglucuronic acid preparations derived from *Mucor hiemalis* showed two bands, a main peak at around 203 nm and a small trough at around 215 nm (spectrum not shown).

**Table 3.**  $^{13}\text{C}$ -NMR chemical shifts of the  $\beta(1-4)$ -linked D-glucuronic acid polymer derived from EPS of *M. hiemalis*.

	Glucuronic acid atom					
	C-1	C-2	C-3	C-4	C-5	C-6
Chemical shift <sup>a</sup> (p.p.m.)	103.03	73.50	74.93	81.49	76.10	≈ 175.8

<sup>a</sup>  $\pm 0.01$  ppm.

## Discussion

Acid-insoluble polyglucuronic acid preparations could be isolated by hydrolysis of antigenic EPSs of different mucoralean mould species. With NMR methods it was shown that these acid-insoluble polymers were essentially homopolymers of  $\beta(1-4)$ -linked D-glucuronic acid containing a small amount of differently linked  $\beta$ -D-glcA residues and traces of fucose. However, in contrast with the initial polysaccharides (8), no antigenic activity was left with these glucuronic acid polymers in the ELISA with antibodies raised against native EPS of *Mucor racemosus*.

Characterization of the polyuronides by chemical methods was hindered by the very strong  $\beta(1-4)$ -glcA glycosidic linkages. The polymers were found to be very resistant towards acid hydrolysis, and also complete reduction could not be achieved. Incomplete reduction was previously mentioned by Dow *et al.* (11) for glucuronic acid containing polymers.

The presence of fucose residues after the severe acid treatment can only be explained by assuming that single unit fucose residues served as aglycon in glycosidic linkages with glucuronic acid residues. This aldobiuronic type of linkage with the neutral sugar residue as reducing end is reported to be very acid resistant (1,3). The circular dichroism spectrum of polyglucuronic acid derived from *M. hiemalis* was very similar to the spectrum previously reported for  $\beta(1-4)$ -glcA in deacetylated xanthan (19) and therefore consistent with the proposed structure.

As a result of this, the polymers of glucuronic acid can be considered as a genuine part of all extracellular polysaccharides of species belonging to the order of Mucorales tested. The molecular mass of these polymers varied from 5.5 to 10 kD indicating an average of 30-60 glcA residues. The type of linkages of the residues liberated by acid hydrolysis remains unclear. It is unlikely that these residues originally were part of the  $\beta(1-4)$ -linked backbone as only monomeric glcA residues were found in the hydrolysates. However, they could be involved in glycosidic linkages with neutral sugars in side chains of the native extracellular polysaccharides. Since all EPS preparations tested were hydrolysed identically, it is likely that the variations in length of the  $\beta(1-4)$ -glcA polymers, and the amount of glcA in these polymers relative to that in the initial EPS preparations, indicate structural differences

between the various EPS preparations.

The  $\beta(1-4)$ -linked D-glucuronic acid polymers isolated from extracellular polysaccharides of mould species belonging to Mucorales may be similar to mucoric acid, the polyuronide which was isolated from cell walls of these moulds (2,6,30). However, in all preparations tested only one polyglucuronic acid fraction could be isolated from EPS as opposed to two distinct fractions varying in molecular mass and charge, isolated from cell walls of *Absidia cylindrospora*, *Mucor mucedo*, *Rhizopus stolonifer* (30) and *Mucor rouxii* (11). The  $\beta(1-4)$  polyglucuronides isolated from EPS preparations resembled mostly fraction II of the mucoric acid preparations isolated from mycelia by Tsuchihashi *et al.* (30), as they behave similarly on an anion-exchange column and in a size-exclusion chromatography system.

Biosynthesis of mucoran in the cell wall of *Mucor rouxii* is reported to be dependent on the action of fucosyl transferases using polyglucuronic acid as a precursor (5). It is not clear whether the presence of traces fucose in our isolated polyglucuronides indicate a role in the biosynthesis of EPSs as previously proposed (10).

In conclusion, the polymers of  $\beta(1-4)$ -linked D-glucuronic acid can be considered as a common and characteristic structural element of EPSs of moulds belonging to Mucorales. However, the antigenic properties of the native EPSs do not reside in these  $\beta(1-4)$ -glucuronic acid segments, but probably in the neutral sugar part.

## References

1. Bartnicki-Garcia, S. and B. Lindberg. 1972. Partial characterization of mucoran: the glucuronomannan component. *Carbohydr. Res.* 23:75-85.
2. Bartnicki-Garcia, S. and E. Reyes. 1968. Polyuronides in the cell walls of *Mucor rouxii*. *Biochim. Biophys. Acta* 170:54-62.
3. BeMiller, J.N. 1967. Acid-catalyzed hydrolysis of glycosides. *Adv. Carbohydr. Chem.* 22:25-108.
4. Blumenkrantz, N. and G. Asboe-Hansen. 1973. New method for quantitative determination of uronic acids. *Anal. Biochem.* 54:484-489.
5. Camacho-Aguero, S., R. Balcazar-Orozco and A. Flores-Carreón. 1990. Biosynthesis of polyuronides in *Mucor rouxii*: Partial characterization of fucosyl transferase. *Exp. Mycol.* 14:227-233.
6. Datema, R., H. Van den Ende and J.G.H. Wessels. 1977. The hyphal wall of *Mucor mucedo*. 1. Polyanionic polymers. *Eur. J. Biochem.* 80:611-619.
7. De Ruiter, G.A., T. Hoopman, A.W. Van der Lugt, S.H.W. Notermans and M.J.R. Nout. 1992. Immunochemical detection of Mucorales species in food, p. 221-227. In R.A. Samson, A.D. Hocking, J.I. Pitt and A.D. King (eds), *Modern Methods in Food Mycology*, Elsevier Publishers, Amsterdam.
8. De Ruiter, G.A., A.W. Van der Lugt, A.G.J. Voragen, F.M. Rombouts and S.H.W. Notermans. 1991. High-performance size-exclusion chromatography and ELISA detection of extracellular polysaccharides from Mucorales. *Carbohydr. Res.* 215:47-57 (this thesis, Chapter 3).
9. De Ruiter, G.A., P. Smid, A.W. Van der Lugt, J.H. Van Boom, S.H.W. Notermans and F.M. Rombouts. 1991. Immunogenic extracellular polysaccharides of Mucorales, p. 169-180. In J.-P. Latgé and D. Boucias (eds), *Fungal Cell Wall and Immune Response*. NATO ASI Ser. H 53. Springer Verlag, Berlin.
10. Dow, J.M., R.R. Carreón and V.D. Villa. 1981. Role of membranes of mycelial *Mucor rouxii* in synthesis

- and secretion of cell wall matrix polymers. *J. Bacteriol.* 145:272-279.
11. Dow, J.M., D.W. Darnall and V.D. Villa. 1983. Two distinct classes of polyuronide from the cell walls of a dimorphic fungus *Mucor rouxii*. *J. Bacteriol.* 155:1088-1093.
  12. Englyst, H.N. and J.H. Cummings. 1984. Simplified method for the measurement of total non-starch polysaccharides by gas-liquid chromatography of constituent sugars as alditol acetates. *Analyst* 109:937-942.
  13. Hakomori, S. 1964. A rapid permethylation of glycolipid, and polysaccharide catalyzed by methylsulfinyl carbanion in dimethyl sulfoxide. *J. Biochem. (Tokyo)* 55:205-208.
  14. Hough, L. and M.B. Perry. 1955. An extracellular polysaccharide from *Mucor racemosus*. *Biochem. J.* 61:viii-ix.
  15. De Ruiter, G.A., H.A. Schols, A.G.J. Voragen and F.M. Rombouts. 1992. Carbohydrate analysis of water-soluble uronic acid containing polysaccharides with high-performance anion-exchange chromatography using methanolysis combined with TFA hydrolysis is superior to four other methods. *Anal. Biochem.* 207:176-185 (this thesis, Chapter 4).
  16. Martin, S.M. and G.A. Adams. 1956. A survey of fungal polysaccharides. *Can. J. Microbiol.* 34:715-721.
  17. McNeil, M., J. Darvill, A.G. Darvill, P. Albersheim, R. Van Veen, P. Hooykaas, R. Schilperoort and A. Dell. 1986. The discernible, structural features of the acidic polysaccharides secreted by different *Rhizobium* species are the same. *Carbohydr. Res.* 146:307-326.
  18. Miyazaki, T. and T. Irino. 1972. Studies on fungal polysaccharides. X. Extracellular heteroglycans of *Absidia cylindrospora* and *Mucor mucedo*. *Chem. Pharm. Bull.* 20:330-335.
  19. Morris, E.R., D.A. Rees, G. Young, M.D. Walkinshaw and A. Darke. 1977. Order-disorder transition for a bacterial polysaccharide in solution. A role for polysaccharide conformation in recognition between *Xanthomonas* pathogen and its plant host. *J. Mol. Biol.* 110:1-16.
  20. Notermans, S. and C.J. Heuvelman. 1985. Immunological detection of moulds in food by using the enzyme-linked immunosorbent assay (ELISA); preparation of antigens. *Int. J. Food Microbiol.* 2:247-258.
  21. Nout, M.J.R. and F.M. Rombouts. 1991. A review: Recent developments in tempe research. *J. Appl. Bacteriol.* 69:609-633.
  22. Pilnik, W. and A.G.J. Voragen. 1970. Pectic substances and other uronides, p. 53-87. In A.C. Hulme (ed), *The biochemistry of fruits and their products*. vol. I. Academic Press, London.
  23. Pitt, J.I. and A.D. Hocking. 1985. *Fungi and Food Spoilage*. Academic Press, Sydney, New York.
  24. Rombouts, F.M. and J.-F. Thibault. 1986. Feruloylated pectic substances from sugar-beet pulp. *Carbohydr. Res.* 154:177-187.
  25. Sedmak, J.J. and S.E. Grossberg. 1977. A rapid, sensitive, and versatile assay for protein using coomassie brilliant blue G250. *Anal. Biochem.* 79:544-552.
  26. Shively, J.E. and H.E. Conrad. 1976. Formation of anhydrosugars in the chemical depolymerization of heparin. *Biochem.* 15:3932-3942.
  27. Sime, W.J. 1990. Alginates, p. 53-78. In P. Harris (ed), *Food Gels*. Elsevier Appl. Sc., London.
  28. Taylor, R.L. and H.E. Conrad. 1972. Stoichiometric depolymerization of polyuronides and glycosaminoglycuronans to monosaccharides following reduction of their carbodiimide-activated carboxyl groups. *Biochem.* 11:1383-1388.
  29. Thibault, J.-F. 1979. Automatisation du dosage des substances pectiques par la méthode au méta-hydroxydiphényl. *Lebensm. Wiss. Technol.* 12:247-251.
  30. Tsuchihashi, H., T. Yadomae and T. Miyazaki. 1983. Structural analysis of the cell-wall D-glucuronans from the fungi *Absidia cylindrospora*, *Mucor mucedo* and *Rhizopus nigricans*. *Carbohydr. Res.* 111:330-335.
  31. Tsuchihashi, H., T. Yadomae and T. Miyazaki. 1983. Structural analyses of L-idurono-D-glucuronans (Phallic acids) isolated from fungi belonging to the Phallales. *Carbohydr. Res.* 122:174-177.

## 2-O-methyl-mannose is a constituent of the epitopes of mucoralean extracellular polysaccharides

*Journal of Bacteriology*<sup>1</sup> (1993) submitted.

The structure of the carbohydrate epitopes of the extracellular polysaccharides from mould species belonging to Mucorales was studied by their degradation with a purified exo- $\alpha$ -D-mannanase and a  $\alpha$ -mannosidase. Analysis of the reaction products after enzymatic treatment, using high-performance anion-exchange chromatography with pulsed-amperometric detection and gas-liquid chromatography combined with mass spectrometry, revealed the presence of 2-O-methyl-mannose residues. This compound is a constituent of the polysaccharides from the mould genera *Mucor*, *Rhizopus*, *Rhizomucor*, *Absidia*, *Syncephalastrum* and *Thamnidium*. Its occurrence in fungi has not been reported up till now. Degradation studies with the newly isolated epitope-degrading exo- $\alpha$ -D-mannanase and an  $\alpha$ -mannosidase from Jack beans indicated an important role for these 2-O-methyl-mannose residues in the carbohydrate epitopes of mucoralean moulds.

### Introduction

Moulds belonging to the order of Mucorales (Zygomycetes), including the genera *Mucor*, *Rhizopus*, *Rhizomucor*, *Syncephalastrum*, *Absidia* and *Thamnidium* have a worldwide distribution and are responsible for many cases of food spoilage (26,27). Some mucoralean moulds are important as the cause of mucormycosis (zygomycosis) in humans (16,32). Antigenic polysaccharides are excreted by all species of this order which have been tested. The polysaccharides possess antigenic properties similar to those of the cell wall material (7,8,12). Polyclonal immunoglobulin G (IgG) antibodies raised against extracellular polysaccharides (EPSs) of *Mucor racemosus* are very specific for mould species belonging to Mucorales. No cross reactions with EPSs from other not related mould genera are observed (8).

---

<sup>1</sup>Authors: G.A. De Ruiter, A.W. Van Bruggen-van der Lugt, P. Smid, J.H. van Boom, and F.M. Rombouts.

In a search for the antigenic entities of the EPSs derived from mucoralean moulds, attempts have been made to characterize the EPSs chemically and immunologically (1,9,13,15,19,20,23,36). In these studies, the presence of fucose, mannose, galactose, glucose, hexosamines, glucuronic acid and protein was established. Furthermore, polymers of  $\beta$ -D-(1-4)-glucuronic acid have been described as a structural entity of these polysaccharides (4), but these are not antigenic (4,14,21,23,35). Immunologically active oligomers were isolated from the EPS of *Absidia corymbifera* and characterised as  $\alpha$ (1-6)-linked mannose residues. Consequently,  $\alpha$ (1-6)-linked mannose sequences were proposed as common antigenic determinants of Mucorales (22). Further studies pointed to a possible role for  $\alpha$ (1-2)-mannose residues in these epitopes (36). However, antibodies raised against mucoralean polysaccharides did not show any cross-reactivity towards mannans obtained from various yeasts such as *Candida albicans* and *Saccharomyces cerevisiae* which are composed of  $\alpha$ (1-2)- and  $\alpha$ (1-6)-linked mannose residues mainly (8,12,23). Also, synthesized dimers of both  $\alpha$ (1-2)- and  $\alpha$ (1-6)-linked mannose residues did not bind to an high-performance immunoaffinity column prepared from IgG antibodies raised against EPS of *M. racemosus* (6). To explain these apparent contrasting results, the structure of the epitopes of mucoralean polysaccharides have to be studied with more refined methods.

Recently, we have shown that purified enzymes can be used as sophisticated tools for the elucidation of fungal carbohydrate epitopes. The use of an *exo*- $\beta$ -D-galactofuranosidase combined with reductive-cleavage analysis of the EPSs allowed us to prove that  $\beta$ -D-(1-5)-linked galactofuranoside oligomers were uniquely responsible for the antigenic properties of *Penicillium* and *Aspergillus* (33).

In this paper, the purification is reported of an *exo*- $\alpha$ -D-mannanase which is able to degrade specifically the antigenic parts of the mucoralean EPSs. These EPSs were degraded with this enzyme and the products were analysed by high-performance anion-exchange chromatography (HPAEC) and by gas-liquid chromatography (GLC)-mass spectrometry after derivatisation to alditol acetates. 2-O-Methyl-mannose residues were detected and their role as antigenic determinants of these moulds is discussed.

## Materials and methods

### *Isolation and purification of EPSs*

Extracellular polysaccharides of the strains *Mucor hiemalis* CBS 201.28, *M. racemosus* CBS 222.81, *M. circinelloides* M 40, *Rhizopus stolonifer* CBS 609.82, *Rhizomucor pusillus* CBS 432.78, *Absidia corymbifera* LU 017, *Syncephalastrum racemosum* CBS 443.59, and *Thamnidium elegans* CBS 342.55 were produced, isolated and purified by

ethanol precipitation as described (9). Mannans from the yeasts *Candida lambica* PB 1 B, *Hansenula holstii* CBS 2028, *Pichia membranaefaciens* CBS 107, and *Saccharomyces exiguus* WM 5 were isolated as described (8,9).

#### *Periodate oxidation*

A polysaccharide sample (5 mg) was treated with 2 ml of a solution of 50 mM NaIO<sub>4</sub> in 0.25 M formic acid, adjusted to pH 3.7 with 1 M NaOH, for different incubation times at 4 °C. The excess periodate was inactivated after incubation by addition of 400 µl of 1,2-ethane diol and incubation for 1 h. The oxidized polysaccharide was reduced by addition of 4 ml of 0.5 M sodium borohydride in 1 M NaOH and incubation for 16 h at 25 °C. The mixture was cooled on ice and 300 µl of acetic acid was added twice to destroy the excess of NaBH<sub>4</sub>. The polysaccharide was recovered by lyophilization after one night dialysis against running tap water followed by 24 h dialysis against several changes of distilled water.

#### *Enzyme preparations*

The epitope-degrading exo- $\alpha$ -D-mannanase was purified from a crude enzyme preparation of fungal origin (*Trichoderma harzianum*), commercially available as Glucanex (Novo Nordisk Ferment AG, Dittingen, Switzerland). An  $\alpha$ -D-mannosidase (EC 3.2.1.24) isolated from Jack beans (*Canavalia ensiformis*) was obtained from Sigma Chemical Co. (M 7257, St. Louis, MO, USA) and used without further purification.

#### *Determination of the neutral sugar composition and protein content*

The carbohydrate composition of EPS fractions was determined after liberation of the respective sugar residues by methanolysis combined with TFA hydrolysis as described recently (5). Subsequently, the amount of liberated monosaccharide residues was estimated with the use of HPAEC using a Dionex Bio-LC high-performance liquid chromatography system (Dionex, Sunnyvale, CA U.S.A.) equipped with a CarboPac PA 100 column (4 x 250 mm) and pulsed-amperometric detection using a gold working electrode and an Ag-AgCl reference electrode as described (5).

Protein was determined by the colorimetric method of Sedmak and Grossberg (29), with bovine serum albumin (BSA) as the standard.

#### *Immunochemical analysis*

A non-competitive sandwich ELISA was carried out by first binding antibodies to the wall of a microtiter plate, followed by the addition of the sample to the wells and finally

by using the same antibodies conjugated to peroxidase. Polyclonal IgG antibodies (1000/1201) were obtained by immunization of rabbits with EPS from *M. racemosus* (24), and used in a sandwich ELISA using polyvinyl microtiter plates as described (9). The ELISA reactivity was expressed as the minimal detectable concentration of the EPSs which is the concentration of EPS in distilled water just giving a positive reaction, i.e. an extinction at 450 nm > 0.1 above that of a blank, containing no antigenic EPSs.

#### *Purification of the epitope-degrading exo- $\alpha$ -D-mannanase*

The purification was carried out at 4 °C, and all buffers contained 0.01 % (w/v) sodium azide to prevent microbial growth. Five grams of Glucanex were dissolved in 10 ml of 10 mM sodium acetate (pH 5.0) and the solution was centrifuged to remove solids. The epitope-degrading enzyme was isolated and purified from this preparation using anion-exchange chromatography and adsorption chromatography with an hydroxyapatite column as summarized in Fig. 1 according to the procedure as described previously for the purification of an exo- $\beta$ -D-galactofuranosidase (33). The final purification step was performed on an FPLC-system (fast protein liquid chromatography; Pharmacia LKB, Uppsala, Sweden) equipped with a Mono S HR 5/5 cation-exchange column (50 x 5 mm). Elution was done with sodium succinate buffer (20 mM, pH 4.0) and a sodium chloride gradient from 0 to 0.1 M, at a flow rate of 1 ml/min. During gradient elution, peak control was used to elute protein peaks with a minimum amount of contamination by maintaining the composition of the eluent at a fixed value during elution of the peaks. The epitope-degrading activity of different enzyme fractions was measured by incubation of EPS from *M. racemosus* and the respective enzyme fractions followed by a sandwich ELISA. Incubation was performed in a reaction mixture containing 175  $\mu$ l of EPS (10  $\mu$ g/ml) in 50 mM sodium acetate (pH 5.5) and 25  $\mu$ l of an enzyme fraction. After incubation for 16 h at 30 °C, the enzyme was inactivated by heat treatment (5 min, 100 °C) prior to the ELISA. The purity of the fractions containing the epitope-degrading enzyme was checked by sodium dodecyl sulphate (SDS)-gel electrophoresis.

#### *SDS-gel electrophoresis, isoelectric focusing and titration curve*

Determination of the molecular mass was performed by SDS-gel electrophoresis on a 10–15 % polyacrylamide gradient gel using the PhastSystem (Pharmacia LKB) according to the instructions of the supplier. Standards in the range of 10 to 100 kDa were used for calibration. The determination of the isoelectric point, isoelectric focusing and titration curves were performed on homogeneous polyacrylamide gels containing Pharmalyte carrier ampholytes, which generate a linear pH gradient from 3 to 9 in the gel. Standards with an isoelectric point in the range of 3 to 9 were used. Proteins were detected by Coomassie brilliant blue R-250 and silver staining.



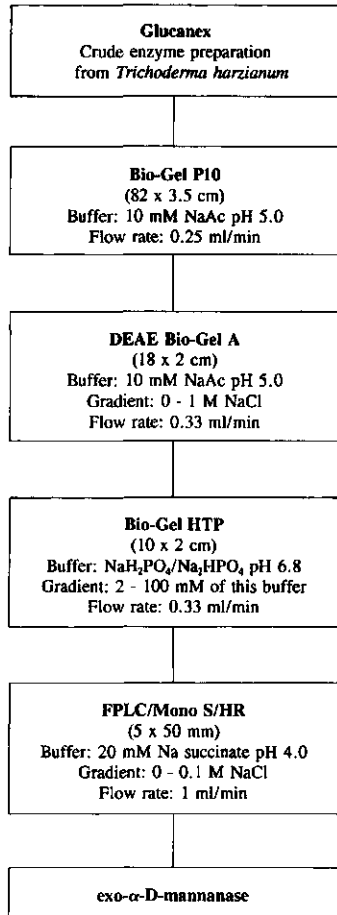

**Fig. 1.** Scheme of the purification of the mucoralean epitope-degrading exo- $\alpha$ -D-mannanase from a crude preparation of *Trichoderma harzianum*.

#### *Determination of the enzyme activity, temperature and pH optimum*

The activity of the purified exo- $\alpha$ -D-mannanase fraction (12.5  $\mu$ l) and the  $\alpha$ -D-mannosidase from Jack beans (12.5  $\mu$ l) was expressed in milliunits (mU) calculated after incubation with 175  $\mu$ l (1 mg/ml) of EPS from *M. racemosus* at 30 °C in 12.5  $\mu$ l of 2 M sodium acetate buffer (pH 5.0). One mU was defined as the amount of enzyme able to release one nmol mannose from this EPS preparation per minute at 30 °C and pH 5.0. The digests were subsequently analysed for the amount of mannose released after incubation for 1 and 2 h, using HPAEC as described above. Optimum temperature and optimum pH were determined with 350  $\mu$ l of a solution of EPS (1 mg/ml) from *M.*

*racemosus* buffered with 25  $\mu$ l of 2 M sodium acetate with a pH varying from 3 to 6. These solutions were incubated with 0.45 mU (25  $\mu$ l containing 125 ng of protein) purified exo- $\alpha$ -D-mannanase for 2 h at different temperatures between 20 and 60 °C. After inactivation of the enzyme (5 min, 100 °C) the release of carbohydrate residues was measured by HPAEC as described above.

#### *Substrate specificity of the enzymes*

Enzyme activity towards various *p*-nitrophenyl-glycosides (Sigma, St. Louis, Mo., U.S.A.) was measured spectrophotometrically at 405 nm, using the molar extinction coefficient 13.700 M<sup>-1</sup>cm<sup>-1</sup>. Differently linked mannose oligomers were used to test the specificity of the two enzymes. The dimers Me 2-*O*-( $\alpha$ -D-man)- $\alpha$ -D-man, Me 6-*O*-( $\alpha$ -D-man)- $\alpha$ -D-man and the corresponding  $\alpha$ -D-(1-2)-linked tetramer were synthesized using the iodonium ion-assisted stereospecific glycosylation procedure as described recently (30) and the non-methylated 3-linked dimer was purchased (Sigma M 8897). An aliquot of 50  $\mu$ l of the respective oligomers (2 mg/ml) was diluted with 135  $\mu$ l of 150 mM sodium acetate (pH 5) and incubated with 0.75 mU of the respective enzyme for 16 h at 30 °C. The amount of mannose released was determined by HPAEC as described above.

The mannan-degrading activity of the enzymes was also tested by incubation with four different yeast mannans. Incubation was performed using 175  $\mu$ g of purified mannan in 250  $\mu$ l of 80 mM sodium acetate buffer (pH 5) and 0.75 mU of the respective enzymes at 30 °C for 16 h. After inactivation of the enzymes, the products were analysed with HPAEC as described above.

Glucanase side activities were measured after incubation of the enzymes with different glucans as described (33).

#### *Enzymatic degradation of the epitopes of EPSs of mucoralean moulds*

Enzyme specificity was further studied by analysis of the reaction products after enzyme treatment of EPSs from different mucoralean species. An aliquot of 175  $\mu$ l of EPS solution (1 mg/ml) and 10  $\mu$ l of 2 M sodium acetate buffer (pH 5.0) were incubated with 0.75 mU (65  $\mu$ l) of either enzyme at 30 °C for 16 h, respectively. The antigenicity of the native and enzyme-treated EPSs were measured using the sandwich ELISA. After inactivation (5 min, 100 °C) the reaction products were analysed using HPAEC as described above and by GLC-mass spectrometry after derivatisation to alditol acetates.

#### *Preparation and analysis of alditol acetates*

The reaction products after enzymatic degradation were separated from the remaining polymeric material by using a Microsep filter (Filtron Technology Corp., Northborough,

MA, U.S.A.) with a cutoff of 10 kDa. The filtrate was transferred to a screw-cap tube and evaporated to dryness by a stream of air (25 °C). No further chemical hydrolysis was applied to the samples. The monosaccharides released by the enzyme were first reduced to alditols with NaBH<sub>4</sub> and subsequently converted into their corresponding alditol acetates using 1-methyl imidazole and acetic anhydride (5,10). Finally, ethylacetate was added and the solution was transferred to a vial and sealed. The alditol acetates were analysed by GLC-mass spectrometry using a Hewlett-Packard 5890-5970 MSD equipped with a Chrompack CP Sil 19 CB (Middelburg, The Netherlands) capillary column (26 m, i.d. 0.22 mm, film thickness 0.18 µm) with a temperature gradient of 160-250 °C, 2 °C/min.

## Results

### *Periodate treatment of the EPSs*

As the EPS preparations of Mucorales contain both carbohydrate and protein segments, the antigenicities were studied by periodate treatment. Short treatment of glycoproteins with a low concentration of periodate is reported to attack specifically the vicinal OH-groups of carbohydrate residues and does hardly affect the amino acids of the protein part (2). The EPS preparations were treated with 50 mM sodium periodate for periods of 15 min, 1 h, 8 h, 24 h and 6 days. The antigenicity of the EPSs before and after periodate treatment was established by the sandwich ELISA. In all cases, a complete loss of antigenicity of the polysaccharides was observed after periodate treatment (results not shown). Sugar analysis before and after periodate treatment by methanolysis combined with TFA hydrolysis and HPAEC revealed that the galactose, mannose and glucose residues were destroyed by periodate treatment, whereas the fucose residues were hardly affected (results not shown).

### *Purification of the epitope-degrading exo- $\alpha$ -D-mannanase*

Forty crude enzyme preparations were checked on their ability to degrade the antigenic determinants of EPSs from Mucorales. Glucanex, an enzyme preparation isolated from the fungus *Trichoderma harzianum*, was found to contain this activity. The enzyme did not bind to the DEAE Bio-Gel A anion-exchange column and was not retained on a hydroxyapatite-column (Fig. 1). The non-adsorbing fraction of the latter column was separated further with a Mono S/HR cation-exchange column using the FPLC (Fig. 2). To point out the protein fractions which were able to degrade the epitopes of *M. racemosus* EPS, each fraction eluting from this column was incubated with EPS and the

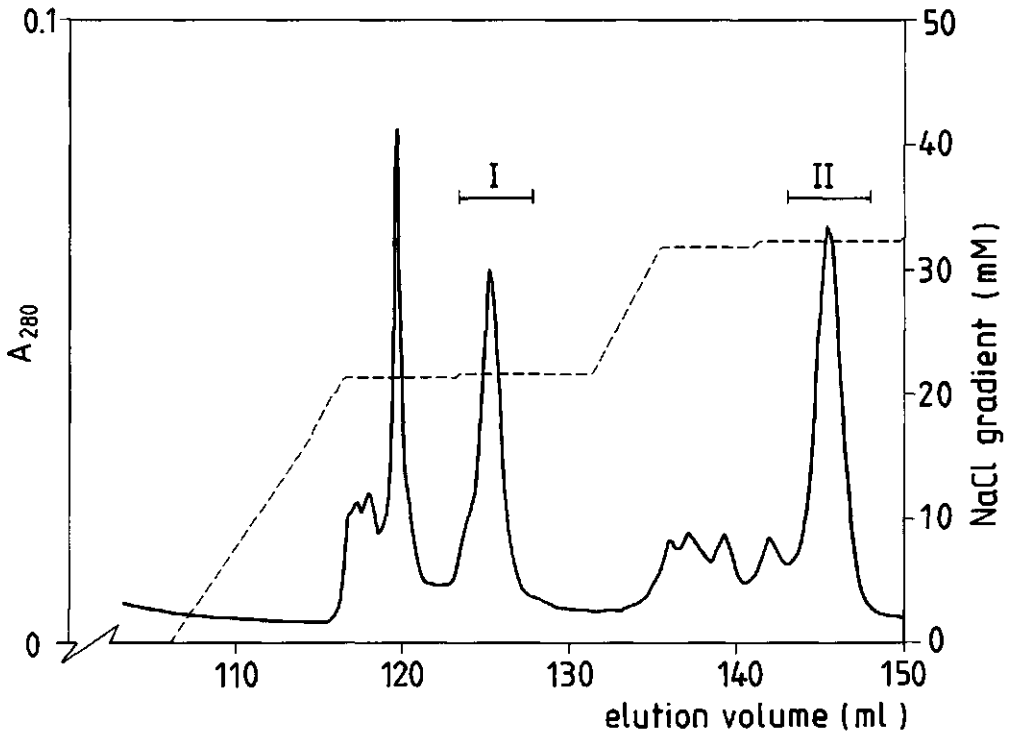
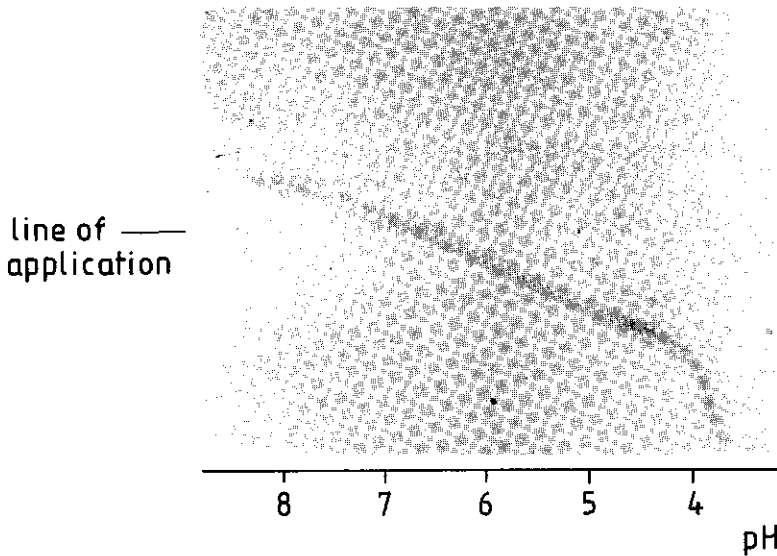

**Fig. 2.** FPLC purification of the epitope-degrading exo- $\alpha$ -D-mannanase on a mono S cation-exchange column using a sodium chloride gradient in a sodium succinate buffer. Symbols: —,  $A_{280}$ ; ----, NaCl concentration of the effluent. Fractions I and II were pooled as indicated.

ELISA thereof was measured subsequently. The fractions which possessed epitope-degrading activity (I and II; Fig. 2) were checked by isoelectric focusing and two enzyme fractions could be isolated. The isoelectric points of the two fractions were 6.6 and 7.0, respectively. Their molecular masses measured by SDS-gel electrophoresis were identical (50 kDa). The titration curves, indicating the purity and the electrophoretic mobility of the protein at different pH values, revealed homogeneous enzymes as illustrated for fraction I in Fig. 3.

#### *Activity of the enzymes towards various substrates*

In all cases, the enzyme fractions I and II obtained from cation-exchange chromatography (Fig. 2) showed identical activities towards the different substrates tested and only differed in their isoelectric point. Therefore, these fractions were considered to be similar and called epitope-degrading exo- $\alpha$ -D-mannanase in the rest of this paper. The enzyme



**Fig. 3.** Titration curve of the purified epitope-degrading exo- $\alpha$ -D-mannanase (I), using a pH gradient from 3 to 9. The protein on the gel was stained with silver.

did not show any activity towards the *p*-nitrophenyl derivatives of the pyranose residues of  $\alpha$ - and  $\beta$ -D-mannose,  $\beta$ -D-glucose,  $\alpha$ -L-fucose, and  $\beta$ -D-glucuronic acid even after incubation for 24 h. The epitope-degrading exo- $\alpha$ -D-mannanase was active towards the  $\alpha$ -D-(1-2)-mannose dimer and tetramer, showed a slight activity towards the  $\alpha$ -D-(1-3)-dimer of mannose, but was not active on the  $\alpha$ -D-(1-6)-dimer of mannose. Opposed to this, the  $\alpha$ -D-mannosidase from Jack beans showed activity towards the *p*-nitrophenyl derivative of  $\alpha$ -D-mannose, and was also able to hydrolyse the glycosidic linkages of all the  $\alpha$ -linked D-mannose oligomers tested.

Both the  $\alpha$ -D-mannosidase and our exo- $\alpha$ -D-mannanase released similar amounts of mannose after incubation with the yeast mannans tested. The epitope-degrading exo- $\alpha$ -D-mannanase contained traces of glucanase activity as the enzyme was able to release minor amounts of glucose from glucans, while the  $\alpha$ -D-mannosidase did not contain this activity. However, no release of glucose was observed after incubation with the mucoralean EPS preparations, therefore, no attempts were made to remove this glucanase side-activity.

#### *Enzymatic degradation of the EPSs of mucoralean moulds*

The action of the purified exo- $\alpha$ -D-mannanase on the EPSs of Mucorales was compared with the action of  $\alpha$ -D-mannosidase. The immunoreactivity of eight EPS preparations originating from six different genera within the order of Mucorales was determined both

**Table 1.** Immunoreactivity of mucoralean EPSs tested with a sandwich ELISA before and after treatment (16 h, 30 °C, pH 5.0) with  $\alpha$ -D-mannosidase or the epitope degrading *exo*- $\alpha$ -D-mannanase<sup>a</sup>.

Origin of EPS	Native EPS	After treatment with	
		$\alpha$ -D-mannosidase	<i>exo</i> - $\alpha$ -D-mannanase
<i>M. racemosus</i>	++	+	-
<i>M. hiemalis</i>	++	++	-
<i>M. circinelloides</i>	++++	++++	+
<i>R. stolonifer</i>	+++	+++	-
<i>Rhm. pusillus</i>	+++	+++	-
<i>A. corymbifera</i>	++	++	-
<i>S. racemosum</i>	++	++	-
<i>T. elegans</i>	++	++	-

<sup>a</sup> Immunoreactivity expressed as the minimal detectable concentration in the ELISA: + + + +, < 10 ng/ml; + + +, 10 - 100 ng/ml; + +, 100 - 1000 ng/ml; +, 1 - 10  $\mu$ g/ml; -, > 10  $\mu$ g/ml.

before and after treatment with the enzymes by measuring their ELISA reactivities. As shown in Table 1, treatment of the EPSs with the Jack bean  $\alpha$ -D-mannosidase did not affect the antigenicity of the polysaccharides, as the ELISA reactivity before and after enzyme treatment was almost similar. Opposed to this, incubation with the *exo*- $\alpha$ -D-mannanase resulted in a complete disappearance of the antigenicity of the mucoralean EPSs as in most cases the minimal detectable concentration before enzyme treatment (10 to 1000 ng/ml) increased to more than 10  $\mu$ g/ml after enzyme treatment (Table 1).

The reaction products obtained after degradation of the mucoralean EPSs were analysed with HPAEC as illustrated for *M. circinelloides* in Fig. 4. Mannose was released with  $\alpha$ -D-mannosidase (Fig. 4a) and with the epitope-degrading *exo*- $\alpha$ -D-mannanase (Fig. 4b) as is apparent from the peak with a retention time of 12.5 min in this chromatographic system. The amount of mannose liberated from the mucoralean EPSs by the *exo*- $\alpha$ -D-mannanase was in all cases slightly higher than the amount released by  $\alpha$ -D-mannosidase, except in case of *M. racemosus*, as shown in Table 2. The HPAEC chromatogram of the reaction products of the epitope-degrading enzyme (Fig. 4b) revealed the presence of a characteristic second peak with a retention time of approx. 8.3 min. This compound was released after enzymatic treatment of all EPS preparations of Mucorales tested with the epitope-degrading *exo*- $\alpha$ -D-mannanase enzyme but not with the  $\alpha$ -D-mannosidase. However, it was not possible to identify the structure of this compound with the use of HPAEC technology. Compounds which are expected to elute in this region using these chromatographic conditions are arabinose, methyl-ethers of sugars and the 2-deoxy-2-aminosugars (5,17).

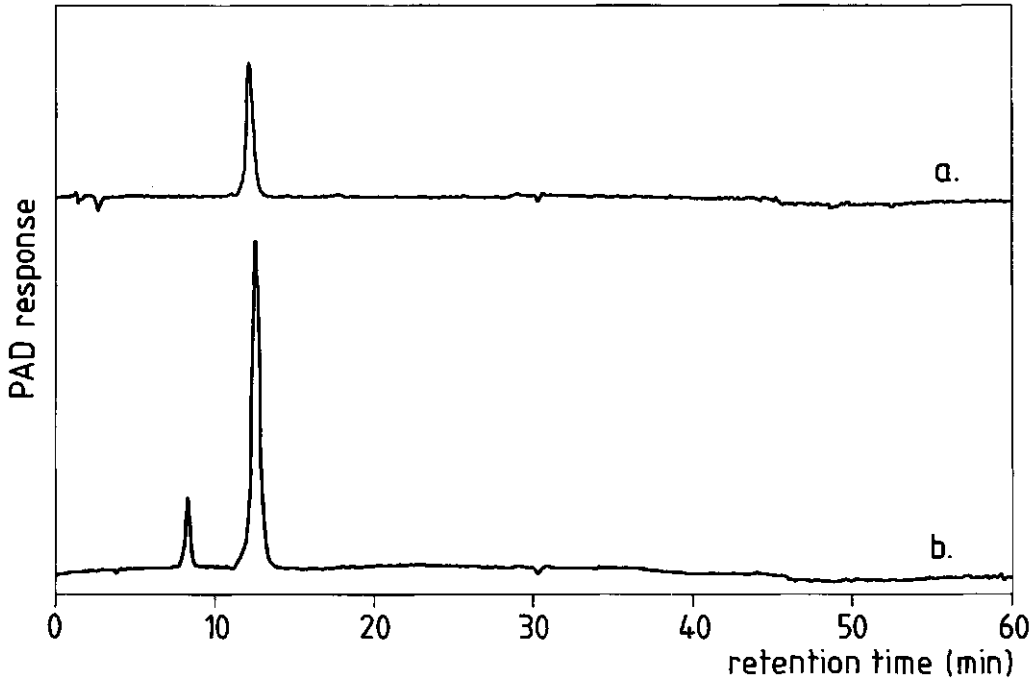

**Fig. 4.** High-performance anion-exchange chromatogram of the reaction products obtained after incubation of EPS from *Mucor circinelloides* with the  $\alpha$ -D-mannosidase (a) and with the epitope-degrading exo- $\alpha$ -D-mannanase (b). The main peak with a retention time of 12.5 min represents mannose. PAD, pulsed-amperometric detection.

#### GLC-mass spectrometry analysis of the enzyme reaction products

In order to characterize the unknown compound with a retention time of 8.3 min on the HPAEC system, the EPS reaction products obtained with the epitope-degrading enzyme were isolated by filtration. This filtration step resulted in a slight loss of material probably retained by the filter material. After separation, the products released by the enzymes were converted into the corresponding alditol acetates after reduction of the aldehyde function on the C-1 to an alcohol without any further chemical hydrolysis step. The alditol acetates prepared from the reaction mixture of the EPS preparation of *M. hiemalis* were analysed by GLC-mass spectrometry resulting in the chromatogram shown in Fig. 5, with mannose (retention time 21.7 min) as the main component. The mass spectrum of the unknown compound (inset) with a retention time of 19.3 min was identified as belonging to the alditol acetate of a 2-*O*-methyl-hexose residue (11). In principle, the mass spectrum shown in Fig. 5 can originate from the alditol acetates of 2-*O*-methyl-mannose, 2-*O*-methyl-galactose and 2-*O*-methyl-glucose as their alditol

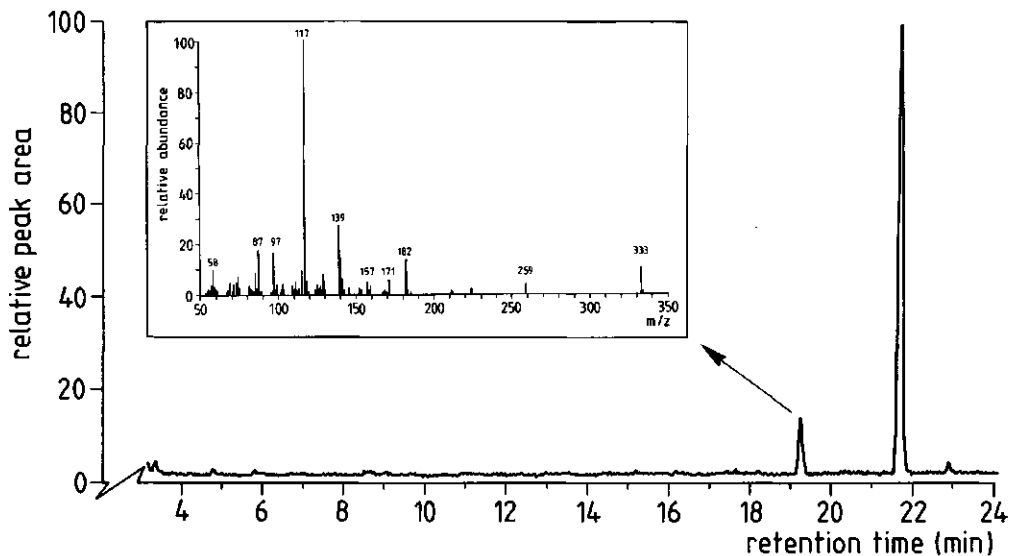

**Fig. 5.** GLC-mass spectrometry chromatogram of the reaction products obtained after incubation of EPS from *Mucor hiemalis* with the epitope-degrading exo- $\alpha$ -D-mannanase after derivatisation to alditol acetates. The mass spectrum of the compound with a retention time 19.3 min, which is assigned to 2-*O*-methyl-mannose, is given as inset.

acetates only differ in their retention time on the GLC column (11). Therefore, the retention time of the characteristic unknown compound was compared with the retention times of the alditol acetates of the 2-*O*-methyl ethers of mannose, galactose and glucose, using GLC columns with different polarity (results not shown). This unequivocally revealed that the presence of both 2-*O*-methyl-glucose and 2-*O*-methyl-galactose could be excluded. In conclusion, our epitope-degrading exo- $\alpha$ -D-mannanase released both mannose and 2-*O*-methyl-mannose residues from *M. hiemalis* EPS. No attempts were made to reveal the absolute configuration (D or L) of the 2-*O*-methyl-mannose residues.

The amount of 2-*O*-methyl-mannose residues which was liberated by this enzyme was determined by HPAEC from seven other mucoralean EPS preparations as listed in Table 2. Quantification was performed using the molar response factors from mannose (5).

#### *Combined enzymatic treatment of EPSs*

The role of the mannose and the 2-*O*-methyl-mannose residues in the antigenicity of the mucoralean polysaccharides was further studied by combined enzyme treatment. Eight different EPS preparations were incubated first with the  $\alpha$ -D-mannosidase from Jack beans and checked for their remaining ELISA activity, which did not decrease. After removal of



**Table 2.** Products liberated upon degradation of EPSs isolated from moulds belonging to the order of Mucorales with  $\alpha$ -D-mannosidase, the epitope-degrading exo- $\alpha$ -D-mannanase and the two enzymes consecutively.

Origin of EPS	$\alpha$ -D-mannosidase	exo- $\alpha$ -D-mannanase		exo- $\alpha$ -D-mannanase after $\alpha$ -D-mannosidase
	Man <sup>a</sup>	Man <sup>a</sup>	2-O-Me-Man <sup>b</sup>	additional Man <sup>c</sup>
<i>M. racemosus</i>	8.1 (63)	7.0 (54)	0.1	0.2
<i>M. hiemalis</i>	2.1 (14)	3.2 (20)	0.2	0.4
<i>M. circinelloides</i>	2.4 (7)	6.7 (19)	0.9	0.6
<i>R. stolonifer</i>	2.8 (29)	3.2 (33)	0.3	0.2
<i>Rhm. pusillus</i>	5.7 (37)	6.2 (41)	0.3	0.4
<i>A. corymbifera</i>	0.6 (8)	1.1 (14)	0.4	< 0.1
<i>S. racemosum</i>	11.5 (55)	15.1 (73)	0.3	0.6
<i>T. elegans</i>	1.6 (19)	2.4 (28)	0.2	0.3

<sup>a</sup> Expressed in  $\mu$ g released from 175  $\mu$ g of EPS used in the incubation experiments. The values in brackets represent the amount expressed as relative to the initial amount of mannose present in these EPSs (calculated with data derived from ref. 5).

<sup>b</sup> Amount of 2-O-methyl-mannose residues liberated from 175  $\mu$ g EPS expressed in  $\mu$ g, calculated with the relative response factor of mannose (5).

<sup>c</sup> Expressed in  $\mu$ g, EPS (175  $\mu$ g) was first incubated with  $\alpha$ -D-mannosidase and after removal of the reaction products by filtration subsequently incubated with exo- $\alpha$ -D-mannanase. Values were not corrected for slight losses due to filtration.

the liberated mannose residues by filtration, the  $\alpha$ -D-mannosidase-treated EPSs were incubated with the epitope-degrading exo- $\alpha$ -D-mannanase. Along with the characteristic 2-O-methyl-mannose residues (not listed) additional mannose was liberated in all cases (shown in Table 2) after subsequent incubation with the exo- $\alpha$ -D-mannanase.

## Discussion

Mild periodate oxidation of the antigenic mucoralean EPSs was done to find out if the antigenicity of EPSs resides in the carbohydrate or in the protein moiety. This treatment resulted in the complete loss of ELISA reactivity with IgG antibodies raised against the EPS of *M. racemosus* and in the loss of some sugar residues. As amino acids of glycoproteins can only be oxidized by periodate if higher concentrations and longer incubation times are used (2), it can be assumed that only sugar residues containing

vicinal -OH groups have been oxidized with 50 mM sodium periodate in less than 1 h as used in this study. Therefore, the antigenicity of EPS preparations of moulds belonging to the order of Mucorales is based on the integrity of those sugar residues. As the fucose residues were not affected by periodate oxidation it can be assumed that they play no role in the antigenicity of these EPS preparations with polyclonal IgG antibodies. This is in agreement with previous hapten inhibition studies with synthesized fucose oligomers (7,30).

To reveal the composition of the carbohydrate epitopes, an enzyme which was able to decrease the ELISA reactivity of mucoralean polysaccharides, was purified to homogeneity. This enzyme acted as an exo-enzyme as only monomers were released from yeast mannans and from fungal EPSs. However, no activity was found on the *p*-nitrophenyl-derivative of  $\alpha$ -D-mannose, indicating that the enzyme needs more than one sugar residue for binding. Although the absolute configuration of the released products was not determined, it is very likely that the enzyme only released monomers with the D-configuration as it was able to degrade  $\alpha$ (1-2)-linked oligomers synthesized from D-mannose. Therefore, this enzyme should be called an exo- $\alpha$ -D-mannanase (31) as opposed to the  $\alpha$ -D-mannosidase from Jack beans which also acted on the *p*-nitrophenyl- $\alpha$ -D-mannoside. The exo- $\alpha$ -D-mannanase, purified from *Trichoderma harzianum*, liberated both the terminal residues from  $\alpha$ -D-(1-2)-linked chains of mannose and terminal 2-*O*-methyl-mannose residues. The  $\alpha$ -D-mannosidase was able to split off non-reducing terminal  $\alpha$ -D-mannose residues only but did not influence the antigenicity of EPSs of Mucorales. Probably, the  $\alpha$ -D-mannosidase was hindered by 2-*O*-methyl-mannose residues whereas the exo- $\alpha$ -D-mannanase was not.

Incubation of the EPS preparations with  $\alpha$ -D-mannosidase followed by exo- $\alpha$ -D-mannanase showed that the second enzyme liberates additional mannose residues. However, as the  $\alpha$ -D-mannosidase cleaves all the freely exposed differently linked  $\alpha$ -D-mannose residues, it can be concluded that the mannose residues which are liberated after subsequent exo- $\alpha$ -D-mannanase treatment originate from mannose-chains which arise after removal of the 2-*O*-methyl-mannose residues. This enzyme completely abolished the ELISA activity of polysaccharides from Mucorales, whereas the  $\alpha$ -D-mannosidase did not affect this activity. It can therefore be concluded that the epitopes reactive with polyclonal IgG antibodies carry a 2-*O*-methyl-mannose residue at their non-reducing terminal. However, these results do not allow to conclude if the epitopes are entirely made up of 2-*O*-methyl-mannose, or partly also of mannose residues. The presence of the terminal 2-*O*-methyl-mannose residue at the mucoralean epitopes clearly explains why cross-reactions of polyclonal IgG antibodies raised against EPSs from Mucorales were never observed with mannans from the yeast species of the genera *Saccharomyces* and *Candida* which are mainly constituted of  $\alpha$ (1-2)- and  $\alpha$ (1-6)-linked D-mannose chains.

*O*-Methyl ethers of sugars are characteristic constituents of lipopolysaccharides from photosynthetic bacteria (18,34). The 2-*O*-methyl-mannose residue has been determined in

a lipopolysaccharide from the cyanobacterium *Synechocystis* (28). In fungi, the O-methyl ethers of sugars are less common, but the 3-O-methyl ether from mannose has been reported as an important compound of the conidial walls of *Coccidioides immitis* (3,18). To our knowledge, the occurrence of 2-O-methyl-mannose in fungi has never been reported before. Also, 2-O-methyl mannose has been reported in soil after hydrolysis of raw humus (25), in which it may have originated from polysaccharides of mucoralean moulds, as these are ubiquitously present in soil (27).

In conclusion, this purified exo- $\alpha$ -D-mannanase was a very useful tool for the elucidation of the antigenic determinants of EPSs of different species of Mucorales. It was shown that 2-O-methyl-mannose is a constituent of the antigenic part of polysaccharides of the genera *Mucor*, *Rhizopus*, *Rhizomucor*, *Absidia*, *Syncephalastrum* and *Thamnidium*. This compound could be detected in the reaction products by HPAEC and identified by GLC-mass-spectrometry. Consecutive action of  $\alpha$ -D-mannosidase and the epitope-degrading exo- $\alpha$ -D-mannanase shows that nearly all antigenic reactivity is abolished by removal from the EPSs of 2-O-methyl-mannose and some additional mannose. It can therefore not be concluded if the epitopes reactive with the polyclonal IgG epitopes are entirely made up of 2-O-methyl-mannose or if any  $\alpha$ (1-2)-linked mannose residues are also part of it.

## References

1. Bartnicki-Garcia, S., and B. Lindberg. 1972. Partial characterization of mucoran: the glucuronomannan component. *Carbohydr. Res.* 23:75-85.
2. Clamp, J.R., and L. Hough. 1965. The periodate oxidation of amino acids with reference to studies on glycoproteins. *Biochem. J.* 94:17-24.
3. Cole, G.T., and T.N. Kirkland. 1991. Conidia of *Coccidioides immitis*. Their significance in disease initiation, p. 403-443. In G.T. Cole and H.C. Hoch (ed.), *The fungal spore and disease initiation in plants and animals*. Plenum Press, New York.
4. De Ruiter, G.A., S.L. Josso, I.J. Colquhoun, A.G.J. Voragen, and F.M. Rombouts. 1992. Isolation and characterization of  $\beta$ (1-4)-D-glucuronans from extracellular polysaccharides of moulds belonging to Mucorales. *Carbohydr. Polym.* 18:1-7 (this thesis, Chapter 6).
5. De Ruiter, G.A., H.A. Schols, A.G.J. Voragen, and F.M. Rombouts. 1992. Carbohydrate analysis of water-soluble uronic acid containing polysaccharides with high-performance anion-exchange chromatography using methanolysis combined with TFA hydrolysis is superior to four other methods. *Anal. Biochem.* 207:176-185 (this thesis, Chapter 4).
6. De Ruiter, G.A., P. Smid, H.A. Schols, J.H. Van Boom, and F.M. Rombouts. 1992. Detection of fungal carbohydrate antigens by high-performance immunoaffinity chromatography using a protein A column with covalently linked immunoglobulin G. *J. Chromatogr.* 584:69-76 (this thesis, Chapter 5).
7. De Ruiter, G.A., P. Smid, A.W. Van der Lugt, J.H. Van Boom, S.H.W. Notermans, and F.M. Rombouts. 1991. Immunogenic extracellular polysaccharides of Mucorales, p. 169-180. In J.-P. Latgé and D. Boucias (ed.), *Fungal Cell Wall and Immune Response*. NATO ASI Ser. H 53, Springer

Verlag, Berlin.

8. De Ruiter, G.A., A.W. Van Bruggen-van der Lugt, M.J.R. Nout, W.J. Middelhoven, P.S.S. Soentoro, S.H.W. Notermans, and F.M. Rombouts. 1992. Formation of antigenic extracellular polysaccharides by selected strains of *Mucor* spp., *Rhizopus* spp., *Rhizomucor* spp., *Absidia corymbifera* and *Syncephalastrum racemosum*. *Antonie van Leeuwenhoek* 62:189-199 (this thesis, Chapter 2).
9. De Ruiter, G.A., A.W. Van der Lugt, A.G.J. Voragen, F.M. Rombouts, and S.H.W. Notermans. 1991. High-performance size-exclusion chromatography and ELISA detection of extracellular polysaccharides from Mucorales. *Carbohydr. Res.* 215:47-57 (this thesis, Chapter 3).
10. Englyst, H.N., and J.H. Cummings. 1984. Simplified method for the measurement of total non-starch polysaccharides by gas-liquid chromatography of constituent sugars as alditol acetates. *Analyst* 109:937-942.
11. Jansson, P.-E., L. Kenne, H. Liedgren, B. Lindberg, and J. Lönnngren. 1976. A practical guide to the methylation analysis of carbohydrates. *Chem. Comm.* 8, University of Stockholm.
12. Hayashi, O., T. Yadomae, H. Yamada, and T. Miyazaki. 1978. Cross-reactivity of antiserum to *Absidia cylindrospora* among some Mucorales and other fungi. *J. Gen. Microbiol.* 108:345-347.
13. Hayashi, O., H. Yamada, T. Yadomae, and T. Miyazaki. 1978. Purification and partial characterization of the serologically active substance from *Absidia cylindrospora*. *J. Gen. Microbiol.* 106:289-295.
14. Hearn, V.M., and D.W.R. Mackenzie. 1980. The preparation and partial purification of fractions from mycelial fungi with antigenic activity. *Mol. Immunol.* 17:1097-1103.
15. Hough, L., and M.B. Perry. 1955. An extracellular polysaccharide from *Mucor racemosus*. *Biochem. J.* 61:viii-ix.
16. Kaufman, L., L.F. Turner, and D.W. McLaughlin. 1989. Indirect enzyme-linked immunosorbent assay for zygomycosis. *J. Clin. Microbiol.* 27:1979-1982.
17. Lee, Y.C. 1990. High-performance anion-exchange chromatography for carbohydrate analysis. *Anal. Biochem.* 189:151-162.
18. Lindberg, B. 1990. Components of bacterial polysaccharides. *Adv. Carbohydr. Chem. Biochem.* 48:279-318.
19. Miyazaki, T., and T. Irino. 1971. Studies on fungal polysaccharides. VIII. Extracellular heteroglycans of *Rhizopus nigricans*. *Chem. Pharm. Bull.* (Tokyo) 19:1450-1454.
20. Miyazaki, T., and T. Irino. 1972. Studies on fungal polysaccharides. X. Extracellular heteroglycans of *Absidia cylindrospora* and *Mucor mucedo*. *Chem. Pharm. Bull.* (Tokyo) 20:330-335.
21. Miyazaki, T., I. Suzuki, H. Yamada, T. Yadomae, Y. Kumazawa, and K. Mizunoe. 1977. Serologically active substance(s) from *Absidia cylindrospora*. *Kitasato Arch. Exp. Med.* 50:1-11.
22. Miyazaki, T., O. Hayashi, Y. Ohshima, and T. Yadomae. 1979. Studies on fungal polysaccharides: The immunological determinant of the serologically active substances from *Absidia cylindrospora*, *Mucor hiemalis* and *Rhizopus nigricans*. *J. Gen. Microbiol.* 111:417-422.
23. Miyazaki, T., T. Yadomae, H. Yamada, O. Hayashi, I. Suzuki, and Y. Ohshima. 1980. Immunological examination of the polysaccharides of Mucorales, p. 81-94. In Sandford P.A., and Matsuda K. (ed.), *Fungal Polysaccharides*. American Chemical Society Symp. Ser. 126, Washington.
24. Notermans, S., and C.J. Heuvelman. 1985. Immunological detection of moulds in food by using the enzyme-linked immunosorbent assay (ELISA); preparations of antigens. *Int. J. Food. Microbiol.* 2:247-258.
25. Oger, G. 1980. The complexity of forest soil carbohydrates as demonstrated by 27 different O-methyl monosaccharides, 10 previously unknown in nature. *Soil Sci.* 129:1-4.

26. Pitt, J.I., and A.D. Hocking. 1985. *Fungi and Food Spoilage*, p. 143-167. Academic Press, Sydney, New York.
27. Samson R.A., and E.S. Van Reenen-Hoekstra. 1988. *Introduction to food-borne fungi*. Centraalbureau voor Schimmelcultures, Baarn.
28. Schmidt, W., G. Drews, J. Weckesser, and H. Mayer. 1980. Lipopolysaccharides in four strains of the unicellular cyanobacterium *Synechocystis*. *Arch. Microbiol.* 127:217-222.
29. Sedmak, J.J., and S.E. Grossberg. 1977. A rapid, sensitive and versatile assay for protein using coomassie brilliant blue G250. *Anal. Biochem.* 79:544-552.
30. Smid, P., G.A. De Ruiter, G.A. Van der Marel, F.M. Rombouts, and J.H. Van Boom. 1991. Iodonium-ion assisted stereospecific glycosylation: synthesis of oligosaccharides containing  $\alpha(1-4)$ -linked L-fucopyranosyl units. *J. Carbohydr. Chem.* 10:833-849.
31. Snaith, S.M., and G.A. Levvy. 1973.  $\alpha$ -D-mannosidase. *Adv. Carbohydr. Chem. Biochem.* 28:401-445.
32. Sugar, A.M. 1992. Mucormycosis. *Clin. Infect. Dis.* 14(Suppl. 1):S126-S129.
33. Van Bruggen-van der Lugt, A.W., H.J. Kamphuis, G.A. De Ruiter, P. Mischnick, J.H. Van Boom, and F.M. Rombouts. 1992. New structural features of the antigenic polysaccharides of *Penicillium* and *Aspergillus* species revealed with exo- $\beta$ -D-galactofuranosidase. *J. Bacteriol.* 174:6096-6102.
34. Weckesser, J., G. Drews, and H. Mayer. 1979. Lipopolysaccharides of photosynthetic prokaryotes. *Ann. Rev. Microbiol.* 33:215-239.
35. Yamada, H., Y. Ohshima, and T. Miyazaki. 1982. Heterogeneity and antigenic properties of mannoheteroglycan from *Absidia cylindrospora*. *J. Gen. Microbiol.* 128:189-197.
36. Yamada, H., Y. Ohshima, and T. Miyazaki. 1982. Characterization of extracellular mannoheteroglycans from *Absidia cylindrospora*. *Chem. Pharm. Bull. (Tokyo)* 30:1784-1791.



## Characterization of 2-*O*-methyl-mannose containing epitopes of antigenic polysaccharides from *Mucor racemosus*

*Carbohydrate Research*<sup>1</sup> (1993) to be submitted.

Two mannan fractions which are highly reactive with rabbit IgG antibodies were isolated from the extracellular polysaccharides of *Mucor racemosus*. The role of the 2-*O*-methyl-mannose residues in the antigenicity was assessed by specific degradation of the epitopes with an *exo*- $\alpha$ -D-mannanase. As revealed by ethylation analysis, the remaining not-immunoreactive mannan was devoid of 2-*O*-methyl-mannose residues. Hapten inhibition experiments with synthetic oligosaccharides revealed that a trimer based on  $\alpha$ (1-2)-linked mannose residues with a 2-*O*-methyl-mannose residue at the non-reducing terminal and another on  $\alpha$ (1-6)-linked 2-*O*-methyl-mannose residues were able to inhibit this immunoreaction almost completely. Therefore, it was concluded that the antigenicity of mucoralean polysaccharides is based on 2-*O*-methyl mannose residues. However, as strongly suggested by our hapten inhibition experiments the 2-*O*-methyl-mannose residues can only be recognised by antibodies if these residues have a terminal position in short chains of related sugar residues. Probably, the direct role in the antigenic reaction of the carbohydrates in this spacer is limited, but their indirect role may be important as their spacer-function allows the expression of the antigenicity of the immunodominant terminal 2-*O*-methyl-mannose residues in the epitopes of the EPSs of mucoralean moulds.

### Introduction

Mixtures of extracellular polysaccharides (EPSs) are excreted by moulds belonging to the order of Mucorales (Zygomycetes), including the genera *Mucor*, *Rhizopus*, *Rhizomucor*, *Syncephalastrum*, *Absidia* and *Thamnidium* (5,10). An increasing interest is

---

<sup>1</sup>This chapter also appeared in the PhD-thesis of P. Smid (State University Leiden, the Netherlands) in an extended version, which includes the synthesis of compounds 1 to 8 (Table 1). I gratefully acknowledge Dr. P. Mischnick (University of Hamburg, Germany) who performed the ethylation analysis experiments as described in this chapter, and kindly provided Fig. 2.

being shown for the antigenic properties of these EPSs, as target compounds for immunological detection and identification of mucormycosis in man (16,17) and for detection of mucoralean moulds in food and feed (7,25,26).

Polyclonal immunoglobulin G (IgG) antibodies raised in rabbits against EPSs of *Mucor racemosus* and *Absidia cylindrospora* were found to be specific for mould species belonging to Mucorales as no cross reactions were observed with EPSs from other not related mould genera (7,12). Antibodies with similar reactivity have been obtained after immunisation of rabbits with a fraction of the mycelium of the latter mould (23). Therefore, it was assumed that the antigens from the cell walls of Mucorales species contain identical epitopes as the antigenic EPSs (5,10,12,14,15,21). Furthermore, it has been established that the epitopes reactive with rabbit IgG have to be ascribed to sugar residues (11,12,23).

The EPSs of several species of Mucorales were partly characterized and it was demonstrated that antigenicity was associated with the mannose and fucose containing fractions (1,6,13,19,20,22,23,35-37). The uronic acids were not antigenic in rabbits (8,15,21,23,36). Two antigenic fractions from *Absidia cylindrospora*, which constituted only a minor amount of the total EPSs, were studied by Yamada *et al.* (36). The first was a fucomannopeptide containing a minor amount of uronic acid (designated as FMP-II) and the second fraction was a mannoprotein (MP). The mannose glycosidic linkages present in these fractions were mainly  $\alpha(1-2)$ - and  $\alpha(1-6)$  as shown by methylation analysis (35-37). These authors assumed an important role for  $\alpha(1-6)$ -linked mannopyranosyl oligomers as a common antigenic determinant of Mucorales (22,23,35). Other reports indicate that  $\alpha(1-2)$ -mannose linkages might also play a role in the epitopes of Mucorales (37). Recently, 2-*O*-methyl-mannose residues were discovered in mucoralean EPSs by the use of a specific epitope degrading *exo- $\alpha$ -D-mannanase* (11). It was shown that these residues most likely occupied the non-reducing terminal positions of the epitopes.

In all of the above-mentioned studies, the methylation analysis procedure was used to characterize the glycosidic linkages of the antigenic carbohydrate fractions of these moulds. However, a disadvantage of this commonly used method is that methyl-ethers of sugars escape detection. It is not possible to distinguish between the naturally present -*O*-methyl groups and -*O*-methyl groups which are obtained by chemical substitution during methylation analysis. Therefore, to elucidate the structure of these Mucorales carbohydrate epitopes and to assess the role of the newly found 2-*O*-methyl-mannose residues, other methods are required. A suitable alternative is ethylation analysis. Furthermore, hapten inhibition experiments with synthetic oligomers can provide additional proof for the structure of the epitopes (5,27).

In the present study, two fractions which are reactive with rabbit IgG were isolated from the EPSs of *Mucor racemosus*. The role of the 2-*O*-methyl-mannose residues in the antigenicity was assessed by specific degradation of the epitopes with an *exo- $\alpha$ -D-mannanase*. The structure of the two polysaccharide fractions was studied in detail by



ethylation analysis. Furthermore, the capacity of several synthetic oligosaccharides containing mannose and/or 2-*O*-methyl-mannose residues to inhibit the reaction between the EPS of *Mucor racemosus* and the rabbit IgG antibodies raised against this preparation, was assessed using an indirect competitive ELISA. Finally, based on the results obtained, a model is proposed for the structure of the carbohydrate epitopes of polysaccharides of moulds belonging to the order of Mucorales.

## Materials and methods

### *Isolation and purification of EPSs*

Extracellular polysaccharides of the mould strains *Mucor hiemalis* Wehmer CBS 201.28 and *M. racemosus* Fres. CBS 222.81 were produced, isolated and purified by ethanol precipitation as described (6).

### *Enzyme preparations*

Exo- $\alpha$ -D-mannanase was purified from a crude enzyme preparation of fungal origin (*Trichoderma harzianum*) as described recently (11). An  $\alpha$ -D-mannosidase (EC 3.2.1.24) isolated from Jack beans (*Canavalia ensiformis*) was obtained from Sigma Chemical Co. (M 7257, St. Louis, MO, U.S.A.) and used without further purification.

### *Synthetic oligosaccharides*

Eight saccharides containing mannose and 2-*O*-methyl-mannose residues were synthesized previously by Smid (31,32) according to the recently developed iodonium-ion mediated glycosylation procedure of properly protected ethyl 1-thio- $\alpha$ -D-mannopyranosides in which *N*-iodosuccinimide and trifluoromethane sulphonic acid (cat.) are used as promoter. The structures of the compounds used are listed in Table 1.

### *Determination of the sugar composition and protein content*

The carbohydrate composition of the EPS fractions was determined by methanolysis combined with TFA hydrolysis as described recently (9). Subsequently, the quantity of the monosaccharide residues was estimated with the use of high-performance anion-exchange chromatography (HPAEC) using a Dionex Bio-LC HPLC-system (Dionex, Sunnyvale, CA U.S.A.) equipped with a CarboPac PA 100 column (4 x 250 mm) and pulsed-amperometric detection with a gold working electrode and an Ag-AgCl reference

**Table 1.** Saccharides consisting of mannose and 2-*O*-methyl-mannose residues which are synthesized by P. Smid (32).

Compound	Number of residues	Structure	Molecular mass
1	1	$\alpha$ -D-man- <i>O</i> -Me	194.18
2	1	2- <i>O</i> -Me- $\alpha$ -D-man- <i>O</i> -Me	208.21
3	2	$\alpha$ -D-man-(1-6)- $\alpha$ -D-man- <i>O</i> -Me	356.33
4	2	$\alpha$ -D-man-(1-2)- $\alpha$ -D-man- <i>O</i> -Me	356.33
5	3	$\alpha$ -D-man-(1-2)- $\alpha$ -D-man-(1-2)- $\alpha$ -D-man- <i>O</i> -Me	518.47
6	3	2- <i>O</i> -Me- $\alpha$ -D-man-(1-2)- $\alpha$ -D-man-(1-2)- $\alpha$ -D-man- <i>O</i> -Me	532.50
7	3	2- <i>O</i> -Me- $\alpha$ -D-man-(1-6)-2- <i>O</i> -Me- $\alpha$ -D-man-(1-6)-2- <i>O</i> -Me- $\alpha$ -D-man- <i>O</i> -Me	560.55
8	4	$\alpha$ -D-man-(1-2)- $\alpha$ -D-man-(1-2)- $\alpha$ -D-man-(1-2)- $\alpha$ -D-man- <i>O</i> -Me	680.62

electrode as described (9). The amount of 2-*O*-methyl-mannose residues was measured with HPAEC using the molar response factor of mannose. The presence of 2-*O*-methyl-mannose residues was confirmed by conversion of the products after methanolysis and TFA hydrolysis to alditol acetates after reduction and subsequent derivatisation using 1-methyl imidazole and acetic anhydride as described (11). Subsequently, the presence of the alditol acetate from the 2-*O*-methyl-mannose residues was determined by gas-liquid chromatography combined with mass spectrometry as described (11).

Protein was determined by the colorimetric method of Sedmak and Grossberg (30), with bovine serum albumin (BSA) as the standard.

#### Hapten inhibition experiments

The inhibitory capacity of the synthetic oligosaccharides was assessed using an indirect competition ELISA as described by Notermans *et al.* (27). Each well of a polyvinyl microtitre plate (Dynatech, Chantilly, VA U.S.A.) was coated with 100  $\mu$ l of a solution of 5  $\mu$ g/ml of EPS from *Mucor racemosus* in phosphate-buffered saline (PBS). After incubation for 16 h at 25 °C, the trays were washed three times with PBS containing 0.05% Tween 20 (PBST). Next, 50  $\mu$ l of PBS was added to each well and 50  $\mu$ l of the respective oligosaccharide preparation (5 mg/ml) was added to the first well and subsequently diluted serially by transferring each time 50  $\mu$ l to the next well. Polyclonal IgG antibodies (1000/1201) were obtained by immunization of two rabbits with EPS from *M. racemosus* as described by Notermans and Heuvelman (25), 50  $\mu$ l of a solution of these antibodies in PBS (10  $\mu$ g/ml) containing 1% (w/v) of BSA was added to each well and incubated for 1.5 h at room temperature. After washing three times with PBST, 100  $\mu$ l of a 1000-fold diluted solution of peroxidase-conjugated goat anti-rabbit antibodies

(Sigma Immunochemicals A-8275, St. Louis, MO, U.S.A.) in PBST containing 1% (w/v) BSA was added to each well. Incubation was performed for 1.5 h at 25 °C after which time the plates were rinsed three times with PBST. Finally, 100  $\mu$ l of a substrate solution containing 3,3',5,5'-tetramethyl benzidine prepared according to Bos *et al.* (3) was added to each well and after incubation for 30 min, the reaction was stopped by the addition of 50  $\mu$ l of 2 M H<sub>2</sub>SO<sub>4</sub> to each well. The absorbance of the yellow colour was measured spectrophotometrically at 450 nm.

### *Sandwich ELISA*

A non-competitive sandwich ELISA was carried out by first binding polyclonal IgG antibodies (1000/1201) to the wall of a microtitre plate, followed by the addition of the sample to the wells and finally by using the same antibodies conjugated to peroxidase (6). The sandwich ELISA was carried out using polyvinyl microtitre plates and 3,3',5,5'-tetramethyl benzidine as the peroxidase substrate as described above. The ELISA reactivity was expressed as the minimal detectable concentration of the antigenic material which is defined as the lowest concentration just giving a positive reaction, *i.e.* an extinction at 450 nm > 0.1 above that of a blank, containing no antigenic EPS.

### *Ethylation analysis*

About 1 mg of the sample was dissolved in 150  $\mu$ l of dimethylsulphoxide in a V-vial. Freshly prepared 1.5 M lithium dimethylsulphanyl anion (750  $\mu$ l) was added through the septum cap and the mixture was stirred for 2 h at room temperature. To the ice-cooled solution 900  $\mu$ l of ethyliodide (Merck, Darmstadt, Germany) was added and the mixture was stirred for another 2 h at room temperature. Ethylation was repeated twice, but the third time 2.25 ml ethyliodide was used. The perethylated polymeric products were isolated by dialysis and subsequent extraction with dichloromethane.

One third of the sample was hydrolysed with 2 M trifluoroacetic acid at 120 °C for 2 h. After evaporation of the acid, the residue was reduced with 0.5 M sodium borodeuteride in 2 M ammonia for 1 h at 60 °C. The excess of sodium borodeuteride was destroyed with acetic anhydride and the borate was removed subsequently by repeated evaporation with acidic methanol. The residue was acetylated with acetic acid and pyridine at 90 °C for 2 h. The reaction mixture was washed with a solution of saturated NaHCO<sub>3</sub> and the products were extracted with dichloromethane. Identification and quantification of the partially ethylated alditol acetates was performed by one- and two-dimensional GLC-mass spectrometry as described previously (34).

### *Anion-exchange chromatography*

Anion-exchange chromatography was performed on a column (12 x 1.6 cm) of DEAE-Sephacrose CL-6B (Pharmacia, Uppsala, Sweden), equilibrated with 0.05 M sodium acetate buffer (pH 5.0). After loading of the sample of EPS (4 ml of a 2.5 mg/ml solution), the column was washed with 25 ml of buffer and then eluted at 30 ml/h with a linear gradient (100 ml) of 0.05–1 M sodium acetate buffer, followed by 50 ml of 1 M buffer. Fractions (3 ml) were assayed for neutral sugars and glucuronic acid by the automated orcinol method and automated *m*-hydroxydiphenyl method, respectively (6).

### *Size-exclusion chromatography*

Size-exclusion chromatography was performed on a column (91 x 1.5 cm) of Bio-Gel P-10 (200-400 mesh; Bio-Rad Labs, Richmond, CA U.S.A.) eluted with 0.1 M sodium acetate buffer (pH 4.0) at 8 ml/h. Samples of polysaccharides were dissolved in 2 ml of this buffer and loaded onto the column. Fractions of 1.9 ml were collected and analysed on their neutral sugar content using the automated orcinol method as described above. In order to pool the collected fractions optimally, the molecular weight distributions were checked using size-exclusion chromatography in the high-performance mode as described (6). This was performed on an SP8800 HPLC-system (Spectra Physics, San Jose, CA, U.S.A.) equipped with three Bio-Gel TSK columns in series (40XL, 30XL, 20XL; 300 x 7.5 mm; Bio-Rad Labs, Richmond, USA) in combination with a TSK-XL guard column (40 x 6 mm) at 30 °C using 0.4 M acetic acid/sodium acetate (pH 3.0) as eluent with a flow of 0.8 ml/min (6). An aliquot of 20  $\mu$ l sample was injected into the system and the effluent was monitored using a Shodex SE-61 Refractive Index detector. The apparent molecular masses of the respective fractions were estimated by calibration of the system with dextran standards (10k, 40k, 70k and 500k; Pharmacia, Uppsala, Sweden) using software obtained from Spectra-Physics.

### *Degradation of the epitopes of the antigenic polysaccharides*

Periodate oxidation was performed on fractions isolated from the EPS preparations of both *Mucor* species by treatment with 50 mM sodium periodate for different times (11).

The antigenic polysaccharides were also studied by analysis of the reaction products after treatment with exo- $\alpha$ -D-mannanase and  $\alpha$ -mannosidase as described (11). An aliquot of 175  $\mu$ l of polysaccharide solution (1 mg/ml) and 10  $\mu$ l of 2 M sodium acetate buffer (pH 5.0) with 0.01 % sodium azide were incubated with 65  $\mu$ l (0.75 mU) of the exo- $\alpha$ -D-mannanase or with a similar amount of the  $\alpha$ -mannosidase at 30 °C for 16 h. After inactivation of the enzyme (5 min, 100 °C), the antigenicities of the native and enzyme-treated EPSs were measured using the sandwich ELISA. The reaction products were

**Table 2.** Sugar composition determined after methanolysis and subsequent TFA hydrolysis of the fractions from EPS from *Mucor racemosus* obtained after separation by DEAE anion-exchange chromatography<sup>a</sup>.

Fraction of DEAE column	Carbohydrate composition <sup>b</sup>					
	Fuc	2-O-Me-Man <sup>c</sup>	Man	Gal	Glc	GlcA
I	6	1	84	1	7	1
II	10	1	79	2	4	4
III	27	-	9	11	2	51

<sup>a</sup> Values are the average of duplicate experiments.

<sup>b</sup> Sugar composition expressed in mole percentages.

<sup>c</sup> 2-O-Methyl mannose residues. The amount was calculated by taking the relative molar response factor of mannose (9; cf. Table 2, p. 52).

analysed using HPAEC as described above and confirmed by GLC-mass spectrometry after derivatisation to alditol acetates as described (11).

After enzyme incubation the remaining mannan polymers were isolated by removing the reaction products by using a Microsep filter (Filtron Technology Corp., Northborough, MA, U.S.A.) with a cutoff of 10 kDa.

## Results

### *Separation of the EPSs of Mucor racemosus by anion-exchange chromatography*

EPS of *Mucor racemosus* was separated by DEAE anion-exchange chromatography in three main fractions similar as shown for the EPS of *M. hiemalis* in Fig. 3 of Chapter 3 (p. 40). The antigenicity of the fractions was determined by sandwich ELISA, which revealed that only fractions I and II were reactive with the polyclonal IgG antibodies raised in rabbits against EPS of *Mucor racemosus* (cf. Chapter 3).

The sugar composition of the fractions from the DEAE anion-exchange column was determined by HPAEC after methanolysis combined with TFA hydrolysis (Table 2). The non-binding DEAE fraction I (not containing glucuronic acid) and fraction II which could be released with low amounts of buffer salts (containing a few percent of glucuronic acid) were mainly composed of mannose residues. Fraction III from the anion-exchange column, which may be identical to mucoran described by Bartnicki-Garcia and Lindberg (1), could only be released from the column with 0.9–1 M of buffer salts, and contained approximately 50% glucuronic acid.

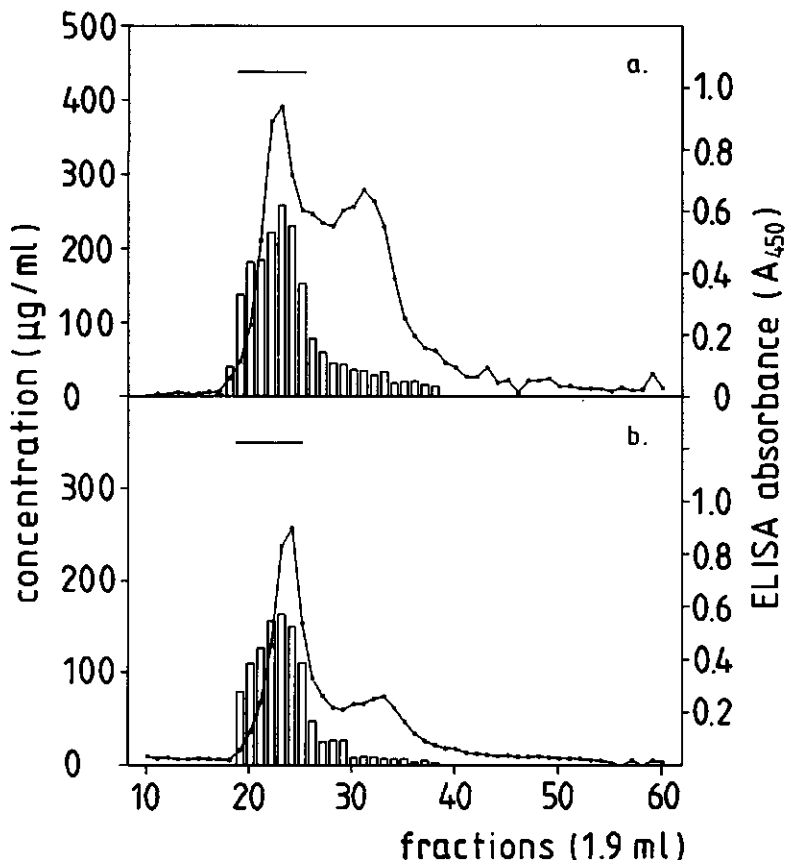

**Fig. 1.** Separation of the fractions I (a) and II (b) obtained from DEAE anion-exchange chromatography of the EPSs from *M. racemosus* (cf. Fig. 3, p. 40) by size-exclusion chromatography (P-10 column) followed by colorimetric sugar determination (line) and sandwich ELISA detection (bars) of the different fractions.

#### *Size-exclusion chromatography*

Fractions I and II from the DEAE anion-exchange column were separated further by size-exclusion chromatography using a P-10 column, as shown in Fig. 1. The chromatographic behaviour of DEAE fraction I (Fig. 1a) was almost similar to that of fraction II of this DEAE column (Fig. 1b). The collected fractions were analysed for their carbohydrate content by the automated orcinol method and for their immunochemical activity using the sandwich ELISA. The most antigenic fractions were pooled as indicated in Fig. 1 (horizontal bars), dialysed and lyophilized, and called Mannan I (Fig. 1a) and Mannan II (Fig. 1b), respectively.

**Table 3.** Carbohydrate composition of the highly antigenic Mannans I and II obtained by P-10 size-exclusion chromatography of the EPSs from *Mucor racemosus*<sup>a</sup>.

Mannan	Carbohydrate composition <sup>b</sup>					
	Fuc	2-O-Me-Man <sup>c</sup>	Man	Gal	Glc	GlcA
I	5	2	82	2	9	0
II	7	1	80	2	8	2

<sup>a, b, c</sup>: See legend Table 1.

### Composition of Mannans I and II

As shown in Table 3, the antigenic Mannans I and II were mainly composed of mannose residues, with low amounts of glucose, fucose and galactose and in case of Mannan II also some glucuronic acid. Furthermore, one or two percent of 2-*O*-methyl-mannose residues were present in both mannans. The carbohydrate content of the Mannans I and II was 88% and 84%, respectively. Only traces of protein could be detected in these mannans (results not shown).

Both mannans were examined with ethylation analysis which revealed that both were mainly constituted of (1-2)-linked mannose residues (36-40%), terminal mannose residues (25%), (1-6)-linked mannose residues (9-14%), differently branched mannose residues (11-15%) and terminal 2-*O*-methyl-mannose residues (1-2%). The latter compound was apparent from the mass-spectrum shown in Fig. 2, which identifies 1,5-di-*O*-acetyl-3,4,6-tri-*O*-ethyl-2-*O*-methyl-mannitol. Since this compound was the only 2-*O*-methyl-mannose derivative present, it was concluded that most likely 2-*O*-methyl-mannose is present as terminal residues only.

### Immunochemical reactivity of mannans I and II

The antigenicity of both mannans from *Mucor racemosus* was determined using the sandwich ELISA. The minimal detectable concentration of Mannan I was approx. 10 ng per ml whereas the minimal concentration of Mannan II was approx. 10 times higher.

After mild periodate oxidation with 50 mM sodium periodate for 30 min the ELISA reactivity of both mannans was almost completely abolished (results not shown). Mild periodate is able to oxidize vicinal *cis*- or *trans*-hydroxyl groups without any influence on the protein part which is present in these mannans (4).

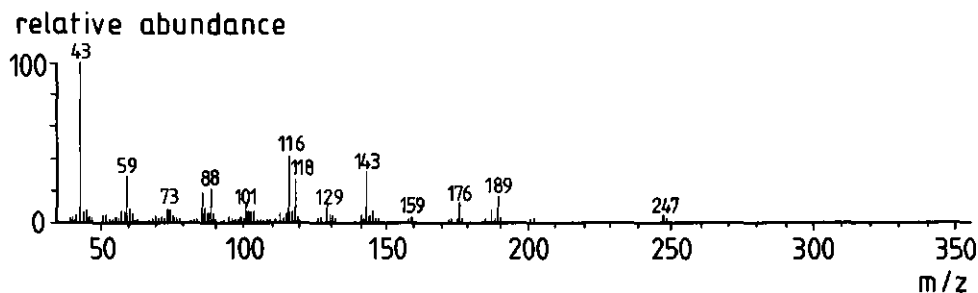

**Fig. 2.** Electron impact-mass spectrum of 1,5-di-*O*-acetyl-3,4,6-tri-*O*-ethyl-2-*O*-methyl-mannitol, which originates from terminal 2-*O*-methyl-mannose residues. This compound was determined after ethylation analysis of Mannans I and II.

### *Enzymatic degradation of the mannans*

To elucidate those parts of the antigenic mannans which act as epitopes reactive with the polyclonal rabbit-IgG antibodies, Mannans I and II were treated with either of two enzymes,  $\alpha$ -mannosidase and exo- $\alpha$ -D-mannanase (*cf.* Chapter 7). As shown in Table 4, both enzymes released similar amounts of mannose residues from the antigenic mannans from *Mucor racemosus*. The ELISA activity of the mannans was hardly affected after treatment with  $\alpha$ -mannosidase, whereas this activity was abolished completely after treatment with exo- $\alpha$ -D-mannanase. The latter enzyme also released 2-*O*-methyl-mannose residues.

The remaining mannan polymers were isolated by filtration and their composition was determined by ethylation analysis. This revealed that the amount of  $\alpha$ (1-2)-linked mannose residues decreased considerably after treatment of the mannans with both enzymes. Furthermore, the relative amounts of 2-*O*-methyl-mannose residues increased after  $\alpha$ -mannosidase treatment whereas this compound could not be detected anymore in the remaining mannans after treatment with the exo- $\alpha$ -D-mannanase (results not shown).

### *Selection of mannose and 2-O-methyl-mannose containing oligomers for synthesis*

Degradation of the antigenic mannans isolated from *Mucor racemosus* point to an important role for the 2-*O*-methyl-mannose residues, but does not give a clue for the role of the mannose residues themselves. Therefore, differently linked oligomers were synthesized with mannose and 2-*O*-methyl-mannose residues and hapten-inhibition studies were performed with these oligomers. Mild periodate oxidation indicated that the carbohydrate residues which are involved in the epitopes have to be interlinked in such a way that vicinal hydroxyl groups remain. To meet this requirement, the glycosidic



**Table 4.** Products liberated upon degradation of the antigenic Mannans I and II isolated from EPS from *Mucor racemosus* and their remaining ELISA reactivity<sup>a</sup>

Mannan	Native ELISA <sup>b</sup>	$\alpha$ -mannosidase		exo- $\alpha$ -D-mannanase		
		Man <sup>c</sup>	ELISA	Man	2-O-Me Man <sup>d</sup>	ELISA
I	++++	18 (14)	+++	17 (13)	0.3	-
II	++	14 (12)	++	13 (11)	0.2	-

<sup>a</sup> Values are the average of duplicate experiments.

<sup>b</sup> Antigenicity of the mannans expressed as minimal detectable concentration in the sandwich ELISA: +++++, < 10 ng/ml; +++, 10-100 ng/ml; ++, 100-1000 ng/ml; +, 1-10  $\mu$ g/ml; -, > 10  $\mu$ g/ml.

<sup>c</sup> Amount of mannose expressed in  $\mu$ g released from 175  $\mu$ g of the respective mannans after enzyme incubation. The values in brackets represent the amount expressed relative to the initial amount of mannose present in these EPSs, calculated with data from Table 2.

<sup>d</sup> 2-O-Methyl mannose residues. The amount was calculated by taking the relative molar response factor of mannose (9; cf. Table 2, p. 52).

linkages of the mannose residues can only be (1-2)-, (1-4)- or (1-6) whereas the 2-O-methyl mannose residues can only be (1-6)-linked. Taking these considerations into account, eight different monomers and oligomers as listed in Table 1 were synthesized (32). As preliminary experiments have indicated that the mannose residues were only immunoreactive if  $\alpha$ -linked, these oligomers were all synthesized starting from Me-O- $\alpha$ -D-mannose residues.

### Hapten inhibition experiments

With the synthetic monomers and oligomers as listed in Table 1, inhibition experiments were performed with an indirect competition ELISA using polyclonal rabbit-IgG antibodies raised against the EPS of *Mucor racemosus*. The  $\alpha$ -monomer of mannose (compound 1) and the dimer of  $\alpha$ (1-6)-linked mannose (compound 3) did not inhibit this reaction below a concentration of 3  $\mu$ mol/ml. The percentage inhibition in the competition ELISA using different concentrations of the compounds 2, 5, 6, 7 and 8 (Table 1) is shown in Fig. 3. The highest inhibition could be obtained with the trimers 6 and 7, which both carry a terminal 2-O-methyl-mannose residue. Compound 5, which differs only from compound 6 by the lack of a methyl-ether at the 2-position of the terminal mannose residue, had a significantly lower inhibitory capacity. Furthermore, the monomeric  $\alpha$ -methyl 2-O-methyl-D-mannose residue exhibits a significant inhibitory capacity, whereas the monomeric  $\alpha$ -methyl-D-mannose does not.

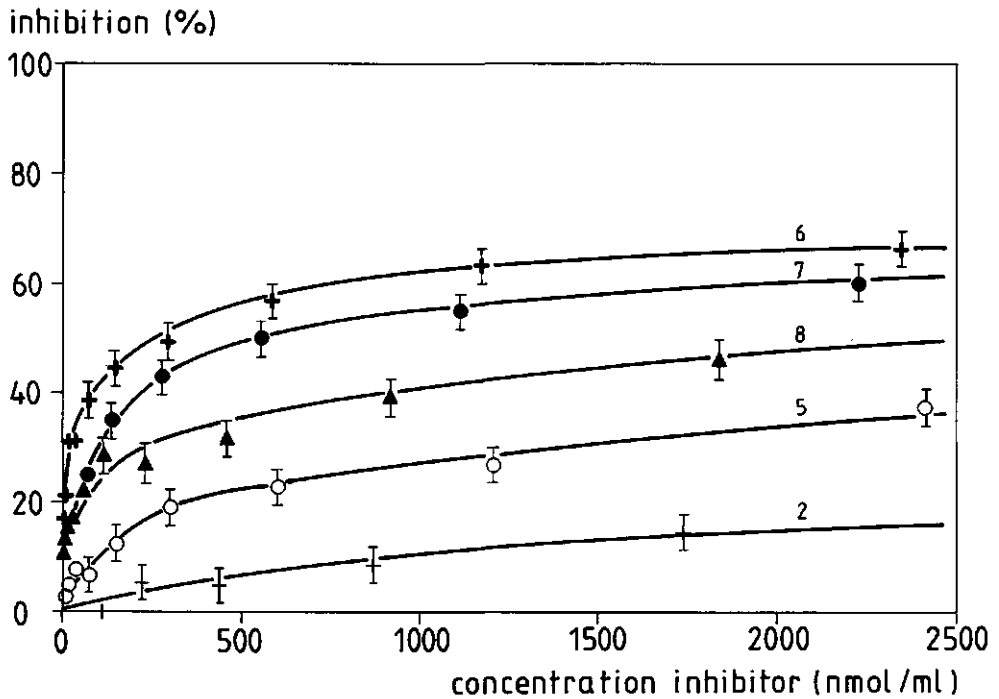

**Fig. 3.** Inhibition of the reaction between EPS of *Mucor racemosus* and IgG antibodies raised in rabbits against this EPS, with mannose and 2-O-methyl-mannose oligosaccharides as performed in an indirect ELISA. Numbers of curves refer to the compounds as listed in Table 1.

The 50% inhibition concentration of the multivalent native EPS of *Mucor racemosus* was 4  $\mu\text{g/ml}$ . This amount is similar for all the other EPS preparations from species belonging to the genera *Mucor*, *Rhizopus*, *Rhizomucor*, *Syncephalastrum*, *Absidia* and *Thamnidium* which have been tested in this ELISA system (results not shown), but about 50 times lower than for oligomer 6 in Fig. 3, of which about 400 nanomol/ml (*i.e.* 210  $\mu\text{g/ml}$ ) was required for 50% inhibition.

## Discussion

Two mannan fractions were isolated from the crude EPS preparation of *M. racemosus* which were reactive with polyclonal rabbit-IgG antibodies raised against this preparation.

These fractions represent only a few percent of the initial preparation. The epitope reactive with the rabbit-IgG is entirely based on carbohydrate residues present on these mannans, as mild periodate oxidation completely abolished the antigenicity.

Mannan I is immunochemically most active, contained 40% (1-2)-linked mannose residues and is probably similar to the mannoprotein fraction isolated previously from EPS of *Absidia cylindrospora* (36). Mannan II is composed of mannose, fucose and a small amount of glucuronic acid, and is probably similar to the fucomannopeptide as described by Yamada *et al.* (36).

Both mannans contain one to two percent of terminal 2-*O*-methyl mannose residues, but carbohydrate analysis of these mannans solely does not provide sufficiently detailed information on the exact composition of the epitopes. An important clue came from treatment of the mannans with the recently purified exo- $\alpha$ -D-mannanase, which completely removed the ELISA reactivity by releasing mannose and 2-*O*-methyl mannose residues (11). As revealed by ethylation analysis, the remaining not-immunoreactive mannan was devoid of 2-*O*-methyl-mannose residues. Therefore, it was concluded that the antigenicity of mucoralean polysaccharides is entirely based on mannose and 2-*O*-methyl mannose residues containing vicinal hydroxyl groups.

Hapten inhibition experiments with synthetic oligosaccharides which meet the above mentioned requirements for the possible structure of the epitopes, revealed that two trimers were able to inhibit this immunoreaction almost completely. Trimer 6 (Table 1) is based on  $\alpha$ (1-2)-linked mannose residues and trimer 7 on  $\alpha$ (1-6)-linked 2-*O*-methyl-mannose residues, and both carry a 2-*O*-methyl-mannose residue at the non-reducing terminal. The concentration of these trimers which is able to inhibit the immunoreaction for 50% (about 400 nmol/ml) is similar to the reported 50% inhibition concentration (480 nmol/ml) of a  $\beta$ (1-5)-linked D-galactofuranose trimer in the indirect ELISA using IgG antibodies raised against *Penicillium* species (27). Since compounds 1, 3, 4 and 5 (Table 1) showed much weaker or no inhibition potency, it is unlikely that the  $\alpha$ (1-2)-linked or  $\alpha$ (1-6)-linked mannose oligomers represent the epitopes of these moulds as suggested previously by Miyazaki *et al.* (23) and Yamada *et al.* (37). Characterization of the antigenic oligosaccharides in the latter studies was mainly based on methylation analysis, which do not allow for the detection of 2-*O*-methyl-mannose residues. Therefore, it is most likely that 2-*O*-methyl-mannose residues in these oligomers were characterized erroneously as mannose residues.

However, none of the synthesized oligomers did inhibit the antibody-antigen reaction to the same extent as the native EPS did. This can be explained by considering that IgG antibodies are bivalent in their reaction with antigens as each molecule has two combining sites (paratopes). One EPS molecule also contains many epitopes and consequently their functional affinity (avidity) results in a considerable increase in the stability of the binding between antibody and antigen. This increase can be up to 1000-fold compared to monovalent binding in hapten inhibition experiments (33). Therefore, the inhibitory

capacity of the multivalent EPSs in this indirect ELISA can hardly be compared with the inhibition of monovalent isolated or synthetic oligosaccharides.

Little is known about the size of carbohydrate epitopes compared to that of protein epitopes. The recognition site of T-cell receptors towards protein epitopes, appears to be a groove of approx. 2.5 nm long and 1 nm wide between two long  $\alpha$ -helices located on the top surface of the molecule (2,24). Two types of grooves have been described with similar size: type I is closed at both ends (18) indicating that the corresponding epitopes are based on peptides of 8 to 10 amino acid residues and type II, which is probably open at one end and probably requires slightly larger epitopes (approx. 14 amino acids) (24). Although T-cell receptors only recognize foreign antigens that are associated with a particular human leucocyte antigen (HLA), it may be expected that soluble antigens are recognized by IgG paratopes in a similar way.

Typically, proteins possess a variety of different epitopes, each of which occurs in small numbers (29). Protein epitopes are either so-called linear epitopes or conformational epitopes. The latter are often composed of patches of several adjacent and not adjacent amino acids of which the conformation results in the specific exposure of the antigenic determinants. In contrast, it can be assumed that the conformation of the carbohydrate epitopes is largely determined by the sequence of sugar residues only, since this sequence also determines the three-dimensional shape (28). Assuming that the above mentioned groove model would also be valid for the binding of carbohydrate epitopes to IgG paratopes, the number of residues involved in these epitopes has to be much lower than the number of amino acids in protein epitopes, as the pyranose-ring of a mannose residue is approx. 0.6 nm long.

The results of both the specific degradation of the mannans with the *exo*- $\alpha$ -D-mannanase and analysis of the remaining mannans by ethylation analysis indicate that 2-*O*-methylmannose residues are almost entirely responsible for the antigenic reaction of these polysaccharides, and occupy the non-reducing terminal positions of the epitopes. However, as strongly suggested by our inhibition experiments they can only be recognised by antibodies if these residues have a terminal position in short chains of related sugar residues. Most likely, mannose residues which are substituted at the C-2 position, can act as suitable spacer. Probably, the direct role in the antigenic reaction of the carbohydrate residues in this linking chain is limited, but its indirect role in the antigenicity may be important as their spacer-function allows the expression of the terminal 2-*O*-methylmannose residues as epitopes.

## References

1. Bartnicki-Garcia, S., and B. Lindberg. 1972. Partial characterization of mucoran: the glucuronomannan

- component. *Carbohydr. Res.* 23:75-85.
2. Bjorkman, P.J., M.A. Saper, B. Samraoui, W.S. Bennett, J.L. Strominger and D.C. Wiley. 1987. Structure of the human class I histocompatibility antigen, HLA-A2. *Nature* 329:506-512.
  3. Bos, E.S., A.A. van der Doelen, N. van Rooy, and A.H.W.M. Schuurs. 1981. 3,3',5,5'-Tetramethylbenzidine as an Ames test negative chromogen for horse-radish peroxidase in enzyme-immunoassay. *J. Immunoassay* 2:187-204.
  4. Clamp, J.R., and L. Hough. 1965. The periodate oxidation of amino acids with reference to studies on glycoproteins. *Biochem. J.* 94:17-24.
  5. De Ruiter, G.A., P. Smid, A.W. Van der Lugt, J.H. Van Boom, S.H.W. Notermans, and F.M. Rombouts. 1991. Immunogenic extracellular polysaccharides of Mucorales, p. 169-180. In J.-P. Latgé and D. Boucias (ed.), *Fungal Cell Wall and Immune Response*. NATO ASI Ser. H 53, Springer Verlag, Berlin.
  6. De Ruiter, G.A., A.W. Van der Lugt, A.G.J. Voragen, F.M. Rombouts, and S.H.W. Notermans. 1991. High-performance size-exclusion chromatography and ELISA detection of extracellular polysaccharides from Mucorales. *Carbohydr. Res.* 215:47-57 (this thesis, Chapter 3).
  7. De Ruiter, G.A., T. Hoopman, A.W. Van der Lugt, S.H.W. Notermans, and M.J.R. Nout. 1992. Immunochemical detection of Mucorales species in foods, p. 221-227. In R.A. Samson, A.D. Hocking, J.I. Pitt, and A.D. King (ed.), *Modern Methods in Food Mycology*. Elsevier, Amsterdam.
  8. De Ruiter, G.A., S.L. Josso, I.J. Colquhoun, A.G.J. Voragen, and F.M. Rombouts. 1992. Isolation and characterization of  $\beta(1-4)$ -D-glucuronans from extracellular polysaccharides of moulds belonging to Mucorales. *Carbohydr. Polym.* 18:1-7 (this thesis, Chapter 6).
  9. De Ruiter, G.A., H.A. Schols, A.G.J. Voragen, and F.M. Rombouts. 1992. Carbohydrate analysis of water-soluble uronic acid containing polysaccharides with high-performance anion-exchange chromatography using methanolysis combined with TFA hydrolysis is superior to four other methods. *Anal. Biochem.* 207:176-185 (this thesis, Chapter 4).
  10. De Ruiter, G.A., A.W. Van Bruggen-van der Lugt, M.J.R. Nout, W.J. Middelhoven, P.S.S. Soentoro, S.H.W. Notermans, and F.M. Rombouts. 1992. Formation of antigenic extracellular polysaccharides by selected strains of *Mucor* spp., *Rhizopus* spp., *Rhizomucor* spp., *Absidia corymbifera* and *Syncephalastrum racemosum*. *Antonie van Leeuwenhoek* 62:189-199 (this thesis, Chapter 2).
  11. De Ruiter, G.A., A.W. Van Bruggen-van der Lugt, P. Smid, J.H. Van Boom, and F. M. Rombouts. 1993. 2-O-methyl-mannose is a constituent of the epitopes of mucoralean extracellular polysaccharides. *J. Bacteriol.* (submitted; this thesis, Chapter 7).
  12. Hayashi, O., T. Yadomae, H. Yamada, and T. Miyazaki. 1978. Cross-reactivity of antiserum to *Absidia cylindrospora* among some Mucorales and other fungi. *J. Gen. Microbiol.* 108:345-347.
  13. Hayashi, O., H. Yamada, T. Yadomae, and T. Miyazaki. 1978. Purification and partial characterization of the serologically active substance from *Absidia cylindrospora*. *J. Gen. Microbiol.* 106:289-295.
  14. Hayashi, O., T. Yadomae, and T. Miyazaki. 1979. Distribution of the antigenic substance among *Absidia cylindrospora*, *Mucor hiemalis* and *Rhizopus nigricans*. *Jpn. J. Med. Mycol.* 20:181-185.
  15. Hearn, V.M., and D.W.R. Mackenzie. 1980. The preparation and partial purification of fractions from mycelial fungi with antigenic activity. *Mol. Immunol.* 17:1097-1103.
  16. Jones, K.W., and L. Kaufman. 1978. Development and evaluation of an immunodiffusion test for diagnosis of systematic zygomycosis (mucormycosis): preliminary report. *J. Clin. Microbiol.* 7:97-103.
  17. Kaufman, L., L.F. Turner, and D.W. MacLaughlin. 1989. Indirect ELISA for zygomycosis. *J. Clin. Microbiol.* 27:1979-1982.
  18. Madden, D.R., J.C. Gorga, J.L. Strominger, and D.C. Wiley. The structure of HLA-B27 reveals nonamer self-peptides bound in an extended conformation. *Nature* 353:321-325.

19. Miyazaki, T., and T. Irino. 1971. Studies on fungal polysaccharides. VIII. Extracellular heteroglycans of *Rhizopus nigricans*. *Chem. Pharm. Bull.* 19:1450-1454.
20. Miyazaki, T., and T. Irino. 1972. Studies on fungal polysaccharides. X. Extracellular heteroglycans of *Absidia cylindrospora* and *Mucor mucedo*. *Chem. Pharm. Bull.* 20:330-335.
21. Miyazaki, T., I. Suzuki, H. Yamada, T. Yadomae, Y. Kumazawa, and K. Mizunoe. 1977. Serologically active substance(s) from *Absidia cylindrospora*. *Kitasato Arch. Exp. Med.* 50:1-11.
22. Miyazaki, T., O. Hayashi, Y. Ohshima, and T. Yadomae. 1979. Studies on fungal polysaccharides: The immunological determinant of the serologically active substances from *Absidia cylindrospora*, *Mucor hiemalis* and *Rhizopus nigricans*. *J. Gen. Microbiol.* 111:417-422.
23. Miyazaki, T., T. Yadomae, H. Yamada, O. Hayashi, I. Suzuki, and Y. Ohshima. 1980. Immunochemical examination of the polysaccharides of Mucorales, p. 81-94. In Sandford P.A., and Matsuda K. (ed.), *Fungal Polysaccharides*. ACS Symposium Series 126, Washington.
24. Neeffjes, J.J., and H.L. Ploegh. 1992. Review: Intracellular transport of MHC class II molecules. *Immunol. Today* 13:179-185.
25. Notermans, S., and C.J. Heuvelman. 1985. Immunological detection of moulds in food by using the enzyme-linked immunosorbent assay (ELISA); preparations of antigens. *Int. J. Food. Microbiol.* 2:247-258.
26. Notermans, S., C.J. Heuvelman, R.R. Beumer, and R. Maas. 1986. Immunological detection of moulds in food: relation between antigen production and growth. *Int. J. Food Microbiol.* 3:253-261.
27. Notermans, S., G.H. Veeneman, C.W.E.M. van Zuylen, P. Hoogerhout, and J.H. van Boom. 1988. (1→5)-linked  $\beta$ -D-galactofuranosides are immunodominant in extracellular polysaccharides of *Penicillium* and *Aspergillus* species. *Mol. Immunol.* 25:975-979.
28. Rees, D.A. 1977. Polysaccharide shapes. 80 p. Chapman and Hall. London.
29. Richter, A.W. 1981. The immune response to polysaccharides, p. 235-246. In C. Steffen, and H. Ludwig (eds.), *Clinical Immunology and Allergology*. Elsevier, Amsterdam.
30. Sedmak, J. J., and S. E. Grossberg. 1977. A rapid, sensitive and versatile assay for protein using coomassie brilliant blue G250. *Anal. Biochem.* 79:544-552.
31. Smid, P., G. A. De Ruiter, G. A. Van der Marel, F. M. Rombouts, and J. H. Van Boom. 1991. Iodonium-ion assisted stereospecific glycosylation: synthesis of oligosaccharides containing  $\alpha$ (1-4)-linked L-fucopyranosyl units. *J. Carbohydr. Chem.* 10:833-849.
32. Smid, P. 1993. *Use of monosaccharides in the preparation of biologically active compounds*. PhD-thesis. State University Leiden.
33. Steward, M. 1989. Antigen recognition, p. 7.1-7.10. In I. Roitt, J. Brostoff, and D. Male (eds.), *Immunology*. Churchill Livingstone, London.
34. Van Bruggen-van der Lugt, A. W., H. J. Kamphuis, G. A. De Ruiter, P. Mischnick, J. H. Van Boom, and F. M. Rombouts. 1992. New structural features of the antigenic polysaccharides of *Penicillium* and *Aspergillus* species revealed with exo- $\beta$ -D-galactofuranosidase. *J. Bacteriol.* 174:6096-6102.
35. Yamada, H., Y. Ohshima, and T. Miyazaki. 1982. Characterisation of fucomannopeptide and mannoprotein from *Absidia cylindrospora*. *Carbohydr. Res.* 110:113-126.
36. Yamada, H., Y. Ohshima, and T. Miyazaki. 1982. Heterogeneity and antigenic properties of mannoheteroglycan from *Absidia cylindrospora*. *J. Gen. Microbiol.* 128:189-197.
37. Yamada, H., Y. Ohshima, and T. Miyazaki. 1982. Characterization of extracellular mannoheteroglycans from *Absidia cylindrospora*. *Chem. Pharm. Bull.* 30:1784-1791.

## The value of antigenic extracellular polysaccharides for the classification of the *Mortierella isabellina* group (Mucorales)

*Mycological Research*<sup>1</sup> (1993) 97: in press.

The chemical and antigenic characteristics of extracellular polysaccharides of moulds belonging to the *Mortierella isabellina* group were used for taxonomical classification of this group. The extracellular polysaccharides were studied to establish the affinity of the group to either the Mucoraceae or the Mortierellaceae. The extracellular polysaccharides showed antigenic similarity with Mucoraceae and related families, as they reacted with IgG antibodies raised against EPS from *Mucor racemosus*. Also, the presence of  $\beta(1-4)$ -D-glucuronic acid polymers, previously established as characteristic for these families, support classification in this affinity.

### Introduction

The genus *Mortierella* Coemans (fam. Mortierellaceae) is generally characterized by white lanose colonies, mostly with a garlic-like odour, and sporangia that lack a columella, and sometimes the formation of hyaline zygosporangia with one strongly inflated suspensor. A number of species around *M. ramanniana* (Möller) Linnem. and *M. isabellina* Oudem. were included in *Mortierella* by Linnemann (15). They deviate from the genus by velvety colonies with a dense layer of erect sporangiophores, in some species pigmented spores, and sometimes a small columella. A garlic-like odour is absent. No zygosporangia have ever been seen in any species of this group. Some of the species had originally been placed in *Mucor* L. : Fr., but the texture of the low colonies is atypical of this genus and the columella of the sporangia is absent or small. Reddish sporangiospores are otherwise unknown in *Mucor*.

Gams (11) recognized that this group, described by several authors as '*Mortierella isabellina* and related species' was unrelated to the rest of the genus and classified it as a separate subgenus, *Micromucor* W. Gams, pending further information on its relationship to the Mortierellaceae or the Mucoraceae, about which other morphological features do

---

<sup>1</sup>Authors: G.A. De Ruiter, A.W. Van Bruggen-van der Lugt, F.M. Rombouts, and W. Gams.

not provide enough information (11,21). More sophisticated techniques such as RFLP-mapping and immunological methods are becoming available for this purpose (10,12-14).

De Ruiter *et al.* (3,4,6) have shown that species from different genera of the Mucorales (families: Mucoraceae, Thamniaceae, Syncephalastraceae) reacted similarly to polyclonal immunoglobulin G (IgG) antibodies raised against the EPS of *Mucor racemosus* Fres. excreted in liquid cultures. The above-mentioned families, with the exclusion of the Mortierellaceae, will be referred to in this paper as the mucoralean group. These polyclonal antibodies were found to be very specific for mould species belonging to the mucoralean group. No reactivity of the IgG antibodies was found with species belonging to the genera *Penicillium* Link : Fr., *Aspergillus* Mich. ex Link : Fr., *Paecilomyces* Bain., *Talaromyces* C. Benj., *Trichoderma* Pers. : Fr., *Wallemia* Johan-Olsen, *Trichothecium* Link : Fr., *Fusarium* Link : Fr. and *Cladosporium* Link : Fr. and 38 yeast strains belonging to 20 different genera, with the exception of the yeast *Pichia membranaefaciens* (Hansen) Hansen (6).

The chemical analysis of the extracellular polysaccharides (EPS) of mucoralean moulds revealed the presence of a fraction containing both fucose and glucuronic acid residues (4,17,23). This combination of sugars was found to be characteristic for moulds of this order. From EPS of mucoralean moulds a characteristic  $\beta(1-4)$ -linked D-glucuronic acid polymer could be isolated after severe acid treatment (5). So far, this polyglucuronic acid has only been found in intracellular and extracellular polysaccharides of moulds belonging to Mucorales (2,8,20). Until now, no information about excreted polysaccharides from moulds of the *Mortierella isabellina* group is available.

The present study was initiated to establish the affinity of the *Mortierella isabellina* group to either the Mucoraceae or the Mortierellaceae, using the antigenic properties of the extracellular polysaccharides. The chemical and antigenic features of the EPS preparations of the *Mortierella isabellina* group were compared with those derived from three *Mortierella* species and with *Mucor racemosus*. The EPS preparations were examined on the presence of the fucose plus glucuronic acid-containing fraction and the  $\beta(1-4)$ -glucuronan polymer, and on their ELISA reactivity using IgG antibodies raised against the EPS of *Mucor racemosus*, *Penicillium digitatum* Sacc. and *Fusarium moniliforme* Sheldon, respectively.

## Materials and methods

### Moulds

The following isolates were taken from the collection of the Centraalbureau voor Schimmelcultures, Baarn (CBS). The first three are representatives of *Mortierella*



subgenus *Mortierella*, the remaining ones of subgenus *Micromucor* or *Umbelopsis* Amos & Barnett. For the time being, they are all referred to under their *Mortierella* binomials: *M. polycephala* Coemans, CBS 327.72; *M. reticulata* van Tieghem, CBS 452.74; *M. hyalina* (Harz) W. Gams, CBS 654.68; *M. nana* Linnem., CBS 730.70; *M. roseonana* W. Gams, CBS 473.74; *M. ramanniana* (Möller) Linnem. var. *ramanniana*, CBS 243.58; *M. isabellina* Oudem., CBS 560.63; *M. ovata* Yip, CBS 499.82; and *M. vinacea* Dixon-Stewart, CBS 236.82. In addition, one strain of *Mucor racemosus* Fres., CBS 222.81, was studied as a representative of the Mucoraceae.

### *Isolation and purification of EPS*

Moulds used in this study were grown in shaking cultures with yeast-nitrogen base (YNB, Difco Labs., Detroit, U.S.A.) as basal synthetic culture medium (6.7 g/l) supplemented with 30 g/l glucose as carbon source. The initial pH of the culture fluid was 5.1. In the case of *M. polycephala* and *M. reticulata* the pH was adjusted to 7.0 by the addition of 1 M sodium hydroxide. Inoculation was performed either with 0.1 ml of a spore suspension or by using micro-colonies of freshly germinated spores. EPS of the moulds were isolated from the culture fluid and purified by ethanol precipitation as described by De Ruiter *et al.* (4).

### *Chemical characterization of EPS*

The neutral sugar composition of the EPS was determined after conversion to alditol acetates by gas-liquid chromatography. Neutral sugars were released by pre-treatment with 12 M sulphuric acid for 1 h at 30 °C, followed by hydrolysis with 1 M H<sub>2</sub>SO<sub>4</sub> for 3 h at 100 °C. Sugars were converted to their alditol acetates after reduction with sodium borohydride and subsequent derivatization using 1-methyl imidazole and acetic anhydride as described (9), and analysed using inositol as the internal standard.

The glucuronic acid content was determined by the automated *m*-hydroxydiphenyl method (19) slightly modified by the addition of 0.0125 M sodium tetraborate to the sulphuric acid. Glucuronic acid was used as standard. The nature of the uronic acid component was determined using a high-performance anion-exchange chromatography system of Dionex (Sunnyvale, CA, U.S.A.) with pulsed-amperometric detection as described by De Ruiter *et al.* (7).

The protein content was measured using the colorimetric method according to Lowry *et al.* (16) with bovine serum albumin as standard.

### *Molecular weight distribution*

The molecular weight distribution was studied using high-performance size-exclusion

chromatography, which was performed on an SP8800 HPLC system (Spectra Physics, San José, CA, U.S.A.) equipped with three Bio-Gel TSK columns in series (40 XL, 30 XL, 20 XL; 300 × 7.5 mm; Bio-Rad Labs, Richmond, CA, U.S.A.) in combination with a TSK-XL guard column (40 × 6 mm) at 30 °C using 0.4 M acetic acid/sodium acetate (pH 3.0) as eluent with a flow rate of 0.8 ml/min (4). The molecular weight calibration of this system was performed by using dextran standards (10, 40, 70 and 500 kD; Pharmacia, Uppsala, Sweden).

#### *Anion-exchange chromatography*

This was performed on a column (12 × 1.6 cm) of DEAE-Sepharose CL-6B (Pharmacia, Uppsala, Sweden), equilibrated with 0.05 M sodium acetate buffer (pH 5.0). After loading the sample of EPS (1 ml of a 5 mg/ml solution), the column was washed with 25 ml of buffer and then eluted with a linear gradient of 0.05–1 M sodium acetate buffer (50 ml), followed by 25 ml of 1 M buffer. Finally, to ensure that all material was released, the column was washed with 50 ml of 2 M sodium acetate buffer, pH 5.0. Fractions were assayed for both glucuronic acid and neutral sugars by the automated assay using a Skalar 5100 autoanalyser (Skalar Analytical, Breda, The Netherlands).

#### *Isolation and purification of the $\beta(1-4)$ -glucuronan*

The  $\beta(1-4)$ -D-polyglucuronic acid was isolated from the EPS preparations after treatment with 2 M HCl (100 °C, 4 h) and purified using DEAE anion-exchange chromatography as described (5).

#### *NMR spectroscopy*

The  $^{13}\text{C}$ -NMR (50 MHz) spectrum of  $\beta(1-4)$ -D-polyglucuronic acid isolated from EPS of *M. isabellina* was obtained with a Bruker AC200E spectrometer in a 5 mm tube at 25 °C. An aliquot of 10 mg of sample was dissolved in 0.5 ml  $\text{D}_2\text{O}$  and the pD was adjusted to 7.0 using a few microlitres of a 0.05 M NaOH solution. The chemical shift for the methyl group of internal acetone was taken to be 31.07 p.p.m. with respect to the signal for  $\text{Me}_4\text{Si}$ .

#### *Sandwich ELISA*

Immunochemical determination of the extracellular polysaccharides was performed using a sandwich ELISA as described (4,18) with polyclonal IgG antibodies raised against extracellular polysaccharides from *Mucor racemosus* (1000/1201; anti-*Mucor*), *Penicillium digitatum* M 58 (332; anti-*Penicillium*) and *Fusarium moniliforme* M 26 (724; anti-

**Table 1.** Mycelial dry weight and yield of excreted polysaccharides of three *Mortierella* species, six species belonging to the *Mortierella isabellina* group and *Mucor racemosus*, grown in synthetic liquid cultures using ammonium sulphate as nitrogen source and glucose as carbon source at their optimum temperature of growth.

Mould	Strain (CBS)	Incubation (days)	Mycelial dry weight (mg/l)	EPS (mg/l)	Ratio <sup>b</sup>
<i>M. polycephala</i>	327.72	8	723	22	0.03
<i>M. reticulata</i>	452.74	8	658	28	0.04
<i>M. hyalina</i>	654.68	7	2800	402	0.14
<i>M. nana</i>	730.70	17	1708	144	0.08
<i>M. roseonana</i>	473.74	6	3711	541	0.15
<i>M. ramanniana</i>					
var. <i>ramanniana</i> <sup>a</sup>	243.58	7	746	96	0.13
<i>M. isabellina</i>	560.63	8	9778	1502	0.15
<i>M. ovata</i>	499.82	6	693	90	0.13
<i>M. vinacea</i>	236.82	6	958	335	0.35
<i>Mucor racemosus</i>	222.81	8	8429	895	0.11

<sup>a</sup> Culture (200 ml) which was incubated with 5 micro-colonies of germinated spores in each flask.

<sup>b</sup> Calculated as the amount of EPS relative to the amount of biomass.

*Fusarium*), respectively. The ELISA reactivity was expressed as the titre of the EPS which is the reciprocal dilution of a solution of 100 µg/ml EPS in distilled water just giving a positive reaction, *i.e.* an extinction  $\geq 0.1$  above that of a blank containing no antigenic EPS.

## Results

### *Production of extracellular polysaccharides*

All mould species tested in this study were able to excrete a considerable amount of extracellular polysaccharides (Table 1). *M. polycephala* and *M. reticulata* did not grow out in the liquid synthetic culture medium with an initial pH of 5.1, even if different incubation temperatures between 15 and 25 °C were used. After raising the pH of the culture liquid to 7.0 by the addition of some sodium hydroxide, the inoculated spores of these moulds did grow out to mycelial pellets and excreted polysaccharides. The amounts of excreted polysaccharides relative to the amount of mycelial dry weight varied between 0.03 and 0.14 for representatives of *Mortierella* subgenus *Mortierella*. For moulds

**Table 2.** Sugar composition of EPS preparations of *Mortierella* species (*sensu lato*) and *Mucor racemosus* determined after sulphuric acid hydrolysis<sup>a</sup>.

Mould species	Sugar content (mole %) <sup>b</sup>				
	Fuc	Man	Gal	Glc	GlcA
<i>Mortierella polycephala</i>	17	8	15	43	17
<i>M. reticulata</i>	10	17	20	33	20
<i>M. hyalina</i>	38	9	12	6	35
<i>M. nana</i>	42	22	13	6	17
<i>M. roseonana</i>	43	20	14	2	21
<i>M. ramanniana</i>	32	30	11	8	19
<i>M. isabellina</i>	54	15	13	1	17
<i>M. ovata</i>	11	6	2	71	10
<i>M. vinacea</i>	32	30	11	2	25
<i>Mucor racemosus</i>	21	30	8	2	39

<sup>a</sup> Values are the averages of duplicate experiments. These experiments were carried out before those described in Chapter 4. Therefore, it can be assumed that methanolysis followed by TFA hydrolysis provides more accurate data on the sugar composition of these EPSs than the use of sulphuric acid (*cf.* EPS of *Mortierella isabellina*; Table 5, p. 58).

<sup>b</sup> The sugar content of the EPS preparations varied between 50 and 80 % (w/w).

belonging to the *Mortierella isabellina* group it varied between 0.08 and 0.35, as can be derived from Table 1.

#### Chemical characterization of EPS

Chemical analysis of the EPS preparations revealed the presence of protein, neutral sugars and uronic acid. The amount of protein varied between 15 and 36% for representatives of *Mortierella* subgenus *Mortierella* and between 9 and 25% for EPS preparations from moulds belonging to the *Mortierella isabellina* group. However, the protein content was measured using the colorimetric assay with the Folin phenol dye, which mainly reacts with the phenol groups of the amino acids involved. Therefore these values can only be considered indicative until the relative proportion of these amino acids is known.

The presence of uronic acids (Table 2) was established using the colorimetric *m*-hydroxy diphenyl assay (19). This reagent cannot discriminate between the various uronic acids such as glucuronic acid, galacturonic acid or mannuronic acid. Therefore, the nature of the uronic acid involved was established using high-performance anion-exchange chromatography of the EPS preparations after hydrolysis (7). This unequivocally revealed the presence of glucuronic acid (GlcA) only.

The nature of the neutral sugar residues in the EPS preparations was determined after

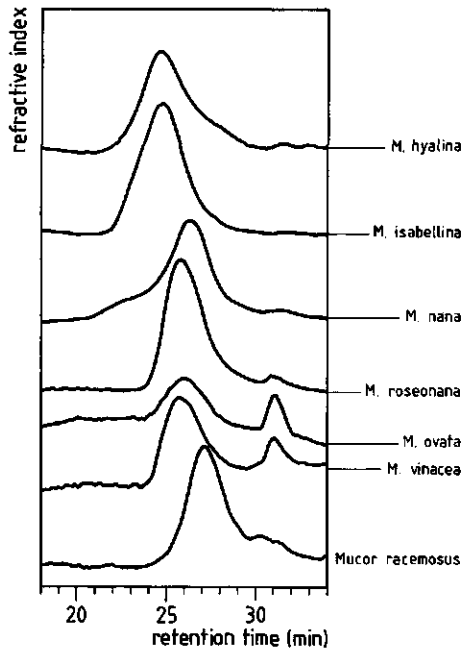

**Fig. 1.** High-performance size-exclusion chromatography of EPS preparations of *Mucor racemosus* and various *Mortierella* species.

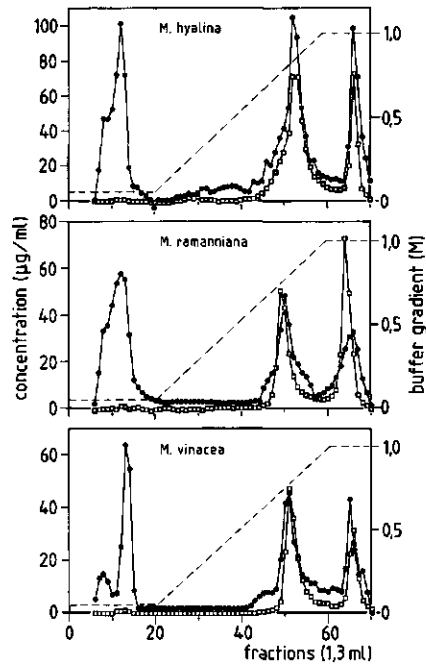

**Fig. 2.** DEAE anion-exchange chromatography of the EPS preparations of three *Mortierella* species. -●-●-, neutral sugar content; -□-□-, glucuronic acid content; - - -, gradient of sodium acetate buffer (pH 5.0).

hydrolysis of the polysaccharides followed by derivatization to alditol acetates. This procedure revealed the presence of various amounts of fucose (Fuc), mannose (Man), galactose (Gal) and glucose (Glc) in all preparations as listed in Table 2. However, a precipitate was obtained after acid hydrolysis of all the EPS except those derived from *M. polycephala* and *M. reticulata*, indicating incomplete hydrolysis in spite of the drastic acid hydrolysis with sulphuric acid.

#### *Molecular weight distribution of the EPS*

Some of the EPS studied were applied to high-performance size-exclusion chromatography. The mol. wt distributions of the various EPS preparations are shown in Fig. 1. In all preparations of the species provisionally referred to as *Mortierella*, a main peak with a retention time between 23 and 26 min could be detected. This corresponds to a molecular mass of 80 to 300 kD if the system is calibrated with dextran standards. The mol. wt distribution of EPS of *Mucor racemosus* as shown in the same figure and as

**Table 3.** Characteristics of the purified acid-resistant precipitates of *M. isabellina* (*Mortierella isabellina* group) and *M. hyalina* (*Mortierella* subgenus *Mortierella*).

Species	Yield related to		GlcA	Molecular
	EPS <sup>a</sup>	GlcA <sup>b</sup>	content <sup>c</sup>	mass <sup>d</sup>
<i>Mortierella hyalina</i>	4	2	14	Mixture
<i>Mortierella isabellina</i>	20	89	66	9

<sup>a</sup> Expressed as percentage (w/w) of initial amount of EPS.

<sup>b</sup> Expressed as percentage (w/w) of initial amount of GlcA in EPS.

<sup>c</sup> Determined by the automated *m*-hdp method using GlcA as the standard.

<sup>d</sup> In kilo Dalton; calibration with dextran standard.

determined previously (4) showed a unimodal distribution with a retention time between 27 and 29 min, corresponding to a molecular mass between 10 and 50 kD.

#### *Anion-exchange chromatography*

The EPS preparations of *M. hyalina*, *M. vinacea* and *M. ramanniana* were also tested on their behaviour on a DEAE anion-exchange column as shown in Fig. 2. The three chromatograms are very similar. Roughly three fractions in the EPS preparations can be distinguished. The first consisting only of neutral sugars is not able to bind to the DEAE column. The second and third fractions contained glucuronic acid residues and neutral sugars and could be released from the column with increasing amounts of sodium acetate. Washing the column with 2 M buffer did not release any further material. The ELISA activity of EPS from *M. ramanniana* and *M. vinacea* was mainly found in the non-binding DEAE fraction (void).

#### *Isolation and characterization of the precipitate of the acid hydrolysis*

Complete hydrolysis of most of the EPS preparations could not be achieved. Even after using the severe Saeman hydrolysis (12 M sulphuric acid, 1 h, 30 °C, followed by 1 M, 3 h, 100 °C) a precipitate remained. This acid-insoluble but alkali-soluble precipitate was isolated and purified from the EPS preparations of *M. hyalina* and *M. isabellina* (Table 3).

The acid-resistant fraction remaining after 2 M HCl hydrolysis (100 °C, 4 h) isolated from *M. hyalina* was less than 4 % of the initial amount of EPS and contained only 14% GlcA, whilst the major part was protein. Separation of this fraction using high-performance size-exclusion chromatography revealed a multimodal mol. wt distribution (not shown). No attempts were made to characterize this fraction further.

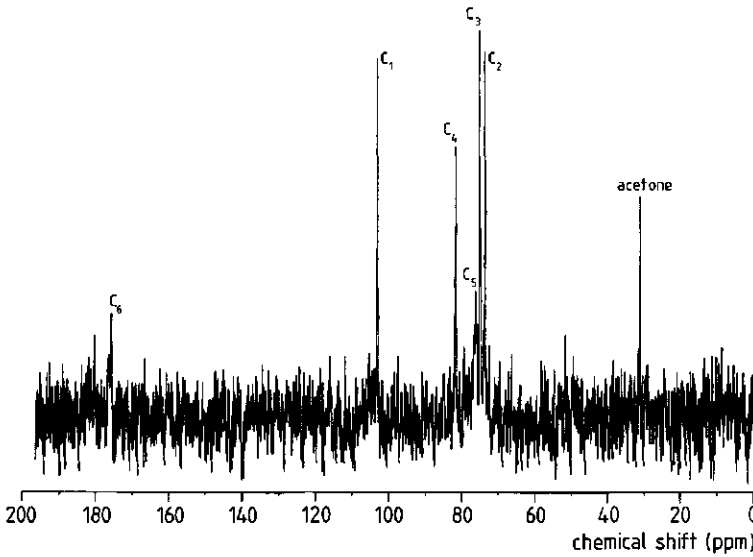

**Fig. 3.**  $^{13}\text{C}$ -NMR spectrum (50 MHz) of  $\beta(1-4)$ -linked glucuronic acid polymer derived from extracellular polysaccharides of *Mortierella isabellina*.  $^{13}\text{C}$  Chemical shifts (ppm) of the respective carbon atoms:  $\text{C}_1$  103.07;  $\text{C}_2$  73.56;  $\text{C}_3$  74.98;  $\text{C}_4$  81.54;  $\text{C}_5$  76.18;  $\text{C}_6$  175.8.

The acid-resistant fraction of *M. isabellina* contained 89% of the GlcA initially present in the native EPS preparation. Characterization of this fraction by both chemical analysis and NMR-spectroscopy (Fig. 3) revealed the presence of a polymer of  $\beta(1-4)$ -D-glucuronic acid with a unimodal mol. wt distribution corresponding to a molecular mass of approx. 9 kD if calibrated with dextran standards.

#### *Antigenic activity of the EPS preparations with different IgG antibodies*

The antigenic activity of the various EPS preparations was tested in a sandwich ELISA using polyclonal IgG antibodies raised in rabbits against extracellular polysaccharides of *Mucor racemosus*, *Penicillium digitatum* and *Fusarium moniliforme*. As shown in Table 4, the EPS preparations of *M. polycephala*, *M. reticulata* and *M. hyalina* (fam. Mortierellaceae) did not show any ELISA activity with the three different polyclonal IgG antibodies tested. The other EPS tested did give a weak positive reaction

in the *Mucor*-ELISA. The titres of the *M. nana* and *M. roseonana* preparations were of the same level as EPS preparations of various mould species belonging to the mucoralean group (3). No antigenic activity of these EPS preparations was found with the antibodies raised against EPS from *Penicillium* and *Fusarium*.

## Discussion

All mould species tested in this study were able to excrete considerable amounts of extracellular polysaccharides. The yields of EPS relative to the biomass varied for the different species using the synthetic growth medium with glucose as carbon source. However, EPS production of the species belonging to *Mortierella* subgenus *Mortierella*, the *Mortierella isabellina* group, and *Mucor racemosus* did not differ significantly. *M. polycephala* and *M. reticulata* differed from the other species as a result of their inability to grow in this synthetic culture medium with an initial pH of 5.1, but this feature is certainly not characteristic of the whole subgenus.

All EPS preparations tested did contain both fucose and glucuronic acid. This combination was previously found to be characteristic for species of the mucoralean group (17). The sugar composition of the EPS of mucoralean species was found to be dependent on carbon source and nitrogen source (6). However, no significant difference in the sugar composition of the EPS preparations from the three groups of moulds involved can be derived from the present data. It can be concluded that the presence of both Fuc and GlcA is not limited to species of the mucoralean group as hitherto assumed and that this combination also occurs in EPS of *Mortierella* species.

Contrasting with the molecular mass of EPS from *Mucor* species of approx. 30 kD with a unimodal distribution, the preparations of the *Mortierella isabellina* group are constituted of higher molecular masses between 50 and 300 kD, which were found to be bimodal in some of the species. However, EPS preparations from species of the genera *Rhizopus* Ehrenb., *Rhizomucor* (Lucet & Cost.) Wehmer ex Vuill., *Absidia* v. Tieghem, *Syncephalastrum* Schroeter and *Thamnidium* Link also showed multimodal mol. wt distributions with higher molecular masses (4).

Separation using anion-exchange chromatography revealed the presence of three main fractions in the EPS tested. These chromatograms are similar to the DEAE anion-exchange chromatograms of EPS preparations from the mucoralean group (4). No clear difference can be seen in the behaviour on anion-exchange columns between the three groups of moulds considered.

The EPS of *M. isabellina* gave a considerable amount of precipitate after treatment with 2 M HCl, which was characterized as a  $\beta(1-4)$ -D-glucuronic acid polymer. The  $^{13}\text{C}$ -NMR spectrum was identical to the spectrum previously reported for  $\beta(1-4)$ -D-polyglucu-



**Table 4.** ELISA reactivity<sup>a</sup> of different EPS preparations of *Mortierella* species (*sensu lato*) and an EPS preparation of *Mucor racemosus* carried out with IgG antibodies raised against EPS from *Mucor racemosus*, *Penicillium digitatum* and *Fusarium moniliforme*.

Mould species	ELISA titres <sup>b</sup>		
	anti- <i>Mucor</i>	anti- <i>Penicillium</i>	anti- <i>Fusarium</i>
<i>Mortierella polycephala</i>	-	-	-
<i>M. reticulata</i>	-	-	-
<i>M. hyalina</i>	-	-	-
<i>M. nana</i>	+++	-	-
<i>M. roseonana</i>	+++	-	-
<i>M. ramanniana</i>	+	-	-
<i>M. isabellina</i>	++	-	-
<i>M. ovata</i>	+	-	-
<i>M. vinacea</i>	+	-	-
<i>Mucor racemosus</i>	++++	-	-

<sup>a</sup> Values are the averages of duplicate experiments.

<sup>b</sup> ELISA titre of 100 µg/ml solutions of EPS: -, no ELISA reactivity; +, 1 ≤ titre ≤ 10; ++, 10 ≤ titre ≤ 100; +++, 100 ≤ titre ≤ 1000; +++++, titre > 1000.

ronan of *M. hiemalis* Wehmer (5). The mol. wt distribution of this polymer was similar to those isolated from several mucoralean EPS preparations (5). In contrast, the EPS of *M. hyalina* did not contain this β(1-4)-D-glucuronic acid polymer.

Immunological characterization of EPS preparations from mould species belonging to the *Mortierella isabellina* group did give a positive ELISA reaction with anti-*Mucor* IgG antibodies only. The ELISA activity of EPS from *M. ramanniana* and *M. vinacea* is found in the non-binding fraction from the anion-exchange column and therefore similar to the characteristics of the mucoralean EPS preparations (4). These results reveal a clear immunological difference between the *Mortierella isabellina* group and the species belonging to *Mortierella* subgenus *Mortierella*, as the latter did not react with anti-*Mucor* IgG.

The structure of cell-wall polysaccharides of fungi has been proposed to be used as important features in fungal chemotaxonomy (1,17). The chromatographic analysis of hydrolysed whole-cell preparations has given characteristic chitin patterns for many species of Mucorales (22). The same technique has been applied to six species of the *M. isabellina* group, four of *Mortierella* subgenus *Mortierella*, and some other mucoralean fungi, but did not provide significantly differing results (A.C.M. Weijman, pers. comm.). This method obviously is too crude to be used in this particular case. The chemical and immunological features of extracellular polysaccharides allow observation of finer differences, which can be useful for classification purposes.

The species selected for this study are considered representative of the *Mortierella isabellina* group, and analysis of the EPS shows a chemotaxonomical difference with the species of *Mortierella* subgenus *Mortierella*. It is unlikely that the *M. isabellina* group is related to the Mortierellaceae as they show antigenic similarity with mucoralean species. The EPS from *Mortierella* subgenus *Mortierella* also differ from both other groups as the  $\beta(1-4)$ -D-glucuronan polymer is lacking. However, the *M. isabellina* group also deviates from the Mucoraceae and related families as the antigenic activity of the EPS is lower. Only *M. nana* and *M. roseonana* showed a higher reactivity towards the *M. racemosus* IgG antibodies, suggesting a possible bipartition between these species and the remaining species of the *Mortierella isabellina* group. In spite of the useful chemotaxonomical characterization of the extracellular polysaccharides, additional approaches will have to be applied before a final decision about familial and generic classification can be made.

## References

1. Bartnicki-García, S. (1968). Cell wall chemistry, morphogenesis, and taxonomy of fungi. *Annual Review of Microbiology* **22**, 87-108.
2. Bartnicki-García, S. & Reyes, E. (1968). Polyuronides in the cell walls of *Mucor rouxii*. *Biochimica et Biophysica Acta* **170**, 54-62.
3. De Ruiter, G.A., Smid, P., Van der Lugt, A.W., Van Boom, J.H., Notermans, S.H.W. & Rombouts, F.M. (1991). Immunogenic extracellular polysaccharides of Mucorales. In *Fungal Cell Wall and Immune Response* (ed. J.-P. Latgé & D. Boucias), pp. 169-180. NATO ASI Series H 53, Springer Verlag, Heidelberg, Berlin.
4. De Ruiter, G.A., Van der Lugt, A.W., Voragen, A.G.J., Rombouts, F.M. & Notermans, S.H.W. (1991). High-performance size-exclusion chromatography and ELISA detection of extracellular polysaccharides from Mucorales. *Carbohydrate Research* **215**, 47-57 (this thesis, Chapter 3).
5. De Ruiter, G.A., Josso, S.L., Colquhoun, I.J., Voragen, A.G.J. & Rombouts, F.M. (1992). Isolation and characterization of  $\beta(1-4)$ -D-glucuronans from extracellular polysaccharides of moulds belonging to Mucorales. *Carbohydrate Polymers* **18**, 1-7 (this thesis, Chapter 6).
6. De Ruiter, G.A., Van Bruggen-van der Lugt, A.W., Nout, M.J.R., Middelhoven, W.J., Soentoro, P.S.S., Notermans, S.H.W. & Rombouts, F.M. (1992). Formation of antigenic polysaccharides by selected strains of *Mucor* spp., *Rhizopus* spp., *Rhizomucor* spp., *Absidia corymbifera* and *Syncephalastrum racemosum*. *Antonie van Leeuwenhoek* **62**, 189-199 (this thesis, Chapter 2).
7. De Ruiter, G.A., Schols, H.A., Voragen, A.G.J. & Rombouts, F.M. (1992). Carbohydrate analysis of water-soluble uronic acid containing polysaccharides with high-performance anion-exchange chromatography using methanolysis combined with TFA hydrolysis is superior to four other methods. *Analytical Biochemistry* **207**, 176-185 (this thesis, Chapter 4).
8. Dow, J.M., Darnall, D.W. & Villa, V.D. (1983). Two distinct classes of polyuronide from the cell walls of a dimorphic fungus, *Mucor rouxii*. *Journal of Bacteriology* **155**, 1088-1093.
9. Englyst, H.N. & Cummings, J.H. (1984). Simplified method for the measurement of total non-starch polysaccharides by gas-liquid chromatography of constituent sugars as alditol acetates. *Analyst* **109**, 937-942.

10. Fuhrmann, B., Roquebert, M.F., Van Hoegaerden, M. & Strosberg, A.D. (1989). Immunological differentiation of *Penicillium* species. *Canadian Journal of Microbiology* **35**, 1043–1047.
11. Gams, W. (1977). A key to the species of *Mortierella*. *Persoonia* **9**, 381–391.
12. Hawksworth, D.L. & Bridge, P.D. (1988). Recent and future developments in techniques of value in the systematics of fungi. *Mycosystema* **1**, 5–19.
13. Ianelli, D., Capparelli, R., Cristinzio, G., Marziano, F., Scala, F. & Noviello, C. (1982). Serological differentiation among *formae speciales* and physiological races of *Fusarium oxysporum*. *Mycologia* **74**, 313–319.
14. Kusters-van Someren, M.A., Samson, R.A. & Visser, J. (1991). The use of RFLP analysis in classification of the black Aspergilli: reinterpretation of the *Aspergillus niger* aggregate. *Current Genetics* **19**, 21–26.
15. Linnemann, G. (1941). *Die Mucorineen-Gattung Mortierella Coemans*. Pflanzenforschung, H. 23. G. Fischer: Jena.
16. Lowry, O.H., Rosebrough, N.J., Farr A.L. & Randall, R.J. (1951). Protein measurement with the folin phenol reagent. *Journal of Biological Chemistry* **193**, 265–275.
17. Miyazaki, T., Yadomae, T., Yamada, H., Hayashi, O., Suzuki, I. & Ohshima, Y. (1980). Immunochemical examination of the polysaccharides of Mucorales. In *Fungal Polysaccharides* (ed. P.A. Sandford & K. Matsuda), pp. 81–94. Symp. Ser. 126, American Chemical Society: Washington.
18. Notermans, S. & Heuvelman, C.J. (1985). Immunological detection of moulds in food by using the enzyme-linked immunosorbent assay (ELISA); preparation of the antigens. *International Journal of Food Microbiology* **2**, 247–258.
19. Thibault, J.-F. (1979). Automatisation du dosage des substances pectiques par la méthode au méta-hydroxydiphenyl. *Lebensmittel-Wissenschaft und Technologie* **12**, 247–251.
20. Tsuchihashi, H., Yadomae, T. & Miyazaki, T. (1983). Structural analysis of the cell-wall D-glucuronans from the fungi *Absidia cylindrospora*, *Mucor mucedo* and *Rhizopus nigricans*. *Carbohydrate Research* **111**, 330–335.
21. Turner, M. (1963). Studies in the genus *Mortierella*. 1. *Mortierella isabellina* and related species. *Transactions of the British Mycological Society* **46**, 262–272.
22. Weijman, A.C.M. & Meuzelaar, H.L.C. (1979). Biochemical contributions to the taxonomic status of the Endogonaceae. *Canadian Journal of Botany* **57**, 284–291.
23. Yamada, H., Ohshima, Y. & Miyazaki, T. (1982). Characterisation of extracellular mannoheteroglycans from *Absidia cylindrospora*. *Chemical and Pharmaceutical Bulletin* **30**, 1784–1791.



## The production and partial characterization of a monoclonal IgG antibody specific for moulds belonging to the order of Mucorales

*Journal of General Microbiology*<sup>1</sup> (1993) in press.

A monoclonal antibodies (mAb) was raised against extracellular polysaccharides from *Mucor racemosus* after intrasplenic immunization of mice. An indirect ELISA and a DOT-BLOT assay were developed with this mAb. The IgG antibody was found to be very specific for all mould species belonging to the order of Mucorales tested except species belonging to the genus *Mortierella* sensu stricto. No cross-reactions were observed with other moulds or yeasts. The antigenicity of the polysaccharides of these moulds with this mAb is based on carbohydrate epitopes other than 2-*O*-methyl-mannose residues which are responsible for the reactivity with polyclonal rabbit antibodies. The mAb may be suited for specific detection of mucoralean species in food and for diagnosis of mucormycosis in humans.

### Introduction

Moulds belonging to the order of Mucorales (Zygomycetes), including the genera *Mucor*, *Rhizopus*, *Rhizomucor*, *Syncephalastrum*, *Absidia*, *Choanephora* and *Thamnidium* have been found in many parts of the world. Some species are important as causal agents of mucormycosis in man (25). Some are pathogenic for crop plants and many can cause food spoilage resulting in a huge economic loss (21). In general, the presence of moulds in food is often associated with loss of quality, therefore early detection of moulds is important.

Modern detection methods in food mycology are based on the recognition of fungal antigenic polysaccharides by specific immunoassays (11,19). Recently, the development of a specific ELISA for species of Mucorales was described and successfully used to detect these species in food (8).

The characterization of polyclonal IgG antibodies (pAbs) from rabbits against the EPS

---

<sup>1</sup>Authors: G.A. De Ruiter, A.W. Van Bruggen-van der Lugt, W. Bos, S.H.W. Notermans, F.M. Rombouts, and H. Hofstra.

of *Mucor racemosus*, was described recently (10). These antibodies were characterized as almost specific for moulds belonging to the order of Mucorales, as cross-reactivity was only observed towards the yeast *Pichia membranaefaciens* but not to any other species of moulds tested. To enhance the specificity and the feasibility to commercialize specific test kits, monoclonal antibodies (mAbs) are necessary (16). Recently, mAbs have been described specific for *Penicillium*, *Aspergillus* and *Botrytis* species and used in the analysis of foods and feeds (4,15,24). Until now, no monoclonal antibodies specific for mould species belonging to the order of Mucorales have been reported.

The extracellular polysaccharides (EPSs) of Mucorales consist mainly of carbohydrates and protein, with fucose, galactose, mannose, glucose and glucuronic acid as the main sugar residues (2,6,7,18). Glucuronic acid is present as  $\beta(1-4)$ -linked D-glucuronic acid polymers, an important structural entity of these EPSs (9). Furthermore, these EPS preparations contain a fraction with 2-O-methyl-mannose residues which are immunoreactive with polyclonal rabbit antibodies (13).

In the present report, we describe the production of a monoclonal IgG antibody against EPS of *Mucor racemosus* and the development of an indirect ELISA and a DOT-BLOT assay based on these antibodies. These assays were used to determine the specificity of the mAb and to compare its activity with that of polyclonal IgG antibodies. Furthermore, the structure of the epitopes of the EPSs reactive with these mAbs was studied by specific enzymatic degradation and periodate treatments of the antigenic EPSs.

## Material and methods

### *Extracellular polysaccharides*

EPSs of 29 strains of moulds (Table 1) were produced, isolated and purified by ethanol precipitation as described (7). Also, 39 yeast strains were tested (10; Table 1, p. 24).

### *Preparation of hybridomas*

Mice (BALB/c, female, 6 weeks old) were obtained from Charles River Wiga GmbH (Sulzfeld, Germany). Mice were immunized by intrasplenic injection of 50  $\mu$ g EPS from *Mucor racemosus* in PBS (70 mM sodium phosphate, pH 7.2, 150 mM NaCl) (22). The mice were given one booster immunization by intrasplenic injection with 50  $\mu$ g EPS on day 14, and killed three days after the booster injection and the spleens were removed and macerated.

The mouse myeloma cell line P3x63Ag8.653 (ATCC: CRL 1580; Rockville, MA, U.S.A.) was maintained at 37 °C in 5 % CO<sub>2</sub> atmosphere in 4.5 g/l glucose Dulbecco's

modified Eagle medium (DMEM, Gibco Ltd., Renfrewshire, UK) supplemented with 10 % heat-inactivated bovine calf serum (BCS, HyClone Labs., Logan, UT, U.S.A.), 6 mM glutamine (ICN Flow, High Wycombe, UK), 50  $\mu\text{g}/\text{ml}$  kanamycin (ICN Flow), 10 units/ml penicillin (Gibco) and 10  $\mu\text{g}/\text{ml}$  streptomycin (Gibco). On the day of hybridization the myeloma cells were collected by centrifugation at 250 g, washed twice with DMEM without BCS, and suspended in this medium.

Cell fusion was performed according to the polyethylene-glycol (PEG) method (14). A PEG solution was prepared by mixing equal amounts of autoclaved PEG (molecular mass approx. 4000; Serva) and serumless DMEM, and kept at 37 °C. The PEG solution (1 ml) was added to the splenocyte-myeloma cell mixture in 1 min with mixing. The resulting mixture was kept at 37 °C for 1.5 min and 10 ml of serum-free DMEM was added. DMEM (10 ml) with 10% (w/v) BCS was added and the mixture was kept at room temperature for 5 min. Cells were collected by centrifugation and suspended in 50 ml AH-medium, consisting of DMEM with 10 % (w/v) BCS, glutamine, kanamycin, penicillin, streptomycin, 10% (v/v) human endothelial cell growth supplement (Costar, Cambridge MA, U.S.A.), 0.1 mM hypoxanthine and 1  $\mu\text{g}/\text{ml}$  azaserine. The cells were distributed at a density of  $1 \times 10^5$  viable spleen cells per well in 96-well sterile culture trays (Intermed Nunclon, Roskilde, Denmark).

Wells testing positive for antibody production by indirect ELISA as described below, were expanded by a modified limiting dilution technique (5). H-medium, (AH-medium without hypoxanthine) was added to 96-well sterile microculture plates (100  $\mu\text{l}$  per well) except for the last column of wells into which 50  $\mu\text{l}$  of medium was added. Cells from positive wells were transferred to the first well in the first column of the expansion plates, and serially diluted down the first column and then across each row by transferring 50  $\mu\text{l}$  from each well to the next. The plates were examined for growth after 7–10 days and wells in which growth was observed were assayed for antibody production by the indirect ELISA method. Wells tested positive were expanded again by the modified limiting dilution technique. Finally, wells positive for antibody were expanded by transferring to 24-well sterile cell culture plates, and subsequently expanded to 50-ml flasks and 500-ml culture flasks. Cells in logarithmic growth were frozen by control rate freezing in DMEM with 10 % (v/v) dimethyl sulphoxide (DMSO) and stored in the vapour phase of a liquid nitrogen freezer.

#### *Determination of the immunoglobulin subclass and concentration of the mAb*

Isotyping of the monoclonal antibodies produced by these lines was performed using a mouse mAb isotyping kit (Life Technologies A.S., Roskilde, Denmark) according to the instructions of the supplier.

The concentration of the mAb IgG in the supernatant was determined using an ELISA, by coating 100  $\mu\text{l}$  of a 10  $\mu\text{g}/\text{ml}$  solution of goat anti-mouse IgG + IgM antibodies (4153;

Tago Inc., Burlingame, CA, U.S.A.) in PBS for 3 h at 37 °C. The plates were washed three times with PBS containing 0.05% (w/v) Tween 20 (PBST). Next, the wells were filled with 50 µl of PBST, 100 µl of the mAb containing supernatant was added to the first well and subsequently diluted serially by transferring each time 50 µl to the next well. After incubation for 1 h at 37 °C, the plates were washed three times with PBST, and 100 µl of peroxidase conjugated to goat anti-mouse IgG (Zymed Laboratories Inc., San Francisco, CA, U.S.A.) was added to each well (1:2000 in PBST with 1% BCS). Following incubation for 1 h at 37 °C, the plates were washed three times with PBST and incubated with 100 µl of 3,3',5,5'-tetramethylbenzidine in dimethyl sulphoxide containing H<sub>2</sub>O<sub>2</sub> prepared according to Bos *et al.* (3). The peroxidase reaction was stopped after incubation for 30 min at 25 °C by adding 50 µl of 2 M H<sub>2</sub>SO<sub>4</sub> to each well. The absorbance of the yellow colour was measured spectrophotometrically at 450 nm. Calculation of the concentration mAb IgG1 was performed by comparing the ELISA titration curve of the supernatant with those of a sample of mouse IgG1 (Southern Biotechnology Associates Inc., Birmingham, AL, U.S.A.) which was diluted from a 1 mg/ml solution on the same microtitre plate for calibration.

#### *Indirect ELISA for polyclonal and monoclonal IgG*

Polyclonal IgG antibodies (pAb 1000/1201) were obtained by immunization of rabbits with EPS isolated from *Mucor racemosus* as described (19). The IgG fraction of the serum was purified using selective precipitation with octanoic acid as described (23). The ELISA was carried out essentially as described by Notermans *et al.* (20). For this, wells of polyvinyl chloride microtitre plates (Dynatech, Chantilly, VA U.S.A.) were coated with 100 µl of a 5 µg/ml preparation of EPS derived from *Mucor racemosus* in PBS for 16 h at 25 °C. After washing three times in PBST, 100 µl of different dilutions of either the pAb diluted in PBS containing 1% (w/v) bovine serum albumin (BSA) or the mAb diluted in PBS were added and incubated for 1.5 h at 25 °C. In the pAb ELISA, peroxidase-conjugated goat anti-rabbit antibodies (Sigma Immunochemicals A-8275, St. Louis, MO, U.S.A.) were used and in case of the mAb ELISA, peroxidase-conjugated to goat anti-mouse antibodies (Sigma A-4416) were used. The respective conjugates were diluted 1000-fold in PBST containing 1% (w/v) BSA and 100 µl was subsequently added to each well. Incubation was performed for 1.5 h at 25 °C after which time the plates were rinsed three times with PBST. Finally, 100 µl of 3,3',5,5'-tetramethylbenzidine substrate was added as described above. The ELISA reactivity was expressed as the titre, defined as the reciprocal dilution of a solution of 10 µg/ml antibody just giving a positive reaction, i.e. an extinction  $\geq 0.1$  above that of a blank.



### *DOT-BLOT analysis*

Antigenic fungal polysaccharides were bound to nitrocellulose membranes (NC; 0.1  $\mu\text{m}$ ; Schleicher & Schüll, Dassel, Germany) by spotting droplets (2  $\mu\text{l}$ ) of 50 mg/ml preparations of various EPS in PBS buffer (pH 7.2). After the antigen had been allowed to air-dry onto the membrane for 30 min at 25 °C, it was blocked with a 0.1 % (w/v) solution of sodium caseinate (DMV Campina, Veghel, The Netherlands) in PBS for 1 h at 25 °C. The resulting membrane was then exposed to solutions of either the mAb 12.8 or the pAb 1000/1201 in PBS containing 0.5 % (w/v) BSA. Prior to use, the mAb containing supernatant was diluted ten times while a pAb solution was used with a similar concentration of protein. Both were incubated for 16 h at 25 °C. After washing the membrane with PBST three times, 2 min, the nitrocellulose membranes were incubated with the anti-mouse or anti-rabbit antibodies conjugated with peroxidase as described above for the indirect ELISAs for 1.5 h at 25 °C. Finally, the nitrocellulose membranes were washed (PBST, 3 x 2 min) and coloured by dipping for 30 min in a ready-to-use substrate solution of 4-chloro-1-naphthol (PrestoSol BL, Janssen Biotech N.V., Olen, Belgium) which is converted by the peroxidase enzyme in a dense blue colour. The optical density of the spots was measured using a laser densitometer (Computing densitometer 300A, Molecular Dynamics, Sunnyvale, CA, U.S.A.) equipped with a helium-neon laser ( $\lambda$  672 nm) using ImageQuant 3.15 software. The values were corrected by subtracting the OD of the nitrocellulose paper.

### *Enzyme treatment of the EPSs*

The exo- $\alpha$ -D-mannanase which specifically degraded the carbohydrate epitopes of mucoralean EPSs reactive with the polyclonal IgG antibodies, was purified from a crude enzyme preparation of fungal origin (*Trichoderma harzianum*), commercially available as Glucanex (13). An  $\alpha$ -mannosidase (EC 3.2.1.24) isolated from Jack beans (*Canavalia ensiformis*) was obtained from Sigma Chemical Co. (M 7257), and used without further purification. Ten  $\mu\text{l}$  of 2 M sodium acetate buffer (pH 5.0) was added to 175  $\mu\text{l}$  of EPS solution (1 mg/ml) and 65  $\mu\text{l}$  (0.75 mU) of the pAb epitope-degrading exo- $\alpha$ -D-mannanase or, alternatively, 0.75 mU of  $\alpha$ -mannosidase. Incubation was performed at 30 °C for 16 h and the enzymes were subsequently inactivated by heat treatment (5 min, 100 °C). The antigenicities of the native and the different enzyme-treated EPSs were measured using the ELISAs as described above.

### *Periodate oxidation of the antigens*

A polysaccharide sample (5 mg) was treated with 2 ml of a solution of 50 mM  $\text{NaIO}_4$  in 0.25 M formic acid, adjusted to pH 3.7 with 1 M NaOH, for 1 h at 4 °C. The excess

periodate was inactivated after incubation by the addition of 400  $\mu$ l 1,2-ethane diol and incubated for 1 h. The oxidized polysaccharide was reduced by adding 4 ml of 0.5 M sodium borohydride in 1 M NaOH and incubated for 16 h at 25 °C. The mixture was cooled on ice and 300  $\mu$ l of acetic acid was added twice to destroy the excess of NaBH<sub>4</sub>. The polysaccharide was recovered after one night dialysis against running tap-water followed by dialysis against several batches of distilled water for 24 h, and finally lyophilized.

## Results

### *Production of a monoclonal antibody against Mucor racemosus*

Fusion of spleen cells of mice immunized intrasplenically with EPS from the mould *Mucor racemosus* and 8-azaguanine-resistant myeloma P3x63.Ag8 cells yielded 490 hybridomas of which 9 were reactive with EPS of *Mucor racemosus*. The hybridomas were tested for antibody production in the indirect ELISA in which EPS of *Mucor racemosus* was coated to the microtitre plates. Supernatants from these wells were tested for cross-reactivity with EPS preparations from a number of moulds, including representatives of *Penicillium*, *Aspergillus*, *Fusarium*, *Botrytis*, *Alternaria*, and *Cladosporium*. Only one of these hybridomas (12.8) showed a strong reaction with EPS from *Mucor racemosus* and no reaction with EPSs from moulds belonging to other genera. Cells from this well were cloned, and wells positive for growth and antibody production were subcloned once more as described. The resulting clone (designated as mAb 12.8) was grown in the DMEM-medium as described and the supernatant was used for all further experiments. MAb 12.8 was typed as IgG of the subclass 1 (kappa). The concentration of the IgG1 mAb in the supernatant was estimated at 25  $\mu$ g/ml IgG, as determined by ELISA.

### *Specificity of mAb 12.8*

The specificity of mAb 12.8 was studied by determination of the titres of 29 different EPS preparations of the mould genera *Mucor*, *Rhizopus*, *Rhizomucor*, *Absidia*, *Syncephalastrum*, *Thamnidium*, *Mortierella*, *Penicillium*, *Aspergillus*, *Fusarium*, *Alternaria*, *Botrytis*, and *Cladosporium*. As can be derived from Table 1, mAb 12.8 gave a positive immunoreaction with the EPS preparations from all mucoralean moulds tested, except species of the genus *Mortierella* sensu stricto which includes the species *reticulata*, *hyalina* and *polycephala* (12). No reactivity was observed with other mould species often occurring in food such as *Penicillium*, *Aspergillus* and *Fusarium*. Furthermore, 39 yeast

**Table 1.** Reactivity of mAb 12.8 and pAb 1000/1201 raised against the EPS of *Mucor racemosus* with extracellular polysaccharides of different moulds.

Mould strain	Indirect ELISA titre <sup>1</sup>	
	mAb 12.8	pAb 1000/1201
<i>Mucor racemosus</i> Fres., CBS 222.81	+++	+++
<i>Mucor hiemalis</i> Wehmer CBS 201.28	+++	++
<i>Mucor circinelloides</i> van Tieghem RIVM M 40	+	+++
<i>Rhizopus stolonifer</i> (Ehrenb.) Lind CBS 609.82	++	++
<i>Rhizopus oryzae</i> Went & Prinsen Geerlings LU 581	++	++
<i>Rhizomucor pusillus</i> (Lindt) Schipper CBS 432.78	+++	++
<i>Rhizomucor miehei</i> (Cooney & Emerson) Schipper CBS 371.71	+++	++
<i>Absidia corymbifera</i> (Cohn) Sacc. & Trotter LU 017	+	++
<i>Thamnidium elegans</i> Link CBS 342.55	+	++
<i>Syncephalastrum racemosum</i> Cohn CBS 443.59	+	++
<i>Mortierella reticulata</i> van Tieghem CBS 452.74	-	-
<i>Mortierella hyalina</i> (Harz) W. Gams CBS 654.68	-	-
<i>Mortierella polycephala</i> Coemans CBS 327.72	-	-
<i>Mortierella roseonana</i> W. Gams CBS 473.74	++	++
<i>Mortierella nana</i> Linnem, CBS 730.70	++	++
<i>Mortierella ramanniana</i> (Möller) Linnem. var. <i>ramanniana</i> CBS 243.58	++	+
<i>Mortierella ovata</i> Yip CBS 499.82	+	+
<i>Mortierella isabellina</i> Oudem. CBS 560.63	+	+
<i>Penicillium citrinum</i> Thom	-	-
<i>Penicillium dierckxi</i> Biourge	-	-
<i>Penicillium aurantiogriseum</i> Dierckx CBS 342.51	-	-
<i>Penicillium digitatum</i> Sacc. RIVM M58	-	-
<i>Aspergillus fumigatus</i> Fres. RIVM M3	-	-
<i>Aspergillus niger</i> van Tieghem	-	-
<i>Fusarium solani</i> (Mart.) Sacc. CBS 165.87	-	-
<i>Fusarium poae</i> (Peck) Wollenweber CBS 446.67	-	-
<i>Alternaria alternata</i> (Fr.) Keissler	-	-
<i>Botrytis cinerea</i> Pers.	-	-
<i>Cladosporium cladosporioides</i> (Fres.) de Vries CBS 143.65	-	-
<i>Pichia membranaefaciens</i> (Hansen) Hansen	-	++

<sup>1</sup> Microtitre plates coated with 5 µg/ml of the respective EPS preparation. ELISA reactivity expressed as the titre, defined as the reciprocal dilution of a solution of 10 µg/ml antibody just giving a positive reaction. -, ≤ 10; +, 10 < titre ≤ 100; ++, 100 < titre ≤ 1000; +++, titre > 1000. Experiments were carried out in triplicate.

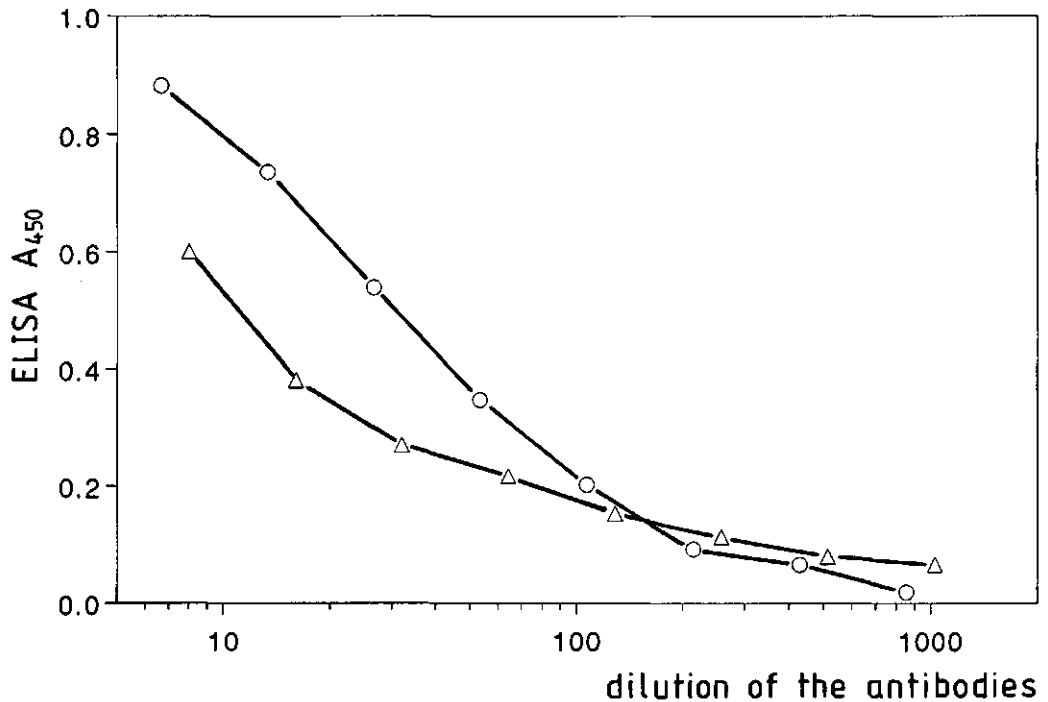
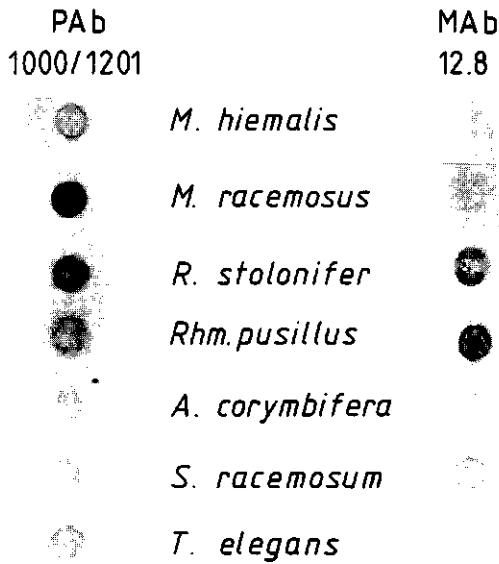

**Fig. 1.** Titration curves of the mAb 12.8 (-△-) and pAb 1000/1201 (-○-) in an indirect ELISA coated with a preparation of EPS (5 µg/ml) from *Mucor racemosus*. The values represent the dilution of a 10 µg/ml solution of the respective antibodies.

species belonging to 20 different genera (see Table 1 page 24) were tested for cross-reactivity with the monoclonal antibody 12.8. These yeasts did not show any reactivity towards mAb 12.8. Even the yeast *Pichia membranaefaciens*, which did give a clear positive immunoreaction with pAb 1000/1201, did not show cross-reactivity with this monoclonal antibody (Table 1).

#### *Reactivity of polyclonal and monoclonal antibodies raised against M. racemosus*

The reactivity of mAb 12.8 was compared with the reactivity of pAb 1000/1201 antibodies raised in rabbits against the same EPS preparation of *M. racemosus* as described previously (10). This was performed by determination of the titration curves in the respective indirect ELISAs after binding of 5 µg/ml of the same EPS preparation of *M. racemosus* to the wall of microtitre plates. As shown in Fig. 1, both the pAb



**Fig. 2.** DOT-BLOT analysis of mucoralean EPSs with mAb 12.8 and pAb 1000/1201. After correction for the optical density of the nitrocellulose paper itself, the limits for black were set at OD 0.22 and 0.70 for mAb 12.8 and for pAb 1000/1201, respectively.

1000/1201 and the mAb 12.8 were reactive with this EPS preparation of *M. racemosus*, however, slightly higher extinctions could be obtained with the polyclonal antibodies. A more detailed comparison of the selectivity of both antibodies was made by determination of the titres towards different EPS preparations obtained from moulds belonging to Mucorales as listed in Table 1. Both antibodies reacted with all mucoralean EPSs tested, but their activity towards the various EPSs differed significantly. PAb 1000/1201 gave the highest reactivity with the EPS preparation of *Mucor circinelloides* whereas mAb 12.8 gave only a weak immunoreaction with this EPS. In contrast, the EPSs from *Rhizomucor* species showed a much higher reaction with mAb 12.8 than with pAb 1000/1201. To exclude the possibility that these differences in reactivity were caused by differences in binding properties of the EPS preparations to the wall of the microtitre plates, a DOT-BLOT assay was developed for the polyclonal and monoclonal antibodies.

### *Development of a DOT-BLOT assay*

A DOT-BLOT assay in which the polysaccharide antigens were directly bound to nitrocellulose (NC) paper was developed by testing various conditions for binding the EPSs to the NC, using different buffers with pH values in the range of 5 to 9. Maximum binding was obtained by spotting droplets of 2  $\mu$ l containing 100  $\mu$ g of EPS in PBS (pH 7.2) followed by air-drying for 30 min. Optimal blocking of the NC was performed with a solution of 0.1% (w/v) sodium caseinate. Both BSA and a crude milk protein were not very effective blockers as concentrations of more than 1% (w/v) were needed for complete blocking. After washing, the NC was incubated with the respective antibodies in similar concentration and subsequently incubated with the respective peroxidase conjugates. The NC membranes were developed with the recently available ready-to-use 4-chloro-1-naphthol substrate PrestoSol.

The mucoralean EPS preparations used in this DOT-BLOT assay revealed a different reactivity of mAb 12.8 and pAb 1000/1201 as shown in Fig. 2. EPS from *M. racemosus* gave the strongest immunoreaction with pAb 1000/1201 whereas *Rhizomucor pusillus* gave the highest density with mAb 12.8.

### *Determination of the monoclonal antibody epitopes*

The antigenic determinants of the mAb 12.8 were partly characterized by analysing the reactivity of the mAb with various fractions of the EPSs. Also, the influence of mild periodate oxidation and degradation of the EPSs with specific enzymes on the mAb antigenicity were studied (Table 2). Mild periodate oxidation, which is reported to be specific for sugar residues containing vicinal hydroxyl groups, completely destroyed the reactivity of the mucoralean EPSs with both the pAb and the mAb. The polyclonal antibodies raised against EPS of *M. racemosus* reacted with two specific polysaccharide fractions, the first not binding to a DEAE anion-exchange column (DEAE I) and the second which could be eluted from this column with 200–300 mM of buffer salt (DEAE II) similar as shown for the EPS of *Mucor hiemalis* (7). As shown in Table 2, mAb 12.8 did not react at all with these pAb-reactive fractions but reacted with the major polysaccharide fraction (DEAE III) of mucoralean EPSs. This DEAE III fraction was eluted from the anion-exchange column with 0.9–1 M of sodium acetate buffer pH 5.0 (7; this thesis p. 40). This main polysaccharide, sometimes called mucoran, is characteristic of moulds belonging to Mucorales and it contains approximately 50 % glucuronic acid (1,7). Recently, we isolated the  $\beta$ (1–4)-linked D-glucuronic acid polymeric backbone of this polysaccharide (9), but mAb 12.8 was not reactive with this preparation.

Treatment of mucoralean EPSs with an exo- $\alpha$ -D-mannanase, which is able to degrade specifically the epitopes of these EPSs reactive with pAb 1000/1201 (13), did not degrade the epitopes reactive with mAb 12.8, as shown in Table 2. Treatment of the EPSs with a

**Table 2.** Reactivity of mAb 12.8 and pAb 1000/1201 IgG antibodies with different fractions of the EPSs from Mucorales and EPSs subjected to various treatments.

EPS from	Fraction	Treatment	ELISA reactivity <sup>1</sup>	
			mAb	pAb
<i>Mucor racemosus</i>	DEAE I <sup>2</sup>		-	+++
	DEAE II		-	++
	DEAE III		+++	-
<i>Rhizopus stolonifer</i>	DEAE I		-	+++
	DEAE II		-	++
	DEAE III		+++	-
<i>Rhizomucor pusillus</i>	DEAE I		-	+++
	DEAE II		-	+++
	DEAE III		+++	-
<i>Mucor hiemalis</i>	Polyglucuronic acid <sup>3</sup>		-	-
<i>Mucor hiemalis</i>		Periodate oxidation	-	-
<i>Rhizopus oryzae</i>		Periodate oxidation	-	-
<i>Absidia corymbifera</i>		Periodate oxidation	-	-
<i>Mucor racemosus</i>		Exo- $\alpha$ -D-mannanase <sup>4</sup>	+++	-
<i>Rhizopus stolonifer</i>		Exo- $\alpha$ -D-mannanase	+++	-
<i>Mucor racemosus</i>		$\alpha$ -Mannosidase	+++	+++
<i>Rhizopus stolonifer</i>		$\alpha$ -Mannosidase	+++	+++

<sup>1</sup> See legend Table 1.

<sup>2</sup> Fractions of a DEAE anion-exchange chromatography similar as shown for *M. hiemalis* in Fig. 3 of De Ruiter *et al.* (7; this thesis Chapter 3, p. 40).

<sup>3</sup> Polymer of  $\beta(1-4)$ -linked D-glucuronic acid as described in De Ruiter *et al.* (9; this thesis, Chapter 6).

<sup>4</sup> Isolated from an enzyme preparation from *Trichoderma harzianum* (13).

$\alpha$ -mannosidase, which hydrolyses non-reducing terminal mannose residues did not have any influence on the immunoreactivity with mAb 12.8 and pAb 1000/1201.

## Discussion

The monoclonal antibody raised against EPS isolated from *M. racemosus* was specific for all mould species belonging to the order of Mucorales. No cross-reactions were observed with EPSs from mould or yeast species tested other than Mucorales. This mAb was found to be more specific for mucoralean moulds than the polyclonal antibodies raised against the same EPS as previously described, as the latter showed cross-reactivity

with the yeast *Pichia membranaefaciens* (10). With these antibodies, an indirect ELISA and a DOT-BLOT assay were developed which may be used to detect these moulds.

The monoclonal mAb 12.8 and the polyclonal pAb 1000/1201 differ in their reactivity with the different mucoralean EPS preparations. PAb 1000/1201 reacted best with EPS from *Mucor racemosus* and *M. circinelloides* whereas mAb 12.8 showed the highest activity towards *M. racemosus* and the *Rhizomucor* species. MAb 12.8 and pAb 1000/1201 reacted similarly with the EPS preparations obtained from species from the *Mortierella isabellina* group. This phenomenon supports the recently described affinity of this group of moulds to the Mucoraceae (12), while *Mortierella* sensu stricto falls outside this affinity.

The immunological reaction between the carbohydrate antigens of these fungal polysaccharides with polyclonal antibodies is based on recognition of 2-*O*-methyl-mannose containing epitopes (13). It can be concluded that mAb 12.8 is also reactive with carbohydrate epitopes as mild periodate treatment of the EPSs completely destroyed their antigenic activity. However, it is unlikely that 2-*O*-methyl-mannose residues are also responsible for the antigenicity towards the monoclonal antibodies. The fractions DEAE I and DEAE II which both contain 2-*O*-methyl-mannose (results not given), were not reactive with mAb 12.8. Furthermore, the *exo*- $\alpha$ -D-mannanase, which specifically degrades the pAb-epitopes, did not have any influence on the ELISA activity of mAb 12.8. However, as the  $\beta$ (1-4)-linked D-glucuronic acid backbone of the mAb reactive polymer did not show any immunological reactivity, it can be assumed that the mAb antigenicity resides in the neutral sugar side-chains of this polymeric fraction. More detailed analysis of this glucuronic acid containing fraction should be performed to elucidate the structure of the carbohydrate mAb-epitopes. Specific enzymes can be very useful for this purpose, as recently described for the elucidation of the carbohydrate epitopes towards polyclonal antibodies of *Penicillium* and *Aspergillus* species and species belonging to the order of Mucorales (13,26).

Apparently, different carbohydrate residues are immunologically active towards the rabbit-raised monospecific polyclonal and mouse-raised monoclonal antibodies. This can be attributed to either the different immunisation procedures used or to different host animal species used. It is a well established fact that subcutaneous immunisation, in general used to obtain polyclonal serum-derived antibodies, elicits a different immune response than intrasplenic, intraperitoneal or intravenous immunisation. In our case we used an intrasplenic immunisation for raising the monoclonal antibodies in mice. It can be assumed that in this particular case the species difference might be the major factor for the difference in immune response. This is strongly suggested from the fact that the polyclonal antibody preparation from rabbits does not contain any antibodies directed towards the same epitope as the monoclonal antibodies, indicating that rabbits are not able to make such antibodies in contrast to mice.



As this mAb 12.8 was found to be highly specific for mucoralean moulds, it may be used to develop reliable easy-to-use diagnostic assays for the detection of species belonging to the Mucorales. In medicine these assays may be useful for diagnosis of mucormycosis in humans, by detection of circulating antigens (17). MAb-based immunoassays may also be very useful to monitor mucoralean mould contamination in food production processes and to avoid fungal spoilage. With this mAb it may be feasible to test raw materials, food and feed on the presence of mucoralean moulds in industrial control laboratories and food inspection services (11).

## References

1. Bartnicki-García S., and Lindberg, B. (1972). Partial characterization of mucoran: the glucuronomannan component. *Carbohydrate Research* 23:75-85.
2. Bartnicki-García S., and Reyes E. (1968). Polyuronides in the cell walls of *Mucor rouxii*. *Biochimica et Biophysica Acta* 170:54-62.
3. Bos E.S., Van der Doelen A.A., Van Rooy N., and Schuurs A.H.W.M. (1981). 3,3',5,5'-tetramethylbenzidine as an Ames test negative chromogen for horse-radish peroxidase in enzyme-immunoassay. *Journal of Immunoassay* 2:187-203.
4. Bossi, R., and Dewey, F.M. (1992). Development of a monoclonal antibody-based immunodetection assay for *Botrytis cinerea*. *Plant Pathology* 41:472-482.
5. Davis, J.M., Pennington, J.E., Kubler, A.M., and Conscience, J.F. (1982). A simple, single-step technique for selecting and cloning hybridomas for the production of monoclonal antibodies. *Journal of Immunological Methods* 50:161-171.
6. De Ruiter, G.A., Smid, P., Van der Lugt, A.W., Van Boom, J.H., Notermans, S.H.W., and Rombouts, F.M. (1991). Immunogenic extracellular polysaccharides of Mucorales. In *Fungal Cell Wall and Immune Response*, pp. 169-180. Edited by J.-P. Latgé, and D. Boucias. NATO ASI Series Vol. H 53, Springer Verlag, Berlin Heidelberg.
7. De Ruiter, G.A., Van der Lugt, A.W., Voragen, A.G.J., Rombouts, F.M., and Notermans, S.H.W. (1991). High-performance size-exclusion chromatography and ELISA detection of extracellular polysaccharides from Mucorales. *Carbohydrate Research* 215:47-57 (this thesis, Chapter 3).
8. De Ruiter, G.A., Hoopman, T., Van der Lugt, A.W., Notermans, S.H.W., and Nout, M.J.R. (1992). Immunochemical detection of Mucorales species in food. In *Modern Methods in Food Mycology*, pp. 221-227. Edited by R.A. Samson, A.D. Hocking, J.I. Pitt, and A.D. King. Elsevier Publishers, Amsterdam.
9. De Ruiter G.A., Josso S.L., Colquhoun I.J., Voragen A.G.J., and Rombouts F.M. (1992). Isolation and characterization of  $\beta(1-4)$ -D-glucuronans from extracellular polysaccharides of moulds belonging to Mucorales. *Carbohydrate Polymers* 18:1-7 (this thesis, Chapter 6).
10. De Ruiter, G.A., Van Bruggen-van der Lugt, A.W., Nout, M.J.R., Middelhoven, W.J., Soentoro, P.S.S., Notermans, S.H.W., and Rombouts, F.M. (1992). Formation of antigenic extracellular polysaccharides by selected strains of *Mucor* spp., *Rhizopus* spp., *Rhizomucor* spp., *Absidia corymbifera* and *Syncephalastrum racemosum*. *Antonie van Leeuwenhoek* 62:189-199 (this thesis, Chapter 2).

11. De Ruiter, G.A., Notermans, S.H.W., and Rombouts, F.M. (1993). Review: New methods in food mycology. *Trends in Food Science and Technology* (In press).
12. De Ruiter, G.A., Van Bruggen-van der Lugt, A.W., Rombouts, F.M., and Gams, W. (1993). Approaches to the classification of the *Mortierella isabellina* group (Mucorales): antigenic extracellular polysaccharides. *Mycological Research* 97: (In press; this thesis, Chapter 9).
13. De Ruiter, G.A., Van Bruggen-van der Lugt, A.W., Smid, P., Van Boom, J.H., and Rombouts, F.M. (1993). 2-O-methyl-mannose is a constituent of the epitopes of mucoralean moulds revealed by specific enzymatic degradation of their polysaccharides. (submitted; this thesis, Chapter 7).
14. De St.Groth, S.F., and Scheidegger, D. (1980). Production of monoclonal antibodies: Strategy and tactics. *Journal of Immunological Methods* 35:1-21.
15. Dewey, F.M., MacDonald, M.M., Phillips, S.I., and Priestley, R.A. (1990). Development of monoclonal-antibody-ELISA and -DIP-stick immunoassays for *Penicillium islandicum* in rice grains. *Journal of General Microbiology* 136:753-760.
16. Dewey, F.M. (1992). Detection of plant-invading fungi by monoclonal antibodies, p. 47-62. In J.M. Duncan, and L. Torrance (Eds.), *Techniques for the rapid detection of plant pathogens*. Blackwell Scientific Publications, Oxford.
17. Kaufman, L., Turner, L.F., and McLaughlin, D.W. (1989). Indirect enzyme-linked immunosorbent assay for zygomycosis. *Journal of Clinical Microbiology* 27:1979-1982.
18. Miyazaki T., Yadomae T., Yamada H., Hayashi O., Suzuki I., and Ohshima Y. (1980). Immunochemical Examination of the polysaccharides of Mucorales. In *Fungal Polysaccharides*, pp. 81-94. Edited by P.A. Sandford, and K. Matsuda. ACS Symposium Series 126. American Chemical Society, Washington DC.
19. Notermans, S., and Heuvelman, C.J. (1985). Immunological detection of moulds in food by using the enzyme-linked immunosorbent assay (ELISA); preparation of antigens. *International Journal of Food Microbiology* 2:247-258.
20. Notermans, S., Veeneman, G.H., Van Zuylen, C.W.E.M., Hoogerhout, P., and Van Boom, J.H. (1988). (1→5)-linked  $\beta$ -D-galactofuranosides are immunodominant in extracellular polysaccharides of *Penicillium* and *Aspergillus* species. *Molecular Immunology* 25:975-979.
21. Pitt, J.I., and Hocking, A.D. (1985). *Fungi and Food Spoilage*. Academic Press, Sydney. 410 p.
22. Spitz, M. (1986). "Single-shot" intrasplenic immunization for the production of monoclonal antibodies. *Methods in Enzymology* 121:33-41.
23. Steinbuch, M., and Audran, R. (1969). The isolation of IgG from mammalian sera with the aid of caprylic acid. *Archives of Biochemistry and Biophysics* 134:279-284.
24. Stynen, D., Sarfati, J., Goris, A., Prévost, M.-C., Lesourd, M., Kamphuis, H., Darras, V., and Latgé, J.-P. (1992). Rat monoclonal antibodies against *Aspergillus galactomannan*. *Infection and Immunity* 60:2237-2245.
25. Sugar, A.M. (1992). Mucormycosis. *Clinical Infectious Disease* 14 (Suppl 1), S126-129.
26. Van Bruggen-Van der Lugt, A.W., Kamphuis, H.J., De Ruiter, G.A., Mischnick, P., Van Boom, J.H., and Rombouts, F.M. (1992). New structural features of the antigenic extracellular polysaccharides of *Penicillium* and *Aspergillus* species revealed with exo- $\beta$ -D-galactofuranosidase. *Journal of Bacteriology* 174:6096-6102.

## General discussion<sup>1</sup>

### *Modern methods in food mycology*

Mould contamination can cause many undesirable changes in foods which can result in huge economic losses (19). Besides the visual and organoleptic changes of food, the ability of certain species to produce mycotoxins is significant. Therefore, the absence of moulds in food and raw materials can be considered as an important quality aspect. Consequently, early and rapid detection of fungal contamination is necessary to avoid spoilage of food. Many conventional mould detection methods are based on counting the viable propagules. However, as foods are often processed using heat or physical/chemical treatments through which no viable propagules are left, these techniques have serious drawbacks for this purpose. Furthermore, conventional mould detection methods are often laborious and time consuming and therefore not optimal for use in the food industry and food inspection services (9,11,23). As a consequence, there is a continuous need for new methods to identify and detect moulds in food, which are relatively rapid, can be replicated easily and also can be used in the food industry with limited facilities and expertise.

To overcome most of these problems, a new generation of mould detection methods has been developed in the past five years. These methods are based on the specific immunological recognition of mould antigenic extracellular polysaccharides (EPSs) which are heat stable and water soluble (10,11,15,16). As shown in these studies, the successful use of these immunoassays requires detailed knowledge on the structure of the epitopes present on the antigens. The structure of the epitopes can be confirmed by synthesis. Moreover, synthetic epitopes can be used to inhibit the immunological reaction revealing any false-positive reactions of the immunoassays.

In this thesis, the structure of the carbohydrate epitopes of polysaccharides of moulds belonging to the order of Mucorales (Zygomycetes), including species of the genera *Mucor*, *Rhizopus*, *Rhizomucor*, *Absidia*, *Syncephalastrum* and *Thamnidium*, is revealed.

### *Antibodies specific for mucoralean moulds*

The development of immunoassays for detection of moulds in food requires the

---

<sup>1</sup>Part of this chapter will be published as a review: G.A. De Ruiter, S.H.W. Notermans and F.M. Rombouts, (1993) New methods in food mycology, in: *Trends in Food Science and Technology*.

availability of antibodies, either polyclonal or monoclonal, with a known specificity and a detailed knowledge of the structure of the epitope which is recognized. Both polyclonal and monoclonal IgG antibodies have been obtained against EPS of *Mucor racemosus* which were very specific for all mould species belonging to the order of Mucorales, including the genera *Mucor*, *Rhizopus*, *Rhizomucor*, *Absidia*, *Syncephalastrum* and *Thamnidium*. The rabbit polyclonal antibodies were only cross-reactive with the yeast *Pichia membranaefaciens* and the mouse monoclonal antibodies were even more specific, as no cross-reactions were observed with any other yeast or mould tested. Both IgG antibodies were monospecific for mucoralean moulds, and the paratopes of these immunoglobulins recognize different carbohydrate epitopes which are both unique for these moulds.

As shown in Chapters 9 and 10, these specific antibodies can also be used for classification of moulds. In these chapters, the chemical and antigenic characteristics of extracellular polysaccharides of moulds belonging to the *Mortierella isabellina* group were used to establish the affinity of the group to either the Mortierellaceae or the Mucoraceae. As both the polyclonal and monoclonal IgG antibodies were reactive with EPSs derived from species belonging to this group, it could be established that species belonging to the *Mortierella isabellina* group contain epitopes identical to those of the Mucoraceae tested and not to those of Mortierellaceae.

#### *Structure of epitopes: needle in a haystack?*

Antibodies are specific for epitopes or antigenic determinants rather than for the whole antigen molecule. Therefore, the elucidation of the structure of the epitopes, which can represent only a very minor part of the antigens, can be compared with searching for a needle in a haystack. Conventional methods such as sugar analysis after hydrolysis of the polysaccharides and subsequent analysis of the respective alditol acetates, methylation analysis and the production of different oligomers by partial acid hydrolysis, commonly used for elucidation of fungal epitopes are often not able to discriminate microgram amounts of compounds. Many reports provide conflicting results as the methods applied are insensitive and not fully appropriate for this purpose. Therefore, adequate methods which are specific and sensitive should be used taking advantage of the antigenic properties of the target compounds.

In this thesis, a general protocol was developed to reveal the structure of the epitopes of moulds, as shown schematically in Fig. 1. This protocol can only be used successfully if the antibodies available are monospecific to a group of moulds and do not give cross-reactions with other species. This protocol is based on the interaction of four different approaches. First, those fractions from the EPS mixture which are antigenic should be separated from the non-antigenic polysaccharides using chromatographic techniques. Also, accurate methods should be available to test saccharides on their immunochemical

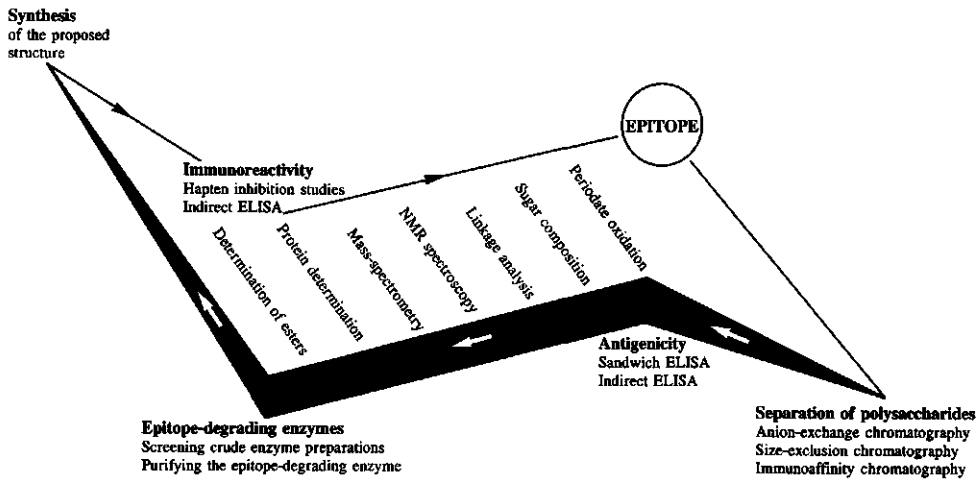

**Fig. 1.** Schematic protocol for the elucidation of carbohydrate epitopes of antigenic polysaccharides.

reactivity with different antibodies. The third approach includes the purification of specific enzymes which are able to remove the antigenicity of the EPSs tested with ELISA. Finally, to prove the proposed structure of the epitopes, it is essential that these structures are synthesized and subsequently tested for immunochemical activity. However, a central place in this protocol is occupied by sensitive analytical methods available for the characterization of polysaccharides and their degradation products, as shown in Fig. 1.

### *The role of carbohydrates*

As described in Chapter 2, the water-soluble polymeric material which is excreted by all moulds belonging to Mucorales tested, mainly consists of carbohydrate residues (50 to 90%) and some protein (10 to 50%). This material is often referred to as extracellular polysaccharides (EPSs), although the often considerable amount of protein justifies the term proteoglycan or peptidoglycan for general use.

The role of carbohydrates in the antigenicity of mucoralean EPSs was assessed by using mild periodate treatment. After this treatment of the EPSs, no reactivity in the ELISA remained with either polyclonal rabbit or monoclonal mouse antibodies.

Therefore, it was concluded that the antigenicity is based on the integrity of the carbohydrate residues.

Methods available for analysis of complex polysaccharides are based on determination of their constituent sugar residues obtained after chemical hydrolysis of the native polymers. However, the different glycosidic linkages, specially those including uronic acids, can differ considerably in their susceptibility towards acid hydrolysis. Preferably, accurate analysis of both neutral and acidic sugar residues should be possible in one assay on microgram quantities without the need for derivatisation.

The conventional methods for sugar analysis did not meet these requirements, and therefore a new method was developed (Chapter 4). The successive use of methanolysis and TFA hydrolysis followed by high-performance anion-exchange chromatography (HPAEC) analysis of the monosaccharides provided a rapid, accurate and sensitive assay to determine the exact carbohydrate composition of the uronic acid containing mucoralean EPSs on the microgram scale. With this method the presence of fucose, mannose, glucose, galactose, and glucuronic acid residues in the mucoralean EPSs was established as well as their relative amounts.

### *Separation of the EPSs*

Anion-exchange chromatography followed by ELISA detection of the different fractions was used successfully to separate the EPSs based on differences in the amount of negatively charged uronic acids. The major part, a fraction containing approx. 50% glucuronic acid (sometimes called mucoran), was found to be antigenic in mice (monoclonal IgG) but not antigenic in rabbits (polyclonal IgG). This fraction was difficult to analyse due to the considerable amount of highly acid-resistant glycosidic linkages of the glucuronic acid residues. A  $\beta(1-4)$ -linked D-glucuronan polymer isolated from the mucoralean EPS preparations did not react with the antibodies raised in mice and rabbits (Chapter 6). This glucuronan is possibly the backbone of mucoran, but this is not in agreement with the study of Bartnicki-Garcia and Lindberg (1), who proposed an alternating structure of mannose and glucuronic acid residues as backbone of this molecule. It is unlikely that these alternating sequences are a major structural entity or even represent the backbone, as these authors overlooked the fact that most of the glucuronic-acid containing material, was not released from their anion-exchange column.

To get an indication about the nature of the sugar residues involved in the immunoreactivity of the mucoralean EPSs with rabbit antibodies, those polysaccharides which are antigenic should be discriminated from the non-antigenic polysaccharides. As only laborious methods were available for this purpose, a rapid method was developed in which high-performance size-exclusion chromatography (HPSEC) was combined with ELISA detection (Chapter 3). This method allowed the rapid screening and determination of fractions for the presence of antigenic polysaccharides, which enabled an optimal

choice of column material to be used for isolation of the antigenic fractions. The use of this HPSEC-ELISA method allowed detection of a common rabbit antigenic fraction with an apparent molecular mass of approximately 30 kDa, characteristic for moulds of the Mucorales. The antigenic polysaccharides could also be separated from the non-antigenic polysaccharides with immobilized antibodies. As demonstrated for polyclonal rabbit antibodies the antigenic polysaccharides could be separated in one step with an immunoaffinity column with covalently linked IgG antibodies (Chapter 5).

### *Occurrence of the antigenic fraction*

Many polyclonal antibodies were raised in rabbits against the fungal cell walls and fractions of culture filtrates after removal of the mycelium by filtration (8,13). The antibodies obtained reacted with identical carbohydrate epitopes present on immunochemically similar specific polysaccharides characteristic for the mucoralean group, which are distributed in the main parts of the mould. Until now, it is uncertain if these antigenic polysaccharides are also present in the spores of these species. Based on these findings, it can be proposed that the epitopes are not randomly distributed on different polysaccharides in the EPS mixture, but are only present on very specific polysaccharides which are only a minor part of the total EPS. This phenomenon was previously observed for rabbit-raised antibodies against different parts of *Penicillium* and *Aspergillus* moulds (11), and it can be assumed that this is a general phenomenon for moulds. This fact greatly enhances the feasibility of detecting related moulds by immunoassays, based on antibodies recognizing these characteristic polysaccharides, present in most parts of the mould, possibly with the exception of the spores (7).

### *Structure of the epitopes: the use of specific epitope-degrading enzymes*

A valuable approach to reveal the structure of fungal carbohydrate epitopes is the use of purified enzymes which are able to degrade the epitopes as tested and screened with ELISA. This method was recently used as a sophisticated tool for the elucidation of the epitopes of EPSs of *Penicillium* and *Aspergillus* species (22). The use of an exo- $\beta$ -D-galactofuranosidase combined with reductive-cleavage analysis of the EPSs allowed us to prove that  $\beta(1-5)$ -linked D-galactofuranoside oligomers are uniquely responsible for the antigenic properties of *Penicillium* and *Aspergillus*.

In this thesis (Chapter 7), the purification of an exo- $\alpha$ -D-mannanase was described from the same source, a commercial enzyme preparation from *Trichoderma harzianum*. This enzyme was able to degrade specifically the antigenic parts of the mucoralean EPSs reactive with rabbit-raised antibodies. The EPSs were treated with this enzyme and the liberated products were analysed by high-performance anion-exchange chromatography and by gas-liquid chromatography (GLC)-mass spectrometry after derivatization to alditol

acetates. An  $\alpha$ -mannosidase available from Jack beans (*Canavalia ensiformis*) was able to split off terminal  $\alpha$ -D-mannose residues but did not influence the antigenicity of EPSs of Mucorales. The *exo*- $\alpha$ -D-mannanase completely abolished the ELISA activity of polysaccharides from Mucorales by hydrolysing the terminal  $\alpha$ -D-mannose residues from  $\alpha(1-2)$ -linked chains of D-mannose and terminal 2-O-methyl-mannose residues. In all mucoralean EPS preparations this 2-O-methyl-mannose residue was identified. It represents less than 0.5% (w/w) in all samples tested, and was initially overlooked with all other methods. To our knowledge, this compound has never been reported to occur in fungi. It was revealed that the epitopes of Mucorales carry a 2-O-methyl-mannose residue at the non-reducing terminal.

#### *Hapten inhibition studies*

Additional proof for the structure of the epitope can only be obtained by synthesis of the compound and subsequent analysis of its immunological activity. Methods for selective synthesis of carbohydrate oligomers are summarized and described elsewhere (20,21). The affinity of a single IgG paratope with these oligosaccharides can be tested in an hapten-inhibition experiment. To this end, an indirect competition ELISA was performed in which purified EPS antigens were bound to the wall of a microtitre plate and the respective oligomers were subsequently added with the IgG antibodies (18). The inhibitory activity of these oligosaccharides in this ELISA was determined at different concentrations, expressed in nanomoles per ml.

However, IgG antibodies are bivalent in their reaction with antigens as each molecule has two combining sites (paratopes). EPS molecules are multivalent as several antigenic binding sites (epitopes) are present on one molecule. Therefore, their functional affinity (avidity) results in a considerable increase in the stability of the binding between antibody and antigen. There may be a 1000-fold increase in the binding energy between IgG and multivalent antigen using both valencies compared to monovalent binding. Therefore, the inhibitory capacity of the multivalent EPSs in the indirect ELISA can hardly be compared with the inhibition of monovalent isolated or synthetic oligosaccharides.

Hapten inhibition experiments with synthetic oligosaccharides revealed that two trimers were able to inhibit this immunoreaction almost completely. The first is based on two  $\alpha(1-2)$ -linked mannose residues and a 2-O-methyl-mannose residue at the non-reducing terminal and the second on three  $\alpha(1-6)$ -linked 2-O-methyl-mannose residues. The concentration of these trimers, both carrying a terminal 2-O-methyl-mannose residue, which is required to obtain 50% inhibition of the immunoreaction is about 300 nmol/ml. This amount is similar to the 50% inhibition concentration of a  $\beta(1-5)$ -linked D-galactofuranose trimer in the indirect ELISA using IgG antibodies raised against *Penicillium* species which is approximately 480 nmol/ml (18).



### *Structure of the epitopes: methylation analysis*

Determination of the glycosidic linkages of carbohydrate residues is often performed by methylation analysis. Basically, the method involves the methylation of all free hydroxyl groups of a polysaccharide prior to hydrolysis. The hydroxyl groups involved in ring closure and in the glycosidic linkage are made available by hydrolysis of the polysaccharide and are subsequently acetylated. The resulting partially methylated alditol acetates are analysed by gas-liquid chromatography and mass-spectrometry. A disadvantage of this method is the difficulty in obtaining a complete methylation, but a more serious problem is that methyl-ethers of sugar residues escape detection, as it is not possible to distinguish between the naturally present *-O*-methyl group and an *-O*-methyl group obtained by chemical substitution. Therefore, the *-O*-methyl ethers of sugar residues which might be present in a sample can escape detection. This problem can be solved by the use of ethylation analysis as shown in this thesis (Chapter 8).

Ethylation analysis of highly antigenic mannans before and after degradation with the epitope-degrading *exo- $\alpha$ -D*-mannanase revealed that after enzyme treatment the 2-*O*-methyl-mannose residues could no longer be detected in the remaining mannans. It was concluded that the immunoreactivity of the mucoralean moulds with polyclonal IgG antibodies is mainly based on the 2-*O*-methyl-mannose residues. That is why initial methylation experiments carried out on these EPSs in early stages of this research did not yield any clue for the determination of the epitopes. Furthermore, it can be assumed that the results of the methylation analyses on antigenic mucoralean oligosaccharides performed by Miyazaki and coworkers (13) were erroneously interpreted as proof of  $\alpha(1-6)$ -linked mannose residues. However, it is most likely, that the oligomers they isolated indeed contained 2-*O*-methyl-mannose residues which were not recognized. This explains all the apparently conflicting results they observed with cross-reactions with yeast mannans and the lack of inhibition of synthetic  $\alpha(1-6)$ -linked mannose oligomers.

### *Size of the mucoralean carbohydrate epitopes*

Little is known about the size of carbohydrate epitopes compared to the knowledge of protein epitopes. A model has been proposed for the antigen recognition site of T-cell receptors with protein epitopes, which is based on a groove of approx. 2.5 nm long and 1 nm wide between two long  $\alpha$ -helices located on the top surface of the molecule (2,14). Two types of grooves have been proposed with similar size: type I is closed at both ends indicating that the corresponding epitopes are based on peptides of 8 to 10 amino acid residues and type II, which is probably open at one end and requires slightly larger epitopes (approx. 14 amino acids). Although T-cell receptors only recognize foreign antigens that are associated with a particular human leucocyte antigen (HLA), it may be expected that the recognition of soluble antigens by isolated antibodies occurs in a similar

way.

Protein epitopes are often constituted by patches of many adjacent amino acids in which their conformation, mainly defined by the secondary and tertiary structures, results in the specific exposure of the antigenic determinants. However, as polysaccharides normally do not have a tertiary structure, it can be assumed that the conformation of the carbohydrate epitopes depends solely on the carbohydrate sequence (primary structure). If the groove model is also valid for carbohydrate epitopes, it can be assumed that the number of residues involved in these epitopes has to be much lower than the number of amino acids in protein epitopes, as the pyranose-ring of a mannose residue is approx. 0.6 nm long.

The results of both the specific degradation of the mannans with the *exo- $\alpha$ -D*-mannanase and analysis of the remaining mannans by ethylation analysis clearly revealed that in all cases 2-*O*-methyl-mannose residues occupy the non-reducing terminal position of the epitopes. Furthermore, it can be assumed the terminal 2-*O*-methyl-mannose residues are almost entirely responsible for the antigenicity of these moulds. However, as strongly suggested by our hapten inhibition experiments, they can only be recognized by antibodies if these residues are placed at the end of a short chain of related sugar residues. Most likely, mannose residues which are substituted at the C-2 position, can act as a suitable spacer. Probably, the direct role in antigenicity of this short chain is limited, but its indirect role in the antigenicity is important as the linking chain allows the expression of the antigenicity of the terminal 2-*O*-methyl-mannose residues. Therefore, in our opinion, the 2-*O*-methyl-mannose residues can be considered as the immunodominant part of the epitopes of polysaccharides of moulds belonging to the order of Mucorales reactive with rabbit-raised antibodies.

### *Monoclonal antibodies*

Monoclonal antibodies have proved useful in the development of sensitive immunoassays for the detection of mycelium or EPSs of specific fungi in foods and feeds (4,5). Despite the high initial cost of monoclonal antibodies, their use in commercially available immunoassays is well established, as they can be produced *in vitro* in virtually unlimited amounts without test animals. As shown in this thesis (Chapter 10) monoclonal antibodies are not necessarily more specific and may be less sensitive than polyclonal antibodies. Both in the case of the Eurotiales anamorph-genera *Aspergillus* and *Penicillium* and in the case of the Mucorales, very specific polyclonal and monoclonal antibodies could be obtained. However, probably due to the different animals used, these are reactive with different but characteristic epitopes of various compounds of these groups of moulds.

### *Development of immunoassays for Mucorales*

An ELISA and dot-blot assay have been developed which enable the identification and detection of mould species belonging to the order of Mucorales in foods. As low as 1 ng/ml antigenic EPS could be detected by the sandwich ELISA in the supernatants of ten-times diluted food extracts. It has been demonstrated that with this sensitivity contamination of 100 litre of grape juice with the juice of one moulded grape can be detected easily.

Samples of flour showed a good correlation between colony count of Mucorales species and the ELISA titre (3). Many food products are heat-treated, filtered or gamma-irradiated leaving no viable mould propagules. Therefore, the results of immunoassays of processed foods do not correlate with the common viable counting techniques. It can be assumed that in these cases the immunoassays give a better indication for the (previous) presence of moulds than do plating techniques. Additionally, especially for dried products, the use of immunoassays can reduce the analysis time from days to hours. The mucoralean sandwich ELISA has only rarely given false-positive reactions with food samples, e.g. walnuts, which are also observed for the ELISA of species of *Penicillium* and *Aspergillus* (3,10,17).

### *Future developments of immunoassays for moulds*

For various reasons there is a tendency in the food industry to produce food products with ever increasing shelf-lives. In these products rapid bacterial spoilage is under control, but mould spoilage may remain a problem, because moulds are more versatile than bacteria in overcoming environmental stress factors, such as low water activity and low pH. However, fungal contamination of foods not only affects their quality but also their safety, because of the possible production of mycotoxins. At present more than 100 mycotoxins are described, mainly produced by species belonging to the genera *Aspergillus*, *Penicillium* and *Fusarium* (6). In the future, it is likely that the number of known mycotoxins will be even greater, and the practical feasibility of testing raw materials or foods for all of these different mycotoxins will decrease accordingly. The presently most commonly used detection methods, which are based on the enumeration of viable propagules present in foods, are not very satisfactory, as moulds can be inactivated or removed during food processing without removal of the mycotoxins. Immunoassays would be more appropriate for the analysis of processed foods.

The main advantages of the use of immunoassays are their rapidity, accuracy and sensitivity. Simple test kits can be manufactured that allow reliable results to be obtained within 30 to 180 minutes. Immunoassays enable detection of the previous presence of moulds in food products that have been heat-treated or filtered during processing. Furthermore, the direct identification of moulds directly in food samples down to the

genus level is possible with immunoassays. Some researchers will consider the high specificity of these immunoassays for groups of moulds as a disadvantage, as they are used to determining the total mould colony count, if they wish to determine the total mould colony count, in which there is no discrimination between different groups of moulds. However, the use of 'cocktails' of antibodies in the immunoassays can solve this problem satisfactorily. Also, identification of moulds directly in food samples down to the genus level is possible with immunoassays. Immunoassays are of limited use if moulds have to be identified in food or raw materials to species or even strain level. However, it is possible that desirable specificity of immunoassays may be achieved by "enzymatic peeling" of EPSs, subsequent use of these altered EPSs for antibody production and study of specificity of these antibodies. DNA-techniques such as RFLP-mapping are being developed for the identification of pure strains of moulds isolated from food products (12).

Therefore, with regard to detection of moulds in food, it may be expected that immunoassays will gradually replace the traditional enumeration techniques and microscopic examination. Widespread implementation of mould immunoassays requires adaptation and a change in attitude of industrial control laboratories and food inspection services. The introduction of law-enforced guidelines for the mycological quality of food products might accelerate the adaptation in the future. The availability of test kits for the most important fungal food contaminants will also make antigen detection more attractive. Finally, potential customers will be convinced more easily when more data have been published on the practical use of these assays (3), from which insight can be obtained in the relationship between the results obtained from the immunoassays and the actual mycological quality of the product.

### *Conclusion*

This thesis is a contribution to the basic knowledge of the structure of extracellular polysaccharides from moulds. This knowledge can be used in the development of immunochemical detection methods for moulds, particularly in food products. These studies were specifically directed towards the elucidation of the structure of epitopes occurring in extracellular polysaccharides of mould belonging to the order Mucorales. A protocol was described based on a set of methods, some of them newly developed to achieve this goal. This approach appeared fruitful in discovering that the immunochemical reactivity of fungal EPSs reside mainly in non-reducing terminal sugar residues. The immunodominant structures were completely revealed for *Penicillium* and *Aspergillus* species and for the species belonging to the order Mucorales. The epitopes of the latter were solely based on 2-O-methyl-mannose residues.

Furthermore this thesis contributes to the basic knowledge of the immunochemistry of carbohydrates in general. It can be expected that the same approach can be used to

investigate structural features of any biological polysaccharide or glycoconjugate which is or can be made immunologically active. The methodology is particularly suitable in detecting minor sugars with unusual structure which occur at the non-reducing terminals of biopolymers and may have specific biological functions. Specific enzymatic removal of such sugars may uncover structures of which the biological function or specificity (e.g. immunochemical reactivity) may be studied subsequently.

## References

1. Bartnicki-García S., and Lindberg, B. (1972). Partial characterization of mucoran: the glucuronomannan component. *Carbohydrate Research* 23:75-85.
2. Bjorkman, P.J., Saper, M.A., Samraoui, B., Bennett, W.S., Strominger, J.L., and Wiley, D.C. (1987). The foreign antigen binding site and T cell recognition regions of class I histocompatibility antigens. *Nature* (London) 329:512-518.
3. De Ruiter, G.A., Hoopman, T., Van der Lugt, A.W., Notermans, S.H.W., and Nout, M.J.R. (1992). Immunochemical detection of Mucorales species in foods, p. 221-227. In R.A. Samson, A.D. Hocking, J.I. Pitt, and A.D. King, *Modern Methods in Food Mycology*. Elsevier Publishers, Amsterdam.
4. De Ruiter, G.A., Kamphuis, H.J., Van Boom, J.H., Notermans, S.H.W., and Rombouts, F.M. (1993). The development of immunoassays for rapid detection of moulds. In D.H. Vuijk, J.J. Dekkers, and H.C. van der Plas (ed.), *Developing Agricultural Biotechnology in the Netherlands*. Pudoc, Wageningen.
5. Dewey, F.M. (1992). Detection of plant-invading fungi by monoclonal antibodies, p. 47-62. In J.M. Duncan, and L. Torrance (Eds.), *Techniques for the rapid detection of plant pathogens*. Blackwell Scientific Publications, Oxford.
6. Frisvad, J.C., and Samson, R.A. (1991). Filamentous fungi in foods and feeds: Ecology, spoilage, and mycotoxin production, p. 31-68. In D.K. Arora, K.G. Mukerji, and E.H. Marth (Eds.), *Handbook of Applied Mycology*. Vol. 3: *Foods and Feeds*. Marcel Dekker Inc., New York.
7. Girardin, H., and Latgé, J.-P. (1992). Comparison of *Neosartorya fischeri* varieties based on protein profiles and immunoactivities, p. 177-187. In R.A. Samson, A.D. Hocking, J.I. Pitt, and A.D. King, *Modern Methods in Food Mycology*. Elsevier Publishers, Amsterdam.
8. Hayashi, O., Yamada, H., Yadomae, T., and Miyazaki, T. (1978). Purification and partial characterization of the serologically active substance from *Absidia cylindrospora*. *Journal of General Microbiology* 106:289-295.
9. Jarvis, B., Seiler, D.A.L., Ould, A.J.L. and Williams, A.P. (1983). Observations on the enumeration of moulds in food and feedingstuffs. *Journal of Applied Bacteriology* 55:325-336.
10. Kamphuis, H.J., Notermans, S., Veeneman, G.H., Van Boom, J.H., and Rombouts, F.M. (1989). A rapid and reliable method for the detection of molds in foods: using the latex agglutination assay. *Journal of Food Protection* 52:244-247.
11. Kamphuis, H.J. (1992). *Extracellular polysaccharides as target compounds for the immunological detection of Aspergillus and Penicillium in food*. PhD-thesis, Wageningen Agricultural University.
12. Kusters-van Someren, M.A., Samson, R.A., and Visser, J. (1991). The use of RFLP analysis in classification of the black Aspergilli: reinterpretation of the *Aspergillus niger* aggregate. *Current Genetics* 19:21-26.

13. Miyazaki T., Yadomae T., Yamada H., Hayashi O., Suzuki I., and Ohshima Y. (1980). Immunochemical Examination of the polysaccharides of Mucorales, pp. 81-94. In P.A. Sandford, and K. Matsuda (Eds.), *Fungal Polysaccharides*. ACS Symposium Series 126. American Chemical Society, Washington DC.
14. Neefjes, J.J., and Ploegh, H.L. (1992). Intracellular transport of MHC class II molecules. *Immunology Today* 13:179-183.
15. Notermans, S., and Heuvelman, C.J. (1985). Immunological detection of moulds in food by using the enzyme-linked immunosorbent assay (ELISA); preparation of antigens. *International Journal of Food Microbiology* 2:247-258.
16. Notermans, S., and Kamphuis, H. (1990). Detection of moulds in food by Latex agglutination: a collaborative study. *Food and Agricultural Immunology* 2:37-46.
17. Notermans, S., and Kamphuis, H.J. (1992). Detection of fungi in foods by latex agglutination: a collaborative study, p. 205-212. In R.A. Samson, A.D. Hocking, J.I. Pitt, and A.D. King, *Modern Methods in Food Mycology*. Elsevier Publishers, Amsterdam.
18. Notermans, S., Veeneman, G.H., Van Zuylen, C.W.E.M., Hoogerhout, P., and Van Boom, J.H. (1988). (1→5)-linked  $\beta$ -D-galactofuranosides are immunodominant in extracellular polysaccharides of *Penicillium* and *Aspergillus* species. *Molecular Immunology* 25:975-979.
19. Pitt, J.I., and Hocking, A.D. (1985). *Fungi and Food Spoilage*. Academic Press, Sydney. 410 p.
20. Smid, P., De Ruiter, G.A., Van der Marel, G.A., Rombouts, F.M., and Van Boom, J.H. (1991). Iodinium-ion assisted stereospecific glycosylation: synthesis of oligosaccharides containing  $\alpha$ (1-4)-linked L-fucopyranosyl units. *Journal of Carbohydrate Chemistry* 10:833-849.
21. Smid, P. (1993). *Use of monosaccharides in the preparation of biologically active compounds*. PhD-thesis, State University of Leiden.
22. Van Bruggen-Van der Lugt, A.W., Kamphuis, H.J., De Ruiter, G.A., Mischnick, P., Van Boom, J.H., and Rombouts, F.M. (1992). New structural features of the antigenic extracellular polysaccharides of *Penicillium* and *Aspergillus* species revealed with exo- $\beta$ -D-galactofuranosidase. *Journal of Bacteriology* 174:6096-6102.
23. Williams P.A. (1989). Fungi in foods - Rapid detection methods, pp. 255-272. In M.R. Adams, and C.F.A. Hope (Eds.), *Rapid methods in food microbiology*, Vol. 26: *Progress in industrial microbiology*. Elsevier Publishers, Amsterdam.

## SUMMARY

In this thesis the characterization is described of the antigenic determinants (epitopes) of the extracellular polysaccharides (EPSs) from moulds belonging to the order of Mucorales. Detailed knowledge of the structure of these epitopes allows for further development of a new generation of methods for reliable detection of moulds in food. These immunoassays, such as the ELISA (Enzyme-linked Immunosorbent Assay), the latex agglutination assay and the dot-blot assay, are based on the specific recognition of antigenic EPSs by IgG antibodies raised against these polysaccharides.

As described in Chapter 2, the water-soluble extracellular polysaccharides which are excreted under various conditions of growth by the mucoralean moulds tested, including the genera *Mucor*, *Rhizopus*, *Rhizomucor*, *Absidia*, *Syncephalastrum* and *Thamnidium*, consist mainly of carbohydrate residues and some protein. The polyclonal IgG antibodies raised in rabbits against EPS of *Mucor racemosus* were very specific for species of Mucorales as no cross-reactivity with other moulds was observed. In Chapter 10, the production and characterization of mouse-monoclonal IgG antibodies against the same EPS is described. These antibodies are also very specific for mucoralean moulds but based on different epitopes. However, as shown in Chapter 10, monoclonal antibodies are not necessarily more specific and may be less sensitive than polyclonal antibodies. The immunogenic specificity provides a taxonomic value to EPS as was shown by analysis of EPS preparations of species belonging to the *Mortierella isabellina* group, which pointed to a classification of this group into the Mucoraceae and not to the Mortierellaceae (Chapter 9).

A new method was developed (Chapter 4) for accurate sugar analysis of complex carbohydrate structures with acid sugar residues. This method includes the successive use of methanolysis and TFA hydrolysis followed by high-performance anion-exchange chromatography (HPAEC) analysis of the monosaccharides. This method provided a rapid, accurate and sensitive assay to determine the exact carbohydrate composition of the uronic-acid containing mucoralean EPSs on the microgram scale without any derivatisation. With this method the presence of fucose, mannose, glucose, galactose, and glucuronic acid residues in the mucoralean EPSs was established as well as their relative amounts.

A rapid method was developed in which high-performance size-exclusion chromatography (HPSEC) was combined with ELISA detection (Chapter 3). This method allowed the rapid screening and determination of fractions for the presence of antigenic polysaccharides, and enabled an optimal choice for column material to be used for isolation of the antigenic fractions. With this method a common rabbit antigenic fraction, characteristic for moulds of Mucorales, was found. It had an apparent molecular mass of approx. 30 kDa. This fraction accounted for only a minor part of the total EPSs and was mainly composed of mannose residues. The major part, a fraction containing approx.

50% glucuronic acid which is known in the literature as mucoran, was found to be antigenic in mice (monoclonal IgG) but not antigenic in rabbits (polyclonal IgG). A  $\beta(1-4)$ -linked D-glucuronan polymer isolated from the mucoralean EPS preparations did not react with the antibodies raised in mice and rabbits (Chapter 6). The antigenic polysaccharides could also be separated from the non-antigenic polysaccharides with immobilized antibodies. As demonstrated for polyclonal rabbit IgG the antigenic polysaccharides could be separated in one step with an immunoaffinity column with covalently linked IgG antibodies (Chapter 5).

A valuable approach to reveal the structure of fungal carbohydrate epitopes, is the use of purified enzymes which are able to degrade the epitopes which can then be screened with ELISA. In Chapter 7, such an enzyme was purified from a commercial enzyme preparation from *Trichoderma harzianum*. It appeared to be an exo- $\alpha$ -D-mannanase. EPSs were treated with this enzyme and the products were analysed by high-performance anion-exchange chromatography and by gas-liquid chromatography/mass spectrometry after derivatisation to alditol acetates. The exo- $\alpha$ -D-mannanase removed the ELISA activity of polysaccharides from Mucorales by hydrolysing the terminal  $\alpha$ -D-mannose residues from  $\alpha(1-2)$ -linked chains of D-mannose and terminal 2-O-methyl-mannose residues. This 2-O-methyl-mannose residue was identified in all mucoralean EPS preparations. It represents less than 0.5% (w/w) in all samples tested, and was initially overlooked with all other methods. In particular, determination of glycosidic linkages of carbohydrate residues is often performed by methylation analysis, a method which leaves 2-O-methyl-mannose residues undetected. To our knowledge, this compound has never been reported to occur in fungi. It was proved that the epitopes reactive with rabbit-IgG of Mucorales carry this 2-O-methyl-mannose residue at the non-reducing terminal.

As shown in Chapter 8, the antigenic activity of the mucoralean moulds with polyclonal IgG antibodies is mainly based on the 2-O-methyl-mannose residues. Therefore, it can be assumed that the results of the methylation analyses on antigenic mucoralean oligosaccharides performed by Miyazaki and coworkers were erroneously interpreted as proof of  $\alpha(1-6)$ -linked mannose residues. It is most likely, that the oligomers they isolated indeed carried 2-O-methyl-mannose residues at the non-reducing end which were not recognised. Finally, the structure of the epitopes reactive with rabbit-IgG raised against mucoralean EPSs was consolidated by hapten-inhibition experiments with synthetic oligosaccharides, which unequivocally proved that 2-O-methyl-mannose residues play a vital role in this immunochemical reaction (Chapter 8).

This thesis is a contribution to the basic knowledge of the structure of extracellular polysaccharides from moulds. This knowledge can be used in the development of immunochemical methods for moulds, particularly in food products. A protocol was developed to elucidate the antigenic determinant of fungal polysaccharides. This approach appeared fruitful in discovering that the immunochemical reactivity of EPSs from Mucorales moulds reside mainly in non-reducing terminal 2-O-methyl-mannose residues.



Furthermore, this thesis can be considered as a contribution to the development of the knowledge of immunochemistry of sugars in general. This approach may be used to investigate structural features of any polysaccharide or glycoconjugate which is or can be made immunologically active. The methodology is particularly suitable in detecting minor sugars with unusual structure which occur at non-reducing terminals of biopolymers and may have specific biological functions. Specific enzymatic removal of such sugars may uncover structures of which the biological function or specificity (e.g. immunochemical reactivity) may be studied subsequently.

In dit proefschrift wordt de karakterisering van de antigene determinanten (epitopen) van extracellulaire polysachariden (EPSen) van schimmels behorende tot de orde der Mucorales beschreven. Kennis van de structuur van deze epitopen maakt de verdere ontwikkeling van een nieuwe generatie methoden voor schimmeldetectie in levensmiddelen mogelijk. Deze immunologische bepalingmethoden, zoals de ELISA (Enzyme-Linked ImmunoSorbent Assay), de latex-agglutinatie test en de dot-blot test, zijn gebaseerd op de specifieke herkenning van water-oplosbare en hitte-stabiele antigene extracellulaire schimmelpolysachariden door immunoglobuline G (IgG) antilichamen, die opgewekt zijn tegen deze EPSen.

Deze water-oplosbare EPSen worden, zoals in hoofdstuk 2 staat beschreven, uitgescheiden door alle species van Mucorales die getest zijn onder verschillende groeiomstandigheden. De in de levensmiddelenmycologie van belang zijnde species van deze orde behoren tot de geslachten *Mucor*, *Rhizopus*, *Rhizomucor*, *Absidia*, *Syncephalastrum* en *Thamnidium*. EPSen van representatieve species hiervan zijn onderzocht en blijken te bestaan uit koolhydraten en een beetje eiwit. De polyclonale IgG konijnantilichamen die zijn opgewekt tegen de EPS van *Mucor racemosus*, zijn zeer specifiek voor Mucorales species, omdat geen kruisreactiviteit werd waargenomen met schimmels die niet tot deze orde behoren.

Naast de gebruikte polyclonale antilichamen wordt in hoofdstuk 10 de productie en karakterisering van monoclonale muis-antilichamen beschreven, die zijn opgewekt tegen dezelfde EPS. Deze monoclonale antilichamen bleken specifiek te zijn voor andere suikerepitopen van schimmels behorende tot de orde der Mucorales. Echter, zoals beschreven in dit hoofdstuk, monoclonale antilichamen zijn niet per definitie specifiek of gevoeliger dan polyclonale antilichamen. De extracellulaire polysachariden van schimmels hebben ook een grote taxonomische waarde, zoals is gebleken bij de immunologische analyse van EPSen van species die tot de *Mortierella isabellina* groep worden gerekend. Zoals beschreven in hoofdstuk 9, is het waarschijnlijk dat deze schimmels moeten worden geclassificeerd in de familie van de Mucoraceae en niet in die van de Mortierellaceae, wat veel onderzoekers tot nu toe hebben aangenomen.

In dit proefschrift is een algemeen protocol ontwikkeld, waarmee de structuur van suikerepitopen kan worden opgehelderd van elke polysacharide of elk glycoconjugaat met antigene eigenschappen. Het protocol bestaat uit vier verschillende benaderingswijzen, elk met een aantal specifieke methoden, waarvan sommige in dit proefschrift zijn behandeld. Deze vier benaderingswijzen kunnen alleen met succes worden gebruikt voor de opheldering van de structuur van epitopen als ook gevoelige en nauwkeurige methoden beschikbaar zijn voor de karakterisering van de EPSen en fracties die daaruit zijn geïsoleerd. De antigeniciteit van deze schimmelpolysachariden is uitsluitend gebaseerd op de suikermoleculen, omdat na milde perijodaat oxidatie van de EPSen geen ELISA-activiteit meer kan worden aangetoond.

Verder is er een nieuwe methode ontwikkeld (Hoofdstuk 4) voor de accurate suikeranalyse van polysachariden, die bestaat uit achtereenvolgens methanolyse, hydrolyse met trifluor azijnzuur en analyse van de vrijgemaakte monosachariden met behulp van anionen-wisselings-chromatografie. Met deze methode is het mogelijk om snel, nauwkeurig en gevoelig de exacte suikersamenstelling van de uronzuur-bevattende schimmel-polysachariden vast te stellen zonder dat hoeft te worden gederiviseerd. Zo konden ook de hoeveelheden fucose, mannose, glucose, galactose en glucuronzuur in de EPSen van Mucorales nauwkeurig worden vastgesteld.

Er is ook een methode ontwikkeld om op een snelle manier de immunologisch actieve fracties te detecteren in een mengsel van polysachariden, waarbij gebruik wordt gemaakt van gel-permeatie chromatografie op een HPLC-systeem, gecombineerd met ELISA-detectie van de verschillende fracties (Hoofdstuk 3). Op deze wijze kunnen snel fracties worden gescreend op hun immunologische activiteit en daarmee kan een optimale keus worden gemaakt voor de methode om deze fracties op grotere schaal te isoleren. Zo kon bovendien worden aangetoond dat EPSen van Mucorales een gemeenschappelijke en karakteristieke antigene fractie bevatten met een molecuulmassa van ongeveer 30 kDa. Deze fractie vormt echter een zeer klein deel van de totale EPS en bestaat voornamelijk uit mannose.

Het grootste gedeelte van alle EPSen van Mucorales wordt gevormd door een fractie die ongeveer 50% glucuronzuur bevat en die vaak 'mucoran' wordt genoemd. Deze fractie is immunologisch actief met de monoclonale antilichamen (muis IgG), maar niet met de polyclonale antilichamen (konijn IgG). De analyse van deze fractie werd bemoeilijkt door de aanwezigheid van een grote hoeveelheid zeer zuur-resistente glycosidische bindingen van glucuronzuur eenheden. Uit alle EPSen van Mucorales kon een  $\beta(1-4)$ -gebonden D-glucuronzuur polymeer worden geïsoleerd, dat karakteristiek is voor deze schimmels en nooit eerder in micro-organismen is gevonden (Hoofdstuk 6). Dit glucuronzuur polymeer was echter niet immunologisch reactief.

Een andere manier om de antigene fracties uit EPS te isoleren wordt beschreven in hoofdstuk 5, waar gebruik wordt gemaakt van immuno-affiniteits-chromatografie. IgG antilichamen konden covalent worden gebonden aan kolom materiaal, waarmee de antigene fracties in één stap konden worden gescheiden van de niet immunologisch actieve polysachariden.

Een waardevolle benaderingswijze voor de structuuropheldering van suikerepitopen van schimmelpolysachariden is het gebruik van opgezuiverde enzymen die in staat zijn om deze specifiek af te breken. In hoofdstuk 7 wordt de opzuivering en karakterisering van een enzym beschreven uit een ruw enzympreparaat van de schimmel *Trichoderma harzianum*. Dit enzym bleek een exo- $\alpha$ -D-mannanase te zijn. Het is in staat om specifiek de epitopen van de EPSen van Mucorales die reactief zijn met de polyclonale antilichamen opgewekt in konijnen, af te breken. Na analyse van de producten die gevormd werden na enzym-incubatie met zowel HPLC anion-wisselings-chromatografie

als gas-chromatografie en massa-spectrometrie na derivatisering tot alditol acetaten, bleken mannose en 2-*O*-methyl-mannose te worden vrijgemaakt. Het exo- $\alpha$ -D-mannanase is in staat om de ELISA-reactiviteit volledig af te breken door hydrolyse van de eendstellige  $\alpha$ -D-mannose van ketens van  $\alpha$ (1-2)-gebonden mannose en eendstellige 2-*O*-methyl-mannose eenheden.

In alle onderzochte EPSen kon 2-*O*-methyl-mannose in kleine hoeveelheden worden aangetoond. Voorzover bekend, is deze component nooit eerder in schimmels gevonden en door de kleine hoeveelheden in eerdere onderzoeken over het hoofd gezien. Onderzoek met andere enzympreparaten heeft aangetoond dat alle epitopen van Mucorales schimmels een 2-*O*-methyl-mannose eenheid op het niet-reducerende einde bevatten.

De aard van de glycosidische bindingen tussen de verschillende suikereenheden wordt veelal vastgesteld door methyleringsanalyse. Echter, zoals in hoofdstuk 7 wordt uiteengezet, spelen 2-*O*-methyl-mannose eenheden een belangrijke rol in de antigeniciteit van deze polysachariden. Door de aanwezigheid van de methyl-groep op de C2 is methyleringsanalyse in dit geval onbruikbaar om de glycosidische binding van deze eenheden vast te stellen. Daarom is in deze dissertatie ethyleringsanalyse met succes toegepast om de bindingen van deze eenheden te onderzoeken. Tevens kan daarom worden aangenomen dat de resultaten van de methyleringsanalyses, uitgevoerd door de groep van Miyazaki, foutief zijn geïnterpreteerd als bewijs voor de aanwezigheid van  $\alpha$ (1-6)-gebonden mannose eenheden.

In hoofdstuk 8 zijn hapteen-inhibitie experimenten uitgevoerd met verschillende gesynthetiseerde oligomeren die uit mannose en 2-*O*-methyl-mannose eenheden bestaan. Hiermee kon uiteindelijk een structuurmodel worden opgesteld voor de suikerepitopen van schimmelpolysachariden van Mucorales species, die verantwoordelijk zijn voor de immunologische reactie in konijnen. Deze terminale eenheden kunnen worden beschouwd als het belangrijkste suikerresidu van de epitop.

De eindconclusie is dat dit proefschrift een bijdrage vormt in de ontwikkeling van specifieke immunologische methoden voor de detectie van schimmels behorende tot de orde der Mucorales in levensmiddelen. Het is speciaal gericht op de structuuropheldering van de epitopen die voorkomen op de extracellulaire polysachariden van genoemde schimmels. Deze dissertatie kan bovendien worden beschouwd als een bijdrage aan de kennis van de immunochemie van suikers in het algemeen. Het ontwikkelde protocol kan worden toegepast voor de structuuropheldering van elke polysacharide of elk glycoconjugaat dat immunologisch actief is of immunologisch actief kan worden gemaakt. De methodologie is vooral geschikt voor de detectie van kleine hoeveelheden bijzondere suikers, die terminaal gebonden zijn aan het niet-reducerende eind van biopolymeren, welke een specifieke biologische functie kunnen hebben. Specifieke enzymatische verwijdering van dergelijke suikers kan structuren aan het licht brengen waarvan vervolgens de biologische functie of specificiteit (bijvoorbeeld immunologische reactiviteit) kan worden onderzocht.

*Een proefschrift kan nooit het werk zijn van één persoon, het komt tot stand door de kennis, de ervaring en het werk van veel mensen te combineren. Ik bedank iedereen, binnen en buiten de sectie LMMB & LMC, die zich op welke wijze ook voor mij heeft ingezet, enkele mensen noem ik met naam.*

*Frans Rombouts, ik ben er trots op dat ik bij jou mocht promoveren. Op een fenomenale manier heb je mij in de geheimen der wetenschap ingewijd en mijn manuscripten gecorrigeerd. Altijd eerlijk en optimistisch heb je mij vier jaar lang gestimuleerd om onderzoek te doen en dit uit te dragen op congressen.*

*Prof. dr J.H. van Boom, als promotor was u voortdurend betrokken bij het onderzoek. Uw onvoorwaardelijke toewijding aan de wetenschap heeft op mij diepe indruk gemaakt.*

*Servé Notermans, grondlegger van het principe waarop dit proefschrift is gebaseerd, van jou heb ik veel geleerd. Jouw manier van onderzoek doen en het schrijven van artikelen heb ik snel overgenomen en is succesvol gebleken.*

*Henri Kamphuis en Pieter Smid, als AIO werkend aan hetzelfde project, met jullie heb ik op een collegiale wijze samengewerkt. Al die keren dat wij ergens in Europa in een plaatselijke kroeg ons onderzoek 'wetenschappelijk' hebben geëvalueerd, zal ik niet gauw vergeten: 'Sea, Sun en Science' blijft toch een ideale combinatie!*

*Ben van den Broek en Andrea van Bruggen-van der Lugt, het was geweldig om met jullie het lab te delen. Ben, je humor, relativiseringsvermogen en computerkennis waren onmisbaar om vier jaar lang met plezier op de labs 520, 521 en 522 te werken. Andrea, jou kan ik niet in een paar regels bedanken, jouw bijdrage aan dit proefschrift is evident. Onze samenwerking was een voorbeeld van perfectie, en de diepgaande gesprekken die wij gezeten aan onze labtafel al pipetterend hebben gevoerd, zal ik nooit vergeten.*

*Henk Schols en Fons Voragen, dankbaar heb ik gebruik gemaakt van jullie ervaring op het gebied van de suikerchemie en -chromatografie. Jullie bijdrage was essentieel, en onze samenwerking leidde tot een weldadige symbiose.*

*Jan Cozijnsen en Kees Teunis, gas-chromatografie en massa-spectrometrie waren onmogelijk geweest zonder jullie enthousiaste hulp.*

*Petra Mischnick, I'm impressed by your 'Gründlichkeit'.*

*Wilhelm Bos, Ian Colquhoun, Walter Gams, Harmen Hofstra, Gerrit Keizer, Wouter Middelhoven, Rob Nout, Rob Samson en Dirk Stynen, bedankt voor alle waardevolle suggesties en correcties op m'n manuscripten.*

*Tineke Hoopman, Maud Goedhals, Sylvia Josso, Claudy Seelen, Wouter Moormann, Monique Putman, Annemieke van den Elzen, Anna Geleta, Freddy Rasing en Margo de Kort, jullie hebben als doctoraal studenten een essentiële bijdrage geleverd.*

*Medepromovendi Eva-Maria Düsterhöft, Harry Gruppen, Martijn van Iersel, Felix Kormelink, Marian Verbruggen en Jean-Paul Vincken, jullie waren gave collega's.*

*Ron, Monique, Corné, Eric en Edmee, het was gezellig in ons huis.*

*Bestuur 84-II en 85-I, de onvergetelijke bestuursuitjes waren soms hard nodig.*

*Tenslotte, Ria, Leen, Annette, Jolina, Aad-Jan, PK en Petra, ik heb jullie de laatste jaren allemaal wat te kort gedaan, maar zonder jullie steun was het niet gelukt.*

Gerhard

## CURRICULUM VITAE

Gerhard Adriaan de Ruiter werd op 31 december 1963 geboren te Bolnes (gemeente Ridderkerk). In juni 1982 behaalde hij het diploma ongedeelde VWO aan het Jan Arentsz college te Alkmaar. In datzelfde jaar begon hij de studie Levensmiddelentechnologie aan de toenmalige Landbouwhogeschool te Wageningen. In de doctoraal fase werden de hoofdvakken Levensmiddelenchemie (prof. dr ir A.G.J. Voragen en prof. dr W. Pilnik) en Organische Chemie (dr J.B.P.A. Wijnberg en prof. dr Æ. de Groot) gevolgd. Aansluitend werd een half jaar stage gelopen bij het AFRC Institute of Food Research te Norwich (Engeland), Laboratory of Molecular Biophysics (dr V.J. Morris) en Laboratory of Molecular Spectroscopy (dr I.J. Colquhoun), waarna hij in november 1988 afstudeerde aan de Landbouwuniversiteit.

Van november 1988 tot december 1992 was hij als onderzoeker in opleiding (OIO) in dienst bij de Nederlandse Organisatie voor Wetenschappelijk Onderzoek (NWO) te Den Haag op een project gefinancierd door de Stichting Technische Wetenschappen (STW) te Utrecht. Het onderzoek, zoals beschreven in dit proefschrift, is uitgevoerd onder leiding van prof. dr ir F.M. Rombouts bij de sectie Levensmiddelenchemie en -microbiologie van de vakgroep Levensmiddelentechnologie van de Landbouwuniversiteit te Wageningen in samenwerking met de vakgroep Bio-organische Chemie van de Rijksuniversiteit Leiden (prof. dr J.H. van Boom) en het Rijksinstituut voor Volksgezondheid en Milieuhygiëne (RIVM) te Bilthoven (dr S.H.W. Notermans).

Vanaf mei 1993 zal hij werkzaam zijn op de afdeling Food Processing, Division of Breeding (dr K. Tanaka), van het Fruit Tree Research Station te Tsukuba (Japan).

## LIST OF PUBLICATIONS

- I.J. Colquhoun, G.A. De Ruiter, H.A. Schols, and A.G.J. Voragen (1990). Identification by n.m.r. spectroscopy of oligosaccharides obtained by treatment of the hairy regions of apple pectin with rhamnogalacturonase. *Carbohydrate Research* (206) 131-144.
- M. Pidoux, G.A. De Ruiter, B.E. Brooker, I.J. Colquhoun, and V.J. Morris (1990). Microscopic and chemical studies of a gelling polysaccharide from *Lactobacillus hilgardii*. *Carbohydrate Polymers* (13) 351-362.
- G.A. De Ruiter, P. Smid, A.W. van der Lugt, J.H. van Boom, S.H.W. Notermans, and F.M. Rombouts (1991) Immunogenic extracellular polysaccharides of Mucorales, p. 169-180. In J.-P. Latgé and D. Boucias (Eds.), *Fungal Cell Wall and Immune Response*. NATO ASI Series H 53, Springer Verlag, Berlin, Heidelberg.
- G.A. De Ruiter, A.W. Van der Lugt, A.G.J. Voragen, F.M. Rombouts, and S.H.W. Notermans (1991). High-performance size-exclusion chromatography and ELISA detection of extracellular polysaccharides from Mucorales. *Carbohydrate Research* (215) 47-57.
- P. Smid, G.A. De Ruiter, G.A. van der Marel, F.M. Rombouts, and J.H. van Boom (1991). Iodonium-ion assisted stereospecific glycosylation: Synthesis of oligosaccharides containing  $\alpha(1-4)$ -linked L-fucopyranosyl units. *Journal of Carbohydrate Chemistry* (10) 833-849.
- G.A. De Ruiter, S.L. Josso, I.J. Colquhoun, A.G.J. Voragen, and F.M. Rombouts (1992). Isolation and characterization of  $\beta(1-4)$ -D-glucuronans from extracellular polysaccharides of moulds belonging to Mucorales. *Carbohydrate Polymers* (18) 1-7.
- G.A. De Ruiter, T. Hoopman, A.W. Van der Lugt, S.H.W. Notermans, and M.J.R. Nout (1992). Immunochemical detection of Mucorales species in food, p. 221-227. In R.A. Samson, A.D. Hocking, J.I. Pitt and A.D. King (Eds.), *Modern Methods of Food Mycology*. Elsevier Publishers, Amsterdam.
- G.A. De Ruiter, H.A. Schols, A.G.J. Voragen, and F.M. Rombouts (1992). Carbohydrate analysis of water-soluble uronic acid containing polysaccharides with high-performance anion-exchange chromatography using methanolysis combined with TFA hydrolysis is superior to four other methods. *Analytical Biochemistry* (207) 176-185.
- G.A. De Ruiter, P. Smid, H.A. Schols, J.H. Van Boom, and F.M. Rombouts (1992). Detection of fungal carbohydrate antigens by high-performance immunoaffinity chromatography using a protein A column with covalently linked immunoglobulin G. *Journal of Chromatography* (584) 69-76.



- G.A. De Ruiter, A.W. Van Bruggen-van der Lugt, M.J.R. Nout, W.J. Middelhoven, P.S.S. Soentoro, S.H.W. Notermans, and F.M. Rombouts (1992). Formation of antigenic extracellular polysaccharides by selected strains of *Mucor* spp., *Rhizopus* spp., *Rhizomucor* spp., *Absidia corymbifera* and *Syncephalastrum racemosum*. *Antonie van Leeuwenhoek* (62) 189-199.
- H.J. Kamphuis, G.A. De Ruiter, G.H. Veeneman, J.H. Van Boom, F.M. Rombouts, and S.H.W. Notermans (1992). Detection of *Aspergillus* and *Penicillium* extracellular polysaccharides (EPS) by ELISA: using antibodies raised against acid hydrolysed EPS. *Antonie van Leeuwenhoek* (61) 323-332.
- S. Notermans, H. Kamphuis, P. Smid, G.A. De Ruiter, J.H. Van Boom, and F.M. Rombouts. (1992). Immunoassays for specific detection of moulds of the order Mucorales and the genus *Botrytis*. In Proceedings 3<sup>rd</sup> world-congress foodborne infections and intoxications, Berlin, 16-19 June, p. 631-634.
- A.W. Van Bruggen-van der Lugt, H.J. Kamphuis, G.A. De Ruiter, P. Mischnick, J.H. Van Boom, and F.M. Rombouts (1992). New structural features of the antigenic extracellular polysaccharides of *Penicillium* and *Aspergillus* species revealed with *exo-β-D-galactofuranosidase*. *Journal of Bacteriology* (174) 6096-6102.
- G. Beldman, M.J.F. Searle-van Leeuwen, G.A. De Ruiter, H.A. Siliha, and A.G.J. Voragen (1993). Degradation of arabinans by arabinanases from *Aspergillus aculeatus* and *Aspergillus niger*. *Carbohydrate Polymers* (In press).
- G.A. De Ruiter, W. Bos, A.W. Van Bruggen-van der Lugt, H. Hofstra, and F.M. Rombouts (1993). Development of an ELISA and DOT-BLOT assay to detect *Mucor racemosus* and related species of the order Mucorales. In *Modern detection assays for plant pathogenic fungi*. (In press).
- G.A. De Ruiter, H.J. Kamphuis, S.H.W. Notermans, J.H. Van Boom, and F.M. Rombouts. (1993). The development of immunoassays for the rapid detection of moulds. In D.H. Vuijk, J.J. Dekkers, and H.C. van der Plas (Eds.), *Developing Agricultural Biotechnology in the Netherlands*. Pudoc, Wageningen (In press).
- G.A. De Ruiter, S.H.W. Notermans and F.M. Rombouts (1993). Review: New methods in food mycology. *Trends in Food Science and Technology* (In press).
- G.A. De Ruiter, A.W. Van Bruggen-van der Lugt, W. Bos, S.H.W. Notermans, F.M. Rombouts, and H. Hofstra (1993). The production and partial characterization of a monoclonal IgG antibody specific for moulds belonging to the order of Mucorales. *Journal of General Microbiology* (In press).

G.A. De Ruiter, A.W. Van Bruggen-van der Lugt, F.M. Rombouts, and W. Gams (1993). Approaches to the classification of the *Mortierella isabellina* group (Mucorales): antigenic extracellular polysaccharides. *Mycological Research* (97: In press).

G.A. De Ruiter, A.W. Van Bruggen-van der Lugt, P. Smid, J.H. Van Boom, and F.M. Rombouts (1993). 2-O-methyl mannose is a constituent of the epitopes of mucoralean extracellular polysaccharides. *Journal of Bacteriology* (submitted).

H.J. Kamphuis, G.A. De Ruiter, S.H.W. Notermans, and F.M. Rombouts (1993). Production of antigenic extracellular polysaccharides (EPS) by *Penicillium aurantiogriseum* and *Penicillium digitatum*. *Food and Agricultural Immunology* (In press).

P. Mischnick, and G.A. De Ruiter (1993). Investigation of the structure of the antigenic galactomannans of *Aspergillus* and *Penicillium* species using reductive-cleavage. *Carbohydrate Research* (submitted).

P. Smid, G.A. De Ruiter, P. Mischnick, S.H.W. Notermans, F.M. Rombouts, and J.H. van Boom (1993). Characterization of 2-O-methyl-mannose containing epitopes of antigenic polysaccharides from *Mucor racemosus*. *Carbohydrate Research* (to be submitted).