

Chapter 4

Gears* and boats

P.C. Goudswaard, P.J. Mous, W. Ligtoet & W.L.T. van Densen

In this chapter fishing gears and boats that were used during the research of HEST/TAFIRI are described. Attention is paid to construction, operation and maintenance of gears and boats, as well as to their fishing selectivity. Advice is given on use of the gears for different types of research.

* Although, in standard English the word 'gear' is used for both singular and plural instances, the word 'gears' is in common use amongst fisheries experts.

4.1 Gill nets

Gill nets are passive fishing gear, only catching fish which try to make their way through them, getting stuck in the meshes in the process. Catches are thus highly dependent on the activity patterns of the fish and on the characteristics of the gear, like mesh size and twine type. An extensive description of types of gill nets is given in the FAO *Catalogue of small-scale fishing gear* (FAO 1987). Artisanal gill nets are described in Sections 2.7 and 2.9.

The types of gill nets used during the HEST/TAFIRI period are described in *Table 4.1*.

For information regarding the manufacture of gill nets we refer to Cole & Rogers (1985) and Karlsen & Bjarnason (1986).

General description of a gill net

The main components of a gill net are the webbing, the float line, the floats, the lead line and the gavel lines (*Figure 4.1*).

The horizontal hanging ratio (E) defines the shape of the mesh (*Figure 4.2*). It is defined as the length of the float or lead lines (L) relative to the stretched length of the netting (L_0), with N as number of meshes and m as the mesh size, here always given in cm stretched mesh (Karlsen & Bjarnason 1986).

$$E = \frac{L}{L_0} = \frac{L}{(N.m)}$$

Table 4.1 Types of gill nets used during the HEST/TAFIRI research period. Gill nets were used for research on *Lates*, *Rastrineobola* and haplochromines. For each target species different nets were used.

	<i>Lates</i>	<i>Rastrineobola</i>	<i>Rastrineobola</i>	Haplochromines	Haplochromines
Mesh size	100 - 210 mm	8 & 13 mm	8 & 13 mm	25 mm	25 - 51 mm
Hanging ratio	0.3 - 0.6	0.67	0.67	0.67	0.67
Length	25 m	ca. 5 m	15 m	ca. 5 m	30 - 60 m
Height	2 - 2.5 m	variable	1.5 m	variable	ca. 1.5 m
Twine	ply 210/6 - 210/48	monofilament, 10/00	monofilament, 10/00	ply 210/2 double	ply 210/2 double
Material	nylon	nylon	nylon	nylon	nylon
Mounting	float line lead line	wooden beam steel bar	float line lead line	wooden beam steel bar	float line lead line
Location in water column	bottom surface	total water column	bottom middle surface	total water column	bottom middle surface
Total number of nets used	41	1	3	1 - 2	3 - 6
Size range of catch	30 - 105 cm TL	4 - 7 cm TL	4 - 7 cm TL	5.5 - 8 cm SL	5.5 - 13 cm SL

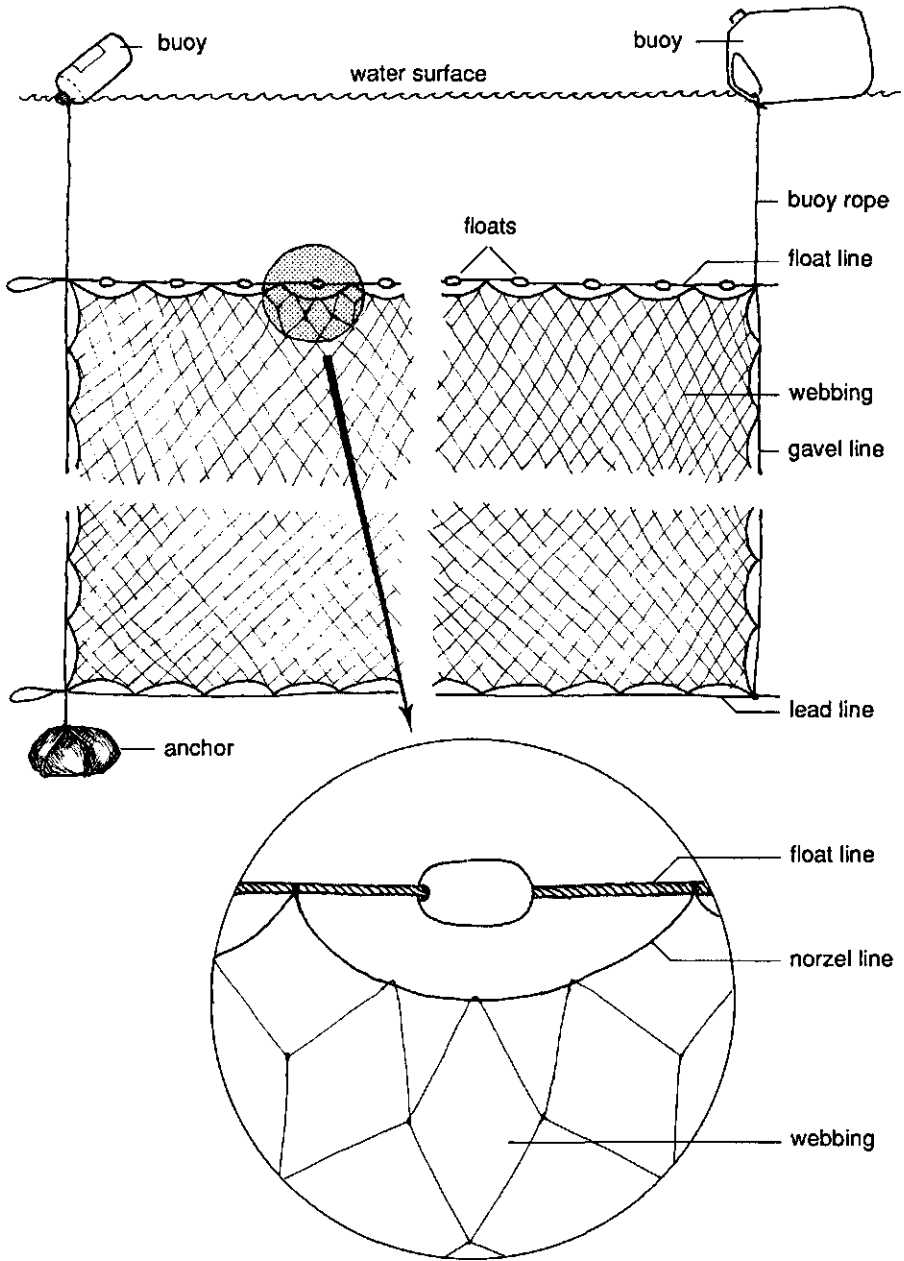

Figure 4.1 Drawing of a gill net, showing the main components. The detail shows the hanging of the netting on the float line.

Mesh size and twine

Since gill nets are very selective, the choice of the 'right' mesh size for a particular species and/or length class is of great importance. The thickness of twine has been demonstrated to have a notable effect on fishing efficiency. The thickness of the twine and the material it is made of are coded according to international standards. The code 210/4 represents the weight of 9000 m of single yarn (210 g), and the number of yarns of which the twine is composed (4). Another commonly used standard is the R tex value. More information on these standards can be found in FAO (1987). Usually, thinner twines achieve higher catch efficiencies, which is explained by their lower visibility and a higher flexibility compared with thicker twines (Hamley 1975). The preferred twine thickness depends on the strength of the fish, which is illustrated by comparing the twines used in the professional gill net fishery for *Oreochromis niloticus* and the research fishery for *Lates*. For *Oreochromis niloticus* gill nets of 10.2 cm (4") and 12.8 cm (5") mesh size and twines of 210/4 ply are used. However, for *Lates* 210/9 ply proved to be most appropriate with these mesh sizes. Monofilaments and multi-monofilaments have a better catch efficiency than the multifilaments, but are more expensive and difficult to repair.

Frame

The most important factor to take into account in deciding which type of float line must be taken, is that it should be strong enough to withstand the hauling forces applied. It is also advisable to avoid ropes which are too thin so that the cutting of hands and fingers during hauling is restricted to a minimum. Float lines made of buoyant materials, e.g. polypropylene and polyethylene, are the most suitable. Float lines for smaller mesh sizes of 2.5-10.2 cm (1-4") are mostly made from gripolene rope with a diameter of 4 mm; for larger meshes a diameter of 7 mm or more is appropriate.

Lead lines are composed of a mantle of braided nylon or polyester cords and a core of lead. The most important considerations for the float lines are also valid for lead lines.

Many types of floats exist. Local fishermen use home-made floats from a variety of materials (wood, PVC, polystyrene) or machine-made cylindrical floats of polystyrene. The major considerations in choosing floats are that they should not get entangled in the netting, i.e. they must be larger than the meshes, and that they are easy to handle. Although large floats have these advantages, a line of small floats gives the netting a better hanging profile than a few larger floats over the same distance.

Sinkers have the same function as a lead line. The latter is preferred because it is easier to handle and less work to mount. If sinkers are to be used, considerations similar to those applying to the choice of floats should be applied.

Construction

Netting material is usually sold in bundles, which may constitute the basic unit for one gill net. On each bundle the following information is listed: mesh size, twine thickness (ply), stretched length of the bundle in metres or in yards, and the depth in number of meshes. In the case of unidentified bundles or otherwise unknown quantities of netting material, the dimensions must be determined by measuring the mesh size and counting the number of meshes in two directions rectangular to each other. If gill nets of a standard length are required (e.g. 25x2 m), the bundles must be cut to the desired netting length according to the required hanging ratio.

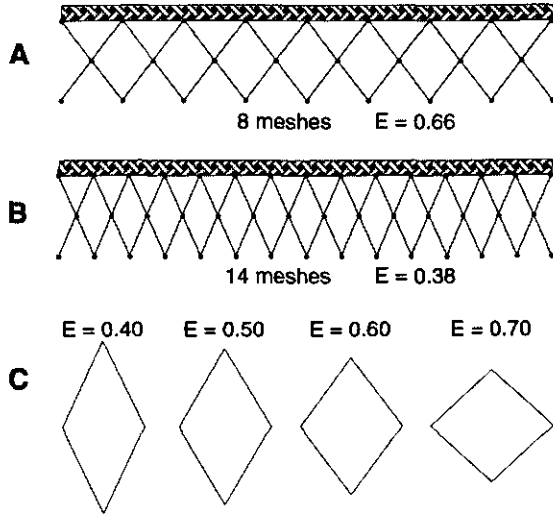

Figure 4.2 Different hanging ratios for gill nets (19 cm mesh). A: Rope 1 metre, stretched net 8x19 cm = 1.52 m, hanging ratio $E = 0.66$. B: Rope 1 metre, stretched net 14x19 cm = 2.66 m, hanging ratio $E = 0.38$. C: Meshes with hanging ratios 0.40, 0.50, 0.60 and 0.70. (After Karlsen & Bjarnason 1986).

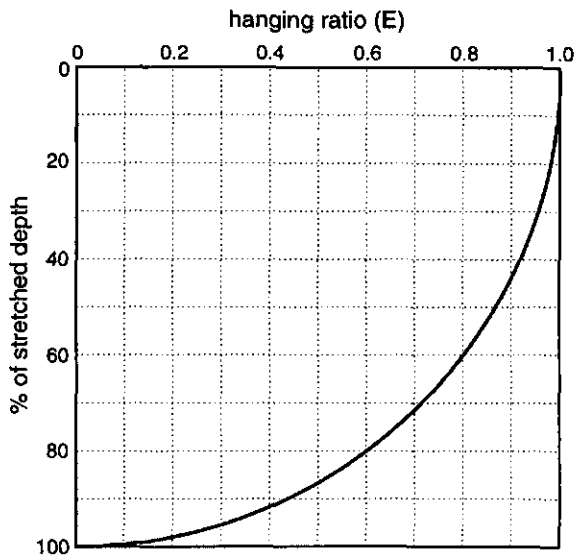

Figure 4.3 Relation between hung depth of netting and horizontal hanging ratio. (After Karlsen & Bjarnason 1986).

Length of float and lead line (L) can be calculated from the stretched length of netting (L_0) and the hanging ratio (E):

$$L = E \cdot L_0$$

If the float and lead lines are to be joined to other nets or to connecting cables, they should be extended by at least 0.5 m at each side of the netting. The weight of the lead line of a gill net ranges from 3.5-18.0 kg per 100 m. If the gill nets are meant to be used higher in the water column, a slight positive buoyancy is required. In order to achieve this, the easiest approach is to determine the number of floats per metre by cutting 1 m each of float line, lead line and netting (as mounted), tying them together, and seeing how many floats it takes to make this bundle float.

Length of gavel line (L_g) can be calculated from the number of meshes high (N), the stretched mesh size (m) and the hanging ratio (E) using the formula:

$$L_g = N \cdot m \cdot \sqrt{1-E^2}$$

or it can be easily read from *Figure 4.3* which shows the relationship between the horizontal hanging ratio (E) and the resulting depth as a percentage of stretched depth.

Mounting

The process of mounting is given here step by step:

1. To ensure that the netting is correctly mounted to the float line, it is important to mark the point where the norzel line should be attached to the float, lead and gavel lines. Also, marks should be made for positioning the floats at equal intervals along the length of the line, according to the total number of floats to be used (*Figure 4.4*). One can choose to attach the floats either to the same line as the netting, or to a separate line. In both cases it is recommended that the floats are fixed individually.
2. The netting and floats are attached to the float line according to the marks.
3. The netting is mounted to the lead line according to the marks.
4. Gavel lines are attached to the float line, each end with a small loop, to permit easy connection to other nets.
5. Netting is mounted to the gavel lines according to the marks.
6. Gavel lines are attached to the lead line, each end with a small loop.
7. If the floats are attached to a separate line, this line is then attached to the netting line.

Vertical gill nets

Vertical gill nets cover the whole water column (*Figure 4.5*). They were used in the HEST/TAFIRI research to study the diurnal vertical migration of *Rastrineobola* and haplochromines.

Due to the restricted width of the net (*ca.* 5 m), vertical nets can only be used for rather small, abundant fish species like *Rastrineobola*, juvenile *Lates* (less than 15 cm) and haplochromines. Research has been carried out with mesh sizes of 0.8-2.5 cm (Witte 1984; Goldschmidt *et al.* 1990; Wanink 1992).

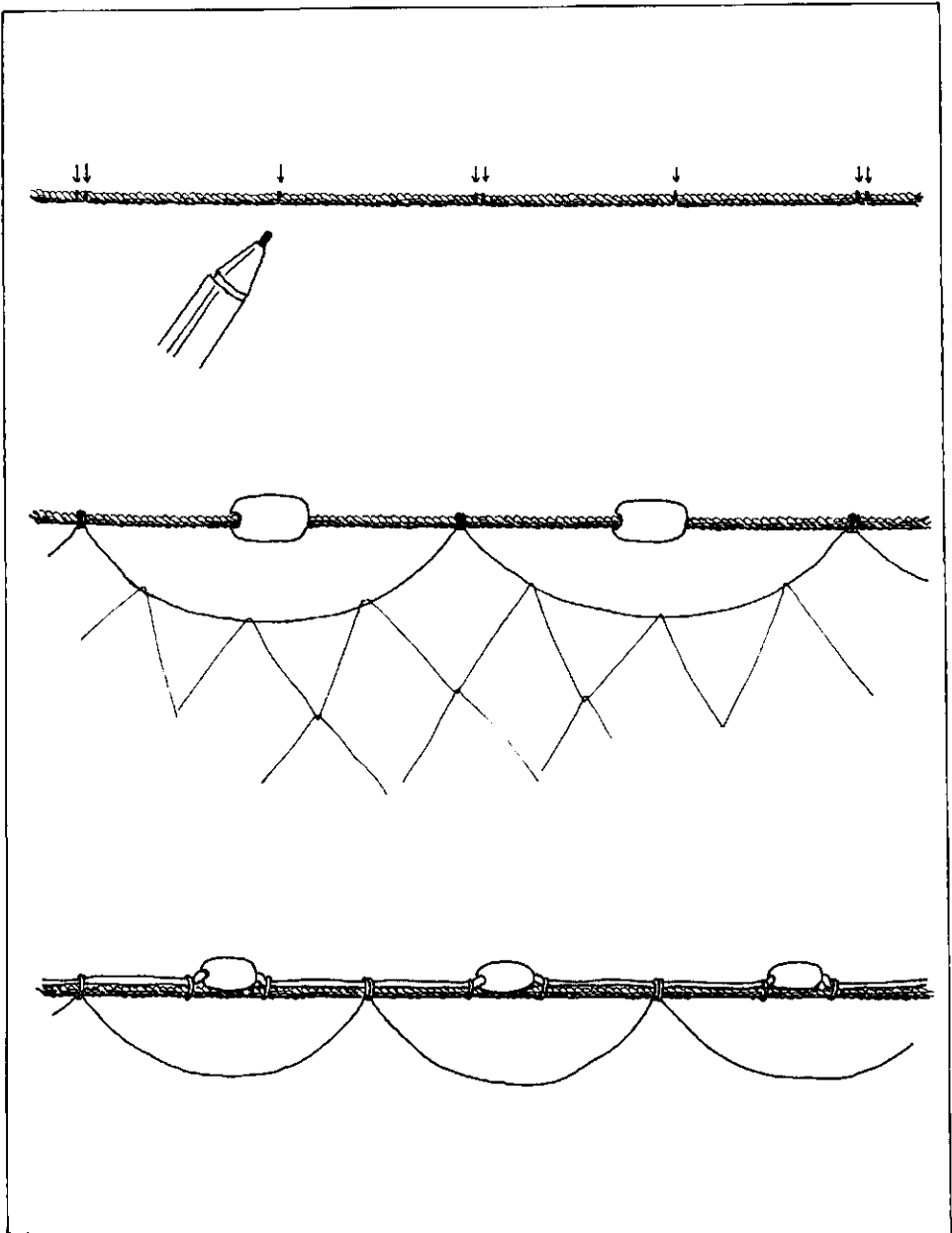

Figure 4.4 Marking the float line to ensure proper spacing of the norzel lines and floats. Floats can be placed on the float line itself (middle illustration) or attached to it with a second line (lower illustration).

The most conspicuous structures in the vertical nets are a sisal pole attached to the float line which serves as a float, and an iron bar attached to the bottom line (without lead) as a sinker. The sisal pole is assembled from two pieces of sisal about 3 m long, cut lengthwise, while the iron bar consists of two sections, each of 3 m length. Both sisal pole and iron bar can be folded in half to facilitate transportation, and can then be assembled on the site of the fishing operation. The iron bars are assembled by slotting one into a socket on the other (see detail *Figure 4.5*), while the sisal poles are simply bound together with a rope.

Between the sisal pole and the iron bar two strong gavel lines are mounted, which should be able to withstand the pulling forces and prevent the netting from tearing. The gavel lines should be of such a length that the nets can be used at the greatest depth in the research area. For operations in shallower parts, the length can easily be adjusted by tying part of the netting either to the pole or the iron bar. Especially when the very delicate monofilament netting is used, two extra lines should be installed parallel to the gavel lines. These extra lines should be slightly shorter than the actual gavel lines, so that most of the pulling force acts on them. Mounting the netting to the float, lead and gavel lines, is similar to the operations described above.

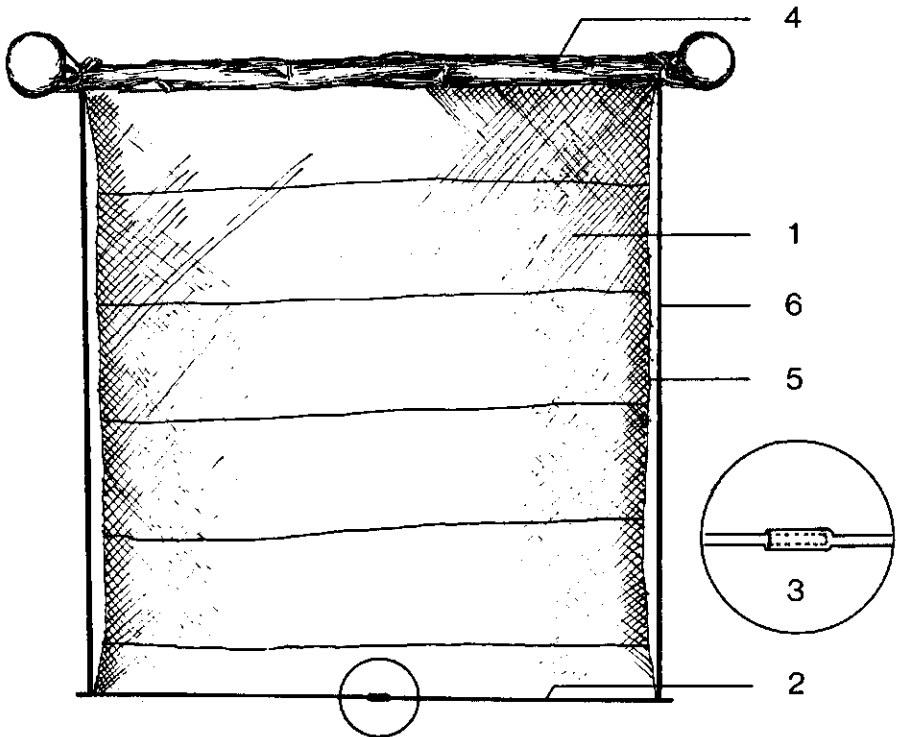

Figure 4.5 A vertical gill net which covers the whole water column. 1 = netting with depth markers; 2 = iron bar as lead line; 3 = detail of socket; 4 = sisal pole as float with extra floats attached to the ends; 5 = gavel lines; 6 = extra gavel lines.

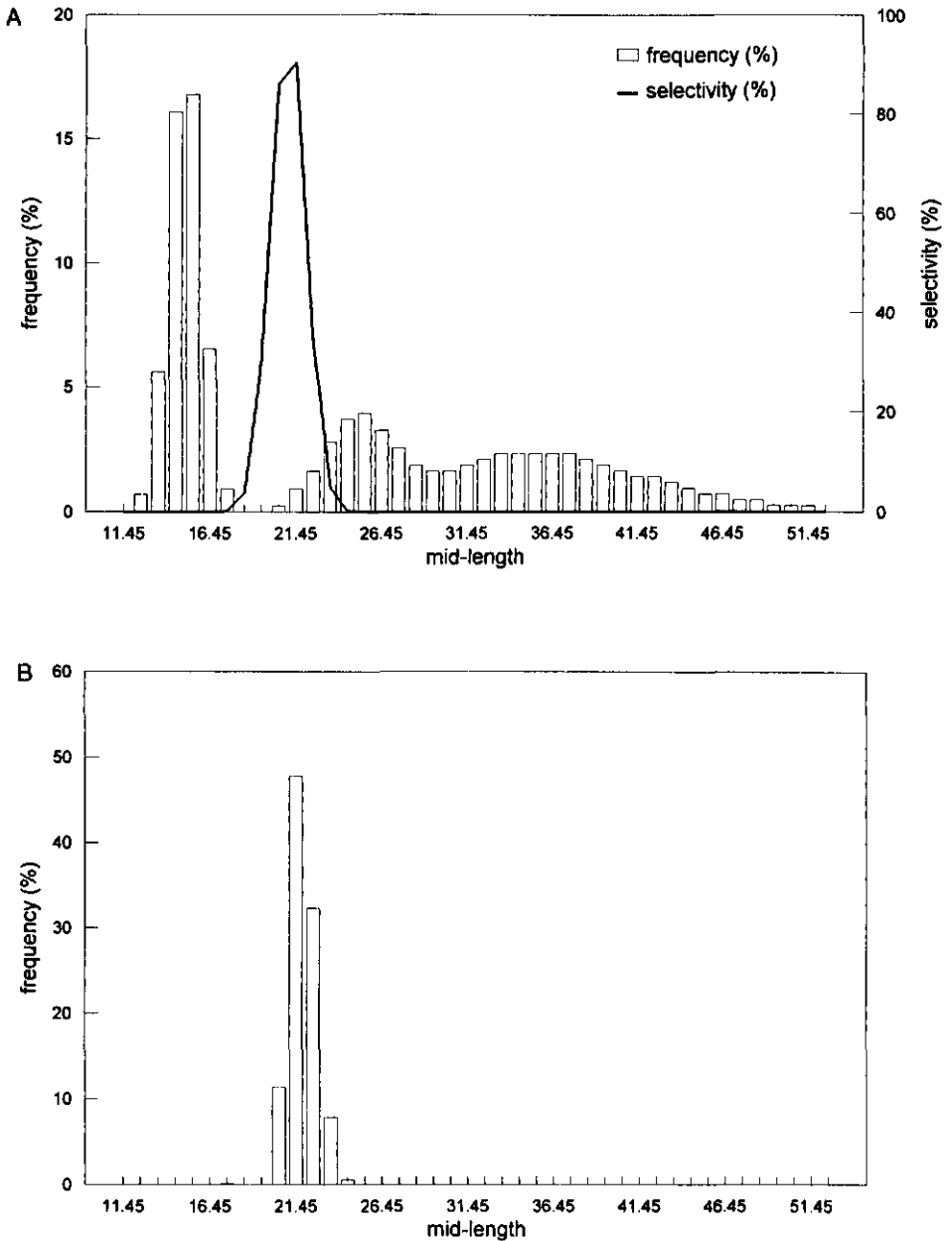

Figure 4.6 Gill net catches resulting from a typical normal selectivity curve and the size structure of the fished population. The length of the fish (l_0), where there is maximum selectivity, is 21.0 cm. The length-frequency distribution of the catch (B) is quite different from the length-frequency distribution of the population (A, bars) as a result of the selectivity characteristics of the gill net (A, curve).

4.2 Gill net selectivity

Gill nets are about the most selective gear used in commercial fishing. The size-frequency distribution of a gill net catch, therefore, may give little indication of that of the sampled population. In *Figure 4.6A* a typical selectivity curve is drawn, and the dependence of the catch on selectivity and population structure is illustrated.

Size-selectivity can be expressed as a function of fish length for a given mesh size (type A-curve) or as a function of mesh size for a given fish length (type B-curve; *Figure 4.7*). Fishes can get caught in the nets by their gills, or they get wedged or tangled at different points of their bodies. In the first two cases, it has been suggested (Baranov 1914; Holt 1963) that the A-type selectivity curves are bell-shaped (as in the selectivity curve in *Figure 4.6A*) and can be described by a normal distribution. For various fish species, however, which are prominently captured as well at other positions, or tangled, asymmetrical positively skewed selectivity curves have been established (e.g. for *Clarias*, Gulland & Harding 1961).

The condition of the fish is also a determining factor for those specimens being caught by wedging, since maximum girth changes with the condition of a fish. The size of pikeperch and perch caught, and their respective selectivity curves, have been shown to differ considerably between years in which the average condition of the fish changed (Kipling 1963; McCombie & Berst 1969; Van Densen 1987).

Knowledge of size selectivity is needed when sampling fish stocks with gill nets for research purposes as well as when managing a commercial gill net fishery. The proper mesh sizes must be determined in order to obtain the maximum yield. A review on gill net selectivity is given by Hamley (1975).

In Lake Victoria, estimates on gill net selectivity were made for *Clarias gariepinus* (Gulland & Harding 1961), *Oreochromis esculentus* (Garrod 1961) and *Oreochromis leucostictus* and *Tilapia zillii* (Welcomme 1968).

In increasing order of sophistication in the required materials, the three most relevant methods for determining gill net selectivity, among those described in Hamley (1975), are inference from girth measurements, indirect estimates and direct estimates.

Inference from girth measurements

This method is described by Sechin (1969) and Kawamura (1972) and has more recently been applied by Clarke & King (1986) and by Ehrhardt & Die (1988). Selectivity curves are estimated from measurements of maximum girth and head girth over the operculum, using the assumption that all fish are fully selected when

$$G_c \leq 2m \leq G_{\max}$$

where G_c is the girth at the head, $2m$ is the perimeter of the mesh (= 2 times the stretched mesh size) and G_{\max} is the maximum girth. Plump individuals will be caught at a relatively shorter length than more slender fish. As there is a natural variance in the length-girth relationships, this is supposed to cause a bell-shaped selectivity curve (*Figure 4.8*). An obvious problem with this method is that neither tangling, nor wedging in front of the operculum girth, as has been found for instance with *Lates*, is accounted for.

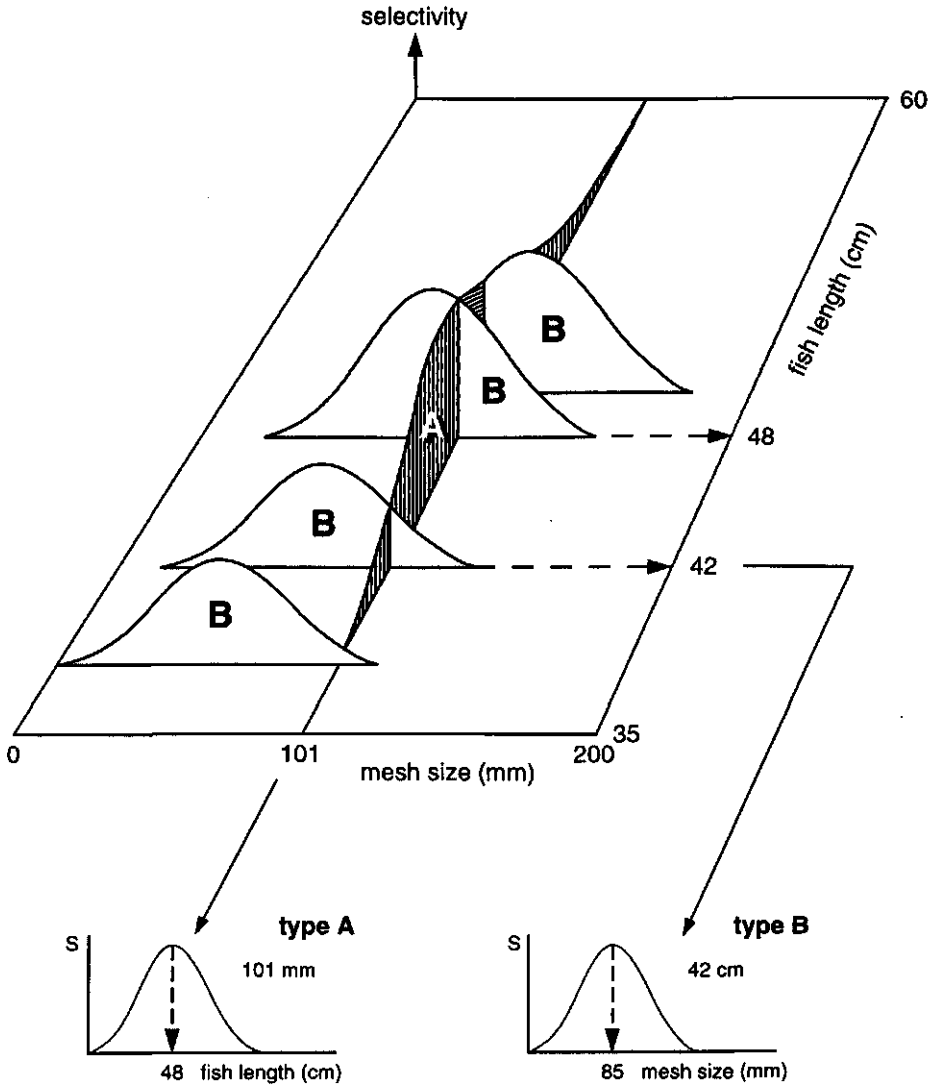

Fig. 4.7 The relationship between mesh size, fish length and selectivity, illustrating the different curves estimated via the Holt method and Gulland & Harding method. Type A curves, estimated with Holt (1963), intersect the Type B curves, estimated with Gulland & Harding (1961), at right angles. (After Hamley 1975).

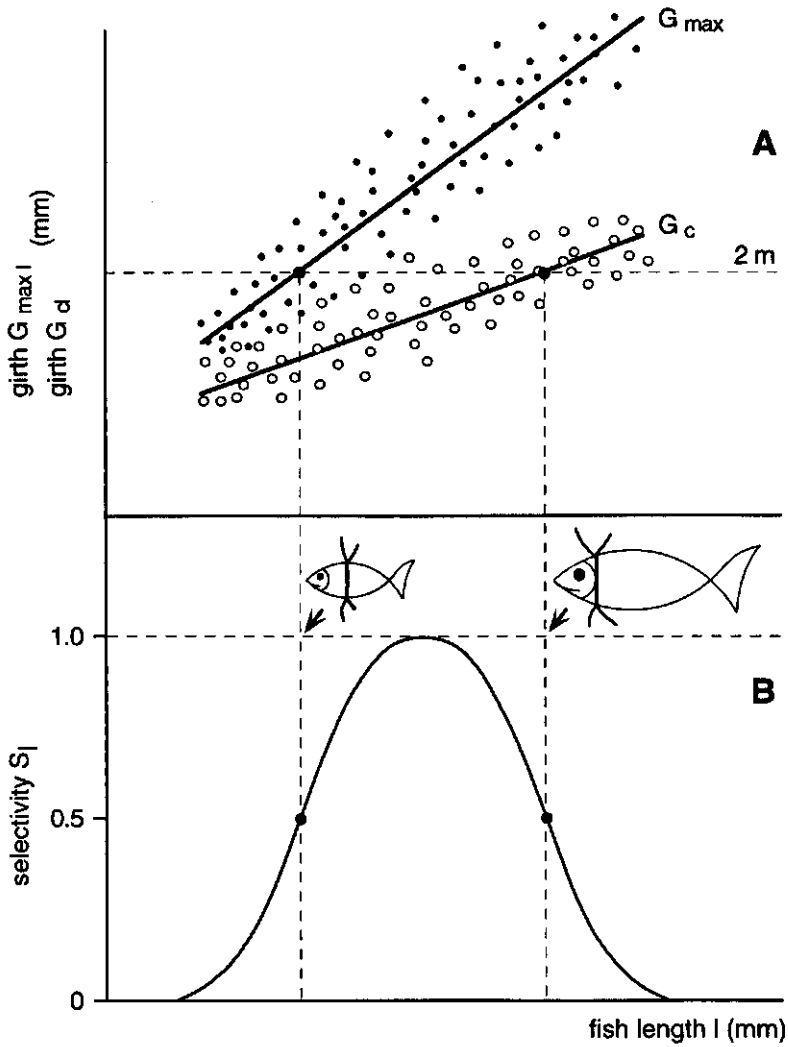

Figure 4.8 The estimation of the gill net selectivity curve according to Sechin (1969). Relationships between both maximum girth and operculum girth and fish length are established (A). Assuming no difference in the variance between length classes in both relationships the selectivity curve is inferred from the relationships and their variances (B). The selectivity curve is a cumulative distribution function of the standard normal distribution Φ , with: S_l = selectivity for length class l ; m = mesh size; G_{maxl} = mean maximum girth for fish of size class l ; σ_{maxl}^2 = variance of G_{maxl} ; G_{cl} = mean operculum girth for fish of size class l ; σ_{cl}^2 = variance of G_{cl}

$$\text{Lefthand side } S_l = 1 - \Phi \left(\frac{2m - G_{maxl}}{\sigma_{maxl}} \right); \quad \text{Righthand side } S_l = \Phi \left(\frac{2m - G_{cl}}{\sigma_{cl}} \right);$$

$$\text{Combined } S_l = \Phi \left(\frac{2m - G_{cl}}{\sigma_{cl}} \right) \left[1 - \Phi \left(\frac{2m - G_{maxl}}{\sigma_{maxl}} \right) \right]$$

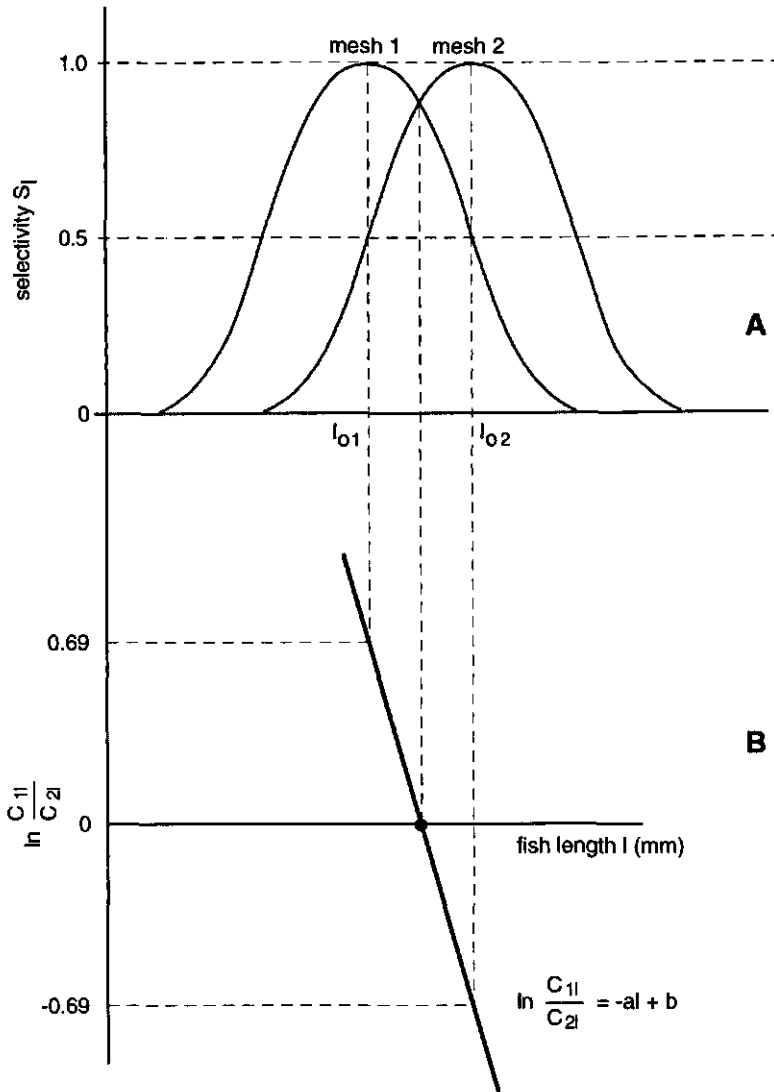

Figure 4.9 The estimation of the gill net selectivity curve according to Holt (1963). The selectivity curves of gill nets with slightly different mesh sizes are assumed to be normal distributions (A) $S_{l_i} = E \frac{(l - l_{o_i})^2}{2\sigma^2}$. The ratio in the catches in the two gill nets (m_1 and m_2) per size category l will then decrease exponentially. Linearization via \ln -transformation of this ratio reveals constants from which the proportionality (k) between mesh size (m) and optimum length (l_o) per mesh size and the constant variance can be deduced (B):

$$\hat{k} = \frac{-2a}{b(m_1 + m_2)} \quad \hat{\sigma}^2 = \frac{2a(m_2 - m_1)}{b^2(m_2 + m_1)}$$

Baranov (1914) gives a rough estimate of the 'best mesh' (the mesh size at which a fish with a certain maximum girth is retained most efficiently):

$$BM = \frac{G_{\max}}{K}$$

where BM is the perimeter of the 'best mesh', G_{\max} is the maximum girth and K is a species-specific constant. The value of K averages 1.25 (1.08-1.35) (Hamley 1975).

Indirect estimates

Indirect estimates are obtained by comparing the size distributions of gill net catches of different mesh sizes. No knowledge about the true size structure of the fish population is required. The accuracy of the estimate relies on the accuracy of assumptions about the nature of the selectivity curves.

The most commonly known methods are those described by Holt (1963) and Gulland & Harding (1961). With the Holt method one needs to set the same length of gill net simultaneously for two slightly different mesh sizes. From the ratio in the catch per length category of fish in the two gill nets, the characteristics describing the selectivity curve, assumed to be a normal distribution, can be deduced (Figure 4.9).

When the Holt method is applied one assumes:

- A proportionality (k) between mesh size (m) on the one hand and body length at which fish is caught most efficiently (l_o) on the other hand, so $l_o = k \times m$.
- A normally distributed selectivity as a function of fish length with equal variance for each mesh size.
- That the maximum efficiency at modal fish length is constant for all mesh sizes.

The Holt method has been used to estimate gill net selectivity for *Oreochromis esculentus* (Garrod 1961). An example of the estimation of gill net selectivity parameters according to Holt can be found in Section 6.6.

Gulland & Harding (1961) used several mesh sizes at the same time to catch *Clarias gariepinus*. First, they established the relationship between fish length and the best mesh size to use to catch that size of fish most efficiently (via B-curve). Second, they calculated relative efficiencies per fish length and deduced a generalized selectivity as a function of the ratio best mesh/mesh used. As the best mesh is known for every fish length, the selectivity curve per mesh size could be deduced from the generalized selectivity curve (Figure 4.10).

Direct estimates

Direct estimates are obtained by comparing the size distribution of the gill net catches with the size distribution of the population. The size structure of the population can be found by sampling with a type of gear that has known selectivity characteristics. The advantage of direct estimates is that no special assumptions are needed about the nature of the selectivity curves, and therefore these are usually the most reliable estimates available.

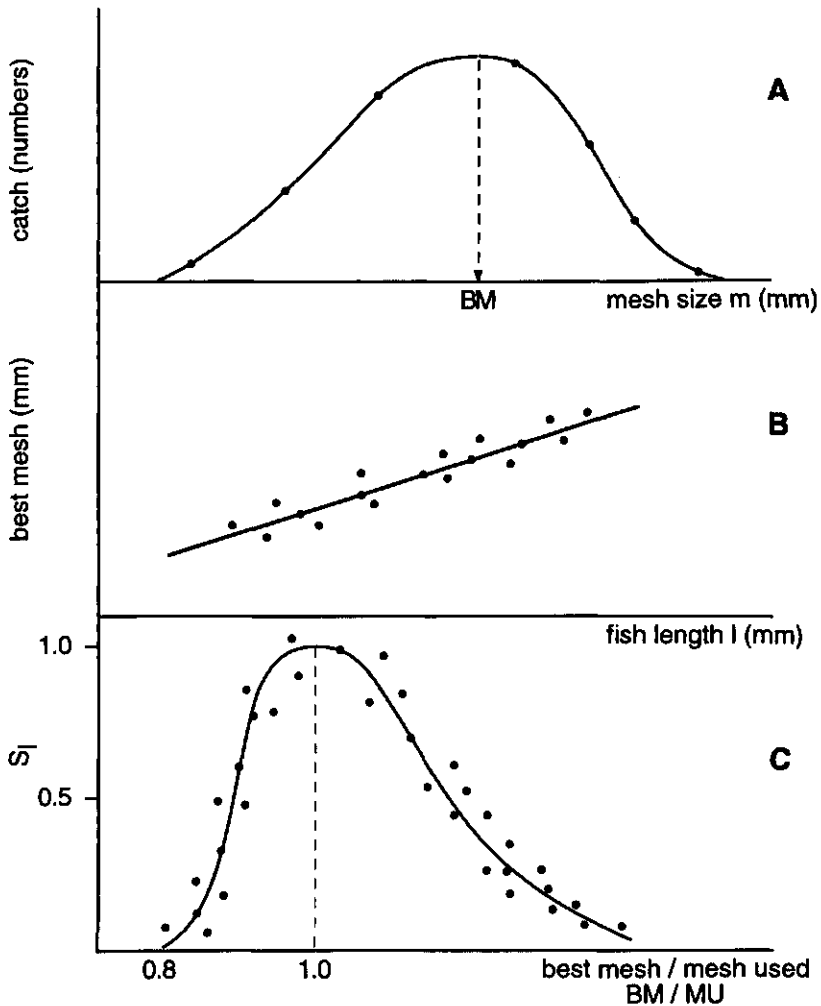

Figure 4.10 The estimation of the gill net selectivity curve according to Gulland & Harding (1961). Nets with different mesh sizes are set and from the recorded catches the best mesh (BM) for a given fish length is estimated (A) and these best meshes are combined in a linear relationship with fish length (B). Assuming that all B - selectivity curves belong to a general curve with a relative index for the size of the fish with respect to the mesh size (best mesh/mesh used on the X-axis), this curve can be reconstructed from the catches per mesh size and length category of the fish (C).

4.3 Operation of gill nets

There are two ways of setting and hauling gill nets, with and without the use of fish boxes.

Nets in boxes

In the HEST/TAFIRI research, plastic fish boxes with a volume of about 50 litres were used to contain the nets. Two boxes were used for each net, the side with the floats was put into one box, and the lower side (lead line) into the other. The two boxes could be stacked for transport or storage (*Figure 4.11*).

If fishing is carried out with different types of nets, each net should be coded, *e.g.* on the floats with a waterproof marker. Each 2 m of float line should have at least 1 marked float. Nets can be attached to each other by musketon hooks. The musketon hooks can also be used to attach the nets to the box.

Setting a larger gill net (with a height of more than 1.5 m) is done by two persons, while small gill nets can be set by just one person. The net is set from the boxes while the boat drifts in the wind, and therefore a location must be found where there are no obstacles in the drift path.

The nets must be anchored (*Figure 4.12*), with two anchors or weights (*ca.* 15 kg) for a bottom set of nets. Two large buoys are needed to mark the beginning and end of the set. The anchoring rope with the weight attached is connected to the lead line and float line; the net is lowered and the buoy is connected to the anchoring rope. Then, while the boat drifts, the net is set. One person takes care that the lead line does not get stuck or entangled, the other person does the same for the float line. If one box of nets is almost set, the next set of nets is connected to it. In the case of a floating net, an anchoring weight of about 5 kg is connected by rope to the lead line of each third net (*Figure 4.12*), to avoid entanglement while it is in the water. The length of the rope should be greater than the maximum depth of the water. Finally, an anchor and a buoy are attached to the last net.

If the wind direction changes during setting there are two ways of tackling this problem:

- Haul the net and set again.
- Use the outboard engine in reverse to continue setting the net in the predetermined direction. One person should man the outboard engine, the other one should guide the net. It is of great importance that the speed is kept as low as possible, and that the net is set in a straight line. The person who is manning the outboard engine should orientate himself to a fixed point on the shoreline.

Essentially, the hauling of the net is the reverse process of setting. Hauling is done against the wind. First the anchoring rope is hauled, and the beginning of the net is attached to the boxes. Then the net is hauled, the lead line is put in one box, the float line in the other (*Figure 4.13*). The fish can be removed while hauling the net, or, if this is difficult, they can remain in the net and be removed later.

Nets kept in hand

The nets must be bundled before setting and before storing. Bundle the float line as if you were bundling a single rope. Make sure that the nooses are of the same size. Use the last noose to tie the bundle together. Coding the net can be done as described above.

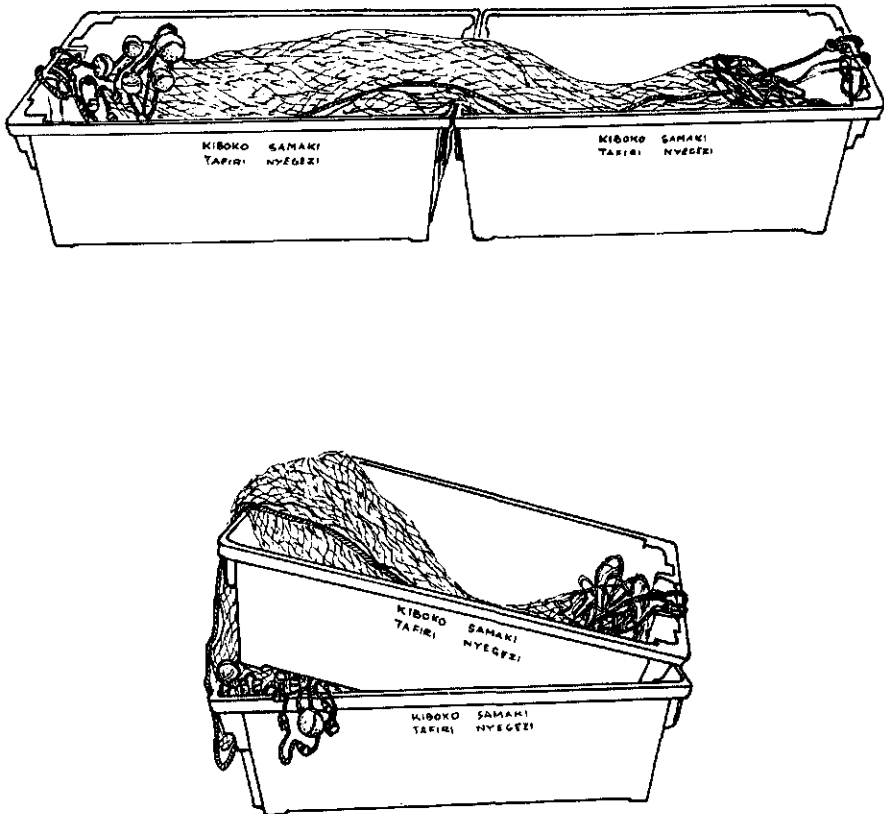

Figure 4.11 *Lates* gill nets in two boxes (top). The lower drawing shows the same pair of boxes, ready for transport to the boat or for storing.

While setting, one person should stand in the boat with the netting bundle in his hand. The net is anchored as described above. While the boat moves, this person lets the nooses slip one by one.

Hauling does not differ much from the method where the net is put into the boxes, but instead it is placed on the bottom of the boat.

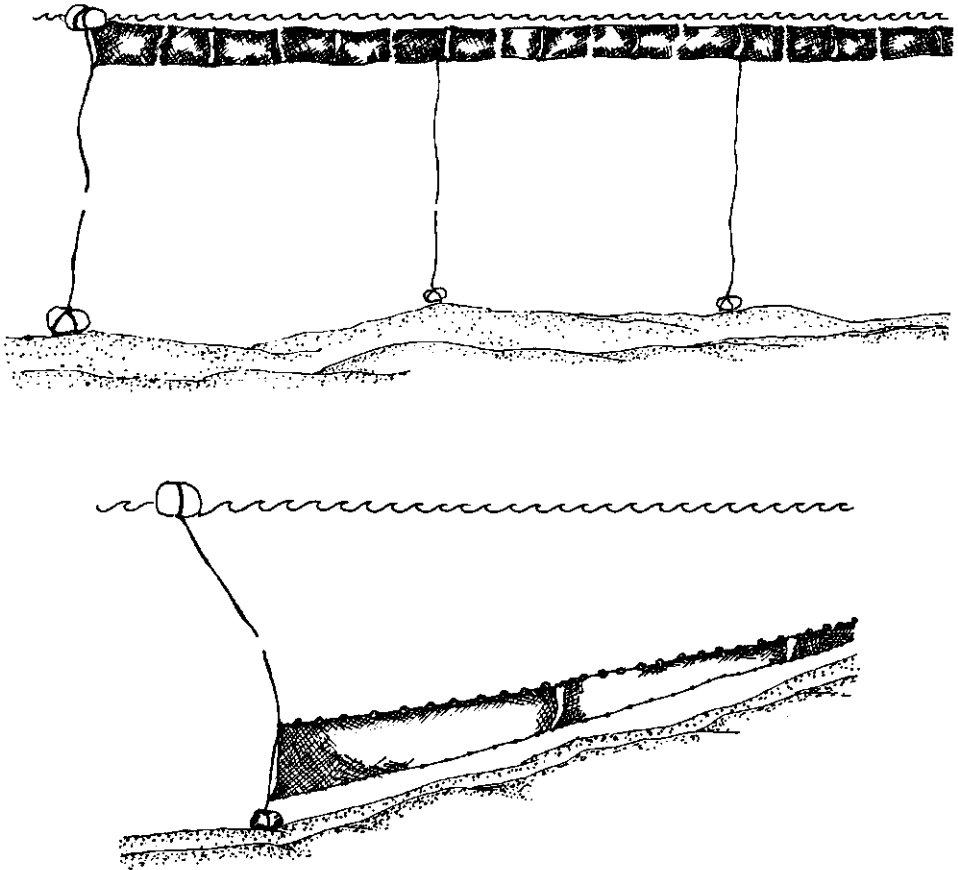

Figure 4.12 Floating gill net (top) and bottom set gill net (bottom) with anchoring weights and buoys.

Cleaning and maintenance

Cleaning a net entails removing fish (if the fish were not removed while hauling), removing debris and disentangling the net. If the net was put into boxes, cleaning is done while shifting the net into a second pair of boxes (*Figure 4.14*). After cleaning, a net can be dried and stored.

Nets should be stored in a dry place which is dark and well ventilated. Nets can be hung on wooden pins; if they were stored in boxes they can stay in the boxes. Nets should not be stacked on top of each other since this may cause rotting of the underlying nets. Great care should be taken to avoid damage by rodents. Contact with corrosive metal, *e.g.* iron nails, should be avoided.

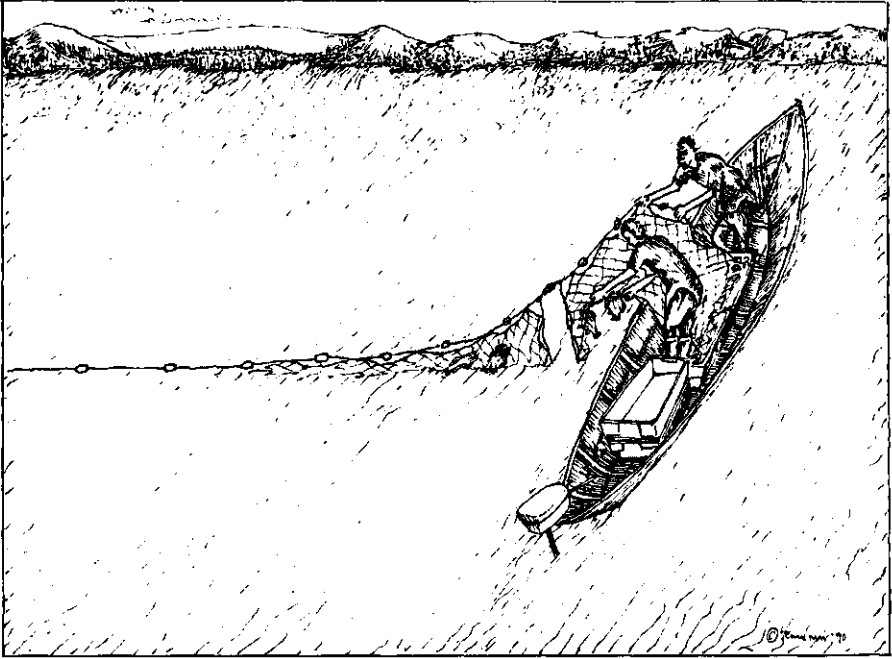

Figure 4.13 Hauling the net in boxes.

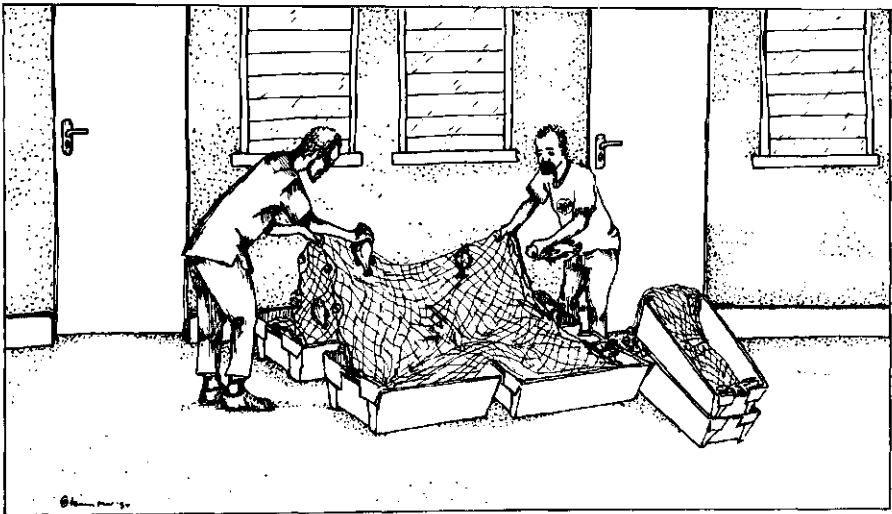

Figure 4.14 Cleaning the net.

The webbing of nets should be repaired regularly. Missing floats and sinkers should be replaced. If the lead line, the bottom line and gavel lines are worn out, they should be replaced, since they may break during hauling. Also, the mounting of the webbing should be checked and repaired as necessary.

4.4 Types and design of trawl gear

Trawls are active fishing gear. The net is dragged through the water by a fishing vessel during which process the fish are caught. Demersal fish can be caught with a bottom trawl, pelagic fishes with a midwater trawl or a surface trawl. The trawl can be pulled by one vessel or by two (pair trawling). A trawl net which is pulled through the water causes resistance and reduces the speed of the boat.

Bottom trawl or otter trawl

Bottom trawling has been practised at a small scale in Lake Victoria since the 1960s for research as well as for commercial purposes. Between boat and net are two steel cables, onto each of which an otter board is fixed. The otter boards keep the net open horizontally. To keep the net aperture open vertically the ground rope of the net is made to sink by adding pieces of chain to it, while some floats are attached to the head rope. The amount of chain and number of floats differs for every newly-designed net and must be established empirically. In Lake Victoria, relatively little weight is added to the ground rope because of the very soft bottom of the lake.

The otter boards of a bottom trawl can be attached to the net by one or two steel cables (*Figure 4.15*). For trawling on Lake Victoria the system with a single cable is preferred. This is because sunken papyrus islands easily get stuck between the cables if the other system is used. As a rule of thumb the weight of the otter boards in kilograms should be approximately equal to the horse power of the engine, although this is not true for work on Lake Victoria. At high altitudes (Lake Victoria is 1134 m asl) the power of the diesel engine is reduced, and the soft bottom of Lake Victoria causes extra resistance. Thus, on this lake, every unit of horsepower permits 0.65 kg of otter board weight. To prevent the otter boards from digging into the soft mud, a sledge can be made on the underside of each otter board (*Figure 4.16*). The otter boards used by R.V. Kiboko (105 hp) are rectangular: length 120 cm, height 60 cm, weight 68 kg. The point of application of the force is $\frac{2}{3}$ of the way along the board (*Figure 4.16*). The boards are made of local hardwood ('maninga').

The position in which otter boards move through the water is very important for their performance (*Figures 4.15, 4.16*). An indication of the position of the otter boards during trawling can be obtained from the sledge. The part which is in contact with the bottom will be polished after some hours of trawling. By connecting a short piece of chain to the lower part of the bridle, the position of the otter board can be adjusted easily (*Figures 4.15B,C*). The vertical net opening can be adjusted by means of the bridles on the trawl net (*Figures 4.15D,E*).

During a research program neither otter boards nor net design should be changed, as any alteration will lead to differences in efficiency which would make it impossible to make comparisons between catches.

The design of the net used by R.V. Kiboko is given in *Figure 4.17*. The design of the net used by a small trawler operated by a 20 or 25 hp outboard engine is given in *Figure 4.18*.

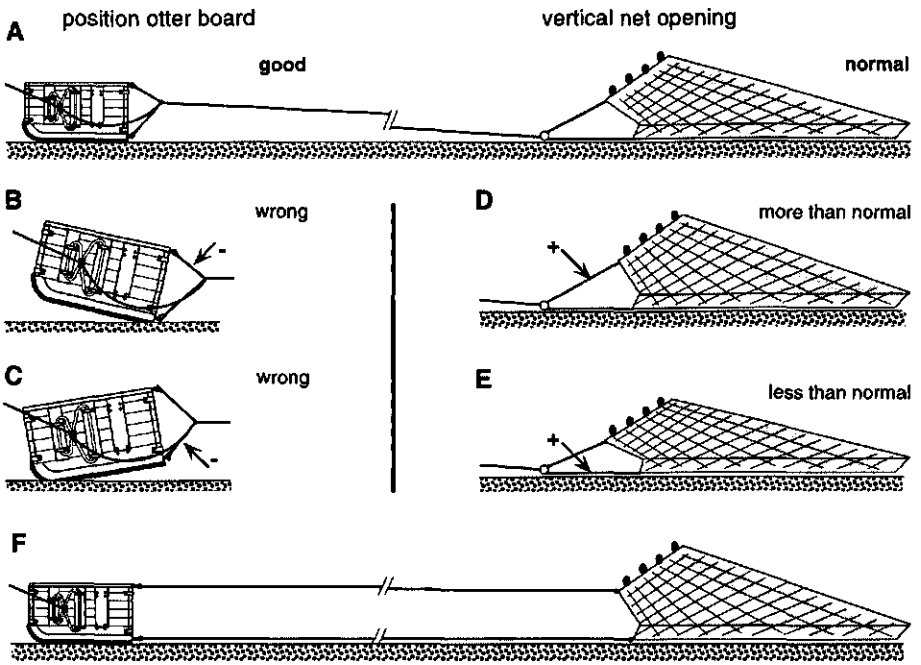

Figure 4.15 Trawl net and (right) otter board connected by a single cable. The proper position of the otter board and a normal vertical net opening are depicted (A). If the upper (B) or the lower line (C) of the otter board is too short the position will be wrong. The vertical net opening can be adjusted with the bridles on the net. Increasing the length of the upper line will result in a higher opening (D), increasing the length of the lower line in a lower opening (E). The use of two cables between the otter board and net (F) is not preferred in Lake Victoria because of the greater risk of entangling papyrus remains.

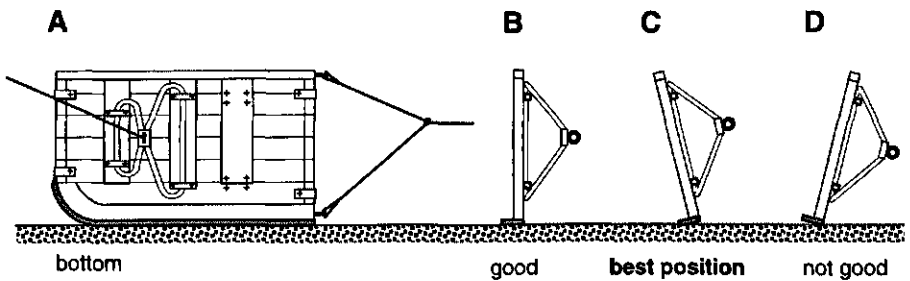

Figure 4.16 The right otter board of the R.V. Kiboko (105 hp) in lateral view (A) and in frontal view (B,C,D); the wrong (D), good (B) and best (C) positions of the otter board are indicated.

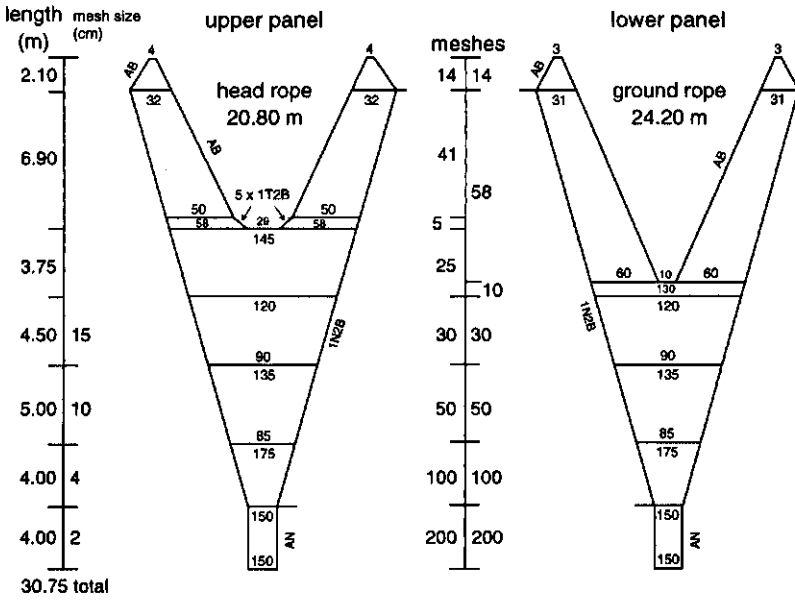

Figure 4.17 Design of the bottom trawl net of R.V. Kiboko (105 hp).

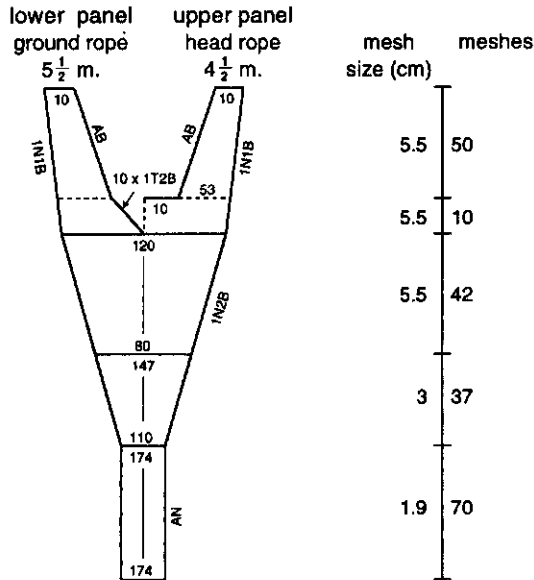

Figure 4.18 Design of the bottom trawl net of a small trawler, powered by a 25 hp outboard engine.

Pelagic trawl

Pelagic trawling was not attempted during the HEST/TAFIRI research; neither was it used commercially on Lake Victoria until 1990.

Surface trawl

Surface trawling was carried out during the HEST/TAFIRI research for *Rastrineobola* (Wanink 1991; Wanink *et al.* 1993) and, before the upsurge of the *Lates* population, for surface dwelling haplochromines (Goldschmidt *et al.* 1990; Witte *et al.* 1992b; Wanink *et al.* 1993). The net was pulled by a boat with a 25 hp outboard engine. Three nokalon buoys kept the head rope floating, while pieces of chain kept the ground rope down. The net was kept open horizontally by a 4.5 m floating beam (sisal pole) and a 4.5 m iron bar. Both the beam and the bar were attached to the cables at a distance of 4.75 m from the net (*Figure 4.19*). During fishing ca. 60 m of cable should be given and the boat should describe a curve while towing so that the net is outside the area disturbed by the boat.

Pair trawling

Pair trawling can be used for bottom, pelagic and surface trawls. The two equal vessels each pull one side of the net in a parallel course and keep the towed net open horizontally without otter boards. This technique overcomes some of the disadvantages to be found in other types of fishing, as double towing power is available, while power losses due to resistance of the otter boards are avoided. This makes it possible to increase trawling speed, to use a larger net, or to use boats with smaller engines. Another advantage is that, in contrast to otter board trawling, the vessels do not travel over the top of the fish which form the potential catch. Thus, at least in shallow water, the fish are not driven away from the area in front of the net. Instead, fish are herded together during pair trawling. Thus, the efficiency of a pair trawl may be high compared with that of an otter trawl. It should be realized, however, that two boats and two crews are needed for this fishing technique and that operation is more difficult. Pair trawling in Lake Victoria is done on an experimental commercial basis with vessels powered by 35 hp inboard engines.

4.5 Construction and maintenance of trawl gear

Netting material for trawl nets can be obtained in 3 ways:

- By the purchase of netting materials locally available.
- By the import of netting materials from abroad.
- By the import of ready made trawl nets from abroad.

Netting materials for trawl nets are only occasionally available in Tanzania. Proper steel cable and floats are very hard to obtain and so importation is necessary in most cases. The construction of a trawl net, from webbing to a finished net, will take experienced people several days, if the specifications of the net are clearly defined. The import of complete nets is much more expensive.

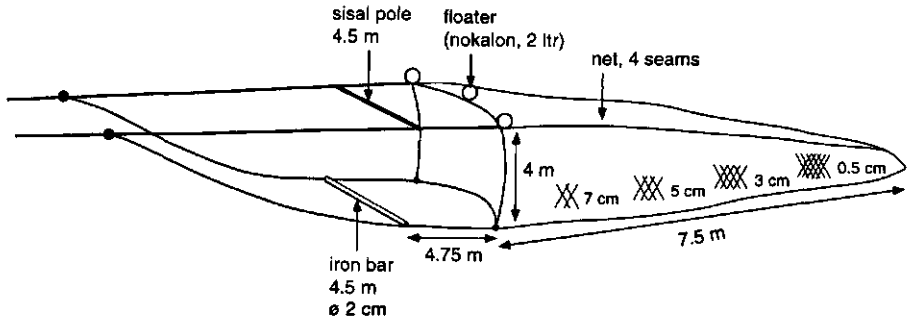

Figure 4.19 Surface trawl of a small trawler (powered by a 25 hp outboard engine). The net is kept open by a floating sisal pole and a sinking iron bar.

Steel cable

Steel cables with polyamide protection are used for the parts of cable which drag over the bottom during trawling (ground rope and bridle). Experience with R.V. Kiboko in Lake Victoria indicates that these cables last for approximately 1000 fishing hours (3 years fishing activities). Normal steel cable (10 mm diameter) is used to shoot and haul the net. Such cables lasted for 2000 fishing hours in Lake Victoria. The cables must be properly wound on the winch, to prevent them slipping off the drums. It is wise to put more cable on the drums than is strictly necessary, since it is then possible to remove the last 10-25 m when it becomes worn out, as this section is the most susceptible to wear and tear.

Otter boards

Wooden otter boards can be produced in Tanzania from materials available locally (see Section 4.4 and *Figure 4.16*). They last for several years if they are made of hardwood (not the local pine wood). When an otter board model from somewhere else is copied, it must be borne in mind that the weight of the wood may cause such an otter board to perform quite differently from the original design.

Floats

The best floats for trawling are nokalon balls. If handled with care they last a very long time. Two types were used during our surveys, those with a central hole and those with a separate plug which is screwed into the ball. The floats with a plug are easier to change and this may be advantageous.

Sinkers

Although special sinkers are available for trawl nets, on almost every trawl the ground rope is kept on the bottom with pieces of ordinary chain. They are easy to fix to the cable. The chain should be fixed to the ground rope over its whole length.

Netting material (webbing)

Most netting material is polyamide or polyamide with another synthetic fibre woven into the twine. Polyamide sinks in water, where it increases its length slightly. The material is sensitive to sunshine and oil, which causes twines to harden and to break. The net itself is a tapering bag with meshes which are large at the front and decreasing in size towards the rear. The net is tapered by reducing the meshes at the sides of the webbing. Different pieces of net with different mesh sizes are braided together by taking several meshes of the smaller webbing to one mesh of the larger. The last part of the net is called the codend and is usually covered with a thick large-meshed codend cover to facilitate lifting the codend on board. For specifications, construction and repairing of trawl nets refer to Garner (1962), Schärfe (1978) and Klust (1982).

4.6 Selectivity of trawls

Size-selectivity curves of trawl nets are usually S-shaped and can be assessed in two ways:

1. Alternate trawls. Nets with different codend mesh are used one after the other and the size structures of the catches are compared after a number of trawls. The difference between the mesh sizes of the two nets should be sufficiently large, so that the selection ranges of the two nets do not overlap too much (*Figure 4.20*).
2. Codend cover trawling. A fine mesh codend is fixed over the existing codend of a trawl net (codend cover). By measuring the fish which are retained by the codend and the codend cover it is possible to calculate what proportion per size category of fish is passing through the inner codend. The selection ranges of the codend and the codend cover should not overlap too much. In the Mwanza Gulf of Lake Victoria, this method has the disadvantage that debris frequently clogs the cover so that filtering of the water becomes obstructed and the inner net behaves differently from the situation where there is no codend cover.

The selectivity for *Lates* was assessed by the alternating trawling method. All trawl shots were made in a period of one week, in one specific area and at one depth, and only the codend of the trawl net was changed, keeping the front part of the net the same. A proportional relationship is assumed between the length of the fish caught with 50% efficiency (l_{50}) and the mesh size of the codend (m):

$$l_{50} = s \times m.$$

l_{50} was 20.0 cm TL for a codend of 6 cm (see Section 6.6 and *Figure 4.21*). Substitution in the equation resulted in $s = 3.33$. This means that the l_{50} for a codend of 2 cm, as used during the regular monitoring program, is 6.7 cm TL.

The selectivity curve for *Lates* is probably not perfectly S-shaped. With larger sizes of fish, the trawl efficiency decreases since some of the fish stay swimming in front of the trawl and large fish can sustain swimming for longer than small ones. It is thought that fish larger than 75 cm were under-represented in the R.V. Kiboko trawl catch. The R.V. Kiboko trawled with a speed of 3 nautical miles/hr (= 1.54 m/s).

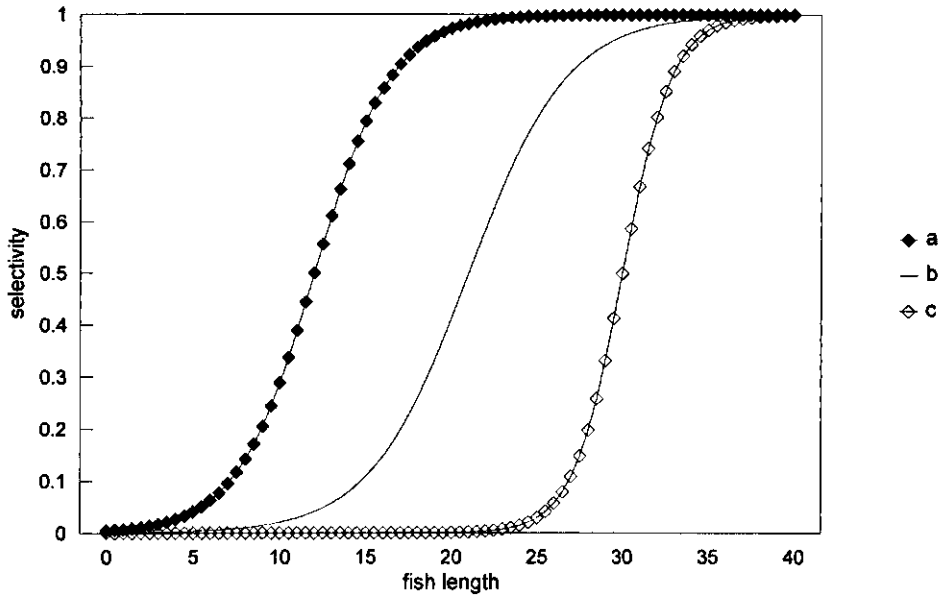

Figure 4.20 Theoretical trawl selectivity curves of codénds with mesh a, b and c. The selectivity curves of mesh a and c do not overlap. The selectivity curves of mesh a and c do overlap with the selectivity curve of mesh b.

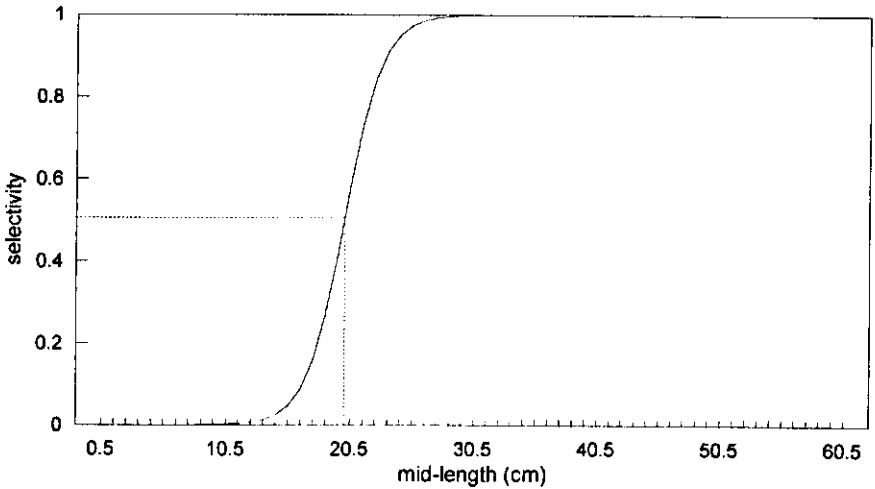

Figure 4.21 Selectivity curve to *Lates* of a 6 cm codend. $l_{50} = 20.0$ cm.

4.7 Operation of trawl nets

Although the actual trawl fishing is the responsibility of the crew of the fishing vessel, the fisheries biologist should know the fishing practice and supervise his data collection.

Shooting

When the net is shot it is important to observe the following guidelines:

- The boat must move straight forward.
- The codend line and the codend are thrown in the water first, and successively, the whole net will be pulled overboard by the codend itself.
- When the ground rope slips overboard, the head rope must be checked to see that it is hanging free from the ground rope. If not, the crew must correct this.
- When the net is overboard, the otter boards must be connected to the cables. When they are shot, the boat must make its desired speed (*Figures 4.22 and 4.23*).

The amount of cable given is roughly 4 times the fishing depth. The two steel cables on either side of the net must be set at exactly the same lengths. Differences as small as half a metre reduce the efficiency of the net. The cable length can be measured by marks spliced into the cables at regular intervals. When the desired cable length is given, fishing starts. Consequently, that moment is regarded as the beginning of the trawling time. Trawling should be done in a straight line wherever possible, but if the vessel meets an obstacle, turns should be made very gradually. If this is not possible (*e.g.* because the obstacle was not seen in time) trawling should be stopped and the net should be hauled.

Hauling

Hauling must be done quickly to prevent fish from escaping. During hauling the vessel should continue to move forward.

Trawl casualties

Sometimes an otter board sticks in the mud. In such a case all power acts on the line which holds the otter board which is stuck. This cable should be released, after which the free otter board and net can be secured. Next, an attempt can be made to pull the otter board out of the mud in the reverse direction. Sunken papyrus islands may cause obstruction of the net when they are caught. To remove papyrus from the net, hold the codend of the net and pull the net backwards onto the boat. In this way all trapped material will drop out. If this is not possible, all papyrus roots must be removed manually, while the net remains in the water.

Trawl maintenance

A fisheries biologist must check the nets regularly in order to keep the catching characteristics of the net constant so that catches can be compared with each other. A fisheries biologist must understand how nets are maintained in order to see if repairs are made correctly, and to judge if the properties of the net have changed.



Figure 4.22 Shooting/hauling the bottom trawl of a small, outboard engine powered trawler.

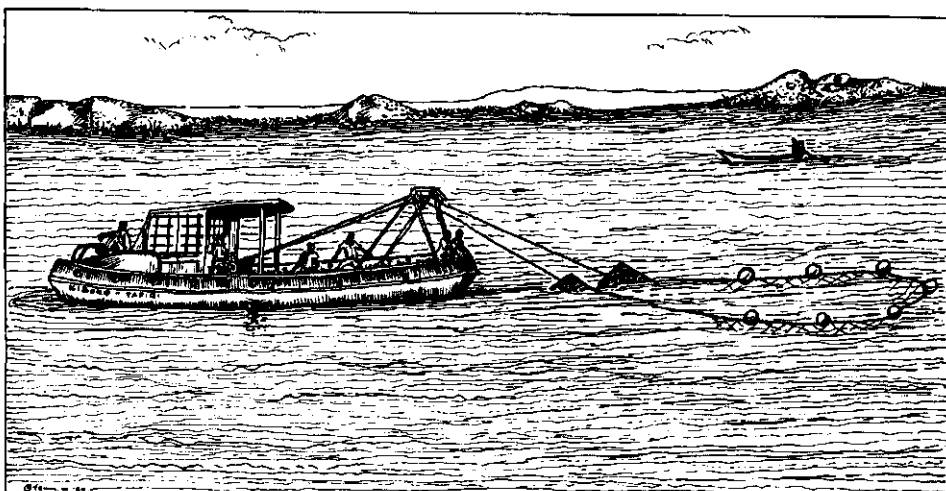

Figure 4.23 Shooting/hauling the net of the R.V. Kiboko.

A problem with trawl nets is that after some time the netting material moves to the central point of the ground and head rope. This must be adjusted regularly. Although polyamide nets are strong and do not decay when they are wet, it is advisable to dry them before they are stored.

On a trawler at least one spare trawl net and a variety of netting materials must be available. A number of floats, pieces of chain, and shackles should always be kept at hand. A trawl net on the R.V. Kiboko lasted for approximately 800 fishing hours.

4.8 Seines

Mosquito seines

Mosquito seines were not used for regular sampling during the HEST/TAFIRI research, but some experiments were made with a home made mosquito seine having a mesh size of 2 mm (stretched).

The operation took place from sandy beaches. A small seine of about 20 m length was set from a small open boat and was manned by 3 men on each wing. Mosquito seines can only be operated on fishing grounds with sandy bottoms, since too much debris makes hauling the nets impossible. The catches of the HEST/TAFIRI trials consisted of molluscs, haplochromines, juvenile *Rastrineobola* and debris. The selectivity of the mosquito seine was not assessed, but it is reasonable to assume that all fish in the catching area were caught, fry included. Catching area is defined as the area swept by the mosquito seine.

From these trials it can be concluded that mosquito seines are useful for sampling *Lates*, *Rastrineobola* and tilapiine juveniles on sandy-bottomed fishing grounds. It is recommended that a seine of 20 m length be used, with hauling lines of 20 m on each side.

Large beach seines

Large beach seines (length up to 1200 m) were not used during the HEST/TAFIRI research. However, observations on the catches of the larger commercial beach seines yielded useful information on the length-frequency distribution of the *Lates* stock. For details on operation and construction of larger beach seines see Section 2.7. The advantage of the larger beach seine compared with trawling is that the larger *Lates* do not escape. Thus, it gives a better reflection of the actual size structure of the population. Constraints on the use of beach seines for sampling are the time needed for hauling (up to 8 hours for beach seines of 1200 m), the man power needed (up to 40 persons for beach seines of 1200 m) and the limited sampling area (sandy beaches only). For research purposes, beach seines with a length of 200 m manned by 8 people can be used with hauling lines 200 m long.

4.9 Selectivity of seines

The selectivity of a beach seine net is thought to resemble the selectivity of a trawl net. The 50% retention length is characterized concordantly:

$$l_{50} = s \times m$$

wherein m refers to the mesh size in the codend and s is a constant.

4.10 Fishing with light

Artisanal fishermen use several types of gear in combination with light attraction to catch *Rastrineobola* (see Section 2.8). The four main types of gear are beach seines, scoop nets, lift nets and encircling nets.

Beach seining for *Rastrineobola* in combination with light is not recommended for research purposes, because of the susceptibility of the fishing operation to weather conditions and because of the low efficiency compared with the other fishing methods.

The lift net is by far the most efficient type of fishing gear for *Rastrineobola* (see Section 2.8). However, four skilled fishermen are needed for sampling and material input requirements are high. Two specially equipped boats (one catamaran), a net, an outboard engine of at least 7 hp and some 3 pressure lamps are needed.

Scoop netting and fishing with an encircling net are probably the most suitable fishing methods for research with light fishing. Except for the net, standard equipment can be used. Scoop netting can be done with a team of only 2 men. A small boat (about 5 m length) and several lamps are needed. An outboard engine is useful if sampling is to take place on distant fishing grounds. Artisanal fishermen concentrate the lamps before scooping, but for research it is better to anchor the lamps and to collect the fish concentrated under each lamp. In that way no fish are lost while concentrating the lamps. According to the fishermen, less fish are lost while hauling with the encircling net than with scoop nets, and therefore this gear is more suitable for research. However, manpower requirements are higher. About 5 men are needed for hauling the net (Figure 2.36), while a scoop net is manned by just one person (Figure 2.32). Further details on the operation and construction of gear can be found in Section 2.8. It is recommended that smaller meshed gear be used than that used by artisanal fishermen. Trials should reveal the smallest mesh size at which hauling the net does not cause too much drag.

4.11 Selectivity of fishery with light

Fishing with a lift net in Lake Victoria is done in combination with a lamp to attract the *Rastrineobola*. This means that light, as a factor, interferes with the selectivity of the lift nets related to mesh size. Some evidence was found for a diurnal, vertical migration pattern of adult and juvenile *Rastrineobola* (Figure 2.5; Wanink 1988, 1992). The juveniles move towards the bottom at night, and the adults move towards the surface. This could imply that adult *Rastrineobola* are more easily attracted to the lamp than the juveniles. The mesh selectivity is probably similar to that of a trawl net.

4.12 Sampling with hook and line

During the HEST/TAFIRI research, angling was carried out only to collect haplochromines in rocky habitats for taxonomic and ecological research (van Oijen *et al.* 1981; Witte *et al.* 1992b). For this purpose hooks smaller than no. 10 were baited with earth worms. Little is known about the selectivity of hook and line fishing methods. Most probably the selection curve is unimodal, and dependent on hook size (Ralston 1990). Since not much is known of the selectivity, and since the efficiency varies highly with the skill of the fisherman, one should be careful in interpreting data obtained in this way.

4.13 Construction and maintenance of large research vessels

Steel trawlers are built at several places around the lake. In Mwanza steel boats are built at the Pasiansi shipyard. In May 1990, a 14 m fishing vessel from this yard cost approximately 7 000 000.00 Tsh excluding gear (1 US\$ = 198 Tsh).

In Port Bell (Uganda), Kisumu (Kenya) and Mwanza (Tanzania) the railway companies each run a slipway or drydock.

For Lake Victoria, a double shine above a round framed hull is favoured as this makes the vessel more stable under severe weather conditions. A high front, at least 1.75 m above the waterline, is required because of high waves on the lake. It is advisable to give the steering house a double roof so that it does not get too hot inside. A trawler for research purposes needs some special features:

- As a research vessel will go on overnight fishing trips some facilities for the comfort of the crew, like a toilet and enough room to sleep, are required.
- For laboratory work, writing *etc.* it is very useful to have a work-bench with a sink and running water inside the steering house, behind a large window to provide light.
- A large working deck is favoured, to facilitate the sorting and storing of fish. If possible, a large fixed fish-measuring table should be built on deck with a working height of 1.10 m.
- There should be a 220 V AC and a 12 V DC power source available.

Boats are expensive to run. Proper maintenance prevents damage and helps to reduce the running costs. Also, repairs may interrupt the sampling program. Since researchers have the final responsibility for the research program they should know when repairs must be made and they should know during which periods the boat will be serviced.

Tidiness

It is important to avoid dirt and pests like cockroaches and rats. Cockroaches can be avoided by storing foodstuffs in closed tins and by cleanliness inside the boat. Rats usually enter boats when they are moored alongside jetties. Rats can cause considerable damage not only to electric wiring, echosounders, radars and other delicate items, but also to data sheets. Eradication of rats on board is imperative.

Hull maintenance

For boats operating on Lake Victoria, hull maintenance does not take as much time and money as it does for ships operating on sea water. Zinc anodes last for decades, while rust is hardly a problem. The main concern is dirty water standing inside the boat. Docking the boat once a year for cleaning and painting gives the hull a very long life. Cleaning and painting a boat of about 15 m length takes three days if the hull is cleaned immediately on the day of docking (wet cleaning is easier than dry cleaning). Painting will take a day, while drying for at least 24 hours is recommended. It is advisable to involve the crew of the boat in the maintenance.

Fuel

Fuel supply is a major concern while operating a vessel. In cases where diesel supply is irregular it is important to have a diesel storage tank available. These tanks can best be placed in the open air rather than underground in order that leakages may be detected

and also to make cleaning easier. Diesel is often contaminated due to transport in tanks which carry all kinds of different liquids, and in addition condensation of moisture from the air inside these tanks may cause water to enter the fuel tank of the vessel. For this reason it is important to install a prefilter (water separator) in the engine room of a vessel with a glass, which must be checked daily and cleaned whenever dirt is seen.

Engine oils should preferably be bought in single-use packages to avoid contamination with sand and other materials.

Daily maintenance

Within the daily maintenance routine, a check of the water-cooling system and a greasing of the main shaft should be included. Each week, every turning object such as the winch and cable blocks should be greased. After starting the engine, one should check that water is not coming out of the exhaust and also that the electrical system is in good order. After work, the batteries should be disconnected from the engine and other equipment, to avoid deterioration of the batteries.

A maintenance log book should be kept on board. In this book the daily engine working hours must be noted as well as oil changes, filter replacements *etc.* With this book (a responsibility for the skipper), a quick diagnosis can be facilitated in case of problems.

Mooring

It is preferable that a fishing vessel in Lake Victoria is not moored ashore or at a jetty to avoid opportunistic theft. It is better to anchor the vessel a little way offshore. A quantity of heavy scrap iron (engine blocks) tied with a heavy iron chain can serve as a permanent anchoring point. It is important to check the condition of the chain and steel cable once or twice a year. A special danger in Lake Victoria is the presence of floating papyrus islands. When the anchored boat is in the drift path of a big island, it is best to move the boat temporarily, as it will be almost impossible for a single steel cable and sinker to hold both the boat and the floating island. For this reason it is important that the skipper or a crew member is always nearby.

Crew

It is important that a permanent, disciplined crew is responsible for the boat and that neither an improvised crew nor alternating crew members are appointed. It is important that crew members are familiar with all activities on board so that the duties of an absent crew member can easily be taken over by others. This is a particularly good practice if the crew of a research vessel is involved in the collection of scientific data during fishing trips. It is essential that the crew knows what is to be done on board and why. The skipper should note exactly in his fishing log book when the trawl is shot and hauled and how much fish is caught. After some training, sub-sampling and measuring of the catch can be done satisfactorily by the crew. They can also perform standard measurements, like temperature and oxygen recordings, Secchi disc readings, water sampling and zooplankton monitoring. This greatly facilitates the work of the scientific staff, and may also give the crew an idea of the purpose of the fishing trip and increase their involvement and responsibility. The HEST/TAFIRI experience concerning this aspect was very satisfying.

4.14 Types, construction and maintenance of small open boats

Canoes and other small vessels have some advantages over large research vessels. They are cheaper in use, they are easily manoeuvrable and they can be used in shallow areas. Of course, there are also some disadvantages. It is not possible to use large fishing gear, the radius of action is limited, and there is no working space.

Small vessels can be made of wood, steel, synthetic materials and aluminium. Wooden boats are relatively cheap and can be made locally. In May 1990 a wooden canoe, as most commonly used for gill netting, was priced at 50 000 Tsh while a comparable design in steel cost 350 000 Tsh (1 US\$ = 198 Tsh). Wooden boats require more maintenance than other types. They are normally made watertight by hammering cotton strings into the seams. This has to be done several times a year as the cotton decays very quickly in the water. Wooden boats which stay in the water are often affected by the larvae of an insect (boring mayfly), although painting helps to prevent this damage. A wooden boat lasts for approximately 12 years if properly maintained. Steel boats require less maintenance than wooden ones, as steel has only to be painted once a year to prevent corrosion. Steel boats can be built locally (see Section 4.13), but boats of aluminium and synthetic materials are not currently produced in Tanzania. Aluminium and plastic boats are light and easy to manoeuvre, and they are about the same price as steel boats. A disadvantage of aluminium is that it is not easy to repair and there are few workshops in Tanzania where aluminium boats can be repaired. There are several types of plastic boats, but we only discuss fibreglass boats here. Fibreglass is not as strong as aluminium, but it can be repaired easily. Fibreglass requires a minimum of maintenance; if a fibreglass boat is not used for some time it is best to store it in a dry place, out of the sun, since ultraviolet light causes fibreglass to deteriorate.

A small open boat for research purposes should comply with some special requirements:

- The bottom of the boat should be flat so that equipment can easily be placed on the floor.
- The width of the boat should be such that fish boxes can easily be placed in the boat.
- There should be enough floating capacity.
- The boards of the boat should be smooth and without any projections behind which the nets can hook when they are set or hauled.
- There should be a place to keep papers and equipment free from water.
- If the boat is to be used overnight there should be enough space for at least two persons to sleep in it.
- There should be a ring or a bar in the front of the boat so that it can be pulled by another vessel.

At the Mwanza TAFIRI Centre, fibreglass and steel canoes were used for several years. The dimensions of the steel canoes, which were made locally, were length 850 cm, beam 130 cm and height 60 cm.

Every boat must be registered at the regional fisheries office, where it will be given a registration number. It is important to burn this number into the wood or melt it into the fibreglass, whilst it can be welded onto a steel boat. This is not only for the convenience of the fisheries authorities but may also be useful in case of theft.

4.15 Engines

The most commonly used engines are diesel and petrol. Boat engines exist in two principal forms: inboard and outboard. In general, inboard engines use diesel and outboard engines use petrol. The advantages and disadvantages of diesel-powered inboard engines and petrol-powered outboard engines are listed by Cole & Rogers (1982, 1985) and cited here:

Advantages of diesel-powered inboard engines:

1. Diesel is generally cheaper than petrol.
2. Fuel consumption is low.
3. They are not easy to steal.
4. They require relatively little maintenance.
5. They are durable and very reliable for long working times.
6. Spare parts are sometimes interchangeable with non-marine engines of the same brand.

Disadvantages of diesel-powered inboard engines:

1. Engines are voluminous and heavy.
2. They are not easy to switch from one boat to another.
3. Diesel engines are more expensive than petrol engines.
4. Repairs require specialised technicians.
5. Diesel oil is not as easily available as petrol.
6. They are not easily transported to a workshop for major repairs.

Advantages of petrol powered outboard engines:

1. The engines are relatively small.
2. They are easy to switch from one boat to another.
3. They are generally cheaper to buy.
4. Fuel is available almost everywhere.
5. Technical know-how is more general than for diesel engines.
6. They can be mounted on almost every type of traditional fishing boat.
7. No propeller shaft alignment problems.

Disadvantages of petrol powered outboard engines:

1. Petrol is more expensive than diesel.
2. There is an enhanced danger of fire.
3. Fuel consumption increases tremendously with power output.
4. They are easy to steal.
5. Lubrication ratios differ between engines and should not be neglected.
6. They are less reliable and frequently break down.
7. They have short working lives.
8. Spare parts are relatively expensive.
9. Engines above 20 hp are heavy.

Diesel engines differ in arrangement of the cylinders: in-line, v-type, horizontally opposed and radial. In general the in-line type is the easiest to maintain and is therefore preferable. The choice of engine brand depends largely on what is locally available and whether there are spare parts available. For example marine Scania engines resemble the Scania truck engines, which are abundant in Tanzania, and many spare parts are the same.

Outboard engines are usually produced in two forms, long and short tailed. A long tailed engine is approximately 30 cm longer than a short tailed one, so that the propeller goes deeper into the water, thus improving the efficiency of the engine. A short tailed engine is used in more shallow areas. For Lake Victoria a long tailed engine is favoured.

Engines perform below their nominal capacity if they are operated at high altitudes. For Lake Victoria, at 1134 m asl, a 100 hp diesel engine develops only 85 hp. It is particularly important to consider this in the case of trawler engines. The shape and tonnage of the trawler, the type of propeller and the shaft connections finally determine the power of a trawler.

To prevent damage to the propeller it is advisable to construct a steel ring around the propeller. Since it is possible that the mounting of outboard engines can break or slip, every outboard engine must be connected with a rope or small chain to the boat. If an engine drops into the water while running, the engine can be retrieved by the line. After such an incident, the whole fuel system must be cleaned as soon as possible. This can be done by removing the spark plugs and pouring clean petrol straight into the cylinders (explosion rooms), while the propeller is engaged and moved around by hand.

If an outboard engine is stored for some time, the engine must be kept upright and mounted on a stool. In this way oil leakage is avoided, while water can leak out of the cooling system.