

# **Physiological functions of phytochromes in tomato: a study using photomorphogenic mutants**

Fysiologische functies van fytochromen in tomaat:  
een studie gebruikmakend van fotomorfogenetische mutanten

**Promotor:** dr. W.J. Vredenberg  
hoogleraar in de plantenfysiologie  
met bijzondere aandacht voor de fysische aspecten

**Co-promotor:** dr. R.E. Kendrick  
universitair hoofddocent bij de vakgroep Plantenfysiologie

PN02701, 2198

Leonardus Hubertus Joseph Kerckhoffs

**Physiological functions of phytochromes in tomato:  
a study using photomorphogenic mutants**

**Proefschrift**

ter verkrijging van de graad van doctor  
op gezag van de rector magnificus  
van de Landbouwniversiteit Wageningen,  
dr. C.M. Karssen,  
in het openbaar te verdedigen  
op vrijdag 20 december 1996  
des namiddags te vier uur in de Aula.

ISBN 931402

This research was supported by a grant from the Foundation for Life Sciences (SLW), formerly the Foundation for Biological Research (BION), which is subsidized by the Netherlands Organization for Scientific Research (NWO).

Cover design: Alex B. Haasdijk

BIBLIOTHEEK  
LANDBOUWUNIVERSITEIT  
WAGENINGEN

CIP-data Koninklijke Bibliotheek, Den Haag

Kerckhoffs, L.H.J.

Physiological functions of phytochromes in tomato: a study using photomorphogenic mutants / L.H.J. Kerckhoffs. - [S.l. : s.n.]

Thesis Wageningen. - With ref. - with summary in Dutch.

ISBN 90-5485-627-0

Subject headings: photomorphogenesis / phytochrome / mutants / plant physiology / *Lycopersicon esculentum*

## Stellingen

1. De far-red light-insensitive (*fri*) en temporarily red light-insensitive (*tri*) mutanten in tomaat zijn respectievelijk fytochroom A en fytochroom B1 mutanten.
2. In monochromatisch rood licht fungeren zowel fytochroom A als B1 als hoofdrolspelers in de anthocyaanbiosynthese in zaailingen van tomaat, terwijl micro-injectie studies alleen een rol voor fytochroom A toekennen.  
Dit proefschrift.  
Kunkel *et al.* (1996). *Plant J.* 10: 625-636.
3. Het eerder afbreken van het ontwikkelingsprogramma in de *hp-1* en *hp-2* mutanten in tomaat onder continu verrood licht, in vergelijking met het wildtype, is een uitermate interessant verschijnsel, mede gezien het feit dat ook de fenotypisch gelijkende transgene tomaat waarin het *PHYA3* van haver tot overexpressie is gebracht onder deze omstandigheden een identieke respons vertoont.  
Dit proefschrift.
4. In de schaduwmiijdende reactie hebben fytochroom B1 en B2 zeer waarschijnlijk sterk overlappende functies.  
Dit proefschrift.
5. Opbrengstderving in commerciële gewassen door ongewenste schaduwmiijdende reacties als gevolg van een hoge plantdichtheid kunnen worden tegengegaan door het via biotechnologische weg tot overexpressie brengen van fytochroom.  
Robson *et al.* (1996). *Nat. Biotechnol.* 14: 995-998.
6. De reorganisatie van LUW-DLO tot een Kenniscentrum Wageningen is nadelig voor de positie van het eerste-fase onderwijs.
7. De exportheffing van de EU in de winter 1995/1996 op tarwe, om daarmee de tarweprijs binnen de EU lager te maken dan die op de wereldmarkt, wekt de indruk dat de liberalisering van markten alleen gehanteerd wordt, zolang het gunstig is voor de consument.
8. De grootste uitdaging van alle genoomprojecten is het vinden van de precieze biologische functies van alle beschreven genen.
9. De beoordeling van wetenschappelijke manuscripten en onderzoeksvorstellen door gelijken (het zgn. *peer review*) leidt vaak tot het beoefenen van wetenschap met voorkennis.
10. Wetenschappelijke creativiteit komt vaak pas na zessen.

11. Het is mogelijk géén toeval dat het opheffen van de leerstoel graslandkunde aan de LUW samenvalt met de deplorabele toestand van de grasmat in de Amsterdam Arena.
12. Door geruchtmakende uitspraken van mgr. Muskens, zoals het toestaan dat armen een brood mogen stelen, is de armoede in Nederland op de politieke agenda gezet.
13. Het inbraakbeveiligingssysteem van het Botanisch Centrum is uitermate geschikt om een circadiaan ritme te handhaven tijdens het schrijven van een proefschrift.
14. In Maastricht duurt de kortste dag een half uur langer dan die in Groningen.
15. "Mij lijkt slechts één ding zeker: mensen die beweren dat mensen die van dieren houden niet van mensen houden, houden niet van mensen die van dieren houden".  
Koos van Zomeren (1995). "Wat wil de koe".
16. Het veelvuldig voorkomen van de naam Kerckhoffs op lijsten van complicen en gehangenen van de gevreesde Bokkenrijders-bende (tweede helft 18e eeuw) maakt de naam Kerckhoffs berucht.  
J.H.H. Kerckhoffs, emeritus-pastoor (1995). "300 jaar Kerckhoffs, een familie-kroniek".

Stellingen behorende bij het proefschrift "Physiological functions of phytochromes in tomato: a study using photomorphogenic mutants".

Huib Kerckhoffs,  
Wageningen, 20 december 1996.

*"Of the many intricate and beautiful control mechanisms living organisms have evolved to optimize their survival in a variable and changing environment, none is more elegant than the phytochrome system of plants"*

Warren L. Butler, a pioneer in the study of phytochrome



Voor Pien

# Dankwoord

Dit proefschrift is het resultaat van een aantal jaren onderzoek aan fytochroom in tomaat waaraan ik met groot plezier en voldoening heb gewerkt. Hierbij zijn natuurlijk veel mensen betrokken geweest. Een aantal van hen wil ik daarom graag speciaal bedanken in dit voorwoord.

Als eerste natuurlijk mijn directe begeleider Dick Kendrick. Zijn inbreng kende letterlijk geen grenzen en ik ben hem zeer veel dank verschuldigd voor alle support, verhelderende discussies en creatieve interpretaties van de verkregen resultaten. Dick is behalve in Wageningen ook in Japan werkzaam. Hij heeft mij daarom ook steeds in de gelegenheid gesteld om bepaalde lijnen van onderzoek in laboratoria in diverse buitenlandse landen uit te voeren, oa. in zijn eigen lab in Japan. Daarnaast stimuleerde Dick ook het bijwonen van congressen en ik heb dan ook vele internationale congressen kunnen bezoeken om over eigen onderzoek te rapporteren, maar vooral ook om ideeën uit te wisselen en andere mensen te ontmoeten. Ook Chris Kendrick was zeer behulpzaam met het redigeren van teksten en handige computertips. Jullie gastvrijheid in Bennekom was ongekend en de deur stond altijd open. Ik wil jullie allebei bijzonder bedanken voor jullie grote inbreng, maar ook voor de gezellige tijd.

Mariëlle Schreuder die als analist werkzaam is in onze groep, is ook zeer betrokken geweest bij dit onderzoek. De beschreven thresholdbox-proeven zijn door jou met grote zorgvuldigheid en precisie uitgevoerd. Daarnaast zorgde jij ook voor de voortgang van het onderzoek en begeleiding van onze studenten in Wageningen wanneer Dick en ik in het buitenland verbleven. Ook was jouw inbreng in de layout voor dit proefschrift groot omdat je met veel toewijding de figuren gemaakt hebt met SigmaPlot. Mariëlle, enorm bedankt!

Uiteraard ook mijn promotor Wim Vredenberg voor het mede-initiëren van dit project en jouw continue interesse. Hoewel jij ons behoorlijk vrij liet, was toch ook de bijdrage in de laatste fase leerzaam en nuttig. Bedankt voor het zorgvuldig doornemen van de diverse manuscripten.

Met Maarten Koornneef en Ageeth van Tuinen (vakgroep Erfelijkheidsleer) is zeer intensief samengewerkt. Jullie waren de hofleveranciers van de gebruikte mutanten en het was een voorrecht om er mee te werken. Samen met Ageeth zijn ook de eerste fysiologische karakterisering van de beschreven mutanten. We zijn beiden zo ongeveer gelijk begonnen, jij bij Maarten en ik bij Dick en het is een voorbeeld van hoe interdisciplinair onderzoek elkaar aanvult en versterkt. Ook Corrie Hanhart voor het vele werk in de vermeerderings- en kruisingsprogramma's van de mutanten.

De studenten die in het kader van een afstudeervak of stage een belangrijke bijdrage hebben geleverd: allereerst Natasja de Groot (studente Biologie, LUW) die de fysiologische karakterisering van de 'high-pigment'-achtige mutanten heeft



uitgevoerd, waarvan de resultaten in Hoofdstuk 5 zijn opgenomen. Je hebt met veel inzet en zorg de proeven uitgevoerd. Rob van der Valk (student Tuinbouw, LUW) heeft de eerste karakterisering van diverse mutanten op vruchtniveau uitgevoerd (Hoofdstuk 6) en ondanks vele moeilijkheden in het vinden van de juiste extractie-methode, ben je er toch goed uitgekomen. Michel Sengers (stagiaire, Agrarische Hogeschool Den Bosch), die diverse mutanten heeft gevolgd met de groeimeter (Hoofdstuk 8). Ondanks de relatief korte tijd die jij tot je beschikking had, heb jij zelfs nog een begin gemaakt om een automatisch watergeefstelsel te ontwikkelen. Ondanks dat ik een deel van de tijd in Japan verbleef, konden we via email goed met elkaar communiceren.

De planten die gebruikt werden voor de groeimeter en andere proeven werden door Leen Peterse opgekweekt en verzorgd. Aart van Ommeren en Henk Melissen hielpen mee met de vermeerdering van de tomaten bij ons in de kas.

Jan van Kreel, Ruth van der Laan en Ben van der Swaluw voor alle technische hand- en spandiensten waar nodig. Altijd werden verzoeken gehonoreerd en snel uitgevoerd. Willem Tonk voor alle hulp bij het verder ontwikkelen van de groeimeter, met name het realiseren van de fotosynthetische belichtingen, het tunen en opnieuw uitlijnen van de 'zwevende nullen', en vele andere technische verbeteringen die zijn ingebracht. In de meest eindeloze discussies bij jou thuis ontstonden toch ook vaak heldere ideeën en oplossingen. Rienk Bouma, Leo Herben en Chris Massop voor de ondersteuning op het gebied van de computers en software. Tot op het laatste moment heb ik kunnen rekenen op hulp waar dat nodig was. Allemaal zeer bedankt voor alle hulp en gezellige samenwerking.

De layout van dit proefschrift is verzorgd in nauwe samenwerking met Alex Haasdijk van de vakgroep Plantencytologie en -morfologie (PCM). Samen met Paul van Snippenburg zijn alle figuren in lijn opgenomen en de vele foto's en blots gerasterd. Met name de door jullie gemaakte technische tekeningen van de diverse ontwerpen van Willem Tonk, waarvan enkele door hemzelf voorbereid waren, zijn mijns inziens zeer fraai en verhelderend. Vakwerk! en bedankt voor de gastvrijheid bij jullie op de tekenkamer. Verder wil ik ook de afdeling Mediaservice in het Biotechnion en Siep Massalt (PCM) bedanken voor het fotowerk.

Mijn aanstelling begon op de vakgroep Plantenfysiologisch Onderzoek, gehuisvest in het imposante 'Schip van Blauw'. Later zijn we opgegaan in de vakgroep Plantenfysiologie en kwamen we in 'De Banaan' terecht: een architectonisch hoogstandje van deze tijd. Deze verhuizing had behoorlijk veel voeten in de aarde, o.a. de hele groeimeteropstelling moest worden ontmanteld en opnieuw worden opgebouwd. De verhuizing schiep echter ook nieuwe mogelijkheden: we kregen de beschikking over up-to-date dark-room faciliteiten en er werden nieuwe belichtingskasten gebouwd in samenwerking met Ad Veenendaal en Rinus van Ginkel (TFDL, Wageningen) naar ontwerp van Willem Tonk. Voor de belichtingen hadden we plezierige contacten met Sylvania BioSystems in Wageningen: Rien van Lieburg en Willem Verbeek bedankt voor de belangstelling in ons onderzoek. Naast de vele tegenslagen met de groeimeter tijdens de PFO-periode (problemen met koelwater, etc) kon de groeimeter nu dan goed

functioneren, wat leidde tot publiceerbare resultaten. Naast eerder genoemde mensen betrokken bij de groeimeter, wil ik ook Dirk Ruyter bedanken voor het schrijven van aanvullende software om de gigantische data-sets te verwerken en te reduceren tot handzame en verantwoorde figuren.

Verder de collega's van binnen en buiten de vakgroep Plantenfysiologie voor hun behulpzaamheid, prettige samenwerking en werksfeer en alle anderen die hebben bijgedragen aan het onderzoek, maar tevergeefs zoeken naar hun persoonlijke dankuwel (en ik dus per ongeluk vergeten ben) wil ik hierbij ook bedanken.

A significant part of the research described in this thesis was performed abroad. I would like to thank Harry Smith, Garry Whitelam and Mike Jackson (University of Leicester, UK) for the facilities used in the supplementary daytime far-red light experiments, which were performed in the Botanical Gardens, several miles from the department. Further I would like to thank the people from lab 322 (Paul Robson and Emma Johnson) and Ian Gilbert for their support. Special thanks for all people I worked with in the Laboratory of Photoperception and Signal Transduction, Frontier Research Program, RIKEN, Japan especially: Akira Nagatani, Enrique López-Juez, Ken-Ichi Tomizawa, Koji Sakamoto, Haruko Okomoto, Matthew Terry, Jim Weller, Andrzej Tretyn, Chii-Gong Tong, Christian Haas and Stan Roux. Also I would like to express my gratitude towards Hiroko Kobayashi and Mitsue Ishikawa for all their help in finding my way in and around RIKEN. It was really a pleasure to work with such an international group of people and I enjoyed my time there both scientifically and socially very much. Also Prof. N. Takahashi and his wife for their interest in my work. Finally I would like to thank Lee Pratt and Marie-Michèle Cordonnier-Pratt (University of Georgia, GA, USA) for their warm hospitality and being valued teachers. Also special thanks to Bernie Hauser for sharing his expertise (including home-brewery tips). I'm really looking forward to come back to Athens early next year and join Lee's research group as a post-doc.

De vele discussies tijdens de befaamde vrijdagmiddagborrels ("sorry, Jet!") in 'Loburg' en later in 'de Zaaier', bij insiders bekend als het "Het Instituut", hebben zeer zeker bijgedragen tot de kwaliteit van dit proefschrift. Al was het alleen maar om alle ergerenissen en frustaties weer eens van je af te praten, maar ook om de (wetenschappelijke) zoekers weer eens te richten en de vrijheidsgraden weer aan te vullen. De vaste kern, Egbert, Koop, Connie en Jan, maar ook de vele anderen, bedankt!. Verder natuurlijk ook de andere vrienden/vriendinnen bedankt voor jullie belangstelling. De diverse bezoeken samen met Willem Straatman aan de nog echt ouderwetse (ze bestaan nog!) en dito gezellige Jordaneze cafés wil ik ook hier noemen.

Er zijn vele congressen bezocht in binnen- en buitenland en ik ben de vakgroep maar vooral de Nederlandse Organisatie voor Wetenschappelijk Onderzoek (NWO) dankbaar voor de financiële ondersteuning hierbij. De coulante houding van NWO om mij negen maanden verlenging te verlenen in verband met de vertraging opgelopen door een ziekte van Pfeiffer (juist toen ik startte) en in verband met de eerder genoemde verhuizing wil ik hierbij ook noemen. Verder wil

ik NWO hierbij ook bedanken voor het honoreren van het vervolgproject dat ik heb geschreven en dat aansluitend zal worden uitgevoerd in de USA.

Ik draag het proefschrift op aan mijn ouders, met name voor hun niet aflatende belangstelling en steun voor alles wat mij bezig hield in Wageningen. Ik heb dit bijzonder gewaardeerd. Het onderzoek stond soms wel heel erg ver af van jullie dagelijkse praktijk en de daar bijbehorende gewassen. Maar ook daar spelen fytochromen een belangrijk regulerende rol, ik weet het nu zeker! Natuurlijk ook Petra, Alex, Anne, Kim, Marc en Marjon, bedankt voor jullie continue interesse.

Als laatste maar zeker niet de minste wil ik Jet bedanken, je bent fantastisch en ik heb zeer veel bewondering voor jou. Ook Pien bedankt voor alle afleiding, ook jij bent fantastisch! Ik heb ontzettend veel zin om nu niet eens alleen, maar gezellig met jullie naar het buitenland te gaan om samen te werken aan de toekomst.

huub

# Contents

Abstract	xvii
Abbreviations	xviii

## 1 Introduction

1.1 Phytochrome	1
1.1.1 Discovery of phytochrome	1
1.1.2 Molecular properties of phytochrome	3
1.1.3 Evidence for at least two pools of phytochrome	4
1.1.4 The phytochrome multigene family	5
1.1.5 Phytochrome-mediated response modes	6
1.1.5.1 Detection of the dark-to-light transition	6
1.1.5.2 High-irradiance responses	6
1.1.5.3 Phytochrome as a light-quality sensor	7
1.1.6 Phytochrome signal transduction	8
1.1.7 Function of phytochromes	9
1.2 Blue light/UV-A photoreceptors	10
1.3 UV-B photoreceptors	10
1.4 Co-action between pigment systems	11
1.5 Photomorphogenic mutants	11
1.5.1 Phytochrome photoreceptor mutants	11
1.5.1.1 Chromophore mutants	11
1.5.1.2 Type-specific mutants	13
1.5.2 B/UV-A photoreceptor mutants	14
1.5.3 Transduction chain mutants	15
1.6 Tomato as a model plant species	18
1.7 Outline of the thesis	18
1.8 Published work	19

## 2 Analysis of far-red light-insensitive mutants indicates the *FRI* locus is the gene encoding the apoprotein of phytochrome A in tomato

2.1 Introduction	21
2.2 Materials and methods	23
2.2.1 Plant material	23
2.2.1.1 Mutant isolation	23
2.2.1.2 Pretreatment of the seeds	24
2.2.1.3 Growth conditions	24

2.2.2	Phytochrome assays	24
2.2.2.1	Growth of plant material for the phytochrome assays	24
2.2.2.2	<i>In-vivo</i> phytochrome spectrophotometry	25
2.2.2.3	Western-blot analysis	26
2.2.2.4	Northern-blot analysis	27
2.2.3	Anthocyanin assay	28
2.2.4	Experiments	29
2.2.4.1	Continuous broad-band light experiment	29
2.2.4.2	White-light experiment	29
2.2.4.3	Light-pulse experiment	29
2.2.4.4	End-of-day FR experiment	29
2.2.5	Light facilities and light measurements	30
2.2.5.1	Light cabinets	30
2.2.5.2	Light sources	31
2.2.5.3	Light measurements	33
2.3	Results	33
2.3.1	Phenotypes	33
2.3.2	Phytochrome assays	35
2.3.2.1	<i>In-vivo</i> spectrophotometry	35
2.3.2.2	Western-blot analysis	36
2.3.2.3	Northern-blot analysis	40
2.3.3	Physiological characterization	40
2.3.3.1	De-etiolation	40
2.3.3.2	Low fluence response experiments	41
2.3.3.3	End-of-day FR experiments	41
2.3.3.4	Germination	41
2.4	Discussion	41
2.4.1	The <i>FRI</i> locus is probably the <i>PHYA</i> structural gene	41
2.4.2	The role of phytochrome A	44

### **3 Analysis of temporarily red light-insensitive mutants indicates the *TRI* locus is the gene encoding the apoprotein of phytochrome B1**

3.1	Introduction	47
3.2	Materials and methods	49
3.2.1	Plant material	49
3.2.1.1	Mutant isolation	49
3.2.1.2	Construction of the double mutants	50
3.2.1.3	Pretreatment of the seeds	50
3.2.2	Phytochrome assays	51
3.2.3	Anthocyanin assay	51
3.2.4	Chlorophyll assay	51
3.2.5	Experiments	51
3.2.5.1	Continuous broad-band light experiment	51

3.2.5.2	White-light experiment	52
3.2.5.3	Light-pulse experiment	52
3.2.5.4	Delayed-R experiment	52
3.2.5.5	End-of-day FR experiment	52
3.2.5.6	Supplementary daytime FR experiment	53
3.2.6	Light facilities and light measurements	53
3.2.6.1	Light cabinets	53
3.2.6.2	Light sources and light measurements	53
3.3	Results	54
3.3.1	Phenotypes	54
3.3.1.1	Phenotypes of the <i>tri</i> mutants	54
3.3.1.2	Phenotypes of the <i>au<sup>w</sup></i> and <i>au<sup>w</sup>,tri<sup>1</sup></i> mutants	57
3.3.2	Phytochrome assays	59
3.3.2.1	The <i>tri</i> alleles	59
3.3.2.2	Double mutants	63
3.3.3	Physiological characterization	67
3.3.3.1	Low fluence response experiments	67
3.3.3.2	Delayed-R experiment	68
3.3.3.3	End-of-day FR and supplementary daytime FR experiments	69
3.4	Discussion	71
3.4.1	Comparison to other species	71
3.4.1.1	Phenotype	71
3.4.1.2	Responses to end-of-day FR and supplementary daylight FR	72
3.4.2	The <i>TRI</i> locus is probably the <i>PHYB1</i> structural gene	72
3.4.3	The role of phytochrome B1 in tomato	73

#### **4 Phytochrome control of anthocyanin biosynthesis in tomato seedlings: analysis using photomorphogenic mutants**

4.1	Introduction	75
4.2	Materials and methods	77
4.2.1	Plant material	77
4.2.1.1	Genotypes	77
4.2.1.2	Pretreatment of the seeds	78
4.2.2	Anthocyanin assay	78
4.2.3	Experiments	78
4.2.3.1	White-light experiment	78
4.2.3.2	Light-pulse experiments	78
4.2.3.3	Light-pretreatment experiment	79
4.2.3.4	Threshold-box experiments	79
4.2.4	Light facilities and light measurements	79
4.2.4.1	Light cabinets and sources	79

4.2.4.2 Threshold-box units	79
4.2.4.3 Light measurements	80
4.3 Results and discussion	81
4.3.1 White-light/dark cycles	81
4.3.2 Light-pulse experiments	83
4.3.3 Light-pretreatment experiment	84
4.3.4 Fluence rate-response relationships at different wavelengths	84
4.3.5 The role of phytochrome types in tomato anthocyanin biosynthesis	92
<b>5 Physiological characterization of exaggerated-photoresponse mutants of tomato</b>	
5.1 Introduction	95
5.2 Materials and methods	97
5.2.1 Plant material	97
5.2.1.1 Genotypes	97
5.2.1.2 Pretreatment of the seeds	98
5.2.2 Phytochrome assays	98
5.2.3 Anthocyanin and chlorophyll assays	98
5.2.4 Experiments	99
5.2.4.1 Continuous broad-band light experiment	99
5.2.4.2 White-light experiment	99
5.2.4.3 Light-pretreatment experiment	99
5.2.4.4 Threshold-box experiment	99
5.2.4.5 Supplementary daytime FR experiment	100
5.2.5 Light facilities and light measurements	100
5.2.5.1 Light cabinets and sources	100
5.2.5.2 Light measurements	100
5.3 Results and discussion	101
5.3.1 Immunochemical and <i>in-vivo</i> spectrophotometrical analysis of phytochrome	101
5.3.2 Hypocotyl growth	103
5.3.3 Anthocyanin biosynthesis	105
5.3.4 Elongation to supplementary daytime FR	109
5.3.5 Greenhouse observations	109
5.4 Concluding remarks	110
<b>6 A study of shade-avoidance responses and fruit development in the <i>aurea</i> and <i>high-pigment-1</i> mutants of tomato</b>	
6.1 Introduction	113
6.2 Materials and methods	116
6.2.1 Plant material	116

6.2.2	Phytochrome assays	116
6.2.3	Anthocyanin assay	116
6.2.4	Chlorophyll and carotenoids assays	116
6.2.5	Experiments	117
6.2.5.1	Supplementary daytime FR experiments	117
6.2.5.2	Fruit characterization	117
6.2.6	Light facilities and measurements	118
6.2.6.1	Light cabinets and light sources	118
6.2.6.2	Light measurements and phytochrome photoequilibrium calculations	118
6.3	Results and discussion	120
6.3.1	Immunochemical and <i>in-vivo</i> spectrophotometrical analysis of phytochrome	120
6.3.2	Supplementary daytime FR experiments	121
6.3.2.1	Elongation responses	121
6.3.2.2	Anthocyanin and chlorophyll biosynthesis	125
6.3.3	Fruit characterization	128
6.4	Concluding remarks	131

## **7 A high-resolution plant growth-measuring apparatus to study stem growth kinetics**

7.1	Introduction	133
7.2	Description of the growth-measuring apparatus	134
7.2.1	The growth-measuring apparatus	134
7.2.2	The control unit	135
7.2.3	The measuring unit	135
7.2.4	The displacement-detection device ('floating zero')	139
7.2.5	Calibration procedure	141
7.2.6	Facilities for irradiation	141
7.2.7	Numerical data processing and graphical data presentation	142
7.2.8	Experimental protocol	142
7.2.9	Growth of plants	142
7.3	Results and discussion	143

## **8 Growth analysis of wild-type and photomorphogenic-mutant tomato plants**

8.1	Introduction	147
8.2	Materials and methods	148
8.2.1	Plant material	148
8.2.2	Plant growth conditions	149
8.2.3	Growth-measuring apparatus	149
8.2.4	Light sources and light measurements	150



8.2.5 Presentation of the results	150
8.3 Results and discussion	150
<b>9 General discussion</b>	
9.1 Evolution of phytochrome	159
9.2 Photoreceptor mutants	160
9.3 Phytochrome signal transduction	163
9.4 Co-action of photoreceptors and signal amplification	167
9.5 Future research	169
References	171
Samenvatting	189
Curriculum vitae	195

## Abstract

Kerckhoffs, L.H.J. (1996). Physiological functions of phytochromes in tomato: a study using photomorphogenic mutants. PhD thesis, Department of Plant Physiology, Wageningen Agricultural University, Arboretumlaan 4, NL-6703 BD Wageningen, The Netherlands. xx + 195 pp., dutch summary.

Plant morphogenesis is influenced greatly by the irradiance, quality, direction and periodicity of the ambient light. At least three different photomorphogenic photoreceptors have been distinguished: (i) the red light (R)- and far-red light (FR)-absorbing phytochromes; (ii) the UV-A and blue light (B)-absorbing cryptochromes; and (iii) the UV-B photoreceptor. The phytochromes, which are the best characterized photosensory photoreceptors, are encoded by a small multigene family. In tomato (*Lycopersicon esculentum* Mill.) five phytochrome genes have been cloned: *PHYA*, *PHYB1*, *PHYB2*, *PHYE* and *PHYF*. In this thesis a genetic approach is used to assign functions to the different phytochrome types in tomato. Two classes of phytochrome mutants in tomato were analyzed both molecularly and physiologically: (i) phytochrome photoreceptor mutants: far-red light-insensitive (*fri*) mutants, deficient in phytochrome A (*phyA*); temporarily red light-insensitive (*tri*) mutants, deficient in phytochrome B1 (*phyB1*) and a phytochrome chromophore biosynthesis mutant *aurea* (*au*); (ii) signal transduction chain mutants: high-pigment-1 (*hp-1*), high-pigment-2 (*hp-2*), *atroviolacea* (*atv*) and Intensive pigmentation (*Ip*). In adult plant stages *fri* mutants are hardly phenotypically distinguishable from wild type (WT) in white light (WL). The *phyB1*-deficient *tri* mutants are only insensitive during the first two days upon transition from darkness to R. The *tri* mutants are slightly taller than the WT when grown in WL. The kinetics of stem elongation rate of these mutants were determined very precisely using a custom-built plant growth-measuring apparatus as well as their response to vegetational shade light. The immature fruits of *hp-1* and *hp-2* mutants have higher chlorophyll levels and are darker-green in colour than WT. The signal transduction chain mutants all exhibit exaggerated phytochrome responses, *i.e.* high anthocyanin synthesis and short hypocotyl length compared to WT. Anthocyanin biosynthesis that accumulated during a 24-h period of different monochromatic irradiations was determined. At 660 nm the fluence rate-response relationships for induction of anthocyanin in WT are complex, showing a low fluence rate response (LFRR) and a fluence rate dependent high irradiance response (HIR), which have been attributed to *phyA* and *phyB1*, respectively. The *hp-1* mutant exhibits a strong amplification of both the LFRR and HIR. The *atv* mutant shows strongest amplification of the HIR component. The *Ip* mutant exhibits an exaggerated anthocyanin response in B. The results are discussed in relationship to the published work on photomorphogenesis.

Keywords: photomorphogenesis, phytochrome, mutants, tomato, *Lycopersicon esculentum* Mill., plant physiology.

# Abbreviations

A	absorbance
$\Delta A$	difference in absorbance
$\Delta \Delta A_{730-800}$	difference in absorbance difference between 730 and 800 nm
$A_{535}$	absorbance at 535 nm
AC	tomato cultivar Ailsa Craig
<i>atv</i>	<i>atroviolacea</i> mutant of tomato
<i>au</i>	<i>aurea</i> mutant of tomato
B	blue light
<i>blu</i>	<u>blue</u> light-insensitive mutant of <i>Arabidopsis</i>
<i>cop</i>	<u>constitutively-photomorphogenic</u> mutant of <i>Arabidopsis</i>
cRNA	complementary ribonucleic acid
CRY	undesigned cryptochrome gene
CRY	undesigned cryptochrome apoprotein
D	dark(ness)
Da	Dalton, unit of atomic mass (g.mol <sup>-1</sup> )
<i>det</i>	<u>de-etiolation</u> mutant of <i>Arabidopsis</i>
<i>ein</i>	<u>elongated internode</u> mutant of <i>Brassica</i>
EMS	ethyl methane sulphonate
EODFR	end-of-day far-red light
FR	far-red light
FR-HIR	far-red light-high irradiance response
<i>fhy</i>	far-red <u>elongated hypocotyl</u> mutant of <i>Arabidopsis</i>
<i>fre</i>	far-red <u>elongated</u> mutant of <i>Arabidopsis</i>
<i>fri</i>	far-red light-insensitive mutant of tomato
<i>fus</i>	<i>fusca</i> mutant in <i>Arabidopsis</i>
FW	fresh weight
GT	tobacco mosaic virus resistant tomato breeding line of a MoneyMaker type
HIR	high irradiance response
<i>hp</i>	<u>high pigment</u> mutant of tomato
<i>hy</i>	long- <u>hypocotyl</u> mutant of <i>Arabidopsis</i>
<i>Ip</i>	<u>Intense pigmentation</u> mutant of tomato
<i>ma</i>	<u>ma</u> turity mutant of sorghum
mAP5	monoclonal antibody directed to pea phytochrome A apoprotein
mAT1	monoclonal antibody directed to tobacco phytochrome B apoprotein
MM	tomato cultivar MoneyMaker

mRNA	messenger RNA
<i>nph</i>	<u>n</u> on-phototropic <u>h</u> ypocotyl mutant of <i>Arabidopsis</i>
PAR	photosynthetically active radiation (400–700 nm)
<i>pcd</i>	phytochrome <u>ch</u> romophore <u>d</u> eficient mutant of pea
<i>pew</i>	partly <u>e</u> tiolated in <u>w</u> hite light mutant of <i>Nicotiana plumbaginifolia</i>
$\phi$	phytochrome photoequilibrium, Pfr/(Pfr+Pr)
<i>PHY</i>	undesigned phytochrome gene
<i>PHYA, PHYB1, etc.</i>	phytochrome gene of type A, B1, <i>etc.</i>
<i>phyA, phyB, etc.</i>	phytochrome mutant, mutated in the phytochrome structural gene of type A, B, <i>etc.</i>
<i>PHY</i>	undesigned phytochrome apoprotein
<i>PHYA, PHYB1, etc.</i>	phytochrome apoprotein of type A, B1, <i>etc.</i>
<i>phy</i>	undesigned phytochrome holoprotein
<i>phyA, phyB1, etc.</i>	phytochrome holoprotein of type A, B1, <i>etc.</i>
Pr (Pfr)	red (far-red) light-absorbing form of undesigned phytochrome holoprotein
Ptot	total spectrophotometrically detectable phytochrome
<i>lh</i>	long <u>h</u> ypocotyl mutant of cucumber
LED	light-emitting diode
LFR	low fluence response
LFRR	low fluence rate response
<i>lv</i>	elongated mutant of pea
<i>lw</i>	dwarf mutant of pea
UV-A	ultraviolet-A (315–400 nm)
UV-B	ultraviolet-B (280–315 nm)
v/v	volume/volume
w/v	weight/volume
WL	white light
WT	wild type
R	red light
R:FR	red light:far red light photon ratio ( $\zeta$ )
R-HIR	red light-high irradiance response
RH	relative humidity
RNA	ribonucleic acid
SDS-PAGE	sodium dodecylsulfate-polyacrylamide gel electrophoresis
SE	standard error of the mean
SER	stem elongation rate
<i>tri</i>	temporarily red light-insensitive mutant of tomato
$T_{max}$	transmission maximum
VLFR	very low fluence response
<i>yg-2</i>	yellow-green-2 mutant of tomato

# CHAPTER 1

## Introduction

Higher plants are sedentary organisms that therefore have to be adaptive and flexible in response to external stimuli. Photomorphogenesis is the way plants process the information content of the light environment and modify their growth and development accordingly (Kendrick and Kronenberg, 1994). During evolution, colonization of the land by seed plants necessitated germination of the seeds below the ground, which 'led' to the evolution of the strategy of dark growth (*etiolation*), all resources being put into elongation growth in a search for the light environment before seed resources are exhausted (see Fig. 1.1). The selection pressure for an efficient transition from heterotrophic growth, utilizing stored seed reserves, to a green autotrophic self-sufficient photosynthetic plant (*de-etiolation*) has led to the evolution of an impressive battery of photoreceptors. Once established, plants have to be able to compete for available photosynthetic light with their neighbours and most species respond to light direction by growth orientation (*phototropism*) and to subtle changes in light quality caused by neighbouring plants by a stimulation of elongation growth (*shade-avoidance response*). The transition from vegetative growth to flowering is also synchronized with the seasons and plants again use photoreceptors to perceive daylength as a reliable signal for the time of year. To be able to respond to this important array of different light signals, plants utilize at least three photoreceptor systems: a UV-B photoreceptor (Yatsunami *et al.*, 1982; Beggs and Wellman, 1985), UV-A/blue light (B) photoreceptors (Ahmad and Cashmore, 1993; Liscum and Briggs, 1995) and the most extensively studied red light (R)/far-red light (FR)-reversible phytochromes (Sage, 1992 and references therein).

### 1.1 Phytochrome

#### 1.1.1 Discovery of phytochrome

In the early twenties Garner and Allard discovered that the length of the day was the critical factor in the control of flowering. This discovery of photoperiodism (Garner and Allard, 1920) was a scientific breakthrough and the practical consequences have been enormous for the horticultural industry. Subsequent studies at the U.S. Department of Agriculture Research Center (Beltsville, MD, USA) concentrated on the mechanism of this photoperiodic control (Parker *et al.*,



**Figure 1.1.** Tomato seedlings grown for 6 days in either darkness (left) or continuous white light (right), resulting in an etiolated and a de-etiolated phenotype, respectively.

1946). This research quantified the efficiency of various narrow wavebands of radiation (action spectra) in inhibition of flowering of short-day plants. However, it was a study of lettuce germination, which was a follow-up of observations by Flint and McAlister (1935), which led directly to the discovery of a photoreversible pigment by Borthwick *et al.* (1952a). In this classical paper, it was first proposed that a photoreversible pigment acted as a switch: it could be turned on by red light (R) with a maximum at 660 nm or off by far-red light (FR) with a maximum at 730 nm, and in multiple alternating R and FR irradiations the final position determined the response. Borthwick *et al.* (1954) strengthened the case for a single pigment being involved in two photo-interconvertible forms: a FR-absorbing (active) form (Pfr) and a R-absorbing (inactive) form (Pr). Other reports demonstrated similar photoreversible control of flowering (Borthwick *et al.*, 1952b), leaf and hypocotyl elongation (Downs, 1955), pigmentation of the tomato fruit cuticle (Piringer and Heinze, 1954) and straightening of the plumular hook of etiolated bean plants (Withrow *et al.*, 1957). Hundreds of these classical phytochrome-mediated responses have been described (Correll *et al.*, 1977; Shropshire Jr. and Mohr, 1983).

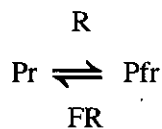
In 1959 Butler and his colleagues were able to detect the pigment directly by *in-vivo* differential spectrophotometry in dark (D)-grown maize seedlings and showed it to be a protein by denaturation upon boiling (Butler *et al.*, 1959). Shortly afterwards Borthwick and Hendricks (1960) officially proposed the term phytochrome (from the Greek words for 'plant' and 'colour') for "*the pigment controlling photo-responsive development of plants*".

Since its discovery, phytochrome has been found in representatives of all major groups within the plant kingdom, including angiosperms, gymnosperms, ferns, bryophytes and algae.

### 1.1.2 Molecular properties of phytochrome

It was not until the early eighties that Vierstra and Quail (1983) developed a fully reliable isolation and purification procedure which yielded a full-size 124-kDa phytochrome from etiolated oat seedlings, and made an extensive characterization of the phytochrome molecule possible (Furuya and Song, 1994).

Phytochrome is Y-shaped, generated by dimerization of two identical monomers (Jones and Erickson, 1989). Each monomer is composed of an apoprotein of approximately 1100 amino acids, which consist of two discrete domains: an NH<sub>2</sub>-terminal domain of about 74 kDa that contains a linear open-chain tetrapyrrole chromophore (phytochromobilin) covalently linked *via* a thiol-ether linkage to a cysteine residue (located about 320 residues from the NH<sub>2</sub> terminus), and a COOH-terminal domain of about 55 kDa that possesses the site(s) responsible for dimerization (Romanowski and Song, 1992; Edgerton and Jones, 1992). As a result of interactions between the polypeptide (apoprotein) and the chromophore, which absorbs light maximally in the 600–760 nm waveband, phytochrome is a photochromic pigment, *i.e.* can be repeatedly interconverted by light between two photo-isomers. A simplified scheme for this photoconversion is:



The absorption bands of the two forms overlap. Because of this a photo-equilibrium ( $\phi$ ) is being established, *i.e.* the proportion of total phytochrome molecules as the Pfr form at photoequilibrium. The precise value of  $\phi$  depends on the wavelength applied (light quality). Using the formulae of Mancinelli (1994) the value of  $\phi$  at equilibrium for FR and R is about 0.02 and 0.87, respectively. Under conditions of constant illumination, phytochrome cycles continuously between its two forms (*i.e.* phytochrome cycling).

The actual phototransformation itself between the two forms involves a *cis*- to *trans*-isomerization of one of the double bonds within the tetrapyrrole chromophore, a re-orientation of the chromophore relative to the polypeptide (becoming more exposed) and multiple conformational changes within the polypeptide, especially near the NH<sub>2</sub>-terminus (Vierstra, 1993; Furuya and Song, 1994).

Phytochrome is synthesized as Pr, the chromophore being exported from the plastids and assembled with apoprotein in the cytoplasm. Upon photoconversion to Pfr (Hendricks, 1964) it becomes active and initiates the diverse array of responses under its control. One of the most rapid effects triggered by Pfr is an alteration of gene expression, involving either transcriptional activation and repression of specific genes (Quail, 1991; Thompson and White, 1991; Li *et al.*, 1993; Terzaghi and Cashmore, 1995). Paradoxically, R can be viewed not only as necessary for converting phytochrome to the physiologically active Pfr form, but also for initiating the rapid breakdown of the Pfr pool (Vierstra, 1994). Moreover, Pfr down regulates the *de-novo* synthesis of Pr (Colbert, 1991).

### 1.1.3 Evidence for at least two pools of phytochrome

Early physiological data already provided evidence that not all the phytochrome is destroyed by light (Downs *et al.*, 1957). Biochemical data later suggested that at least two pools of phytochrome exist, one labile that predominates in etiolated plants and the other stable and present at a low concentration that predominates in light-grown plants (Butler and Lane, 1965; Siegelman and Butler, 1965; Hillman, 1967). Both a light-labile and a light-stable phytochrome were also detected by spectrophotometry (Brockmann and Schäfer, 1982). Subsequently, immunochemical studies defined two different phytochrome types in oat and pea (Abe *et al.*, 1985; Hilton and Thomas, 1985; Shimazaki and Pratt, 1985; Tokuhiisa *et al.*, 1985). An important step forward was the observation that the phytochrome types in pea differ in their amino acid sequence and therefore must be the products of different genes (Abe *et al.*, 1989). The classical light-labile phytochrome, predominant in etiolated tissue, decays in the light to a very low level in pea (Abe *et al.*, 1985) or to an undetectable level in oat (Pratt *et al.*, 1991). This phytochrome has been named type I (Furuya, 1989; 1993). The light-stable phytochrome, which was revealed in light-grown pea tissue was named type II. Both type I and II are photoreversible, but differ in: (i) the stability of their Pfr forms; (ii) immunochemical and spectral properties; (iii) their proportions present in the plant at different stages (*e.g.* etiolated and de-etiolated seedlings); and (iv) their differential contribution to the regulation of different responses (Mancinelli, 1994).



### 1.1.4 The phytochrome multigene family

Direct molecular evidence that angiosperms contain several types of phytochrome encoded by a small multigene family was provided initially from studies with *Arabidopsis*. These phytochrome (*PHY*) genes were designated by *PHYA* through *PHYE* (Sharrock and Quail, 1989; Clack *et al.*, 1994). The *PHYA* gene which encodes the *PHYA* apoprotein was closely related to genes cloned earlier from oat (Hershey *et al.*, 1985; Hershey *et al.*, 1987; Grimm *et al.*, 1988), zucchini (Sharrock *et al.*, 1986), pea (Sato, 1988), maize (Christensen and Quail, 1989) and rice (Kay *et al.*, 1989a). All these genes encode the phytochrome that accumulates to relatively high levels in etiolated seedlings (Quail, 1991; 1994; Pratt, 1995). The phytochrome, formerly known as light-labile phytochrome, etiolated phytochrome or type I phytochrome, corresponds to phytochrome A (*phyA*; Quail, 1994). The other *PHY* genes characterized, *PHYB*, *PHYC* (Sharrock and Quail, 1989), *PHYD* and *PHYE* (Clack *et al.*, 1994), encode for phytochrome apoproteins *PHYB* through *PHYE*, respectively. After insertion of the chromophore these apoproteins form phytochrome B through phytochrome E (*phyB-E*) (Quail *et al.*, 1994). The light-stable phytochrome, green-plant phytochrome or type II phytochrome (Quail, 1994) is composed of *phyB* and presumably other phytochromes. Study of their properties is not easy since they are present at very low levels. Pairwise comparisons of the deduced amino-acid sequences among all five *PHY* yield identities of 46–56 %, with the exception of the comparison between *PHYB* and *PHYD*, which yields greater than 80 % identity (Clack *et al.*, 1994). Consequently, these five *PHYs* can be assigned to four subfamilies: *PHYA*, *PHYB* (which includes *PHYD*), *PHYC* and *PHYE* (Pratt, 1995).

In tomato there is evidence that the *PHY* family is composed of even more than five members (Pratt, 1995; Hauser *et al.*, 1995). The polymerase chain reaction (PCR)-derived gene fragments for five tomato *PHYs* have been sequenced. Four of these genes, *PHYA*, *PHYB1*, *PHYB2* and *PHYE*, are members of previously identified *PHY* subfamilies, while the fifth, *PHYF*, is identified as a member of a new *PHY* subfamily. *PHYA*, *PHYB1*, *PHYB2* and *PHYE* fragments encode amino-acid sequences that share 88–98 % sequence identity with their *Arabidopsis* counterparts. The *PHYF* fragment, however, encodes a polypeptide that shares only 65–74 % sequence identity with previously identified *Arabidopsis* phytochromes. Phylogenetic studies suggest that *PHYF* might be widespread among angiosperms (Hauser *et al.*, 1995). As in *Arabidopsis*, two of these genes (*PHYB1* and *PHYB2*) have been identified as members of the *PHYB* subfamily (Pratt *et al.*, 1995). In addition to the two *B*-type genes in *Arabidopsis* and tomato, there is preliminary evidence for three *PHYBs* in *Daucus* (Mathews *et al.*, 1995). Kern *et al.* (1993) have also suggested that tobacco and potato might each have two *PHYBs*. Thus, the size of the *PHYB* subfamily, and its plasticity among different plant groups, is unclear. In sorghum, three *PHYs* (*PHYA*, *PHYB* and *PHYC*) have

been identified by sequence comparisons of PCR fragments to known *PHYs* (Pratt, 1995). There is also evidence for additional *PHYs* in the sorghum genome (Pratt, 1995). Many other complete *PHY* clones have been obtained and sequenced from non-angiosperms, including mosses, lycopods, ferns and algae, as well as in gymnosperms, establishing that the *PHY* family is widespread throughout the plant kingdom (Pratt, 1995).

### 1.1.5 Phytochrome-mediated response modes

It has become clear that phytochromes function *via* different response modes (Mancinelli, 1994) dependent on the fluence rate and duration of the incident light.

#### 1.1.5.1 Detection of the dark-to-light transition

In the detection of the onset of light two main response modes can be distinguished:

(i) *Very low fluence response (VLFR)*. The VLFRs (Blaauw *et al.*, 1968; Raven and Spruit, 1973; Mandoli and Briggs, 1981), are saturated at extremely low fluences of about less than  $100 \text{ nmol.m}^{-2}$ , comparable to the quantity of light emitted by a few firefly flashes. The VLFRs are not reversible by FR, but can even be induced by FR alone. The VLFRs have been observed in D-imbibed seeds or seedlings grown in total D, in which all of the phytochrome is present as Pr (Smith and Whitelam, 1990). In this respect care must be taken using 'safelights', because exposure to dim-green safelight can elicit and even saturate a VLFR.

(ii) *Low fluence response (LFR)*. The LFRs are the classical phytochrome-mediated responses. They are induced by a single pulse of R, and show reversibility by subsequent FR. The effectiveness of FR in reversing the inductive effects of R decreases and is eventually lost as progressively longer D intervals are inserted between R and FR. The LFR obeys the Bunsen-Roscoe law (*i.e.* reciprocal relationship between the fluence rate and duration of incident light). The photon fluences required for saturation of the response by R vary from 1 to  $1000 \mu\text{mol.m}^{-2}$ , corresponding to a proportion of total phytochrome as Pfr, ranging from 0.01 to 0.87, the latter value being equivalent to the  $\phi$  value at equilibrium. The LFRs are observed in imbibed seeds, etiolated seedlings and light-grown plants (Smith and Whitelam, 1990).

#### 1.1.5.2 High-irradiance responses

In contrast to the inductive VLFR and LFR, the high-irradiance responses (HIRs) require continuous, long term exposures to relatively high fluence rates (Mohr, 1972; Mancinelli and Rabino, 1978; Mancinelli, 1994). The term 'high' irradiance response is a misnomer because the fluence rate required to cause these responses is very much less than that provided by sunlight in the natural environment (Smith

and Whitelam, 1990). These HIRs show no R/FR reversibility and do not obey the Bunsen-Roscoe reciprocity law. The extent of the HIR is a function of wavelength, irradiance and duration of the light treatment. Their action spectra differ from the induction spectra of the classical phytochrome responses, showing a sharp peak in the FR and a broad band of activity in the B (Schäfer, 1976). The HIR is only readily observed in etiolated seedlings, and as seedlings de-etiolate the HIR become less evident (Smith and Whitelam, 1990). The HIR shows a maximum activity at wavelengths that maintain a low Pfr concentration for a prolonged period of time, yet give sufficient Pfr for a response. Depending on species, etiolated seedlings usually show a FR-HIR, whereas on transfer to light, seedlings exhibit a shift towards a R-HIR, reflecting a depletion of the labile pool of phyA (Mancinelli, 1994).

Attempts to explain the fluence-rate dependency of the HIRs usually refer to the importance of photochemical turnover (cycling) between Pr and Pfr (Hartmann, 1966). It has been hypothesized that a short-lived phytochrome intermediate might participate in a reaction affecting growth; at higher rates of photoconversion, this intermediate would build up to greater levels and thus confer a fluence-rate dependence on the HIR (Cosgrove, 1994). Phytochrome is the pigment responsible for the HIR in the R and FR region of the spectrum (Schäfer, 1976). While the irradiance dependence has not yet been fully explained, it is clear that phytochrome acts in some way as a photon counter. Whether the considerable activity of the B/UV-A region of the spectrum is due to absorption by phytochrome alone or other pigments is still an open question, although B very effectively cycles phytochrome.

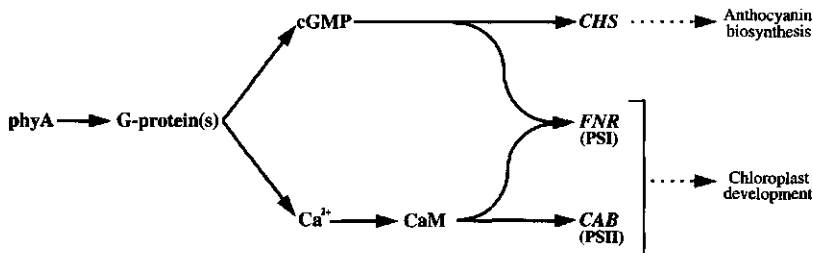
#### *1.1.5.3 Phytochrome as a light-quality sensor*

The photochromicity between Pr and Pfr means that phytochrome has the capacity to sense small changes in the relative amounts of R and FR in the ambient radiation. Assuming the photon fluence rate is sufficient to drive the photoconversions to photoequilibrium, a simple quantitative relationship exists between the R:FR photon ratio ( $\zeta$ ) and the proportions of Pr and Pfr present (Smith and Holmes, 1977). Sensing the R:FR ratio has been proposed as the fundamental sensory function of phytochrome in green plants, since they compete with other plants for available photosynthetic radiation (Smith, 1982). In the natural environment the R:FR ratio is a sensitive indicator of shading, which results from a relative increase in the proportion of FR to other wavelengths. Plants have developed different strategies to adapt to vegetational shade, which can be viewed as two extremes: shade tolerance and shade avoidance (Smith, 1994). Shade tolerance involves relatively low growth rates, the conservation of energy and resources and the development of photosynthetic structures that are especially efficient at low light levels (Smith, 1994). The opposite extreme, shade avoidance is a syndrome of growth and developmental changes in which internode and

petiole elongation is increased, as well as additional changes in photosynthate partitioning and leaf performance, increase in apical dominance and acceleration of flowering and senescence (Smith, 1994). As the name suggests, if successful, shade avoidance has the overall effect of projecting the photosynthetic structures (usually leaves) into those parts of the environmental mosaic in which the resource of light is abundant. In a similar fashion, plants are able to detect near-neighbours as a consequence of spectral quality of laterally reflected light (Ballaré *et al.*, 1987; 1990).

### 1.1.6 Phytochrome signal transduction

There is still only sketchy information about the chain of events which lie downstream of photoreceptors involved in photomorphogenesis. However, it is clear that they ultimately lead to modifications of growth and development, which include the switching on and off of genes. The genes involved in plant signal transduction that have been cloned so far were recently reviewed by Redhead and Palme (1996). Progress has also been made at the level of transcription and factors that interact with light-responsive promoters have been characterized (Batschauer *et al.*, 1994). However, there remains a large black box which can be loosely defined as the 'signal transduction chain'. It is obvious that plant hormones will play a key role in some responses. The signal transduction probably involves phosphorylation of proteins, activation of heterotrimeric GTP-binding proteins (G-proteins, which consist of three subunits denoted  $G\alpha$ ,  $G\beta$  and  $G\gamma$ ) and changes in phosphatidylinositol and calcium metabolism (Roux, 1994; Bowler and Chua, 1994; Millar *et al.*, 1994). For phytochrome, the *au* (*aurea*, see 1.5.1.1) mutant has been used successfully as a phytochrome-deficient background in which phytochrome and/or signal transduction activators and inhibitors have been micro-injected (Neuhaus *et al.*, 1993). Using the hypocotyl as a test material it has been shown (Fig. 1.2) that there are two signalling pathways resulting from activation



**Figure 1.2.** A model of *phyA* signal transduction pathways. Anthocyanin biosynthesis was monitored by chalcone synthase (*CHS*) gene expression. Photosystem I (PSI) and II (PSII) development were monitored by ferredoxin NADP<sup>+</sup> oxidoreductase (*FNR*) and chlorophyll *a/b*-binding protein (*CAB*) gene expression, respectively. After Bowler *et al.* (1994a; 1994b).

of heterotrimeric G-protein(s): one leading to anthocyanin biosynthesis which requires cyclic GMP (cGMP) and a second, which requires both calcium and calmodulin (CaM), induces the gene expression of chlorophyll *a/b*-binding proteins (CAB). However, both pathways have 'crosstalk' and are both required for full development of the functional plastids (Neuhaus *et al.*, 1993; Bowler and Chua, 1994; Bowler *et al.*, 1994a; 1994b).

### 1.1.7 Function of phytochromes

It has been recognized for some time that the complexity and diversity of responses attributed to phytochrome are inconsistent with the action of a single molecular species of the photoreceptor. The realization that phytochrome is a family of photoreceptors encoded by multiple, divergent genes could explain all the different modes of phytochrome-mediated responses by assuming that the different, but closely related phytochromes have specialized regulatory roles in controlling the overall response of plants to the complexities of the light environment. Clues about the possible functions of the different phytochrome types can be obtained from expression studies. In *Arabidopsis*, tobacco and tomato, expression of the different *PHYs* are somewhat constitutive, with *PHYA* mRNA almost always predominating (Adam *et al.*, 1994; 1996; Somers and Quail, 1995; Hauser *et al.*, 1995; in press). However, a pronounced negative photo-regulation of *PHYA* mRNA upon illumination is observed (Sharrock and Quail, 1989; Clack *et al.*, 1994; Pratt, 1995). Specific differences in *PHY* expression patterns are more evident in tomato. On a whole-plant basis, large differences (up to 1000-fold) in transcript levels occur among the different *PHYs*, but also substantial differences exist in the expression level of individual *PHY* throughout the life cycle and within the plant (Wang *et al.*, 1993; Pratt, 1995; Hauser *et al.*, in press). Notably, *PHYE* mRNA is several fold more abundant in mature plants than in seedlings, in contrast to all other transcripts, whose abundance peaks at an earlier age. While *PHYF* mRNA is normally present at a very low level, it reaches the level of other transcripts in fruits of mature plants (Hauser *et al.*, 1995, in press). Indications of differences in distribution, provide clues to the functions of some of the previously uncharacterized phytochromes. Their confirmation by studies at the protein level with specific antibodies to the individual phytochromes are eagerly awaited (Pratt, 1995).

In recent years our understanding of phytochrome action and function has been significantly advanced through the analysis of photomorphogenic mutants and phytochrome overexpression studies (see 1.5).

## 1.2 Blue light/UV-A photoreceptors

It is evident that several B/UV-A absorbing photoreceptors mediate responses such as hypocotyl extension, leaf development, phototropism and the transcription of various genes (Liscum and Hangarter, 1994; Short and Briggs, 1994; Senger and Schmidt, 1994; Jenkins *et al.*, 1995; Ahmad and Cashmore, 1996). Phototropic responses enable seedlings to orientate their cotyledons and primary leaves for maximal photosynthetic light capture which is an important process during seedling establishment in the light environment. The specific effects of B and UV-A cannot be solely explained through the absorption of these wavelengths by phytochrome. However, these B/UV-A photoreceptors have not been fully characterized and their precise number has not been established (Jenkins *et al.*, 1995). The cloning of *HY4* (Ahmad and Cashmore, 1993) encoding for a B-photoreceptor, called cryptochrome (CRY1) and the finding of the *nph* (non-phototropic hypocotyl) mutants at the *NPH* locus have helped to resolve the situation. The *NPH1* gene encodes a putative photoreceptor mediating phototropic responses (Liscum and Briggs, 1995; 1996). These discoveries are major breakthroughs in B photomorphogenesis. The signal transduction components through which they control plant gene expression and development are largely unknown (Kaufman, 1993; Jenkins *et al.*, 1995). There are indications that phosphorylation mediated by a 120-kDa photoreceptor in phototropism is an early step in the signal transduction chain leading to curvature as a result of differential growth (Reymond *et al.*, 1992). Recently, it was established that the B/UV-A phototransduction processes of *CHS* expression in *Arabidopsis* involve calcium, but are independent from CaM (Christie and Jenkins, 1996).

## 1.3 UV-B photoreceptors

There is little information on the nature of the UV-B photoreceptors and their signal transduction(s) (Jenkins *et al.*, 1995). The action spectrum of the putative photoreceptor shows a single intense peak at 290 nm and no action at wavelengths longer than 350 nm (Yatsuhashi *et al.*, 1982; Beggs and Wellmann, 1985). Exposure to UV-B has various physiological effects on plants, most of them indicative of damage to cellular components (Tevini and Teramura, 1989; Stapleton, 1992). Plants have evolved several mechanisms to limit the potentially damaging effects of UV-B, which involve either shielding by accumulation of UV-absorbing compounds (Lois, 1994) or DNA repair (Quaite *et al.*, 1994).

## 1.4 Co-action between pigment systems

Mohr (1994) proposed a model of co-action between B/UV-A photoreceptors and the phytochrome photoreceptor system. The Pfr is considered as the effector which for instance causes anthocyanin synthesis through activation of gene expression, while the B/UV-A effect is considered as amplifying responsiveness towards Pfr. The study of co-action is inevitably complicated by the fact that B/UV-A is also absorbed by phytochrome leading to Pfr production and phytochrome cycling. In the case of the *au* mutant of tomato it has been proposed that activation of the B/UV-A photoreceptor results in an increased phytochrome responsiveness to the residual low amounts of phytochrome (below detection limits) enabling it to survive in white light (Oelmüller and Kendrick, 1991), while the mutation is lethal in R where phytochrome alone is excited.

Phototropism is controlled by a separate unrelated sensing system (Liscum and Briggs, 1995; 1996). However, there is also an interaction with phytochrome in which *phyA* is responsible for R-induced phototropic enhancement in *Arabidopsis* (Parks *et al.*, 1996). Janoudi and Poff (1992) suggested that phytochrome modifies the phototropic response by modulating a component in the B signal transduction pathway. Studies with various phytochrome mutants has identified *phyA* as responsible for this enhancement (Liscum and Hangarter, 1994). An opposite result was found when studying light interacting in the inhibition of hypocotyl elongation in *Arabidopsis* seedlings. Here a strong synergism was found between *phyB* and *CRY1*, while none was found for *phyA* and *CRY1* (Casal and Boccalandro, 1995).

## 1.5 Photomorphogenic mutants

Photomorphogenic mutants would be expected to have a strong pleiotropic phenotype, since many responses are regulated by light and would be modified when the mutation affects the photoreceptor itself (photoreceptor mutants) or steps in the cascade of events immediately following the perception of light (signal-transduction mutants). Photoreceptor mutants can be divided into two categories: chromophore and type-specific apoprotein mutants (Kendrick and Nagatani, 1991; Reed *et al.*, 1992; Chory, 1993; Koornneef and Kendrick, 1994; Liscum and Hangarter, 1994; Whitelam and Harberd, 1994).

### 1.5.1 Phytochrome photoreceptor mutants

#### 1.5.1.1 Chromophore mutants

Mutants that are thought to be deficient in all types of phytochrome probably have a defect associated with the common phytochrome chromophore, such as the *hy*

(long hypocotyl) mutants at three loci (*HY1-2*, *HY6*) in *Arabidopsis* (Koornneef *et al.*, 1980; Chory *et al.*, 1989a; Parks *et al.*, 1989; Parks and Quail, 1991). These mutants exhibit an insensitivity to both continuous R and FR, whereas continuous B remains relatively effective in inhibition of hypocotyl elongation (Koornneef *et al.*, 1980; Goto *et al.*, 1993). All these mutants are pale yellow, make fewer leaves and have increased apical dominance and flower early (Goto *et al.*, 1991; Chory, 1993). These mutants accumulate near-normal levels of phytochrome polypeptide, but lack the spectrophotometrically detectable chromoproteins (Chory *et al.*, 1989a; Parks and Quail, 1991). A wild-type (WT) phenotype can in most cases be restored by feeding the mutant plants the tetrapyrrole precursor biliverdin IX $\alpha$ , indicating that they affect steps prior to biliverdin formation in the chromophore biosynthetic pathway (Parks and Quail, 1991; Nagatani *et al.*, 1993). Other examples include the *pew* (partly etiolated in white light) mutants at two loci (*PEW1-2*) in *Nicotiana plumbaginifolia* (Kraepiel *et al.*, 1994) and the *pcd* (phytochrome chromophore deficient) mutants at two loci (*PCD1-2*) in pea (Weller *et al.*, 1996; Terry *et al.*, in press).

The *au* and *yg-2* (yellow-green-2) mutants in tomato have frequently been considered specifically deficient in phyA. Van Tuinen *et al.* (1996a) have demonstrated that expression of an oat *PHYA3* gene in *au* and *yg-2* is very ineffective in restoring the WT phenotype, even though oat *PHYA3* is active in tomato (Boylan and Quail, 1989). Since the *au* and *yg-2* mutants map to chromosomes 1 and 12, respectively, they cannot be specific phyA-deficient mutants (see below), since the *PHYA* gene maps to chromosome 10 (Van Tuinen *et al.*, 1996b). Recently, it was established by Terry and Kendrick (1996) that the *au* mutant is defective in synthesis of the phytochrome phytochromobilin chromophore. The first committed step in phytochromobilin synthesis is the conversion of heme to biliverdin IX $\alpha$ , presumably catalyzed by heme oxygenase. Biliverdin IX $\alpha$  is then reduced by phytochromobilin synthase to 3Z-phytochromobilin, which in turn is isomerized by phytochromobilin isomerase to 3E-phytochromobilin (Terry *et al.*, 1993). In a HPLC-based analysis, it was concluded that *yg-2* is deficient in heme oxygenase, catalyzing the production of biliverdin IX $\alpha$ , while *au* is deficient in phytochromobilin synthase, catalyzing the production of 3Z-phytochromobilin from biliverdin (Terry and Kendrick, 1996). Taken together there is strong evidence that the *Arabidopsis* *hyl* and *hy6*, the *Nicotiana* *pew1* and pea *pcd1* are tomato *yg-2* homologues, while *Arabidopsis* *hy2* and pea *pcd2* are tomato *au* homologues, in biochemistry and phenotype (Terry *et al.*, in press). The precise character of the *pew2* mutation is still unknown. It is interesting that PHYA accumulates to, at best, 20 % of the WT level in the *au* and *yg-2* mutants (Sharma *et al.*, 1993; Van Tuinen *et al.*, 1996a), while PHYA levels are close that of WT in *hyl*, *hy2*, *hy6* (Chory *et al.*, 1989a; Parks *et al.*, 1989), *pcd1*, *pcd2* (Terry *et al.*, in press), *pew1* and *pew2* (Kraepiel *et al.*, 1994). Another common feature is the apparent leaky nature of the mutations. These mutants can therefore synthesize low levels of



phytochrome chromophore and as a consequence functional phytochromes accumulate in more mature tissues, while a pronounced chlorotic phenotype is retained.

In addition, *hy1*, *hy2*, *hy6* and *au* are all widely used as phytochrome-deficient controls in genetic, physiological, and biochemical studies (Neuhaus *et al.*, 1993; Bowler *et al.*, 1994a; 1994b; Millar *et al.*, 1995; Kunkel *et al.*, 1996) and further knowledge about the sites of action and potential secondary effects of such mutations will therefore assist in interpretation of such studies.

#### 1.5.1.2 Type-specific mutants

These mutants are dealt with in three categories:

(i) *Mutants deficient in phyA*. Mutants deficient in *phyA* in *Arabidopsis*, are identified by their long hypocotyls under continuous FR. These mutants have been called *hy8* (long hypocotyl) by Parks and Quail (1993), *fre* (far-red elongated) by Nagatani *et al.* (1993) and *fhy2* (far-red long hypocotyl) by Whitelam *et al.* (1993). They carry mutations in the *PHYA* gene (Dehesh *et al.*, 1993; Whitelam *et al.*, 1993; Reed *et al.*, 1994) and therefore referred to as *phyA* alleles. Seedlings of the *fun1* (far-red unresponsive) mutant in pea are also insensitive to FR (Weller *et al.*, 1995b) and are expected to be deficient in *phyA* (J.L. Weller, pers. comm.).

(ii) *Mutants deficient in phyB*. Mutant in several species have been shown to be deficient in *phyB*. These mutants all have seedlings which are deficient in responsiveness in the R region of the spectrum and adult plants which are elongated, often flowering early. In *Arabidopsis* the *hy3* mutation (Koornneef *et al.*, 1980) has been shown to be in the *PHYB* gene (Reed *et al.*, 1993). The *lh* (long hypocotyl) mutant in cucumber (Adamse *et al.*, 1987; Peters *et al.*, 1991; López-Juez *et al.*, 1992), the elongated (*lv*) mutant of pea (Nagatani *et al.*, 1990; Weller *et al.*, 1995a) and the *ein* (elongated internode) mutant of *Brassica* (Rood *et al.*, 1990; Devlin *et al.*, 1992) are deficient in *PHYB*-like apoprotein, as is the *ma<sub>3</sub><sup>R</sup>* (maturity) mutant in sorghum (Childs *et al.*, 1991; 1992), which has recently been confirmed as a mutation of the *PHYB* gene (Childs *et al.*, 1996). These mutants are constitutively tall and mimic the response shown by the WT to shade of other plants, pointing to the dominant role of *phyB* in the shade-avoidance response. Some of these mutants have modified gibberellin (GA) metabolism or responsiveness indicating the importance of GAs in the shade-avoidance response (Rood *et al.*, 1990; Beall *et al.*, 1991; López-Juez *et al.*, 1995; Swain and Olszewski, 1996).

(iii) *Overexpression and antisense of PHY genes*. Once *PHY* genes were cloned, it became possible to introduce them into plants and examine the effect of phytochrome overexpression, or in converse, antisense techniques can be used to silence specific *PHY* genes. These studies have complemented and confirmed what has been concluded from the use of mutants. The overexpression of *PHYA* leads to a retention of the FR-HIR attributable to *phyA* (McCormac *et al.*, 1992;

Casal *et al.*, 1996) and overexpression of phyB increases the responsiveness in the R region of the spectrum (Wagner *et al.*, 1996a). Overexpression of chimeric proteins reveals that the chromophore-binding, NH<sub>2</sub>-terminal domain is used for photoperception as might be expected, but it is the COOH-terminal domain of phyA and phyB which relays both the R and FR signals to the transduction chain (Quail *et al.*, 1995; Wagner *et al.*, 1996a; 1996b). Antisense-phyB plants in potato have similar phenotypes to the phyB mutants above and interestingly have a modified response to daylength (Jackson *et al.*, 1996). The overexpression of phyC has been carried out in *Arabidopsis*, displaying slightly exaggerated cotyledon expansion responses under both B and R (Halliday and Whitelam, 1995). Results of overexpression of other phytochromes in sense or antisense configuration will hopefully reveal their functions.

### 1.5.2 B/UV-A photoreceptor mutants

Koornneef *et al.* (1980) isolated and described a long hypocotyl mutant (*hy4*) that was defective in the perception of B. The *hy4* mutant has normal responsiveness in the R and FR regions of the spectrum and spectrophotometrical and immunological studies revealed it has normal phytochrome (Koornneef *et al.*, 1980; Chory *et al.*, 1989a; Somers *et al.*, 1991). Hypocotyl growth is therefore regulated by B via a separate B photoreceptor and phytochrome plays only a secondary role in perception of this spectral region. Liscum and Hangarter (1991) reported the isolation of *blu* (blue light uninhibited) mutants at three loci (*BLU1-3*) in *Arabidopsis* in which hypocotyl extension is specifically inhibited by B. Although the original genetic analysis indicated that these mutations were at different loci to *hy4*, subsequent analysis has shown that this is incorrect and the *blu* mutants are in fact alleles of *hy4* (Jenkins *et al.*, 1995). The genetics are not straightforward because *HY4* is incompletely dominant (Koornneef *et al.*, 1980). The fact that both *blu1* and *hy4* show almost normal responsiveness to UV-A suggests that yet another photoreceptor is active at shorter wavelengths and that the perception of B and UV-A is not mediated by a single photoreceptor (Young *et al.*, 1992). The fact that phototropism and B inhibition of hypocotyl elongation are genetically separable (Liscum *et al.*, 1992), also indicates that these processes are controlled by different B photoreceptors.

Ahmad and Cashmore (1993) cloned the *HY4* gene by T-DNA tagging. The *HY4* gene encodes a 75-kDa flavoprotein with sequence homology to microbial DNA photolyases, which catalyzes a DNA-repair which is mediated by B and UV-A. Lin *et al.* (1995a) proposed the name cryptochrome (CRY1) for this B photoreceptor mediating B-dependent inhibition of hypocotyl elongation in *Arabidopsis*. CRY1 can bind two types of chromophores simultaneously, a flavin and a pterin (Lin *et al.*, 1995b; Malhotra *et al.*, 1995). Overexpression the CRY1 protein in transgenic tobacco results in increased sensitivity to B (Lin *et al.*,

1995a). Recently, Ahmad and Cashmore (1996) reported *CRY2*, with a *CRY1*-related sequence in the *Arabidopsis* genome, giving evidence for a small *CRY* gene family.

Liscum and Briggs (1995) reported the isolation of *nph* mutants at four loci (*NPH1-4*) in *Arabidopsis* that lack or have severely impaired phototropic responses. The *Arabidopsis* JK224 and JK218 phototropic mutants reported earlier (Khurana and Poff, 1989) were shown to be alleles of *nph1* and *nph3*, respectively. The putative NPH1 photoreceptor apoprotein regulates all the phototropic responses in *Arabidopsis* and is genetically and biochemically distinct from the HY4 (*CRY1*) apoprotein. They both have a different light-harvesting chromophore composition (Short and Briggs, 1994; Liscum and Briggs, 1995; Ahmad and Cashmore, 1996). In contrast to the *nph* mutants, which are defective in shoot and root phototropism, the *rpt* (root phototropism) mutants at three loci (*RPT1-3*) in *Arabidopsis* (Okada and Shimura, 1992) are specifically defective in root phototropism.

### 1.5.3 Transduction chain mutants

A signal transduction chain mutant that is specific for a photoreceptor should have the same phenotype as a photoreceptor mutant for the photoreceptor concerned. It is clear that the screens used for a particular photoreceptor would be expected to pick up mutants in its transduction chain. This appears not to have been the case and although photoreceptor mutants have been found in many species there are very few mutants in the down-stream reactions initiated as a consequence of photoexcitation. On the one hand, this may indicate that the elements of the signal transduction chain share critical steps with other signalling processes in cells and any such mutants are lethal. On the other hand, there may be genetic redundancy for these important steps in photoreceptor signalling.

Mutants in regulatory genes of seedling development can be pleiotropic or specific for particular responses. The *Arabidopsis hy5* (Koornneef *et al.*, 1980), *fhy1* and *fhy3* mutants (Whitelam *et al.*, 1993) show the D-grown characteristic of long hypocotyls when grown in R, FR and B for the *hy5* mutant; and only in FR for the *fhy1* and *fhy3* mutants, resembling the *phyA* photoreceptor mutants. The *FHY1* and *FHY3* gene products presumably act downstream of *PHYA* in transmitting a signal specific for phyA (Johnson *et al.*, 1994), whereas the *HY5* gene product may integrate the signals from multiple photoreceptors to mediate inhibition of hypocotyl cell elongation in response to B, R and FR downstream of phyA, phyB and *CRY1* (Chory, 1992; Von Arnim and Deng, 1996). Recently, a mutant reduced in *CAB* gene expression was described and designated as *cue* (C*A*B u*n*d*e*r*e*x*p*r**e*s*s*e*d*) at one locus (*CUE1*) in *Arabidopsis* (Li *et al.*, 1995). The *cue1* mutant is an example of mutants defective in the light-dependent expression*

of specific genes and the *CUE1* gene has been identified as a positive regulator of light-dependent nuclear and plastid gene expression (Li *et al.*, 1995).

Another class of mutants display a light-grown phenotype when grown in the D. These mutants display a constitutive light response and are designated as *det* (*de-etiolated*; Chory *et al.*, 1989b) at three loci (*DET1-3*); as *cop* (constitutive photomorphogenic; Deng *et al.*, 1991) at eight loci (*COP1-4, 8-11*); and as *fus* (*fusca*; Castle and Meinke, 1994; Miséra *et al.*, 1994) at four loci (*FUS4-5, 11-12*) in *Arabidopsis*; and as *lip* (light-independent photomorphogenesis) at one locus (*LIP1*) in pea (Frances *et al.*, 1992). The pleiotropic mutations in the *DET1* (Chory *et al.*, 1989b; Chory and Peto, 1990); *COP1* (Deng *et al.*, 1991; Deng and Quail, 1992); *COP9* (Wei and Deng, 1992; Wei *et al.*, 1994a); *COP8, COP10-11* (Wei *et al.*, 1994b); *FUS4-5, 11-12* (Miséra *et al.*, 1994) loci display most light-grown characteristics in D, including expression of photosynthetic genes, inhibition of hypocotyl elongation, cotyledon unfolding and chloroplast and leaf development. The similarity of the phenotypes corresponding to the 10 pleiotropic mutations suggests that their gene products may interact (McNellis and Deng, 1995; Von Arnim and Deng, 1996; Kwok *et al.*, 1996).

Mutations in the *DET2* (Chory *et al.*, 1991); *DET3* (Cabrera y Poch *et al.*, 1993); *COP2-4* (Hou *et al.*, 1993); *DOC1-3* (dark overexpression of *gab*; Li *et al.*, 1994); *AMPL* (altered meristem program; Chaudhury *et al.*, 1993); *GUNI-3* (genome uncoupled; Susek *et al.*, 1993); *PRC1* (procuste; Desnos *et al.*, 1996); and *ICX1* (increased chalcone synthase expression; Jackson *et al.*, 1995) loci are less pleiotropic and regulate specific subsets of seedling photomorphogenesis. Although these mutants all have phenotypes in D, exhibiting a partially de-etiolated phenotype in the absence of light, they are either dwarf or lethal when grown in the light. The recessive nature of all *DET, COP, FUS* and *LIP* mutants has led to the hypothesis that they encode repressors or components of repressor complexes which normally endow a plant with the capacity for etiolation in the absence of light (Vierstra, 1993; McNellis and Deng, 1995). Photomorphogenesis appears to be a default developmental pathway, which must be repressed in the D to allow etiolation to occur (Wei *et al.*, 1994b). The *COP/DET/FUS/LIP* gene products might function as a developmental switch involved in light signal transduction and also contribute to the repression of photomorphogenic responses in seedling roots under light conditions. There are also clues for multiple transduction pathways, integrating light and hormonal effects. Treatment of WT *Arabidopsis* seedlings with cytokinin or abscisic acid leads to phenocopies of *det1* and *fus* mutants (Chory *et al.*, 1994; Castle and Meinke, 1994). Recently, it was established that *DET2* encodes a reductase in brassinosteroid metabolism (Li *et al.*, 1996). Brassinosteroids are a recently defined new class of plant hormones (Sakurai and Fujioka, 1993). The WT phenotype of *det2* can be rescued by application of brassinolide (Li *et al.*, 1996).

Analysis of the phenotypes of double mutants (epistasis) can define the order of gene action within a pathway, and helps to elucidate the organization and complexity of branched and/or parallel pathways. Double mutants with *hy5* demonstrate that *hy5* is epistatic to the *det/cop/fus* mutants and it is possible that DET/COP/FUS directly interact with HY5 (Ang and Deng, 1994; Wei *et al.*, 1994a; 1994b).

Recently, two *shy* (suppressor of *hy2* mutation) mutants at two loci (*SHY1-2*) in *Arabidopsis* have been identified, that suppress the elongated hypocotyl phenotype of the *hy2* mutant (Kim *et al.*, 1996). Whereas *shy2* suppresses the *hy2* phenotype in both R and FR, *shy1* suppresses the *hy2* phenotype only in R, indicating that *shy1* may be specific for phyB signalling. Both mutants are dominant and also show photomorphogenic phenotypes when grown in D.

In tomato the *hp-1* (high-pigment-1) mutant exhibits exaggerated phytochrome responses, whereas the phytochrome content of etiolated seedlings and the characteristics of the phytochrome system are similar to that in WT (Adamse *et al.*, 1989; Peters *et al.*, 1989; 1992a). Therefore, so far, there is no evidence to suggest that the *hp-1* mutant is a photoreceptor mutant. In contrast to WT, the *hp-1* mutant does not require co-action of the B photoreceptor and phytochrome for normal development and exhibits maximum anthocyanin synthesis and hypocotyl growth inhibition in R alone *i.e.* the mutation mimics the action of B. On the basis of its recessive (loss-of-function) nature it was proposed that the phytochrome action in etiolated seedlings is under the constraint of the *HP-1* gene product (HP-1) (Peters *et al.*, 1992a). Both exposure to B and the *hp-1* mutation appear to result in reduction of HP-1 or its effectiveness. The exaggerated response of the *hp-1* mutant compared to WT fits the definition of "responsiveness amplification" proposed by Mohr (1994) to describe the amplification of a phytochrome response as a result of pre-irradiation which excites either the B photoreceptor or phytochrome. It was proposed that the *hp-1* mutation is associated with this amplification step in the phytochrome transduction chain (Peters *et al.*, 1992a). There are also mutants which are similar in some aspects to the *hp-1* mutant phenotype of tomato, but map to different loci, such as *hp-2* (high-pigment-2) (Soressi, 1975), *atv* (*atroviolacea*) (Rick, 1963) and *Ip* (Intense pigmentation) (Rick, 1974). The *lw* mutant of pea (Weller and Reid, 1993) has a similar phenotype and recently it has been reported that the *her* (hypocotyl elongation repressed) mutants of *Arabidopsis* are a further example of this class (Ichikawa *et al.*, 1996). A study of the photoregulation of phenylalanine ammonia lyase (PAL), a key enzyme in flavonoid biosynthesis, showed a higher level in the tomato *hp-1* mutant when compared to the WT level (Goud *et al.*, 1991). Goud and Sharma (1994) demonstrated that pulses of R are effective in the induction of amylase and nitrate reductase (NR) activity in the WT and that the *hp-1* mutant again exhibits an amplified response. This amplification of synthesis of enzymes in unrelated biochemical pathways points to action of the *HP-1* gene product at

some fundamental point in the photo-induced signal transduction chain leading to modification of gene expression.

## 1.6 Tomato as a model plant species

Tomato (*Lycopersicon esculentum* Mill.) is an excellent alternative model plant species to the almost universally adopted *Arabidopsis*. Tomato compares quite favourably in many respects and has the advantage that the seeds are relatively large and develop into seedlings which are more amenable to physiological, biochemical and biophysical analysis. Perhaps most important, from the point of view of our understanding of the control of plant growth and development in general, we must remember that the growth and development of a cruciferous rosette plant, such as *Arabidopsis*, may not be typical of all angiosperms. Therefore parallel studies on other species with a different growth habit are of great potential value. In addition, being an economically important crop, tomato is genetically well characterized and many mutants already exist, some of which have been shown to be photomorphogenic mutants (see above) and there are detailed genetic and RFLP maps available. Comparison of the *Arabidopsis* and tomato *PHY* families, which are the only two so far characterized in any detail, reveals notable differences. Exhaustive genomic Southern-blot analyses indicate that tomato has more than the five *PHYs* reported for *Arabidopsis* (Hauser *et al.*, 1995; Pratt *et al.*, in press).

## 1.7 Outline of the thesis

This thesis presents a molecularly and physiologically analysis of: the far-red light insensitive (*fri*) mutants of tomato (Chapter 2); the temporary red-light insensitive (*tri*) mutants of tomato (Chapter 3) and the phytochrome control of anthocyanin biosynthesis in these photomorphogenic mutants and newly derived double mutants of tomato (Chapter 4). In Chapter 5 exaggerated-photoresponse mutants, high-pigment-1 (*hp-1*), high-pigment-2 (*hp-2*), *atroviolacea* (*atv*) and Intensive pigmentation (*Ip*) of tomato are presented. The shade-avoidance response and fruit development of *hp-1* and *au* mutants of tomato are reported in Chapter 6. A custom-built, high-resolution plant growth-measuring apparatus is described in Chapter 7 and the analysis of growth of WT and photomorphogenic mutants of tomato with and without end-of day FR is presented in Chapter 8. The thesis is concluded with a general discussion (Chapter 9).

## 1.8 Published work

List of publications related or derived from the work described in this thesis:

- Kerckhoffs, L.H.J.**, R.E. Kendrick, G.C. Whitelam and H. Smith (1992). Extension growth and anthocyanin responses of photomorphogenic tomato mutants to changes in the phytochrome photoequilibrium during the daily photoperiod. *Photochem. Photobiol.* **56**: 611–615.
- Koornneef, M., A. van Tuinen, **L.H.J. Kerckhoffs**, J.L. Peters and R.E. Kendrick (1992). Photomorphogenetic mutants of higher plants. In: *Progress in Plant Growth Regulation* (Edited by C.M. Karssen, L.C. van Loon and D. Vreugdenhil), pp. 54–64. Kluwer Academic Publishers, Dordrecht, the Netherlands.
- Kendrick, R.E., **L.H.J. Kerckhoffs**, A.S. Pundsnes, A. van Tuinen, M. Koornneef, A. Nagatani, M.J. Terry, A. Tretyn, M.-M. Cordonnier-Pratt, B. Hauser and L.H. Pratt (1994). Photomorphogenic mutants of tomato. *Euphytica* **79**: 227–234.
- Kendrick, R.E., J.L. Peters, **L.H.J. Kerckhoffs**, A. Van Tuinen and M. Koornneef (1994). Photomorphogenic mutants of tomato. In: *Molecular Botany: Signals and the Environment* (Edited by D.J. Bowles, P.M. Gilmartin, J.P. Knox and G.G. Lunt), pp.249–256. Portland Press, London, UK.
- Van Tuinen, A., **L.H.J. Kerckhoffs**, A. Nagatani, R.E. Kendrick and M. Koornneef (1995). Far-red light-insensitive, phytochrome A-deficient mutants of tomato. *Mol. Gen. Genet.* **246**: 133–141.
- Van Tuinen, A., **L.H.J. Kerckhoffs**, A. Nagatani, R.E. Kendrick and M. Koornneef (1995). A temporarily red light-insensitive mutant of tomato lacks a light-stable, B-like phytochrome. *Plant Physiol.* **108**: 939–947.
- Kerckhoffs, L.H.J.**, A. Van Tuinen, B.A. Hauser, M.-M. Cordonnier-Pratt, A. Nagatani, M. Koornneef, L.H. Pratt, R.E. Kendrick (1996). Molecular analysis of *tri*-mutant alleles in tomato indicates the *Tri* locus is the gene encoding the apoprotein of phytochrome B1. *Planta* **199**: 152–157.
- Van Tuinen, A., C.J. Hanhart, **L.H.J. Kerckhoffs**, A. Nagatani, M.T. Boylan, P.H. Quail, R.E. Kendrick and M. Koornneef (1996). Analysis of phytochrome-deficient *yellow-green-2* and *aurea* mutants of tomato. *Plant J.* **9**: 173–182.
- Kerckhoffs, L.H.J.**, M.E.L. Schreuder, A. Van Tuinen, M. Koornneef and R.E. Kendrick (in press). Phytochrome control of anthocyanin biosynthesis in tomato seedlings: analysis using photomorphogenic mutants. *Photochem. Photobiol.*
- Kerckhoffs, L.H.J.**, N.A.M.A. De Groot, A. Van Tuinen, M.E.L. Schreuder, A. Nagatani, M. Koornneef and R.E. Kendrick (in press). Physiological characterization of exaggerated-photo-response mutants of tomato. *J. Plant Physiol.*
- Kerckhoffs, L.H.J.**, P. Adamse, W.J.M. Tonk, R. Van Ginkel, J. Van Kreef, A. Veenendaal, T.P.L. Ruyter, W.F. Buurmeijer, R.M. Bouma and R.E. Kendrick (in press). A high-resolution plant growth-measuring apparatus to study stem growth kinetics. *Sci. Hort.*
- Kerckhoffs, L.H.J.**, M. Sengers and R.E. Kendrick (in press). Growth analysis of wild-type and photomorphogenic-mutant tomato plants. *Physiol. Plant.*
- Pratt, L.H., M.-M. Cordonnier-Pratt, B.A. Hauser, R.M. Alba, P.M. Kelmenson, R.E. Kendrick, M. Matsui, G.I. Lazarova, T. Kubota, T. Tsuge, S. Frances, M. Szell, J.L. Peters, **L.H.J. Kerckhoffs**, M. Koornneef and A. Van Tuinen (in press). Phytochrome family and functions in tomato. In: *Proceedings of the 12th International Photobiology Congress*, Vienna, Austria.

# CHAPTER 2

## Analysis of far-red light-insensitive mutants indicates the *FRI* locus is the gene encoding the apoprotein of phytochrome A in tomato

**Abstract.** Two monogenic recessive mutants of tomato (*Lycopersicon esculentum* Mill.) at the far-red light insensitive (*FRI*) locus (*fri*<sup>1</sup> and *fri*<sup>2</sup> in the genetic background cultivar MoneyMaker) have been studied. These mutants, which are allelic, are totally insensitive to far-red light (FR) resulting in an etiolated phenotype (long hypocotyls and rudimentary cotyledons). In white light these mutants are hardly distinguishable from the wild type (WT). Western-blot analysis shows that the phytochrome A polypeptide is essentially absent in the *fri* mutants as is the bulk spectrophotometrically detectable labile phytochrome pool in etiolated seedlings. A phytochrome B-like polypeptide is present in normal amounts compared to WT and a low stable phytochrome pool can be readily detected by spectrophotometry in the *fri* mutants. Northern-blot analysis shows a selective modification of *PHYA* transcripts in both *fri* alleles, resulting in two bands in both mutants, whereas only one band is seen in the case of WT. In these mutants the transcripts of other members of the tomato phytochrome gene family (*PHYB1*, *PHYB2*, *PHYE* and *PHYF*) were indistinguishable in size and abundance from WT. Thus, it appears that the *fri* locus specifically affects *PHYA* gene expression. Inhibition of hypocotyl growth by a R pulse given every 4 h, is quantitatively similar in the *fri* mutants and WT and the effect is to a large extent red light (R)/FR reversible. Adult plants of the *fri* mutants show retarded growth and are prone to wilting in the greenhouse, but exhibit a normal elongation response to FR given at the end of the daily photoperiod. It is proposed that the *fri* mutants are phytochrome A mutants which have normal pools of other phytochromes.

### 2.1 Introduction

Photomorphogenesis in plants is regulated by different groups of photoreceptors: phytochromes, which exist in two photochromic forms, Pr and Pfr, absorbing red light (R) and far-red light (FR), respectively; a blue light (B)/UV-A-absorbing photoreceptor often referred to as cryptochrome, and a UV-B-absorbing photoreceptor. The phytochrome photoreceptor system is the best characterized photoreceptor in higher plants and plays an important role in mediation of plant developmental responses to light throughout the life cycle of plants. The phytochromes control processes such as seed germination, de-etiolation (inhibition of

*This chapter has in part been published:*

Van Tuinen and Kerckhoffs *et al.* (1995). *Mol. Gen. Genet.* **246**: 133–141.



hypocotyl growth, opening of the apical hook, expansion of the cotyledons, development of chloroplasts, accumulation of anthocyanin), shade avoidance and induction of flowering (Kendrick and Kronenberg, 1994). Phytochrome not only exists in multiple types, but also works *via* different modes *e.g.* a low fluence response (LFR), which is R/FR reversible and a high irradiance response (HIR) which is irradiance and duration dependent (Mancinelli, 1994).

The phytochrome (phy) family of photoreceptors in *Arabidopsis* consists of five members, phyA, phyB, phyC, phyD and phyE, whose apoproteins PHYA, PHYB, PHYC, PHYD and PHYE are encoded by a corresponding number of divergent genes, designated *PHYA*, *PHYB*, *PHYC*, *PHYD* and *PHYE*, respectively (Sharrock and Quail, 1989; Clack *et al.*, 1994). The *PHYA* and *PHYB* genes are also present in rice (Dehesh *et al.*, 1991), potato (Heyer and Gatz, 1992a; 1992b) and tobacco (Adam *et al.*, 1993; Kern *et al.*, 1993). *PHYA*, *PHYB* and *PHYC* genes are present in sorghum (Pratt, 1995). It has recently been established that the *PHY* gene family in tomato (*Lycopersicon esculentum* Mill.) is even more complex and so far five members have been identified: *PHYA*, *PHYB1*, *PHYB2*, *PHYE* and *PHYF*, and there may be as many as nine to thirteen members in total (Pratt, 1995; Hauser *et al.*, 1995). Through comparisons of peptide sequence and deduced amino acid sequence, it is accepted that among these members of the phytochrome gene family, the *PHYA* gene encodes the well-characterized light-labile phytochrome or type I phytochrome (Quail, 1991). In etiolated plant tissue phyA accumulates to relatively high levels in etiolated plant tissue, but is rapidly degraded upon exposure of such tissue to R or white light (WL) to levels that are very low in pea (Abe *et al.*, 1985) and *Arabidopsis* (Sharrock and Quail, 1989; Somers *et al.*, 1991) or undetectable in oat (Pratt *et al.*, 1991). This depletion is due to degradation of Pfr and to light-mediated down-regulation of *PHYA* gene expression (Quail, 1991). Although phyA is still present in fully de-etiolated plants, type II or light-stable phytochromes, such as phyB, phyC, phyD and phyF predominate (Quail, 1991; Pratt, 1995).

The existence of multiple phytochrome species together with the diversity of phytochrome responses and response modes have led to the conclusion that different phytochromes may have discrete roles or functions (Smith and Whitelam, 1990; Whitelam and Harberd, 1994). The use of mutant and transgenic plants having either reduced (or null) or overexpressed levels of specific phytochrome species has greatly advanced the current understanding of phytochrome function. So far three types of phytochrome mutants have been characterized: (i) mutants deficient in the biosynthesis of phytochrome chromophore in *Arabidopsis* (Parks and Quail, 1991), *Nicotiana plumbaginifolia* (Kraepiel *et al.*, 1994), pea (Weller *et al.*, 1996) and tomato (Terry and Kendrick, 1996) and thus causing a corresponding depletion in the levels of active phytochrome (both light-labile and light-stable phytochromes); (ii) mutants deficient in phyB in *Arabidopsis* (Reed *et al.*, 1993), cucumber (López-Juez *et al.*, 1992), *Brassica* (Devlin *et al.*, 1992), pea

(Weller *et al.*, 1995a) and sorghum (Childs *et al.*, 1992; 1996); (iii) mutants deficient in phyA, so far only described in *Arabidopsis*: *hy8* (Parks and Quail, 1993; Dehesh *et al.*, 1993), *fre* (Nagatani *et al.*, 1993) and *fhy* (Whitelam *et al.*, 1993) mutants, which all carry lesions in the structural gene for phytochrome A (Dehesh *et al.*, 1993; Whitelam *et al.*, 1993; Reed *et al.*, 1994).

The phyB-deficient mutants indicate that phytochrome B is primarily responsible for R perception during de-etiolation. The phyA-deficient mutants in *Arabidopsis* are defective in responsiveness to FR (Parks and Quail, 1993). These observations are consistent with physiological studies that indicate a light-labile phytochrome is responsible for the FR-mediated hypocotyl growth inhibition of etiolated seedlings, *via* the so-called FR-HIR and that a light-stable phytochrome mediates the effect of R (Beggs *et al.*, 1980).

In tomato, which is an attractive model system because of its favourable size for physiological experiments, the extensively studied *au* mutant has been considered a phyA-deficient mutant. Recently, it has been established that the *au* mutant is deficient in biosynthesis of the phytochrome chromophore (Terry and Kendrick, 1996) and consequently deficient in all types of phytochromes. In an endeavour to search for type-specific phytochrome mutants in tomato, we have screened for mutants under different broad-band wavelengths in an attempt to avoid 'escape' of mutants with minor phenotypic effects in WL.

In this chapter a physiological characterization and an analysis at the levels of spectrophotometrically detectable phytochrome, phytochrome apoproteins and mRNAs will be presented for two mutants, shown to be allelic, which are insensitive to FR. These results indicate they are putative mutants in the structural gene that encodes for the PHYA apoprotein.

## **2.2 Materials and methods**

### **2.2.1 Plant material**

#### *2.2.1.1 Mutant isolation*

Two monogenic recessive mutants of tomato (*Lycopersicon esculentum* Mill.) cultivar MoneyMaker (MM) were obtained by treating seeds with ethyl methane sulphonate (EMS) for 24 h in darkness (D) at 25 °C (Koornneef *et al.*, 1990). The population of  $M_1$  plants was divided into groups of approximately 10 plants and per group  $M_2$  seeds were harvested. The  $M_2$  seed groups were screened for mutants with phenotypes deviating from wild type (WT) in continuous broad-band R and blue light (B). Two independently induced mutants 1-7RL and 1-17BL were selected for their slightly longer hypocotyls in R and B, respectively.

In a broad-band spectral scan both mutants, unlike the WT, were shown to be completely insensitive to FR and therefore the gene symbol *fri* (far-red light insensitive) is proposed for these mutants. Genetic complementation analysis showed that the two mutants were allelic (Van Tuinen *et al.*, 1995a). At the seedling stage, the 1-7RL is more extreme than the 1-17BL and we refer to them as *fri*<sup>1</sup> and *fri*<sup>2</sup>, respectively. Under continuous FR the progeny of selfed F<sub>1</sub> plants from the cross between the new mutant lines and the WT parent segregated in a 3:1 ( $\chi^2 = 3.59$ ,  $p > 0,05$ ) ratio of normal to elongated hypocotyls expected for a monogenic recessive mutation (Van Tuinen *et al.*, 1995a).

### 2.2.1.2 Pretreatment of the seeds

**Surface sterilization.** In all experiments seeds were surface sterilized for 5 min in a 1/10 (v/v) dilution of commercial bleach (7 % [w/v] NaClO<sub>3</sub>) and washed thoroughly for 10 min in running tap water before sowing.

**Pregermination.** To obtain a higher germination percentage and to synchronize the time of emergence, seeds were pregerminated before final sowing under dim-green safelight. The surface-sterilized seeds were sown in plastic boxes with transparent lids (10x10x7 cm) on one layer of filter paper (T300-45 mm; Schut, Heelsum, the Netherlands) moistened with 7.4 mL germination buffer (10 mM NaH<sub>2</sub>PO<sub>4</sub>·H<sub>2</sub>O, 10 mM K<sub>2</sub>HPO<sub>4</sub>, 5 mM KNO<sub>3</sub>, pH 7.5) after Georghiou and Kendrick (1991) and placed in light-tight boxes in a darkroom at 25 °C. After 48 h of pretreatment, the pregerminated seeds (showing radicle emergence) were planted out under dim-green safelight in plastic trays (30x20x5 cm) or plastic pots (9x9x10 cm) filled with a potting compost/sand mixture (3:1, v/v).

### 2.2.1.3 Growth conditions

All experiments were performed at a constant temperature of 25 °C and a relative humidity (RH) of 70 %. Experiments carried out in plastic trays and pots were carefully watered with a watering can once a day under experimental conditions, *e.g.* D-controls (viewed under safelight) were watered under dim-green safelight and absolute D controls were watered in absolute D. Where indicated, plants were manipulated in dim-green safelight with a fluence rate of *ca.* 30 nmol.m<sup>-2</sup>.s<sup>-1</sup>.

## 2.2.2 Phytochrome assays

### 2.2.2.1 Growth of plant material for the phytochrome assays

**Seedlings.** Surface-sterilized seeds were sown on 0.6 % (w/v) agar-medium containing 0.46 g.L<sup>-1</sup> Murashige-Skoog basal salts (Murashige and Skoog, 1962) in plastic plant tissue culture containers (Plantcon; Flow Laboratories Inc., McLean, VA, USA). For spectrophotometry and Western-blot analysis, seedlings were grown at 25 °C for 4 days either in D or irradiated with R (20 μmol.m<sup>-2</sup>.s<sup>-1</sup>) for 1–4 h prior to harvest. The upper 1 cm of the hypocotyls, including the

cotyledons, were harvested under dim-green safelight after gently removing any remaining seed coats. For *in-vivo* spectrophotometry the samples were collected on ice and used immediately. Samples for immunoblotting were frozen in liquid nitrogen and stored at  $-80^{\circ}\text{C}$  before analysis. For Northern-blot analysis seedlings were grown at  $25^{\circ}\text{C}$  for 4 days in D. Whole seedlings were harvested, weighed, frozen in liquid nitrogen, ground to a fine powder and stored at  $-80^{\circ}\text{C}$  before analysis.

*White-light grown plants.* For Western-blot analysis plants were grown in pots containing a 2:3 (v/v) granular-clay based compost/vermiculite mixture in a 16-h WL ( $150\ \mu\text{mol}\cdot\text{m}^{-2}\cdot\text{s}^{-1}$  photosynthetically active radiation [PAR])/8-h D cycles in a phytotron (Koitoiron KG-206HL-D; Koito, Tokyo, Japan) in Japan at  $25^{\circ}\text{C}$ . Twenty-one days after sowing, leaf samples were harvested (only leaflets were used, obtained from leaf number 2 and 3), weighed and frozen in liquid nitrogen and stored at  $-80^{\circ}\text{C}$  before extraction for immunoblotting. For Northern-blot analysis plants were grown for 18 days in potting-compost in a greenhouse (Athens, GA, USA) without supplementary lighting. Complete plants were harvested usually in mid-afternoon, frozen in liquid nitrogen, ground to a fine powder and stored at  $-80^{\circ}\text{C}$  before analysis.

#### 2.2.2.2 *In-vivo phytochrome spectrophotometry*

*Dual-wavelength spectrophotometry.* All *in-vivo* spectrophotometric measurements of total spectrophotometrically detectable phytochrome (Ptot) were made using a dual-wavelength recording spectrophotometer (model 557; Hitachi, Tokyo, Japan). For each measurement about 0.4 g tissue (collected from 40 seedlings) was gently packed into a precooled custom-built stainless steel cuvette with glass windows (10 mm in diameter and about 4-mm path length). All samples were kept at  $4^{\circ}\text{C}$  during measurements. The phytochrome content was measured using alternating monochromatic 730 and 800 nm measuring beams (at 100 Hz), resulting in a difference in absorbance between 730 and 800 nm ( $\Delta A_{730-800}$ ). The spectrophotometer was equipped with an actinic irradiation unit for photoconverting the sample with saturating irradiations of R (30 s) and FR (60 s). These actinic irradiations were sufficient to induce essentially full photoconversion, as determined by kinetic measurements. The Ptot is measured by subtracting the  $\Delta A_{730-800}$  after a FR irradiation from that after a R irradiation and expressed as  $\Delta(\Delta A_{730-800})/40$  seedlings  $\pm$  standard error (SE). The detection limit of the spectrophotometer is  $2\cdot 10^{-4}\Delta(\Delta A_{730-800})$ .

*Difference spectrophotometry.* Difference spectra were made using a recording difference spectrophotometer (model 3410; Hitachi) by subtracting the absorption spectrum determined after saturating irradiation of FR (60 s) from that measured after R (30 s). The absorption spectra were determined between 550 and 800 nm with a scan speed of  $120\ \text{nm}\cdot\text{min}^{-1}$ .

2.2.2.3 Western-blot analysis

*Phytochrome extraction from seedlings.* After adding 20 mg insoluble polyvinylpyrrolidone (PVP) about 0.2 g (collected from 20 seedlings) frozen material was homogenized in 0.2 mL extraction buffer [= 100 mM Tris-Cl (pH 8.3 at 25 °C), 50 % (v/v) ethylene glycol, 140 mM ammonium sulphate, 56 mM 2-mercaptoethanol, 20 mM sodium bisulphate, 10 mM EDTA, 4 mM phenylmethylsulphonyl fluoride, and additional protease inhibitors: aprotinin (2  $\mu\text{g}\cdot\text{mL}^{-1}$ ) leupeptin (2  $\mu\text{g}\cdot\text{mL}^{-1}$ ), pepstatin A (1  $\mu\text{g}\cdot\text{mL}^{-1}$ ) and 4 mM iodoacetamide]. Tissue was homogenized at full speed for 1 min in a microfuge tube precooled with liquid nitrogen using an homogenizer, which just fitted inside the tube. The homogenate was centrifuged at 0 °C for 15 min at 18,000 g in a microfuge and the supernatant was carefully collected. The supernatant was mixed directly with 2x standard concentration sodium dodecyl sulphate (SDS)-sample buffer. The samples (ca. 0.8 mL) contained the final concentrations: 62.5 mM Tris-Cl (pH 6.8 at 25 °C), 2 % (w/v) SDS, 10 % (v/v) glycerol, 5 % (v/v) 2-mercaptoethanol and 0.001 % (w/v) bromophenol blue as the dye (Laemmli, 1970) and heated to 100 °C for 2 min to dissociated the proteins completely, transferred on ice, and centrifuged at 12,000 g for 2 min. Subsequently 5  $\mu\text{L}$  was immediately used for the SDS-PAGE and the remainder was stored at -20 °C for further analysis.

*Phytochrome extraction from leaves.* About 0.5 g of frozen leaves were homogenized after adding 50 mg insoluble PVP in 0.5 mL extraction buffer, using a blender (Phycotron; Niti-on, Tokyo, Japan) at full speed for 1 min. The homogenate was centrifuged at 0 °C for 15 min at 15,000 g. The supernatant was carefully collected and polyethylenimine was added to a final concentration of 0.1 %. The extract was vortexed and after centrifugation for 10 min at 12,000 g saturated ammonium sulphate solution (0.725:1, v/v) was added to the supernatant and the extract was gently stirred for 30 min. The ammonium sulphate precipitate was collected by centrifugation at 12,000 g for 15 min, directly resuspended into 1x SDS-sample buffer and heated to 100 °C for 2 min, transferred on ice and centrifuged at 12,000 g for 2 min. Subsequently, 4  $\mu\text{L}$  was immediately used for the SDS-PAGE and the remainder was stored at -20 °C for further analysis.

*SDS-PAGE.* Proteins were electrophoresed in 6.5 % (w/v) SDS-polyacrylamide gels, using prestained molecular mass standards (SDS-7B markers; Sigma, St. Louis, MO, USA). The apparent molecular mass of these prestained markers was recalibrated using high molecular mass standards (SDS-6H markers; Sigma).

*Immunoblotting.* After separation by SDS-PAGE, polypeptides were electroblotted onto a nylon filter (FineBlott; Atto, Tokyo, Japan) in 100 mM Tris-Cl, 192 mM glycine and 25 % (v/v) methanol. The membranes were blocked in a series of Tris-Cl buffer-saline Tween (TBST) solutions, all containing 20 mM Tris-Cl (pH 7.5 at 25 °C), and varying Tween-20 and NaCl concentrations: (i) 2 % (v/v) Tween and 500 mM NaCl for 3 min; (ii) 0.05 % (v/v) Tween and 500 mM

NaCl for 10 min; (iii) 0.05 % (v/v) Tween and 150 mM NaCl for 5 min. Incubation with the primary antibody was in 20 mM Tris-Cl (pH 7.5 at 25 °C), 150 mM NaCl and 1 % (w/v) fat-free milk powder. The monoclonal antibodies to PHYA and PHYB were mAP5 (Nagatani *et al.*, 1984) and mAT1 (López-Juez *et al.*, 1992) at 2 µg.mL<sup>-1</sup> and as a 1:1 dilution of hybridoma culture supernatant, respectively. Incubation was at room temperature for 2 h. After washing three times in 20 mM Tris-Cl (pH 7.5 at 25 °C), 0.05 % (v/v) Tween and 150 mM NaCl, the membranes were incubated for 45 min with a 1:5000 dilution of alkaline-phosphatase-conjugated goat antibodies to mouse immunoglobulin G (IgG), washed and stained for alkaline phosphatase according to the manufacturer's instructions (Protoblot kit; Promega, Madison, WI, USA).

#### 2.2.2.4 Northern-blot analysis

*Poly(A<sup>+</sup>) extraction.* About 0.2 g of frozen powder and 1.8 mL of RNase-free lysis buffer [= 0.1 M Tris-Cl (pH 8.0 at 25 °C), 0.5 M lithium chloride, 10 mM EDTA (pH 8.0), 1 % (w/v) lithium laurylsulfate (LiDS), 5 mM dithiothreitol (DTT) and 100 U RNasin (Promega)], were homogenized with a Vortex for 30 s. Poly(A<sup>+</sup>) RNA was purified using magnetic Dynabeads M-280 oligo(dT)<sub>25</sub> (DynaL, Skøyen, Oslo, Norway) according to the manufacturers instructions and collected in 400 µL deionized and distilled water, treated with diethylpyrocarbonate (DEPC). The concentration of poly(A<sup>+</sup>) RNA was measured spectrophotometrically (HP 8452A Diode Array Spectrophotometer; HewlettPackard, Palo Alto, CA, USA) at A<sub>260</sub> (Sambrook *et al.*, 1989).

*Agarose gel electrophoresis and Northern transfer.* Between 0.35–1.5 µg of poly(A<sup>+</sup>) RNA was dissolved in a volume of 20 µL, consisting of 50 % deionized formamide, 1x RNA electrophoresis buffer [= 20 mM 3-(N-morpholino)propane-sulphonic acid (MOPS), 5 mM sodium acetate, 1 mM EDTA, pH adjusted to 7.0 with NaOH at 25 °C], 5 % (v/v) deionized formaldehyde, 8 % (v/v) glycerol, 25 µg.mL<sup>-1</sup> ethidium bromide and 0.002 % (w/v) bromophenol blue. After incubating at 68 °C for 10 min and a subsequent transfer on ice-water for 2 min, this denatured RNA was electrophoresed through a 1 % (w/v) agarose gel containing 3 % deionized formaldehyde in 1x RNA electrophoresis buffer, using a 0.24–9.5 kb RNA ladder as nucleic acid molecular size standard (Gibco BRL, Gaithersburg, MD, USA). The RNA in the gel was blotted to Gene Screen Plus membrane (NEN/DuPont, Boston, MA, USA) in 10x SSC [= 1.5 M NaCl, 0.15 M sodium citrate, pH 7.0] according to the manufacturer's instructions. RNA was cross-linked to the nylon membrane with 120 mJ.cm<sup>-2</sup> of UV (FB-UUVXL-1000; Fisher Scientific, Pittsburgh, PA, USA).

*Synthesis of complementary RNAs.* Radiolabelled complementary RNA (cRNA) probes were transcribed from pTΔΦA-1, pTΔΦB1-1, pTΔΦB2-1, pTΔΦE-1, pTΔΦF-1 plasmids (Hauser *et al.*, 1995) digested with *bam*H I endonuclease. Probes were synthesized at 37 °C for 45 min in a volume of 20 µL, consisting of

1x transcription-buffer [= 40 mM Tris-Cl (pH 7.5 at 22 °C), 400  $\mu$ M rATP, 400  $\mu$ M rGTP, 400  $\mu$ M rCTP, 6.0 mM MgCl<sub>2</sub>, 4.0 mM spermidine], 10 mM DTT, 20  $\mu$ M rUTP, 0.5  $\mu$ g template DNA, 3.7 MBq <sup>32</sup>P-rUTP (specific activity: 111 TBq.mmol<sup>-1</sup>; ICN Biomedicals, Irvine, CA, USA), 40 U RNasin (Promega), and 20 U T3 RNA polymerase (Promega). The actin probe was obtained from pAAc2-1 plasmids (provided by R. Meagher, University of Georgia, Athens, GA, USA) which contains an *Arabidopsis ACTIN* gene. This plasmid was digested with *Xba* I endonuclease, after which a cRNA was transcribed using SP6 RNA polymerase (Promega) instead of T3 RNA polymerase. The DNA templates were destroyed by adding 50 ng DNase I.  $\mu$ L<sup>-1</sup> of the transcription reaction mixture and incubating at 37 °C for 10 min. Unincorporated radioactivity was removed by purification through a Qiagen Tip-20 (Qiagen, Chatsworth, CA, USA) according to the manufacturer's instructions for purification of RNA run-on transcripts.

**RNA hybridization.** The RNA blots were prehybridized at 68 °C for at least 4 h in 50 % deionized formamide, 500 mM sodium phosphate (pH 7.0), 1 % SDS and 100  $\mu$ g.mL<sup>-1</sup> heat-denatured and sonicated single-stranded salmon sperm DNA in 5x SSPE [= 0.9 M NaCl, 50 mM Na<sub>3</sub>PO<sub>4</sub>, 5 mM EDTA (pH 7.5 at 25 °C) (Sambrook *et al.*, 1989)] and 1x Denhardt's solution [= 0.02 % (w/v) Ficoll, 0.02 % (w/v) bovine serum albumin (BSA), 0.02 % (w/v) PVP (Sambrook *et al.*, 1989)]. Subsequently, approximately 1.8 MBq of radiolabelled *PHYA*, *PHYB1*, *PHYB2*, *PHYE*, *PHYF* and *ACTIN* cRNA transcribed as before from pT $\Delta$  $\Phi$ A-1, pT $\Delta$  $\Phi$ B1-1, pT $\Delta$  $\Phi$ B2-1, pT $\Delta$  $\Phi$ E-1, pT $\Delta$  $\Phi$ F-1, pAAc2-1, respectively (Hauser *et al.*, 1995), were added to the prehybridization solution together with an additional 100  $\mu$ g.mL<sup>-1</sup> sonicated single-stranded salmon sperm DNA and incubated overnight at 68 °C. The hybridized blots were rinsed 2x 5 min in 1x SSC, 1 % SDS at 68 °C and subsequently washed 3x 20 min in 0.1x SSC, 0.1 % SDS at 68 °C. Blots were exposed to X-ray film and PhosphorImager plates and images were subsequently obtained and analyzed with a Molecular Dynamics PhosphorImager (Model 425F; Molecular Dynamics, Sunnyvale, CA, USA) (Johnston *et al.*, 1990). Total actin transcript levels were used as an indicator to determine if equivalent amounts of RNA were present in different samples.

### 2.2.3 Anthocyanin assay

For the determination of anthocyanin, samples were extracted with 1.2 mL acidified (0.3 % HCl, v/v) methanol for 24 h in D while being shaken. A partitioning was performed by the addition of 0.9 mL H<sub>2</sub>O and 2.4 mL chloroform to the extracts (after Folch *et al.*, 1957). The samples were centrifuged for 30 min at 2000 g. The absorbance (A) of the top phase was determined spectrophotometrically (DU-64; Beckman Instruments, Fullerton, CA, USA) at 535 nm (A<sub>535</sub>).

## **2.2.4 Experiments**

### *2.2.4.1 Continuous broad-band light experiment*

Surface-sterilized and pregerminated seeds were sown in trays and incubated in D for 72 h at 25 °C. The irradiation with continuous B, R and FR ( $3 \mu\text{mol}\cdot\text{m}^{-2}\cdot\text{s}^{-1}$ ) was started just before the seedlings emerged through the soil surface (= day 0). The length of 20 hypocotyls (from soil surface to the hypocotyl hook or cotyledons after opening of the hypocotyl hook) under B, R, FR and in D (viewed under safelight) was measured with a ruler on a daily basis for 7 days. In addition, the hypocotyl length of 20 seedlings grown in absolute D for the duration of the experiment was measured. For determination of the anthocyanin, samples (4 replicates) of 5 hypocotyls were taken at the end of the experiment (day 7).

### *2.2.4.2 White-light experiment*

Surface-sterilized and pregerminated seeds were planted out under dim-green safelight in a potting compost/sand mixture in plastic trays and incubated in a phytotron in a 16-h WL ( $150 \mu\text{mol}\cdot\text{m}^{-2}\cdot\text{s}^{-1}$  PAR)/8-h D cycle at 25 °C. Every seedling was marked on emergence, making it possible to measure the hypocotyl length of each seedling after the appropriate number of WL/D cycles. The length of the 20 hypocotyls (from root to the hypocotyl hook or cotyledons after opening of the hypocotyl hook) of the seedlings was destructively measured on a daily basis for 7 days.

### *2.2.4.3 Light-pulse experiment*

Surface-sterilized and pregerminated seeds were sown in trays and incubated in D for 48 h at 25 °C. Pulses of R (3 min,  $8 \mu\text{mol}\cdot\text{m}^{-2}\cdot\text{s}^{-1}$ ) or R immediately followed by FR (6 min,  $7 \mu\text{mol}\cdot\text{m}^{-2}\cdot\text{s}^{-1}$ ), both saturating for attaining phytochrome photoequilibrium, were given every 4 h beginning at the time of emergence of the first seedlings. During the pulse irradiation 15 seedlings per treatment were marked individually on emergence enabling the measurement of hypocotyl length of each seedling after the appropriate number of pulses (6, 12, 18 or 24).

### *2.2.4.4 End-of-day FR experiment*

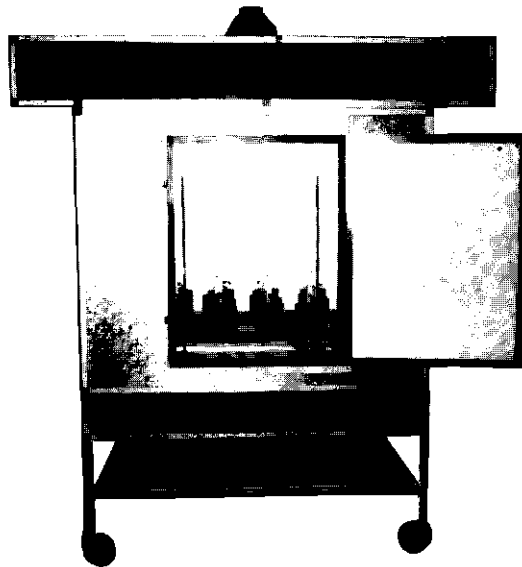
Surface-sterilized and pregerminated seeds were sown in pots and grown for 12 days in a phytotron in a 16-h WL ( $160 \mu\text{mol}\cdot\text{m}^{-2}\cdot\text{s}^{-1}$  PAR)/8-h D cycle at 25 °C RH of 65–70 %. At day 13, the plants were transferred to cabinets and allowed to adjust to the lower level of WL ( $60 \mu\text{mol}\cdot\text{m}^{-2}\cdot\text{s}^{-1}$  PAR) for 3 days. Plants were then selected for uniform height and after the daily WL period received an immediate 20 min FR ( $5 \mu\text{mol}\cdot\text{m}^{-2}\cdot\text{s}^{-1}$ ) irradiation, *i.e.* end-of-day FR (EODFR), before the D period (+ EODFR). The controls were grown in a similar cabinet and received no FR irradiation (– EODFR). Plant height (20 replicates) was measured every 3 days over a 12-day treatment with or without EODFR.



## 2.2.5 Light facilities and light measurements

### 2.2.5.1 Light cabinets

We designed 10 light cabinets, which are housed in the new dark-room facilities in the basement of the new wing of the department of Plant Physiology. The new custom-designed movable light cabinets (Fig. 2.1) were made of synthetic material (Vikupor; Vink, Didam, the Netherlands), covered with aluminium sheets on the outer surface. The inner dimensions of the cabinets are: 75 cm wide, 125 cm long and 100 cm high. Seedlings or plants are placed on a height-adjustable plateau (range 80 cm). The lamp compartment on top of the cabinet provides space for maximal 12 fluorescent tubes, depending on the type. Special reflectors are used to ensure uniform light distribution. Filters are mounted in combination with a diffusor-plate (Vink) between the lamp compartment and the cabinet. Variation of fluence rates is obtained by the adjustable plateau in the cabinets and with the use of a continuously variable dimmer unit and time switches (Sylvania Bio-Systems, Wageningen, the Netherlands). Through air-inlets in the bottom of the cabinet an air-exchange is maintained by a fan on top of the cabinet, which discharges the heat produced by the light sources. The cabinets were housed in a temperature- and RH-controlled darkroom maintained at  $25 \pm 0.5$  °C and  $70 \pm 5$  %, respectively, and the cabinets were used for irradiation with WL, B, R and FR (Fig. 2.2).

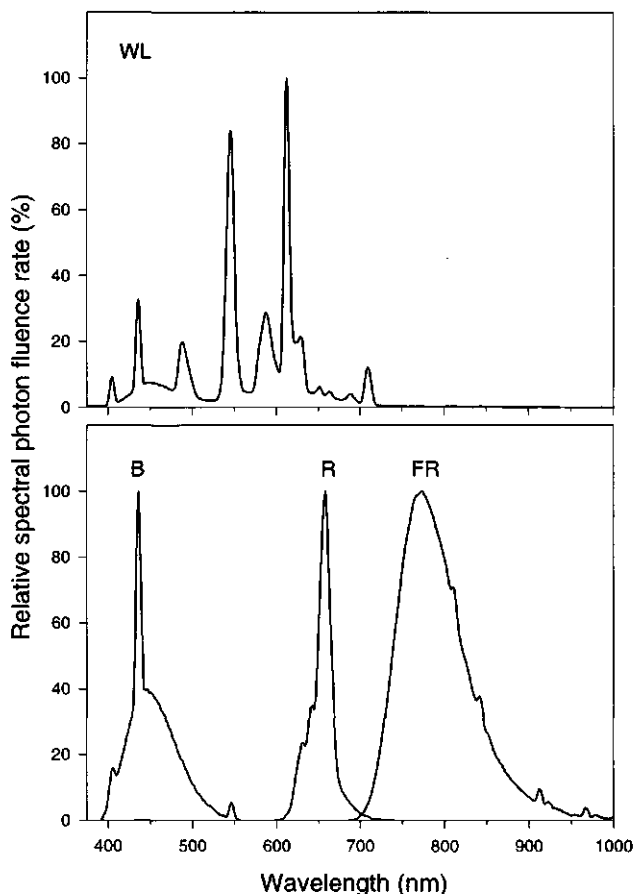


**Figure 2.1.** Movable light cabinet with the door open (see text for details).

### 2.2.5.2 Light sources

**White light.** The WL was obtained from: (i) Toshiba DR400/T(L) fluorescent tubes (Toshiba, Tokyo, Japan) in combination with Mitsubishi MLRBOC 400F-U HQI lamps (Mitsubishi, Tokyo, Japan) (López-Juez *et al.*, 1995) for WL-grown plants used in the phytochrome assays (phytotron, Japan); (ii) Philips TL40W/33 and TLMF140W/33 fluorescent tubes (Philips, Eindhoven, the Netherlands) in the WL experiment (phytotron, Wageningen); (iii) Philips TLD50W/84HF fluorescent tubes (phytotron, Wageningen) and Philips TLD32W/84HF fluorescent tubes (light cabinets, Wageningen) for WL in the EODFR experiment. The spectrum of the Philips TLD32W/84HF is shown in Fig. 2.2.

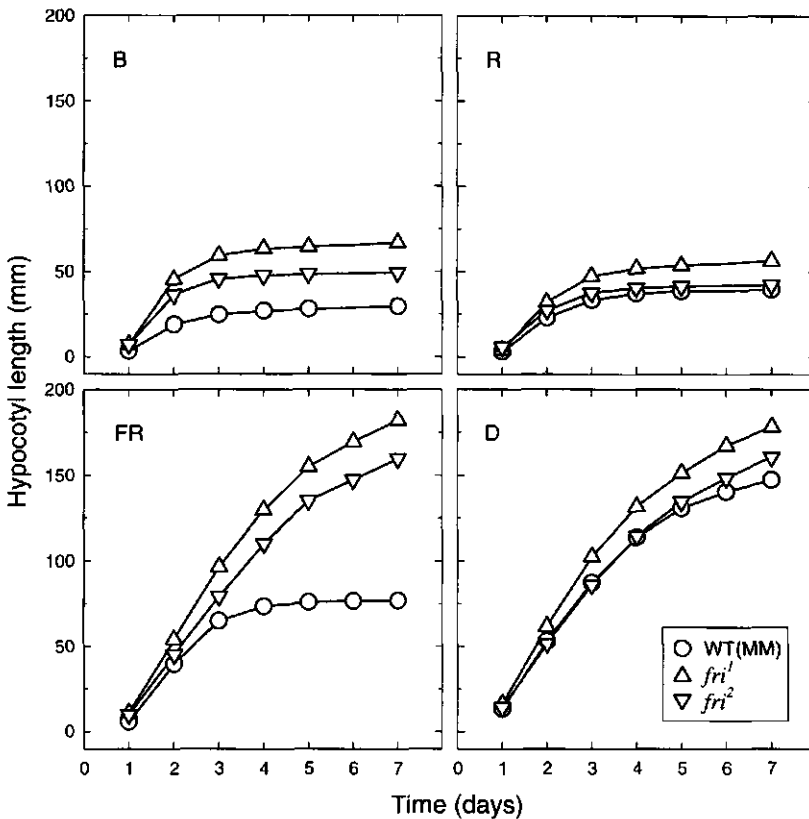
**Blue light.** The B was obtained from Philips TL40W/18 monophosphor fluorescent tubes filtered through 3-mm Plexiglas blue 248 (Röhm und Haas, Darmstadt, Germany). This spectrum is shown in Fig. 2.2.



**Figure 2.2.** Relative spectral photon distributions of the WL (upper panel); and broad-band B, R and FR sources (lower panel).

**Red light.** The R was obtained from: (i) National FL20S.W.SDL.NU fluorescent tubes filtered through 3-mm red acrylic (Shinkolite A102; Mitsubishi Rayon, Tokyo, Japan) in the phytochrome assays (used for 1–4 h R irradiation) in Japan; (ii) a xenon-lamp (150 W; Ushio, Tokyo, Japan) filtered through a 658-nm interference filter (Vacuum Optics, Tokyo, Japan) for *in-vivo* spectrophotometry performed in Japan; (iii) Philips TL40W/103339 monophosphor fluorescent tubes filtered through two layers of primary-red filter (Lee; Flashlight Sales, Utrecht, the Netherlands) in the continuous broad-band and light-pulse experiment. This spectrum is shown in Fig. 2.2.

**Far-red light.** The FR was obtained from: (i) a xenon-lamp (150 W; Ushio) filtered through a 748-nm interference filter (Vacuum Optics) for *in-vivo* spectrophotometry; (ii) Sylvania F48T12/232/HO fluorescent tubes (Osram Sylvania, Danvers, MA, USA) filtered through one layer of primary-red and one layer of dark-green filter (Lee) in the continuous broad-band light experiment, this



**Figure 2.3.** The hypocotyl length of WT (MM), and derived *fri*<sup>1</sup> and *fri*<sup>2</sup> mutant tomato seedlings. Seedlings were grown for 7 days in continuous broad-band B, R, FR ( $3 \mu\text{mol}\cdot\text{m}^{-2}\cdot\text{s}^{-1}$ ) and D (viewed under dim-green safelight). The mean hypocotyl length (mm)  $\pm$  SE of the absolute D control of WT (MM), *fri*<sup>1</sup> and *fri*<sup>2</sup> seedlings at the end of the 7-day period was:  $157 \pm 2$ ,  $172 \pm 2$  and  $157 \pm 2$ , respectively. The SE in all cases was smaller than the symbols used.

spectrum is shown in Fig. 2.2; (iii) Sylvania F48T12/232/VHO fluorescent tubes wrapped with one layer dark-green and one layer primary-red filter (Lee) in the light-pulse and EODFR experiments.

*Green safelight.* The dim-green safelight was obtained from (i) Philips TLD 36W/84 fluorescent tubes filtered through 6 layers of primary-green filter (Lee); (ii) portable custom-built torches with Philips TL8W/33 fluorescent tubes wrapped with 6 layers of primary-green filter (Lee).

The fluence rates and exposure times are given in the description of each experiment.

### 2.2.5.3 Light measurements

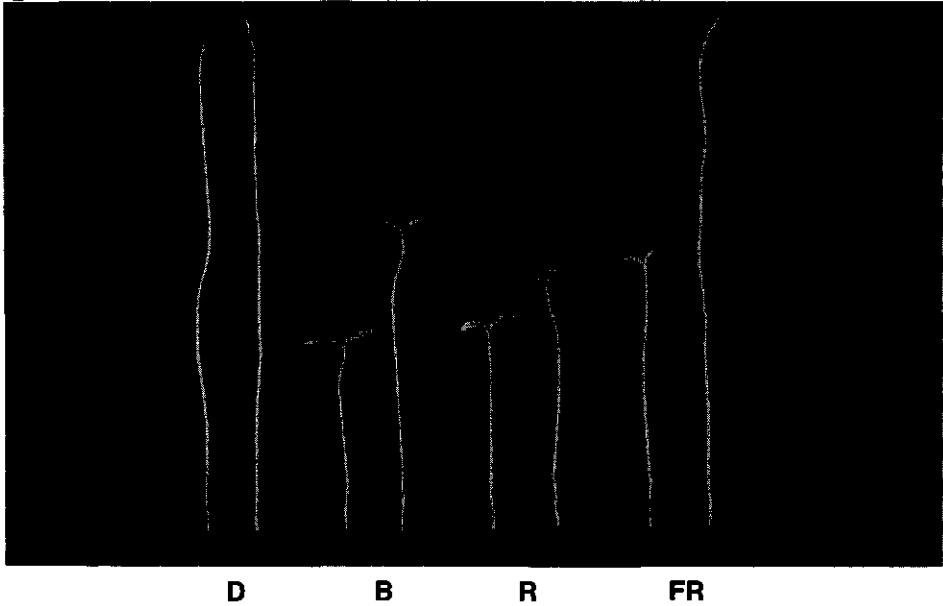
Fluence rates and spectral distributions of the light sources were recorded with a calibrated LI-1800 spectroradiometer (Li-Cor, Lincoln, NE, USA), using a cosine-corrected remote probe (1800-11; Li-Cor) placed horizontally at seedling or plant height. Additional light measurements, mostly routinely fluence-rate measurements, were recorded with a Skye SKP-200 unit (Skye Instruments, Powys, UK) supplied with a calibrated Skye SKP-215 quantum sensor head.

## 2.3 Results

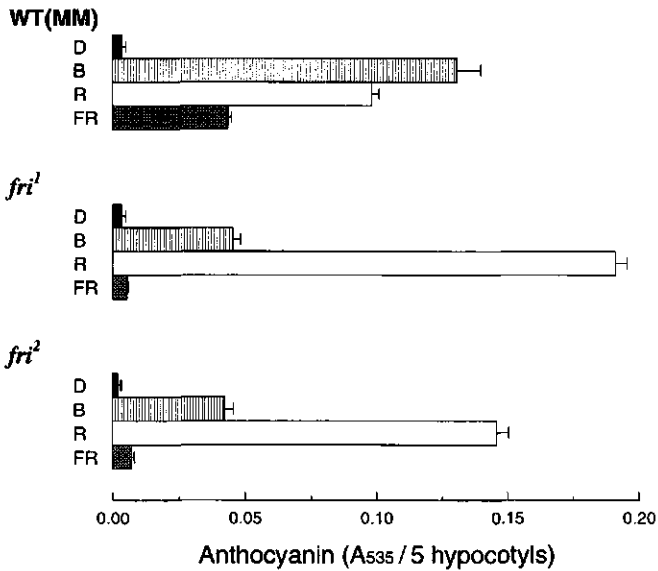
### 2.3.1 Phenotypes

The kinetics of inhibition of hypocotyl elongation under continuous low-fluence B, R and FR for 7 days of the *fri*<sup>1</sup> and *fri*<sup>2</sup> mutants, compared to their corresponding WT is shown in Figure 2.3. The phenotype of *fri*<sup>1</sup> and WT, 7 days after emergence under these conditions is shown in Figure 2.4. In comparison to WT, in B both *fri* mutants have elongated hypocotyls, whereas in R only the *fri*<sup>1</sup> is slightly more elongated. When grown in FR, both *fri*<sup>1</sup> and *fri*<sup>2</sup> mutants do not differ from plants grown in D, thus are completely blind to FR. The hypocotyls are elongated, the apical hooks closed and the cotyledons are unexpanded. The WT plants grown in FR exhibit less hypocotyl growth inhibition than in B and R, and the cotyledons remain yellow, but fully expand.

The anthocyanin content after 7 days continuous B, R, FR and D for both *fri* mutants compared to WT is given in Figure 2.5. The *fri* mutants, compared to WT, show a reduced anthocyanin accumulation under B, whereas under FR almost no anthocyanin is synthesized. However in R the *fri*<sup>1</sup> and *fri*<sup>2</sup> mutants show an enhanced, although quantitatively different, anthocyanin accumulation compared to WT.



**Figure 2.4.** Phenotypes of WT (MM) and derived *fri'* mutant tomato seedlings. Seedlings were grown for 7 days after emergence in D and continuous broad-band B, R and FR ( $3 \mu\text{mol}\cdot\text{m}^{-2}\cdot\text{s}^{-1}$ ). For each treatment the seedling on the left is the WT (MM) and that on the right is the *fri'* mutant.



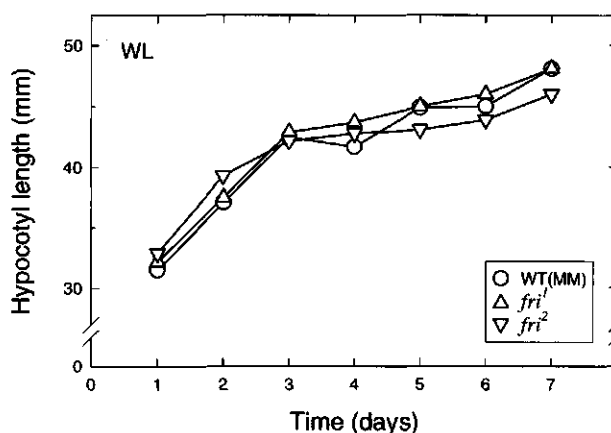
**Figure 2.5.** The anthocyanin content ( $A_{535}/5$  hypocotyls  $\pm$  SE) of WT (MM), and derived *fri'* and *fri*<sup>2</sup> mutant tomato seedlings. Seedlings were grown for 7 days in continuous broad-band B, R, and FR ( $3 \mu\text{mol}\cdot\text{m}^{-2}\cdot\text{s}^{-1}$ ) and absolute D.

When grown in a 16-h WL ( $150 \mu\text{mol}\cdot\text{m}^{-2}\cdot\text{s}^{-1}$  PAR)/8-h D cycle, the *fri* mutant seedlings are phenotypically hardly distinguishable from WT (Fig. 2.6). A very slightly retarded growth becomes obvious for both *fri* mutants, when grown under the same WL/D-cycle (but at a lower light level) for 25 days (Fig. 2.7). This retarded growth becomes much more obvious in plants grown in the greenhouse and the *fri* mutant plants wilt strongly on sunny days. Preliminary data indicate that detached leaves of *fri* mutant plants do not show an enhanced water loss as is found in abscisic acid-deficient mutants where this is due to their inability to close their stomata (A. Van Tuinen, pers. comm.). Noteworthy is the appearance of adventitious roots along the stem-axis in adult *fri*<sup>1</sup> mutants when grown under greenhouse conditions. The *fri*<sup>1</sup> mutant is more extreme at seedling stage (the hypocotyls in R have more anthocyanin and are slightly longer), whereas the *fri*<sup>2</sup> mutant is much more extreme in adult WL-grown plants being more inhibited in stem growth extension and more susceptible to wilting under greenhouse conditions.

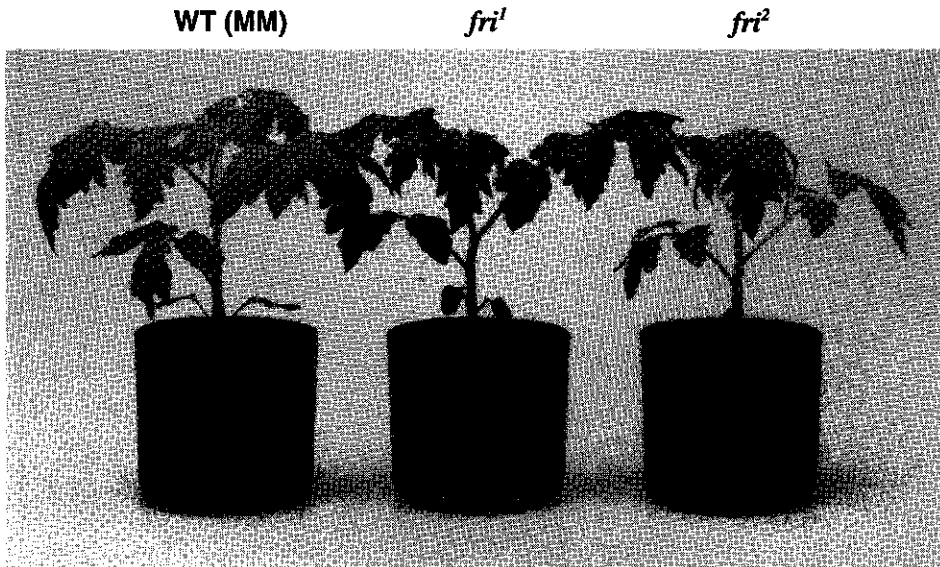
### 2.3.2 Phytochrome assays

#### 2.3.2.1 In-vivo spectrophotometry

Figure 2.8 shows representative difference spectra for *in-vivo* phytochrome phototransformation in standard samples of 4-day-old D-grown WT and *fri*<sup>1</sup> seedlings. The amount of total spectrophotometrically detectable phytochrome (Ptot) in the *fri*<sup>1</sup> mutant is approximately  $1.5 \cdot 10^{-3} \Delta(\Delta A_{730-800})$ , which is 8–10 % of that in WT. The signal is far above the detection level of the spectrophotometer, which was  $0.2 \cdot 10^{-3} \Delta(\Delta A_{730-800})$ . The destruction kinetics of Ptot in the 4-day-old WT and *fri* mutant seedlings during irradiation with continuous R (Fig. 2.9) show



**Figure 2.6.** The hypocotyl length of WT (MM), and derived *fri*<sup>1</sup> and *fri*<sup>2</sup> mutant tomato seedlings. Seedlings were grown in a 16-h WL ( $150 \mu\text{mol}\cdot\text{m}^{-2}\cdot\text{s}^{-1}$  PAR)/8-h D cycle for 7 days. The SE in all cases was smaller than the symbols used.



**Figure 2.7.** Phenotypes of WT (MM) and derived *fri*<sup>1</sup> and *fri*<sup>2</sup> mutant tomato plants. Plants were grown in a 16-h WL ( $100 \mu\text{mol}\cdot\text{m}^{-2}\cdot\text{s}^{-1}$  PAR)/8-h D cycle for 25 days.

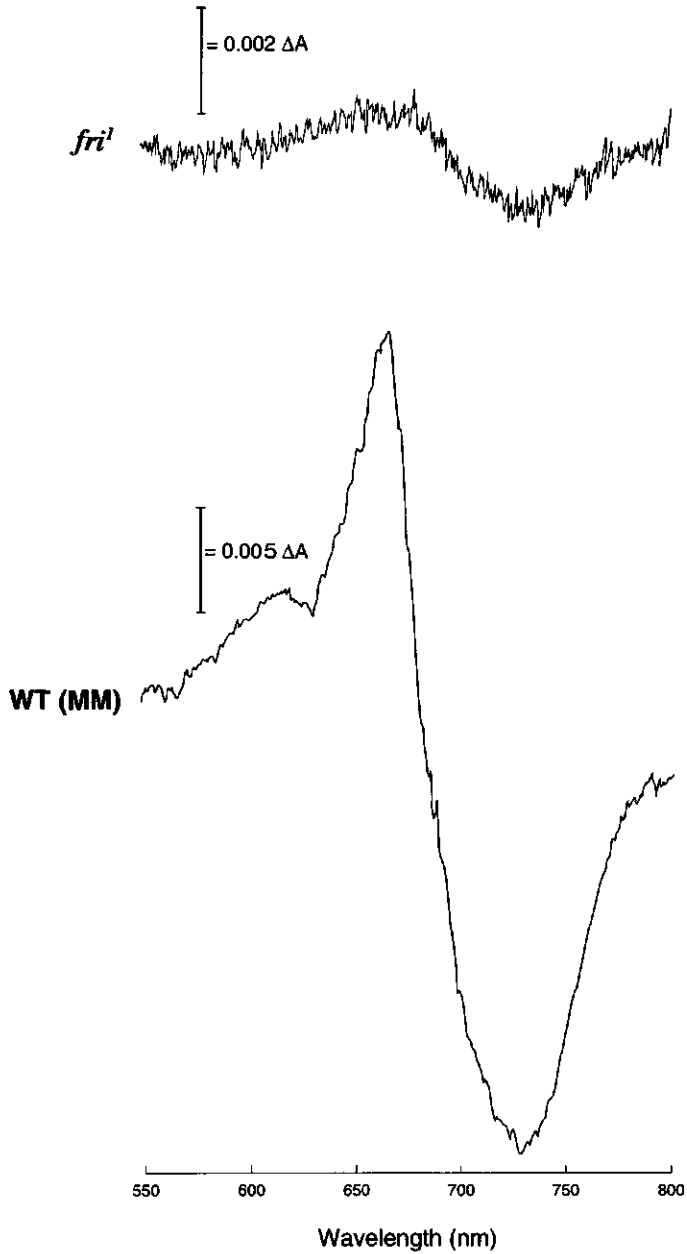
a steady-state low level of Ptot in the *fri* mutants is not susceptible to destruction during the R irradiation. The 4-h R irradiation resulted in a depletion of Ptot in WT to a same residual level as in both *fri* mutants, representing a light-stable fraction of Ptot.

#### 2.3.2.2 Western-blot analysis

Using an antibody to pea PHYA (mAP5) no immunochemically detectable phyA apoprotein (PHYA) was observed in extracts of 4-day-old etiolated seedlings of both *fri* mutants (Fig. 2.10). In WT a band at 116 kDa is detected which, as expected for phyA, is strongly depleted during a 4-h R irradiation. The very faint staining detectable in both *fri* mutants is estimated as less than 1 % of the 116-kDa band on the basis of a dilution series of the WT (Fig. 2.11) and is quite likely due to the fact that the antibody used for the detection of PHYA, recognizes other minor phytochrome species. Immunoblot analysis with specific antibodies raised against native tomato PHYA, when available, will prove whether the *fri* mutants are slightly leaky or not.

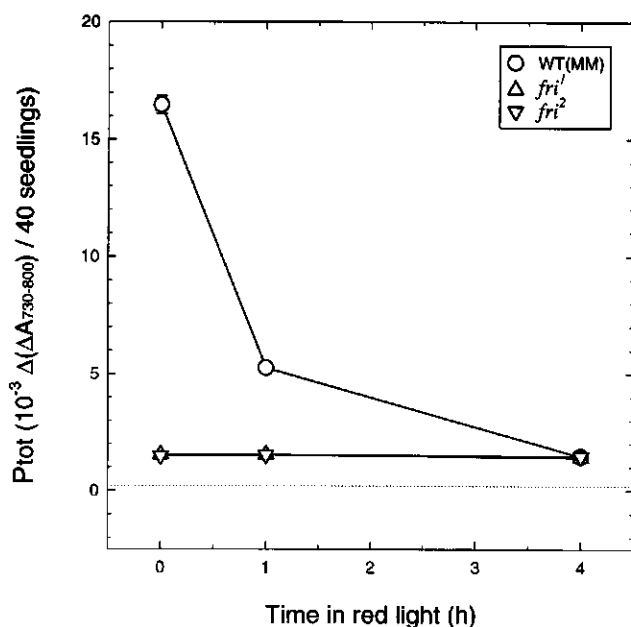
Using an antibody to tobacco phyB polypeptide PHYB (mAT1), no differences were observed between WT and both *fri* mutants. After a 4-h R irradiation a similar pattern was observed, indicating that these PHYB-like proteins detected by mAT1 are relatively stable under these conditions (Fig. 2.10). As expected, this pattern was retained in WL-grown plants of the both *fri* mutants (Fig. 2.12).

*Analysis of the phytochrome A-deficient fri mutants of tomato*

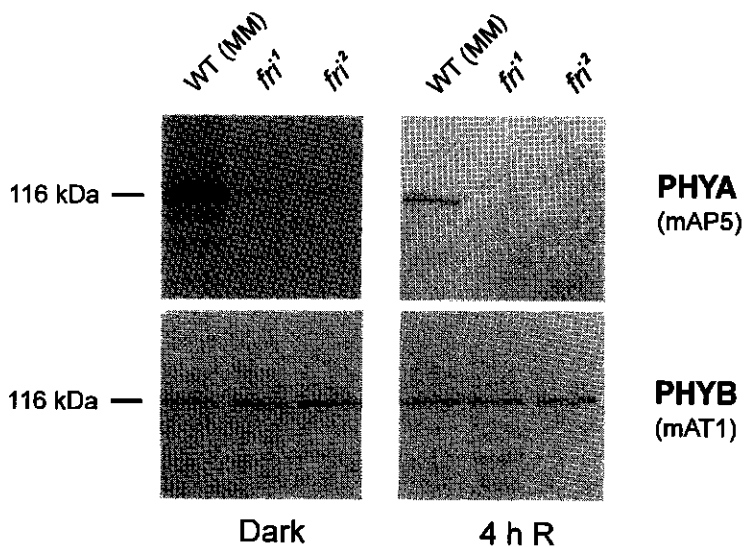


**Figure 2.8.** Difference spectrum for *in-vivo* phytochrome phototransformation in dark-grown 4-day-old WT (MM) and derived *fri* mutant tomato seedlings, obtained by subtracting the absorption spectrum determined after FR irradiation from that measured after R irradiation (Pr-Pfr). Scan speed for measurement was  $120 \text{ nm} \cdot \text{min}^{-1}$ .



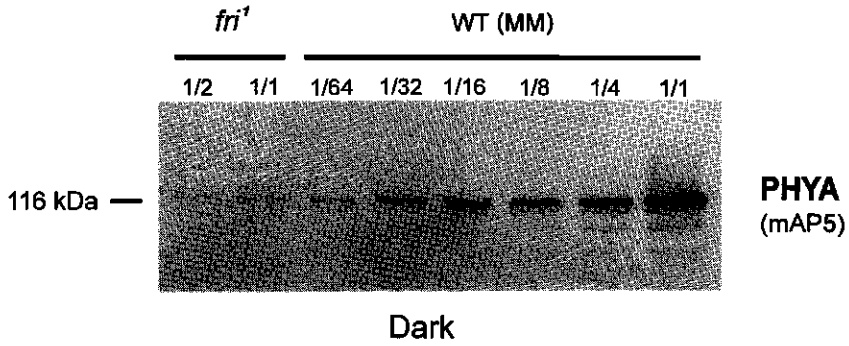


**Figure 2.9.** Destruction kinetics of total spectrophotometrically detectable phytochrome (Ptot) in 4-day-old WT (MM), and derived *fri*<sup>1</sup> and *fri*<sup>2</sup> mutant tomato seedlings during irradiation with continuous R ( $20 \mu\text{mol}\cdot\text{m}^{-2}\cdot\text{s}^{-1}$ ) at  $25^\circ\text{C}$ . Ptot is expressed as  $\Delta(\Delta A_{730-800})/40$  seedlings. The dashed horizontal line indicates the detection limit for the spectrophotometer. Error bars represent the SE.

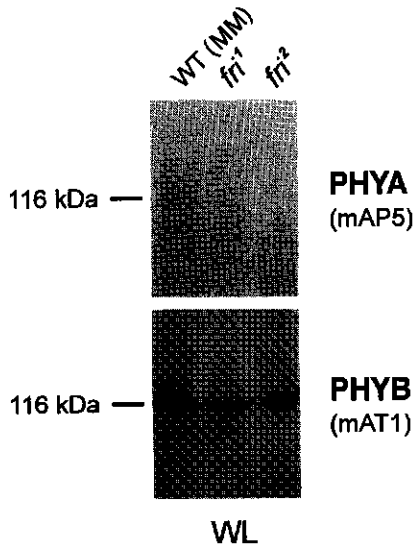


**Figure 2.10.** Western-blot analysis of phytochrome A and B polypeptides (PHYA and PHYB, respectively) in crude extracts of WT (MM), and derived *fri*<sup>1</sup> and *fri*<sup>2</sup> mutant tomato seedlings. Dark-grown 4-day-old seedlings, or seedlings of the same age but exposed to 4 h R ( $20 \mu\text{mol}\cdot\text{m}^{-2}\cdot\text{s}^{-1}$ ), were used for the detection of PHYA and PHYB with monoclonal antibodies mAP5 and mAT1, respectively.

Analysis of the phytochrome A-deficient *fri* mutants of tomato



**Figure 2.11.** Western-blot analysis of a serial dilution of phytochrome A polypeptide (PHYA) in crude extracts of WT (MM) and derived *fri*<sup>1</sup> mutant tomato seedlings. Dark-grown 4-day-old seedlings were used for the detection of PHYA with monoclonal antibody mAP5.



**Figure 2.12.** Western-blot analysis of phytochrome A and B polypeptides (PHYA and PHYB, respectively) in crude leaf extracts of WT (MM) and derived *fri*<sup>1</sup> and *fri*<sup>2</sup> mutant tomato plants. Plants grown in a 16-h WL ( $150 \mu\text{mol}\cdot\text{m}^{-2}\cdot\text{s}^{-1}$  PAR)/8-h D cycle for 21 days, were used for the detection of PHYA and PHYB with monoclonal antibodies mAP5 and mAT1, respectively.

## Chapter 2

### 2.3.2.3 Northern-blot analysis

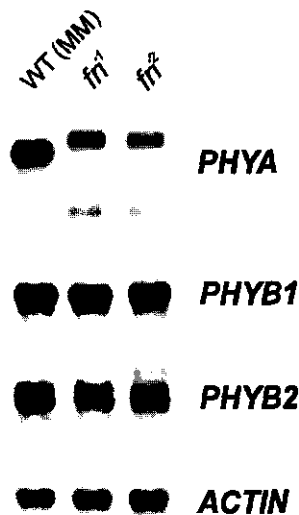
Hauser *et al.* (1995) showed that the phytochrome gene family consists of at least five members in tomato: *PHYA*, two *PHYBs* (*PHYB1* and *PHYB2*), *PHYE* and *PHYF*. Northern-blot analysis established that each of these *PHYs* is expressed as a mRNA sufficiently large (3.8–4.7 kb) to encode a full-length PHY (Hauser *et al.*, 1995).

Using gene-specific cRNA probes it is clearly demonstrated that *PHYA* mRNA is modified in both *fri* mutants, revealing two aberrant bands in the Northern blots (Fig. 2.13). No differences in amount or size of *PHYA*, *PHYB2*, *PHYE* and *PHYF* mRNAs were observed between the WT and the *fri*-alleles (Fig. 2.13; data not shown).

### 2.3.3 Physiological characterization

#### 2.3.3.1 De-etiolation

After 7 days in D both *fri* mutants and the WT exhibit efficient chlorophyll biosynthesis and cotyledon expansion on transfer to WL. However, after 7 days in FR, while the *fri* mutants de-etiolate, the WT seedlings that have expanded their cotyledons lose their capacity to green in WL (Van Tuinen *et al.*, 1995a).



**Figure 2.13.** Northern-blot analysis of *PHYA*, *PHYB1* and *PHYB2* mRNA present in 1.0  $\mu\text{g}$  poly(A)<sup>+</sup> RNA. RNA was isolated from WT (MM), and derived *fri*<sup>1</sup> and *fri*<sup>2</sup> mutant tomato seedlings. Seedlings were grown at 25 °C for 4 days in darkness. The <sup>32</sup>P-radiolabelling was detected and quantitated with a PhosphorImager using *ACTIN* mRNA (present in 0.5  $\mu\text{g}$  poly(A)<sup>+</sup> RNA) as an internal standard.

Although, this FR block of cotyledon greening never occurs in the natural light environment, it provides a simple screen for mutants in phyA-signalling (Barnes *et al.*, 1996).

#### *2.3.3.2 Low fluence response experiments*

In continuous low fluence broad-band R the hypocotyl growth of the *fri* mutants is only slightly less inhibited than the WT (Figs. 2.3 and 2.4). Spectrophotometric analysis showed that the PHYA pool is essentially depleted after 4 h R (Fig. 2.9). This suggests the involvement of phyB and/or other stable type phytochrome(s) in the LFR of hypocotyl growth inhibition. It is therefore expected that the phyA-deficient *fri* mutants display normal R/FR reversibility for hypocotyl growth inhibition. To test this hypothesis the effect of pulses of R or R immediately followed by FR (both saturating for phytochrome photoconversion) given every 4 h on hypocotyl growth inhibition were investigated (Fig. 2.14). As expected the R/FR reversibility of the hypocotyl growth inhibition is retained in the *fri* mutants.

#### *2.3.3.3 End-of-day FR experiments*

Although both *fri* mutants show a retarded growth habit compared to WT, they respond to EODFR treatment with an increase in plant height qualitatively similar to WT (Fig. 2.15). This suggests that the phytochrome involved, presumably phyB, functions normally and, moreover, that phyA has little or no influence on stem elongation of tomato in WL.

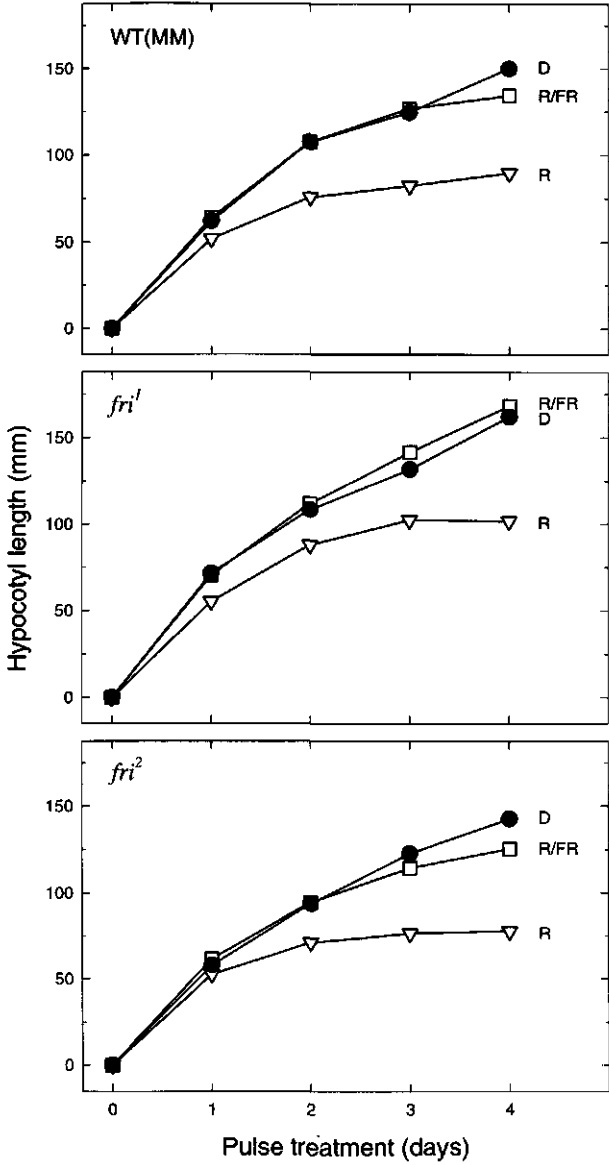
#### *2.3.3.4 Germination*

Unlike the *au* mutant (Koornneef *et al.*, 1985), seeds of the *fri*<sup>1</sup> mutant which germinate in D are inhibited by continuous FR (Van Tuinen *et al.*, 1995a).

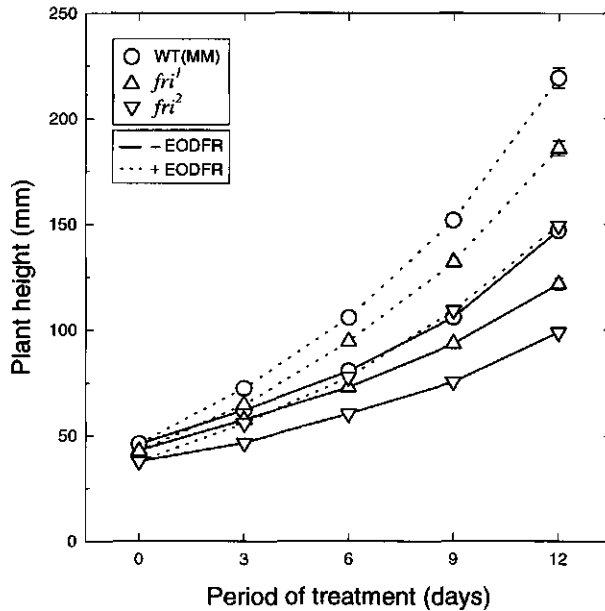
## **2.4 Discussion**

### **2.4.1 The *FRI* locus is probably the *PHYA* structural gene**

We have shown that two mutants at the *FRI* locus of tomato differ in the same way with respect to WT in their photobiology. The loss of sensitivity to FR correlates with the lack of the bulk pool of phytochrome in etiolated seedlings (predominantly phyA; Figs. 2.8 and 2.9) and the immunochemically detectable PHYA (Figs. 2.10 and 2.12), points to a defect in phytochrome A in both *fri* mutants. Northern analysis showed that the *PHYA* mRNA has two aberrant bands (Fig. 2.13). The *fri* mutants and the *PHYA* gene were recently mapped by classical and RFLP analysis at an indistinguishable position on chromosome 10 (Van Tuinen *et al.*, 1996b), confirming our prediction that the two loci are identical (*FRI* = *PHYA*).



**Figure 2.14.** Hypocotyl length of WT (MM), and derived *fri*<sup>1</sup> and *fri*<sup>2</sup> mutant tomato seedlings. Seedlings were treated with pulses of R or R immediately followed by FR and a D control. The R and FR pulses (both saturating for phytochrome photoconversion) were repeated every 4 h from the time of emergence. The SE in all cases was smaller than the symbols used.



**Figure 2.15.** Plant height of WT (MM), and derived *fri*<sup>1</sup> and *fri*<sup>2</sup> mutant tomato plants. Plants were grown in a 16-h WL (60  $\mu\text{mol}\cdot\text{m}^{-2}\cdot\text{s}^{-1}$  PAR)/8-h D cycle. After 17 days from sowing plants were either submitted to an immediate 8-h D period (-EODFR) or given a 20-min FR pulse before the D period (+EODFR) for 15 days. Error bars represent the SE.

Recent analysis of the *PHYA* gene of the *fri*<sup>1</sup> and *fri*<sup>2</sup> mutants revealed a mutation comprising an adenine (A)-to-thymine (T) nucleotide substitution at the 3' splicing site of the first intron in the main open reading frame. Sequence data of several reverse transcriptase-polymerase chain reaction (RT-PCR) clones confirmed the presence of this intron in mature transcripts from both mutants. Two in-frame stop codons in the retained intron, lead in most instances to a failure to remove this intron during mRNA maturation (Lazarova *et al.*, 1996), an observation which is consistent with the Northern-blot data (Fig. 2.13). Lazarova *et al.* (1996) demonstrated unambiguously that both *fri* mutants are *phyA* mutants.

The extensively studied *au* and an *au*-like *yellow-green 2* (*yg-2*) mutant in tomato, have long been considered as *phyA*-deficient mutants (Koornneef *et al.*, 1985; Parks *et al.*, 1987; Sharrock *et al.*, 1988). The recent mapping of *phyA* to chromosome 10 has demonstrated that neither *au* nor *yg-2*, which map to chromosome 1 and 12, respectively, are simply mutants deficient in *phyA* alone (Van Tuinen *et al.*, 1996a; 1996b). Recently, the *au* and *yg-2* mutants were classified as deficient in phytochrome chromophore biosynthesis (Terry and Kendrick, 1996), implying a deficiency in all types of phytochrome.

### 2.4.2 The role of phytochrome A

Photomorphogenic mutants with a similar D phenotype in FR, but which exhibit hypocotyl inhibition under other wavelengths have been shown to be phyA mutants in *Arabidopsis*: *hy8* (Parks and Quail, 1993; Dehesh *et al.*, 1993), *fre* (Nagatani *et al.*, 1993) and *fhy2* (Whitelam *et al.*, 1993). The phyA-deficient *fri* mutants in tomato resemble these of *Arabidopsis*. In contrast to the *Arabidopsis* phyA mutants, the tomato *fri* mutants show a slightly reduced sensitivity to B and R, which allowed their initial selection. This indicates that in tomato, phyA can weakly mediate responses to these wavelengths.

In both species it is established that phyA mediates the FR-HIR for hypocotyl inhibition in etiolated seedlings and that the other members of the phy family are unable, alone or together, to substitute for phyA in this photosensory capacity. Moreover, because transgenic *Arabidopsis* and tobacco overexpressing *PHYA* exhibit enhanced sensitivity to FR, the capacity to mediate the FR-HIR appears to be an intrinsic property of phyA (McCormac *et al.*, 1991; Whitelam *et al.*, 1992). The effectiveness of phyA in the WT in continuous FR is explained by the lability of the FR-absorbing form of phyA (PfrA), the steady state of which is lower in FR, resulting in a higher integrated level of Pfr being maintained than in R (Mancinelli, 1994). The evolution of a light-labile phytochrome may thus be an elegant solution to the problem of how to use a phytochrome, whose action normally is inhibited by FR, to mediate responses to FR (Reed *et al.*, 1994). The ability to respond to FR might be particularly useful to plants germinating under leaves or thin layers of soil, environments potentially enriched in FR (Smith, 1982; 1994; 1995; Botto *et al.*, 1996).

The phyA-deficient mutants have a more or less WT responsiveness to R and WL, implying that phyA does not play a major role in regulating photomorphogenesis under these conditions (Parks and Quail, 1993). The fact that the *au* mutant is more or less blind to R (Koornneef *et al.*, 1985; see Fig. 3.1) and recently proved to be deficient in the biosynthesis of phytochrome chromophore (Terry and Kendrick, 1996), thus deficient in all types of phytochrome, gives an additional indication of the involvement of phyB and/or other phytochromes in the photocontrol of hypocotyl growth inhibition.

In the *fri* mutant, FR is still able to photoconvert phytochrome by depletion of the FR-absorbing form of phytochrome (Pfr), as shown in the EODFR, LFR and germination experiments in which the *fri* mutants resemble WT. These responses are therefore apparently mediated by other phytochromes, whose effectiveness is determined by the photoequilibrium between R-absorbing form of phytochrome (Pr) and Pfr at any particular wavelength, meaning that R is more effective than FR.

The most striking conclusion we can draw from the phenotypes of the *Arabidopsis* and tomato phyA mutants is the very minor or even absence of a role of this

most abundant (in darkness) phytochrome species in light-grown plants. While young *fri*-mutant plants grown in the phytotron are only slightly retarded compared to the WT, the older plants in the greenhouse exhibit strong wilting on sunny days which presumably accounts for their slower growth. The normal green leaf colour of the *fri* mutants and growth habit in general is in strong contrast to the phenotype of the *au* and *yg-2* mutants of tomato (Van Tuinen *et al.*, 1996a), which at both the seedling and adult plant stage are characterized by a pale-green phenotype. We now assume that these effects, formerly attributed exclusively to the *phyA* deficiency of these mutants (Adamse *et al.*, 1988) might be due to the deficiency of other phytochrome types and/or other effects of a defect in tetrapyrrole biosynthesis (Terry and Kendrick, 1996).

**Acknowledgements.** We thank Willem Tonk (Division of Development and Technology, UNIFARM, Wageningen), Willem Verbeek, Rien van Lieburg and Albert Kühn (Sylvania BioSystems, Wageningen) and Ad Veenendaal (Division of Instrumentation and Measurement Technology, IMAG-DLO, Wageningen) for assistance in the design and construction of the light cabinets. Part of this work was carried out at the Laboratory for Photoperception and Signal Transduction, Frontier Research Program, Institute of Physical and Chemical Research (RIKEN), Japan; and at the Botany Department, University of Georgia, GA, USA and supported by USDA NRICGP grant 93-00939 to L.H. Pratt and M.-M. Cordonnier-Pratt.



# CHAPTER 3

## Analysis of temporarily red light-insensitive mutants indicates the *TRI* locus is the gene encoding the apoprotein of phytochrome B1

**Abstract.** Four monogenic recessive mutants of tomato (*Lycopersicon esculentum* Mill.) at the temporarily red light-insensitive (*TRI*) locus (*tri<sup>1</sup>* and *tri<sup>2</sup>*, in the genetic background breeding line GT; *tri<sup>3</sup>* and *tri<sup>4</sup>*, in the genetic background cultivar MoneyMaker) have been studied. These mutants, which are allelic, are only insensitive to continuous red light (R) during the first 2 days upon transition from darkness to R, resulting in long hypocotyls and small cotyledons. In white light these mutants have slightly longer hypocotyls than wild type (WT). Western-blot analysis shows that the *tri<sup>1</sup>* mutant is deficient in a relatively light-stable phytochrome apoprotein (116 kDa) that is recognized in WT by an antibody to tobacco phytochrome B; *tri<sup>3</sup>* has a 116-kDa band, but is reduced in abundance; *tri<sup>2</sup>* and *tri<sup>4</sup>* have bands of lower molecular mass and reduced abundance at ca. 105 and 95 kDa, respectively. These patterns are also found in light-grown plants. Northern-blot analysis for *PHYB1* mRNA showed for *tri<sup>2</sup>* a transcript ca. 2 kb larger; a transcript of WT size but much reduced in abundance for *tri<sup>4</sup>*; *tri<sup>1</sup>* and *tri<sup>3</sup>* have transcripts of equivalent size and abundance to WT. In these mutants the transcripts of other members of the tomato phytochrome gene family (*PHYA*, *PHYB2*, *PHYE*, *PHYF*) were indistinguishable in size and abundance from WT. Thus, it appears that the *tri* locus specifically affects *PHYB1* gene expression. It is concluded that phyB1 plays a major role during de-etiolation. Unlike phytochrome-B mutants in other plants, de-etiolated seedlings of the *tri* mutants exhibit normal responses to end-of-day far-red (EODFR) and supplementary far-red during the day. Since phyB1 and phyB2 are closely related, it is proposed there might be redundancy between them for these responses. In addition the *aurea<sup>w</sup>*, *tri<sup>1</sup>* (*au<sup>w</sup>*, *tri<sup>1</sup>*), high-pigment-1<sup>w</sup>, *tri<sup>1</sup>* (*hp-1<sup>w</sup>*, *tri<sup>1</sup>*) and *fri<sup>1</sup>*, *tri<sup>1</sup>* double-mutants were also characterized.

### 3.1 Introduction

Phytochromes are the best characterized photomorphogenic photoreceptors in plants and are responsible for many developmental responses to light (Kendrick and Kronenberg, 1994). Phytochrome is a chromoprotein, consisting of two subunits with a molecular mass of 114–130 kDa each, depending on the plant species (Quail, 1991). Each subunit is composed of a phytochrome apoprotein

*This chapter has in part been published:*

Kerckhoffs *et al.* (1996). *Planta* **199**: 152–157.

Van Tuinen and Kerckhoffs *et al.* (1995). *Plant Physiol.* **108**: 939–947.

(PHY) to which a linear tetrapyrrole chromophore is covalently attached (Terry *et al.*, 1993). Phytochromes undergo photoconversion between two spectrally distinct molecular forms: the red light (R)-absorbing form (Pr) and the far-red light (FR)-absorbing form (Pfr). Phytochromes enable the plant to sense the ambient light environment in several ways: quantitatively (photon-counting), qualitatively (measuring the ratio of red to far-red light) and by several response modes: a low fluence response (LFR), which is R/FR reversible, and a high irradiance response (HIR), which is irradiance and duration dependent (Mancinelli, 1994).

A small gene family encodes the distinct molecular species of phytochrome in all higher plants species so far studied. The first characterized phytochrome family was in *Arabidopsis*, where five phytochrome genes (*PHYs*) have been identified (*PHYA-E*) (Sharrock and Quail, 1989; Clack *et al.*, 1994). These five *PHYs* comprise four subfamilies on the basis of deduced amino acid sequence homology: *A*, *B* (which includes *PHYD*), *C* and *E* (Quail, 1991; Pratt, 1995).

Recent research reports the presence of an even more complex *PHY* family in tomato (*Lycopersicon esculentum* Mill.). So far five members have been identified: *PHYA*, two *PHYBs* (*PHYB1* and *PHYB2*), *PHYE* and *PHYF*, the latter being so named because it has no preferential amino acid sequence similarity to any other known *PHY* (Hauser *et al.*, 1995). The individual *PHYs* show unique spatial and temporal patterns of gene expression during the life cycle of the plant (Pratt, 1995; Hauser *et al.*, in press), which could yield functionally distinct phytochromes that possess discrete photosensory functions and/or mediate different photomorphogenic responses temporally and spatially.

Studies of type-specific phytochrome mutants and/or transgenic plants overexpressing a specific phytochrome are extremely useful tools in order to assign function(s) and action to the individual members of the phy family (Kendrick and Nagatani, 1991; Koornneef and Kendrick, 1994; Whitelam and Harberd, 1994). Several type-specific mutants have been characterized so far: (i) mutants that are deficient in all types of phytochrome, probably caused by a defect in the biosynthesis of the common phytochrome chromophore, such as the *hyl*, *hy2* and *hy6* (= *hyl*) mutants in *Arabidopsis* (Chory *et al.*, 1989a; Parks and Quail, 1991), the *pew* mutants of *Nicotiana plumbaginifolia* (Kraepiel *et al.*, 1994), the *pcd1* mutant in pea (Weller *et al.*, 1996), and the *au* and *yg-2* mutants in tomato (Terry and Kendrick, 1996; Van Tuinen *et al.*, 1996a). (ii) the *phyA*-deficient mutants in *Arabidopsis* (Dehesh *et al.*, 1993; Nagatani *et al.*, 1993; Whitelam *et al.*, 1993) and tomato (Chapter 2). (iii) the *phyB*-deficient *hy3* mutants in *Arabidopsis* (Somers *et al.*, 1991; Reed *et al.*, 1993), the *lh* mutant in cucumber (Adamse *et al.*, 1987; Peters *et al.*, 1991; López-Juez *et al.*, 1992), the *ein* mutant in *Brassica* (Devlin *et al.*, 1992), the *lv* mutants in pea (Weller *et al.*, 1995a) and the *ma<sub>3</sub><sup>R</sup>* mutant of sorghum (Childs *et al.*, 1991; 1992; 1996). In the case of the *Arabidopsis hy3* (= *phyB*) and sorghum *ma<sub>3</sub><sup>R</sup>* (= *phyB*) mutants it has been proven

that the mutation is located in the *PHYB* gene itself (Reed *et al.*, 1993; Childs *et al.*, 1996). Complementary studies with transgenic lines overexpressing *PHYA* or *PHYB* have also been carried out (Boylan and Quail, 1989; 1991; Kay *et al.*, 1989b; Keller *et al.*, 1989; Cherry *et al.*, 1991; Wagner *et al.*, 1991; McCormac *et al.*, 1993; Jordan *et al.*, 1995) which demonstrate induction of a general light-exaggerated phenotype.

In general, etiolated seedlings of mutants at the *PHYA* locus respond to continuous R but not to continuous FR, whereas etiolated seedlings of mutants at the *PHYB* locus respond to continuous FR, but show reduced responsiveness to continuous R (Quail *et al.*, 1995). A common feature of the phyB-deficient mutants is the absence of, or a severely reduced, shade-avoidance response, resulting in an elongated stature and a slightly reduced chlorophyll content.

In this chapter a physiological characterization and an analysis of spectrophotometrically detectable phytochrome, phytochrome apoproteins and mRNAs will be presented for four alleles at the *TRI* locus. These results indicate they are putative mutants in the structural gene that encodes the PHYB1 apoprotein. In addition the *aurea<sup>w</sup>, tri<sup>l</sup>* (*au<sup>w</sup>, tri<sup>l</sup>*), high-pigment-1<sup>w</sup>, *tri<sup>l</sup>* (*hp-1<sup>w</sup>, tri<sup>l</sup>*) and *fri<sup>l</sup>, tri<sup>l</sup>* double-mutants were also characterized.

## 3.2 Materials and methods

### 3.2.1 Plant material

#### 3.2.1.1 Mutant isolation

Four monogenic recessive mutants of tomato (*Lycopersicon esculentum* Mill.) cultivar MoneyMaker (MM) and a tobacco mosaic virus resistant breeding line GT (GT) were isolated: three were obtained by treating seeds with ethyl methane sulphonate (EMS) for 24 h in darkness (D) at 25 °C (Koornneef *et al.*, 1990) and one additional monogenic recessive mutant arose as a somaclonal variant in the progeny of plants regenerated from tissue culture described by Van den Bulk *et al.* (1990). The M<sub>2</sub> seed groups were screened for mutants deviating from WT: (i) screening for slightly longer hypocotyls in white light (WL), resulted in two independently induced mutants, C66 and B10, selected in the M<sub>2</sub> generation derived from 1650 M<sub>1</sub> plants (Experiments II and III in Koornneef *et al.*, 1990) and the somaclonal variant sc72, selected in 1052 progenies of regenerated WT (MM) plants (Van den Bulk *et al.*, 1990); (ii) screening for longer hypocotyls in continuous broad-band R yielded 2-19ARL, selected in M<sub>2</sub> material described by Van Tuinen *et al.* (1995a).

In broad-band spectral study experiments all the mutants show a reduced hypocotyl growth inhibition in R. Since the mutants are only insensitive to R

during the first 2 days of R treatment (Fig. 3.1), the gene symbol *tri* (temporarily red light insensitive) is proposed for these mutants. Genetic complementation analysis showed that the four mutants were allelic. The different alleles have been numbered in order of isolation:  $tri^1 = C66$ ;  $tri^2 = B10$ ;  $tri^3 = sc72$ ;  $tri^4 = 2-19ARL$ . The  $tri^1$  and  $tri^2$  alleles are in the genetic background GT, while the  $tri^3$  and  $tri^4$  alleles are in the genetic background MM. Under continuous R the progeny of selfed  $F_1$  plants from the cross between the new mutant lines and the WT parent segregated in a 3:1 ( $\chi^2 = 0.92$ ,  $p > 0.05$  for the  $F_2$  WT  $\times$   $tri^1$ ) ratio of normal to elongated hypocotyls and normal to small cotyledons expected for a monogenic recessive mutation. The hypocotyl length of the heterozygote  $F_1$  is slightly longer than that of the WT plant due to partial dominance of the mutation (Van Tuinen *et al.*, 1995b).

### 3.2.1.2 Construction of the double mutants

The double mutants were obtained from segregating populations derived from crosses of the monogenic mutants. The  $fri^1, tri^1$  double mutant was identified by screening for  $fri^1$  plants (insensitiveness to FR) in the  $F_2$  generation and subsequently by testing  $F_3$  progenies of several such plants for insensitivity to R (the  $tri^1$  phenotype). The phenotype of the  $fri^1, tri^1$  double mutant in white light (WL) resembles the  $tri^1$  mutant. The  $au^w, tri^1$  double mutant was derived from crosses of  $au^w$  (W616) described by Koornneef *et al.* (1985) and the  $tri^1$  mutant; and was identified in a  $F_3$  line derived from an  $au^w$  like  $F_2$  plant which segregated as approximately 25 % slightly taller seedlings with reduced anthocyanin. The  $hp-1^w, tri^1$  double mutant was derived from crosses of  $hp-1^w$  (WB3) described by Peters *et al.* (1989) and the  $tri^1$  mutant was selected as follows: the  $tri^1$  phytochrome mutants were identified in the  $F_2$  generations and subsequently  $hp-1^w$  segregants among these plants in the  $F_3$  progeny of these  $F_2$  plants on the basis of the  $hp$  phenotype (high anthocyanin level and dark-green immature fruit colour; see Chapter 5). The hypocotyl length in R of the  $hp-1^w, tri^1$  double mutant is intermediate between the two monogenic mutants. The adult plant and fruit phenotype in WL of the  $hp-1^w, tri^1$  double mutant with  $hp-1^w$  resembled that of the  $hp-1^w$  monogenic mutant. For all double mutants allelism tests with the monogenic mutants confirmed the predicted phenotype.

### 3.2.1.3 Pretreatment of the seeds

In the WL, delayed-R and end-of-day FR (EODFR) experiments, seeds were surface sterilized and pregerminated before final sowing in plastic trays with a potting compost/sand mixture (3:1, v/v) as described in the previous chapter (see 2.2.1.2). In the other experiments (broad-band light, light-pulse and daytime FR experiments) seeds were directly sown (*i.e.* non-pretreated) in plastic trays using the same potting compost/sand mixture.

To compensate for the retardation of germination of the *au<sup>w</sup>* (Koornneef *et al.*, 1985; Adamse *et al.*, 1988) and *au<sup>w</sup>, tri<sup>l</sup>* mutants, seeds were pretreated 12 h longer (60 h of pretreatment) or sown 12 h before those of the WTs and other genotypes in the EODFR and the continuous broad-band light experiments, respectively.

### 3.2.2 Phytochrome assays

Methodology for *in-vivo* phytochrome spectrophotometry, Western- and Northern-blot analysis is described in the previous chapter (see 2.2.2). For the study of phytochrome destruction by *in-vivo* spectrophotometry seedlings were irradiated with R for 0.5–6 h prior to harvest.

### 3.2.3 Anthocyanin assay

Methodology for anthocyanin determination is described in the previous chapter (see 2.2.3). In the EODFR and supplementary daytime FR experiments the anthocyanin content is expressed on a fresh-weight (FW) basis ( $A_{535}/g$  FW).

### 3.2.4 Chlorophyll assay

For the determination of chlorophyll in the EODFR experiment, samples were weighed and extracted with 3.0 mL dimethylsulfoxide (DMSO) for WTs (GT and MM) and *tri<sup>l</sup>*; and with 1.5 mL DMSO for *au<sup>w</sup>* and *au<sup>w</sup>, tri<sup>l</sup>*, for 12 h in D (after Hiscox and Israelstam, 1979). After 2 h incubation at 65 °C and cooling down to 20 °C the absorbance (A) at 649 and 665 nm was determined spectrophotometrically (DU-64; Beckman Instruments, Fullerton, CA, USA). Chlorophyll *a* and *b* were calculated on a FW basis using the equations published by Lichtenthaler and Wellburn (1983) for ethanol (96 %, v/v).

### 3.2.5 Experiments

#### 3.2.5.1 Continuous broad-band light experiment

Non-pretreated WT(MM), WT(GT), *tri<sup>l</sup>*, *tri<sup>3</sup>*, *au<sup>w</sup>* and *au<sup>w</sup>, tri<sup>l</sup>* seeds were directly sown in trays and incubated in D for 96–108 h at 25 °C. The irradiation with continuous B, R and FR ( $3 \mu\text{mol}\cdot\text{m}^{-2}\cdot\text{s}^{-1}$ ) was started just before the seedlings emerged through the soil surface (= day 0). The length of 20 hypocotyls (from soil surface to the hypocotyl hook or cotyledons after opening of the hypocotyl hook) under B, R, FR and in D (viewed under dim-green safelight) was measured with a ruler on a daily basis for 7 days. In addition, the hypocotyl length of 20 seedlings grown in absolute D for the duration of the experiment was measured. For determination of the anthocyanin, samples (4 replicates) of 5 hypocotyls were taken at the end of the experiment (day 7).

3.2.5.2 *White-light experiment*

Surface-sterilized and pregerminated WT(MM), WT(GT), *tri*<sup>l</sup>, *au*<sup>w</sup> and *au*<sup>w</sup>,*tri*<sup>l</sup> seeds were sown in plastic trays and incubated in a phytotron in a 16-h WL (150  $\mu\text{mol.m}^{-2}.\text{s}^{-1}$  photosynthetically active radiation [PAR])/8-h D cycle at 25 °C. Every seedling was marked on emergence, making it possible to measure the hypocotyl length of each seedling after the appropriate number of WL/D cycles. The length of the 20 hypocotyls (from root basis to the hypocotyl hook or cotyledons after opening of the hypocotyl hook) of the seedlings was destructively measured on a daily basis for 7 days.

3.2.5.3 *Light-pulse experiment*

Non-pretreated WT(GT) and *tri*<sup>l</sup> seeds were directly sown in trays and incubated in D for 108 h at 25 °C. Pulses of R (3 min, 10  $\mu\text{mol.m}^{-2}.\text{s}^{-1}$ ) or R immediately followed by FR (6 min, 13  $\mu\text{mol.m}^{-2}.\text{s}^{-1}$ ), both saturating for attaining phytochrome photoequilibrium, were given every 4 h beginning at the time of emergence of the first seedlings. During the pulse irradiation 20 seedlings per treatment were marked individually on emergence enabling the measurement of hypocotyl length of each seedling after the appropriate number of pulses (6, 12, 18 or 24).

3.2.5.4 *Delayed-R experiment*

Surface-sterilized and pregerminated WT (GT) and *tri*<sup>l</sup> seeds were sown in trays and incubated in D for 60 h at 25 °C. The irradiation with continuous R (3  $\mu\text{mol.m}^{-2}.\text{s}^{-1}$ ) was started just before the first seedlings emerged through the soil surface. All seedlings which had just emerged were marked (= day 0) and the length of 20 hypocotyls (from soil surface to the hypocotyl hook or cotyledons after opening of the hypocotyl hook) was measured with a ruler on a daily basis for 6 days. In addition, the hypocotyl length of seedlings grown in D (viewed under dim-green safelight) was also measured daily. After the measurement of the seedlings grown in R for 1 day, and in D for 1 or 2 days, remaining seedlings were transferred to D and continuous R, respectively (indicated by: 1 d R-D; 1 d D-R and 2 d D-R) in 20 replicates. The hypocotyl length of 20 seedlings grown in absolute D for the duration of the experiment was also measured. For determination of the anthocyanin, samples (4 replicates) of 5 hypocotyls were taken at the end of the experiment (day 6).

3.2.5.5 *End-of-day FR experiment*

Surface-sterilized and pregerminated WT(MM), WT(GT), *tri*<sup>l</sup>, *au*<sup>w</sup> and *au*<sup>w</sup>,*tri*<sup>l</sup> seeds were sown in trays and grown for 12 days in a phytotron with a daily irradiation schedule of 16-h WL (190  $\mu\text{mol.m}^{-2}.\text{s}^{-1}$  PAR)/8-h D cycles at 25 °C and relative humidity of 65–70 %. At day 15 the seedlings were transplanted into plastic pots (10x10x11 cm) and after transfer to cabinets at day 18 allowed to adjust to the lower level of WL (125  $\mu\text{mol.m}^{-2}.\text{s}^{-1}$  PAR) for 1 day before start of the experimental treatment. Plants were then selected for uniform height and after

the daily WL period received an immediate 20 min FR ( $5 \mu\text{mol.m}^{-2}.\text{s}^{-1}$ ) irradiation, *i.e.* end-of-day FR (EODFR) before the D period (+ EODFR). The controls were grown in a similar cabinet and received no FR irradiation (– EODFR). Plant height (8 replicates) was measured every 3 days during a 15-day treatment with and without EODFR.

For determination of the anthocyanin, samples (8 replicates) of young leaves, comparably developed (5–15 mm in length) were taken at the end of the experiment (day 15). For determination of the chlorophyll, samples (8 replicates) of leaf number 4 were taken at the end of the experiment (day 15).

#### *3.2.5.6 Supplementary daytime FR experiment*

Non-pretreated WT(GT), *tri*<sup>1</sup> and *tri*<sup>2</sup> seeds were directly sown in trays and grown in a 16-h WL ( $170 \mu\text{mol.m}^{-2}.\text{s}^{-1}$  PAR)/8-h D cycle for 7 days at 25 °C. The plants were then transplanted into plastic pots (10x10x8.5 cm) and transferred to a cabinet with the same cycle, but higher irradiance ( $230 \mu\text{mol.m}^{-2}.\text{s}^{-1}$  PAR) which had a R:FR photon ratio of 6.90. After 18 days the plants were transferred to two cabinets with a similar 16-h WL/8-h D cycle (– FR), one of which had additional FR (+ FR) which is not photosynthetically active and reduces the R:FR photon ratio to 0.13 (see 6.2.5.1 and 6.2.6.1). Plant height (6 replicates) was measured every other day during a 6-day treatment with and without supplementary daytime FR.

For determination of the anthocyanin, samples (6 replicates) of young leaves, comparably developed (5–15 mm in length) were taken at the end of the experiment (day 6).

### **3.2.6 Light facilities and light measurements**

#### *3.2.6.1 Light cabinets*

The continuous broad-band, delayed-R and light-pulse experiment were carried out in the cabinets for low irradiance, described by De Lint (1960); the EODFR experiment was carried out in movable cabinets, described by Joustra (1970); all performed in Wageningen. The supplementary daytime FR experiment was performed in cabinets at the Botany Department, University of Leicester, Leicester, UK (see also 6.2.6.1).

#### *3.2.6.2 Light sources and light measurements*

*White light.* The WL was obtained from: (i) Philips TL40W/33 and TLMF-140W/33 fluorescent tubes (Philips, Eindhoven, the Netherlands) in the WL experiment in the phytotron in Wageningen; (ii) Philips TL40W/33 fluorescent tubes in the EODFR experiment; (iii) Philips BFT 75/85W/35 fluorescent tubes in the supplementary daytime FR experiment.

**Blue light.** The B was obtained from Philips TL40W/18 monophosphor fluorescent tubes filtered through 3-mm Plexiglas blue 248 (Röhme and Haas, Darmstadt, Germany; see 2.2.5.2).

**Red light.** The R was obtained from: (i) Philips TL40W/103339 monophosphor fluorescent tubes filtered through 3-mm Plexiglas red 501 (Röhme and Haas) in the continuous broad-band light and delayed-R experiments; (ii) light-emitting diodes (NLS01, 660 nm peak transmission, bandwidth at 50 % of the transmission maximum 25 nm; Sylvania BioSystems, Wageningen, the Netherlands) in the light-pulse experiment.

**Far-red light.** The FR was obtained from: (i) a bank of 60 W 240 V incandescent lamps filtered through 10-cm running tap water and 3-mm Plexiglas red 501 and blue 627 (Röhme and Haas), as described by Koornneef *et al.* (1980), in the continuous broad-band light and light-pulse experiments; (ii) Sylvania F48T12/232/VHO fluorescent tubes (Osram Sylvania, Danvers, MA, USA) wrapped with one layer dark-green and one layer primary-red filter (Lee; Flashlight Sales, Utrecht, the Netherlands) in the EODFR experiments; (iii) Lohuis R75/500 W tungsten halogen lamps, filtered through 4 cm of cooled flowing water and 3-mm Perspex red 4400 and green 6600 (ICI, Darwen, UK) for the supplementary daytime FR experiment.

Light-sources used in the phytochrome assays are described in 2.2.5.2. The fluence rates and exposure times used are given in the description of each experiment. Light measurements were performed as described in 2.2.5.3.

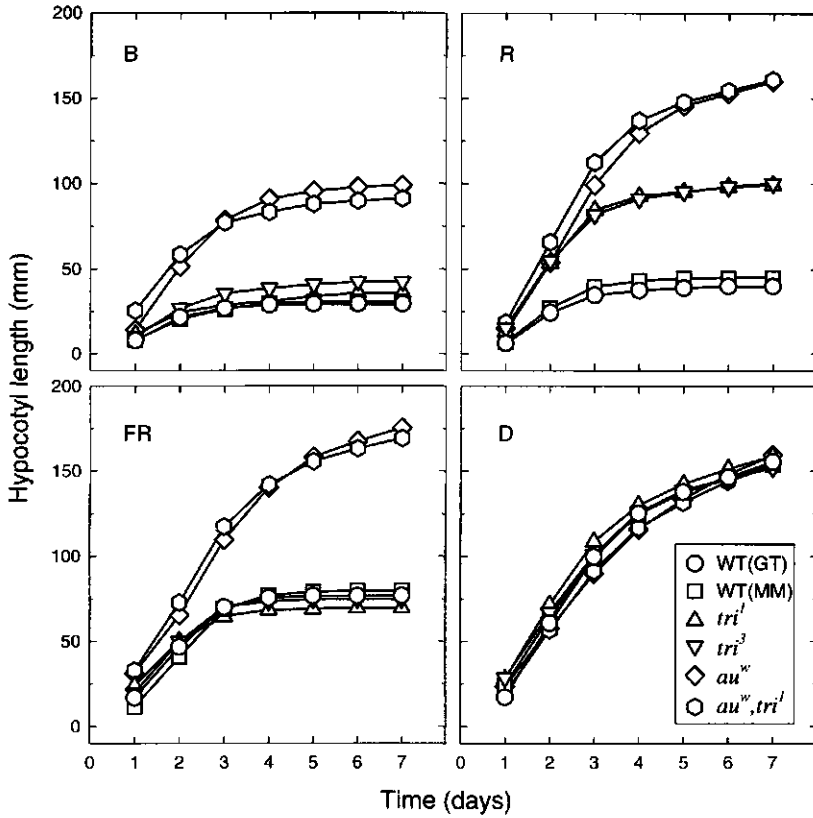
## 3.3 Results

### 3.3.1 Phenotypes

#### 3.3.1.1 Phenotypes of the *tri* mutants

The kinetics of inhibition of hypocotyl elongation under continuous low-fluence B, R and FR for 7 days of the *tri*<sup>1</sup> and *tri*<sup>3</sup> mutants, compared to their corresponding WT backgrounds is shown in Figure 3.1. The phenotype of the *tri*<sup>1</sup> and WT (GT) after 7 days after emergence under these conditions is shown in Figure 3.2. In FR and D, there is no difference between the WTs and the *tri* mutants. In B the hypocotyls of the *tri*<sup>1</sup> and *tri*<sup>3</sup> mutants are slightly elongated compared to their corresponding WTs. In R, both *tri* mutants have longer hypocotyls compared to the WTs as a consequence of a temporarily insensitivity to R during the first 2 days. Figure 3.3 shows the reduced inhibition of hypocotyl elongation and hook opening in R for the four *tri* alleles compared to the corresponding WTs (GT and MM) grown for 4 days after emergence. The four mutants exhibit longer hypocotyls, which contain less anthocyanin than the WTs in R.

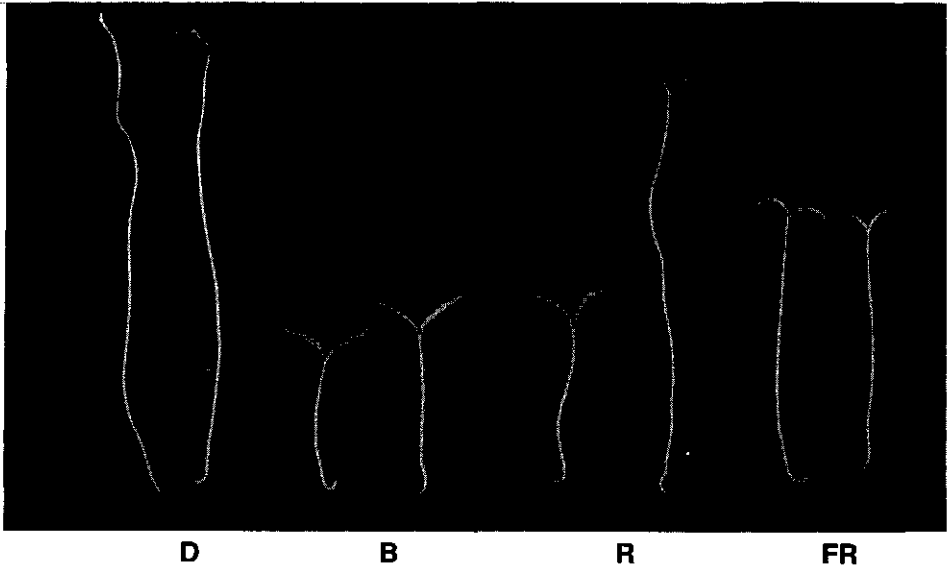




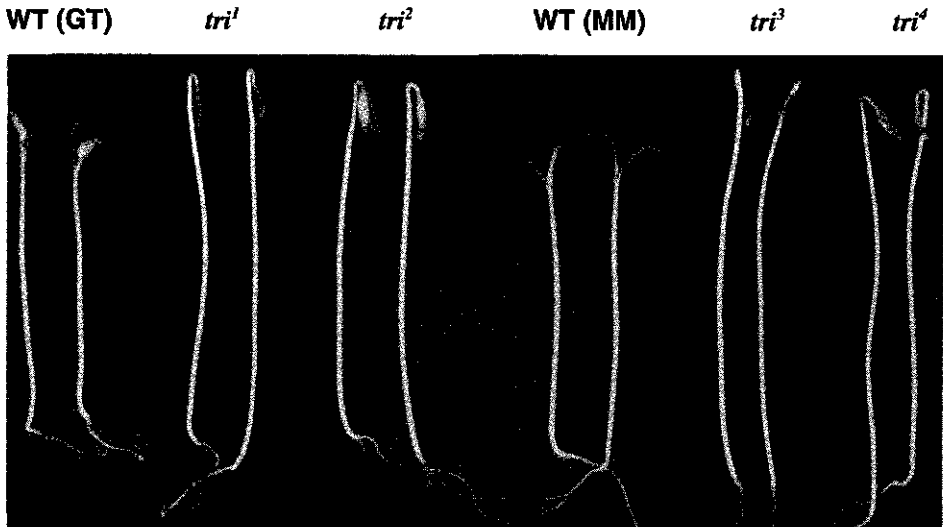
**Figure 3.1.** The hypocotyl length of: WT (GT) and derived *tri*<sup>1</sup>; WT (MM), and derived *tri*<sup>2</sup> and *au*<sup>w</sup>; *au*<sup>w</sup>,*tri*<sup>1</sup> double-mutant (mixed genetic background) tomato seedlings. Seedlings were grown for 7 days in continuous broad-band B, R, FR (3  $\mu\text{mol}\cdot\text{m}^{-2}\cdot\text{s}^{-1}$ ) and D (viewed under dim-green safelight). The mean hypocotyl length (mm)  $\pm$  SE of the absolute D control of WT (GT), WT (MM), *tri*<sup>1</sup>, *tri*<sup>2</sup>, *au*<sup>w</sup> and *au*<sup>w</sup>,*tri*<sup>1</sup> at the end of the 7-day period was: 165  $\pm$  2, 158  $\pm$  3, 169  $\pm$  2, 161  $\pm$  2, 166  $\pm$  2 and 167  $\pm$  2, respectively. The SE in all cases was smaller than the symbols used.

The apical hook opening is retarded in the *tri* mutants (Fig. 3.3). However, the cotyledons exhibit normal chlorophyll synthesis indicating that these two processes are uncoupled from hypocotyl elongation and anthocyanin accumulation. The retarded hook-opening could be an effect of growing the seedlings in relatively closed containers, which might lead to enhanced levels of ethylene. These results indicate that the *tri* mutants might exhibit a higher sensitivity to ethylene. Dark-grown seedlings of the *tri*<sup>2</sup> mutant exhibit an exaggerated curvature of the apical hook (Fig. 3.4), which is known as one aspect of the 'triple response' and is normally seen as a result of application of ethylene to etiolated seedlings (Guzmán and Ecker, 1990; Ecker, 1995).

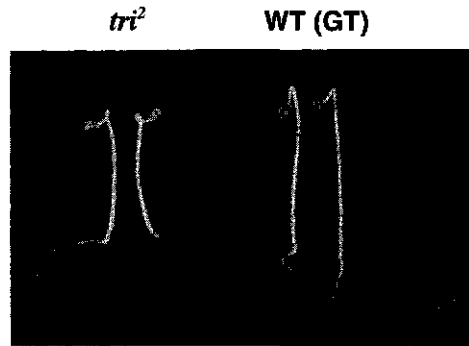
The anthocyanin content after 7 days continuous D, B, R and FR for the *tri*<sup>1</sup> and *tri*<sup>2</sup> mutant compared to their WTs is given in Figure 3.5. Both *tri* mutants show



**Figure 3.2.** Phenotypes of WT (GT) and derived *tri*<sup>1</sup> mutant tomato seedlings. Seedlings were grown for 7 days after emergence in D and continuous broad-band B, R and FR ( $3 \mu\text{mol}\cdot\text{m}^{-2}\cdot\text{s}^{-1}$ ). For each treatment the seedling on the left is the WT (GT) and that on the right is the *tri*<sup>1</sup> mutant.



**Figure 3.3.** Phenotypes of: WT (GT), and derived *tri*<sup>1</sup> and *tri*<sup>2</sup>; WT (MM), and derived *tri*<sup>3</sup> and *tri*<sup>4</sup> mutant tomato seedlings. Seedlings were grown for 2 days in D on filter paper, moistened with germination buffer, and transferred to continuous broad-band R ( $3 \mu\text{mol}\cdot\text{m}^{-2}\cdot\text{s}^{-1}$ ) for 4 days.



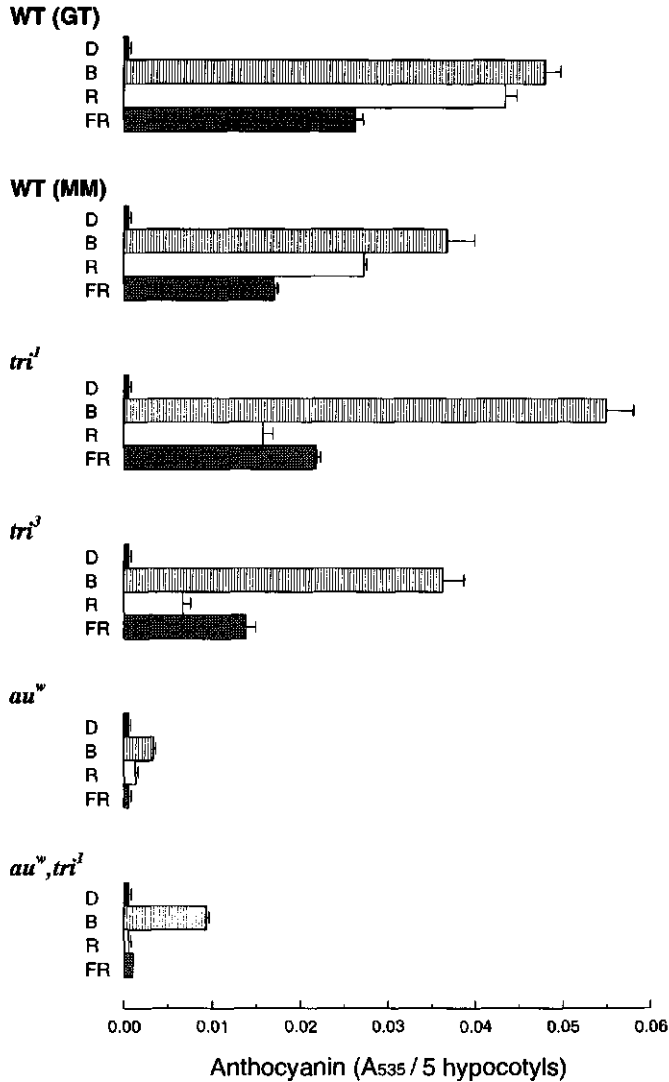
**Figure 3.4.** Phenotypes of WT (GT) and derived *tri*<sup>2</sup> mutant tomato seedlings, showing the exaggerated curvature of the apical hook in the *tri*<sup>2</sup> mutant. Seedlings were grown on agar medium in Plantcon<sup>®</sup> containers in D for 3.5 days. *Note:* the seed coats are still attached in both genotypes.

a reduced anthocyanin accumulation under R compared to WT's and are affected by the genetic background. However, the reduced anthocyanin accumulation in the *tri*<sup>1</sup> and *tri*<sup>3</sup> mutant phenotypes are qualitatively similar. Under B and FR much smaller differences were seen in anthocyanin accumulation between the *tri* mutants and WT's. There is an inverse relationship between cotyledon area and chlorophyll content expressed on a fresh-weight basis, suggesting that total chlorophyll production is little influenced by the mutation (Van Tuinen *et al.*, 1995b).

When grown in a 16-h WL (150  $\mu\text{mol}\cdot\text{m}^{-2}\cdot\text{s}^{-1}$  PAR)/8-h D cycle the *tri*<sup>1</sup> mutant is slightly elongated at the seedling stage compared to WT (Fig. 3.6). In older stages, under the same conditions, the *tri* mutants are slightly taller than their corresponding WT's. The difference in height between the *tri* mutants and their corresponding WT's becomes more apparent with age. However, there is a strong interaction between phenotype and the light-conditions. Under relatively low light conditions (16-h WL [100  $\mu\text{mol}\cdot\text{m}^{-2}\cdot\text{s}^{-1}$  PAR]/8-h D cycle) the *tri* phenotype is more pronounced (Fig. 3.7). Young immature leaves of the *tri* mutants possess less anthocyanin than the corresponding WT (see the controls in Table 3.2). Older *tri*<sup>1</sup> mutant seedlings show an early chlorosis of the first leaves, leading to premature senescence, compared to WT and the other three alleles.

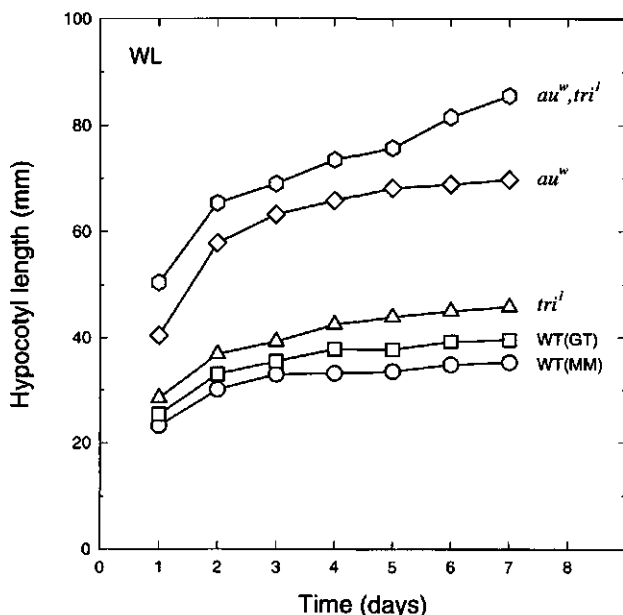
### 3.3.1.2 Phenotypes of the *au*<sup>w</sup> and *au*<sup>w</sup>,*tri*<sup>1</sup> mutants

The kinetics of inhibition of hypocotyl elongation under continuous low-fluence B, R and FR for 7 days of the *au*<sup>w</sup> and *au*<sup>w</sup>,*tri*<sup>1</sup> mutants, compared to their corresponding WT's is also shown in Figure 3.1. In R and FR both *au*<sup>w</sup> and *au*<sup>w</sup>,*tri*<sup>1</sup> mutants do not differ from seedlings grown in D, whereas in B a reduced inhibition of hypocotyl elongation occurred, as described for the *au*<sup>w</sup> by Koornneef *et al.* (1985) and Adamse *et al.* (1988). The anthocyanin content after 7 days continuous D, B, R and FR for the *au*<sup>w</sup> and *au*<sup>w</sup>,*tri*<sup>1</sup> mutant compared to their



**Figure 3.5.** The anthocyanin content ( $A_{535}/5$  hypocotyls  $\pm$  SE) of: WT (GT) and derived *tri*<sup>1</sup>; WT (MM), and derived *tri*<sup>3</sup> and *au*<sup>w</sup>; *au*<sup>w</sup>,*tri*<sup>1</sup> double-mutant (mixed background) tomato seedlings. Seedlings were grown for 7 days in continuous broad-band B, R, and FR ( $3 \mu\text{mol}\cdot\text{m}^{-2}\cdot\text{s}^{-1}$ ) and absolute D.

corresponding WT is given in Figure 3.5. Only in B is a detectable level of anthocyanin obtained, which is enhanced in the *au*<sup>w</sup>,*tri*<sup>1</sup>. The *tri* mutation still affects the amount of anthocyanin in the *au*<sup>w</sup>,*tri*<sup>1</sup>. When grown in 16-h WL/8-h D cycle both mutants show reduced hypocotyl inhibition (Fig. 3.6), most dramatically in the *au*<sup>w</sup>,*tri*<sup>1</sup> mutant.



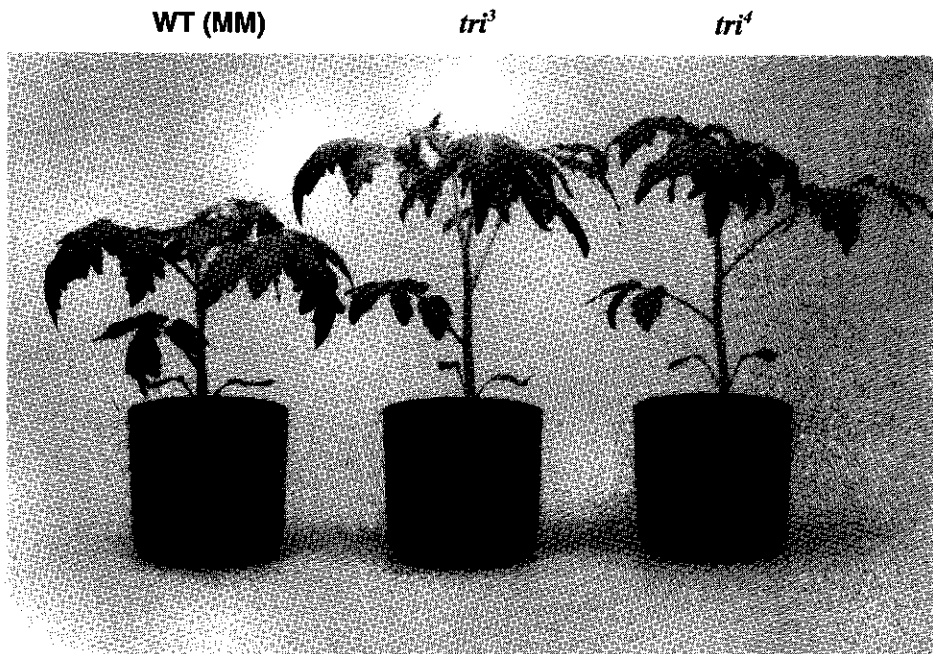
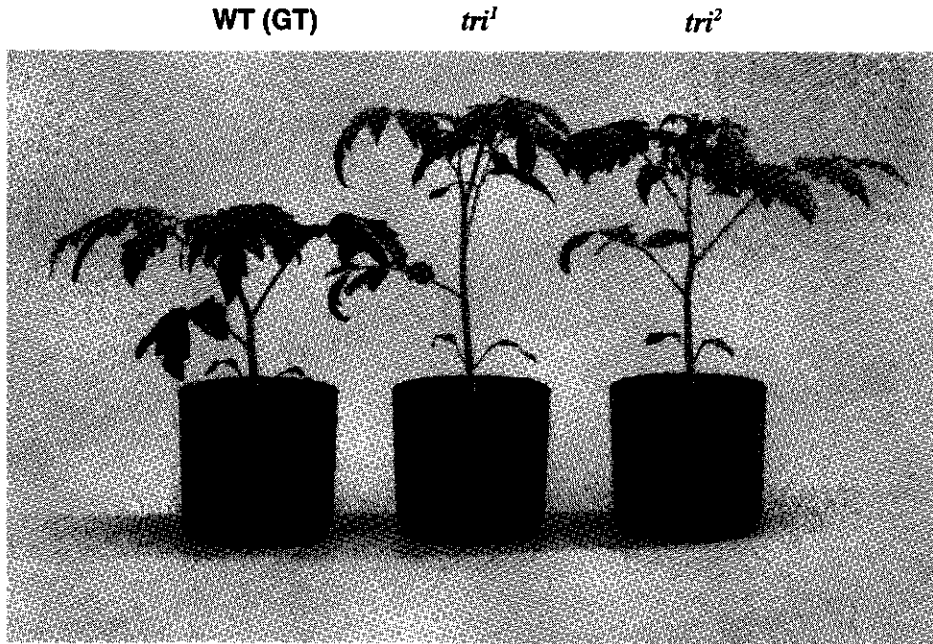
**Figure 3.6.** The hypocotyl length of: WT(GT) and derived *tri<sup>1</sup>*; WT(MM), and derived *tri<sup>3</sup>* and *au<sup>w</sup>*; *au<sup>w</sup>, tri<sup>1</sup>* double-mutant (mixed genetic background) tomato seedlings. Seedlings were grown in a 16-h WL (150  $\mu\text{mol}\cdot\text{m}^{-2}\cdot\text{s}^{-1}$  PAR)/8-h D cycle for 7 days. The SE in all cases was smaller than the symbols used.

### 3.3.2 Phytochrome assays

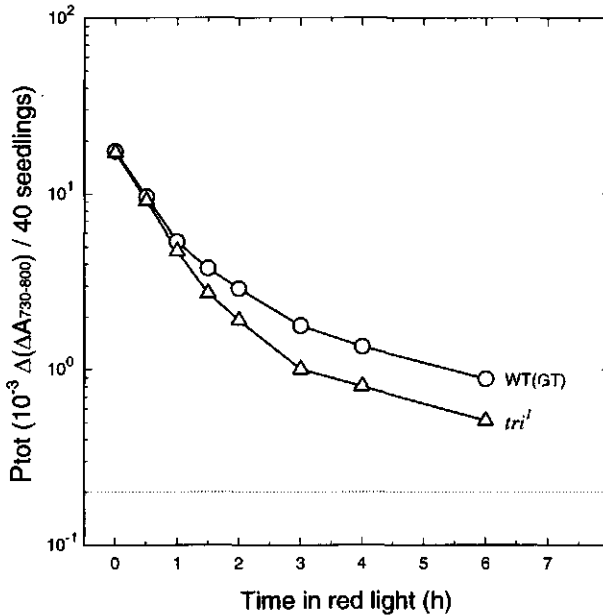
#### 3.3.2.1 The tri alleles

**In-vivo spectrophotometry.** The destruction kinetics of total spectrophotometrically detectable phytochrome (Ptot) in 4-day-old WT (GT) and the *tri<sup>1</sup>* mutant seedlings during irradiation with continuous R (Fig. 3.8) resulted in a depletion Ptot. No significant difference between the WT and the *tri<sup>1</sup>* mutant was seen during the first hour. However, after 1.5 h a significant difference in Ptot decay is detected in the *tri<sup>1</sup>* mutant. This could indicate that a predominantly light-stable phytochrome is deficient in the *tri<sup>1</sup>* mutant. Subtraction of the residual stable phytochrome pool and replotting the data demonstrates approximate first-order destruction kinetics for the labile phytochrome pool (data not shown). A similar pattern in Ptot kinetics was observed for all *tri* alleles in continuous R, although levels of Ptot in 4-day-old seedlings of GT, *tri<sup>1</sup>* and *tri<sup>2</sup>* are higher than in 4-day-old seedlings of MM, *tri<sup>3</sup>* and *tri<sup>4</sup>* (Table 3.1). After 4 h continuous R the *tri* alleles all have significantly less Ptot than their corresponding WTs, *ca.* 40 % less for *tri<sup>1</sup>*, *tri<sup>3</sup>* and *tri<sup>4</sup>* and *ca.* 20 % less for *tri<sup>2</sup>* (Table 3.1).

**Western-blot analysis.** Using an antibody to pea PHYA (mAP5), no differences were observed in extracts of 4-day-old D-grown seedlings between the WTs (GT and MM) and the four *tri* alleles (Fig. 3.9). As expected for phyA, a 4-h R



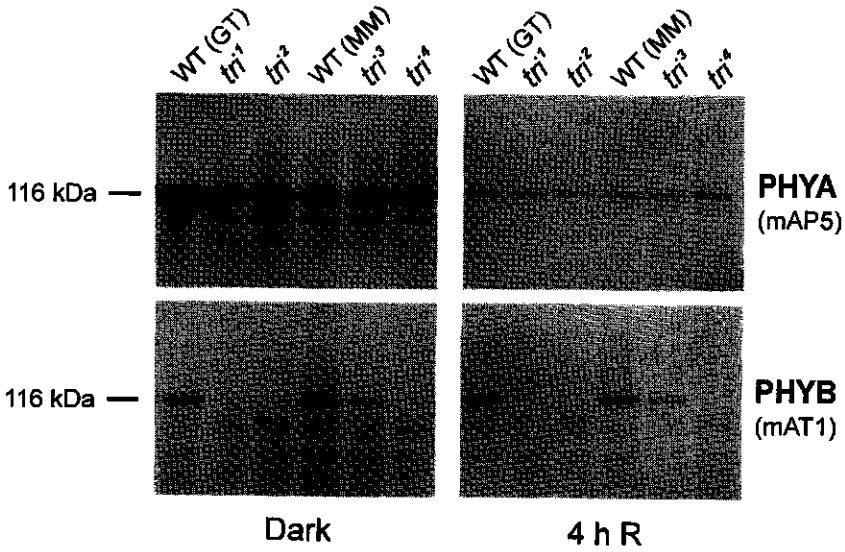
**Figure 3.7.** Phenotypes of: WT (GT), and derived *tri*<sup>1</sup> and *tri*<sup>2</sup> (upper panel); WT (MM), and derived *tri*<sup>3</sup> and *tri*<sup>4</sup> mutant tomato plants (lower panel). Plants were grown in a 16-h WL ( $100 \mu\text{mol}\cdot\text{m}^{-2}\cdot\text{s}^{-1}$  PAR)/8-h D cycle for 25 days.



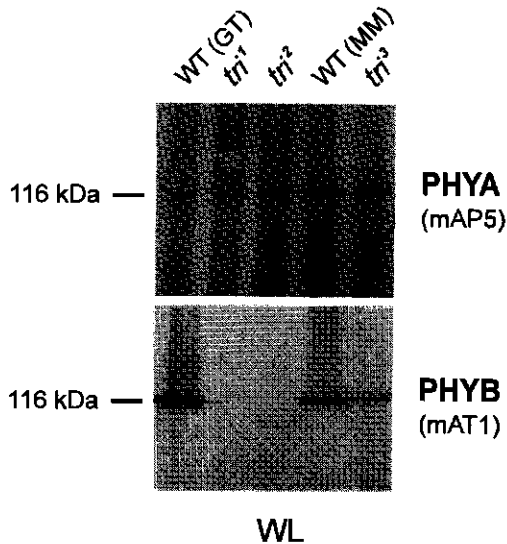
**Figure 3.8.** Destruction kinetics of total spectrophotometrically detectable phytochrome (Ptot) in 4-day-old WT (GT) and derived *tri*<sup>1</sup> mutant tomato seedlings during irradiation with continuous R (20  $\mu\text{mol}\cdot\text{m}^{-2}\cdot\text{s}^{-1}$ ) at 25 °C. Ptot is expressed as  $\Delta(\Delta A_{730-800})/40$  seedlings, plotted on a logarithmic scale. The dashed horizontal line indicates the detection limit for the spectrophotometer. The SE in all cases was smaller than the symbols used.

**Table 3.1.** *In-vivo* measurement of total spectrophotometrically detectable phytochrome (Ptot) in: WT (GT), and derived *tri*<sup>1</sup> and *tri*<sup>2</sup>; WT (MM), and derived *tri*<sup>3</sup> and *tri*<sup>4</sup> mutant tomato plants. The Ptot in dark-grown 4-day-old seedlings, or seedlings of the same age but exposed to 4 h R (20  $\mu\text{mol}\cdot\text{m}^{-2}\cdot\text{s}^{-1}$ ), was measured using a dual-wavelength spectrophotometer and is expressed as  $10^{-3}\Delta(\Delta A_{730-800})/40$  seedlings  $\pm$  SE.

Genotype	Treatment	
	Dark	4 h R
WT (GT)	17.69 $\pm$ 0.29	1.33 $\pm$ 0.05
<i>tri</i> <sup>1</sup>	17.23 $\pm$ 0.43	0.77 $\pm$ 0.01
<i>tri</i> <sup>2</sup>	17.48 $\pm$ 0.41	1.03 $\pm$ 0.04
WT (MM)	15.98 $\pm$ 0.31	1.40 $\pm$ 0.03
<i>tri</i> <sup>3</sup>	15.44 $\pm$ 0.15	0.80 $\pm$ 0.03
<i>tri</i> <sup>4</sup>	15.25 $\pm$ 0.75	0.83 $\pm$ 0.08



**Figure 3.9.** Western-blot analysis of phytochrome A and B polypeptides (PHYA and PHYB, respectively) in crude extracts from: WT (GT), and derived *tri*<sup>1</sup> and *tri*<sup>2</sup>; WT (MM), and derived *tri*<sup>3</sup> and *tri*<sup>4</sup> mutant tomato seedlings. Dark-grown 4-day-old seedlings, or seedlings of the same age but exposed to 4 h R ( $20 \mu\text{mol}\cdot\text{m}^{-2}\cdot\text{s}^{-1}$ ), were used for the detection of PHYA and PHYB with monoclonal antibodies mAP5 and mAT1, respectively.



**Figure 3.10.** Western-blot analysis of phytochrome A and B polypeptides (PHYA and PHYB, respectively) in crude leaf extracts from: WT (GT), and derived *tri*<sup>1</sup> and *tri*<sup>2</sup>; WT (MM), and derived *tri*<sup>3</sup> mutant tomato plants. Plants grown in a 16-h WL ( $150 \mu\text{mol}\cdot\text{m}^{-2}\cdot\text{s}^{-1}$  PAR)/8-h D cycle for 21 days, were used for the detection of PHYA and PHYB with monoclonal antibodies mAP5 and mAT1, respectively.



irradiation strongly depletes the light-labile phyA pool in all the genotypes.

Using an antibody to tobacco PHYB (mAT1), a band at 116 kDa is detected in both WTs. However it is absent or below the detection limit in the *tri*<sup>1</sup> mutant (Fig. 3.9). The *tri*<sup>3</sup> allele has a 116-kDa band of strongly reduced intensity of 10 % of that in WT, estimated from serial dilutions of WT (data not shown). Antibody mAT1 recognizes truncated proteins of reduced abundance at *ca.* 105 and 95 kDa in the *tri*<sup>2</sup> and *tri*<sup>4</sup> mutants, respectively, and the 116 kDa band is absent. After a 4-h R irradiation a similar pattern is observed, indicating that these PHYB-like proteins detected by mAT1 are relatively stable under these conditions. These patterns were retained in WL-grown plants of all four *tri* mutants indicating that the lack of responsiveness is not due to a temporal deficiency of PHYB apoprotein accumulation during de-etiolation as shown for the *tri*<sup>1</sup>, *tri*<sup>2</sup> and *tri*<sup>3</sup> mutants in Figure 3.10.

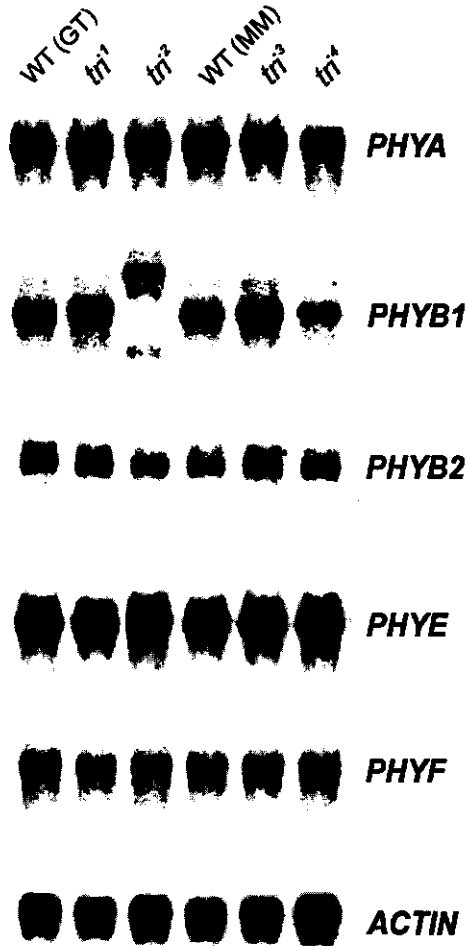
*Northern-blot analysis.* Hauser *et al.* (1995) showed that the phytochrome gene family consists of at least five members in tomato: *PHYA*, two *PHYBs* (*PHYB1* and *PHYB2*), *PHYE* and *PHYF*. Northern-blot analysis establishes that each of these *PHYs* is expressed as an mRNA sufficiently large (3.8–4.7 kb) to encode a full-length PHY (Hauser *et al.*, 1995).

Using gene-specific cRNA probes, no differences in amount or size of *PHYA*, *PHYB2*, *PHYE* and *PHYF* mRNAs were observed between the WTs and the *tri*-alleles (Fig. 3.11). While *PHYB1* mRNA did not differ between both WTs and *tri*<sup>1</sup> and *tri*<sup>3</sup> mutants, the *tri*<sup>2</sup> mutant does have a transcript about 2 kb larger than WT and a weak band of smaller size than the *PHYB1* band in the WT. In the *tri*<sup>4</sup> mutant the level of transcript is reduced (Fig. 3.11).

### 3.3.2.2 Double mutants

*In-vivo spectrophotometry.* Spectrophotometric analysis of the Ptot (Fig. 3.12) revealed the expected deficiencies in the *au*<sup>w</sup>,*tri*<sup>1</sup> double mutant, as was the case in the monogenic *au*<sup>w</sup> (Koornneef *et al.*, 1985). The signals in *au*<sup>w</sup> and *au*<sup>w</sup>,*tri*<sup>1</sup> were below the detection limit of the spectrophotometer, which was  $0.2 \cdot 10^{-3} \Delta(\Delta A_{730-800})$ . Both etiolated *au*<sup>w</sup> and *au*<sup>w</sup>,*tri*<sup>1</sup> seedlings therefore contain < 1 % of the Ptot present in the WT. The *fri*<sup>1</sup>,*tri*<sup>1</sup> double mutant has a low level of total phytochrome, which was not susceptible to destruction during a 4 h R irradiation. This low level was identical to that in the *tri*<sup>1</sup> after a 4 h R irradiation. The *hp-1*<sup>w</sup>,*tri*<sup>1</sup> essentially resembles the monogenic *tri*<sup>1</sup> (data not shown). Figure 3.12 also includes data for the monogenic *fri*<sup>1</sup> (Chapter 2) and *tri*<sup>1</sup> (Fig. 3.8) mutants for comparison.

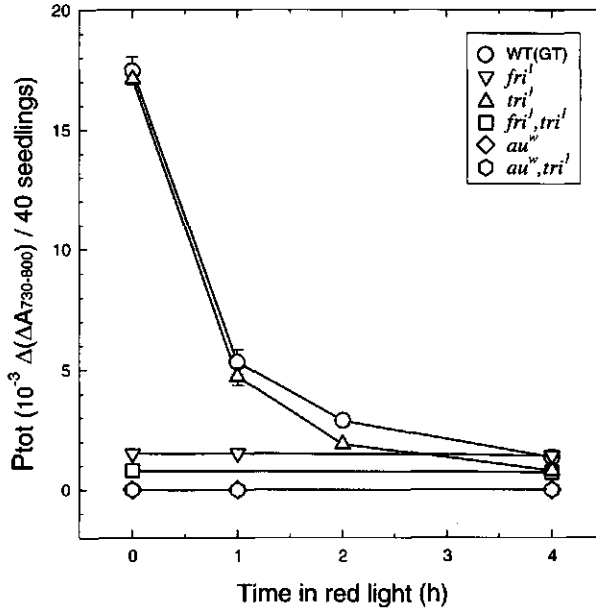
*Western-blot analysis.* Analysis revealed the expected deficiencies: no immunochemically detectable 116 kDa-phyA polypeptide (PHYA) and 116 kDa-phyB-like polypeptide (PHYB) in the *fri*<sup>1</sup>,*tri*<sup>1</sup> double mutant (Fig. 3.13); no immuno-



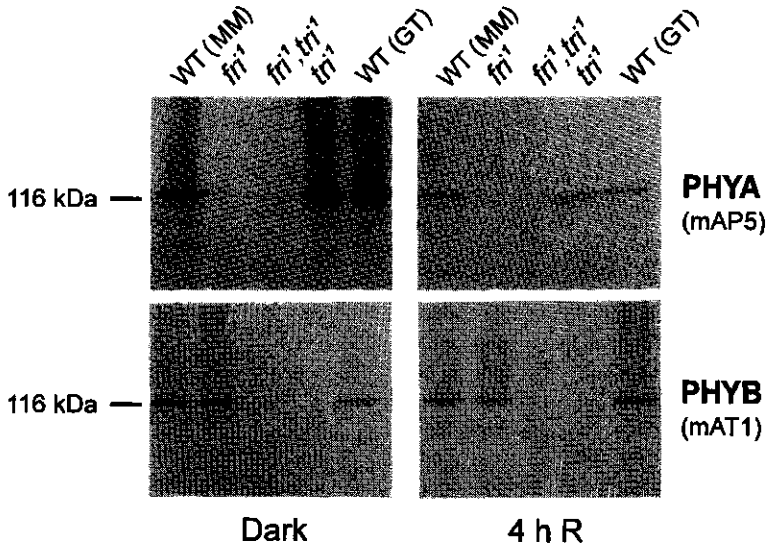
**Figure 3.11.** Northern-blot analysis of *PHYA*, *PHYB1*, *PHYB2*, *PHYE* and *PHYF* mRNA present in 1.0, 1.0, 1.0, 1.5, 1.5  $\mu\text{g poly(A)}^+$  RNA, respectively. RNA was isolated from: WT (GT), and derived *tri*<sup>1</sup> and *tri*<sup>2</sup>; WT (MM), and derived *tri*<sup>3</sup> and *tri*<sup>4</sup> mutant tomato plants. Plants were grown in a greenhouse for 18 days. The <sup>32</sup>P photolabelling was detected and quantitated with a PhosphorImager using *ACTIN* mRNA (present in 0.35  $\mu\text{g poly(A)}^+$  RNA) as an internal standard.

chemically detectable PHYB in the *au*<sup>w</sup>,*tri*<sup>1</sup> (Fig. 3.14A) and *hp-1*<sup>w</sup>,*tri*<sup>1</sup> double mutant (Fig. 3.14B). The *au*<sup>w</sup> and *au*<sup>w</sup>,*tri*<sup>1</sup> mutants show a reduced level of PHYA (ca. 25 % of the WT), which was not degraded by a 4-h R irradiation as in WT and is in agreement with the observation of no spectrophotometrically active phytochrome, *i.e.* no PrA - PfrA photoconversion, in the *au*<sup>w</sup> monogenic and *au*<sup>w</sup> double-mutants.

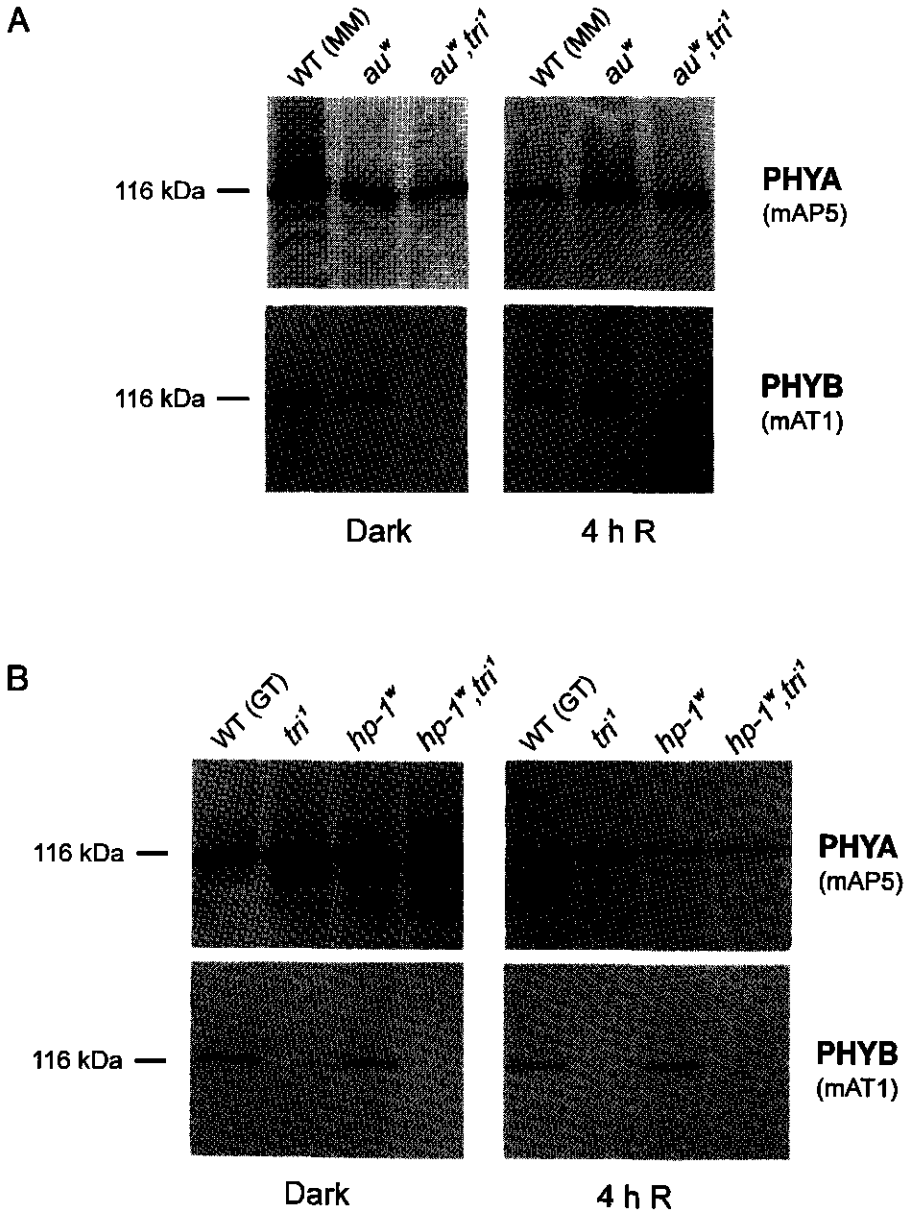
Analysis of the phytochrome B1-deficient tri mutants of tomato



**Figure 3.12.** Destruction kinetics of total spectrophotometrically detectable phytochrome (Ptot) in 4-day-old WT (GT), *tri*<sup>1</sup>, *fri*<sup>1</sup>, *au*<sup>w</sup>, *fri*<sup>1</sup>,*tri*<sup>1</sup> and *au*<sup>w</sup>,*tri*<sup>1</sup> mutant tomato seedlings during irradiation with continuous R (20 μmol.m<sup>-2</sup>.s<sup>-1</sup>) at 25 °C. The Ptot is expressed as Δ(ΔA<sub>730-800</sub>)/40 seedlings, plotted on a linear scale. Error bars represent the SE.



**Figure 3.13.** Western-blot analysis of phytochrome A and B polypeptides (PHYA and PHYB, respectively) in crude extracts of: WT (GT) and derived *tri*<sup>1</sup>; WT (MM) and derived *fri*<sup>1</sup>; *fri*<sup>1</sup>,*tri*<sup>1</sup> double-mutant (mixed genetic background) tomato seedlings. Dark-grown 4-day-old seedlings, or seedlings of the same age but exposed to 4 h R (20 μmol.m<sup>-2</sup>.s<sup>-1</sup>), were used for the detection of PHYA and PHYB with monoclonal antibodies mAP5 and mAT1, respectively.

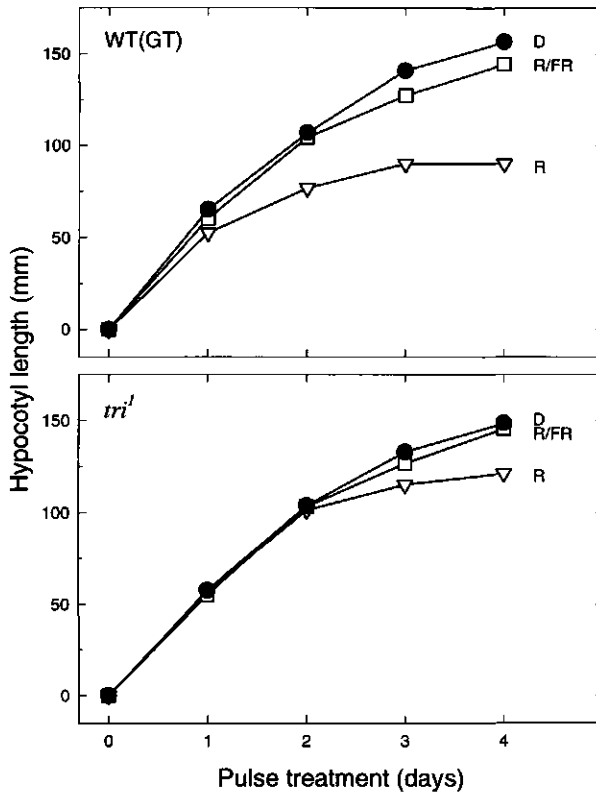


**Figure 3.14.** Western-blot analysis of phytochrome A and B polypeptides (PHYA and PHYB, respectively) in crude extracts of: (A) WT (MM) and derived *au<sup>\*</sup>*; *au<sup>\*</sup>, tri<sup>1</sup>* double-mutant (mixed genetic background) tomato seedlings; (B) WT (GT), and derived *tri<sup>1</sup>*, *hp-1<sup>w</sup>* and *hp-1<sup>w</sup>, tri<sup>1</sup>* double-mutant tomato seedlings. Dark-grown 4-day-old seedlings, or seedlings of the same age but exposed to 4 h R ( $20 \mu\text{mol.m}^{-2}.\text{s}^{-1}$ ), were used for the detection of PHYA and PHYB with monoclonal antibodies mAP5 and mAT1, respectively.

### 3.3.3 Physiological characterization

#### 3.3.3.1 Low fluence response experiments

The phyB1-deficient *tri* mutants, in contrast to the phyA-deficient *fri* mutants (Chapter 2), show retarded and reduced hypocotyl growth inhibition in continuous broad-band R (Fig. 3.1). Whereas spectrophotometric analysis has shown that the phyA pool is depleted after 4 h R (see 2.3.2.1), phyB and/or other light-stable type phytochrome(s) must play the major role in growth inhibition under continuous R. We tested the involvement of a low fluence response (LFR), which is R/FR reversible, in hypocotyl growth inhibition with pulses of R or R immediately followed by FR (both saturating for phytochrome photoconversion) given every 4 h on hypocotyl growth inhibition. Figure 3.15 shows that the *tri*<sup>1</sup> mutant is insensitive to R only during the first 2 days of pulse treatment. Thereafter the inhibitory effect of R on hypocotyl elongation growth and FR reversibility are exhibited in the *tri* mutants. Since the phyB-like phytochrome is still below

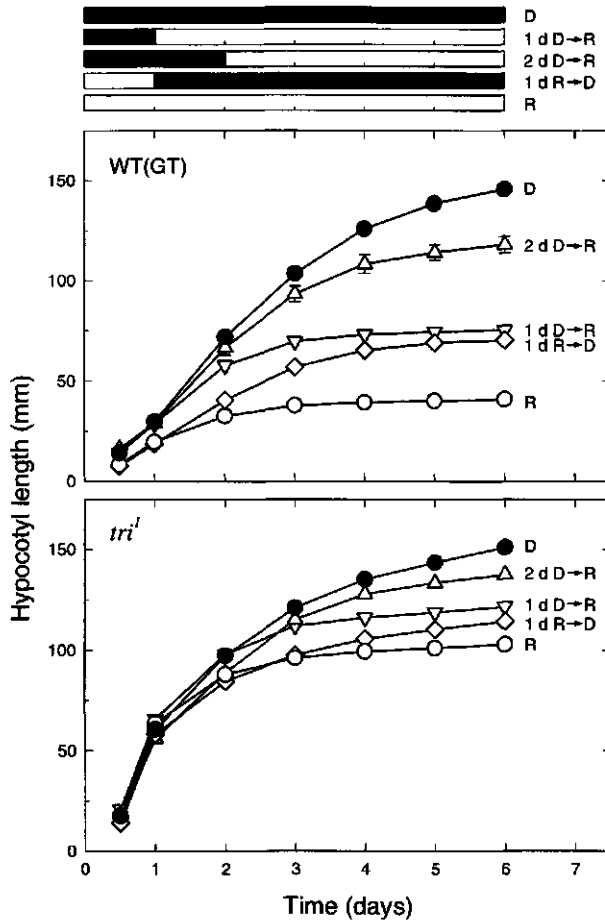


**Figure 3.15.** Hypocotyl length of WT (GT) and derived *tri*<sup>1</sup> mutant tomato seedlings. Seedlings were treated with pulses of R or R immediately followed by FR and a D control. The R and FR pulses (both saturating for phytochrome photoconversion) were repeated every 4 h from the time of emergence. The SE in all cases was smaller than the symbols used.

detection limits in older WL-grown plants of the *tri*<sup>1</sup> mutant (Fig. 3.10), the temporal appearance of responsiveness to R cannot be explained by a delay in appearance of the phyB-like phytochrome detected by the antibody used.

3.3.3.2 Delayed-R experiment

To test whether the 2-day period of insensitivity to R for hypocotyl growth inhibition of the *tri*<sup>1</sup> mutant depends on a temporal pattern of development or on the time after a transfer from D, seedlings were grown in D, in continuous R, grown and kept in D for 1 or 2 day(s) after emergence before transfer to continuous R or grown and kept in R for 1 day after emergence before transfer to D (Fig. 3.16). The WT exhibits a significant response to R within 24 h after



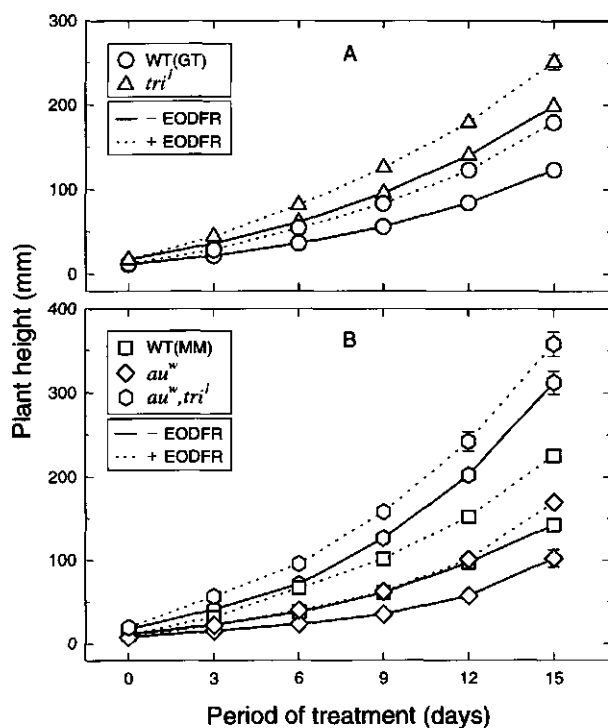
**Figure 3.16.** Hypocotyl length of WT (GT) and derived *tri*<sup>1</sup> mutant tomato seedlings. Seedlings were grown for 6 days after emergence in D, continuous R ( $3 \mu\text{mol}\cdot\text{m}^{-2}\cdot\text{s}^{-1}$ ), transferred to R after a D period of 1 day (1 d D→R) or 2 days (2 d D→R) or transferred to D after a R period of 1 day (1 d R→D). Error bars represent the SE.

transfer from D to R after 1 or 2 day(s), and after transfer from R to D after 1 day. The *tri*<sup>i</sup> mutant stays insensitive to R for 2 days following the transfer from D to R irrespective of the length of the preceding D period. Although no inhibition occurs during the first day, the *tri*<sup>i</sup> mutant is able to sense R given for 1 day before transfer to D. This small effect suggests appearance of responsiveness to a stable phytochrome species.

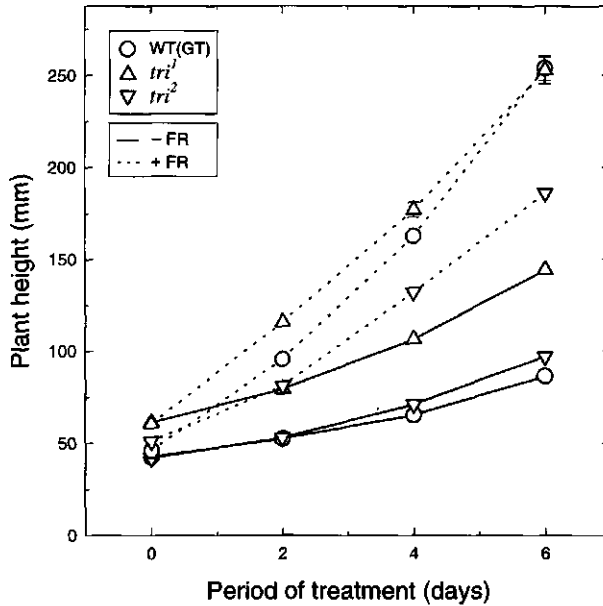
In all treatments where seedlings emerged in D, no anthocyanin was synthesized in either genotype. The anthocyanin content ( $A_{535}/5$  hypocotyls  $\pm$  SE) in continuous R was  $0.110 \pm 0.003$  and  $0.043 \pm 0.002$  for WT and *tri*<sup>i</sup>, respectively. The transfer from R to D after 1 day gives a 15 % reduction in anthocyanin content in both WT and *tri*<sup>i</sup>.

### 3.3.3.3 End-of-day FR and supplementary daytime FR experiments

All genotypes respond to EODFR treatment with an increase in plant height that is quantitatively similar to both WTs (Fig. 3.17), although the absolute height of the *tri*<sup>i</sup> and *au*<sup>w</sup> mutant is somewhat higher and lower, respectively. The *au*<sup>w</sup>,*tri*<sup>i</sup>



**Figure 3.17.** Plant height of: (A) WT (GT) and derived *tri*<sup>i</sup> mutant tomato plants; (B) WT (MM) and derived *au*<sup>w</sup>; *au*<sup>w</sup>,*tri*<sup>i</sup> double-mutant (mixed genetic background) tomato plants. Plants were grown in a 16-h WL ( $125 \mu\text{mol}\cdot\text{m}^{-2}\cdot\text{s}^{-1}$  PAR)/8-h D cycle. After 19 days from sowing, plants were submitted to an immediate 8-h D (-EODFR) period or given a 20-min FR pulse before the D period (+EODFR). Error bars represent the SE.



**Figure 3.18.** Plant height of WT (GT), and derived *tri*<sup>1</sup> and *tri*<sup>2</sup> mutant tomato plants. Plants were grown in a 16-h WL ( $230 \mu\text{mol}\cdot\text{m}^{-2}\cdot\text{s}^{-1}$  PAR)/8-h D cycle. After 18 days from sowing, plants were submitted to a similar WL/D cycle (-FR) or a similar WL/D cycle with supplementary daytime FR (+FR). Error bars represent the SE.

double mutant established a response to EODFR during the first 6 days of treatment, whereafter no response seemed to occur. This is probably due to a maximal shade-avoidance response due to the severe phytochrome deficiency in *au<sup>w</sup>,tri<sup>1</sup>*.

Both *tri*<sup>1</sup> and *tri*<sup>2</sup> mutants, and their corresponding WT (MM) also show a typical promotion of elongation growth in response to supplementary FR during the daily photoperiod (Fig. 3.18). The response is apparently slightly less in the *tri*<sup>1</sup> mutant compared to the WT, but this could be due to attainment of the maximal growth possible under these conditions. The *tri*<sup>2</sup> mutant, which is hardly indistinguishable from the WT in the control (-FR), showed a weaker response to supplementary daytime FR.

Table 3.2 shows the total chlorophyll *a* and *b* in the EODFR experiment, and anthocyanin content in both the EODFR and supplementary daytime FR experiments. There is a little effect of EODFR treatment on chlorophyll levels, whereas EODFR and supplementary daytime FR leads to drastic reduction or total loss, of detectable anthocyanin in young comparable developed leaves, respectively (see also 6.3.2.2).



**Table 3.2.** Comparison of the FR-effect at the end of the experiments on: total chlorophyll *a* and *b* (mg/g FW), extracted from the fourth leaf in the EODFR experiment; anthocyanin ( $A_{535}$ /g FW), extracted from young, comparably developed leaves (5–15 mm leaf length) in the EODFR and supplementary daytime FR experiment. In the EODFR treatment 19-day-old plants received a 20-min FR pulse ( $4.6 \mu\text{mol}\cdot\text{m}^{-2}\cdot\text{s}^{-1}$ ) immediate after the daily WL for 15 days. In the daytime FR treatment 18-day-old plants received FR ( $600 \mu\text{mol}\cdot\text{m}^{-2}\cdot\text{s}^{-1}$ ) during the daily WL period for 6 days. The FR treatments are indicated by + EODFR or + FR, and the controls receiving no EODFR or daytime FR are indicated by – EODFR or – FR.

Genotype	EODFR				Daytime FR	
	Chlorophyll (mg/g FW)		Anthocyanin ( $A_{535}$ /g FW)		Anthocyanin ( $A_{535}$ /g FW)	
	– EODFR	+ EODFR	– EODFR	+ EODFR	– FR	+ FR
WT (GT)	2.72 ± 0.02	2.65 ± 0.05	1.39 ± 0.07	0.69 ± 0.09	4.64 ± 0.34	0
<i>tri</i> <sup>1</sup>	2.82 ± 0.05	2.67 ± 0.07	0.60 ± 0.06	0.10 ± 0.01	2.43 ± 0.51	0
<i>tri</i> <sup>2</sup>	nd*	nd*	nd*	nd*	3.30 ± 0.16	0
<i>au</i> <sup>w</sup> , <i>tri</i> <sup>1</sup>	0.90 ± 0.02	0.80 ± 0.06	0	0	nd*	nd*
<i>au</i> <sup>w</sup>	0.57 ± 0.03	0.61 ± 0.03	0	0	nd*	nd*
WT (MM)	2.72 ± 0.06	2.72 ± 0.05	1.95 ± 0.13	0.54 ± 0.06	5.65 ± 0.36	0

\* not determined

### 3.4 Discussion

#### 3.4.1 Comparison to other species

##### 3.4.1.1 Phenotype

The *tri* mutants of tomato resemble the phyB mutants in *Arabidopsis*, sorghum, *Brassica*, pea and cucumber, in having an elongated phenotype in continuous R compared to the WT. All have the appearance of shade-avoidance species grown under vegetation shade (Robson *et al.*, 1993). In contrast to these mutants, in which the inhibition of elongation growth and cotyledon expansion in R is essentially lost, the *tri* mutants are insensitive to R only during the first 2 days upon transition from D to R (Figs. 3.1, 3.2, 3.15 and 3.16). This results in a phenotype in continuous R with longer hypocotyls and smaller cotyledons, but less extreme, for instance, than that of the almost completely R- and FR-blind tomato *au*<sup>w</sup> mutant (Figs 3.1). Another feature of the *hy3* (= *phyB*) mutant in *Arabidopsis* is that root hairs of WL-grown plants are much longer, while roots are shorter (Reed *et al.*, 1993). In contrast, the *tri* mutants do not differ in these characteristics from WT (data not shown).

3.4.1.2 Responses to end-of-day FR and supplementary daytime FR

The EODFR response (Fig. 3.17) and the effect of supplementary daytime FR (Fig. 3.18), are commonly accepted to be predominantly regulated by phyB (Adamse *et al.*, 1987; Devlin *et al.*, 1992; López-Juez *et al.*, 1992; Reed *et al.*, 1993). However, these shade-avoidance responses are present in the *tri* mutants. In addition, preliminary experiments indicate that another phyB-mediated response, simulated phototropism (Adamse *et al.*, 1988), as a result of covering one of the cotyledons with aluminium foil (Shuttleworth and Black, 1977), is also present in the *tri* mutant (results not shown). The fact that the *tri* mutants still respond to EODFR and supplementary daytime FR treatment distinguishes this mutant from previously described phyB-deficient mutants in other species (Whitelam and Smith, 1991).

3.4.2 The *TRI* locus is probably the *PHYB1* structural gene

We have shown that four mutants at the *TRI* locus of tomato differ in the same way with respect to WT in their photobiology. The loss of these photoresponses correlates with a reduction in spectrophotometrically detectable light-stable phytochrome. A mutation leading to reduction in phytochrome might be due to: (i) a lack of apoprotein biosynthesis as a consequence of a mutation in a structural *PHY*; (ii) a mutation in a regulatory gene; (iii) a mutation in phytochrome chromophore biosynthesis; (iv) a mutation affecting stability of either a *PHY* mRNA or PHY apoprotein.

Mutations affecting chromophore biosynthesis are likely to affect all phytochrome types, which is not the case in the *tri* mutants which contain the normal level of light-labile phyA. Furthermore, the *au* and *yg-2* mutants, which are yellow in appearance, are chromophore mutants in tomato, possessing no spectrophotometrically detectable phytochrome in etiolated seedlings (Sharma *et al.*, 1993; Terry and Kendrick, 1996; Van Tuinen *et al.*, 1996a).

Mutations in genes affecting the regulation of synthesis or stability of phytochrome might be phytochrome-type specific, but would then be expected to affect only the protein level in a quantitative way. The observation that *tri* alleles differ from WT either quantitatively (*tri*<sup>1</sup> and *tri*<sup>3</sup>) in a protein recognized by a PHYB-like antibody or produce a truncated PHYB-like protein (*tri*<sup>2</sup> and *tri*<sup>4</sup>) can be best explained by proposing that they possess mutations in a structural *PHYB* gene. The difference in spectrally active phytochrome after 4–6 h of R between WT and the *tri*<sup>1</sup> mutant presumably reflects the absence of this PHYB-like apoprotein (Fig. 3.8 and Table 3.1). That the *PHYB* gene involved is *PHYB1* is concluded from the observations with a specific *PHYB1* probe that an aberrant mRNA is observed in the *tri*<sup>2</sup> mutant and a reduced level of this mRNA is seen in the *tri*<sup>4</sup> mutant. The larger *PHYB1* mRNA in the *tri*<sup>2</sup> mutant presumably originates from incorrect splicing of the mRNA. Since the *tri* alleles differ at both protein

and mRNA levels, it seems unlikely that the *TRI* locus regulates phytochrome at the level of transcription or translation. The observation that the *tri*<sup>1</sup> mutant has no immunodetectable protein, yet the *PHYB1* mRNA level appears normal, indicates that this mRNA might contain a premature stop codon. Other possibilities could account for the lower level of protein of normal size in the *tri*<sup>3</sup> mutant, such as substitution of an amino acid that affects stability. The truncated protein in the *tri*<sup>2</sup> mutant might still be partially photoactive since it possesses significantly more spectrally active phytochrome after 4 h R than the other *tri* alleles.

The monoclonal antibody raised against tobacco PHYB (mAT1) detects a PHY in WT tomato, but fails to detect a polypeptide by Western-blot analysis in the *tri*<sup>1</sup> mutant, which is in agreement with the conclusion of Pratt *et al.* (1995) that the tobacco PHYB used to raise the mAT1 antibody is orthologous to tomato PHYB1. It is therefore possible that the mAT1 antibody used in this study is highly specific for tomato PHYB1, thus accounting for no other band being present in the Western blot of the *tri*<sup>1</sup> mutant. However it cannot be excluded that phyB2 is a very low abundance protein.

The *tri* mutants and the *PHYB1* gene were recently mapped by classical and RFLP analysis at a similar position on chromosome 1 (Van Tuinen *et al.*, 1996b), reinforcing our prediction that the two loci are identical. Because the wild-type tomato *PHYB1* sequence has recently been determined and sequencing of putative mutant alleles is underway, it will soon be established unambiguously whether *TRI* = *PHYB1* (Kubota *et al.*, 1996).

### **3.4.3 The role of phytochrome B1 in tomato**

Molecular phylogenetic analyses indicate that the tomato *PHYB* subfamily (*PHYB1* and *PHYB2*) is related to *Arabidopsis PHYB* and *PHYD*, the latter being a B-type phytochrome (Pratt *et al.*, 1995). However these analyses fail to establish any orthologous relationship between either of the tomato *PHYBs* and either *Arabidopsis PHYB* or *PHYD*. This observation raises the possibility that there is no general 'phyB function' in all species throughout the plant kingdom (Pratt *et al.*, 1995). Consequently, *Arabidopsis PHYB* mutants cannot be considered strictly equivalent to the putative *PHYB1* mutants at the *TRI* locus in tomato. The observation that the *Arabidopsis hy3* mutants have lost their responsiveness to EODFR (Nagatani *et al.*, 1991), while tomato *tri* mutants retain a normal EODFR-response (Fig. 3.17) and daytime FR (Fig. 3.18) is consistent with this conclusion (Pratt *et al.*, 1995). Whether these discrepancies reflect actual differences between tomato phyB1 and *Arabidopsis* phyB functions, or whether they reflect ability of other phytochromes in these two organisms to replace them, remains to be determined. Kendrick *et al.* (1994) hypothesized that phyB1 and phyB2 are both able to regulate the EODFR response in tomato and that this redundancy also explains the temporarily insensitivity to R. This could also explain why no

### Chapter 3

constitutively tall mutants have been selected in tomato. The *tri* mutants are the first examples of mutants that indicate that a process thought to be regulated by phyB exclusively seems, at least in tomato, to involve more than one light-stable type of phytochrome.

It is interesting to note that López-Juez *et al.* (1992) used the same mAT1 antibody used in this study to characterize the tall *lh* mutant of cucumber and demonstrated that it lacks a light-stable PHYB-like phytochrome. It may be that cucumber has no PHYB ortholog to take over the function of a missing phyB, again supporting the difference between tomato and other species. The same could be the case in *Arabidopsis hy3* (= *phyB*) mutants, where the closely related phyD fails to compensate for a lack of phyB (Clack *et al.*, 1994).

**Acknowledgements.** We thank Harry Smith and Garry Whitelam, University of Leicester, UK for the facilities used in the supplementary daytime FR experiment. Part of this work was carried out at the Laboratory for Photoperception and Signal Transduction, Frontier Research Program, Institute of Physical and Chemical Research (RIKEN), Japan; an at the Botany Department, University of Georgia, GA, USA and supported by USDA NRICGP grant 93-00939 to L.H. Pratt and M.-M. Cordonnier-Pratt.

# CHAPTER 4

## Phytochrome control of anthocyanin biosynthesis in tomato seedlings: analysis using photomorphogenic mutants

**Abstract.** Anthocyanin biosynthesis has been studied in hypocotyls and whole seedlings of tomato (*Lycopersicon esculentum* Mill.) wild types (WTs) and photomorphogenic mutants. In white light (WL)/dark (D) cycles the *fri*<sup>1</sup> mutant, deficient in phytochrome A (phyA), shows an enhancement of anthocyanin accumulation, whereas the *tri*<sup>1</sup> mutant, deficient in phytochrome B1 (phyB1) has a WT-level of anthocyanin. Under pulses of red light (R) or R followed by far-red light (FR) given every 4 h, phyA is responsible for the non-R/FR reversible response, whereas phyB1 is partially responsible for the R/FR reversible response. From R and blue light (B) pretreatment studies, B is most effective in increasing phytochrome responsiveness, whereas under R itself it appears to be dependent on the presence of phyB1. Anthocyanin biosynthesis during a 24-h period of monochromatic irradiation at different fluence rates of 4-day-old D-grown seedlings has been studied. At 660 nm the fluence rate-response relationships for induction of anthocyanin in the WTs are similar, yet complex, showing a low fluence rate response (LFRR) and a fluence rate dependent high irradiance response (HIR). The high-pigment-1<sup>w</sup> (*hp-1<sup>w</sup>*) mutant exhibits a strong amplification of both the LFRR and HIR. The *fri*<sup>1</sup> mutant, lacks the LFRR whilst retaining a normal HIR. In contrast, a transgenic tomato line overexpressing the oat *PHYA3* gene shows a dramatic amplification of the LFRR. The *tri*<sup>1</sup> mutant, retains the LFRR, but lacks the HIR, whereas the *fri*<sup>1</sup>, *tri*<sup>1</sup> double mutant lacks both components. Only a LFRR is seen at 729 nm in WT, however an appreciable HIR is observed at 704 nm, which is retained in the *tri*<sup>1</sup> mutant and is absent in the *fri*<sup>1</sup> mutant, indicating the labile phyA pool regulates this response component.

### 4.1 Introduction

Anthocyanin synthesis is one aspect of the de-etiolation process that occurs in tomato seedlings on emergence into the light environment. This critical step in the development is achieved by the co-action (Mohr, 1994) of at least two classes of photoreceptors: one absorbing in the UV-A/blue light (B) regions, sometimes referred to as cryptochrome (Ahmad and Cashmore, 1996); and the phytochromes, absorbing in the red (R) and far-red (FR) spectral region. There are at least five phytochrome genes expressed in tomato called *PHYA*, *PHYB1*, *PHYB2*, *PHYE* and *PHYF* (Hauser *et al.*, 1995) and response to R and FR must be achieved by one or

more of them. Studies using mutants and transgenic plants overexpressing phytochrome genes have demonstrated that there are both overlapping and discrete roles that have been attributed to different members of the phytochrome gene family (Whitelam and Harberd, 1994; Quail *et al.*, 1995).

Different response modes of phytochrome can be distinguished, which can be classified according to the light quantity and duration required to induce the response. Low fluence responses (LFRs) are by definition R/FR reversible and fluence rate dependent until the photoequilibrium between the R absorbing (Pr) and FR absorbing (Pfr) forms of phytochrome is established. High irradiance responses (HIRs) are typically achieved by continuous irradiation and remain fluence-rate dependent even after the photoequilibrium is reached. Phytochrome cycling rate is therefore somehow monitored in a HIR (Mancinelli, 1994).

During de-etiolation it appears that both phytochrome A (phyA) and phytochrome B (phyB) can inhibit hypocotyl growth in *Arabidopsis*, but in continuous irradiation experiments, they convey responsiveness to the FR and R regions of the spectrum, respectively (Whitelam and Harberd, 1994; Reed *et al.*, 1994). Effectiveness of the FR region of the spectrum is predicted in the case of a labile phytochrome, since FR maintains a low steady-state level of phytochrome in its active Pfr form and conserves the phyA pool which is labile in its Pfr form (Hartmann, 1966; Beggs *et al.*, 1980; Holmes and Schäfer, 1981; Wall and Johnson, 1983; Smith and Whitelam, 1990). This response is therefore characteristic of dark (D)-grown seedlings. It has been proposed that the FR-HIR plays an important role in seedling establishment in the natural environment (Smith, 1994; 1995; Quail *et al.*, 1995). Plants overexpressing phyA retain a near FR-HIR in light-grown plants (McCormac *et al.*, 1991; 1992). The phyA pool has also been implicated as the active phytochrome type involved in the very low fluence response (VLFR) inducing germination (Hamazato *et al.*, 1995; Botto *et al.*, 1996) and regulation of chlorophyll *alb*-binding protein (*CAB*) gene expression (Hamazato *et al.*, 1995) in *Arabidopsis*.

Juvenile anthocyanin biosynthesis in tomato has been extensively studied and involves the co-action of B photoreceptors and phytochromes. From studies with sorghum, mustard and tomato (Mohr, 1994; Drumm-Herrel, 1987), it was concluded that Pfr is the effector in anthocyanin biosynthesis through activation of gene expression, while the B/UV-A effect was considered as establishing responsiveness to Pfr. In tomato, a B pretreatment enhanced the R/FR reversible (phytochrome regulated) anthocyanin biosynthesis that occurred during a subsequent 24-h D period (Drumm-Herrel and Mohr, 1982; Peters *et al.*, 1992a).

Mutants deficient in phytochromes have been selected in tomato. The *au* mutant is a chromophore biosynthesis mutant (Terry and Kendrick, 1996) and therefore would be predicted to be deficient in more than one type of phytochrome. However its phenotype and phytochrome measurements in adult plants suggest that later in development some phytochrome is present and active (Sharma *et al.*,

1993; Van Tuinen *et al.*, 1996a) indicating the leaky nature of the mutation. The FR-insensitive (*fri<sup>1</sup>*) mutant has been shown to be deficient in phyA (Chapter 2) and the temporarily R-insensitive (*tri<sup>1</sup>*) mutant to be deficient in phyB1 (Chapter 3). Mutants showing phytochrome exaggerated phenotypes have also been identified (Kendrick *et al.*, 1994). The recessive *hp-1* mutant exhibits exaggerated phytochrome responses and it has been proposed that these are due to the loss of a repressor of phytochrome action which is encoded by the *HP-1* gene (Peters *et al.*, 1992a).

In this chapter an analysis of anthocyanin accumulation during de-etiolation will be presented, utilizing photomorphogenic mutants and an assignment of the different response components involved will be made to individual members of the phytochrome gene family in tomato.

## 4.2 Materials and methods

### 4.2.1 Plant material

#### 4.2.1.1 Genotypes

A summary of the 12 genotypes of tomato (*Lycopersicon esculentum* Mill.), comprising four monogenic mutants, four double mutants, one transgenic line and their corresponding wild types (WTs) used in this study, is given in Table 4.1. The construction of the double mutants is described in the previously (3.2.1). In

**Table 4.1.** Summary of genotypes used in this chapter.

Genotype	Genetic background	Mutant classification	Reference
Wild type	MoneyMaker (MM)	-	Koornneef <i>et al.</i> (1985)
Wild type	Breeding line GT (GT)	-	Peters <i>et al.</i> (1989)
Wild type	VF36	-	Boylan and Quail (1989)
<i>fri<sup>1</sup></i>	MM	PhyA deficient (phyA <sup>-</sup> )	Chapter 2
<i>tri<sup>1</sup></i>	GT	PhyB1 deficient (phyB1 <sup>-</sup> )	Chapter 3
<i>au<sup>w</sup></i>	MM	Phytochrome chromophore deficient (chr <sup>-</sup> )	Koornneef <i>et al.</i> (1985)
<i>hp-1<sup>w</sup></i>	GT	Exaggerated phytochrome responses (resp <sup>+</sup> )	Peters <i>et al.</i> (1989)
<i>fri<sup>1</sup>, tri<sup>1</sup></i>	MM & GT	phyA <sup>-</sup> & phyB1 <sup>-</sup>	Chapter 3
<i>au<sup>w</sup>, tri<sup>1</sup></i>	MM & GT	chr <sup>-</sup> & phyB1 <sup>-</sup>	Chapter 3
<i>hp-1<sup>w</sup>, fri<sup>1</sup></i>	GT & MM	resp <sup>+</sup> & phyA <sup>-</sup>	This chapter
<i>hp-1<sup>w</sup>, tri<sup>1</sup></i>	GT	resp <sup>+</sup> & phyB1 <sup>-</sup>	Chapter 3
<i>PHYA3</i>	VF36	Transgenic line overexpressing oat <i>PHYA3</i>	Boylan and Quail (1989)

addition a newly derived *hp-1<sup>w</sup>,fri<sup>l</sup>* double mutant was obtained, following the same strategy as for the *hp-1<sup>w</sup>,tri<sup>l</sup>* double mutant (see 3.2.1.2). Analysis of phytochrome revealed the expected deficiency in phyA-polypeptide (PHYA) and WT-level in phyB-like polypeptide (PHYB) in the *hp-1<sup>w</sup>,fri<sup>l</sup>* (data not shown). The PHYB antibody used is known to recognize the PHYB1 pool in tomato.

#### 4.2.1.2 Pretreatment of the seeds

In all experiments, except the light-pulse experiment using the WT (GT) and the *tri<sup>l</sup>* mutant, seeds were surface sterilized as described in 2.2.1.2. In the light-pulse experiment using the WT (MM) and the *fri<sup>l</sup>* mutant, and the WL experiment seeds used were also pregerminated (showing radicle emergence), before final sowing under dim-green safelight, to obtain a more synchronized population of seedlings as described in 2.2.1.2. In the light-pretreatment and threshold-box experiments surface-sterilized seeds were directly sown in plastic boxes with transparent boxes on filter paper moistened with germination buffer (see 2.2.1.2). In the light-pulse experiment using the WT (GT) and the *tri<sup>l</sup>* mutant, seeds were directly sown in trays without the pretreatment.

To compensate for the retardation of germination of the *au<sup>w</sup>* and *au<sup>w</sup>,tri<sup>l</sup>* mutants, seeds were pretreated 12 h longer, as described in 3.2.1.3.

#### 4.2.2 Anthocyanin assay

Methodology for anthocyanin determination is described in 2.2.3. The anthocyanin content is expressed as  $A_{535}$  per 5 hypocotyls or per 10 whole seedlings.

#### 4.2.3 Experiments

##### 4.2.3.1 White-light experiment

Surface-sterilized and pregerminated WTs (MM, GT), *fri<sup>l</sup>*, *tri<sup>l</sup>*, *au<sup>w</sup>* and *au<sup>w</sup>,tri<sup>l</sup>* seeds were sown in trays and transferred to a phytotron in 16-h white light (WL) ( $150 \mu\text{mol}\cdot\text{m}^{-2}\cdot\text{s}^{-1}$  photosynthetically active radiation [PAR])/8-h D cycles at 25 °C. Every seedling was marked on emergence, enabling assay of the anthocyanin content after the appropriate number of WL/D cycles. The anthocyanin content in 6 replicates of 5 hypocotyls was measured on a daily basis for 7 days.

##### 4.2.3.2 Light-pulse experiments

Surface-sterilized and pregerminated WT (MM) and *fri<sup>l</sup>* seeds, and non-pretreated WT (GT) and *tri<sup>l</sup>* seeds (see 2.2.4.3 and 3.2.5.3, respectively), sown in trays, were incubated in D for 48 or 108 h, respectively, at 25 °C. Pulses of R or R immediately followed by FR, both saturating for phytochrome photoconversion, were given every 4 h, beginning at the time of emergence of the first seedlings.



During the pulse irradiation, every seedling was marked on emergence, enabling the anthocyanin assay after the appropriate number of pulses (6, 12, 18 or 24). The anthocyanin content in 4 replicates of 5 hypocotyls was measured.

#### *4.2.3.3 Light-pretreatment experiment*

Surface-sterilized WT (GT) and *tri*<sup>1</sup> seeds were sown in plastic boxes with transparent lids and incubated in D for 84 h at 25 °C. A subsequent 12-h B or R pretreatment (both 3  $\mu\text{mol}\cdot\text{m}^{-2}\cdot\text{s}^{-1}$ ) was terminated by a pulse of R (3 min, 10  $\mu\text{mol}\cdot\text{m}^{-2}\cdot\text{s}^{-1}$ ), FR (6 min, 13  $\mu\text{mol}\cdot\text{m}^{-2}\cdot\text{s}^{-1}$ ) or R followed by FR (both saturating for phytochrome photoconversion). The boxes were then transferred to D for 24 h before anthocyanin determination in 4 replicates of 10 whole seedlings.

#### *4.2.3.4 Threshold-box experiments*

Surface-sterilized seeds, of all genotypes listed in Table 4.1, were sown in plastic boxes with transparent lids and incubated in D for 90 h at 25 °C before exposure to 24-h continuous monochromatic light of different fluence rates in a threshold-box unit (see below). Anthocyanin was determined at the end of the 24-h light treatment in 4–8 replicates of 10 whole seedlings.

### **4.2.4 Light facilities and light measurements**

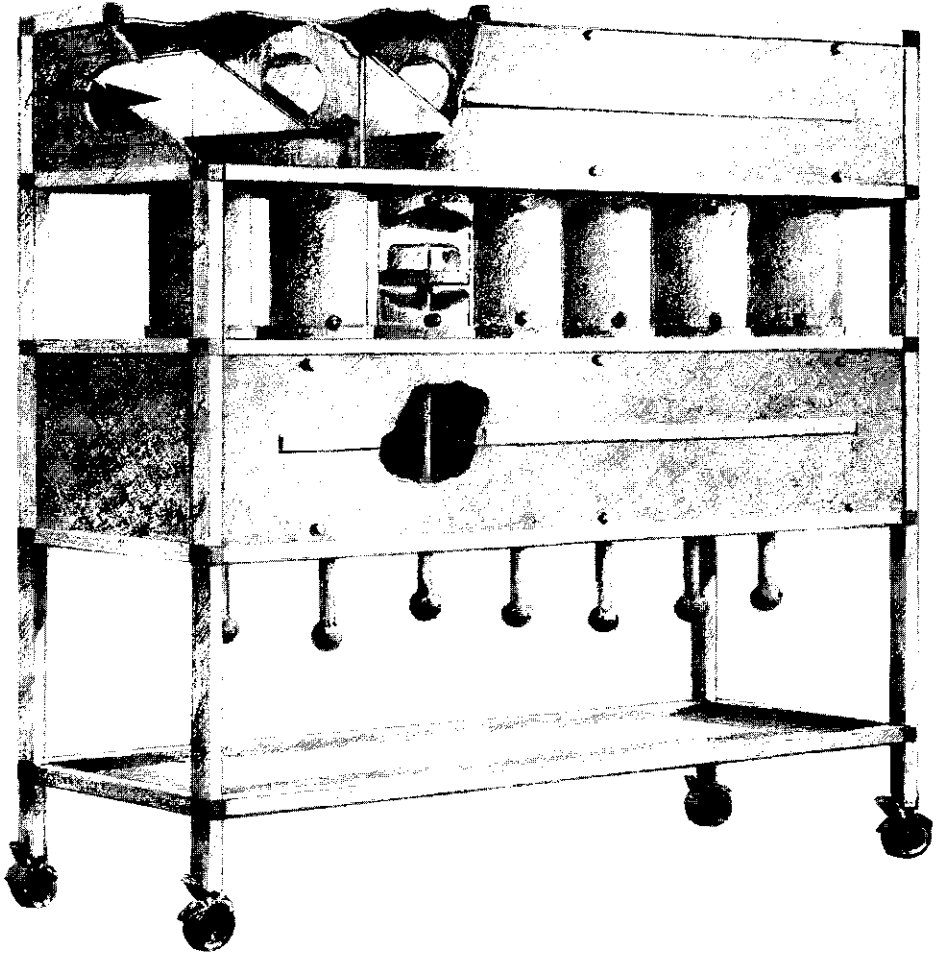
#### *4.2.4.1 Light cabinets and sources*

The WL experiment was performed in a phytotron (Wageningen); the WL-source is described in 3.2.6.2. The light-pulse experiment using WT (GT) and *tri*<sup>1</sup> (see 3.2.5.3) and the light-pretreatment experiment were performed in cabinets for low irradiance described by De Lint (1960); the B-, R- and FR-sources are described in 3.2.6.2. The light-pulse experiment using WT (MM) and *fri*<sup>1</sup> (see 2.2.4.3) were performed in light cabinets, described in 2.2.5.1; the R- and FR-sources are described in 2.2.5.2.

#### *4.2.4.2 Threshold-box units*

The threshold-box unit consists of a series of neutral beam-splitters (100x145x1 mm, reflection/transmission 50/50 %; Balzers, Liechtenstein), which enabled 6 fluence rates to be studied simultaneously over a fluence-rate range of 4 log units (ca. 0.01–200  $\mu\text{mol}\cdot\text{m}^{-2}\cdot\text{s}^{-1}$ ) and a D control (Fig. 4.1). The plastic boxes containing the seedlings were placed on height-adjustable platforms, which rotated during irradiation to optimize light-distribution.

Light was obtained from a xenon short-arc lamp (XBO-4000 W/HS OFR; Osram, Berlin, Germany) in combination with the following interference filters with peak transmissions: 448 nm (Balzers, Liechtenstein; bandwidth at 50 % of the transmission maximum ( $T_{\text{max}}$ ) 12.8 nm); 652 nm (Baird-Atomic, Bedford, USA; bandwidth at 50 %  $T_{\text{max}}$  13.2 nm); 660 nm (Schott, Mainz, Germany; bandwidth at 50 %  $T_{\text{max}}$  10.6 nm); 681 nm (Baird-Atomic, bandwidth at 50 %  $T_{\text{max}}$



**Figure 4.1.** Schematic diagram of a threshold-box unit with parts of the outer casing removed to show the neutral beam splitters in the top compartment and a plastic box containing the seedlings on a rotating height-adjustable platform in one of the seven experimental chambers below. The arrow indicates the direction of the incoming monochromatic light generated by the xenon short-arc lamp in combination with an interference filter.

4.2 nm), 704 nm (Baird-Atomic, bandwidth at 50 %  $T_{\max}$  11.9 nm) and 729 nm (Baird-Atomic, bandwidth at 50 %  $T_{\max}$  10.0 nm).

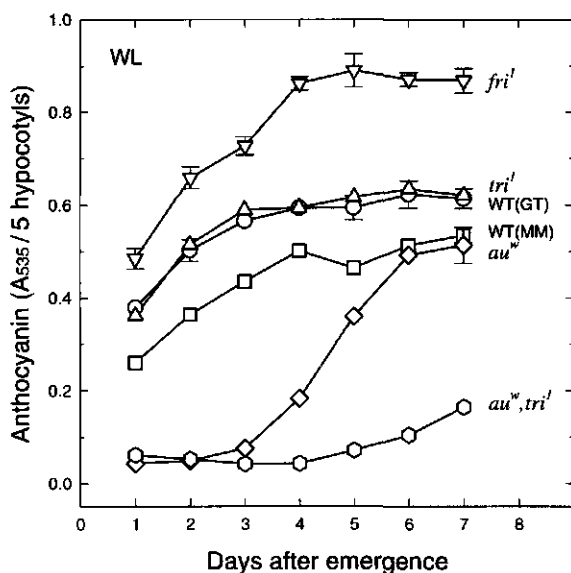
#### 4.2.4.3 Light measurements

All light measurements were recorded with a LI-1800 spectroradiometer (Li-Cor, Lincoln, NE, USA) as described in 2.2.5.3. The fluence rates in the threshold-box experiments were measured with a radiometer (Optometer Model S370; United Detector Technology, Hawthorne, CA, USA), supplied with a calibrated silicon 1-cm<sup>2</sup> detector head (Model 221; United Detector Technology).

## 4.3 Results and discussion

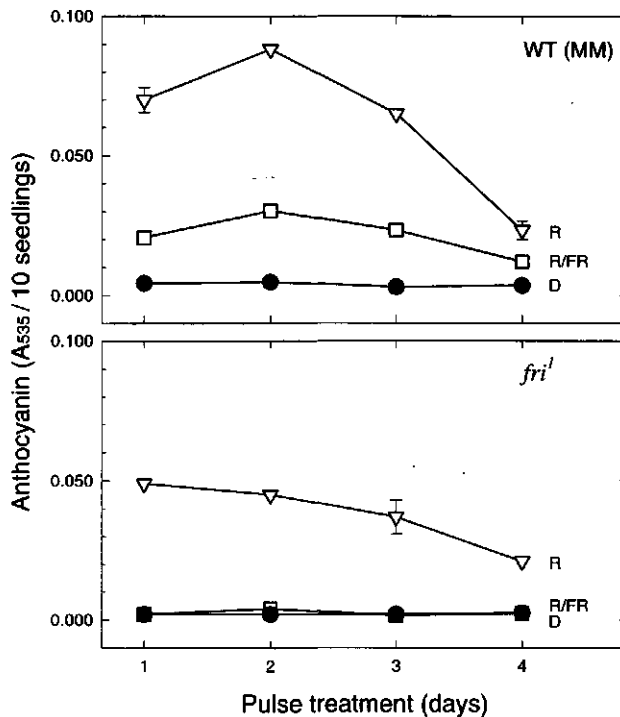
### 4.3.1 White light/dark cycles

The kinetics of anthocyanin accumulation in WL/D cycles was studied for the various phytochrome-deficient mutants. The accumulation of anthocyanin in hypocotyls from both WT (GT and MM) increases during the first 4 days after emergence in WL/D cycles (Fig. 4.2). Only a quantitative difference is seen between both WT. The *phyB1*-deficient *tri*<sup>1</sup> mutant does not differ significantly from its corresponding WT (GT), however hypocotyls are slightly elongated compared to the WT at the end of the experiment (see Fig. 3.6). Surprisingly, the *phyA*-deficient *fri*<sup>1</sup> mutant accumulates more anthocyanin than its corresponding WT (MM), despite hypocotyls of both genotypes being almost identical (see Fig. 2.6). The *au*<sup>w</sup> mutant shows no detectable anthocyanin accumulation during the first 3 days in agreement with earlier observations (Peters *et al.*, 1992a), but over the next 4 days it accumulates to a level very similar to that of its near-isogenic WT (MM), despite its very elongated hypocotyl (see Fig 3.6). The double mutant *au*<sup>w</sup>,*tri*<sup>1</sup> demonstrates a greater delay in anthocyanin accumulation than observed in *au*<sup>w</sup>, and after 7 days it contains about 20 % of the level in the *au*<sup>w</sup> mutant. Under these conditions, the *au*<sup>w</sup> mutation, which has a deficiency in phytochrome chromophore biosynthesis (Terry and Kendrick, 1996), has the most pronounced phenotype and therefore is proposed to be deficient in more than one type of



**Figure 4.2.** Anthocyanin accumulation ( $A_{535}/5$  hypocotyls  $\pm$  SE) in: WT (MM), and derived *fri*<sup>1</sup> and *au*<sup>w</sup>; WT (GT) and derived *tri*<sup>1</sup>; *au*<sup>w</sup>,*tri*<sup>1</sup> double-mutant (mixed genetic background) tomato seedlings. Seedlings were grown in a 16-h WL ( $150 \mu\text{mol}\cdot\text{m}^{-2}\cdot\text{s}^{-1}$  PAR)/8-h D cycle for 7 days.

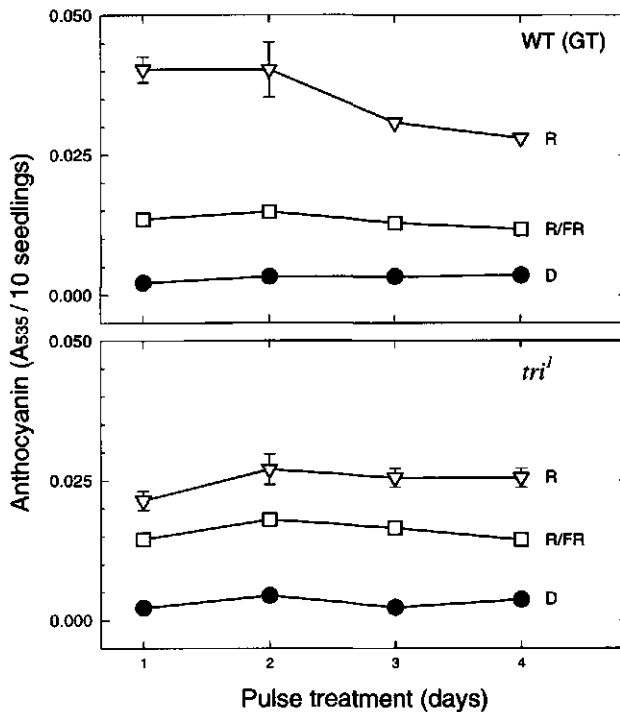
phytochrome. A delay of *ca.* 3 days in the time-course of anthocyanin formation occurs in the case of the *au<sup>w</sup>* mutant compared to WT, which could reflect the gradual appearance of some phytochrome chromophore due to leakiness of the *au<sup>w</sup>* mutation (Van Tuinen *et al.*, 1996a). The reduction of anthocyanin biosynthesis in the *au<sup>w</sup>, tri<sup>l</sup>* double mutant, indicates that the late accumulation of anthocyanin in the *au<sup>w</sup>* mutant is largely mediated by phyB1. However, under this WL/D-cycle treatment the absence of phyB1 in the *tri<sup>l</sup>* mutant has little effect on anthocyanin accumulation, presumably indicating that other phytochromes are sufficient to saturate the response. This suggests that other phytochromes compensate for the loss of phyB1 completely. Paradoxically, absence of phyA in the *fri<sup>l</sup>* mutant enhances the anthocyanin response suggesting an antagonistic effect of phyA on the action of other phytochromes in the WTs. The *fri<sup>l</sup>, tri<sup>l</sup>* double mutant has a hypocotyl length and anthocyanin content very similar to the monogenic *tri<sup>l</sup>* mutant under these conditions (data not shown). This indicates that phyA plays a little role in de-etiolation under this white fluorescent light regime in the *tri<sup>l</sup>* mutant.



**Figure 4.3.** Anthocyanin accumulation ( $A_{535}/5$  hypocotyls  $\pm$  SE) in WT (MM) and derived *fri<sup>l</sup>* mutant tomato seedlings. Seedlings were treated with pulses of R or R followed immediately by FR and a dark control (D). The R and FR pulses (both saturating for phytochrome photoconversion) were repeated every 4 h for 4 days from the time of emergence.

### 4.3.2 Light-pulse experiments

To investigate the role of the LFR in anthocyanin accumulation etiolated seedlings were treated with pulses of R or R followed immediately by FR. The maximum anthocyanin accumulation in hypocotyls (Figs. 4.3 and 4.4) was achieved during the first day of a R-pulse treatment, given every 4 h, presumably by an accumulative LFR. With time there was a gradual loss of anthocyanin in both WT's (GT and MM) and about two-thirds of the response is FR reversible if each R pulse is immediately followed by a FR pulse. In the case of the *fri*<sup>1</sup> mutant the response to R pulses is reduced compared to its WT control, but this reduced residual response is completely FR reversible (Fig. 4.3), indicating that phyA is involved in the non-R/FR reversible accumulation of anthocyanin. In the case of the *tri*<sup>1</sup> mutant a reduced response to R pulses is observed compared to the WT control and a smaller proportion of the response is FR reversible than in the WT (Fig. 4.4), suggesting a role of phyB1 in the R/FR reversible response. Since no HIR is likely, these light-pulse experiments have to be interpreted on the basis of VLFR and LFR phytochrome responses. We conclude phyA is responsible for the non-



**Figure 4.4.** Anthocyanin accumulation (A<sub>535</sub>/5 hypocotyls ± SE) in WT (GT) and derived *tri*<sup>1</sup> mutant tomato seedlings. Seedlings were treated with pulses of R or R followed immediately by FR and a dark control (D). The R and FR pulses (both saturating for phytochrome photoconversion) were repeated every 4 h for 4 days from the time of emergence.

R/FR reversible response, which could reflect either a residual LFR or VLFR, whereas phyB1 is partially responsible for regulation of the R/FR reversible LFR. Other stable phytochromes and phyA might play a role in the latter response.

The hypocotyl growth of the *tri<sup>1</sup>* mutant has been shown to be totally insensitive to R pulses during the first 2 days (Chapter 3). However, with respect to anthocyanin formation no insensitivity is seen, demonstrating the independent nature of these two components of the de-etiolation response.

#### 4.3.3 Light-pretreatment experiment

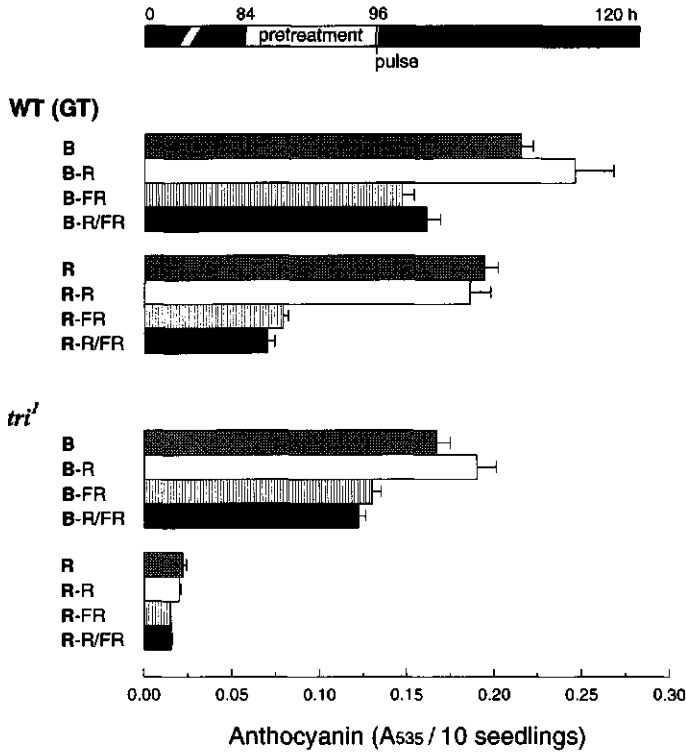
Anthocyanin accumulation was studied during a 24-h D period after B and R pretreatments (Drumm-Herrel and Mohr, 1982; Adamse *et al.*, 1989) terminated by an inductive pulse of R or a R pulse followed immediately by a FR pulse. Prolonged exposures to high fluence rates are required to obtain accumulation of large quantities of anthocyanin *i.e.* HIR conditions. The anthocyanin which accumulates after a 12-h light pretreatment terminated with a R pulse and 24-h D period is a result of phytochrome and cryptochrome increasing phytochrome responsiveness during the pretreatment. The magnitude of the R/FR reversible response by light pulses at the end of the pretreatment period can be taken as a measure of the increased phytochrome responsiveness (Drumm-Herrel and Mohr, 1982; Adamse *et al.*, 1989). For the seedlings of WT (GT) pretreated with R, about 60 % of the anthocyanin response is FR reversible (Fig. 4.5). However, in the case of the *tri<sup>1</sup>* mutant only a low level of anthocyanin accumulates and there is little evidence for FR reversion. In contrast, after a B pretreatment terminated with a R pulse, the *tri<sup>1</sup>* mutant accumulates only about 20 % less anthocyanin than the WT control and a similar proportion of the response to that in the WT (about 30 %) is FR reversible (Fig. 4.5).

From these experiments we conclude that B is important in the increased phytochrome responsiveness, *i.e.* the same amount of Pfr leads to a higher response (Mohr, 1994), particularly in the absence of phyB1 in the *tri<sup>1</sup>* mutant. This increased phytochrome responsiveness enables the residual phytochromes to result in accumulation of considerable anthocyanin. This indicates that phyA or other phytochromes are involved in the R/FR reversible LFR after B increased phytochrome responsiveness. The effectiveness of a R pretreatment in increasing phytochrome responsiveness appears to be dependent to a large extent upon the presence of phyB1.

#### 4.3.4 Fluence rate-response relationships at different wavelengths

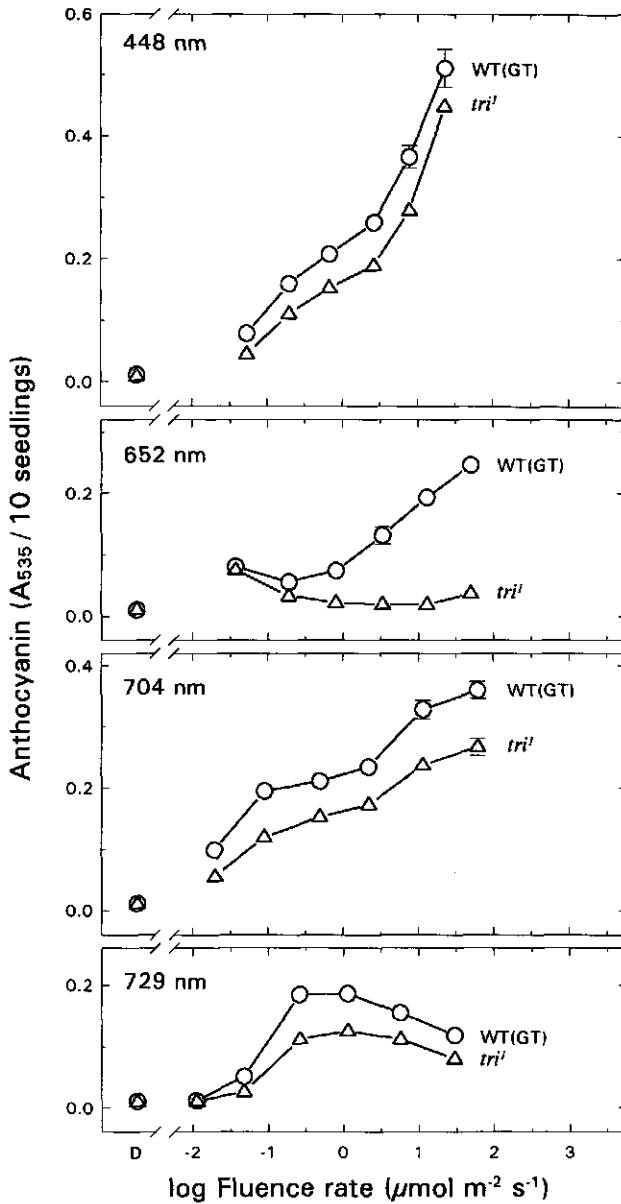
To study the quantitative effects of the photomorphogenic mutations, fluence rate-response relationships for anthocyanin synthesis during a 24-h continuous monochromatic light treatment were determined (Figs. 4.6–4.12). The fluence rate-

Analysis of the photocontrol of anthocyanin biosynthesis



**Figure 4.5.** The anthocyanin content ( $A_{535}/10$  seedlings  $\pm$  SE) in WT (GT) and derived *tri<sup>1</sup>* mutant tomato seedlings. Seedlings were pretreated with either 12 h B ( $3 \mu\text{mol}\cdot\text{m}^{-2}\cdot\text{s}^{-1}$ ) or R ( $3 \mu\text{mol}\cdot\text{m}^{-2}\cdot\text{s}^{-1}$ ), terminated with a pulse of R or a R pulse followed by a FR (both saturating for phytochrome photoconversion). All seedlings were then kept in D for 24 h prior to the anthocyanin extraction.

response relationships for anthocyanin synthesis in monochromatic light, are complex and consist of at least two components. In agreement with Peters *et al.* (1992a), we interpret the first part of the fluence rate-response relationships for 652, 660, 681, 704 and 729 nm light as a low fluence rate response (LFRR), reflecting the gradual production of Pfr, and the subsequent rise in response at higher fluence rates as a HIR. In the fluence rate-response relationships in 652, 660 and 704 nm light, the LFRR and HIR overlap at intermediate fluence rates. At 729 nm only a LFRR component is observed, presumably due to the low phytochrome cycling rate at this wavelength. The optimum curve can be explained by the LFRR component being mediated by a labile phytochrome, which undergoes destruction in its Pfr form. If this is the case the LFRR should shift to lower fluence rates at wavelengths which maintain higher phytochrome photoequilibria. The data at 704, 660 and 652 nm in Figs. 4.6 and 4.7 support this conclusion. However, the interpretation of these experiments is complicated by changes in phytochrome responsiveness. The B irradiation (448 nm) causes a

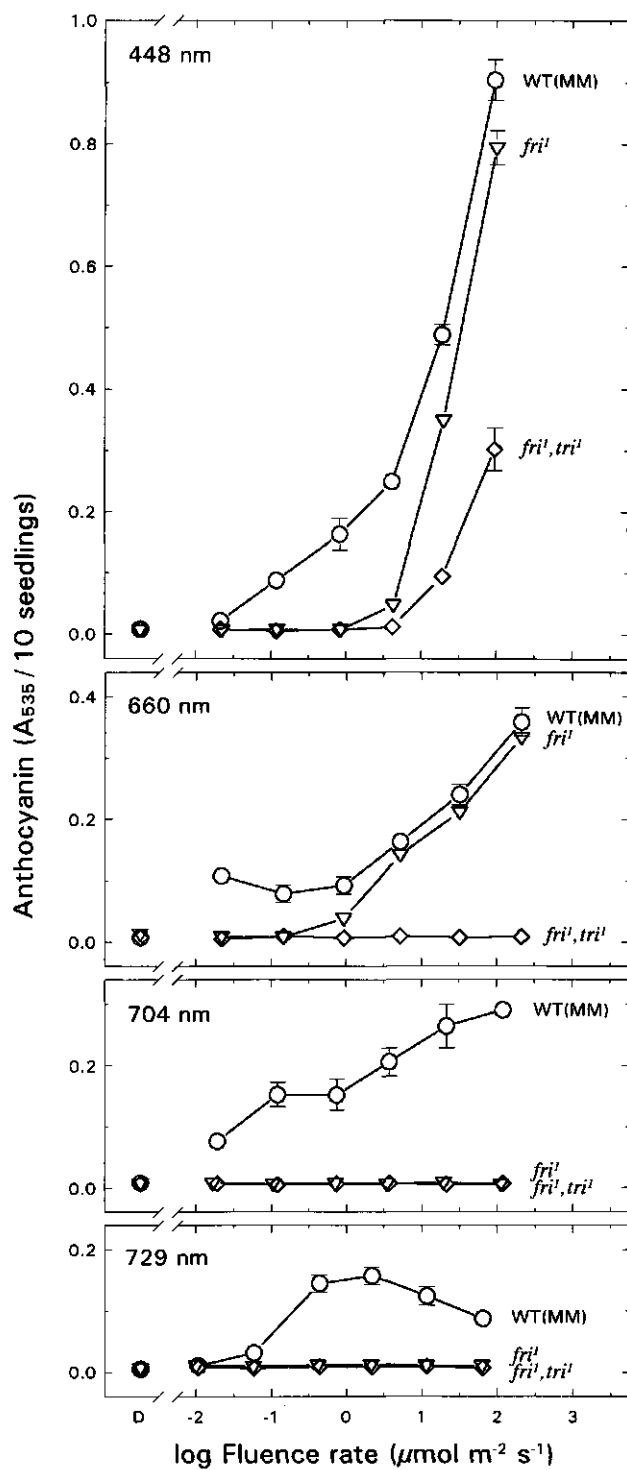


**Figure 4.6.** Anthocyanin accumulation ( $A_{535}/10$  seedlings  $\pm$  SE) in WT (GT) and derived  $tri^1$  mutant tomato seedlings. Dark-grown 4-day-old seedlings were given a 24-h irradiation with 448, 652, 704 and 729 nm of different fluence rates. D = dark control.

**Figure 4.7.** Anthocyanin accumulation ( $A_{535}/10$  seedlings  $\pm$  SE) in: WT (MM) and derived  $fri^1$ ;  $fri^1, tri^1$  double-mutant (mixed genetic background) tomato seedlings. Dark-grown 4-day-old seedlings were given a 24-h irradiation with 448, 660, 704 and 729 nm of different fluence rates. D = dark control.



Analysis of the photocontrol of anthocyanin biosynthesis

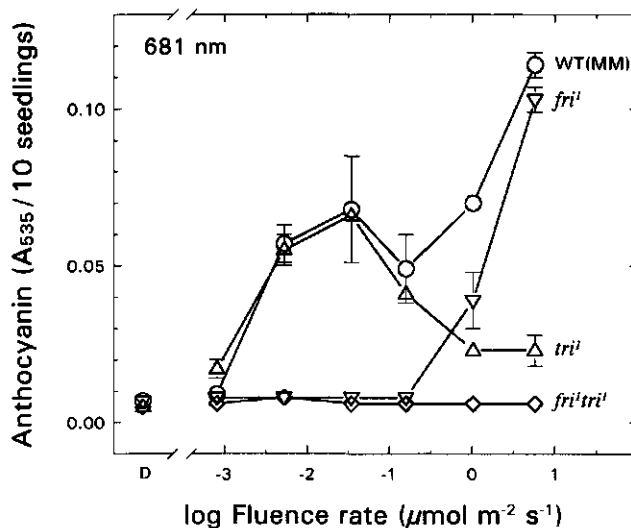


strong response, due to perception and co-action of both cryptochrome and phytochrome, leading to the highest response observed. It must be remembered that phytochrome participates in increasing phytochrome responsiveness and in addition plays a role in the response observed, even under B.

The responses of the *tri*<sup>1</sup> mutant, deficient in phyB1, are shown in Figure 4.6. A large difference compared to WT is at 652 nm, where the *tri*<sup>1</sup> mutant clearly lacks the R-HIR component. At 448, 704 and 729 nm only a slightly reduced response occurs. These results demonstrate a clear residual near-FR (704 nm) and FR response in the phyB1 mutant and indicates that phyB1 regulates the R-HIR in anthocyanin biosynthesis. The B and the near-FR HIRs must be mediated by other photoreceptors. The near-FR HIR is mediated by phyA (see below). However interpretation of the B-HIR is difficult since the B photoreceptor and residual phytochromes are both excited by B.

The responses of the *fri*<sup>1</sup> mutant deficient in phyA, and the *fri*<sup>1</sup>,*tri*<sup>1</sup> double mutant deficient in both phyA and phyB1 are shown in Figure 4.7. The differences in the response between WT and *fri*<sup>1</sup> and *fri*<sup>1</sup>,*tri*<sup>1</sup> at 448, 660, 704 and 729 nm must reflect the deficiency in phyA or both phyA and phyB1, respectively. The *fri*<sup>1</sup> mutant in R (660 nm) clearly lacks the LFRR response, but retains the HIR component, whereas the *fri*<sup>1</sup>,*tri*<sup>1</sup> double mutant lacks both LFRR and HIR components. At 704 and 729 nm both the *fri*<sup>1</sup> mutant and the *fri*<sup>1</sup>,*tri*<sup>1</sup> double mutant lack any detectable response, indicating that phyA mediates the response at these wavelengths. In B (448 nm) the *fri*<sup>1</sup> mutant lacks the LFR component, whereas the *fri*<sup>1</sup>,*tri*<sup>1</sup> double mutant has a reduced HIR response at higher fluence rates, however, a clear residual response is seen. This indicates that phyA regulates the LFRR and the near FR-HIR in anthocyanin biosynthesis. Figure 4.8 shows the fluence rate response curves for the *fri*<sup>1</sup>, *tri*<sup>1</sup> and *fri*<sup>1</sup>,*tri*<sup>1</sup> mutants and WT (MM) at 681 nm. It clearly demonstrates the unambiguous role for both phyA and phyB1 in the LFRR and HIR, respectively, which are both exhibited in the WT. As expected, absence of phyA and phyB1, as occurs in the phyA- and phyB1-deficient *fri*<sup>1</sup>,*tri*<sup>1</sup> double mutant, results in essentially no anthocyanin synthesis at this wavelength.

In R (660 nm) the *hp-1*<sup>w</sup> mutant exhibits a strong amplification of both the LFRR and HIR components of anthocyanin biosynthesis (Figs. 4.9 and 4.11), as shown for the *hp-1* (in an AC-background) by Peters *et al.* (1992a). In the *hp-1*,*tri*<sup>1</sup> double mutant the LFRR is amplified and the R-HIR component is largely lost (Fig. 4.9) compared to the monogenic *hp-1*<sup>w</sup> mutant. Figure 4.10 shows the phenotype of 5-day-old seedlings of WT (GT), *tri*<sup>1</sup>, *hp-1*<sup>w</sup> and *hp-1*<sup>w</sup>,*tri*<sup>1</sup> after 24-h 660 nm monochromatic irradiation at the highest fluence rate (250  $\mu\text{mol}\cdot\text{m}^{-2}\cdot\text{s}^{-1}$ ). The *tri*<sup>1</sup> mutation results in a delayed photomorphogenesis (*i.e.* an elongated hypocotyl, which contains almost no anthocyanin and has a closed apical hook at this fluence rate) compared to WT. The *hp-1*<sup>w</sup> mutation results in an exaggerated photomorphogenesis (*i.e.* a shorter hypocotyl with high levels of anthocyanin and

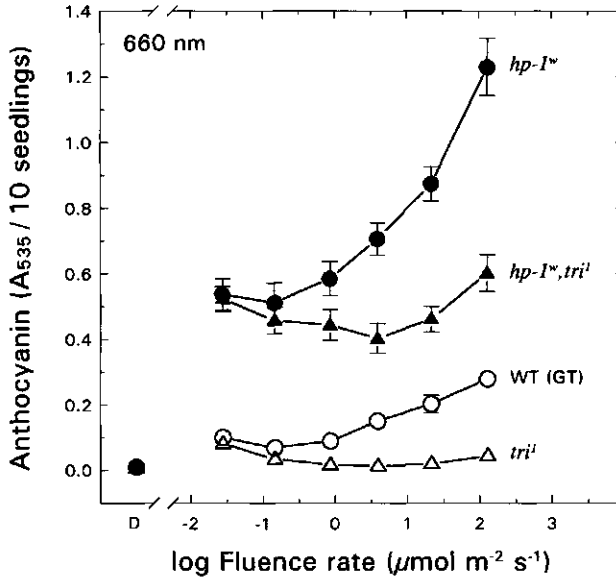


**Figure 4.8.** Anthocyanin accumulation ( $A_{535}/10$  seedlings  $\pm$  SE) in: WT (MM) and derived  $fri^1$ ;  $tri^1$ ;  $fri^1, tri^1$  double-mutant (mixed genetic background) tomato seedlings. Dark-grown 4-day-old seedlings were given a 24-h irradiation with 681 nm of different fluence rates. D = dark control.

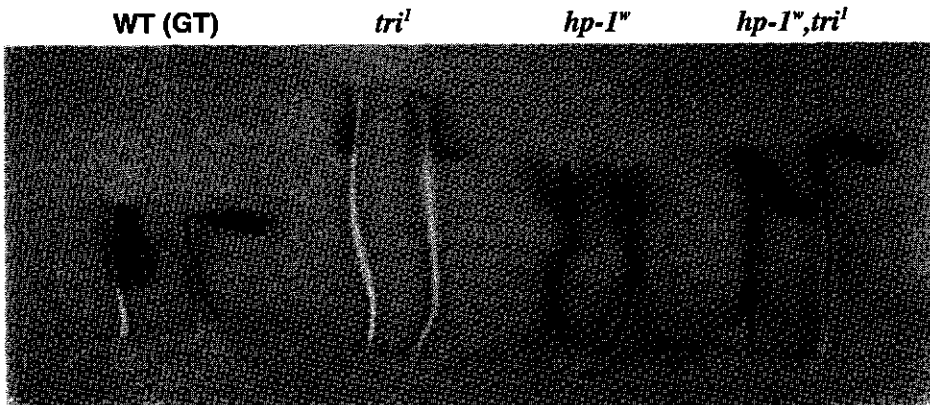
a fully open apical hook). Both aspects are combined in the  $hp-1^w, tri^1$  double mutant, where the hypocotyl length, anthocyanin content and apical hook opening are intermediate between the two monogenic mutants. In the  $hp-1^w, fri^1$  double mutant the LFRR is absent and the R-HIR response is strongly amplified (Fig. 4.11) compared to the WT. These results are consistent with a model in which both the LFRR and HIR are amplified by the  $hp-1^w$  mutation at some downstream step of the transduction chain common to phyA and phyB1 leading to anthocyanin production.

A transgenic tomato line overexpressing the oat *PHYA3* gene (Boylan and Quail, 1989) has an enhanced anthocyanin response with the most dramatic amplification occurring in the LFRR range, whilst retaining a quantitatively similar HIR response to that of its corresponding WT (Fig. 4.12). This transgenic tomato line presumably maintains a higher than normal phyA pool, enhanced by the slower degradation of oat phyA3 than the endogenous tomato phyA (Boylan and Quail, 1989; 1991; McCormac *et al.*, 1992; Van Tuinen *et al.*, 1996a). This again points to the importance of phyA in the LFRR and suggests that phyA cannot participate in the phyB1 R-HIR leading to anthocyanin accumulation. There is a remarkable qualitatively and quantitatively similarity in response between the transgenic tomato line overexpressing the oat *PHYA3* gene (Fig. 4.12) and the  $hp-1^w, tri^1$  double mutant (Fig. 4.9).

The severely phytochrome deficient, phytochrome chromophore mutant *au* (Terry and Kendrick, 1996) has been shown previously (Peters *et al.*, 1992a) to lack any detectable anthocyanin biosynthesis after 24-h R irradiation. The lack of



**Figure 4.9.** Anthocyanin accumulation ( $A_{635}/10$  seedlings  $\pm$  SE) in WT (GT) and derived  $tri^1$ ,  $hp-1^w$ , and  $hp-1^w, tri^1$  double-mutant tomato seedlings. Dark-grown 4-day-old seedlings were given a 24-h irradiation with 660 nm of different fluence rates. D = dark control.



**Figure 4.10.** Phenotypes of 5-day-old WT (GT) and derived  $tri^1$ ,  $hp-1^w$  and  $hp-1^w, tri^1$  double-mutant tomato seedlings after a 24-h 660-nm monochromatic irradiation with a fluence rate of  $250 \mu\text{mol.m}^{-2}.\text{s}^{-1}$ .

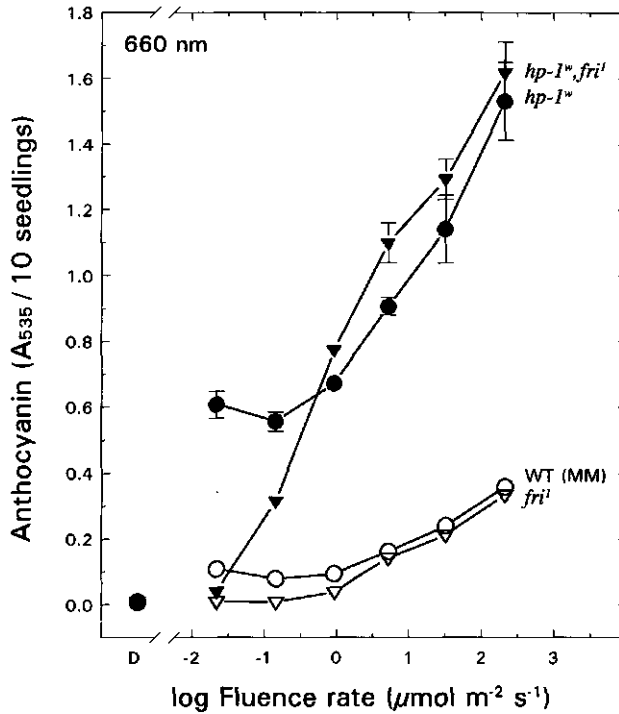


Figure 4.11. Anthocyanin accumulation ( $A_{535}/10$  seedlings  $\pm$  SE) in: WT (MM) and derived  $fri^1$ ;  $hp-1^{-}$ ;  $hp-1^{-}; fri^1$  double-mutant (mixed genetic background) tomato seedlings. Dark-grown 4-day-old seedlings were given a 24-h irradiation with 660 nm of different fluence rates. D = dark control.

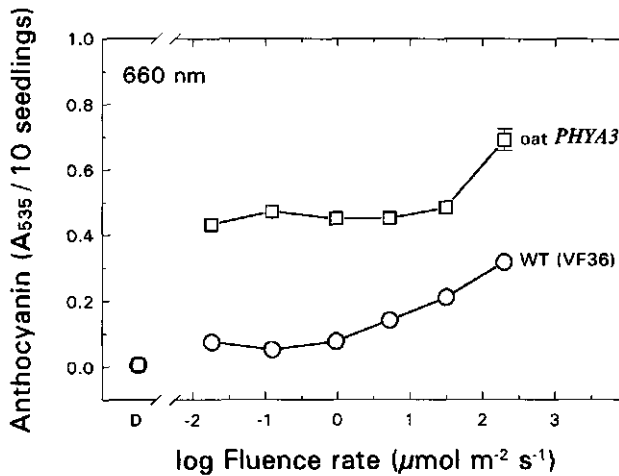


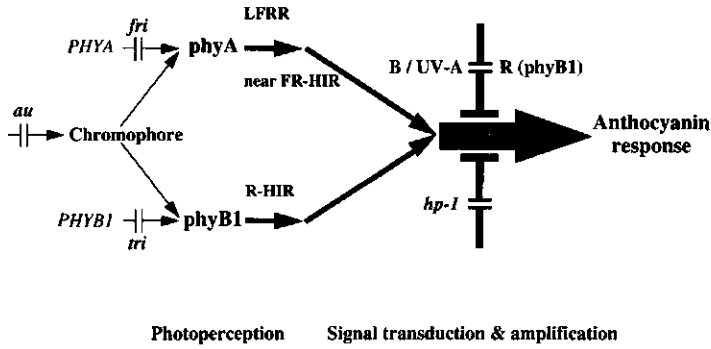
Figure 4.12. Anthocyanin accumulation ( $A_{535}/10$  seedlings  $\pm$  SE) in WT (VF36) and transgenic tomato seedlings, overexpressing the oat *PHYA3* gene. Dark-grown 4-day-old seedlings were given a 24-h irradiation with 660 nm of different fluence rates. D = dark control.

responsiveness of *au* is indicative of insufficient chromophore to produce significant levels of both phyA and phyB1. The insensitivity to B observed in *au* indicates that phytochrome is essential for B responsiveness. The residual effect at 448 nm in the *fri<sup>1</sup>,tri<sup>1</sup>* double mutant presumably reflects the action or co-action of phytochromes other than phyA and phyB1 and/or action of the B-photoreceptor. As expected, the *au<sup>m</sup>,tri<sup>1</sup>* double mutant (data not shown) also shows no detectable anthocyanin biosynthesis at 660 nm, demonstrating that the *au<sup>m</sup>* mutation is epistatic to *tri<sup>1</sup>*.

#### 4.3.5 The role of phytochrome types in tomato anthocyanin biosynthesis

We can attribute discrete physiological functions to different members of the tomato phytochrome gene family in anthocyanin biosynthesis. We conclude that phyA regulates the LFRR and the near FR-HIR, while phyB1 regulates the R-HIR and plays a role in increasing phytochrome responsiveness. The amplified response, using a transgenic tomato line overexpressing the oat *PHYA3* gene, points to a specific receptor for phyA in the LFRR component. The *hp-1<sup>m</sup>* exaggerated-response mutant indicates that phytochrome action in etiolated seedlings is under the constraint of HP-1 (Peters *et al.*, 1992a). In contrast to WT, the *hp-1<sup>m</sup>* mutant does not require co-action of the B photoreceptor for attainment of high anthocyanin levels (Adamse *et al.*, 1989; Peters *et al.*, 1989; 1992a). Both exposure to B and the *hp-1<sup>m</sup>* mutation appear to result in reduction of repression of the anthocyanin signal transduction chain. On the basis of its recessive (loss-of-function) nature, Adamse *et al.* (1989) proposed that this exaggerated response of the *hp-1* mutant is associated with the amplification step downstream of the phyA and phyB1 signal transduction chains. This is consistent with the theory advanced by Mohr (1994). Although B is indicated as acting *via* a separate repressive step, it cannot be excluded that it acts *via* inhibition of the pathway leading to a single repressor: the *HP-1* gene product. The present findings are summarized schematically in Figure 4.13.

The anthocyanin responses taking place during de-etiolation show a strong tissue specificity in the hypocotyl, restricted to the single sub-epidermal layer of cells (Neuhaus *et al.*, 1993). Both LFRR and HIR components, regulated by different members of the phytochrome gene family, result in an accumulation of anthocyanin in the same sub-epidermal cells. Micro-injection studies by Neuhaus *et al.* (1993) in the *au* mutant revealed two parallel pathways in the signal transduction chain of phyA. The anthocyanin response has been shown to be inducible by micro-injection of cGMP alone and in the presence of calcium (Neuhaus *et al.*, 1993; Bowler *et al.*, 1994a; 1994b) could lead to the development of fully functional plastids, indicating 'crosstalk' between the signal transduction pathways involved in the regulation of gene expression during de-etiolation. Using such a system, coupled with the mutants we have available and those under



**Figure 4.13.** Assignment of components of the anthocyanin accumulation response to individual phytochromes in tomato seedlings. Arrows indicate the signal transduction chains of phyA and phyB1. The large arrow indicates signal amplification. The flat-ended lines represent repressors of the signal amplification step, which are proposed to be reduced in the *hp-1* mutant and upon irradiation via both a B/UV-A photoreceptor and phytochrome.

characterization, will enable us to unravel the complexity of the phytochrome transduction chain. Injection studies using phyB1 would be of great interest, since we demonstrate here that phyB1 is responsible for a significant proportion of anthocyanin biosynthesis in R. In addition, the observation that the *au<sup>w</sup>* mutant itself is capable of producing a considerable amount of anthocyanin, which to a large extent is dependent on the presence of phyB1, is consistent with the leaky nature of the *au* mutation (Sharma *et al.*, 1993; Van Tuinen *et al.*, 1996a). This raises the question as to whether micro-injection studies of phyA into *au* simply reflect the specific transduction chain leading from phyA to anthocyanin production or reflect the interaction of phyA with residual phyB1.

**Acknowledgement.** We are grateful to Margaret Boylan and Peter Quail (University of California, Berkeley, CA and Plant Gene Expression Center, ARS-USDA, Albany, CA, USA) for provision of the *PHYA3* transgenic line.

# CHAPTER 5

## Physiological characterization of exaggerated-photoresponse mutants of tomato

**Abstract.** Four monogenic mutants in tomato (*Lycopersicon esculentum* Mill.): three recessive mutations; high-pigment-1 (*hp-1*), high-pigment-2 (*hp-2*), *atroviolacea* (*atv*) and one dominant mutation; Intense pigmentation (*Ip*) were used in this study. These mutants all show exaggerated photoresponses during de-etiolation, seedlings having shorter hypocotyls and higher anthocyanin levels. The *hp-1* and *hp-2* have higher chlorophyll levels in immature fruit giving them a dark-green colour. Spectrophotometrical and immunological analysis of phytochrome A and phytochrome B revealed no differences between the mutants and the wild types (WTs), suggesting that the mutants are not photoreceptor mutants. Both *hp-1* and *hp-2* accumulate high levels of anthocyanin in continuous blue (B) and red (R) broad-band light. In contrast *atv* has a WT level of anthocyanin in B and an exaggerated response in R. The *Ip* mutant has the opposite response: a WT level of anthocyanin in R and an exaggerated response in B. In B and R pretreatment studies, all mutants show an enhanced R/far-red light (FR)-reversible response compared to WT, but the *Ip* mutant shows a preferentially enhanced response in B. The *hp-1* mutant exhibits a strong amplification of both the low fluence rate response and high irradiance response components of anthocyanin biosynthesis in red light. The *atv* mutant shows strongest amplification of the HIR component. The *Ip* mutant exhibits an exaggerated anthocyanin response in B. All four mutants exhibit a normal elongation response to supplementary FR during the daily photoperiod.

### 5.1 Introduction

Photomorphogenesis is the process by which light regulates aspects of plant growth and development (Kendrick and Kronenberg, 1994). The plant utilizes three classes of photoreceptors (phytochromes, cryptochromes and a UV-B photoreceptor) in sensing the light environment. Photomorphogenesis in tomato is being studied with the aid of mutants which are either modified in their photoreceptor composition or in their signal transduction chain(s).

Mutations affecting the signal transduction chain(s) can be divided into at least four classes typified by: (i) the *hy5* mutant in *Arabidopsis* (Koornneef *et al.*, 1980), showing reduced hypocotyl inhibition by all spectral response regions, affecting a common step in the signal transduction of multiple phytochromes; (ii) the *fhy1* and *fhy3* mutants in *Arabidopsis* (Whitelam *et al.*, 1993), defective in far-



red light (FR)-mediated inhibition in hypocotyl elongation, despite normal levels of functional phytochrome A (phyA); (iii) the *det* (Chory *et al.*, 1989b), *cop* (Deng *et al.*, 1991) and *fus* mutants in *Arabidopsis* (Miséra *et al.*, 1994), and the *lip* mutant in pea (Frances *et al.*, 1992), having a constitutive light phenotype in darkness (D); (iv) mutants exhibiting hyper-responsiveness to light, e.g. the high-pigment (*hp*), Intense pigmentation (*Ip*) and *atroviolacea* (*atv*) mutants (Kendrick *et al.*, 1994) in tomato, the *lw* mutant in pea (Weller and Reid, 1993) and recently the hypocotyl elongation repressed (*her*) mutant (Ichikawa *et al.*, 1996) in *Arabidopsis*.

In a general light-signal transduction pathway-concept the pleiotropic *COP/DET/FUS* gene products could be viewed as components of a general developmental master repressor whose activity is modulated by light. The *COP/DET/FUS* complex is upstream of a positive regulator *HY5*, where *FHY* is a specific regulator in the phyA-transduction chain (McNellis and Deng, 1995; Quail *et al.*, 1995; Von Arnim and Deng, 1996). In contrast, *HP* in tomato has to be responsible for repression of light-signal transduction, since no *hp* specific phenotype is exhibited in D (Peters *et al.*, 1992a).

A spontaneous monogenic recessive mutant (Webb Special or 'Black Queen') at the *HP* locus in tomato was found as early as 1917 at the New Jersey farms of the Campbell Soup Co. (Reynard, 1956) and originally described by Thompson (1955). The monogenic recessive *hp* mutants are characterized by the production of high levels of carotenoids (pro-vitamin A) and lycopenes, increased levels of ascorbic acid (vitamin C) in mature fruits and have a dark-green foliage and immature fruit colour due to elevated chlorophyll levels compared to wild-type (WT) plants (Kerr, 1960; 1965; Thompson, 1961; Thompson *et al.*, 1962; Von Wettstein-Knowles, 1968a; 1968b; Sanders *et al.*, 1975; Jarret *et al.*, 1984; Martin, 1986). The *hp* mutant hypocotyl has a pinkish colour just below the soil surface (Kerr, 1965). Under continuous red light (R) or yellow light the hypocotyls of *hp* seedlings have a higher anthocyanin content and are more inhibited in growth compared to WT (Kerr, 1965; Mochizuki and Kamimura, 1985; Peters *et al.*, 1989). The reduced plant growth can be partially overcome by gibberellin (Van Wann, 1995).

Soressi (1975) described a recessive *hp-2* mutant, which was phenotypically similar, but not-allelic to *hp*. Mochizuki and Kamimura (1986) concluded that *hp-2* was allelic to *hp*, but recently Van Tuinen *et al.* (1996b) confirmed the original observation by Soressi (1975) that they were different genes and called the loci *HP-1* (previously *HP*) and *HP-2*.

Additional alleles of both *hp-1* and *hp-2* have been described thereafter (Peters *et al.*, 1989; Van Tuinen *et al.*, 1996b). Some of these alleles e.g. *hp-1<sup>w</sup>* (WB3), previously called *hp<sup>w</sup>*, and *hp-2<sup>l</sup>* are phenotypically stronger than earlier alleles as appears from their much darker green foliage and immature fruit colour.

The *atv* and *Ip* mutations are similar in some aspects to those mutated at the

*HP-1* and *HP-2* loci, but not allelic (Kendrick *et al.*, 1994). The *atv* mutant is derived from a segregant in a natural population of *Lycopersicon pimpinellifolium* from the Galápagos (Rick, 1963), but is almost certainly a *L. cheesmanii* accession (C.M Rick, pers. comm.). This mutant is characterized by strong anthocyanin pigmentation, especially under cool conditions, in stems, leaf veins, and even green fruits (Rick *et al.*, 1968; Von Wettstein-Knowles, 1968a; 1968b). The *Ip* mutant originates as a segregant from the wild species *L. chmielewski* backcrossed in *L. esculentum*. It resembles the *hp-1* mutant phenotypically, but differs in its dominance and has a more vigorous behaviour than *hp-1* (Rick, 1974).

The *hp-1* mutant was partially characterized in earlier studies by Adamse *et al.* (1989) and Peters *et al.* (1989, 1992a), who suggested that it modifies a basic process affecting photomorphogenesis rather than originating from a mutation affecting a specific response on the basis of its pleiotropic phenotype. The phytochrome content and the characteristics of the phytochrome system, so far investigated, are similar to that in the wild type (WT) (Peters *et al.*, 1992a). In contrast to WT, the *hp-1* mutant does not require co-action of a blue light (B) photoreceptor and phytochrome to exhibit high levels of anthocyanin synthesis and enables complete de-etiolation under R. On the basis of the recessive (loss-of-function) nature of the mutation, Peters *et al.* (1992a) proposed that the phytochrome action is under constraint of the *HP-1* gene product (HP-1), which represses the light-signal transduction. In this study we present a physiological characterization and analysis of phytochrome in the *hp-1*, *hp-2*, *atv* and *Ip* exaggerated-photoresponse mutants.

## 5.2 Materials and methods

### 5.2.1 Plant material

#### 5.2.1.1 Genotypes

Four non-allelic exaggerated-photoresponse mutants of tomato (*Lycopersicon esculentum* Mill.) were used: (i) three recessive mutants: the high pigment-1 (*hp-1*), the high-pigment-2 (*hp-2*) and the atroviolacea (*atv*); (ii) one dominant mutant: the Intense pigmentation (*Ip*). These mutants and the corresponding WTs (AC and GT) are listed in Table 5.1. Seeds of the original mutants were obtained from (i) Dr. J.W. Maxon Smith, Glasshouse Crop Research Institute (Littlehampton, UK) for GCR 60; (ii) from the Tomato Genetic Resource Center (Davis, CA, USA) for LA797 and LA1500; (iii) from Dr. G.P. Soressi (Italy) for the *hp-2* mutant in a San Morzano type (cultivar Garim). The *atv* and *Ip* mutants were backcrossed once with GT. For physiological experiments  $F_6$ - $F_{10}$  lines

**Table 5.1.** Summary of genotypes used in this chapter.

Genotype	Genetic background	Collection number	Reference
Wild type	Ailsa Craig (AC)	-	-
Wild type	Breeding line GT (GT)	-	-
<i>hp-1</i>	AC	GCR60	Maxon Smith and Ritchie (1983)
<i>hp-1<sup>w</sup></i>	GT	WB3	Peters <i>et al.</i> (1989)
<i>hp-2</i>	GT / San Marzano <sup>a</sup>	hp2	Soressi (1975)
<i>atv</i>	GT / mixed <sup>b</sup>	LA797	Rick (1963)
<i>lp</i>	GT / mixed <sup>c</sup>	LA1500	Rick (1974)

<sup>a</sup> The original *hp-2* mutant is in *L. esculentum*, type San Marzano and backcrossed with GT.

<sup>b</sup> The original *atv* mutant is derived from *L. pimpinellifolium*, as originally described by Rick (1963), but is almost certainly a *L. cheesmanii* accession (C.M. Rick, pers. comm.) and backcrossed with GT.

<sup>c</sup> The original *lp* mutant is in *L. chmielewski* and backcrossed with GT.

derived from these crosses were used by selecting lines carrying the recessive uniform ripening (*u*) allele in addition to the *hp-1*, *hp-2*, *atv* and *lp* alleles.

#### 5.2.1.2 Pretreatment of the seeds

In all experiments, except in the daytime supplementary FR experiment, seeds were surface sterilized as described in 2.2.1.2. In the continuous broad-band light experiment seeds were also pregerminated (showing radicle emergence) before final sowing to obtain a higher germination percentage and to synchronize the time of emergence as described in 2.2.1.2. In the light-pretreatment and threshold-box experiments surface-sterilized seeds were directly sown in plastic boxes with transparent lids on filter paper moistened with germination buffer (see 2.2.1.2).

### 5.2.2 Phytochrome assays

Methodology for *in-vivo* phytochrome spectrophotometry and Western-blot analysis is described in 2.2.2.

### 5.2.3 Anthocyanin and chlorophyll assays

Methodology for anthocyanin determination is described in 2.2.3. In the supplementary daytime FR experiment the anthocyanin content is expressed on a fresh-weight (FW) basis ( $A_{535}/g$  FW).

Methodology for chlorophyll determination in the continuous broad-band light experiment is described in 3.2.4. Samples grown under FR and in D, and samples grown under B and R, were incubated in 2.5 and 5.0 mL DMSO, respectively.

## 5.2.4 Experiments

### 5.2.4.1 Continuous broad-band light experiment

Surface-sterilized and pregerminated WT (GT), *hp-1<sup>w</sup>*, *hp-2*, *atv* and *Ip* seeds sown in trays were incubated for 72 h at 25 °C. The irradiation with continuous B, R and FR ( $3 \mu\text{mol}\cdot\text{m}^{-2}\cdot\text{s}^{-1}$ ) was started just before the seedlings emerged through the soil surface (= day 0). The lengths of 20 hypocotyls (from soil surface to the hypocotyl hook or cotyledons after opening of the hypocotyl hook) under B, R, FR and in D (viewed under dim-green safelight) were measured with a ruler on a daily basis for 7 days. In addition, the hypocotyl lengths of 20 seedlings grown in absolute D for the duration of the experiment were measured.

For determination of the anthocyanin, samples (4 replicates) of 5 hypocotyls were taken at the end of the experiment (day 7). Both roots and cotyledons were removed. For determination of the chlorophyll *a* and *b*, samples (4 replicates) of 5 pairs of cotyledons were taken at the end of the experiment (day 7).

### 5.2.4.2 White-light experiment

Surface-sterilized and pregerminated WT (GT), *hp-1<sup>w</sup>*, *hp-2*, *atv* and *Ip* seeds sown in trays were incubated in a 16-h white light (WL,  $250 \mu\text{mol}\cdot\text{m}^{-2}\cdot\text{s}^{-1}$  photosynthetically active radiation [PAR])/8-h D cycle at 25 °C. Every seedling was marked on emergence, enabling the hypocotyl length of each seedling after the appropriate number of WL/D cycles to be measured. After 7 days after emergence the length of 20 hypocotyls was measured and anthocyanin was extracted in 4 replicates of 5 hypocotyls and in 6 replicates from 3 pairs of cotyledons.

### 5.2.4.3 Light-pretreatment experiment

Surface-sterilized WT (GT), *hp-1<sup>w</sup>*, *hp-2*, *atv* and *Ip* seeds were sown in plastic boxes with transparent lids and incubated in D for 84 h at 25 °C. A 12-h B or R pretreatment (both  $3 \mu\text{mol}\cdot\text{m}^{-2}\cdot\text{s}^{-1}$ ) was terminated by a pulse of R (5 min,  $3 \mu\text{mol}\cdot\text{m}^{-2}\cdot\text{s}^{-1}$ ), FR (10 min,  $10 \mu\text{mol}\cdot\text{m}^{-2}\cdot\text{s}^{-1}$ ) or R immediately followed by FR. Both pulses were saturating for phytochrome photoconversion. The boxes were then transferred to D for 24 h before anthocyanin determination in 4 replicates of 10 whole seedlings.

### 5.2.4.4 Threshold-box experiment

Surface-sterilized WT (GT), *hp-1<sup>w</sup>*, *atv* and *Ip* seeds were sown in plastic boxes with transparent lids and incubated in D for 90 h at 25 °C before exposure to 24-h continuous monochromatic R (660 nm) in a threshold-box unit (see 4.2.4.2). Anthocyanin was determined at the end of the 24-h 660 nm monochromatic irradiation of different fluence rates in four replicates of 10 whole seedlings.

*5.2.4.5 Supplementary daytime FR experiment*

Non-pretreated WT<sub>s</sub> (AC and GT), *hp-1*, *hp-2*, *atv* and *lp* seeds were directly sown in trays and grown in a 16-h WL ( $170 \mu\text{mol}\cdot\text{m}^{-2}\cdot\text{s}^{-1}$  PAR)/8-h D cycle for seven days at 25 °C. The plants were then transplanted into plastic pots (10x10x8.5 cm) and transferred to a cabinet with the same cycle, but higher irradiance ( $230 \mu\text{mol}\cdot\text{m}^{-2}\cdot\text{s}^{-1}$  PAR) which had a R:FR photon ratio of 6.90. After 18 days the plants were transferred to two cabinets with a similar 16-h WL/8-h D cycle (-FR), one of which had additional FR (+FR), which is not photosynthetically active and reduces the R:FR photon ratio to 0.13 (see 6.2.5.1 and 6.2.6.1). Plant height (6 replicates) was measured every other day during a 6-day treatment with and without supplementary daytime FR.

For determination of the anthocyanin, samples (6 replicates) of young leaves, of comparable development (5–15 mm in length) were taken at the end of the experiment (day 6).

**5.2.5 Light facilities and light measurements**

*5.2.5.1 Light cabinets and sources*

The WL experiment was performed in a phytotron (Wageningen); the WL-source is described in 3.2.6.2. The continuous broad-band light experiment was performed in cabinets for low irradiance described by De Lint (1960); the B-, R- and FR-sources are described in 3.2.6.2. The light-pretreatment experiment was performed in the light-cabinets, described in 2.2.5.1; the R- and FR-sources are described in 2.2.5.2. The threshold-box experiments light were performed in the threshold-box units (see 4.2.4.2), using an interference filter (Schott, Mainz, Germany) with a peak transmission at 660 nm and a bandwidth of 10.6 nm at 50 % of the transmission maximum. The supplementary daytime FR experiment was performed in cabinets at the Botany Department, University of Leicester, Leicester, UK (see 6.2.6.1); the light-sources are described in 6.2.6.1. The light sources used in the phytochrome assays are described in 2.2.5.2.

*5.2.5.2 Light measurements*

Fluence rates and spectral distributions of the light sources were recorded using a cosine-corrected remote probe connected to a calibrated LI-1800 spectroradiometer (Li-Cor, Lincoln, NE, USA), as described in 2.2.5.3.

### 5.3 Results and discussion

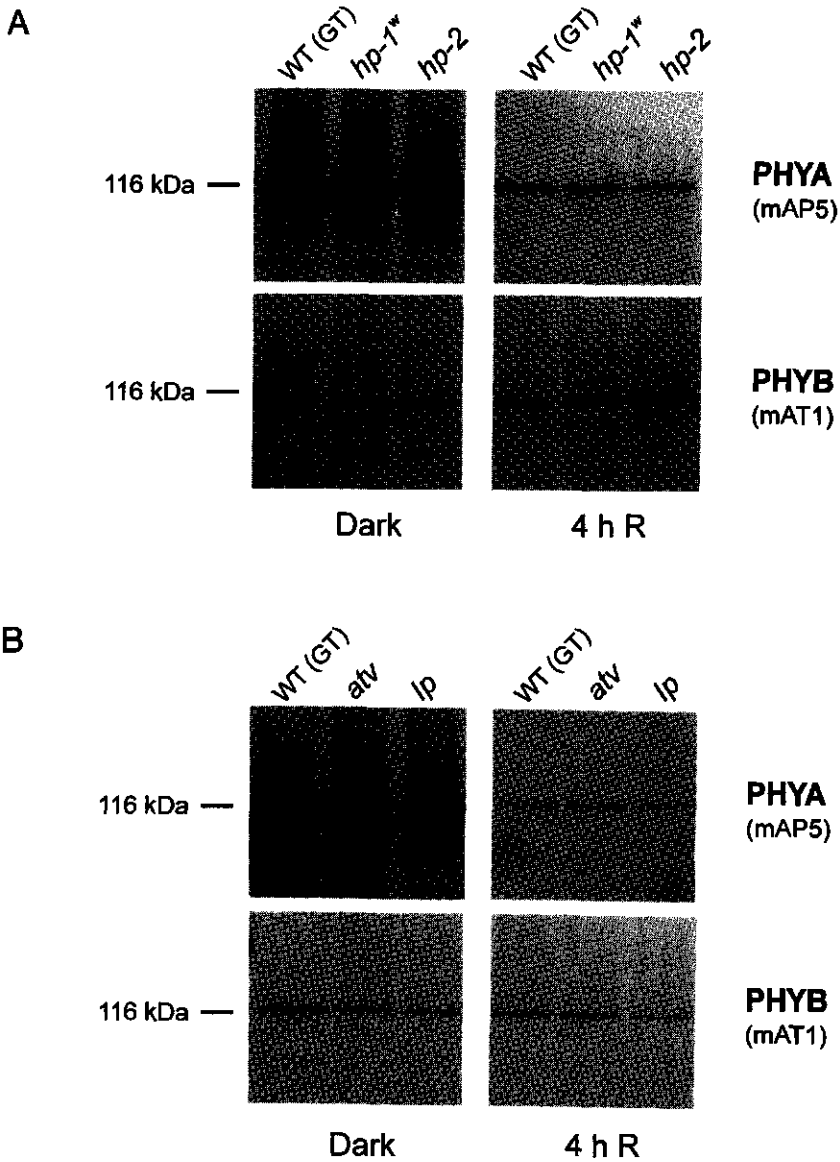
#### 5.3.1 Immunochemical and *in-vivo* spectrophotometrical analysis of phytochrome

No differences in phytochrome A (phyA) polypeptide (PHYA) and phytochrome B (phyB)-like polypeptide (PHYB) were observed in extracts of etiolated seedlings of the WT (GT) and derived *hp-1<sup>w</sup>* and *hp-2* mutants (Fig. 5.1A) and of the WT (GT) and derived *atv* and *Ip* mutants (Fig. 5.1A). The PHYB antibody used is known from an earlier study to recognize the PHYB1 pool in tomato (Chapter 3). As expected for phyA, a 4-h R irradiation strongly depleted the light-labile phyA pool (Chapters 2 and 3). Only in the case of the *Ip* mutant was there an indication of a reduced level of PHYB, after a 4-h R irradiation. However this small effect could be explained on the basis of genetic background effects, since the mutants have only been backcrossed into GT once.

Analysis of the total spectrophotometrically detectable phytochrome (Ptot) in the *hp-1<sup>w</sup>*, *hp-2* and *atv* mutants showed they all have a similar level, comparable to the WT (Table 5.2). The residual fraction of Ptot present after a 4-h R irradiation, which depletes the light-labile phyA pool, represents the level of light-stable phytochromes, as shown in similar experiments using the phyA-deficient *fri* tomato mutants (Chapter 2). The *Ip* mutant shows a significantly lower Ptot level after 4-h R irradiation than the other genotypes, indicating a slight reduction in the stable fraction, which is consistent with the Western-blot analysis.

**Table 5.2.** *In-vivo* measurement of total spectrophotometrically detectable phytochrome (Ptot) in WT (GT), and derived *hp-1<sup>w</sup>*, *hp-2*, *atv* and *Ip* mutant tomato seedlings. The Ptot in dark-grown 4-day-old seedlings, or seedlings of the same age exposed to 4 h R ( $20 \mu\text{mol}\cdot\text{m}^{-2}\cdot\text{s}^{-1}$ ), was measured using a dual-wavelength spectrophotometer and is expressed as  $10^{-3} \Delta(\Delta A_{730-800})/40$  seedlings  $\pm$  SE.

Genotype	Treatment	
	Dark	4 h R
WT (GT)	17.47 $\pm$ 0.59	1.35 $\pm$ 0.05
<i>hp-1<sup>w</sup></i>	16.65 $\pm$ 0.47	1.13 $\pm$ 0.02
<i>hp-2</i>	17.38 $\pm$ 0.75	1.17 $\pm$ 0.02
<i>atv</i>	17.22 $\pm$ 0.63	1.38 $\pm$ 0.02
<i>Ip</i>	16.33 $\pm$ 0.66	0.89 $\pm$ 0.04

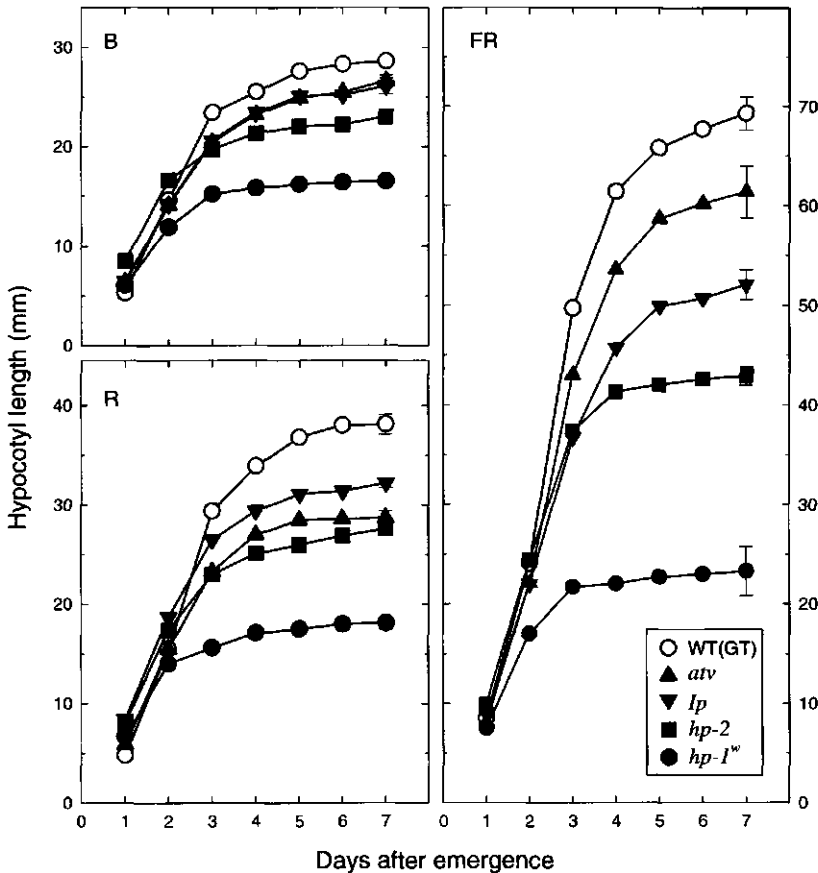


**Figure 5.1.** Western-blot analysis of phytochrome A and B polypeptides (PHYA and PHYB, respectively) in crude extracts of: (A) WT (GT), and derived *hp-1<sup>w</sup>* and *hp-2* mutant tomato seedlings; (B) WT (GT), and derived *atv* and *lp* mutant tomato seedlings. Dark-grown 4-day-old seedlings, or seedlings of the same age but exposed to 4 h R ( $20 \mu\text{mol}\cdot\text{m}^{-2}\cdot\text{s}^{-1}$ ), were used for the detection of PHYA and PHYB with monoclonal antibodies mAP5 and mAT1, respectively.

### 5.3.2 Hypocotyl growth

In continuous low fluence broad-band irradiation experiments at equal photon fluence rate ( $3 \mu\text{mol}\cdot\text{m}^{-2}\cdot\text{s}^{-1}$ ) a strong inhibition of hypocotyl length after 7 days in B, R and FR is seen for all genotypes studied, compared to the D control (Fig. 5.2). The hypocotyl length of the *hp-1<sup>w</sup>* mutant is the most strongly inhibited compared to the other genotypes in all treatments, followed by the *hp-2* mutant. The *atv* and *Ip* mutants exhibit an intermediate inhibition compared to WT in B, R and FR. In addition, chlorophyll *a* and *b* content was similar in the *hp-1<sup>w</sup>*, *hp-2*, *atv* and *Ip* mutants compared to WT at the end of the 7-day treatment under continuous low fluence broad-band B and R (data not shown).

In a similar series of experiments the two different *hp-1* alleles, *hp-1<sup>w</sup>* (WB3)



**Figure 5.2.** The hypocotyl length of WT (GT), and derived *hp-1<sup>w</sup>*, *hp-2*, *atv* and *Ip* mutant tomato seedlings. Seedlings were grown for 7 days in continuous broad-band B, R, FR ( $3 \mu\text{mol}\cdot\text{m}^{-2}\cdot\text{s}^{-1}$ ). The mean hypocotyl length (mm)  $\pm$  SE of the absolute D control of WT (GT), *hp-1<sup>w</sup>*, *hp-2*, *atv* and *Ip* at the end of the 7-day period was:  $154 \pm 3$ ,  $133 \pm 3$ ,  $153 \pm 3$ ,  $152 \pm 3$  and  $163 \pm 2$ , respectively. For clarity only the SE for the last data points are shown.



and *hp-1* (GCR60) in three different genetic backgrounds (AC, MM and GT), exhibit a similar inhibition of hypocotyl elongation under continuous low fluence broad-band irradiation of R and FR, demonstrating the inhibition is independent of the genetic background (data not shown).

When grown in a 16-h WL ( $250 \mu\text{mol}\cdot\text{m}^{-2}\cdot\text{s}^{-1}$  PAR)/8-h D cycle for seven days the hypocotyls of the *hp-1<sup>w</sup>*, *hp-2*, *atv* and *Ip* are similar in length compared to the WT (Table 5.3).

Early reports of the *hp-1* mutant emphasized its subnormal and less vigorous behaviour with respect to seed germination and seedling growth compared to WT (Thompson *et al.*, 1962; Kerr, 1965; Rick, 1974). In our experiments using *hp-1<sup>w</sup>*, *hp-2*, *atv* and *Ip* mutants these responses were very similar to that in the WT.

One interesting aspect of the phenotype of the *hp-1<sup>w</sup>* and *hp-2* mutants is that under continuous FR, 6–7 days after emergence both mutants seem to abort their developmental program. The hypocotyls just below the hypocotyl hook collapse resulting in the hypocotyl breaking just below the cotyledons. This lethality under continuous FR was not seen in *atv* and *Ip*, but under the same conditions it was also obvious in a tomato line overexpressing the oat *PHYA3* gene (Boylan and Quail, 1989), which has an equivalent phenotype to *hp* mutants. Thompson *et al.* (1962) reported that stems of the *hp* mutants were brittle, resulting in a higher mortality. In tomato (Van Tuinen *et al.*, 1995a) and *Arabidopsis* (Barnes *et al.*, 1996) continuous FR induces a block of greening of the cotyledons in subsequent WL. It has been proposed this is caused by a phyA-dependent irreversible repression of the protochlorophyllide reductase genes (*POR*), coupled with irreversible plastid damage (Barnes *et al.*, 1996). We hypothesize that the lethality under continuous FR in both *hp-1<sup>w</sup>* and *hp-2* mutants, may be related to a promotion of the FR-signalling (phyA-signalling), whereas *atv*, *Ip* and WT are unaffected. However, transferring seedlings to WL after 7-d treatment of FR is lethal for all the genotypes. Only the phyA-deficient *fri* mutants green and survive

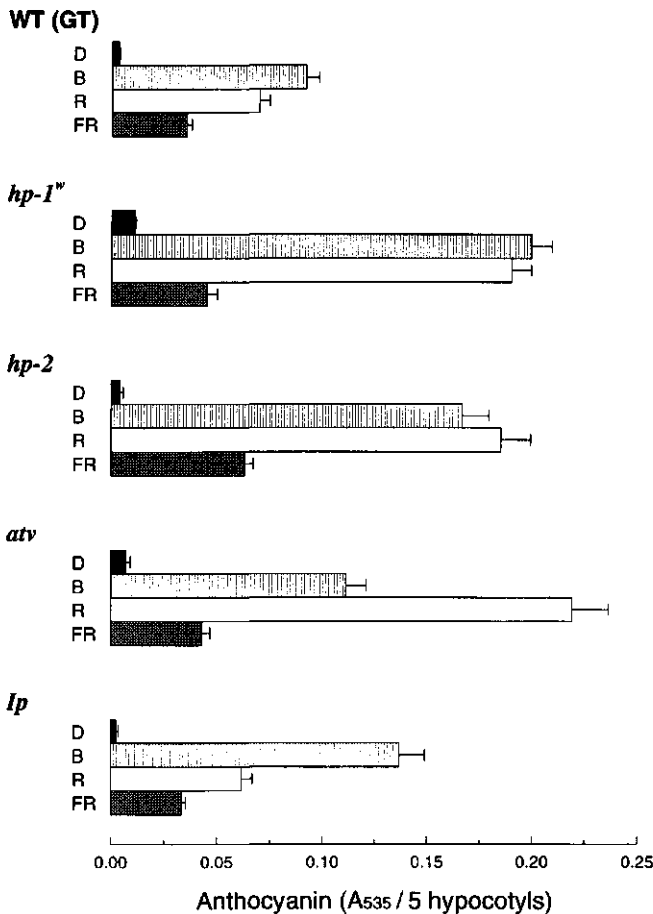
**Table 5.3.** The hypocotyl length (mm)  $\pm$  SE and the anthocyanin content ( $A_{535}$ )  $\pm$  SE per 5 hypocotyls and per 3 pairs of cotyledons of WT (GT), and derived *hp-1<sup>w</sup>*, *hp-2*, *atv* and *Ip* mutant tomato seedlings. Seedlings were grown in a 16-h WL ( $250 \mu\text{mol}\cdot\text{m}^{-2}\cdot\text{s}^{-1}$  PAR)/8-h D cycle for 7 days.

Genotype	Length (mm)		Anthocyanin content ( $A_{535}$ )	
	Hypocotyls		Hypocotyls	Cotyledons
WT (GT)	38.4 $\pm$ 0.6		0.81 $\pm$ 0.02	1.44 $\pm$ 0.15
<i>hp-1<sup>w</sup></i>	37.3 $\pm$ 0.8		1.22 $\pm$ 0.03	1.35 $\pm$ 0.08
<i>hp-2</i>	40.0 $\pm$ 0.9		1.06 $\pm$ 0.02	1.14 $\pm$ 0.22
<i>atv</i>	39.6 $\pm$ 0.8		1.27 $\pm$ 0.03	1.40 $\pm$ 0.12
<i>Ip</i>	38.2 $\pm$ 0.8		0.96 $\pm$ 0.04	1.23 $\pm$ 0.12

such transfer (Van Tuinen *et al.*, 1995a), indicating the unambiguous role of phyA in this process.

### 5.3.3 Anthocyanin biosynthesis

The anthocyanin content of the tomato hypocotyls of the different genotypes at the end of a 7-day treatment under continuous low fluence broad-band B, R and FR is given in Fig. 5.3. The *hp-1<sup>w</sup>*, *hp-2*, *atv* and *Ip* mutants show an enhanced anthocyanin content compared to WT. Both *hp-1<sup>w</sup>* and *hp-2* mutants exhibited an almost equal anthocyanin response in B and R. The *Ip* mutant has a WT-level of anthocyanin in R, but in B it has a level twice as high as in R. This is in sharp contrast to the *atv* mutant which exhibits twice as much anthocyanin in R as in B.



**Figure 5.3.** The anthocyanin content ( $A_{535}/5$  hypocotyls  $\pm$  SE) in WT (GT), and derived *hp-1<sup>w</sup>*, *hp-2*, *atv* and *Ip* mutant tomato seedlings. Seedlings were grown for 7 days in continuous broad-band B, R, and FR ( $3 \mu\text{mol}\cdot\text{m}^{-2}\cdot\text{s}^{-1}$ ) and in absolute D.

This suggests that the *Ip* mutation, may be specific for B photoreceptor signalling, whilst the *atv* mutation is specific for phytochrome signalling.

The anthocyanin content in hypocotyls of the different genotypes grown in a 16-h WL ( $250 \mu\text{mol.m}^{-2}.\text{s}^{-1}$  PAR)/8-h D cycle for 7 days (Table 5.3) clearly shows an increase in anthocyanin for all the mutants compared to the WT, the highest level being in *atv* and *hp-1*. In contrast, no dramatic differences in hypocotyl growth under the same conditions were observed. The anthocyanin content was also measured in cotyledons (Table 5.3), and only slightly different values were seen between the genotypes.

An histological study by Von Wettstein-Knowles (1968b) using WL-grown *hp-1* and *atv* mutants, revealed almost uniformly 'black' mature stems and a dense anthocyanin pigmentation of the whole leaf in the *atv* mutant compared to *hp-1*, while the latter had less anthocyanin in stems and a strong association of anthocyanin with leaf veins. This indicates that the effect of the *hp-1* mutation has a different tissue expression than the *atv* mutation.

Anthocyanin synthesis was also studied during a 24-h D period after B and R pretreatments (Drumm-Herrel and Mohr, 1982) terminated by an inductive pulse of R or a R pulse followed immediately by a FR pulse. The R/FR reversible anthocyanin synthesis during a subsequent 24-h D period after pretreatment of 12-h B or R (Fig. 5.4) was *ca.* 5-fold higher in the *hp-1* mutant than in the WT. There is no difference between R and B pretreatments in *hp-1*, whereas in WT the B pretreatment is about twice as effective than R. In the *hp-2* mutant the R pulse after a B pretreatment significantly increases the anthocyanin content, in contrast to the saturated response in the *hp-1*, *atv* and *Ip* mutants. Under these conditions the *Ip* mutant exhibits a relatively low response amplification after a R pretreatment, whereas the other mutants respond to both R and B pretreatments. In the first day after transition from D to R (4 days from sowing) there is a very high competence for anthocyanin formation in tomato which gradually declines over the next seven days (data not shown). However, in these light-pretreatment experiments the *atv* mutant is far more responsive to R than the *Ip* mutant. Collectively the above experiments and those under prolonged broad-band irradiation (Fig. 5.3) point to the specificity of the *Ip* mutation for a B-dependent response amplification pathway.

A detailed fluence-rate response study for anthocyanin biosynthesis was carried out using 4-day-old *hp-1<sup>w</sup>*, *atv* and *Ip* mutants and WT (GT) under 660-nm monochromatic irradiation for 24 h in a threshold-box unit (Fig. 5.5). The WT fluence rate response relationship shows two components: a low fluence rate response (LFRR) and a high irradiance response (HIR). The results confirm earlier studies with *hp-1* indicating that both the LFRR and the HIR components are amplified in R (Peters *et al.*, 1992a). However, the *atv* mutant shows a much stronger amplification of the HIR compared to the LFRR, whereas the *Ip* mutant exhibits no dramatic amplification of either response components in R, confirming

Physiological characterization of exaggerated-photoresponse mutants

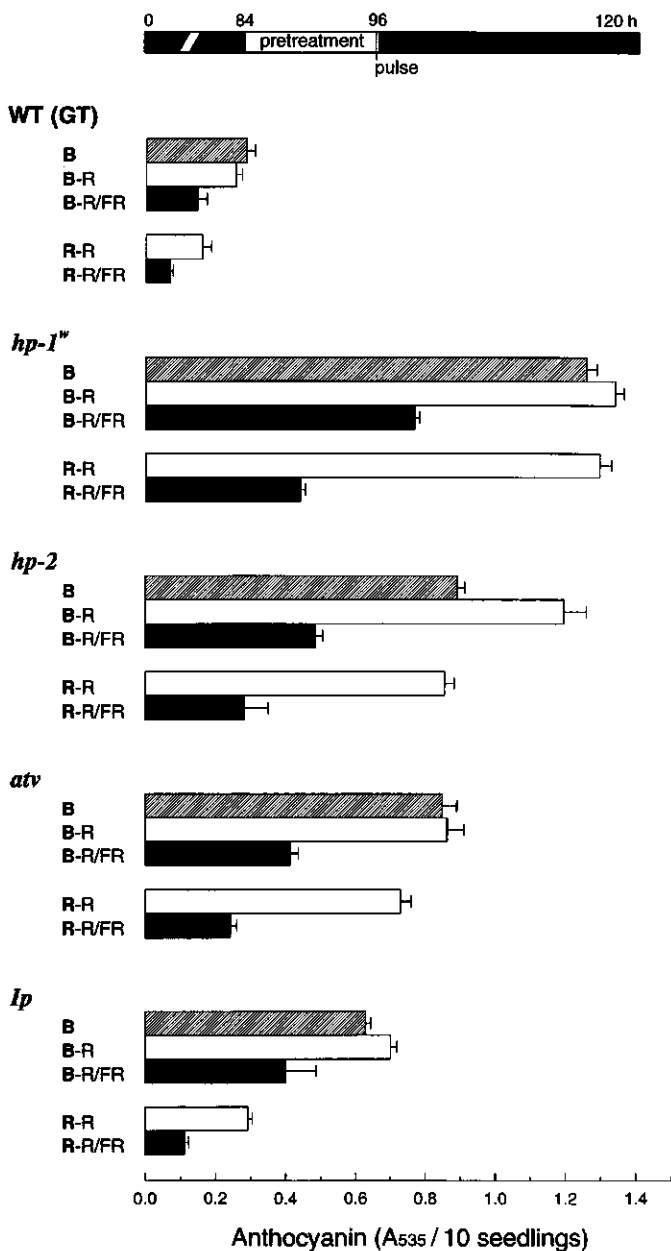
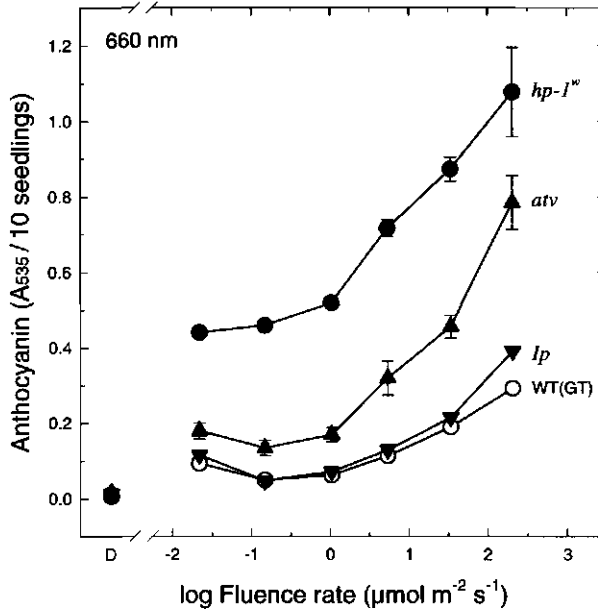


Figure 5.4. The anthocyanin content ( $A_{535}/10$  seedlings  $\pm$  SE) in WT (GT), and derived *hp-1<sup>m</sup>*, *hp-2*, *atv* and *Ip* mutant tomato seedlings. Seedlings were pretreated with either 12 h B ( $3 \mu\text{mol}\cdot\text{m}^{-2}\cdot\text{s}^{-1}$ ) or 12 h R ( $3 \mu\text{mol}\cdot\text{m}^{-2}\cdot\text{s}^{-1}$ ) terminated with no pulse, a pulse of R, a pulse of FR or a R pulse immediately followed by FR pulse (all pulses were saturating for phytochrome photoconversion). All seedlings were then kept in D for 24 h prior to the anthocyanin extraction.



**Figure 5.5.** Anthocyanin accumulation ( $A_{339}/10$  seedlings  $\pm$  SE) in WT (GT), and derived  $hp-1^{-}$ ,  $atv$ , and  $Ip$  mutant tomato seedlings. Dark-grown 4-day-old seedlings were given a 24-h monochromatic irradiation with 660 nm of different fluence rates. D = dark control.

that  $Ip$  has little influence on phytochrome signalling under R. Since the LFRR and HIR components in R have been attributed to phyA and phyB1, respectively (Chapter 4), the amplification seen in the  $atv$  mutant appears to show specificity for the phyB1 HIR pathway. This supports the idea of discrete signalling pathways of phyA and phyB1 upstream of the common signal transduction chain leading to anthocyanin biosynthesis. Further support for this concept is provided by experiments with a transgenic tomato line overexpressing the oat *PHYA3* gene, which show a dramatic amplification of the LFRR component, whilst retaining a normal phyB1 HIR (Chapter 4).

In a supplementary daytime FR experiment the anthocyanin content of the youngest leaves was measured in plants grown in a 16-h WL ( $230 \mu\text{mol.m}^{-2}.\text{s}^{-1}$  PAR)/8-h D cycle for 24 days (Table 5.4). In WL, the  $hp-1$ ,  $hp-2$  and  $atv$  mutants without supplementary daytime FR all had similar high levels of anthocyanin, ca. 30% higher than the control. The  $Ip$  mutant had a WT-level of anthocyanin. All genotypes exhibited a cessation of anthocyanin biosynthesis in young leaves when exposed to supplementary daytime FR as described for the  $hp-1$  mutant (Kerckhoffs *et al.*, 1992; Chapter 6).

**Table 5.4.** The increase in plant height (mm)  $\pm$  SE and anthocyanin content ( $A_{535}$ /g FW)  $\pm$  SE of comparable developed young growing leaves of WT (AC and GT), and derived *hp-1*, *hp-2*, *atv* and *lp* tomato mutant plants treated with and without daytime supplementary FR. Plants were grown in a 16-h WL (230  $\mu\text{mol}\cdot\text{m}^{-2}\cdot\text{s}^{-1}$  PAR)/8-h dark (D) cycle. After 18 days from sowing plants were grown under conditions of 16-h WL (- FR) or 16-h WL with supplementary daytime FR (+ FR) continued for 6 days. The anthocyanin content was measured at the end of the treatment.

Genotype	Increase in plant height (mm)		Anthocyanin ( $A_{535}$ /g FW)	
	- FR	+ FR	- FR	+ FR
WT (AC)	39.8 $\pm$ 2.2	197.4 $\pm$ 5.1	4.86 $\pm$ 0.33	0
<i>hp-1</i>	22.2 $\pm$ 0.7	148.8 $\pm$ 3.8	6.05 $\pm$ 0.52	0
WT (GT)	43.6 $\pm$ 2.0	208.0 $\pm$ 6.8	4.64 $\pm$ 0.39	0
<i>hp-2</i>	20.6 $\pm$ 0.5	114.6 $\pm$ 6.8	6.10 $\pm$ 0.38	0
<i>atv</i>	25.2 $\pm$ 1.2	111.3 $\pm$ 9.6	5.90 $\pm$ 0.59	0
<i>lp</i>	31.8 $\pm$ 1.5	158.8 $\pm$ 5.5	4.73 $\pm$ 0.53	0

### 5.3.4 Elongation to supplementary daytime FR

In a supplementary daytime FR experiment *hp-1*, *hp-2*, *atv* and *lp* mutant plants, grown in a 16-h WL (230  $\mu\text{mol}\cdot\text{m}^{-2}\cdot\text{s}^{-1}$  PAR)/8-h D cycle for 24 days, show a qualitatively similar elongation responses compared to the WT's (Table 5.4), as shown for the *hp-1* mutant (Chapter 6). The *hp-1* mutant also exhibits a normal end-of-day FR (EODFR) response (Peters *et al.*, 1992b; Chapter 8). However, the response to supplementary daytime FR is almost an order of magnitude greater. This indicates that despite their compact phenotype, these mutants exhibit a normal shade-avoidance response.

### 5.3.5 Greenhouse observations

The immature fruit colour of tomato plants was monitored in the greenhouse during the summer (Wageningen). The *hp-1* and *hp-2* mutants have darker green fruits compared to WT. The *atv* mutant fruits have a WT colour, whereas the *lp* mutant fruits are only slightly more dark green. The *hp-1* and *hp-2* mutants appear to have additional pleiotropic effect on fruits, having a more elongated shape as well as a dark-green colour.

### 5.4 Concluding remarks

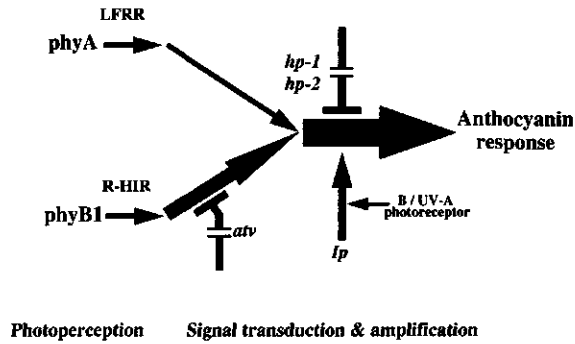
The nature of the processes influenced by the *hp-1*, *hp-2*, *atv* and *Ip* mutations is still unknown. The *HP-1*, *HP-2* and *ATV* genes are proposed to encode repressors of phytochrome signal amplification on the basis of their recessive (loss-of-function) nature. However, the *Ip* mutant is reported to be dominant (Rick, 1974) and presumably results in a promotion of phytochrome signal amplification. The *hp-1*, *hp-2*, *atv* and *Ip* mutations are pleiotropic for different photomorphogenic responses, and therefore not specific anthocyanin response mutants. The phytochrome characteristics studied to date show no significantly higher level of phytochrome in these mutants than in the WT. Therefore the difference observed cannot be explained by a higher absolute level of the active FR-absorbing form of phytochrome (Pfr). The *phyA* and *phyB1* phytochrome gene family members, have been demonstrated as the phytochromes which are necessary for anthocyanin biosynthesis under R (Chapter 4). While it is theoretically possible that other phytochromes can play a role it is difficult to test such a hypothesis at present until type specific antibodies to all tomato phytochromes become available. The *Ip* mutant appears to be specific for B photoreceptor signalling and the *atv* mutant specific for phytochrome signalling. A comparison of several phenotypical characteristics of the *hp-1<sup>w</sup>*, *hp-2*, *atv* and *Ip* mutants, compared to WT is given in Table 5.5.

**Table 5.5.** Comparison of the exaggerated-photoresponse mutants to WT (GT).

Parameter	Genotype				
	WT	<i>hp-1<sup>w</sup></i>	<i>hp-2</i>	<i>atv</i>	<i>Ip</i>
Phytochrome					
<i>phyA</i>	+	+	+	+	+
<i>phyB</i>	+	+	+	+	+
Anthocyanin					
In red light	+	+++	+++	+++	+
In blue light	+	+++	+++	+	+++
Hypocotyl inhibition					
In red light	+	+++	++	++	++
In blue light	+	+++	+++	+++	+++
Chlorophyll content					
Cotyledons	+	+	+	+	+
Immature fruit	+	+++	+++	+	+

+ = WT level or response

## Physiological characterization of exaggerated-photoresponse mutants



**Figure 5.6.** Working hypothesis indicating the signal transduction chains leading to anthocyanin biosynthesis in young tomato seedlings and the proposed sites of action of the exaggerated-photoresponse mutants, based on their recessive nature for *hp-1*, *hp-2* and *atv* and dominant nature for *ip*. The arrows represent promotive effects, and the flat-ended lines represent an inhibitory action or repressive effect. The increasing size of the arrows indicates signal amplification.

We hypothesized that the *hp-1* and *hp-2* are mutations in a common pathway since they are similar in overall phenotype and no novel phenotypes were observed in putative double mutants (data not shown). A summarized scheme of the present findings is shown in Figure 5.6. The cloning of these genes is of great interest and will provide a valuable insight into the complexities of signal amplification in photomorphogenesis.

**Acknowledgements.** We thank Harry Smith and Garry Whitelam, University of Leicester, UK for the facilities used in the supplementary daytime FR experiment. Part of this work was carried out at the Laboratory for Photoperception and Signal Transduction, Frontier Research Program, Institute of Physical and Chemical Research (RIKEN), Japan.



# CHAPTER 6

## A study of shade-avoidance responses and fruit development in the *aurea* and *high-pigment-1* mutants of tomato

**Abstract.** Four genotypes of tomato (*Lycopersicon esculentum* Mill.) in the genetic background Ailsa Craig were used: an *aurea* (*au*) mutant, deficient in the biosynthesis of phytochrome chromophore; a high-pigment-1 (*hp-1*) mutant, showing exaggerated phytochrome responses at the time of de-etiolation; the *au, hp-1* double mutant and the near-isogenic wild type (WT). A study of etiolated seedlings revealed no differences in spectrophotometrically and immunochemically detectable phytochrome in the WT and *hp-1* mutant, whereas the *au* and *au, hp-1* mutants both lacked any spectrophotometrically detectable phytochrome. A dramatic increase in plant height resulting from an increase in the length of all internodes, for each of the genotypes studied was observed upon reduction of the red light: far-red light photon ratio (R:FR) from 6.90 to 0.13 by addition of FR for the whole photoperiod. A concomitant increase in leaf length was also observed. The fact that *au* and *au, hp-1* mutants, both deficient in the phytochrome chromophore biosynthesis, respond to this reduction in the R:FR is consistent with the leaky nature of the *au* mutation and demonstrates that the phytochrome pool that mediates this response is present and fully functional. Anthocyanin was detectable in the comparably developed young growing leaves of the WT and *hp-1* mutant under the high R:FR, but not in the *au* and *au, hp-1* mutants. The kinetics of anthocyanin decrease in the young growing leaves was investigated in the *hp-1* mutant and the results suggest a very rapid cessation of flavonoid biosynthesis upon reduction of the R:FR. The functions of different phytochrome types in these responses are discussed. In addition, a study of fruit development of the four genotypes grown under greenhouse conditions was carried out. The *hp-1* phenotype, *i.e.* dark-green foliage and immature fruit colour due to high chlorophyll levels, is also expressed in the *au, hp-1* double mutant. Carotenoid content of the *hp-1* mutant fruits is also higher than that of the WT fruits. The *au, hp-1* was shown to be intermediate in total chlorophyll and carotenoid level between that of the monogenic *au* and *hp-1* mutants. The 40–45 day-old *au, hp-1* fruits resemble *hp-1* fruits more than *au* fruits.

### 6.1 Introduction

The control of plant development by light involves at least three different photoreceptors: phytochrome, which exist in two photochromic forms, Pr and Pfr,

absorbing red light (R) and far-red light (FR), respectively; a blue light (B)/UV-A-absorbing photoreceptor, often referred to as cryptochrome and a UV-B-absorbing photoreceptor. Phytochrome is the best understood photoreceptor and is comprised of a family of light-labile and light-stable photoreceptors (Furuya, 1989). The light-labile phytochrome, referred to as type I phytochrome (PI) is encoded by *PHYA* and accumulate to high levels in etiolated seedlings, where it acts as an antenna for the sensitive detection of light and the induction of the de-etiolation process. The light-stable phytochromes, referred to as type II (PII) are phytochromes which accumulates in light-grown tissue and the genes for PII are constitutively expressed (Sharrock and Quail, 1989). These two types of phytochrome have been proposed to have discrete functions on the basis of physiological evidence (Smith and Whitelam, 1990). Smith (1982) has proposed that one specific function of phytochrome is related to the perception of a reduced proportion of R relative to FR, *i.e.* reduced R:FR photon ratio (R:FR), occurring in the light environment, which initiates the shade-avoidance response. Cultivation of the plants in cabinets under controlled environmental conditions in which the R:FR is varied, whilst the total photosynthetically active radiation (PAR) is held constant, enables the shade-avoidance response to be studied in the laboratory. An inverse linear relationship between the phytochrome photoequilibrium ( $\phi$ ),  $Pfr/(Pfr + Pr)$ , and response (*e.g.* internode extension) has been observed (Morgan and Smith, 1978; Casal and Smith, 1989). Exposure of the plants to daily end-of-day FR (EODFR) (Downs *et al.*, 1957; Kasperbauer, 1971), which reduces the level of Pfr during the following dark (D) period, results in a phenotype that is similar, but less extreme than that due to the shade-avoidance response. While EODFR and a day-time reduction in R:FR result in qualitatively the same response the underlying mechanisms are probably different. In the case of the EODFR response the level of Pfr during the D period is clearly important and escape from FR effectiveness experiments suggest that the presence of Pfr is required for many hours to keep plants short (Peters *et al.*, 1992b). In contrast relatively small changes in R:FR during the light period can result in rapid (time scale of minutes) modulations of elongation growth (Morgan *et al.*, 1980; Child and Smith, 1987).

The assignment of specific functions to the different phytochromes is being studied with the aid of mutants in which certain parts of the photomorphogenic pathway are eliminated or altered (Kendrick and Nagatani, 1991; Koornneef *et al.*, 1992). One of the most extensively studied photomorphogenic mutants of tomato to date is the *au* mutant, which was initially thought to be specifically deficient in the bulk light-labile phytochrome pool. Recently, Terry and Kendrick (1996) proved that *au* is deficient in the biosynthesis of the phytochrome chromophore and therefore proposed it is deficient in more than one type of phytochrome. This deficiency in phytochrome in the *au* mutant makes it a lethal mutation if the seedling is grown under R. In white light (WL) the *au* mutant has a longer hypocotyl and delayed anthocyanin accumulation compare to the wild type (WT)

(see 4.3.1). Adult light-grown plants have yellow-green leaves which are slightly juvenile in appearance, but despite their reduced chlorophyll content they grow extremely well. The yellow colour of the leaves indicates that greening continues to be defective in mature *au* mutant plants. Surprisingly, the *au*-mutant leaves show net photosynthesis rates comparable to WT, despite their reduced chlorophyll content (López-Juez *et al.*, 1990; Becker *et al.*, 1992). The monogenic recessive high-pigment (*hp-1*) mutant shows exaggerated phytochrome responses (Chapter 5), particularly at the seedling stage, *i.e.* an opposite phenotype to the *au* mutant: shorter hypocotyl, more anthocyanin and darker green leaves than WT (Peters *et al.*, 1989; 1992a). The *hp-1* mutant is phenotypically similar at the seedling stage to transgenic tomato plants overexpressing an oat *PHYA3* gene (Boylan and Quail, 1989). The *au, hp-1* double mutant, expected to be deficient in the biosynthesis of the phytochrome chromophore, has a phenotype closer to *au* than *hp-1* at the seedling stage, demonstrating the *au* mutation is epistatic to *hp-1*. In WL-grown plants the *hp-1* mutation appears to have a dwarfing effect in the *au, hp-1* double mutant, particularly when fluorescent lighting is used. The *au* mutant has been shown to exhibit a normal EODFR response, resulting in an increase in plant height (Adamse *et al.*, 1988; López-Juez *et al.*, 1990; Peters *et al.*, 1992b), which is consistent with the gradual accumulation of phytochromes in light-grown plants due to the leakiness of the mutation (Terry and Kendrick, 1996; Van Tuinen *et al.*, 1996a). The *au, hp-1* double mutant and the *hp-1* mutant also respond to EODFR (Peters *et al.*, 1992b).

Ripening of the tomato fruit is a complex developmental process involving several major changes in the fruit character (Khudairi, 1972). Foliar pigments ( $\beta$ -carotene, chlorophylls and various xanthophylls) accumulate in the growing immature-green fruit. During the mature-green and breaker stages (*i.e.* an incipient pink colour, developing around the blossom end of the fruit), the chlorophyll content of the pericarp falls steeply as a consequence of the differentiation of chloroplasts in chromoplasts (Edwards and Reuter, 1967; Harris and Spurr, 1969). This chloroplast-chromoplast transition results in the accumulation of carotenoids, mainly lycopene at the end of the ripening, which give the ripe tomato fruit its characteristic red colour (Khudairi, 1972; Rabinowitch *et al.*, 1975; Brady, 1987). The pigment accumulation in maturing tomato fruit is controlled by phytochrome (Piringer and Heinze, 1954; Khudairi and Arboleda, 1971; Thomas and Jen, 1975). At no stage of development were any flavonoids (*e.g.* anthocyanins) detected in tomato fruits (Khudairi, 1972; Laval-Martin *et al.*, 1975). The mature *au* fruits have a white-green appearance, but in later stages of fruit ripening they turn red like the WT. The *hp-1* fruits have a dark-green immature fruit colour due to high chlorophyll levels. The higher lycopene and carotene content of ripe fruits results in a deep-red colour (Thompson *et al.*, 1962; Baker and Tomes, 1964; Sanders *et al.*, 1975; Mohr, 1979; Frecknall and Pattenden, 1984).

The aim of this study was to investigate the responses of the *au*, *hp-1* and *au, hp-1* mutants along with their near-isogenic WT, to changes in R:FR during the whole of the daily photoperiod and to quantify the effect of the *au* and *hp-1* mutations at the fruit level. In addition, we have made an analysis of the phytochrome status in etiolated seedlings of WT, *hp-1*, *au* and *au, hp-1* by spectrophotometry and immunology.

## 6.2 Materials and methods

### 6.2.1 Plant material

Three recessive mutants of tomato (*Lycopersicon esculentum* Mill.) cultivar Ailsa Craig (AC) were used: two monogenic *au* and *hp-1* mutants, and the *au, hp-1* double mutant. Both *au* (GCR 360) and *hp-1* (GCR 60) were described by Maxon Smith and Ritchie (1983). The *au, hp-1* double mutant was described by Adamse *et al.* (1989). The overall morphology of this double mutant resembled the *au* phenotype at the seedling stage.

### 6.2.2 Phytochrome assays

Methodology for *in-vivo* phytochrome spectrophotometry and Western-blot analysis is described in 2.2.2.

### 6.2.3 Anthocyanin assay

Methodology for anthocyanin determination is described in 2.2.3. Anthocyanin content is expressed on a fresh-weight (FW) basis ( $A_{535}/g$  FW).

### 6.2.4 Chlorophyll and carotenoids assays

Chlorophyll was extracted from 0.10 g leaf samples (only leaflets of mature leaves were used) by immersion in 10 mL *N,N*-dimethylformamide (DMF) and incubated in D for 48 h at 4 °C after Moran and Porath (1980). Absorbance at 647 and 664 nm was determined spectrophotometrically (Lambda 5 UV/VIS; Perkin-Elmer, Beaconsfield, UK). Chlorophyll *a* and *b* were calculated on a FW basis using the equations published by Inskeep and Bloom (1985).

For determination of chlorophyll *a* and *b*, and total carotenoids in fruits, samples were obtained with a cork-bore (diameter 1.024 cm) from the equator of the fruit, using the outer firm portion of the pericarp, without the locular tissue containing the seeds. The discs were incubated in 5 mL dimethylsulfoxide (DMSO) at 65 °C

(after Hiscox and Israelstam, 1979) for 4 days in D. After cooling down to 20 °C the absorption at 470, 649 and 665 nm was determined spectrophotometrically (DU-64; Beckman Instruments, Fullerton, CA, USA). Chlorophyll *a* and *b*, and total carotenoids were calculated per cm<sup>2</sup> fruit area, using the equations published by Lichtenthaler and Wellburn (1983) for ethanol (96 %, v/v). Leaves were also assayed following this procedure in the same experiment.

## 6.2.5 Experiments

### 6.2.5.1 Supplementary daytime FR experiments

Seedlings were raised from seed at 25 °C in plastic trays with a potting compost/sand mixture (3:1, v/v) and grown in a 16-h WL (170 μmol.m<sup>-2</sup>.s<sup>-1</sup> photosynthetically active radiation [PAR])/ 8-h D cycle for 7 days. The plants were then transplanted into plastic pots (10x10x8.5 cm) and transferred to a cabinet (Fisons, Loughborough, UK) with the same cycle, but higher irradiance (230 μmol.m<sup>-2</sup>.s<sup>-1</sup> PAR), which had a R:FR of 6.90, establishing a φ of 0.72. After 17–21 days from sowing plants were transferred to two cabinets (Fisons) with a similar 16-h WL/8-h D cycle (–FR), one of which had additional FR (+FR), which is not photosynthetically active and reduces the R:FR to 0.13 and φ to 0.37 (Table 6.1). The supplementary daytime FR had a duration of 15 h 45 min, switched on/off a few minutes later/earlier than the WL background, to prevent any EODFR effects in this experiment. All other environmental conditions within the cabinets were identical, with a 16-h photoperiod at a constant temperature of 25 °C day/night and relative humidity of 70 %. Every two days the length of each internode and the total plant height in 8 replicates was measured with a ruler to an accuracy of 1 mm. The length of each leaf (including petiole) was also measured with a ruler in 8 replicates at the beginning and the end of each experiment. Internodes and leaves were numbered from below (hypocotyl and cotyledons = 0). For determination of the anthocyanin, samples (6 replicates) of young leaves, of comparable development (5–15 mm in length) were taken at the end of the experiment. In experiments involving the kinetics of anthocyanin formation (7 replicates) during a 5-day period of FR treatment in the *hp-1* mutant samples with a corkbore (diameter 1.3 cm) from the top-leaflet of leaf number 4 were also taken. For the determination of chlorophyll, samples (5 replicates) of full-grown leaves were taken.

### 6.2.5.2 Fruit characterization

Seedlings were grown in trays in a greenhouse under natural light conditions at 25 °C. After two weeks, the plants were transplanted into soil in the same greenhouse (March, 1993). Plants were grown in rows (row distance 0.75 m, within-row distance 0.5 m) and trained to individual wires. Plants were given a NPK fertilizer solution (0.2 %, w/v) containing magnesium with trace elements

(Kristalon 19N+6P+20K+3Mg; Hydro Agri, Vlaardingen, the Netherlands), supplemented with calcium (Dolokal). Pests and diseases were chemically controlled. Flowers were pollinated three times a week with the aid of a vibrator ('electric bee').

Fruit set was defined by a visible spreading of the sepals (= day 0). All trusses were pruned to four fruits per truss just after fruit set. One fruit per truss (randomly chosen) was allowed to reach the ripe fruit stage (full-red colour) and acted as a reference to define retrospectively the developmental stage of the other three fruits during interim harvests. All observations were made daily. To determine the growth kinetics of the fruits, fruit diameters were measured with a pair of callipers. These measurements were related to the maximal diameter at the full-grown stage.

To determine the chlorophyll *a* and *b*, and total carotenoids 35–40 day-old fruits (just before the turning stage or breaker stage, when colour change was incipient) were analyzed. In addition chlorophyll *a* and *b* contents of full-grown leaves were analyzed.

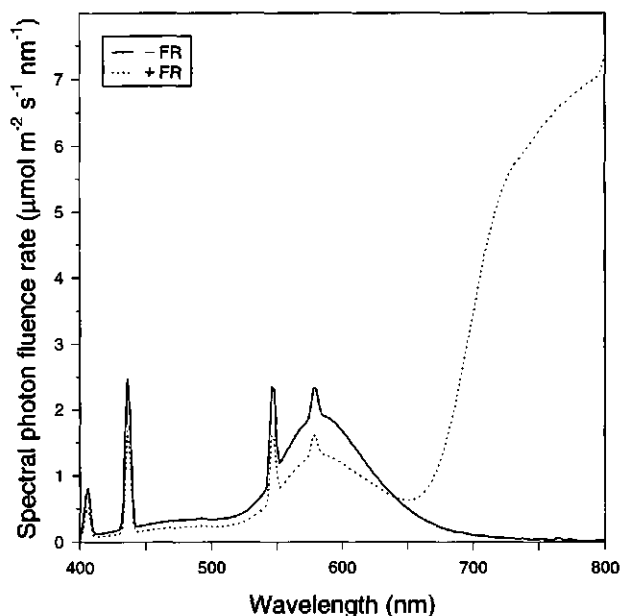
## 6.2.6 Light facilities and measurements

### 6.2.6.1 Light cabinets and light sources

In the supplementary daytime FR experiments, two R:FR-treatment cabinets (Fisons, Loughborough, UK) of similar design were used, which were housed in the Botanical Gardens Facility of the Botany Department, University of Leicester, UK. The WL cabinet (–FR) was provided by banks of Philips BFT 75/85W/35 fluorescent tubes. The WL with additional FR cabinet (+FR) contained the same tubes, supplemented by interspersed banks of Lohuis R7S/500W tungsten halogen lamps (20 kW in total), which were filtered through 4 cm of cooled flowing water and one layer (3 mm) of red (Number 4400) and one layer of green (Number 6600) Perspex (SBA, Leicester, UK). The design allows for uniform levels of PAR (400–700 nm) and wide ranges of R:FR. The spectral photon distribution in the two experimental cabinets is given in Figure 6.1. The light sources used in the phytochrome assays are described in 2.2.5.2.

### 6.2.6.2 Light measurements and phytochrome photoequilibrium calculations

Fluence rates and spectral distributions of the light sources were recorded by placing the cosine-corrected remote probe of a calibrated LI-1800 spectroradiometer (Li-Cor, Lincoln, NE, USA) horizontally at plant height. The PAR (400–700 nm) and the photon irradiance (400–800 nm) were measured and R:FR was calculated as the ratio of fluence rates over the 654–664 nm and 724–734 nm wavelength intervals. Phytochrome photoequilibrium ( $\phi$ ) was calculated by the method of Hayward (1984), using a computer program which integrates the



**Figure 6.1.** Spectral photon distribution in the two experimental cabinets, the WL (-FR) cabinet and the WL with supplementary daytime FR (+FR) cabinet, respectively.

spectral photon fluence-rate data between 400 and 800 nm with the absorption coefficients and quantum efficiencies for photoconversion of the Pr and Pfr forms of oat Type I phytochrome. The value of the phytochrome photoequilibrium for the WL with additional FR cabinet by this method ( $\varphi = 0.37$ ) is higher than that based on the abbreviated method ( $\varphi = 0.20$ ) using the R:FR since the light source in that cabinet is relatively rich in blue light, whereas both methods give a similar value for the high R:FR cabinet. The spectral characteristics of the two growth cabinets are summarized in Table 6.1 and Fig. 6.1.

**Table 6.1.** Spectral characteristics of the two experimental cabinets, the WL (-FR) cabinet and the WL with supplementary daytime FR (+FR) cabinet, respectively. At the start of the daily 8-h D periods the phytochrome photoequilibrium ( $\varphi$ ) was 0.72 in both treatments (see text for details).

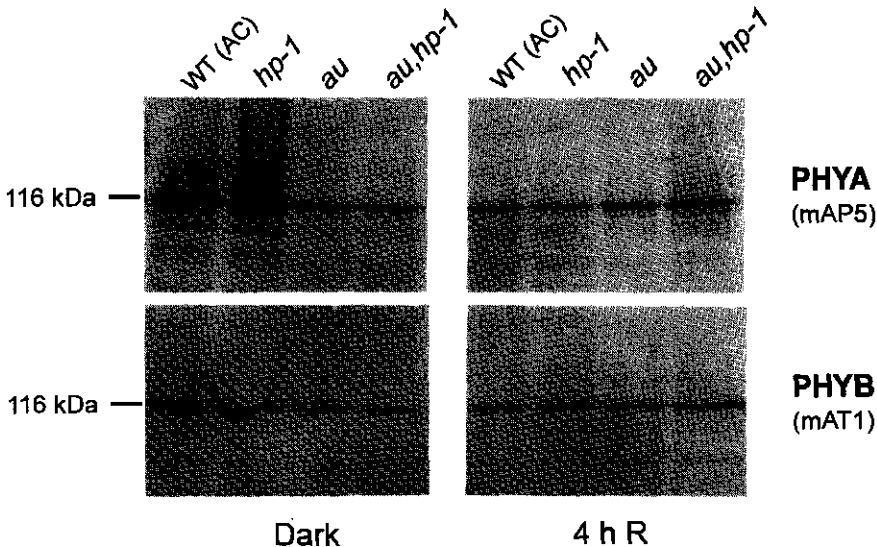
Parameter	-FR	+FR
Phytochrome photoequilibrium ( $\varphi$ )	0.72	0.37
R:FR	6.90	0.13
PAR (400–700 nm) [ $\mu\text{mol}\cdot\text{m}^{-2}\cdot\text{s}^{-1}$ ]	230	236
Photon irradiance (400–800 nm) [ $\mu\text{mol}\cdot\text{m}^{-2}\cdot\text{s}^{-1}$ ]	234	839

### 6.3 Results and discussion

#### 6.3.1 Immunochemical and *in-vivo* spectrophotometrical analysis of phytochrome

Using an antibody to pea phytochrome A polypeptide (mAP5) no differences were observed in extracts of 4-day-old dark-grown seedlings of WT (AC) and *hp-1* mutants (Fig. 6.2). In extracts of the *au* and *au, hp-1* double mutant the amount of 116-kDa phytochrome A polypeptide (PHYA) is lower, *ca.* 20–25 % compared to WT, which is in agreement with Sharma *et al.* (1993) and Van Tuinen *et al.* (1996a). In contrast to the WT and the *hp-1* mutant, this low amount of PHYA is not degraded by a 4-h R irradiation. This observation suggests that the PHYA in the *au* and *au, hp-1* mutants is not spectrophotometrically active. Using an antibody to tobacco phytochrome B polypeptide (mAT1) no differences were observed between the four genotypes in D and after a 4-h R irradiation (Fig. 6.2) as previously shown for *au* by Sharma *et al.* (1993).

The data for destruction of total spectrophotometrically detectable phytochrome (Ptot) in 4-day-old genotypes is shown in Table 6.2. The signals of the *au* and *au, hp-1* mutants are below the detection limit of the spectrophotometer (see 2.2.2.2.), therefore contain less than 1 % of the Ptot present in the WT. These data reconfirmed the initial observation by Koornneef *et al.* (1985) for *au<sup>w</sup>* (in a MoneyMaker background). The WT and the *hp-1* mutant show the same destruc-



**Figure 6.2.** Western-blot analysis of phytochrome A and B polypeptides (PHYA and PHYB, respectively) in crude extracts of WT (AC), and derived *hp-1*, *au* and *au, hp-1* mutant tomato seedlings. Dark-grown 4-day-old seedlings, or seedlings of the same age but exposed to 4 h R ( $20 \mu\text{mol}\cdot\text{m}^{-2}\cdot\text{s}^{-1}$ ), were used for the detection of PHYA and PHYB with monoclonal antibodies mAP5 and mAT1, respectively.



**Table 6.2.** *In-vivo* measurement of total spectrophotometrically detectable phytochrome (Ptot) in WT (AC), and derived *hp-1*, *au* and *au, hp-1* mutant tomato seedlings. The Ptot in dark-grown 4-day-old seedlings, or seedlings of the same age exposed to 4 h R ( $20 \mu\text{mol}\cdot\text{m}^{-2}\cdot\text{s}^{-1}$ ), was measured using a dual-wavelength spectrophotometer and is expressed as  $10^{-3} \Delta(\Delta A_{730-800})/40$  seedlings  $\pm$  SE.

Genotype	Treatment	
	Dark	4 h R
WT (AC)	15.83 $\pm$ 0.34	0.93 $\pm$ 0.03
<i>hp-1</i>	16.00 $\pm$ 0.26	0.84 $\pm$ 0.09
<i>au</i>	0	0
<i>au, hp-1</i>	0	0

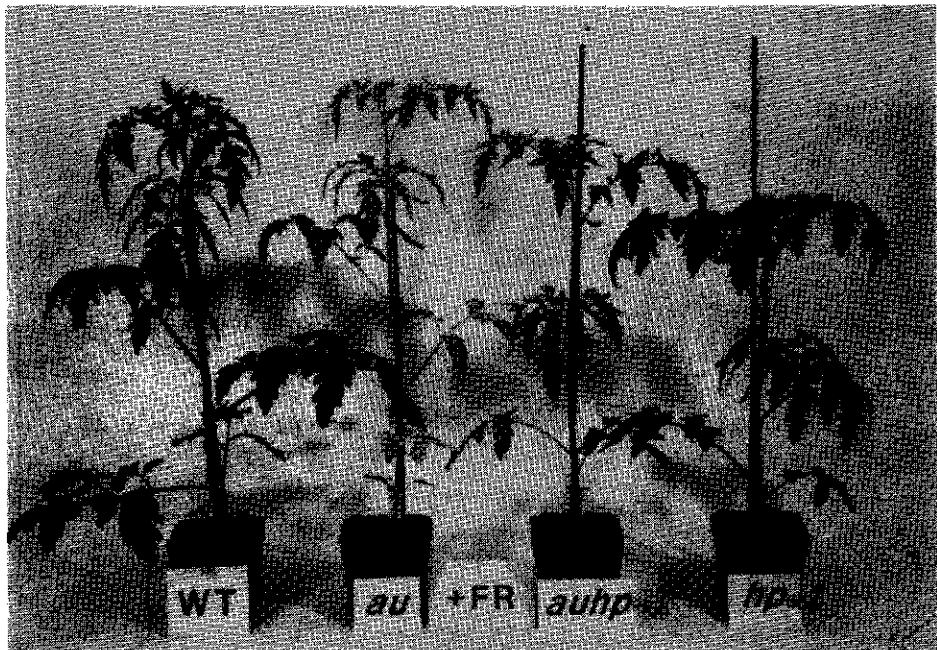
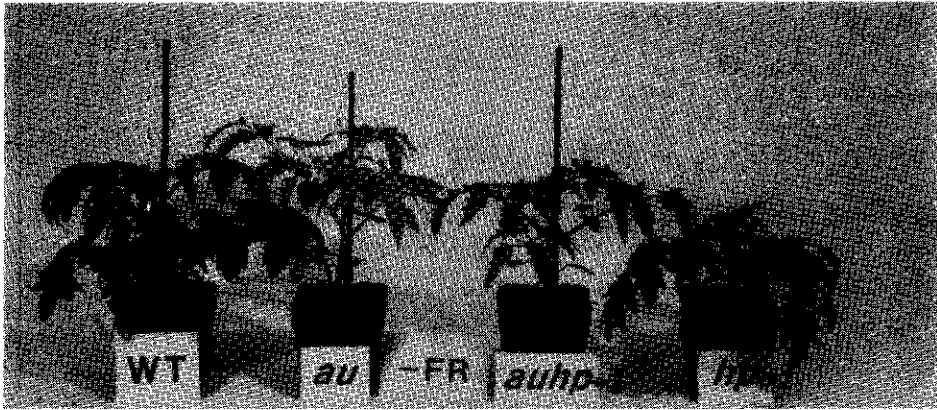
tion kinetics during R, which is in agreement with the observations by Peters *et al.* (1992a).

Both immunochemical and *in-vivo* spectrophotometrical analysis of phytochrome revealed no differences between *au* and *au, hp-1*.

### 6.3.2 Supplementary daytime FR experiments

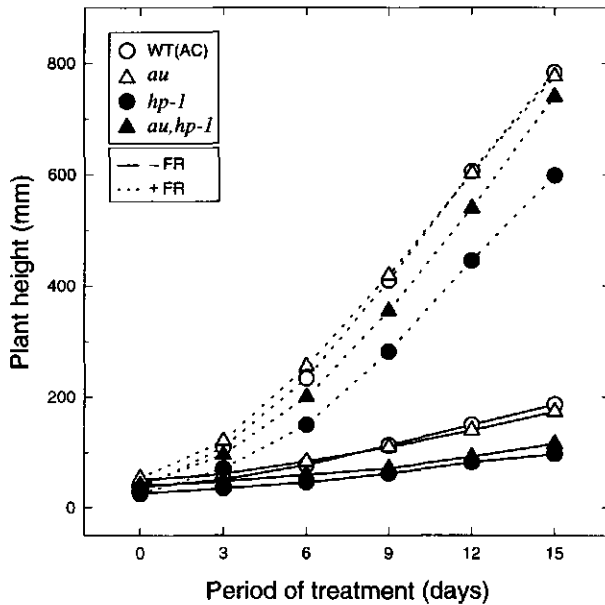
#### 6.3.2.1 Elongation responses

Light-grown plants have the capacity to detect changes in the environmental light quality and initiate a shade-avoidance response if exposed to reduced R:FR as a consequence of light absorption and/or reflection by other plants (Holmes and Smith, 1975; Casal and Smith, 1989). Under conditions of continuous supplementary FR irradiation during almost the whole of the photoperiod, a dramatic increase in elongation growth occurs for all four genotypes studied (Figs. 6.3 and 6.4) as a result of an increase in the length of all internodes (Fig. 6.5). Internode number four was just visible at 17 days after sowing when the supplementary daytime FR treatment started. This response to supplementary daytime FR is almost an order of magnitude greater than previously observed for EODFR treatment on these genotypes (Peters *et al.*, 1992b). Since EODFR results in a reduction of the  $\phi$  value from 0.72 to  $< 0.05$  at the beginning of the D period, it is clear that the results here with supplementary FR cannot be attributed to an EOD response, since the supplementary FR stopped just before the end of the light period, giving time for the  $\phi$  value of 0.72, characteristic of the white fluorescent light, to be attained. A concomitant increase of leaf length was also observed for the leaves fully developed under supplementary FR conditions for all four genotypes (Fig. 6.6), whereas EODFR experiments showed no detectable effect on this parameter (López-Juez *et al.*, 1990; Peters *et al.*, 1992b). This increase may have been partially caused by a higher leaf temperature that resulted from the additional infra-red radiation from the FR sources (Corré, 1983). Despite the



**Figure 6.3.** Phenotypes of 29-day-old WT (AC), and derived *au*; *au, hp-1*; and *hp-1* mutant tomato plants. Plants were grown in a 16-h WL ( $230 \mu\text{mol}\cdot\text{m}^{-2}\cdot\text{s}^{-1}$  PAR)/8-h D cycle. After 21 days from sowing plants were grown under conditions of 16-h WL (-FR; upper panel) or 16-h WL with supplementary daytime FR (+FR; lower panel) continued for 8 days. The actual plant height (mm) was for WT (AC): 113, 393; *au*: 132, 424; *au, hp-1*: 98, 359; *hp-1*: 69, 290; in -FR and +FR, respectively.

inefficient de-etiolation exhibited by the *au* mutant and the *au, hp-1* double mutant, light-grown plants displayed an apparently normal shade-avoidance response to daytime reduction in R:FR in terms of elongation growth. These results confirm



**Figure 6.4.** The plant height of WT (AC), and derived *hp-1*, *au* and *au,hp-1* mutant tomato plants. Plants were grown in a 16-h WL ( $230 \mu\text{mol}\cdot\text{m}^{-2}\cdot\text{s}^{-1}$  PAR)/8-h D cycle. After 17 days from sowing plants were grown under conditions of 16-h WL (-FR) or 16-h WL with supplementary daytime FR (+FR) continued for 15 days. The SE was in all cases, smaller than the symbols used.

the preliminary results with an *au* mutant in a different genetic background (Whitelam and Smith, 1991). The *au* mutant also exhibits a normal EODFR response (Adamse *et al.*, 1988; López-Juez *et al.*, 1990; Peters *et al.*, 1992b). Since the *au* and the *au,hp-1* mutants are deficient in the biosynthesis of phytochrome chromophore, it is proposed that *au* and *au,hp-1* are leaky mutants and thus able to synthesize phytochrome chromophore in more mature tissues leading to functional phytochromes at later stages of development.

The *hp-1* mutant responded very similarly to WT to reduction in daytime R:FR. Transgenic tobacco plants overexpressing oat *PHYA* exposed to supplementary daytime FR showed no or the opposite response to that expected (McCormac *et al.*, 1991). Despite the fact that *hp-1* seedlings exhibit exaggerated phytochrome responses (Peters *et al.*, 1992a) and are similar to transgenic tomato seedlings overexpressing the oat *PHYA3* gene (Boylan and Quail, 1989), there is no evidence of an inhibitory effect of supplementary daytime FR on elongation growth in WL-grown plants supplemented with daytime FR.

Data from experiments with other mutants (Somers *et al.*, 1991; Nagatani *et al.*, 1991; López-Juez *et al.*, 1992), which have been shown to be deficient in a light-stable phytochrome (phyB) lend support to the conclusion that the different phytochromes present in plants play important roles at different stages in

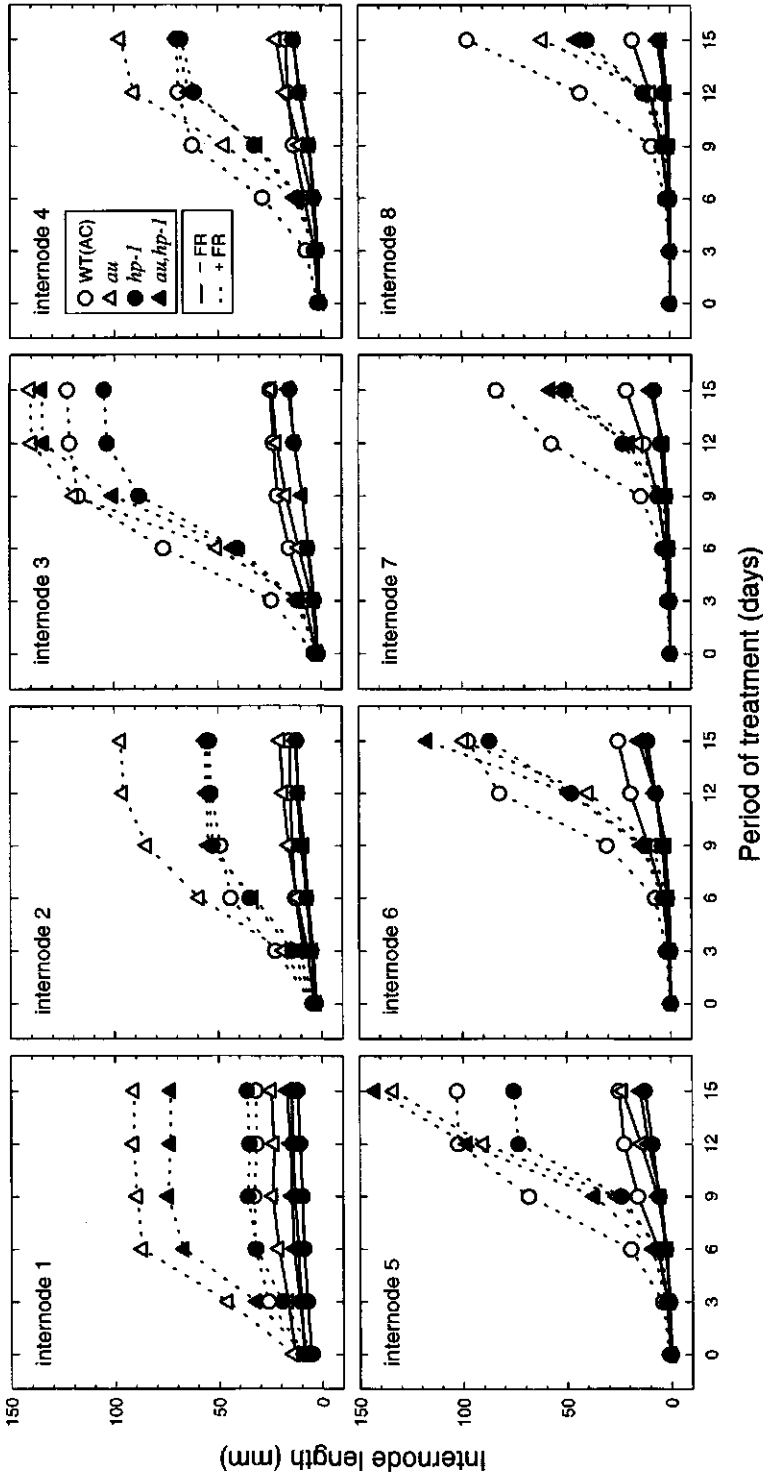
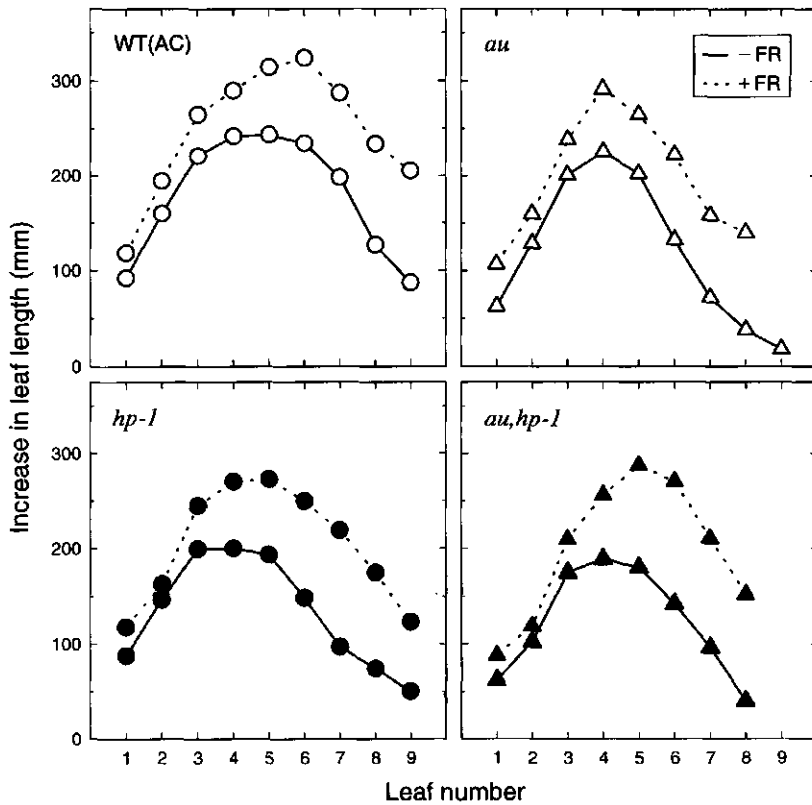


Figure 6.5. The internode length of internode numbers 1–8 of WT (AC), and derived *hp-1*, *au* and *au, hp-1* mutant tomato plants. Plants were grown in a 16-h WL (230  $\mu\text{mol}\cdot\text{m}^{-2}\cdot\text{s}^{-1}$  PAR/8-h D cycle. After 17 days from sowing plants were grown under conditions of 16-h WL (-FR) or 16-h WL with supplementary daytime FR (+FR) continued for 15 days. The SE was in all cases smaller than the symbols used.

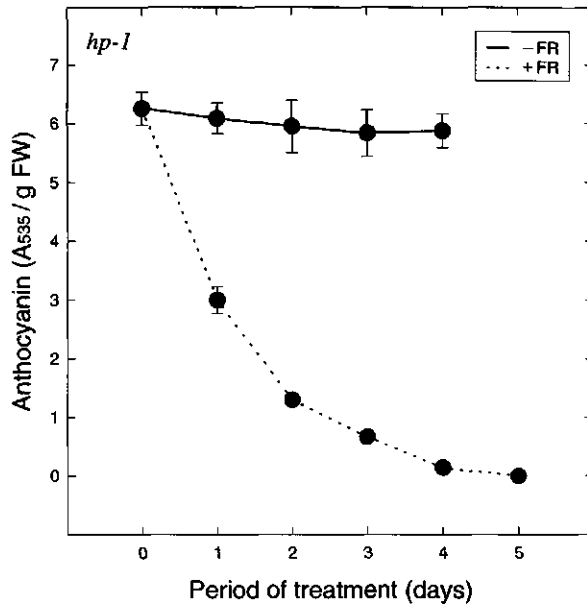


**Figure 6.6.** The increase in leaf length of WT (AC), and derived *hp-1*, *au* and *au, hp-1* mutant tomato plants. Plants were grown in a 16-h WL ( $230 \mu\text{mol.m}^{-2}.\text{s}^{-1}$  PAR)/8-h D cycle. After 17 days from sowing plants (just after appearance of leaf number 4) were grown under conditions of 16-h WL (- FR) or 16-h WL with supplementary daytime FR (+ FR) continued for 15 days. Except for leaf number 2 of the *hp-1* mutant, all leaf lengths are significantly longer ( $P \leq 0.05$ ) in the + FR treatment.

development. These mutants appear to have largely lost the capacity to respond to supplementary daytime FR and have a phenotype typical of WT plants grown under extreme vegetational shade. Adult plants of the *au* and *au, hp-1* double mutant showed a quantitatively similar elongation response to reduction in R:FR indicating that a *phyB* is fully functional in these mutants.

### 6.3.2.2 Anthocyanin and chlorophyll biosynthesis

The biosynthesis of anthocyanin takes place mainly in the young growing leaves after which dilution occurs during leaf growth. The potential for anthocyanin synthesis appears to be lost in the mature *au* mutants, since under WL (R:FR = 6.90) conditions it is only found in the WT and *hp-1* mutant, *i.e.* it is absent in the *au* and *au, hp-1* double mutants (Table 6.3). Under a low R:FR (0.13) a very rapid cessation of anthocyanin synthesis appears to occur in young growing leaves of

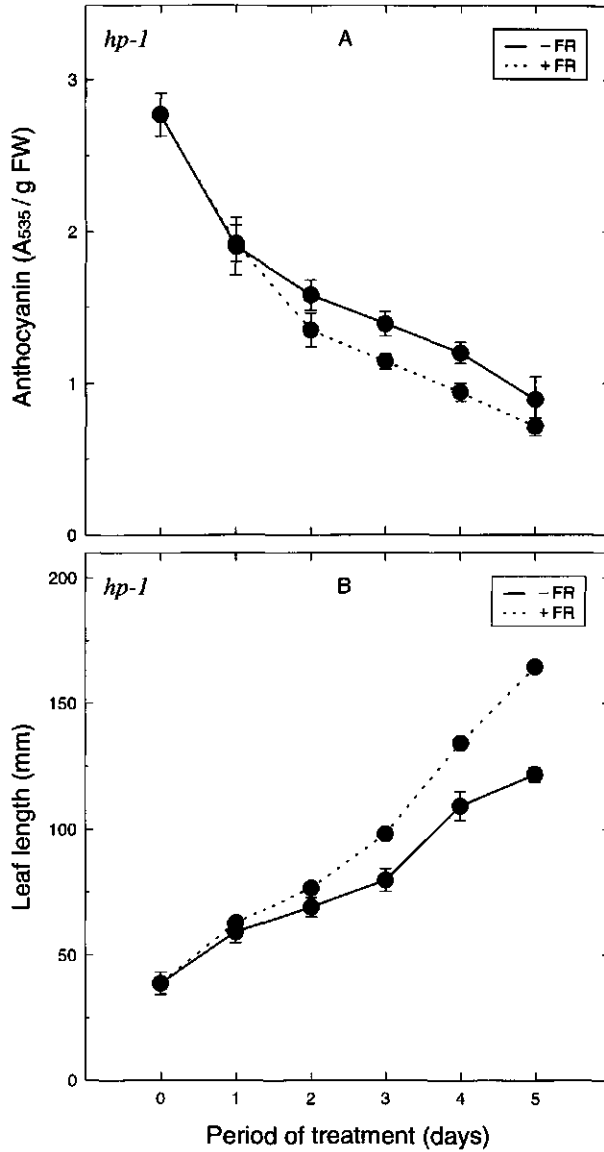


**Figure 6.7.** The anthocyanin content ( $A_{535}/g$  FW  $\pm$  SE) of the comparably developed young growing leaves (5–15 mm in length) of *hp-1* mutant tomato plants. Plants were grown in a 16-h WL (230  $\mu\text{mol}\cdot\text{m}^{-2}\cdot\text{s}^{-1}$  PAR)/8-h D cycle. After 20 days from sowing plants were grown under conditions of 16-h WL (–FR) or 16-h WL with supplementary daytime FR (+FR) continued for 4 days in either –FR treatment or 5 days in +FR treatment.

the *hp-1* mutant, whereas at high R:FR (6.90) the anthocyanin content remains constant (Fig. 6.7). After 4 days of treatment there was no detectable anthocyanin in the young growing leaves which had fully developed under the low R:FR conditions. Figure 6.8A shows the change in anthocyanin content for a fixed leaf position (leaf number 4) in the same experiment. Under both conditions a decrease

**Table 6.3.** Comparison of the effect of supplementary daytime FR on anthocyanin content ( $A_{535}/g$  FW  $\pm$  SE) in comparably developed young leaves (5–15 mm in length) and on total chlorophyll *a* and *b* (mg/g FW  $\pm$  SE) in mature leaves in WT (AC), and derived *hp-1*, *au* and *au, hp-1* mutant tomato plants. Plants were grown in a 16-h WL (230  $\mu\text{mol}\cdot\text{m}^{-2}\cdot\text{s}^{-1}$  PAR)/8-h D cycle. After 17 days from sowing plants were grown under conditions of 16-h WL (–FR) or 16-h WL with supplementary daytime FR (+FR) continued for 15 days. Both anthocyanin and chlorophyll content were measured at the end of the treatment.

Genotype	Anthocyanin ( $A_{535}/g$ FW)		Chlorophyll (mg/g FW)	
	–FR	+FR	–FR	+FR
WT (AC)	5.66 $\pm$ 0.28	0	3.58 $\pm$ 0.16	3.41 $\pm$ 0.22
<i>hp-1</i>	7.04 $\pm$ 0.49	0	3.60 $\pm$ 0.22	3.49 $\pm$ 0.19
<i>au</i>	0	0	0.45 $\pm$ 0.05	0.87 $\pm$ 0.12
<i>au, hp-1</i>	0	0	1.05 $\pm$ 0.10	1.12 $\pm$ 0.07



**Figure 6.8.** The anthocyanin content (A; A<sub>535</sub>/g FW ± SE) and the length (B; mm ± SE) of the fourth leaves of *hp-1* mutant tomato plants. Plants were grown in a 16-h WL (230 μmol.m<sup>-2</sup>.s<sup>-1</sup> PAR)/8-h D cycle. After 20 days from sowing plants were grown under conditions of 16-h WL (-FR) or 16-h WL with supplementary daytime FR (+FR) continued for 5 days.

in anthocyanin was shown, but under low R:FR it is further reduced due to increased dilution, resulting from the enhanced growth (Fig. 6.8B). Increasing the R:FR from 6.9 to 8.0 resulted in a prompt increase in anthocyanin content (data not shown), indicating that the capacity for anthocyanin formation is sensitive to

slight changes in R:FR. Similar results were also observed in the WT. In contrast to the stage of de-etiolation when much higher anthocyanin levels are observed in the *hp-1* mutant than WT (Peters *et al.*, 1989), in adult plants the anthocyanin levels in young leaves are of the same order of magnitude (Table 6.3). Under low R:FR (0.13) conditions, no anthocyanin was detectable in all four genotypes. In EODFR treatments (López-Juez *et al.*, 1990; Peters *et al.*, 1992b) the anthocyanin content decreases strongly in the WT and *hp-1* mutant, but levels were still detectable.

In addition, the total chlorophyll content in the WT and *hp-1* mutant were similar under both treatments (Table 6.3). Both *au* and the *au, hp-1* double mutant have largely reduced levels of total chlorophylls, however *au* responds with an increase in total chlorophylls in the FR treatment. These observations are in agreement with those in EODFR experiments (López-Juez *et al.*, 1990; Peters *et al.*, 1992b).

### 6.3.3 Fruit characterization

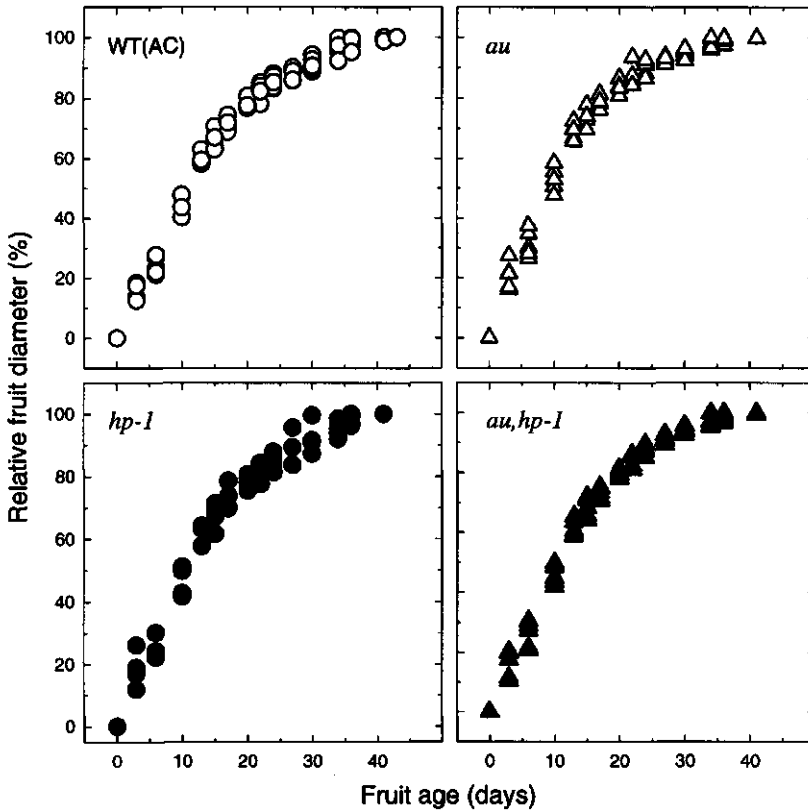
In an attempt to correlate the content of pigments to a fruit parameter, we have studied fruit diameter, fruit developmental stage and fruit age. The kinetics in fruit development (fruit diameter *vs.* fruit age) are very similar for the four genotypes studied (Fig. 6.9). All genotypes reached their final similar fruit diameter by 40–45 days after fruit set.

The total chlorophyll content *vs.* fruit age is plotted in Figure 6.10A. The WT exhibit a decrease in chlorophyll content with age. In contrast, *hp-1*, *au* and *au, hp-1* show a gradual rise in chlorophyll content, with the strongest effect for *au, hp-1*. The WT showed a decrease in chlorophyll content during fruit growth,

**Table 6.4.** Comparison of chlorophyll *a* (Chl *a*) and *b* (Chl *b*), and total carotenoids ( $\mu\text{g}/\text{cm}^2 \pm \text{SE}$ ) determined in full-grown leaves and in 35–40 day-old fruits of WT (AC), and derived *hp-1*, *au* and *au, hp-1* mutant tomato plants. Plants were grown in a greenhouse.

Organ	Genotype	Parameter ( $\mu\text{g}/\text{cm}^2$ )		
		Chl <i>a</i>	Chl <i>b</i>	Carotenoids
Leaves	WT (AC)	41.4 $\pm$ 0.8	5.0 $\pm$ 0.4	8.8 $\pm$ 0.1
	<i>hp-1</i>	40.2 $\pm$ 2.1	5.2 $\pm$ 0.4	8.0 $\pm$ 0.4
	<i>au</i>	14.6 $\pm$ 0.9	0.4 $\pm$ 0.3	4.4 $\pm$ 0.1
	<i>au, hp-1</i>	19.5 $\pm$ 0.9	1.1 $\pm$ 0.1	5.5 $\pm$ 0.2
Fruits	WT (AC)	10.2 $\pm$ 0.6	2.8 $\pm$ 0.1	3.0 $\pm$ 0.2
	<i>hp-1</i>	17.1 $\pm$ 0.9	3.9 $\pm$ 0.2	4.1 $\pm$ 0.3
	<i>au</i>	3.9 $\pm$ 0.2	0.9 $\pm$ 0.1	2.4 $\pm$ 0.2
	<i>au, hp-1</i>	8.7 $\pm$ 0.6	1.5 $\pm$ 0.2	3.2 $\pm$ 0.3

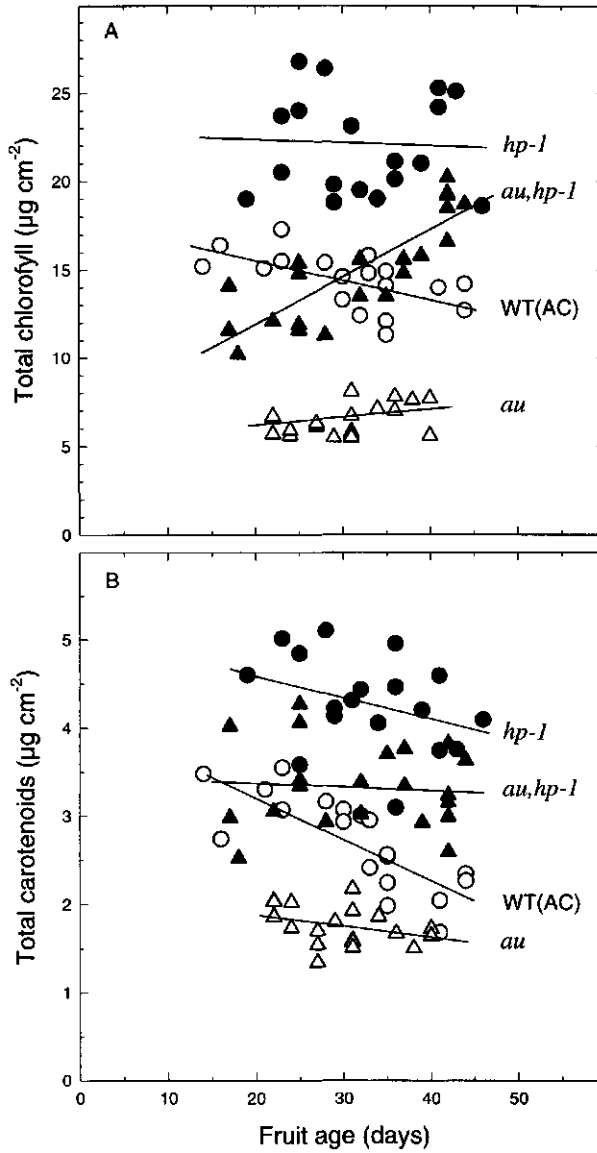




**Figure 6.9.** Relationships between the relative fruit diameter (diameter expressed as % of the final fruit diameter) and fruit age (days) in WT (AC), and derived *hp-1*, *au* and *au, hp-1* mutant tomato plants. Fruit age was determined as days after fruit set. The final fruit diameter (mm  $\pm$  SE) was for WT (AC):  $45.1 \pm 1.1$ , *au*:  $42.0 \pm 1.3$ , *hp-1*:  $43.6 \pm 1.2$  and *au, hp-1*:  $43.1 \pm 1.5$ .

which was much less than calculated on the base of dilution due to growth (Fig. 6.9). This indicates that chlorophyll synthesis is sustained throughout fruit growth. The highest chlorophyll content was found for the monogenic *hp-1* mutant and the lowest values was for the *au* mutant. The *hp-1* fruits showed a slight increase during development.

Total carotenoid content vs. fruit age is plotted in Figure 6.10B. In all the genotypes a decrease in total carotenoid content occurs, the most dramatic being for WT and *hp-1*. Table 6.4 shows similar results for 35–40 day-old fruits (mature size), as well as chlorophyll and carotenoid levels in leaf discs of mature leaves of the same plants. The *hp-1*-mutant fruits have the highest carotenoid level throughout development. For both total chlorophyll and carotenoid content of fruits it is clear that the *au* mutation is not completely epistatic to *hp-1*, as is also the case for mature leaves (Tables 6.3 and 6.4).



**Figure 6.10.** Kinetics of total chlorophyll (A;  $\mu\text{g cm}^{-2}$ ); and total carotenoids (B;  $\mu\text{g cm}^{-2}$ ) in 15–45 day-old fruits of WT (AC), and derived *hp-1*, *au* and *au,hp-1* mutant tomato plants. Plants were grown in a greenhouse. Fruit age was defined as days after fruit set.

## 6.4 Concluding remarks

The photomorphogenic mutants of tomato used in this study, which have a very pronounced phenotype at the stage of de-etiolation, all exhibit a normal stimulation of extension growth response to supplementary FR applied during the daily photoperiod (shade-avoidance response). Such results indicate that phytochrome is present and fully functional in light-grown plants of all these mutants, whereas at the de-etiolation stage phytochrome responses are severally modified. These observations are compatible with the *au* mutation being a leaky mutation leading to the gradual accumulation of phytochromes involved in photomorphogenesis of light-grown plants.

In WL-grown plants the *hp-1* mutants have a dwarf phenotype and this dwarf effect is seen in the *au, hp-1* double mutant, particularly when fluorescent lighting (high R:FR) is used. It is also shown that the *hp-1* phenotype is expressed during fruit development (dark-green pigmentation due to chlorophyll accumulation as well as having a high carotenoid content) and this phenotype is retained in the *au, hp-1* double mutant. These results with WL-grown plants suggest that the *au* mutation is not completely epistatic to *hp-1* suggesting that the *au* mutation is no longer limiting in mature plants, presumably due to the gradual accumulation of functional phytochromes due to the leakiness of the *au* mutation. Since no differences in the level or properties of phytochrome have been observed between etiolated seedlings of the WT and the *hp-1* mutant etiolated seedlings, these observations are compatible with the concept of the *hp-1* mutation resulting in the amplification of phytochrome responses, *via* loss of the HP-1 phytochrome signal transduction repressor (Chapters 4 and 5; Peters *et al.*, 1992a), which is involved in both the de-etiolation and the shade-avoidance responses.

**Acknowledgements.** We thank Harry Smith and Garry Whitelam, University of Leicester, UK for the facilities used in the supplementary daytime FR experiments; Mike Jackson, University of Leicester, UK for valuable technical assistance in the supplementary daytime FR experiments; and Rob van der Valk, MSc-student, Wageningen Agricultural University, for performing the experiments on fruit characterization. Part of this work was carried out at the Laboratory for Photoperception and Signal Transduction, Frontier Research Program, Institute of Physical and Chemical Research (RIKEN), Japan.

# CHAPTER 7

## A high-resolution plant growth-measuring apparatus to study stem growth kinetics

**Abstract.** A custom-designed high-resolution plant growth-measuring apparatus, controlled by a microcomputer is described. Plants are attached with a ligature thread to a measuring arm, which is part of the displacement-detection device ('floating zero'). The floating zero is mounted on a sledge fastened to a precision spindle and follows growth with a constant upward tension. A time interval ( $\geq 1$  s) is set at which the floating zero is adjusted and growth is registered via an incremental encoder with a resolution of 1  $\mu\text{m}$ . The measuring devices are mounted on a vibration-free table and it has its own climate-control system with photosynthetic lighting from above. The growth of a plant can be followed over a period of several days. Data from individual plants are saved, mean growth rate calculated and smoothed. Results using tomato (*Lycopersicon esculentum* Mill.) plants are presented. They demonstrate that the growth of a tomato plant has a characteristic pattern during the daily light/dark cycle. The capability to accurately measure growth is discussed in relationship to environmental factors, such as light quality, temperature and pollution.

### 7.1 Introduction

The accurate measurement and prediction of plant growth is a problem that has long intrigued biologists. Conventional growth studies using a ruler provide valuable information about cumulative growth over long time periods. Depending on the particular plant, measurements of growth parameters are usually taken at a daily interval to obtain significant results. As a consequence detailed information about the daily growth pattern and possible circadian rhythms in growth rate are lost. Furthermore, touching the plants during measurement may lead to thigmomorphogenic phenomena, which result in an altered growth behaviour (Jaffe, 1976).

Plants are capable of responding rapidly to changes in environmental factors, such as irradiance, light quality and temperature. In order to detect these rapid responses in elongation growth, sensitive measuring methods have to be applied, since growth rate changes will be at most a few micrometers per second. Several short-term growth studies have revealed so called 'growth-rate transients'. Such transients, while not making any significant contribution to the total elongation, can provide information about the existing differences in kinetics of growth

responses (Cosgrove, 1981a; Gaba and Black, 1983; Kristie and Jolliffe, 1986; Prat and Parésys, 1995).

Methods for the continuous measurement of plant growth have been used since the time of the autographic auxanometers of Sachs (1874). Anderson and Kerr (1943) and Wilson (1948) used auxanometers to monitor accurately the diurnal fluctuations of growth in stem length. To obtain high-resolution measurements of elongation changes new methods were developed, which enable accurate continuous registration of growth of intact plants, such as the linear variable differential transformers (LVDTs) used by Meijer (1968). Since then, displacement transducers have frequently been applied to study rapid growth responses to light and other environmental conditions (Penny *et al.*, 1974; Cosgrove, 1981a; Van Volkenburgh *et al.*, 1983; Lecharny *et al.*, 1985; Child and Smith, 1987; Shinkle and Jones, 1988; Prat and Parésys, 1989; Behringer *et al.*, 1990; Bertram and Karlsen, 1994a; Ruiz Fernandez and Wagner, 1994). Optical growth analysis methods, which have the advantage of not making physical contact with the plant, have been used: such as the interferometric measurement technique (Fox and Puffer, 1976; Jiang and Staude, 1989), time-lapse photography (Hart *et al.*, 1982; Baskin *et al.*, 1985) and video registration (Jaffe *et al.*, 1985; MacDonald *et al.*, 1987; Popescu *et al.*, 1989).

We designed a growth-measuring apparatus using a custom-made detection device with a mechanical coupling to the plant, controlled by a microcomputer to study extension growth kinetics. The layout of the apparatus and the unit controlling the temperature, humidity and air-flow rate enables measurement under very strict environmental conditions to minimize the variability in magnitude of the measured responses. With this growth-measuring device it is possible to measure plant growth at high resolution over many days. We have used this experimental set-up to investigate the fundamental growth characteristics of tomato plants.

## **7.2 Description of the growth-measuring apparatus**

### **7.2.1 The growth-measuring apparatus**

A schematic diagram of the custom-designed growth-measuring apparatus, is shown in Figure 7.1. Two independent systems, with three measuring devices each, enables six plants to be measured simultaneously. To reduce vibrations, the three measuring devices are mounted on one vibration-free table, consisting of a heavy steel plate which rests on air cushions (*ca.* 132 kPa) and from which a heavy (*ca.* 400 kg) base filled with grit is suspended. Each measuring device is enclosed in a light-tight and thermally insulated chamber. The chambers can be

easily opened to set up an experiment; a sight-window in the removable lid facilitates observation during the experiments without the necessity of opening the chamber. This window can be closed to prevent incoming light. The chambers are mechanically isolated from the vibration-free table with the measuring devices. Humidified air circulates at a constant adjustable laminar flow rate through the three interconnected chambers regulated by a climate-control unit. The total air-volume is *ca.* 2 m<sup>3</sup> and the air-exchange can be regulated. To avoid undesirable light reflections (and corrosion) all aluminium components are anodized and painted black. The complete apparatus is enclosed in a temperature-controlled room maintained at 25 ± 1 °C.

### **7.2.2 The control unit**

A single board microprocessor (ARCOM, based on ARC41, Z8 Basic/DEBUG; Tekelec Airtronic, Zoetermeer, the Netherlands) controls the growth-measuring apparatus (Fig. 7.2). A special program prompts the operator for the parameters of the experiment, *e.g.* cycle time, number of channels to sample and irradiation schedule. The cycle time is the time interval between two consecutive adjustments of the measuring unit, *i.e.* the time between two growth measurements. The microprocessor with real-time clock/calendar for control, measurement and data logging is connected to a personal computer where further data-acquisition and handling takes place.

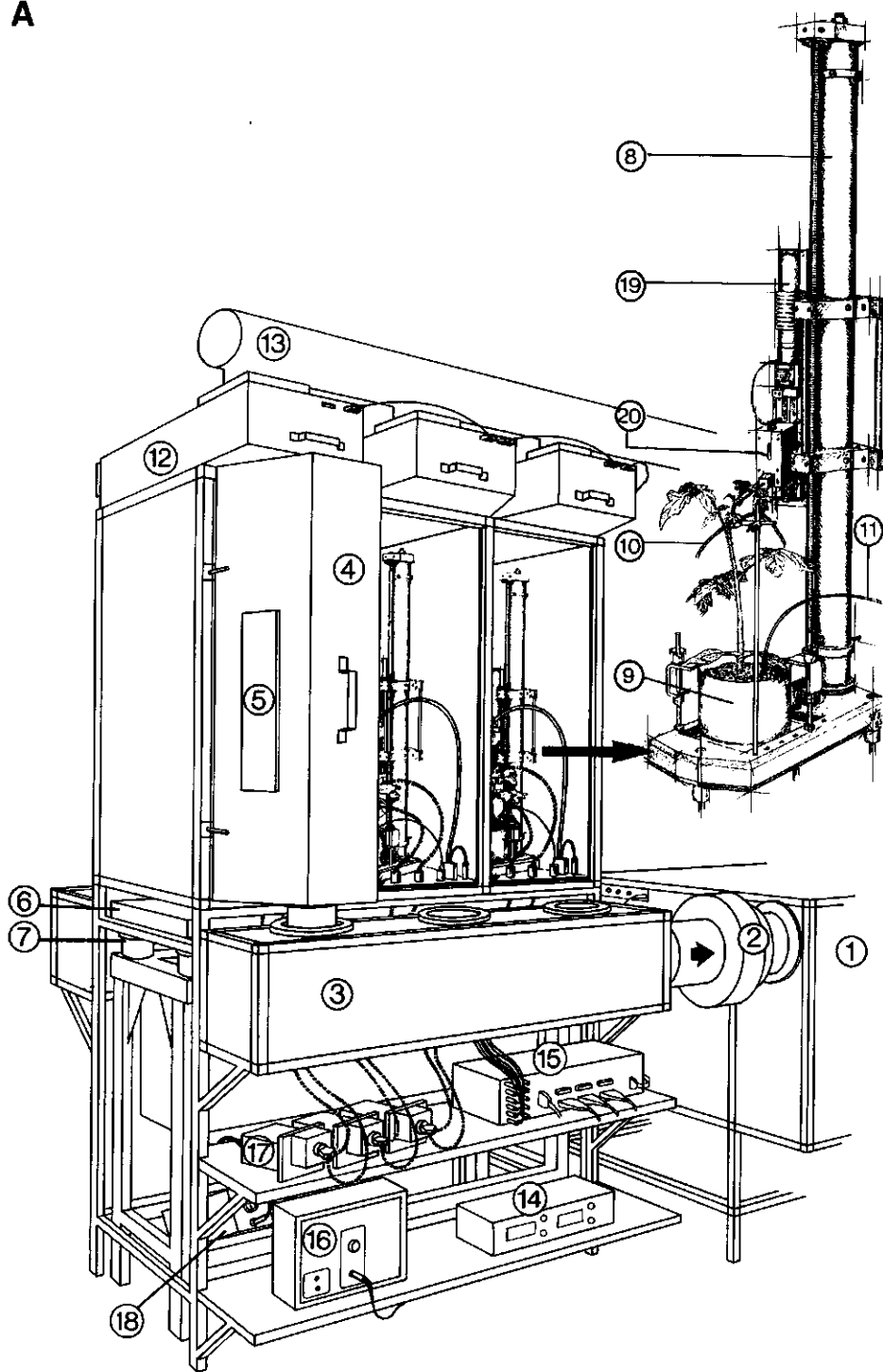
### **7.2.3 The measuring unit**

A schematic diagram of the measuring unit ('translator') with an integrated flow diagram is given in Figure 7.2. The measuring unit is mounted on a column (Fig. 7.1) with a motorized spindle (M12x3) and can be raised and lowered to position it at the actual height of the plant (range 70 cm). The pot containing the experimental plant is clamped to the base of the column. It is possible to place two measuring units on one column to enable differential measurements.

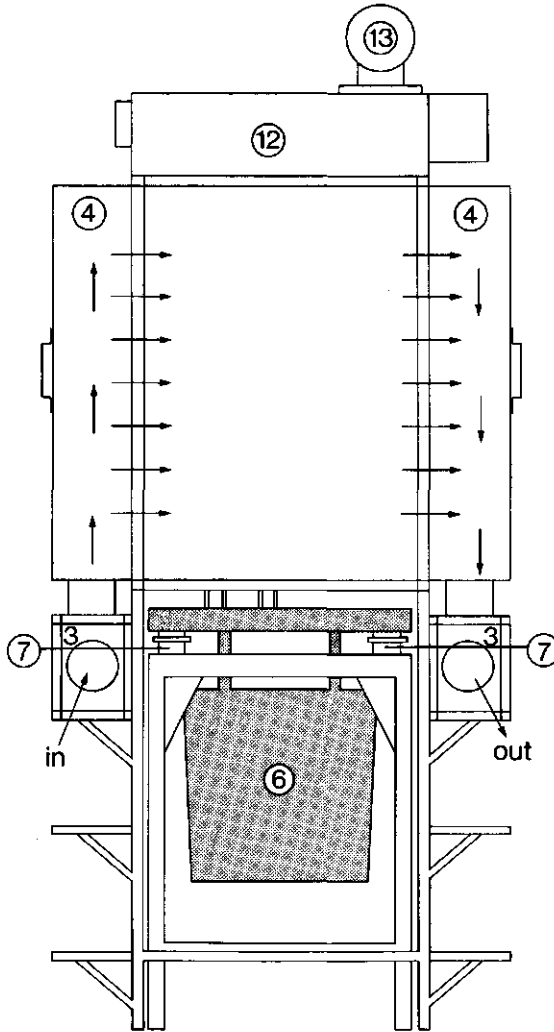
The measuring unit consists of the following components: a cylindrical coil direct current (DC) motor (GS1000PTS; Faulhaber, Schönaich, Germany) with a tacho generator (ARIB01; Mattke, Freiburg, Germany) combined with a proportional integrating circuit, *i.e.* a four quadrant linear adjusting amplifier (MAR 9/03; Mattke), attached to a satellite reduction (1:10) gear (UE30CC; Faulhaber) and an incremental encoder (UT100CC; Faulhaber), which are all fastened sequentially to a precision spindle (M5x0.5), on which a sledge is mounted, by high-quality roller bearings (RS 040-130-050; Föhrenbach, Unadingen, Germany). The displacement-detection device ('floating zero') is mounted on the sledge.

The incremental encoder counts the number of angular rotations of the motor on the spindle. Inside the encoder are two metal discs with 500 equally spaced

A



B

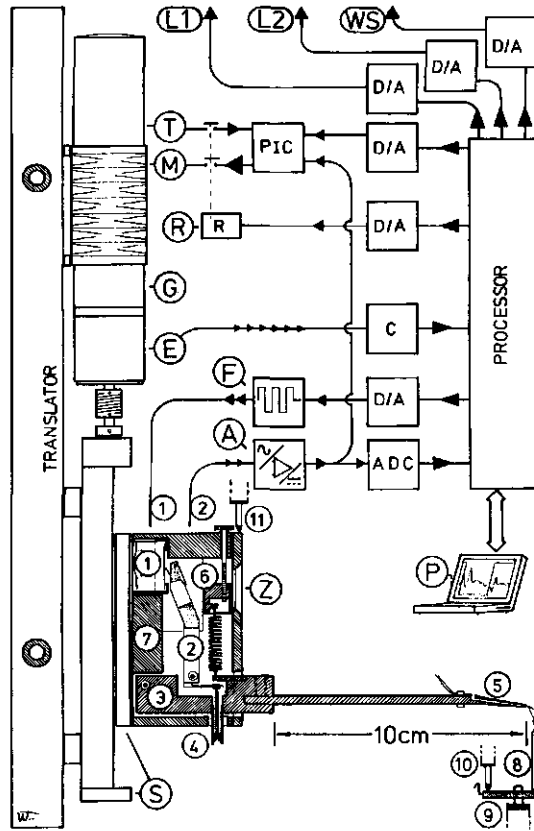


**Figure 7.1.** Schematic diagram of the plant growth-measuring apparatus and part of the temperature-, humidity- and air flow control unit. Only one of two independent systems is shown.

(A) Front view, with two chambers opened, showing the measuring devices with the experimental plants (*top right*, shows on a larger scale the measuring device and measuring unit with the floating zero connected to a plant). (B) Side view, showing the vibration-free table (hatched), and the air flow in and out the chambers.

(1) Climate-control unit, regulating the temperature and relative humidity of the air flow; (2) adjustable circulation pump; (3) air-flow chamber; (4) removable hollow lid, with special filter for uniform air flow; (5) sight-window, closed; (6) vibration-free table; (7) air cushions; (8) measuring device; (9) experimental plant; (10) fibre-optic light guides, held in position by adjustable clamps; (11) watering system; (12) irradiation unit; (13) independent cooling system for the irradiation units; (14) climate-control unit controller; (15) control unit and interface between ARCOM-personal computer (not shown), and measuring units and facilities for irradiation; (16) control unit for the motorized spindle of the measuring device; (17) custom-made projector assembly; (18) 0-250 W adjustable power supply for (17); (19) measuring unit (translator); (20) floating zero.





**Figure 7.2.** Flow diagram of the measuring unit (translator) with the floating zero. Only one of six measuring units is shown.

(T) tachogenerator; (M) DC motor; (G) reduction gear; (E) encoder; (Z) floating zero; (S) precision spindle with a sledge; (PIC) proportional integrating circuit; (R) relay; (D/A) digital in- and output; (C) counter; (ADC) analog-to-digital converter; (F) function generator; (A) amplifier; (PROCESSOR) ARCOM microprocessor; (P) personal computer; (L1) white-light irradiation unit; (L2) supplementary-light irradiation unit; (WS) watering system; (1) microphone (connected to F); (2) pick-up element with arm (connected to A); (3) measuring-arm block; (4) adjustable gas-reduction spring, connecting (2) and (3); (5) measuring arm with a loop of thread; (6) calibrated pull-spring; (7) anodized aluminium base; (8) weight; (9) micropositioning device; (10), (11) micropositioning controllers. *Note:* parts (8), (9), (10) and (11) are only in use to calibrate the floating zero.

apertures: one is stationary and one rotates with the motor. Two light-emitting diodes (LEDs) are positioned on one side of the discs and two photodiodes on the other. The light from the LEDs is transmitted only when the apertures of both discs are lined up; during a complete revolution there will be 500 alternating light and dark periods. The pitch of the microspindle is 0.5 mm, so each change in diode-signal corresponds with a resolution  $\pm 1 \mu\text{m}$ . The apertures of the two photodiodes are positioned so that a light period on one detector corresponds to a dark period on the other. Both photodiodes produce a signal each time a light



**Figure 7.3.** Detail of the attachment of the measuring arm from the floating zero to a tomato plant, showing the adjustable loop of ligature thread connected to the youngest internode possible. The fibre-optic light guides, held in position by adjustable clamps enable local irradiation to a growing internode.

period has been detected. This results in two square wave signals from the encoder to the counter, which are  $90^\circ$  out of phase. The information concerning the extent and direction of the motor-movement is relayed to the microprocessor. The assembly of the components described was carried out by Elmekanic, Hilversum, the Netherlands.

#### **7.2.4 The displacement-detection device ('floating zero')**

The floating zero (Fig. 7.2) enables repeated indication of a preselected electrical signal (equivalent to a position within a few nanometers) each time a measurement is completed. The 10-cm long measuring arm from the floating zero is connected to the plant by the youngest internode possible, *via* the hollow tip, with an adjustable loop of ligature thread (Fig. 7.3). The ligature thread is impregnated with silicon rubber to avoid abrasive damage to the stem. A constant upward tension is maintained on the plant, which can be regulated with an adjustable calibrated stainless steel pull spring (T-41030; Tevema-Barnes, Amsterdam, the Netherlands) from 0.5 to 5 g. A very small upward tension is possible when bearings, transmissions and the pick-up signal amplifier of the floating zero are tuned optimally. The rigid nature of the measuring arm essentially eliminates

circumnutational movements. Such movements can also be reduced by increasing the length of the thread attached to the measuring arm. Each measuring device has to be tuned separately because of differences in the individual components.

The sledge with the floating zero is mounted on a precision spindle with an adjustment range of 40 mm. The DC motor raises or lowers the sledge. For safety reasons two microswitches, directly connected to the motor supply, limit this movement. The measuring arm is coupled with an adjustable gas-reduction spring from a gaslighter (Bic-B3), to a pick-up element (MMC-4; Bang & Olufsen, Struer, Denmark) with a part of the tangential arm (no. 3152378; Bang & Olufsen) and a heavy-duty clock balance shaft mounted in sapphire bearings. A function generator induces a 1.25-kHz vibration of a membrane (Melinex ICI 75  $\mu\text{m}$ ; Snijunie BV, Enkhuizen, the Netherlands) mounted with an iron assembly cap to a microphone (D58E; AKG, Vienna, Austria). The pick-up needle touches the membrane and converts the vibration into an electrical signal between 0 and 1 mV. This AC signal is amplified and converted to 0–5 V DC and then converted to a digital signal. The ARCOM microprocessor follows each measuring device in sequence, activating the function generator and checking the level of the signal from the floating zero. The flow diagram of the measuring unit is given in Figure 7.2. When the pre-set cycle time with a minimum value of 1 s is reached and the signal is above a certain pre-selected threshold value, the microprocessor orders the motor to move the floating zero upwards. The movement of the motor is proportional to the signal generated from the floating zero. The pick-up signal determines (*via* the adjusting amplifier and the reduction gear) the velocity of the motor and therefore follows the growth of the plant proportionally. As a result, the measuring arm is raised with the sledge and tilts due to the loop of thread attached to the plant and the spring that adjusts the upward tension. The sapphire bearings, the balance shaft and a friction-free transmission ensures the pick-up element moves backwards, when the measuring arm moves downwards. The tension of the needle on the membrane reduces so the induced signal decreases and due to the feedback between motor and signal the motor stops when the signal decreases beneath a threshold value. Simultaneously the encoder keeps track of the displacement of the floating zero. If the adjustment cannot be completed within one cycle time a special code is stored, indicating this event, and the adjustment continues in the next cycle. The DC motor and the tacho generator are disconnected *via* a relay each time when a measurement is completed to prevent any interference from possible electrical disturbance.

The growth-measuring apparatus can register growth with a resolution of 1  $\mu\text{m}$  during a variable time interval with a minimum of 1 s. This was demonstrated under controlled conditions by attachment to a rigidly mounted micropositioning device (data not shown) and with a rapidly growing etiolated cucumber seedling, with a linear growth rate, in darkness. In the latter case, 90 % of the raw data

measurements taken with a 1 s cycle time fall within the range of  $\pm 1 \mu\text{m}$  (Adamse, 1988).

For long-term measurements it is necessary to simultaneously reposition the floating zero downwards and the measuring unit upwards manually, when the 40 mm maximum growth has been reached. Depending on the growth of the experimental plants, this was done on a daily basis.

### **7.2.5 Calibration procedure**

A custom-built, manually-operated hydraulic micropositioning device is calibrated by a micropositioning controller (EM25; Kroeplin, Schlüchtern, Germany), on which a weight (0.5 g) rests, which is connected to the measuring arm of the floating zero (Fig. 7.2). This device is used to monitor the repositioning of the floating zero and was itself calibrated by another micropositioning controller (Magnescale LY-101; Sony, Tokyo, Japan). This procedure is also used to tune each floating zero separately and to check the stability of the system.

### **7.2.6 Facilities for irradiation**

White light is supplied by 16 fluorescent tubes (TLD18W/84; Philips, Eindhoven, the Netherlands), which could be switched in groups to adjust the irradiance, located in a custom-designed irradiation unit on top of the chambers (Fig. 7.1). Maximum irradiation is  $200 \mu\text{mol}\cdot\text{m}^{-2}\cdot\text{s}^{-1}$ , photosynthetically active radiation (PAR). The irradiation units have their own cooling-system using cooled air at 12 °C. A diffusor-plate (Vink, Didam, the Netherlands) is mounted between the irradiation unit and the chamber with the measuring device. Two small safelights (Philips TL8W/33, wrapped with two layers of primary-green filter [Lee, Flashlight Sales, Utrecht, the Netherlands]) are mounted in the irradiation units to facilitate handling of plant material in the case of experiments with dark-grown material.

Supplementary light is given *via* fibre-optic light guides (1600 mm long, 4 mm diameter; Schott, Tiel, the Netherlands) applied bi-directionally to a growing internode (Fig. 7.3). A custom-made projector assembly fitted with a Philips 250/7748S EHS quartz-iodide projection lamp is used. The projector is equipped with a heat-filter and a position for the insertion of an interference filter to obtain the desired light quality, *e.g.* far-red, red or blue light. The fibers are held in position by adjustable clamps to special arms either on the measuring unit to follow the growing plant or at a fixed level using a stand mounted to the base of the measuring device.

The irradiation schedule is programmed by the microprocessor, which automatically switches the lights, both photosynthetic and supplementary, on and off

after a preselected number of cycle times and registers this together with the other data gathered at that specific cycle time.

### 7.2.7 Numerical data processing and graphical data presentation

The data stored in the buffer of the microprocessor are automatically collected on a personal computer. After decoding, each single raw data-file is analyzed and checked with a user-defined strength parameter to facilitate detection and exclusion of values that lie outside the normal physiological ranges. This value is adjustable and very few data points are involved (typically < 1 % of the data points collected), which we believe predominantly arise as a consequence of electrical interference. The software generates a data-report for each file. From the processed data-sets basic statistics are calculated resulting in mean cumulative growth and mean stem elongation rate (SER) for each cycle-time. Custom data smoothing algorithms using the moving mean method have been applied. The results are displayed on the terminal and printer and stored in a way that enables the use of several commercially available graphical programs.

### 7.2.8 Experimental protocol

In the experiments described, the upward-tension of the adjustable spring in the floating zero, was set to 0.8 g. A threshold value of 30 mV was used, to start/stop the DC motor. The cycle-time was set to 30 s, which is sufficient to monitor the growth with a high resolution in the case of white-light grown tomato plants. The irradiation was  $75 \mu\text{mol}\cdot\text{m}^{-2}\cdot\text{s}^{-1}$  (PAR) on plant level. The environmental conditions, regulated by the climate-control unit were: temperature,  $25.0 \pm 0.25$  °C; relative humidity,  $70 \pm 5$  % and the laminar flow rate  $0.2 \text{ m}\cdot\text{s}^{-1}$ .

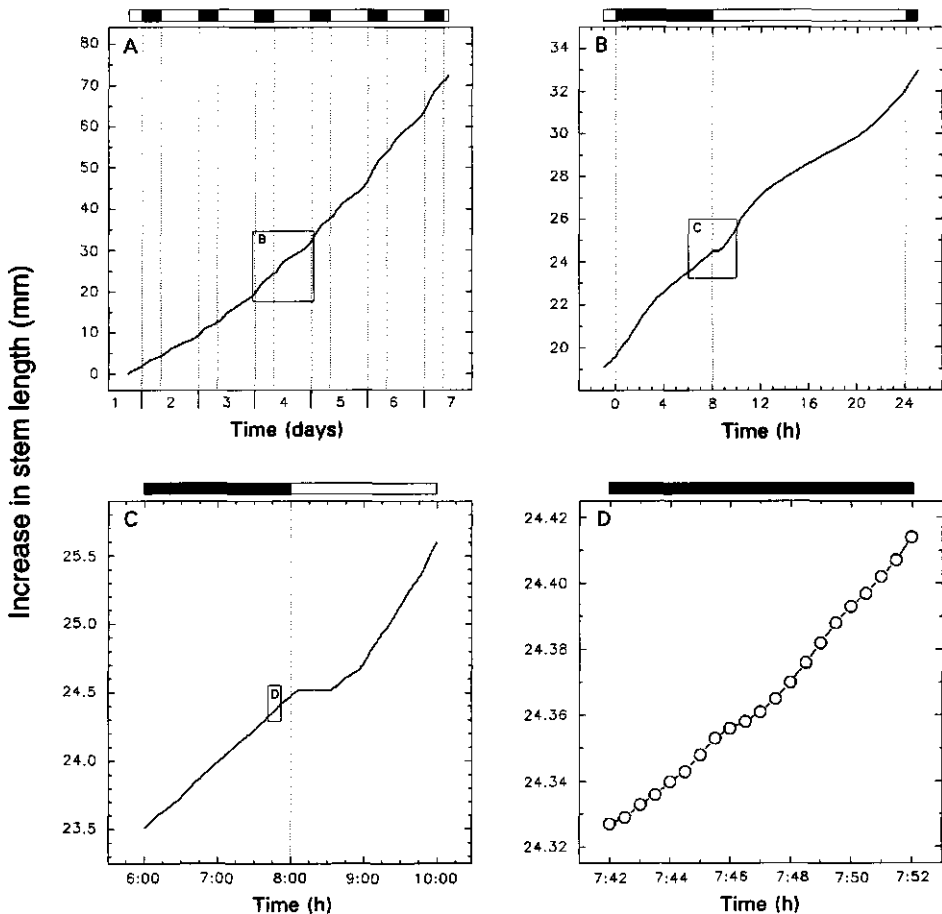
### 7.2.9 Growth of plants

Tomato (*Lycopersicon esculentum* Mill.) wild-type (WT, cv. MoneyMaker) plants were grown in 16-h white light (WL,  $75 \mu\text{mol}\cdot\text{m}^{-2}\cdot\text{s}^{-1}$  PAR)/8-h dark (D) cycles. Before monitoring growth the plants were preconditioned under identical conditions for at least 4–5 days in the growth-measuring apparatus. The age of the plants at the first day of the measurements was either 18 or 19 days from sowing. The measuring arm was connected to the youngest internode (number 3 or 4) possible (Fig. 7.3).

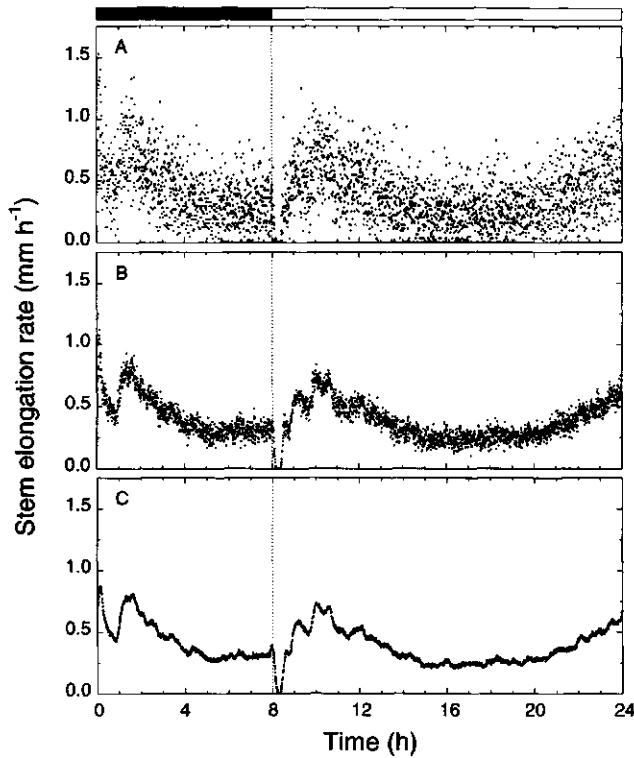
Water given to the plants was controlled to maintain an optimal water supply. The daily water consumption was empirically estimated and given to the plant in equal portions three times a day. We observed no detectable change in growth rate associated with the time of water application. An automatic watering system is currently being developed.

### 7.3 Results and discussion

Many studies of the kinetics of stem elongation have been carried out with light-grown plants over relatively short time periods. Little is known about the long-term kinetics of stem elongation. With the growth-measuring apparatus described measurements over long periods can be carried out, with the precision and resolution of short-term measurements. Figure 7.4A shows the stem extension below the attachment point of an individual 18-day-old tomato plant during seven consecutive days using the growth-measuring apparatus. Figures 7.4B, 7.4C and 7.4D show progressive amplification of Fig. 7.4A, for intervals of 26 h, 4 h and



**Figure 7.4.** Extension growth of an individual 18-day-old wild-type tomato plant (cv. MoneyMaker) grown in a 16-h day WL ( $75 \mu\text{mol}\cdot\text{m}^{-2}\cdot\text{s}^{-1}$  PAR)/8-h D cycle (indicated by open and closed bars, respectively). Each amplification is indicated in the preceding figure by a rectangle. (A) Data over a 7-day period, day 1 = 18 days from sowing. (B) Amplified part of A (26 h period); (C) amplified part of B (4 h); (D) amplified part of C (10 min), showing the individual 30-s data points.



**Figure 7.5.** Mean stem extension growth rate of 21-day-old wild-type tomato plants (*cv.* Money-Maker) grown in a 16-h WL ( $75 \mu\text{mol}\cdot\text{m}^{-2}\cdot\text{s}^{-1}$  PAR)/8-h D cycle (indicated by open and closed bars, respectively). (A) Mean data of 5 plants showing growth rate every 30 s. (B) 5-point running mean through the data in A. (C) 25-point running mean through the data in A.

10 min, respectively. Figure 7.4D shows the individual 30-s data points.

Figure 7.5 shows the mean SER for 21-day-old tomato plants during a 16-h WL ( $75 \mu\text{mol}\cdot\text{m}^{-2}\cdot\text{s}^{-1}$  PAR)/8-h D cycle. Figure 7.5A shows the mean original values for data derived from five plants, each point representing the mean SER of five plants for a 30-s period. Figures 7.5B and 7.5C show the 5- and a 25-point running mean of the original data, respectively. This pattern of growth rate changes have been shown to be highly reproducible in other tomato genotypes (Chapter 8).

The experiments in Figures 7.4 and 7.5 clearly demonstrate the underlying rhythm that is exhibited during growth of a tomato plant. This rhythm exhibits peaks of growth early in the light period and the beginning of the night. The slowest periods of growth are soon after the onset of the light, at the end of the night and the middle of the day. The sharp transient increase and decrease in growth rate at the beginning of the dark period and light period, probably reflect transient changes in water availability for growth as a result of closure and opening of stomata, respectively.

Despite the limitation of the number of plants that can be measured simultaneously, this equipment provides a powerful technique to monitor detailed growth kinetics over a long-term period of measurement, due to the fact that the floating zero is coupled to the plant and is adjusted every cycle time maintaining a constant upward tension during consecutive measurements. The necessary mechanical coupling of the plant to the floating zero prevents this method and others using transducers from being applied to motion not parallel to the stem axis. Restrictions of this type do not occur for optical methods, however caution must be exercised since modification of plant growth response by the infra-red illumination, used with the infra-red sensitive camera for photobiological experiments has been reported (Johnson *et al.*, 1996).

The daily patterns in stem elongation rate of the internodes and the effects resulting in transients can be analyzed very precisely with this growth-measuring device. Such studies will provide information about the regulatory network of processes that play a role in plant growth. From a physiological point of view the characteristics of the apparatus allow many other uses: in the study of photomorphogenesis we can quantify the effects on stem elongation of light quality, light quantity and photoperiodicity. Thermomorphogenic effects, such as effects of DIF (difference between day temperature and night temperature) on stem elongation can also be measured. Effects of transport of assimilates and water in the process of stem extension can also be studied. It is also possible to study other environmental effects by introduction of controlled levels of pollutants or enhanced levels of CO<sub>2</sub> via the climate-control unit.



# CHAPTER 8

## Growth analysis of wild-type and photomorphogenic-mutant tomato plants

**Abstract.** A custom-designed high-resolution plant growth-measuring apparatus, controlled by a microcomputer has been used to study extension growth kinetics of wild-type and photomorphogenic-mutant tomato (*Lycopersicon esculentum* Mill.) plants with and without end-of-day far-red light (EODFR). The following photomorphogenic mutants were used: far-red insensitive (*fri<sup>1</sup>*): deficient in phytochrome A (phyA); temporarily red light-insensitive (*tri<sup>3</sup>*): deficient in phytochrome B1 (phyB1) and their corresponding wild type (WT) cv. MoneyMaker; *aurea* (*au*): deficient in phytochrome chromophore biosynthesis; high-pigment-1 (*hp-1*): exhibiting exaggerated phytochrome responses and their near-isogenic WT cv. Ailsa Craig. The stem elongation rate (SER) during a 24-h period of all the genotypes studied shows a similar pattern, having two dramatic transients, one shortly after the onset of the light period (a sharp decline in SER) and another shortly after the start of the dark period (a sharp increase in SER). These transients are probably associated with water relations as a consequence of opening and closure of the stomata. The fastest SER occurs during the dramatic oscillations early in the dark period. Between the genotypes there are large quantitative differences in SER. All the genotypes tested exhibited a strong EODFR response, resulting in a relative promotion of SER during the first period after the start of EODFR and in the subsequent light and dark periods. These results indicate that phyA, absent in the *fri<sup>1</sup>* mutant, does not play a major role in SER of light-grown tomato plants. Whereas phyB1, absent in the *tri<sup>3</sup>* mutant, is partly responsible for the compact stature of WT plants. An additional phytochrome other than phyA and phyB1 must therefore be capable of eliciting the EODFR response.

### 8.1 Introduction

Photomorphogenesis is the process by which light regulates processes involved in aspects of plant growth and development by means of at least three classes of photoreceptors: phytochromes which absorb predominantly in the red (R) and far-red (FR) region of the spectrum, blue light (B)/UV-A photoreceptor(s) and UV-B photoreceptor(s) (Kendrick and Kronenberg, 1994). Of these photoreceptors the phytochromes are the most extensively studied.

Phytochromes are encoded by a small gene family in all plant species so far studied (Quail, 1994). Recently, the tomato (*Lycopersicon esculentum* Mill.) phytochrome family has been partially characterized and to date five phytochrome

genes (*PHY*) have been identified: *PHYA*, *PHYB1*, *PHYB2*, *PHYE* and *PHYF* (Hauser *et al.*, 1995). These genes encode the apoproteins *PHYA*, *PHYB1*, *PHYB2*, *PHYE* and *PHYF*, which after assembly to the tetrapyrrole chromophore result in the photoreversible holophytochromes *phyA*, *phyB1*, *phyB2*, *phyE* and *phyF*, respectively. Studies of phytochrome mutants (both type-specific or chromophore biosynthesis mutants) and mutants exhibiting exaggerated phytochrome responses are useful in order to assign function(s) to the individual members of the phytochrome family and understand the mechanism(s) of phytochrome action (Kendrick and Nagatani, 1991; Kendrick *et al.*, 1994).

One of the events mediated by phytochrome in light-grown plants is the shade-avoidance syndrome resulting in a promotion of stem elongation in an attempt to grow out of the shade or avoid the proximity of other plants. This complex response results from the detection of a decrease in the relative proportion of R to FR by phytochrome and detection of reduced irradiance. One of the methods often used to simulate the phytochrome involvement in this process in the laboratory is to briefly irradiate plants with end-of-day far-red (EODFR) (Downs *et al.*, 1957; Kasperbauer, 1971).

Several studies of the kinetics of stem elongation have been carried out with light-grown plants under laboratory (e.g. Lechary and Jacques, 1980; Lechary and Wagner, 1984; Bertram and Lercari, 1996) and greenhouse conditions (Bertram and Karlsen, 1994a; 1994b). For tomato and *Chenopodium rubrum* endogenous circadian rhythms in SER have been observed (Assaad Ibrahim *et al.*, 1981; Lechary and Wagner, 1984; Ruiz Fernandez and Wagner, 1994).

The aim of this study was to investigate stem extension growth kinetics of several photomorphogenic mutants and the influence of EODFR irradiation on them over several days using a very sensitive computerized custom-designed growth-measuring apparatus.

## 8.2 Materials and methods

### 8.2.1 Plant material

Growth measurements were carried out in two series of experiments using different sets of wild-type (WT) and photomorphogenic-mutant tomato (*Lycopersicon esculentum* Mill.) plants.

Experimental series 1. Three genotypes in the genetic background MoneyMaker (MM) were used: FR insensitive (*fri<sup>1</sup>*), deficient in *phyA* (Chapter 2); temporarily red light-insensitive (*tri<sup>3</sup>*), deficient in *phyB1* (Chapter 3) and their corresponding WT. Growth measurements were carried out every 30 s starting with 19-day-old plants connected by the youngest internode possible (internode number

3 or 4). At this stage all the genotypes had the same number of internodes, but the *tri<sup>3</sup>* mutants were slightly taller than the *fri<sup>1</sup>* mutants and the WTs.

Experimental series 2. Three genotypes of tomato in the genetic background Ailsa Craig (AC) were used: aurea (*au*), deficient in biosynthesis of phytochrome chromophore (Terry and Kendrick, 1996; Van Tuinen *et al.*, 1996a); high-pigment-1 (*hp-1*), exhibiting exaggerated phytochrome responses (Kendrick *et al.*, 1994) and their near-isogenic WT. Growth measurements were carried out every 60 s starting with 27-day-old plants connected by the youngest internode possible (internode number 6 or 7). At this stage all the genotypes had the same number of internodes, but the *hp-1* mutants were much more compact and the *au* mutants were a little taller than the WTs.

### 8.2.2 Plant growth conditions

Plants were grown in a potting compost/sand mixture in 11-cm diameter pots (Charme; Ypma, Zwanenburg, the Netherlands) in 16-h white light (WL; 75  $\mu\text{mol}\cdot\text{m}^{-2}\cdot\text{s}^{-1}$ , photosynthetically active radiation [PAR])/8-h dark (D) cycles with and without EODFR. The EODFR was given *via* fibre-optic light-guides, applied bi-directionally for 10 min to a growing internode (1 or 2 internode(s) below the internode connected to the growth meter), switched on directly when WL was switched off under the control of the microcomputer.

The environmental conditions, regulated by the climate-control unit were  $25.0 \pm 0.25$  °C and relative humidity  $70 \pm 5$  %. Water given to the plants was controlled to maintain an optimal water supply. The daily water consumption was empirically estimated and given to the plant in equal portions three times a day *via* a remote control.

Before monitoring growth the plants were preconditioned under identical conditions for at least 4–5 days.

### 8.2.3 Growth-measuring apparatus

The study of extension growth was carried out with a custom-designed plant growth-measuring apparatus, controlled by a microcomputer which allows long-term and high resolution stem elongation measurements of three individual plants simultaneously under controlled environmental conditions (Chapter 7).

Briefly, the plant is connected by the youngest internode possible *via* a ligature thread to a 10-cm long measuring arm, with a constant upward tension of 0.8 g. The measuring arm is part of the displacement detection device ('floating zero') which is mounted on a sledge fastened to a precision spindle. A time-interval (30 s for experimental series 1 and 60 s for experimental series 2) is set at which the floating zero is adjusted and growth is registered *via* an incremental encoder with a resolution of 1  $\mu\text{m}$ . Continuous measurements of growth can be monitored over

several days, by repositioning the floating zero and the measuring unit when necessary. In the experiments described we measured three plants simultaneously. A microprocessor collects all data and passes it to a PC for further calculations, statistical analysis and graphical presentations of the results.

### 8.2.4 Light sources and light measurements

The WL was obtained from Philips TLD18W/84 fluorescent tubes. The FR was obtained from Philips 250/7748S EHS quartz-iodide projection lamps, using interference filters (peak transmission at 739 nm; bandwidth at 50 % of the transmission maximum 12 nm; Schott, Mainz, Germany) and irradiance (ca. 90  $\mu\text{mol}\cdot\text{m}^{-2}\cdot\text{s}^{-1}$  per light guide) for 10 min was sufficient to establish a  $\phi$ -value of 0.02 in the irradiated internode. Where  $\phi$  is the proportion of the total phytochrome molecules present as Pfr at photoequilibrium.

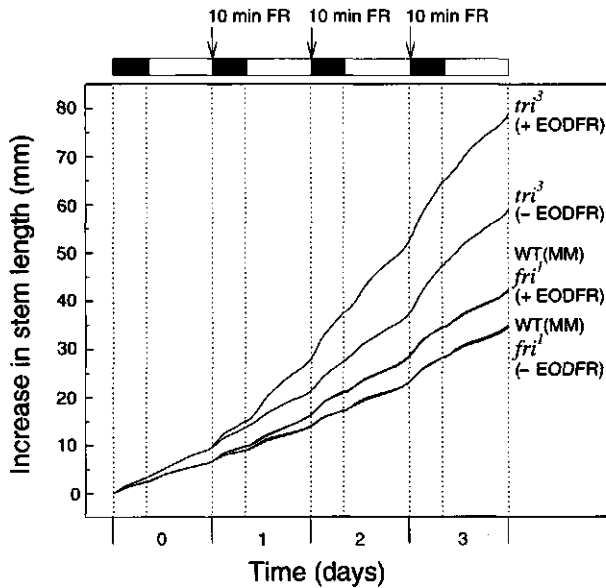
Fluence rates and spectral distributions of the light sources were recorded using a calibrated LI-1800 spectroradiometer (Li-Cor, Lincoln, NE, USA). The cosine-corrected remote probe (1800-11; Li-Cor) was placed horizontally at plant height for measurement of the WL irradiance. For measuring the FR the light-guide was placed 1 cm above the probe.

### 8.2.5 Presentation of the results

The mean value was obtained from five plants (experimental series 1) or three plants (experimental series 2) per genotype, measured individually over more than four days. A 5-point running mean was applied to give a clear indication of the underlying growth rate. *Note:* the first 24 h period of the experiment is designated by day 0; The EODFR treatment (followed over three 24-h periods) starts at the beginning of the night period of day 1.

## 8.3 Results and discussion

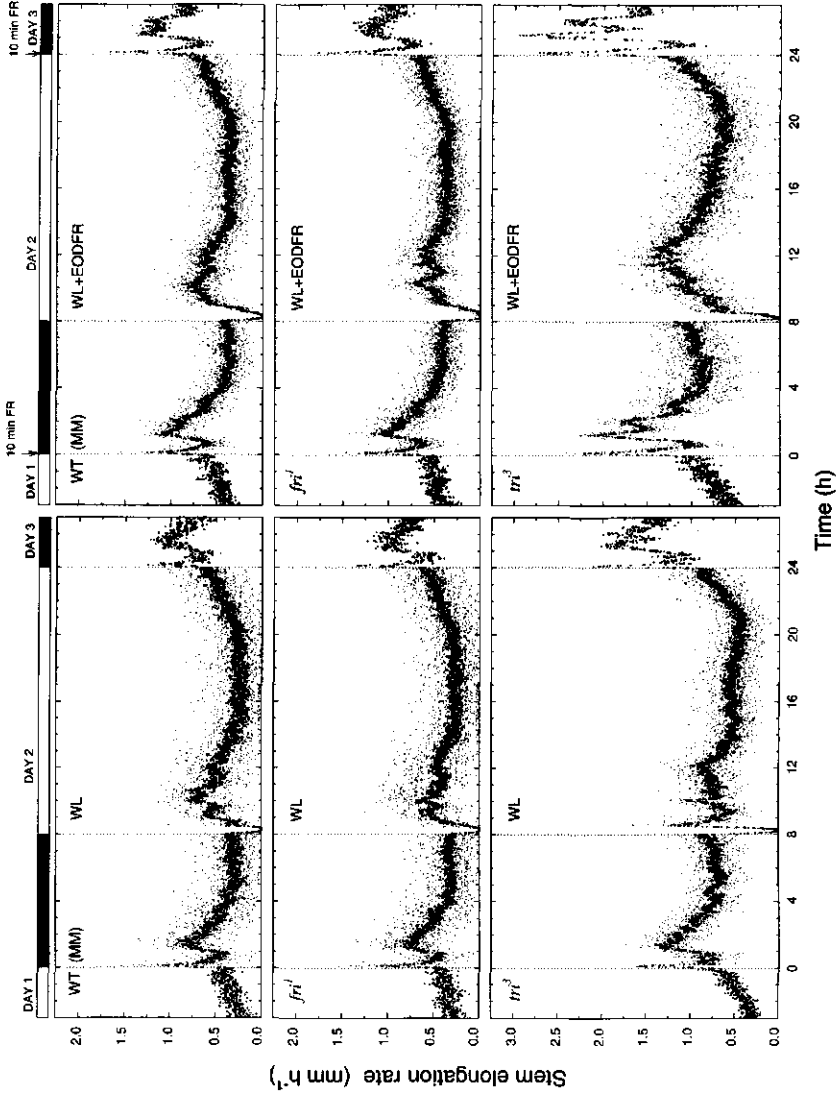
The extension growth of the WT (MM) and *fri*<sup>1</sup> and *tri*<sup>3</sup> mutants (experimental series 1; Figs. 8.1–8.3) and the WT (AC) and the *au* and *hp-1* mutants (experimental series 2; Figs. 8.4–8.5) all showed a similar general pattern. The EODFR treatment gave a significant promotion of growth during the first D period, which is sustained in the subsequent light and D periods and was similar for all genotypes studied. The stem extension kinetics for the WT and *fri*<sup>1</sup> mutant were remarkably similar in control WL/D cycles. The EODFR treatment resulted in an equal increase in elongation growth in WT and *fri*<sup>1</sup>. Between *au*, *tri*<sup>3</sup> and *hp-1* mutants there were only quantitative differences in the increase in stem length



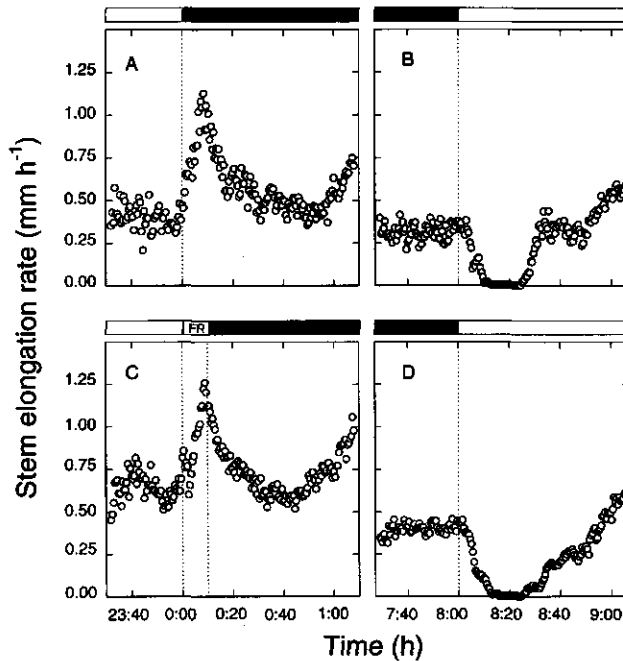
**Figure 8.1.** Increase in stem length of WT (MM), and derived *fri*<sup>1</sup> and *tri*<sup>3</sup> mutant tomato plants (experimental series 1; 5 replicates). Plants were grown in a 16-h WL ( $75 \mu\text{mol}\cdot\text{m}^{-2}\cdot\text{s}^{-1}$  PAR)/8-h D cycle. After 20 days from sowing, plants were either submitted to an immediate 8-h D (- EODFR) period or given a 10-min FR (as indicated) before the D period (+ EODFR), starting at the beginning of the D period of day 1. Increase in stem length was followed cumulatively (every 30 s) over 4 days, starting one day before the EODFR treatment (= day 0). *Note:* The WT (MM) and *fri*<sup>1</sup> mutant are almost indistinguishable under both treatments.

compared to their corresponding WT's in both treatments, despite the fact that the genotypes in experimental series 2 were eight days older than those in experimental series 1. All genotypes studied exhibited the so called 'persistent effect' of Pfr removal at the end of the light period, despite the fact that the same phytochrome photoequilibrium was rapidly established in both EODFR and control plants at the beginning of the photoperiod: the EODFR treated plants continued to grow at a faster rate than the control during the main photoperiod (Casal and Smith, 1988; Casal and Kendrick, 1993).

The SER of the WT (MM), *fri*<sup>1</sup> and *tri*<sup>3</sup> genotypes (experimental series 1; Fig. 8.2) and of the WT (AC), *au* and *hp-1* genotypes (experimental series 2; Fig. 8.5), during the third 24-h period (day 2), had similar kinetic patterns. The SER of WT (AC) in experimental series 2 was slightly greater than WT (MM) most likely due to the 8-day difference in age. In general the SER for both WT's, exhibited the following characteristics: after the start of the D period a transient increase in SER occurred, which set in motion an oscillatory pattern, which gradually damped out with an underlying gradual increase in SER showing a maximum after approximately 2 h. A gradual decrease in SER occurred reaching a stationary level after approximately 4 h. During the dramatic oscillations at the beginning of the



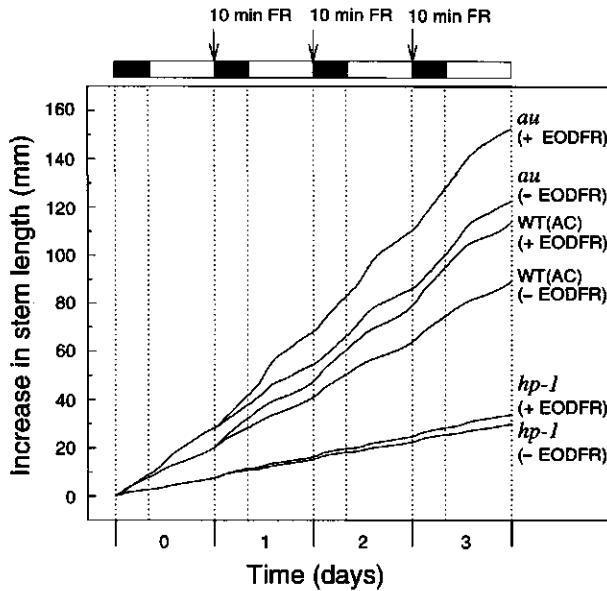
**Figure 8.2.** Stem elongation rate of WT (MM), and derived *frt<sup>1</sup>* and *frt<sup>3</sup>* mutant tomato plants, during the third 24-h period (= day 2) in WL (left panels) and WL + EODFR (right panels). The dots represent the mean of the original data (experimental series 1, measured every 30 s; 5 replicates), the bold dots represent the 5-point running mean. The dark and light periods are indicated by closed and open bars, respectively.



**Figure 8.3.** Stem elongation rate in detail, using a 5-point running mean, of tomato WT (MM) on day 1–2 during the dramatic transients, one shortly after the start of the dark period (panels A and C), one shortly after the onset of the light (panels B and D) in the – EODFR (panels A and B) and + EODFR (panels C and D) treatments (experimental series 1, measured every 30 s; 5 replicates). The dark and light periods are indicated by closed and open bars, respectively.

D period the fastest growth rates were observed. After the onset of the light a transient decrease in SER occurred, reaching almost zero, which set in motion an oscillatory pattern, which gradually damped out with an underlying gradual increase in SER showing a maximum after approximately 2 h. The SER gradually decreased during the day, having a minimum after 8–9 h, and then gradually increased towards the end of the light period. The *fri*<sup>1</sup> and *tri*<sup>3</sup> (Fig. 8.2) and *hp-1* (Fig. 8.5) mutants exhibited a similar WT pattern of SER. The *au* mutant had a different growth pattern, showing no gradual decrease in SER during the D period and almost no gradual increase in SER towards the end of the light period (Fig. 8.5). Despite both *au* and *tri*<sup>3</sup> having an elongated phenotype, the underlying growth pattern differed significantly. The mean SER during the night period was slightly higher than that of the light period for all genotypes studied.

Figure 8.3 shows the two dramatic transients for WT (MM), one shortly after the start of the D period (*ca.* 9 min), showing a sharp increase in growth rate and one shortly after the onset of the light (*ca.* 8 min), showing a sharp decline in growth rate to zero for several minutes. The transients at the start of the D period were similar with and without EODFR (Fig. 8.3). The transients are possibly

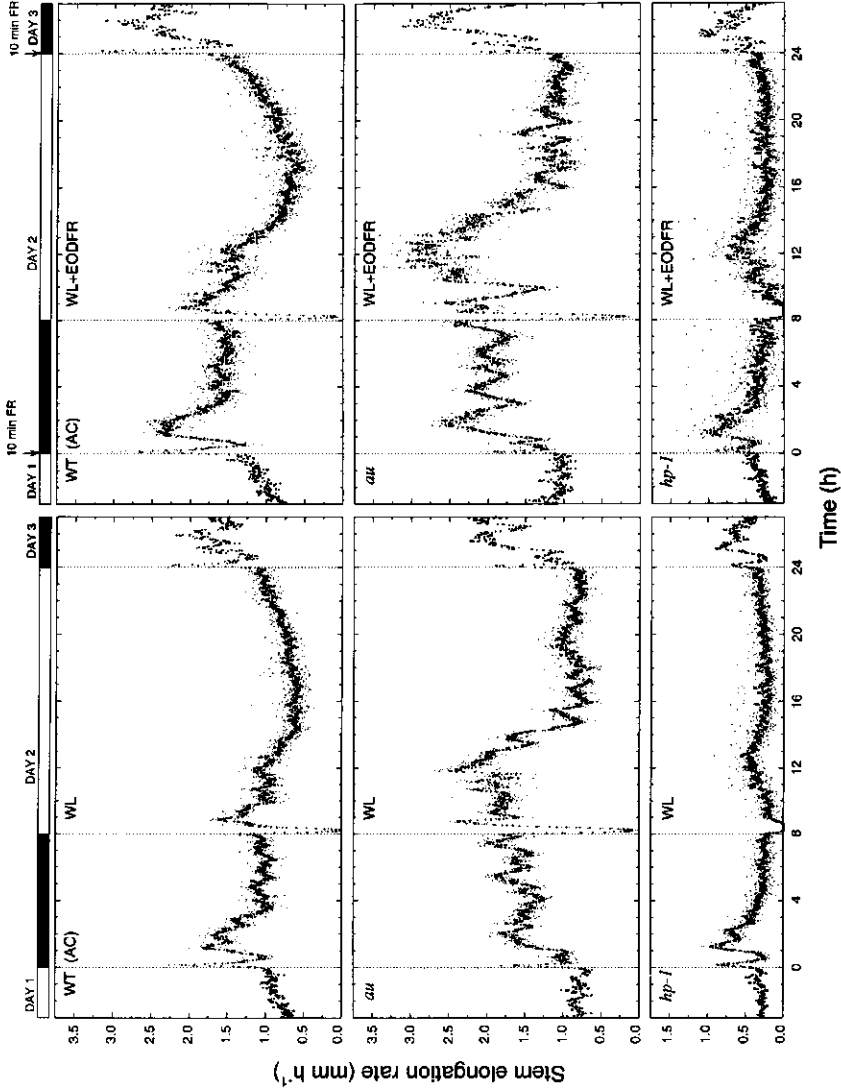


**Figure 8.4.** Increase in stem length of WT (AC), and derived *au* and *hp-1* mutant tomato plants (experimental series 2; 3 replicates). Plants were grown in a 16-h WL ( $75 \mu\text{mol}\cdot\text{m}^{-2}\cdot\text{s}^{-1}$  PAR)/8-h D cycle. After 28 days from sowing, plants were either submitted to an immediate 8-h D (- EODFR) period or given a 10-min FR (as indicated) before the D period (+ EODFR), starting at the beginning of the D period of day 1. Increase in stem length was followed cumulatively (every 60 s) over 4 days, starting one day before the EODFR treatment (= day 0).

associated with water relations as a consequence of opening and closure of the stomata. Stomata opening is regulated by a B photoreceptor (Zeiger, 1994). The transient oscillations in growth have been observed for seedlings exposed to B and these were presumably a consequence of variations in the rate of cell elongation (Cosgrove, 1981b; Kristie and Jolliffe, 1986). The described pattern: a direct decrease in SER when light was switched on, followed by an increase within minutes, and an opposite pattern immediately when light was switched off, has been observed in other species, e.g. for wheat leaves (Christ, 1978), lemons (Bartholomew, 1926) and potato (Schnieders *et al.*, 1988).

The *au* mutant is a 'leaky' chromophore mutant (Terry and Kendrick, 1996) and had a high growth rate (Fig. 8.5; 125 and 145 % compared to the WT (AC) in the D and light periods, respectively) consistent with deficiency in Pfr. The light hypersensitive *hp-1* mutant had a very strong phenotype in WL and had a relatively reduced growth rate (Fig. 8.5; 32 and 36 % compared to the WT (AC) in the D and light periods, respectively). However, both mutants exhibited a normal EODFR response (López-Juez *et al.*, 1990, Peters *et al.*, 1992b, Casal and Kendrick, 1993). The phyA-deficient *fri<sup>1</sup>* mutant exhibited almost an identical growth rate compared to the WT (MM) (Fig. 8.2; 102 and 97 % in the D and light periods, respectively), whereas the phyB1-deficient *tri<sup>3</sup>* mutant maintained a high





**Figure 8.5.** Stem elongation rate of WT (AC), and derived *au* and *hp-1* mutant tomato plants, during the third 24-h period (= day 2) in WL (left panels) and WL + EODFR (right panels). The dots represent the mean of the original data (experimental series 2, measured every 60 s; 3 replicates), the bold dots represent the 5-point running mean. The dark and light periods are indicated by closed and open bars, respectively.

growth rate (Fig. 8.2; 194 and 161 % compared to the WT (MM) in the D and light periods, respectively).

In these experiments all the genotypes showed a clear EODFR response (Figs. 8.1 and 8.4). During the subsequent second night and day the relative increase in SER as a result of EODFR was similar during the light and D periods (Table 8.1). Supplementary daytime FR resulted in a qualitatively similar increase in plant height in both the *au* and *hp-1* mutants (Whitelam and Smith, 1991; Chapter 6). Such results indicated that phytochrome is present and functional in light-grown *au* plants, whereas at the de-etiolation stage phytochrome responses were very severely reduced (Kendrick *et al.*, 1994). The reduced growth rate of the *hp-1* mutant (about one third of the WT control) clearly showed that the *hp-1* mutation results in a dwarf phenotype. Since this is opposite to the phenotype associated with phytochrome deficiency, it is consistent with the hypothesis that the *hp-1* mutation results in an exaggerated response to Pfr (Kendrick *et al.*, 1994).

In these experiments under relatively low light levels, phyA played a minor role in stem elongation growth in light-grown plants, but phyB1 clearly played a role in this process. At higher light levels perhaps other phytochromes were capable of saturating the stem elongation response. Therefore the phyB1 deficiency in the *tri<sup>3</sup>* mutant was most exaggerated under low light levels. The *au* mutant exhibited an intermediate response. This would be consistent with it having a deficiency in chromophore biosynthesis which depleted the phytochromes available, including phyB1. However the *au* and *tri<sup>3</sup>* mutants exhibited a normal EODFR response, in contrast to phyB-deficient mutants described so far in other species: *Arabidopsis* (Reed *et al.*, 1993), cucumber (Adamse *et al.*, 1987; López-Juez *et al.*, 1992) and *Brassica* (Devlin *et al.*, 1992). Since phyB1 and phyB2 are closely related (Pratt *et al.*, 1995), we hypothesize that they are both able to regulate the EODFR response in tomato. Such a redundancy could explain why no constitutively tall phytochrome mutants have been selected in tomato. Mutagenesis of a *fri, tri* double

**Table 8.1.** Summary of % increase in SER, relative to the control (WL), as a result of EODFR treatment (WL + EODFR) during the second night and day following the start of the treatment (data derived from Figs. 8.2 and 8.5).

Genotype	% increase in SER	
	Night	Day
WT (MM)	27	25
<i>fri<sup>1</sup></i>	32	23
<i>tri<sup>3</sup></i>	34	45
WT (AC)	44	30
<i>au</i>	29	32
<i>hp-1</i>	14	10

*Growth analysis of wild-type and photomorphogenic-mutant tomato plants*

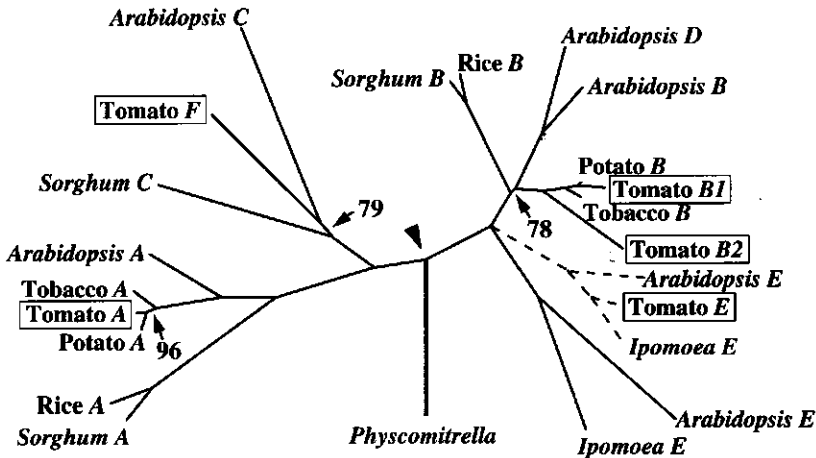
mutant, which itself has only a mild elongated phenotype similar to the monogenic *tri* mutants, should enable selection of tall mutants (putants) deficient in the residual phytochrome (phyB2), proposed to be capable of regulating the EODFR response.

# CHAPTER 9

## General discussion

### 9.1 Evolution of phytochrome

The natural light environment is complex and variable, providing a range of signals to which plant development and metabolism are responsive. This occurs at virtually every stage of a plant's life cycle, from seed germination to senescence. The light-dependent development of plants is governed by the combined action of three classes of photoreceptor systems, collectively scanning the entire daylight spectrum. The red light (R)/far-red light (FR)-absorbing phytochromes are the best characterized photoreceptors in plants and are encoded by a multigene family. In *Arabidopsis* the complete *PHY* gene family has been described and consist of five members (Sharrock and Quail, 1989; Clack *et al.*, 1994). In tomato, five *PHYs* has been described (Hauser *et al.*, 1995; Pratt, 1995). The relationships among these five tomato *PHYs*, the five *Arabidopsis PHYs* and other selected representatives of this family in other species are represented as a phylogenetic tree derived from their sequences in Figure 9.1. This tree is based on the assumption that present day



**Figure 9.1.** Phylogenetic tree illustrating the relationships among various *PHYs*, including those from tomato. Deduced amino acids from the first three exons (1130 residues in the aligned sequences) were used to construct this tree with PHYLIP. This neighbour-joining tree was obtained with PROTDIST, NEIGHBOR and DRAWTREE. Branch lengths are proportional to the extent of sequence divergence. All nodes have bootstrap values of 100 except for the three indicated. the arrowhead indicates the presumed node from which all present-day angiosperm derive. Because only limited sequence data is available for tomato *PHYE*, the branch including this *PHY* (---) was calculated by an identical analysis limited to 103 residues (ILHRI through HYPAT) and superimposed on the larger tree. After Pratt *et al.*, (in press).

angiosperm *PHYs* arose as a consequence of gene duplications and sequence divergence from a progenitor phytochrome, pre-existing the angiosperms, represented by the moss *Physcomitrella* (indicated by an arrowhead). While two B-type *PHYs* have been described for both *Arabidopsis* (*PHYB* and *PHYD*) and tomato (*PHYB1* and *PHYB2*), it has not been possible to determine, for example, whether *Arabidopsis PHYB* is orthologous to tomato *PHYB1* or *PHYB2* (Pratt *et al.*, 1995). It appears that a progenitor *PHYB* duplicated independently in two lineages leading to the *PHYs* in the present-day Crucifereae and Brassicaceae (Fig. 9.1). Tomato *PHYF* is most closely related to *Arabidopsis PHYC*, although it has been considered as a member of a novel subfamily because of the extensive divergence between the two genes, about the same distance as that between *Arabidopsis PHYB* and *PHYE*. Assuming that all present *PHYs* originate from a single progenitor gene, it might be predicted that this progenitor arose in the cyanobacteria. This prediction arises largely from the remarkably similar structures of phytochromobilin, the phytochrome chromophore, and phycocyanin, the chromophore of cyanobacterial phycobiliproteins (Siegelman *et al.*, 1966; Rüdiger and Thümmel, 1994). However, although no evidence for such a progenitor in the cyanobacteria has yet been published (Pratt, 1995), phytochrome-related sequences have been recently found (Kehoe and Grossman, 1996). A large number of angiosperm and non-angiosperm *PHY* partial sequences have been described by Mathews *et al.* (1995) and Kolukisaoglu *et al.* (1995), which can be summarized as follows: (i) a gene duplication is thought to have occurred prior to the formation of gymnosperms, giving rise to the progenitors of the *PHY(A/C/F)* and *PHY(B/E)* subfamilies; (ii) both these subfamilies underwent a second duplication, giving rise to *PHYA* and *PHY(C/F)*; the *PHYB* and *PHYE* subfamilies; (iii) the present *PHYC* and *PHYF* subfamilies would then have resulted from a duplication of the *PHY(C/F)* progenitor (Pratt, 1995). In addition to these relatively ancient *PHY* duplications, there is growing evidence that more recent duplications have occurred in both the *PHYA* and *PHYB* subfamilies. Duplications leading to truncated pseudogenes have been reported in pea (Sato, 1990) and maize (Chistensen and Quail, 1989).

## 9.2 Photoreceptor mutants

Mutants modified with respect to specific phytochrome types are extremely useful tools which enable the function(s) to be assigned to each individual phytochrome. We have isolated mutants in tomato at two loci which result in plants that are: (i) completely blind to FR (*fri*) at the de-etiolation stage which have been shown to be *phyA* mutants and which have a normal wild-type (WT) phenotype in white light (WL) (Chapter 2). Recently, the *fri* mutation has been shown to be a nucleotide substitution of an adenine (A) for a thymine (T) at the 3' junction of the

intron between exons 1 and 2 in the *PHYA* gene, which leads in most instances to a failure to remove this intron during mRNA maturation (Lazarova *et al.*, 1996), consistent with the Northern-blot data (Chapter 2); (ii) temporarily R insensitive (*tri*) upon transfer from dark(ness) (D) which have been shown to be (putative) phyB1 mutants on the basis of immunology, mRNA studies (Chapter 3) and mapping data (Van Tuinen *et al.*, 1996b). The WL-grown plants of the *tri* mutant are only slightly taller than the WT, and the *fri,tri* double mutant has been constructed which is phenotypically similar to the monogenic *tri* mutant. This demonstrates that phyA plays, at best, a minor role in determining the stature of WL-grown tomato plants: the residual photoreceptors other than phyA and phyB1 sustaining a relatively normal photomorphogenesis. In other words, this indicates that there is redundancy between the different photoreceptors. Measurements of growth at lower light levels reveals that the *tri* mutant is much more elongated than the corresponding WT indicating that the phytochromes involved in the regulation of plant height are only completely redundant at high light levels (Chapter 8). Unlike phyB mutants isolated in other species, the *tri* mutant of tomato retains a strong response to end-of-day FR (EODFR) and vegetational shade (Chapters 6 and 8). This indicates that the phytochrome family members which play a dominant role in the light phenotype (architecture) are different in different species. We hypothesize that this is attained predominantly by the second B-type phytochrome in tomato (phyB2) (Kendrick *et al.*, 1994; Pratt *et al.*, 1995). It should be noted, however, that the apparent insensitivity to supplementary daytime FR and EODFR on flowering of the *hy3* (*phyB*) mutants in *Arabidopsis* is not found when they are studied in a more extreme genetic background (Halliday *et al.*, 1994; Bagnall *et al.*, 1995; Devlin *et al.*, 1996), which has also been explained by the proposal of the action of other light-stable phytochromes.

Thus, while both phyA and phyB1 mediate at least in part the same response, inhibition of hypocotyl elongation, they do so in response to different parameters of the light environment. However, phyA and phyB could function through different transduction chains before converging to result in the same terminal response. In *Arabidopsis*, seed germination is promoted by phyB *via* a low fluence response (LFR) (Botto *et al.*, 1995) and by phyA *via* a very low fluence response (VLFR) (Shinomura *et al.*, 1994; 1996; Botto *et al.*, 1996; Furuya and Schäfer, 1996). Recently, Shinomura *et al.* (1996) established that the phyA response is  $10^4$  times more photosensitive than the phyB response for the induction of germination, which strengthened the possibility that phyA and phyB act through different mechanisms. The VLFR has been proposed to be mediated by Pfr,Pr heterodimers (VanDerWoude, 1985; Furuya and Schäfer, 1996). It seems reasonably safe to conclude that individual phytochromes have specialized photosensory functions independent of each other, both in terms of what they sense and, at least in part, the responses they mediate (Quail *et al.*, 1995). In addition, other phytochromes must play important roles in photomorphogenesis of tomato. This is based on the

observations (i) that the *fri,tri* double mutant (deficient in phyA and phyB1) differs little from WT when grown in WL/D cycles (Kendrick *et al.*, 1994); (ii) the *fri,tri* double mutant has normal fruit development and ripening characteristics. Both these observations imply phytochromes other than phyA and phyB1 have physiological functions. The preferential expression of *PHYB2* and *PHYF* in ripening fruits, leads to the suggestion that one or both of the phytochromes encoded by these genes is or are responsible for the photocontrol of fruit maturation (Hauser *et al.*, in press). Moreover each of the five characterized tomato *PHYs* exhibits a unique pattern of expression both temporally and spatially (Hauser *et al.*, in press), even the closely related *PHYB1* and *PHYB2* (Pratt *et al.*, 1995), suggesting unique roles for these encoded phytochromes.

The exact functions of the phytochromes, other than phyA and phyB, still remains unclear. If these proteins have a similar function to phyB, but expressed at lower levels, then this would explain the leakiness that has sometimes been reported for phyB mutants. It will be difficult to find mutants of these genes, unless these phytochromes have specific functions. Recently, it was established that the Wassilewskija (Ws) ecotype of *Arabidopsis* is a natural phyD mutant, having a 14-bp deletion that results in a premature stop codon, thereby yielding in what is most likely a null mutant (Sharrock, 1996). Initial data suggest that phyD appears to have phenotypic effects similar to those of phyB. Whether these two phytochromes have independent functions, as the inability of phyD to substitute fully for phyB would indicate (Koornneef and Kendrick, 1994), or whether the phenotype of the phyB mutants results from a 'dosage effect', remains to be determined.

Starting with the phyA,phyB1-deficient *fri,tri* double mutant, screening for mutants in additional photoreceptors has been initiated (M. Koornneef and R.E. Kendrick, pers. comm.). During the last two years about 4000  $\gamma$ -mutagenized  $M_1$  *fri,tri* double-mutant plants have been grown, 50 % of which proved to be sterile. Seed has been collected from the remaining individual plants, as well as leaf material for extraction of DNA. This has produced a valuable resource for selection strategies for many different types of mutants. The use of  $\gamma$  irradiation as a mutagen often leads to deletions which facilitate the analysis of mutants (hopefully nulls) at the molecular level. A reliable screening procedure at the DNA level is feasible, and utilizing the already available probes and PCR primers specific for known phytochromes and B photoreceptors which are either available or soon will be, it will be possible to detect deletions within the photoreceptor genes for which we have, as yet, no defined function. Screening of  $M_2$  plants for tall seedlings under WL has resulted in 8 novel mutants of this type so far, along with a number of dwarfs. Although allelism tests have not yet been performed for all the new mutants, preliminary data suggest they represent at least 5 different loci. These mutants can be considered as suppressors and enhancers of the *fri,tri* phenotype. These provisional results support our hypothesis for genetic redundancy between photoreceptors in photomorphogenesis, since in all previous

screens in the WT background no such tall phenotypes have been picked up. In addition, transposon tagging is a feasible alternative approach in tomato. As an example, when a transposable element has been mapped close to the *PHY* gene of interest, it is possible to activate the transposable element and hope that it jumps into the *PHY* gene resulting in its inactivation. Now the *PHY* genes in tomato are cloned, gene silencing techniques (antisense and co-suppression) can be used to investigate functions of each phytochrome family member. To confirm any putants isolated by these different approaches, are deficient in a particular phytochrome antibodies which are specific for each of the different members of the phytochrome gene family will be required.

There is evidence for a strong co-action/interaction between the B photoreceptor(s) and phytochrome in tomato. We have already demonstrated that in the case of anthocyanin biosynthesis the *fri,tri* double mutant is essentially blind in the R and FR region of the spectrum but retains a strong residual response to B (Chapter 4). Such a response is amenable for rapid screening of seedlings for new B photoreceptor and signal transduction-chain mutants. In addition, mutants selected for long hypocotyls in B have already been isolated following EMS mutagenesis of WT, and they await detailed analysis. One such mutant, isolation no. Z3-78 (A. van Tuinen and M. Koornneef, pers. comm.) has almost no phenotype in WL, but when combined as a double mutant with the phyB1-deficient *tri* mutation results in a plant which is extremely tall in WL. No differences in phyA polypeptide (PHYA) and phyB-like polypeptide (PHYB) compared to WT were observed in extracts of etiolated seedlings of Z3-78 (data not shown). It is obvious that other alleles at the Z3-78 locus should be picked up in our mutagenesis screens starting with the *fri,tri* double mutant under WL. The *CRY1* and *CRY2* genes which encode B photoreceptors involved in hypocotyl growth and anthocyanin biosynthesis have been cloned from *Arabidopsis* and have been shown to encode a photolyase-like protein which has pterin and flavin chromophores (Ahmad and Cashmore, 1993; 1996; Batschauer, 1996). Recently the *CRY1* homologue in tomato has been cloned (G. Guiliano, pers. comm.). In addition, the putative B/UV-A photoreceptor mutants for the phototropic photoreceptor (*nph1*) should soon be cloned (Liscum and Briggs, 1995).

### 9.3 Phytochrome signal transduction

Mutants with deficiencies in phytochrome signal transduction would be very helpful in elucidating the mechanisms of phytochrome action. One group of loss-of-function mutants have some aspects of the phenotype of light-grown plants when grown in the D. Amongst these are *COP*, *DET* and *FUS* loci of *Arabidopsis* (Chory, 1993; Deng, 1994; Miséra *et al.*, 1994) which are involved in suppressing photomorphogenic development in D (Kwok *et al.*, 1996). Consistent with a wide-



spread evolution of *COP/DET/FUS*-like functions, a *lip* mutant in pea has been described (Frances *et al.*, 1992). On the basis of the recessive nature of these mutations and their pleiotropic phenotype, it has been proposed that the photomorphogenic pathway constitutes the default route of development, whereas the etiolation pathway is an relatively recent evolutionary adaptation pioneered by the angiosperms to exhibit etiolation in D (Wei *et al.*, 1994b; Von Arnim and Deng, 1996). However, for certain light-regulated processes the pleiotropic *COP/DET/FUS* loci are not required, because some mutants of these loci seem to retain normal phytochrome control of seed germination (Deng *et al.*, 1991; Wei *et al.*, 1994b; Kwok *et al.*, 1996). It seems that one of the first functions of the phytochrome signalling cascade may be to de-repress light-regulated development by inactivating such master repressors as the *COP/DET/FUS* proteins. Although an equivalent was found in pea (Frances *et al.*, 1992), no similar phenotypes were found in tomato in D screens following ethyl methane sulphonate (EMS) mutagenesis (A. van Tuinen and M. Koornneef, pers. comm.). Recently, the *Arabidopsis COP1* homologous genes have been cloned and are being characterized in rice, spinach and tomato (Frances *et al.*, 1996; Tsuge *et al.*, 1996).

The HD (homeodomain) proteins encoded by *HB* (homeobox) genes are important in regulating developmental processes in animals, and have recently also been found in plants. These HD proteins bind specific DNA sequences and regulate transcription of their target genes. The *Arabidopsis thaliana* homeobox (*ATHB*) genes encode proteins, which contain the leucine zipper dimerization motif (*Zip*) (Sessa *et al.*, 1993). Two members of the HD-*Zip* family (*ATHB-2* and *ATHB-4*) show a strong, rapid increase in their mRNA abundance when treated with FR (Carabelli *et al.*, 1993) indicating that light quality (changes in R:FR ratio) rather than light-dark transition regulates the expression of these genes. These changes normally occur at dawn and dusk, and also during the day under the canopy (shade avoidance). Recently, it was demonstrated that a phytochrome other than A and B plays a role in the expression of *ATHB-2* (Carabelli *et al.*, 1996). This rapid change could be a reflection of a component of the signal transduction chain involved in the shade-avoidance response which includes the rapid cessation of anthocyanin biosynthesis in the young growing leaves (Chapter 6). It is likely that these two *HB* genes, *ATHB-2* and *ATHB-4* (Carabelli *et al.*, 1993) and one other light-induced *HB* gene (*ATH1*), which was derepressed in D-grown *cop1* and *det1* mutants (Quaedvlieg *et al.*, 1995), may act as downstream effectors of the *COP/DET/FUS* proteins (Von Arnim and Deng, 1996).

Light signals and plant hormones control an overlapping set of processes in seedling growth and development. Both light and gibberellins control hypocotyl elongation (Rood *et al.*, 1990; Beall *et al.*, 1991; Foster *et al.*, 1994; Weller *et al.*, 1994; López-Juez *et al.*, 1995; Reed *et al.*, 1996; Sponsel *et al.*, 1996). Also auxins have been implicated in mediating phytochrome responses (Law and Davies, 1990; Jones *et al.*, 1991; Behringer and Davies, 1992; Kraepiel *et al.*,

1995). External stimuli can induce some aspects of photomorphogenesis in *D. Chory et al.* (1994) reported that cytokinins, when applied to D-germinated *Arabidopsis*, enabled the WT seedlings to display some phenotypic features of *det1* mutants. However, endogenous cytokinin levels in D and light-grown seedlings and in *det1* and *det2* mutants were not consistent with the notion that light signals are transmitted simply by a change in cytokinin concentration. Furthermore an additive and probably independent co-action of cytokinin and light has been demonstrated for the control of hypocotyl elongation (Su and Howell, 1995). Recently Li *et al.* (1996) established that the *Arabidopsis* *DET2* gene encodes a reductase in the brassinolide biosynthetic pathway. It seems that this distinct new class of phytohormones has an important role in light-regulated development in higher plants (Szeekeres *et al.*, 1996).

The cascade of events following the amplification of the perceived signal is still a black box and is largely undefined (Bowler and Chua, 1994; Millar *et al.*, 1994; Chamovitz and Deng, 1996; Chapter 1). However, numerous reports have suggested an involvement of phosphorylation in phytochrome responses and that kinases and phosphatases are important in various steps of the signal transduction pathway leading from light perception to photomorphogenesis. There are indications that phytochrome itself functions as a kinase (Wong and Lagarias, 1989; Wong *et al.*, 1989; Roux, 1994; Lagarias *et al.*, 1996). It appears that phytochrome from the moss *Ceratodon* possesses kinase activity in a fused 300-amino acid C-terminal domain (Thümmler *et al.*, 1992; Algarra *et al.*, 1993). So far, no higher plant *PHYs* have been found that encode such protein kinase fusions, but the possibility that the kinase domain became separated from phytochrome during evolution is appealing. If so, it is possible that each of the various phytochromes has its own associated kinase, which is selectively activated by light. Such an organization would clearly facilitate the ability of each phytochrome to act independently in regulating photomorphogenesis (Vierstra, 1993). However, despite the detection of protein kinase activity that co-purifies with *phyA* (Kim *et al.*, 1989; Grimm *et al.*, 1989), conclusive evidence that phytochrome has intrinsic protein kinase activity is still awaited. There is also extensive evidence that  $Ca^{2+}$  (Bossen, 1990; Tretyan *et al.*, 1991; Shacklock *et al.*, 1992) and heterotrimeric G-proteins (Romero *et al.*, 1991; Romero and Lam, 1993; Kaufman, 1994) are involved in phytochrome responses.

A model combining several classic signalling molecules, such as heterotrimeric G-proteins,  $Ca^{2+}$ , and cGMP in a phytochrome signal transduction cascade has emerged from a series of novel single-cell micro-injection studies in the hypocotyl cells of the tomato *au* mutant (Neuhaus *et al.*, 1993; Bowler *et al.*, 1994a; 1994b). Chloroplast development, anthocyanin accumulation and expression of a photoregulated *CAB*- $\beta$ -glucuronidase (GUS) reporter gene were monitored after injection of purified oat *phyA* in combination with inhibitors, activators, and putative signalling compounds. This has led to a model, in which *PHYA*

photoconversion leads to activation of a heterotrimeric G-protein(s) in a cell autonomous way (restricted to the injected cell). This in turn activates three subsequent pathways: (i) a cGMP pathway, leading to anthocyanin accumulation; (ii) a  $\text{Ca}^{2+}$  dependent pathway acting *via* calmodulin, resulting in the biogenesis of chloroplasts; (iii) a  $\text{Ca}^{2+}$ -calmodulin/cGMP pathway, leading to fully mature chloroplasts (Neuhaus *et al.*, 1993; Bowler *et al.*, 1994a; 1994b; see Fig. 1.2). Since G-protein activation is the earliest event in the proposed pathway, heterotrimeric G-proteins remain likely to be close to or part of a hypothetical phytochrome receptor. A number of G-protein genes have been cloned in *Arabidopsis*, maize and tomato (e.g. Ma *et al.*, 1990; 1991; Weiss *et al.*, 1994; Redhead and Palme, 1996). Many G-proteins are membrane-associated and coupled to transmembrane receptors (Chang *et al.*, 1993; Neer, 1995; Millner and Causier, 1996), suggesting the requirement for additional components to couple the relatively hydrophilic phytochrome molecule or its signal upon photoconversion to the G-protein (Elich and Chory, 1994). The aforementioned micro-injection studies of Neuhaus *et al.* (1993) and Bowler *et al.* (1994a; 1994b) provide an important contribution in the elucidation of the phytochrome-signalling pathways. However, due to the leaky nature of the *au* mutation (Terry and Kendrick, 1996; Van Tuinen *et al.*, 1996a), it is difficult to determine the direct effect of the micro-injected non-native phyA from its interaction with residual native phyB1 in the process of anthocyanin accumulation. Another puzzling result is the fact that micro-injected phyA elicited the anthocyanin response in epidermal cells (Neuhaus *et al.*, 1993), which in the WT is a response restricted to the subepidermal layer. Therefore one must be careful about extending conclusions from non-natural responses to the mechanisms of endogenous phytochrome signalling pathways. Additional studies using phyB1 would be of great interest, because phyB1 is responsible for a significant proportion of anthocyanin biosynthesis occurring in seedlings in R (Chapter 4). Recently, Kunkel *et al.* (1996) failed to induce anthocyanin biosynthesis by micro-injection of phyB in the *au* mutant, although it did induce chloroplast development. This raises the question as to why this is the case, when in the present work it is shown that phyB1 plays an important role in anthocyanin biosynthesis. One possible explanation is that excitation of additional phytochromes, which are also deficient in the *au* mutant, are required for the anthocyanin response.

In addition, it is clear that many plant growth and developmental processes that are regulated by phytochrome are also influenced by other factors such as environmental conditions, stress, hormones, etc. It seems likely that signalling components like  $\text{Ca}^{2+}$ , cGMP, and G-proteins will be involved in numerous pathways in plants as they are in animals, which emphasize that caution should be taken in analyzing responses by pharmacological approaches (Elich and Chory, 1994). However, micro-injection of phyA and phyB into the *fri, tri* double mutant

would be very helpful in further understanding the nature of the interaction between these two phytochrome species in tomato.

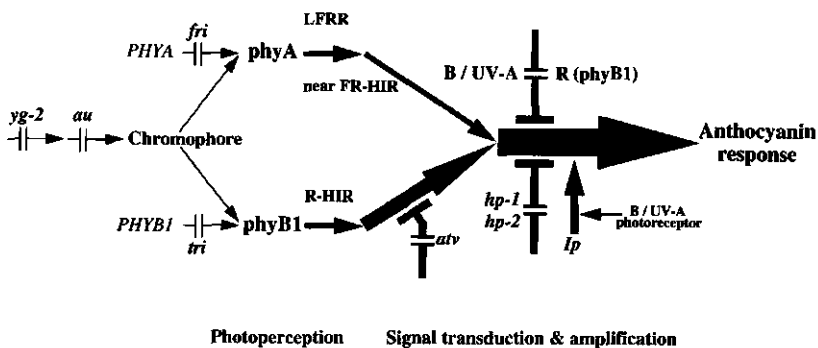
Another approach to understand the function of phytochrome is to investigate the structure of the phytochrome molecule. Domain-swapping experiments revealed the determinants of the photosensory specificity of phyA and phyB toward continuous R and FR to be in the NH<sub>2</sub>-terminal half, whereas the COOH-terminal domain carries determinants necessary for execution of phytochrome regulatory activity (Quail *et al.*, 1995). Present findings suggest that the contrasting photosensory information gathered by phyA and phyB through their NH<sub>2</sub>-terminal domain may be transduced to downstream signalling components through a common biochemical mechanism involving the regulatory activity of the COOH-terminal domains (Wagner *et al.*, 1996a). Interestingly, modification of amino acids near the NH<sub>2</sub>-terminus have been shown to enhance the activity of a phytochrome when overexpressed in plants (Stockhaus *et al.*, 1992; Vierstra *et al.*, 1996). Recently, evidence has been presented that the phyB molecule contains putative nuclear localization signals within its COOH-terminal region, which enable it to be targeted to the nucleus in its Pfr form (Nagatani and Sakamoto, 1996).

#### 9.4 Co-action of photoreceptors and signal amplification

It is possible that mutants lacking or having a defective photoreceptor would be considerably disadvantaged in the natural environment. It is predicted that a seedling that can anticipate the soil surface a few millimeters beneath it is at an advantage in that it can start to prepare itself for the light environment before its food reserves become limiting. It therefore appears that many of the responses that we study in the laboratory with specific spectral regimes where we induce saturation of the de-etiolation process are largely artifactual from the point of view of a plant in nature approaching the soil surface. Under such conditions it is possible to envisage the selective advantage for development of multiple photoreceptors, capable of perceiving light throughout the daylight spectrum to control this critical change in the growth strategy of a plant. In the natural environment, unlike in the laboratory, the process of de-etiolation appears to be achieved with the help of several photoreceptors, no one being saturated. A role for phyA *via* the FR-HIR has been shown to be important for seedling establishment under dense canopies on the basis of studies using phyA-deficient mutants (Yanovsky *et al.*, 1995). Once emerged into the light environment it appears that phyA is largely redundant and phyB takes over a major role in the detection of vegetational shade. Only future research will reveal the possible secret roles of other phytochromes and B photoreceptors during the life cycle of a plant. The analysis of plants with deficiencies or overexpression of these remaining

phytochromes will be of great importance to answer these questions. The possibility exists of making plants tolerant to vegetational shade by producing transgenic lines overexpressing phytochromes. This promising biotechnological technique could improve yields by preventing the undesirable shade-avoidance reaction when plants are grown at higher densities in field studies (Robson *et al.*, 1996; Quail, 1996).

Juvenile anthocyanin (Drumm-Herrel, 1987) is proposed to act as a photoprotectant. It is formed as a response to many different stimuli, not only to light, but also to elicitors, general stress and hormones (Mol *et al.*, 1996). The light-dependent anthocyanin biosynthesis is an attractive model system to study the mechanism(s) of photoregulation and possible interaction of different photoreceptors with phytochrome (Mancinelli, 1985). Using a genetic approach, we have shown that *phyA* and *phyB1* are responsible for the anthocyanin accumulation, in the LFRR and the HIR, respectively (Chapter 4). The exaggerated photoresponse mutants have a pleiotropic phenotype which includes an amplified anthocyanin response (Chapter 5). The data in this thesis provides evidence for a complex series of interactions between photoreceptors leading to anthocyanin biosynthesis. Signals derived from *phyA* and *phyB1* account for all of the anthocyanin which accumulates under R as shown in Figure 9.2. The *HP-1* and *HP-2* genes are proposed to encode or regulate the formation of a repressor which acts at a common point in the signal from *phyA* and *phyB1* signal transduction chains which could be a key reaction in flavonoid biosynthetic pathway. The *ATV* gene product appears to be associated specifically with the *phyB1* pathway, whilst *IP* appears to a repressor of B-dependent phytochrome signal amplification.



**Figure 9.2.** Schematic diagram summarizing the assignment of components of the anthocyanin accumulation response to individual phytochromes in tomato seedlings. Arrows indicate the signal transduction chains of *phyA* and *phyB1*, which are blocked in the *fri* and *tri* mutants, respectively. The large arrow indicates signal amplification. The flat-ended lines represent repressors of the signal amplification steps. The proposed action of the exaggerated-photoresponse mutants, based on their recessive nature for *hp-1*, *hp-2* and *atv* and dominant nature for *Ip* mutations is indicated. In addition, response amplification is stimulated *via* action of both *phyB1* and B/UV-A. Mutants deficient in phytochrome chromophore biosynthesis (*au* and *yg-2*) lead to reduction in response due to a deficiency of *phyA* and *phyB1*.

Attempts to clone *HP-1* (J.J. Giovannoni, pers. comm.) and *HP-2* (C. Bowler, pers. comm.) are in progress. Cloning of *ATV* and *IP* would also be of great interest. During the next few years great advances are anticipated in our understanding of the steps involved in signal transduction and amplification.

## **9.5 Future research**

Priority for future research should be to determine how light signals are perceived by distinct photoreceptors and are integrated to control cellular development and differentiation. A comprehensive understanding will not only reveal the components involved, but also how they interact with other stimuli, such as hormones, to reach an accurate response to subtle light signals in the natural environment. Many decisions taken are not simply all-or-none, but are quantitative in nature. Physiological studies will play an increasingly greater role in understanding these processes, utilizing the mutant and transgenic plants produced by molecular biologists and geneticists. To achieve a global picture of photomorphogenesis studies on species in addition to *Arabidopsis* are advisable. To this end, the work presented in this thesis reveals an insight into the photomorphogenesis of tomato.

# References

- Abe, H., K.T. Yamamoto, A. Nagatani and M. Furuya (1985). Characterization of green tissue-specific phytochrome isolated immunochemically from pea seedlings. *Plant Cell Physiol.* **26**: 1387–1399.
- Abe, H., K. Takio, K. Titani and M. Furuya (1989). Amino-terminal amino acid sequences of pea phytochrome II fragments obtained by limited proteolysis. *Plant Cell Physiol.* **30**: 1089–1097.
- Adam, E., M. Deak, S. Kay, N.-H. Chua and F. Nagy (1993). Sequence of a tobacco (*Nicotiana tabacum*) gene coding for type A phytochrome. *Plant Physiol.* **101**: 1407–1408.
- Adam, E., M. Szell, M. Szekeres, E. Schäfer and F. Nagy (1994). The developmental and tissue-specific expression of tobacco phytochrome-A genes. *Plant J.* **6**: 283–293.
- Adam, E., L. Kozma-Bognar, C. Kolar, E. Schäfer and F. Nagy (1996). The tissue-specific expression of a tobacco phytochrome B gene. *Plant Physiol.* **110**: 1081–1088.
- Adamse, P., P.A.P.M. Jaspers, R.E. Kendrick and M. Koornneef (1987). Photomorphogenetic responses of a long hypocotyl mutant of *Cucumis sativus* L. *J. Plant Physiol.* **127**: 481–491.
- Adamse, P. (1988). *Mutants as an Aid to the Study of Higher Plant Photomorphogenesis*. PhD-thesis, Wageningen Agricultural University, Wageningen, The Netherlands.
- Adamse, P., P.A.P.M. Jaspers, J.A. Bakker, J.C. Wesselius, G.H. Heeringa, R.E. Kendrick and M. Koornneef (1988). Photophysiology of a tomato mutant deficient in labile phytochrome. *J. Plant Physiol.* **133**: 436–440.
- Adamse, P., J.L. Peters, P.A.P.M. Jaspers, A. van Tuinen, M. Koornneef and R.E. Kendrick (1989). Photocontrol of anthocyanin synthesis in tomato seedlings: a genetic approach. *Photochem. Photobiol.* **50**: 107–111.
- Ahmad, M. and A.R. Cashmore (1993). *HY4* gene of *A. thaliana* encodes a protein with characteristics of a blue-light photoreceptor. *Nature* **366**: 162–166.
- Ahmad, M. and A.R. Cashmore (1996). Seeing blue: the discovery of cryptochrome. *Plant Mol. Biol.* **30**: 851–861.
- Algarra, P., S. Linder and F. Thümmler (1993). Biochemical evidence that phytochrome of the moss *Ceratodon purpureus* is a light-regulated protein kinase. *FEBS Lett.* **315**: 69–73.
- Anderson, D.B. and T. Kerr (1943). A note on the growth behavior of cotton bolls. *Plant Physiol.* **18**: 261–269.
- Ang, L.-H. and X.-W. Deng (1994). Regulatory hierarchy of photomorphogenic loci: allele-specific and light-dependent interaction between the *HY5* and *COP1* loci. *Plant Cell* **6**: 613–628.
- Assaad Ibrahim, C., A. Lecharny and B. Millet (1981). Circadian endogenous growth rhythm in tomato. *Plant Physiol.* **67** (Suppl.): 113.
- Bagnall, D.J., R.W. King, G.C. Whitelam, M.T. Boylan, D. Wagner and P.H. Quail (1995). Flowering responses to altered expression of phytochrome in mutants and transgenic lines of *Arabidopsis thaliana* (L.) Heynh. *Plant Physiol.* **108**: 1495–1503.
- Baker, L.R. and M.L. Tomes (1964). Carotenoids and chlorophylls in two tomato mutants and their hybrid. *Proc. Amer. Soc. Hort. Sci.* **85**: 507–513.
- Ballaré, C.L., R.A. Sánchez, A.L. Scopel, J.J. Casal and C.M. Ghersa (1987). Early detection of neighbour plants by phytochrome perception of spectral changes in reflected sunlight. *Plant Cell Environ.* **10**: 551–557.
- Ballaré, C.L., A.L. Scopel and R.A. Sánchez (1990). Far-red radiation reflected from adjacent leaves: an early signal of competition in plant canopies. *Science* **247**: 329–332.
- Barnes, S.A., N.K. Nishizawa, R.B. Quaggio, G.C. Whitelam and N.-H. Chua (1996). Far-red light blocks greening of *Arabidopsis* seedlings via a phytochrome A-mediated change in plastid development. *Plant Cell* **8**: 601–615.
- Bartholomew, E.T. (1926). Internal decline of lemons III. Water deficit in lemon fruits caused by excessive leaf evaporation. *Am. J. Bot.* **13**: 102–117.
- Baskin, T.I., M. Iino, P.B. Green and W.R. Briggs (1985). High-resolution measurement of growth during first positive phototropism in maize. *Plant Cell Environ.* **8**: 595–603.
- Batschauer, A., P.M. Gilmartin, F. Nagy and E. Schäfer (1994). The molecular biology of photoregulated genes. In: *Photomorphogenesis in Plants*, 2nd Ed. (Edited by R.E. Kendrick and G.H.M. Kronenberg), pp. 559–599. Kluwer Academic Publishers, Dordrecht, The Netherlands.
- Batschauer, A. (1996). Photolyases and related proteins – Their role in DNA-repair and blue/UV-A light perception. In: *Book of Abstracts*, S195. 12th International Congress on Photobiology, Vienna, Austria.

## References

- Beall, F.D., P.W. Morgan, L.N. Mander, F.R. Miller and K.H. Babb (1991). Genetic regulation of development in *Sorghum bicolor*. V. The  $ma_3^R$  allele results in gibberellin enrichment. *Plant Physiol.* **95**: 116–125.
- Becker, T.W., C. Foyer and M. Caboche (1992). Light-regulated expression of the nitrate-reductase and nitrite-reductase genes in tomato and in the phytochrome-deficient *aurea* mutant of tomato. *Planta* **188**: 39–47.
- Beggs, C.J., M.G. Holmes, M. Jabben and E. Schäfer (1980). Action spectra for the inhibition of hypocotyl growth by continuous irradiation in light and dark-grown *Sinapis alba* L. seedlings. *Plant Physiol.* **66**: 615–618.
- Beggs, C.J. and E. Wellmann (1985). Analysis of light-controlled anthocyanin formation in coleoptiles of *Zea mays* L.: the role of UV-B, blue, red and far-red light. *Photochem. Photobiol.* **41**: 481–486.
- Behringer, F.J., P.J. Davies and J.B. Reid (1990). Genetic analysis of the role of gibberellin in the red light inhibition of stem elongation in etiolated seedlings. *Plant Physiol.* **94**: 432–439.
- Behringer, F.J. and P.J. Davies (1992). Indole-3-acetic acid levels after phytochrome-mediated changes in the stem elongation rate of dark- and light-grown *Pisum* seedlings. *Planta* **188**: 85–92.
- Bertram, L. and P. Karlens (1994a). Patterns in stem elongation rate in chrysanthemum and tomato plants in relation to irradiance and day/night temperature. *Sci. Hort.* **58**: 139–150.
- Bertram, L. and P. Karlens (1994b). A comparison study on stem elongation of several greenhouse plants. *Sci. Hort.* **59**: 265–274.
- Bertram, L. and B. Lercari (1996). The use of UV radiation to control the architecture of *Salvia splendens* plants. II. Relationships between PAR levels and UV radiation in the photoregulation of stem elongation. *Photochem. Photobiol.* **64**: 131–136.
- Blaauw, O.H., G. Blaauw-Jansen and W.J. van Leeuwen (1968). An irreversible red-light-induced growth response in *Avena*. *Planta* **82**: 87–104.
- Borthwick, H.A., S.B. Hendricks, M.W. Parker, E.H. Toole and V.K. Toole (1952a). A reversible photoreaction controlling seed germination. *Proc. Natl. Acad. Sci. USA* **38**: 662–666.
- Borthwick, H.A., S.B. Hendricks and M.W. Parker (1952b). The reaction controlling floral initiation. *Proc. Natl. Acad. Sci. USA* **38**: 929–934.
- Borthwick, H.A., S.B. Hendricks, E.H. Toole and V.K. Toole (1954). Action of light on lettuce-seed germination. *Bot. Gaz.* **115**: 205–225.
- Borthwick, H.A. and S.B. Hendricks (1960). Photoperiodism in plants. *Science* **132**: 1223–1228.
- Bossen, M.E. (1990). *Plant Protoplasts as a Model System to Study Phytochrome-Regulated Changes in the Plasma Membrane*. PhD-thesis, Wageningen Agricultural University, Wageningen, The Netherlands.
- Botto, J.F., R.A. Sánchez and J.J. Casal (1995). Role of phytochrome B in the induction of seed germination by light in *Arabidopsis thaliana*. *J. Plant Physiol.* **146**: 307–312.
- Botto, J.F., R.A. Sánchez, G.C. Whitelam and J.J. Casal (1996). Phytochrome A mediates the promotion of seed germination by very low fluences of light and canopy shade light in *Arabidopsis*. *Plant Physiol.* **110**: 439–444.
- Bowler, C. and N.-H. Chua (1994). Emerging themes of plant signal transduction. *Plant Cell* **6**: 1529–1541.
- Bowler, C., G. Neuhaus, H. Yamagata and N.-H. Chua (1994a). Cyclic GMP and calcium mediate phytochrome phototransduction. *Cell* **77**: 73–81.
- Bowler, C., H. Yamagata, G. Neuhaus and N.-H. Chua (1994b). Phytochrome signal transduction pathways are regulated by reciprocal control mechanisms. *Genes Dev.* **8**: 2188–2202.
- Boylan, M.T. and P.H. Quail (1989). Oat phytochrome is biologically active in transgenic tomatoes. *Plant Cell* **1**: 765–773.
- Boylan, M.T. and P.H. Quail (1991). Phytochrome A overexpression inhibits hypocotyl elongation in transgenic *Arabidopsis*. *Proc. Natl. Acad. Sci. USA* **88**: 10806–10810.
- Brady, C.J. (1987). Fruit ripening. *Ann. Rev. Plant Physiol.* **38**: 155–178.
- Brockmann, J. and E. Schäfer (1982). Analysis of  $P_{fr}$  destruction in *Amaranthus caudatus* L. – Evidence for two pools of phytochrome. *Photochem. Photobiol.* **35**: 555–558.
- Butler, W.L., K.H. Norris, H.W. Siegelman and S.B. Hendricks (1959). Detection, assay, and preliminary purification of the pigment controlling photoresponsive development of plants. *Proc. Natl. Acad. Sci. USA* **45**: 1703–1708.
- Butler, W.L. and H.C. Lane (1965). Dark transformations of phytochrome in vivo. II. *Plant Physiol.* **40**: 13–17.



- Cabrera y Poch, H.L., C.A. Peto and J. Chory (1993). A mutation in the *Arabidopsis* *DET3* gene uncouples photoregulated leaf development from gene expression and chloroplast biogenesis. *Plant J.* **4**: 671–682.
- Carabelli, M., G. Sessa, S. Baima, G. Morelli and I. Ruberti (1993). The *Arabidopsis* *Athb-2* and *-4* genes are strongly induced by far-red-rich light. *Plant J.* **4**: 469–479.
- Carabelli, M., U. Borello, G. Morelli, G. Whitelam and I. Ruberti (1996). Twilight-zone and canopy shade induction of the *Athb-2* homeobox gene in green plants. In: *Book of Abstracts*, P196. 7th International Conference on Arabidopsis Research, Norwich, UK.
- Casal, J.J. and H. Smith (1988). Persistent effects of changes in phytochrome status on internode growth in light-grown mustard: occurrence, kinetics and locus of perception. *Planta* **175**: 214–220.
- Casal, J.J. and H. Smith (1989). The function, action and adaptive significance of phytochrome in light-grown plants. *Plant Cell Environ.* **12**: 855–862.
- Casal, J.J. and R.E. Kendrick (1993). Impaired phytochrome-mediated shade-avoidance responses in the *aurea* mutant of tomato. *Plant Cell Environ.* **16**: 703–710.
- Casal, J.J. and H. Boccalandro (1995). Co-action between phytochrome B and HY4 in *Arabidopsis thaliana*. *Planta* **197**: 213–218.
- Casal, J.J., R.C. Clough and R.D. Vierstra (1996). High-irradiance responses induced by far-red light in grass seedlings of the wild type or overexpressing phytochrome A. *Planta* **200**: 132–137.
- Castle, L.A. and D.W. Meinke (1994). A *FUSCA* gene of *Arabidopsis* encodes a novel protein essential for plant development. *Plant Cell* **6**: 25–41.
- Chamovitz, D.A. and X.-W. Deng (1996). Light signaling in plants. *Critical Rev. Plant Sci.* **15**: 455–478.
- Chang, C., S.F. Kwok, A.B. Bleecker and E.M. Meyerowitz (1993). *Arabidopsis* ethylene-response gene *ETR1*: similarity of product to two-component regulators. *Science* **262**: 539–544.
- Chaudhury, A.M., S. Letham, S. Craig and E.S. Dennis (1993). *amp1* – a mutant with high cytokinin levels and altered embryonic pattern, faster vegetative growth, constitutive photomorphogenesis and precocious flowering. *Plant J.* **4**: 907–916.
- Cherry, J.R., H.P. Hershey and R.D. Vierstra (1991). Characterization of tobacco expressing functional oat phytochrome. Domains responsible for the rapid degradation of Pfr are conserved between monocots and dicots. *Plant Physiol.* **96**: 775–785.
- Child, R. and H. Smith (1987). Phytochrome action in light-grown mustard: kinetics, fluence-rate compensation and ecological significance. *Planta* **172**: 219–229.
- Childs, K.L., L.H. Pratt and P.W. Morgan (1991). Genetic regulation of development in *Sorghum bicolor*. VI. The *ma<sub>3</sub><sup>R</sup>* allele results in abnormal phytochrome physiology. *Plant Physiol.* **97**: 714–719.
- Childs, K.L., M.-M. Cordonnier-Pratt, L.H. Pratt and P.W. Morgan (1992). Genetic regulation of development in *Sorghum bicolor*. VII. *ma<sub>3</sub><sup>R</sup>* flowering mutant lacks a phytochrome that predominates in green tissue. *Plant Physiol.* **99**: 765–770.
- Childs, K.L., P.W. Morgan, F.R. Miller, L.H. Pratt, M.-M. Cordonnier-Pratt and J.E. Mullet (1996). The *Sorghum bicolor* photoperiod sensitivity gene, *Ma<sub>3</sub>*, encodes a phytochrome B. *Plant Physiol.* **111** (Suppl.): 45.
- Chory, J., C.A. Peto, M. Ashbaugh, R. Saganich, L. Pratt and F. Ausubel (1989a). Different roles for phytochrome in etiolated and green plants deduced from characterization of *Arabidopsis thaliana* mutants. *Plant Cell* **1**: 867–880.
- Chory, J., C. Peto, R. Feinbaum, L. Pratt and F. Ausubel (1989b). *Arabidopsis thaliana* mutant that develops as a light-grown plant in the absence of light. *Cell* **58**: 991–999.
- Chory, J. and C.A. Peto (1990). Mutations in the *DET1* gene affect cell-type-specific expression of light-regulated genes and chloroplast development in *Arabidopsis*. *Proc. Natl. Acad. Sci. USA* **87**: 8776–8780.
- Chory, J., P. Nagpal and C.A. Peto (1991). Phenotypic and genetic analysis of *det2*, a new mutant that affects light-regulated seedling development in *Arabidopsis*. *Plant Cell* **3**: 445–459.
- Chory, J. (1992). A genetic model for light-regulated seedling development in *Arabidopsis*. *Development* **115**: 337–354.
- Chory, J. (1993). Out of darkness: mutants reveal pathways controlling light-regulated development in plants. *Trends Genet.* **9**: 167–172.
- Chory, J., D. Reinecke, S. Sim, T. Washburn and M. Brenner (1994). A role for cytokinins in etiolation in *Arabidopsis*. *det* mutants have an altered response to cytokinins. *Plant Physiol.* **104**: 339–347.

## References

- Christ, R.A. (1978). The elongation rate of wheat leaves. II. Effect of sudden light change on the elongation rate. *J. Exp. Bot.* **29**: 611–618.
- Christensen, A.H. and P.H. Quail (1989). Structure and expression of a maize phytochrome-encoding gene. *Gene* **85**: 381–390.
- Christie, J.M. and G.I. Jenkins (1996). Distinct UV-B and UV-A/blue light signal transduction pathways induce chalcone synthase gene expression in Arabidopsis cells. *Plant Cell* **8**: 1555–1567.
- Clack, T., S. Mathews and R.A. Sharrock (1994). The phytochrome apoprotein family in Arabidopsis is encoded by five genes: the sequences and expression of *PHYD* and *PHYE*. *Plant Mol. Biol.* **25**: 413–427.
- Colbert, J.T. (1991). Regulation of type I phytochrome mRNA abundance. *Physiol. Plant.* **82**: 327–332.
- Corré, W.J. (1983). Growth and morphogenesis of sun and shade plants II. The influence of light quality. *Acta Bot. Neerl.* **32**: 185–202.
- Correll, D.L., J.L. Edwards and W. Shropshire Jr. (1977). *Phytochrome: A Bibliography with Author, Biological Materials, Taxonomic, and Subject Indexes of Publications Prior to 1975*. Smithsonian Institution Press, Washington D.C., USA.
- Cosgrove, D.J. (1981a). Rapid suppression of growth by blue light. Occurrence, time course, and general characteristics. *Plant Physiol.* **67**: 584–590.
- Cosgrove, D.J. (1981b). Analysis of the dynamic and steady-state responses of growth rate and turgor pressure to changes in cell parameters. *Plant Physiol.* **68**: 1439–1446.
- Cosgrove, D.J. (1994). Photomodulation of growth. In: *Photomorphogenesis in Plants*, 2nd Ed. (Edited by R.E. Kendrick and G.H.M. Kronenberg), pp. 631–658. Kluwer Academic Publishers, Dordrecht, The Netherlands.
- De Lint, P.J.A.L. (1960). An attempt to analysis of the effect of light on stem elongation and flowering in *Hyoscyamus niger* L. *Meded. Landbouwhogeschool Wageningen* **60** (14): 1–59.
- Dehesh, K., J. Tepperman, A.H. Christensen and P.H. Quail (1991). *phyB* is evolutionarily conserved and constitutively expressed in rice seedling shoots. *Mol. Gen. Genet.* **225**: 305–313.
- Dehesh, K., C. Franci, B.M. Parks, K.A. Seeley, T.W. Short, J.M. Tepperman and P.H. Quail (1993). Arabidopsis *HY8* locus encodes phytochrome A. *Plant Cell* **5**: 1081–1088.
- Deng, X.-W., T. Caspar and P.H. Quail (1991). *cop1*: a regulatory locus involved in light-controlled development and gene expression in Arabidopsis. *Genes Dev.* **5**: 1172–1182.
- Deng, X.-W. and P.H. Quail (1992). Genetic and phenotypic characterization of *cop1* mutants of Arabidopsis thaliana. *Plant J.* **2**: 83–95.
- Deng, X.-W. (1994). Fresh view of light signal transduction in plants. *Cell* **76**: 423–426.
- Desnos, T., V. Orbović, C. Bellini, J. Kronenberger, M. Caboche, J. Traas and H. Höfte (1996). *Procuste1* mutants identify two distinct genetic pathways controlling hypocotyl cell elongation, respectively in dark- and light-grown Arabidopsis seedlings. *Development* **122**: 683–693.
- Devlin, P.F., S.B. Rood, D.E. Somers, P.H. Quail and G.C. Whitelam (1992). Photophysiology of the elongated internode (*ein*) mutant of Brassica rapa. *ein* mutant lacks a detectable phytochrome B-like polypeptide. *Plant Physiol.* **100**: 1442–1447.
- Devlin, P.F., K.J. Halliday, N.P. Harberd and G.C. Whitelam (1996). Novel phytochromes control flowering and internode elongation responses in Arabidopsis *phyA phyB* mutants. In: *Book of Abstracts*, S61. 7th International Conference on Arabidopsis Research, Norwich, UK.
- Downs, R.J. (1955). Photoreversibility of leaf and hypocotyl elongation of dark grown red kidney bean seedlings. *Plant Physiol.* **30**: 468–473.
- Downs, R.J., S.B. Hendricks and H.A. Borthwick (1957). Photoreversible control of elongation of Pinto beans and other plants under normal conditions of growth. *Bot. Gaz.* **118**: 199–208.
- Drumm-Herrel, H. and H. Mohr (1982). The effect of prolonged light exposure on the effectiveness of phytochrome in anthocyanin synthesis in tomato seedlings. *Photochem. Photobiol.* **35**: 233–236.
- Drumm-Herrel, H. (1987). Blue light control of pigment biosynthesis – Anthocyanin biosynthesis. In: *Blue Light Responses: Phenomena and Occurrence in Plants and Microorganisms*, Vol. 1. (Edited by H. Senger), pp. 65–74. CRC Press, Florida, USA.
- Ecker, J.R. (1995). The ethylene signal transduction pathway in plants. *Science* **268**: 667–675.
- Edgerton, M.D. and A.M. Jones (1992). Localization of protein-protein interactions between subunits of phytochrome. *Plant Cell* **4**: 161–171.
- Edwards, R.A. and F.H. Reuter (1967). Pigment changes during the maturation of tomato fruit. *Food Technol. Austral.* **19**: 352–357.

- Elich, T.D. and J. Chory (1994). Initial events in phytochrome signalling: still in the dark. *Plant Mol. Biol.* **26**: 1315–1327.
- Flint, L.H. and E.D. McAlister (1935). Wave lengths of radiation in the visible spectrum inhibiting the germination of light-sensitive lettuce seed. *Smithson. Misc. Collect.* **94**: 1–11.
- Folch, J., M. Lees and G.H.S. Stanley (1957). A simple method for the isolation and purification of total lipides from animal tissues. *J. Biol. Chem.* **226**: 496–509.
- Foster, K.R., F.R. Miller, K.L. Childs and P.W. Morgan (1994). Genetic regulation of development in *Sorghum bicolor*. VIII. Shoot growth, tillering, flowering, gibberellin biosynthesis, and phytochrome levels are differentially affected by dosage of the *ma<sub>3</sub><sup>R</sup>* allele. *Plant Physiol.* **105**: 941–948.
- Fox, M.D. and L.G. Puffer (1976). Analysis of transient plant movements by holographic interferometry. *Nature* **261**: 488–490.
- Frances, S., M.J. White, M.D. Edgerton, A.M. Jones, R.C. Elliott and W.F. Thompson (1992). Initial characterization of a pea mutant with light-independent photomorphogenesis. *Plant Cell* **4**: 1519–1530.
- Frances, S., T. Tsuge, M. Matsui, X.-W. Deng and R.E. Kendrick (1996). Characterization of *CONSTITUTIVE PHOTOMORPHOGENESIS 1 (COP1)* homologues of tomato and rice. In: *Book of Abstracts*, O23. 12th International Congress on Photobiology, Vienna, Austria.
- Frecknall, E.A. and G. Pattenden (1984). Carotenoid differences in isogenic lines of tomato fruit colour mutants. *Phytochemistry* **23**: 1707–1710.
- Furuya, M. (1989). Molecular properties and biogenesis of phytochrome I and II. *Adv. Biophys.* **25**: 133–167.
- Furuya, M. (1993). Phytochromes: their molecular species, gene families, and functions. *Annu. Rev. Plant Physiol. Plant Mol. Biol.* **44**: 617–645.
- Furuya, M. and P.-S. Song (1994). Assembly and properties of holophytochrome. In: *Photomorphogenesis in Plants*, 2nd Ed. (Edited by R.E. Kendrick and G.H.M. Kronenberg), pp. 105–140. Kluwer Academic Publishers, Dordrecht, The Netherlands.
- Furuya, M. and E. Schäfer (1996). Photoperception and signalling of induction reactions by different phytochromes. *Trends Plant Sci.* **1**: 301–307.
- Gaba, V. and M. Black (1983). Photocontrol of hypocotyl elongation in de-etiolated *Cucumis sativus* L. A blue-light-induced post-illumination burst of growth. *Photochem. Photobiol.* **38**: 473–476.
- Garner, W.W. and H.A. Allard (1920). Effect of the relative length of day and night and other factors of the environment on growth and reproduction in plants. *J. Agric. Res.* **18**: 553–606.
- Georghiou, K. and R.E. Kendrick (1991). The germination characteristics of phytochrome-deficient *aurea* mutant tomato seeds. *Physiol. Plant.* **82**: 127–133.
- Goto, N., T. Kumagai and M. Koornneef (1991). Flowering responses to light-breaks in photomorphogenic mutants of *Arabidopsis thaliana*, a long-day plant. *Physiol. Plant.* **83**: 209–215.
- Goto, N., K.T. Yamamoto and M. Watanabe (1993). Action spectra for inhibition of hypocotyl growth of wild-type plants and of the *hy2* long-hypocotyl mutant of *Arabidopsis thaliana* L. *Photochem. Photobiol.* **57**: 867–871.
- Goud, K.V., R. Sharma, R.E. Kendrick and M. Furuya (1991). Photoregulation of phenylalanine ammonia lyase is not correlated with anthocyanin induction in photomorphogenic mutants of tomato (*Lycopersicon esculentum*). *Plant Cell Physiol.* **32**: 1251–1258.
- Goud, K.V. and R. Sharma (1994). Retention of photoinduction of cytosolic enzymes in *aurea* mutant of tomato (*Lycopersicon esculentum*). *Plant Physiol.* **105**: 643–650.
- Grimm, R., C. Eckerskorn, F. Lottspeich, C. Zenger and W. Rüdiger (1988). Sequence analysis of proteolytic fragments of 124-kilodalton phytochrome from etiolated *Avena sativa* L.: conclusions on the conformation of the native protein. *Planta* **174**: 396–401.
- Grimm, R., D. Gast and W. Rüdiger (1989). Characterization of a protein-kinase activity associated with phytochrome from etiolated oat (*Avena sativa* L.) seedlings. *Planta* **178**: 199–206.
- Guzmán, P. and J.R. Ecker (1990). Exploiting the triple response of *Arabidopsis* to identify ethylene-related mutants. *Plant Cell* **2**: 513–523.
- Halliday, K.J., M. Koornneef and G.C. Whitelam (1994). Phytochrome B and at least one other phytochrome mediate the accelerated flowering response of *Arabidopsis thaliana* L. to low red/far-red ratio. *Plant Physiol.* **104**: 1311–1315.
- Halliday, K. and G.C. Whitelam (1995). Phytochrome B and phytochrome C from *Arabidopsis* are biologically active in transgenic tobacco seedlings. In: *Book of Abstracts*, p.84. European Symposium on Photomorphogenesis in Plants, Sitges, Barcelona, Spain.

## References

- Hamazato, F., T. Shinomura, J. Chory and M. Furuya (1995). Phytochrome A-specific induction of *cab* gene expression in *Arabidopsis thaliana*. *Plant Cell Physiol.* **36** (Suppl.): s128.
- Harris, W.M. and A.R. Spurr (1969). Chromoplasts of tomato fruits. II. The red tomato. *Amer. J. Bot.* **56**: 380-389.
- Hart, J.W., D.C. Gordon and I.R. MacDonald (1982). Analysis of growth during phototropic curvature of cress hypocotyls. *Plant Cell Environ.* **5**: 361-366.
- Hartmann, K.M. (1966). A general hypothesis to interpret 'high energy phenomena' of photomorphogenesis on the basis of phytochrome. *Photochem. Photobiol.* **5**: 349-366.
- Hauser, B.A., M.-M. Cordonnier-Pratt, F. Daniel-Vedele and L.H. Pratt (1995). The phytochrome gene family in tomato includes a novel subfamily. *Plant Mol. Biol.* **29**: 1143-1155.
- Hauser, B.A., L.H. Pratt and M.-M. Cordonnier-Pratt (in press). Absolute quantification of five phytochrome transcripts in seedlings and mature plants of tomato (*Solanum lycopersicon* L.). *Planta*.
- Hayward, P.M. (1984). Determination of phytochrome parameters from radiation measurements. In: *Techniques in Photomorphogenesis* (Edited by H. Smith and M.G. Holmes), pp. 159-173. Academic Press, London, UK.
- Hendricks, S.B. (1964). Photochemical aspects of plant photoperiodicity. In: *Photophysiology* (Edited by A.C. Geise), pp. 305-331. Academic Press, New York, USA.
- Hershey, H.P., R.F. Barker, K.B. Idler, J.L. Lissimore and P.H. Quail (1985). Analysis of cloned cDNA and genomic sequences for phytochrome: complete amino acid sequences for two gene products expressed in etiolated *Avena*. *Nucl. Acids Res.* **13**: 8543-8559.
- Hershey, H.P., R.F. Barker, K.B. Idler, M.G. Murray and P.H. Quail (1987). Nucleotide sequence and characterization of a gene encoding the phytochrome polypeptide from *Avena*. *Gene* **61**: 339-348.
- Heyer, A. and C. Gatz (1992a). Isolation and characterization of a cDNA-clone coding for potato type A phytochrome. *Plant Mol. Biol.* **18**: 535-544.
- Heyer, A. and C. Gatz (1992b). Isolation and characterization of a cDNA-clone coding for potato type B phytochrome. *Plant Mol. Biol.* **20**: 589-600.
- Hillman, W.S. (1967). The physiology of phytochrome. *Ann. Rev. Plant Physiol.* **18**: 301-324.
- Hilton, J.R. and B. Thomas (1985). A comparison of seed and seedling phytochrome in *Avena sativa* L. using monoclonal antibodies. *J. Exp. Bot.* **36**: 1937-1946.
- Hiscox, J.D. and G.F. Israelstam (1979). A method for the extraction of chlorophyll from leaf tissue without maceration. *Can. J. Bot.* **57**: 1332-1334.
- Holmes, M.G. and H. Smith (1975). The function of phytochrome in plants growing in the natural environment. *Nature* **254**: 512-514.
- Holmes, M.G. and E. Schäfer (1981). Action spectra for changes in the "high irradiance reaction" in hypocotyls of *Sinapis alba* L. *Planta* **153**: 267-272.
- Hou, Y., A.G. Von Arnim and X.-W. Deng (1993). A new class of *Arabidopsis* constitutive photomorphogenic genes involved in regulating cotyledon development. *Plant Cell* **5**: 329-339.
- Ichikawa, H., A. Tanaka, S. Tano and A. Nagatani (1996). Isolation and characterization of photomorphogenic mutants of *Arabidopsis* which promote transduction of light-signal. In: *Book of Abstracts*, P190. 7th International Conference on *Arabidopsis* Research, Norwich, UK.
- Inskeep, W.P. and P.R. Bloom (1985). Extinction coefficients of chlorophyll *a* and *b* in *N,N*-dimethylformamide and 80% acetone. *Plant Physiol.* **77**: 483-485.
- Jackson, J.A., G. Fuglevand, B.A. Brown, M.J. Shaw and G.I. Jenkins (1995). Isolation of *Arabidopsis* mutants altered in the light-regulation of chalcone synthase gene expression using a transgenic screening approach. *Plant J.* **8**: 369-380.
- Jackson, S.D., A. Heyer, J. Dietze and S. Prat (1996). Phytochrome B mediates the photoperiodic control of tuber formation in potato. *Plant J.* **9**: 159-166.
- Jaffe, M.J. (1976). Thigmomorphogenesis: electrical resistance and mechanical correlates of the early events of growth retardation due to mechanical stimulation in beans. *Z. Pflanzenphysiol.* **78**: 24-32.
- Jaffe, M.J., A.H. Wakefield, F. Telewski, E. Gulley and R. Biro (1985). Computer-assisted image analysis of plant growth, thigmomorphogenesis, and gravitropism. *Plant Physiol.* **77**: 722-730.
- Janoudi, A.-K. and K.L. Poff (1992). Action spectrum for enhancement of phototropism by *Arabidopsis thaliana* seedlings. *Photochem. Photobiol.* **56**: 655-659.
- Jarret, R.L., H. Sayama and E.C. Tigchelaar (1984). Pleiotropic effects associated with the chlorophyll intensifier mutations *high pigment* and *dark green* in tomato. *J. Amer. Soc. Hort. Sci.* **109**: 873-878.

- Jenkins, G.I., J.M. Christie, G. Fuglevand, J.C. Long and J.A. Jackson (1995). Plant responses to UV and blue light: biochemical and genetic approaches. *Plant Sci.* **112**: 117–138.
- Jiang, Z. and W. Staude (1989). An interferometric method for plant growth measurements. *J. Exp. Bot.* **40**: 1169–1173.
- Johnson, C.F., C.S. Brown, R.M. Wheeler, J.C. Sager, D.K. Chapman and G.F. Deitzer (1996). Infrared light-emitting diode radiation causes gravitropic and morphological effects in dark-grown oat seedlings. *Photochem. Photobiol.* **63**: 238–242.
- Johnson, E., M. Bradley, N.P. Harber and G.C. Whitelam (1994). Photoresponses of light-grown *phyA* mutants of *Arabidopsis*. Phytochrome A is required for the perception of daylength extensions. *Plant Physiol.* **105**: 141–149.
- Johnston, R.F., S.C. Pickett and D.L. Barker (1990). Autoradiography using storage phosphor technology. *Electrophoresis* **11**: 355–360.
- Jones, A.M. and H.P. Erickson (1989). Domain structure of phytochrome from *Avena sativa* visualized by electron microscopy. *Photochem. Photobiol.* **49**: 479–483.
- Jones, A.M., D.S. Cochran, P.M. Lamerson, M.L. Evans and J.D. Cohen (1991). Red light-regulated growth. I. Changes in the abundance of indoleacetic acid and a 22-kilodalton auxin-binding protein in the maize mesocotyl. *Plant Physiol.* **97**: 352–358.
- Jordan, E.T., P.M. Hatfield, D. Hondred, M. Talon, J.A.D. Zeevaart and R.D. Vierstra (1995). Phytochrome A overexpression in transgenic tobacco. Correlation of dwarf phenotype with high concentrations of phytochrome in vascular tissue and attenuated gibberellin levels. *Plant Physiol.* **107**: 797–805.
- Joustra, M.K. (1970). Flower initiation in *Hyoscyamus niger* L. as influenced by widely divergent daylengths in different light qualities. *Meded. Landbouwhogeschool Wageningen* **70** (19): 1–78.
- Kasperbauer, M.J. (1971). Spectral distribution of light in a tobacco canopy and effects of end-of-day light quality on growth and development. *Plant Physiol.* **47**: 775–778.
- Kaufman, L.S. (1993). Transduction of blue-light signals. *Plant Physiol.* **102**: 333–337.
- Kaufman, L.S. (1994). GTP-binding signalling proteins in higher plants. *J. Photochem. Photobiol. B: Biol.* **22**: 3–7.
- Kay, S.A., B. Keith, K. Shinozaki and N.-H. Chua (1989a). The sequence of the rice phytochrome gene. *Nucl. Acids Res.* **17**: 2865–2866.
- Kay, S.A., A. Nagatani, B. Keith, M. Deak, M. Furuya and N.-H. Chua (1989b). Rice phytochrome is biologically active in transgenic tobacco. *Plant Cell* **1**: 775–782.
- Kehoe, D.M. and A.R. Grossman (1996). Similarity of a chromatic adaptation sensor to phytochrome and ethylene receptors. *Science* **273**: 1409–1412.
- Keller, J.M., J. Shanklin, R.D. Vierstra and H.P. Hershey (1989). Expression of a functional monocotyledonous phytochrome in transgenic tobacco. *EMBO J.* **8**: 1005–1012.
- Kendrick, R.E. and A. Nagatani (1991). Phytochrome mutants. *Plant J.* **1**: 133–139.
- Kendrick, R.E. and G.H.M. Kronenberg (eds.) (1994). *Photomorphogenesis in Plants*, 2nd Ed. Kluwer Academic Publishers, Dordrecht, The Netherlands.
- Kendrick, R.E., L.H.J. Kerckhoffs, A.S. Pundsnes, A. van Tuinen, M. Koornneef, A. Nagatani, M.J. Terry, A. Tretyn, M.-M. Cordonnier-Pratt, B. Hauser and L.H. Pratt (1994). Photomorphogenic mutants of tomato. *Euphytica* **79**: 227–234.
- Kerckhoffs, L.H.J., R.E. Kendrick, G.C. Whitelam and H. Smith (1992). Extension growth and anthocyanin responses of photomorphogenic tomato mutants to changes in the phytochrome photoequilibrium during the daily photoperiod. *Photochem. Photobiol.* **56**: 611–615.
- Kerckhoffs, L.H.J., A. Van Tuinen, B.A. Hauser, M.-M. Cordonnier-Pratt, A. Nagatani, M. Koornneef, L.H. Pratt, R.E. Kendrick (1996). Molecular analysis of *tri*-mutant alleles in tomato indicates the *Tri* locus is the gene encoding the apoprotein of phytochrome B1. *Planta* **199**: 152–157.
- Kerckhoffs, L.H.J., M.E.L. Schreuder, A. Van Tuinen, M. Koornneef and R.E. Kendrick (in press). Phytochrome control of anthocyanin biosynthesis in tomato seedlings: analysis using photomorphogenic mutants. *Photochem. Photobiol.*
- Kerckhoffs, L.H.J., N.A.M.A. De Groot, A. Van Tuinen, M.E.L. Schreuder, A. Nagatani, M. Koornneef and R.E. Kendrick (in press). Physiological characterization of exaggerated-photoresponse mutants of tomato. *J. Plant Physiol.*
- Kerckhoffs, L.H.J., P. Adamse, W.J.M. Tonk, R. Van Ginkel, J. Van Kreel, A. Veenendaal, T.P.L. Ruyter, W.F. Buurmeijer, R.M. Bouma and R.E. Kendrick (in press). A high-resolution plant growth-measuring apparatus to study stem growth kinetics. *Sci. Hort.*

## References

- Kerckhoffs, L.H.J., M. Sengers and R.E. Kendrick (in press). Growth analysis of wild-type and photomorphogenic mutant tomato plants. *Physiol. Plant.*
- Kern, R., A. Gasch, M. Deak, S.A. Kay and N.-H. Chua (1993). *phyB* of tobacco, a new member of the phytochrome family. *Plant Physiol.* **102**: 1363–1364.
- Kerr, E.A. (1960). High pigment ratios. *Tomato Genet. Coop. Rpt.* **10**: 18–19.
- Kerr, E.A. (1965). Identification of high-pigment, *hp*, tomatoes in the seedling stage. *Can. J. Plant Sci.* **45**: 104–105.
- Khudairi, A.K. and O.P. Arboleda (1971). Phytochrome-mediated carotenoid biosynthesis and its influence by plant hormones. *Physiol. Plant.* **24**: 18–22.
- Khudairi, A.K. (1972). The ripening of tomatoes. A molecular ecological approach to the physiology of fruit ripening. *Amer. Sci.* **60**: 696–707.
- Khurana, J.P. and K.L. Poff (1989). Mutants of *Arabidopsis thaliana* with altered phototropism. *Planta* **178**: 400–406.
- Kim, B.C., M.S. Soh, B.J. Kang, M. Furuya and H.G. Nam (1996). Two dominant photomorphogenic mutations of *Arabidopsis thaliana* identified as suppressor mutations of *hy2*. *Plant J.* **9**: 441–456.
- Kim, I.-S., U. Bai and P.-S. Song (1989). A purified 124-kDa oat phytochrome does not possess a protein kinase activity. *Photochem. Photobiol.* **49**: 319–323.
- Kolukisaoglu, H.Ü., S. Marx, C. Wiegmann, S. Hanelt and H.A.W. Schneider-Poetsch (1995). Divergence of the phytochrome gene family predates angiosperm evolution and suggests that *Selaginella* and *Equisetum* arose prior to *Psilotum*. *J. Mol. Evol.* **41**: 329–337.
- Koornneef, M., E. Rolff and C.J.P. Spruit (1980). Genetic control of light-inhibited hypocotyl elongation in *Arabidopsis thaliana* (L.) HEYNH. *Z. Pflanzenphysiol.* **100**: 147–160.
- Koornneef, M., J.W. Cone, R.G. Dekens, E.G. O'Herne-Robers, C.J.P. Spruit and R.E. Kendrick (1985). Photomorphogenic responses of long hypocotyl mutants of tomato. *J. Plant Physiol.* **120**: 153–165.
- Koornneef, M., T.D.G. Bosma, C.J. Hanhart, J.H. Van der Veen and J.A.D. Zeevaart (1990). The isolation and characterization of gibberellin-deficient mutants in tomato. *Theor. Appl. Genet.* **80**: 852–857.
- Koornneef, M., A. van Tuinen, L.H.J. Kerckhoffs, J.L. Peters and R.E. Kendrick (1992). Photomorphogenic mutants of higher plants. In: *Progress in Plant Growth Regulation* (Edited by C.M. Karssen, L.C. van Loon and D. Vreugdenhil), pp. 54–64. Kluwer Academic Publishers, Dordrecht, the Netherlands.
- Koornneef, M. and R.E. Kendrick (1994). Photomorphogenic mutants of higher plants. In: *Photomorphogenesis in Plants*, 2nd Ed. (Edited by R.E. Kendrick and G.H.M. Kronenberg), pp. 601–628. Kluwer Academic Publishers, Dordrecht, the Netherlands.
- Kraepiel, Y., M. Julien, M.-M. Cordonnier-Pratt and L. Pratt (1994). Identification of two loci involved in phytochrome expression in *Nicotiana plumbaginifolia* and lethality of the corresponding double mutant. *Mol. Gen. Genet.* **242**: 559–565.
- Kraepiel, Y., K. Marrec, B. Sotta, M. Caboche and E. Miginiac (1995). In vitro morphogenic characteristics of phytochrome mutants in *Nicotiana plumbaginifolia* are modified and correlated to high indole-3-acetic acid levels. *Planta* **197**: 142–146.
- Kristie, D.N. and P.A. Jolliffe (1986). High-resolution studies of growth oscillations during stem elongation. *Can. J. Bot.* **64**: 2399–2405.
- Kubota, T., M. Matsui, S. Frances, K. Yoshizawa, M. Szell, G.I. Lazarova, M.-M. Cordonnier-Pratt, L.H. Pratt and R.E. Kendrick (1996). Analysis of the tomato phytochrome B1 gene and putative phytochrome B1 (*tri*) mutants. In: *Book of Abstracts*, P91. 12th International Congress on Photobiology, Vienna, Austria.
- Kunkel, T., G. Neuhaus, A. Batschauer, N.-H. Chua and E. Schäfer (1996). Functional analysis of yeast-derived phytochrome A and B phycocyanobilin adducts. *Plant J.* **10**: 625–636.
- Kwok, S.F., B. Piekos, S. Miséra and X.-W. Deng (1996). A complement of ten essential and pleiotropic *Arabidopsis COP/DET/FUS* genes is necessary for repression of photomorphogenesis in darkness. *Plant Physiol.* **110**: 731–742.
- Laemmli, U.K. (1970). Cleavage of structural proteins during the assembly of the head of bacteriophage T4. *Nature* **227**: 680–685.
- Lagarias, J.C., D.M. Lagarias, J.T. Murphy, K.-C. Yeh and S.-H. Wu (1996). Structure-function analysis of the phytochrome photoreceptor. In: *Book of Abstracts*, S159. 12th International Congress on Photobiology, Vienna, Austria.

- Laval-Martin, D., J. Quennemet and R. Monéger (1975). Pigment evolution in *Lycopersicon esculentum* fruits during growth and ripening. *Phytochemistry* **14**: 2357–2362.
- Law, D.M. and P.J. Davies (1990). Comparative indole-3-acetic acid levels in the slender pea and other pea phenotypes. *Plant Physiol.* **93**: 1539–1543.
- Lazarova, G.I., M.-M. Cordonnier-Pratt, L.H.J. Kerckhoffs, J. Brandstaedter, M. Matsui, L.H. Pratt and R.E. Kendrick (1996). Impaired splicing of *PHYA* transcripts in tomato mutants insensitive to far-red light. In: *Book of abstracts*, P25. Conference on Molecular Biology of Tomato, Berkeley, CA, USA.
- Lecharny, A. and R. Jacques (1980). Light inhibition of internode elongation in green plants. A kinetic study with *Vigna sinensis* L. *Planta* **149**: 384–388.
- Lecharny, A. and E. Wagner (1984). Stem extension rate in light-grown plants. Evidence for an endogenous circadian rhythm in *Chenopodium rubrum*. *Physiol. Plant.* **60**: 437–443.
- Lecharny, A., M. Schwall and E. Wagner (1985). Stem extension rate in light-grown plants. Effects of photo- and thermoperiodic treatments on the endogenous circadian rhythm in *Chenopodium rubrum*. *Plant Physiol.* **79**: 625–629.
- Li, H.-m., T. Washburn and J. Chory (1993). Regulation of gene expression by light. *Curr. Opin. Cell Biol.* **5**: 455–460.
- Li, H.-m., L. Altschmied and J. Chory (1994). *Arabidopsis* mutants define downstream branches in the phototransduction pathway. *Genes Dev.* **8**: 339–349.
- Li, H.-m., K. Culligan, R.A. Dixon and J. Chory (1995). *CUE1*: a mesophyll cell-specific positive regulator of light-controlled gene expression in *Arabidopsis*. *Plant Cell* **7**: 1599–1610.
- Li, J., P. Nagpal, V. Vitart, T.C. McMorris and J. Chory (1996). A role for brassinosteroids in light-dependent development of *Arabidopsis*. *Science* **272**: 398–401.
- Lichtenthaler, H.K. and A.R. Wellburn (1983). Determinations of total carotenoids and chlorophylls *a* and *b* of leaf extracts in different solvents. *Biochem. Soc. Trans.* **11**: 591–592.
- Lin, C., M. Ahmad, D. Gordon and A.R. Cashmore (1995a). Expression of an *Arabidopsis* cryptochrome gene in transgenic tobacco results in hypersensitivity to blue, UV-A, and green light. *Proc. Natl. Acad. Sci. USA* **92**: 8423–8427.
- Lin, C., D.E. Robertson, M. Ahmad, A.A. Raibekas, M. Schuman Jorns, P.L. Dutton and A.R. Cashmore (1995b). Association of flavin adenine dinucleotide with the *Arabidopsis* blue light receptor CRY1. *Science* **269**: 968–970.
- Liscum, E. and R.P. Hangarter (1991). *Arabidopsis* mutants lacking blue light-dependent inhibition of hypocotyl elongation. *Plant Cell* **3**: 685–694.
- Liscum, E., J.C. Young, K.L. Poff and R.P. Hangarter (1992). Genetic separation of phototropism and blue light inhibition of stem elongation. *Plant Physiol* **100**: 267–271.
- Liscum, E. and R.P. Hangarter (1994). Mutational analysis of blue-light sensing in *Arabidopsis*. *Plant Cell Environ.* **17**: 639–648.
- Liscum, E. and W.R. Briggs (1995). Mutations in the *NPH1* locus of *Arabidopsis* disrupt the perception of phototropic stimuli. *Plant Cell* **7**: 473–485.
- Liscum, E. and W.R. Briggs (1996). Mutations of *Arabidopsis* in potential transduction and response components of the phototropic signaling pathway. *Plant Physiol.* **112**: 291–296.
- Lois, R. (1994). Accumulation of UV-absorbing flavonoids induced by UV-B radiation in *Arabidopsis thaliana* L. Mechanisms of UV-resistance in *Arabidopsis*. *Planta* **194**: 498–503.
- López-Juez, E., A. Nagatani, W.F. Buurmeijer, J.L. Peters, M. Furuya, R.E. Kendrick and J.C. Wesseliuss (1990). Response of light-grown wild-type and *aurea*-mutant tomato plants to end-of-day far-red light. *J. Photochem. Photobiol. B: Biol.* **4**: 391–405.
- López-Juez, E., A. Nagatani, K.-I. Tomizawa, M. Deak, R. Kern, R.E. Kendrick and M. Furuya (1992). The cucumber long hypocotyl mutant lacks a light-stable PHYB-like phytochrome. *Plant Cell* **4**: 241–251.
- López-Juez, E., M. Kobayashi, A. Sakurai, Y. Kamiya and R.E. Kendrick (1995). Phytochrome, gibberellins, and hypocotyl growth. A study using the cucumber (*Cucumis sativus* L.) long hypocotyl mutant. *Plant Physiol.* **107**: 131–140.
- Ma, H., M.F. Yanofsky and E.M. Meyerowitz (1990). Molecular cloning and characterization of *GPA1*, a G protein  $\alpha$  subunit gene from *Arabidopsis thaliana*. *Proc. Natl. Acad. Sci. USA* **87**: 3821–3825.
- Ma, H., M.F. Yanofsky and H. Huang (1991). Isolation and sequence analysis of *TGA1* cDNAs encoding a tomato G protein  $\alpha$  subunit. *Gene* **107**: 189–195.

## References

- MacDonald, I.R., D.C. Gordon and J.W. Hart (1987). *Cyclamen* coiling – the migration of a growth response. *Plant Cell Environ.* **10**: 613–617.
- Malhotra, K., S.-T. Kim, A. Batschauer, L. Dawut and A. Sancar (1995). Putative blue-light photoreceptors from *Arabidopsis thaliana* and *Sinapis alba* with a high degree of sequence homology to DNA photolyase contain the two photolyase cofactors but lack DNA repair activity. *Biochemistry* **34**: 6892–6899.
- Mancinelli, A.L. and I. Rabino (1978). The "high irradiance responses" of plant photomorphogenesis. *Bot. Rev.* **44**: 129–180.
- Mancinelli, A.L. (1985). Light-dependent anthocyanin synthesis: a model system for the study of plant photomorphogenesis. *Bot. Rev.* **51**: 107–157.
- Mancinelli, A.L. (1994). The physiology of phytochrome action. In: *Photomorphogenesis in Plants*, 2nd Ed. (Edited by R.E. Kendrick and G.H.M. Kronenberg), pp. 211–269. Kluwer Academic Publishers, Dordrecht, The Netherlands.
- Mandoli, D.F. and W.R. Briggs (1981). Phytochrome control of two low-irradiance responses in etiolated oat seedlings. *Plant Physiol.* **67**: 733–739.
- Martin, F.W. (1986). Interaction of a green fruit color modifying gene on vitamin C content of tomato. *Tomato Genet. Coop. Rpt.* **36**: 10.
- Mathews, S., M. Lavin and R.A. Sharrock (1995). Evolution of the phytochrome gene family and its utility for phylogenetic analyses of angiosperms. *Ann. Missouri Bot. Gard.* **82**: 296–321.
- Maxon Smith, J.W. and D.B. Ritchie (1983). A collection of near-isogenic lines of tomato: research tool of the future? *Plant Mol. Biol. Rep.* **1**: 41–45.
- McCormac, A.C., J.R. Cherry, H.P. Hershey, R.D. Vierstra and H. Smith (1991). Photoresponses of transgenic tobacco plants expressing an oat phytochrome gene. *Planta* **185**: 162–170.
- McCormac, A., G. Whitelam and H. Smith (1992). Light-grown plants of transgenic tobacco expressing an introduced oat phytochrome A gene under the control of a constitutive viral promoter exhibit persistent growth inhibition by far-red light. *Planta* **188**: 173–181.
- McCormac, A.C., D. Wagner, M.T. Boylan, P.H. Quail, H. Smith and G.C. Whitelam (1993). Photoresponses of transgenic *Arabidopsis* seedlings expressing introduced phytochrome B-encoding cDNAs: evidence that phytochrome A and phytochrome B have distinct photoregulatory functions. *Plant J.* **4**: 19–27.
- McNellis, T.W. and X.-W. Deng (1995). Light control of seedling morphogenetic pattern. *Plant Cell* **7**: 1749–1761.
- Meijer, G. (1968). Rapid growth inhibition of gherkin hypocotyls in blue light. *Acta Bot. Neerl.* **17**: 9–14.
- Millar, A.J., R.B. McGrath and N.-H. Chua (1994). Phytochrome phototransduction pathways. *Annu. Rev. Genet.* **28**: 325–349.
- Millar, A.J., M. Straume, J. Chory, N.-H. Chua and S.A. Kay (1995). The regulation of circadian period by phototransduction pathways in *Arabidopsis*. *Science* **267**: 1163–1166.
- Millner, P.A. and B.E. Causier (1996). G-protein coupled receptors in plant cells. *J. Exp. Bot.* **47**: 983–992.
- Miséra, S., A.J. Müller, U. Weiland-Heidecker and G. Jürgens (1994). The *FUSCA* genes of *Arabidopsis*: negative regulators of light responses. *Mol. Gen. Genet.* **244**: 242–252.
- Mochizuki, T. and S. Kamimura (1985). Photosensitive method for selection of *hp* at the cotyledon stage. *Tomato Genet. Coop. Rpt.* **35**: 12–13.
- Mochizuki, T. and S. Kamimura (1986). Allelism test of high-pigment phenotypes by the 'Yellow film method'. *Tomato Genet. Coop. Rpt.* **36**: 15–16.
- Mohr, W.P. (1979). Pigment bodies in fruits of crimson and high-pigment lines of tomatoes. *Ann. Bot.* **44**: 427–434.
- Mohr, H. (1972). *Lectures on Photomorphogenesis*. Springer-Verlag, New York, USA.
- Mohr, H. (1994). Coaction between pigment systems. In: *Photomorphogenesis in Plants*, 2nd Ed. (Edited by R.E. Kendrick and G.H.M. Kronenberg), pp. 353–373. Kluwer Academic Publishers, Dordrecht, The Netherlands.
- Mol, J., G. Jenkins, E. Schäfer and D. Weiss (1996). Signal perception, transduction, and gene expression involved in anthocyanin biosynthesis. *Critical Rev. Plant Sci.* **15**: 525–557.
- Moran, R. and D. Porath (1980). Chlorophyll determination in intact tissues using *N,N*-dimethyl-formamide. *Plant Physiol.* **65**: 478–479.
- Morgan, D.C. and H. Smith (1978). The relationship between phytochrome photoequilibrium and development in light grown *Chenopodium album* L. *Planta* **142**: 187–193.



- Morgan, D.C., T. O'Brien and H. Smith (1980). Rapid photomodulation of stem extension in light-grown *Sinapis alba* L. Studies on kinetics, site of perception and photoreceptor. *Planta* **150**: 95–101.
- Murashige, T. and F. Skoog (1962). A revised medium for rapid growth and bio assays with tobacco tissue cultures. *Physiol. Plant.* **15**: 473–497.
- Nagatani, A., K.T. Yamamoto, M. Furuya, T. Fukumoto and A. Yamashita (1984). Production and characterization of monoclonal antibodies which distinguish different surface structures of pea (*Pisum sativum* cv. Alaska) phytochrome. *Plant Cell Physiol.* **25**: 1059–1068.
- Nagatani, A., J.B. Reid, J.J. Ross, A. Dunnewijk and M. Furuya (1990). Internode length in *Pisum*. The response to light quality, and phytochrome type I and II levels in *lv* plants. *J. Plant Physiol.* **135**: 667–674.
- Nagatani, A., J. Chory and M. Furuya (1991). Phytochrome B is not detectable in the *hy3* mutant of *Arabidopsis*, which is deficient in responding to end-of-day far-red light treatments. *Plant Cell Physiol.* **32**: 1119–1122.
- Nagatani, A., J.W. Reed and J. Chory (1993). Isolation and initial characterization of *Arabidopsis* mutants that are deficient in phytochrome A. *Plant Physiol.* **102**: 269–277.
- Nagatani, A. and K. Sakamoto (1996). Light-dependent nuclear localization of phytochrome B. In: *Book of Abstracts*, S116. 12th International Congress on Photobiology, Vienna, Austria.
- Neer, E.J. (1995). Heterotrimeric G proteins: organizers of transmembrane signals. *Cell* **80**: 249–257.
- Neuhaus, G., C. Bowler, R. Kern and N.-H. Chua (1993). Calcium/calmodulin-dependent and -independent phytochrome signal transduction pathways. *Cell* **73**: 937–952.
- Oelmüller, R. and R.E. Kendrick (1991). Blue light is required for survival of the tomato phytochrome-deficient *aurea* mutant and the expression of four nuclear genes coding for plastidic proteins. *Plant Mol. Biol.* **16**: 293–299.
- Okada, K. and Y. Shimura (1992). Mutational analysis of root gravitropism and phototropism of *Arabidopsis thaliana* seedlings. *Aust. J. Plant Physiol.* **19**: 439–448.
- Parker, M.W., S.B. Hendricks, H.A. Borthwick and N.J. Scully (1946). Action spectrum for the photoperiodic control of floral initiation of short-day plants. *Bot. Gaz.* **108**: 1–26.
- Parks, B.M., A.M. Jones, P. Adamse, M. Koornneef, R.E. Kendrick and P.H. Quail (1987). The *aurea* mutant of tomato is deficient in spectrophotometrically and immunochemically detectable phytochrome. *Plant Mol. Biol.* **9**: 97–107.
- Parks, B.M., J. Shanklin, M. Koornneef, R.E. Kendrick and P.H. Quail (1989). Immunochemically detectable phytochrome is present at normal levels but is photochemically nonfunctional in the *hy 1* and *hy 2* long hypocotyl mutants of *Arabidopsis*. *Plant Mol. Biol.* **12**: 425–437.
- Parks, B.M. and P.H. Quail (1991). Phytochrome-deficient *hy1* and *hy2* long hypocotyl mutants of *Arabidopsis* are defective in phytochrome chromophore biosynthesis. *Plant Cell* **3**: 1177–1186.
- Parks, B.M. and P.H. Quail (1993). *hy8*, a new class of *Arabidopsis* long hypocotyl mutants deficient in functional phytochrome A. *Plant Cell* **5**: 39–48.
- Parks, B.M., P.H. Quail and R.P. Hangarter (1996). Phytochrome A regulates red-light induction of phototropic enhancement in *Arabidopsis*. *Plant Physiol.* **110**: 155–162.
- Penny, D., P. Penny and D.C. Marshall (1974). High resolution measurement of plant growth. *Can. J. Bot.* **52**: 959–969.
- Peters, J.L., A. van Tuinen, P. Adamse, R.E. Kendrick and M. Koornneef (1989). High pigment mutants of tomato exhibit high sensitivity for phytochrome action. *J. Plant Physiol.* **134**: 661–666.
- Peters, J.L., R.E. Kendrick and H. Mohr (1991). Phytochrome content and hypocotyl growth of long-hypocotyl mutant and wild-type cucumber seedlings during de-etiolation. *J. Plant Physiol.* **137**: 291–296.
- Peters, J.L., M.E.L. Schreuder, S.J.W. Verduin and R.E. Kendrick (1992a). Physiological characterization of a high-pigment mutant of tomato. *Photochem. Photobiol.* **56**: 75–82.
- Peters, J.L., M.E.L. Schreuder, G.H. Heeringa, J.C. Wesseliuss, R.E. Kendrick and M. Koornneef (1992b). Analysis of the response of photomorphogenetic tomato mutants to end-of-day far-red light. *Acta Hort.* **305**: 67–77.
- Piringer, A.A. and P.H. Heinze (1954). Effect of light on the formation of a pigment in the tomato fruit cuticle. *Plant Physiol.* **29**: 467–472.
- Popescu, T., F. Zängler, B. Sturm and L. Fukshansky (1989). Image analyzer used for data acquisition in phototropism studies. *Photochem. Photobiol.* **50**: 701–705.
- Prat, R. and G. Parésys (1989). Multiple use apparatus for cell wall extensibility and cell elongation studies. *Plant Physiol. Biochem.* **27**: 955–962.

## References

- Pratt, R. and G. Parésys (1995). High resolution study of plant cell growth kinetics. *Plant Physiol. Biochem.* **33**: 709–716.
- Pratt, L.H., S.J. Stewart, Y. Shimazaki, Y.-C. Wang and M.-M. Cordonnier (1991). Monoclonal antibodies directed to phytochrome from green leaves of *Avena sativa* L. cross-react weakly or not at all with the phytochrome that is most abundant in etiolated shoots of the same species. *Planta* **184**: 87–95.
- Pratt, L.H. (1995). Phytochromes: differential properties, expression patterns and molecular evolution. *Photochem. Photobiol.* **61**: 10–21.
- Pratt, L.H., M.-M. Cordonnier-Pratt, B. Hauser and M. Caboche (1995). Tomato contains two differentially expressed genes encoding B-type phytochromes, neither of which can be considered an ortholog of *Arabidopsis* phytochrome B. *Planta* **197**: 203–206.
- Pratt, L.H., M.-M. Cordonnier-Pratt, B.A. Hauser, R.M. Alba, P.M. Kelmenson, R.E. Kendrick, M. Matsui, G.I. Lazarova, T. Kubota, T. Tsuge, S. Frances, M. Szell, J.L. Peters, L.H.J. Kerckhoffs, M. Koornneef and A. Van Tuinen (in press). Phytochrome family and functions in tomato. In: *Proceedings of the 12th International Congress on Photobiology*, Vienna, Austria.
- Quaedvlieg, N., J. Dockx, F. Rook, P. Weisbeek and S. Smekens (1995). The homeobox gene *ATH1* of *Arabidopsis* is derepressed in the photomorphogenic mutants *cop1* and *det1*. *Plant Cell* **7**: 117–129.
- Quail, P.H. (1991). Phytochrome: a light-activated molecular switch that regulates plant gene expression. *Annu. Rev. Genet.* **25**: 389–409.
- Quail, P.H. (1994). Phytochrome genes and their expression. In: *Photomorphogenesis in Plants*, 2nd Ed. (Edited by R.E. Kendrick and G.H.M. Kronenberg), pp. 71–104. Kluwer Academic Publishers, Dordrecht, the Netherlands.
- Quail, P.H., W.R. Briggs, J. Chory, R.P. Hangarter, N.P. Harberd, R.E. Kendrick, M. Koornneef, B. Parks, R.A. Sharrock, E. Schäfer, W.F. Thompson and G.C. Whitelam (1994). Spotlight on phytochrome nomenclature. *Plant Cell* **6**: 468–471.
- Quail, P.H., M.T. Boylan, B.M. Parks, T.W. Short, Y. Xu and D. Wagner (1995). Phytochromes: photosensory perception and signal transduction. *Science* **268**: 675–680.
- Quail, P.H. (1996). A new vision for plant productivity. *Nat. Biotechnol.* **14**: 945.
- Quate, F.E., S. Takayanagi, J. Ruffini, J.C. Sutherland and B.M. Sutherland (1994). DNA damage levels determine cyclobutyl pyrimidine dimer repair mechanisms in alfalfa seedlings. *Plant Cell* **6**: 1635–1641.
- Rabinowitch, H.D., P. Budowski and N. Kedar (1975). Carotenoids and epoxide cycles in mature-green tomatoes. *Planta* **122**: 91–97.
- Raven, C.W. and C.J.P. Spruit (1973). Induction of rapid chlorophyll accumulation in dark grown seedlings. III. Transport model for phytochrome action. *Acta Bot. Neerl.* **22**: 135–143.
- Redhead, C.R. and K. Palme (1996). The genes of plant signal transduction. *Critical Rev. Plant Sci.* **15**: 425–454.
- Reed, J.W., P. Nagpal and J. Chory (1992). Searching for phytochrome mutants. *Photochem. Photobiol.* **56**: 833–838.
- Reed, J.W., P. Nagpal, D.S. Poole, M. Furuya and J. Chory (1993). Mutations in the gene for the red/far-red light receptor phytochrome B alter cell elongation and physiological responses throughout *Arabidopsis* development. *Plant Cell* **5**: 147–157.
- Reed, J.W., A. Nagatani, T.D. Elich, M. Fagan and J. Chory (1994). Phytochrome A and phytochrome B have overlapping but distinct functions in *Arabidopsis* development. *Plant Physiol.* **104**: 1139–1149.
- Reed, J.W., K.R. Foster, P.W. Morgan and J. Chory (1996). Phytochrome B affects responsiveness to gibberellins in *Arabidopsis*. *Plant Physiol.* **112**: 337–342.
- Reymond, P., T.W. Short, W.R. Briggs and K.L. Poff (1992). Light-induced phosphorylation of a membrane protein plays an early role in signal transduction for phototropism in *Arabidopsis thaliana*. *Proc. Natl. Acad. Sci. USA* **89**: 4718–4721.
- Reynard, G.B. (1956). Origin of the Webb Special (Black Queen) tomato. *Tomato Genet. Coop. Rpt.* **6**: 22.
- Rick, C.M. (1963). Biosystematic studies on Galápagos tomatoes. *Occ. Pap. Calif. Acad. Sci.* **44**: 59–77.
- Rick, C.M., A.F. Reeves and R.W. Zobel (1968). Inheritance and linkage relations of four new mutants. *Tomato Genet. Coop. Rpt.* **18**: 34–35.

- Rick, C.M. (1974). High soluble-solids content in large-fruited tomato lines derived from a wild green-fruited species. *Hilgardia* **42**: 493–510.
- Robson, P.R.H., G.C. Whitelam and H. Smith (1993). Selected components of the shade-avoidance syndrome are displayed in a normal manner in mutants of *Arabidopsis thaliana* and *Brassica rapa* deficient in phytochrome B. *Plant Physiol.* **102**: 1179–1184.
- Robson, P.R.H., A.C. McCormac, A.S. Irvine and H. Smith (1996). Genetic engineering of harvest index in tobacco through overexpression of a phytochrome gene. *Nat. Biotechnol.* **14**: 995–998.
- Romanowski, M. and P.-S. Song (1992). Structural domains of phytochrome deduced from homologies in amino acid sequences. *J. Protein Chem.* **11**: 139–155.
- Romero, L.C., D. Sommer, C. Gotor and P.-S. Song (1991). G-proteins in etiolated *Avena* seedlings. Possible phytochrome regulation. *FEBS Lett.* **282**: 341–346.
- Romero, L.C. and E. Lam (1993). Guanine nucleotide binding protein involvement in early steps of phytochrome-regulated gene expression. *Proc. Natl. Acad. Sci. USA* **90**: 1465–1469.
- Rood, S.B., P.H. Williams, D. Pearce, N. Murofushi, L.N. Mander and R.P. Pharis (1990). A mutant gene that increases gibberellin production in *Brassica*. *Plant Physiol.* **93**: 1168–1174.
- Roux, S.J. (1994). Signal transduction in phytochrome responses. In: *Photomorphogenesis in Plants*, 2nd Ed. (Edited by R.E. Kendrick and G.H.M. Kronenberg), pp. 187–209. Kluwer Academic Publishers, Dordrecht, The Netherlands.
- Rüdiger, W. and F. Thümmler (1994). The phytochrome chromophore. In: *Photomorphogenesis in Plants*, 2nd Ed. (Edited by R.E. Kendrick and G.H.M. Kronenberg), pp. 51–69. Kluwer Academic Publishers, Dordrecht, The Netherlands.
- Ruiz Fernandez, S. and E. Wagner (1994). A new method of measurement and analysis of the stem extension growth rate to demonstrate complete synchronisation of *Chenopodium rubrum* plants by environmental conditions. *J. Plant Physiol.* **144**: 362–369.
- Sachs, J. (1874). *Lehrbuch der Botanik*. Verlag von Wilhelm Engelmann, Leipzig, Germany.
- Sage, L.C. (1992). *Pigment of the Imagination. A History of Phytochrome Research*. Academic Press, New York, USA.
- Sakurai, A. and S. Fujioka (1993). The current status of physiology and biochemistry of brassinosteroids. *Plant Growth Reg.* **13**: 147–159.
- Sambrook, J., E.F. Fritsch and T. Maniatis (1989). *Molecular Cloning. A Laboratory Manual*, 2nd Ed. Cold Spring Harbor Laboratory Press, Cold Spring Harbor, NY, USA.
- Sanders, D.C., D.M. Pharr and T.R. Konsler (1975). Chlorophyll content of a dark green mutant of 'Manapal' tomato. *HortScience* **10**: 262–264.
- Sato, N. (1988). Nucleotide sequence and expression of the phytochrome gene in *Pisum sativum*: differential regulation by light of multiple transcripts. *Plant Mol. Biol.* **11**: 697–710.
- Sato, N. (1990). Nucleotide sequence of a pseudogene for pea phytochrome reminiscent of an incorrect splicing event. *Nucl. Acids Res.* **18**: 3632.
- Schäfer, E. (1976). The 'high irradiance reaction'. In: *Light and Plant Development* (Edited by H. Smith), pp. 45–59. Butterworths, London, UK.
- Schmieders, B.J., L.H.J. Kerckhoffs and P.C. Struik (1988). Diel changes in tuber volume. *Potato Res.* **31**: 129–135.
- Senger, H. and W. Schmidt (1994). Diversity of photoreceptors. In: *Photomorphogenesis in Plants*, 2nd Ed. (Edited by R.E. Kendrick and G.H.M. Kronenberg), pp. 301–325. Kluwer Academic Publishers, Dordrecht, The Netherlands.
- Sessa, G., G. Morelli and I. Ruberti (1993). The Athb-1 and -2 HD-Zip domains homodimerize forming complexes of different DNA binding specificities. *EMBO J.* **12**: 3507–3517.
- Shacklock, P.S., N.D. Read and A.J. Trewavas (1992). Cytosolic free calcium mediates red light-induced photomorphogenesis. *Nature* **358**: 753–755.
- Sharma, R., E. López-Juez, A. Nagatani and M. Furuya (1993). Identification of photo-inactive phytochrome A in etiolated seedlings and photo-active phytochrome B in green leaves of the *aurea* mutant of tomato. *Plant J.* **4**: 1035–1042.
- Sharrock, R.A., J.L. Lissemore and P.H. Quail (1986). Nucleotide and amino acid sequence of a *Cucurbita* phytochrome cDNA clone: identification of conserved features by comparison with *Avena* phytochrome. *Gene* **47**: 287–295.
- Sharrock, R.A., B.M. Parks, M. Koornneef and P.H. Quail (1988). Molecular analysis of the phytochrome deficiency in an *aurea* mutant of tomato. *Mol. Gen. Genet.* **213**: 9–14.

## References

- Sharrock, R.A. and P.H. Quail (1989). Novel phytochrome sequences in *Arabidopsis thaliana*: structure, evolution, and differential expression of a plant regulatory photoreceptor family. *Genes Dev.* **3**: 1745–1757.
- Sharrock, R.A. (1996). Structure and function of the *Arabidopsis* phytochrome photoreceptor family. In: *Book of Abstracts*, p.82S. 24th Annual Meeting of the American Society for Photobiology, Atlanta, GA, USA.
- Shimazaki, Y. and L.H. Pratt (1985). Immunochemical detection with rabbit polyclonal and mouse monoclonal antibodies of different pools of phytochrome from etiolated and green *Avena* shoots. *Planta* **164**: 333–344.
- Shinkle, J.R. and R.L. Jones (1988). Inhibition of stem elongation in *Cucumis* seedlings by blue light requires calcium. *Plant Physiol.* **86**: 960–966.
- Shinomura, T., A. Nagatani, J. Chory and M. Furuya (1994). The induction of seed germination in *Arabidopsis thaliana* is regulated principally by phytochrome B and secondarily by phytochrome A. *Plant Physiol.* **104**: 363–371.
- Shinomura, T., A. Nagatani, H. Hanzawa, M. Kubota, M. Watanabe and M. Furuya (1996). Action spectra for phytochrome A- and B-specific photoinduction of seed germination in *Arabidopsis thaliana*. *Proc. Natl. Acad. Sci. USA* **93**: 8129–8133.
- Short, T.W. and W.R. Briggs (1994). The transduction of blue light signals in higher plants. *Annu. Rev. Plant Physiol. Plant Mol. Biol.* **45**: 143–171.
- Shropshire Jr., W. and H. Mohr (eds.) (1983). *Photomorphogenesis*. *Encycl. Plant Physiol. New Ser.* **16A–B**. Springer-Verlag, Berlin, Germany.
- Shuttleworth, J.E. and M. Black (1977). The role of cotyledons in phototropism of de-etiolated seedlings. *Planta* **135**: 51–55.
- Siegelman, H.W. and W.L. Butler (1965). Properties of phytochrome. *Ann. Rev. Plant Physiol.* **16**: 383–392.
- Siegelman, H.W., B.C. Turner and S.B. Hendricks (1966). The chromophore of phytochrome. *Plant Physiol.* **41**: 1289–1292.
- Smith, H. and M.G. Holmes (1977). The function of phytochrome in the natural environment—III. Measurement and calculation of phytochrome photoequilibria. *Photochem. Photobiol.* **25**: 547–550.
- Smith, H. (1982). Light quality, photoperception, and plant strategy. *Ann. Rev. Plant Physiol.* **33**: 481–518.
- Smith, H. and G.C. Whitelam (1990). Phytochrome, a family of photoreceptors with multiple physiological roles. *Plant Cell Environ.* **13**: 695–707.
- Smith, H. (1994). Sensing the light environment: the functions of the phytochrome family. In: *Photomorphogenesis in Plants*, 2nd Ed. (Edited by R.E. Kendrick and G.H.M. Kronenberg), pp. 377–416. Kluwer Academic Publishers, Dordrecht, The Netherlands.
- Smith, H. (1995). Physiological and ecological function within the phytochrome family. *Annu. Rev. Plant Physiol. Plant Mol. Biol.* **46**: 289–315.
- Somers, D.E., R.A. Sharrock, J.M. Tepperman and P.H. Quail (1991). The *hy3* long hypocotyl mutant of *Arabidopsis* is deficient in phytochrome B. *Plant Cell* **3**: 1263–1274.
- Somers, D.E. and P.H. Quail (1995). Temporal and spatial expression patterns of *PHYA* and *PHYB* genes in *Arabidopsis*. *Plant J.* **7**: 413–427.
- Soressi, G.P. (1975). New spontaneous or chemically-induced fruit-ripening tomato mutants. *Tomato Genet. Coop. Rpt.* **25**: 21–22.
- Sponsel, V.M., J.J. Ross, M.R. Reynolds, G.M. Symons and J.B. Reid (1996). The gibberellin status of *lip1*, a mutant of pea that exhibits light-independent photomorphogenesis. *Plant Physiol.* **112**: 61–66.
- Stapleton, A.E. (1992). Ultraviolet radiation and plants: burning questions. *Plant Cell* **4**: 1353–1358.
- Stockhaus, J., A. Nagatani, U. Halfter, S. Kay, M. Furuya and N.-H. Chua (1992). Serine-to-alanine substitutions at the amino-terminal region of phytochrome A result in an increase in biological activity. *Genes Dev.* **6**: 2364–2372.
- Su, W. and S.H. Howell (1995). The effects of cytokinin and light on hypocotyl elongation in *Arabidopsis* seedlings are independent and additive. *Plant Physiol.* **108**: 1423–1430.
- Susek, R.E., F.M. Ausubel and J. Chory (1993). Signal transduction mutants of *Arabidopsis* uncouple nuclear *CAB* and *RBCS* gene expression from chloroplast development. *Cell* **74**: 787–799.
- Swain, S.M. and N.E. Olszewski (1996). Genetic analysis of gibberellin signal transduction. *Plant Physiol.* **112**: 11–17.

- Szekeres, M., K. Németh, Z. Koncz-Kálmán, J. Mathur, A. Kauschmann, T. Altmann, G.P. Rédei, F. Nagy, J. Schell and C. Koncz (1996). Brassinosteroids rescue the deficiency of CYP90, a cytochrome P450, controlling cell elongation and de-etiolation in *Arabidopsis*. *Cell* **85**: 171–182.
- Terry, M.J., J.A. Wahleithner and J.C. Lagarias (1993). Biosynthesis of the plant photoreceptor phytochrome. *Arch. Biochem. Biophys.* **306**: 1–15.
- Terry, M.J. and R.E. Kendrick (1996). The *aurea* and *yellow-green-2* mutants of tomato are deficient in phytochrome chromophore synthesis. *J. Biol. Chem.* **271**: 21681–21686.
- Terry, M.J., J.L. Weller and I.B. Taylor (in press). Analysis of phytochrome chromophore-deficient mutants. In: *Proceedings of the 12th International Congress on Photobiology*, Vienna, Austria.
- Terzaghi, W.B. and A.R. Cashmore (1995). Light-regulated transcription. *Annu. Rev. Plant Physiol. Plant Mol. Biol.* **46**: 445–474.
- Tevini, M. and A.H. Teramura (1989). UV-B effects on terrestrial plants. *Photochem. Photobiol.* **50**: 479–487.
- Thomas, R.L. and J.J. Jen (1975). Phytochrome-mediated carotenoids biosynthesis in ripening tomatoes. *Plant Physiol.* **56**: 452–453.
- Thompson, A.E. (1955). Inheritance of high total carotenoid pigments in tomato fruits. *Science* **121**: 896–897.
- Thompson, A.E. (1961). A comparison of fruit quality constituents of normal and high pigment tomatoes. *Proc. Amer. Soc. Hort. Sci.* **78**: 464–473.
- Thompson, A.E., R.W. Hepler and E.A. Kerr (1962). Clarification of the inheritance of high total carotenoid pigments in the tomato. *Proc. Amer. Soc. Hort. Sci.* **81**: 434–442.
- Thompson, W.F. and M.J. White (1991). Physiological and molecular studies of light-regulated nuclear genes in higher plants. *Annu. Rev. Plant Physiol. Plant Mol. Biol.* **42**: 423–466.
- Thümmler, F., M. Dufner, P. Kreisl and P. Dittich (1992). Molecular cloning of a novel phytochrome gene of the moss *Ceratodon purpureus* which encodes a putative light-regulated protein kinase. *Plant Mol. Biol.* **20**: 1003–1017.
- Tokuhsa, J.G., S.M. Daniels and P.H. Quail (1985). Phytochrome in green tissue: spectral and immunochemical evidence for two distinct molecular species of phytochrome in light-grown *Avena sativa* L. *Planta* **164**: 321–332.
- Tretyn, A., R.E. Kendrick and G. Wagner (1991). The role(s) of calcium ions in phytochrome action. *Photochem. Photobiol.* **54**: 1135–1155.
- Tsuge, T., S. Frances, D. Chamovitz, M. Matsui and X.-W. Deng (1996). Isolation and characterization of *Arabidopsis COP1* homologous genes in both mono- and dicotyledonous plants. In: *Book of Abstracts*, P187. 7th International Conference on Arabidopsis Research, Norwich, UK.
- Van Volkenburgh, E., S. Hunt and W.J. Davies (1983). A simple instrument for measuring cell-wall extensibility. *Ann. Bot.* **51**: 669–672.
- Van den Bulk, R.W., H.J.M. Löffler, W.H. Lindhout and M. Koornneef (1990). Somaclonal variation in tomato: effect of explant source and a comparison with chemical mutagenesis. *Theor. Appl. Genet.* **80**: 817–825.
- Van Tuinen, A., L.H.J. Kerckhoffs, A. Nagatani, R.E. Kendrick and M. Koornneef (1995a). Far-red light-insensitive, phytochrome A-deficient mutants of tomato. *Mol. Gen. Genet.* **246**: 133–141.
- Van Tuinen, A., L.H.J. Kerckhoffs, A. Nagatani, R.E. Kendrick and M. Koornneef (1995b). A temporarily red light-insensitive mutant of tomato lacks a light-stable, B-like phytochrome. *Plant Physiol.* **108**: 939–947.
- Van Tuinen, A., C.J. Hanhart, L.H.J. Kerckhoffs, A. Nagatani, M.T. Boylan, P.H. Quail, R.E. Kendrick and M. Koornneef (1996a). Analysis of phytochrome-deficient *yellow-green-2* and *aurea* mutants of tomato. *Plant J.* **9**: 173–182.
- Van Tuinen, A., M.-M. Cordonnier-Pratt, L.H. Pratt, R. Verkerk, P. Zabel and M. Koornneef (1996b). The mapping of phytochrome genes and photomorphogenic mutants of tomato. *Theor. Appl. Genet.* (in press).
- Van Wann, E. (1995). Reduced plant growth in tomato mutants *high pigment* and *dark green* partially overcome by gibberellin. *HortScience* **30**: 379.
- VanDerWoude, W.J. (1985). A dimeric mechanism for the action of phytochrome: evidence from photothermal interactions in lettuce seed germination. *Photochem. Photobiol.* **42**: 655–661.
- Vierstra, R.D. and P.H. Quail (1983). Purification and initial characterization of 124-kilodalton phytochrome from *Avena*. *Biochemistry* **22**: 2498–2505.

## References

- Vierstra, R.D. (1993). Illuminating phytochrome functions. There is light at the end of the tunnel. *Plant Physiol.* **103**: 679–684.
- Vierstra, R.D. (1994). Phytochrome degradation. In: *Photomorphogenesis in Plants*, 2nd Ed. (Edited by R.E. Kendrick and G.H.M. Kronenberg), pp. 141–162. Kluwer Academic Publishers, Dordrecht, The Netherlands.
- Vierstra, R.D., E.T. Jordan and R.C. Clough (1996). Analysis of structural domains required for phytochrome function by *in vitro* mutagenesis. In: *Book of Abstracts*, S164. 12th International Congress on Photobiology, Vienna, Austria.
- Von Arnim, A. and X.-W. Deng (1996). Light control of seedling development. *Annu. Rev. Plant Physiol. Plant Mol. Biol.* **47**: 215–243.
- Von Wettstein-Knowles, P. (1968a). Mutations affecting anthocyanin synthesis in the tomato I. Genetics, histology, and biochemistry. *Hereditas* **60**: 317–346.
- Von Wettstein-Knowles, P. (1968b). Mutations affecting anthocyanin synthesis in the tomato. II. Physiology. *Hereditas* **61**: 255–275.
- Wagner, D., J.M. Tepperman and P.H. Quail (1991). Overexpression of phytochrome B induces a short hypocotyl phenotype in transgenic Arabidopsis. *Plant Cell* **3**: 1275–1288.
- Wagner, D., C.D. Fairchild, R.M. Kuhn and P.H. Quail (1996a). Chromophore-bearing NH<sub>2</sub>-terminal domains of phytochromes A and B determine their photosensory specificity and differential light lability. *Proc. Natl. Acad. Sci. USA* **93**: 4011–4015.
- Wagner, D., M. Kolozsvari and P.H. Quail (1996b). Two small spatially distinct regions of phytochrome B are required for efficient signaling rates. *Plant Cell* **8**: 859–871.
- Wall, J.K. and C.B. Johnson (1983). An analysis of phytochrome action in the 'high-irradiance response'. *Planta* **159**: 387–397.
- Wang, Y.-C., M.-M. Cordonnier-Pratt and L.H. Pratt (1993). Temporal and light regulation of the expression of three phytochromes in germinating seeds and young seedlings of *Avena sativa* L. *Planta* **189**: 384–390.
- Wei, N. and X.-W. Deng (1992). COP9: a new genetic locus involved in light-regulated development and gene expression in Arabidopsis. *Plant Cell* **4**: 1507–1518.
- Wei, N., D.A. Chamovitz and X.-W. Deng (1994a). Arabidopsis COP9 is a component of a novel signaling complex mediating light control of development. *Cell* **78**: 117–124.
- Wei, N., S.F. Kwok, A.G. Von Arnim, A. Lee, T.W. McNellis, B. Piekos and X.-W. Deng (1994b). Arabidopsis COP8, COP10, and COP11 genes are involved in repression of photomorphogenic development in darkness. *Plant Cell* **6**: 629–643.
- Weiss, C.A., C.W. Garnaat, K. Mukai, Y. Hu and H. Ma (1994). Isolation of cDNAs encoding guanine nucleotide-binding protein  $\beta$ -subunit homologues from maize (ZGB1) and Arabidopsis (AGB1). *Proc. Natl. Acad. Sci. USA* **91**: 9554–9558.
- Weller, J.L. and J.B. Reid (1993). Photoperiodism and photocontrol of stem elongation in two photomorphogenic mutants of *Pisum sativum* L. *Planta* **189**: 15–23.
- Weller, J.L., J.J. Ross and J.B. Reid (1994). Gibberellins and phytochrome regulation of stem elongation in pea. *Planta* **192**: 489–496.
- Weller, J.L., A. Nagatani, R.E. Kendrick, I.C. Murfet and J.B. Reid (1995a). New *lv* mutants of pea are deficient in phytochrome B. *Plant Physiol.* **108**: 525–532.
- Weller, J.L., M.J. Terry, R.E. Kendrick, C. Rameau and J.B. Reid (1995b). Recent advances in the genetic control of photomorphogenesis in pea. In: *Book of Abstracts*, p.125. European Symposium on Photomorphogenesis in Plants, Sitges, Barcelona, Spain.
- Weller, J.L., M.J. Terry, C. Rameau, J.B. Reid and R.E. Kendrick (1996). The phytochrome-deficient *pcd1* mutant of pea is unable to convert heme to biliverdin IX $\alpha$ . *Plant Cell* **8**: 55–67.
- Whitelam, G.C. and H. Smith (1991). Retention of phytochrome-mediated shade avoidance responses in phytochrome-deficient mutants of Arabidopsis, cucumber and tomato. *J. Plant Physiol.* **139**: 119–125.
- Whitelam, G.C., A.C. McCormac, M.T. Boylan and P.H. Quail (1992). Photoresponses of Arabidopsis seedlings expressing an introduced oat *phyA* cDNA: persistence of etiolated plant type responses in light-grown plants. *Photochem. Photobiol.* **56**: 617–621.
- Whitelam, G.C., E. Johnson, J. Peng, P. Carol, M.L. Anderson, J.S. Cowl and N.P. Harberd (1993). Phytochrome A null mutants of Arabidopsis display a wild-type phenotype in white light. *Plant Cell* **5**: 757–768.
- Whitelam, G.C. and N.P. Harberd (1994). Action and function of phytochrome family members revealed through the study of mutant and transgenic plants. *Plant Cell Environ.* **17**: 615–625.

- Wilson, C.C. (1948). Diurnal fluctuations of growth in length of tomato stem. *Plant Physiol.* **23**: 156-157.
- Withrow, R.B., W.H. Klein and V. Elstad (1957). Action spectra of photomorphogenic induction and its photoinactivation. *Plant Physiol.* **32**: 453-462.
- Wong, Y.-S. and J.C. Lagarias (1989). Affinity labeling of *Avena* phytochrome with ATP analogs. *Proc. Natl. Acad. Sci. USA* **86**: 3469-3473.
- Wong, Y.-S., R.W. McMichael Jr. and J.C. Lagarias (1989). Properties of a polycation-stimulated protein kinase associated with purified *Avena* phytochrome. *Plant Physiol.* **91**: 709-718.
- Yanovsky, M.J., J.J. Casal and G.C. Whitelam (1995). Phytochrome A, phytochrome B and HY4 are involved in hypocotyl growth responses to natural radiation in *Arabidopsis*: weak de-etiolation of the *phyA* mutant under dense canopies. *Plant Cell Environ.* **18**: 788-794.
- Yatsushashi, H., T. Hashimoto and S. Shimizu (1982). Ultraviolet action spectrum for anthocyanin formation in broom sorghum first internodes. *Plant Physiol.* **70**: 735-741.
- Young, J.C., E. Liscum and R.P. Hangarter (1992) Spectral-dependence of light-inhibited hypocotyl elongation in photomorphogenic mutants of *Arabidopsis*: evidence for a UV-A photosensor. *Planta* **188**: 106-114
- Zeiger, E. (1994). The photobiology of stomatal movements. In: *Photomorphogenesis in Plants*, 2nd Ed. (Edited by R.E. Kendrick and G.H.M. Kronenberg), pp. 683-706. Kluwer Academic Publishers, Dordrecht, The Netherlands.

## Samenvatting

Licht is voor planten van essentieel belang als energiebron die groei mogelijk maakt *via* de fotosynthese. In dit proces wordt kooldioxide (CO<sub>2</sub>) omgezet in suikers die als grondstoffen voor de plant dienen. Omdat planten gebonden zijn aan hun standplaats hebben zij gedurende de evolutie allerlei mechanismen ontwikkeld om zich continu aan te passen aan veranderingen in het omringende (licht-)milieu, zoals de hoeveelheid licht (lichtkwantiteit), de daglengte, de richting van het licht en de spectrale samenstelling van het licht (lichtkwaliteit). Op deze manier kunnen planten het beschikbare licht zo optimaal mogelijk blijven gebruiken in de fotosynthese. Daarnaast zijn er nog andere factoren die de plant beïnvloeden zoals zwaartekracht, temperatuur en beschikbaarheid van water en nutriënten. De processen waarbij de plant het licht als informatiebron gebruikt om vervolgens de groei en ontwikkeling zo optimaal mogelijk af te stellen aan het omringende beschikbare licht, vatten we samen als *fotomorfogenese*. De effecten van licht op de plant zijn waarneembaar tijdens de hele levenscyclus van het moment van kieming tot aan het afsterven van de plant. Een treffend voorbeeld is o.a. een vergelijking tussen een donker-gegroeide kiemplant en een in licht-gegroeide kiemplant (zie Fig. 1.1). In licht-gegroeide (gedeëtiolerde) kiemplanten ontvouwen de kiemblaadjes (cotylen) zich en wordt de lengtegroei geremd in tegenstelling tot de donker-gegroeide (geëtiolerde) kiemplant die, met de cotylen veilig opgeborgen in een zgn. hoek, zo snel mogelijk het licht probeert te vinden. Om het licht te kunnen waarnemen is de plant uitgerust met pigmenten (fotoreceptoren). Deze pigmenten die de plant informatie verschaffen omtrent het omringende lichtmilieu zijn onderverdeeld in drie groepen: (i) de fytochromen, die voornamelijk rood (R, 600–700 nm) en verrood (FR, 700–800 nm) absorberen; (ii) de cryptochromen, die ultraviolet-A (UV-A, 315–400 nm) en blauw (B, 400–500 nm) absorberen; en (iii) een ultraviolet-B fotoreceptor, die ultraviolet-B (UV-B, 280–315 nm) absorbeert.

Van de verschillende fotoreceptoren zijn de fytochromen het best gekarakteriseerd. Deze fytochromen zijn blauw-groen van kleur. Als gevolg van hun lage concentratie zijn ze slechts te detecteren met behulp van gevoelige apparatuur voor het meten van absorpties. Een fytochrom-molecuul is opgebouwd uit twee eiwit-chromofoor complexen. Het chromofoor is verantwoordelijk voor de absorptie van het licht. Het fytochrom-molecuul komt in twee vormen voor, een R-absorberende niet-actieve vorm (Pr) en een FR-absorberende actieve vorm (Pfr). Een Pr kan door R worden omgezet in een actieve Pfr en een Pfr kan door FR worden omgezet in een niet-actieve Pr. Deze zgn. omkeerbaarheid leidde in 1952 tot de ontdekking van het fytochrom. De fysiologisch actieve Pfr-vorm is verantwoordelijk voor de respons (o.a. kieming, deëtiolering, expressie van genen). Beide vormen van het fytochrom hebben gedeeltelijk overlappende



absorptiespectra waardoor er een dynamisch evenwicht tussen beide vormen ontstaat. Dit wordt aangeduid als het fytochromevenwicht ( $\phi$ ) wat de verhouding van het Pfr ten opzichte van het totaal fytochroom aangeeft. Er bestaan meerdere typen van het fytochroom. De eiwit-eenheden van het fytochroom worden gecodeerd door een fytochroom gen-familie. In studies aan de genetisch modelplant zandraket (*Arabidopsis thaliana*) zijn vijf fytochroom-genen (*PHYs*) beschreven: *PHYA*, *PHYB*, *PHYC*, *PHYD* en *PHYE*. Deze genen coderen voor vijf fytochroom-eiwitten (*PHYs*): *PHYA*, *PHYB*, *PHYC*, *PHYD* en *PHYE*. Functionele fytochromen ontstaan na het inbouwen van het chromofoor aan de fytochroom-eiwitten, resulterend in respectievelijk *phyA*, *phyB*, *phyC*, *phyD* en *phyE*. Ook in andere plantensoorten zijn meerdere fytochroom-genen gevonden. In tomaat (*Lycopersicon esculentum* Mill.) zijn ook vijf fytochroom-genen beschreven tw. *PHYA*, *PHYB1*, *PHYB2*, *PHYE* en *PHYF*. Deze genen komen in ruimte en tijd op verschillende wijze tot expressie in de plant. De relaties tussen de fytochroom-genen in diverse plantensoorten is zichtbaar in Fig. 9.1.

Dit proefschrift beschrijft het onderzoek naar de fysiologische functies van de fytochromen in tomaat. Hierbij werd gebruik gemaakt van fotomorfogenetische mutanten. Dit onderzoek werd gefinancierd door de Nederlandse Stichting voor Wetenschappelijk Onderzoek (NWO), stond onder leiding van Dr. R.E. Kendrick en Prof. Dr. W.J. Vredenberg (vakgroep Plantenfysiologie, Landbouwniversiteit Wageningen) en is uitgevoerd in intensieve samenwerking met diverse andere onderzoeksgroepen in Wageningen, Engeland, Japan en USA. Twee fytochromen in tomaat stonden centraal in deze studie, nl. *phyA* en *phyB1*. Het *phyA* is een zgn. labiel fytochroom. Dit type fytochroom is in donker-gegroeiende planten zeer overvloedig aanwezig en wordt bij de overgang naar en onder invloed van licht afgebroken tot een laag evenwichtsniveau. De overige fytochromen zijn stabiel en worden niet afgebroken door het licht en zijn op een laag niveau aanwezig. In samenwerking met de vakgroep Erfelijkheidsleer (Prof. Dr. M. Koorneef en ir. A. van Tuinen) zijn diverse mutanten in tomaat geïsoleerd door middel van een chemische behandeling. Deze mutanten werden geselecteerd onder diverse kleuren licht omdat de te verwachten mutaties in de fotoreceptoren dan specifiek tot uiting kwamen.

In Hoofdstuk 2 worden twee mutanten beschreven die als zaailing volledig kleurenblind zijn in verrood licht (FR). Hierdoor werden deze mutanten in FR niet geremd in hun lengtegroei (Fig. 2.4). In de andere kleuren gedragen deze mutanten zich als een normale zaailing (wildtype). Dit afwijkende gedrag was aanleiding om deze mutanten *far-red light insensitive (fri)* te noemen. Deze mutanten zijn in samenwerking met anderen fysiologisch en moleculair-biologisch gekarakteriseerd ten opzichte van het bijbehorende wildtype (WT). Hieruit bleek dat de *fri* mutanten gemuteerd zijn in het *PHYA* gen. In Hoofdstuk 3 worden vier mutanten beschreven die als zaailing tijdelijk kleurenblind zijn in rood licht (R). Hierdoor worden ze in R in veel mindere mate geremd in hun lengtegroei dan het wildtype

(zie Fig. 3.2). In de andere kleuren gedragen deze mutanten zich als WT. Dit afwijkende gedrag was aanleiding om deze mutanten *temporarily red-light insensitive* (*tri*) te noemen. Ook deze mutanten zijn fysiologisch en moleculair-biologisch gekarakteriseerd ten opzichte van het WT. Hieruit bleek dat de *tri* mutanten gemuteerd zijn in het *PHYB1* gen. In Hoofdstuk 5 worden mutanten beschreven die zgn. overdreven fytochroom responsen vertonen. Dit uit zich o.a. in een gedrongen groei en in extra door fytochroom gereguleerde vorming van een rood-paars pigment, anthocyaan. Dit verhoogde anthocyaan-gehalte geeft aanleiding tot hun naamgeving: twee *high pigment* (*hp-1* en *hp-2*) mutanten, een *intensive pigmentation* (*Ip*) mutant en een *atroviolacea* (*atv*; latijns voor high pigment) mutant. Deze mutanten zijn niet gemuteerd in een van de bekende fytochroom-genen maar worden geclassificeerd als potentiële fytochroom transductieketen mutanten. Ook deze mutanten zijn fysiologisch gekarakteriseerd en beschreven in hun responsen.

De *phyA*- en *phyB1*-deficiënte mutanten zijn bijzonder waardevol in het toekennen van functies van de fytochromen in de plant. De *fri* (*phyA*-deficiënte) mutanten verschillen alleen dramatisch ten opzichte van het WT als zaailing onder FR. Als volwassen planten zijn er in vergelijking met het WT onder laboratorium-omstandigheden geen grote verschillen in groei en ontwikkeling. In de kas is één van de *fri* mutanten gevoelig voor verwelking. De *tri* (*phyB1*-deficiënte) mutanten vertonen wel grote verschillen met het WT gedurende de levenscyclus van de plant. Deze mutanten vertonen ook onder wit licht (WL) omstandigheden een grotere stengelstrekking. Deze verschillen worden versterkt in lagere hoeveelheden WL. Een methode om een zgn. schaduw-mijdende reactie te induceren is planten blootstellen aan extra FR gedurende de hele dag of aan FR gedurende een korte periode (meestal 10–20 min) aan het begin van de nacht (zgn. eind-van-de-dag FR). In het WT leidt deze behandeling met FR tot een groeiversnelling. In tegenstelling tot de tot nu toe gekarakteriseerde *phyB*-deficiënte mutanten in andere plantensoorten, reageren de *tri* (*phyB1*-deficiënte) mutanten net als het WT wel op deze behandeling. Deze effecten konden zeer nauwkeurig gemeten worden (Hoofdstuk 7) met een in eigen beheer gebouwde groeimeter (Fig. 7.1). Onder de proefomstandigheden bleken de *fri* mutanten niet te onderscheiden van het WT. De *tri* mutant vertoonde een verdubbeling van de groeisnelheid ten opzichte van het WT (Hoofdstuk 8). Naast de *tri* mutanten vertoonde ook de *fri* mutanten een normale eind-van-de-dag FR respons. Deze afwijkende reactie op het schaduw-licht in de *phyB1*-missende *tri* mutant leidde tot de conclusie dat in tomaten andere fytochromen en zeer waarschijnlijk het nauw verwante *phyB2* ook een rol kunnen spelen in deze schaduw-mijdende reactie.

In Hoofdstuk 4 werden de *fri* en de *tri* mutanten, samen met diverse g onderzocht in een specifieke fytochroom gereguleerde respons, te weten de anthocyaanvorming na een 24-uurs belichting. Dit werd gedaan in een in eigen beheer gebouwde 'threshold-box' (Fig. 4.1). Hierin kan gelijktijdig een per

in eigen beheer gebouwde 'threshold-box' (Fig. 4.1). Hierin kan gelijktijdig een per compartiment verschillende hoeveelheid licht worden aangeboden aan meerdere bakjes zaailingen. Uit deze proeven kon geconcludeerd worden dat het wildtype twee karakteristieke reacties laat zien, te weten een lage en een hoge lichtintensiteits reactie. In R bleek dat in de *fri* mutant de lage lichtintensiteits-component (LFRR) volledig ontbrak terwijl in de *tri* mutant de hoge lichtintensiteits-component (HIR) vrijwel volledig ontbrak. In de *fri,tri* dubbelmutant bleek totaal geen anthocyaan te worden gevormd. De *hp-1* mutant vertoonde een versterkte reactie van beide responsen. De *hp-1* geïntroduceerd in de *fri* en *tri* als dubbelmutanten leidde tot een versterking van de respons, zoals aanwezig in de enkele (monogene) mutant.

De transductieketen mutanten zijn waardevol bij het ophelderen van het mechanisme van de signaaltransductie. De vier gekarakteriseerde mutanten (*hp-1*, *hp-2*, *Ip* en *atv*) leiden allemaal tot een versterking van de fytochroomresponsen. Uit proeven in de threshold-box waar specifiek de anthocyaan-vorming werd bestudeerd, bleek dat de *atv* mutant specifiek de phyB1 gereguleerde respons (HIR) te versterken. De *Ip* mutant vertoonde voornamelijk specifiek in B een versterkte reactie waardoor er mogelijk een interactie is met de signaaltransductieketen van de B fotoreceptor. We speculeren dat de gen-producten HP-1, HP-2 en ATV in het WT de fytochroomwerking remmen. In de *hp-1*, *hp-2* en *atv* mutanten zijn deze remmers gemuteerd en niet werkzaam. De *Ip* mutant is een dominante mutatie die de fytochroom signaaltransductie rechtstreeks versterkt.

De *aurea* (*au*) mutant is in aansluiting op eerder onderzoek verder gekarakteriseerd (Hoofdstuk 6). Uit recent onderzoek is gebleken dat *au* een chromofoor-mutant is. Hoewel deze mutant dus niet gestoord is in de vorming van fytochroom-eiwitten vindt er door deze chromofoor-mutatie geen assemblering plaats van het chromofoor aan het eiwit. Hierdoor worden er geen functionele fytochromen gevormd. De schaduwrijdende reactie van de *au*, de *hp-1* en de *au,hp-1* dubbelmutant werd onderzocht door de planten bloot te stellen aan extra FR gedurende de hele dag. Het bleek dat deze set van drie mutanten reageerden met een dramatische groeiversnelling onder FR-rijke omstandigheden. Uit deze proef bleek zeer nadrukkelijk dat er in volwassen *au* en *au,hp* mutanten functioneel fytochroom aanwezig is, waardoor de mutatie in de chromofoorbiosynthese niet helemaal volledig is in de *au* mutant. In veel responsen blijkt dat de *au* mutatie geïntroduceerd in de *au,hp-1* dubbelmutant overheersend is waardoor de *au,hp-1* dubbelmutant erg veel lijkt op de *au* mutant. In het onderzoek naar pigment samenstelling in de vrucht (Hoofdstuk 6) bleek echter dat de *au,hp-1* dubbelmutant juist zowel *au* als ook *hp-1* karakteristieken had.

Met deze serie mutanten is het ons gelukt een beter inzicht te krijgen in de specifieke fysiologische functies van bepaalde fytochromen (phyA en phyB1) in tomaat. Er worden nieuwe mutant selecties uitgevoerd uitgaande van de *fri,tri* dubbelmutant. Toekomstig onderzoek zal zeker, gebruikmakend van deze nieuwe

potentiële mutanten (putanten), ook de specifieke functies van de andere fytochromen en de interacties tussen de diverse typen fytochroom blootleggen. De verdere opheldering van de complexe fytochroom transductieketen zal eveneens een groot aandachtspunt blijven in het toekomstig fytochroomonderzoek.

## Curriculum vitae

Leonardus Hubertus Joseph (Huub) Kerckhoffs werd geboren op 12 juni 1963 te Middenmeer. Na het behalen van het VWO diploma aan het Werenfridus Lyceum te Hoorn, begon hij in september 1983 met de studie Landbouwplantenteelt aan de toenmalige Landbouwhogeschool te Wageningen. Het propaedeuse-examen werd in oktober 1984 *cum laude* behaald. De doctoraal-fase omvatte de volgende hoofdvakken: Landbouwplantenteelt (bij Prof. Dr. P.C. Struik) en Plantenfysiologie (bij Prof. Dr. Bruinsma en Dr. D. Vreugdenhil). Verder werd er een uitgebreide stage doorgebracht bij het toenmalige Centrum voor Agrobiologisch Onderzoek (CABO), Wageningen (bij Dr. J. Vos). Het doctoraalexamen Landbouwplantenteelt (specialisatie Gewasbiologie) werd in augustus 1989 eveneens *cum laude* behaald. Aansluitend werd hij aangesteld als toegevoegd onderzoeker bij de toenmalige vakgroep Landbouwplantenteelt en Graslandkunde van de Landbouwuniversiteit Wageningen in een project: "Beïnvloeding van de knolgrootteverdeling bij de aardappel" (bij Prof. Dr. P.C. Struik). In september 1990 is hij begonnen als onderzoeker in opleiding (OIO) voor de toenmalige Stichting voor Biologisch Onderzoek (BION), later opgegaan in de Stichting Levenswetenschappen (SLW), gefinancierd door de Nederlandse Organisatie voor Wetenschappelijk Onderzoek (NWO), aan de toenmalige vakgroep Plantenfysiologisch Onderzoek (in 1993 opgegaan in de vakgroep Plantenfysiologie) binnen de Onderzoeksschool Experimentele Plantenwetenschappen (EPW) van de Landbouwuniversiteit Wageningen (bij Dr. R.E. Kendrick en Prof. Dr. W.J. Vredenberg). Het onderzoek aan deze vakgroep heeft geleid tot dit proefschrift. Tijdens het promotieonderzoek werden diverse perioden doorgebracht aan buitenlandse laboratoria. In 1991, vijf maanden aan het Botany Department, University of Leicester, Leicester, UK (Prof. H. Smith and Dr. G.C. Whitlam). In 1993, zeven maanden als Frontier Researcher in het Laboratory for Photoperception and Signal Transduction, Frontier Research Program, The Institute of Physical and Chemical Research (RIKEN), Wako-shi, Saitama, Japan (Dr. R.E. Kendrick and Prof. Dr. N. Takahashi). In 1994, vier maanden aan het Botany Department, University of Georgia, Athens, GA, USA (Prof. Dr. L.H. Pratt and Dr. M.-M. Cordonnier-Pratt). Per 1 januari 1997 zal hij middels een door NWO toegekend TALENT-stipendium als post-doc onderzoek gaan verrichten aan: "A new member of the phytochrome family: properties and functions of phyF" aan het Botany Department, University of Georgia, Athens, GA, USA in de groep van Prof. Dr. L.H. Pratt. De auteur is getrouwd met Henriët Woudenberg en vader van Pien.