



Sustainable Use of Phosphorus

EU Tender ENV.B.1/ETU/2009/0025

J.J. Schröder, D. Cordell, A.L. Smit & A. Rosemarin





Sustainable Use of Phosphorus

EU Tender ENV.B.1/ETU/2009/0025

J.J. Schröder¹, D. Cordell², A.L. Smit¹ & A. Rosemarin²

¹ Wageningen University and Research Centre

² Stockholm Environment Institute (SEI)

© 2010 Wageningen, DLO Foundation

All rights reserved. No part of this publication may be reproduced, stored in a retrieval system or transmitted, in any form or by any means, electronic, mechanical, photocopying, recording or otherwise, without the prior written permission of the DLO Foundation, Plant Research International, Business Unit Agrosystems.

The Foundation DLO is not responsible for any damage caused by using the content of this report.

Disclaimer:

The contents of this report do not necessarily represent the position of the European Commission

Plant Research International, part of Wageningen UR Business Unit Agrosystems

Address : P.O. Box 616, 6700 AP Wageningen, The Netherlands
: Wageningen Campus, Droevendaalsesteeg 1, Wageningen, The Netherlands
Tel. : +31 317 48 05 24
Fax : +31 317 41 80 94
E-mail : info.pri@wur.nl
Internet : www.pri.wur.nl

Stockholm Environment Institute (SEI)

EcoSanRes programme
Kräftriket 2B
SE-106 91, Stockholm
Sweden

Table of contents

	page
Preface	1
Executive summary	3
1. Introduction	7
1.1 Global cycling of phosphorus	7
1.2 The introduction of fertilizer	7
1.3 Food security and fertilizers	7
1.4 Losses	8
1.5 Governance of phosphorus-resources	8
1.6 Overview of the report	8
2. A review of the phosphorus situation in the world	9
2.1 The significance of phosphorus scarcity	9
2.1.1 Defining sustainable phosphorus use	9
2.1.2 Phosphorus scarcity linked to food security and fertilizer accessibility	10
2.2 Phosphate rock availability	12
2.2.1 USGS data: phosphate rock reserves, reserve base and resources	14
2.2.2 Other data sources	16
2.2.3 Data uncertainty and reliability	16
2.3 Peak phosphorus	17
2.4 Geopolitical aspects	18
2.5 Demand	19
2.5.1 Current consumption of fertilizer phosphorus	19
2.5.2 Estimates of future demand and associated consequences	21
2.6 Conclusion	28
3. Inefficiencies and environmental impacts of current phosphorus use	31
3.1 Global phosphorus flows through the food production and consumption system	31
3.2 Mining and beneficiation losses	35
3.3 Fertilizer production and distribution losses	37
3.4 Sources of phosphorus loss in agriculture	37
3.4.1 Introduction	37
3.4.2 Soil surface balances	38
3.4.3 Food production, processing and retailing	44
3.4.4 Excretion and solid waste management	44
3.5 Environmental impact of phosphorus use - from mine to fork	44
3.5.1 Overview of environmental impacts	44
3.5.2 Impacts during mining and fertilizer production	45
3.5.3 Impacts during fertilizer application and use in agriculture	48
3.5.4 Impacts during organic waste treatment and recovery	49
3.5.5 Life cycle energy consumption - from mine to field	50

	page
3.6 Country/Regional Case studies	52
3.6.1 Introduction	52
3.6.2 Switzerland	55
3.6.3 The Netherlands	60
3.6.4 Baltic Sea Region	64
3.6.5 Ireland and Spain: similar but different	68
3.6.6 Synthesis of the case studies	69
3.7 Conclusion	70
4. Sustainable strategies for improving phosphorus use management	71
4.1 Reducing mining losses and increasing recovery	71
4.2 Efficiency in agriculture	72
4.2.1 Introduction	72
4.2.2 Optimising land use	73
4.2.3 Preventing erosion	73
4.2.4 Maintaining soil quality	74
4.2.5 Improving fertilizer recommendations	74
4.2.6 Fertilizer placement methods	76
4.2.7 Improving crop genotypes and promoting mycorrhizas	76
4.2.8 Adjusting inputs to outputs	77
4.2.9 Exporting manure	77
4.2.10 Adjusting livestock diets	78
4.3 Efficiency in food commodity chain	78
4.4 Phosphorus recovery and reuse from waste streams	79
4.4.1 Drivers for phosphorus recovery	79
4.4.2 Sources of phosphorus for recovery and reuse	80
4.4.3 Processes and technologies for the recovery and reuse of phosphorus	85
4.4.4 Potential recovery of phosphorus from additional sinks	92
4.4.5 Future challenges and opportunities	93
4.5 Conclusion	95
5. Policy implications and recommendations	97
5.1 Introduction	97
5.2 Scope and impact of existing policies	97
5.2.1 EU policies	97
5.2.2 Lack of global governance of phosphorus	98
5.3 Short-term policies	99
5.3.1 Raising awareness of phosphorus sustainability	99
5.3.2 Lack of Internalization of costs	100
5.3.3 Economic measures	100
5.3.4 Regulatory measures	102
5.4 Policies directed at more fundamental aspects of phosphorus use	103
5.4.1 Institutional changes	103
5.4.2 Reforming agriculture	104
5.4.3 Facilitating recycling	106
5.4.4 Population size and consumption patterns	107
5.5 Research recommendations	107
5.6 Conclusion	108
6. References	111
Appendix I. Data requirement of a phosphorus balance	5 pp.
Appendix II. Available technologies	3 pp.

Preface

There is a growing awareness that the European way of life is as yet based on a gradual depletion of fossil reserves and that this cannot last forever. Until recently, phosphorus was not thought of as being one of these finite reserves. Instead of recovering phosphorus for reuse from our 'waste' streams, we keep on extracting phosphorus from non-renewable phosphate rock deposits elsewhere in the world and use it to replace the phosphorus that is lost or dumped as waste.

Because it is an essential element for our present and future food security with no substitute, the handling of this element must change towards more sustainable practices. The urgency is in part determined by the remaining amount of high quality phosphate rock considered economically extractable. Estimates of these amounts are made by the United States Geological Survey (USGS). Their figures have recently been revised by the International Fertilizer Development Centre (IFDC), however the IFDC's report had not been made public at the time of writing. We have tried in vain to get a draft copy of the report and so all estimates of reserves and the reserve base rely on figures from the USGS. The findings of the IFDC report, and future prognoses, have been annotated by the Global Phosphorus Research Initiative (GPRI; http://phosphorusfutures.net/files/GPRI_Statement_responseIFDC_final.pdf). The GPRI concludes that findings of the IFDC report will only have a marginal effect on the time available to identify, develop and implement effective methods to fully close the global phosphorus cycle. The report does not affect the finiteness of the resource as such.

We are grateful that the European Commission has acknowledged that phosphorus deserves due attention and that it was decided to support the present project. The Commission has asked us to make an estimate of current and future phosphorus supplies and demand, to identify where phosphorus is lost between 'mine and fork', and to review the environmental implications of these losses and other issues associated with the use of phosphate rock. Last but not least the Commission wanted us to focus on the identification of measures, both technical and managerial, aimed at reducing phosphorus losses and a promotion of sustainable use and reuse.

We would like to thank the Directorate General for the Environment (DG Env) of the European Commission for their supervision of the project. Mr Leonardo Nicolia and Mrs Agnieszka Romanowicz are gratefully acknowledged along with the several other attendees of meetings at DG Env, for the fruitful discussions that we have had during the production of the report.

Finally, we would like to express the hope that this report will contribute in its own way towards a more sustainable use of phosphorus both within the EU and abroad.

The authors

October 8, 2010

Executive summary

Phosphorus is essential for food production, however its use is not without implications. Attention to sustainable phosphorus use is no longer solely focused on reducing detrimental environmental impacts, but also explicitly linked to food security. That is, sustainable phosphorus use must ensure that all the world's farmers have sufficient access to phosphorus in the long run to produce enough food to feed humanity, whilst minimizing adverse environmental and social impacts.

While the European Union has for many decades seen itself as a food secure region, this report demonstrates the ways in which the EU food system is in fact highly vulnerable to future phosphorus scarcity. Without phosphorus, agricultural production will be lower and, consequently, less food can be produced. At this moment the EU is almost entirely dependent on imported phosphate rock, phosphoric acid, phosphate fertilizers and feed supplements containing phosphorus. The world's main source of phosphorus is phosphate rock. It is a non-renewable resource. Cheap, high-quality reserves are becoming increasingly scarce.

There is currently a vigorous debate regarding the lifetime of remaining high quality phosphate rock reserves, with estimates varying from a few decades to a few hundred years. Despite the uncertainty, there is general consensus that the quality of remaining reserves is in decline (both in terms of P_2O_5 content and the presence of heavy metals and other contaminants), that phosphate layers are becoming more physically difficult to access, that more waste is being generated and that costs are increasing. At the same time, the global demand for phosphorus is expected to increase - primarily due to an increasing demand for food from a growing world population. The increasing popularity of meat and dairy products (which require more phosphorus to produce) in developing economies, and phosphorus demand for non-food uses, may further increase global demand.

Further, regardless of the exact lifetime of reserves, the uneven geological distribution of phosphate rock means that China, Morocco, the US, South Africa and Jordan control 85% of global reserves, making the EU as a phosphate importer vulnerable to geopolitical tensions in these countries, and to volatile prices (as demonstrated during the recent 800% spike in the price of phosphate rock in 2008).

The phosphorus situation for individual member states varies, depending on several local factors and drivers. For the EU27 as a whole import of phosphorus is dominated by concentrated products for the fertilizer industry. Phosphorus imports with feed or food take place to a lesser extent. However, in countries with an extensive livestock production phosphorus imports with feed materials dominate.

If the amount of phosphorus entering a spatial entity (field, farm, region, country, continent) exceeds the amount of phosphorus exported from that entity, there is a so-called phosphorus surplus. Such an imbalance of import and export of phosphorus leads to either accumulation in agricultural soils, accumulation in the waste sector or to emissions to the environment. The present report shows that a better internal recycling of phosphorus allows for a reduction of imports and, thus, the surplus. It is illustrated that such return flows of phosphorus from industries and urban areas back to agriculture is currently small for various reasons, an important one being the concern for contaminants, e.g. in sewage sludge.

Only about one-fifth of the mined phosphorus is eventually eaten. Each step between mine and fork is associated with losses. Losses do not always reflect emissions into water bodies because a fraction of it is stored in phosphogypsum stock piles, in agricultural soils, in landfills, in ash deposits or in construction materials. Although not lost in the sense of dissipation, potential re-use is often limited for technical and economical reasons. A considerable fraction of the difference between mined phosphorus and ingested phosphorus, however, is truly lost to water bodies leading to eutrophication and loss of quality. Losses should also be reduced because the use of phosphorus is linked to other unwanted environmental effects, such as the loss of landscape quality, green house gas emissions, excessive fresh water consumption, radio activity, cadmium accumulation and fluorine emission. Pathways of phosphorus loss and the character of environmental effects differ considerably from country to country and depending on the position in

the chain from mine to fork. The typology of losses is important because it can help to develop specific response strategies. That is why strategies to abate losses and improve the use efficiency of phosphorus must differ as well.

Measures to improve the use of phosphorus are identified and outlined in detail in this report. Sustainable phosphorus use will require an integrated approach that combines efficiency and reuse, in order to reduce current phosphorus losses, minimise environmental impacts, conserve a finite resource and ensure all the world's farmers have access to phosphorus. Improving the efficiency of phosphorus use will buy the time needed to implement more fundamental sustainable phosphorus use measures, as in the end only efficiencies close to 100% will make the use of phosphorus sustainable. Improvements in efficiency can be achieved by reducing losses in mining, fertilizer production and agriculture. They can also come from changing the ways we handle wastes containing phosphorus in processing industries, and in the way we use phosphorus in our households and specialized waste-treatment installations. An important aspect of sustainable phosphorus use is that recovery of phosphorus from waste streams is not just needed to reduce water pollution, but for the sake of sustainability phosphorus must be recovered in an uncontaminated and plant-available form. Not all current recovery methods yield these types of fertilizer substitutes. Numerous examples of the strengths, weaknesses, opportunities and threats of measures along the path from mine to fork are given in the form of research findings and practical examples. It is concluded that 'end of pipe' measures, including the suggestion that phosphorus could be recovered from seawater, do not seem realistic, if only because of the energy consumption they would involve.

As sustainable phosphorus use will sooner or later become essential for global food security, action is needed. As far as the required actions are concerned, the report has identified short-term and long-term policy options which could improve the current level of phosphorus use efficiency in agriculture. The report emphasizes, however, that policies should not be developed in isolation, let alone for agriculture only, but that all parts of the chain, that is primary production, processing and consumption, should be addressed in an integrative way. The current reliance on imported rock-based phosphorus ('3 kg P per European citizen per year') can not be continued in the long run. To become truly sustainable, phosphorus use efficiency must approach a level close to 100% in each chain. Therefore, a full recycling of phosphorus will become a condition *sine qua non* for global and European food security. The urgency of policies and measures needed for that will be determined by the phosphate rock reserves considered exploitable (including geopolitically and legally accessible), the prevention of accumulation and losses, the size of the global population and its preferences in terms of food, feed, fibers and fuels, and its appreciation of biodiversity. This will require drastic adjustments to the way we manage agriculture, and it may also require adjustments to our society as a whole, including the processing of our 'wastes'. In preparation of that it is recommended to:

- establish a representative and global platform representing all key stakeholders dealing with phosphorus in different parts of the food system, to facilitate an effective governance of phosphorus, given the uneven distribution of supply and demand in space and time,
- raise public awareness of the scarcity of phosphate rock, whilst presenting policy options and measures showing a way out of the problem,
- promote independent assessments of long-term phosphorus supplies and demand, taking into account available techniques, population size and alternative consumption patterns, in order to identify solutions and adapt these to local conditions and requirements,
- discourage the use of phosphorus for other purposes than safeguarding food security,
- internalize the costs associated with the negative effects of phosphorus use into the price of phosphorus commodities,
- develop a concerted set of economic incentives and regulatory measures directed at the reduction of phosphorus losses per unit area and per unit produce, and the promotion of optimized re-use of phosphorus recovered from 'wastes',
- initiate research to determine how production, processing and consumption of food could be improved into an integrated strategy in order to maximize the re-use of phosphorus whilst minimizing energy consumption,
- consider the development of a EU directive on phosphorus linked to food security.

Glossary and abbreviations

DAP	Diammonium phosphate
FAO	Food and Agricultural Organization of the United Nations
FAOSTATS	Online statistical database of the FAO
GPRI	Global Phosphorus Research Initiative
IAASTD	International Assessment of Agricultural Knowledge, Science and Technology for Development
IFA	International Fertilizer Industry Association
K	Potassium
MAP ¹	Monoammonium phosphate
MT	Million metric tonnes
N	Nitrogen
OCP	Office Cherifien de Phosphate (Morocco's phosphate company)
P	Phosphorus
Phosphate rock reserve	Economically and technically exploitable rock phosphate resource
Phosphate rock reserve base	Demonstrated, potentially, economically exploitable rock phosphate resource
Phosphate resource	Identified and undiscovered resources of rock phosphate in forms and amounts making their future exploitation potentially feasible
Struvite	magnesium-ammonium-phosphate
UN	United Nations
USGS	US Geological Survey
WHO	World Health Organization of the United Nations
WTO	World Trade Organization
	Phosphate rock <i>reserves</i> contains approximately 26-34% P ₂ O ₅ , (phosphate rock <i>reserve base</i> contains less P ₂ O ₅)

Units and conversion

t	Metric tonne (= 1000 kg)
kt	= kilo tonne = Mkg = million kg
Mt	= million tonne = billion kg (10 ⁹ kg)
P ₂ O ₅ vs. P	P = 0.44 * P ₂ O ₅ ; P ₂ O ₅ = 2.29 * P
GJ; EJ	GigaJoule, ExaJoule

¹ Struvite is also referred to as MAP (magnesium-ammonium-phosphate), however to avoid ambiguity, the common name struvite has been used.

1. Introduction

This chapter provides an overview of the natural phosphorus cycle and how, through the development of fertilizer from phosphate rock, humankind has interrupted this cycle and caused a net depletion which will have a major impact on future food security. We briefly summarize the more short-term anthropogenic influences on the global flows of phosphorus such as agricultural activities and other developments. We also refer to the need for improved governance systems in order to return to more sustainable practices.

1.1 Global cycling of phosphorus

From a geochemical point of view the long-term global phosphorus cycle has four major components (Ruttenberg, 2003) (i) tectonic uplift and exposure of phosphorus-bearing rocks to the forces of weathering; (ii) physical erosion and chemical weathering of rocks producing soils and providing dissolved and particulate phosphorus to rivers; (iii) riverine transport of phosphorus to flood plains, lakes and oceans; and (iv) sedimentation of phosphorus associated with organic and mineral matter and burial in sediments. The cycle begins anew with the uplift of sediments into the weathering regime.

In the pre-industrial period, societal production, processing and consumption of food, feed and fibre were closely related in space and time. Phosphorus which was removed from the soil with crops from agricultural production areas was compensated for via regular flooding or shifting cultivation, or it was supplemented by phosphorus in manure from livestock grazing on surrounding rangeland. Waste products containing phosphorus (manure, crop residues, human waste) were necessary to improve the soil fertility, or to maintain it at a level which produced reasonable yields.

1.2 The introduction of fertilizer

The introduction of mineral phosphorus fertilizer enabled the phosphorus which is lost from the soil when crops are harvested to be more easily replaced. This led, in general, to less recycling of waste products from society and agriculture. Mineral fertilizers (especially nitrogen (N) but also phosphorus (P)) led to a substantial increase in agricultural yields, and also to a spatial segregation between production and consumption. Mixed farming, at least in developed countries, was no longer necessary, and so arable farming and livestock farming became spatially segregated. One of the consequences was the concentration of intensive livestock farming, usually close to densely populated areas. Imports of feed from other countries further reduced the connection between livestock and arable areas. This took place to such an extent that the resulting manure production was in excess of what the surrounding arable areas could accept from an environmental point of view.

The use of mineral fertilizers not only led to intensification and specialization; it also allowed the human population to grow and afforded humankind a more affluent diet. However, it also led to less recycling of waste streams back to the sites of production. Manure, for example, was no longer seen as a valuable and vital resource for agriculture. Recycling in general and mixed farming in particular were from then on no longer a *condition sine qua non*.

1.3 Food security and fertilizers

Nowadays food production has become highly dependent on the use of phosphorus fertilizer, whereas the reuse of alternative phosphorus sources receives much less attention. This can be considered an unsustainable development because the rock deposits from which most phosphorus fertilizers originate are finite. Food availability and security will sooner or later be threatened when this valuable resource becomes scarce. In addition, the geopolitical aspects are a reason for concern, because phosphorus reserves are found in a limited number of countries. In order to improve sustainability, global agriculture has to become less dependent on mineral phosphorus fertilizer.

1.4 Losses

Looking at the global path of phosphorus from ‘mine to fork’, the efficiency seems low: only around one-fifth of the phosphorus mined for fertilizer production is in the end consumed by the human population (Cordell *et al.*, 2009a). Losses of phosphorus occur in all stages between mine and fork and include mining losses, losses due to soil erosion (phosphorus eventually ending up in the oceans sediments), crop losses as well as food losses. Another type of loss occurs in the waste sector when phosphorus-rich materials end up in landfill or in sewage sludge. Some member states discourage the reuse of sewage sludge for environmental concerns. Sludge is instead incinerated. Further losses can occur if manure is not used appropriately for crop production, or if it is even used for other purposes than fertilizing crops. Although not a loss in the strict sense of the word, accumulation of phosphorus in agricultural soils also is factor which can explain the apparent low efficiency from mine to fork. The reasons for accumulating can range from improving soil fertility or crop specific fertilizer recommendation schemes to regional surpluses of phosphorus due to concentration of livestock production.

1.5 Governance of phosphorus-resources

Although phosphorus deposits are essential for global food security, their possible exhaustion is currently not an issue on the agenda of international organizations or national governments (Cordell, 2010). Restrictions on the use of fertilizers are usually motivated by the negative impacts of excessive inputs in agriculture (leading to unacceptable pollution of water bodies), rather than by the threat of a possible shortage in the future. More efficient utilization of phosphorus is necessary, but will not alone be sufficient to make global agriculture sustainable. It will, however, provide the necessary time to develop recommendations, regulations and integrated policies for the full recovery and reuse of phosphorus. Sustainability requires both the prevention of direct losses (such as the losses resulting from mining and soil erosion) and the recycling of phosphorus from the waste streams from industrial and urban sectors back to agriculture.

1.6 Overview of the report

This report provides a detailed analysis of implications, requirements and solutions directed towards the sustainable use of phosphorus. Chapter 2 focuses on the finiteness of phosphate rock reserves, the present and future demand and geopolitical aspects of the trade in phosphate rock. Chapter 3 addresses the losses of phosphorus in mining and how it is used by society, and the environmental impacts of these losses and other environmental aspects linked to the use of phosphorus. Chapter 4 gives an inventory of measures directed at a more sustainable use of phosphorus, including possible changes in mining technology, fertilizer production, the use of phosphorus in agriculture, food processing and the handling of ‘wastes’ from industrial and urban sectors. Note that whenever full recovery and reuse of a substance is needed to achieve sustainability (as in the case of phosphorus according to the present state of knowledge), the term ‘waste’ is in fact inappropriate since in an ideal world, wastes do not exist. For the remainder of this report we continue to use the term ‘waste’ because the alternative term ‘by-products’ could be incorrectly read as referring to engineered products that already have a positive value.

Finally, Chapter 5 describes recommendations and possible regulations to achieve a more sustainable use of phosphorus in the future, both in the short term and long term. This chapter also includes several recommendations for future research.

2. A review of the phosphorus situation in the world

2.1 The significance of phosphorus scarcity

2.1.1 Defining sustainable phosphorus use

Sustainable phosphorus use has to date mostly been associated with minimizing environmental pollution. However, as demonstrated in this chapter, a new global understanding of phosphorus as a *scarce* resource is emerging. Phosphorus is one of the most essential elements to humanity. Without it, life would not exist. There is no substitute for phosphorus in crop growth and phosphorus cannot be synthetically manufactured. This means that ensuring the availability and accessibility of phosphorus in both the short and long term is critical to global food production. Prominent science writers such as the chemist Isaac Asimov described phosphorus as 'life's bottleneck':

We may be able to substitute nuclear power for coal, and plastics for wood, and yeast for meat, and friendliness for isolation—but for phosphorus there is neither substitute nor replacement' (Asimov, 1974).

This means any definition of sustainable phosphorus use will need to consider not only the pollution of aquatic ecosystems, but also the fundamental link to food security. A proposed sustainable global goal of 'phosphorus security' would ensure:

That all the world's farmers have access to sufficient phosphorus in the short and long term to grow enough food to feed a growing world population, while ensuring farmer livelihoods and minimizing detrimental environmental and social impacts (Cordell, 2010), p.123).

Phosphorus security therefore requires an integrated approach, addressing the multiple aims of environmental protection, food security, farmer livelihood security, cost-effectiveness and long-term availability (see Cordell (2010) for a detailed explanation of phosphorus security and associated goals). In short, phosphorus security would ensure that :

- the amounts of phosphorus (and related resources) that are *wasted* throughout the entire food production and consumption system are kept to a minimum.
- the use of phosphorus has no net negative impact, from its at-source effects or its downstream effects, on the *environment*, including water, land and biota.
- phosphorus fertilizers are produced, transported, used, recovered and managed in a way that minimizes life cycle *energy* consumption.
- sufficient phosphorus of appropriate quality is physically *available* both in the short term and longer term for farmers to utilize for fertilizers.
- the whole-of-society *costs* of producing, trading, using and recovering phosphorus are minimized.
- all the world's agricultural soils are sufficiently *fertile* to ensure high crop yields (with appropriate management).
- sufficient fertilizers for food availability are secured ensuring *global food security*.
- all people have sufficient phosphorus intake for a *healthy* and balanced diet.
- *geopolitical* interests do not steer the sourcing, use or reuse of phosphorus for food production.
- there is equitable *access* to phosphorus sources and current and future generations are not compromised directly or indirectly by the sourcing, use or re-use of phosphorus for food production.
- there is independent, equitable and transparent *governance* of phosphorus resources for long-term food security.

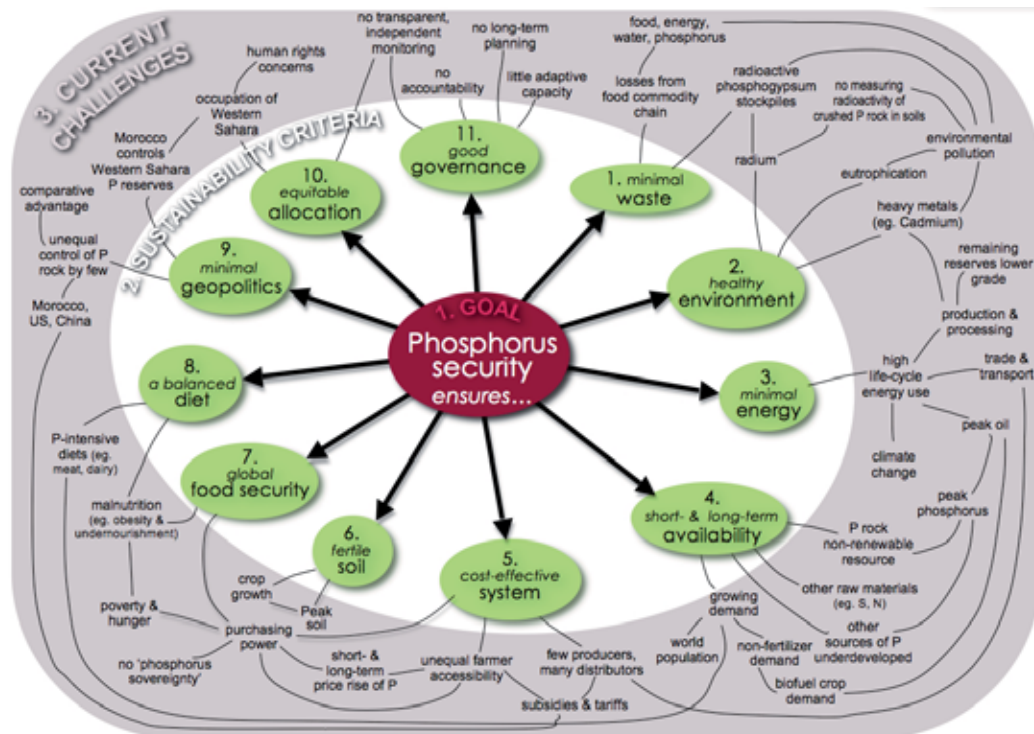

Figure 2-1. Conceptual diagram indicating that the goal of global phosphorus security (1) has multiple associated sustainability criteria (2) is required to address the diverse current challenges (3) is associated with phosphorus scarcity (Cordell, 2010).

2.1.2 Phosphorus scarcity linked to food security and fertilizer accessibility

In a world which will be home to nine billion people by the middle of this century, producing enough food and other vital resources is likely to be a substantial challenge for humanity. The UN's Food and Agricultural Organization (FAO) states that food security 'exists when all people, at all times, have access to sufficient, safe and nutritious food to meet their dietary needs for an active and healthy life' (FAO, 2005b). Food security therefore means ensuring access to nutritious food, as well as access to the natural resources (land, water, energy and nutrients) and human resources (soil science knowledge, labor, purchasing power) that are essential for producing it (Ericksen, 2008). While dominant discussions on global food security have captured many of these issues, including the challenges of water and energy scarcity (SIWI-IWMI, 2004; Pfeiffer, 2006), future phosphorus scarcity has been largely omitted to date (Figure 2-1 and Figure 2-2).

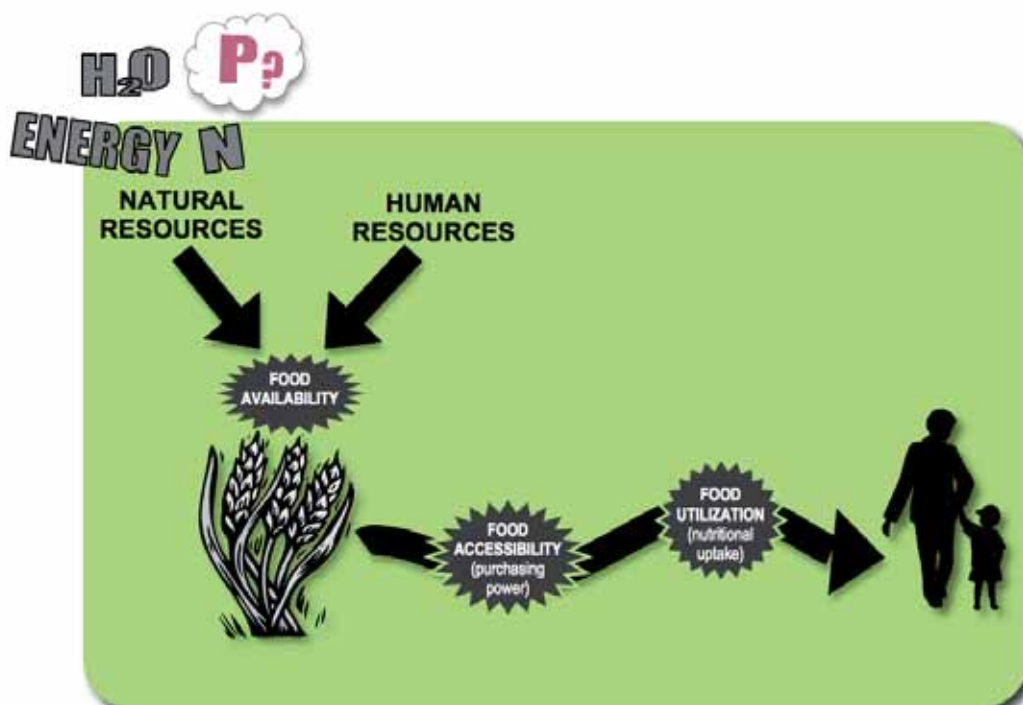

Figure 2-2. Three key themes of global food security: food availability, food accessibility and food utilization. Phosphorus scarcity has been missing from the food availability discourse to date (Cordell, 2010).

Historically, farmers relied on natural soil phosphorus to grow crops (with the addition of local manures and human excreta to some extent). However increased famine and soil degradation led to a search for external sources of phosphorus fertilizers including guano, ground bones and phosphate rock (Emsley, 2000) to boost crop yields. Phosphate rock in particular was seen as a cheap and plentiful source of phosphorus and this became widely used in addition to organic sources. The widespread use of phosphate rock contributed to a dramatic increase in global crop yields and has saved many people from starvation over the past half-century. Today, humanity is effectively dependent on mined phosphate rock to maintain high crop yields to meet increasing food and fibre demand (Cordell *et al.*, 2009a). Figure 2-3 illustrates the global production of phosphate rock since 1970.

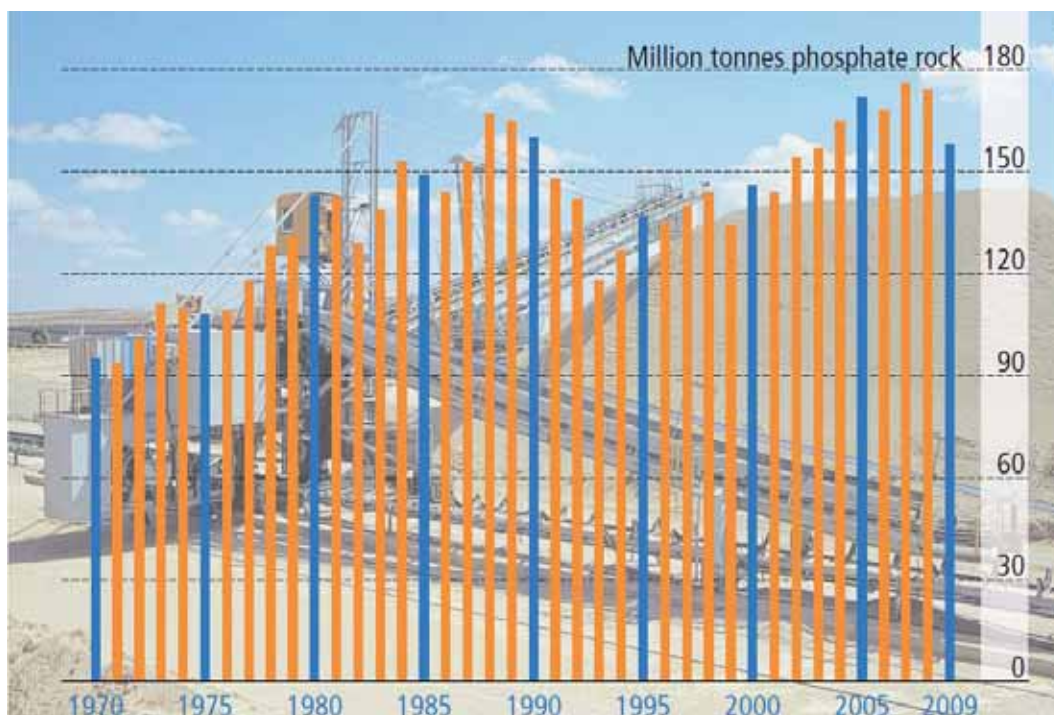

Figure 2-3. Global annual production of phosphate rock since 1970 according to IFA statistics (Prud'homme, (2010a).

The importance of phosphorus and the need to raise soil fertility in nutrient-deficient areas like Sub-Saharan Africa is relatively well understood in food security debates (Blair, 2008). However, few food security discussions have explicitly addressed the emerging challenge of where and how phosphorus will be obtained in the future to ensure continuous food availability for a growing world population (Cordell, 2010).

An unprecedented 1.02 billion people, one-sixth of all humanity, are malnourished today (FAO, 2009). Many of the world's hungry are in fact smallholder farmers and their families. An important dimension of food accessibility and household wellbeing is therefore fertilizer accessibility and farmer livelihoods. Farmer accessibility to fertilizers or fertilizer markets is critical to both livelihood security and global crop yields (Cordell, 2010). Many poor farmers around the world cannot access the phosphate fertilizer market due to low purchasing power or because they don't have access to credit (IFPRI, 2003). Further, in Sub-Saharan Africa, where fertilizers are most needed, phosphate fertilizers can cost farmers two to six times more at the farm gate than they cost European farmers (Runge-Metzger, 1995; Fresco, 2003). The recent price spike and anticipated future price spikes further reduce the purchasing power of poor farmers and hence compromise their access to fertilizers.

2.2 Phosphate rock availability

Whilst phosphorus is the 11th most abundant element in the Earth's crust, only a small percentage is present in high enough concentrations to be utilized by humans for producing fertilizers and other products (Smil, 2000; Millennium Ecosystem Assessment, 2005a). Further, much of the phosphate rock that is in high enough concentrations (such as nodules on the deep sea bed), is not physically accessible, contains prohibitive levels of contaminants (such as cadmium), or is constrained by other factors. These constraints limit the amount of high-quality, highly accessible phosphate rock available for use (Cordell, 2010). Figure 2-4 indicates these multiple constraints or 'bottlenecks' limiting the availability of phosphorus for productive use in food consumption.

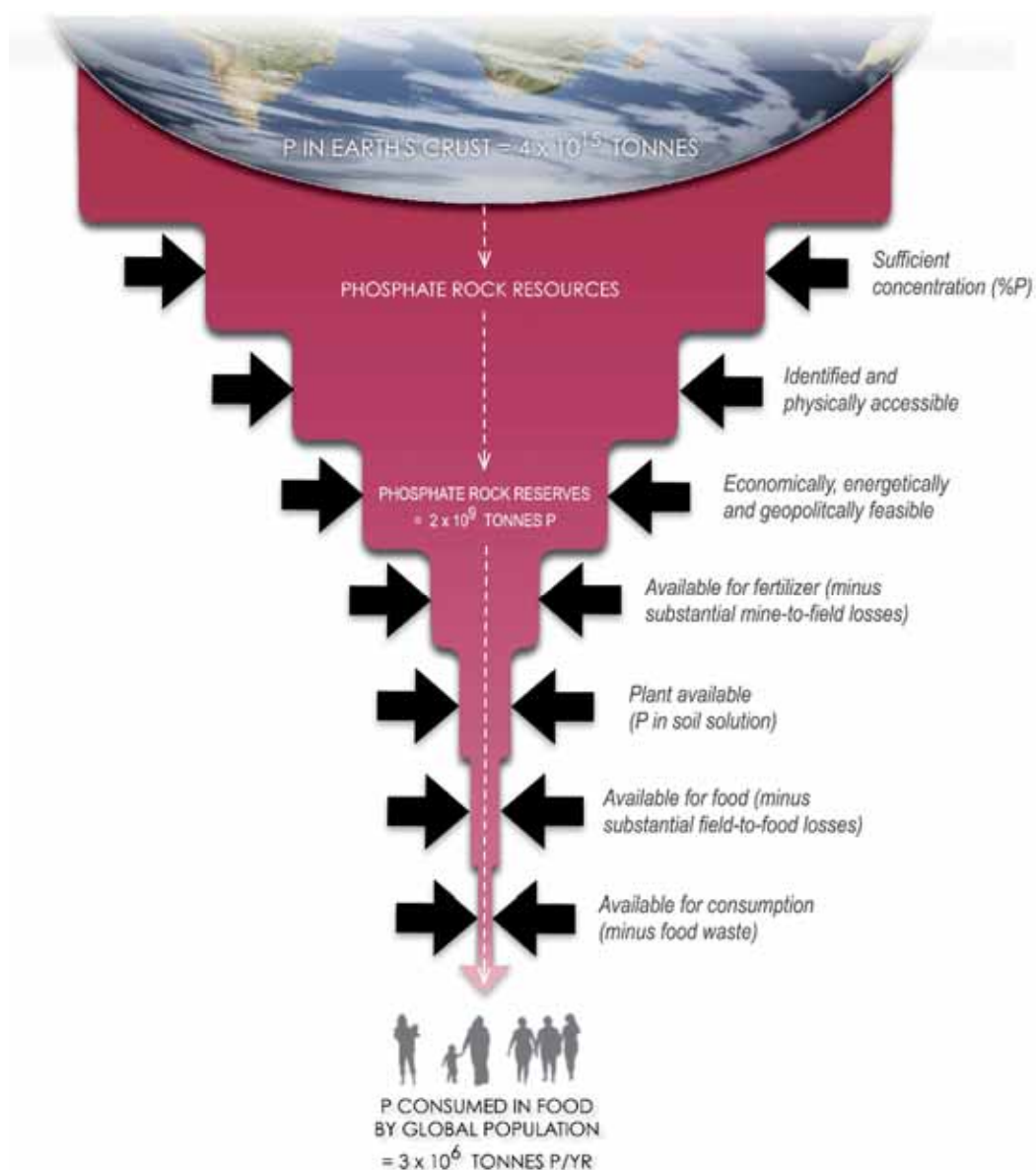

Figure 2-4. Phosphorus availability bottlenecks: physical, economic, social and ecological factors limiting the availability of phosphorus for productive use by humans for fertilizers and hence food production. Units are in P (Cordell and White, forthcoming).

Figure 2-4 also indicates ecological, social and physical constraining factors limiting the productive use of phosphate rock beyond the mine. The most significant constraining ecological factor is the bioavailability of phosphorus to plants. The Millennium Ecosystem Assessment explains:

The lithosphere is the ultimate source of all phosphorus in the biosphere ... Paradoxically, while apatite (the naturally occurring phosphate rock) is one of the most easily weathered primary minerals, phosphorus is amongst the least biologically available major nutrients. This is because the forms of phosphorus in the biosphere are poorly soluble, immobile, or otherwise inaccessible (Millennium Ecosystem Assessment, 2005).

Phosphate rock, like oil, is a non-renewable resource and high-grade reserves are becoming increasingly scarce. The phosphorus in phosphate rock - from mineralisation of dead aquatic organisms to tectonic uplift and weathering, has taken 10-15 million years to form naturally. Estimates of remaining reserves vary widely, partly due to a scarcity of data, compounded by inconsistent use of terms and a lack of transparency in assumptions (Cordell, 2010).

Table 2-1 indicates various estimates of the lifetime of reserves by different authors. Note that the term *reserves* pertains to the amounts that are currently considered economically and technically recoverable, and these amounts are smaller than total resources (consult section 2.2.1 for further definitions).

Table 2-1. *Estimates of availability of remaining phosphate rock reserves.*

Author	Estimated of reserves	lifetimeAssumptions/notes
Steen (1998)	60-130 years	2-3% increase demand rates, 'most likely' 2% increase until 2020 and 0% growth thereafter if efficiency and reuse measures are implemented.
Smil (2000)	80 years	At 'current rate of extraction'
Smit <i>et al.</i> (2009))	69-100 years	Assuming 0.7-2% increase until 2050, and 0% increase after 2050
Vaccari (2009)	90 years	At 'current rates'
Fixen (2009)	93 years	At 2007-2008 production rates

2.2.1 USGS data: phosphate rock reserves, reserve base and resources

The US Geological Survey (USGS) collects and publishes the most widely available datasets on the world's metals and mineral commodities, including phosphate rock. The widely used USGS classification typology (USGS, 2009) for mineral resources (and indeed earlier classifications such as Phillips (1977) are based largely on two variables - certainty and feasibility of economic recovery (depicted in Figure 2-5). Data on phosphate rock are normally reported by USGS using the two categories: Reserves and Reserve Base (e.g. see Jasinski (2008; 2009)). Reserve Base refers to the theoretically available deposits and Reserves stands for that part of the Reserve Base that is economic to mine according to current standards. The term 'resources' is also used by USGS classifications, but it is often misused which can lead to miscalculations (see section 2.2.3).

USGS (2009) define these three terms as:

Resource - 'A concentration of naturally occurring [phosphate] in or on the Earth's crust in such form and amount that economic extraction of a commodity from the concentration is currently or potentially feasible'. This is the broadest category and includes both identified and undiscovered phosphate - for example deposits in the continental shelf.

Reserve base - 'That part of an identified resource that meets specified minimum physical and chemical criteria related to current mining and production practices, including those for grade, quality, thickness, and depth. The reserve base is the in-place demonstrated (measured plus indicated) resource from which reserves are estimated. It may encompass those parts of the resource that have a reasonable potential for becoming economically available within planning horizons beyond those that assume proven technology and current economics'.

Reserve - 'That part of the reserve base which could be economically extracted or produced at the time of determination. The term reserves need not signify that extraction facilities are in place and operative. Reserves include only recoverable materials' (For which extraction is economically and technically feasible).

Cumulative Production	IDENTIFIED RESOURCES			UNDISCOVERED RESOURCES	
	Demonstrated		Inferred	Probability Range	
	Measured	Indicated		Hypothetical	(or) Speculative
ECONOMIC	Reserves		Inferred Reserves		
MARGINALLY ECONOMIC	Marginal Reserves		Inferred Marginal Reserves	+	
SUBECONOMIC	Demonstrated Subeconomic Resources		Inferred Subeconomic Resources	+	
Other Occurrences	Includes nonconventional and low-grade materials				

Figure 2-5. USGS classification system for mineral resources (USGS, 2009).

USGS reports current reserves at 16,000 million tonnes of phosphate rock (containing approximately 30% P_2O_5). The reserve data in Figure 2-6 represent what is deemed to have been demonstrated to be economically and technically feasible to recover. It does not include exploration of new sources, resources such as phosphate concentrations on the sea bed, or unreported reserves of individual countries. As of 2002 there were 1,600 significant deposits identified in the world (Orris and Chernoff, 2004). The latest USGS data (Figure 2-6) show that 85% of these reserves are found in five countries. New mines are being started in Peru, Saudi Arabia, US (pending licensing bottlenecks), Jordan, Australia and Namibia (offshore sands). Offshore exploration is also occurring in other regions, such as the Chatham Islands (New Zealand). In order to improve the economics of phosphate mining, uranium is being brought forward in Jordan as a profitable by-product, as is iron in Australia. Extraction of phosphate from the tailings of the large iron mine in Kiruna (northern Sweden) is also being suggested.

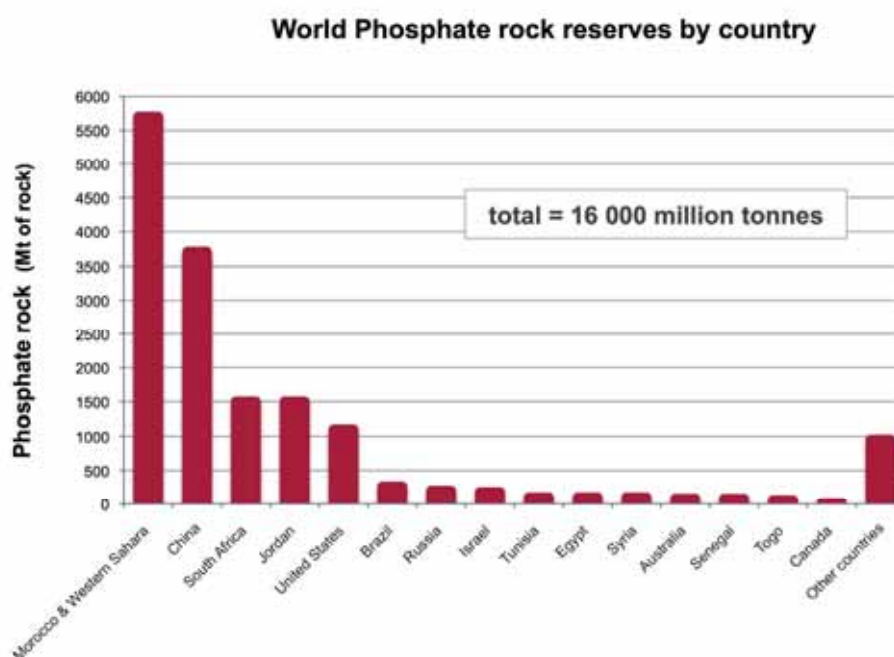

Figure 2-6. USGS estimates of reported remaining world phosphate rock reserves in 2009, indicated by country/region. Units are in million tonnes of phosphate rock. Data: USGS, 2010.

Further, as noted earlier, all of the phosphorus content of these reported phosphate rock reserves is not all available for use in fertilizers - a substantial proportion of these reserves is lost during mining, beneficiation, storage, transport and fertilizer processing. The magnitude of these mining and fertilizer production losses is discussed in more detail and quantified in section 3.2 and 3.3.

2.2.2 Other data sources

An assessment of phosphate rock reserves has been carried out by IFDC (International Fertilizer Development Centre) based on secondary data sources and input from the industry. However the IFDC report was unavailable for viewing at the time of completion of the present report.²

2.2.3 Data uncertainty and reliability

Understanding the magnitude (and quality) of reserves is important for estimating both the peak phosphorus timeline and other depletion scenarios. However there are substantial concerns about the reliability of publicly available data on global phosphate rock reserves. These concerns are echoed by both industry representatives and scientists (Ward, 2008; Fixen, 2009; Cordell, 2010; Prud'homme, 2010a).

There are a number of different sources of phosphate rock reserve data unreliability, including³:

- Basic uncertainties associated with physically estimating geological phosphate rock reserves and deposits at the exploration stage (such as extrapolating ore grades and other characteristics from the analysis of core samples from drill holes).
- Reserves figures are dynamic and depend on costs. Assumptions behind USGS data are considered outdated, leading to inaccurate estimates of cumulative reserve figures (Fixen, 2009; Prud'homme, 2010a).
- USGS figures are based on self-reporting by individual countries or companies, and each uses different assumptions for reserves such as different financial criteria (value of the deposit in \$/tonne), hence the cumulative figure for reserves are based on inconsistent assumptions (USGS, 2010).
- Lack of transparency of the above assumptions also raises concerns about data quality. For example, China's reported reserves doubled overnight when it joined the World Trade Organisation. Further, in 2007, reported world reserves totalled 18,000 million tonnes, while in 2008 they decreased to 15,000 million tonnes, largely because China altered its reported reserves (Jasinski, 2008; Jasinski, 2009).
- As USGS has been the only source of publicly available phosphate rock reserve data, almost all analyses rely on these baseline data, and there has been little opportunity to triangulate with other sources.

Other data sources are typically produced and owned by commercial interests, meaning that the data production itself (often undertaken by the mining industry) is not independent and transparent and the resultant data are only available at a high cost⁴, if at all.

Such data scarcity and unreliability are not unique to phosphate commodities. Similar concerns have been reported for other globally significant resources (Chanceler and Rotter, (2009). However because phosphorus cannot be substituted and is critically linked with food production, it can be argued that more accurate, independently produced, and publicly available data are required. Further recommendations are provided in Chapter 5 and in Cordell (2010).

² See note on the IFDC report in the Preface.

³ See section 3.4.2 in Cordell (2010) for further details.

⁴ Fertilizer Week statistics costs 2,850 Euros, see: <http://www.cruonline.crugroup.com/FertilizersChemicals/FertilizerWeek/tabid/177/Default.aspx>.

2.3 Peak phosphorus

There is an ongoing and vigorous debate regarding 'peak phosphorus', with some proponents at one extreme arguing global production has already peaked (Dery and Anderson, 2007), while others dismiss the plausibility of the theory (Prud'homme, 2010a). Proponents of the peak theory argue that while estimates of remaining high-grade reserves range from 50-100 years, and estimates of reserve base vary even more, the critical point could indeed occur decades before these depletion estimates (Cordell *et al.*, 2009a). In a similar way to oil reserves, the rate of global production of high-grade phosphate rock will eventually reach a maximum or 'peak', based on the finite nature of non-renewable resources. Hubbert (1949), and later others, argue that the important period is not when 100% of the reserve is depleted, but when the high quality, highly accessible reserves have been depleted. After this point, the quality of remaining reserves is lower and they are harder to access, making them uneconomical to mine and process.

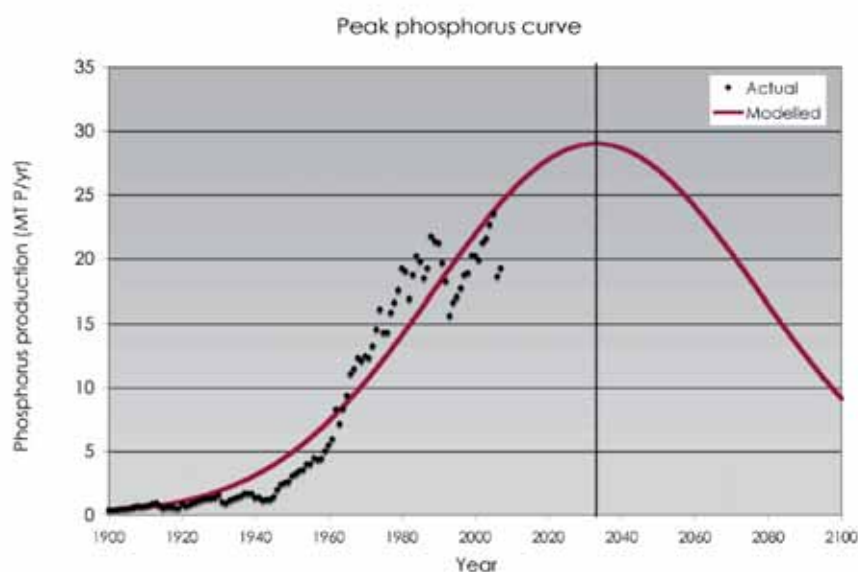

Figure 2-7. Peak phosphorus curve, indicating a peak in global phosphorus production could occur by 2035. Units are in Mt of P, not phosphate rock. Data based on USGS estimates of global phosphate rock reserves and industry data on historical annual production (Cordell, 2009a).

Based on USGS and industry data, (Cordell *et al.*, 2009a) predict a peak in global phosphate production to occur by 2035 (Figure 2-7). After the peak, supply is expected to decrease each year, constrained by economic and energy costs, despite rising demand (Cordell *et al.*, 2009a). Dery and Anderson (2007) estimate that peak phosphorus occurred in 1989. However this was a mini-peak, probably due to a marked fall in phosphate demand after the collapse of the Soviet Union, coupled with new policies in Europe and North America to use phosphorus more efficiently. Production in recent years has surpassed this mini-peak (as evident in Figure 2-3 in section 2.1.2).

Some critics of the peak theory argue that there will not be a problem as the market will ensure that supply will keep up with demand, because as a resource becomes scarce, prices rise and trigger new investments in lower-grade deposits. Other critics don't dispute the fact that phosphate production will eventually reach a peak if left unchecked, but rather, they dispute the timeline. The exact timing of peak phosphorus may indeed be earlier or later than that presented in Figure 2-7 depending on actual size of reserves, and other demand or supply side factors such as economic booms or downturns, the manipulation of production, growth in non-fertilizer phosphorus-demanding products, or the introduction of policies or technologies that increase the efficient use of phosphorus (Cordell, 2010). It is interesting to note that the US has been extracting a steadily decreasing amount of phosphate rock since 1995 (USGS, 2010) so one could argue the peak there has already occurred.

While the exact timing of the global peak may be disputed, there is a general consensus among industry representatives and scientists that the quality of remaining reserves is declining due to: a) lower concentrations of phosphorus (% P_2O_5) in the remaining phosphate rock reserves; and b) increasing concentrations of heavy metals like cadmium and also uranium. Further, remaining reserves tend to be less physically accessible (Cordell and White, forthcoming).

This means both economic and environmental costs increase as quality decreases, since extracting the same nutrient (P) value from the ore, requires increasingly more energy and input resources (such as water, sulphur and energy), and simultaneously generates more output wastes (such as phosphogypsum, water pollution and greenhouse gases) (Cordell, 2010). These environmental impacts are discussed in detail in section 3.5.

2.4 Geopolitical aspects

Geopolitical dimensions of phosphorus scarcity can also restrict the availability of phosphate for use in food production in the short or long term. For example, while all farmers need access to phosphorus, most of the world's remaining phosphate rock reserves (approximately 85%) are controlled by five countries, the main players being Morocco, China and the US (USGS, 2010). In addition the most common process for phosphorus extraction includes the use of sulfuric acid which is mainly produced by countries in the North where most oil refining occurs because sulfuric acid is a by-product of the petroleum industry (Figure 2-8). A free trade agreement was signed between US and Morocco in 2004 which in effect guarantees the US extended access to phosphate (Rosemarin, 2004). India is the largest country in the world that is also dependent on Moroccan reserves and has no trade with China.

In 2008 China imposed a 135% export tariff to secure domestic supply for food production, a move which essentially halted exports from the region overnight, and by 2009 the US and EU had gone to the WTO claiming China was exhibiting anti-competitive behaviour (Fertilizer Week, 2008; Euronews, 2009). The EU is almost entirely dependent on imports of phosphorus (see section 2.5.2). The US is expected to deplete its own high-grade reserves in the coming decades. This may threaten the stability of the market as soon as this becomes public knowledge. The market response could be similar to what happened during 2008 when prices spiked by 800%. The US increasingly imports phosphate rock from Morocco. However Morocco currently occupies Western Sahara and controls that region's reserves in defiance of UN resolutions (Corell, 2002). The contested nature of the ownership of the Western Saharan reserves means there is an ethical concern that companies, countries and consumers are knowingly or unknowingly supporting an occupation, and a practical concern that insecurity in the region could lead to a disruption in supply (Cordell, 2010).

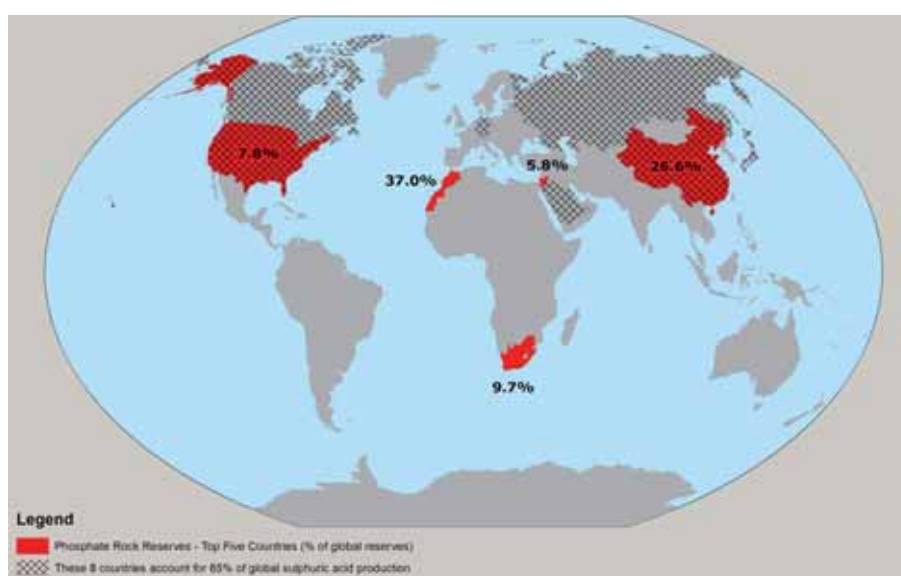

Figure 2-8. Distribution of economic phosphorus reserves in the top five countries containing 90% of the capacity including the 8 countries that dominate sulphuric acid production (Rosemarin et al., 2009).

2.5 Demand

2.5.1 Current consumption of fertilizer phosphorus

Approximately 90% of all phosphate demand is for food production - primarily for the production of agricultural fertilizer (82%) and a smaller fraction for animal feed additions (7%) and food additives (1-2%). The remaining 9% goes to industrial uses such as detergents and metal treatment and other industrial applications (Prud'homme, 2010b). See Figure 2-9. The fraction used for detergents has decreased in recent years due to regulations in many countries in response to phosphate pollution of surface water which causes eutrophication, algal blooms, poor water quality and fish kills. With efficient flocculation steps in sewage treatment plants, it is possible to retain for potential reuse most of the phosphate originating from detergents.

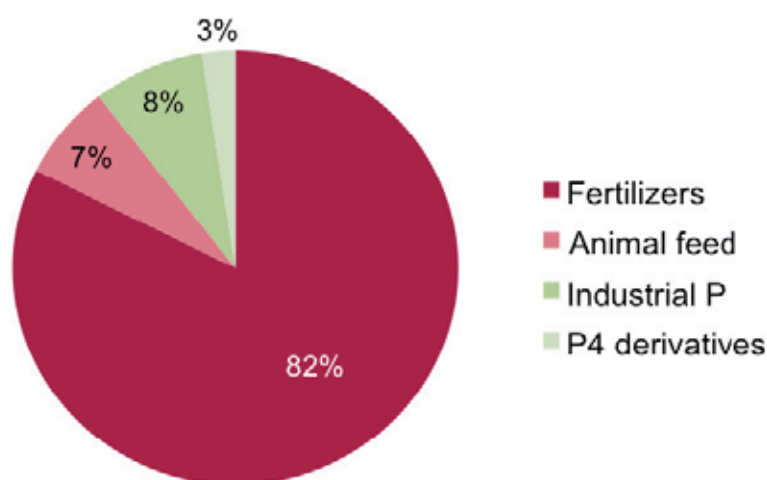

Figure 2-9. Breakdown of phosphorus end uses, indicating the overwhelming demand is for fertilizers. Data sourced from Prud'Homme (2010b).

The global consumption of fertilizer phosphorus amounted to 17.8 Mt/a of P in 2008 (Heffer and Prud'homme (2008)). If this amount of phosphorus was evenly spread over the entire global land area devoted to all forms of agriculture (5 billion ha according to FAOSTAT), this would equate to 4 kg P per ha per year. If fertilizer phosphorus was applied to arable soils only (1.4 billion ha), the average annual rate would be 13 kg P per ha. In reality, however, the application rates across the world are nothing like this. They range from more than 10 kg P per ha in Asia and North America and about 6 kg P per ha in Europe, to less than 2 kg P per ha in Africa (FAOSTAT). These figures take on even more meaning in view of the 3 kg P taken up and removed per ton of wheat grain and they illustrate how dependent agriculture has become on mineral phosphorus fertilizer. Heffer and Prud'homme (2008) expect global fertilizer phosphorus consumption to increase from 17.8 Mt P/a in 2008 to 19.8 Mt P/a by 2012. Such figures correspond with an annual growth rate of 2.7%.

The material below focuses on phosphorus fertilizer demand, first broken down by country. Some publications provide information on how phosphorus fertilizer is applied per crop, although these figures might not be too accurate as sometimes phosphorus is not applied for specific crops but at the farm level (crop rotation).

Consumption per crop category

In line with the area used for cereals, a large fraction of the phosphorus fertilizer (nearly 50%) was used for wheat, rice and maize. Plant oil crops also receive a fair share (12% of total consumption) as do fruit and vegetables (18%) (Table 2-2 below). This table also shows that in 2007/8 there was a small decrease for cereals and an increase for oil crops.

Table 2-2. *Phosphate fertilizer use in 2006/7 and 2007/8 (estimate) by crop at the global level (Heffer, 2009)*.*

Crop Category	Quantity (Mt P)		Share (%)	
	2006-2006/7	2006-2006/7	Estimate 2007-2007/8	Estimate 2007-2007/8
Wheat	2.8	16.4	2.8	16.2
Rice	2.1	12.6	2.1	12.3
Maize	2.1	12.8	2.1	12.4
Other Cereals	0.8	4.8	0.9	5.1
<i>Cereals</i>	<i>7.8</i>	<i>46.6</i>	<i>7.9</i>	<i>46.0</i>
Soybean	1.1	6.8	1.3	7.5
Oil Palm	0.1	0.8	0.1	0.8
Other Oilseeds	0.8	4.7	0.8	4.7
<i>Oil seeds</i>	<i>2.1</i>	<i>12.3</i>	<i>2.3</i>	<i>13.1</i>
Cotton	0.7	4.1	0.7	4.0
Sugar Crops	0.7	3.9	0.7	3.9
Fruits & Vegetables	3.0	17.8	3.1	17.9
Other Crops	2.5	15.3	2.7	15.1
<i>Total</i>	<i>16.7</i>	<i>100</i>	<i>17.2</i>	<i>100</i>

* *Phosphate fertilizer data has been converted from P₂O₅ to P.*

Consumption by country

Table 2-3 shows the annual consumption rates of fertilizer per country. Four countries account for 65% of the global consumption: China, India, USA and Brazil. Including the EU-27 this percentage amounts to 74% of the annual global consumption. Cereal crops in most countries receive the greater part of the available phosphorus fertilizer (whether or not they are imported). For 'oil crops' the table shows that countries which apply more than the global average for this crop category include Brazil (soy), Indonesia and Argentina.

Table 2-3. Consumption of phosphorus-fertilizer per country and crop category (Heffer, 2009)*.

Country	Consumption (Mt/a of P)	Global share (%)	Cereals	Oil seeds	Cotton	Sugar Crops	Fruits & Vegetables	Other Crops
China	5.2	30.5%	39%	8%	4%	2%	34%	13%
India	2.5	14.6%	52%	10%	8%	5%	11%	16%
USA	1.8	10.4%	62%	13%	3%	1%	6%	16%
EU-27	1.5	8.8%	53%	8%	1%	3%	12%	23%
Brazil	1.6	9.3%	28%	43%	4%	9%	5%	12%
Indonesia	0.2	1.3%	37%	31%	0%	5%	10%	17%
Pakistan	0.3	1.6%	49%	2%	16%	10%	5%	19%
Canada	0.2	1.3%	63%	25%	0%	1%	1%	11%
Vietnam	0.3	1.6%	79%	4%	0%	3%	4%	9%
Australia	0.4	2.5%	53%	8%	0%	3%	5%	31%
Turkey	0.2	1.3%	60%	5%	5%	3%	14%	12%
Russia	0.2	1.2%	68%	8%	0%	15%	1%	8%
Argentina	0.3	1.8%	50%	37%	0%	0%	7%	5%
Iran	0.2	1.1%	52%	8%	2%	3%	23%	13%
Rest of the World	2.2	12.8%	39%	11%	4%	6%	21%	19%
Total		100.0%	46%	13%	4%	4%	18%	15%
Total in Mt P/a	17.2		7.9	2.3	0.7	0.7	3.1	2.7

* Phosphate fertilizer data has been converted from P_2O_5 to P.

2.5.2 Estimates of future demand and associated consequences

Current global and European demand

Global demand

Heffer and Prud'homme (2008) identify some of the anticipated trends which may influence the consumption of fertilizer, some of them being related to crop-based bio energy production:

- a large maize area replacing other crops in the USA
- more soybean, sugar cane and maize in Brazil
- more soybean and cereals in Argentina
- the end of the 'set aside' of agricultural land in the EU
- more cereals, oilseeds and sugar beet in the Commonwealth of Independent States
- more cash crops in India
- more maize, fruits and vegetables and less wheat and rice in China
- more oil palm in Indonesia and Malaysia
- increasing arable areas in Argentina, Brazil, Indonesia, Malaysia, Russia and Ukraine

The higher demand in recent years is attributed to higher commodity prices and to policies promoting fertilizer use in many Asian countries. Increases in fertilizer demand in general, not necessarily for phosphorus, have been especially strong in Latin America (+12.8%), Eastern Europe and Central Asia (+6.3%), East Asia (+6.1%) and South Asia (+3.4%). However, in Western Europe the consumption of mineral fertilizers, including phosphorus, has recently decreased slightly. The drivers responsible for the increase in phosphorus demand are the increased production of crop-based bio energy and bio fuels (as opposed to 'waste'-based bio energy) together with the world population increase and average income growth in emerging Asian nations. Heffer and Prud'homme (2008) suggest that the impact of crop-based bio energy and bio fuel production on world fertilizer demand is mostly *indirect* through its

influence on international cereal, oilseed and sugar prices, which provide strong incentives for increasing fertilizer application rates on crops grown for food or feed. They expect consumption growth to be modest in Western and Central Europe, but in all the other regions demand should go up by 3-4%.

For the medium term a steady growth is projected. By 2012/13 annual growth in global phosphorus demand is anticipated to reach 2.8%.

EU27 demand

Richards and Dawson (2008) recently undertook an analysis of phosphorus use in the European Union (EU27) as a whole. A summary of their findings is presented in Figure 2-10.

Most phosphorus passing the EU27 borders is imported as phosphate rock and phosphoric acid (net import 1.61 Mt P, including 0.29 Mt P as animal feed additives) and as food and feed (net import 0.22 Mt P, of which 0.16 Mt P is oilcakes). The EU27 thus appears to be a significant sink for traded phosphorus most of which ends up in the agricultural sector. Richards and Dawson (2008) estimate that 3.69 Mt P is added to agricultural soils, of which 1.32 Mt P are from mineral fertilizers and 2.06 Mt P are from manures. Analyses such as these reveal that agriculture in the EU, as well as elsewhere in the world, is sustained by considerable imports of phosphate rock, of processed phosphate and of phosphate incorporated in feeds. A relatively small amount of phosphate, 0.54 Mt/a, is mined within the EU27 itself. It is clear that EU agriculture is anything but self-sufficient as far as phosphorus is concerned.

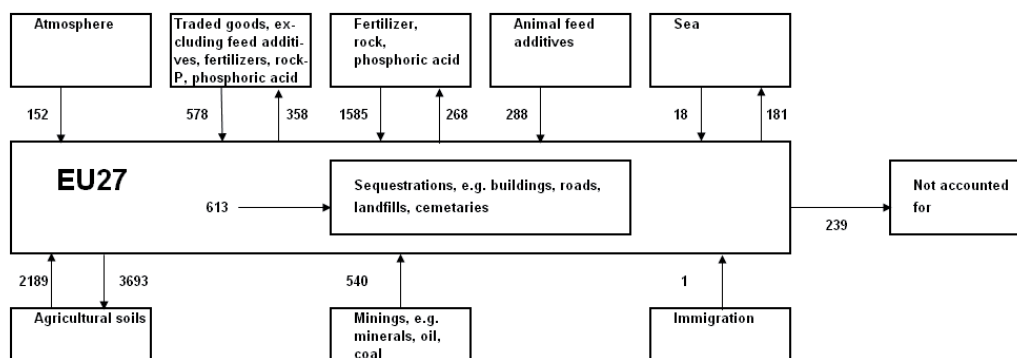

Figure 2-10. Estimated Phosphorus Fluxes in the EU27 (kt/a of P) in 2006 (Richards & Dawson, 2008).⁵

Future demand

Population growth

The demand for phosphorus is strongly linked to population size, food requirements and agricultural outputs. Predictions of world population increase can hence serve as a first approximation of future increased phosphorus demand. Estimates of (regional) population growth made by the United Nations rely on assumptions about demographic factors like mortality/fertility rates, international migration and the spread of diseases such as AIDS. Medium and high predictions for the world population in the year 2050 are nine billion and 11 billion people

⁵ Note that the all the input and commercial output variables of this balance, as well as the fate of the difference between both (i.e. emissions to the sea and sequestrations), were estimated separately. Not unexpectedly, the sum of estimated commercial outputs, emissions and sequestration, did not completely counter the estimated sum of inputs. The discrepancy is referred to as 'not accounted for'. The positive value of this term implies that one of the inputs has been overestimated and/or one of the outputs, sequestrations or emissions has been underestimated.

respectively (Anonymous, 2007). Compared to the present 6.8 billion people this is an increase of 30-50%. The implication could be that global phosphorus consumption must increase by the same percentages, assuming that the efficiency of phosphorus fertilization will remain the same. Note that such an increase corresponds to an annual growth rate of 1% at most, which is considerably less than the currently observed growth rate of fertilizer phosphorus consumption which is running at 2.25% demand growth (Figure 2-11).

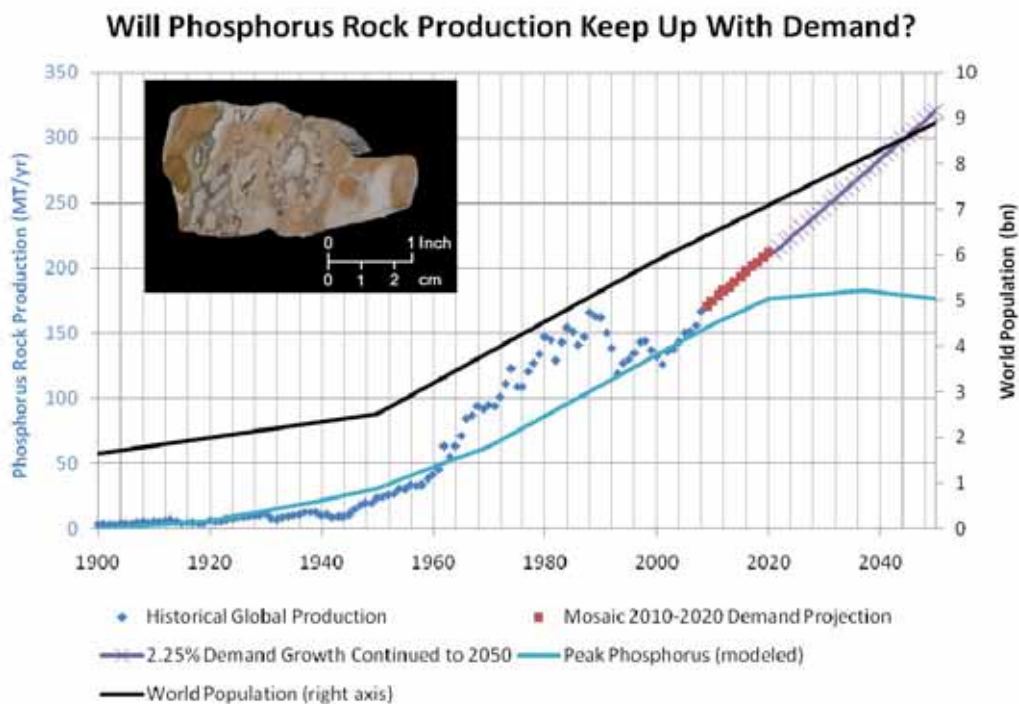

Figure 2-11. Trends in global population, mining of phosphate rock and market demand projection to 2050 (Keane, 2009).

Additional considerations influencing phosphorus demand

Other important factors that can potentially increase the future demand for phosphorus include: changing dietary preferences, crop-based bio energy demand, aquaculture and urbanization.

It is likely that such increases may be countered to a small extent by increased adoption of efficient technologies and practices in agriculture and in other key sectors in the food production and consumption chain. Further, demand may eventually slow down as markets mature in regions currently experiencing high demand (as has been the case in Northern America and parts of Europe). However it can be assumed that total phosphorus demand will continue to see net increases as long as population continues to increase.

Changing dietary preferences

Worldwide, around 30% of the cereals produced are used as cattle feed (Steinfeld *et al.*, 2006) while in Europe this figure is 60%. A change in diets towards more meat consumption in the developing countries will therefore translate into an increasing demand for cereals. According to data published in Rosegrant *et al.*, (2001) an additional 650 Mt of cereals will be produced in 2020, of which 15% will be in developed countries (Table 2-4). This would require an *additional* input of a minimum of 1.95 Mt/a of P just to compensate for the phosphorus removed from fields with the harvested cereals (assuming a P content of 0.3%). This additional phosphorus is equivalent to more than 10% of the current world use of fertilizer phosphorus.

Table 2-4. Global production of cereals in 1997 and 2020 in Mt P (Rosegrant *et al.*, 2001).

	1997	2020
Developed countries	725	822
Developing countries	1118	1675
World	1843	2497

For soy beans a similar calculation can be made. A 2005 prognosis (ABIOVE, 2005) predicts an increase in global soya bean volumes from 235 to 307 Mt by 2020. In Brazil, the 2007 production of 57 Mt of soy bean on 21 Mha will increase to 108 Mt by 2020. On average, phosphorus fertilization in Brazil of soy beans is 28 kg P ha⁻¹ whereas 25 kg ha⁻¹ is removed with the crop. The implication is that by 2020 at least 0.8 Mt of P is required (e.g. fertilizer input) to meet the prognosis. This amount of fertilizer would then be more than 4.5% of the current global use of fertilizer phosphorus, a substantial amount for one crop in one country.

The consequences of changing dietary preferences were also recently explored by Smit *et al.*, (2009) and Cordell *et al.*, (2009b). As the retention of phosphorus in the human body is limited, Liu *et al.* (2008), Jönsson *et al.* (2004), Smit *et al.* (2009) and Cordell *et al.*, (2009b) all argue that phosphorus consumption by humans can be calculated from either data on the amount and composition of human excreta or from data on diets. Estimates based on human excreta range from 0.5 kg P per capita per year (Smil, 2000b; Cordell *et al.*, 2009a; Smit *et al.*, 2009) to 1.2 kg P per capita per year (Kirchmann and Pettersson, 1995). As indicated, phosphorus consumption in a particular diet can also be approximated by ascertaining the phosphorus concentrations of the constituents of that diet and combining them (<http://faostat.fao.org>) (Beukeboom, 1996). According to this method, average excretion in 2003 would have been 1.0 kg P per capita per year, ranging from 0.9 kg P in less developed countries to 1.4 kg P in developed countries (Table 2-5). These differences appear to result from the more affluent diets in so-called developed countries in which phosphorus in dairy, eggs and meat represents 50% of the total phosphorus consumption compared to 23% in less developed countries. Global phosphorus consumption and excretion, according to these calculations, would be 6.52 Mt P per year. This intake is far above the consensus estimate of around 3 Mt P for global excretion. Cordell *et al.*, (2009a) estimate an average vegetarian diet results in approximately 0.3 kg P per capita per year, while an average meat-based diet results in approximately twice as much phosphorus (0.6 kg P) in excreta.

Table 2-5. Apparent annual human consumption of phosphorus (kg P per capita per year) in 2003 through the dietary constituents in developed and less developed countries (based on production data (<http://faostat.fao.org>) and P-contents (Beukeboom, 1996).

Constituent	Developed countries	Less developed countries
Cereals, potatoes, vegetables	0.55	0.62
Milk, butter, cheese, eggs	0.26	0.07
Meat	0.44	0.15
Fish	0.15	0.11
Total	1.39	0.94

An explanation for this discrepancy could be that phosphorus concentrations in Beukeboom (1996) may not apply to crops grown on soils with a low phosphorus status. A more likely explanation for the difference is that the FAO estimates of consumption are based on harvested amounts which will be (much) higher than the amounts processed, marketed and eventually eaten. Losses are substantial in developed as well as in developing countries. Whereas in

developing countries losses occur mainly along the journey from field to retail outlet, the losses in developed countries may be substantial in the retail or household area. Because of this uncertainty Smit *et al.* (2009) decided to employ the most common value of 0.5 kg P excretion per person per year (resulting in a global excretion of about 3 Mt P in 2003), but yet take account of dietary effects on the excretion of individuals. The ratio of consumed phosphorus in the two diets of Table 2-5 was used to estimate phosphorus excretion in such a way that the weighted sum of phosphorus excreted in developed countries and developing countries arrived at a global excretion of 3 Mt P in 2003. To achieve this, Smit *et al.*, (2009) had to adopt intakes of 0.64 and 0.43 kg P per capita per year for developed and developing countries respectively. As the global use of phosphorus fertilizer in 2003 was around 16.2 Mt of P, Smit *et al.* (2009) calculated a ratio of fertilizer use to consumption of 5.4. Assuming the same ratio for 2020, a world population of 7.7 billion people (<http://esa.un.org>) would, without change in diets, raise the need for phosphorus fertilizer input to about 19 Mt P, an increase of nearly 20%. If on the other hand, people in developing countries would by then have the same phosphorus intake as in the developed countries, then the demand for fertilizer phosphorus would rise to nearly 27 Mt; an increase of 64%. By 2050, with a global population of 9 billion people, phosphorus demand would increase by 41% and 96%, respectively for current and affluent diets. In their analysis of long-term phosphorus demand scenarios, Cordell *et al.*, (2009b) estimate that in a business-as-usual scenario, current global phosphorus demand could increase by 50% by 2050, while a preferred scenario (in which global meat consumption is substantially reduced) could reduce current global phosphorus demand by 15% and 25% in 2050 and 2100 respectively.

Table 2-6 also shows the anticipated fertilizer use if a more favourable ratio of 4.3 was attained instead of 5.4. Such a decrease (-20%) in ratio has a large impact on phosphorus demand, but requires changes in the way phosphorus fertilizer is used as well as improvements in the way organic wastes, including manure, are recycled. Note, however, that the ambition level of such a change is relatively low. Instead of losing approximately 80 kg P per 100 kg fertilizer P from farm to plate, losses must be reduced to approximately 75 kg P per 100 kg fertilizer P.

Table 2-6. Anticipated global phosphorus fertilizer use in 2020 (in Mt P and relative to the use in 2003), as function of diets and the ratio between phosphorus-consumption and phosphorus fertilizer use.

Year	Population (10 ⁹)			P-consumption (kg P/capita/yr)			Consumed/ P-fertilizer use			
	Developed	Developing	Total	Diet	Developed	Developing	Global, Mt P	Mt/Mt	P-fertilizer use Mt P	Relative
2003	1.21	5.15	6.36	Current	0.64	0.43	3.0	5.4	16.2	100%
2020	1.27	6.41	7.68	Current	0.64	0.43	3.6	5.4	19.4	119%
				Affluent	0.64	0.64	4.9	5.4	26.7	164%
2050	1.28	7.87	9.15	Current	0.64	0.43	4.2	5.4	22.8	141%
				Affluent	0.64	0.64	5.9	5.4	31.8	196%
2020	1.27	6.41	7.68	Current	0.64	0.43	3.6	4.3	15.5	96%
				Affluent	0.64	0.64	4.9	4.3	21.4	132%
2050	1.28	7.87	9.15	Current	0.64	0.43	4.2	4.3	18.3	113%
				Affluent	0.64	0.64	5.9	4.3	25.4	157%

Crop-based bio energy

As well as being affected by a growing world population and changing diets, global phosphorus demand will also be influenced by the production of bio energy and bio fuel crops. It has been suggested to grow these types of crops on land that has so far not been used by agriculture in order to avoid competition with food and feed crops. It should be borne in mind that the need for phosphorus fertilizer will be even greater on this so-called marginal land as it will generally have a low phosphorus fertility status.

The production of crops for bio energy (feedstock for power plants and boilers) and bio fuels (energy for transportation) have increased rapidly over the past few years. Decision makers in the USA and EU have recently adopted new policies on renewable energy sources. These policies set new mandatory blending targets for bio fuels that are more ambitious than previous ones. Heffer and Prud'homme (2008) estimate fertilizer use for growing bio fuel crops in 2007/2008. The total fertilizer phosphorus requirement derived from their graph amounts to around 0.34 Mt of P (Table 2-7).

Table 2-7. Global phosphorus use on Bio fuel crops in 2007/08 (derived from a graph in Heffer and Prud'homme (2008)).

Destination	Mt of P
USA, maize for ethanol	0.24
Brazil, sugar cane for ethanol	0.05
EU, rapeseed for biodiesel	0.01
Other	0.04
Total	0.34

Aquaculture

The rapidly increasing aquaculture production of seaweeds and fish (Einarsson and Emerson, 2009), may also require additional phosphorus, particularly if aquaculture is to be expanded for energy production, inspired by the relatively high oil content that can be found in some algae species (Chisti, 2007). Following the calculation procedure proposed by Chisti (2007), an oil content in algae of 50% and a P-content of 0.6% in the dry mass would result in a factor of 0.36 kg P/GJ (Gigajoule) energy from algae.

If 10% of global transportation fuel is to be replaced (approximately 9 EJ (Exajoule) in 2020), it would need at least 3.3 Mt of phosphorus fertilizer per year - around 20% of the current global use if none of the phosphorus in the residues was recycled. As with bio energy and bio fuel crops, the degree of recycling is a key issue with respect to prognoses of future demand of fertilizer phosphorus.

Urbanization effects

Another trend in global development that may affect future demand for phosphorus is increasing urbanization. Urbanization is associated with a lower recycling of human waste. According to Liu (2005) the application of human waste in agriculture is common in Asia and was common in Europe but is less prevalent elsewhere. In urban areas, human waste is recycled less than in rural areas. In China the percentage of human waste that is recycled for agricultural purposes from urban areas dramatically decreased from 90% in 1980 to less than 30% in the late 1990s. In rural areas about 94% was returned to cropland in 1990. It is estimated that in Europe the recycling rate of urban sewage sludge averaged about 50% in the 1990s. Liu (2005) assumes that globally about 20% of urban human waste and about 70% of rural human waste are recycled at present, amounting to 1.5 Mt P annually. This might be too optimistic as according to Cordell (2008) only 0.3 Mt P returns to crop land. In addition, urbanization

generally occupies intensively managed soils with a good phosphorus status and this land may have to be replaced by the reclamation of land with a low phosphorus status which needs a phosphorus investment.

Until now the trend toward increased urbanization has meant less recycling, however it can be argued that here also, opportunities become apparent. A concentration of phosphorus in urban areas could also improve the potential to recover and reuse it. Standard sanitation in urban areas usually implies that human excreta are vastly diluted with water which makes recycling more difficult. Additional challenges surrounding the contamination of sewage with pharmaceuticals, heavy metals and so on are dealt with in section 4.4 of Chapter 4.

Pooled estimates for future demand

Smit *et al.*, (2009) calculate that currently economically exploitable phosphorus resources will be depleted within 125 years at today's consumption rates. If phosphorus consumption keeps pace with the expected global population increases, the currently estimated economically viable phosphorus resources will be depleted within 70-100 years. As indicated in the preceding paragraphs, the transition to a more affluent diet and the use of crop-based biomass for energy purposes, may both lead to an additional consumption of phosphorus. Table 2-8 provides a summary of two scenarios differing in assumptions with respect to i) the ratio between fertilizer phosphorus and food phosphorus intake and ii) the extent of recycling phosphorus from the produced biomass. Considering the amount of phosphorus involved, the ratio between phosphorus fertilizer use and the phosphorus eventually consumed in food, and the recycling of excreted phosphorus, will all have to be improved.

2.6 Conclusion

Phosphorus is almost entirely used for the production of food (90%). The world's main source of phosphorus is phosphate rock which is a non-renewable resource and economic, high-quality reserves are becoming increasingly scarce. There is currently a vigorous debate regarding the expected lifetime of the remaining high-quality phosphate rock reserves, with estimates varying from a few decades to a few hundred years. Despite the uncertainty, there is general consensus that the quality of remaining reserves is in decline (both in terms of diminishing P_2O_5 content and the increasing presence of heavy metals and other contaminants), phosphate layers are becoming more physically difficult to access, more waste is being generated and costs are increasing.

Compounding these constraints on phosphorus availability are the substantial inequities in the distribution of phosphate reserves and associated geopolitical tensions. With only a few countries controlling the world's remaining high-quality reserves, importing countries are vulnerable to supply disruptions, price volatility and other market forces. This is of particular concern to poor farmers working with phosphorus-deficient soils, as is the case in much of Sub-Saharan Africa. Whilst the EU does not suffer from extensive food insecurity, it is almost entirely dependent on imported phosphate rock, phosphate fertilizers and phosphate feed to support a combined population of 500 million EU citizens.

At the same time, the demand for phosphorus is expected to increase globally - primarily due to an increasing demand for food from a growing world population. A move to diets containing more meat and dairy (which require more phosphorus to produce) and phosphorus demand for non-food uses may also further increase global demand.

Table 2-8. Summary of current and anticipated additional use of fertilizer phosphorus as influenced by efficiency and recycling (see also Table 2-6).

	Scenario ¹ A	Scenario ¹ B
Current use of phosphorus fertilizer in 2008	19.3	19.3
Extra demand:		
2020: 7.7 billion people	+3.2	-0.7
2020: + developing world adopts western diet	+10.5	+5.2
2050: 9.2 billion people	+ 6.6	+2.0
2050: + developing world adopts western diet	+15.6	+9.2
10% of transport fuel from bio fuel crops	+2.7	+0.5
10% of global energy from bio energy crops	+2.3	+1.2
another 10% of transport fuel from algae	+3.3	+0.7
Total demand in:		
2020	41.3	26.2
2050	49.8	32.9

¹ Scenario A: Assuming the current conversion of fertilizer P to food P (factor 5.4) (see also Table 2-6). Scenario B: Assuming a fertilizer P to food P ratio of 4.3; and recycling of P in bio fuel crops, bio energy crops, and algae of resp. 80%, 50% and 80%.

3. Inefficiencies and environmental impacts of current phosphorus use

This chapter identifies the ways in which the current use of phosphorus in the food production and consumption system are unsustainable. This is done by first identifying how phosphorus is being mismanaged, resulting in losses at all key stages from mine to field to fork to excretion, followed by an assessment of environmental impacts at all stages. Finally, a closer look is taken at European countries with different situations concerning phosphorus.

3.1 Global phosphorus flows through the food production and consumption system

While societal use of phosphorus is predominantly for crop growth in agriculture, substantial flows of phosphorus occur both upstream and downstream of the field. Figure 3-1 indicates the major flows of phosphorus through the global food production and consumption system in millions of tonnes of P per year (Mt/a of P). While phosphorus cycles between the lithosphere (soil and rock) and the hydrosphere (lakes, rivers and oceans) at rates of 'millions of years' in the global biogeochemical phosphorus cycle, flows in the human food system cycle in 'days to years'.

There are substantial losses at all stages: mining and fertilizer processing, transport and storage, application, harvest, food processing and retailing, and food consumption. A key finding from the analysis of phosphorus flows through the global food system (Cordell *et al.*, 2009a), is that while approximately 3 Mt/a of P is consumed in the food eaten by the global population, five times this amount is mined in phosphate rock specifically for food production (Cordell *et al.*, 2009a) as illustrated in Figure 3-1. Losses can occur at all stages of the food production and consumption system: mining and fertilizer processing, transport and storage, application, harvest, food processing and retailing, and food consumption. An inefficiency such as this, of around 80%, is easily interpreted as an absolute loss but this is not necessarily the case, as will be explained later. It is important to distinguish between the various types of 'losses' as this distinction will inform the mode of sustainable management response (for example increasing efficiency or recovery as detailed in Chapter 4). Specific phosphorus losses (and their orders of magnitude) in the global food system from mine to fork are described below. Lundqvist *et al.*, (2008) and Cordell (2010) classify losses as avoidable (inefficient management), unavoidable (generally cannot be avoided but could potentially be recovered) or as losses which are related inherently to the fact that there is an extra cycle needed to produce animal products from feed (see Figure 3-1 below). Elaborating on these publications we now distinguish between: permanent losses (*from* the food production and consumption chain) and temporary losses (*within* the food production and consumption). Table 3-1 gives some examples of both categories of losses occurring in the chain from mine to household as well as possible strategies to avoid or minimise these losses. Note that some of the apparent loss of 80% occurs later on in the pathway, between crop production and consumption (see section 3.4.3 and 3.4.4) and considerable additional losses occur between mining and the production of the fertilizer (Villalba *et al.*, (2008). In the chain from fertilizer supply to crop production the permanent losses pertain to such things as erosion losses and the removal of manure from agricultural destinations. The second category entails missed opportunities - that is, the flows of phosphorus produced by society that are as yet not recycled to agricultural fields. There is a variety of reasons why this does not happen, one of them being concerns about contamination with heavy metals or diseases. The third category consists of the apparent losses due to accumulation, which can be an important factor to explain the apparent low efficiency from fertilizer to food. An important temporary loss, the accumulation of phosphorus in soils, takes place if the phosphorus off-take with crops (the product which is harvested and exported from the field) is smaller than the input of phosphorus (from manure and fertilizer). Strictly speaking, an accumulation of phosphorus in soils is not necessarily a loss of phosphorus; it may be available again for crop production in the long term. However, on the global scale there is a neutral (Smil, 2000) or even a negative phosphorus balance for crop land (Liu *et al.*, 2008) implying that accumulation in some regions is balanced by depletion in other (less privileged) regions (Stoorvogel *et al.*, 1993; Smaling, 2005). From a broader perspective, the consequences of these regional differences in accumulation/depletion are important. Even with the complete

recovery and re-use of P from wastes in the future, local inputs of 'fresh' (fertilizer) phosphorus would still be necessary whenever the distribution of the recovered P was imperfect.

Accumulation takes place at various spatial scales (continent, country, region, farm, and even within fields). The factors causing accumulation include the concentration of livestock particularly of livestock for which productivity is enhanced with phosphorus additives, and the experienced profitability of an extremely high phosphorus soil status for the production of certain types of crops. The reasons behind this will be addressed in sections 4.2.9 and 4.2.10.

Table 3-1. *Typology of phosphorus losses. Understanding the type of phosphorus losses in the current food production & consumption system is important because it can inform an appropriate sustainable response strategy*

Loss type ^c	Examples	Sustainable response strategy according to loss type
A. PERMANENT LOSSES from the food production & consumption system ^a	I. LOSSES TO ENVIRONMENT	<ul style="list-style-type: none"> • Reduce spillages, wastage • New recovery techniques to avoid radioactive risk • Process improvements in e.g. phosphoric acid, superphosphate, DAP and MAP production • New and more efficient recovery techniques
	<ul style="list-style-type: none"> • Mining losses (to environment) • Losses in rock amelioration and P extraction • Losses in fertiliser production • Phosphogypsum stockpiles • Spillage of fertilizer during storage and transport • Erosion, runoff, leaching (to water or non-arable land) and eventually to the oceans sediments 	<ul style="list-style-type: none"> • Reduce spillages, wastage • Buffer strips, improved soil mgt and cover crops during winter • Discouragement of erosion sensitive (arable) crops • Good management of manure (application rate, time etc.) to prevent losses to water
	II SEQUESTERED or made otherwise unavailable for agriculture	<ul style="list-style-type: none"> • Productively reuse manure on arable land • Avoid discharge to water • Encourage efficient recovery of P for productive reuse in agriculture
	<ul style="list-style-type: none"> • 'Dumping' of manure on non-agricultural areas • Wastewater discharged to rivers, oceans • Incineration of manure (e.g. for energy) • Sequestration in (building) materials as the result of incineration of landfill, sewage sludge, slaughter waste • Land filled solid including organic waste 	<ul style="list-style-type: none"> • Ensure resultant P in incineration ash is available for productive reuse as fertilizer arable land • Extraction of P • Prioritize P for food security • Avoid disposal & reuse instead on arable land

Table 3-1. *Typology of phosphorus losses. (continued)*

Loss type ^c	Examples	Sustainable response strategy according to loss type
B. TEMPORARY LOSSES within the food production & consumption system ^b : (i.e. potentially recoverable)	<p>I. ACCUMULATION in agricultural soil</p> <ul style="list-style-type: none"> Excess P in soils due to: Abundant (risk averse) fertilization Aiming at maximal crop yield <p>II. ORGANIC WASTE BY-PRODUCTS losses (due to inefficient use, unnecessary waste production or suboptimal recycling)</p> <ul style="list-style-type: none"> Crop residues, hay Organic waste from food and feed industry (e.g. oil press cakes) Food preparation & consumption waste Human excreta 	<ul style="list-style-type: none"> Soil testing and management Better utilization of soil P reserves Fertilizer placement Mycorrhizal fungi Breeding (e.g. to improve root characteristics) Critical review of P-recommendations for fertilization and desired P status of soils Policies aiming at livestock production to be proportional to the surrounding arable area Composting of manure with other organic rest streams Manure processing and export of nutrients from surplus areas Phytase feed enrichment to decrease P content in manure Using low P feed Improve reuse in agriculture Regulation? (BSE related topics) Prioritize P use for food purposes Stimulation of recycling of P-containing residues of processed bio fuel crops thereby returning the nutrients to the site of production Improve reuse management to conserve nutrients Improved management (e.g. reduce spillages, wastage) Composting with other organic rest streams Reduce spillages (in household & retail) Collecting organic household waste followed by biogas production and/or composting Source separation of human excreta and (direct) reuse in agriculture Sewage sludge reuse following composting or incineration Composting with other waste streams

Notes: ^aPermanently lost from the system, where system boundary is the entire food production & consumption system, from mine to field to fork. Hence 'loss' implies a phosphorus flux that is exported from the system. ^bTemporarily lost from the sub-system (e.g. farm, or household), but not lost from the whole system, hence can be potentially recovered). ^cLosses can move between permanent and temporary - for example, the temporary loss of phosphorus in soil accumulating on the farm, can become a permanent loss if lost to water due to erosion.

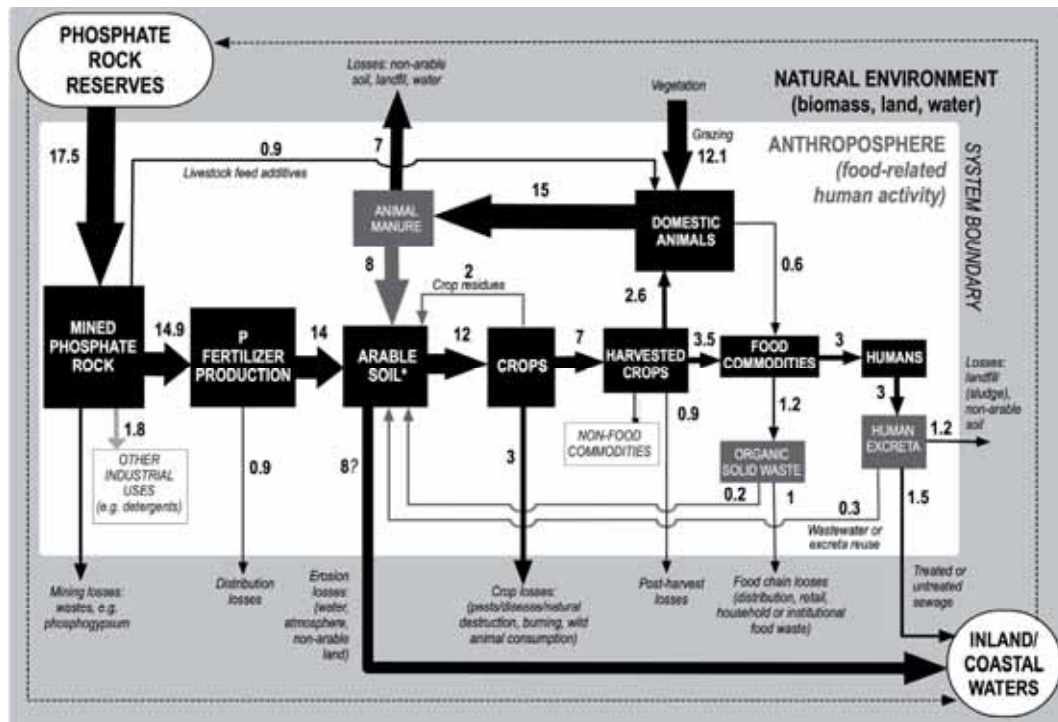

Figure 3-1. Key phosphorus flows through the global food production and consumption system, indicating phosphorus usage, losses and recovery at each key stage. Units are in million tonnes phosphorus/yr (Cordell, 2009a).

3.2 Mining and beneficiation losses

Around 17.5 Mt of P is mined in phosphate rock each year. Most of this is for food production (82% fertilizers, 5% feed and a small percentage for food additives), while the remainder is for detergents (10%) and other industrial uses (3%). Some phosphate is lost during the beneficiation (concentration) process whereby contaminants (such as iron phosphate) are removed and discharged into rivers or contained (UNEP, 2001). Phosphate is also lost via spillages during storage and transport of phosphate rock. In a recent study conducted by the International Fertilizer Industry Association Prud'homme (2010b) estimates that losses in the mining and processing stage (Figure 3-2) include:

- Extraction losses - typical mining efficiencies reported by industry run from 45% upwards with an average at 82% (i.e. 18% losses) and 2/3 of the capacity at or above that average (Prud'homme, 2010b);
- Primary processing losses - efficiency at this stage runs from 45% and upwards, averaging at 84% (i.e. 16% handling and process losses).

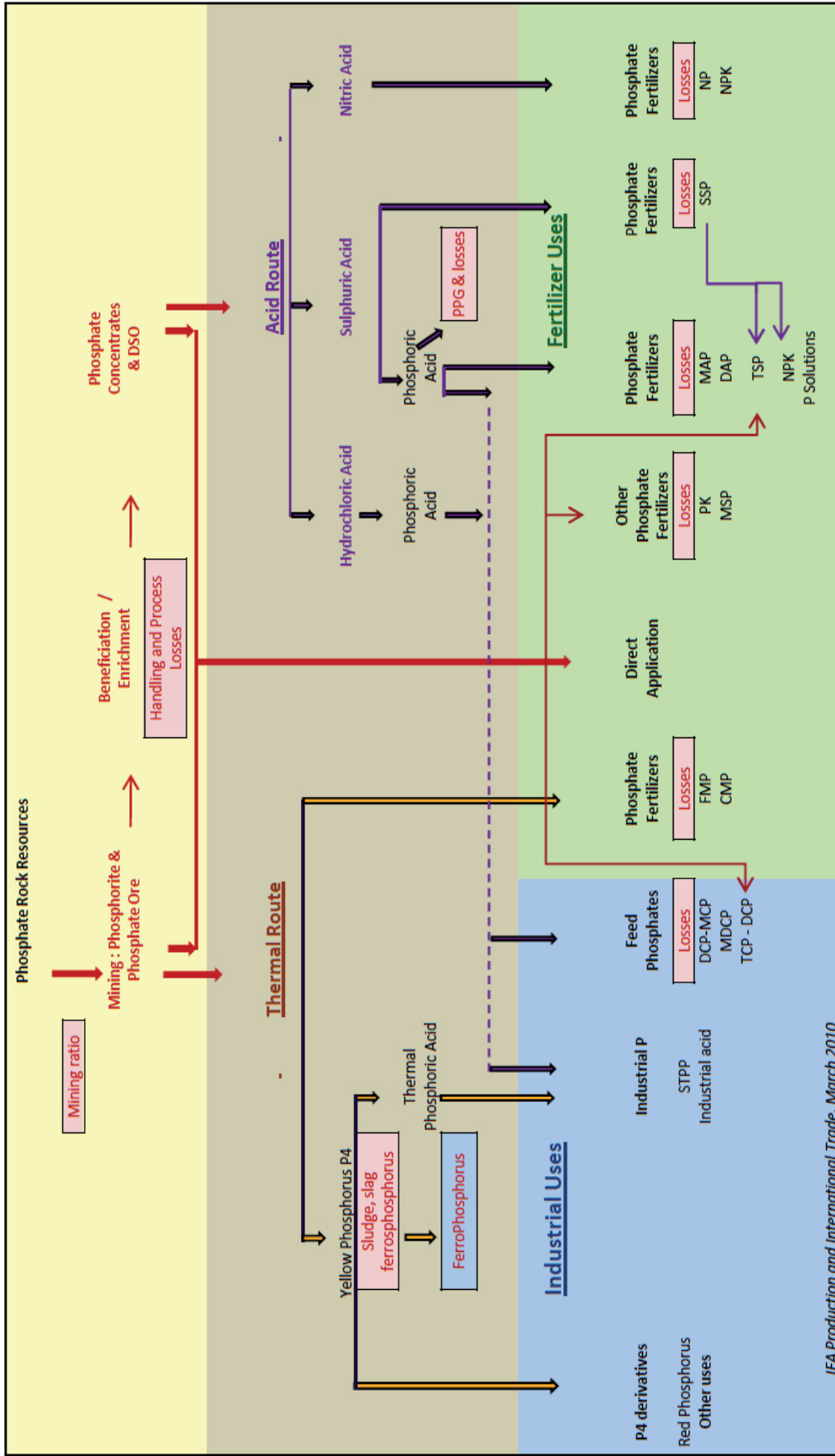

Figure 3-2. Losses occurring during mining and beneficiation, primary and secondary processing and distribution. Losses are indicated in boxes (Prud'Homme, 2010b).

Mining recovery rates could be improved, aided by new technologies and adequate financial incentives. The average grade of phosphate rock concentrates (following beneficiation) are on the average dropping gradually year by year from about 31% in 1986 to about 30% at present. Based on this, Prud'Homme (2010b) anticipates there will be an increased importance attached to minimizing losses in the mining and processing stages. Some storage and transport losses could be reduced through improved management and technical practices.

3.3 Fertilizer production and distribution losses

Approximately 14.9 Mt/a of P in phosphate rock is processed into phosphate products either via the acid route (predominantly for fertilizer production), thermal route (for industrial and feed phosphates), or for direct application as fertilizer. In the acid route, which is by far the most common process, sulphuric acid is reacted with phosphate rock to yield phosphoric acid. Process losses are 20% or less and average 5% with half of the industries running at that level or better. This 5% equates to around 2 Mt P_2O_5 , predominantly in the form of the byproduct phosphogypsum (Prud'homme, 2010b). Typically 4-5 tonnes of phosphogypsum is generated for every tonne of phosphoric acid. Prud'Homme also estimates that 10% losses occur during the thermal route as sludge and slag ferrophosphorus, equating to around 0.3 Mt P_2O_5 . Other losses can occur from spillages (e.g. from torn fertilizer bags), spoilage, theft and other losses during handling, storage and transport (IFA, 2000a; IFA, 2000b).

While the amount of phosphorus in phosphogypsum stockpiles is substantial, it is currently not used due to radioactivity concerns (due to the presence of radioisotopes from the decay series of uranium and thorium). However in the future safe processing techniques may facilitate the recovery of phosphorus from phosphogypsum stockpiles (Hilton *et al.*, 2010). Some storage and transport losses could be reduced through improved management and technical practices. Further, global trends towards vertical integration of the industry (that is, processing phosphate products closer to the mine site) may reduce transport and storage losses.

3.4 Sources of phosphorus loss in agriculture

3.4.1 Introduction

With a growing human population and a tendency for higher meat consumption, more food and feed need to be produced. In agriculture, even with the best available techniques, losses occur. It is therefore almost inevitable that an increase in the agricultural production area (also stimulated by the need for bio energy crops) will lead not only to higher phosphorus consumption, but also to more losses of phosphorus. Globally, erosion (mainly induced by wind and water and to a lesser extent by tillage on slopes and erosion due to soil particles adhering to lifted crops in particular) is probably contributing most to the worldwide loss of phosphorus and subsequent soil degradation. Phosphorus can also be made agronomically ineffective via accumulation in soils beyond justifiable levels. The accumulation of phosphorus is usually caused by high livestock densities leading to regional phosphorus surpluses, and subsequently to excessive phosphorus inputs from manure in the surrounding arable region. The problem is aggravated by the use of phosphorus-rich feed in intensive livestock farming and sometimes even the use of phosphorus-salt additions to feed. In some cases, however, the accumulation of phosphorus can be justified from a crop production perspective, as the concentration of plant-available phosphorus in the soil is low due to the binding capacity of the soil. This can make it worthwhile to improve the fertility status and for this, large amounts of phosphorus may be necessary. This type of phosphorus management is also encouraged by the low fertilizer price, at least in the Western world. All these factors lead to the accumulation of phosphorus in soils. A low concentration of phosphorus in the soil solution implies for many crops that rooting characteristics (especially root length) are important for the acquisition of phosphorus by the crop. This explains why, especially for fast growing annual crops with a short field period, much more phosphorus is usually recommended than the amount that is taken off by the crops. Whether or not the symbiosis with mycorrhiza fungi can be of value in this type of agrosystem is often discussed (Grant *et al.*, 2005). These aspects will be addressed in more detail in section 4.2.7.

Losses of phosphorus from the crop itself are relatively small. Once phosphorus is taken up it becomes a constituent of the crop mass. In arable crops, the major part of this mass is eventually exported in the form of

harvested material. This is particularly true for grain crops as phosphorus is preferentially invested in the seeds. This trait is a remnant of the wild ancestors of our crops which developed this trait to ensure that the 'next generation' has a sufficient supply of the, once scarce, element P. In grazed crops almost all of the consumed phosphorus is deposited in situ as urine and faeces. This phosphorus will again be available for crop growth and should thus not be considered to be a loss either.

A fraction of the crop-phosphorus of both arable crops and grazed vegetation will be lost due to diseases and pests. The phosphorus consumed by diseases and pests will to a certain extent be deposited within the crop itself and will hence be fully available for subsequent crops and thus not lost. Pests such as deer, rats or locusts, however, may remove some phosphorus from the agro-ecosystems as they also defecate outside the field. Note that in Europe this type of phosphorus loss has become relatively rare. Even in the absence of such yield-reducing factors, only a fraction of the phosphorus that is taken up by the crop eventually crosses the field boundaries, as the so-called crop residues (roots, stubbles, haulms, husks, pods, and so on) are left in or on the soil. Some inevitable harvest losses, due to such things as grains lost during combine harvesting, mean that another small proportion of crop phosphorus will not become available for eventual consumption. However, this is not a true loss as the phosphorus will become fully available for subsequent crops, just as the phosphorus in crop residues does. All in all, in European crop losses are of little relevance from the point of view of phosphorus.

3.4.2 Soil surface balances

Errors and time lags

The difference between the amounts of phosphorus (P) applied to land and the amounts removed in harvested crops - that is, the soil surface phosphorus surplus, indicates how much phosphorus is accumulated or lost via leaching, run-off or other forms of erosion. According to OECD definitions (OECD, 2010b) the input terms of this balance sheet consist of (1) mineral fertilizer phosphorus, (2) phosphorus in manure and other organic resources where these are not withdrawn from agriculture, (3) atmospherically deposited phosphorus, and (4) phosphorus in seeds. Outputs are the phosphorus in harvested crops and grazed vegetation. Whenever applicable, input and output terms should be corrected for stock changes to get a reliable figure of the phosphorus that has entered or left the soil. All these balance terms are afflicted with errors. Their impact on the accuracy of the final phosphorus surplus is negligible as far as the input terms for mineral fertilizer are concerned because of their relatively accurate registration and constant concentrations. The same holds for the impacts of errors related to deposition and seeds as these two terms generally contribute less than 1 kg P per ha per year. The manure input term, however, is associated with a large error because it is derived from livestock numbers and national default values for the phosphorus excretion per animal category. Errors associated with the output terms of phosphorus are considerable too. This is not only because the amounts of phosphorus removed are based on national default values instead of factual values for phosphorus concentrations per crop type, but particularly because the yields of grazed crops are based on estimated yields that have at best been approximated from the observed livestock production and attendant feed requirements.

The collection and processing of required data appears to be extremely time consuming. Consequently, the lag time is considerable, particularly if data need to be combined to convert them into relevant indicators. Such a time lag definitely applies to phosphorus surpluses, whereas the data needed to construct the phosphorus balance (such as mineral fertilizer use and livestock numbers) are usually more recent. When up-to-date information about indicator values is lacking, one can resort to proxies. As mineral fertilizer use and livestock numbers are the dominant determinants of the phosphorus surplus, these parameters can be used as proxies for the phosphorus surplus. Unfortunately, the years for which these proxies are available do not always coincide with the most recent years for which data on phosphorus surpluses are available.

State of the art

The most recent overview of phosphorus surpluses in individual European countries as provided by the OECD (2010a) pertains to 2004. As for the EU15, the surplus ranges from values close to zero in Eastern Europe to 15 kg

P per ha or more in Belgium, The Netherlands and Portugal. The surplus average is 7 kg P per ha, which is close to the 8 kg P per ha that Richards and Dawson (2008) calculated for the year 2006 for the EU27 as a whole. The differences between countries are considerable (Table 3-2).

In almost all European countries, phosphorus surpluses have been reduced drastically during the past 15 years. In Eastern Europe phosphorus balances have become close to zero or even negative (Figure 3-3). Considering these long-term changes of phosphorus surpluses, it is of interest to know what phosphorus surpluses are like today. As OECD data do not go any further than 2004, we have to resort to proxies for which more recent data are available. As indicated before, there are close positive relationships between livestock densities (Eurostat, 2010), manure-phosphorus applications (OECD, 2010a) and phosphorus surpluses (Figure 3-4 A-C below). The scatter around the relationship between livestock density and manure phosphorus application (Figure 3-4A) results from (1) differences in the extent to which excreted manure is removed from the national agriculture (that is, exported) or, conversely, the extent to which manure is being imported, the differences in phosphorus excretion per livestock unit (LU) across animal categories and the differences in phosphorus excretion per LU within animal categories. Regarding the latter, it is concerning that the default phosphorus excretion per head of common animal categories as adopted by the OECD vary more than what appears plausible as a result of differences in animal nutrition (Table 3-3). Despite this variation, livestock density seems a reasonable proxy for phosphorus surpluses (Figure 3-4C). Considering that livestock densities in Europe have hardly changed between 2003 and 2007 (Figure 3-5) and assuming that (1) similar amounts of excreted manure-phosphorus have been exchanged between nations, and (2) average phosphorus-excretion per livestock unit has not essentially changed, it is not likely that this term of the phosphorus balance has changed much. It is also unlikely that the inputs of phosphorus via deposition or seeds and the outputs of phosphorus via harvests have significantly changed in the course of time. The input of mineral fertilizer has changed only slightly.

According to EFMA data (EFMA, 2010), mineral fertilizer use decreased by 0.2 kg P per ha per year between 1999 and 2008 in the EU15, whereas use increased by on average 0.2 kg P per ha per year during this period in Eastern Europe (Figure 3-6).

The observed developments of livestock densities and mineral fertilizer use between 2003/04 and 2007/08 allow us to conclude that present phosphorus surpluses (2010) will probably differ less than a few kg P per ha (in either direction) from the 2004 OECD surpluses. A serious point of concern, however, is represented by the default values that the OECD has been using for the phosphorus excretion of specific animal categories in various countries. Correction of these numbers will probably have a much greater impact on national phosphorus surpluses than the use of more recent input data.

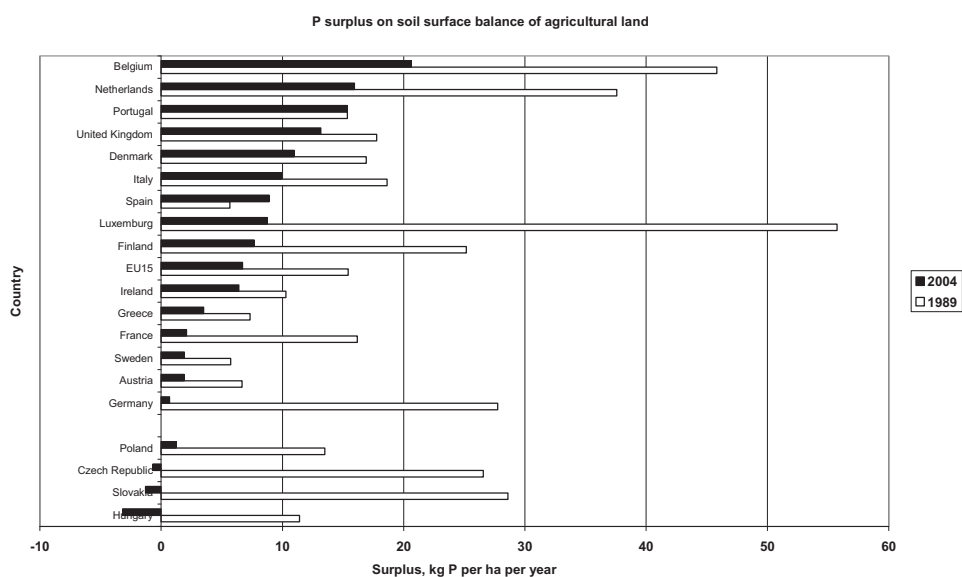

Figure 3-3. Phosphorus surpluses in 1989 and 2004 (kg P per ha UAA (Utilised Agricultural Area) of 15 OECD countries (OECD, 2010a).

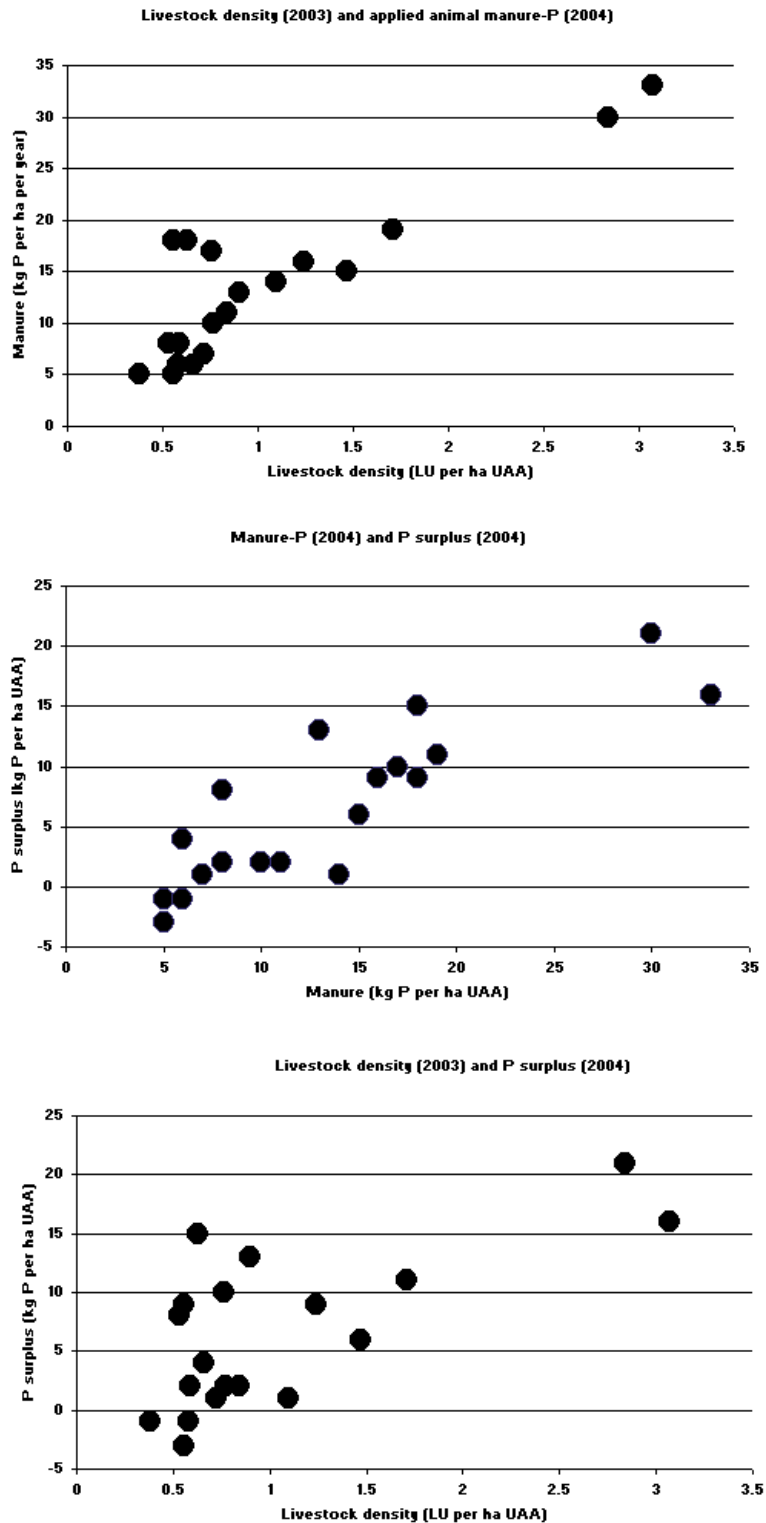

Figure 3-4. Relationships between livestock densities and the applied phosphorus in the form of manure (3-4A), between applied manure-phosphorus and phosphorus soil surface surplus (3-4B), and between livestock densities and phosphorus soil surface surplus (3-4C) in 19 European OECD countries (2003-2004) (OECD, 2010a; Eurostat, 2010).

Table 3-2. Soil surface balance for phosphorus ($\text{kg P ha}^{-1} \text{ yr}^{-1}$) in OECD countries in 2004 (OECD, 2010a).

Balance terms:	Country																				
	BE ⁶	NL	PT	UK	DK	IT	ES	LU	FI	EU15	IE	EL	FR	SE	AT	PL	DE	CZ	SK	HU	
Inputs																					
Mineral fertilizer	18	12	7	9	8	14	9	19	9	9	10	5	11	6	6	8	9	6	3	6	
Organic	30	33	18	13	19	17	18	16	8	14	15	6	11	8	10	7	14	6	5	5	
Deposition	0	1	0	0	0	0	0	0	0	0	0	0	0	0	1	0	0	1	0	0	
Seeds	0	0	0	0	0	0	0	0	0	0	0	0	1	0	0	1	0	0	0	0	
<i>TOTAL</i>	48	45	25	22	28	32	27	35	17	24	25	12	22	14	17	15	23	13	8	11	
Outputs																					
Harvested/grazed	28	29	9	9	17	22	18	26	10	18	19	8	20	12	15	14	23	14	10	15	
Surplus	21	16	15	13	11	10	9	9	8	7	6	4	2	2	2	1	1	-1	-1	-3	

⁶ *BE Belgium, NL Netherlands, PT Portugal, UK United Kingdom, DK Denmark, IT Italy, ES Spain, LU Luxembourg, FI Finland, IE Ireland, EL Greece, FR France, SE Sweden, AT Austria, PL Poland, DE Germany, CZ Czech Republic, SL Slovakia, HU Hungary

Table 3-3. Apparent phosphate excretion (kg P₂O₅ per head) for dairy cows and fattening pigs (>50 kg live weight), as used by the OECD for the translation of animal numbers into manure production (OECD, 2010a).

Country	Dairy cows	Fattening pigs > 50 kg
Netherlands	25	4.6
Poland	25	9.2
Ireland	30	4.6
Belgium	32	4.6
Luxemburg	34	6.9
Czech Republic	34	9.2
Sweden	37	7.6
Portugal	37	6.9
Greece	37	6.9
United Kingdom	37	6.9
Finland	39	6.0
Austria	39	5.0
France	39	6.4
Germany	39	6.0
Slovakia	41	6.9
Denmark	44	6.9
Hungary	50	6.9
Spain	85	18.3
Italy	110	12.1

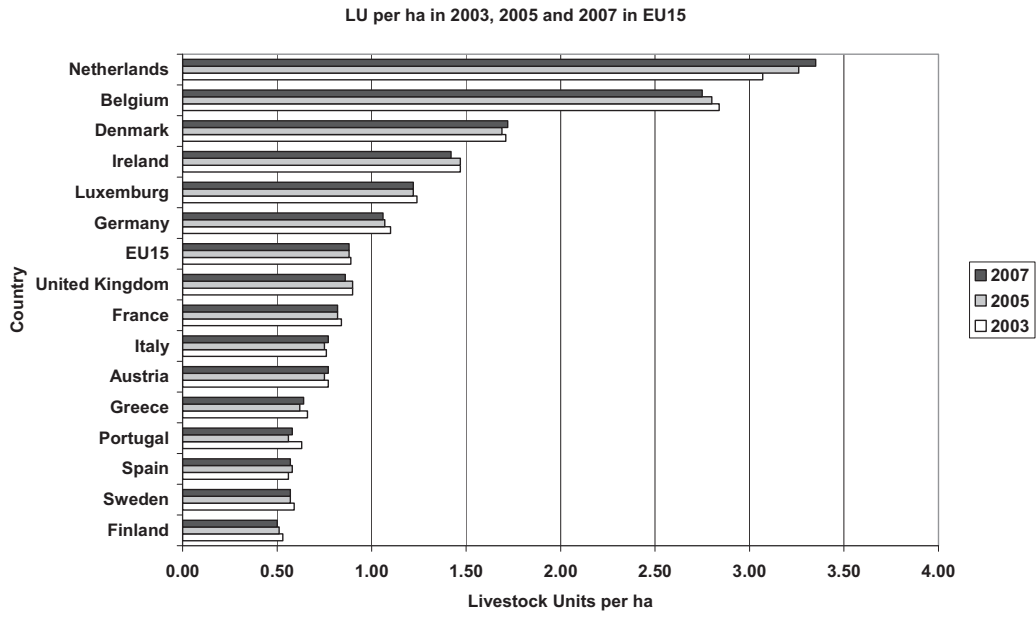

Figure 3-5. Livestock density (LU per ha UAA (Utilised Agricultural Area) in EU15 countries in 2003, 2005 and 2007 (Eurostat, 2010).

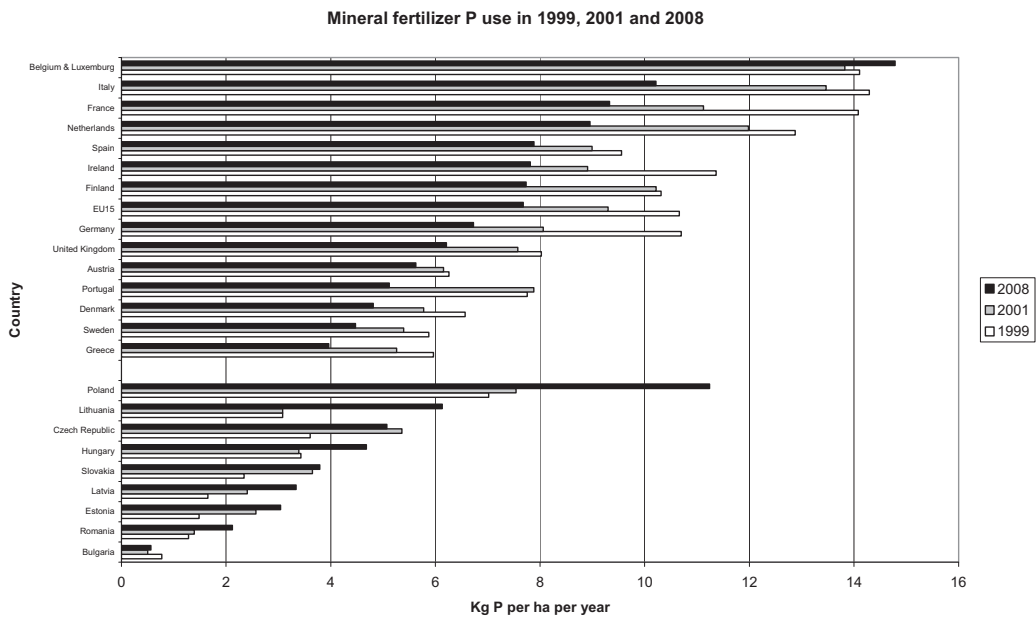

Figure 3-6. Mineral fertilizer use (kg phosphorus per ha UAA) in EU25 in 1999, 2001 and 2008 (EFMA, 2010).

3.4.3 Food production, processing and retailing

While phosphorus is lost from mine to field in the form of phosphate rock or phosphate, it is also 'lost' from field to fork in the form of organic waste (such as the phosphorus contained in food waste or excreta) or losses which are related to the extra cycle which occurs when producing animal products from feed. However these 'post-harvest' losses, amounting to over 30% in the US (Kantor *et al.*, 1997), have been largely ignored and the focus to date has been on reducing phosphorus losses in agriculture (Smil, 2000; Lundqvist *et al.*, 2008; Cordell, 2010).

Up to 50% of 7 Mt/a of P in harvests is estimated to be lost in food production and consumption. Losses at specific stages in the food commodity chain include:

- **Crop storage, processing and trade** - harvested crop losses can potentially occur during storage (such as spoilage due to pests and disease and spillage), processing (such as by-product crop residues not required for primary processing) and trade (e.g. spillages or losses).
- **Bulk food processing, storage, trade** - losses that occur when converting processed agricultural commodities into food commodities, ranging from removal of husks of grains (for processed white rice, bread for example), to losses due to damage, spoilage or below-standard products during trade. Many products today have extensive associated food miles due to the longer distances and more processing steps involved in the globalised food commodity chain, leading to increased wastage (Ericksen, 2008; Lundqvist *et al.*, 2008).
- **Food retailing** - losses that occur during retailing of food items, including spoilt or unspoilt food discarded at supermarkets, markets, other food outlets. Food safety is important in food retailing, however many supermarkets are under consumer pressure or even legal obligation to discard (not sell) food past the stated expiry date, even if the food is perfectly edible (Lundqvist *et al.*, 2008).
- **Food storage, preparation and consumption** - losses that occur typically at the final destination prior to or during consumption (such as spoilage in household fridges or pantries, potato peelings during preparation to edible or inedible dinner plate scraps). In some parts of the developed world (such as the UK), 60% of food waste is estimated to be edible, and hence avoidable by improved food and meal planning (WRAP, 2008).

3.4.4 Excretion and solid waste management

Almost 100% of the phosphorus consumed in food is excreted in urine and faeces. This means the 3 Mt/a of P in food actually eaten is excreted. Globally, only a small fraction of human excreta is actually treated before disposal or reuse. It is estimated that approximately 10% is currently reused either as untreated or treated wastewater, sludge, ash from incinerated sludge or use directly via composting toilets or direct defecation. The remaining 2.7 Mt/a of P either ends up discharged to water or non-agricultural land as effluent or landfilled (Cordell *et al.*, 2009a). The 1.2 Mt/a of P in organic food waste is either informally dumped, centrally disposed of, incinerated (containing around 1 Mt/a of P) or processed and reused (around 0.2 Mt/a of P).

3.5 Environmental impact of phosphorus use - from mine to fork

This section outlines the key environmental impacts of phosphorus use. While the impacts in agriculture are substantial, impacts at other key stages are also important. The impacts identified in this chapter are of global significance with specific relevance to the EU indicated through examples or case studies.

3.5.1 Overview of environmental impacts

Direct and indirect environmental impacts of phosphorus use result from the consumption of resources (such as water, energy, phosphate rock), mismanagement and the generation of waste either in large volumes or with high toxicity, which can in turn pollute receiving environments and damage ecosystems. Literature on the environmental impact of phosphate tends to focus specifically on one aspect, such as localised impacts during the mining and

processing of phosphate rock (such as water pollution) or on the specific ecological impact of phosphorus leakage from agricultural soils to aquatic ecosystems (Millennium Ecosystem Assessment, 2005a). However the environmental impacts of phosphorus extend from mine to field to fork (Cordell, 2010). These impacts span a range of scales and sectors:

- **The stage** in the food production and consumption system - mine, to field, to fork to receiving environment;
- **A spatial** scale - global, regional, national, local impacts;
- **A temporal** scale - short-, medium- or long-term; and
- **The responsible** parties - global society, local community, mining/fertilizer/food industry, farmers, retailers, water/sanitation service providers, urban planners, government.

The following matrix (Table 3-4) indicates the types of environmental impacts that can occur at each stage of the food production and consumption system and includes some examples.

Table 3-4. Categorization of environmental impacts of phosphorus use from mine to fork.

STAGE	IMPACT TYPE		scale		Responsibility
	Spatial (global, regional, local)	Temporal (short-term, long-term)	scale	Responsibility	industry,
Mining & production	fertilizer e.g. local phosphogypsum stockpiles				e.g. mining industry, national policy makers, fertilizer industry
Fertilizer use & application	e.g. excess P runoff from farm manure/fertilizer	e.g. medium-term impact of eutrophication in EU			e.g. farmers, fertilizer industry
Harvest & food processing					
Food preparation & consumption	&e.g. food waste in globalized food commodity chain				e.g. food consumers, industry,
Excretion, treatment & disposal/reuse	&E.g. cities generating large flow of phosphorus in urban wastes				

The following sections 3.5.2-3.5.4 provide more detailed descriptions of environmental impacts at each stage in the food production and consumption system. The life cycle energy costs are discussed in section 3.5.5. The measures required to abate or control the environmental effects are addressed in Chapter 4.

3.5.2 Impacts during mining and fertilizer production

Most phosphorus fertilizers used by the world’s farmers are manufactured from phosphate rock that has been mined in Morocco or Western Sahara, China, the US or several other countries (see section 2.2.1). While there are some mining and fertilizer production operations within the EU (Finland), most chemical fertilizer used within EU countries comes from phosphate rock in distant mines.

Whilst the process for mining phosphate rock and manufacturing the product into phosphate fertilizers is relatively simple compared to the high-tech, high energy-consuming process for producing nitrogen fertilizers, it is not without its environmental impacts. These environmental impacts, which can occur at any stage from mining exploration to fertilizer distribution, and can be short- to long-term, or local to global, are outlined below. The local impacts of the mining component (mine site environmental impacts) are described in UNEP (2001) and summarised in Figure 3-7.

- Exploration and mining (like most surface mining operations) disturbs the immediate natural landscape and ecosystems where the mine is located due to local land disturbances, air emissions, water contamination, noise and vibration (UNEP, 2001). Such activities can have a relatively greater environmental impact in ecologically sensitive areas or highly populated areas (such as Florida).
- During the beneficiation (concentration) and the cleaning process some phosphate is lost when contaminants (such as iron phosphate) are removed and discharged to rivers or contained (UNEP, 2001). Water pollution can also occur at this stage due to inappropriate management (such as breaking of tailings dams).
- Energy (typically sourced from fossil fuels) is required during phosphate rock mining, processing, transport and fertilizer production and transport. Energy costs are described in further detail in section 3.5.5.
- In an era of global water scarcity, water consumption during mining and processing is also an environmental impact. This is more significant in regions where water is scarce, such as Jordan, the Western Sahara and Australia.
- As noted in Chapter 2, phosphate rock is a non-renewable resource, and high-grade reserves are finite. This has important consequences for the long-term global environmental impacts of the mining and fertilizer production stage. Increasing energy and other resource inputs (such as sulphur and water) are required to mine and process lower quality rock, and this generates more waste and pollution.
- Uranium and cadmium (among other minerals) are naturally geochemically associated with phosphate rock and should be removed during the beneficiation or phosphate fertilizer production process. Once released into the environment or transferred to soils, these elements may pose a risk to ecosystems and humans - uranium due to its radioactivity and cadmium due to its toxicity. However, according to Nziguheba & Smolders (2008) accumulation of Cd no longer continues in most European soils. Cadmium concentrations of phosphate rock differ from region to region, as indicated in Table 3-5 below. According to Elsner (2008) (cited in Hermann (2009)), sedimentary phosphate deposits (e.g from North Africa) have higher cadmium concentrations than igneous deposits (e.g. from Russia).
- Regarding fertilizer production and processing, the greatest environmental impact is associated with the generation of phosphogypsum stockpiles during processing of phosphoric acid (phosphate rock reacted with sulphuric acid) (IFA, 2000b). While phosphorus is present in phosphogypsum stockpiles in substantial amounts (4-5 tonnes generated for every tonne of phosphate produced), it is currently not used due to concerns about the radioactivity of phosphogypsum (Wissa, 2003). Phosphogypsum is either wet or dry stacked, and there are some concerns over radioactive material leaching to groundwater or being transported to adjacent land due to wind erosion.
- Fluorine emissions during phosphate fertilizer processing are also a serious potential environmental concern, as leaked fluorine can pollute water bodies and adversely affect biodiversity.
- Environmental impacts during fertilizer distribution to the farm gate include the energy required for global transport, and phosphate fertilizer losses due to spillages (for example from torn fertilizer bags), spoilage, theft and other losses during handling, storage and transport (IFA, 2000a; IFA, 2000b).

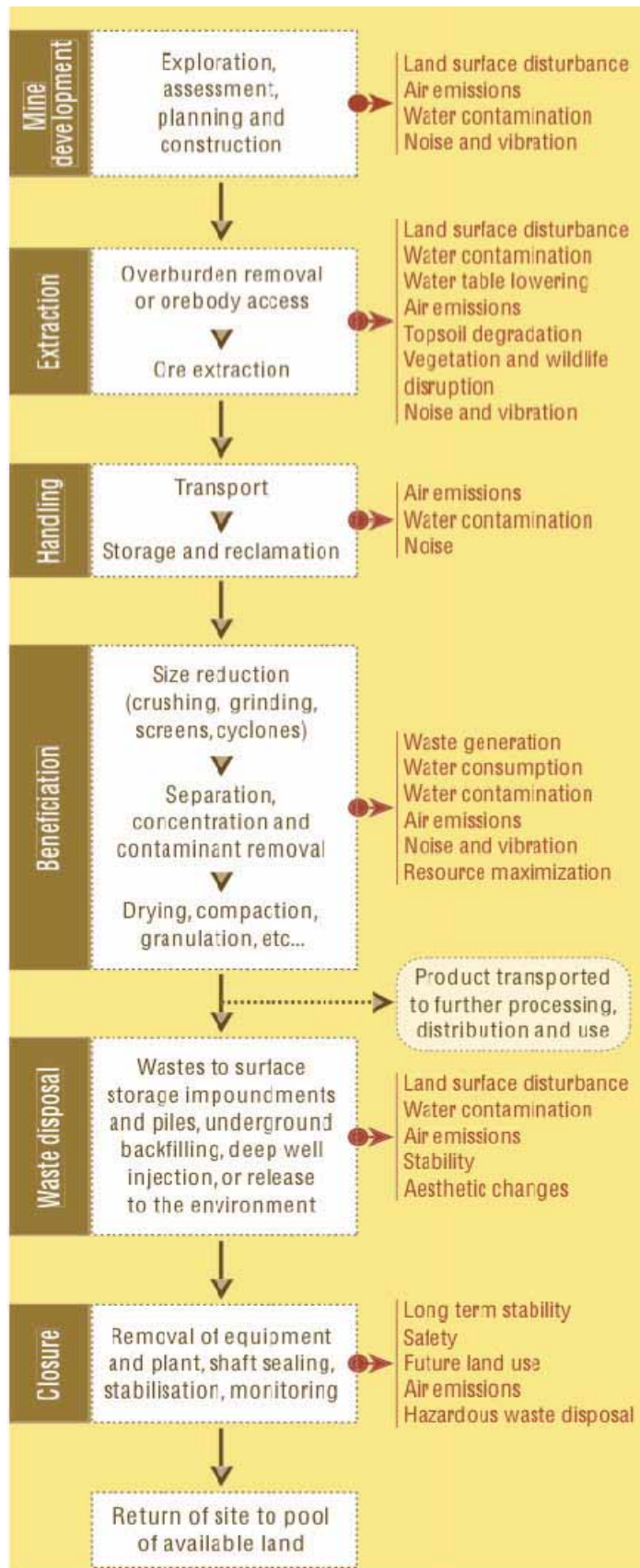

Figure 3-7. Potential local environmental impacts of phosphate rock mining process, from extraction to beneficiation (UNEP, 2001, p.20).

Table 3-5. Cd content (mg/kg P) of phosphate rock reserves from different geographical regions (Elsner, 2008) (cited in Hermann, 2009).

Country	Cd-content (mg/kg P)	Type of deposit
South Africa	0.04-4	igneous
Russia	0.1-2	igneous
USA	3-165	sedimentary
Jordan	5-12	sedimentary
Morocco	6-73	sedimentary
Israel	7-55	sedimentary
Tunisia	41	sedimentary
Senegal	71-148	sedimentary
Togo	72-79	sedimentary
Other countries*	0.1-28	sedimentary/ igneous

* Algeria, Syria, Finland, Sweden.

3.5.3 Impacts during fertilizer application and use in agriculture

This section identifies the environmental impacts from when fertilizers reach the farm gate, to the effects following application and use. Fertilizers are applied to a substantial proportion of the world's agricultural soils. In the EU27 alone, 136 million hectares of land are fertilized (European Fertilizer Manufacturers Association, 2008). While phosphate rock is the main source of phosphorus in fertilizers used globally, other sources such as manure (and to a lesser extent green wastes, other organic wastes and excreta) are also widely used. Indeed, it is estimated that manure is the main source of phosphorus used in agriculture in the EU (Soil Service of Belgium, 2005). However, the production of these manures is to a considerable extent sustained with feedstuffs that are themselves produced outside Europe - using mineral fertilizer phosphorus. The environmental impact of eutrophication can occur regardless of the source of phosphorus, while other impacts (such as the presence of cadmium) are more dependent on the source of phosphorus.

- Arguably the largest environmental impact of phosphorus use in agriculture is associated with the effect that phosphorus which is lost or leached from the farm has on aquatic ecosystem functioning and biodiversity. Although not as mobile as nitrogen, phosphorus can leak from the field via wind or water erosion (adsorbed to soil particles or organic matter) and a smaller fraction is transported in solution in soil water (via leaching to groundwater or overland-flow (run-off)). The phosphorus comes from either applied fertilizers and manures that have not been absorbed by plant roots, or natural soil phosphorus. Because phosphorus is often the limiting nutrient in inland and estuarine waters, excess phosphorus can trigger the growth of algal blooms, which a) block sunlight, reducing the dissolved oxygen and resulting in anoxic bottom waters, and b) following the algae's death and decomposition, toxic compounds are released which result in substantial fish kills and reductions in aquatic biodiversity (Correll, 1998). While the extent of eutrophication and dead zones varies from region to region, it is a known global environmental problem that requires integrated and medium-term planning (Steffen *et al.*, 2004; Millennium Ecosystem Assessment, 2005a). Within the EU, persistent eutrophied waters (and algal blooms) occur in the Baltic Sea, in the coastal region of Brittany (France) and some Mediterranean coast zones (European Environment Agency, 2001; Helcom, 2005; Soil Service of Belgium, 2005).
- As noted in 3.5.2 above, some heavy metals, such as cadmium, are naturally found in phosphate rock. This means, unless they are removed, the application of phosphate rock-based fertilizers can result in the distribution of toxic substances in soils. Cadmium can be toxic to living organisms in high doses. While cadmium is slowly accumulating in some agricultural soils (including some within the EU), the International Fertilizer Industry Association (IFA, 2000b) suggests these are not yet in high enough concentrations to warrant action, and further that few cost-effective measures for removing cadmium from fertilizers are available. The amount of soil cadmium depends on a number of factors, including cadmium concentrations of the original phosphate rock,

fertilizer application rates and other sources of cadmium. It is estimated that around 50% of soil cadmium in European countries comes from atmospheric deposition from industrial practices (IFA, 2000b). Cadmium levels range widely in phosphate rock with the lowest levels (0.2 mg Cd/kg P) in igneous ores to over 800 mg Cd/kg P in sedimentary rock (Oosterhuis et al., 2000). In order to avoid enriching arable soil with cadmium from fertilizer in Sweden it is advised that the load should not exceed 10 mg Cd/kg P based on an application rate of 22 kg P/ha/yr (Eriksson, 2009). Fertiliser can be rendered nearly cadmium-free through calcination if the dry thermal process is used to extract the P from the rock. Due to the high energy demand calcination is an expensive treatment. This is even more true for processes such as co-crystallisation with calcium sulphate anhydrate (Oosterhuis et al., 2000). The relatively high level of cadmium in the Morocco/Western Sahara rock should become an issue especially in (eg OECD) countries that monitor cadmium levels in soil and crops. Purification of phosphoric acid to remove contaminants will become more common place as the lower grade (eg cadmium and uranium -contaminated) rocks come on stream. Processes showing good purity that are also affordable include the use of methyl isobutyl ketone (MIBK) and tributyl phosphate (TBP) (Ahmed et al., 2007).

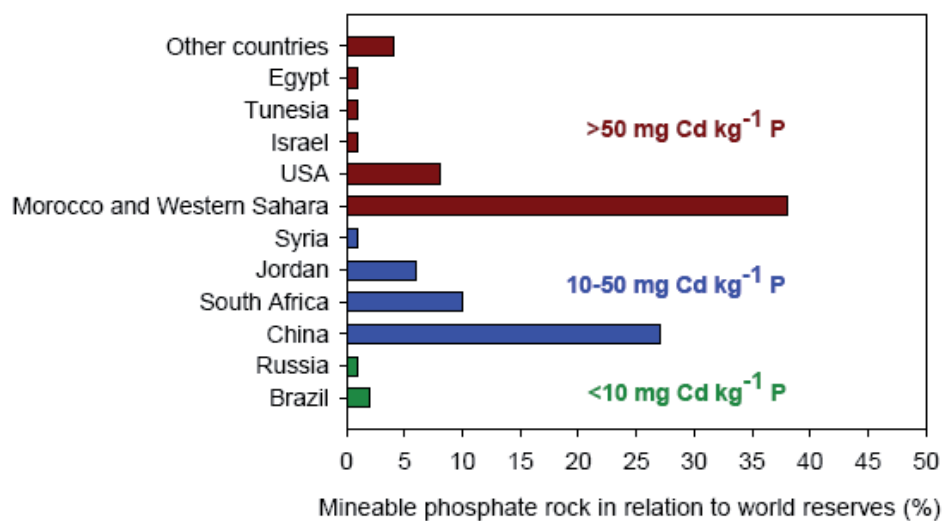

Figure 3-8. Cadmium levels in phosphate rock including the relative size of the reserve. From Cohen, Y. 2010 (pers comm.) based on USGS (2009) and McLaughlin et al. (1996).

- The application of phosphate rock-based fertilizers also results in the transfer of residuals of the decay series of uranium and thorium to agricultural soils. There are concerns that in some cases this could result in agricultural soils that are above acceptable limits, risking exposure to workers and crops (Saueia *et al.*, 2005). While radiation levels can vary above and below acceptable radiation limits, there are no standard procedures in place for ensuring the measurement of soil radioactivity due to applied phosphate rock (or phosphate fertilizers).
- Energy required during fertilizer application (see section 3.5.5 below).

3.5.4 Impacts during organic waste treatment and recovery

Once food is consumed, most of the phosphorus (approximately 98%) is excreted in urine and faeces (Jönsson *et al.*, 2004). Food and post-harvest material not consumed becomes organic waste. Mismanagement of both excreta other organic waste can result in substantial environmental impacts.

- The most significant potential environmental impact of phosphorus in excreta and wastewater fractions is eutrophication. Although all excreta within the EU should be treated (in accordance with public health standards),

not all systems ensure environmental health protection, including loss of nutrients like phosphorus to waterways. In particular Ireland, Belgium, Italy, Greece, Portugal, Spain, Poland, Hungary, Slovenia, Bulgaria, Romania, Czech Republic, Slovakia and the Baltic States have yet to come close to conforming to the Urban Wastewater Directive and require major investments in collector systems and sewage treatment plants (EEA, 2009). While the EU Water Framework Directive (2000/60/EC) does require minimum standards for the recovery of nutrients, not all existing systems (such as onsite septic tanks with infiltration) have been retrofitted with appropriate nutrient removal technology.

- In centralized (and other) wastewater systems, energy and chemicals (such as alum, chlorine etc.) are required to flush wastewater at source (e.g. toilet, factory, slaughterhouse), pump and transmit wastewater to treatment plants, treat the wastewater and associated by-products and in some instances recover components (such as phosphorus). In some parts of the EU, the reuse of phosphorus-containing sludge as fertilizer is prohibited due to the presence of other toxic substances in the sludge, such as heavy metals like cadmium and mercury. In these situations, the sludge must be stored or disposed of. For example in Sweden, a substantial amount of sludge generated in the populous southern part of the country is trucked north and disposed of in abandoned mines.

3.5.5 Life cycle energy consumption - from mine to field

Fertilizer production consumes about 1.2% of the world's energy and is responsible for about 1.2% of the total emission of greenhouse gases (Kongshaug, 1998). Nitrogen production requires 92.5% of the energy used in producing fertilizers, phosphate requires 3% and potassium 4.5%. The energy cost of *extraction* and *processing* phosphate ore accounts for 16% of the total production cost of fertilizer (Prud'homme, 2010b).

This section goes beyond these estimates and also includes mining, packaging, transportation and farm application. Sections 3.5.2 - 3.5.4 indicated that energy consumption is an environmental impact at all stages of the anthropogenic phosphorus cycle. Whilst a full Life Cycle Analysis LCA of phosphorus was not possible within the scope of this project, the EU Joint Research Centre (JRC) has recently initiated such an analysis. The results of this work are not yet published.

In most cases, the energy for producing and trading phosphate fertilizers based on phosphate rock has relied on fossil fuels. This creates a number of challenges for business-as-usual phosphorus use in the future, namely:

- the energy required for the extraction of phosphorus from rock and the subsequent upgrading to a raw material suitable for fertilizer production will increase as easily exploitable high-grade reserves are gradually becoming depleted;
- the above development will increase the greenhouse gas emissions and energy costs per unit of phosphorus nutrient yielded;
- the price of fertilizer will probably increase as a result, particularly because the price of energy will rise as well;
- short (or long-) term disruptions in energy supply (due to peak oil for example) could feasibly disrupt the annual supply of fertilizers, in turn affecting farmers' financial wellbeing, at least in regions where crop yields are responsive to withheld fertilizer phosphorus.

The following Table 3-6 indicates the energy-consuming activities associated with each stage of the production and use of phosphorus from mine to field. The relative energy consumption is indicated based on estimates from European and US sources. While energy consumption and greenhouse gas emissions in the fertilizer sector are generally associated with nitrogen fertilizers (both their production and their use in agriculture), substantial energy is nevertheless consumed in relation to the phosphorus use in the food production and consumption system, particularly in the global trade. For example, phosphate rock and fertilizers are one of the most highly traded commodities in the world, and the trade is reliant on cheap fossil fuels. In a carbon-constrained future, shipping 30 million tonnes of phosphate rock and fertilizers around the globe each year may no longer be appropriate or possible (Cordell, 2010).

Approximately five tonnes of phosphate ore must be mined and beneficiated to produce 1 tonne of commercial phosphate rock with an average of 32% P₂O₅ content (Kongshaug, 1998). The total energy requirement for the production of dry sedimentary phosphate rock can be as low as 0.3 GJ/t P₂O₅ or 0.13 MegaJoule MJ/kg P. Apatite requires more energy, running at about 10 times that level. The common dehydrate process requiring ground rock yields approximately 28% P₂O₅ and uses about 4 GJ/t P₂O₅ or 1.76 MJ/kg P. The sulphuric acid requirement is 2.76 tonnes per tonne of produced P₂O₅ or 1.21 tonnes per tonne of produced P. This is an exothermic process and normally is discounted from the energy consumption. This excess released energy can be reused in modern sulphuric acid processes.

Mining, beneficiation and waste disposal consume about 10 MJ/kg P. Chemical extraction consumes less than 0.3 MJ/kg P in Europe while the world average is about 10 times that. Packaging and transport consume nearly 4 MJ/kg P. Finally farm application consumes less than 1 MJ/kg P. In total the world consumes about 20 MJ/kg P based on the data available. Taking into account the reuse of heat from the exothermic sulphuric acid reaction, modern BAT mining and extraction industries combine to use about 13 MJ/kg.

Table 3-6. *Indicative life cycle energy consumption associated with phosphorus use from mine to field.*

STAGE	Activity associated with energy use	Energy consumption (in MJ per kg P)
Mining production	<ul style="list-style-type: none"> Mining (fuel and electricity to drive heavy machinery/equipment) e.g. draglines, pumps and pit cars Water pumping and treatment Beneficiation /floatation, screens and trommel) 	<ul style="list-style-type: none"> 12^a
	<ul style="list-style-type: none"> Production and processing of other raw material inputs (including energy required to mine, process and transport raw materials to phosphate processing site) 	<ul style="list-style-type: none"> N/A
Fertilizer production and distribution	<ul style="list-style-type: none"> Fertilizer manufacturing, including chemical process reacting sulphuric and other acids with phosphate rock 	<ul style="list-style-type: none"> 0.2-0.3^b 3.4^c -7.3^d
	<ul style="list-style-type: none"> Substantial energy costs associated with international shipping and land transport of fertilizer products; approx 30 million tonnes of phosphate traded globally each year 	<ul style="list-style-type: none"> N/A
Fertilizer application	<ul style="list-style-type: none"> Distribution and retailing 	<ul style="list-style-type: none"> 3.7^e
	<ul style="list-style-type: none"> Machinery for on-farm fertilizer application 	<ul style="list-style-type: none"> 0.7^f

^a US data for energy consumed in mining, beneficiation and waste disposal (US Dept of Energy, 2002).

^b average European energy requirement in production of phosphoric acid for the hemi-hydrate and di-hydrate processes, respectively (EFMA, 2000).

^c world average energy requirement for production (Helsel, 1992).

^d exothermic energy release from sulphuric acid (Kongshaug, 1998).

^e world average energy requirement for packaging and transport (Helsel, 1992).

^f (Helsel, 1992).

Reuse of waste heat has been explored in order to provide energy savings in the thermal processing of phosphoric acid. The idea is to use a 'phosphorus burning boiler' with an anti-corrosive ceramic inner coating reusing a continuous flow of by-product steam (8 bars) to upgrade older energy-wasting 2- step thermal extraction process which for example still exists in China. For the production of 85% phosphoric acid, the phosphorus burning boiler can recover 54% of the total inlet heat and thereby reduce the consumption coal for steam production by 100% and that for power by 80%. This has significant economic and environmental benefits and should provide an incentive to retrofit the thermal process industries instead of shutting these down in favour of wet acid production (Zan *et al.*, 2006).

The alternative - that is, the production of fertilizers based on phosphorus recovered from 'wastes' such as excreta, manure, food waste and other organic materials, also costs energy. This energy is likely to be context-specific and depends on a number of factors (Cordell *et al.*, 2009b), including:

- The type of recovery system (e.g. for phosphorus recovery from excreta: energy consumed in source-separating composting toilet, struvite formation at wastewater treatment plant, vacuum flush toilets with digester, incineration, etc);
- The distance required to transport the recovered phosphorus to its final destination (for example, transporting treated manure for use in another location, transporting food waste and excreta from urban centres to agriculture). Johansson (2001) estimates human urine can be transported 100 km and remain more energy efficient than the use of mineral fertilizers⁷. Similarly, Fealy and Schröder (2008) conclude that the transport of livestock manure from livestock regions to arable regions becomes energetically questionable beyond distances of 50-75 km. Apparently, it is not always self-evident that recycling wastes is more energy efficient than using mineral fertilizers, as energy is needed to either remove the water associated with the nutrients or to transport that water.
- The degree to which the source must be treated prior to reuse (e.g. removal of heavy metals from mixed wastewater versus direct use of source-separated human urine).

These technologies and processes are discussed further in section 4.4 of Chapter 4.

3.6 Country/Regional Case studies

3.6.1 Introduction

Measures directed at an improvement of the use efficiency should be focussed on the most relevant fluxes. Richards and Dawson (2008) have extensively discussed the difficulties that they encountered when trying to put numbers to the various phosphorus fluxes passing the boundaries of EU27. If data of all thinkable inputs and outputs are retrieved independently, one will rarely find that the difference between inputs and outputs arrives at the theoretical value of exactly zero. Therefore it is necessary to continuously scrutinize data and conclusions based on these data, assuming that reality can thus be approximated step by step. Having said this, it is useless to wait for better data because preliminary estimates can at least give indications of the orders of magnitude. Based on data presented by Richards & Dawson (2008), some updates (FAOSTAT, 2010b; FAOSTAT, 2010a) and additional data presented in this report, we have drafted a diagram of the major fluxes across the boundaries of EU27 and within it (Figure 3-9). Three comments must be made here. Each number must apparently be afflicted with a large error term (relative value around 33%) to obtain a consistent flow chart. This means that numbers indeed reflect nothing more than orders of magnitude. Secondly, for a number of fluxes the amounts of phosphorus are, to our knowledge, simply unknown for EU27 as a whole. Examples are the amounts of phosphorus in industrial by-products that are recycled by livestock or used as soil amendment in addition to sewage sludge. Note that some fluxes are complementary. Putting better numbers to such fluxes in the future may have implications for the numbers attached to other fluxes, if consistency is required. Thirdly, it must be emphasized that measures should be tailored to local conditions. The

⁷ Based on Swedish conditions.

specific cases presented hereafter illustrate that fluxes that are relevant in one country or region, are not necessarily relevant in others.

Figure 3-9 shows that much more phosphorus flows through the livestock sector than through the arable sector. This does not only result from the net imports of feeds (e.g. feed additives, pressed oil cakes, cereals (FAOSTAT, 2010a)), but as much from the fact that of the total European agricultural land (around 190 million hectares) around 70% is devoted to the production of animal feed (grassland, forage maize, peas and cereals grown for feed) (FAOSTAT, 2010b). Consequently, animal manure also represents a substantial flux. About half of the phosphorus taken up by crops is eventually exported in the form of products to processing industries or directly to the households of the 500 million inhabitants of EU27. Together they annually excrete around 0.3 Mt of phosphorus of which much ends up in sewage sludge together with the phosphorus recovered from waste water from other sources. To close the balance (i.e. to supply the phosphorus that is annually taken up by crops and, according to Richards & Dawson (2008), accumulated in soils), only a small amount of the wastes from industries and households appears to be recycled. If future research would indicate that accumulation is less than currently assumed, it would imply that even less of the phosphorus in wastes is recycled and more of it is lost to surface water, landfills or constructions. If future research would indicate that crop-uptakes are higher than assumed here (average only 10 kg P per ha, as it includes extensively managed grasslands), it would imply that more of the phosphorus in wastes must have been recycled. In that case this would not imply a positive impact on surface water, because higher crop uptakes also imply proportionally higher phosphorus exports to industries and households. The diagram shows that phosphorus imported for the production of mineral fertilizer represents a major flux as well. The magnitude of it is more or less equivalent to the, average, annual phosphorus soil surplus calculated by Richards & Dawson (2008) and the OECD (OECD, 2010a). It can be argued that this surplus is required to compensate for erosion losses. However, the ongoing enrichment of soils in Western-Europe in particular, suggests that erosion can not always justify phosphorus inputs. The consequent potential savings on mineral fertilizer phosphorus can only be realized, however, if alternative sources of phosphorus (manures, sludges, other industrial and urban wastes) are available at reasonable distance. Moreover, erosion of phosphorus can be avoided to a large extent, as indicated in Chapter 4. Note that where erosion occurs, the associated phosphorus is eventually lost to surface water.

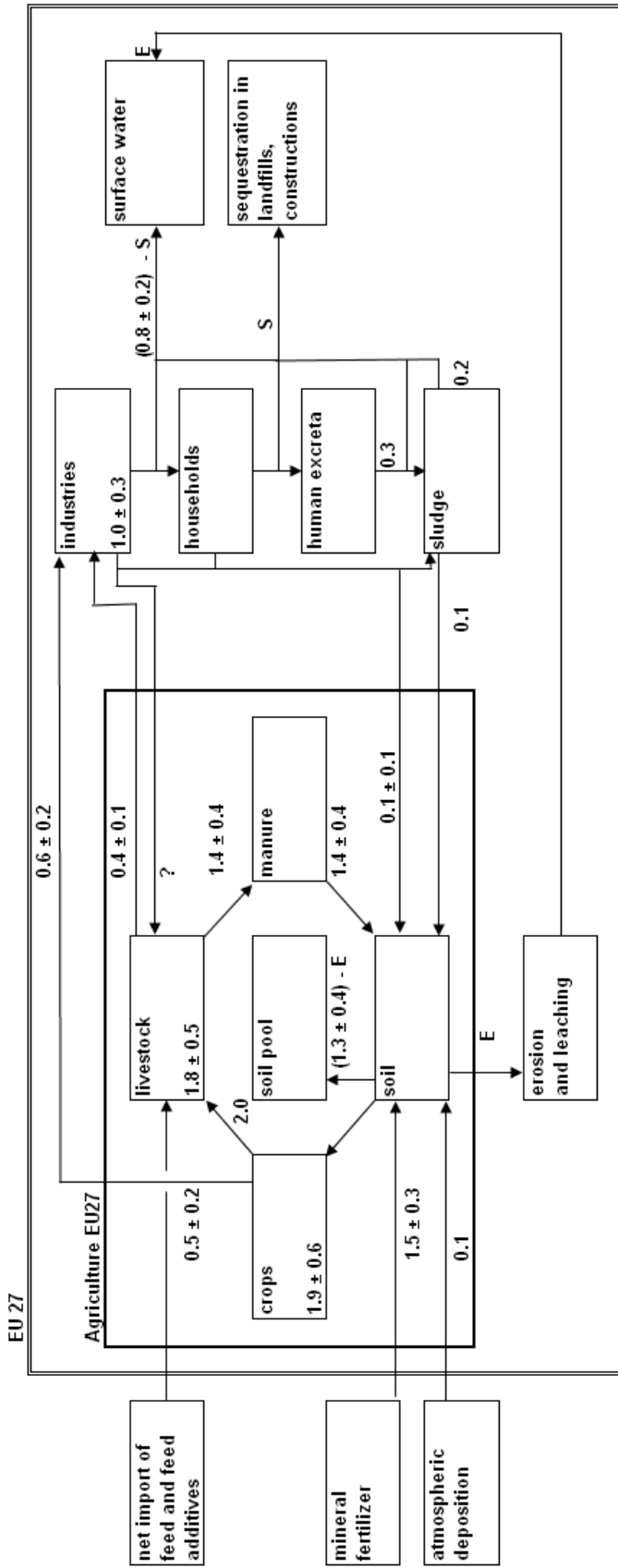

S: amount of phosphorus sequestered in landfills, constructions, etc. (the higher the value, the lower the apparent emission to surface water)
 E: amount of phosphorus lost through erosion and leaching (the higher the value, the lower the accumulation / the higher the depletion of soil fertility)

Figure 3-9. The net flows of phosphorus (Mt/a of P) imported into the EU27 (reference year 2006-2007), and the flows of phosphorus within EU27 agriculture and EU27 as a whole (all numbers in Mt/a of P with an estimated error of $\pm 33\%$) (after Richards & Dawson (2008), FAOSTAT (2010b; 2010a) completed with updated figures from the present report).

3.6.2 Switzerland

This case study is entirely based on an analysis which Binder and co-workers (Binder *et al.*, 2009) carried out. They quantified for the year 2006 most of the phosphorus flows in Switzerland and applied a material flow analysis. In their analysis Binder *et al.*, distinguish between the following subsystems:

- *Agricultural Animals* (Production of meat, milk and eggs, and including all processes needed for the production and provision of animal feeds. This subsystem is not just restricted to agricultural activities as it includes the importation and processing of feed and animal products).
- *Agricultural Plants* (Production of field crops, fruits, feed etc. and including all processes needed for the production and provision of plant nutrients, and forestry, paper, building timber and energy products).
- *Households and trades*, all processes connected with the consumption of foods and products containing wood, and detergents
- *The Chemical industry*, all processes connected with imports and processes of detergents and similar products.
- *The Waste sector*, which includes all processes involved in the disposal and the treatment of liquid and solid wastes
- *Ground and surface waters* - this includes surface waters, lakes, and their sediments

Switzerland, like the rest of Europe, is a net importer of phosphorus (Table 3-7). Annually around 16.5 Mkg of P is imported and almost 4 Mkg of P is exported in (waste) products and via the water flows which leave the country. Ninety per cent of the imports are used in agriculture (feeds and fertilizer). As in most countries the phosphorus cycle is dominated by the agricultural and waste sectors.

Accumulation in the agricultural system is restricted to the Agricultural Plants subsystem and amounts to 3.5 Mkg of P /a. Switzerland has around 1 Mha of agricultural area (pastures, 746,000 ha; arable land, 280,000 ha; permanent crops etc 35,000ha), consult: <http://www.agr.bfs.admin.ch>). So the accumulation on average would not exceed 3-4 kg of P/ha/a. Whereas in the Agricultural Plants subsystem the phosphorus not taken up by plants accumulates in the soil, the surplus in the Agricultural Animals subsystem is exported to the waste subsystem (around 3 Mkg of P/a). In total in the year 2006, 9 Mkg of P/a accumulated in the waste subsystem. This means that each year around 6 Mkg of P accumulates in the waste system from sources other than the agricultural production chain.

The input of Swiss households (see Table 3-8) is dominated by food (78%), detergents (11%) and fertilization of gardens (8%). More than 90% of the phosphorus input in the Households and trades subsystem eventually ends up in the Waste subsystem, with sewage (63%) and landfill (26%) being the major flows.

Focusing on the agricultural subsystems (plant and animal), Table 3-9 shows that the dominant flows between these subsystems are manure (29 Mkg of P) and feed (30 Mkg of P). An important input for the Plant subsystem is further fertilizer (6 Mkg of P, 15%) and for the Animal subsystem imported feed (16%). On the output side it can be noted that the food eventually produced in both systems contains relatively low amounts of phosphorus (11% and 10% respectively of total output).

For Switzerland, 13.5 Mkg of P was processed in the waste subsystem. This amount was imported mainly from the Animal (3 Mkg of P) and Household (10 Mkg of P) subsystems. Table 3-10 shows that only minor flows from the Waste system return to Agriculture (plant or animal). In total 1.7 Mkg of P is exported (animal waste and fly ash), and the same amount (only 1.7 Mkg) is recycled for crop growth in agriculture or gardens. This means that there is an annual accumulation of 9 Mkg of P in Switzerland. This accumulation occurs in a form which cannot be reused in agriculture. Sewage sludge is used as input for the cement industry (2.8 Mkg of P), or in landfills or deposits of ashes from incinerators (6.3 Mkg of P).

Table 3-7. The national phosphorus balance for Switzerland (Binder et al., 2009) in the year 2006.

Import	Products	Mkg of P	%
Animals subsystem	Feed	5.70	34%
	Live animals	0.03	0.2%
	Food (animals)	0.70	4%
Plants subsystem	Fertilizer	5.90	35%
	Food (vegetal)	2.50	15%
Chem. industry subsystem	Chemicals	0.30	2%
	Products	1.50	9%
Household subsystem	Precipitation	0.02	0.1%
	<i>Total</i>	<i>16.65</i>	<i>100%</i>
Export			
Plants subsystem	Wood & paper	0.07	2%
Waste subsystem	Fly ash	0.19	5%
	Animal Waste	1.51	38%
Surface water subsystem	Water flow abroad	2.16	55%
	<i>Total</i>	<i>3.92</i>	<i>100%</i>
Accumulation			
Plants subsystem		3.55	28%
Waste subsystem		9.05	72%
	<i>Total</i>	<i>12.59</i>	<i>100%</i>

Table 3-8. Inflow and outflow of Swiss households in t P/a (after Binder et al., 2009).

Input household	precipitation	23	0%
	Food (animal)	3488	36%
	Garden fertilizer	180	2%
	Food (vegetal)	4016	42%
	Wood	71	1%
	Energy wood	158	2%
	Paper	107	1%
	Detergents	1031	11%
	Garden organic fertilizer	592	6%
		9666	100%
Output Household	Paper (recycling)	69	1%
	Sewer	6097	63%
	Waste/ landfill	2503	26%
	Compost	998	10%
		9667	

Table 3-9. Swiss phosphorus flows in the subsystem Plant and Animal (Binder et al., 2009).

Plant subsystem			Animal subsystem		
Input	Mkg of P	%	Input	Mkg of P	%
Imported fertilizer	5.9	15%	Imported feed	5.6	16%
Imported food (veg.)	2.5	6%	Imported live animals	0.0	0%
Animal manure	29.4	75%	Imported food (animal)	0.7	2%
Sewage sludge as fertilizer	0.6	2%	Feed (from subs. Plant)	29.6	82%
Compost	0.5	1%			
Rest	0.1	0%			
<i>Total</i>	<i>39.0</i>	<i>100</i>	<i>Total</i>	<i>35.9</i>	<i>100%</i>
Output			Output		
Feed	29.6	84%	Manure	29.4	82%
Food (veg.)	4.0	11%	Food (animal)	3.5	10%
Erosion, run off leaching	1.1	3%	Animal Waste	3.0	8%
Rest (energy wood, paper, fert.)	0.7	2%	Rest	0.0	0%
<i>Total</i>	<i>35.3</i>	<i>100%</i>	<i>Total</i>	<i>35.9</i>	<i>100%</i>
<i>Accumulation</i>	<i>3.6</i>		<i>Accumulation</i>	<i>0.0</i>	

Table 3-10. Phosphorus flows in the waste subsystem (Binder et al., 2009).

Waste subsystem			
Input	Product	Mkg of P	%
From Animal	Animal waste	3.0	22%
From Plant	Plant waste	0.1	1%
From Industry	Sewer	0.8	6%
From Household	Sewer	6.1	45%
From Household	Household refuse	2.5	19%
From Household	Kitchen waste	1.0	7%
<i>Total</i>		<i>13.5</i>	<i>100%</i>
Output			
Exported	Animal waste	1.5	34%
To Plant	Sewage sludge used as fertilizer	0.6	13%
To Plant	Compost	0.5	11%
To Household	Garden Compost	0.6	13%
To Water	Effluent wastewater treatment plants	1.1	24%
Exported	Fly ash	0.2	4%
<i>Total</i>		<i>4.4</i>	<i>100%</i>
Accumulation		9.0	
viz.			
	Depots Mono incineration plants for sewage sludge	5.8	64%
	Depots rest streams (landfill, incineration)	0.5	5%
	Cement industry	2.8	31%

Binder *et al.*, (2009) conclude that although the potential for phosphorus recycling is very large in the Waste subsystem (13.5 Mkg of P/a) it is done to a very limited extent (only 1.7 Mkg of P/a). In total the losses are more than 10 Mkg of P/a, consisting of deposits, input to the cement industry and the effluent of waste water treatment plants.

The Chemical Industry subsystem is characterized by the import of chemicals (0.36 Mkg of P) and trade products (1.46 Mkg of P). No accumulation takes place as the same amount is transferred to other subsystems (to household in the form of detergents (1 Mkg of P) and to waste (effluents of industry in water, 0.786 Mkg of P)

Concluding with the Water subsystem: the input is around 2 Mkg of P/a. Half of this amount originates from Agriculture and half from Waste (effluent waste water treatment plants). More or less the same amount is exported abroad in water flows.

Conclusions

- Switzerland is a net importer of phosphorus (import 16.5 Mkg of P and export 4 Mkg of P), leading to an accumulation of more than 12.5 Mkg of P/a, of which 9 Mkg is in the waste system and 3.5 Mkg is in Agriculture.
- In Figure 3-10 (corresponding to Abb 3 in Binder *et al.* (2009)) the complete flows of phosphorus between the five subsystems in Switzerland are shown. It can be seen that an intensive cycling of phosphorus occurs between the Animal and Plant subsystems in the exchange of feed and manure (30 Mkg of P/a). Compensation of the phosphorus-containing output (food) and the losses to Waste and Water, comes mainly from the importation of feed (6 M kg of P) and mineral fertilizer (also 6 Mkg of P). Return flows from society (households) to Agriculture are almost negligible.
- The household subsystem is characterized by Binder *et al.* (2009) as a once-through process, with an input of nearly 10 Mkg of P (78% food, 10% detergents, 9% fertilizers). Consumed goods are directly transferred to the waste industry in the form of various waste substances. Household is the main input (70%) to the Waste subsystem.
- In the Waste sector 13.5 Mkg of P is processed annually, and only 13% (1.7 Mkg of P) is recycled to agriculture or gardens. Around 1.5 Mkg of P is exported abroad and therefore losses are around 10 Mkg of P. Most of this ends up in landfills or is incinerated (6.3 Mkg of P) or the cement factories (3 Mkg of P).
- Binder *et al.* (2009) conclude that from the point of view of resources, phosphorus is not optimally managed and improvement is needed. Some potential recycling paths such as animal waste or the use of sewage sludge as fertilizer have been prohibited in recent years (due to hygiene concerns and risks to the environment). However, according to the authors it should be possible to largely close the phosphorus cycle, and thereby reduce imports of mineral fertilizer. They considered the following options:
 -
 - Use of sewage sludge as fertilizer
 - Use of animal meal as fertilizer
 - Use of animal meal as animal feed
 - Recycling of green waste.

With a combination of these options the authors estimate that a 50% reduction in the import of mineral fertilizer should be possible, although a side effect would be that the accumulation of phosphorus in the agricultural sector would be doubled, probably causing environmental problems. This higher accumulation in agricultural soils is due to the authors' assumption that sewage sludge/ashes are less effective as phosphorus fertilizers. Consequently, they believe larger applications of the treated waste-based phosphorus would be necessary to bring about a comparable effect in terms of plant-available phosphorus.
- The greatest potential is in the management of sewage sludge.
 - As a first step the ashes of the existing incineration plants could be separately deposited in a landfill site. This could ensure their later use as raw material in fertilizer production as soon as this process is commercially viable. In the next step animal wastes could be converted in the same treatment process
 - By contrast, the authors do not give priority to the separate collection of green waste in the whole of Switzerland, since the remaining potential for this is only small.

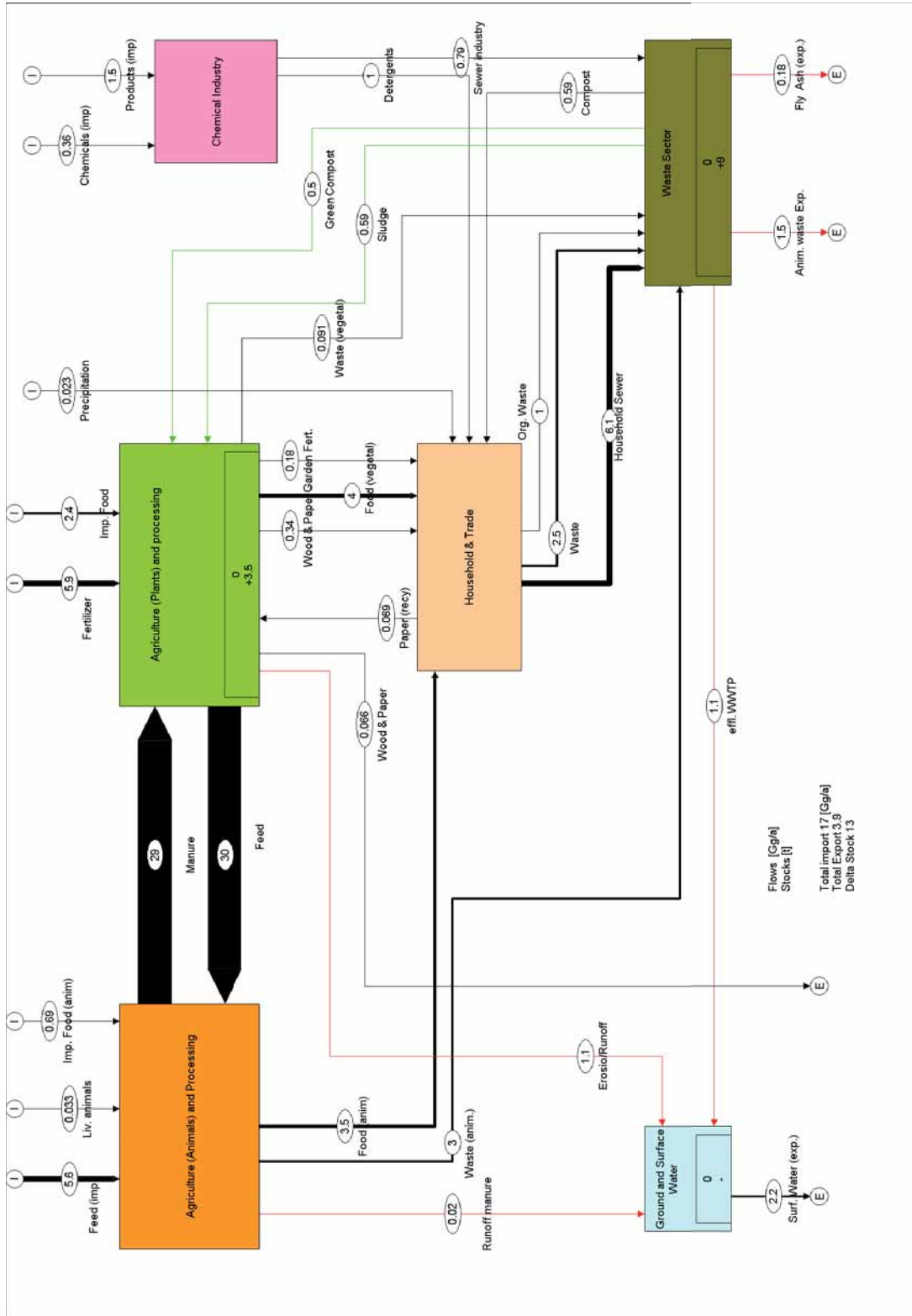

Figure 3-10. National phosphorus flows of Switzerland in 2006 (conform Abb 2 in Binder et al., (2009). Flow values indicated (within the ovals) are expressed in Mkg of P. Accumulation in the subsystems Waste and Agriculture (Plants) is indicated within the square boxes (also in Mkg of P).

3.6.3 The Netherlands

This case study for the Netherlands is entirely based on the preliminary results of a Dutch project carried out by the institutes Plant Research International, Applied Plant Research (PPO) and the Animal Science Group. In this project phosphorus flows in agriculture and society were quantified in order to create scenarios involving more stringent regulations on phosphorus input in agriculture and a future scarcity of phosphorus.

The first report on this project will appear in the fall of 2010 (Smit *et al.*, 2010). This report is summarized below by combining several identified sectors. Although similarities with the Swiss case study exist there are also differences which are apparent in the definition of the sectors:

- *Agriculture.* For this summary all the basic agricultural production activities are pooled in Agriculture, including vegetal and animal production (e.g. arable crops for feed or food; milk, meat, etc.). So in contrast to the Swiss study it does **not** include processing of agricultural products (this is included in the Industry sector).
- *Industry.* This sector includes industrial (processing) activities in the food, feed and non-food industries.
- *Households,* comprises all processes in the household area in connection with consumption of food, detergents and other non-food products
- *Waste Sector* includes all processes to do with the disposal and treatment of wastes from industry or households
- *Environment/Sequestered* includes emission to surface waters and rivers, but also the spots where phosphorus accumulates or where it is sequestered. This can be in the form of landfills but also cement (one of the destinations of phosphorus in sewage sludge is the cement industry), deposits of incineration ashes etc.)

National phosphorus-balance

In Figure 3-11 the national phosphorus flows between the sectors are indicated. The national balance shows a surplus of 60 Mkg of P in the year 2005, the result of the national importation of 108 Mkg of P and the export of 49 Mkg of P. Table 3-11 gives more details on the character of import and export products.

Table 3-11. The national phosphorus budget for the Netherlands in the year 2005.

	Sector	Products	
Import	Agriculture	Fertilizer	21.0
		Live animals	0.2
	Industry	Feed	50.4
		non-food	1.4
		Food	28.0
		Feed-additives	7.2
	Total imports	108.2	
Export	Sector		
	Agriculture	Manure	7.0
	Industry	Food products	26.3
		Slaughter waste	11.3
		Non-Food	1.3
	Waste	Waste	2.7
	Total export	48.5	
	Balance	59.7	

In addition to a large inflow of phosphorus with feed products (50 Mkg of P/a) the Netherlands also has a net importation of 21 Mkg of P in mineral fertilizer. In the year 2005 only 7 Mkg of P was exported with manure. Exported food products (including live animals) amounted to 26 Mkg of P. An interesting result of the analysis was the estimation that more than 10 Mkg of P was exported annually in slaughter waste (especially bone meal which is for the greater part reused in pet food and fertilizer, but also used for the production of porcelain abroad).

Agriculture

Phosphorus flows in agriculture (see Figure 3-11) can be characterized by a large input flow via Industry (the import of feed), the return flow of products to Industry (crops, meat, milk etc) being even smaller than the feed imports. Taking account of the other flows shows that there is an accumulation of 31 Mkg of P (half of the national phosphorus surplus). This accumulation takes place in agricultural soils. The agricultural area in the Netherlands is around 2 Mha (including arable, grazing land, maize land, vegetables etc.) which implies that the accumulation per hectare is more than 15 kg of P/ha/a. Only a very small flow of phosphorus is returned from society (household/waste industry) to agriculture.

Households

Phosphorus flows in the household area are shown in Table 3-12. Phosphorus enters the household almost entirely with food, supplemented with detergents (mainly for dishwashers). On the output side more than 60% leaves the household in the sewer system, and 30% in household refuse (which is mostly incinerated). Organic kitchen and garden waste, separated from household refuse and eventually composted, is estimated at 6% of the household output.

Table 3-12. *Input and output of phosphorus of the Dutch Household area (in Mkg of P).*

Household	In/Out	Products		
	In	Food (animal)	11.4	57%
		Food (veg.)	7.1	36%
		Non-Food (detergents)	1.3	7%
		<i>Total</i>	<i>19.8</i>	<i>100%</i>
	Out	Sewer	12.4	63%
		Landfill/Incineration	6.2	31%
		Compost	1.2	6%
		<i>Total</i>	<i>19.8</i>	<i>100%</i>

Waste Industry

Two-thirds of the waste which is processed by the waste sector comes from households and one-third comes from industry (Table 3-13). In total almost 30 Mkg of P goes to the Waste sector each year. On the output side it can be observed that recycling to Agriculture is almost negligible, whereas the main output is to the Environment/Sequestered sector (25 Mkg of P).

Table 3-13. Phosphorus flows in the Dutch Waste industry (in Mkg of P).

Waste sector			
	Sector	Products	
In	Household	Sewer, Compost, Landfill	19.8
	Industry	Waste (from Feed, Food and non-food industry)	9.8
		<i>Total</i>	<i>29.6</i>
Out	Export	Exported sludge and compost	2.7
	Industry, Household	Reused in industry	0.2
	Agriculture	Compost, used in agriculture	1.8
	Environment/Sequestered	Sewage sludge (+ Incineration), Landfill, Cement Industry, Surface Water	24.9
		<i>Total</i>	<i>29.6</i>

Environment/Sequestered

Similar to Agriculture, half of the national surplus accumulates in this sector (another 28 Mkg of P/a). Table 3-14 also shows that around 7 Mkg of P ends up in the water system (groundwater, rivers, lakes etc.). Of this amount, 3.5 Mkg of P is from the effluent of industrial or communal wastewater treatment plants (which have an average efficiency of more than 80%) and 3.3 Mkg P originates from agriculture due to leaching and runoff. Sewage sludge is not used in agriculture nowadays but is instead incinerated, and the resulting phosphorus-rich ashes are not recycled to agriculture. Also the cement industry uses phosphorus-rich input material, either sludge or incinerated (diseased) animals, leading to sequestered phosphorus in cement. Household refuse ends up in landfill, most of it being incinerated as well.

Table 3-14. Phosphorus flows in the Environment/Sequestered sector.

Environment/Sequestered			
	Sector	Products	
In	Waste	Effluent wastewater treatment plants	3.5
	Agriculture	Leaching & Runoff	3.3
		<i>Total to Surface water</i>	<i>6.8</i>
	Waste	Incinerated sludge	10.4
	Waste	Input for cement industry	3.9
	Waste	To Landfill/Incineration	7.1
		<i>Total Sequestered</i>	<i>21.4</i>
		<i>Total</i>	<i>28.2</i>

Conclusions

- Figure 3-11 summarizes the flows between the main sectors. The Netherlands is a net importer of phosphorus (import 108 Mkg of P and export 48 Mkg of P), leading to an accumulation of 60 Mkg of P/a. Of this 60 Mkg total, 31 Mkg of P accumulates within Agriculture in agricultural soil. Emissions from agriculture to the environment (water) are estimated to be more than 3 Mkg of P.

- Another 28 Mkg of P accumulates either in the environment (water) or is sequestered mainly via the Waste sector.
- Almost half of the national import of phosphorus comes in animal feed (mainly for intensive livestock production)
- The relatively large intensive livestock sector produces not only manure in excess of the available land area, but also results in substantial amounts of slaughter waste. Especially the phosphorus rich bones (estimated at more than 10 Mkg of P) is exported, the greater part being reused.
- The input to households amounts to nearly 20 Mkg of P (93% food, 7% detergents). Consumed goods are directly transferred to the Waste industry in the form of various waste substances. the Household sector is the main input (66%) to the Waste Industry.
- Return flows from society (Household and Waste industry) to Agriculture are almost negligible. In the Waste sector annually 30 Mkg of P is processed, but not more than maximum 2 Mkg is recycled to agriculture or gardens. Around 2.7 Mkg of P is exported abroad and therefore more than 25 Mkg ends up either in surface water (from wastewater plants), in incinerator ashes or in cement.
- It can be concluded that potential recycling paths are not used (or are forbidden) for the following reasons: environmental concerns (heavy metals in sewage sludge), hygiene concerns (direct use of feces and urine), and concerns about diseases (BSE).
- For a more sustainable use of phosphorus in the Netherlands various options can be followed. To reduce accumulation in agricultural soils two ways are open: i) by reducing the production of phosphorus in manure by using feeds low in phosphorus (i.e. via lower excretion of phosphorus per animal) or via a reduction in the number of animals. And ii) by processing manure followed by exporting nutrients. Further possibilities for more sustainability exist in recycling of phosphorus in sewage sludge or slaughter waste e.g. by applying advanced technologies nowadays available to recover the phosphorus.

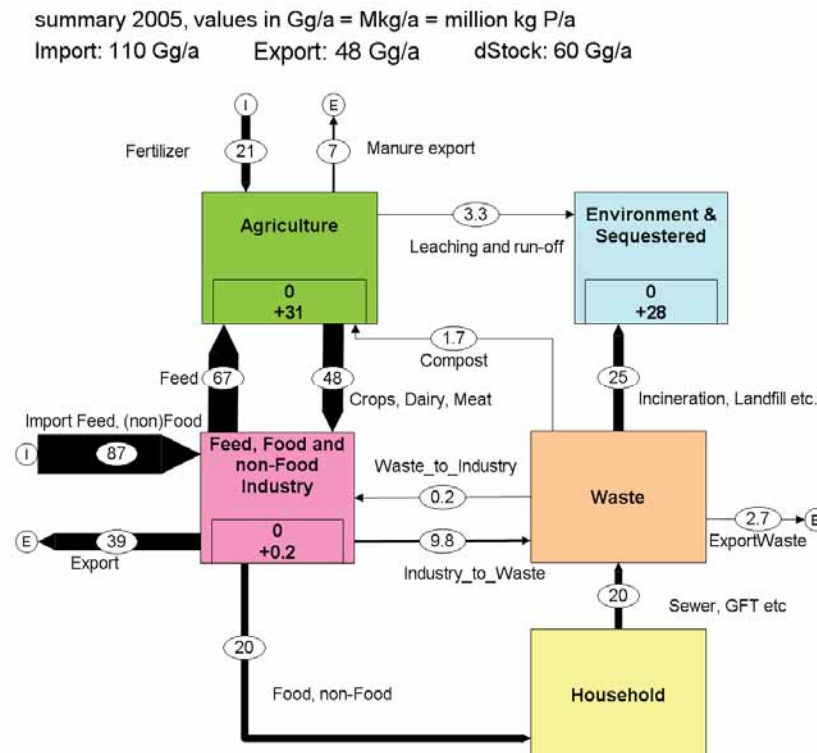

Figure 3-11. A summary of the main flows in the Netherlands in the year 2005 between the Agriculture, Environment/Sequestered, Industry, Waste management and the Household sectors. Flows are in Mkg of P/a. E= Exported, I= Imported. Surpluses for some sectors are indicated in the boxes (after Smit et al., (2010) in prep).

3.6.4 Baltic Sea Region

Phosphorus Point and Diffuse Source Flows

The Baltic Sea region comprises nine riparian countries: Denmark, Estonia, Finland, Germany, Latvia, Lithuania, Poland, Russia and Sweden. In addition, Belarus, the Czech Republic, Norway, Slovakia and Ukraine, all have waterways which drain into the Baltic Sea. The population of the drainage basin is 85 million with 45% living in Poland (Figure 3-12).

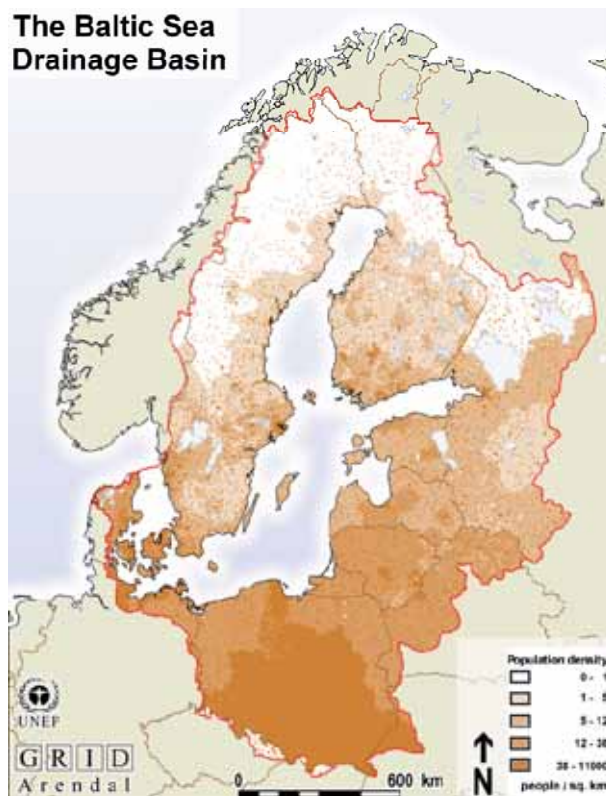

Figure 3-12. Population density of the Baltic Sea drainage basin region (Grid-Arendal, 2001).

The largest source of phosphorus by far is from Poland due to extensive runoff from intensive agricultural activities and the high population in this part of the drainage basin. The flows from Poland make up about 30% of the total (Table 3-15 and Figure 3-13).

Table 3-15. Riverine, coastal and direct point and diffuse source inputs of P_{total} of 9 countries in 1994-2006 as totals, t/a (Helcom, 2008).

COUNTRY	1994	1995	1996	1997	1998	1999	2000	2001	2002	2003	2004	2005	2006
Denmark	3621.4	2588.1	1602.7	1488.9	2039.0	2214.0	1864.9	1715.0	2098.0	1198.0	1578.3	1717.7	1468.1
Estonia	1425.9	1316.0	735.6	937.5	1240.7	1748.1	965.0	1346.0	1237.4	1023.4	1501.6	1763.0	785.7
Finland	3507.5	3586.9	3194.8	3040.4	4475.1	3437.6	4835.4	3407.0	2239.3	2001.5	3434.9	3382.4	3488.2
Germany	955.4	685.9	447.2	417.9	716.9	567.9	486.4	457.9	751.7	345.6	418.4	387.9	487.1
Latvia	2205.2	2060.5	1009.6	1471.1	2918.7	2148.6	2207.0	2266.6	1862.9	1797.2	3178.2	2738.4	2796.3
Lithuania	3985.8	1372.7	1496.1	2418.0	3228.1	3611.8	1950.4	2733.7	3073.1	1324.1	2565.3	1358.8	1241.3
Poland	13344.9	14265.4	13461.9	16882.8	16833.9	14740.1	12555.4	13589.5	12957.5	8458.4	9746.0	8910.7	10163.6
Russia	4192.0	9263.0	4187.7	3810.6	4048.8	3866.0	6196.1	4376.7	5956.8	4746.1	7429.5	7565.3	4071.6
Sweden	4296.9	4720.2	2438.7	4061.2	4773.5	4734.5	4945.3	4327.2	3154.6	2249.5	3341.6	3552.4	3712.4
Total Baltic	37534.9	39858.8	28574.3	34528.5	40274.6	37068.8	36005.9	34219.5	33331.2	23143.9	33193.8	31376.5	28214.3

It can also be seen that the phosphorus loading is closely related to the level of water runoff. This demonstrates the central role of erosion in the net loss of phosphorus from farming areas. The runoff levels are continuing without any significant decrease. Point-source improvements such as sewage treatment plants and industries are receiving major attention but agriculture losses are apparently more challenging.

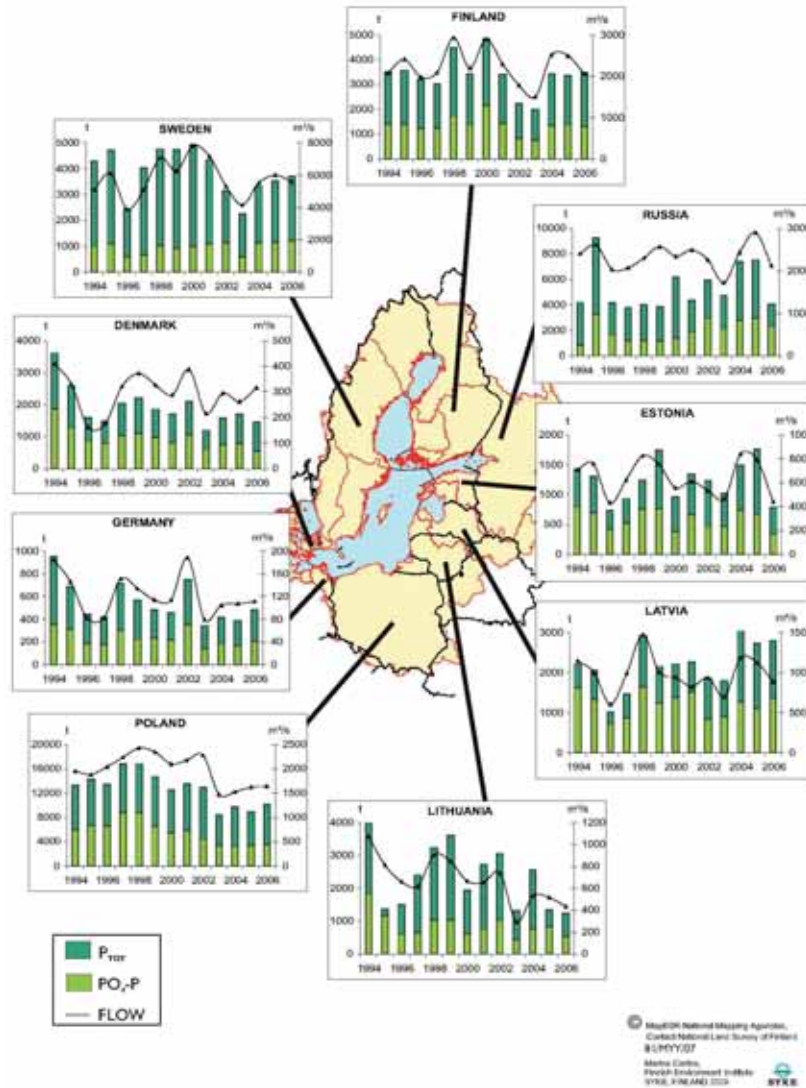

Figure 3-13. Direct inputs of phosphorus (P_{total} , $PO_4\text{-P}$) in t/a to the Baltic Sea showing the river, coastal and direct point and diffuse source flows in m^3/s of 1994-2006 of the nine countries (Note variable scales in the graphs).

The Baltic functions essentially as a closed inland sea with a narrow and shallow opening to the North Sea. This means that there is a net accumulation of phosphorus in the sediments. Depending on meteorological events this internal loading continues to aggravate the eutrophication situation. Almost every summer the Baltic Proper area develops massive cyanobacterial blooms (Figure 3-14) which are toxic to mammals. These blue green algae can fix gaseous nitrogen and thus are not nitrogen limited. The phosphate available in the open sea is thus the determining factor in the size of the annual blooms. In general the phosphorus situation is worse in the Baltic Proper. Winter dissolved inorganic phosphorus (DIP) which is the best trend indicator, is highest in the that area (Figure 3-15).

Number of days with cyanobacteria observations during the period 1997-2009

SMHI

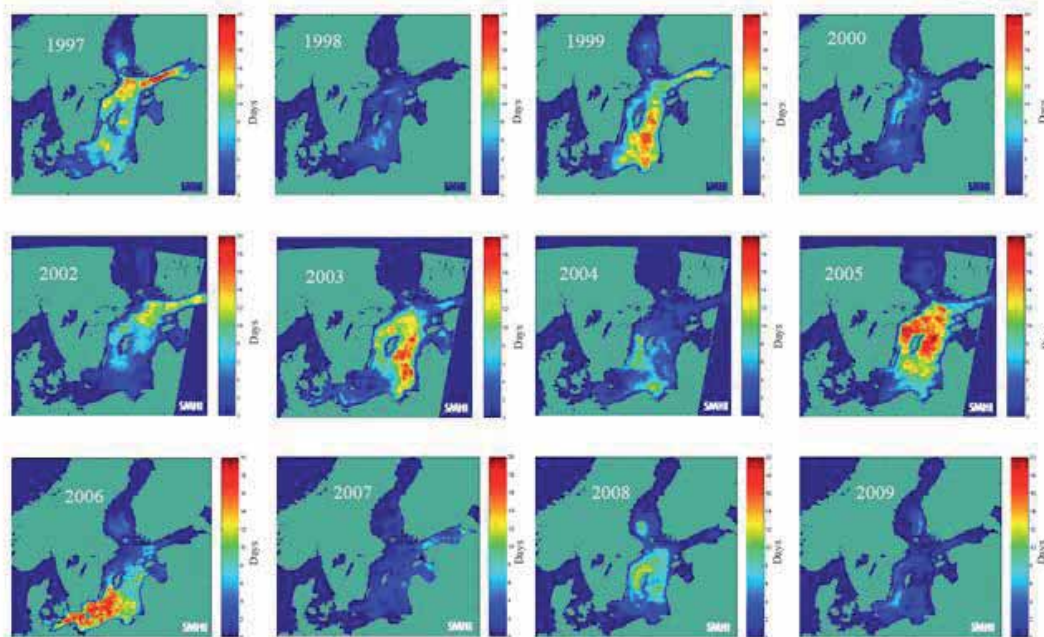

Figure 3-14. Number days with cyanobacterial blooms during 1997-2009 (Helcom, 2009).

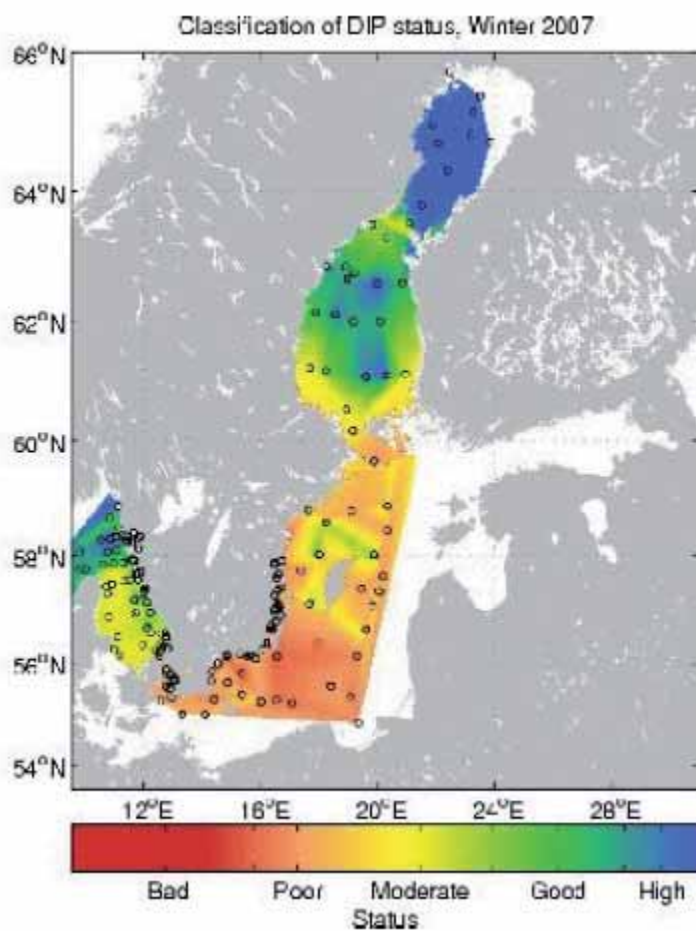

Figure 3-15. Ecological quality assessment of the winter dissolved phosphate (DIP) concentrations in the Baltic (Helcom, 2008).

Between 1997 and 2001 the use of phosphorus fertilizer decreased in Germany, Finland, Sweden and Denmark but was on the increase in Poland, Latvia, Estonia and Lithuania (Figure 3-16).

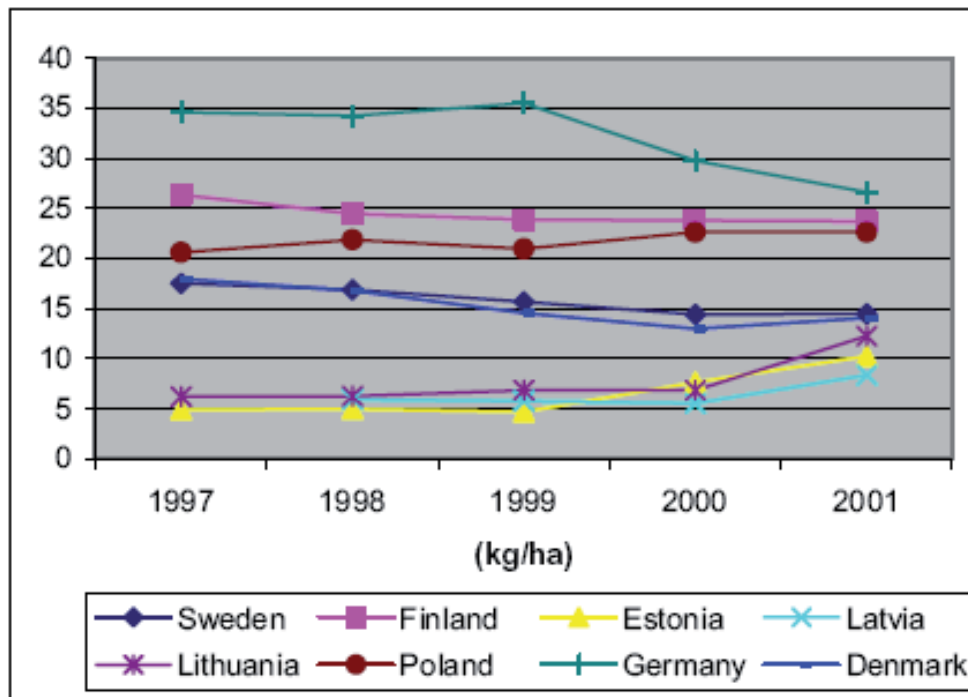

Figure 3-16. Phosphate (P_2O_5) in phosphorus fertilizer per hectare arable land in the EU countries around the Baltic Sea in 1997-2001 (Eurostat web site).

The following list provides some indication of what is being discussed and done in the Baltic Sea Region to reduce losses of phosphorus and nitrogen from agriculture (Helcom, 2007):

Land use

- Converting arable land to extensive grassland

Soil management

- Plant cover in winter
- Minimal cultivation systems
- Cultivate land for crop establishment in spring rather than autumn
- Catch crops
- Ploughing of ley on sandy soils in autumn
- Controlled sub-surface drainage

Fertiliser and manure management

- Nutrient balances
- Conversion from conventional to organic production
- Reduced fertilisation
- Application techniques of manure
- Integration of **fertiliser** and manure nutrient supply
- Liming
- Avoiding the application of **fertilisers** and manure to high-risk areas
- Avoiding the spreading of **fertilisers** and manure during high-risk periods
- Increasing the capacity of manure storage
- Transporting manure to neighbouring farms

- Slurry separation
- Composting solid manure
- Biogas production
- Pelletisation of manure
- Incineration of poultry litter

Animal feeding

- Adopting phase feeding of livestock
- Reducing dietary nitrogen and phosphorus intakes
- Phytase supplementation
- Wet feed and fermentation

Farm infrastructure

- Establishment of wetlands
- Buffer zones

Other

- Effective purification of runoff waters
- Systematic on-farm individual advice

Note that many but not all of these recommendations are considered productive by the authors of the present report. In Chapters 4 and 5, for instance, we explain why organic agriculture is not *per se* contributing to a more efficient use of phosphorus. This applies also to manure treatment (composting, biogas production, pelletisation, incineration). Treatment could turn manure into a handier product, but does not change the phosphorus content, and nor is it a guarantee for full recycling. Finally, wetlands and buffer zones can indeed reduce downstream phosphorus concentrations, but do not support recycling unless their vegetation is regularly harvested and reused as a fertilizer resource.

3.6.5 Ireland and Spain: similar but different

Member states may have comparable phosphorus surpluses but their impact on the phosphorus concentrations in surface water may be different. In addition, the supposed impact of this phosphorus on water quality may be different, and so are the measures that are deemed necessary to address the problem. This can be illustrated by comparing Ireland and Spain. The phosphorus surpluses per unit area in these countries (OECD, 2010a) are 6 and 9 kg P per ha per year respectively and are thus quite similar.

The surplus in Ireland is associated with an estimated average loss to surface water of 2-3 kg P per ha, losses being greater from arable land than from pastures (McGarrigle, 2009). Fortunately, around 90% of the land in Ireland is permanently covered with grassland and annual precipitation usually exceeds 1000 mm. Consequently, phosphorus concentrations in surface water are relatively low and over 70% of the rivers in Ireland are thus considered unpolluted (Richards *et al.*, 2009). Nevertheless, 15% of the groundwater bodies and 22% of the estuaries are considered eutrophic. This appears to be the direct result of a relatively stringent definition, assuming that the ecological quality is under pressure from phosphorus concentrations of as low as 0.015-0.030 mg P per liter (Richards *et al.*, 2009). Drastic adjustments to Irish agriculture are hence considered necessary to comply with the Water Framework Directive (European Commission, 2000b). These adjustments will not just pertain to the pig sector linked to arable soils in the north (Fealy and Schröder, 2008), but also to the dairy sector (Richards *et al.*, 2009).

Land use in Spain is dominated by arable farming and permanent cultures. As in Ireland, intensive livestock holdings are not evenly distributed over the country but are concentrated, mainly in the north-east. This causes local manure-phosphorus surpluses (Berenguer *et al.*, 2008). Annual rainfall ranges from over 1000 mm in the north-west to less than 200 mm in the south-east. Rainfall is extremely irregularly distributed in space and time and is sometimes concentrated in just a few storms. As a consequence, erosion is a major problem in Spain with occasional soil losses

of over 50 tonnes per hectare (Garcia-Ruiz, 2010). Erosion problems are aggravated by the ongoing extension of cereal, olive and almond production sites on sloping land. Land abandonment may increase erosion risks as well wherever rainfall is too low to support a spontaneous re-establishment of the natural vegetation. The loss of phosphorus that will undoubtedly be associated with this erosion (consult section 4.2.3), is not as intensively monitored as it is in Ireland. The criterion for eutrophication is set at 0.15 mg (reactive) P per liter - ten times as high as in Ireland. Nevertheless, of all rivers, reservoirs and lakes, 60%, 70% and 80%, respectively, are considered eutrophic and thus require action (Alvarez-Cobelas *et al.*, 1992). The major concern of Spain, however, is currently not water quality but the management of water quantities.

3.6.6 Synthesis of the case studies

The European Union as a whole is anything but self-sufficient as far as phosphorus is concerned. The food production of each of the 500 million European citizens is fully based on an annual import of, on average, 3 kg P per person per year from countries outside the EU27. However, within the EU large differences exist between individual countries. We will briefly focus on some aspects dealing with the flows of phosphorus in agriculture and society.

Import of phosphorus

The analysis of phosphorus flows made by Richards and Dawson (2008) made clear that the phosphorus supply in the EU27 is highly dependent on imports, either in more or less pure form (fertilizer in the form of finished products, phosphoric acid or phosphate rock, and feed additives,) or in the form of traded goods containing phosphorus, such as food, feed or feed concentrates (e.g. the import of soya, oil cakes etc.). For the EU27 as a whole the import of P is dominated by fertilizer, representing roughly 70% of the total phosphorus import.

For individual countries, however, the picture is more shaded. We illustrate this with the in-depth case studies for the Netherlands and Switzerland, two countries for which an almost complete picture of the phosphorus flows exist. For the Netherlands the import of fertilizer is only 20% of the national phosphorus import, whereas import with feed and feed-additives amounts to more than 50%. In Switzerland, however, the import of phosphorus with fertilizer and feed is more or less in balance (both around 35%). In both cases, the complement of 30% includes the phosphorus contained in imported food and non-food products.

Surplus and accumulation of P

The total national accumulation for Switzerland amounts to in total 12.6 Mkg of P. Around 28% of this is accumulating in agricultural soils, which corresponds to 3-4 kg of P/a. In the Netherlands the national accumulation of phosphorus is much larger (around 60 Mkg of P) and dominated by the annual accumulation in agricultural soils (around 30 Mkg of P). On a area basis this corresponds with around 15 kg of P/ha annually. This is a relatively high value compared to other EU countries such as Ireland and Spain, with soil surpluses of 6 and 9 kg P/ha, respectively. However, concentrations of livestock lead to much higher local phosphorus surpluses in Spain and Ireland as well, comparable with the situation in The Netherlands.

Environmental impact

In the Netherlands almost 7 Mkg of P (9% of the national surplus) ends up in the surface water. Roughly 50% of it originates directly from agriculture (diffuse emissions) and the other 50% from the effluent of waste water treatment plants (point emissions). The same pattern holds for Switzerland. Of the total loss of around 2 Mkg to surface water, 50% originates from agriculture and 50% from the waste water treatment plants.

For the Baltic region the environmental problems associated with the use of phosphorus are especially manifest in the Baltic Sea area. These problems, in particular algal blooms, are predominantly caused by run-off and erosion. The largest source come from Poland, as a consequence of its relatively intensive agricultural activities and its large population.

In Ireland estimated diffuse losses from agricultural land are considerable, amounting to 2-3 kg P per ha. However, due to a precipitation of more than 1,000 mm and also because most of the land is permanently covered with grassland, the resulting P-concentration in surface water is relatively low. In Spain especially erosion is considered as the main factor which causes phosphorus losses.

The waste sector and recycling of phosphorus

Switzerland and the Netherlands have similarities and differences in the way they recycle phosphorus. Both countries have considerable internal flows of phosphorus taking place within their agricultural sectors. Only a fraction of these flows leaves the agricultural system in the form of food. Phosphorus entering Swiss households in the form of food amounts to around 7.5 Mkg of P annually. Only 24% of this amount is reused in agriculture, half of it as sewage sludge and the other half as compost. More than 90% of the sewage sludge in Switzerland is incinerated and the resulting ashes are not recycled but end up in a deposit.

The internal flows within the agricultural sector in The Netherlands are even larger and the phosphorus in food entering the Dutch households is nearly 20 Mkg. In this case the return flow from society to agriculture is even more negligible, as not more than 10% (2 Mkg of P) is recycled to agriculture or private gardens. Agriculture reuse of sewage sludge is banned in The Netherlands and sludge is thus incinerated. In addition a significant proportion of slaughter waste (especially the bones rich in P) are exported for non-agricultural purposes.

3.7 Conclusion

Only about one-fifth of the mined phosphorus is eventually eaten. Each step between mine and fork is associated with losses (Table 3-16). Losses do not always reflect emissions into water bodies because a fraction of it is stored in phosphogypsum stock piles, in agricultural soils, in landfills, in ash deposits or in construction materials. Although not lost in the sense of dissipation, potential re-use is limited for technical and economical reasons. A considerable fraction of the difference between mined phosphorus and ingested phosphorus, however, is truly lost to water bodies leading to eutrophication and loss of quality. Losses should also be reduced because the use of phosphorus is linked to other unwanted environmental effects, such as the loss of landscape quality, green house gas emissions, excessive fresh water consumption, radio-activity, cadmium accumulation and fluorine emission.

Pathways of phosphorus loss and the character of environmental effects differ considerably from country to country. That is why strategies to abate losses and improve the use efficiency of phosphorus must differ as well.

Table 3-16. Conversion efficiencies (%) 'from mine to fork' per separate step and integrated over the entire trajectory.

	deposits	mined rock	beneficiated rock	finished fertilizer	food from farm	ingested by humans
mining	100	82				
rock processing		100	84			
fertilizer production			100	95		
agricultural production				100	70	
food processing, distribution, consumption					100	40
from mining to consumption	100	82	69	65	46	19

4. Sustainable strategies for improving phosphorus use management

This chapter outlines sustainable response strategies for improving phosphorus use efficiency and recovery in the entire food production and consumption chain. There is no single solution which can bring about a sustainable phosphorus cycle. Rather, this will involve an integrated strategy that seeks to increase phosphorus use efficiency throughout the food system, and simultaneously seeks to recover unavoidable phosphorus losses. A recent global phosphorus scenario analysis (Figure 4-1), indicates that meeting the world's increasing long-term phosphorus demand would probably require demand management measures to reduce business-as-usual demand by an order of 70%, and the remaining 30% could be met through high recovery rates of phosphorus from all sources.

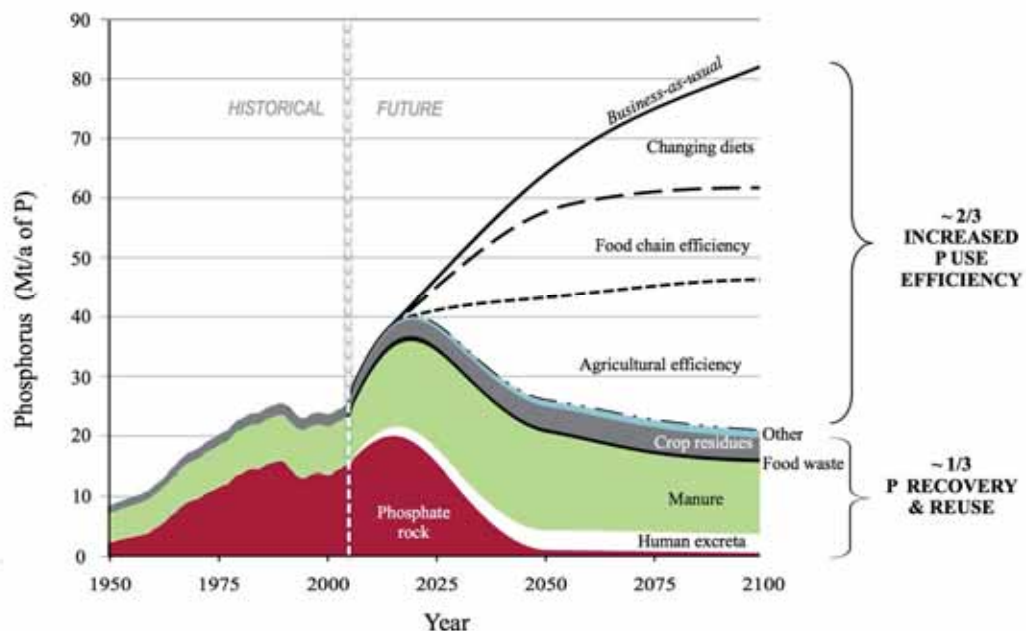

Figure 4-1. A sustainable scenario for meeting long-term future phosphorus demand through phosphorus use efficiency and recovery (Redrawn from Cordell, 2009b).

While section 3.1-3.4 identified phosphorus losses from mine to field to fork, the following sections identify opportunities for improving phosphorus use efficiency and increasing recovery throughout the food production and consumption chain, including during: mining and fertiliser production, fertiliser and manure application, cropping, food production, food consumption - excreta.

4.1 Reducing mining losses and increasing recovery

The mining and extraction processes are summarized in the following diagram (Figure 4-2). Each step involves potential losses of material from the process of aqueous beneficiation of the ore, through to the addition of sulphuric acid which produces phosphoric acid.

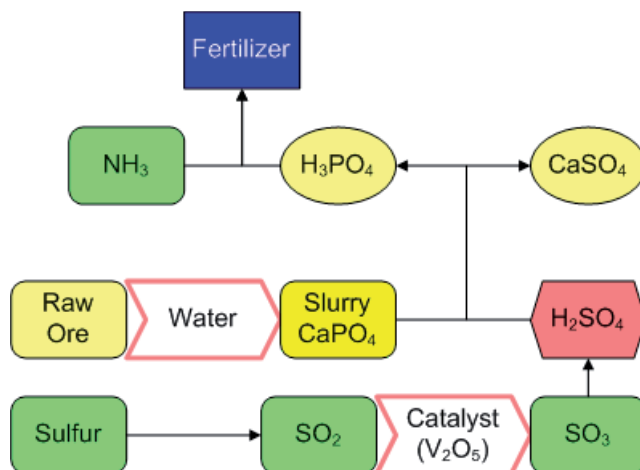

Figure 4-2. The different steps in deriving products from phosphate rock. <http://phosphatemin.org/a.html>.

Exactly what efficiency improvements the mining and processing industries can achieve are not well known. It has been estimated that 33% of the P is lost through mining, processing, and other metallurgical operations (Kippenberger, 2001). An additional 10% is lost in transportation and handling (Lauriente, 2003). The overall mining efficiency in China, for example, was only 49% in 2000 (CNCIC, 2002).

Nor has there been up to now much incentive to improve process and handling efficiencies. Even if the market and governance systems demand higher yields, there will be a physical limit to what is possible, placing even greater demands on the use efficiency in agriculture and on reuse strategies to economize on the downstream losses.

Although often overlooked from a sustainable phosphorus use perspective, there are significant opportunities for efficiency gains in the mining and fertiliser sector. The mining and fertiliser losses identified in sections 3.1-3.3 can be reduced through improved technology and management at all steps of the material flow.

Other potential sustainable measures in the phosphate mining and fertiliser sector include (UNEP, 2001; Cordell, 2010):

- Minimising onsite environmental and social impacts (e.g. pollution/breaching of tailings dams)
- Investing in renewable, that is recovery-based, sources of phosphorus that can be sold on the market
- Investing in efficient technologies for extraction. For example, the Belgian company Ecophos (www.ecophos.com) claims the development of a new extraction process which can be used for low grade phosphate rock (down to 20% P_2O_5). Also investment in new technologies for cadmium removal.
- Developing efficient and safe techniques to recover phosphorus from phosphogypsum heaps
- Contributing to mitigating downstream impacts, in accordance with Extended Producer Responsibility Frameworks.

4.2 Efficiency in agriculture

4.2.1 Introduction

This section reviews a range of potential measures to improve phosphorus use efficiency. Both the nature of current inefficiencies and opportunities for improvement are identified and discussed. The analysis starts with agricultural land use and the losses to which tilled soils in particular are exposed. Subsequently, phosphorus flows crossing the boundaries of an individual field are investigated. Finally, the livestock component is addressed together with the attendant measures needed for improved phosphorus use efficiency in farms that involve both crops and animals.

4.2.2 Optimising land use

Agriculture is mainly an outdoor activity and growing conditions are thus not always fully under control. Consequently, some losses of phosphorus are inevitable even if soils, crops and fertilizers are managed according to the best available techniques. On a global scale these inevitable losses from fields will be more extensive, the larger the area under agriculture and the higher the phosphorus content of the soil. It is therefore imperative to find the optimal balance between achieving sufficiently high productivity per hectare, limiting land demand but requiring a sufficient phosphorus content, and keeping phosphorus contents in soils low to minimize losses per hectare, even if it will require more land to produce the same volume of food on phosphorus deficient soils. The composition of the human diet is also a determinant of land use and associated phosphorus losses, since more land is generally needed to produce meat and dairy products than plant-based products (Gerben-Leenes and Nonhebel, 2002). The same holds for additional land claims to produce bio energy crops (Smit *et al.*, 2009).

4.2.3 Preventing erosion

Phosphorus is not only depleted from soils by growing crops but also by erosion. Erosion includes water erosion, wind erosion, tillage erosion and the erosion resulting from soil particles adhering to lifted crops such as sugar beets (Verheijen *et al.*, 2009). Louwagie *et al.* (2009) report that of the total European land area 12 and 4 per cent respectively are exposed to water erosion and wind erosion. Water erosion is above all a problem in southern Spain, western Italy and Greece. The extent of the problem is determined by the slope gradient, the slope length, rainfall and rainfall distribution. Wind erosion is mainly an issue in a belt of sandy soils stretching from the south of England via The Netherlands, Denmark and Northern Germany to Poland. Both types of erosion predominantly occur in tilled fields, particularly when crop cultivation leaves the soil uncovered for longer periods. Examples of crops for which this is a problem include potatoes, sugar beets, maize, and sunflower (Louwagie *et al.*, 2009).

Quantifying the phosphorus loss associated with erosion is fraught with difficulty. Firstly, eroded material is not really lost as long as it is deposited and subsequently accounted for as an input in the receiving agricultural area. Secondly, quantification is also troublesome because data sets tend to be derived from experiments in regions where erosion is an issue. Up-scaling these data to a larger area including the more flat regions, in particular those with a permanent cover in the form of grassland, is an inaccurate process. Estimates of the amounts of soil lost via erosion range from 5 to 40 tons per hectare per year for an average European arable soil (Verheijen *et al.*, 2009) to 10 tons per hectare at most for the major part of Europe (Louwagie *et al.*, 2009). Thirdly, it is even more complicated to translate these losses of soil into phosphorus losses as that requires knowledge of the phosphorus concentrations in the eroded material. A limited amount of material can be associated with a high phosphorus loss, as the light fraction ('clay') is more easily eroded and tends to contain more phosphorus than the coarse fraction (Quinton, 2002). Data provided in Hooda *et al.* (2000) suggest that phosphorus concentrations in an average European soil range between 0.05 and 0.10 per cent. This implies that erosion of 10 tons of soil per hectare per year represents an annual loss of 5-10 kg P per hectare. This is a considerable amount but less than the numbers given in Smil (2000) and Ruttenberg (2003) who estimate that at a global scale 20-30 Mt/a of P is lost via erosion. This would be equivalent to an annual loss of 15-20 kg P per hectare, assuming that erosion from land other than arable land is negligible. More recently Liu *et al.* (2008) provide data suggesting that approximately 13, 8 and 3 kg P per hectare respectively are lost annually from arable soils, overgrazed pastures and ordinary pastures, respectively.

Regardless of the exact quantity of phosphorus lost, the magnitude of the loss justifies measures to address the problem. If eutrophication can start from a phosphorus concentration in water of around 0.10 mg total P per liter (Correll, 1998), measures should be imposed to prevent more than 0.2-0.6 kg P per hectare being eroded by a typical European precipitation surplus of 200-600 mm.

Many erosion abatement measures are directed at improving the infiltration capacity of soils to minimize run-off. They include: minimum tillage without removal of crop residues (mulching), ridge tillage, sub-soiling, terracing, contour ploughing, buffer stripping, cover crop establishment, conversion of arable land into grassland, agro-forestry, or complete reforestation (Louwagie *et al.*, 2009). Common European bans on the spreading of fertilizers

and manures on frozen or snow-covered land (De Clercq *et al.*, 2001), will by themselves, or combined with a mandatory incorporation of manure on bare soils, also reduce the risk of erosion and phosphorus loss, including the loss that may occur via the less visible process of surface runoff from seemingly flat but water-logged fields.

Erosion results in a need for additional phosphorus inputs if the fertility of soils is to be maintained, but might eventually also lead to their complete abandonment. This may in turn result in the reclamation of new areas that often need large phosphorus inputs before they can be at all productive. Generally, statistics on net land use do not reveal this turnover rate due to soil degradation, let alone its implications for phosphorus demand.

4.2.4 Maintaining soil quality

The presence of phosphorus in a soil is not a guarantee of its productiveness. Soils must have many other characteristics to ensure that this phosphorus is available to crops and that it can be efficiently utilized, once taken up. This complex set of characteristics is called soil quality (Beare *et al.*, 1999). It encompasses aspects such as having the right pH, organic matter content, resilience against physical and biological perturbations, and fertility-enhancing biodiversity. However, too much focus on each of these aspects in isolation (Giller *et al.*, 1997; Letey *et al.*, 2003) can harm rather than improve the use efficiency of resources. Returning crop residues to the soil, for instance, may stimulate soil life and thus improve soil structure, but it means that these residues are no longer available as feed or fuel. The concept of soil quality is therefore still a subject of fierce debate (Giller *et al.*, 1997; Letey *et al.*, 2003). Regardless of this ongoing debate, it is absolutely safe to say that more phosphorus will be needed to attain a certain yield if the pH of a soil is suboptimal, if a soil contains too little or too much water, or if soil compaction hampers root growth. Optimising soil quality can therefore unlock the available phosphorus, reduce the need for fertilizer phosphorus supplements, and improve the use efficiency of phosphorus.

4.2.5 Improving fertilizer recommendations

Plants will not grow if their roots cannot find phosphorus in the soil (Laegreid *et al.*, 1999). Yields on about two-thirds of the global farmland are limited by insufficient soil phosphorus levels (Cakmak, 2002). Hence, most farmers apply phosphorus in the form of manures, composts, bio-solids or mineral fertilizer, just to compensate for the phosphorus that is exported in produce (that is in crops, meat, eggs, milk, wool, etc.). In Western Europe more phosphorus is generally added than is exported from farms. This practice is to some extent based on unjustified fears of yield penalties but may also be based on sound economic considerations (Neeteson *et al.*, 2006). Crop yields, particularly for shallow rooting species grown in rows, are maximized if the soil phosphorus status is high. As the concentration of dissolved phosphorus in the soil water is low (Hilton *et al.*, 2010), relatively little phosphorus is acquired via the water that plants take up for their transpiration. This implies that crops must capture most of their phosphorus via interception - that is, via growing roots scavenging the surrounding soil volume (Hilton *et al.*, 2010). Annual crops can be short of phosphorus, especially when young. The daily uptake of phosphorus in kilograms per hectare may be low when plants are young, but the daily uptake demand per unit of root length is relatively high then, as the root proliferation is just starting (Figure 4-3). Under these circumstances only a high phosphorus status will facilitate a sufficient diffusion of phosphorus to the root surface. Unfortunately, large amounts of phosphorus are needed to improve the phosphorus status compared to the annual off-take rate of phosphorus. This means that even farmers strictly following guidelines for phosphorus fertilization must accumulate considerable amounts of phosphorus to reach the required status. Römer (2009) concludes that 70-80 per cent of the soils in European countries show average or high-level phosphorus status. He states that at these locations it would be possible to maintain yields for several years without phosphorus fertilisation. In Germany, as in most other European countries, a recommended range of soil fertility applies. Römer (2009) concludes that within this recommended range, approximately 500 kg P per hectare would be needed to bring the soil from the lowest to the highest recommended fertility level. This amount is equivalent to the phosphorus taken off by crops in around 20 years. He calls for a critical revision of the recommendation system to ensure a more efficient use of phosphorus fertilizer. In line with this observation, Neyroud and Lischer (2003) and Jordan-Meille (2009) conclude that the soil tests used for the assessment of available phosphorus in soils across Europe are anything but uniform and appear to give different recommendations

for the same soil and crop types. Climatic differences cannot always explain the observed discrepancies and this suggests that some recommendations have been tainted by a risk-averse attitude.

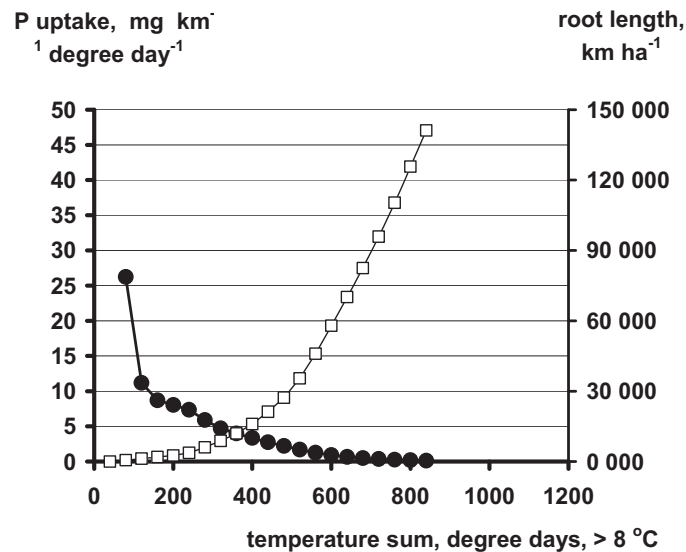

Figure 4-3. The summed root length of a maize crop (\square) and the phosphorus uptake requirement per unit root length (\bullet) in the course of the growing season (expressed as degree-days above 8 °C) (after Schröder, 1999).

The match between demand and supply can be strongly improved by positioning mineral fertilizers close to the expanding root system ('starters') (Stone, 2000a; Stone, 2000b; Ma and Kalb, 2006). The utilization of phosphorus in manures can also benefit from such a positioning close to the anticipated crop row (Sawyer *et al.*, 1991; Schröder *et al.*, 1997). In more general terms one could say that phosphorus utilization can be improved if uniform blanket dressings were replaced by differentiated applications, tuned to the specific needs of individual crops and fields, of patches within fields, of particular positions within the bulk soil, and of periods within seasons. Farming practices characterized by fixed 'insurance' shots of phosphorus, should be replaced by more reasoned 'precision farming' applications.

There is an obvious need for a correct assessment of the true phosphorus requirement of soils and a better knowledge of the phosphorus-supplying ability of the various types of inputs. As for the true phosphorus requirement of soils, phosphorus should not be applied on a routine basis. Applications should instead be determined by the amounts of plant-available phosphorus. These amounts depend on earlier inputs and exports in crop produce and on the tendency of some soils, for example those rich in iron or aluminium, to fix phosphorus.

In relation to the ability of inputs to supply phosphorus, there is often a misleading perception among farmers that phosphorus from a purchased bag of mineral fertilizer is more available to crops than phosphorus from organic resources such as manures and other residues. This attitude promotes the use of mineral fertilizer phosphorus supplements. For a long time, the availability of phosphorus from both mineral fertilizers and organic resources has been assessed following the so-called difference method. This method, according to which the phosphorus uptake of a fertilized crop is compared with the phosphorus uptake of an unfertilized control, often shows that less than 25 per cent of the input is recovered in additional phosphorus uptake, suggesting that the remainder is not available (Hilton *et al.*, 2010). However, this method fails to take account of the so-called residual effect due to which the long-term availability resulting from regular applications is close to 100 per cent for mineral fertilizer phosphorus and phosphorus from other sources alike (Sinclair *et al.*, 1993; Syers *et al.*, 2008). The truly 'inevitable' phosphorus loss is therefore relatively low, unless soils are rich in iron and aluminium. 'Inevitable' phosphorus losses can also be high

if growers want to maintain the phosphorus concentration in the bulk soil at an unnecessarily high level, like keeping a colander filled up with water up to its brim (Hilton *et al.*, 2010).

4.2.6 Fertilizer placement methods

As indicated earlier, phosphorus is best applied in the most intensely rooted parts of a soil. According to fertilizer recommendations in The Netherlands, twice as much phosphorus is needed for a similar yield response if the fertilizer is broadcast rather than positioned sub-surface close to seed rows (van Dijk, 2003). It is the combination of the application method of phosphorus containing inputs and the subsequent tillage that determines whether supply and demand spatially match. This has implications for the optimal positioning of inputs in both the vertical and horizontal planes. As far as the vertical aspect is concerned, manure may be positioned too deep for a good utilization of phosphorus in an attempt to reduce losses of ammonia-nitrogen from manure (Schröder, 2005). Shallow incorporation generally seems the right compromise, if only because phosphorus itself may be lost by run-off if left on top of a water-saturated soil. As for the horizontal aspect of placement, proper attention must be given to spreading techniques. Irregular, patchy spreading patterns increase the heterogeneity of the soil fertility. Consequently, some parts of the field may become over-fertilized, whereas other parts may become deficient. Note that grazing may conflict with this recommendation as phosphorus rates via animal droppings will become too high in places. Local concentrations of phosphorus may be increased where animals tend to cluster in search of shelter or water. This warning about the patchy distribution of manure must not be seen as a general argument for a uniform distribution. In crops with a wide row distance, for instance, yields and phosphorus utilization may benefit from techniques that apply manure close to the anticipated position of rows (Schröder *et al.*, 1997).

4.2.7 Improving crop genotypes and promoting mycorrhizas

When plants are young, root length can be the limiting factor in the acquisition of soil phosphorus. Genotypic differences in the way a plant allocates its assimilates to aboveground parts or roots, and differences in specific root length, differences in branching and differences in the distribution of a given length of roots through the soil profile may all affect the ability of plants to absorb phosphorus (de Willigen and van Noordwijk, 1987). Consequently, the supply of soil phosphorus needed to yield a certain phosphorus uptake, and consequent phosphorus uptake efficiency, could be different. Lack of sufficient phosphorus uptake capacity seems to play a much smaller role with perennials because their roots exploit the total soil volume more or less permanently. Growing perennial instead of annual wheat could thus be a promising strategy (Scheinost *et al.*, 2001). Phosphorus use efficiency of crops is, however, not just determined by uptake efficiency but also by the utilization inside the plant - that is, by the production of the economically relevant crop component per unit phosphorus taken up. It is difficult to say a priori whether there is sufficient genotypic variation of both traits (separately, but more importantly, in combination (Parentoni and Lopes de Souza Junior, 2008)), to justify breeding programs explicitly directed at the improvement of phosphorus use efficiency. Decisions on investments in breeding research should be based on the value for money that is to be gained via alternative investments - that is on the likely improvements in soil and crop management. Simic *et al.* (2009), for instance, found that genotype x phosphorus fertilizer interactions of maize in bred lines were only significant if the pH level of a soil had dropped to an extremely low value. Liming may thus be more cost-effective than a breeding program.

Crops can also extend their uptake capacity through a symbiosis with beneficial fungi. Associations between crops and these so-called arbuscular mycorrhizal (AM) fungi can thus improve the availability of soil phosphorus (Bittman *et al.*, 2006). Grant *et al.* (2005) attribute this to an effectively enlarged root system rather than to an enhanced solubility of phosphorus due to the fungi. Their review shows, however, that carbon costs are involved in hosting AM fungi. However, Smith & Smith (2010) have recently challenged this popular idea of 'carbon drain' and hypothesize that a negative response to AM may be attributable to the inability of plants to take up P through their own roots once they are infected by AM.

Crops manage to suppress AM fungi when the association does not pay off due to a high phosphorus soil status. Even when the soil phosphorus status is low, crop rotation and tillage practices do not always support a sufficient presence of AM fungi. This may require the adoption of minimum tillage techniques, seed inoculation or adjustments to the crop rotation (Grant *et al.*, 2005).

The use of LPA mutants (cereals with a lower content of phytic acid) for food and animal feed, may be another promising strategy. Lott *et al.* (2009) conclude that a widespread use of these mutants could lead to considerable reductions in global phosphorus fertilizer requirements.

4.2.8 Adjusting inputs to outputs

In the preceding sections the focus has been on phosphorus inputs and their availability to crops. Obviously, phosphorus surplus and use efficiency are also determined by the phosphorus output. The amount of phosphorus that eventually leaves the farm via the gate may be easily overestimated. The phosphorus export from dairy farms (including exported animals), for instance, amounts to approximately 1.2 kg P per ton of milk (Beukeboom, 1996), implying that a dairy farm producing 10,000 liters per hectare would, on average, need an annual compensation via fertilizers or feed concentrates of only 12 kg P per hectare. Note that grasslands of dairy farms may take up 45 kg P per hectare or more but this demand can largely be provided for by internally re-circulated manure. In non-livestock farms the phosphorus export with crops amounts to 3 kg and 7 kg P per ton fresh weight for cereals and rape seed, respectively, and to approximately 0.4 kg P per ton for sugar beet, potatoes and vegetables (Beukeboom, 1996; Ehlert *et al.*, 2006). Consequently, the annual compensation needed for this export is around 25 kg P per hectare for a typical arable farm and less than 15 kg P per hectare for horticultural farms (Neeteson *et al.*, 2006).

Circumstantial evidence for a structural overestimation of the amounts of phosphorus exported in produce, and an underestimation of the amounts of phosphorus available from the various types of inputs, is reflected by the ongoing increase of the phosphorus status of many soils in Western Europe (Tunney *et al.*, 1997; Römer, 2009; Reijneveld *et al.*, 2010). This suggests that phosphorus inputs can be reduced and that a much better balance with outputs can be achieved. The over-application of phosphorus may also stem from the inexpensive option of dumping phosphorus-containing residues (e.g. manure) on nearby fields instead of returning them to the remote fields where these residues originated from (see next section).

4.2.9 Exporting manure

Any phosphorus export justifies phosphorus inputs. Phosphorus can leave the farm in the form of crops, milk, eggs, meat and wool, but also in the form of manure. As a matter of fact this has become common practice in many parts of Europe where formerly mixed farms have been split up into farms specialising in either crop production or landless livestock production (Fealy and Schröder, 2008). From a purely theoretical phosphorus use efficiency point of view, it does not matter whether livestock are fed home-produced feeds or imported feeds as long as the phosphorus that is not retained in marketable products - that is, the phosphorus in manure, returns to the land where the feed originates from. The positive relationship between regional livestock densities and phosphorus soil surpluses (as observed, for example, in The Netherlands, Flanders, Brittany and the Po Valley (De Clercq *et al.*, 2001)) shows, however, that in reality such a perfect recycling option is complicated by economic and energetic considerations (Fealy and Schröder, 2008). Consequently, soils generally accumulate phosphorus in regions with a high livestock density, whereas soils may become phosphorus depleted in regions where the feed originates from, unless they are supplemented with mineral fertilizer phosphorus. A more even distribution of livestock over the area where the feed is produced could thus contribute to a more efficient use of phosphorus. Note that even in a mixed farm, such an even distribution is often difficult as nearby fields tend to receive more manure than remote fields, and hence more phosphorus (Vanlauwe *et al.*, 2007).

In regions with manure surpluses there may be incentives to over-apply manure phosphorus even on stockless farms. Horticultural farms, for instance, are inclined to supply their need for organic matter and nitrogen with 'free'

excess manure from neighbouring livestock farms. Due to the relatively low nitrogen-to-phosphorus ratio and organic matter-to-phosphorus ratio, this may easily lead to phosphorus accumulation (Schröder, 2005). This can only be avoided by complementing rotations with crops supplying organic matter and nitrogen, such as cereals or legumes, notwithstanding their lower profitability. Farms in need of nitrogen rather than phosphorus could still use manures without the risk of phosphorus accumulation, if they were only to use the 'liquid' fraction resulting from manure slurry separation. The associated 'solid' fraction, rich in phosphorus, is less bulky and can thus be more easily exported to remote farms in need of phosphorus (Birkmose, 2009; Schröder and Verloop, 2010).

4.2.10 Adjusting livestock diets

The previous section argued that reducing livestock numbers to the locally available land is one measure which will help achieve a better balance of phosphorus inputs and outputs. Reducing phosphorus excretion per animal can have a similar result. The limitations and opportunities are addressed in the present section.

The ability of mammals, non-ruminants in particular, to absorb phosphorus from feed is limited. To avoid production losses due to temporary phosphorus deficiencies, livestock farmers in industrialized countries therefore select feed stocks with naturally high phosphorus concentrations or even add phosphorus salts to feed. Globally, five per cent of phosphorus demand is for feed additives - that is, approximately 1 Mt/a of P. In the EU27, however, a much larger share is used in feed than common in other parts of the world. The EU27 imports 0.3 Mt/a of P as feed additive, next to 1.6 Mt/a of P imported as raw material for fertilizer production (phosphate rock, phosphoric acid) or as commercial fertilizer (Richards and Dawson, 2008). This increased phosphorus input via feed additives reduces the relative utilization of phosphorus within the animal and results in more manure phosphorus being produced. This can lead to an unwanted local phosphorus soil surplus. The production of manure phosphorus can be reduced not only by reducing livestock numbers but also by what may be a more economically attractive option - , reducing the amounts of manure phosphorus excreted per unit milk or meat produced. Phosphorus excretion can, for instance, be reduced by supplying less feed-phosphorus the older the animal gets (so-called 'phase feeding'), by tuning the daily ration of individual animals to their actual production level, and by the use of artificial enzymes (phytases). Such enzymes can improve the availability of feed-phosphorus (phytate). Dietary adjustments such as these can reduce the throughput of phosphorus in farms and can thereby increase the utilization of phosphorus (Pfeffer *et al.*, 2005; Kies *et al.*, 2006; Steen, 2006).

4.3 Efficiency in food commodity chain

As outlined in section 3.1, substantial losses occur between harvest and food consumption. A substantial fraction of these losses are avoidable and can be reduced through increased efficiency, as outlined below. Some losses are however unavoidable, such as inedible wastes like banana peels or bones from meat and fish. Phosphorus can instead be recovered from these unavoidable wastes through sustainability measures discussed in section 4.4.

The following paragraphs highlight potential efficiency measures at each key stage between harvest and food consumption⁸:

Crop storage, processing and trade - Some of these losses may be avoided through improved management or technical practices, however some losses may persist. Responses to losses associated with meat production range from efficiency measures such as using existing genetic variation for the phosphorus uptake efficiency of animals or variations in the lean meat production per unit phosphorus taken up (Cordell, 2010);

Bulk food processing, storage, trade - Producing food closer to the point of demand - mostly demand from cities - could reduce food waste in addition to energy, water and other resources. Urban and peri-urban agriculture is one example of spatial integration of production, processing and consumption (FAO, 1999);

⁸ Crop residues are covered in the Section 3.4.1 above, and management human excreta is addressed in Section 4.4 below.

Food retailing - reducing spillages or wastage of edible food;

Food storage, preparation and consumption - reducing spillages or wastage of edible food. Improved food and meal planning and shopping to reduce wastage (e.g. spoilage), use of leftovers, and avoid disposal of edible foods (even if their stated used by date has passed) (Lundqvist *et al.*, 2008; Baker *et al.*, 2009). Composting unavoidable waste (including both kitchen and garden and other organic matter around the house) can enable phosphorus in organic matter to be recovered for local reuse.

According to Zhang *et al.* (2003) and Pickford (1977), the global range of solid waste generation is 0.2-3 kg per capita daily. Solid waste generation rates of less than 0.4 kg per capita daily can be applied to some cities of developing countries and a range of 1.0-1.5 kg per capita daily for major cities and tourism areas. Generation rates greater than 2 kg per capita daily are applicable to several cities in the USA (Pickford, 1977; Cook and Kalbermatten, 1982). Since food and other organic wastes are often collected together with other kinds of wastes to be processed and treated at a solid waste treatment plant, several methods of solid waste processing have to be utilized to separate out the food waste in case composting is to be employed to stabilize and produce fertilizer from the wastes. These processing methods include mechanical size reduction and component separation (Polprasert, 2007). Organic waste content in municipal solid waste varies between 60% and 75% and contains about 0.3 to 0.9% P (Mkhabela and Warman, 2005; Johna *et al.*, 2006; Jilani, 2007; de la Cruz *et al.*, 2008).

Taking a world per capita average of 0.35 kg of organic waste per day and 0.5% P content, each person yields about 1.8 g of P per day (0.66 kg P per year). On a global and yearly basis this amounts to about 4.5 Mt of P. This is about the same amount that the body excretes at 1.6 g P per day (0.58 kg P per year).

4.4 Phosphorus recovery and reuse from waste streams

Phosphorus recovery and reuse involves several key stages between collection of the source and final reuse (Figure 4-4). Typical stages of any system might include: collection and storage, sanitizing treatment and phosphorus extraction, transport, possible further refinement and finally productive reuse of phosphorus (IWAR TU-Darmstadt, 2010).



Figure 4-4. Key stages in a phosphorus recovery and reuse system: from source collection through to final reuse.

4.4.1 Drivers for phosphorus recovery

P is removed from waste streams for various reasons. The key drivers are important because they can significantly affect the type of system used. Key drivers for the recovery and reuse of phosphorus include:

Pollution prevention - reducing phosphorus from effluent reaching water bodies where it can lead to eutrophication and in turn algal blooms (Barnard, 2009). For example, the EU Water Framework Directive (European Commission, 2000c) requires that potential pollutants are removed from waste water before it is disposed of in surface water);

Fertilizer value - recovered phosphorus is a renewable fertilizer source that can substitute increasingly scarce mineral phosphates (from phosphate rock). In some instances the recovered phosphorus could become a cost-effective alternative and sold to end users. So far, the major motivation for its production from waste water is the prevention of water pollution (Ostara, 2009);

Industrial phosphorus value - recovered phosphorus can also be used in industrial applications, assuming it is present in a form of sufficient quality (Schipper and Korving, 2009);

Improved wastewater treatment - in some instances phosphorus is recovered during wastewater treatment as struvite under controlled circumstances to prevent unintentional struvite formation which can clog and damage wastewater treatment plants upstream (Britton *et al.*, 2009; Hermann, 2009). Struvite is readily formed in wastewater containing phosphate, magnesium and nitrate. The reaction is magnesium-limited and can be exploited to produce an efficient slow release fertiliser (Uysala *et al.*, 2010).

The fertilizer value of recovered phosphorus will perhaps be the most important future driver, and *food production* in turn is seen as the most important use of the fertilizer as it will be essential to meeting the world's long-term food demand. Other non-food fertilizer uses include the crop production of fibers, bio fuels, oils for detergents, turf, ornamental flowers, private lawns and gardens and public landscaping. In addition to fertilizer use, recovered phosphorus can also be reused in industry, including detergents, and food and feed additives (Global Phosphate Forum, 2010).

The key driver will impact the design of the recovery system. For example, the modern practice of recovering phosphorus from wastewater sludge was predominantly driven by a desire to remove phosphorus from effluent to prevent the nutrient from entering waterways (Driver *et al.*, 1999). Reuse of sludge in agriculture was a secondary driver (largely to dispose of sludge on land), and is still a source of quality concerns due to perceived or real risks of heavy metal and other contaminants (Driver, 1998). If use as fertilizer is the primary driver, the quality of the final product and its effectiveness as a fertilizer will be key. Importantly, this means that phosphorus recovery should not only be optimised for pollution prevention, but consider the resultant product and suitability for use in food production and other applications.

4.4.2 Sources of phosphorus for recovery and reuse

Phosphorus can be recovered from mixed wastewater streams, or from separate organic waste fractions, including: urine, faeces, greywater, animal manure excreted ex-farm animal carcasses and slaughterhouse waste (bones, blood, hooves etc), food waste, detergents (laundry, dishwashing), other industrial wastes, crop residues generated ex-farm (e.g. by the food processing industries).

Animal manure (and other animal parts such as bones and blood) are widely used as a source of phosphorus fertilizer in most regions of the world. Human excreta have also been used as a fertilizer for as long as 5000 years in parts of Asia (Matsui, 1997). Urine, for example, contains all the essential plant nutrients (NPK), is essentially sterile and can be directly reused in agriculture (WHO, 2006). Urine and faeces are the largest sources of phosphorus coming from urban areas. Approximately 60-70% of the phosphorus in human excreta is found in urine, while 30% is found in the faecal component. For example, in Sweden, studies found urine contains 0.33 kg/a of P, while faeces contains 0.18 kg/a of P. Results were similar on average for five countries (China, Haiti, India, South Africa and Uganda). Urine was estimated to contain 0.3 kg/a of P and faeces 0.14 kg/a of P (Jönsson *et al.*, 2004). In addition to these 'used' sources, phosphorus can also be obtained from new sources, such as mineral phosphate, algae, seaweed, aquatic sediments and even seawater⁹.

Figure 4-5 indicates the source of phosphorus fertilizers used in 14 EU member states. According to Milieu Ltd *et al.* (2009) in a study for the European Commission around 41% of phosphorus in municipal sewage sludge is currently recovered and reused in agriculture (Table 4-1 provides breakdown by country). So the potential for phosphorus recovery of sewage sludge would be 297 kt/a of P for the EU27. Richards and Dawson (2008) estimate that the phosphorus input of (composted) sewage sludge to agricultural land in the EU27 amounts to 115 kt/a of P. Sourcing sludge for phosphorus deserves great care. Next to the problem of excessive concentrations of contaminants per unit of phosphorus applied, it may be assumed that the availability of phosphorus for plant uptake is low, as long as most of the phosphorus in the recycled sludge will be in the form of aluminium and iron salts (Römer, 2006).

⁹ Though the energy and economics of recovering highly diffuse phosphorus in seawater make it currently unviable.

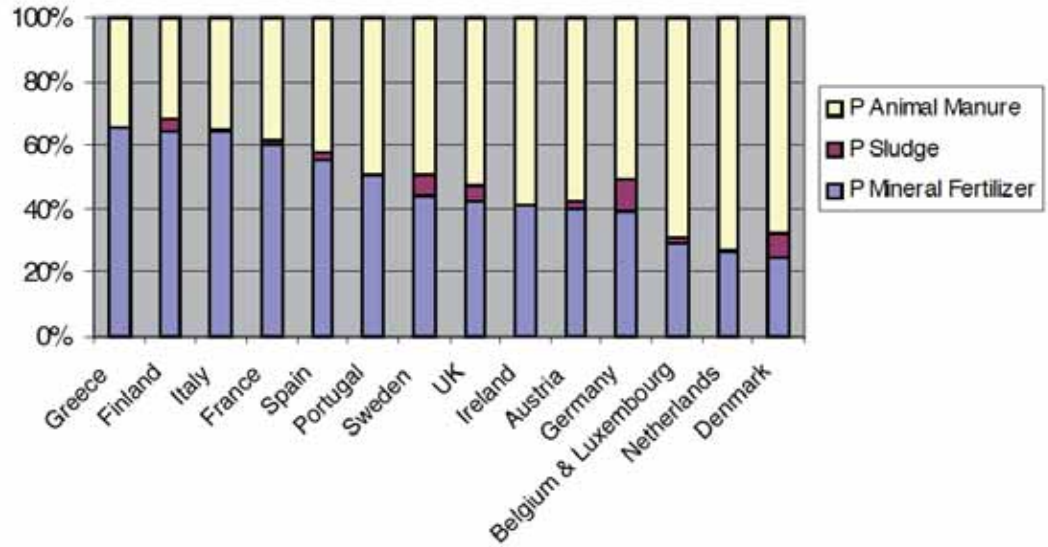

Figure 4-5. Sources of phosphorus fertilizers used in 14 EU Member states - animal manure (European Commission, 2001).

In addition to sewage sludge, crop residues and organic waste from food processing and production (such as oil cakes, food preparation and plate waste) can be effectively reused for their phosphorus content. Industrial wastes and household detergents are also a source of phosphorus that can be recovered.

Table 4-1. Sludge production and use in agriculture expressed as dry matter (DM) and phosphorus (P) (after Milieu Ltd et al., 2009).

Member state	Year	Sludge production (t DS)	Used agriculture (t Dm)	in% used agriculture	in% P total**	P in sludge (kt P)	P to agriculture (kt P)
Austria (a)	2005	252,800	47,190	19%	3.3	8	1.6
Belgium							
Flemish Region	2006	101,913	0	0%	6.7	7	0.0
Walloon Region	2007	31,380	10,927	35%	6.7	2	0.7
Brussels Region	2006	2,967	0	0%	6.7	0.2	0.0
Denmark	2002	140,021	82,029	59%	3.7	5	3.0
Finland	2005	147,000	4,200	3%	2.4	4	0.1
France	2007	1,125,000	787,500	70%	3.3	37	26.0
Germany	2007	2,056,486	592,552	29%	3.3	68	19.6
Greece	2006	125,977	56	0%	3.3	4	0.0
Ireland	2003	42,147	26,743	63%	3.3	1	0.9
Italy	2006	1,071,080	189,554	18%	2.1	22	4.0
Luxembourg	2005	8,200	3,780	46%	3.3	0.3	0.1
Netherlands	2003	550,000	34	0%	3.3	18	0.0
Portugal	2006	401,000	225,300	56%	2	8	4.5
Spain	2006	1,064,972	687,037	65%	3.6	38	24.7
Sweden	2006	210,000	30,000	14%	2.7	6	0.8
United Kingdom	2006	1,544,919	1,050,526	68%	2.2	34	23.1
Sub-total EU 15		8,875,862	3,737,428	42%		264	109
Bulgaria	2006	29,987	11,856	40%	4.3	1	0.5
Cyprus	2006	7,586	3,116	41%	4.9	0	0.2
Czech Republic	2007	231,000	59,983	26%	1.9	4	1.1
Estonia	2005	26,800	3,316	12%	3.4	0.9	0.1
Hungary	2006	128,380	32,813	26%	1.4	2	0.5
Latvia	2006	23,942	8,936	37%	1.3	0	0.1
Lithuania	2007	76,450	24,716	32%	0.9	1	0.2
Malta							0.0
Poland	2006	523,674	88,501	17%	3.3	17	2.9
Romania	2006	137,145	0	0%	3.3	5	0.0
Slovakia	2006	54,780	33,630	61%	1.8	1.0	0.6
Slovenia	2007	21,139	18	0%	3.9	0.8	0.0
Sub-total for EU12		1,260,883	266,885	21%		33	6
Total		9,866,728	4,004,313	41%		297	115

** Phosphorus (P) content of sludge (see Table 4-2); for countries with missing values the average of 3.3% P is assumed (in bold).

However in all cases, the quality of the source is paramount and strategies to either prevent contamination (e.g. through source separation) or sanitize the source may need to be employed. Table 4-2 indicates the quality of sewage sludge in member states.

Table 4-2. Quality of sewage sludge (heavy metals and nutrients) in sewage sludge recycled to agriculture in the year 2006 (Milieu Ltd et al., 2010).¹⁰

Parameter	BE a,b)	DE	ES	FI b)	IT	PT a)	SE	UK	BG	CY	CZ	EE b)	HU	LT	LV	PT	SI	SK b)
Zinc	337	713	744	332	879	341	481	574	465	1188	809	783	824	534	1232	996	410	1235
Copper	72	300	252	244	283	12	349	295	136	180	173	127	185	204	356	153	190	221
Lead	93	37	68	8.9	101	27	24	112	55	23	40	41	36	21	114	51	29	57
Nickel	11	25	30	30	66	15	15	30	13	21	29	19	26	25	47	32	29	26
Chromium	20	37	72	18	86	20	26	61	20	37	53	14	57	34	105	127	37	73
Mercury	0.2	0.4	0.8	0.4	1.4	<1	0.6	1.2	1.2	3.1	1.7	0.6	1.7	0.5	4.2	4.6	0.8	2.7
Cadmium	1	1	2.1	0.6	1.3	<0.4	0.9	1.3	1.6	6.9	1.5	2.8	1.4	1.3	3.6	4	0.7	2.5
Total Nitrogen	3.9	4.3	4.5	3.4	4.1	1.7	4.5	2.8	7.2	4.1	3.6	4.9	3	2.3	3.9	0.9	3.2	3.8
Total Phosphorus	6.7	3.7	3.6	2.4	2.1	2	2.7	2.2	4.3	4.9	1.9	3.4	1.4	0.9	1.3	0.6	3.9	1.8

a) Data from the Flemish Region.

b) Data for 2005 as no values available for 2006.

The total amount of available phosphorus (in thousands of tonnes of P per year) in each source will vary from country to country depending on a number of factors. For example, because almost 100% of the phosphorus in consumed food is excreted, the phosphorus in a nation's excreta is dependent on population size, daily food intake, and dietary preferences (Esrey *et al.*, 2001). Similarly, phosphorus in manure depends on livestock numbers, the animal type, feeding regimes including additives, and the type of housing. Phosphorus in food waste depends on the commodities produced (for example, beans contain 0.6% P, milk contains 0.09% and poultry meat 0.3% P) (Beukeboom, 1996), location of final consumption (domestic or exported), efficiency and complexity of the food commodity chain. Increasing efficiency will reduce avoidable phosphorus losses (such as spoilt food) and therefore less phosphorus in waste will be available for recovery (Cordell *et al.*, 2009b).

Concentrations of phosphorus also differ from source to source, as indicated in Table 4-3. Phosphorus concentrations in organic material are important for at least two reasons. Firstly, knowledge of phosphorus concentrations is required to estimate the total phosphorus available for recovery. Secondly, the phosphorus concentration has strong implications for the viability of phosphorus recovery, storage and transport. In general, the lower the phosphorus concentration, the more the energy required to concentrate the phosphorus (such as through dewatering or other physical or chemical process), or to transport the bulky low concentrated material if it is not going to be used onsite. Some caution should be exercised when using such phosphorus concentration values, as they will depend very much on whether the material is fresh wet-weight, semi-dried, slurry, etc.

¹⁰ *BE Belgium, NL Netherlands, PT Portugal, UK United Kingdom, DK Denmark, IT Italy, ES Spain, LU Luxemburg, FI Finland, IE Ireland, EL Greece, FR France, SE Sweden, AT Austria, PL Poland, DE Germany, CZ Czech Republic, SL Slovakia, HU Hungary

Table 4-3. Typical phosphorus concentrations of different wastes and intermediates (Cordell, 2010).

Organic material	P (% P by weight) ¹¹
Human urine	0.02-0.07
Human faeces	0.52
Human excreta	0.35
Activated sewage sludge	1.4
Sludge (from biogas digester)	0.48-0.77
Struvite	13-14
Cow dung	0.04-0.07
Poultry manure	0.88 -1.27
FYM (Farm Yard Manure)	0.07-0.88
Rural organic matter	0.09
Vermicompost	0.65
Crop residues	0.04-0.33
Urban composted material	0.16-0.44
Oil cake (by-product from oilseed processing)	0.39-1.27
Meatmeal	1.09
Bonemeal	8.73-10.91

(Data sources: Kirchmann and Pettersson, 1995; Vinnerås, 2002; van Dijk, 2003; FAO, 2006b; Hammond et al., 2007; Tilley et al., 2009).

The spatial concentration of phosphorus at the regional or provincial level is also of importance. The concentration of organic phosphorus sources and sinks is highly dependent on population density because at a household level, humans demand phosphorus in food, and excrete phosphorus in urine and faeces. As the world becomes predominantly urbanized, urban centres will become 'P hotspots' due to human excrement and food waste (Cordell, 2010). The phosphorus in these hotspots originated from local or distant agricultural fields, hence returning the phosphorus to these sources would create a more closed phosphorus loop. One could argue that urbanization has on the one hand disturbed recycling due to increased energy demands for long-distance transport and, possibly, due to the reluctance of city dwellers to sustain the production of food with their own excrement. Urbanization could on the other hand facilitate the establishment of efficient collection systems for residues, including human excrement. Many of these collection systems, however, use considerable amounts of flush water. Once excrement is diluted with water, it becomes more expensive to recover the phosphorus.

The concept of eco-industrial parks in industrial ecology (Ayres and Ayres, 2002) could inform a spatial analysis of how human excreta could be feasibly and logistically collected, converted to fertilizer and re-distributed to urban and peri-urban agriculture in an efficient sustainable manner. Fealy and Schröder (2008) show, however, that the distances over which wastes can be returned to agriculture are limited from both an economic and an energetic point of view. This is even more true if nutrient concentrations have become low due to the addition of flush water.

¹¹ Percentage may vary depending on whether fresh wet weight, or semi-dry manure.

4.4.3 Processes and technologies for the recovery and reuse of phosphorus

Phosphorus can be recovered from the abovementioned sources through a wide range of technical processes. Such techniques vary in terms of the processes by which they source, treat and reuse phosphorus in agriculture. Processes range from low-cost, low-tech small-scale systems (such as direct use of household urine and composted faeces), through to more expensive, high-tech, large-scale systems (such as sewage sludge ash or struvite). Indeed, Schenk *et al.* (2009) and Hermann (2009) identify over 30 processes for the recovery of phosphorus from wastewater treatment plants. Appendix II provides a list of available technologies for phosphorus recovery at wastewater treatment plants (Hermann, 2009), according to the waste stream and recovery process. The potential phosphorus recovery rates vary from technology to technology and also depend on local conditions and practices. Figure 4-6 (Cordell *et al.*, 2009b) provides a classification matrix of processes by which phosphorus can be recovered from different sources. Examples are indicated in the white boxes.

Small-scale, decentralised recovery processes

Small-scale or decentralised sanitation systems (ranging from individual onsite systems through to community-scale) are typically developed due to their low cost, or appropriateness for serving remote or low-density populations. Many small-scale systems dispose of treated or untreated excreta/wastewater onto land, rather than water (the latter being typical of large-scale centralised systems). For example, one small-scale sanitation paradigm, ecological sanitation, or 'ecosan', explicitly stresses the need to 'close the loop' on nutrients, including phosphorus, to ensure sustainable nutrient cycles. Ecological sanitation refers to the containment, sanitization and recycling of human excreta on arable land (EcoSanRes, 2003). While the key objectives are protection of public health and the environment, other important goals are the reduction of water use in sanitation systems and reducing the demand for mineral fertilizers in agriculture by recycling nutrients from human excreta. There are numerous documented practical local cases of ecological sanitation around the world, including examples from Southern Africa, China, Vietnam and Mexico (Drangert, 1998; Gumbo and Savenije, 2001; Stockholm Environment Institute, 2005), and in the developed world from Scandinavia, The Netherlands, Switzerland and Germany (Johansson and Kvarnström, 2005; von Münch *et al.*, 2009).

Some small-scale decentralized operations that concentrate nutrients following recovery are also emerging, such as developments to precipitate struvite from source-separated urine in Sweden (Ganrot *et al.*, 2009) and Nepal (Tilley *et al.*, 2009). Other small-scale phosphorus recovery systems include: composted toilet and food waste, household greywater treatment and irrigation, biogas sludge reuse, onsite industrial waste treatment and reuse and the already common practice of farmyard manure reuse. A compendium of sanitation systems and technologies (including some nutrient recovery technology) prepared by EAWAG (Tilley *et al.*, 2008) provides a systematic assessment of the broad range of low-cost, small-scale systems.

Decentralised systems can also offer benefits over centralised systems in terms of potential to reduce energy consumption, losses (such as infiltration losses), costs, water consumption and raw material inputs. For example, 50-70% of the costs of centralised wastewater treatment systems can be in the conveyance (i.e. sewerage network, (Clark, 1997)). In a future challenged with energy and water scarcity, climate change and increased population growth, decentralised systems are likely to play an important role in future sustainable sanitation systems (Maurer, in press; Mitchell *et al.*, in press). Further, separating wastewater streams at source (known as 'source separation') can facilitate appropriate treatment and resource recovery of the different streams, which can have substantially different qualities (for example, urine or household greywater tend to contain substantially less toxic substances compared to industrial wastewater and therefore the two streams need not be treated in the same way) (Mitchell *et al.*, in press).

Factors limiting the use of small-scale decentralized systems can include available land space (particularly in highly dense urban areas) and transferral of management and maintenance responsibilities (e.g. from wastewater service provider to householder, in the case of onsite systems). The following cases provide examples of a range of small-scale systems.

PHOSPHORUS SOURCE:		PHOSPHORUS RECOVERY & REUSE PROCESS:				
		i. source separation & reuse	ii. wastewater mixing & reuse	iii. recovery & reuse of iv. struvite generation & reuse byproducts/ residuals	v. virgin extraction & processing	vi. incineration/ burning & reuse
Type A: USED SOURCES	A1. Human excreta	eg. urine (storage and direct reuse), composted dry faeces		eg. activated sewage sludge from wastewater treatment plant; sludge from biogas/biofuel digester; composted filter cake from sugar factories	eg. from mixed wastewater at the treatment plant	eg. incinerating toilet;
	A2. Greywater	eg. minimum treatment and non-potable reuse	eg. direct use of diluted wastewater; use of treated effluent as irrigation water			
	A3. Animal manure	eg. direct application of manure			eg. from dairy waste	e.g. ashes from burning manure
	A4. Other industrial waste					
	A5. Animal meal	eg. ground bonemeal, meatmeal, bloodmeal		eg. ground bonemeal, meatmeal, bloodmeal		
	A6. Food waste	eg. composted food waste		eg. composted residues from food processing		
	A7. Crop residues	eg. crop residues ploughed back in to field	eg. ground in-sink-orator	eg. oil cakes		e.g. ashes from burning crop residues
	A8. Crops	eg. Green manure		eg. sludge from anaerobic digestion of virgin crops		eg. slash and burn
	A9. Phosphate rock			eg. extracting P from phosphogypsum stockpiles		eg. mining existing and potential reserves; seabed phosphate
	Type B: NEW SOURCES	A10. Aquatic vegetation (eg. algae, seaweed), sediments & seawater				

Figure 4-6. A classification matrix of supply-side measures to meet future global phosphorus needs for food security (Modified from Cordell et al., 2009b).

CASE STUDY 1: HOUSEHOLD-SCALE PHOSPHORUS RECOVERY COMBINING STRUVITE PRECIPITATION AND ZEOLITE ADSORPTION

Country: Sweden

Input source: separated urine and other household wastewater streams.

P output: struvite (magnesium ammonium phosphate) slow release fertilizer

Scale: household (onsite)

System summary: This household-scale system recovers and concentrates phosphorus and other valuable resources onsite for reuse elsewhere, through energy-efficient and commercially available technology. Urine and faeces are separated via the Aquatron system (www.aquatron.se). The phosphorus in the urine fraction is then precipitated as struvite, while the faeces and other organic waste streams are dried. Spilt Box technology (www.splitvision.se) achieves a high volume reduction of wastewater, in addition to capturing waste heat from the wastewater streams for reuse in the house.

Average P recovery rates: 90-98% P removal

Benefits: Concentration of phosphorus at source overcomes the bulky storage and transport barrier associated with using urine directly; precipitation of phosphorus reduces perceived or real health risks associated with pharmaceutical residues in urine, and any other chemical or bacterial pollutants.

Drawbacks: Requires treatment and recovery system onsite connected to toilet and other wastewater fractions.

Resources: (Ganrot *et al.*, 2009); www.splitvision.se

CASE STUDY 2: CO-DIGESTION OF BLACKWATER FROM VACUUM TOILETS AND KITCHEN WASTES LÜBECK

Country: Germany

Input source: kitchen organics, greywater, vacuum-flushed blackwater, urine.

P Output: sludge following anaerobic digestion

Scale: community scale

System summary: The settlement is not connected to the municipal wastewater system. The wastewater is collected and treated in an internal cycle. In the households vacuum toilets with a very low water consumption (0.7-1.2 L per flush) are installed. The blackwater (faeces and urine) is transported via a vacuum sewerage system to a central anaerobic digester. The organic waste from the kitchens is collected separately and is mixed and treated together with the blackwater, initially by thermic hygienisation. This is followed by anaerobic digestion. The liquid residue is stored for a further stabilisation to produce an organic fertiliser. The greywater (wastewater from the kitchen and bathroom) is transported by gravity pipes to several constructed wetlands. After preliminary sedimentation the greywater is fed in intervals to the wetlands, constructed as vertical flow filters.

Average P recovery rates: 90-95% P recovered

Benefits: system uses less water (about 20%) than conventional ones and requires no connection to a large sewer pipe system; the separate greywater system and wetland treatment means the P-rich blackwater from the toilets is not diluted and can be co-digested with the kitchen wastes; operating costs are 25% lower than conventional systems

Drawbacks: initial investment is 40% higher than conventional systems

Resources: www.flintenbreite.de; www.otterwasser.de;

CASE STUDY 3: DIRECT REUSE OF URINE COLLECTED FROM DOUBLE FLUSH URINE-DIVERTING TOILETSKULLÖN

Country: Sweden

Input source: urine

P output: urine

Scale: community scale (onsite)

System summary: 250 modern houses were built with double-flush urine diversion toilets combined with tertiary wastewater treatment. Two different types of urine diverting pedestals have been installed. Collecting tanks for urine are located in each block of houses. A system for collection and use of urine on farmland has been organized.

Average P recovery rates: 99% P recovery from the urine

Benefits: For the Swedish context it is estimated that the monetary value of the nutrients in urine corresponds to the extra costs of spreading urine compared to spreading commercial fertilizer.

Drawbacks: For large-scale systems there are also costs for storage and transport of the urine. In the Kullön case these additional costs were initially charged to the households..

Resources: Kvarnström *et al.* (2006) Urine Diversion: One Step Towards Sustainable Sanitation.
http://www.ecosanres.org/pdf_files/Urine_Diversion_2006-1.pdf

In Swedish <http://www.smaa.se/Templates/Faktasida0.aspx?PageID=83ceded5-86aa-493d-ad37-671ea1bef88e>

Large-scale, centralised recovery processes

Centralised wastewater systems were first developed in the 1800s after severe cholera outbreaks in London coupled with 'The Big Stink' (Abey Suriya, 2008; Ashley *et al.*, 2009). This had substantial public health benefits because it moved pathogenic faecal material away from human settlements, reducing the risk of diseases being spread. However the recovery of nutrients in cities was largely brought to an end by such water-based piped networks. Nutrient recovery was re-introduced in centralised systems in the 1970s to reduce pollution of waterways from increasing phosphorus levels in household and industrial wastewater from detergents and excreta (Barnard, 2009). Nutrient removal from wastewater treatment plants has developed over the past decades from a focus on chemical processes (in the 1980s) to the biological nutrient removal process (in the 1990s) and most recently to struvite recovery and re-use (Hammond *et al.*, 2007; Ashley *et al.*, 2009) and other forms (such as ash from incinerated animal meal). The 2009 International Conference on Nutrient Recovery from Wastewater Streams acknowledged that:

a new 'paradigm' is emerging, globally. Commercial marketing of recovered nutrients as 'green fertilizers' or recycling of nutrients through biomass production to new outlets, such as bio energy, is becoming more widespread (Mavinic et al., 2009).

P can be recovered from multiple streams at a centralised wastewater treatment plant. These streams can include (Hermann, 2009): untreated *wastewater* inflow; sewage *sludge*; *effluent* side stream from sludge dewatering; and *ash* from sludge incineration.

Today for example there are commercial-scale struvite recovery plants (from dewatered sludge) operating in Canada (Ostara, 2009; Rahaman *et al.*, 2009) and Japan (Ueno and Fujii, 2001), while commercial operations in The Netherlands sell nutrients sourced from sludge ash to end users (Schipper and Korving, 2009). There have been trials aiming at producing a marketable fertilizer from municipal sewage in Germany (Adam *et al.*, 2008) and marketable 'biofertilizer' sourced from livestock effluent in Australia (for example, Microfert (2009)). Other examples of large-scale phosphorus recovery systems include wastewater-fed aquaculture, the reuse of sludge, and precipitated calcium-phosphate or effluent emerging from wastewater treatment plants. In almost all of these cases, the source of phosphorus is mixed household and industrial wastewater, and therefore the quality of the inflow will be highly dependent on the sources. Ground bone meal and meat meal from animal carcasses are also frequently used in countries with significant livestock densities, such as Denmark and The Netherlands, however such reuse decreased markedly after the Mad Cow Disease outbreaks in the 1990s (European Union, 2010b; European Union, 2010a). The occurrence of 'mad cow disease' or transmissible spongiform encephalopathies (TSEs) brought about strict legislation prohibiting the feeding to ruminants of animal protein and animal feed containing such protein. As regards the feeding of farm animals with the exception of carnivorous fur-producing animals, it is forbidden to use processed animal protein, gelatine of ruminant origin, blood products, hydrolysed protein, dicalcium and tricalcium phosphates of animal origin (European Union, 2001).

Centralised phosphorus recovery and reuse systems can have benefits such as economies of scale, ease of end-of-pipe additions rather than household or community-scale retrofits and generation of marketable products. However they are limited in terms of large initial costs, energy and resource costs of pipe networks, increased risk of losses (as discussed earlier), and risks of technology 'lock-in'¹³ (Abey Suriya, 2008; Mitchell *et al.*, in press). This is discussed further in section 4.4.5 below. The following cases provide examples of a range of large-scale systems.

¹³ Technology "lock-in" refers to the large investments in technology that make it difficult to change in a timely manner even when more superior or appropriate alternatives are available (see Perkins, R. (2003). Technological "lock-in". Online Encyclopaedia of Ecological Economics, International Society for Ecological Economics.)

CASE STUDY 4: STRUVITE RECOVERY - THE OSTARA EXPERIENCE

Country: Canada and U.S.

Input source: mixed wastewater

P Output: *Crystal Green* struvite (5-28-0 +10% Mg) slow release fertilizer

Scale: centralised, large-scale

System summary: Initially developed by the University of British Columbia in Canada, the Ostara nutrient recovery technology involves a fluidized bed reactor that recovers phosphorus and ammonium from wastewater treatment plants. Wastewater centrate influent from sludge dewatering side streams (ideally following biological treatment) enters the reactor from the bottom, moving up through increasingly larger reactive zones. Magnesium is chemically dosed to facilitate the crystallization process. Crystals form over a period of days (until they reach the desired size - up to 8mm). The struvite is then harvested from the reactor, dried and packaged onsite for sale. The first commercial-scale plant opened in Edmonton in 2007, producing approximately 500 kg/day of struvite. There are now numerous commercial operations using the Ostara fluidized bed reactor in North America. The full-scale commercial operation at Portland's Durham wastewater treatment plant processes 100% of the wastewater through the reactor, at a 90% P recovery rate, yielding 500 tonnes/year of struvite. According to Ostara, while the capital costs for a reactor facility range from \$2-\$4 million, and costs can be recovered in 3-5 years due to maintenance and capacity cost savings and fertilizer revenue. After this time it can provide revenue to the wastewater service provider (e.g. municipality). The main end-users of the Crystal Green struvite product are golf courses, nurseries and specialty agricultural markets.

Average P recovery rates: > 85% P removal

Benefits: can be commercially viable (struvite can be sold to user); standard product (users have a reliable, pure product without contaminants); easy to transport (due to high P concentration); reduces downstream scaling problems that can occur during the sludge dewatering process; Ostara system is add-on to existing wastewater treatment plants, however the concept can be applied to source-separated wastewater fractions (e.g. Case Study 1).

Drawbacks: N removal is low, hence struvite is low in N; requires constant addition of Mg; effluent waste stream still needs treatment and proper disposal (contains heavy metals, pharmaceutical residues etc).

Resources: www.ostara.com; (Britton *et al.*, 2009; Mavinic *et al.*, 2009).

CASE STUDY 5: PHOSPHORUS RECOVERY FROM SEWAGE SLUDGE ASH - THE SNB - THERMPHOS PARTNERSHIP

Country: The Netherlands

Input source: sewage sludge incinerator ash (original source mixed wastewater)

P output: elemental or industrial quality phosphorus

Scale: centralised, large-scale

System summary: Marketable P is recovered from ash by-product generated by the Dutch sewage sludge treatment company, N.V. Slilverwerking Noord-Brabant (SNB). SNB processes approximately 430 kt/a of sludge cake in four parallel incinerators - and this accounts for around 30% of the sludge produced in the Netherlands. Because P has no atmospheric phase, the phosphate in the sludge concentrates in the ash during incineration, leading to a concentration of 35g P per kg ash. Approximately 6 kt/a of P-rich sludge ash is delivered to phosphate producer Thermphos (at Thermphos's expense), for further purification. Thermphos then sells pure P to end users, such as the food producers (for additives) or pharmaceutical companies (for medicines). The collaboration between SNB and phosphate producer Thermphos International is an example of new industry partnerships that can facilitate the effective recovery and reuse of P from urban wastes (Schipper and Korving, 2009).

Average P recovery rates: 75% P removal.

Benefits: Profitable partnership between sludge treatment company and phosphate producer; Energy efficient sludge incineration: SNB claims its sludge incineration installation 'is one of the largest and one of the most environmentally friendly in Europe'; recovered phosphorus is concentrated onsite which avoids costly transport of bulky material.

Drawbacks: sewage sludge ash must be low in iron to be appropriate for P recovery (iron is sometimes added upstream during wastewater treatment, due to the lower cost of iron compared to aluminium); energy required for dewatering and sludge incineration.

Resources: www.phosphaterecovery.com; (Schipper and Korving, 2009).

CASE STUDY 6: MANURE SEPARATION

Country: Denmark

Input source: pig slurry

P output: solid fraction with relatively high P content and low water content

Scale: large-scale central installation and small-scale mobile installations

System summary: As pig slurry is rich in P, relatively little of it can be applied to land if accumulation is to be avoided. Pig farmers are generally short of available spreading land, so substantial amounts of pig manure must be exported to surrounding arable farms. Mechanical separation of pig slurry (typically 9% Dry Matter (DM), N/P ratio \approx 4) into a liquid fraction (\approx 5% DM) poor in P (N/P ratio \approx 6) and a solid fraction (\approx 25% DM) rich in P (N/P ratio \approx 2), enables pig farmers to export just the less bulky solid fraction and helps arable farmers to save on mineral fertilizer P. The energy saved in manufacturing that fertilizer and the reduced transport costs of excess manure by far outweigh the energy needed for the separation process.

Average P recovery rates: (i.e. % of ingoing P ending up in solid fraction): around 60%

Benefits: Particularly important in areas of high livestock concentrations, where land available for manure spreading is not sufficient without risk of environmental pollution (such as Denmark, The Netherlands, Flanders, parts of France, Spain and Italy)

Drawbacks: Adding Fe and Al salts can stimulate the separation process but makes the P in the solid fraction less available to plants. This could make the product commercially less attractive for agricultural use.

Resources: (Birkmose, 2009; Schröder and Verloop, 2010)

4.4.4 Potential recovery of phosphorus from additional sinks

Seawater

From time to time it is suggested that phosphorus can be recovered from seawater. This however is not a realistic option. The concentration of phosphorus in seawater is too low to recycle phosphorus via physico-chemical methods. Duncan Brown (2003) calculates that with an average concentration of phosphorus of $70\mu\text{g L}^{-1}$, seawater would have to be processed at a rate of $2.4 \times 10^5 \text{ km}^3 \text{ year}^{-1}$ if the current use of phosphorus-fertilizer were to be obtained. This would be more than 70 times greater than the total global annual consumption of freshwater.

Aquaculture

Can plants play a role in recovering phosphorus from seawater? Currently it is being investigated whether a large-scale production of seaweed for energy purposes in the North Sea is feasible (Reith *et al.*, 2005). In principle, phosphorus can indeed be recovered in this way. However, the above authors have indicated that the application of additional nutrients, including phosphorus, will be needed to attain commercially attractive production levels, due to the low concentration of nutrients in seawater. Instead of being a valuable by-product, phosphorus would then become a required input and by definition, more would go in than the amounts ever coming out of this system. This would of course prevent any net recovery of phosphorus from seawater.

Currently around 2 Mt dry matter is produced annually worldwide from seaweeds for commercial use (Reith *et al.*, 2005), with a P-content of 0.3% in the dry matter. This results in 0.006 Mt of P (a small amount compared to the current losses from erosion or with fertilizer use, both $> 15 \text{ Mt}$). So, a substantial production of seaweeds is probably constrained by the low phosphorus concentration in seawater. In upwelling zones (along the coasts of Chili, East Africa etc.) this could be different. However, because of the vulnerability of these zones (marine biota depend for the greater part on the nutrients in these upwelling zones) it is not recommended to start large production systems there (W. Brandenburg, PRI pers. comm.). The possibility of recovering phosphorus from rivers and streams in estuaries with seaweeds or algae could be greater.

Fish landings

The one-directional flow of phosphorus towards the ocean can be inferred from the return flow of only 0.3 Mt P which returns to land with fisheries worldwide (Smil, 2000; Smil, 2007). For the EU27 the total catch is 14.5 kt of P (total landings is 17.9 kt of P). For comparison: the discharge to sea by rivers is 180 kt of P (Richards and Dawson, 2008).

Ocean sediments

It must be assumed that particulate phosphorus which eventually ends up in the oceans sediments is diluted to such an extent that a recovery is not an economical option, apart from the technical complications due to the depth of these deposits.

Landfills

Richards and Dawson (2008) estimate sequestration of phosphorus in landfills for food wastes which were not accounted elsewhere. Based on several sources they estimated the biodegradable municipal waste to be 119 kg /capita. Scaled up to the 2006 EU27 population (494 million) this yielded an estimate of 59 Mt of biodegradable waste. It was assumed that these wastes comprised 65% of total biodegradable waste sent to landfills (35% food waste and 30% garden/park waste). At 1.5 kg P/t the total amount of phosphorus sent to landfills was estimated to be 57.4 kt of P annually.

Although still a problematic source of phosphorus, this alternative source is at least more concentrated and accessible than many other alternatives.

4.4.5 Future challenges and opportunities

In addition to new challenge of global phosphorus scarcity, phosphorus recovery will be affected by a number of other global environmental and social challenges, including: climate change, fossil fuel energy scarcity, water scarcity, land-use changes, population growth, urbanisation trends and eutrophication.

The investment in renewable energy systems, both to provide alternatives to scarce fossil fuel energy sources, and to reduce greenhouse gas generation, can potentially compete with phosphorus recovery if not taken into account. For example, generating 'biochar'¹⁴ to replace coal or for use in agricultural soils to sequester carbon, can either permanently remove the phosphorus contained in the original biomass from the food system, or convert the phosphorus to a form unavailable for plants.

Conversely, phosphorus recovery and reuse should ideally not adversely impact energy security (that is, recovery should not result in a net increase energy consumption). However there are still large research and knowledge gaps regarding life cycle energy costs of phosphorus recovery and reuse systems (recovery, refining, transportation) and how such costs compare to the use of mineral phosphate fertilizers (mining, processing, transportation). Some individual studies exist, such as Jönsson (2002) and Tidåker *et al.* (2007) who calculate urine can be transported up to 100-200 km by truck or truck and trailer in the Swedish context and remain more energy-efficient than the production and use of mineral fertilizers. However, more uniform and comprehensive analyses are required to assess different phosphorus recovery and reuse systems under different scenarios.

P recovery is related to and embedded within several important societal sectors, including water and sanitation service provision, food production and consumption, environmental protection, among others. Systems thinking can aid the identification and management of such key influences and interlinkages between sectors (Cordell, 2008). This means future phosphorus recovery systems will need to take into account future trends and drivers within these sectors to ensure they are consistent with preferred future directions and do not, for example, result in technology lock-in (Perkins, 2003; Cordell, 2010). For example, aging infrastructure and new global pressures like climate change mean the water and sanitation industry is at a turning point (Mitchell *et al.*, in press). Future sustainable sanitation systems are therefore trending towards more decentralised systems, to minimise life-cycle energy consumption, infrastructure, losses and costs associated with conveying large volumes of wastewater through a piped network system and importantly, to facilitate resource recovery. Mitchell (2008) suggests a transition towards 'restorative' systems is required, where sanitation systems have positive economic and social outcomes, such as generating resources like energy, water and nutrients, in addition to providing the community with sanitation services.

Other important future directions affecting phosphorus recovery include the paradigm shift in the sustainable production and consumption sector from a focus on 'products' to 'services'¹⁵. With respect to phosphorus, new opportunities arise for the phosphate fertilizer industry to shift from selling fertilizer products, to providing 'soil fertility' or 'food security' services. The concept of 'integrated plant nutrient management' (IPNM) and associated 'Global 4R Nutrient Stewardship Framework', put forward by the International Fertilizer Industry Association (IFA), is one example of a step in this direction (IFA, 2009).

In addition to future trends, 'weights' of the past (such as sunk infrastructure costs) must also be taken into consideration, as they may otherwise inhibit transitions towards sustainable and restorative systems, despite improvements offered by the new system (Abey Suriya, 2008; Mitchell *et al.*, in press). While some phosphorus recovery and reuse systems exist, commercialization and implementation on a global scale to ensure long-term phosphorus security could take decades to develop and significant adjustments to institutional arrangements will be

¹⁴ biomass is converted to biochar through pyrolysis.

¹⁵ For example, one of the leading carpet companies worldwide, Interface Inc, initiated a carpet service model 'Evergreen Lease Program' in 1995 where it provides a carpet 'service' rather than the purchase of a product, and guarantees that no reclaimed carpet will be sent to landfill (Fishbein, B.K. (2000). Carpet Take-Back: EPR American Style. In: Environmental Quality Management, John Wiley & Sons, Inc, Volume 10, Number 1, Autumn 2000, p25-36.)

required to support these infrastructural changes (Cordell *et al.*, 2009a). Tilley (2010) further notes a lack of investment in phosphorus recovery technologies in developing country contexts. Stimulating markets for renewable phosphorus fertilizers through subsidies, taxes, competition and investment grants and supporting demonstrations and trials may be required to facilitate effective phosphorus recovery and reuse systems (Tilley, 2010; Mitchell *et al.*, in press). Until 2008, the price of phosphate rock and associated fertilizer commodities was too low to stimulate investment in recovery systems for their fertilizer value. While the 2008 price has since returned to a lower baseline, the price of fertilizers is expected to increase over the long term (Cordell *et al.*, 2009a). Von Horn and Sartorius (2009) postulate that phosphorus recovery from wastewater treatment plants will become self-sufficient at a price of approximately US\$100/tonne.

Another important weight of the past is the psychological barrier to reusing excrement in food production. Farmers may be reluctant to use wastes because of cultural barriers and perceived or real contamination concerns. For example, while urine is essentially sterile and the global population excretes approximately 2 million tonnes of phosphorus in urine alone each year, Drangert (1998) maintains that a 'urine blindness' of professionals and householders is preventing more serious use of the resource globally. A study of Swiss citizens found a rather high willingness to both use urine-diverting toilets and to consume food fertilized by urine (Pahl-Wosti *et al.*, 2003). However issues of the health and environmental effects of micropollutants were of greater concern than the long-term sustainability issue of closing the nutrient cycle. This means that to overcome this barrier in the long run, phosphorus recovery and reuse systems will need to separate or reduce industrial and urban residues contaminated with heavy metals, pharmaceuticals, hormones and infectious bacteria to below acceptable levels (Vinneras *et al.*, 2008).

The specific types of phosphorus recovery and reuse systems in practice today or under trial tend to reflect local pressures and drivers (Hermann, 2009). For example, severe and recurring algal blooms have been a driver for advances in phosphorus removal technology for municipal wastewater treatment systems and regulation in some Europe countries (such as Sweden, Switzerland, France) (Wilson, 1999). In countries with high livestock densities and low land availability for spreading manures (e.g. in Denmark, Germany, The Netherlands), phosphorus recovery from manure has been a priority (Nyord, 2009).

While such emerging initiatives are certainly on the increase around the world, they are generally not operating within an overarching coordinated framework or strategy at a broader scale. For example, there are no international strategies for sustainable phosphorus recovery and reuse in the context of food security (Cordell, 2010). Local and regional contexts and drivers will differ from region to region, hence there is still a need to investigate the most appropriate ways of recovering phosphorus in a given country as it is likely that no one social-technical solution will meet all needs. Important factors for consideration in designing appropriate and sustainable phosphorus recovery and reuse systems in a given country or region include:

- Total phosphorus available in different waste streams (for example, in The Netherlands manure may be the dominant source of phosphorus, while in other countries such as Germany, sludge may be the largest phosphorus-containing waste stream);
- Potential phosphorus recovery rate (%P) from the system (close to 100% recovery rate of phosphorus will be required to meet global fertilizer demand);
- Physical distance between source and feasible agricultural land or other end uses (the energy consumption, costs and risk of losses during transport of recovered phosphorus to the end user are generally proportional to the overland distance);
- Land space available for intermediate storage or reuse (in some instances, land space is a constraining factor) (TU-Darmstadt, 2010).
- Life cycle energy associated with the collection, storage, transport, treatment, recovery and reuse (in an era of energy scarcity and climate change, fossil fuel energy use will need to be minimised);
- Life cycle costs associated with collection, storage, transport, treatment, recovery and reuse (seeking phosphorus recovery options with lowest cost to society - not just a single stakeholder - will need to be prioritized);
- Key local, regional and global drivers (e.g. high eutrophication problem, dependence on phosphate imports);

- Raw materials required such as input chemicals (e.g. Mg for struvite crystallization);
- Contaminants that could affect the effectiveness of treatment (such as presence of iron in wastewater which compromises phosphorus recovery from incinerated sludge ash) or create health risk to plants, farmers or other phosphorus end users (such as Cadmium);
- By-products and their treatment or management;
- Appropriateness/feasibility of the recovered phosphorus as a fertilizer from the farmer's perspective, including:
 - *Biochemically*, e.g. bioavailability to plant roots, appropriate NPK ratio,
 - *Socially*, e.g. ease of handling, odour, safety;
 - *Logistically*, e.g. available for procurement at appropriate time for growing season;
- Synergies - potential of the system to address services other than food production, by value-adding soil fertility with other related services such as sanitation, pollution prevention, energy/heat production, irrigation (for example, small-scale biogas plants can treat household sewage, generate energy (methane) from the waste through anaerobic digestion and enable the resultant sludge to be reused as fertilizer).

4.5 Conclusion

This chapter has reviewed a broad range of available measures to use phosphorus in a sustainable way. A key message is that improving the use efficiency definitely buys the necessary time to implement these measures, but that in the end only efficiencies close to 100% will make the use of phosphorus sustainable. Improvements of the use efficiency - that is, the reduction of losses - are possible in the mining phase and in the production of fertilizers, the use of phosphorus in agriculture, regardless of phosphorus source, and in the way we handle phosphorus containing wastes in processing industries, households and specialized waste-treatment installations. A second message is that recovery of phosphorus from these waste streams is needed to reduce water pollution, but that for the sake of sustainability, phosphorus must be recovered in an uncontaminated and plant-available form. Not all current recovery methods yield these types of fertilizer-substitutes. Numerous examples of the strengths, weaknesses, opportunities and threats of measures along the path from mine to fork are given in the form of research findings and practical cases. A third message is that 'end of pipe' measures, some of them as literal as the suggested recovery of P from seawater, do not seem realistic, if only from an energetic point of view. As measures will sooner or later become a condition *sine qua non* for global food security, action is needed. The elaboration of the required actions is the subject of the next chapter.

5. Policy implications and recommendations

5.1 Introduction

In order to implement the measures needed for the more efficient use of phosphorus and ultimately the full recycling of phosphorus, changes will be necessary. In this chapter we first have a look at current policies and try to explain why they fail to deliver a sustainable use of phosphorus (5.2). After that we make a distinction between what can be done in the short and medium term (5.3) and what could be considered in the longer term (5.4). Concerning short-term measures we take a look at the scope and impact of ongoing measures (5.3.1) and identify measures to raise awareness, for example through extension and education, in order to achieve the easiest goals (5.3.2). Subsequently we take a look at the internalization of costs associated with the use of phosphorus and identify indicators ('yard sticks') to enforce a more efficient use of phosphorus through economic (5.3.3) and regulatory (5.3.4) instruments. Note that none of the policies are mutually exclusive. The most effective implementation of tools might indeed be a combination of regulation and incentives.

All of the short-term policies essentially involve optimizing a food system that at present is fundamentally unsustainable with respect to phosphorus. Short-term measures, therefore, will at best reduce the rate at which we deplete finite phosphate rock reserves. These policies 'buy time', allowing societies to identify and implement longer-term measures to achieve a truly sustainable use of phosphorus. These more fundamental measures (section 5.4) are dealt with in the sections on required institutional changes (5.4.1), possible reforms of agriculture (5.4.2), policies needed for a full recycling of phosphorus (5.4.3) and considerations pertaining to lifestyles (5.4.4). These sections are followed by a section in which knowledge gaps are identified in the form of research recommendations (5.5). The chapter ends with a conclusion (5.6).

5.2 Scope and impact of existing policies

Chapters 2 and 3 outlined the ways in which the current phosphorus use in agriculture is unsustainable, globally as well as within the EU. Demand for phosphorus is increasing, available sources are decreasing in quantity and quality, and the environmental impacts of current practices are serious. What makes this situation even more serious, and challenging to improve, is the current lack of appropriate institutional arrangements.

5.2.1 EU policies

An extensive review of European policies and regulations on nutrient use, both at the level of the EU as a whole and at the level of individual member states, is given by De Clercq and Sinabell (2001) and De Clercq *et al.* (2001). Examples of these policies and regulations are the Directives on Bathing Water (76/160/EEC), on Sewage Sludge (86/278/EEC), on Urban Waste Water Treatment (91/271/EEC), on Nitrates (91/676/EEC), and on Integrated Pollution Prevention Control (96/61/EEC), all of which have been linked since 2000 in the EU Water Framework Directive. The EU directives have been embedded in national legislation and regularly elaborated in National Action Programmes, such as the ones belonging to the Nitrates Directive (ND). By now, ND Action Programmes are no longer expected just to address losses of nitrate-nitrogen but are also judged on their ability to reduce losses of phosphorus. Note that all these regulations appear to be steered by environmental pollution concerns and not by concerns over the finiteness of fossil phosphate rock reserves. This also applies to European treaties addressing the emission of phosphorus, among many other substances, into European rivers and oceans. These treaties include the HELCOM and OSPAR treaties and the North Sea Conference (De Clercq and Sinabel, 2001).

So far, none of the policies and regulations is based on or includes the awareness that phosphorus is a finite resource for which there is no substitute.

5.2.2 Lack of global governance of phosphorus

Unlike the other biogeochemical cycles that are vital to food production (including the carbon, nitrogen, and hydrogen cycles), there are very little data, research and global governance mechanisms related to long-term sustainable management of the phosphorus cycle (Cordell, 2010). For example, phosphorus scarcity has not received explicit mention or assessment within any of the official reports of the key organizations related to global food security, including: the UN Food and Agricultural Organisation (FAO, 2005a; FAO, 2006; FAO, 2007) the International Food Policy Research Institute (IFPRI, 2002; IFPRI, 2005), the International Assessment of Agricultural Knowledge, Science and Technology for Development (IAASTD, 2008), the Global Environmental Change and Food Systems program (GECAFS, 2006), and the High-level Conference on World Food Security hosted by the FAO (FAO, 2008).

Similarly, none of the major global environmental change assessments and frameworks, such as the Millennium Ecosystem Assessment (2005b), (Planetary Boundaries (Rockström *et al.*, 2009), and the UNEP Sustainable Resource Use Panel (UNEP, 2007) have examined phosphorus scarcity and its long-term sustainability implications. Many of these reports limit their focus to the serious pollution problems which are due to the excessive use of phosphorus and nitrogen fertilizers, or the serious anthropogenic disruptions to the nitrogen and carbon cycles.

An institutional analysis of the global phosphorus cycle reveals that while there are many phosphorus-related actors and policies, there are no organizations, regimes, policies or other governance structures explicitly responsible for addressing long-term phosphorus availability and accessibility for global food production (Cordell, 2010). Further, the institutional structures are fragmented, such that there is a 'mismatch' between the physical flows of phosphorus through the food system, and the institutional structures. For example, while phosphorus physically flows directly from the food humans consume to urine and faeces, there are very few institutional relationships between the food consumption (or food security) sector and the sanitation sector. While phosphorus is important to each sector (e.g. as a 'commodity' in the mining and fertilizer sector, as a 'macro-nutrient' in the food and nutrition sector, and as a 'pollutant' in the water and environmental quality sector), phosphorus *scarcity* is not a priority within any sector.

In the absence of any explicit controlling structures, the market is by default governing the global phosphorus cycle (Cordell, 2010). While the market system has benefits such as efficiency of trade, this alone is not sufficient and serious shortfalls are contributing to an unsustainable phosphorus cycle. For example, the market does not have the capacity to address:

- **Non-substitutability of phosphorus:** the market system assumes infinite substitutability. That is, according to the assumptions of the market, scarcity is relative and when one resource becomes scarce and hence expensive it can always be replaced by another cheaper resource. However phosphorus has no substitute in food production, and therefore phosphorus must be available to future generations if societies are to continue.
- **Equitable distribution:** all farmers need access to phosphorus fertilizers, yet only those with purchasing power can currently access fertilizer markets (or credit). Increasing scarcity of phosphate rock is likely to increase its price over the long term, making fertilizers even less accessible to poor farmers.
- **Long-term time frames:** managing complex global environmental challenges such as climate change, biodiversity loss and energy scarcity, requires consideration of long-term time frames to ensure society can adapt in a timely manner. Peak phosphorus may occur in the coming decades, resulting in a growing gap between phosphorus supply and demand. R&D investment and implementation of innovative phosphorus efficiency and recovery systems could take decades to come online to replace phosphate rock. Yet the market system and its actors are structured to operate on short-term timelines of 5-10 years at most.

Further, there are no structures for monitoring and evaluating the global phosphorus situation and no effective feedback loop designed to correct the system (Cordell, 2008). The significance of this was highlighted in 2008 when the short-term demand temporarily outstripped supply capacity, resulting in an unprecedented price spike, trade protection barriers, fertilizer rationing and even street riots in some instances. As noted in Section 2.2.3 (and further in Cordell (2010)), there is a concerning lack of available, reliable and consistent data on global phosphorus resources and consumption patterns in the global food system upon which a) researchers, scientists and observers

can base analyses and b) phosphorus users, producers and policy-makers can make informed decisions. The information that is available is not independent, transparent or trustworthy, and it has not been produced and managed in a participatory manner.

The unprecedented 800% price spike of phosphate rock commodities in 2008 triggered a new global interest in phosphorus scarcity concerns, reflected in the growing frequency of media, popular science and scientific articles appearing on the topic. Whilst awareness raising is a crucial first step, substantial research and policy action is now required (Cordell, 2010).

It is evident that too little phosphorus will be available for food-producing regions that are still in serious need of a phosphorus boost, once high quality phosphate rock is depleted. Without sufficient phosphorus, the utilization of resources other than phosphorus (land, water, energy, labor, nitrogen) and hence food security, will be threatened. These considerations seem completely absent in current international policies. Even the EU appears to take for granted that its members are self-sufficient as far as the production of food and feed is concerned. This attitude ignores that the EU is a net importer of phosphorus via raw materials for fertilizers and animal feed (Richards and Dawson, 2008). Without these imports the production of meat and dairy will be forced to shrink and built-up soil fertility will be gradually depleted, eventually affecting the yields of crops. Existing policies essentially fail to treat phosphate rock as a finite resource.

It is recommended that the EU considers the development of a specific directive on phosphorus linked to food security. The objectives of such a directive could be ensuring short- and long-term availability and accessibility of phosphorus to farmers (and other P end users) allowing them to produce food, while minimizing adverse environmental impacts related to phosphorus use.

5.3 Short-term policies

5.3.1 Raising awareness of phosphorus sustainability

Some sustainable phosphorus use measures directed at a more efficient use will probably pay for themselves. Examples are the proper use of fertilizer recommendations and the commercially successful recovery of struvite-phosphorus from waste water. Lack of adoption and extension may merely stem from lack of awareness of the need for phosphorus sustainability. For instance, public awareness that phosphate rock is an essential yet finite resource is still at a much lower level than public awareness about fossil fuels resources. Farmers still find it difficult to believe that their use of phosphorus may eventually affect biodiversity in receiving water bodies miles away from their farms. Food industries may be insufficiently aware that they are processing products containing a finite resource. Unaware of its potential value, they may unintentionally treat residues in ways that make it difficult to recover the phosphorus. Consumers may acknowledge that their lifestyles affect the environmental quality via, for instance, greenhouse gases, but they will hardly know that environmental quality is also determined by their consumption of phosphorus. City dwellers may have become so alienated from the production of their food that they find it repulsive to buy food containing fertilizers derived from human excreta. For that matter, even modern farmers have lost the once ubiquitous knowledge of the value of excreta. As a result, many of them still look upon manure as a low-value waste. Authorities, in turn, have realized too late that local concentrations of livestock impose great environmental risks unless the resulting phosphorus surpluses are adequately managed. Once they exist, problems with intensive livestock concentrations cannot be easily tackled.

Wherever lack of awareness is causing the inefficient use of phosphorus, information and knowledge transfer via education and extension, possibly combined with temporary incentives, can address this part of the problem.

5.3.2 Lack of Internalization of costs

In many cases unsustainable use of phosphorus is not based on unawareness but on mere economic expediency. Extravagant use of phosphorus may be motivated by serious concerns about yield depressions in animals and crops under specific circumstances whose incidence cannot be easily foreseen. This may stimulate a liberal use of phosphorus as a kind of insurance. Users of phosphorus may also believe that the quality of waste-based phosphorus fertilizers will be low, and resort to rock-based phosphorus fertilizers instead. Evidently, the price of rock-based fertilizers and feed additives, is still low enough to enable business as usual to continue. More efficient mining and beneficiation techniques, alternative sources of phosphorus and alternative fertilizer use and feeding regimes for animals, simply do not yet pay off under all circumstances, despite local examples which appear to prove the opposite. Examples of practices which have worked on a local level but are yet to attain a more widespread appeal include documented differences in extraction efficiencies of phosphate rock, fertilizer placement techniques, phase feeding of pigs, production of fertilizers based on human urine. The abundant use of phosphorus is partly promoted by its relatively low price. After all, the use of phosphorus is associated with typical externalities, i.e. with traded-off costs imposed on parties for which the user is not charged by an effective market. Examples of these externalities are the missed (future) yields of fields in need of phosphorus and the environmental impact of its use (Pretty *et al.*, 2003).

The costs associated with the negative effects of unsustainable phosphorus use should be internalized to ensure that those who decrease the opportunities for others pay an appropriate price.

5.3.3 Economic measures

As indicated, the loss of water quality as a result of pollution is an obvious example of an externality. If agricultural land use with phosphorus inputs is the trigger for a loss of water quality then phosphorus surplus, phosphorus soil status, phosphorus emissions and phosphorus concentrations can act as the intermediate links between trigger and response. In this way they can provide numerous points of intervention to internalize the costs and to improve the efficiency of phosphorus use. Internalization can be achieved by taxation, fees, tax relief or through grants - the difference between these four types of measures being to a certain extent semantic. Another form of internalization is represented by the imposition of a global or regional quota on an input or an output (e.g. an emission right) followed by the creation of a market where producers can buy allowances (i.e. permissions) at the expense of the rights of others.

If emission is the problem, it seems preferable to choose a parameter that is indicative of that very aspect of the process. However, indicators do not just need to be effective, they must also be efficient (value to be determined at low costs relative to the accuracy of the measurement), attributable (addressing the party causing the emission), responsive (quickly reflecting changed behavior) and integrative (encompassing various societal goals simultaneously to reduce the costs and administrative burdens) all at the same time. It seems utopian to identify such an indicator, so there is no ideal point of application for economic instruments. Handy and simple indicators are generally not the most effective, or the fairest (Schröder *et al.*, 2004). The concentration of phosphorus in a stream, for instance, is certainly indicative of water pollution. However, measuring it can be relatively costly and it is a problem that responds very slowly to changed management. Besides, it is extremely difficult to identify who is to be held most responsible for the pollution. Conversely, livestock density can be easily and cheaply assessed and is attributable, but is at the same time anything but a refined predictor of who is responsible for the phosphorus concentration in water. So, additional indicators somewhere in between 'livestock density' and 'phosphorus concentration in water' are apparently needed.

If all inputs, regardless of their origin, were taxed to discourage excessive use, this would deny the support for inputs originating from recycled 'wastes'. Moreover, the potential loss of phosphorus is determined by the discrepancy between inputs and agricultural outputs (the surplus), rather than by just inputs. There is little point, however, in a low phosphorus surplus per unit area if the price paid for that would be an increased demand for land to produce a required volume of crops. From that perspective it would be better to stimulate and reward production systems with a low surplus per unit output - that is, a high use efficiency ($\text{surplus} / \text{output} = (1 / (\text{output} / \text{input}) - 1)$).

When designing economic instruments, due attention should also be given to unwanted side effects. A unilateral tax on just mineral fertilizer phosphorus, for instance, could make livestock farmers decide to compensate for that by importing more feed concentrates rich in phosphorus. On a global level, this could negate the positive effects of such a tax, particularly if the production of these concentrates is based on crops that were grown abroad with untaxed mineral fertilizer phosphorus. However, if a tax on mineral fertilizer phosphorus would make arable farmers substitute mineral fertilizer with excess manure from neighbouring livestock farmers, taxing could certainly contribute to better balanced regional inputs and outputs of phosphorus, unless the excess manure was industrially processed back into mineral fertilizer phosphorus. The above examples illustrate the complexity of the issue. Figure 5-1 and Table 5-1 show the numerous points of application and the even more numerous combinations of points.

If the ultimate aim is to promote recycling of phosphorus, to reduce the surplus of phosphorus per unit area, to improve its use efficiency, and discourage the excessive use of phosphorus in general, economic instruments should ideally be simultaneously directed at several aspects, that is at inputs and at surpluses both per unit area and per unit produce.

Table 5-1. *Examples of potential price-based economic instruments aiming at different aspects of sustainable use of phosphorus.*

Aspect	Example of instrument	Target stakeholder/ sector
Reduction of the phosphorus surplus per unit area	Incentive directed at removing yield-reducing and yield-limiting factors other than P (e.g. pest control or soil quality improvement could stimulate yield and hence P off-take)	Agriculture sector, farmers, fertilizer producers and distributors
	Subsidy / tax relief on soil sampling, followed-up by fertilizer plans enabling farmers to reduce P inputs	
	Subsidy / tax relief on manure storage capacity, on sophisticated P application equipment, on erosion control	
	Subsidy / tax relief on using feed low in P and phytase addition to feed	
	Subsidy / tax relief on manure export	
	Subsidy on manure processing (fertilizer production from manure)	
	Tax on phosphate rock-based inputs	
	License to produce (e.g. livestock proportional to arable area)	
Recycling of phosphorus	Subsidy / tax relief on source separation systems and waste-based inputs	Water and wastewater service providers, councils, residents Food processors, food consumers
	Charging agricultural outputs with a deposit intended for recycling the P removed with the outputs	
	Examples of issues which specific subsidies could address: <ul style="list-style-type: none"> • use of Al instead of Fe to precipitate P in waste water treatment plants • use of renewable phosphorus fertilizer (from recovered phosphorus) instead of rock-based fertilizers • include recovered phosphorus (such as struvite, urine) in the list of approved EU fertilizers (subject to minimum quality standards) • reuse of slaughter waste in agriculture instead of using bones for China porcelain 	
Others	Tax on unessential uses of phosphate rock i.e. for purposes for which alternatives are available, unlike the production of food	Non-food phosphorus sector; consumers of non-food P goods
	Tax on phosphorus-intensive crop-based bio-energy consumption	
	Tax on phosphorus-intensive meat and dairy consumption	
	Tax relief for those who decide to restrict their family size	

5.3.4 Regulatory measures

Economic measures can move behavior in the desired direction but are not by definition prohibitive, since people can simply decide to pay the taxes and fees or decline the taxes reliefs and subsidies. Authorities can decide to cut off these escape routes via regulatory measures. Examples of these measures include:

- The introduction of minimum target values (e.g. for phosphorus use efficiency, for the recovery fraction of phosphorus from 'wastes'),
- Thresholds (e.g. for phosphorus application rates, phosphorus soil surpluses per unit area or produce, livestock density), or
- Bans (e.g. on the use of iron to precipitate phosphorus from waste water).

Future directives could even consider prohibiting the use of phosphorus for any purpose other than safeguarding food security, as long as phosphate reserves are to be seen as finite and a substantial fraction of the world population suffers from famine and malnutrition.

As far as the reuse of phosphorus in the sanitation sector is concerned, there are plenty of examples from sustainable resource use policies in other sectors (Cordell *et al.*, 2009a). Substantial progress has been made in the materials and waste management sector within the EU, most notably EU directives based on Extended Producer Responsibility (EPR) (such as EU Directive for WEEE¹⁶ and EU Directive for End-of-Life Vehicles (European Commission, 2000a). Such directives require valuable substances in end-of-life products (such as cars, computers, copper pipes, beverage bottles) to be captured and reprocessed directly after use, for reuse in production and manufacturing in new products or for harmful substances (such as mercury) to be substituted by safer alternatives (OECD, 2001). Such mechanisms extend the responsibility for recovery (or removal of harmful substances) up the commodity chain to include producers and other actors rather than the cost being borne by taxpayers and the public sector at the end of the commodity chain. Such EPR mechanisms in the sanitation sector could involve the pharmaceutical and chemical industries in the recovery of pollutants, or avoidance of the growing number of micro-pollutants (in pharmaceuticals, endocrine disruptors and other manufactured chemicals) found in urine and wastewater that originate from industrial products. Such substances (in the order of 50,000 in number) can either contaminate receiving land or water, or in many cases render the excreta/sewage too contaminated or uneconomic to productively reuse. EPR instruments could address the responsibility of the chemical and pharmaceutical industries to better control the products they manufacture and sell, whilst facilitating the efficient recovery of nutrients like phosphorus for reuse in agriculture. Entrepreneurs, wastewater service providers, local councils and householders could also be involved in the effective recovery of nutrients from urban waste streams (Cordell, 2006; Cordell *et al.*, 2009a).

5.4 Policies directed at more fundamental aspects of phosphorus use

5.4.1 Institutional changes

While improving efficiency within agriculture is perhaps the lowest hanging fruit in the short to medium term, this is essentially trying to optimize a fundamentally flawed system. It only buys us time. More fundamental changes will be required in the longer term to ensure a sustainable phosphorus future. As indicated earlier, there is little or no effective governance of the use of phosphorus. Improved institutional arrangements (including the assignment of new actors and/or clearly defined stakeholder roles and responsibilities) will be required to raise awareness and engage all key stakeholders (including parties without a voice, future generations, and other living creatures) (Cordell *et al.*, 2009a). There is still a need to build broad consensus on key issues and goals and hence there is a pressing need for an open dialogue between different stakeholder groups (Cordell, 2010).

Policy-makers will need to initiate the establishment of a representative platform to facilitate effective governance of phosphorus. To be effective and influential, such a body would need to be trusted by key stakeholders (including industry and the civil society) and have a sense of authority and legitimacy. Further, the tasks and outcomes of this body, such as the independent monitoring of phosphorus resources, the provision of data and the analysis of future trends, should be transparent and publicly available.

¹⁶ Waste Electricals and Electronic Equipment (Directive 2002/96/EC)
http://ec.europa.eu/environment/waste/weee/index_en.htm

Some priorities of the platform could include (Cordell, 2010):

- Setting clear goals for phosphorus security, including instruments to implement or operationalize agreed-to goals;
- Identification of most appropriate policy instruments for sustainable phosphorus use that will need to address: phosphate rock scarcity, environmental protection, food security and farmer security;
- Identification of key actors, such as farmers, the fertilizer industry, the food sector, environmental protection authorities, water and wastewater service providers, and solid waste managers
- Clear roles and responsibilities for key stakeholders at the global, EU, and national levels. That is, to clarify where the responsibility for different aspects of phosphorus security might lie. For example, what is the role of the FAO regarding global phosphorus scarcity? What responsibilities do the fertilizer industry and EU-Member policy-makers have? What role can scientific networks play?

5.4.2 Reforming agriculture

Extensification or intensification

Modern agriculture as it can be found in most parts of Europe is deemed to be efficient compared to the past and compared to less developed continents. 'Efficient use of nutrients' is easily misinterpreted as being 'clean' or 'sustainable'. The local loss of a nutrient in kilograms is determined by the mathematical product of hectares, the nutrient inputs per hectare, and the inefficiency of their use.

(that is: $\text{loss} = \text{hectares} \times (\text{input/hectare}) \times (1 - (\text{output/hectare}) / (\text{input/hectare}))$)

So, the impact of losses can still be substantial if a highly efficient use is associated with a high input level and/or many hectares.

It is difficult to judge whether European production systems should be extensified or intensified. From the perspective of resource use efficiency (land, water, labor, energy) and wildlife conservation, intensification seems the way forward. However, from the perspective of local environmental quality requirements, including farmland biodiversity and 'wholeness', integrated water resource management and ecosystems services, there is a need for extensification. This is probably more applicable in Western Europe than in Eastern Europe. Additional research is needed to support decisions on the optimal position on this axis in view of phosphorus use efficiency (Schröder and Bos, 2008).

Due attention needs to be paid to externalizations when evaluating alternative systems. By a partial externalization of specific farm processes - that is, by reducing the system boundaries, the remaining system may appear to have increased its efficiency (Schröder *et al.*, 2003). A landless livestock farm, for instance, exporting all its manure may seem very efficient as it will, theoretically, only be losing some gaseous nitrogen. Similarly, a stockless arable farm using no more phosphorus mineral fertilizer than the amount of phosphorus exported in produce also has a high efficiency. Nitrogen and phosphorus losses and hence the inefficiencies associated with preceding processes (e.g. fertilizer manufacturing, feed production) or subsequent processes (e.g. recycling of manure, processing and consumption of food and feed) are obscured by the administrative disruption of systems into subsystems, in contrast to what the situation was like in pre-industrial times.

Organic farming

Overall sustainable use of phosphorus requires a better adjustment of inputs to outputs, care for and maintenance of the soil quality, a full recycling of nutrients from industries and urban areas, and minimizing the use of finite resources such as phosphate rock. It is useful to examine the role organic farming may have in contributing to this as the above aim incorporates partly the aims of the organic movement. (IFOAM, 2010).

The essential elements of the organic plant production management system are soil fertility management, choice of species and varieties, multiannual crop rotation, recycling organic materials and cultivation techniques.

EU organic farming legislation (EU, 2007) foresees that the fertility and biological activity of the soil shall be maintained and increased by multiannual crop rotation including legumes and other green manure crops, and by the application of livestock manure or organic material, both preferably composted, from organic production. The use of sewage sludge is not allowed but organic manure is permitted at levels of up to 170 kg nitrogen per hectare per year.

At a general level, the inputs of phosphorus in organic agriculture may be lower than in conventional agriculture, but organic agriculture is often just as out of balance with outputs as conventional agriculture (Watson *et al.*, 2002). Organic farming systems can show phosphorous surpluses and deficits depending on management (Stockdale *et al.*, 2001). Surpluses of phosphorus may, for instance, occur when lack of nitrogen limits crop growth. When solid organic manure is the main fertilizer this can occur due to the imbalance between nitrogen and phosphorus in these types of manure (Schröder, 2005). Phosphorus exported in organic produce to industries and urban areas generally does not return to organic farms, because of the difficulties associated with keeping organic waste flows separated from conventional flows, making them unsuitable as a certified organic input.

In addition to EU legislation regarding organic farming, India (Department of Commerce, 2005) and Australia (Organic Federation of Australia, 2005) and other regions do not permit the inclusion of fertilizers based on human excreta/wastewater, due to the perception of the potential heavy metal or pathogenic content. Instead, the phosphorus outputs from organic farms may be compensated with permitted fertilizer inputs derived from crushed phosphate rock, phosphorus imported in organic livestock feed, or manures and bedding material from neighbouring extensive farms. This export can deplete phosphorus soil fertility that may have been built up in a conventional past before the conversion to organic farming. A balanced fertilisation regarding phosphorus is thus a challenge on many organic farms worldwide and, as organic farming further develops and trade in organic products grows, this challenge will grow.

As for the more theoretical considerations, it is worth noting that the loss of phosphorus is to a limited extent an inevitable by-product of agricultural land use. Efficiency of use is thus an additional problem to be overcome due to the extra land requirements associated even with very well managed organic farming. From this point of view it is relevant to note that at least 25 per cent more land is needed to produce a certain diet via perfectly managed organic agriculture than via perfectly managed conventional agriculture. This additional land consumption is due to the less intensive control of pest and diseases (despite wider crop rotations and support of natural enemies), a lack of sufficient nitrogen or the extra land needed to grow sufficient nitrogen-fixing green manures (Stockdale *et al.*, 2001; Trewavas, 2001; Kirchmann & Ryan, 2005; Goulding & Trewavas, 2009).

Organic agriculture, in common with extensive systems of livestock production, encourages livestock to range freely rather than being confined; a trade-off from a phosphorus use efficiency perspective is that the unevenly and superficially deposited manure-phosphorus excreted outdoors may be exposed to a larger risk of losses than the phosphorus collected from confined animals on the assumption that such manure in slurry or more solid form is evenly applied under more appropriate weather conditions. However, in reality nongrazing may be confounded with factors that increase rather than reduce the risk of P loss such as large inputs of P in the form of imported feeds and inappropriate spreading while in the longterm grazing manure deposit patterns will tend to even themselves out, except for places where grazing animals tend to cluster in search of water, lee or shadow.

Despite the possible balance issues, organic farming has a very long history of sustainability. How, then, has it some of its less regulated predecessors been able to feed human populations for so many centuries? The reason would seem to be that, in the past, losses of phosphorus have been compensated by small but constant inputs of phosphorus through weathering, atmospheric deposition and flooding, as well as the phosphorus brought home by livestock allowed to graze on range land during daytime hours. This system with inherent low yields could sustain itself within the boundaries of a limited human population size and modest dietary aspirations. Mineral fertilizers disrupted this delicate balance as they allowed the population to grow, to adopt a more affluent diet, and to disconnect from phosphorus flows that used to replenish the phosphorus reserves of arable land (Duncan Brown, 2003).

However, some of the principles of organic agriculture could and should be a beacon for the use of phosphorus in any system that intends to become sustainable. This applies in particular to the use of tillage and cultivation practices that maintain or increase soil organic matter and water retention, prevent soil erosion and compaction, and enhance the soil structure. Johnston & Dawson (2010), for instance, showed that a good soil structure can reduce the need for a high phosphorus soil status. The promotion of soil life may also play a role in the maintenance of a good soil structure. However, there is no evidence that resources are more efficiently used in the presence of an abundant soil life (Langmeijer *et al.*, 2002; Nett *et al.*, 2010). Outside organic farming, sustainable use of phosphorus would require a smart combination of these principles of organic agriculture with external inputs such as environment-friendly technology and agro-chemicals in the development of approaches to feed the growing world population.

5.4.3 Facilitating recycling

Only a very small fraction of the phosphorus exported from farms via processing industries, markets and our bodies, to our urine and feces, is returned to agriculture (Evans, 2008; Richards and Dawson, 2008). So even if inputs at the farm level were accurately tuned to outputs, the use of phosphorus is still unsustainable as long as it involves permanent reliance on fossil-based mineral phosphorus instead of recycled phosphorus. The finiteness of phosphate rock reserves makes the full recycling of phosphorus eventually necessary. Theoretically, some losses are to be permitted as long as these losses keep pace with the natural regeneration rate of new phosphorus reserves. Current demand for phosphorus far exceeds this regeneration rate.

Policy makers will need to facilitate the establishment of handling systems that ensure that the contamination of industrial and urban residues with heavy metals, pharmaceuticals, hormones and infectious bacteria is kept within acceptable levels (Vinneras *et al.*, 2008).

Policy makers will also need to explicitly promote techniques that not only recover phosphorus from wastes (to avoid pollution) but efficiently convert this phosphorus into renewable phosphorus fertilizers, as an effective alternative to rock-based fertilizer.

To ensure that phosphorus-containing wastes can be re-used as fertilizers or as a feedstock for fertilizer production, policy makers will need to discourage the establishment of waste handling systems that make wastes unattractive or even unsuitable for that purpose.

The use of iron for the precipitation of phosphorus from waste water, for instance, can negatively affect the plant availability of phosphorus when the resulting precipitates are used as a fertilizer. Farmers in turn should be encouraged to use phosphorus recovery from 'wastes' instead of fertilizers based on fossil reserves, via smart combinations of penalties and incentives. As far as potential cultural barriers to reusing human excreta are concerned, there are quite promising results obtained for example in Switzerland. Both consumers (Pahl-Wosti *et al.*, 2003) and farmers (Lienert *et al.*, 2003) appear to have few hesitations in accepting human urine as an alternative phosphorus source.

The need for full recycling, may also require policy makers to re-evaluate how we have presently segregated the production, processing and consumption of crop products (Duncan Brown, 2003). The answer to this type of question is not obvious. One could argue, for instance, that urbanization has on the one hand frustrated recycling due to increased transport distances and the consequent energy consumption. Urbanization has on the other hand supported the establishment of efficient collection systems for residues including human excreta, although they lack in quality due to the mixed fractions. Many of these collection systems use considerable amounts of greywater, flush water and even stormwater. Once diluted with water, it becomes more expensive to recover the phosphorus.

5.4.4 Population size and consumption patterns

A fundamental driver for consumption intensity is population size. This truth applies as much to phosphorus consumption as it does to anything else, implying that one cannot get around answering questions about the carrying capacity of the planet. The total number of people, multiplied by an average of all their consumption patterns, cannot exceed this carrying capacity in the long term, particularly now that growing numbers of people are putting more meat, dairy and bio-energy on their personal shopping lists. For the time being every human and his or her political representatives could at least question activities promoting the consumption of meat, dairy and energy, as these have direct and indirect effects on the demand for phosphorus. Self-evidently, the size of the global population has an effect on phosphorus demand and phosphorus losses as well, so eventually family planning could become a necessary part of personal decisions and policies too.

5.5 Research recommendations

The implementation of 'no regret' measures does not have to wait until the final word has been said about them. Decisions on the fine-tuning and prioritization of measures and policies, however, are still in need of additional research. The most urgent themes are listed below:

- Independent collection and monitoring of baseline data for phosphate rock reserves and trade
- Country-level analyses of phosphorus inputs and phosphorus outputs to identify the most effective measures and policies *in situ* - see Appendix I for an outline of the required methods. Such analyses would need to determine context-specific priority issues, especially for phosphorus-vulnerable regions (that have a phosphorus pollution problem, are highly dependent on phosphorus imports, or have phosphorus-deficient soils)
- Analysis of the financial and energetic cost-effectiveness (comparing food production based on phosphorus from mineral sources to phosphorus recovered from alternative sources), following the LCA principles as presented in <http://lca.jrc.ec.europa.eu/lcainfohub/lcaPage.vm>
- Analysis indicating what kind of financial incentives, grants, taxes or fees would be needed to stimulate or sustain a more sustainable use of phosphorus
- Analysis of the different phosphorus fertilizer recommendations schemes used throughout Europe,
- Analysis of the resource-use efficiency, including that of phosphorus, of the ways that societies spatially organize the production, processing and consumption of food in view of transport distances (long-distance 'global trade' vs. local 'peri-urban')
- Updating of the heavy metal balances associated with food production systems that are either based on rock phosphate-based phosphorus fertilizers or on waste-based phosphorus fertilizers
- Evaluation of the potential for improved solid waste and sanitation systems to provide sound recycled P resources
- Analysis of possible conflicts between recovery techniques needed to remove phosphorus from waste water from a water quality point of view and the techniques needed to ensure that the recovered phosphorus has an agronomic value (e.g. flocculation based on either Fe or Al),
- Scenarios of various governance system alternatives need to be explored.

Research and analysis is likely to have greater influence if key stakeholders are included in the co-generation of knowledge for improved governance. For example, international stakeholder deliberation to build a platform for stakeholder dialogue could increase the research and policy outcomes by: a) reality-checking and contributing to data collection and scenario development and analysis, b) further developing or refining the phosphorus security goals and potential objectives of a EU directive of phosphorus use and c) contributing to consensus-building given the current institutional fragmentation and lack of consensus among the key international stakeholders.

5.6 Conclusion

This chapter has identified short-term and long-term policies to improve the current level of phosphorus use efficiency in agriculture. In addition we have argued that policies should not be developed in isolation, but that primary production and the subsequent processing and consumption of food and feed should be addressed in an integrative way. To become truly sustainable, phosphorus use efficiency in each of these chains must become close to 100%. Therefore, a full recycling of phosphorus will in the long run become a condition *sine qua non* for global food security, thus avoiding 'hard landings'. The urgency of policies and measures needed for that will be determined by the phosphate rock reserves considered exploitable, the prevention of accumulation and losses, the size of the global population and its preferences in terms of food, feed, fibers and fuels, and its appreciation of biodiversity. This will require drastic adjustments to the way we manage agriculture, and it may also require adjustments to our society as a whole, including the processing of our 'wastes'.

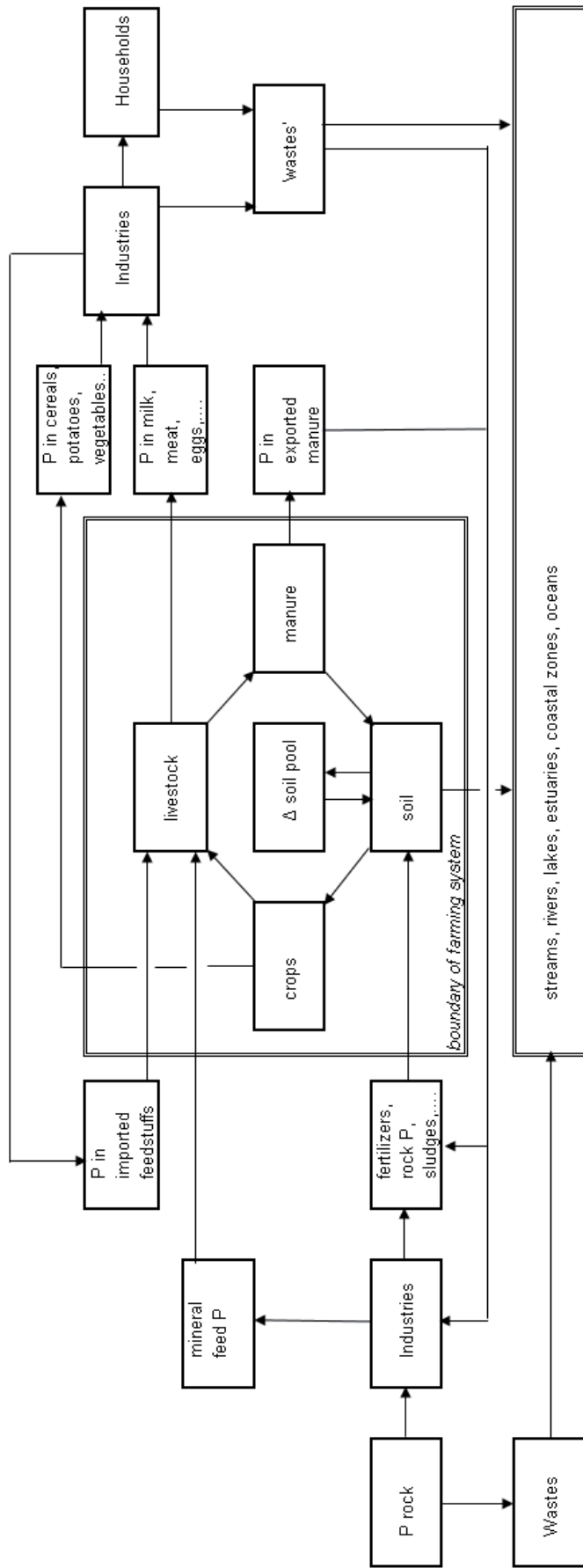

Figure 5-1. Phosphorus fluxes within and across the boundaries of farms, industries and households.

6. References

- Abey Suriya, K.R., 2008.
A Pathway to Sustainability in Urban Sanitation for Developing Asian Countries, Doctoral thesis, Doctor of Philosophy in Sustainable Futures, Institute for Sustainable Futures, University of Technology, Sydney (UTS), Sydney.
- ABIOVE, 2005.
Soya vision. Presentation by C. Lovatelli at the IASC Congress Mumbai 2005. Brazilian Vegetable Oil Industries Association - ABIOVE, São Paulo.
- Adam, C., G. Kley, F.G. Simon & A. Lehmann, 2008.
Recovery of nutrients from sewage sludge - Results of the European research-project SUSAN. *Water Practice and Technology* 3(1).
- Ahmed, H., H. Diamonta, C. Chaker & R. Abdelhamid, 2007.
Purification of wet process phosphoric acid by solvent extraction with TBP and MIBK mixtures. *Separation and Purification Technology* 55: 212-216.
- Alvarez-Cobelas, M., A. Rubio-Olmo & P. Munoz-Ruiz, 1992.
Eutrophication in Spanish freshwater ecosystems, 1992. *Limnetica* 8: 263-266.
- Anonymous, 2005.
Millennium Ecosystem Assessment. Chapter 12: Nutrient Cycling, Volume 1: Current State and Trends, Global Assessment Reports, Millennium Ecosystem Assessment,
<<<http://www.millenniumassessment.org/documents/document.281.aspx.pdf>>>.
- Anonymous, 2007.
United Nations: The 2006 Revision Population base. <http://esa.un.org/unpp/>.
- Ashley, K., D. Mavinic & F. Koch, 2009.
A Brief History of Phosphorus Use and Abuse: from the Philosophers Stone to Nutrient recovery And Re-use. Presentation at the International Conference on Nutrient Recovery from Waste water Streams, May 11, 2009 Vancouver Canada.
- Asimov, I., 1974.
Asimov on Chemistry, Doubleday.
- Baker, D., J. Fear & R. Denniss, 2009.
What a waste: An analysis of household expenditure on food. The Australia Institute. Policy Brief No. 6. November 2009.
- Barnard, J.L., 2009.
Elimination of eutrophication through resource recovery, International Conference on Nutrient Recovery from Wastewater Streams. Edited by Ken Ashley, Don Mavinic and Fred Koch. ISBN: 9781843392323. Published by IWA Publishing, London, UK.
- Beare, M.H., P.H. Williams & K.C. Cameron, 1999.
On-farm monitoring of soil quality for sustainable crop production. In: Proceedings of the 1999 Fertilizer and Lime Research Centre Conference, Massey University, Palmerston North, New Zealand, 81-90.
- Berenguer, P., F. Santiveri, J. Boixadera & J. Lloveras, 2008.
Fertilisation of irrigated maize with pig slurry combined with mineral nitrogen. *European Journal of Agronomy* 28: 635-645.
- Beukeboom, L., 1996.
Kiezen uit gehalten. IKC Ede , 22 p.
- Binder, C.R., L.d. Baan & D. Wittmer, 2009.
Phosphorflüsse der Schweiz. Stand Risiken und Handlungsoptionen. Abschlussbericht. Umwelt-Wissen nr. 0928. Bundesamt für Umwelt Bern. 161 pp. (www.umwelt-schweiz.ch/uw-0928-d).
- Birkmose, T.S., 2009.
Nitrogen recovery from organic manures: improved slurry application techniques and treatment: the Danish scenario. Proceedings 656. International Fertiliser Society, York, UK, 1-24.

- Bittman, S., C.G. Kowalenko, D.E. Hunt, T.A. Forge & X. Wu, 2006.
Starter phosphorus and broadcast nutrients on corn with contrasting colonization by mycorrhizae. *Agronomy Journal* 98: 394-401.
- Blair, D., 2008.
Green revolution needed to feed the poor: UN. New York. Available:
<http://www.smh.com.au/articles/2008/05/19/1211182703408.html> Sydney Morning Herald,.
- Britton, A., R. Prasad, B. Balzer & L. Cabbage, 2009.
A Brief History of Phosphorus Use and Abuse: from the Philosophers Stone to Nutrient Recovery and Re-use. Presentation at the International Conference on Nutrient Recovery from Wastewater Streams, May 11, 2009 Vancouver, Canada, Edited by Don Mavinic, Ken Ashley and Fred Koch. ISBN: 9781843392323. Published by IWA Publishing, London, UK
- Cakmak, I., 2002.
Plant nutrition research: priorities to meet human needs for food in sustainable ways. *Plant and Soil* 247: 3-24.
- Chancerel, P. & V.S. Rotter, 2009.
Stop wasting gold - How a better mining of end-of-life electronic products would save precious resources Davos, Switzerland, World Resources Forum, 16th September, 2009.
- Chisti, Y., 2007.
Biodiesel from microalgae. *Biotechnology Advances* 25(3): 294-306.
- Clark, R.B., 1997.
Optimum Scale for Urban Water Systems, South Australian Department of Environment and Natural Resources. CNCIC, 2002.
(China National Chemical Information Center) China chemical industry yearbook (2001-2002). Beijing, China.
- Cook, D.B. & J.M. Kalbermatten, 1982.
Prospects for Resource Recovery from Urban Solid Wastes in Developing Countries. In *Proceedings Regional Seminar on Solid Waste Management* (Ed. G. Tharun), pp 267-273, Asian Institute of Technology, Bangkok.
- Cordell, D., 2006.
Urine Diversion and Reuse in Australia: A homeless paradigm or sustainable solution for the future?. February 2006. Masters Thesis, Masters of Water Resources & Livelihood Security, Department of Water & Environmental Studies, Linköping University. Available from:
<<http://www.ep.liu.se/undergraduate/abstract.xsql?dbid=8310>>.
- Cordell, D., 2008.
The story of phosphorus: missing global governance of a critical resource. Paper prepared for SENSE Earth Systems Governance, Amsterdam, 24th - 31st August.
- Cordell, D., 2010.
The Story of Phosphorus: Sustainability implications of global phosphorus scarcity for food security, Doctoral thesis. Collaborative PhD between the Institute for Sustainable Futures, University of Technology, Sydney (UTS) and Department of Water and Environmental Studies, Linköping University, Sweden. Linköping University Press, ISBN 978-91-7393-440-4, Linköping.
- Cordell, D., J.-O. Drangert & S. White, 2009a.
The story of phosphorus: Global food security and food for thought. *Global Environmental Change* 19: 292-305.
- Cordell, D., T. Schmid-Neset, S. White & J.-O. Drangert, 2009b.
Preferred future phosphorus scenarios: A framework for meeting long-term phosphorus needs for global food demand. Edited by Don Mavinic, Ken Ashley and Fred Koch. ISBN: 9781843392323. Published by IWA Publishing, London, UK, International Conference on Nutrient Recovery from Wastewater Streams Vancouver, 2009.
- Cordell, D. & S. White, forthcoming.
The future of phosphorus: a review of a globally critical resource. *Sustainability* 1 (2009) (ISSN 2071-1050, www.mdpi.com/journal/sustainability).
- Corell, H., 2002.
Letter dated 29 January 2002 from the Under-Secretary-General for Legal Affairs, the Legal Counsel, addressed to the President of the Security Council, United National Security Council, Under-Secretary-General for Legal Affairs The Legal Counsel.

- Correll, D.L., 1998.
The Role of Phosphorus in the Eutrophication of Receiving Waters: a Review. *Journal of Environmental Quality* 27(March-April): 261-266.
- De Clercq, P. & F. Sinabel, 2001.
EU legislation and multinational environmental legislation with respect to nutrient management. In: De Clercq, P., Gertis, A.C., Hofman, G., Jarvis, S.C, Neeteson, J.J., Sinabell, F. (Eds.). *Nutrient Management Legislation in European Countries*. Ghent University, Department of Soil Management and Soil Care, Ghent, Belgium, 15-31.
- De Clercq, P., F. Sinabell, G. Hofman, S.C. Jarvis, J.J. Neeteson & A.C. Gertis, 2001.
Discussion and conclusions. In: De Clercq, P., A.C. Gertis, G. Hofman, S.C. Jarvis, J.J. Neeteson & F. Sinabell (Eds.). *Nutrient Management Legislation in European Countries*, pp 307-343. Ghent, Belgium, Ghent University, Department of Soil Management and Soil Care, 307-324.
- De Willigen, P. & M. van Noordwijk, 1987.
Roots, plant production and nutrient use efficiency. PhD thesis LU Wageningen, 282 pp.
- Department of Commerce, 2005.
National Programme for Organic Production, India Organic, 6th ed. Ministry of Commerce and Industry, New Delhi.
- Dery, P. & B. Anderson, 2007.
13th August 2007. 'Peak phosphorus.' from <http://www.energybulletin.net>.
- Drangert, J.-O., 1998.
Fighting the urine blindness to provide more sanitation options. *Water SA* 24(2).
- Driver, J., 1998.
Phosphates recovery for recycling from sewage and animal waste. *Phosphorus and Potassium* 216: 17-21.
- Driver, J., D. Lijmbach & I. Steen, 1999.
Why Recover Phosphorus for Recycling, and How? *Environmental Technology* Vol 20(Issue 7 July 1999): p. 651-662
- Duncan Brown, A., 2003.
Feed or feed back. International books; ISBN 905727048X.
- EcoSanRes, 2003.
Closing the Loop on Phosphorus. Stockholm, Stockholm Environment Institute (SEI) funded by SIDA: 2.
- EEA, 2009.
Source <http://www.eea.europa.eu/data-and-maps/indicators/urban-waste-water-treatment/urban-waste-water-treatment-assessment-1>. Accessed October 5, 2010.
- EFMA, 2000.
Best available techniques for pollution prevention and control in the European fertilizer industry. Booklet 8: Production of Phosphoric Acid. Belgium, 42p.
- EFMA, 2010.
<http://epp.eurostat.ec.europa.eu/tgm/table.do?tab=table&init=1&plugin=1&language=en&pcode=tag00091>.
- Ehlert, P.A.I., J.C.v. Middelkoop & P.H.M. Dekker, 2006.
Fosfaatgehalten en fosfaatvoer van landbouwgewassen (In Dutch). Rapport 1348, Alterra, Wageningen, The Netherlands, 63 pp.
- Einarsson, H. & W. Emerson, 2009.
International seafood trade: challenges and opportunities. FAO/University of Akureyri Symposium. 1-2 February 2007, Akureyri, Iceland. FAO Fisheries and Aquaculture Proceedings. No. 13. Rome, FAO. 2009. : 121p.
- Elsner, H., 2008.
Stand der Phosphat-Reserven weltweit. Vortrag zum Symposium Ressourcen schonender Einsatz von Phosphor in der Landwirtschaft Braunschweiger Nährstofftage, 10.-11.11.2008.
- Emsley, J., 2000.
The 13th Element: The Sordid Tale of Murder, Fire, and Phosphorus. New York, John Wiley & Sons, 327 pp, ISBN 0-471-39455-6.
- Ericksen, P.J., 2008.
Conceptualizing food systems for global environmental change research. *Global Environmental Change* 18 (2008): 234-245

Eriksson, J., 2009.

Strategi för att minska kadmiumbelastningen i kedjan mark-livsmedel-människa. Uppsala: Sveriges lantbruksuniversitet. Rapport MAT21 nr 1/2009. ISBN: 978-91-86197-26-1.

Esrey, S., I. Andersson, A. Hillers & R. Sawyer, 2001.

Closing the Loop: Ecological sanitation for food security. Mexico, UNDP & SIDA.

EU, 2008.

Commission Regulation 889/2008, detailed rules for the implementation of regulation 834/2007 on organic production and labeling. Official Journal of the European Union L250, 84 pp.

Euronews, 2009.

US and EU go to WTO over Chinese export curbs.

<http://www.euronews.net/2009/06/23/us-and-eu-go-to-wto-over-chinese-export-curbs/>, 23/06/09 21:00 CET

European Commission, 2000a.

Directive 2000/53/EC of the European Parliament and of the Council of 18th September 2000 on End-of-Life Vehicles - Commission Statements, document 300L0053, Official Journal L 269, 21/10/2000.

European Commission, 2000b.

Directive 2000/60/EC of the European Parliament and of the Council of 23 October 2000 establishing a framework for the Community action in the field of water policy. Brussels, Official Journal of the European Communities, December 22, 2000, pp.1-72.

European Commission, 2000c.

EU Water Framework Directive, Directive 2000/60/EC of the European Parliament and of the Council establishing a framework for the Community action in the field of water policy, Official Journal L 327, 22/12/2000 P. 0001 - 0073.

European Commission, 2001.

Disposal and recycling routes for sewage sludge, Part 3 - Scientific and technical report, European Commission, Luxembourg.

European Environment Agency, 2001.

Eutrophication in Europe's coastal waters. Copenhagen, Topic report 7/2001.

European Fertilizer Manufacturers Association, 2008.

Forecast of food, farming and fertilizer use in the European Union 2008-2018. Brussels, EFMA Annual Forecast 2008.

European Union, 2001.

Prevention, control and eradication of transmissible spongiform encephalopathies (TSEs).

<http://europa.eu/legislation_summaries/food_safety/animal_nutrition/f83001_en.htm>

Accessed Aug 31, 2010.

European Union, 2010a.

<http://ec.europa.eu/cyprus/news/20100716_tse_roadmap_en.htm>.

European Union, 2010b.

<http://ec.europa.eu/food/food/biosafety/tse_bse/docs/roadmap_en.pdf>.

Eurostat, 2010.

<http://epp.eurostat.ec.europa.eu/tgm/table.do?tab=table&init=1&plugin=1&language=en&pcode=tsdpc450>.

Evans, T.D., 2008.

Nutrient and carbon recovery from household and food biowastes. Proceedings No 635, International Fertiliser Society, York, UK, 1-24.

FAO, 1999.

Urban and peri-urban agriculture. Rome, Food and Agriculture Organisation of the United Nations,.

FAO, 2005a.

Assessment of the World Food Security Situation. Rome. Available: <http://www.fao.org/docrep/meeting/009/j4968e/j4968e00.htm>, Food and Agricultural Organisation of the United Nations, Committee on World Food Security, 23-26 May 2005.

FAO, 2005b.

The Special Program for Food Security. Available: <http://www.fao.org/spfs>, Food and Agriculture Organisation of the United Nations.

- FAO, 2006.
Plant nutrition for food security: A guide for integrated nutrient management, FAO Fertilizer And Plant Nutrition Bulletin 16. Rome, Food And Agriculture Organization Of The United Nations.
- FAO, 2007.
Current world fertilizer trends and outlook to 2010/11. Rome, Food and Agriculture Organisation of the United Nations.
- FAO, 2008.
High-level conference on world food security: the challenges of climate change and bioenergy. Soaring food prices: facts, perspectives, impacts and actions required, Rome, 3 - 5 June 2008.
- FAO, 2009.
More people than ever are victims of hunger. Press Release, June 2009, Food and Agriculture Organization of the United Nations.
- FAOSTAT, 2010a.
<<http://faostat.fao.org/site/342/default.aspx>>.
- FAOSTAT, 2010b.
<<http://faostat.fao.org/site/567/default.aspx#ancor>>.
- Fealy, R. & J.J. Schröder, 2008.
Assessment of manure transport distances and their impact on economic and energy costs. Proceedings 642, International Fertiliser Society, York, UK, 28 pp.
- Fertilizer Week, 2008.
Industry ponders the impact of China's trade policy, in Thursday Markets Report, 24th April 2008, British Sulphur Consultants, CRU.
- Fishbein, B.K., 2000.
Carpet Take-Back: EPR American Style. In: Environmental Quality Management, John Wiley & Sons, Inc, Volume 10, Number 1, Autumn 2000, p25-36.
- Fixen, P.E., 2009.
World Fertilizer Nutrient Reserves - A View to the Future. Better Crops 9(3): 8-11.
- Fresco, L., 2003.
Plant nutrients: What we know, guess and do not know. Rome, Assistant Director-General, Agriculture Department Food and Agriculture Organization of the United Nations (FAO) IFA/FAO AGRICULTURE CONFERENCE.
- Ganrot, Z., J. Broberg & S. Byden, 2009.
Energy efficient nutrient recovery from household wastewater using struvite precipitation and zeolite adsorption techniques: A pilot plant study in Sweden. International Conference on Nutrient Recovery from Wastewater Streams. Edited by Ken Ashley, Don Mavinic and Fred Koch. ISBN: 9781843392323. Published by IWA Publishing, London, UK.
- Garcia-Ruiz, J., 2010.
The effects of land uses on soil erosion in Spain: a review. Catena 81 (10): 1-11.
- GECAFS, 2006.
Conceptualising Food Systems for Global Environmental Change (GEC) Research. Wallingford, UK, GECAFS Working Paper 2, P.J. Ericksen, ECI/OUCE, Oxford University, GECAFS International Project Office.
- Gerben-Leenes, P.W. & S. Nonhebel, 2002.
Consumption patterns and their effects on land required for food. Ecological Economics 42: 185-199.
- Giller, K.E., M.H. Beare, P. Lavelle, A.-M.N. Izac & M.J. Swift, 1997.
Agricultural intensification, soil biodiversity and agroecosystem function. Applied Soil Ecology 6: 3-16.
- Global Phosphate Forum, 2010.
Perspectives for phosphates in detergents. Phosphates 2010 International Conference, 22-24 March, 2010, Brussels.
- Goulding, K.W.T. & A.J. Trewavas, 2009.
Can organic agriculture feed the world?
http://www.agbioworld.org/newsletter_wm/index.php?caseid=archive&newsid=2894.

- Grant, C., S. Bittman, M. Montreal, C. Plenchette & C. Morel, 2005.
Soil and fertilizer phosphorus: effects on plant P supply and mycorrhizal development. *Canadian Journal of Plant Science* 85 (1): 3-13.
- Grid-Arendal, 2001.
Population density in the Baltic Sea drainage basin.
<http://maps.grida.no/go/graphic/population_density_in_the_baltic_sea_drainage_basin> Accessed Aug 18, 2010.
- Gumbo, B. & H.H.G. Savenije, 2001.
Inventory of phosphorus fluxes and storage in an urban-shed: options for local nutrient recycling, Internet Dialogue on Ecological Sanitation (15 Nov.-20 Dec. 2001), Delft.
- Hammond, J.P., P.J. White & M.R. Broadley, 2007.
Is struvite a valuable phosphate source for agriculture? Final project report, Warwick HRI, University of Warwick, Warwick.
- Heffer, P., 2009.
Assessment of Fertilizer Use by Crop at the Global Level. IFA publication January 2009 (AgCom/09/28).
- Heffer, P. & M. Prud'homme, 2008.
Medium-Term Outlook for Global Fertilizer Demand, Supply and Trade 2008 - 2012. 76th IFA Annual Conference Vienna (Austria), 19-21 May 2008.
- Helcom, 2005.
Nutrient Pollution to the Baltic Sea in 2000, Baltic Sea Environment Proceedings No.100, Helsinki Commission, Baltic Marine Environment Protection Commission [online], available:
http://www.helcom.fi/publications/en_GB/publications/
- Helcom, 2007.
Examples of measures for reducing phosphorus and nitrogen losses from agriculture. Baltic Sea Action Plan.
<http://www.helcom.fi/BSAP/ActionPlan/otherDocs/en_GB/agri_measures/?u4.highlight=fertiliser> Accessed Aug 18, 2010.
- Helcom, 2008.
Spatial Distribution of the Winter Nutrient Pool.
<http://www.helcom.fi/BSAP_assessment/ifs/ifs2008/en_GB/SpatialDistrNutr/> Accessed Aug 18, 2010.
- Helcom, 2009.
Cyanobacterial blooms in the Baltic Sea HELCOM Indicator Fact Sheets 2009.
<http://www.helcom.fi/BSAP_assessment/ifs/ifs2009/en_GB/cyanobacterial_blooms/> Accessed Aug 18, 2010.
- Helsel, Z.R., 1992.
Energy and alternatives for fertilizer and pesticide use. In: Fluck, R.C. (ed) Energy in Farm Production. Vol 6 in Energy in World Agriculture Elsevier. NY., pp. 177-201
- Hermann, L., 2009.
Recovery of phosphorus from wastewater treatment (translated from: Rückgewinnung von Phosphor aus der Abwassereinigung: Eine Bestandaufnahme). Bern, in German (with English summary),
<http://www.bafu.admin.ch/publikationen/publikation/01517/index.html?lang=de&lang=de>, Umwelt-Wissen Nr. 0929. Bundesamt für Umwelt, 196 S.
- Hilton, J., A.E. Johnston & C.J. Dawson, 2010.
The phosphate life-cycle: rethinking the options for a finite resource. Proceedings 668. International Fertiliser Society, York, UK, 44 pp.
- Hooda, P.S., A.R. Rendell, A.C. Edwards, P.J.A. Withers, M.N. Aitken & V.W. Truesdale, 2000.
Relating Soil Phosphorus Indices to Potential Phosphorus Release to Water. *Journal of Environmental Quality* 29: 1166-1171.
- Hubbert, M.K., 1949.
Energy from fossil fuels. *Science* (109(2823): 103.
- IAASTD, 2008.
International Assessment of Agricultural Knowledge, Science and Technology for Development (IAASTD), agreed to at an Intergovernmental Plenary Session in Johannesburg, South Africa in April, 2008, www.agassessment.org.

- IFA, 2000a.
Mineral Fertilizer Distribution and the Environment. International Fertilizer Industry Association and United Nations Environment Programme, by K.F. Isherwood, March 2000, Paris.
- IFA, 2000b.
Mineral Fertilizer Use and the Environment. International Fertilizer Industry Association and United Nations Environment Programme, by K.F. Isherwood, Revised Edition, February 2000, Paris.
- IFA, 2009.
The Global '4R' Nutrient Stewardship Framework - Developing Fertilizer Best Management Practices for Delivering Economic, Social and Environmental Benefits Paris, Paper drafted by the IFA Task Force on Fertilizer Best Management Practices, International Fertilizer Industry Association.
- IFOAM, 2010.
<http://www.ifoam.org>.
- IFPRI, 2002.
Reaching Sustainable Food Security for All by 2020: Getting the Priorities and Responsibilities Right. Washington, International Food Policy Research Institute.
- IFPRI, 2003.
Ending Hunger by 2050: Crucial Investments and Policies. Washington, International Food Policy Research Institute.
- IFPRI, 2005.
IFPRI's Strategy Toward Food and Nutritional Security: Food Policy Research, Capacity Strengthening and Policy Communications. Washington DC, International Food Policy Research Institute.
- IWAR TU-Darmstadt, 2010.
Phosphorus Recovery website. Darmstadt, available: www.phosphorus-recovery.tu-darmstadt.de, Technische Universität Darmstadt, Institut WAR.
- Jasinski, S.M., 2008.
Phosphate Rock, Mineral Commodity Summaries, US Geological Survey, January 2008
<minerals.usgs.gov/minerals/pubs/commodity/phosphate_rock/>.
- Jasinski, S.M., 2009.
Phosphate Rock, Mineral Commodity Summaries, US Geological Survey, January, 2009, available:
http://minerals.usgs.gov/minerals/pubs/commodity/phosphate_rock/mcs-2009-phosp.pdf.
- Johansson, M., 2001.
Urine Separation - Closing the nutrient cycle. Stockholm, Final Report On The R&D Project Source-Separated Human Urine - A Future Source Of Fertilizer For Agriculture In The Stockholm Region? co-authors: Håkan Jönsson, Department of Agricultural Engineering, Swedish University of Agricultural Sciences, Caroline Höglund, Swedish Institute for Infectious Disease Control, and Anna Richert Stintzing and Lena Rodhe, Swedish Institute of Agricultural and Environmental Engineering, prepared for Stockholm Water, Stockholmshem, HSB.
- Johansson, M. & E. Kvarnström, 2005.
A Review of Sanitation Regulatory Frameworks. Stockholm, EcoSanRes, Stockholm Environment Institute (SEI).
- Johnston, A.E. & C.J. Dawson, 2010.
Physical, chemical and biological attributes of agricultural soils. Proceedings International Fertiliser Society 675, York, UK, 1-40.
- Jönsson, H., 2002.
Urine separating sewage systems - environmental effects and resource usage. Water Science and Technology 46(6-7): 333-340, IWA Publishing.
- Jönsson, H., A.R. Stintzing, B. Vinnerås & E. Salomon, 2004.
Guidelines on the Use of Urine and Faeces in Crop Production. Stockholm, EcoSanRes, Stockholm Environment Institute.
- Jordan-Meille, J., 2009.
Comparaison des méthodes de raisonnement de la fertilisation phosphate en Europe: quels diagnostics, pour quelles préconisations? Actes des Rencontres de Blois des 25 et 26 novembre 2009, Journées COMIFER-GEMAS.
- Kantor, L.S., K. Lipton, A. Manchester & V. Oliveira, 1997.
Estimating and addressing America's food losses. Food Review: Food Loss (January - April), 2-12.

- Keane, E., 2009.
Taking Stock of Phosphorus and Biofuels, Seeking Alpha (<http://seekingalpha.com/article/182522-taking-stock-of-phosphorus-and-biofuels>).
- Kippenberger, C., 2001.
Materials flow and energy required for the production of selected mineral commodities. Hanover, Germany: Bundesanstalt für Geowissenschaften und Rohstoffe.
- Kirchmann, H. & S. Pettersson, 1995.
Human urine - Chemical composition and fertilizer use efficiency. *Fertilizer Research* 40(2): 149-154.
- Kirchmann, H. & M.H. Ryan, 2005.
Nutrient exclusivity in organic farming-does it offer advantages? *Better Crops* 89 (1), 24-29.
- Kongshaug, G., 1998.
Energy consumption and greenhouse gas emissions in fertilizer production. Proceedings IFA Technical Conference Marrakech Sept. 28-Oct 1 1998, 18p.
- Langmeier, M., E. Frossard, M. Kreuzer, P. Mäder, D. Dubois & A. Oberson, 2002.
Nitrogen fertilizer value of cattle manure applied on soils originating from organic and conventional farming systems. *Agronomie* 22, 789-800.
- Laegreid, M., O.C. Böckman & O. Kaarstad, 1999.
Agriculture, Fertilizers and the Environment. CAB International Publishing, Wallingford, UK, 294 pp.
- Lauriente, D.H., 2003.
Phosphate rock. MenloPark, CA: Stanford Research Institute.
- Letey, J., R.E. Sojka, D.R. Upchurch, D.K. Cassel, K.R. Olson, W.A. Payne, S.E. Petrie, G.H. Price, R.J. Reginato, H.D. Scott, P.J. Smethurst & G.B. Triplett, 2003.
Deficiencies in the soil quality concept and its application. *Journal of Soil Water Conservation* 58: 180-187.
- Lienert, J., M. Haller, A. Berner, M. Stauffacher & T.A. Larsen, 2003.
How farmers in Switzerland perceive fertilizers from recycled anthropogenic nutrients (urine). *Water Science and Technology* 48 (1): 47-56.
- Liu, Y., 2005.
Phosphorus flows in China: Physical profiles and environmental regulations PhD thesis Environmental Policy Group, Dept. Soc. Sci, Wageningen University, Wageningen The Netherlands.
- Liu, Y., G. Villalba, R.U. Ayres & H. Schroder, 2008.
Global phosphorus flows and environmental impacts from a consumption perspective. *Journal of Industrial Ecology* 12(2): 229-247.
- Lott, J.N.A., M. Bojarski, J. Kolasa, G.D. Batten & L.C. Campbell, 2009.
A review of the phosphorus content of dry cereal and legume crops of the world. *International Journal of Agricultural Resources, Governance and Ecology* 8(5-6): 351-370.
- Louwagie, G., S.H. Gay & A. Burrell, 2009.
Sustainable agriculture and soil conservation (SoCo); final report. JRC Scientific and Technical Reports EUR 23820EN, Ispra, Italy, 171 pp.
- Lundqvist, J., C.d. Fraiture & D. Molden, 2008.
Saving Water: From Field to Fork - Curbing Losses and Wastage in the Food Chain, SIWI Policy Brief. Stockholm, Stockholm International Water Institute,.
- Matsui, S., 1997.
Nightsoil collection and treatment in Japan. Drangert, J-O., Bew, J. and Winblad, U. (eds.) *Ecological Alternatives in Sanitation. Publications on Water Resources: No 9*. Sida, Stockholm.
- Maurer, M., in press.
The influence of uncertainty on costs of water infrastructure. ch.2.5 in *Wastewater Management: Source Separation and Decentralization*. Eds. T. Larsen, K. Udert, & J Lienert, IWA Publishing.
- Mavinic, D., K. Ashley & F. Koch, Eds., 2009.
Proceedings from the International Conference on Nutrient Recovery from Wastewater Streams Vancouver, 2009, www.nutrientrecovery2009.com. London, IWA Publishing, ISBN: 9781843392323.
- McGarrigle, M., 2009.
Characterisation of Water Bodies in Ireland in relation to Agricultural Pressures. *Tearmann* 7: 35-50.

- Microfert, 2009.
Microfert - Powered by Nature. www.microfert.com.au, Microfert Pty. Ltd.
- Milieu Ltd, WRc and RPA, 2009.
Environmental, economic and social impacts of the use of sewage sludge on land. Summary report 1. Assessment of Existing Knowledge. Study contract DG ENV.G.4/ETU/2008/0076r: 52 pp.
- Millennium Ecosystem Assessment, 2005a.
Chapter 12: Nutrient Cycling, Volume 1: Current State and Trends, Global Assessment Reports, Millennium Ecosystem Assessment, <<http://www.millenniumassessment.org/documents/document.281.aspx.pdf>>.
- Millennium Ecosystem Assessment, 2005b.
Ecosystems and Human Well-being: Synthesis. Washington, DC., Island Press,.
- Mitchell, C., 2008.
Restorative water: beyond sustainable. Waste Management and Environment Magazine July 2008: 20-21.
- Mitchell, C., D. Fam & D. Cordell, in press.
Effectively managing the transition towards restorative futures in the sewage industry: a phosphorus case study. IWA Publishing, In 'Institutional Issues and Innovations' (ed) V Nelson, S Moddemeyer, J Stonebridge.
- Neeteson, J.J., J.J. Schröder, A.L. Smit, J.F.F.P. Bos & K. Verloop, 2006.
Need and opportunities to reduce phosphorus inputs, soil supply and loss from agriculture in the Netherlands. Proceedings no 595, Paper presented to the International Fertiliser Society at a Conference in Cambridge on 15 th December 2006, Cambridge, The International Fertiliser Society.
- Nett, L., S. Aversch, S. Ruppel, J. Rühlmann, C. Feller, E. George & M. Fink, 2010.
Does long-term farmyard manure fertilization affect short-term nitrogen mineralization from farmyard manure? Biol. Fertil. Soils 46, 159-167.
- Neyroud, J.A. & P. Lischer, 2003.
Do different methods to assess soil phosphorus availability across Europe give comparable results?. Journal of Plant Nutrition and Soil Science 166: 422-431.
- Nyord, T., 2009.
Field application methods for the liquid fraction of separated animal slurry in growing cereal crops, International Conference on Nutrient Recovery from Wastewater Streams. Edited by Ken Ashley, Don Mavinic and Fred Koch. ISBN: 9781843392323. Published by IWA Publishing, London, UK.
- Nziguheba, G. & E. Smolders, 2008.
Inputs of trace elements in agricultural soils via phosphate fertilizers in European countries. Science of the Total Environment 390: 53-57.
- OECD, 2001.
Extended Producer Responsibility: A Guidance Manual for Governments. Paris.
- OECD, 2010a.
<http://stats.oecd.org/Index.aspx?DataSetCode=CSP2009>.
- OECD, 2010b.
<http://www.oecd.org/tad/env/indicators>.
- Oosterhuis, F.H., F.H. Brouwer & H.J. Wijnants, 2000.
A possible EU wide charge on cadmium in phosphate fertilisers: Economic and environmental implications. Final Report to the European Commission. Report no. E-00/02. 75p.
- Organic Federation of Australia, 2005.
National Standard for Organic and Bio-Dynamic Produce, Edition 3.1, As amended January 2005, Available: <http://www.ofa.org.au/papers/2005%20Draft%20NATIONAL%20STANDARD.pdf>.
- Ostara, 2009.
Ostara Nutrient Recovery Technologies. www.ostara.com, Homepage.
- Pahl-Wosti, C., A. Schönborn, N. Willi, J. Muncke & T.A. Larsen, 2003.
Investigating consumer attitudes towards the new technology of urine separation. Water Science and Technology 48(1): 57-65.
- Parentoni, S.N. & C. Lopes de Souza Junior, 2008.
Phosphorus acquisition and internal utilization efficiency in tropical maize genotypes. Pesquisa Agropecuária Brasileira 43 (7): 893-901.

- Perkins, R., 2003.
Technological 'lock-in'. Online Encyclopaedia of Ecological Economics, International Society for Ecological Economics.
- Pfeiffer, D.A., 2006.
Eating Fossil Fuels: Oil, Food and the Coming Crisis in Agriculture. Canada, New Society Publishers.
- Phillips, W.G.B., 1977.
Statistical estimation of global mineral resources. *Resources Policy* 1: 268-290.
- Pickford, J., 1977.
Solid Waste in Hot Climates. In *Water, Wastes and Health in Hot Climates* (Eds. R. Feachem, M. McGarry and D. Mara), pp. 320-344, Wiley, Chichester.
- Polprasert, C., 2007.
Organic Waste Recycling: Technology and Management. 3rd ed. IWA Pub. 516p. London.
- Pretty, J.N., C.F. Mason, D.B. Nedwell, R.E. Hine, S. Leaf & R. Dils, 2003.
Environmental costs of freshwater eutrophication in England and Wales. *Environmental Science & Technology* 37 (2): 201-208.
- Prud'homme, M., 2010a.
Peak phosphorus: an issue to be addressed. *Fertilizers and Agriculture*, International Fertilizer Industry Association (IFA), February 2010.
- Prud'homme, M., 2010b.
World Phosphate Rock Flows, Losses and Uses. International Fertilizer Industry Association, Phosphates 2010 International Conference, 22-24 March 2010 Brussels.
- Quinton, J.N., 2002.
Detachment and transport of particle-bound P: processes and prospects for modelling. In: Chardon, W.J. & O.F. Schoumans (Eds.) *Phosphorus losses from agricultural soils: processes at the field scale*. Cost Action 832 Quantifying the Agricultural Contribution to Eutrophication. Alterra, Wageningen, 61-65.
- Rahaman, M.S., D.S. Mavinic, A.T. Briton, M. Zhang, K.P. Fattah & F.A. Koch, 2009.
Numerical investigations of the hydrodynamics of the UBC MAP fluidized bed crystallizer International Conference on Nutrient Recovery from Wastewater Streams. Edited by Ken Ashley, Don Mavinic and Fred Koch. ISBN: 9781843392323. Published by IWA Publishing, London, UK.
- Reith, J.H., E.P. Deurwaarder, K. Hemmes, A.P.W.M. Curvers, P.B. Kamermans, & W.G. Zeeman, 2005.
BIO-OFFSHORE: Grootchalige teelt van zeevieren in combinatie met offshore windparken in de Noordzee. ECN rapport ECN-C-05-008, 137pp. Petten.
- Richards, I.R. & D.J. Dawson, 2008.
Phosphorus imports, exports, fluxes and sinks in Europe. *Proceedings 638*, International Fertilizer Society, York, UK: 1-28.
- Richards, K.G., O. Fenton, M.I. Khalil, A.H. Haria, J. Humphreys, D. Doody, R. Moles, G. Morgan & P. Jordan, 2009.
Good water status: the integration of sustainable grassland production and water resources in Ireland. *Tearmann*, 7: 143-160.
- Rockström, J., W. Steffen, K. Noone, Å. Persson, F.S.C. Chapin III, E.F. Lambin, T.M. Lenton, M. Scheffer, C. Folke, H.J. Schellnhuber, B. Nykvist, C.A.d. Wit, T. Hughes, S.v.d. Leeuw, H. Rodhe, S. Sörlin, P.K. Snyder, R. Costanza, U. Svedin, M. Falkenmark, L. Karlberg, R.W. Corell, V.J. Fabry, J. Hansen, B. Walker, D. Liverman, K. Richardson, P. Crutzen & J.A. Foley, 2009.
A safe operating space for humanity. *Nature* Vol 461 (24 September 2009): pp.472-475.
- Römer, V.W., 2009.
Concepts for a more efficient use of phosphorus based on experimental observations (Ansätze für eine effizientere Nutzung des Phosphors auf der Basis experimenteller Befunde). *Berichte über Landwirtschaft* 87(1): 5-30.
- Römer, W., 2006.
Vergleichende Untersuchungen zur Pflanzenverfügbarkeit von Phosphat aus verschiedenen P-Recycling-Produkten im Keimpflanzenversuch. *Journal of Plant Nutrition and Soil Science* 169: 826-832.
- Rosegrant, M.W., M.S., Paisner, S. Meijer & J. Witcover, 2001.
2020 Global Food Outlook Trends, Alternatives and Choices. International Food Policy Research Institute, Washington DC, August 2001.

- Rosemarin, A., 2004.
In a Fix: The Precarious Geopolitics of Phosphorous. Down to Earth. Center for Science and Environment. p. 27-31.
- Rosemarin, A., G.d. Bruijine & I. Caldwell, 2009.
Peak phosphorus: The next inconvenient truth *The Broker* August 2009(15): p.6-9.
- Runge-Metzger, A., 1995.
'Closing The Cycle: Obstacles To Efficient P Management For Improved Global Food Security.' from <http://www.icsu-scope.org/downloadpubs/scope54/3runge.htm>.
- Ruttenberg, K.C., 2003.
The Global Phosphorus Cycle. *Treatise on Geochemistry* volume (Elsevier Ltd) 9: 585-643.
- Saueia, C.H., B.P. Mazzilli & D.I.T. Fávoro, 2005.
Natural radioactivity in phosphate rock, phosphogypsum and phosphate fertilizers in Brazil. *Journal of Radioanalytical and Nuclear Chemistry* 264(2): 445-448.
- Sawyer, J.E., M.A. Schmitt, R.G. Hoefft, J.C. Siemens & D.H., Vanderholm, 1991.
Corn production associated with liquid beef manure application methods. *Journal of Production Agriculture* 3: 335-344.
- Scheinost, P.L., D.L. Lammer, X. Cai, T.D. Murray & S.S. Jones, 2001.
Perennial wheat: The development of a sustainable cropping system for the U.S., Pacific Northwest. *American Journal of Alternative Agriculture* 16(4): 147-151.
- Schenk, K., H.-P. Fahrni & A. Laube, 2009.
Phosphorous in Switzerland Material flows, targets, options, P-recovery. *World Resources Forum*, 14th-16th September, 2009, Davos, Switzerland.
- Schipper, W.J. & L. Korving, 2009.
Full-scale plant test using sewage sludge ash as raw material for phosphorus production. *Proc. International Conference on Nutrient Recovery*, May 10-13, 2009, Vancouver, Edited by Ken Ashley, Don Mavinic and Fred Koch. ISBN: 9781843392323. Published by IWA Publishing, London, UK: 591-598.
- Schröder, J.J., 1999.
How to reduce nitrate leaching from maize land? *Meststoffen 1999*, (Nutrient Management Institute, Wageningen, The Netherlands): 67-74.
- Schröder, J.J., 2005.
Manure as a suitable component of precise nitrogen nutrition. *Proceedings 574*, International Fertiliser Society, York, UK, : 1-32.
- Schröder, J.J., H.F.M. Aarts, H.F.M. Ten Berge, H. Van Keulen & J.J. Neeteson, 2003.
An evaluation of whole-farm nitrogen balances and related indices for efficient nitrogen use. *European Journal of Agronomy* 20 (1-2): 33-44.
- Schröder, J.J. & J.F.F.P. Bos, 2008.
Relationships between nutrient recycling, environmental impacts and agricultural production. *Proceedings No 624*, International Fertiliser Society, York, UK, 1-28.
- Schröder, J.J., D. Scholefield, F. Cabral & G. Hofmans, 2004.
The effects of nutrient losses from agriculture on ground and surface water quality: the position of science in developing indicators for regulation. *Environmental Science & Policy* 7(1): 15-23.
- Schröder, J.J., L. ten Holte & G. Brouwer, 1997.
Response of silage maize to placement of cattle slurry. *Netherlands Journal of Agricultural Science* 45: 249-261.
- Schröder, J.J. & J. Verloop, 2010.
Slurry separation could allow a wider use of manure within the EU Nitrates Directive. *Proceedings Ramiran Conference*, September 2010, Lissabon, Portugal (in press).
- Simic, D., V. Kovacevic, B. Simic & Z. Rengel, 2009.
Genotypic differences among maize inbred lines in phosphorus fertilizer responsiveness on soils differing in acidity *Communications in Soil Science and Plant Analysis* 40: 815-824.
- Sinclair, A.G., P.D. Johnstone, L. Smith, M.B. O'Connor & L. Nguyen, 1993.
Agronomy, modelling and economics of reactive phosphate rock as slow-release phosphate fertilizers for grassland. *Fertilizer Research* 36: 229-238.

SIWI-HWMI, 2004.

Water-More Nutrition Per Drop, Towards Sustainable Food Production and Consumption Patterns in a Rapidly Changing World. Stockholm International Water Institute, Stockholm.

Smaling, E., 2005.

Harvest for the world, Inaugural address, International Institute for Geo-Information Science and Earth Observation, 2 November 2005, Enschede, The Netherlands.

Smil, V., 2000.

Phosphorus in the Environment: Natural Flows and Human Interferences. *Annual Review of Energy and the Environment* 25: 53-88.

Smil, V., 2007.

Policy for Improved Efficiency in the Food Chain. Stockholm, SIWI Seminar: Water for Food, Bio-fuels or Ecosystems? in World Water Week 2007, August 12th-18th 2007.

Smit, A.L., P. Bindraban, J.J. Schröder, J.G. Conijn & H.G.v.d. Meer, 2009.

Phosphorus in agriculture: global resources, trends and developments. *Plant Research International* (Report 282): 36 pp.

Smit, A.L., J.C.v. Middelkoop, W.v. Dijk, H.v. Reuler, A.J.d. Buck & P.A.C.M.v.d. Sanden, 2010.

A quantification of phosphorus flows in the Netherlands through agricultural production, industrial processing and households. *Plant Research International Report*, Wageningen (in prep.).

Smith, S.E. & F.A. Smith, 2010.

New insights into AM effects on plant phosphorus (P) uptake and growth: time for some fresh thinking. Keynote presentation at the 4th International Symposium on Phosphorus Dynamics in the Soil-Plant Continuum, Beijing, China, 19-23 September 2010.

Soil Service of Belgium, 2005.

Addressing phosphorus related problems in farm practice, FINAL DRAFT 31/08/2005. Leuven-Heverlee, Study carried out on behalf of European Commission, DG Environment, report P/00/027.

Steen, I., 1998.

Phosphorus availability in the 21st Century: Management of a non-renewable resource. *Phosphorus and Potassium* 217: 25-31.

Steffen, W., A. Sanderson, P.D. Tyson, J. Jäger, P.A. Matson, B. Moore, F. Oldfield, K. Richardson, H.J. Schellnhuber, B.L. Turner & R.J. Wasson, 2004.

Global Change and the Earth System: A Planet Under Pressure, Executive Summary. Stockholm, IGBP Secretariat, Royal Swedish Academy of Sciences.

Steinfeld, H., P. Gerber, T. Wassenaar, V. Castel, M. Rosales & C. de Haan, 2006.

Livestock's long shadow: Environmental issues and options. *Renewable Resources Journal* 24(4): 15-17.

Stockdale, E.A., N.H. Lampkin, M. Hovi, R. Keatinge, E.K.M. Lennartsson, D.W. Macdonald, S. Padel, F.H. Tattersall, M.S. Wolfe & C.A. Watson, 2001.

Agronomic and environmental implications of organic systems. *Advances in Agronomy* 70: 261-327.

Stockdale, E.A., M.A. Shepherd, S. Fortune & S.P. Cuttle, 2002.

Soil fertility in organic farming systems: fundamentally different? *Soil Use and Management* 18: 301-308.

Stockholm Environment Institute, 2005.

Sustainable Pathways to Attain the Millennium Development Goals - Assessing the Role of Water, Energy and Sanitation (For the UN World Summit September 2005). Stockholm, SEI.

Stoorvogel, J.J., E.M.A. Smaling & B.H. Janssen, 1993.

Calculating soil nutrient balances in Africa at different scales - I Supra-national scale. *Fertilizer Research* 35(3): 227-235.

Syers, J.K., A.E. Johnston & D. Curtin, 2008.

Efficiency of soil and fertilizer phosphorous use. Reconciling changing concepts of soil phosphorous behaviour with agronomic information. *Food and Agriculture Organization of the United Nations Bulletin* (Rome) 18: 108 pp.

Tidåker, P., B. Mattsson & H. Jönsson, 2007.

Environmental Impact of Wheat Production using human urine and mineral fertilizers - a scenario study. *Journal of Cleaner Production* 15(2007): 52-62.

- Tilley, E., 2010.
Phosphorus and Sanitation, in Neset, TS & Cordell, D. (eds) Proceedings of the international workshop on Phosphorus and Global Food Security, Linköping University, 2010 (forthcoming).
- Tilley, E., B. Gantenbein, R. Khadka, C. Zurbru & K.M. Udert, 2009.
Social and economic feasibility of struvite recovery from Urine at the community level in Nepal International Conference on Nutrient Recovery from Wastewater Streams. Edited by Ken Ashley, Don Mavinic and Fred Koch. ISBN: 9781843392323. Published by IWA Publishing, London, UK.
- Tilley, E., C. Lüthi, A Morel., C. Zurbrügg & R. Schertenleib, 2008.
Compendium of Sanitation Systems and Technologies, Eawag/Sandec, Zurich.
- Trewavas, A.J., 2001.
Urban myths of organic farming. *Nature* 410, 409-410.
- TU-Darmstadt, I., 2010.
Phosphorus Recovery website, Technische Universität Darmstadt, Institut WAR, Darmstadt, available: www.phosphorus-recovery.tu-darmstadt.de.
- Ueno, Y. & M. Fujii, 2001.
Three Years Experience of Operating and Selling Recovered Struvite from Full- Scale Plant. *Environmental Technology* 22(11): 1373 - 1381
- UNEP, 2001.
Environmental Aspects of Phosphate and Potash Mining. United Nations Environment Programme (UNEP) and International Fertilizer Industry Association (IFA), Paris.
- UNEP, 2007.
The International Panel on the Sustainable Use of Natural Resources. Paris, Division of Technology, Industry and Economics, Sustainable Consumption & Production Branch.
- US Dept of Energy, 2002.
Energy and Environmental Profile of the US Mining Industry. Chap 8. Phosphates. 16p.
- USGS, 2009.
Appendix C: A Resource/Reserve Classification for Minerals
<<http://minerals.usgs.gov/minerals/pubs/mcs/2009/mcsapp2009.pdf>>, pp. 191-193, in Mineral Commodity Summaries, US Geological Survey.
- USGS, 2010.
Phosphate Rock Statistics and Information.
http://minerals.usgs.gov/minerals/pubs/commodity/phosphate_rock/ Accessed Aug 29, 2010.
- Uysala, A., Dilsad Yilmazelb, Y. and Demireb, G.N., 2010.
The determination of fertilizer quality of the formed struvite from effluent of a sewage sludge anaerobic digester. *Journal of Hazardous Materials* 181: 248-254.
- Vaccari, D.A., 2009.
Phosphorus, a looming crisis. *Scientific American* jun 2009: 42-47.
- Van Dijk, W., 2003.
Adviesbasis voor de bemesting van akkerbouw- en vollegrondsgroentengewassen (in Dutch). PPO-publicatie (Praktijkonderzoek Plant & Omgeving, Lelystad) nr. 307: 66 pp, 8 bijlagen
- Vanlauwe, B., P. Tittonell & J. Mukalama, 2007.
Whitin-farm soil fertility gradients affect response of maize to fertiliser application in western Kenya. In: Bationo, A., B. Waswa, J. Kihara, J. Kimetu (Eds.) *Advances in integrated soil fertility management in Sub-Saharan Africa: challenges and opportunities*. Springer Netherlands, 121-132.
- Verheijen, F.G.A., R.J.A. Jones, R.J. Rickson & C.J. Smith, 2009.
Tolerable versus actual soil erosion rates in Europe. *Earth Science Reviews* 94: 23-38.
- Villalba, G., Y. Liu, H. Schroder & R.U. Ayres, 2008.
Global Phosphorus Flows in the Industrial Economy From a Production Perspective. *Journal of Industrial Ecology* 12(4): 557-569.
- Vinneras, B., J. Clemens & M. Winkler, 2008.
Non-metallic contaminants in domestic waste, wastewater and manures: constraints to agricultural use. *Proceedings* 640. International Fertiliser Society, York, UK, 1-32.

Von Horn, J. & C. Sartorius, 2009.

Impact of supply and demand on the price development of phosphate (fertilizer). Edited by Don Mavinic, Ken Ashley and Fred Koch. ISBN: 9781843392323. Published by IWA Publishing, London, UK, International Conference on Nutrient Recovery from Wastewater Streams Vancouver, 2009. International Conference on Nutrient Recovery from Wastewater Streams Vancouver, 2009 Edited by Don Mavinic, Ken Ashley and Fred Koch. ISBN: 9781843392323. Published by IWA Publishing, London, UK.

Von Münch, E., A. Schöpe & S. Rüd, 2009.

Ecosan - recycling oriented wastewater management and sanitation systems GTZ, www.gtz.de/ecosan.

Ward, J., 2008.

Peak phosphorus: Quoted reserves vs. production history, Energy Bulletin, Online
<<http://www.energybulletin.net/node/46386>>.

Watson, C.A., H. Bengtsson, M. Ebbesvik, A.K. Löes, A. Myrbeck, E. Salomon, J. Schröder & E.A. Stockdale, 2002.

A review of farm-scale nutrient budgets for organic farms as a tool for management of soil fertility. *Soil Use and Management* 18: 264-273.

WHO, 2006.

Guidelines for the safe use of wastewater, excreta and greywater. Volume 4: Excreta and greywater use in agriculture, World Health Organisation.

Wilson, H., 1999.

Legislative challenges for lake eutrophication control in Europe. *Hydrobiologia* 395-396: 389-401.

Wissa, A.E.Z., 2003.

Phosphogypsum Disposal and The Environment Florida, available:

http://www.fipr.state.fl.us/pondwatercd/phosphogypsum_disposal.htm Ardaman & Associates, Inc.

WRAP, 2008.

The food we waste. Food waste report v2. Waste & Resources Action Programme.

Zan, C., L. Shi, Y.Z. Song & M.S. Zhu, 2006.

Evaluation method for thermal processing of phosphoric acid with waste heat recovery. *Energy* 31: 2791-2804.

Zhang, D.Q., S.K. Tan & R.M. Gersberg, 2003.

Municipal solid waste management in China: Status, problems and challenges. *Journal of Environmental Management* 91: 1623-1633.

Appendix I.

Data requirement of a phosphorus balance

Introduction

To assess whether the soil of a spatial entity (field, farm, region, country, continent) is losing or gaining phosphorus (P), it is necessary to make an inventory of the in-going and out-going P fluxes crossing the boundaries of that entity. The magnitude of fluxes may strongly differ from one place to another and it is indeed the inventory enabling policy makers to address the most relevant fluxes in their specific situation. As P is a ubiquitous constituent of many goods, there are numerous fluxes involved. This appendix shows the complexity the matter and lists the kind of data information needed to set up a P balance.

Balance terms

Option 1

A first indication of the accumulation or depletion of P soil reserves can be obtained from the difference between the imports of P in traded goods including some atmospheric deposition (IM) and local mining of P (LM) entering a spatial entity on the one hand, and the exports (EX) of P leaving that entity on the other hand. The difference between IM+LM and EX reflects the amount of P staying within the entity, i.e. the surplus (SU, with $SU = IM + LM - EX$). By subtracting the P sequestration in cemeteries, landfills, construction materials (CC) and the P point-emitted from industries and urban areas (IU) to surface water from SU, the agricultural P soil surplus (ASU), that is the difference between inputs in the form of mineral fertilizers, sludges, composts and imported feeds and seeds, and the outputs in the form of harvested non-feed crops (including vegetables and non-fed, excess feed crops) and farms exports in the form of meat, milk, wool, and eggs, can be calculated. Subsequently, this ASU can either be combined with observed P accumulations or depletions (i.e. soil pool changes: SP) to estimate the diffuse loss of P to surface water (i.e. diffuse emission from agriculture: AE), or be combined with the diffuse loss of P to surface water to estimate the accumulation in or depletion of P from soils (according to $ASU = SP + AE$).

Options 2 and 3

Data requirement of Option 1 is substantial as it needs a full picture of all the P containing imports, minings and exports (IM, LM, EX), the sequestration (CC) and the point emissions (IU). An alternative (*Option 2*) way of determining the agricultural P soil surplus could be the explicit assessment of inputs and outputs to a farm. The input of P (IA) equals the sum of P in atmospheric deposition, mineral fertilizers, sludges, composts, feed imported to the farms, seeds imported to the farm, and imported or exported manure. The output of P (EA) equals the sum of P in harvested non-feed crops (including vegetables and non-fed, excess, feed crops) and the P in milk, meat, wool and eggs. The agricultural soil surplus ASU then becomes $IA - EA$.

Even *Option 2* can be too ambitious, mainly because it is difficult to assess the amount of P in imported feed and applied manures. Another alternative (*Option 3*) way of determining the agricultural soil P surplus (ASU) could be to estimate the total amount of P applied (PA) as the sum of atmospheric deposition, mineral fertilizers, sludge, compost, seeds and manure (the latter based on animal numbers, animal type specific excretions and registered exports of manure for treatment outside farms), minus the sum of P in harvested non-feed crops (NFC) and the P in grazed and non-grazed feed crops (FC), according to $ASU = PA - NFC - FC$. FC is usually not estimated directly but indirectly as the difference between 'animal type specific feed P requirements' and the P that has been provided through imported feed-P.

Note that *Options 2 and 3* give at best an estimate of the diffuse loss of P from agriculture to surface water (provided that estimates of accumulation or depletion are available), whereas the *Option 1* includes an estimate of the point-emitted P from industries and urban areas as well.

The corresponding P flows of the above alternatives are illustrated in Figure 1. The terms of the different balances are shown in Table 1. Table 2 lists the type of data that are to be retrieved from e.g. Eurostat or Faostat.

Concluding remark

Theoretically all options should more or less yield the same soil P surplus. Similar results become more likely when calculations are based on multi year averages by which annual fluctuations of supplies (e.g. fertilizers supplies, feed supplies) are smoothed. The options are presented as alternatives. However, it may be sensible to assess the agricultural soil P surplus via all three methods at the same time, just to check the consistency. Explicit assessment of all terms (i.e. inputs, outputs but also the surplus instead of calculating the surplus simply as the difference of inputs and outputs) will generally reveal ‘differences not accounted for’. These differences may serve as a signal to reconsider and check overlying terms.

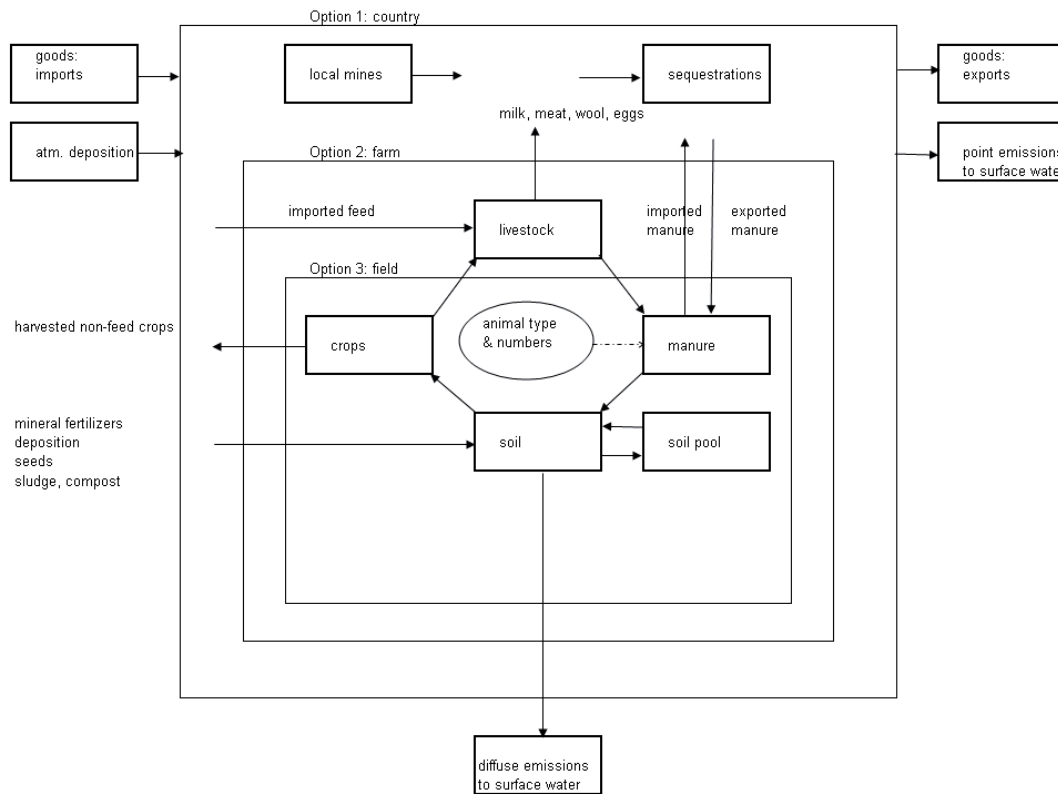

Figure 1. P flows at regional, farm and field scale.

Acronyms of the balance terms (with dimension kg P per year per hectare)

- IM : imports of P in traded goods and atmospheric deposition into the region
- LM : mining of P within the region
- EX : exports of P in traded goods from the region
- SU : regional surplus (or deficit) of P according to $SU = IM + LM - EX$
- CC : sequestration of P in cemeteries, landfills and construction materials
- IU : point emitted P from industries and urban areas
- IA : input of P to farm land in the form of atmospheric deposition, fertilizers, sludges, composts and (processed) feeds and seeds, imported minus exported manure
- EA : export of P from farms in the form of non-feed crops, meat, milk, wool and eggs
- SP : change of soil P pool
- AE : diffuse loss of P from farm land, according to $AE = ASU - SP$
- PA : P applied to farm land as atmospheric deposition, mineral fertilizer, sludge, compost and manure
- NFC : export of P from farms in the form of non-feed crops
- FC : P in grazed and non-grazed feed crops (usually estimated as the difference between animal type specific feed requirements minus imported feed P)
- ASU : soil surplus of farm land, either $ASU = SU - SE - IU$, or $ASU = IA - EA$, or $ASU = PA - NFC - FC$

Table 1. Three alternative way to assess the soil P surplus of farm land.

	Option 1	Option 2	Option 3
country	IM LM EX SU	traded goods atmospheric deposition traded goods =IM+LM-EX	
CC	sequestration	cemeteries landfills construction materials	
IU	point emission	industries urban areas	
farm		IA input to agriculture	deposition mineral fertilizer sludge, compost imported feed imported seed imported minus exported manure
			PA applied P
			deposition mineral fertilizer sludge, compost seed excreted P = (animal type and numbers), corrected for imported and exported manure P
EA	export from agriculture	meat, milk, eggs harvested non-feed crop	NFC+FC export from field
ASU	agricultural soil surplus = SU - CC - IU	ASU agricultural soil surplus = IA - EA	ASU agricultural soil surplus = PA - NFC - FC
SP	soil pool change depletion or accumulation	SP soil pool change depletion or accumulation	SP soil pool change depletion or accumulation
AE	diffuse loss to surface water from agriculture	AE diffuse loss to surface water from agriculture	AE diffuse loss to surface water from agriculture
			grazed and non-grazed feed crop (= default animal type specific feed P requirements minus P in imported feed) + harvested non-feed crop

Table 2. Data requirements for the presented types of calculating soil P surpluses.

	Option:		
	1	2	3
Area size (hectares)	+	+	+
Imported goods and their P concentrations	+		
P mined within the region	+		
Atmospheric P deposition	+	+	+
Exported goods and their P concentrations	+		
Sequestration of P in cemeteries, landfills, construction materials	+		
Point emissions of P from industries and urban areas	(+)		
Soil P pool changes	(+)	(+)	(+)
P in applied fertilizers, sludges, composts		+	+
P in produced, exported and imported manures		+	
P in feed imported to farm		+	+
P in seed imported to farm		+	+
Animal numbers and animal type specific P excretion, corrected for imported and exported manure			+
P in exported milk, meat, wool, eggs		+	
P in exported non-feed crops (preferably crop type specific, combined with relative share in total area)		+	+

Appendix II.

Available technologies

(Source: Hermann, L., 2009.

Rückgewinnung von Phosphor aus der Abwassereinigung- Eine Bestandesaufnahme. Published by Bundesamt für Umwelt BAFU, Bern, Switzerland:

<http://www.bafu.admin.ch/publikationen/publikation/01517/index.html?lang=de> (in German))

Crystallization in main stream and secondary streams

- > DHV Crystalactor® (Giesen A. 2002)
- > Unitika Phosnix (Ueno Y. *et al.*, 2001)
- > Ostara-MAP-Crystallization plant Edmonton (www.ostara.com)
- > MAP crystallization purification plant Treviso (Cecchi F. *et al.*, 2003)
- > Nishihara Struvite Crystallization reactor (Kumashiro K. *et al.*, 2001)
- > P-Roc process (Schuhmann R. *et al.*, 2008)
- > PECO process (Dockhorn T. 2007)
- > Kurita solid bed reactor (Pinnekamp J. *et al.*, 2007)
- > CSIR fluidized bed reactor (Pinnekamp J. *et al.*, 2007)
- > Sydney water board Reactor (Angel R. 1998)

Ion exchange in main stream and secondary streams

- > Rem Nut® process (Petruzzelli *et al.*, 2003)
- > PHOSIEDI (www.phosphorrecycling.de/)

Flocculation in main stream

- > AirPrex process - Water treatment company Berlin (Heinzmann B. *et al.*, 2008)
- > Phostrip process (Kaschka E. & Donnert D. 2003)
- > PRISA process (Montag D. 2008)
- > Adsorption technique (Pinnekamp J. *et al.*, 2007)
- > Magnet separator (Pinnekamp J. *et al.*, 2007)

Recovery of phosphorus from sewage sludge and digested sludge

- > P recovery technology from sewage sludge (Pinnekamp J. *et al.*, 2007)
- > CAMBI Process (www.cambi.com)
- > Aqua Reci Process (Stendahl K. & Jäfverström S. 2003)
- > KREPRO Process (Karlsson I. 2001)
- > KemiCond® process (www.kemira.com)
- > Seaborne process / Gifhorn process (Müller J. 2007)
- > LOPROX process followed by nano filtration (Blöcher C. 2005)
- > ASH DEC/BAM process (Hermann L. 2008, Adam C. 2008)
- > BioCon® process (Hultman B. *et al.*, 2003)
- > SEPHOS process (Schaum C. 2008)
- > PASCH process (Montag D. 2008)
- > ATZ iron bed reactor (Mocker M. & Faulstich M. 2006)
- > Phosphorus fixation in conversion slags (Rex M. & Kühn M. 2008)
- > Mephrec process (dried sewage sludge) (Scheidig *et al.*, 2008)
- > EPHOS process (Bayrisches Landesamt für Umwelt 2008)
- > Eberhard process (Franz M. 2007)

References for appendix II

- Adam, C., 2008.
Recycling von Nährstoffen und Metallen aus Verbrennungsrückständen. Präsentation bei der 138. Sitzung des Wissenschaftlichen Beirats für Düngungsfragen, 1.10.2008, BMELV, Bonn.
- Adam, C., 2008.
Optionen der landwirtschaftlichen Verwertung von P aus der Abwasserreinigung: Technische Möglichkeiten. Präsentation bei den Braunschweiger Nährstofftagen, 11.-12.11.2008.
- Angel, R., 1998.
Removal of phosphate from sewages as amorphous calcium phosphate. Sydney Water Board. Abstract in www.phosphorusrecovery.tu-darmstadt.de
- Blöcher, C., 2005.
Niederdruck-Nassoxidation zur Klärschlammbehandlung. Bayer Technology Services. Vortrag.
Link: www.bayertechnology.com
- Cecchi, F. *et al.*, 2003.
Phosphate Crystallisation Process for P-Recovery applied at Treviso Municipal Wastewater Treatment Plant (Italy), Università degli Studi di Verona.
- Dockhorn, T., 2007.
Rückgewinnung von Phosphat aus Abwasser und Klärschlamm mit dem Peco-Verfahren. Zeitschrift Müll und Abfall 08/07: 380-386.
- Franz, M., 2007.
Phosphate fertilizer from sewage sludge ash (SSA). Waste Management, doi:10.1016/j.wasman.2007.08.011.
- Giesen, A., 2002.
The Crystalactor® - Abwasserbehandlung mittels Kristallisation ohne Abfälle. DHV Water BV, Amersfoort, The Netherlands. Link: www.dhv.com.
- Heinzmann, B. *et al.*, 2008.
Inkrustationsprobleme am Beispiel der Kläranlage Wassmannsdorf. Präsentation. Berliner Wasserbetriebe.
- Heinzmann, B. *et al.*, 2008.
Praxiserfahrungen: Phosphorrückgewinnung bei den Berliner Wasserbetrieben. Workshop Energetische und stoffliche Nutzung von Klärschlamm, Berlin, 30.10.2008.
- Hermann, L., 2008.
Market and Economic Feasibility - P-fertilisers to be developed during the SUSAN-project. Report to the European Commission, 2006; FP6-project SUSAN; Contract No. 016079
- Hultman, B. *et al.*, 2003.
Phosphorus Recovery from Sludge in Sweden - Possibilities to meet Proposed Goals in an Efficient, Sustainable and Economical Way. Department of Land and Water Resources Engineering, Royal Institute of Technology, Stockholm, Sweden.
- Karlsson, I., 2001.
Full scale plant recovering iron phosphate from sewage at Helsingborg, Sweden. Kemira Kemi AB, Helsingborg, Sweden. Link: www.kemira.com.
- Kaschka, E. & D. Donnert, 2003.
Das Phostrip-Verfahren in Kombination mit Aktivfiltration, ein wirtschaftlicher Weg zur P-Rückgewinnung? Posch & Partner GmbH, Innsbruck, Österreich und Forschungszentrum Karlsruhe GmbH, Karlsruhe, Deutschland.
- Kumashiro, K. *et al.*, 2001.
A Pilot Plant Study on Using Seawater as Magnesium Source for Struvite Precipitation, Water Quality Control Section, Construction Bureau, 96-3 Nishimino-Mati, Kokurakita-Ku, Kitakyushu, 803-0801, Japan.
- Mocker, M. & M. Faulstich, 2006.
Verfahren zur Phosphorrückgewinnung aus Klärschlamm. Zeitschrift Müll und Abfall 9/06, Erich Schmidt Verlag GmbH & Co., Berlin.
- Montag, D., 2008.
Phosphorrückgewinnung bei der Abwasserreinigung - Entwicklung eines Verfahrens zur Integration in kommunale Kläranlagen. Dissertation an der Rheinisch-Westfälischen Technischen Hochschule Aachen.

- Müller, J., 2007.
Welche Möglichkeiten der Klärschlammverwertung gibt es ausserhalb der Landwirtschaft? Beispiel: Seaborne Verfahren. Vortrag auf der Internationalen Konferenz zur Umsetzung der EGWasserrahmenrichtlinie und ihrer Auswirkungen im kommunalen Bereich und zur Problematik der Abwasser- und Klärschlammabeseitigung; Osnabrück.
- Petruzzelli, D. *et al.*, 2003.
A new phosphate-selective sorbent for the Rem Nut® process. Laboratory investigation and field experience at a medium size wastewater treatment plant. *Water Science & Technology* Vol 48 No 1: pp 179-184 © IWA Publishing 2003.
- Pinnekamp, J. *et al.*, 2007.
Rückgewinnung eines schadstofffreien, mineralischen Kombinationsdüngers Magnesiumammoniumphosphat - MAP aus Abwasser und Klärschlamm; Schwerpunktstudie in Texte 25/07 des Deutschen Umweltbundesamts (Dessau).
- Rex M. & M. Kühn, 2008.
Phosphat-Düngewirkung von Tiermehlasche vor und nach thermischem Aufschluss in Konverterschlacke. Poster zum Symposium Ressourcen schonender Einsatz von Phosphor in der Landwirtschaft Braunschweiger Nährstofftage, 10.-11.11.2008.
- Schaumm, C., 2008.
Rückgewinnung von Phosphor aus Klärschlamm und Klärschlammmasche. Workshop Energetische und stoffliche Nutzung von Klärschlamm, Berlin, 30.10.2008.
- Scheidig, K. *et al.*, 2008.
Metallurgisches Phosphor Recycling. Poster zum Symposium Ressourcen schonender Einsatz von Phosphor in der Landwirtschaft Braunschweiger Nährstofftage, 10.-11.11.2008.
- Schuhmann, R. *et al.*, 2008.
Phosphorus Recovery from Waste and Process Waters - Today's Elimination Turns into Tomorrow's Recovery. Forschungszentrum Karlsruhe GmbH, CMM - Center of Competence for Material Moisture, Karlsruhe, Deutschland.
- Stendahl, K. & S. Järfverström, 2003: Phosphate recovery from sewage sludge in combination with supercritical water oxidation. Feralco AB, Helsingborg, Sweden. Link: www.feralco.com
- Ueno, Y. *et al.*, 2001.
3 years operating experience selling recovered struvite from full-scale plant. Paper presented at Second International Conference on the recovery of phosphorus from sewage and animal wastes, Noordwijkerhout, March 2001.

