

CIRCULAR-SERIES

INDEX
NUMBER

G3.1

HEATING THE HOME

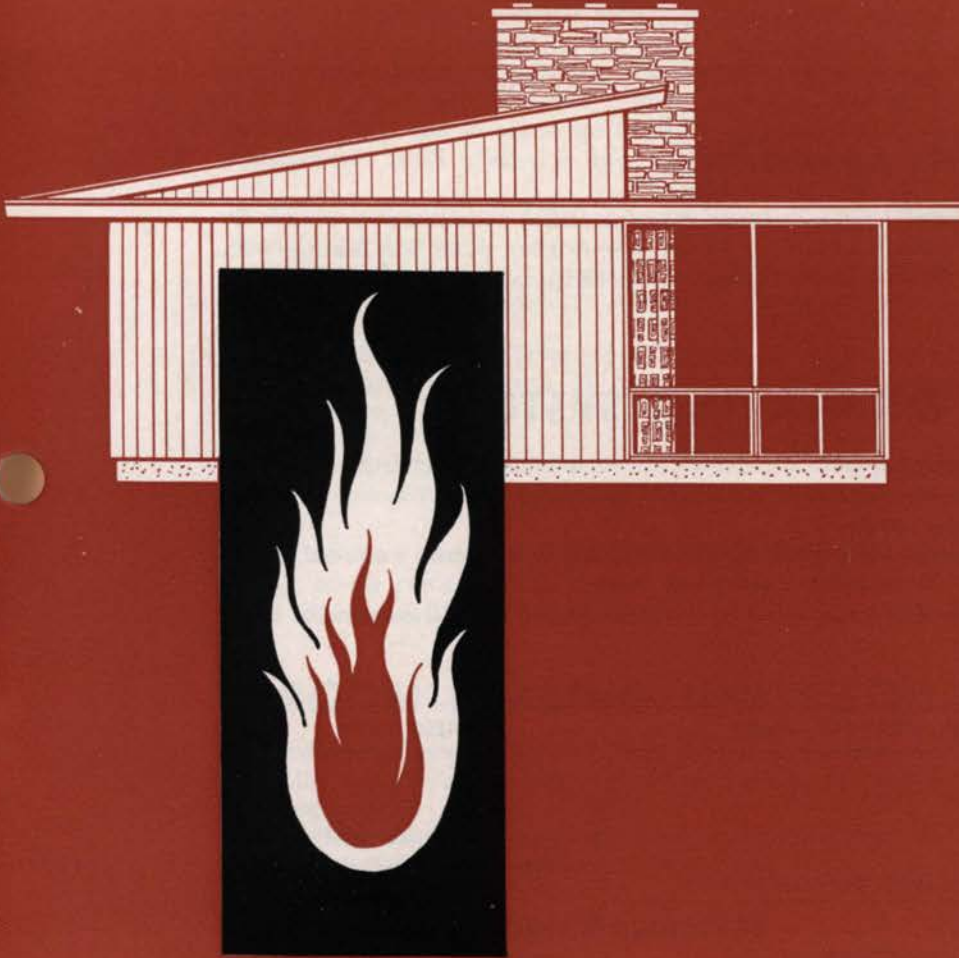

ISSUED BY THE SMALL HOMES COUNCIL

UNIVERSITY OF ILLINOIS BULLETIN

VOLUME 48, NUMBER 71; JUNE, 1951. Published seven times each month by the University of Illinois. Entered as second-class matter December 11, 1912, at the post office at Urbana, Illinois, under the Act of August 24, 1912. Office of Publication, 358 Administration Building, Urbana, Illinois.

COPYRIGHT, 1951, BY THE UNIVERSITY OF ILLINOIS PRESS. Revised edition. All rights reserved. No part of this circular may be reproduced in any form without permission in writing from the Publisher.

This circular is one of a series on small homes. Other circulars are available for 10c each. For information, write to Small Homes Council, Mumford House, University of Illinois, Urbana.

MATERIAL IN THIS CIRCULAR BY W. S. HARRIS, S. KONZO AND R. W. ROOSE
OF THE ENGINEERING EXPERIMENT STATION

Architectural Consultant: J. T. Lendrum

Editor: M. H. Kennedy

Illustrator: W. S. Pusey

Now Price
15¢

HEATING THE HOME
SMALL HOMES COUNCIL

G3.1

REQUIREMENTS FOR AN EFFICIENT HEATING SYSTEM



A central heating system includes 1) the fuel burner; 2) the furnace or boiler; 3) heat distributing equipment, such as ducts and pipes; 4) room heating units (registers, radiators, convectors, baseboard units, concealed panels); and 5) controls.

The efficiency of a heating system depends on correct installation and operation of properly chosen equipment. A heating system is expected to produce comfort twenty-four hours a day throughout the heating season. The real cost of a heating system is not just the cost of the original equipment, but is equal to the initial cost plus maintenance and fuel costs. A "cheap" heating system will cost more in the end than one properly designed and correctly installed.

Heating equipment should meet safety and performance standards set up by heating trade associations and technical societies. Be sure the equipment you buy bears their seal of approval.

The installation of the equipment should satisfy requirements of local ordinances.

The construction of the house also affects the efficiency of a heating system. Excessive heat loss can be avoided through good construction. To make your house as easy to heat as possible, use storm sash and storm doors; caulk joints around window frames; insulate ceiling and outside walls. All of these will pay dividends; they will reduce the initial cost of the heating system, reduce fuel bills, and increase comfort both winter and summer. A good chimney is also necessary for efficient operation of any heating system. (See Small Homes Council circulars: F11.2, "Insulating-Windows and Screens"; F6.0, "Insulation"; F7.0, "Chimneys and Fireplaces"; and F6.2, "Moisture Condensation.")

This circular describes the various central heating systems. Since electrical panels and convectors do not require a central heating plant, they are not included. Before you develop plans for heating with electricity, consult your utility company. In only a few areas are electrical rates low enough to make such installations practical.

WHAT KIND OF HEATING SYSTEM?

While your decision as to the type of heating system will depend on such factors as cost, performance, maintenance requirements and convenience, it will also be influenced by:

Your preference as to room heating units.

The design of your house. For example, gravity systems (warm-air or hot-water) are not generally suited to basementless houses, nor are steam systems usually used.

The chart below lists 1) room heating units used with the various systems, and 2) systems for basement and basementless construction.

	ROOM HEATING UNITS	HOUSE TYPE
HOT-WATER SYSTEMS		
Forced	Baseboard units Convectors Radiators Panels (coils of pipes concealed in panel)	For either: House with basement or Basementless house
Gravity	Baseboard units Convectors Radiators	
STEAM SYSTEMS		
One-Pipe	Convectors Radiators	Not for basementless house
Two-Pipe	Baseboard units Convectors Radiators	Seldom used in small houses Not for basementless house
WARM-AIR SYSTEMS		
Forced	Registers Panels (ducts or channels concealed in panel)	For either: House with basement or Basementless house
Forced-Perimeter	Registers and panels (ducts)	
Gravity	Registers	For compact house with basement Not for basementless house

Fuels

Any fuel may be used with the heating systems described in this circular. Consult your heating contractor regarding the type of fuel that will best meet your requirements. Remember that equipment specifically designed for the fuel you intend to use will give the highest efficiency. (See Small Homes Council circular G3.5, "Fuels and Burners.")

Domestic Hot-Water

With some systems, the boiler can be used to heat water the year-round. Such an installation eliminates the need for a separate water heater and often is the most economical way of securing an adequate supply of hot water for household use. (See Small Homes Council circular G5.0, "Plumbing.")

Controls

Controls may be added to any of the heating systems described. These devices — room thermostats, combustion controls, operating controls (for forced circulation systems only), and safety controls — are designed to "run" your furnace or boiler automatically and to keep your house at an even temperature. They add to your comfort and save money by eliminating overheating. (See Small Homes Council Circular, G3.2, "Controls for Central Heating Systems.")

INSTALLATION

In building a house, consider the heating plant in its relation to the total house construction before any actual work is started. Cooperation between the general or carpentry contractor and the heating contractor will usually result in savings. If the placement of pipes or ducts is planned ahead of time, they can be located in such a way that little cutting of framing members is necessary; thus, the structural frame of the house is not weakened.

Your heating contractor should supply 1) engineered layouts, 2) written guarantees on equipment, and 3) service agreements. If plumbing or electrical connections are necessary in the installation of a heating plant, obtain a statement from the heating contractor as to how much of this work is included in his estimate.

Warm-air systems should be designed and installed in accordance with manuals of instructions issued by the *National Warm Air Heating and Air Conditioning Association, 640 Engineers Building, Cleveland 14, Ohio.*

Hot-water and steam systems should be designed and installed in accordance with installation guides issued by the *Institute of Boiler and Radiator Manufacturers, 608 Fifth Avenue, New York 20, New York.*

The manuals and installation guides are based on research conducted at the University of Illinois.

ROOM HEATING UNITS FOR WARM-AIR SYSTEMS

Forced and gravity warm-air systems require supply registers to bring the warm air from warm-air ducts into the room. For the purposes of this circular, the supply registers are sometimes referred to as room heating units.

Return-air intakes are necessary to take the cooler air from the room. The various types of supply registers and return-air intakes are shown here.

SUPPLY REGISTERS

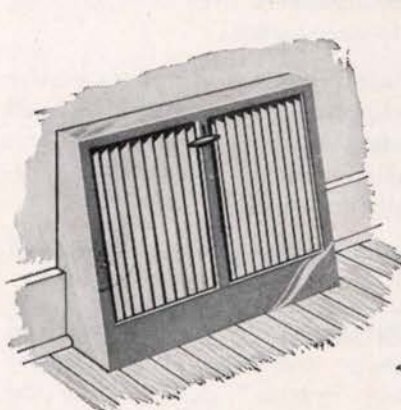

BASEBOARD GRAVITY REGISTER

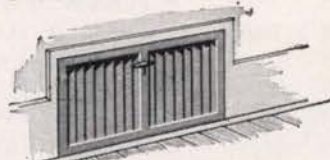

FORCED WARM-AIR REGISTER

This type can be used for ceiling, sidewall, and baseboard installations.

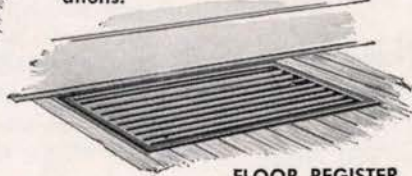

FLOOR REGISTER

RETURN-AIR INTAKES



RETURN-AIR INTAKE
(for gravity system)



RETURN-AIR INTAKE
(for forced system)

GRAVITY WARM-AIR HEATING SYSTEM

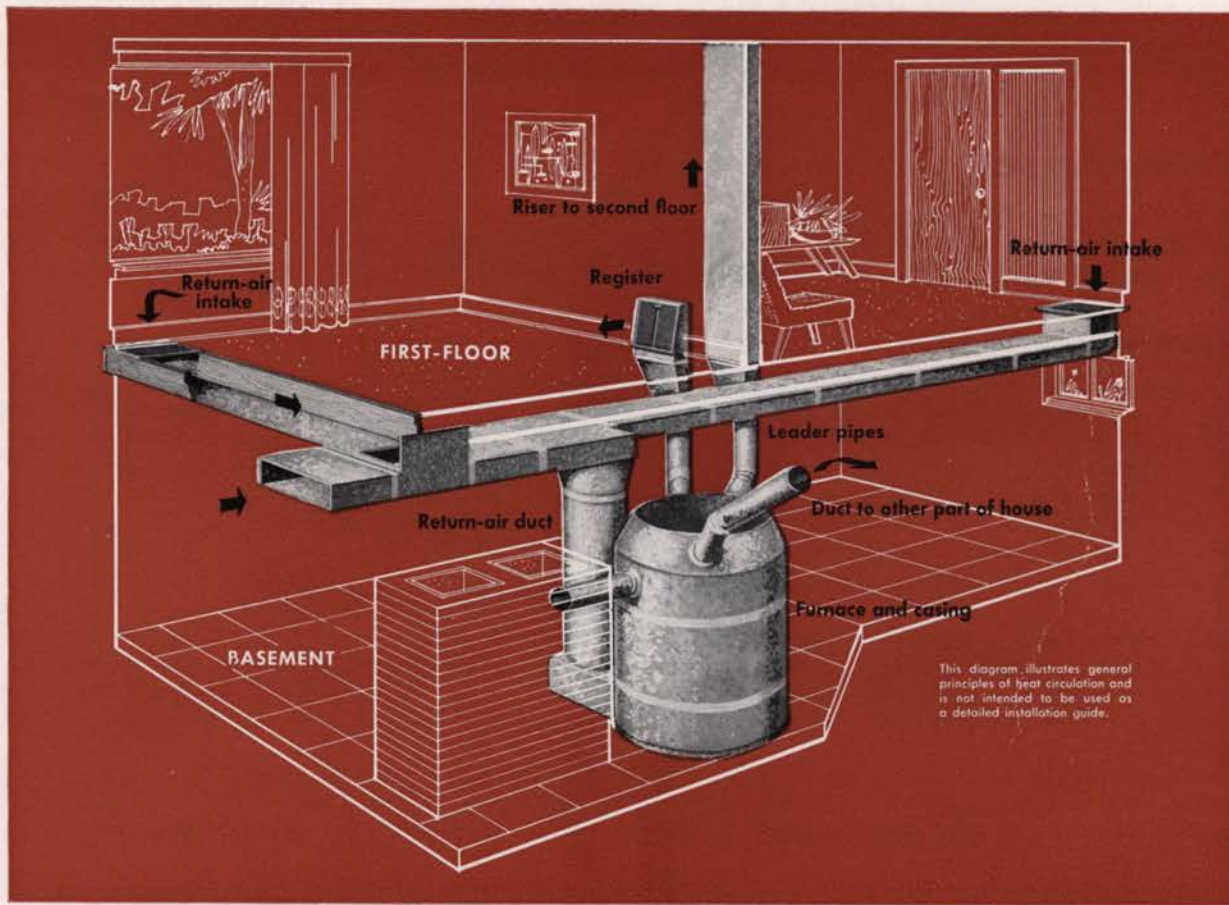

Air circulation in a gravity warm-air system results from the fact that heated air flows upward and cool air flows downward. Air is warmed as it comes into contact with heated surfaces of the furnace. As the air becomes warmer, it rises and flows through leader pipes (and risers if the house has more than one story) to the warm-air supply registers in the rooms. The cooler air in the rooms flows downward and is drawn through return-air intakes (usually located in first-floor rooms) to return-air ducts, and then to the space between the furnace and the furnace casing.

A gravity warm-air system:

- Is economical to install and is well suited to low-cost homes.
- Has no motors or electrical connections other than those required if controls or an automatic burner are used.
- Is simple to operate.
- Responds to rapid changes in outdoor temperatures.
- Is best adapted to a house with a compact floor plan since leader pipes and return-air ducts should be as short as possible.
- Requires a centrally located furnace, and either horizontal or inclined leader pipes. (The inclined

pipes reduce the amount of usable basement head room.)

- Is not suitable for basementless houses or for heating basement rooms since the furnace must be below the level of the rooms to be heated.
- Can be converted to a forced-air system by adding a blower. Usually in conversion, filters are provided, and some changes are made in the duct system and registers. (Filters are not used in gravity systems since they tend to restrict the flow of air.)
- Permits air to be humidified from an evaporating pan inside the furnace casing.

Room Heating Units: Supply registers for gravity warm-air systems are usually installed in the baseboard on the inside walls or in the floor.

Return-air intakes are placed in the floor near an outside wall, usually below windows.

Maintenance: Furnace must be inspected periodically.

Design and Installation: Use Manual 5, "Code and Manual for the Design and Installation of Gravity Warm-Air Heating Systems," published by the National Warm Air Heating and Air Conditioning Association. (See page 3 for address.)

FORCED WARM-AIR HEATING SYSTEM

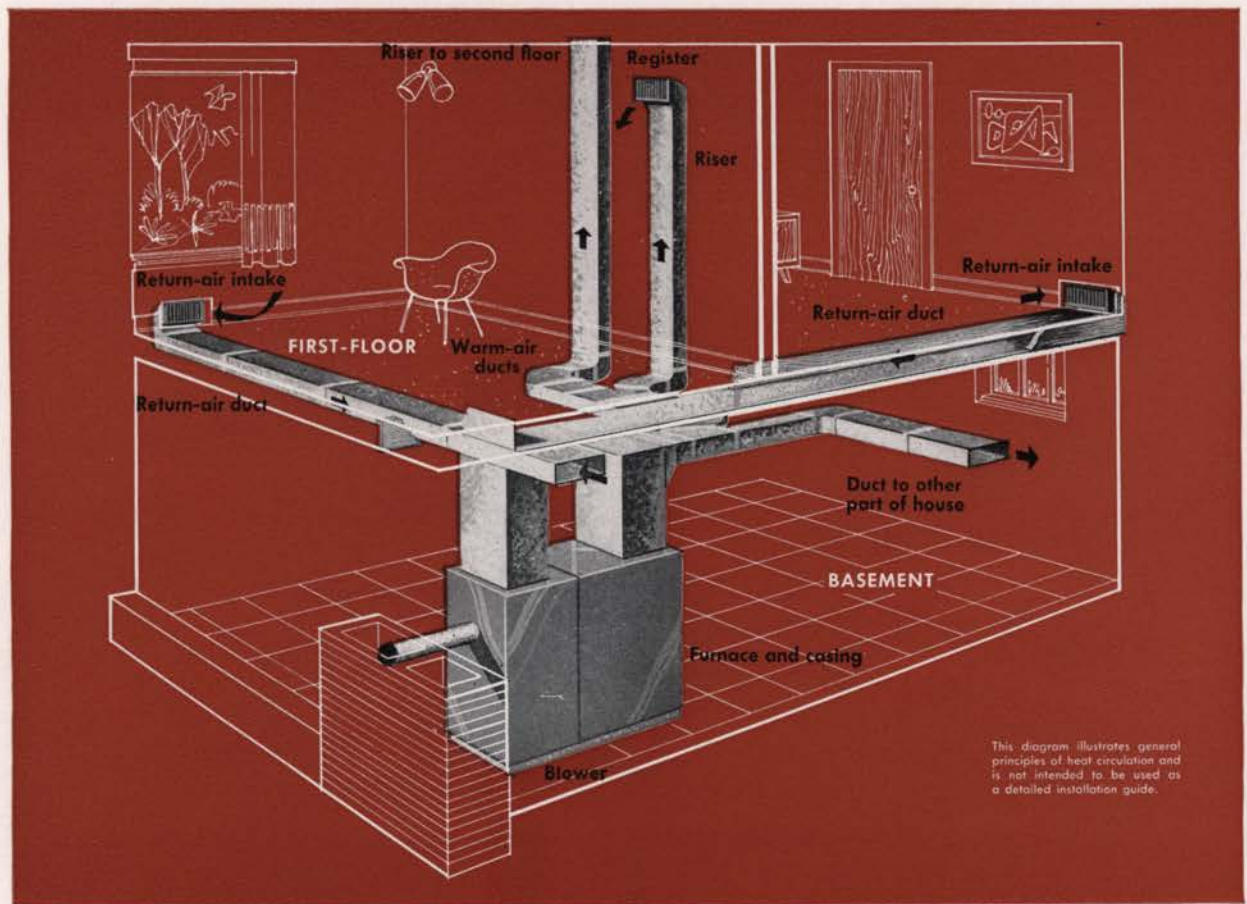

Air circulation in a forced warm-air system is maintained by a blower in the furnace. The air is warmed by the heated surfaces of the furnace and then forced through the warm-air ducts to supply registers in the rooms. The blower draws the cooler air from the rooms down to the furnace through return-air intakes and return-air ducts, and through air filters. This air is then delivered under slight pressure to the space between the furnace and the furnace casing.

A forced warm-air system:

- Responds rapidly to changes in outdoor temperature.
 - Costs more to install than a gravity system.
 - Is adapted to basementless houses and large structures, and to the heating of isolated basement rooms since air circulation is maintained by the blower.
 - Requires less space for the furnace and the ducts than the gravity system. The furnace does not need to be centrally located; all the ducts are smaller and can be installed horizontally at the ceiling level.
 - Has a humidifier to add moisture to the air and filters to clean the air.
- Is not readily usable for summer air-conditioning without the addition of cooling coils, cooling equipment, and a larger capacity blower.
 - Needs a duct to bring air from the outdoors if controlled ventilation is desired.

Room Heating Units: Adjustable vane-type registers, which direct the warm air downward and to the sides, are recommended. These supply registers should be located so that the warm air will not be discharged directly on the occupants. If placed high on the sidewall—about seven feet from the floor—the registers do not interfere with furniture arrangement. The registers may also be located in the ceiling, the floor, the baseboard or low in the sidewall.

Return-air intakes should be on the outside wall below windows or at some other cool spot.

Maintenance: Motor and blower must be oiled, filters cleaned or replaced, and furnace inspected periodically.

Design and Installation: Use Manual 7, "Code and Manual for the Design and Installation of Warm-Air Winter Air-Conditioning Systems," published by the National Warm Air Heating and Air Conditioning Association. (See page 3 for address.)

WARM-AIR PANEL INSTALLATION

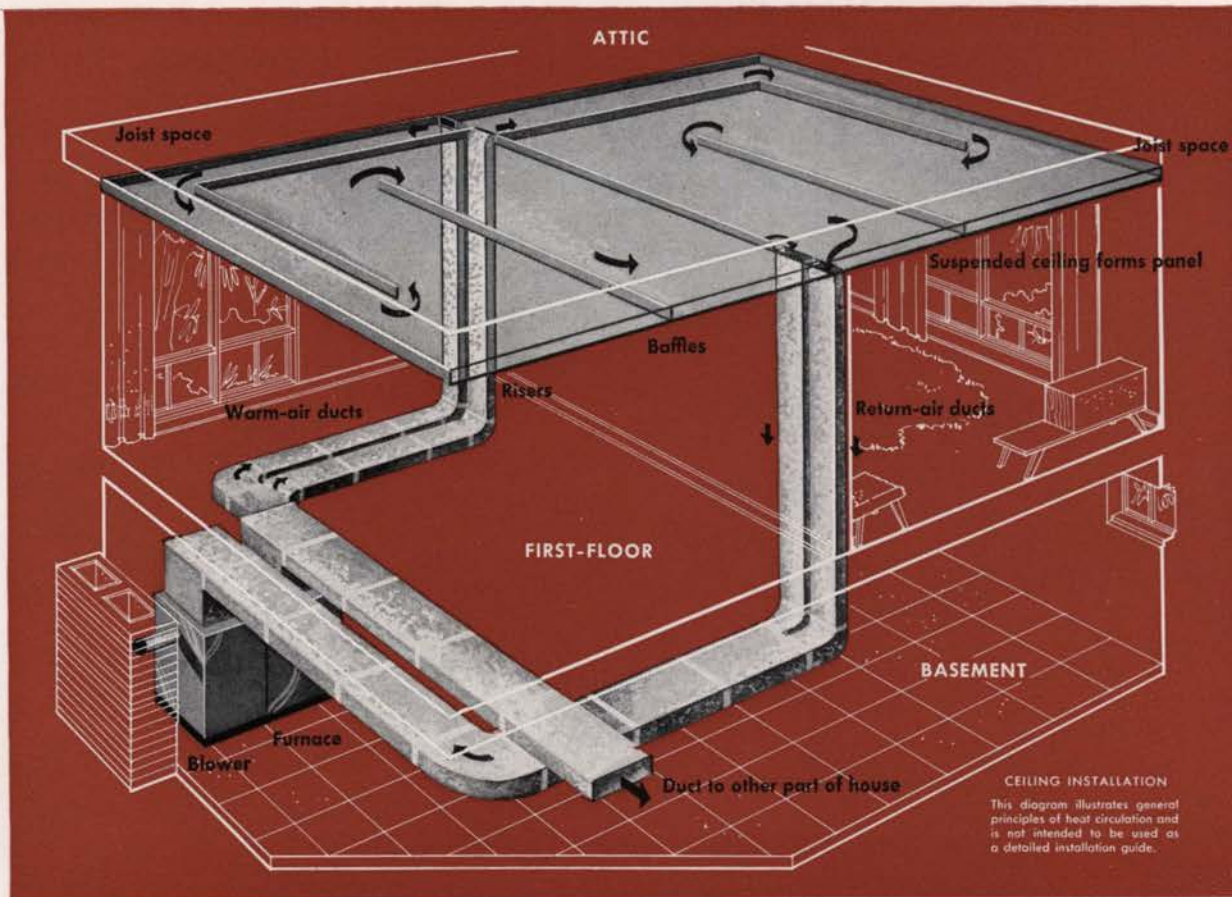

In a warm-air panel heating installation, air heated in the furnace is passed through ducts or channels concealed in the wall, ceiling or floor. Heat from the warm air is transmitted to the surface of the panel and then to the room by radiation (heat rays) and convection (air currents). No registers are necessary although they are sometimes used to introduce some of the warm air directly into the room.

A forced warm-air furnace must be used with heating panels since the air must be circulated mechanically. An automatic fuel burner is essential.

Panel heating is still in the development stage. Whether the floor, the wall or the ceiling is the best surface in which to place the panels is still a matter of controversy; however, panels are generally located in the ceiling (illustrated above).

In ceiling panels, small sheet-metal ducts concealed in the wall partitions carry the warm air from the furnace to air channels which are formed by a suspended ceiling of fire-resistant material.

In floor panels, hollow tile or precast slabs containing channels can be used instead of concealed ducts. These are an integral part of the building.

No research has been conducted as yet on wall panels for warm-air systems.

A warm-air panel installation:

- Requires planning in the early stages of the house design since the system is usually a structural part of the house.
- Can be used in houses with or without basements.
- Has definite limitations on temperatures of panels. Floor surface temperatures should not be more than 85°F. for comfort; surface temperatures of wall or ceiling panels may be as high as 115°-120°F.
- Is well adapted to conventional thermostatic controls but may be subject to overheating or underheating. This is particularly true in houses having large glass areas which are subject to rapid temperature changes due to variations in sun intensity.
- Requires adequate insulation at the back of the panel to prevent heat loss and, consequently, excessive fuel costs.

Maintenance: Motor and blower must be oiled, and furnace inspected periodically.

Design and Installation: Use Manual 7-A, "Code and Manual for the Design and Installation of Warm-Air Ceiling Panel Systems," published by the National Warm Air Heating and Air Conditioning Association. (See page 3 for address.)

WARM-AIR PERIMETER INSTALLATION

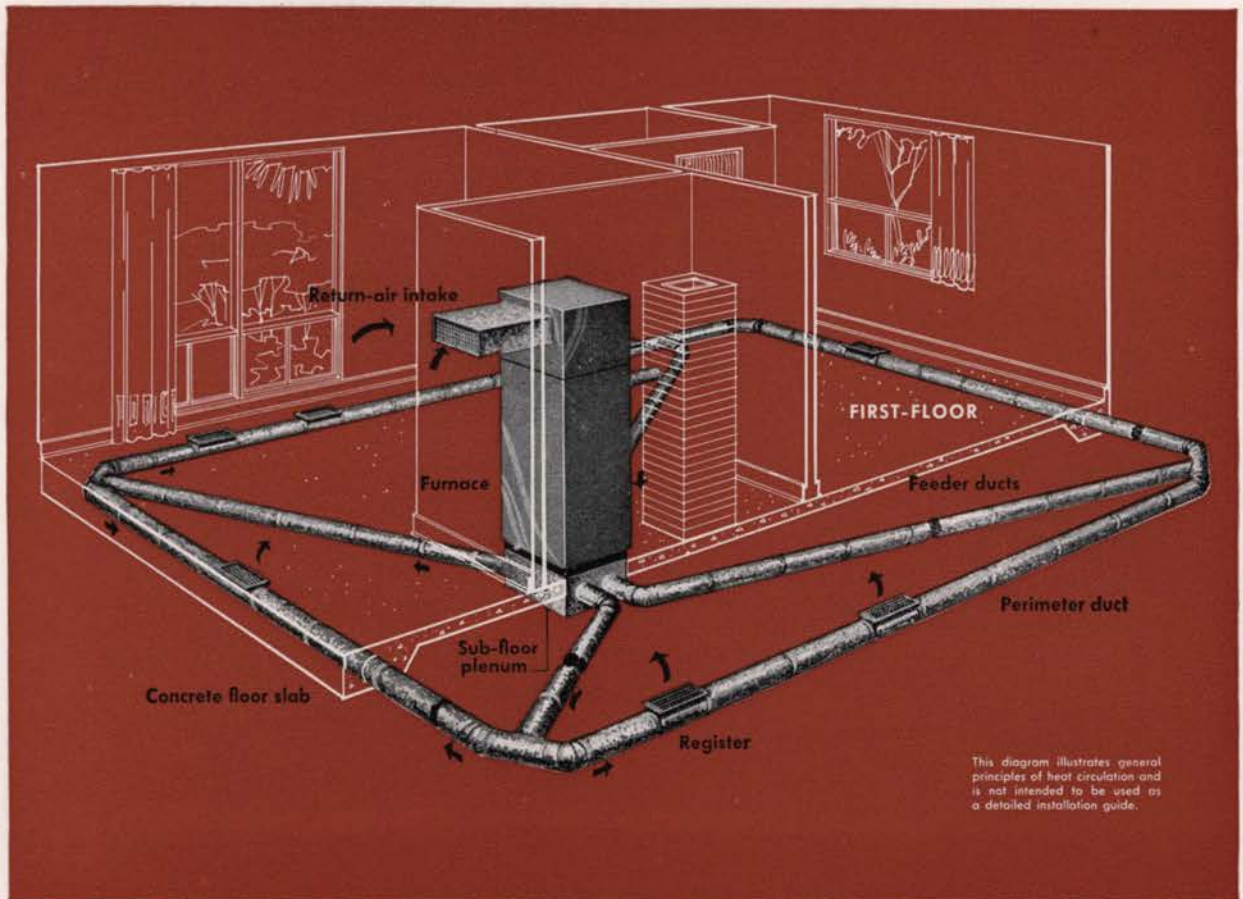

Perimeter heating is intended for basementless houses built on a concrete floor slab. Like a panel installation, it requires a forced warm-air furnace.

Warm air from the furnace is circulated through a duct system which is embedded in the concrete slab. This duct system encircles the slab at its outer edge and is connected to the furnace by feeder ducts.

The warm air in the ducts is discharged into the room through registers — either floor or low side-wall registers placed below windows. Air is taken back to the furnace through return-air intakes at high locations on inside walls, usually close to the furnace.

Several arrangements of perimeter ducts and feeder ducts are possible. These ducts can be of sheet metal, vitrified tile, concrete pipe or other precast forms.

A perimeter heating system:

- Is designed to eliminate cold floors and retain all the advantages of a forced warm-air heating system.

- Is economical to install.
- Needs very little floor area since a down-flow type of furnace has been designed for perimeter installations. This furnace may be placed in closets, alcoves or utility rooms, but provision must be made to supply air to the furnace for combustion purposes. (The furnace should be located as centrally in the house as possible.)
- Requires a well-constructed concrete slab which is laid on suitable porous fill and which has a waterproof membrane and edge insulation.
- Is well adapted to conventional thermostatic controls.
- May be provided with filters to clean the air.

Maintenance: Motor and blower must be oiled, filters cleaned or replaced, and furnace inspected periodically.

Design and Installation: Use Manual 4, "Warm-Air Perimeter Heating," published by the National Warm Air Heating and Air Conditioning Association. (See page 3 for address.)

ROOM HEATING UNITS FOR HOT-WATER OR STEAM SYSTEMS

Radiators, convectors and baseboard units are devices for transferring heat from the water or the steam to the air of rooms. They are referred to in this circular as room heating units.

Radiators, Cast iron

Conventional radiators are composed of vertical tubes through which water or steam passes. In the newer radiators, the tubes are small so that the unit may be recessed in any wall construction if desired. If a radiator is recessed, the wall behind it should be insulated with a minimum of one inch of insulation board, or the equivalent.

Preferred location for a radiator is under a window. Radiators may be partially or fully enclosed in a cabinet.

RECESSED RADIATOR

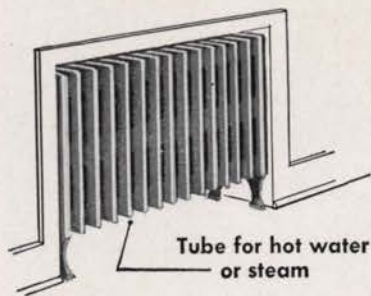

Convectors

Convectors consist of a core (either a small tube or a hollow cast-iron section), which has a number of thin "fins" or metal plates attached to it. Hot water or steam heats the core and fins which, in turn, warm the air passing over them.

The core and fins are enclosed in a cabinet, causing a more effective air flow over the heated surfaces than if they were exposed.

Convectors may be installed against an outside wall, or they may be recessed in the wall with only the air openings exposed. Preferred location for a convector is under a window.

CONVECTOR

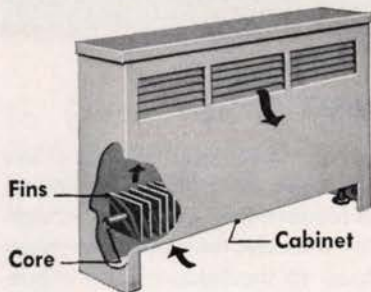

Baseboard Units

Baseboard heating units can be used with hot-water circulating systems or with two-pipe steam systems.

These units resemble conventional baseboards and are installed along the outside walls of each room in place of the usual wood baseboard. Hot water or steam circulating through the sections transmits heat to the room.

Baseboard units are made of 1) hollow sections either cast iron or steel, or 2) finned tube placed behind a sheet-metal enclosure.

Baseboard heating units achieve even temperatures throughout the room because the units distribute the heat near the floor which normally is the coolest part of a room. The concentration of heat near the floor makes the units especially desirable for basementless houses. Baseboard units are adaptable to new construction or modernization work.

BASEBOARD UNITS

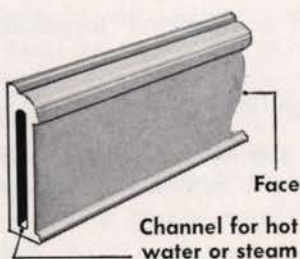

HOLLOW-TYPE

TYPE "R" (full radiant)

Water or steam flows directly behind the baseboard face. Heat from this surface is transmitted to the room.

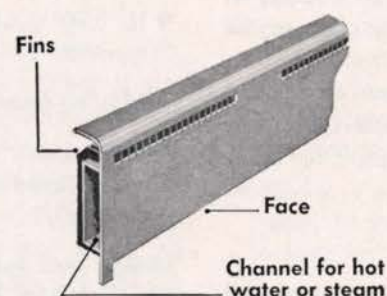

TYPE "RC" (radiant convector)

Operation is similar to Type "R" except that additional heat is supplied to the room by air passing over the fins.

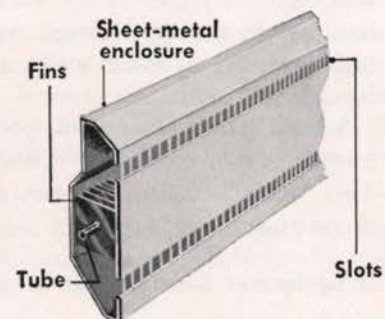

FINNED-TUBE

Hot water or steam passing through tubes heats the tubes and the fins, and the air passing over them. The heated air is delivered to the room through the slots.

STEAM HEATING SYSTEM

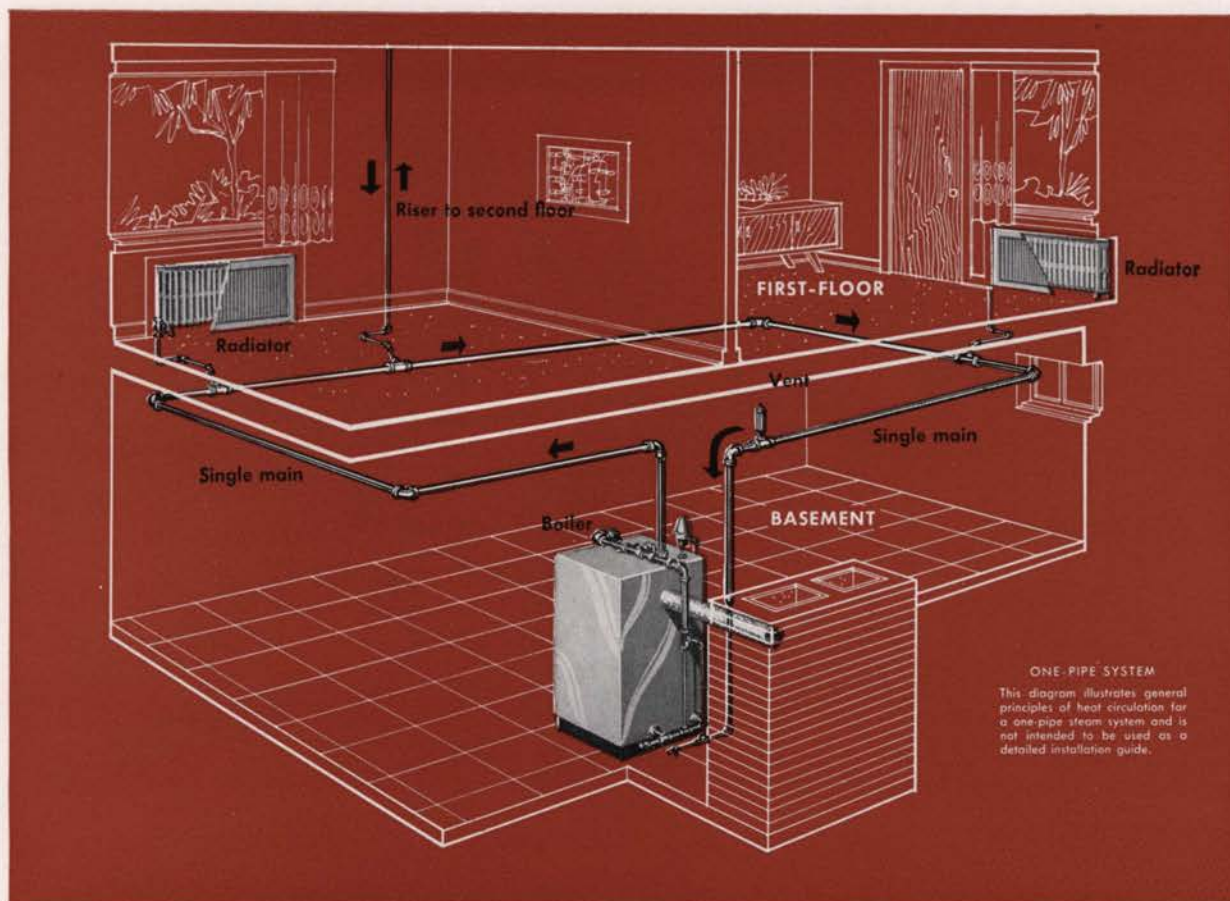

In a steam system, the steam is generated in the boiler and rises to the room heating units. Here it condenses and forms water which is returned to the boiler.

Steam systems may be either one-pipe (shown above) or two-pipe.* The latter is not generally used for small homes because of its cost.

One-Pipe System

In the one-pipe steam system, the pipe which carries the steam to a radiator or convector also returns the condensed steam (water) to the boiler.

Since both steam and water are present in the single main, the pipes must be larger than those of other boiler systems and must be accurately pitched to avoid water pockets and "hammering" in the main.

A one-pipe steam system:

- Is simple and economical to install.
- Has no motors or electrical connections other than those required if controls or an automatic burner are used.
- Heats domestic water the year-round if heating coils are installed in the boiler, and an automatic fuel burner is used.

- Offers difficulty in control as radiator temperature cannot be varied. The radiator valve must be either **entirely on or off** in order to prevent the convectors or radiators from filling with water. (In the two-pipe system, the heat input rate to rooms can be controlled.)
- Is not recommended for basementless houses or for heating basement rooms since the boiler must be below the level of the room heating units.

Room Heating Units: Either radiators or convectors may be used. Baseboard units are not generally recommended for the one-pipe steam system; they may be used with the two-pipe.

Maintenance: The water level in the boiler should be checked regularly, as should the operation of boiler safety controls and the air vents on each radiator or convector.

Design and Installation: Use I-B-R Installation Guide No. 2, "One-Pipe Steam Heating Systems," published by the Institute of Boiler and Radiator Manufacturers. (See page 3 for address.)

* In the two-pipe system (not illustrated), the steam rises through a supply main and risers to the room heating units. Air in the system and the condensed steam (water) are forced through thermostatic traps at the outlets of the radiators into the return main. An air eliminator in the return main expels the air through a vent and allows the water to return to the boiler.

The system can be adapted to basementless structures if a condensation pump or a vacuum pump is added.

GRAVITY HOT-WATER HEATING SYSTEM

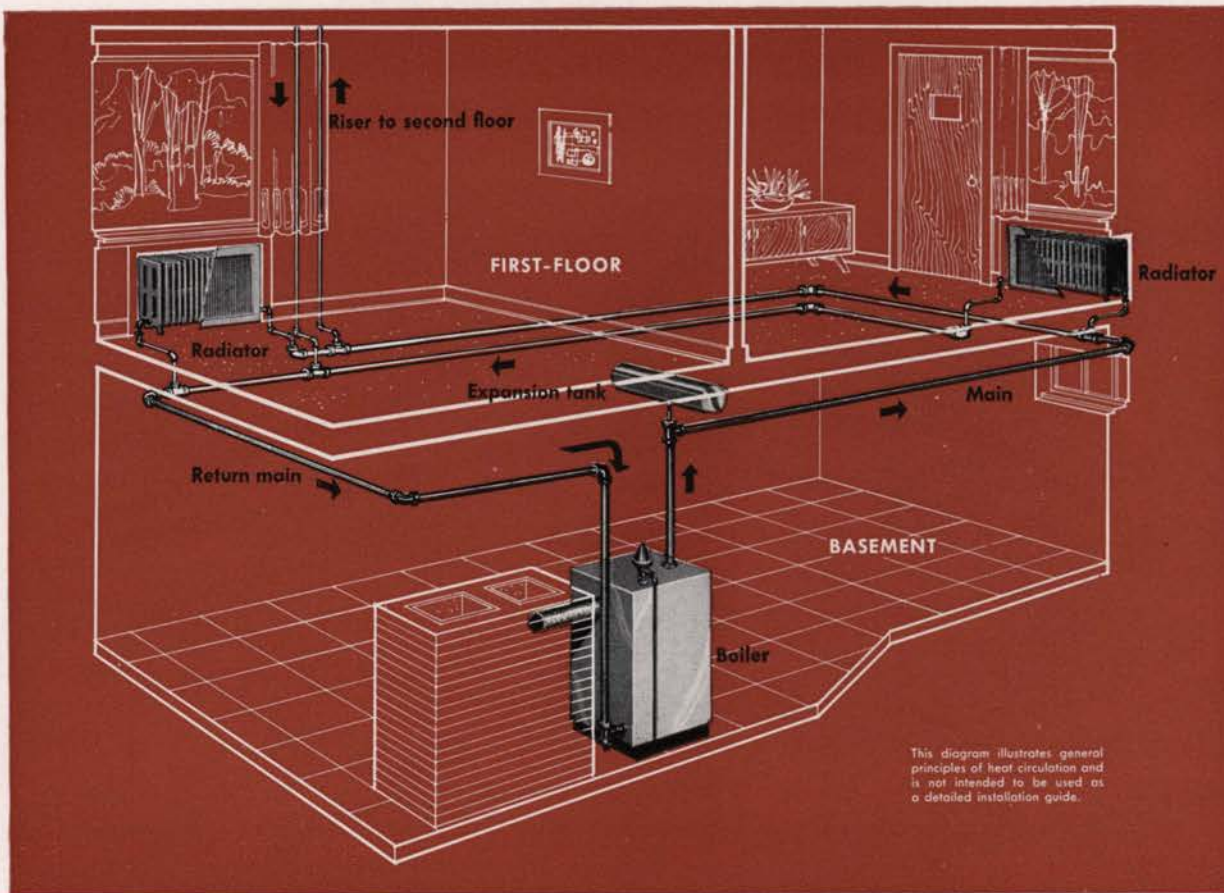

Circulation in a gravity hot-water system results from the fact that heated water flows to the top and cool water to the bottom of a container. Water is heated in the boiler and as it becomes warmer, it rises and flows out through supply pipes (mains and risers) to the room heating units (radiators, convectors or baseboards); the cooled water flows downward through the return pipes (risers and mains) to the bottom of the boiler.

This system may be operated either as a *closed* or as an *open* system.

In the closed, or pressure, system (shown above), the expansion tank is usually located near the boiler. As the heated water expands, the air in the tank is compressed. Since an increase in pressure raises the boiling point of the water, higher temperatures can be maintained in the closed system than in the open system without having steam form in the room heating units. These higher temperatures permit the use of smaller heating units than those needed for the open system.

In the open system, the expansion tank is located above the highest radiator, and the water is "open" or exposed to the air.

A gravity hot-water system:

- Is economical to install as it requires a minimum of special fittings or devices.

- Has no motors or electrical connections other than those required if controls or an automatic burner are used.
- Is not generally recommended for basementless houses or for the heating of basement rooms since the boiler should be at a lower level than the room heating units.
- Requires large supply and return mains in order to reduce friction since circulation of the water is by gravity action.
- Has a slower response to temperature changes than a forced hot-water system because of the larger amount of water retained in pipes and room heating units.

Room Heating Units: Radiators, baseboards or convectors may be used with this system.

Maintenance: Water pressure (altitude) in system must be checked, and room heating units vented regularly unless automatic air vents are used.

Design and Installation: The design and installation of this system should be the work of competent men experienced in gravity hot-water heating.

FORCED HOT-WATER HEATING SYSTEM

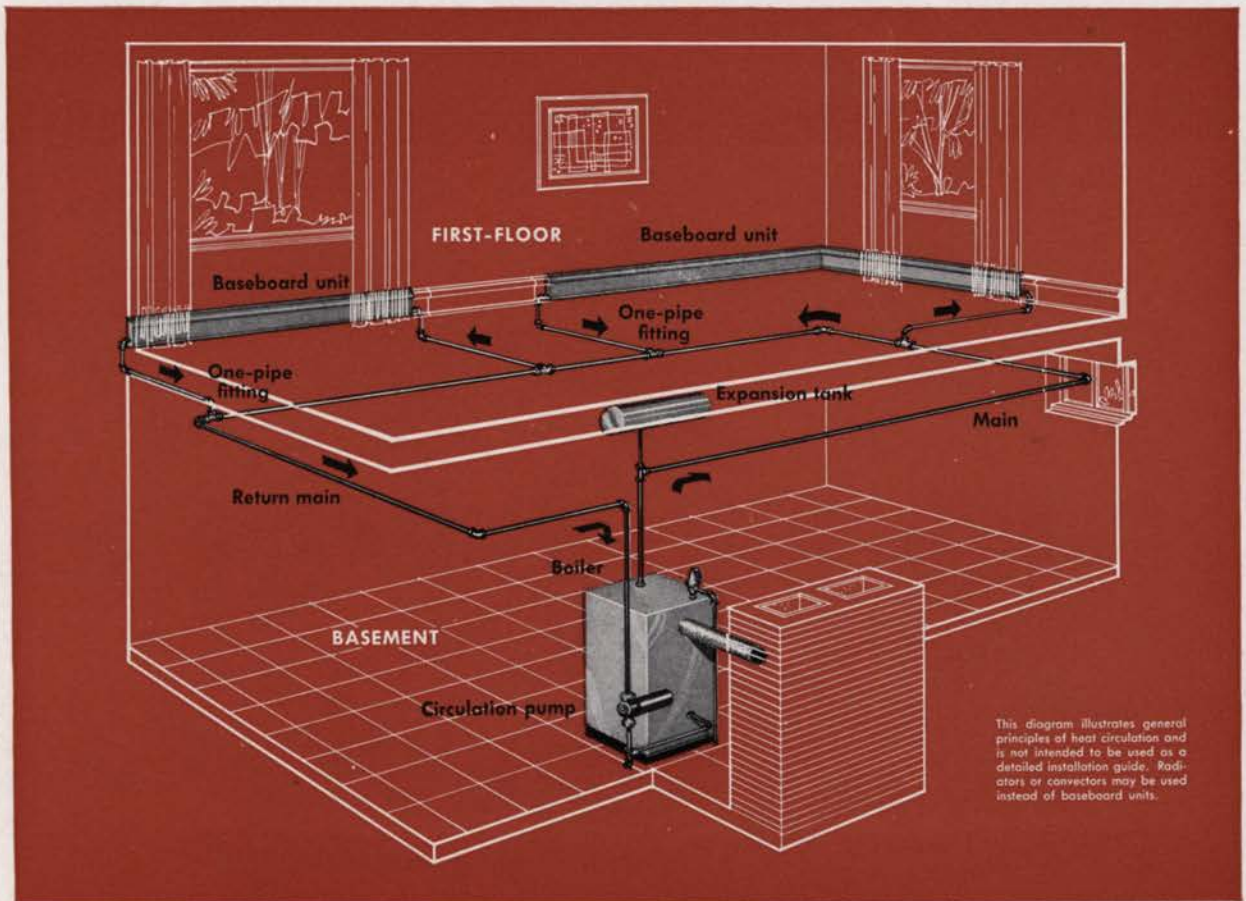

In a forced hot-water system, the water is heated in the boiler and is forced through the pipes (mains and risers) to the room heating units. The circulation of water is produced by the action of a circulating pump at the boiler. The pump is motor driven and requires electrical connections.

Two basic types of piping layout are common:

The one-pipe system (shown above) — This has a single pipe or main which supplies the heated water to the baseboard units (or convectors or radiators) and also returns the cooled water from the units to the boiler.

The two-pipe system — This system has two mains. The heated water is supplied to room heating units through a supply main, and the cooled water is returned to the boiler through a separate return main.

A forced hot-water system:

- Responds rapidly to changes in outside temperature. Temperature of the room heating unit can be varied in accordance with changing weather so that uniform room air temperatures are maintained.
- Can be used to heat domestic water the year-round when heating coils are installed with the boiler and an automatic fuel burner is used.
- Is adapted to basementless houses and to the heating of basement rooms. Circulation of water

by means of the pump makes it possible to locate radiators, baseboard units or convectors either above or below the level of the boiler.

- Makes possible a large amount of usable basement space since small pipes can be used for the mains and risers. (The pump is capable of circulating water against high friction heads, making large pipes unnecessary.)
- Costs more to install than a gravity hot-water system due to the need for the circulating pump and, for one-pipe systems, special fittings. Frequently the reduction in pipe size results in lower labor and material costs which partially offset the cost of the pump and one-pipe fittings.

Room Heating Units: Radiators, convectors or baseboard units may be used.

Maintenance: Water pressure in system must be checked, motor oiled, and room heating units vented regularly unless automatic vents are used.

Design and Installation: For one-pipe systems which use radiators or convectors, use I-B-R Installation Guide No. 100, "One-Pipe Forced Circulation Hot-Water Heating Systems."

For baseboard installations, use I-B-R Installation Guide No. 5, "Baseboard Heating Systems." (See page 3 for address.)

HOT-WATER PANEL INSTALLATION

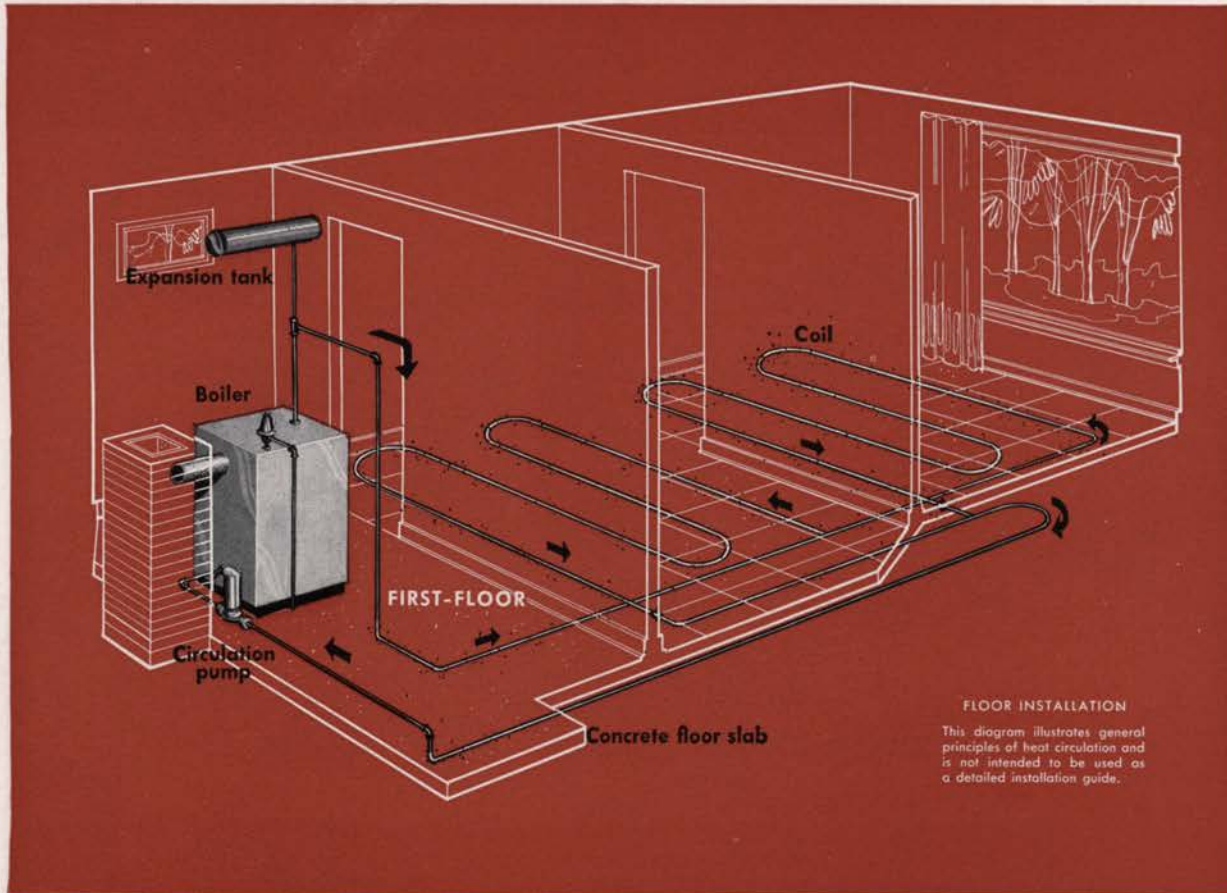

In a hot-water panel heating installation, the water which is heated in the boiler is circulated through pipe coils (tube) concealed in sections of the floor, wall, or ceiling. These are, in effect, the room heating units. No radiators, convectors or baseboard units are necessary. The panels are indistinguishable in appearance from other sections of the floor, wall or ceiling.

The heat from the water is transmitted through the pipe to the surface of the floor, wall or ceiling where it is transmitted to the room by radiation (heat rays) and convection (air currents).

A forced circulation heating system is required for use with a hot-water panel installation. Steam systems can sometimes be used for panel installations, but their use is not practical for homes. The boiler should have an automatic fuel burner and controls.

Panel heating is still in the development stage. Whether the floor, the ceiling or the wall is the best surface in which to embed the coils is still a matter of controversy. A floor installation is illustrated.

A hot-water panel system:

- Requires planning in the early stages of the house design since the system is usually a structural part of the house.

- Can be used in houses with or without basements.
- Is well adapted to conventional thermostatic controls, but may be subject to overheating or underheating. This is particularly true in houses having large glass areas which are subject to rapid temperature changes due to variations in sun intensity.
- Has definite limitations on temperatures of panels. Floor surface temperatures should not be more than 85°F. for comfort; surface temperatures of wall or ceiling panels may be as high as 115°-120°F.
- Requires adequate insulation on the back of the panels to prevent heat loss and, consequently, excessive fuel costs. When installation is made in a floor slab, the slab should be insulated.

Maintenance: Motor and pump must be oiled, and boiler inspected periodically.

Design and Installation: Use I-B-R Installation Guide No. 6, "Panel Heating for Small Structures," published by the Institute of Boiler and Radiator Manufacturers. (See page 3 for address.)