

PETROLEUM RESIDUE UPGRADING VIA DELAYED COKING: A REVIEW

Ashish N. Sawarkar, Aniruddha B. Pandit, Shriniwas D. Samant and Jyeshtharaj B. Joshi*

Institute of Chemical Technology, University of Mumbai, N. P. Marg, Matunga, Mumbai, Maharashtra, 400019, India

World petroleum residue processing capacity has reached about 725 million metric tons per annum (MMTPA). The high demand for transportation fuels and the ever-rising heavy nature of crude oil have resulted in a renewed interest in the bottom-of-the-barrel processing using various conversion processes. Delayed coking, known for processing virtually any refinery stream (which not only poses a serious threat to environment, but also involves a disposal cost) has garnered tremendous importance in the current refining scenario. Needle coke obtained from delayed coking process is a highly sought-after product, which is used in electric arc furnaces (in the form of graphite electrodes) in steel making applications. In the present communication, the published literature has been extensively analyzed and a state-of-the-art review has been written that includes: (1) importance and place of delayed coking as a residue upgrading process in the current refining scenario; (2) coking mechanism and kinetics; (3) design aspects; (4) feedstocks suitable for the production of needle coke; (5) characteristics of needle coke; (6) factors affecting needle coke quality and quantity; and (7) future market for needle coke. An attempt has been made to get the above-mentioned aspects together in a coherent theme so that the information is available at a glance and could be of significant use for researchers and practising refiners.

La capacité de traitement des résidus pétroliers mondiaux a atteint environ 725 millions de tonnes métriques par année (MMTPA). La forte demande de carburants pour le transport et la nature de plus en plus lourde de l'huile brute ont renouvelé l'intérêt pour le traitement des résidus (fond de baril) à l'aide de divers procédés de conversion. La cokéfaction retardée, connue pour traiter virtuellement tout courant de raffinage, qui non seulement constitue une menace sérieuse pour l'environnement, mais également implique des coûts d'élimination, a pris une importance considérable dans le scénario de raffinage actuel. Le coke en aiguilles obtenu à partir du procédé de cokéfaction retardée est un produit très recherché, qui est employé dans les fours à arc électriques (sous la forme d'électrodes de graphite) dans les applications de fabrication de l'acier. Dans le présent article, on a analysé de manière extensive la littérature scientifique et on présente une étude des dernières développements, qui inclut : (i) l'importance et la place de la cokéfaction en tant que procédé de valorisation des résidus dans le scénario de raffinage actuel, (ii) le mécanisme de cokéfaction et la cinétique, (iii) les aspects de la conception, (iv) les approvisionnements convenant à la production de coke en aiguilles, (v) les caractéristiques du coke en aiguilles, (vi) les facteurs influant sur la qualité et la quantité du coke en aiguilles et (vii) le marché futur pour le coke en aiguilles. On a tenté de regrouper ces différents aspects de manière cohérente, de telle sorte que l'information soit disponible au premier coup d'œil et puisse être d'une utilité pratique pour les chercheurs et les raffineurs sur le terrain.

Keywords: petroleum residue, delayed coking, kinetics, needle coke, graphite electrodes

INTRODUCTION

World petroleum refining capacity has reached about 4100 million metric tons per annum (MMTPA) (Swaty, 2005), inclusive of India's refining capacity of about 120 MMTPA (Goyal, 2006). Of late, the petroleum refining industry is facing many new challenges to remain competitive in the world fuels market. One of the major challenges is to fully utilize the existing petroleum resources, while protecting our environment. This very fact has led to the emphasis on the bottom-of-the-barrel residue upgrading. Furthermore, the crudes are getting heavier and demand for light, clean fuels is increasing, leaving the refiners with no option but to expand their residue upgrading capacity (Elliott, 1992; Bansal et al., 1994; Henderson et al., 2005). As the price differential between light crudes and heavy crudes is widening, a trend of processing heavier crudes is catching up fast in the refineries. As a result of this, refiners are

getting burdened with heavy residues that are subsequently obtained by processing heavy crudes. Heavy crudes (≤ 20 °API) yield large amount of residual fractions such as atmospheric residue (AR, initial boiling point, IBP > 343°C) and vacuum residue (VR, IBP > 500°C) as shown in Figure 1 (Boduszynski, 2002). The processes that convert these heavy ends into lighter, more value-added products are termed as bottom-of-the-barrel conversion processes or residue upgrading processes.

Among the various processes available, the delayed coking process is a long-time workhorse as regards the bottom-of-the-barrel upgrading (Schulman et al., 1993). World coking capacity has reached about 210 MMTPA (Swaty, 2005), comprising India's

* Author to whom correspondence may be addressed.
E-mail address: jbj@udct.org

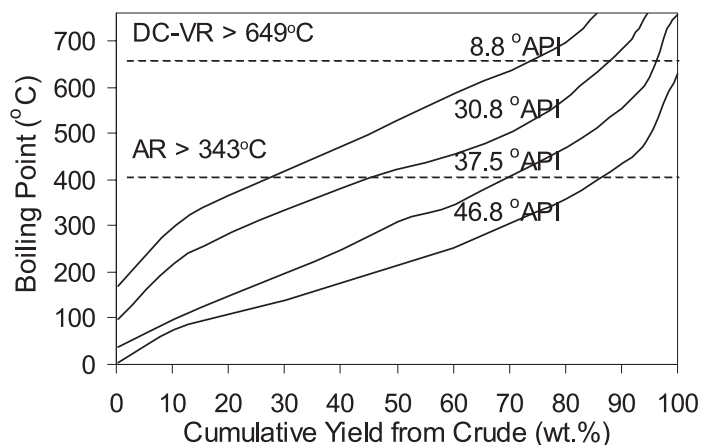

Figure 1. TBP curves for feeds with different API gravity (Boduszynski, 2002)

coking capacity of about 9 MMTPA. In the delayed coking process, the aim is an economical conversion of residual feedstocks, especially vacuum residues (short residues) to lighter, more value-added products and if possible, to produce a coke material of desired quality. The inherent flexibility of the delayed coking process to handle different feedstocks promises the refiner a solution to the problem of decreasing residual fuel demand and takes advantage of the attractive economics of upgrading it to more valuable lighter products (Mekler and Brooks, 1959; Stormont, 1969; Gambro et al., 1969; DeBiase and Elliott, 1982). Conventionally, processes such as coking, visbreaking, vacuum distillation, solvent deasphalting or residual cracking have effected the upgrading of residual feedstocks. All the aforementioned processes result in less residual fuel. However, except for coking, they still produce a liquid bottoms product that requires tankage and cutter stock (Rose, 1971). Therefore, a refinery with delayed coker is said to be “zero resid refinery,” which itself spells the importance of delayed coking in the refinery set-up. This is one of the major advantages of the delayed coking process.

Another advantage is that delayed coking offers a potential means of converting a variety of materials to valuable motor fuels, often while eliminating a low-value or unmarketable refinery stream, or eliminating a stream that not only is environmentally unfriendly, but also involves a disposal cost (Christman, 1999). Yet another advantage of delayed coking is that it not only complements other, more capital intensive, bottom-of-the-barrel conversion technologies, but also works very well as the primary upgrader in the refinery (Sloan et al., 1992; Bansal et al., 1994). Delayed coking can also be used to produce needle coke, a specialty product, if appropriate feedstocks, design techniques and operating parameters are applied (Sarkar, 1998).

The worldwide trend of processing heavy feedstocks in the delayed cokers for getting maximum yield of liquid products has led to the production of fuel grade coke that contains large amounts of sulphur and metals. Currently, about 65% of the petroleum coke produced is fuel grade coke (Shen et al., 1998). Once considered a waste by-product, fuel grade petroleum coke is now an important fuel for the cement industry and competes successfully with coal in several industrial fuel applications such as utilities and cogeneration facilities. Advancements in circulating fluidized bed (CFB) boiler design have enabled the exclusive use of coke as a fuel to steam power generators and cogenerators

(Elliott, 1992). Petroleum coke can also be successfully employed for the production of synthesis gas via gasification route (Furimsky, 1999). Since the fundamental objective of the refiners who process heavy residues to the delayed cokers is to maximize liquid product yield, any value added to the coking process by selling the fuel grade coke is a bonus for the refiners (Elliott, 1992).

NECESSITY OF RESIDUE UPGRADING

Upgrading heavy residuals or bottom-of-the-barrel has always been the goal of the refiner to achieve value addition by producing lighter, more value-added products out of the residual feedstock (Rose, 1971). The refinery scene is changing significantly all over the world and it is driven by environmentally obligated modifications for gasoline and diesel quality. As a result of this, there is an increased need for capacity and flexibility in conversion technology and there is a dramatic increase in refinery hydrogen demand (Schulman et al., 1993). While past emphasis has been on increasing gasoline production, of late, the middle distillates are in great demand. This situation of demand and supply, according to Sloan (1994), calls for an increase in flexibility not only for gas oil boiling range materials, but also for the bottom-of-the-barrel upgrading. The demand for fuel oil is declining as the user industry is switching over to other alternate sources of energy like liquefied natural gas (LNG). The reserves of conventional (light) crude oil are depleting and there is a gradual but sure decline in crude oil quality. Therefore, there is a dire need to fully utilize the limited petroleum resources (Schulman et al., 1993; Bansal et al., 1994; Shen et al., 1998). Consequently, interest is focused on diverting the crude's residual fraction from its traditional use as a heavy fuel component to processes that either convert the residue into high-value products or that provide additional feedstock for downstream conversion units (Sarkar, 1998). The renewed interest in residue upgrading can be attributed to the fact that, lately, ever-heavier crude oils are being processed in the refineries (Christman, 1999), which subsequently produce a significant amount of vacuum residue (may go up to 40 wt.%) (Speight, 2000).

Indian refiners are equally concerned about upgrading the available crude oil for refining, along with other international refiners in the area of residue upgrading, to get more light distillates required for transport fuels and also to provide the needs for the other concerned industries using petroleum products such as fertilizer and petrochemicals. The basic reason for giving extra attention to residue upgrading is that India has less options than to import crude oil with maximum percentage of residues (Sarkar, 1998).

QUALITATIVE DESCRIPTION OF DIFFERENT UPGRADING PROCESSES

Technologies for upgrading heavy feedstocks such as heavy oil, bitumen and residua can be broadly divided into carbon rejection and hydrogen addition processes. Carbon rejection redistributes hydrogen among the various components, resulting in fractions with increased H/C atomic ratios and fractions with lower H/C atomic ratios. On the other hand, hydrogen addition processes involve the reaction of heavy feedstock with an external source of hydrogen, which results in an overall increase in H/C ratio. Within these broad ranges, all upgrading technologies can be subdivided as follows:

1. Carbon rejection processes: visbreaking, steam cracking, fluid

catalytic cracking, and coking;

2. Separation processes: solvent deasphalting;
3. Hydrogen addition processes: hydrocracking, fixed bed catalytic hydroconversion, ebullated catalytic bed hydroconversion, hydrovisbreaking, hydrovisbreaking, and donor solvent processes (Speight, 2000).

Table 1 outlines the comparison of different residue upgrading processes. As can be seen from Table 1, the non-catalytic carbon rejection processes score higher than other processes in simplicity and operating costs and hence have large numbers of units in the world. Table 2 shows the world residue processing capacity in different parts of the world. It can be seen that a major portion of the petroleum residue upgrading (about 63%) is met via thermal processes, viz., visbreaking and delayed coking.

There can be a brief classification of residue upgrading processes under different headings, which have been commercially installed over the years in the refineries. The classification can be as follows:

1. Separation processes: solvent deasphalting;
2. Catalytic process: residue fluidized catalytic cracking (RFCC);
3. Hydrogen-addition processes: residue hydrocracking;
4. Thermal conversion processes: visbreaking, delayed coking, fluid coking and flexi coking.

The solvent deasphalting process involves physical separation and there is no chemical conversion. The limitations of this process are high energy costs and the limited uses of deasphalting tar. Current interest in deasphalting is greatest in areas of the world where demand for motor fuel is low. This

suggests that, in the long run, solvent deasphalting, as a stand-alone residue upgrading process, will be of less interest worldwide (Christman, 1999).

Residue fluidized catalytic cracking (RFCC) involves a vapour phase catalytic cracking reaction. The heavier and more contaminated atmospheric and vacuum residues cannot vaporize and eventually end up getting deposited on the surface of the catalyst and tend to increase the production of coke and deactivate the catalyst. Thus, residue fluidized catalytic cracking (RFCC) is limited in terms of its applicability to process relatively low metal and low asphaltene feeds (Shen et al., 1998).

Residue hydroprocessing can process a little heavier and high metal content feedstocks (Conradson carbon residue (CCR) up to 10 wt.% and metals up to 100–150 ppm) with the aid of new processes such as Chevron's Onstream Catalyst Replacement (OCR) and Shell's HYCON unit. Thus, residue hydroprocessing has a distinct advantage over residue fluidized catalytic cracking as far as processing of heavier feeds is concerned. However, it may be pointed out that although residue hydroprocessing can produce high-quality products and meet the requirement of the reformulated gasoline and diesel in terms of low aromatic and low sulphur, hydrogen resource and high investment limit its application (Shen et al., 1998). Thus, heavy residues containing more than 10 wt.% CCR and 150 ppm of metals can only be processed by using non-catalytic carbon rejection processes as illustrated in Figure 2 (Philips and Liu, 2002).

Thermal conversion processes can handle any kind of feedstock, even extra heavy vacuum residues. Visbreaking is the least costly of the residue upgrading options. However, its major

Table 1. Comparison of different processes for residue upgrading (Sarkar, 1998)

	Non-catalytic	Catalytic	Extraction	Hydrogen addition
Simplicity	High	Medium	Medium	Low
Flexibility	Low	High	Low	High
Cost	Low	Medium	Medium	High
Quality of products	Low	Medium	Medium	High
Resid conversion level	Medium	Medium	Medium	High
Rejection as fuel oil	Medium	Medium	Medium	Medium
Rejection as coke	High	Medium	Medium	Medium
No. of units in world	Large	Large	Average	Average
Recent trends	High	Medium	Medium	Medium
Environmental pollution	High	Medium	Nil	Low
On stream factor	Poor	Medium	Medium	High
Problems	Coke disposal	Heavy residue	High energy	Hydrogen requirement

Table 2. World residue processing capacity, MMTPA (Shen et al., 1998)

Process	U. S. A.	Japan	Europe	Rest of world	Total
Thermal					
a. Cracking/Visbreaking	6.5	1	108.5	82.5	198.5
b. Coking	93	3	31.5	61	188.5
Deasphalting	13	1	0.5	5	19.5
Hydroprocessing	30.5	30.25	9	49.75	119.5
Resid FCC	31.5	12.5	10.5	37	91.5
Total	174.5	47.75	160	235.25	617.5

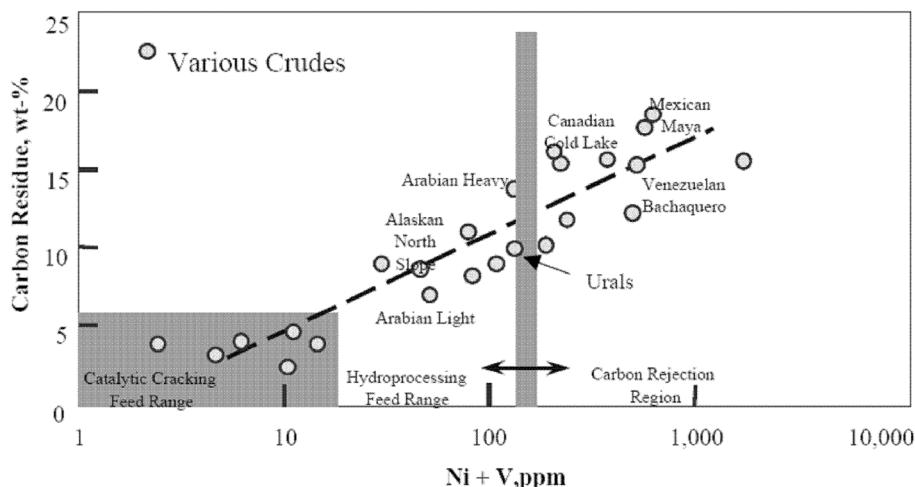

Figure 2. Feasibility region of the commercial residue conversion processes (Phillips and Liu, 2002)

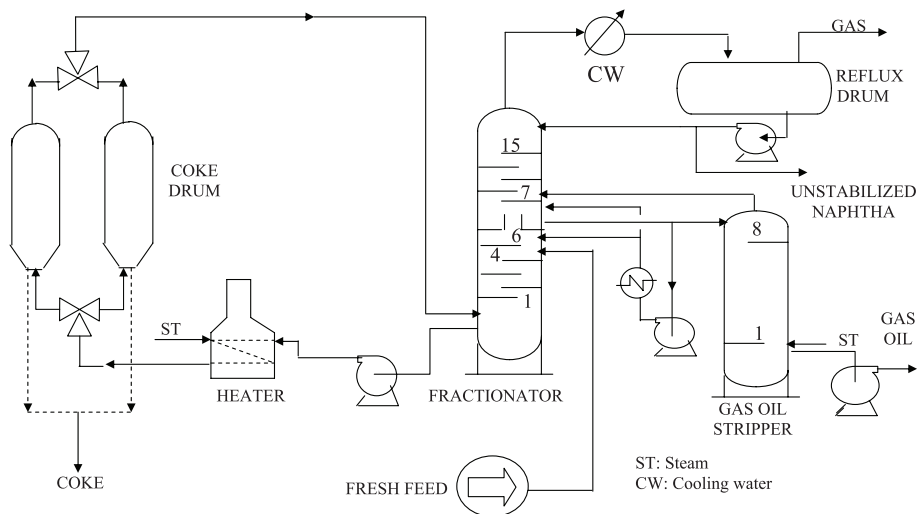

Figure 3. Schematic flow diagram of delayed coking process

product, fuel oil has a dwindling market and provides low margins. The yield of gas and gasoline together is generally limited to a maximum of about 7 wt.% (Zuba, 1998) as the cracking reactions are arrested so that asphaltene flocculation does not take place and in turn a stable fuel oil is obtained. Like deasphalting, current interest in visbreaking is in those areas where motor fuel demand is relatively low. When the motor fuel demand will increase in these areas and refiners will have no option but to process heavier crudes, delayed coking will be more widely used (Christman, 1999).

As regards the status of the delayed coking process in the area of residue upgrading, Christman (1999) reported that by using the carbon rejection technologies, 17 residue upgrading projects were in the construction phase worldwide, 14 in the engineering phase, and another 5 in the planning phase. Out of these 36 projects, two thirds of the projects were getting along with the delayed coking process. This indicates the growing interest in the delayed coking process as the preferred petroleum residue upgrading route.

REACTIONS AND REACTOR ENGINEERING

Delayed coking is a severe form of thermal cracking process that falls in the temperature range of 450–470°C. The name “delayed” comes from the fact that cracking reactions are given sufficient (extended) time to proceed to completion in coke drums that are specially designed to accumulate the coke and not in the heater tubes, which otherwise would have led to the premature shutdown of the unit. Sufficient heat is introduced in the heater tubes for complete destructive distillation, but the reduction to coke does not occur unless and until the residue enters the coke drum. In other words, it can be said that the heating is done in a furnace to initiate cracking and the actual reactions are complemented and completed in the huge and tall coke drums. The first commercial delayed coker began operations at the Whiting refinery of Standard Oil Co. (Indiana) in 1930 (Kasch and Thiele, 1956). Foster Wheeler and ConocoPhillips are the major contributors with regard to the design, engineering and construction of delayed coker units. Foster Wheeler has designed, engineered and built more than 60 delayed coking units ranging in capacity from 50 to 3300 tons per day. ConocoPhillips has worldwide delayed coking operations and produces over 2 million tons per year of combined fuel-grade and high-quality petroleum coke. According to the report of Sloan et al. in 1992, Kellogg had designed and constructed about one third of the world’s delayed coking capacity. Lummus and Flour are the other licensors of delayed coking process having relatively lesser market shares.

Process Description of Delayed Coking

Figure 3 shows the process flow diagram of a delayed coking unit. The feedstock is fed directly to the bottom of the fractionator where it is heated and lighter fractions are removed as side streams. The fractionator bottoms, including a recycle stream of heavy product, are then heated in a furnace whose outlet temperature varies from 480 to 515°C. The heated feedstock enters one of the pair of coking drums where the cracking reactions continue. The cracked products leave as overheads, and coke deposits form on the inner surface of the drum. For continuous operation, two coke drums are used; while one is on stream, the other is being cleaned. The temperature in the coke drum ranges from 415 to 465°C and the pressure from 0.1MPa to 0.4 MPa. Overhead products go to the fractionator, where naphtha and heating oil fractions are recovered. The heavy recycle material is combined with preheated fresh feed and returned to the reactor. The coke drum is usually on stream for about 24 h before getting filled with porous coke. Figure 4 shows a cross-section of a coke drum, and demonstrates how the coke is formed during the delayed coking operation. The coke is formed at the rate of about 0.6 m per hour and progresses during the 24-hour cycle. The material at the

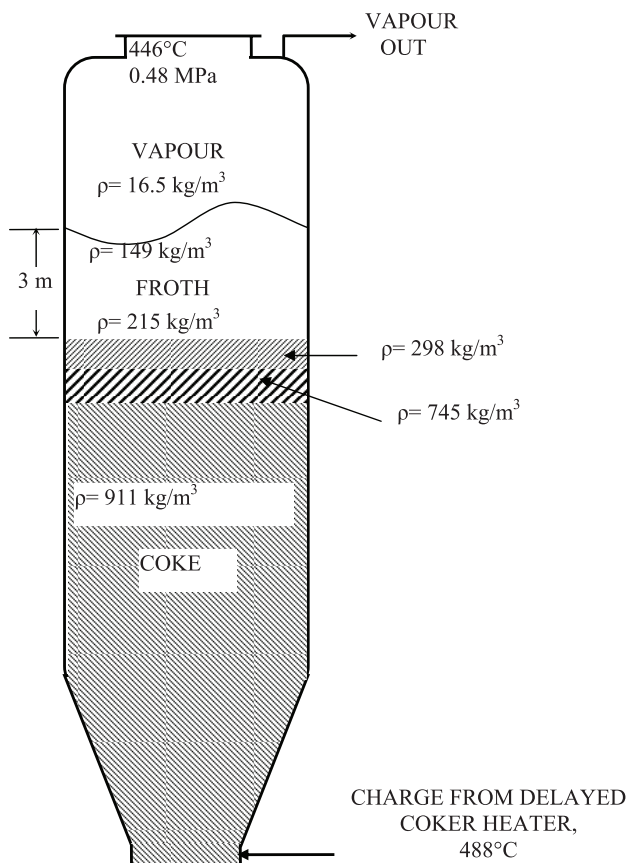

Figure 4. Coke formation in coke drum of a delayed coking unit (Nelson, 1970)

bottom is fully carbonized and develops a porous structure through which gases and liquid can pass. The top layer is not fully carbonized until it is subjected to heat for a prolonged time. At the very top some foam occurs, but subsides during the steaming and cooling cycle. It is important in filling the coke drum to avoid carryover of foam or pitchy material into the vapour lines. Level indicators are handy for detecting the position of the liquid or foam in the drum. These are operated by transmitting a beam from a radioactive source to an instrument mounted near the top of the drum (Nelson, 1970).

The following procedure is practised to remove the coke:

1. The coke deposit is cooled with water;
2. One of the heads of the coking drum is removed to permit the drilling of a hole through the centre of the deposit;
3. A hydraulic cutting device, which uses multiple high-pressure water jets, is inserted into the hole and the wet coke is removed from the drum (Speight, 2000).

Feedstock Characterization Affecting Coking

As far as the feedstock for delayed coking is concerned, heavy residues such as vacuum residue or occasionally atmospheric residue are most commonly fed to the delayed cokers. However, there are many feedstocks that have been fed to the delayed cokers over the years, which include gilsonite (Anon., 1956), lignite pitch (Berber et al., 1968), coal tar pitch (Gambro et al., 1969), refinery hazardous wastes, and used plastics (Christman, 1999). For special applications in which high-quality needle coke is desired, certain highly aromatic heavy oils or blends of such heavy oils have also been processed (Acciarri and Stockman, 1989).

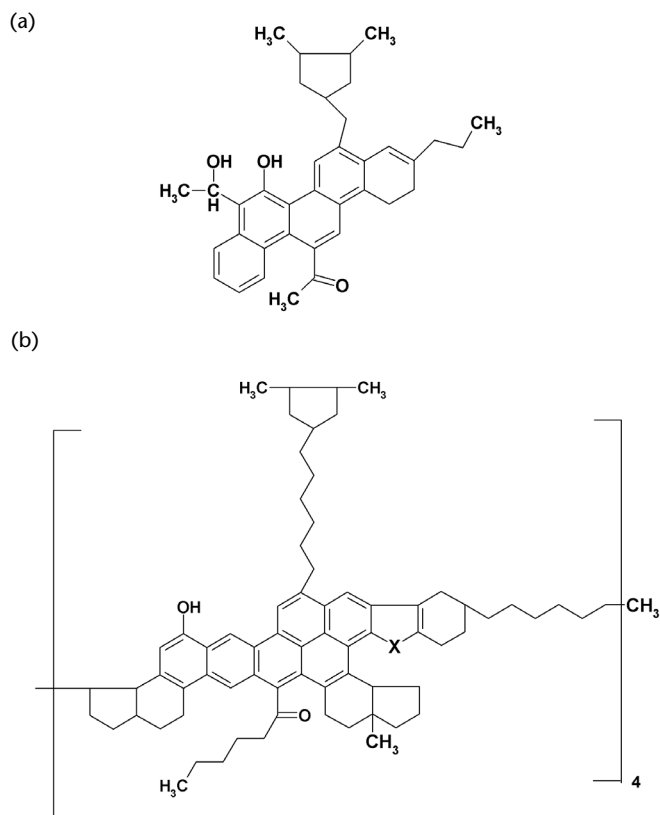

Figure 5. Hypothetical resins structure from (Speight, 1980)

(a) American crude oil

(b) Turkish bitumen

Vacuum residue, which is by far the most common feedstock to delayed coking unit (Rose, 1971; DeBiase and Elliott, 1982), is composed of four fractions, viz., saturates, aromatics, resins and asphaltenes. A brief description of these is given below:

Saturates

These components are found to have an average carbon number in the range of C_{38-50} with relatively low heteroatom content. The structural study shows that it consists of long alkyl chains with few or negligible naphthenic and aromatic rings. The micro-carbon residue (MCR) value (coking tendency) reported is almost 0 wt.%, which indicates that these fractions are completely volatile and cannot directly yield coke.

Aromatics

The aromatic fraction has a slightly higher molecular weight (600 to 750) than saturates with an average carbon number in the range of C_{41-53} . These are simple structures (Jacob, 1971) relative to resins and asphaltenes, having low heteroatom content and an MCR value of about 3.7 wt. %.

Resins

These are viscous, tacky and volatile enough to be distilled with hydrocarbons. Structurally, resins consist of an appreciable amount of aromatic carbon content (40–53%) with intermediate paraffin chain length on naphthenic structures and aromatic rings, and about two thirds of its aromatic carbon atoms are non-bridged. The resin fraction acts as the dispersant for the asphaltenic component in the maltene phase (Di Carlo and Janis, 1992). Figure 5 shows the hypothetical structures of resin

from different sources of crude oil. Figure 5a shows the hypothetical structure from American crude oil and Figure 5b shows the hypothetical structure from a Turkish bitumen. As can be seen from Figures 5a and 5b, the structures associated with resins from American crude oil and Turkish bitumen are substantially different from each other in terms of the linkages between the aromatic structures, heteroatoms, etc.

Asphaltenes

The asphaltene fraction of residues is a brown to black, non-volatile, amorphous substance, which exists as highly dispersed colloid in the oil. Asphaltenes are insoluble in n-alkanes such as n-pentane and n-heptane and soluble in benzene or toluene (IP-143 and ASTM D-4124). Except for small amounts of hydrocarbons adsorbed at the surface, asphaltenes are non-hydrocarbons made of nitrogen, oxygen, sulphur, vanadium and nickel (Jacob, 1971). Asphaltenes resemble a stack or cluster of naphthenic and aromatic molecules. Fused ring aromaticity, small aliphatic side chains, and polar functional groups are the structural features of these pseudo components. Figure 6 shows the asphaltenes postulated as polymers of aromatic and naphthenic ring systems. The heteroatoms (N, O, S) are present as carboxylic acids, carbonyl, phenol, pyrroles, pyridine, thiol, thiophene and sulphones while the metals (Ni and V) are mostly present as organometallic compounds (Gawrys et al., 2002). Figure 7 shows the asphaltenes postulated as polymers of aromatic and naphthenic ring systems accompanied by heteroatoms. The molecular weight of asphaltenes lies in between 3000 and 5000 (Jacob, 1971).

Figure 8 shows the average structural models for the asphaltene fractions. Figures 8a and 8b show the stable asphaltenes, while Figures 8c and 8d show the unstable asphaltenes from different vacuum residues. The asphaltenes and resins in an unstable feed are found to have low H/C ratio, high aromaticity, highly condensed aromatic rings and less alkyl and naphthenic substitution (Leon et al., 2000). Figures 9, 10 and 11 show the hypothetical asphaltene structures from Venezuelan, Californian and Iraqi crude oil, respectively. It can be seen that the complexity of the asphaltene structures is more than the resin structures. Also, the asphaltenes of different origins exhibit different structures as in the case of resins. Thus, it can be said that the physicochemical properties of the crude oil have a pronounced effect on the structures associated with resins and asphaltenes.

The main characteristics of the feedstocks, which govern the quality of distillate and quality of coke, are true boiling point (TBP) cut point, carbon residue, sulphur, metals and paraaffinity and aromaticity of the feedstocks.

TBP cut point

For vacuum residues, a typical TBP cut point is 538°C, but it may be lower or higher depending upon the crude. A TBP cut point of 343°C is typical for atmospheric residues. The TBP cut point defines the concentration of CCR, sulphur, and metals in the feed and thereby affects the product yield as well as product quality.

Carbon residue

It is the most important characteristics in determining the quantity of coke that will be produced from any particular feedstock. The higher the CCR (ASTM D 189), the more the coke that will be produced. In other words, it reveals the coke-forming propensity of the feedstock. Since, in most cases, the objective of

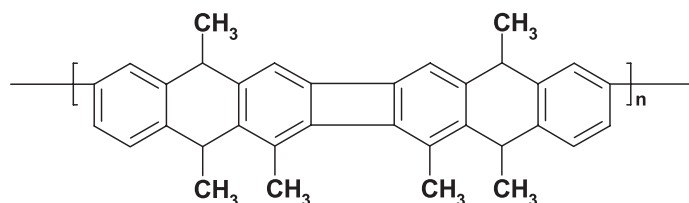
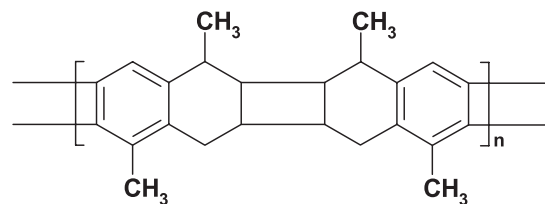
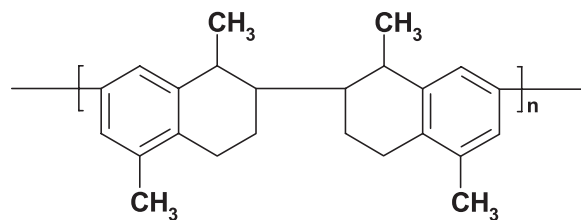

Figure 6. Asphaltenes postulated as polymers of aromatic and naphthenic ring systems (Speight, 1980)

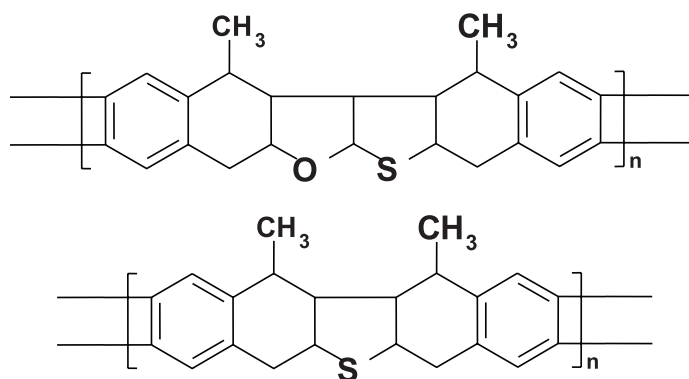

Figure 7. Asphaltenes postulated as polymers of aromatic and naphthenic ring systems accompanied with heteroatoms (Speight, 1980)

delayed coking is to maximize the production of clean liquid products and minimize the production of coke, the higher the CCR, more difficult it is to achieve the same. In recent years as there has been a trend of processing heavier crudes, values of CCR in excess of 20 wt.% and sometimes higher than 30 wt.% are becoming more common (Meyers, 1997).

Sulphur

Sulphur is an objectionable feed impurity, which tends to concentrate in the coke and in the heavy liquid products. In a manner similar to CCR, the sulphur content in the delayed coker feedstock has gone up considerably because of the trend of processing heavy crudes. This trend is going to continue as has been reported by DeBaise and Elliott (1982), Bansal et al. (1994), and Christman (1999).

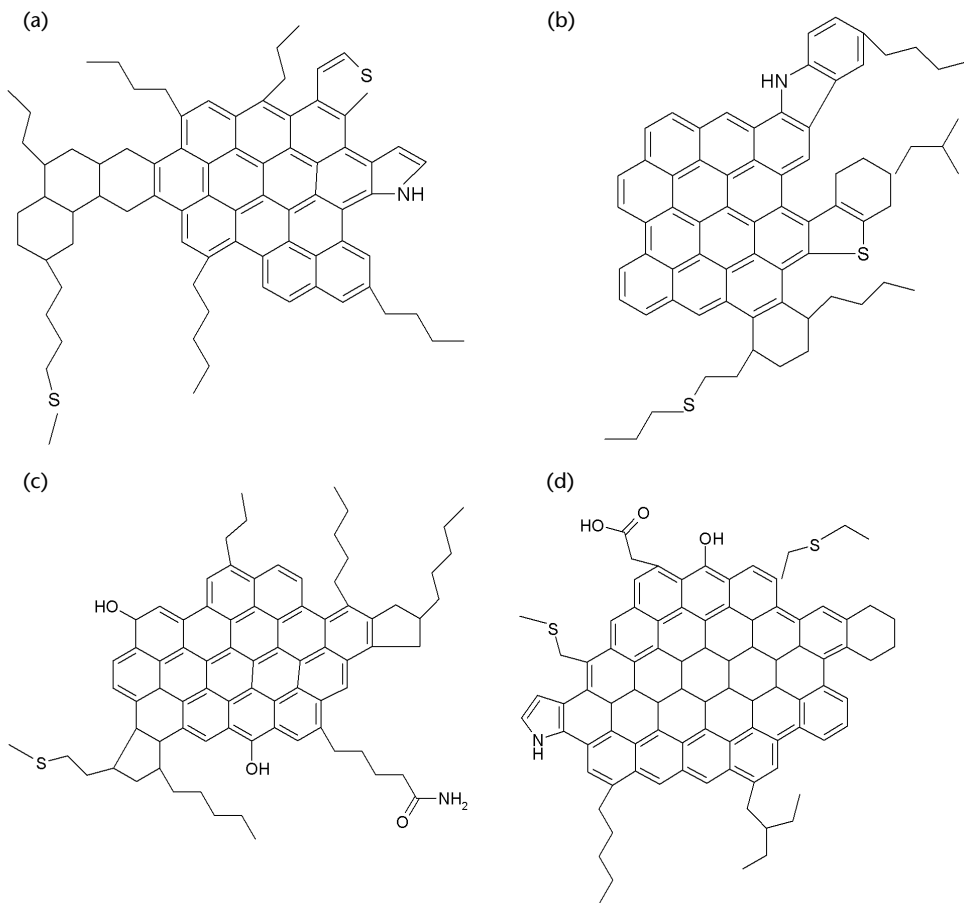

Figure 8. Average structural model for the asphaltene fractions (Leon et al., 2000)
 a, b – Stable asphaltenes from different vacuum residues
 c, d – Unstable asphaltenes from different vacuum residues

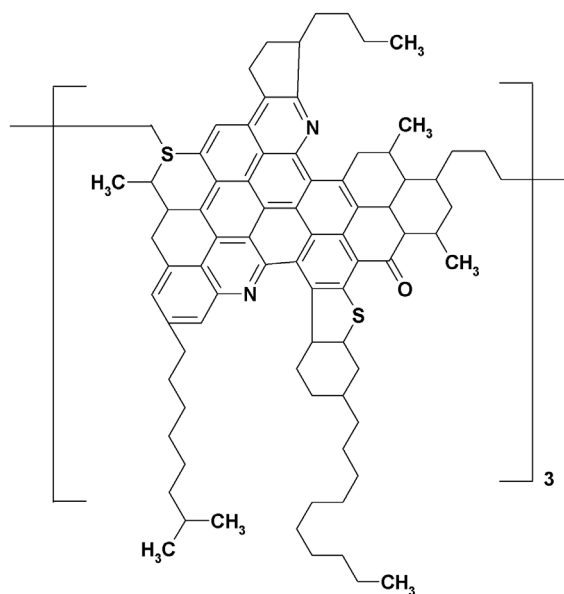

Figure 9. Hypothetical asphaltene structure from Venezuelan crude oil (Speight, 1980)

Metals

Metals such as nickel and vanadium are objectionable feed impurities that tend to be present in increasing quantities in heavier feeds. It has been reported (DeBiase and Elliott, 1982) that essentially all the metals in the feedstock concentrate in coke, thereby producing a low-quality coke.

Table 3 shows the comparison of the delayed coker yields from heavier feedstocks with those from conventional lighter feedstocks at constant operating conditions. It can be seen that among the heavy residues, the Maya residue yields more of naphtha (19.3 wt.%) as against 16.2 wt.% and 13.5 wt.% yield of naphtha, from Orinoco and heavy Arabian residues, respectively. At the same time, the yield of coke (38.3 wt.%) from the Maya residue can be found to be a little higher than the yield of coke (37.9 wt.%) from the Orinoco residue. The yield of coke (33 wt.%) from the Arabian heavy residue can be found to be the lowest amongst the three residues. This can be attributed to the fact that Arabian heavy residue contains less asphaltenes as compared to the other two residues, which is quite evident from the °API values of the three residues shown in Table 3.

Figure 12 shows the variation in the feed properties as a function of H/C atomic ratio and API gravity of the feed. From these figures, it can be seen that: (1) the sulphur and nitrogen content increases with a decrease in the H/C atomic ratio (Figures 12A and 12B), which indicate the concentration of these hetero moieties in aromatic and unsaturated compounds; and (2) H/C atomic ratio decreases with the decrease in API gravity (Figure 12C). The reduction in the H/C ratio indicates an increase in the content of unsaturated

and polycondensed aromatic compounds in the feedstock. This is again confirmed by the observed trends for nC_7 asphaltenes and CCR (Figures 12D and 12E).

Reaction Mechanism and Kinetics

Coke formation during the thermal cracking of residual feedstocks indeed is an intriguing phenomenon. Over the past five decades many researchers worldwide have put in their quality time and efforts to learn the intricacies pertaining to coke formation during the cracking of residual feedstocks.

Magaril and Aksenova (1968) have observed that the coke formation begins only after an accumulation of considerable amount of asphaltenes. The rate of coke formation in a given case is determined by the rate of increase of the asphaltenes in the cracked residue. The process of formation of a new solid phase is made up of the precipitation of asphaltenes from the saturated solution and their subsequent condensation. It was also observed that the time for the inception of coke formation coincides with the time of maximum yield of asphaltenes (Magaril et al., 1971).

According to Jacob (1971), two reaction mechanisms form coke at the time-temperature conditions prevailing in the coke drums. In one, the colloidal suspension of the asphaltene and resin compounds change proportions resulting in the precipitation of the compounds to form a highly cross-linked structure of amorphous coke. The compounds are also subjected to a cleavage of the aliphatic groups following a first order reaction kinetics. The carbon to hydrogen ratio increases from 8–10 in the feed to about 20–24 in the coke with trapped residue. The second

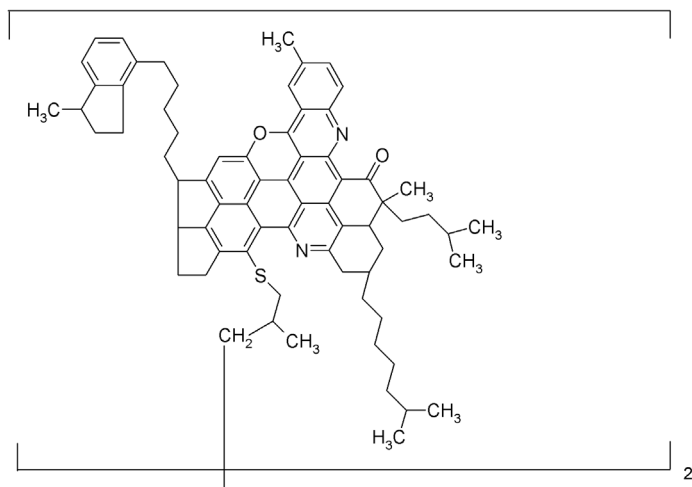

Figure 10. Hypothetical asphaltenes structure from different Californian crude oil (Speight, 1980)

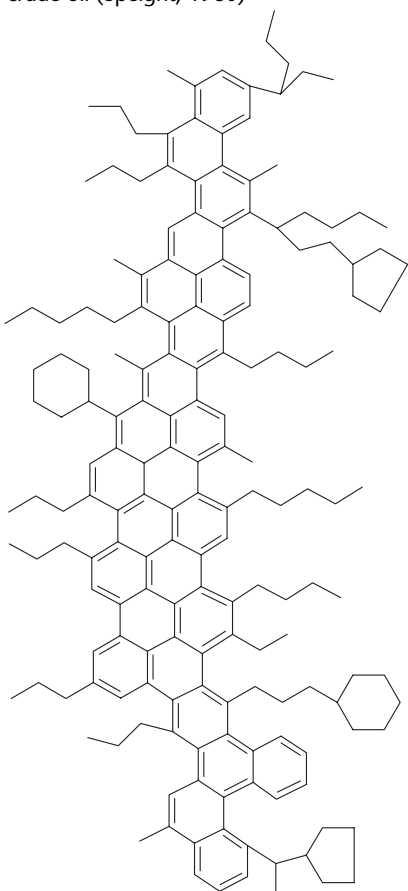

Figure 11. Hypothetical asphaltenes structure from different Iraqi crude oil (Speight, 1980)

mechanism involves the polymerization and condensation of aromatics and grouping a large number of these compounds to such a degree that coke is eventually formed. Hobson (1982) corroborated this fact and reported that coke results from the extensive degradation of relatively heavy molecules to form increasing quantities of light hydrocarbon gases (dry gas) and polycyclic compounds having high carbon to hydrogen ratio. At the temperatures and the pressures normally employed in thermal cracking, the olefins formed from paraffin cracking tend to polymerize into higher molecular weight products. As these molecules themselves crack and repolymerize, their hydrogen

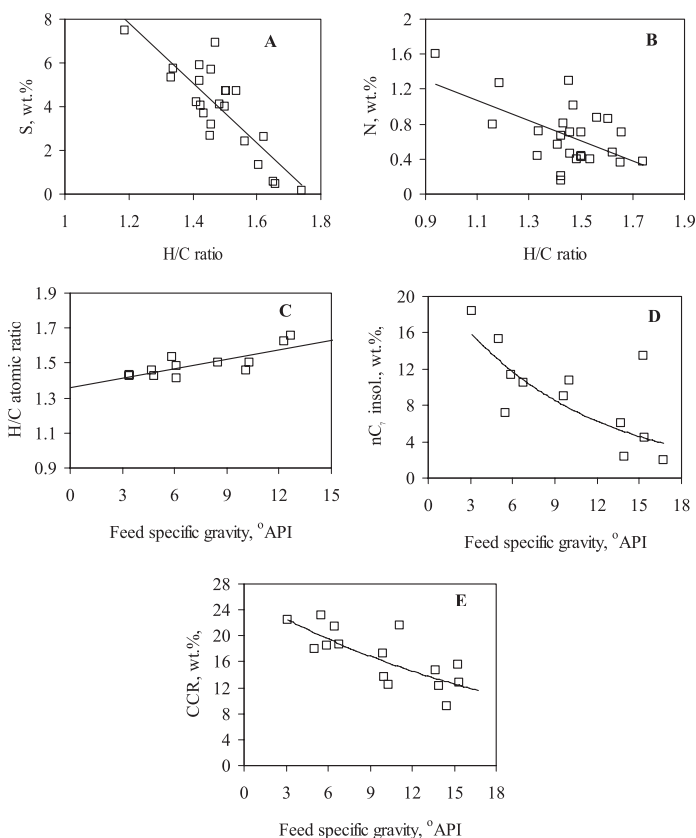

Figure 12. Variation in chemical composition and physical properties of the feed

content continues to decrease. In addition they undergo condensation reactions with ring compounds. These compounds are eventually converted into high molecular weight tar and petroleum coke of low hydrogen-to-carbon ratio.

According to DeBiase and Elliott (1982), three distinct phenomena occur during the formation of coke in the coke drums of the industrial delayed cokers, viz., partial vaporization and mild cracking of the vapour as it passes through the furnaces, cracking of the vapour as it passes through the drum, and successive cracking and polymerization of the heavy liquid trapped in the drum until it is converted to vapour and coke. Savage et al. (1985; 1988) observed a coke induction period for the thermolysis of asphaltenes from an off-shore California crude at 400°C. The induction period disappeared when the thermolysis temperature was raised to 450°C. Because of the nature of the chemical structure of asphaltene molecules present in heavy oils and bitumen and their solubility characteristics, asphaltene molecules form coke rapidly during thermal treatment (Wiehe, 1993). Coke formation during heavy oil upgrading has been elucidated by Wiehe (1994) based on the “pendant-core model.” A further possible simplified form of the pendant-core model and the possible set of reactions leading to the formation of coke have been shown in Figure 13. It has been proposed that the residue contains polymeric structures containing one building block as a non-volatile “core,” which represents more aromatic parts of the molecules (lower H content) and which results into coke. The second building block comprises “pendant” chains, which represent more aliphatic parts of the molecules (higher H content) and which gives volatile components of the polymeric structure.

When a residue is heated, the pendant chains separate to form volatile liquid products. On further cracking, the weak links between the cores break, giving rise to radicals that combine to

Table 3. Yield* comparison for light and heavy feeds (DeBiase and Elliott, 1982)

Items	Crude oil sources of residues					
	Brega	Orinoco	Alaskan North Slope	Maya	Light Arabian	Heavy Arabian
Feeds						
TBP cut point, °C	565+	510+	565+	565+	565+	565+
Gravity, °API	12.3	2.6	8.9	2.6	7.4	4.5
Con. carbon, wt.%	14.6	23.3	16.1	25.5	15.4	24.2
Sulphur, wt.%	1.06	4.4	2.16	4.91	4.1	5.25
Products						
Dry gas and C ₄ , wt.%	7.0	16.3	11.3	13.2	11.1	13.2
C ₅ -193°C Naphtha, wt.%	18.6	16.2	14.6	19.3	16.1	13.5
Gravity, °API	60.7	50.0	57.6	54.9	58.8	55.6
Sulphur, wt.%	0.11	1.25	0.7	0.9	1.0	1.1
193+°C Gas oil, wt.%	52.4	29.6	47.6	29.2	45.8	40.4
Gravity, °API	35.7	18.8	25.1	20.9	28.1	26.5
Sulphur, wt.%	0.83	4.1	1.4	3.6	2.3	2.4
Coke, wt.%	22.0	37.9	26.5	38.3	27.0	33.0
Sulphur, wt.%	1.9	4.3	3.0	5.6	6.4	7.1
Ni+V, ppm	182	3700	607	1854	366	676

*estimated at constant recycle ratio and pressure

form larger units with high C/H ratio, which are true precursors for coke formation. Taking a lead from the pendant-core model, Figure 14 has been hypothesized, which elucidates the eventual formation of graphite-like structure, formed by the clustering of aromatic free radicals and distillate formation by the cracking of the aliphatic linkages that hold the aromatic structures together.

Wiehe and Liang (1996) reported a microemulsion model for petroleum. Figure 15 shows a possible simplified form of the microemulsion model reported by Wiehe and Liang (1996). According to this model, asphaltene are dispersed by the surfactant-like property of resins that in turn are held in solution by aromatics. The saturates act as non-solvents for asphaltene. Stefani (1995) (based on the commercial coker operation experience) reported that the delayed coking mechanism is such that asphaltene are the first particles to appear in the hydrocarbon liquid and can act as "seeds" for coke formation. Initially, these particles are small and can easily entrain in the vapour stream during periods of high coke drum velocity or in the presence of coke drum foam. This phenomenon is especially prominent in the latter parts of the coking cycle when the coke level is closest to the outlet nozzle and also during steam-out and quench when coke drum velocities are much higher than normal.

A coherent summary of the published work can be restated as:

1. The residue comprises saturates, aromatics, resins and asphaltene. The coke formation is a consequence of a series of complex reactions and proceeds from saturates to aromatics to resins to asphaltene and finally to coke;
2. The phase equilibrium of petroleum is a complex and interesting area of research as petroleum itself is an ultra complex fluid. It is a mixture of 10⁵-10⁶ different molecules without a repeating molecular unit. The key step in the formation of coke is liquid-liquid phase separation;
3. During thermal cracking, asphaltene become more aromatic and at a particular stage of conversion they undergo phase separation by breaking of colloidal equilibrium of the whole

residue. Asphaltene undergo condensation and polymerization reactions resulting into the coke formation;

4. The model showing the interconversion along with parallel formation of different boiling fractions has been proposed by Takatsuka et al. (1989) and experimentally validated;
5. With the help of the structural changes at the molecular level and using solvent-resid phase diagram, it was found that the shift from one class to another such as maltene (heptane soluble) to asphaltene (heptane insoluble, toluene soluble) to coke (toluene insoluble) occurs via continuous change in the molecular weight and Conradson carbon residue (CCR) within the same class (Wiehe, 1992). This has been observed and corroborated by Yasar et al. (2001);
6. The concept and existence of certain threshold concentration of asphaltene as solubility limit (S_L) was incorporated in the coke formation model (Wiehe, 1993). Later, using optical microscopy, the onset of neophase separation during thermal cracking was also experimentally proved (Li et al., 1998);
7. Song et al. (1995) have studied the kinetics of coking of Gudao vacuum residue in the temperature range of 400-440°C and 460-500°C. The thermal cracking reactions were found to follow first order kinetics over the studied temperature range;
8. The changes in the chemical structure of resins and asphaltene occurring before and after thermal conversion of the Shengli vacuum residue have been investigated by Wang et al. (1998). It was found that during thermal conversion of vacuum residue, the resins bearing shorter alkyl chains and more peri-condensed aromatic units are responsible for asphaltene formation, while asphaltene bearing shorter alkyl chains and more peri-condensed aromatic units get converted into coke;
9. The effect of solvent properties (with similar solubility parameters such as maltene, 1-methyl naphthalene and tetralin) on solubility limit and coking kinetics has also been explored (Rahmani et al., 2002). It was observed that the hydrogen-donating ability of the solvent and the

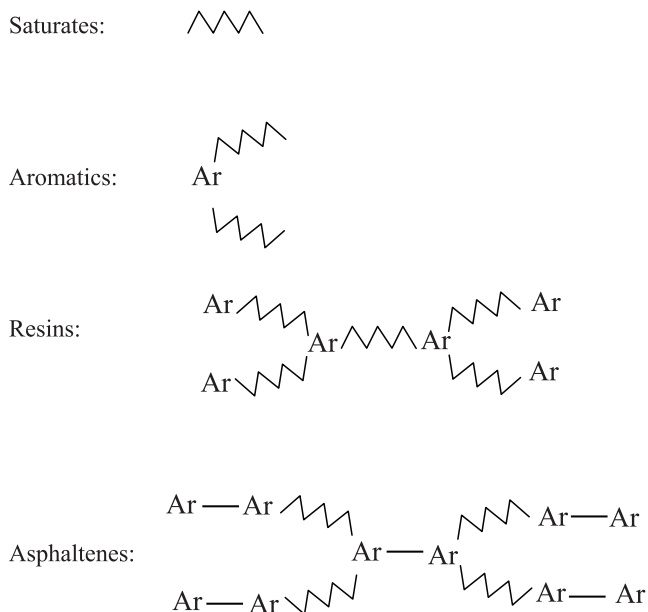

Possible reactions leading to the formation of coke

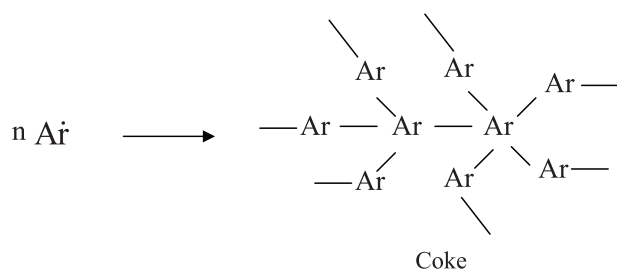
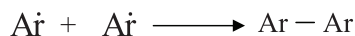
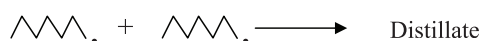
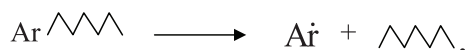



Figure 13. Pendant-core model: Ar-core (aromatic moiety) and -pendant (aliphatic moiety)

hydrogen-accepting ability of the asphaltenes play a major role in determining the ultimate yield of the coke;

10. The effect of structural properties of asphaltenes on the coking rate and coke yield has also been explored by studying the thermal cracking of asphaltenes obtained from different origins. It was found that the coking rate depends on aliphatic sulphide content of the asphaltene, while its aromaticity decides the yield of the coke (Wiehe, 1993);

11. The proposed coking kinetic models have been reported to follow first order kinetics with the range of pseudo activation energies (22–83 kcal/mol) depending upon the feed properties and severity range.

A brief summary comprising the reaction conditions, different feeds studied and the findings of the investigators is given in Table 4. From the foregoing discussion, it can be found that considerable work has been done on coking kinetics with special

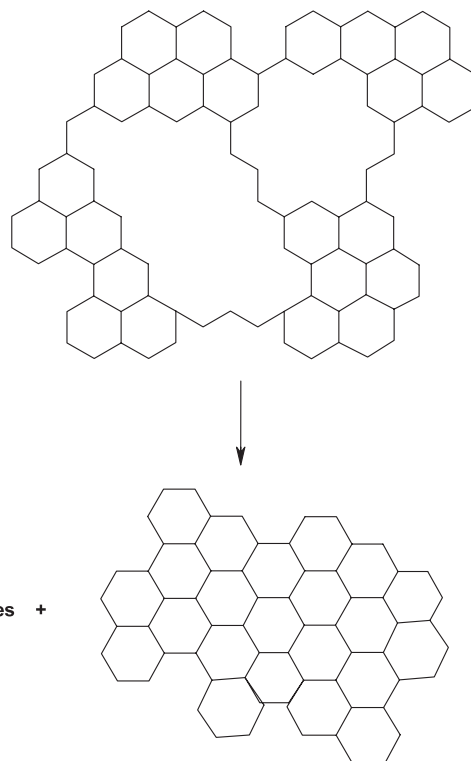

Figure 14. Hypothetical representation of asphaltenes cracking leading to coke formation

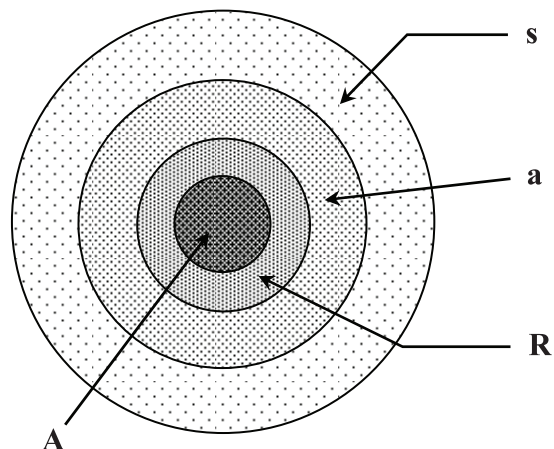

Figure 15. The microemulsion structure of petroleum, containing solutes, A (asphaltenes); dispersants, R (resins); solvents, a (aromatics) and nonsolvents, s (saturates)

emphasis on the mechanism of coke formation, inter-conversion of the solubility class components during conversion, role of these components in coke formation, influence of structural properties on coking rate and yields, etc. The proposed models are based on the mechanistic pseudo components, phase separation, pendant core, etc., which explains the coke formation during thermal conversion.

However, it may be pointed out that the information with regard to the actual coke buildup (inception, growth and saturation of coke formation) in the reactor (batch mode or continuous mode) has not been reported in the literature. Qualitative information can be found (Magaril and Aksenova, 1968) with regard to the coke formation. The authors have reported that coke formation first takes place at the wall of the coking drum.

However, there is no quantification reported as to how much temperature gradient exists between the wall and the centre of the reactor at different processing severities. In view of this, it is desirable to undertake a systematic investigation of the coking behaviour of different feedstocks varying in physico-chemical characteristics in terms of inception, growth and subsequent saturation of coke formation at different processing severities.

With regard to the kinetic modelling, it may be pointed out that most of the models proposed are based on structural changes within the residue and very few models have been proposed that comprise the lumps of industrial relevance and more importantly involve coke as one of the components. After close scrutiny of the available literature, it was found that the model, which comes close on this account, is proposed by Del Bianco et al. (1993). The model proposed by the authors comprises vacuum residue, distillate fraction, reaction intermediate and the coke. A good account of the variation in the rate parameters has been given in the proposed kinetic scheme. However, the proposed kinetic model does not include gas fraction separately and therefore suffers from the lack of information with regard to the rate variation for the paths, which involves gas fraction. Gas (C_1-C_4) forms one of the major products of delayed coking process with the yield up to 9.5 wt.% (Zuba, 1998) depending upon the processing severity. In view of this, it is desirable to propose a kinetic model that includes gas fraction separately so that useful information can be obtained with regard to the rate variations for the paths involving gas fraction, along with rate variations for the paths involving distillates and the unconverted vacuum residue (VR).

Design Aspects

With regard to the design of delayed coking unit, there have been substantial changes over the past several years so as to operate the delayed coking unit for maximum profitability and the changes have been focused on the following areas:

1. Heater;
2. Coke drum;
3. Fractionator;
4. Hydraulic decoking;
5. Coke handling methods;
6. Blowdown recovery.

All the areas have been discussed one by one as follows:

Heater

According to Mekler and Brooks (1959), Meyer and Webb (1960), Elliott (1992) and Sarkar (1998), the heater forms the heart of the delayed coking assembly. The most important function of the coking heater is to heat the feedstock very quickly to the required outlet temperature and pressure without premature coke formation in the tubes, which results in premature shutdown (Mekler and Brooks, 1959). Elliott (1992) corroborated this fact and stated that coking of the coils of the heater poses one of the greatest problems and negative economic impacts on the unit through the loss of unit throughput. These negative impacts are because of the very fact that the heater has to be taken out of service even though only one of the coils is to be decoked. In fact, the term "delayed" coking comes from the necessity of having the coke form in the coke drum and not in the furnace tubes. Thus, while designing the heaters, the foremost aim has always been to inhibit the coke formation in the heater tubes and in turn to increase the run length of the heater.

Factors that affect the heater run length are feedstock quality, operating conditions and how these are maintained within a

narrow range, and in addition, the frequency and handling of upset operations (DeBiase and Elliott, 1982). Until 1970, heater run lengths were to the tune of 12 months (Rose, 1971). With the advancement in the design of heaters, the heater run length was increased to 18 months in 1980 (DeBaise and Elliott, 1982). Presently, with the advent of on-line spalling (decoking) of heater tubes, the run lengths have further increased to about 24 months (Elliott, 1992).

Mekler and Brooks (1959) reported that each feedstock has its critical zone of decomposition where actually the coke formation starts. If the oil passing through this critical zone is in the liquid state and at relatively low linear velocity, then, under the influence of temperature, the slow-moving oil film on the inside surface of the hot tubes tends to polymerize and ultimately deposits coke in the intermediate portion of the heater. In order to mitigate this, it is necessary to provide high turbulence motion in the portion of the coil where the zone of critical decomposition is likely to occur. If the velocity cannot be obtained through the vaporization of a portion of the oil, a small controlled amount of steam, condensate, or boiler feed water should be injected, usually no more than 227 kg per hour per pass (Rose, 1971).

Heck (1972) reported that the furnace design should have following features:

1. High radiant-heat-transfer rate;
2. Good control of firebox heat distribution;
3. High cold velocity;
4. Good peripheral heat distribution to the tubes;
5. Short residence time.

DeBaise and Elliott (1982) reported that higher cold oil velocities should be in the order of 1.82 m/s and the design should provide multiple injections of steam into the heater coil to adjust coil residence time and velocity. Heck (1972) reported that the firebox design, which provides good heat distribution for the least cost, is the horizontal tube, two-zone, floor-fired cabin heater. While designing the firebox it should be noted that small burners are essential and gas firing is preferred. As far as the trends are concerned, DeBaise and Elliott (1982) stated that in addition to more liberal firebox dimensions there has been a tendency to specify allowable average radiant flux rates of the order of 28.39 kW/m² to provide for longer run lengths, future capacity allowances, and, in general, a more conventional heater design. By way of comparison, traditional maximum allowable radiant flux rates range from 31 to 38 kW/m².

As feedstocks to the delayed coking unit are getting heavy, the coking heaters are severely getting affected. As a result of this, heaters, which would normally have had the run lengths of the order of nine months or more, now require more frequent decoking. In this context, Sloan et al. (1992) reported the considerations for improving the heater run lengths and they are as follows:

1. Use of double fired heaters to reduce peak flux rates;
2. Injection of increased amounts of steam in the heater coils;
3. Design for higher cold oil velocities;
4. Minimize flame impingement.

In addition to the aforementioned considerations, temperature monitoring in the radiant coils, minimizing upset conditions, and determining the best coking temperature for a slate of feedstocks processed in the unit are the other means by the virtue of which the heater run lengths can be improved.

The advantages of the double-fired delayed coker heater (Figure 16) reported by Elliott (1992) are as follows:

1. Capability of maximum shop assembly;
2. No field installation of the refractory bridgewall;

Table 4. Reported work on the coking kinetics

Authors	Experimental details	Proposed kinetic model	Conclusions
Magaril (1968)	Resins Quartz test tube 400 160	-	<ol style="list-style-type: none"> There exists a certain saturation concentration of asphaltenes beyond which they precipitate out from saturate solution. Coke formation is the consequence of precipitation and accumulation of asphaltenes. The coking rate is equal to the rate of asphaltenes precipitated.
Magaril et al. (1971)	Asphaltenes isolated from cracked residue and deasphalted bitumen Transformer oil, anthracene oil. Autoclave without stirring 380-410 5-120	-	<ol style="list-style-type: none"> The effect of solvent properties on the kinetics of coke formation was studied. Assuming the spherical shapes of asphaltene and solvent molecules and using their molecular weight and density, the asphaltene concentration in the solution was proposed at various conversions. Coking was found to initiate after certain threshold concentration of asphaltene in the solution and this value was found to be higher for solvent with good solvating power. Coke formation was found to occur after a certain severity of cracking has reached.
Takatsuka et al. (1989)	Residual oil Flow reactor, semibatch, autoclave 400-450 0-450 0.013-0.45		<ol style="list-style-type: none"> Atmospheric equivalent temperature and hydrocarbon (HC) partial pressure were used to estimate the Arrhenius rate parameters. Higher HC partial pressure decreases the reaction rate of polycondensation reactions while cracking rate increases with increasing the reactor pressure. The activation energy for the cracking and polycondensation reactions were estimated to be 60 kcal/mol and 40-50 kcal/mol, respectively.
Wiehe (1992)	VR and its SARA fractions Batch tubing bomb 400 60 7 MPa (N ₂ atm)		<ol style="list-style-type: none"> The solvent-resid phase diagram (plot of molecular weight – Hydrogen content) was proposed to distinguish one pseudocomponent from another and to track the chemical changes that result their movement from one solubility class to another. Elemental analysis and molecular weight of thermal conversion products of resid and SARA fraction was studied. Thermal cracking of the SARA fractions resulted to reduction in their molecular weight, H-content (slightly in case of saturate and aromatics) and coke formation.
Wiehe (1993)	Cold Lake VR (3 g) Quartz tube reactor 400 0-180 Open reactor with continuous N ₂ flow	-	<ol style="list-style-type: none"> Inhibition of heptane solubles for coke formation, a maxima for the asphaltenes formation, which matches with the coke induction period, parallel decrease in the asphaltenes concentration beyond certain heptane solubles (S_L, solubility limit). A kinetic model was proposed that explains the above observations and estimated the disappearance of asphaltenes by first order with rate constant of 0.026 min⁻¹ while S_L was estimated to be 0.49 wt. %.
Del Bianco et al. (1993)	Belaym VR (CCR-20.8 wt. %) Batch reactor 410-470 0-120 1 (N ₂ atm)		<ol style="list-style-type: none"> The coke formation was proposed to be formed via a reaction intermediate (I) E₁-49.4 kcal/mol; A₁-31.97 min⁻¹; E₂-63.9 kcal/mol; A₂-40.92 min⁻¹. Structural study shows that thermal cracking of asphaltenes follow dealkylation reactions. Condensation reactions prevail at higher severity levels.

Song et al. (1995)	Feed Reactor Temp. (°C) Reaction time (min)	Gudao VR (5 g) Batch tubular reactor 400–500 5–80	–	1. Assuming the first order kinetics, the Arrhenius parameters were found to vary from $E_{400-440} -170.7 \text{ kJ/mol}$, $A_{400-440} -7.853e^{10}$ to $E_{460-500} -180 \text{ kJ/mol}$, $A_{460-500} -9.24e^{11}$.
Wang et al. (1998)	Feed Reactor Temp. (°C) Reaction time (min) Pressure (MPa)	Shengli VR (500+) Autoclave with magnetic stirrer 410 60 0.1	–	1. Structural parameters were compared between SARA fractions obtained from the feed and after its thermal cracking. 2. Peri-condensed aromatic resins get converted into asphaltenes, which further condense to give coke formation.
Li et al. (1998)	Feed Reactor Temp. (°C) Reaction time (min) Pressure (MPa)	Shengli, Daqing, Gudao (300 g) FYX-05A autoclave 370–390 10–70 1.0	–	1. The variation in the onset of neophase formation, necessary for the coke formation, was studied using optical microscope for three different VR varying largely in their properties. 2. A stability function, based on the SARA composition, was determined to represent the thermodynamic stability of the VR.
Rahmani et al. (2002)	Feed Reactor Temp. (°C) Reaction time (min) Pressure (MPa)	Athabasca asphaltenes (nC_7 insol. 3 g) Batch microreactor (15 mL) 430 60 0–4 MPa	$H^+ \xrightarrow{k_H} bA^+ + (1-b) V$ $A^+ \xrightarrow{k_A} cA^* + (1-c) (H^+ + V)$ where, H^+ = fraction of reac. nC_7 sol. H^* = fraction of prod. nC_7 sol. A^+ = fract. of reac. asphaltene A^* = fract. of prod. asphaltene V = cracked distillate prod k_A, k_H = reac. rate const. for the thermolysis of reac. asphaltene and nC_7 sol., respectively b, c = stoichiometric coefficients	1. The solubility limit kinetic model was proposed to study thermal cracking of asphaltenes in maltene, 1-methyl naphthalene and tetralin. 2. Coke formation was found to be strongly influenced by the chemical interactions between the asphaltenes and the solvent medium. 3. The hydrogen donating ability of the solvent and the hydrogen accepting ability of the asphaltenes were found to have a pronounced effect on the coke yield. 4. The model proposed was found to be consistent with the data on coke formation from asphaltenes in studied solvents with low hydrogen donating ability.
Rahmani et al. (2003)	Feed Reactor Temp. (°C) Reaction time (min) Pressure (MPa)	Asphaltenes from AL, AH, Maya, GudaoVR Batch microreactor (15 mL) 430 60 9.8 MPa	–	1. Phase separation model was proposed to study the coking kinetics of asphaltenes having range of structural properties. 2. Structural dependency on coking kinetics showed that sulphide content of asphaltenes correlated with the cracking rate while the aromaticity decided the coke yield.
Schabron et al. (2003)	Feed Reactor Temp. (°C) Reaction time (min)	Boscon, Llyodminster, Redwater BC, MaxCL2 (5 g) Tubular reactor 400–450 5–150	–	1. Coke formation involves a complex set of reactions which fall somewhere between zero-order and first-order kinetic mechanisms. 2. Kinetics followed by coke formation is most likely dependent on the source of the residue. 3. The activation energies of the secondary coke formation reactions of the studies feeds were found to be 2.2 to 2.6 times higher than that for the initial coke formation.

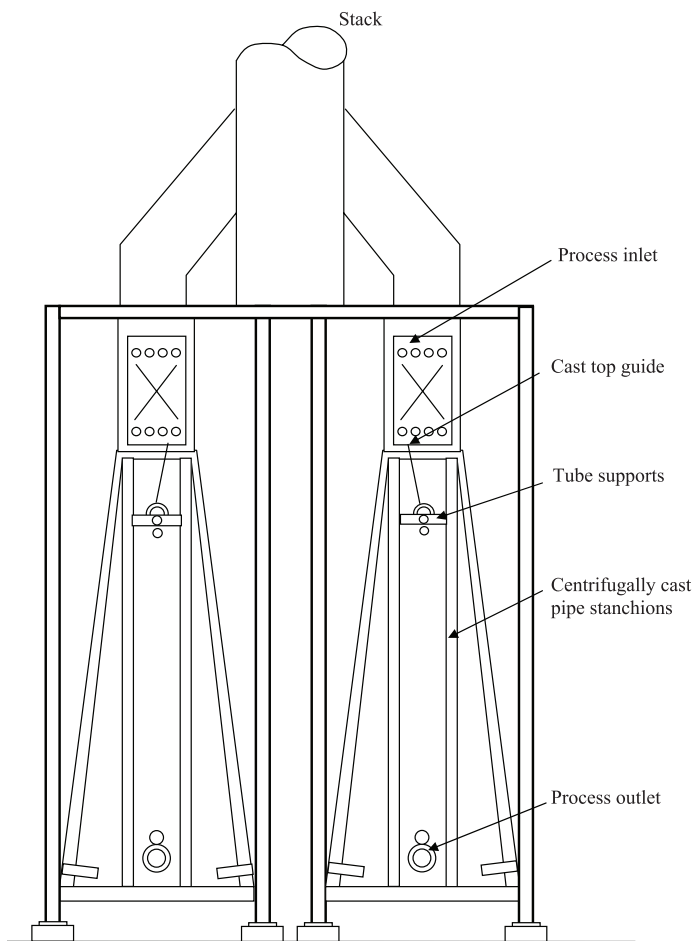

Figure 16. Schematic representation of delayed coker heater (2 pass-double fired) (Elliott, 1992)

3. Burner access from grade;
4. Adaptability to multiply-cell/multiple pass configurations;
5. Adaptability to complete isolation of cells in terms of maintenance, on-line spalling and decoking.

The on-stream time for coker heaters can be improved by using on-line decoking (Sloan et al., 1992). With the advent of this on-line decoking (spalling) the problem of taking the heater out of service has been removed. L. Langseth has developed the technology and techniques for on-line spalling (decoking) of delayed coker heater hydrocarbon process coils without taking the entire heater out of service (Elliott, 1992).

Coke drums

Mekler and Brooks (1959) reported that the main function of coke drums is to provide enough volume for the accumulation of coke produced during the normal cycle of 24 h. In designing a coke drum, however, it is necessary not only to provide sufficient volume for coke but also to consider the maximum allowable superficial vapour velocity in the coke drum to prevent carryover, minimum free board, and the foaming characteristics of the charge stocks. Rose (1971) corroborated this fact and reported that the maximum allowable superficial vapour velocity is the first parameter to be considered. Until 1971, operations at 0.09 to 0.12 m/s without carryover have been reported.

As regards the foaming tendency of the feedstock, the injection of foam depressants or anti-foaming agents in the coke drums during the last 5 or 6 h of the coking cycle has contributed

significantly to longer runs (Rose, 1971). Heck (1972) has also reported that the designer must weigh the foaming tendency of the feed vs. antifoam effectiveness and the designer must also consider the advantages of radioactive level detectors vs. the consequences of a coke carryover.

The most frequently reported difficulties are:

1. Distortion of bottom access hole neck flange;
2. Weld cracking between bottom cone and access hole neck;
3. Crack formation around cone nozzle attachments;
4. Deformation and warping of shell;
5. Cracking of internal alloy lining.

At the inception of the delayed coking process, the diameter of coke drums was 3.04 m and the height was about 12.19 m. With the growing capacity and coke production per unit, the diameter was increased to 6.09 m and the height was increased to over 24.38 m over the years from 1930 to 1955 (Mekler and Brooks, 1959). By 1967, coke drums having a diameter of about 7.92 m were installed. Thus, there has been a substantial increase in the diameter and height of the coke drums over the years and as far as the recent figures are concerned, Christman (1999) reported coke drums having a 8.53 m diameter and a 36.57 m height, and was of the opinion that even larger drums are expected in the future. Table 5 shows the update of coke drum size in terms of its diameter and length.

As regards the material of construction for these coke drums, Mekler and Brooks (1959) and Rose (1971) reported the use of 11–13 chrome lining with 2.8 mm liner thickness. Because of the heavy wall thickness of coke drums, the alloy protection is

Table 5. Summary of the coke drum sizing update

Year	Drum size	
	Diameter (m)	Length (m)
Before 1940	3.0	12.2
1946	5.2	20.7
1952	6.1	25.6
1967	7.3	About 30
1980	8.2	About 35
1999	8.5	36.6

Table 6. Time allotted for different steps involved in a typical 12-hour and 24-hour decoking cycles (Stefani, 1996)

Operation	24-hour cycle, h	12-hour cycle, h
Switch drums	0.5	0.5
Steam out to fractionator	0.5	
Steam out to blowdown	1.0	0.0
Slow water cooling	1.0	3.0
Fast water cooling	5.0	
Water draining	3.0	2.5
Remove heads	1.0	0.25
Hydraulic decoking	4.0	3.0
Replace heads	1.0	0.25
Steam purge and test	1.0	0.5
Drum heat up	6.0	2.0
Total	24.0	12.0

always provided in the form of applied liners or clad materials (Mekler and Brooks, 1959).

Most of the cokers at the beginning of the process were designed for 20 to 24 h coking cycle times. In the late eighties and early nineties the coking cycle time was reduced to 16 to 20 h (Sloan et al., 1992). In the late nineties, it was reduced further to 14 h (Christman, 1999). Table 6 shows the time required for the different steps involved in 12 h and 24 h decoking operations. As can be seen from the table, the time required for the water cooling and drum heat-up for the 12 h decoking cycle has been reduced significantly.

Another important advancement pertaining to coke drums is the removal of the coke drum top and bottom heads. This was a very important advancement in view of safety concerns related to the production of a high flowability shot coke, which could create serious problems for the operators (Sloan et al., 1992). Shot coke is produced when the delayed coker is run under severe conditions with heavy, sour residues as feedstock. Shot coke has a spherical appearance, lower surface area, contains lower volatiles and has the tendency to agglomerate. The deheading device is designed to allow remote control of the deheading operation. It includes the release of the drum bottom head, lowering of the head and moving it away. After the completion of the decoking operation, the deheading device is then replaced and the bottom and top heads are locked in the drum.

One of the major changes in the delayed coking process in the recent past is the low-pressure operation at which the delayed coking units are being run. Operating coke drums at low pressure is gaining momentum in view of maximizing the liquid product (C_5+) yield (Bansal et al., 1994). Table 7 shows the effect of low pressure and low recycle on coking yield of a typical feed having 20.5 wt.% CCR. As can be seen from the table, the yield of C_5+ liquid product is 72.6 wt.% at 0.1 MPa pressure as opposed to 69.7 wt.% at 0.2 MPa pressure. It can also be seen that the coke quantity is reduced at 0.1 MPa pressure and is 29.7 wt.% as opposed to the coke yield of 32.1 wt.% at 0.2 MPa. Although operating at 0.1 MPa coke drum pressure gives an incremental yield of C_5+ liquid product and a reduction in coke yield, many factors can significantly impact economics. Increased cost for larger equipment due to increased vapour volume and piping should be evaluated when considering a new design or revamp of a delayed coker for low coke drum operating pressure (Elliott, 1992; Bansal et al., 1994).

Fractionator

The methods used for the design of the fractionator in the delayed coking above the gas oil tray are the same as those practised in the crude tower fractionator design. The only and major difference is that special attention has to be given to the bottom section of the fractionator below the gas oil tray (Rose, 1971; Heck, 1972). The temperatures in this section of the tower are close to and above incipient cracking temperatures (Rose, 1971). As a

result of this, coke tends to accumulate on the trays over a long period of time. Hence, it is suggested that the trays should be designed to be self-washing and for minimum change of efficiency with coke buildup. Heck (1972) reported that designers should provide: (1) adequate residence time for the furnace; (2) a so-called "heat shield" to lessen direct condensation of gas-oil product from the hot coke-drum vapours to the cool liquid surface; and (3) a place to collect coke solids. With regard to the tower diameter, Sloan (1992) reported that it is usually set by loads in the gas-oil condensing section of the tower above the draw pan. Heat-transfer trays provide high liquid-load capability to minimize the tower diameter. The design of the top section of the coker fractionator is fairly standard (Heck, 1972). To avoid corrosion problems, it has been suggested to drive all water overheads. As the trend is towards low-pressure operation for maximizing distillate yield, the fractionator sizing and specifications of fractionator internals have been affected (Elliott, 1991). Compared to a higher-pressure operation, the increase in vapour volume to be handled requires a cross-sectional area to increase inversely proportional to the square root of the decrease in absolute pressure. Thus, for 0.1 MPa pressure, a 3.96 m diameter fractionator is required as opposed to 3.65 m diameter for 0.17 MPa pressure operation (Elliott, 1992). Fractionator internals are traditionally specified as valve trays. It has been investigated that they are satisfactory on new designs for low pressure (0.1 MPa) cokers. However, for revamp designs, a careful evaluation of all components has led to the recommendations to replace pump-around trays with packed beds, both for increased capacity and to reduce coke drum operating pressure (Sloan, 1992). The load on coke drums and fractionator increases as the capacity increases. Debottlenecking of the fractionator and reducing the internals pressure drop can maximize throughput and lower the coke yield. Grids or structured packing can be used as a replacement for trays to make up for this. These internals are especially desirable in the tower heat-transfer sections where fractionation is not required and the loads are generally the highest (Stefani, 1996).

Hydraulic decoking

Hydraulic decoking has played a major role in the success story of the delayed coking process (Welsh, 1950; Rose, 1971). Welsh (1950) described hydraulic decoking as a method of disrupting, removing and transporting petroleum coke from vertical coke drums through the medium of high-velocity water. The system consists of a cutting head, cutting stem and rotary joint guided by a travelling crosshead. A system of jet water and rotary joint air hoses connects from the crosshead to stationary points at the top of the structure. An air hoist, which controls the raising and lowering operation of the cutter assembly, is located on the operating floor near the top of the coke drum. The high-pressure water required for the impact jets is supplied by a multi-stage centrifugal jet pump, which feeds from a clear water tank. Figure 17 outlines the various steps involved in the decoking of the coke drum.

The discharge pressure of the hydraulic jet pumps employed for this operation until 1950 was in the range of 6.89 to 10.13 MPa for small coke drums (Welsh, 1950). With the advent of large coke drums, Kutler et al. (1970) reported that the discharge pressure has increased to about 21.08 MPa.

With regard to the advancement in hydraulic decoking, Rose (1971) reported that special interlocked controls and bypass valves have been devised to facilitate operation and protect personnel, piping and pump. Two-piece drill stems have been replaced with a single long stem to reduce cutting time. Labour

Table 7. Effects of low pressure and low recycle on coking yields (20.5% CCR Feedstock) (Sloan et al., 1992)

	Earlier designs	Current designs
Coke drum pressure, MPa	0.2	0.1
Recycle ratio	10%	5%
Coke yield, wt.%	32.1	29.7
C_5+ Liquid yield, vol.%	69.7	72.6

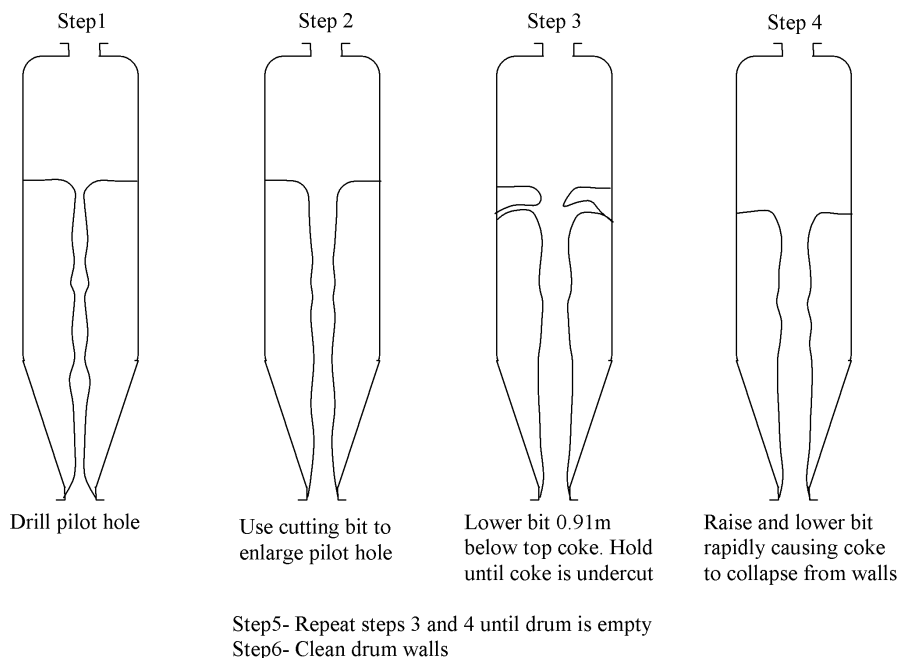

Figure 17. Different steps involved in hydraulic decoking (Nelson, 1970)

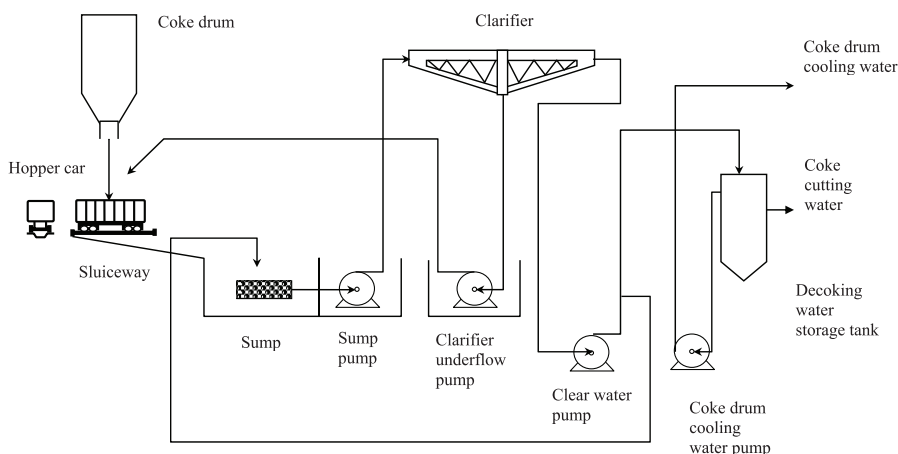

Figure 18. Schematic representation of direct railcar loading associated with decoking system (DeBiase and Elliott, 1982)

and maintenance costs have been further reduced by replacing the hydraulic piping and swivel joints with a high-pressure drill hose. Steel requirements in the superstructures have also been reduced.

Sloan et al. (1992) reported that in order to improve the safety, working environment and operability/maintainability of delayed coking units, the reliability of the system controls and control switches is of utmost importance as it is more closely related to hydraulic decoking. The system must shut down automatically prior to the cutting head being removed from the coke drum. The operating personnel located on the operating floor could be at risk if the system fails. In view of this, the protection of the operating personnel against the forces of water jet has been taken care of in the recent past.

Coke handling

The coke dropping out of the base of the coke drum is accompanied by large volumes of drilling water. Different coke dewatering/

handling systems are available, the most common reported by Hobson (1982) are as follows:

1. Direct railcar loading;
2. Pad or apron loading;
3. Pit loading;
4. Dewatering bins.

Kutler et al. (1970) reported that the direct railcar method (Figure 18), though the cheapest, has limitations such as, more time is required to decoke into cars than any of the other conventional methods of decoking and more care is required when decoking into cars is to be carried out to avoid spillage. This has been corroborated by Hobson (1982) and reported that decoking thus becomes dependent on the railcar movement. These disadvantages of the direct railcar method have given way to methods like pad loading, pit systems, hydrobins and dragline.

Pad loading allows the coke and water to flow from the drum through a chute directly onto a concrete pad, which is placed adjacent to the coke drums. The water drains to the periphery of the pad into a settling maze where coke fines settle out before the clear water is recycled to the decoking water surge tank for re-use. The coke is removed from the pad by a front-end loader or an overhead crane. The front-end loader operation usually associated with pads can have a tendency to increase the generation of coke fines that are environmentally detrimental (DeBiase and Elliott, 1982).

The most widely accepted method for coke handling depicted is the coke pit system (Sloan et al., 1992; Stefani, 1995) shown in Figure 19. Pit loading is very similar to pad loading, except that the coke empties into a rectangular concrete pit generally located below instead of a concrete apron. The decoking water drains out through ports at one or both ends of the pit, depending on the size of the facility. A "heel" or coke located in front of those ports acts to filter coke fines from the water. The remaining coke fines

settle out in the maze before the clear water is pumped into the decoking water storage tank. An overhead crane with a clamshell bucket is required for coke handling. The pit system inherently provides several days storage of coke, presenting an advantage over pad loading (DeBiase and Elliott, 1982).

In dewatering bins, dewatering is met via special vessels, known as dewatering bins or drainage silos. Slurry and gravity flow are the two types of dewatering bin systems. In both designs, coke and cutting water pass through a coke crusher (DeBiase and Elliott, 1982). Dewatering bins have evolved to provide totally enclosed systems to meet exceptional environmental requirements or to prevent coke contamination in areas where sand storms may be a problem (Hobson, 1982). From 1982 to 1992, a clear trend in selection and design of the coke handling and water management systems was developed. Operators are now switching from mainly capital investment considerations towards improved environmental considerations, maintenance and reliability.

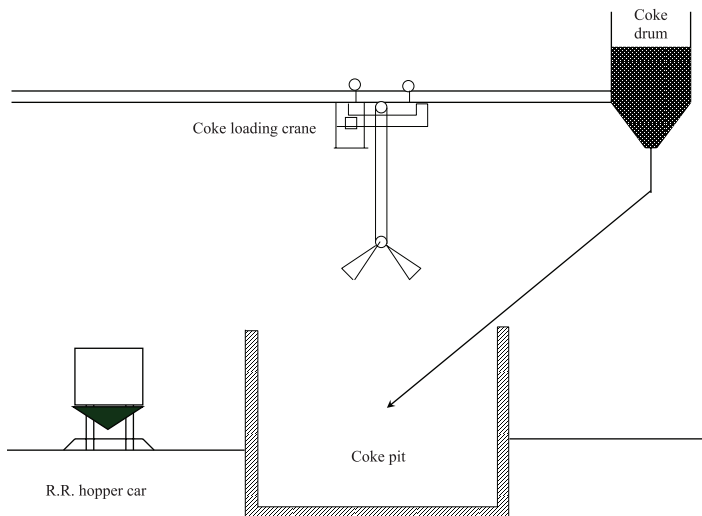

Figure 19. Schematic representation of coke pit system associated with decoking system (DeBiase and Elliott, 1982)

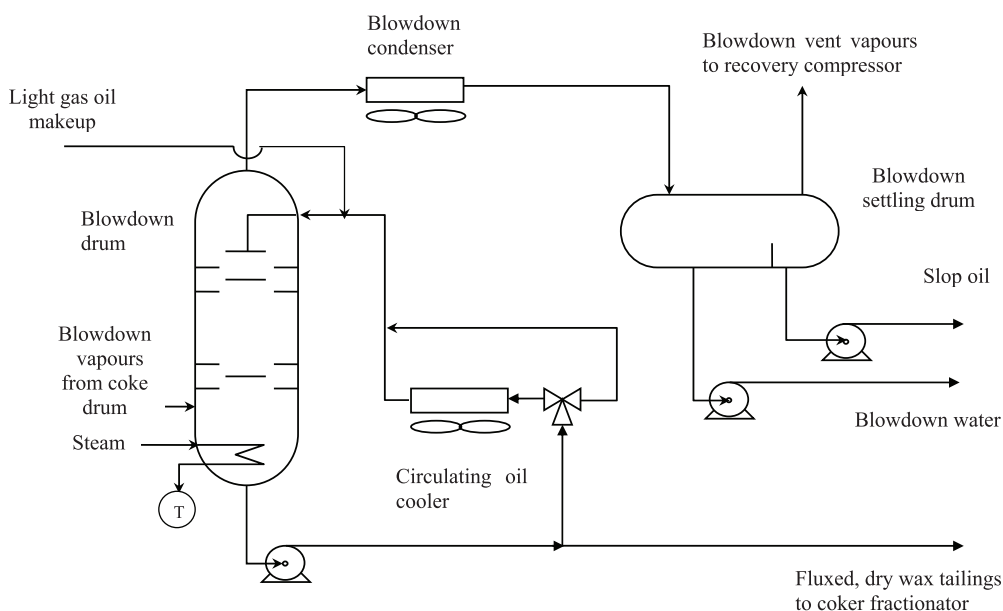

Figure 20. Schematic representation of coker blowdown system (Elliott, 1992)

Blowdown recovery

The recovery of wax tailings has been given considerable attention over the years. In the past, wax tailings were allowed to pass into a pond or the API separator. Over a period of time, these wax tailings would plug up the sewer system. The modern design includes facilities for recovering these wax tailings with a circulating oil stream (Kutler et al., 1970).

The modern coke drum blowdown system (Figure 20) includes a coker blowdown drum, blowdown condenser, blowdown settling drum, blowdown circulating oil cooler and attendant pumps (DeBiase and Elliott, 1982). The composition of the blowdown vent vapours is hydrogen and light hydrocarbon vapours with an average molecular weight varying between 16 and 25.

Increased awareness of environmental concerns has led to several interesting trends related to delayed coker, which include the design of new enclosed blowdown systems for older cokers that do not meet environmental specifications. Environmentally,

the scheduled flaring of vent vapours may not be considered an acceptable practice from the standpoint of total refinery emissions. Economically, these gases can be recovered and used for the fuel value (Elliott, 1992). The blowdown system is tightly integrated with the coker operating and safety systems. The blowdown system must be checked for the maximum load produced during the coking and decoking cycles with all potential relieving scenarios. The incremental debottlenecking approach for the blowdown system can decrease the loads by addressing the whole coker (Stefani, 1996).

NEEDLE COKE

Petroleum coke from the delayed coking process can be categorized as sponge coke, honeycomb coke, shot coke and needle coke depending upon its physical structure (Jacob, 1971; Dymond, 1991). Out of the aforementioned cokes, needle coke is a premium-quality coke. Other types of coke are produced as by-products while processing residues, where the main aim is to get maximum yield of the liquid product. Hence, the most important

aspect pertaining to needle coke is that, unlike other cokes, needle coke is intentionally produced by refiners from selected feedstocks (Dymond, 1991). Needle coke commands a high price (\$550/metric ton) (Acciarri and Stockman, 1989) as opposed to fuel grade coke (\$25–30/metric ton) (Elliott, 1992) because it is categorized as a performance product, not a commodity (Swain, 1991). Different investigators have defined needle coke on the basis of their observations. The observations and in turn, the definitions of needle coke as reported by different investigators, are summarized as follows:

Needle coke is a highly crystalline coke with much less cross-linking (Reis, 1975). Coke with high crystallinity and low coefficient of thermal expansion (CTE) is known as needle coke (Foulkes et al., 1978). The term “needle coke” originates from the needle-like appearance of

the particles (Kuchhal, 1982). Needle coke is highly structured, low metal and sulphur containing delayed coke, having large unidirectional elliptical interconnected pores surrounded by thick fragile walls (Stokes and Guercio, 1995; Singh, 1991).

Needle coke is highly sought-after for more conventional carbon and graphite uses as well as in nuclear reactors and aerospace components (Stormont, 1969). As regards the graphite uses of needle coke, calcined form of needle coke is the major raw material in the making of graphite electrodes, which in turn are used in electric arc steel furnaces (Acciarri and Stockman, 1989). Figure 21 shows the industry relationships of needle coke, graphite electrodes and electric arc furnace steel. An enormous amount of iron and steel is produced in the world to meet the demands of global growth. This very fact has caused an accumulation of large amounts of iron and steel scraps to be regenerated and recycled. Electric furnaces, principally operated for this purpose, require graphite electrodes of superior performance to enable a reduction in cost of steel making by stable long-term operation. Needle coke is used as the best filler for high-perform-

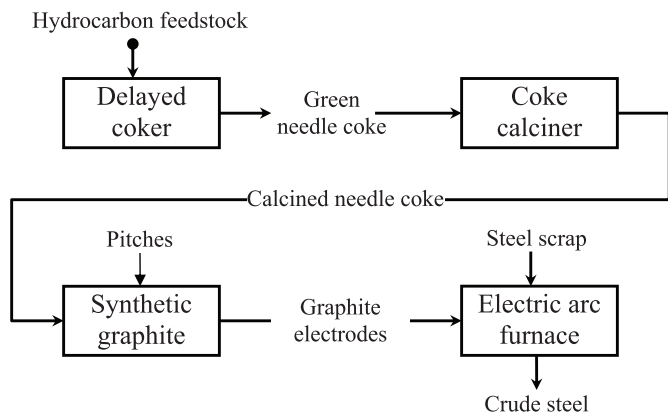

Figure 21. Industry relationships of needle coke, graphite electrodes and electric arc furnace steel (Acciarri and Stockman, 1989)

ance graphite electrodes (Oyama and Todo, 1993). Thus, by far the most important application of needle coke is in electric arc furnaces used in steel industries.

Feedstocks for Needle Coke Production

Over the years different investigators have proposed/studied different feeds for getting premium-quality needle coke. Different feedstocks proposed/studied by different investigators are summarized in the following text.

Slurry oil and decant oil from catalytic cracking and tars from thermally cracked stocks form potential feedstocks for needle coke production (Stormont, 1969). Apart from slurry oil, decant oil and thermal tars, coal tar pitch can also form a very attractive feedstock (Reis, 1975). Extracts from lube operations and residues also can be possible feedstocks for the production of needle coke (Friday, 1975). Apart from the conventional feedstocks like thermal tar, decant oil and slurry oil, straight residua (only atmospheric or vacuum residues that are low in sulphur, metals, asphaltenes and contain good percentage of aromatics) may form part of streams to produce needle coke (Kuchhal, 1982).

Acciarri and Stockman (1989) observed that the needle coke precursors generally consists of hydrocarbon streams of:

1. Low sulphur content catalytic cracker slurry oil;
2. Tars derived from the thermal cracking of refinery gas oils;
3. Hydrodesulphurized catalytic cracked slurry oils;
4. Steam cracker pyrolysis tar;
5. Coal tar pitches.

Mochida et al. (1990) studied the feasibility of producing needle coke out of ethylene tar pitch. Singh (1991) categorized three types of feedstocks with their origins that can be processed to get needle coke and are as follows:

1. Those derived from cracking processes, thermal and catalytic such as FCC decant oils, pyrolysis tar, thermal and visbroken tars;
2. Those derived from the raw lube extraction units;
3. Those derived from the coking of coal.

Todo et al. (1991) studied the cocarbonization of a low sulphur vacuum residue (LSVR) with fluid catalytic cracking decant oil (FCC-DO) by catalytic hydrotreatment leading to the production of needle coke. Kumar et al. (1996) studied the feasibility of producing needle coke from three aromatic extracts obtained by solvent refining of lubricating oil base stocks in a bench scale delayed coker.

Specific physico-chemical characteristics of the feedstocks are of utmost importance in the production of needle coke. Nelson (1978) pointed out that the lower the characterization factor (K_{UOP}) of the feed of the cracking plant, the larger the yield of aromatic rich cycle stock suitable for producing needle coke. Thus, the aromaticity of the feedstock is one of the very important criterions for the selection of the feedstock. The chemical and physical characteristics considered in choosing a proper feedstock for the manufacture of needle coke are summarized as follows (Singh, 1991):

1. Feedstock should have high aromaticity with 60–85% aromatic carbon. Aromaticity, as measured by the Bureau of Mines Correlation Index (BMCI), should be over 100;
2. Feedstock should be of high initial boiling point, over 250°C with not more than 25–30% material boiling below 360°C due to safety considerations and should contain appropriate carbon number range of coke precursors;
3. Feedstock should have characterization factor around 11.4 or lower, with low API gravity;
4. Feedstock should have low sulphur content preferably below 1 wt. % due to the concern for product quality;
5. Feedstock should have low metal, asphaltenes, CCR and wax content;

The aromatic content, sulphur content and CCR for three feedstocks that are known to be suitable for needle coke production are listed in Table 8.

Characteristics of Needle Coke

Needle coke shows strongly defined lines or striations and has a metallic appearance even when ground to its primary particle size. When subjected to X-ray diffraction, individual needles exhibit a characteristic orientation of crystals not shown by non-needle coke (Stormont, 1969). Needle coke has large unidirectional pores, elliptical, largely interconnected and surrounded by thick walls. When this coke is broken, it forms needle-like pieces, hence the name needle coke (Reis, 1975). The needle structure is caused by the large, visible pores having an elongated rather than spherical shape (Scott, 1967).

Needle Coke Production

High-quality needle coke is obtained from the well-known delayed coking process. It is generally coupled with thermal cracker or catalytic cracker, which produces the required raw material (thermal tar/slurry oil) as a feed for the delayed coking operation. Needle coke is produced in blocked operations when the usual feed to the delayed coker is not available or is diverted to some other units (Stormont, 1969). Thus, special feedstocks are required for needle coke production as against the residues that are normally fed to the delayed coker. Secondly, for needle coke production, a higher drum pressure (0.6–1.5 MPa), temperature (475–530°C) and recycle ratio (15–20%) are maintained than that in normal delayed coking operations since the feedstock is refractory (highly aromatic) in nature for the former (Kuchhal, 1982). The effect of operating variables on the yield

Table 8. Needle coke feedstock characteristics (Meyers, 1997)

Feedstock characteristics	Feedstock		
	Slurry oil	Thermal tar no. 1	Thermal tar no. 2
Aromatic content, LV%	61.7	89.8	66.1
Sulphur content, wt. %	0.48	0.07	0.56
Conradson carbon residue, wt. %	5.7	9.4	8.6

Table 9. Effect of operating variables on the yield and quality of coke (Friday, 1975)

Variable	Effect on	
	Coke yield	Coke quality (CTE)
Increase drum pressure	Increase	Variable
Increase drum temperature	Decrease	Improve
Increase coker recycle ratio	Increase	Improve to maximum
Thermal crack cycle	Decrease	Improve

and quality of coke is shown in Table 9. An increase in drum pressure increases the coke yield since more liquid is held in the drum for the conversion. An increase in drum temperature decreases coke yield and better the quality of coke. Similar effects can be found by increasing the coker recycle ratio. However, the operating variables have practical limits that prohibit further change. Also, the limits on each will vary with the type of feedstock employed (Friday, 1975).

Coking Mechanism Pertaining to Needle Coke Formation

Brooks and Taylor (1965) were the first to observe a second semi-liquid phase during coking of coal tar pitch. The second phase, often called the mesophase has also been observed in coking of petroleum stocks, as well as the pitch. Its striking feature is its optical activity, which suggested that it has a crystalline structure while retaining some properties of liquids. Needle coke consists almost entirely of mesophase (Friday, 1975).

Two different reaction mechanisms exist at any given time-temperature conditions pertaining to the delayed coking process. In one, high molecular weight compounds, such as asphaltenes and resins, when subjected to high temperatures, tend to dealkylate straight chain compounds and CH_2 groups, leaving behind a residue of carbon with a highly disordered, cross-linked structure or with many small graphite crystals in a matrix of amorphous carbon and asphalt. Because of these cross-linkages, the platelets lose mobility and graphitization becomes difficult. Therefore, coke formed from this mechanism is not found suitable for premium-grade electrodes. The second mechanism involves the dehydrogenation of heavy oils with subsequent polymerization and condensation of aromatics and then grouping a large number of these compounds to such a degree that the coke is eventually formed. The coke produced in this way contains lesser cross-linkages and has a more crystalline appearance (needle type) than the resin-asphaltene type (sponge, honey comb type). This mechanism has been corroborated by Jacob (1971), who reported that the reaction mechanism involving polymerization and condensation of a large number of aromatic compounds with a low concentration of impurities leads to the formation of coke containing fewer cross-linkages and has a more crystalline appearance. Scott (1967) observed that coke precursors from the aromatic feedstocks have simpler structures and contain fewer cross-linkages, so they apparently remain plastic for a longer period of time during carbonization. This plasticity permits crystallites to be oriented by the upward flow of gases in the coke. The general theory of needle coke formation is based on this partial alignment of crystallites within low boiler vapour bubble walls, which form during the coking process. The fracture of green coke occurs in such a way as to preserve the bubble walls, and the coke has a splintery or needle-like appearance.

Petroleum-derived starting materials yield a wide variety of mesophase morphologies ranging from fine texture isotropic constituents to the fibrous or acicular structure required in the needle coke. As a result, two types of precursor components and reaction sequences occur:

1. Rapid reacting components that precipitate fine mesophase spherules under mild pyrolytic conditions undergo coalescence without appreciable growth to yield fine isotropic micro-constituents that are not readily deformed;
2. The slow reacting components that precipitate fine mesophase spherules under mild pyrolytic conditions grow and coalesce to a coarse and easily deformable mesophase. On continuous pyrolysis these mesophases are extensively deformed by bubble percolation; eventually viscosity significantly increases to allow further deformation and a fine fibrous microstructure of needle coke is established as the mesophase congeals to semicoke.

The conversion of mesophase is a function of molecular weight of the mesophase material as well as the composition of the liquid from which it is formed. The formation of large liquid crystals with preferred orientation as intermediate is most essential for the coke formation of high-quality petroleum coke. After sufficient growth of the mesophase droplet population, a phase inversion occurs with the mesophase becoming continuous. Thereafter, crystalline alignment continues within the liquid mass. Finally, molecular weight becomes very high and cross-linking inhibits graphite sheet orientation. Hence, it has been reasoned that coke must be produced as a relatively quiescent liquid. If the process is "rushed" by excessive temperature gradients, or agitated, the final coefficient of thermal expansion (CTE) of the graphite will be higher due to insufficient or improper alignment before the structure is fixed by the cross-linking and the growth processes. It is for this reason that coke produced by fluid coking cannot be used in graphite manufacture for UHP (ultra high power) electrodes. This is partly due to the high temperatures employed and partly because of the "onion" type (layered) development in such a coke (Friday, 1975).

Factors Affecting the Needle Coke Quality and Quantity

It is known that the petroleum coke quality depends on the type and origin of the feedstock as well as on the operating parameters. By careful selection of these, it is quite possible to improve upon the quality for more selective types of coke. Following are the factors, which are responsible for the coke quality:

Hydrocarbon constituents

The most important variable is the hydrocarbon constituents present in the feed, which range from high and low resins and asphaltenes to aromatics (Stormont, 1969; Kuchhal, 1982). The presence of a high concentration of asphaltenes and resins leads to coke formation with a highly disordered, cross-linked sponge type of coke (high CTE). On the contrary, low percentage of these gives an ordered, crystalline type of needle coke (low CTE). Aromatic hydrocarbons that are resistant to thermal cracking or chemical decomposition appear in the cycle stock as thermal tar, decant or slurry oil. The lower the characterization factor (CF) of the feed to the cracking plant, the larger the yield of aromatic-rich cycle stock suitable for producing needle coke. It is known that recycling reduces the characterization factor of the cycle stock.

Sulphur content

Among the non-metallic impurities, sulphur is one of the most important criterions for the applicability of needle coke in the making of electrodes (Kuchhal, 1982; Acciarri and Stockman, 1989). In petroleum coke, sulphur is present nearly quantitatively in organic bonding as heteroatoms with the aromatic rings. Surprisingly, these C-S bonds have extreme thermal stability and therefore, sulphur remains in the main part with the coke even at calcination temperatures up to 1350°C. At elevated temperatures between 1400°C and 1500°C, sulphur breaks out suddenly by the rupture of heterocyclics and forms volatile C-S compounds. This behaviour is known as "puffing effect" and must be avoided. It has been observed that coke having more than 1.2 wt.% of sulphur gives a vapour formation during electrode manufacture. According to Acciarri and Stockman (1989), if the coke contains high sulphur, the electrode maker has to extend the time requirements as regards the graphitization process in order to minimize irreparable cracking and weakening of the in-process electrode. As a result of slowing down of the graphitization process, energy is consumed to a large extent and there is a loss of production capacity as well.

In general, sulphur in the coke is a function of sulphur in the coker feed. To produce less than 1.5 wt.% of sulphur in the coke, under normal operating conditions, a residue of 0.9–1.0 wt.% sulphur is required. It has been observed that operating conditions also play some role in deciding the sulphur and the final coke content. Coke produced at high pressure and recycled stock have lower sulphur content than expected, since they result directly not only from residues but also effectively from cracked oils having low sulphur content. It has been further observed that sulphur generally exists in larger amounts in the sponge coke produced from high-resin-asphaltene stock than in honeycomb or needle coke. In the super premium grade of electrode coke used as graphite products, sulphur is not allowed to exceed beyond 0.5 wt.%.

Metal impurities

The metal impurities found in the oil system are in the form of Ni, V and Fe. These impurities get condensed in the needle coke during the coking process. A high concentration of these metals in coke affects not only its mechanical strength and resistivity but also how it works. Vanadium in needle coke, if it is used as a graphite steel electrode, increases the consumption of electrode due to oxidation. In the amalgam process, if the graphite electrode is used as an anode in aqueous chlorine-alkaline electrolysis, vanadium reduces the hydrogen over voltage and chlorine can be enriched by hydrogen. Above 20 ppm of vanadium leads to the danger of formation of explosive chlorine/hydrogen gas mixture (Kuchhal, 1982).

Very high purity is required in nuclear applications for two reasons, firstly the neutron absorption by several elements, e.g. gadolinium, europium and boron, and secondly by the different activation behaviour of the elements present under neutron irradiation in forming radioactive isotopes.

Operating variables

Furnace outlet temperature, coke drum pressure and the recycle ratio are the main operating variables, which not only affect the needle coke yield but also its characteristics (Kuchhal, 1982). An increase in the drum pressure results in a higher coke yield because more molecules, even of gas-oil range, contribute to coke formation by remaining in the liquid phase. This not only dilutes sulphur and metal contents of coke but also decreases its CTE.

Higher furnace and drum temperatures produce hard coke, which creates a cutting problem during recovery. Lower temperatures produce more coke but of lower quality. Therefore, the temperature at the outlet of the furnace should be such that the vaporization of the oil is about 5–20 mol.% with minimum coke formation in the furnace coils. To reduce coke formation in the furnace coils, water vapours are introduced prior to the critical zone of decomposition, as has been discussed by Mekler and Brooks (1959). However, Stormont (1969) has observed that the coke produced with the injection of steam in the process not only had a higher CTE but also was more isotropic, i.e., of lower quality.

Calcination

Green petroleum coke from the delayed coking process is essentially a hydrocarbon. Before it can be used as a carbon aggregate it must be converted into elemental carbon by a petrochemical process, and the process, which is imparted for the above-mentioned purpose, is called calcination (Nelson, 1970). It is basically a heat treatment in the temperature range of 1300–1500°C given to the green coke. Essentially, all hydrogen is removed from the coke and the structure of the coke changes toward a graphite. Nelson (1970) pointed out that though this process is conventionally termed as calcination, chemically it is essentially a dehydrogenation reaction, which converts a hydrocarbon into elemental carbon. A number of changes in basic properties and structure of green petroleum coke can be brought about via calcination on removing the chemically bound hydrogen from the hydrocarbon in order to produce elemental carbon. Dehydrogenation and dealkylation reactions bring about the fusion of large aromatic structures into highly organized shapes, similar to the parallel layers of condensed planer C₆ rings that constitute the graphite crystal-lite (Singh, 1991).

Table 10 shows typical ultimate analysis of green petroleum coke and calcined petroleum coke. As can be seen from the table, the green petroleum coke is an electrical insulator while the calcined petroleum coke is an electrical conductor. Most calciners are operated to obtain a specified real density of the calcined product. Anode and specialty cokes are usually calcined before proceeding to their end use. The calcining processes used are the rotary kiln and the rotary hearth processes. Table 11 shows typical specifications of calcined needle coke as proposed by

Table 10. Typical ultimate analysis of green petroleum coke and calcined petroleum coke (Nelson, 1970)

Constituents/properties	Green (carbonized residual)	Calcined (pure carbon)
Carbon, wt.%	91.80	98.40
Hydrogen, wt.%	3.82	0.14
Oxygen, wt.%	1.30	0.02
Nitrogen, wt.%	0.95	0.22
Sulphur, wt.%	1.29	1.20
Ash, wt.%	0.35	0.35
C/H ratio (by weight)	24	910
Real density, kg/m ³	1300	2070
Electrical resistivity, Ohm-m	2.3×10 ⁵	9×10 ⁻⁴

Table 11. Typical Calcined Needle Coke Specifications (Acciarri and Stockman, 1989)

Property	Quality grade		
	Super premium	Premium	Intermediate
Coefficient of thermal expansion (CTE), $\times 10^{-7}/^{\circ}\text{C}$	<2.0	2.0 to 3.0	3.1 to 4.0
Sulphur content, wt. %	<0.5	<0.6	<0.8
Real density, gm/cc	>2.12	>2.12	>2.12
Ash content, wt. %	<0.1	<0.2	<0.2
Particle size distribution, wt. % + 6 Tylor mesh	Maximum practical		
Hardness (attrition factor)	Varies depending upon producer and user		

Table 12. Summary of pricing evolution for needle coke

Year	Cost (\$/ton)
1969	70
1972	80–120
1980	400
1986	500
1989	550

Acciarri and Stockman (1989). As can be seen, the specifications for three grades of calcined needle coke, viz., super premium, premium and intermediate needle coke have been given. Super premium needle coke is used to produce electrodes for the most severe electric arc furnace steelmaking applications, premium needle coke for electrodes intended for less severe applications and intermediate needle coke for even less critical operation.

It has largely been believed that the quality of the final coke is heavily dependent on the manufacturing conditions of green coke. Accordingly, various processes developed to obtain low coefficient of thermal expansion (CTE) products centred on producing needle coke at the delayed coking step itself. In view of this, developments in calcining technology have been primarily aimed at improving efficiency and economy of the calcining units. This opinion however, in the recent past, has proved to be otherwise (Singh, 1991).

Calcination of the green coke has traditionally been carried out in a single stage rotary kiln. Use of the Marathon rotating hearth process, Petrol Chimie vertical kiln (PC), more as a desulphurizing calciner and electric calcination have also been reported (Reis, 1975). Singh (1991) also discussed the new calcining technology developed by Koa Oil Company (Japan), which is a two-stage calcination process. In this, green coke is calcined initially at a temperature from 600–900°C, cooled and then recalcined at a temperature of about 1300–1400°C, the same level as in the traditional method. It has been found that in the temperature range of 700–800°C, the transition points are observed on coke strength, CTE, porosity and X-ray parameters. This new technology reduces the CTE of coke regardless of the type of green coke.

The pricing scenario with regard to needle coke has evolved over a period of time. In 1969, calcined needle coke was sold at \$70/ton and in 1972, the price was in the range of \$80–\$120/ton (Reis, 1975). In 1979, record sales of both needle coke and graphite electrodes were posted. The business climate of 1979 encouraged forecasts of major near-term shortages and continued spiraling prices. Graphite electrode manufacturers initiated programs to increase production. As a result of which, in 1980,

the price approached to \$400/ton (Matson, 1980). However, the worldwide economic recession during 1982–1985 and excess production capacity influenced a new pricing mechanism and hence a slowdown was observed during that period. In 1989, the price approached \$550/metric ton, and it was predicted that increasing demand would make it more costly (Acciarri and Stockman, 1989). Table 12 shows the pricing evolution with regard to the needle coke.

Future Market for Needle Coke

According to Friday (1975), there are many reasons that strengthen the belief of a very bright future for the production of needle coke, which is obtained from the delayed coking process. The impact of the economic disorder in petroleum prices, as well as environmental and social awareness, augments the need for needle coke. The electric arc furnace is a relatively efficient means of producing steel. The electric arc furnace is desirable from an environmentalist's viewpoint since it recycles scrap steel without excessive transportation costs and because air pollution is relatively easy to control compared with other means of steelmaking. So as long as steelmaking continues to grow, electric steel production will grow at a faster rate. Since ultra-high power (UHP) furnaces require extremely high-quality electrodes and therefore coke, the industry will be required to produce growing quantities of needle coke. Acciarri and Stockman (1989) are of the opinion that refiners possessing feedstock advantages, logistics advantages, and sustained efforts to produce a quality needle coke, can find opportunity in a global marketplace that appears to require a new supply development of super-premium-quality needle coke. Swain (1991) reported that the needle coke market will continue to be characterized by contracted sales and infrequent spot market activity. It has also been reported (Oyama and Todo, 1993) that the quality of needle coke needs to be upgraded because the steelmakers, with the progress of steelmaking techniques, are asking for high-quality graphite electrodes. Shen et al. (1998) corroborated this fact and reported that along with the rapid development of electric arc steelmaking furnaces, the demand for premium needle coke is going to grow constantly in the future.

CONCLUSIONS AND SUGGESTIONS FOR FUTURE WORK

The overall conclusions and suggestions for future work can be summarized as follows:

1. With regard to the bottom-of-the-barrel upgrading, the delayed coking process is a long-time workhorse. From its very inception in 1930, it is still the most sought-after residue upgrading process. In fact, it is the lowest investment route

- for residue upgrading, which gives the highest return on investment (ROI);
2. There is a renewed interest in having a delayed coker unit in the refinery set-up as the refiners are left with no option but to process high sulphur, high metal content crudes, which in turn lead to the production of high sulphur, high metal content residues. It has been anticipated that as the crudes will continue to get heavier and the demand for motor fuels will continue to increase, delayed coking would be even more widely used throughout the world;
 3. With regard to the reaction mechanism pertaining to coke formation, it has largely been accepted that coke formation takes place via some reaction intermediate and only after certain induction period as it brings with it a phase inversion from liquid to solid. However, a kinetic model consisting of industrially important fractions under coking conditions has not been attempted as yet. Such a kinetic model comprising industrially important pseudocuts, viz., gas, gasoline, LGO, VGO and coke needs to be developed, which could be of significant use to the practising refiners;
 4. The inception of coke formation in coke drums is a critical input that in turn defines the efficiency of delayed cokers in terms of getting low boiling, more value-added products out of the residue. It has been reported that the coke formation starts at the wall and progresses toward the centre of the reactor. However, no quantification is reported as to how much temperature difference occurs between the hydrocarbon mixture at the wall and at the centre. Hence, batch reaction studies in the temperature range of 430–500°C and a residence times range of 5–120 min need to be carried out so as to investigate the inception of coke formation at low temperature and high residence times and vice-versa;
 5. Advancements in the design features of the delayed coking process are on so as to handle the heavier residues and there is a growing trend for low-pressure operations in view of maximizing the yield of liquid product and to minimize the coke formation;
 6. Various new processes are being employed for the efficient use of fuel grade coke, which is obtained by processing high sulphur and high metal content residues. Among the various processes, gasification of petroleum coke that gives rise to synthesis gas, which in turn can be used in various applications, is gaining widespread acceptance;
 7. The production of steam and electricity via cogeneration for internal use and outside sales is emerging to be the solution to the disposal of this coke. In fact, Petrox, a Chilean refinery has set up a cogeneration plant that burns the coke and supplies steam and electricity to the refinery (Karpenski and Alveal, 1999). The most important part of this cogeneration plant is that it provides a permanent disposal of high sulphur and high metal content green coke produced by the delayed coker, thus solving any problems of unwanted or excess coke;
 8. Since a single feedstock meeting the specifications for the needle coke production is not available in abundance, extensive study on the blends of different feedstocks meeting the specifications needs to be carried out. At the same time, new potentially feasible feedstocks need to be explored for the production of needle coke;
 9. The properties of the feedstocks for the needle coke production should be analyzed (in terms of the hydrocarbon type present and more precisely which type of aromatic hydrocarbons), which will ultimately lead to the proper balance of aromaticity and molecular weight to minimize resulting graphite CTE;

10. It has been found that the mechanism of the formation of needle coke is different from the mechanism of the formation of regular coke. However, the information on the kinetics of needle coke formation is scarce in the published literature. In this regard, studies with potentially feasible feedstocks for needle coke production should be extensively carried out. The generated batch reaction data at different temperatures and residence times under delayed coking conditions with a little higher severity could be of great help for subsequent reaction kinetics model development;
11. All this calls for the systematic investigations at the batch and bench levels, which would involve number of experiments wherein, the different process parameters and different feedstocks and their blends can be studied extensively.

NOMENCLATURE

AR	atmospheric residue (350°C+)
CCR	Conradson carbon residue, wt. %
CTE	coefficient of thermal expansion
E	activation energy, kcal/mol
I	reaction intermediate, wt. %
IBP	initial boiling point, °C
k	rate constant, min ⁻¹
K _{UOP}	characterization factor
LGO	light gas oil (150–350°C)
MMTPA	million metric tons per annum
SARA	saturates, aromatics, resins and asphaltenes
S _L	solubility limit, wt. %
VGO	vacuum gas oil (350–500°C)
VR	vacuum residue (500°C+)

ACKNOWLEDGEMENTS

One of the authors, A. N. Sawarkar, is grateful to the University Grants Commissions (UGC), Government of India, for providing the financial support in the form of a research fellowship. The financial support of United Phosphorous Limited (UPL), India is also gratefully acknowledged.

REFERENCES

- Acciarri, J. A. and G. H. Stockman, "Demand for Superpremium Needle Cokes on Upswing," *Oil Gas J.*, December 25, 118–120 (1989).
- Anon., "New Raw Material for Coke and Gasoline," *Pet Refiner* 35 (8), 153–155 (1956).
- Bansal, S. B., A. R. Gentry and J. C. Moretta, "Improve Your Coking Process," *Hydrocarbon Process.* (2), 63–66 (1994).
- Berber, J. S., R. L. Rice and R. L. Lynch, "Delayed Coking of Low-Temperature Lignite Pitch," *Ind. Eng. Chem. Prod. Res. Develop.* 7 (12), 270–274 (1968).
- Boduszynski, M. M., "Composition of Petroleum Residua," ACS preprints, Petroleum Chemistry Division 47(4), 329–331 (2002).
- Brooks, J. D. and G. H. Taylor, "Coking Studies on Coal Tar Pitch," *Carbon* 3, 185–187 (1965).
- Christman, R. D., "Carbon-Out Processes for Heavy Resids," *World Refining*, November/December 22–24 (1999).
- DeBiase, R. and J. D. Elliott, "Delayed Coking: Latest Trends," *Hydrocarbon Process.* (5), 99–104 (1982).
- Del Bianco, A., N. Panariti, M. Anelli, P. L. Beltrame and P. Carniti, "Thermal Cracking of Petroleum Residues 1. Kinetic Analysis of the Reaction," *Fuel* 72 (1), 75–80 (1993).

- Di Carlo, S. and B. Janis, "Composition and Visbreakability of Petroleum Residues," *Chem. Eng. Sci.* **47** (9-11), 2695-2700 (1992).
- Dymond, R. E., "World Markets for Petroleum Coke," *Hydrocarbon Process.* (9), 162-C-162-J (1991).
- Elliott, J. D., "Design, Operation Factors can Up Coker Liquid Yields," *Oil Gas J.*, February 4, 41-44 (1991).
- Elliott, J. D., "Maximize Distillate Liquid Products," *Hydrocarbon Process.* (1), 75-84 (1992).
- Foulkes, P. B. and M. D. Harper, "Prospects for Coking may Brighten," *Oil Gas J.*, March 20, 85-93 (1978).
- Friday, J. R., "Production of High Quality Needle Coke," in "Proc. 9th World Petroleum Congress," **5**, 187-190 (1975).
- Furimsky, E., "Gasification in Petroleum Refinery of 21st Century," *Oil Gas Sci. Technol.* **54** (5), 597-618 (1999).
- Gambro, A. J., D. T. Shedd, H. W. Wang and T. Yoshida, "Delayed Coking of Coal Tar Pitch," *Chem. Eng. Progress* **65** (5), 75-79 (1969).
- Gawrys, K. L., M. P. Spiecker and P. K. Kilpatrick, "The Role of Asphaltene Solubility and Chemistry on Asphaltene Aggregation," ACS preprints, *Petroleum Chemistry Division* **47** (1), 323-335 (2002).
- Goyal, O. P., "Indian Petroleum Refining Industry," *Chem. Ind. Digest*, Annual-January, 55-63 (2006).
- Heck, S. B., "Design Techniques for Modern Delayed Coker," *Oil Gas J.*, July 24, 46-48 (1972).
- Henderson, R., M. Rodwell and A. Harji, "Consider Modifying your Refinery to Handle Heavy Opportunity Crude Oils," *Hydrocarbon Process.* (9), 47-54 (2005).
- Hobson, G. D., "Cracking and Reforming," in "Modern Petroleum Technology," Applied Science Publishers Ltd, London (1982), pp. 395-411.
- Jacob, R. R., "Coke Quality and How to Make it," *Hydrocarbon Process.* (9), 132-136 (1971).
- Karpenski, M. J. and E. D. Alveal, "Refiner Uses Cogeneration Project to Revamp for High-Sulfur Crudes," *Hydrocarbon Process.* (12), 55-59 (1999).
- Kasch, J. E. and E. W. Thiele, "Delayed Coking—A Modern Process 25 Years Old," *Oil Gas J.*, January 2, 89-90 (1956).
- Kuchhal, Y. K., "Feasibility of Needle Coke Production in India," *Res. Ind.* **27** (3), 30-36 (1982).
- Kumar, M. M., D. C. Madhwal, B. M. L. Bhatia, S. Singh, H. C. Chandola and D. Tandon, "Feasibility of Production of Needle Coke from Lube Oil Extracts," *Indian J. Chem. Technol.* **3** (9), 285-288 (1996).
- Kutler, A. A., R. De Biase, L. W. Zahnstecher and R. L. Godino, "Here is what's New in Delayed Coking," *Oil Gas J.*, April 6, 92-96 (1970).
- Leon, O., E. Rogel, J. Espidel and G. Torres, "Asphaltenes: Structural Characterization Self-Association and Stability Behavior," *Energy Fuels* **14**, 6-10 (2000).
- Li, S., Z. Liu, C. Liu, G. Que, W. Liang and Y. Zhu, "Formation of the Physical Neophase in Terms of SARA Compositions of Vacuum Residua," ACS preprints, *Petroleum Chemistry Division* **43**, 187-189 (1998).
- Magaril, R. Z. and E. I. Aksenova, "Study of the Mechanism of Coke Formation in the Cracking of Petroleum Resins," *Int. Chem. Eng.* **8**, 727-729 (1968).
- Magaril, R. Z., L. F. Ramazaeva and E. I. Aksenova, "Kinetics of the Formation of Coke in Thermal Processing of Crude Oil," *Int. Chem. Eng.* **11** (2), 250-251 (1971).
- Matson, J. A., "Coke is Entering Turbulent Era Now," *Oil Gas J.*, March 24, 93-94 (1980).
- Mekler, V. and M. E. Brooks, "When is Delayed Coking Worthwhile?," *Hydrocarbon Process.* **38** (6), 169-176 (1959).
- Meyer, D. B. and J. C. Webb, "Coker can Handle High Carbon Stock," *Petroleum Refiner* **39** (2), 155-158 (1960).
- Meyers, R. A., "FW Delayed-Coking Process," in "Handbook of Petroleum Refining Processes," McGraw-Hill Publications, New York (1997), pp. 12.25-12.37.
- Mochida, I., Y. Korai, S. M. Zeng, A. Sakanishi, Y. Todo and T. Oyama, "Cocarbonization Properties of Heat-Treated FCC Decant Oils with Low Sulfur Vacuum Residue Leading to Production of Needle Coke," *Sekiyu Gakkaishi* **33**(6), 373-377 (1990).
- Nelson, W. L., "Petroleum Coke Handling Problems," *Hydrocarbon Process.* (2), 176-178 (1970).
- Nelson, W. L., "What are Feedstocks for Production of Needle Coke?," *Oil Gas J.*, December 18, 68-69 (1978).
- Oyama, T. and Y. Todo, "Study on Mechanism of Formation and Quality Improvement of Petroleum-Based Needle Coke," *Sekiyu Gakkaishi* **36** (6), 407-413 (1993).
- Philips, G. and F. Liu, "Advances in Resid Upgradation Technologies Offer Refiners Cost-Effective Options for Zero Fuel Oil Production," in "Proc. European Refining Technology Conference," Paris (2002).
- Rahmani, S., W. C. McCaffrey, H. D. Dettman and M. R. Gray, "Coking Kinetics of Asphaltenes as a Function of Chemical Structure," *Energy Fuels* **17** (4), 1048-1056 (2003).
- Rahmani, S., W. McCaffrey and M. R. Gray, "Kinetics of Solvent Interactions with Asphaltenes during Coke Formation," *Energy Fuels* **16**(1), 148-154 (2002).
- Reis, T., "To Coke, Desulfurize and Calcine Part 2: Coke Quality and its Control," *Hydrocarbon Process.* (6), 97-104 (1975).
- Rose, K. E., "Delayed Coking—What You Should Know," *Hydrocarbon Process.* (7), 85-92 (1971).
- Sarkar, G. N., "Advanced Petroleum Refining," Khanna Publishers, New Delhi, 1st Ed. (1998), pp. 44-49.
- Savage, P. E., M. T. Klein and S. G. Kukes, "Asphaltene Reaction Pathways. 1. Thermolysis," *Ind. Eng. Chem. Process Design Develop.* **24**, 1169-1174 (1985).
- Savage, P. E. and M. T. Klein, "Asphaltene Reaction Pathways. V. Chemical and Mathematical Modeling," *Chem. Eng. Sci.* **44**, 393-404 (1988).
- Schabron, J. F., A. T. Pauli and J. F. Rovani Jr., "Coke Predictability Maps," ACS preprints, *Petroleum Chemistry Division* **48** (1), 1-5 (2003).
- Schulman, B. L., F. E. Biasca, H. E. Johnson and R. L. Dickenson, "Bottom-of-the-Barrel Upgrading Moves Aggressively," *Hydrocarbon Process.* (12), 100-C-100-F (1993).
- Scott, C. B., "Petroleum Coke as a Raw Material for Graphite and Metallurgical Carbon Manufacture," *Chem. Ind.*, July 1, 1124-1131 (1967).
- Shen, H., Z. Ding and R. Li, "Thermal Conversion—An Efficient Way for Heavy Residue Processing," in "Proc. 15th World Petroleum Congress," **2** (1998), pp. 907-913.
- Singh, H., "Needle Coke—A Technological Study," *Erdol und Kohle-Erdgas-Petrochemie* **44**, 67-70 (1991).
- Sloan, D., B. Bansal and J. Fruchtbaum, "Delayed Coking has a Role in Clean Fuels Environment," *Fuel Reformulation*, July/August, 46-54 (1992).
- Sloan, H. D., "Refinery Expansion/Upgrading Means Lighter, Quality Products," *Hydrocarbon Process.* (1), 82-C-82-H (1994).

- Song, F. M., G. J. Yang, S. K. Han, Z. Q. Huang and J. L. Qian, "Study on Coking Kinetics of Chinese Gudao Vacuum Residue," *Fuel Sci. Technol. Int.* **13**(7), 819–835 (1995).
- Speight, J. G., "The Chemistry and Technology of Petroleum," Marcel Dekker Inc., New York (1980), pp. 200–236.
- Speight, J. G., "The Desulfurization of Heavy Oils and Residua," Marcel Dekker Inc., New York (2000), pp. 45–66.
- Stefani, A., "Choosing a Coke Recovery System," *Hydrocarbon Process.* (9), 61–66 (1995).
- Stefani, A., "Debottleneck Delayed Cokers for Greater Profitability," *Hydrocarbon Process.* (6), 99–103 (1996).
- Stefani, A., "Reduce the Impact of Coke Fines on Delayed Cokers," *Hydrocarbon Process.* (8), 110–113 (1997).
- Stokes, C. A. and V. J. Guercio, "Feedstocks for Carbon Black, Needle Coke and Electrode Pitch," *Erdol and Kohle-Erdgas-Petrochemie* **38** (1), 31–34 (1985).
- Stormont, D. H., "Delayed Coking Techniques Feel Effect of Increased Needle-Coke Demand," *Oil Gas J.*, March 17, 75–78 (1969).
- Swain, E. J., "Power, Cement Industries Shape Coke Future," *Oil Gas J.*, May 20, 49–52 (1991).
- Swaty, T. E., "Global Refining Industry Trends: The Present and Future," *Hydrocarbon Process.* (9), 35–46 (2005).
- Takatsuka, T., R. Kajiyama, H. Hashimoto, I. Matsuo and S. Miwa, "A Practical Model of Thermal Cracking of Residual Oil," *J. Chem. Eng. Japan* **22** (3), 304–310 (1989).
- Todo, Y., T. Ohyama, I. Mochida, Y. Korai, K. Sakanishi and X. Zhao, "Improved Cocarbonization Properties of a Petroleum Vacuum Residue by Catalytic Hydrotreatment Leading to Production of Needle Coke," *Sekiyu Gakkaishi* **34** (4), 298–302 (1991).
- Wang, Z., G. Que, W. Liang and J. Qian, "Chemical Structure Analysis of Shengli Crude Vacuum Residuum Related to Thermal Conversion," ACS preprints, Petroleum Chemistry Division **43**(1), 151–154 (1998).
- Welsh, A. F., "Hydraulic Decoking," *Petroleum Process.* (2), 157–160 (1950).
- Wiehe, I. A., "A Solvent-Resid Phase Diagram for Tracking Resid Conversion," *Ind. Eng. Chem. Res.* **31** (2), 530–536 (1992).
- Wiehe, I. A., "A Phase-Separation Kinetic Model for Coke Formation," *Ind. Eng. Chem. Res.* **32**(11), 2447–2454 (1993).
- Wiehe, I. A., "The Pendant-Core Building Block Model of Petroleum Residua," *Energy Fuels* **8**(3), 536–544 (1994).
- Wiehe, I. A. and K. S. Liang, "Asphaltenes, Resins, and Other Petroleum Macromolecules," *Fluid Phase Equilib.* **117**, 201–210 (1996).
- Yasar, M., D. Trauth and M. T. Klein, "Asphaltene and Resid Pyrolysis. 2. Effect of Reaction Environment on Pathways and Selectivities," *Energy Fuel* **15**, 504–509 (2001).
- Zuba, B. I., "Delayed Coking in the CIS," *Hydrocarbon Process.* (10), 132-B–132-G (1998).

Manuscript received November 14, 2006; revised manuscript received January 5, 2007; accepted for publication January 5, 2007.