

Standard free energies of formation of rare earth sesquisulphides

R. AKILA*, K. T. JACOB, A. K. SHUKLA†

*Department of Metallurgy, *also Materials Research Laboratory, and †Solid State and Structural Chemistry Unit, Indian Institute of Science, Bangalore 560 012, India*

An e.m.f. technique is used for the measurement of the Gibbs' energy changes involved in the conversion of the rare earth oxysulphides to the corresponding sesquisulphides in the temperature range 870 to 1120 K. The cell arrangement is

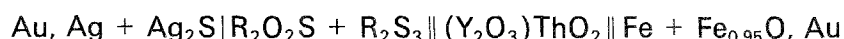

where R = La, Pr, Nd, Sm, Eu and Gd. Ytria-doped thoria is used as the solid electrolyte because it has predominant ionic conduction at the low oxygen potentials developed at the $\text{R}_2\text{O}_2\text{S} + \text{R}_2\text{S}_3$ electrode, especially for systems containing heavier rare earth elements. The sulphur potential at the left-hand electrode is established by the dissociation of Ag_2S to silver in a closed system. The changes in the standard free energy, enthalpy and entropy associated with the conversion of the rare earth oxysulphide to the sesquisulphide all show a smooth variation with rare earth atomic number. Based on these empirical trends, the corresponding thermodynamic functions for terbium, dysprosium and holmium systems are estimated. The measured free energy values are combined with recent data on the standard free energies of formation of the rare earth oxysulphides to obtain the Gibbs' energies of formation of the corresponding sesquisulphides.

1. Introduction

Rare earth sulphides are precipitated as inclusions in steel during the desulphurization of steel with rare earth elements. However, thermodynamic data on the rare earth sulphides are limited in content; the reported enthalpies of formation at 298.15 K are associated with large uncertainties (± 66 kJ) and the Gibbs' energies of formation as a function of temperature are known only for the sulphides of lanthanum, cerium and neodymium [1]. The present study attempts to provide further information on these compounds.

Rare earth sulphides possess defect Th_3P_4 structure, in which eight distorted PTh_6 octahedral groups meet at a point [2, 3]; 10 and 2/3 rare earth (R) atoms are distributed over 12 positions in a cell containing 16 sulphur atoms and the chemical formula actually corresponds to $\text{R}_{2.68}\text{S}_4$. The coordination polyhedron RS_8 is a triangulated dodecahedron. Over the composition range $\text{R}_{2.68}\text{S}_4$ to R_3S_4 , the cell dimensions remain nearly constant, indicating that the R^{3+} ions possibly do not change to R^{2+} ; instead the extra electrons are delocalized.

Kumar and Kay [4] studied the system $\text{La}_2\text{O}_2\text{S}/\text{La}_2\text{S}_3$. The reference electrode in their cell was air/platinum, while the measuring electrode was a mixture of silver, Ag_2S , $\text{La}_2\text{O}_2\text{S}$ and La_2S_3 . With a calcia-stabilized zirconia solid electrolyte, they measured the free energy change associated with the conversion of $\text{La}_2\text{O}_2\text{S}$ to La_2S_3 in the temperature range 950 to 1120 K. The resulting Gibbs' energy of formation of La_2S_3 calculated by them agrees with the data of Mills [1] within their experimental uncertainty of ± 14.6 kJ.

2. Experimental procedure

2.1. Materials

The oxysulphides were prepared in a step-wise process starting from the corresponding oxide. Rare earth sulphates were first precipitated from a solution of the oxide in 60% sulphuric acid. The sulphate crystals were dehydrated and heated in air at 1223 K to produce the oxysulphate which was subjected to hydrogen reduction at 1000 K to produce the oxysulphide. The formation of the oxysulphide was confirmed by X-ray diffraction. The rare earth sesquisulphides were prepared from elements contained in alumina crucibles kept inside evacuated silica capsules.

2.2. Cell arrangement

The experimental arrangement for the cell

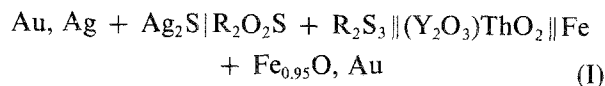

shown in Fig. 1, was similar to that described elsewhere [5]. The yttria-doped thoria (YDT) solid electrolyte crucible contained an equimolar mixture of the rare earth oxysulphide and the corresponding sesquisulphide. YDT was chosen in preference to calcia-stabilized zirconia as it could be used at the much lower oxygen potentials established in these systems without the risk of significant electronic conduction in the electrolyte which can otherwise result in e.m.f.s lower than the true value. A mixture of $\text{Ag} + \text{Ag}_2\text{S}$ in the molar ratio 1 : 2 was placed in an alumina crucible and placed inside the YDT crucible. Approximately 0.02 g CaH_2 was added to the $\text{Ag} + \text{Ag}_2\text{S}$ mixture.

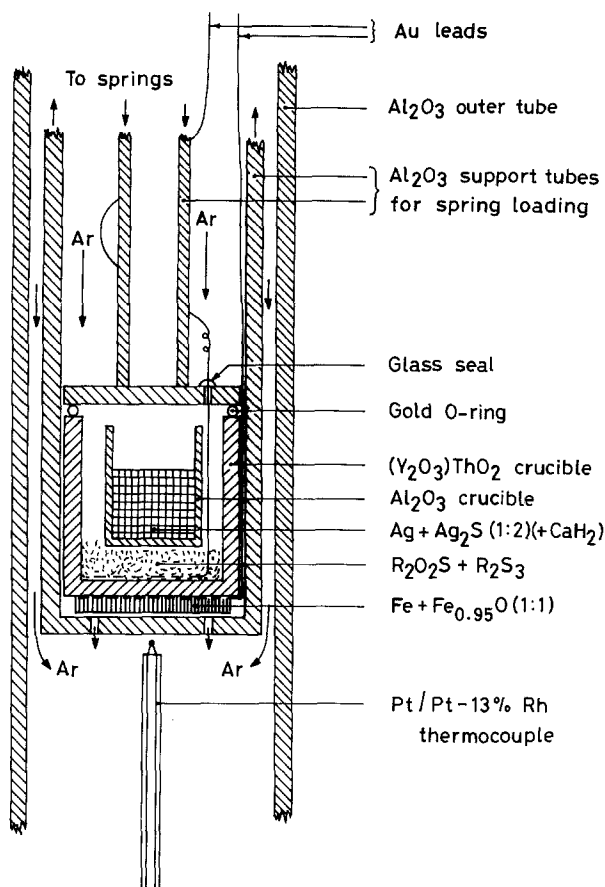
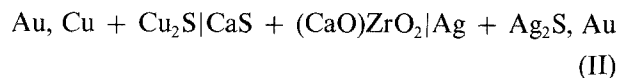

Figure 1 Cell arrangement used for measuring the free energy change involved in the conversion of the rare earth oxysulphide to the corresponding sesquisulphide.

An equilibrium ratio of $\text{H}_2\text{S}|\text{H}_2$ corresponding to $\text{Ag}_2\text{S} + \text{Ag}$ would be established by the reaction of CaH_2 with Ag_2S . The sulphur potential over the $\text{R}_2\text{O}_2\text{S} + \text{R}_2\text{S}_3$ mixture was established via the gas phase. The higher partial pressure of H_2S compared to S_2 resulted in faster cell response. A special feature of the cell design was the physical separation of the sulphur buffer from the rare earth compounds, so that effects due to solid solubility or chemical reaction between the buffer components and electrode materials were avoided. This design differs from that used by Kumar and Kay [4] who mixed their buffer system with the rare earth compounds at the electrode. To ensure that the sulphur pressure was kept constant at the measurement temperature, the YDT crucible was covered by an alumina lid with gold O-ring to ensure gas tightness. A mixture of $\text{Fe} + \text{Fe}_{0.95}\text{O}$ in the molar ratio 1 : 2 was used as the reference electrode. The use of the $\text{Fe} + \text{Fe}_{0.95}\text{O}$ reference electrode reduced the oxygen potential gradient across the electrolyte. The electrochemical flux of oxygen through the electrolyte and consequent polarization effect were thus minimized. The use of a $\text{Cr} + \text{Cr}_2\text{O}_3$ electrode would have resulted in lower oxygen potential than $\text{Fe} + \text{Fe}_{0.95}\text{O}$; however, the electrode is easily polarized. Gold wires served as electrode leads on both sides of the electrolyte; platinum leads were found to react with sulphur in the lower temperature region. Cell temperatures were monitored by a Pt/Pt-13% Rh thermocouple placed close to it. Measurements of cell e.m.f. were performed in the temperature range 870 to 1120 K.

Gibbs' energies of formation of Ag_2S reported by Barin *et al.* [6] are more positive than those of Mills [1] by ~ 2.7 to 7.3 kJ in the temperature range 800 to 1100 K. It was therefore decided to determine the sulphur potential of the $\text{Ag} + \text{Ag}_2\text{S}$ buffer with the cell arrangement



in the temperature range 870 to 1100 K. The $\text{Ag} + \text{Ag}_2\text{S}$ electrode is positive. The biphasic electrolyte used here was identical to that used by Jacob *et al.* [7] and consisted of a dispersion of CaS in a matrix of $(\text{CaO})\text{ZrO}_2$. To maintain the composition of the electrolyte constant, the surfaces of the electrolyte in contact with the electrode were coated with a thin layer of CaS . This prevents the reaction of CaO in the electrolyte with the sulphide phases at the electrodes. The sulphur potential established at each electrode was converted to an equivalent oxygen potential through the equilibrium reaction

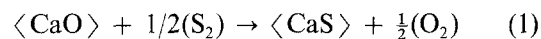

where $\langle \rangle$ represents the solid state and $()$ the gaseous state.

The cell e.m.f.s were measured with a digital voltmeter with an internal impedance greater than $10^{12} \Omega$. The reproducibility of the e.m.f.s was checked by temperature cycling. To check for the reversibility of the cells, small currents ($\sim 100 \mu\text{A}$) were passed through the cell in either direction for short intervals of time (~ 100 sec). The cell e.m.f.s returned to their original values before the titration in 1 to 2 msec. Changes in the flow rate of argon gas through the outer alumina tube did not affect the cell e.m.f.s. The electrode pellets were examined before and after experiment by X-ray diffraction. No changes were detected in the diffraction patterns, suggesting the absence of significant solid solubility or chemical reaction during the experiments.

3. Results and discussion

The e.m.f. of cell (I) is plotted as a function of temperature in Fig. 2 for the different rare earth systems investigated. A least mean squares analysis was carried out for each system and the resulting "best fit" linear equation relating cell e.m.f. to temperature are given in Table I. The experimental results for the rare earth systems of higher atomic number show greater scatter as seen in Fig. 2. This is probably related to the lower oxygen potential over the electrode containing heavier rare earth elements. The cell e.m.f., E , is

TABLE I Least-mean-squares analysis of e.m.f. data of cell I in the temperature range 870 to 1120 K

R	E_1 (mV)
La	$-113.7 + 0.1421T (\pm 0.4)$
Pr	$25.26 + 0.1414T (\pm 0.8)$
Nd	$87.06 + 0.1404T (\pm 2.3)$
Sm	$202.6 + 0.1396T (\pm 4.4)$
Eu	$255.2 + 0.1393T (\pm 3.7)$
Gd	$306.8 + 0.1389T (\pm 4.8)$

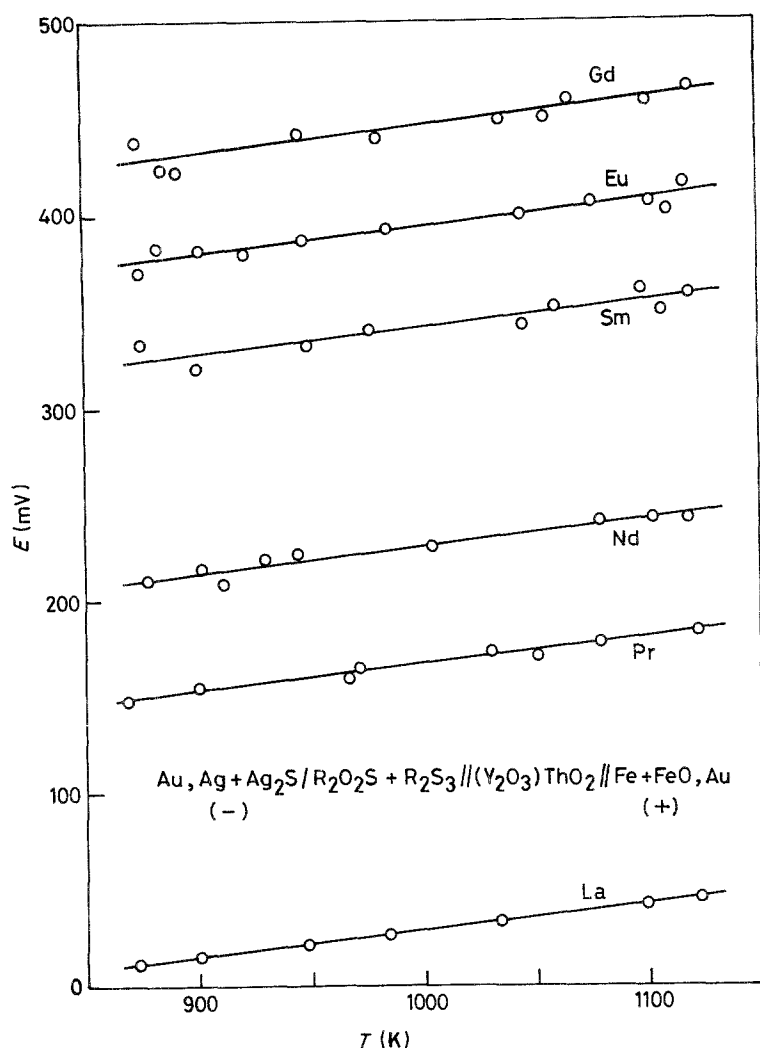
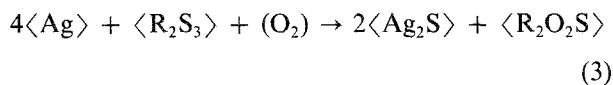

Figure 2 Temperature dependence of the e.m.f. of cell I.

related to the oxygen potentials at the cathode and anode through the Nernst equation

$$E = \frac{RT}{4F} \ln \left(\frac{p''_{O_2}}{p'_{O_2}} \right) \quad (2)$$

where R is the gas constant, T the absolute temperature, F the Faraday constant, p''_{O_2} the oxygen partial pressure at the cathode corresponding to the Fe/Fe_{0.95}O equilibrium and p'_{O_2} the oxygen partial pressure at the anode established by the R₂O₂S + R₂S₃ mixture in equilibrium with the Ag + Ag₂S buffer according to the reaction



The free energy change corresponding to the cell reaction

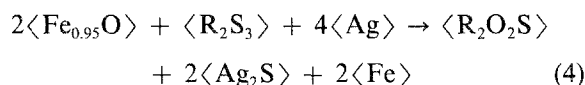

is given by

$$\Delta G^0 = -nFE \quad (5)$$

The free energy of formation of Fe_{0.95}O is taken from Steele [8]

$$\Delta G_f^0 \langle \text{Fe}_{0.95}\text{O} \rangle = -264\,575 + 65.40T (\pm 520) \text{ J mol}^{-1} \quad (6)$$

This relation is valid over the temperature range 870 to 1600 K. The Gibbs' energy of formation of Ag₂S was obtained by combining the e.m.f. data of cell II with the free energy of formation of Cu₂S [9]. The variation of the e.m.f. of cell II with temperature is shown in Fig. 3. The least mean square analysis gives the following equation relating cell e.m.f. to temperature

$$E_{II} = 223.8 + 0.0174T (\pm 0.2) \text{ mV} \quad (7)$$

The Gibbs' energies of Cu₂S in the temperature range 800 to 1200 K, reported by Ferrante *et al.* [9] were fitted to a linear equation as

$$\Delta G_f^0 \langle \text{Cu}_2\text{S} \rangle = -129\,035 + 30.84T (\pm 800) \text{ J mol}^{-1} \quad (8)$$

The values of Ferrante *et al.* [9] were based on their heat capacity measurements down to 5 K. These data were thus chosen in preference to values in the compilation of Mills [1], which were based on the heat capacity measurements of Anderson [10] down to 56 K. The values given by Equation 8 are more positive than those of Mills by ~4 kJ over the temperature range. Combining Equations 7 and 8, the standard free energy of formation of Ag₂S is given by

$$\Delta G_f^0 \langle \text{Ag}_2\text{S} \rangle = -85\,845 + 34.2T (\pm 800) \text{ J mol}^{-1} \quad (9)$$

The Gibbs' energy values given by this equation are in

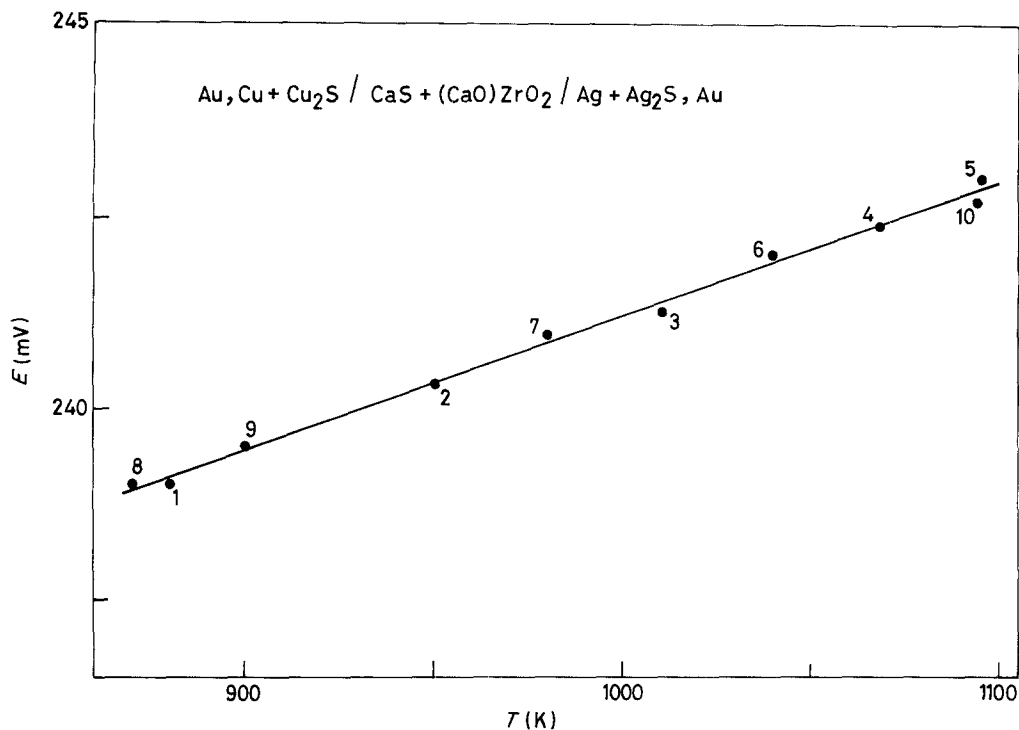

Figure 3 Variation of the e.m.f. of cell II with temperature.

good agreement with the compiled values of Barin *et al.* [6], the present result being more negative by 850 J mol^{-1} . The values reported by Mills [1] are more negative (by 2 to 6.5 kJ) than those given by Equation 9. The heat capacity values of Ag_2S used by Mills are based on the study of Perrott and Fletcher [11], which

covers the temperature range from 323 to 673 K. Heat capacities at higher temperatures were estimated [1]. Barin *et al.* [6] have used more recent heat-capacity data of Thompson and Flengas [12] based on their heat-content measurements between 323 and 1300 K. The Gibbs' energies of formation of Ag_2S obtained in

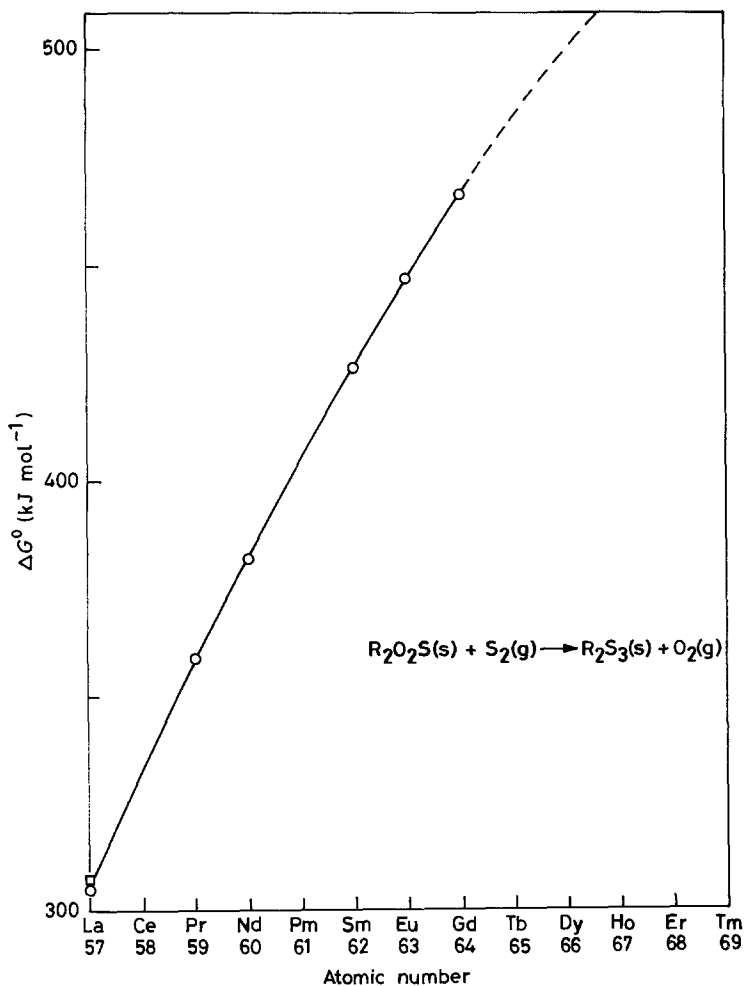

Figure 4 Standard Gibbs' energy change accompanying the conversion of the rare earth oxysulphide to the corresponding sesquisulphide at 1100 K plotted as a function of rare earth atomic number. (○) Present work, (□) Kumar and Kay [4].

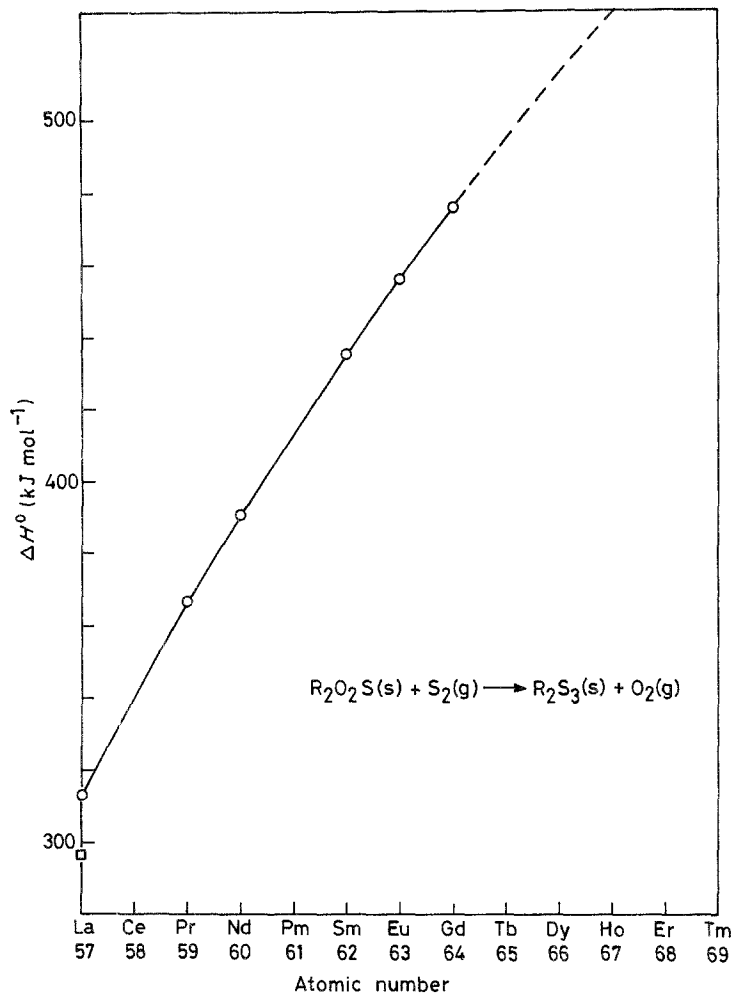
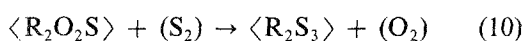

Figure 5 Variation of standard enthalpy change for Reaction 10 with rare earth atomic number. (○) Present work, (□) Kumar and Kay [4].

this study are more positive than those of Robie *et al.* [13] by $\sim 1.5 \text{ kJ mol}^{-1}$. Equations 6 and 9 are then combined with Equation 5 to obtain the standard free energy change for the conversion of the oxysulphide to the sesquisulphide according to the reaction,



The temperature dependence of the standard Gibbs' energy change for Reaction 10 for the different rare earth systems studied in the present work are summarized in Table II. A plot of ΔG^0 at 1100 K as a function of the rare earth atomic number (Fig. 4) shows a smooth increase with increasing atomic number. The free energy value obtained by Kumar and Kay [4] for the lanthanum system is more positive by 1.85 kJ. The value for the chemical potential of diatomic sulphur associated with $\text{Ag} + \text{Ag}_2\text{S}$ buffer used by Kumar and Kay [4] is, however, 1.63 kJ mol^{-1} more negative than that obtained in this study. If their results are recalculated using the data from this study

TABLE II Standard Gibbs' energy change associated with the conversion of the rare earth oxysulphide to the corresponding sesquisulphide in the temperature range 870 to 1120 K.

R	ΔG_{10}^0 (J mol ⁻¹)
La	313 580 - 7.53T(±965)
Pr	367 210 - 7.81T(±1005)
Nd	391 065 - 8.20T(±1305)
Sm	435 670 - 8.51T(±1950)
Eu	455 970 - 8.62T(±1715)
Gd	475 865 - 8.79T(±2085)

for Ag_2S , their free energy change for Reaction 10 would become more positive than that obtained in this study by 5.12 kJ. The standard enthalpy changes associated with Reaction 10 show a behaviour similar to the free energy changes, increasing with increasing atomic number, as seen in Fig. 5. For lanthanum, the value given by Kumar and Kay [4] is smaller by 16.8 kJ. The standard entropy change, associated with the reaction, obtained by them is negative, while for all the systems in the present study, the entropy change is positive and increases with increasing atomic number (Fig. 6). In spite of these large differences in the enthalpy and entropy values reported by Kumar and Kay [4] with the present work, the difference in free energy is small.

The free energy changes associated with Reaction 10 obtained in this study have been combined with an earlier work [5] giving the standard free energies of formation of the rare earth oxysulphides. The resulting Gibbs' energies of formation of the rare earth sesquisulphides at 1100 K have been plotted in Fig. 7 as a function of atomic number. Table III gives the linear dependencies of ΔG_f^0 of the rare earth sulphides on temperature. The main source of uncertainty in these values arises from the inaccuracy (± 8 to 15 kJ mol^{-1}) in the Gibbs' energies of formation of rare earth oxides, from which these data were derived. As more accurate data on free energies of formation of the rare earth oxides become available, the data obtained in this study and in [5] may be used to obtain more accurate values for the standard free energies of

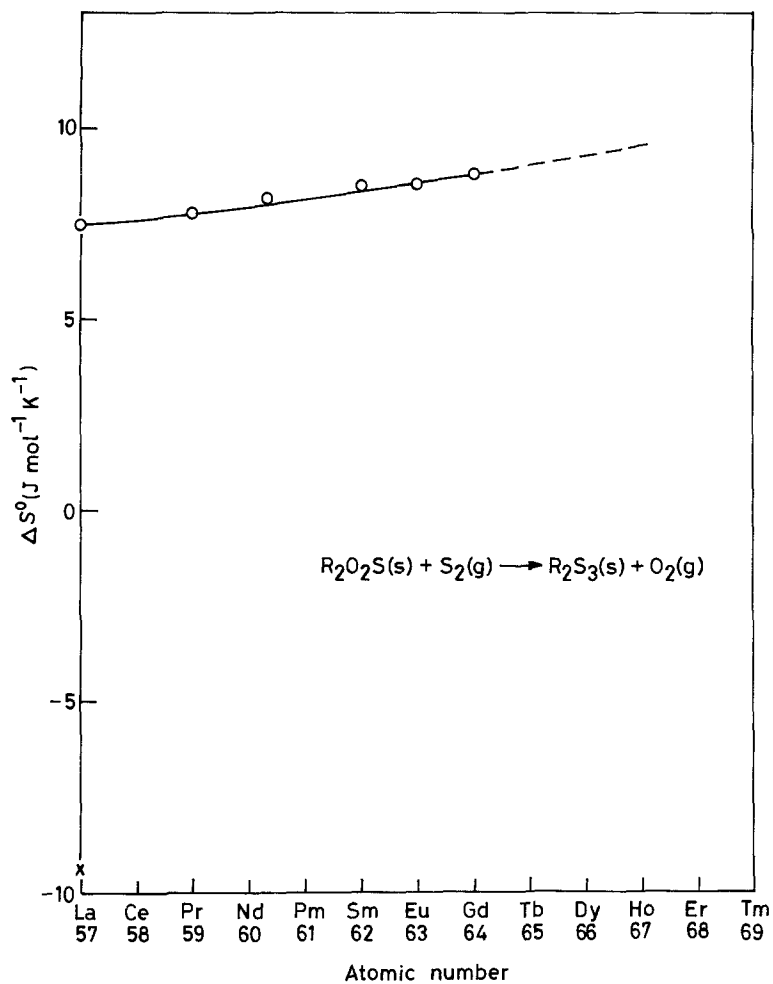

Figure 6 Dependence of the standard entropy change for the conversion of oxysulphide to sesquisulphide on the atomic number of the rare earth element. (○) Present work, (×) Kumar and Kay [4].

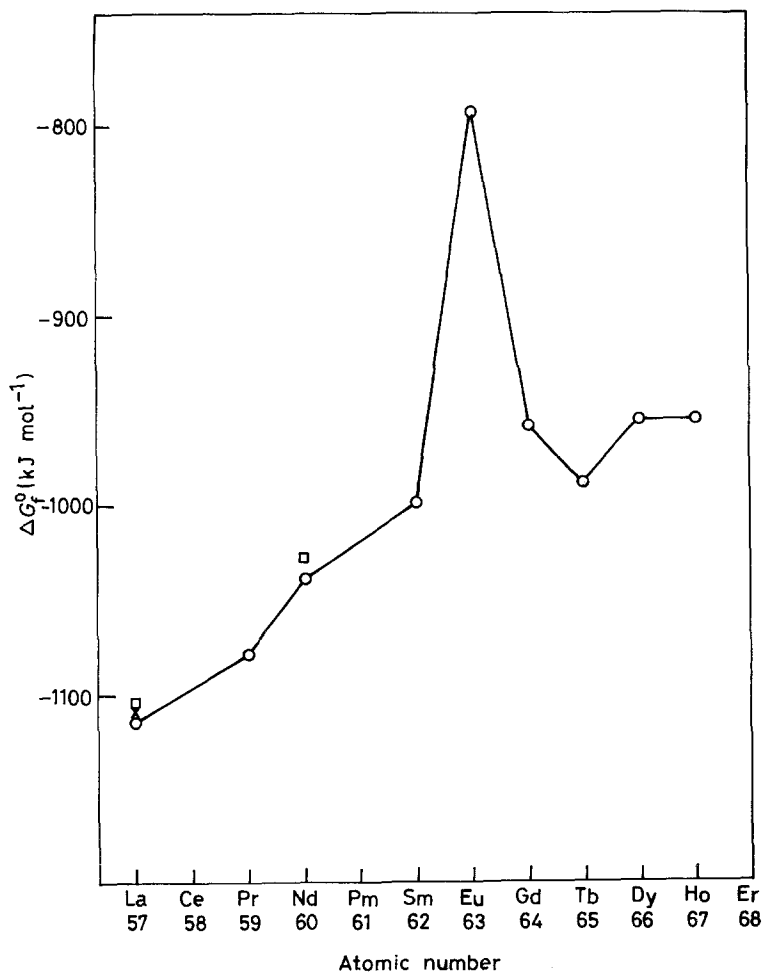

Figure 7 Plot of Gibbs' energies of formation of rare earth sesquisulphides from elements at 1100 K as a function of the rare earth atomic number. (○) Present work, (×) Kumar and Kay [4], (□) Mills [1].

TABLE III Standard free energies of formation of rare earth sesquisulphides (R_2S_3) from elements in the temperature range 900 to 1100 K

R	$\Delta G_f^\circ (J mol^{-1})$
La	$-1403640 + 264.66T (\pm 10900)$
Pr	$-1370370 + 265.80T (\pm 15000)$
Nd	$-1329125 + 265.52T (\pm 9200)$
Sm	$-1298630 + 274.30T (\pm 10200)$
Eu	$-1108210 + 288.91T (\pm 12200)$
Gd	$-1248590 + 265.12T (\pm 12400)$
Tb	$-1258805 + 255.96T (\pm 13000)^*$
Dy	$-1235355 + 258.70T (\pm 13000)^*$
Ho	$-1237415 + 263.42T (\pm 13000)^*$

*Estimated on the basis of empirical trends observed in this study.

formation of the corresponding sesquisulphides. The free energies of formation of the rare earth sesquisulphides of lanthanum and neodymium given in the evaluation by Mills [1] are more positive by 9.8 and 10.8 kJ, respectively. The free energy of formation of La_2S_3 reported by Kumar and Kay [4] is in good agreement with the data obtained in this study.

The standard free energy of formation of Eu_2S_3 is considerably less negative than those of Sm_2S_3 and Gd_2S_3 as shown in Fig. 7. Since the Eu^{2+} ion has a half filled 4f shell, it is associated with higher stability. Extra energy has to be supplied to convert Eu^{2+} to Eu^{3+} . The promotion energy is approximately 100 kJ. This accounts for the less negative free energy of formation of Eu^{3+} as compared to its neighbours.

Acknowledgement

The authors are grateful to the Board of Research in Nuclear Sciences, Department of Atomic Energy, Government of India, for financial support.

References

1. K. C. MILLS, "Thermodynamic Data for Inorganic Sulphides, Selenides and Tellurides" (Butterworths, London, 1974).
2. W. H. ZACHARIASEN, *Acta Crystallogr.* **2** (1949) 57.
3. A. F. WELLS, "Structural Inorganic Chemistry", 4th Edn (Oxford University Press, Oxford, 1975) p. 620.
4. R. V. KUMAR and D. A. R. KAY, *Met. Trans. B.* **16** (1985) 287.
5. R. AKILA, K. T. JACOB and A. K. SHUKLA, *ibid.*
6. I. BARIN, O. KNACKE and O. KUBASCHEWSKI, "Thermochemical Properties of Inorganic Substances" (Springer-Verlag, Berlin, New York, 1977).
7. K. T. JACOB, M. IWASE and Y. WASEDA, *J. Appl. Electrochem.* **12** (1982) 55.
8. B. C. H. STEELE, in "Electromotive Force Measurements in High Temperature Systems", edited by C. B. Alcock (The Institution of Mining and Metallurgy, London, 1968) p. 3.
9. M. J. FERRANTE, J. M. STUVE, G. E. DAUT and L. B. PANKRATZ, "Low Temperature Heat Capacities and High Temperature Enthalpies of Cuprous and Cupric Sulfides", RI 8305 (US Department of the Interior, Bureau of Mines, 1978).
10. C. T. ANDERSON, *J. Amer. Chem. Soc.* **54** (1932) 107.
11. C. M. PERROTT and N. H. FLETCHER, *J. Chem. Phys.* **50** (1969) 2344.
12. W. T. THOMPSON and S. N. FLENGAS, *Can. J. Chem.* **49** (1971) 1550.
13. R. A. ROBIE, B. S. HEMINGWAY and J. R. FISHER, "Thermodynamic Properties of Minerals and Related substances at 298.15 K and 1 bar pressure and at high temperature", Geological Survey Bulletin 1452 (US Department of the Interior, 1979) p. 213.

Received 21 July

and accepted 22 September 1986