

Modelling the impact of sky-bridges on total evacuation in high-rise buildings

Egzon Haliti

Department of Fire Safety Engineering and Systems Safety
Lund University, Sweden

Brandteknik och Riskhantering
Lunds tekniska högskola
Lunds universitet

Report 5448, Lund 2013

**Modelling the impact of sky-bridges on total
evacuation in high-rise buildings**

Egzon Haliti

Lund 2013

Titel

Modellering av förbindelsegångars inverkan på total utrymning av höga byggnader

Title

Modelling the impact of sky-bridges on total evacuation for high-rise buildings

Författare/Author

Egzon Haliti

Report 5448

ISSN: 1402-3504

ISRN: LUTVDG/TVBB--5448--SE

Number of pages: 99

Illustrations: Egzon Haliti

Keywords

Sky-bridges, stairs, total evacuation, evacuation model, Pathfinder, egress, congestion, merging flow, high-rise buildings, tall buildings, human behaviour, risk perception.

Sökord

Sky-bridges, trappor, samtidig utrymning, utrymningsmodell, Pathfinder, utrymning, trängsel, samgående flöden, höga byggnader, människors beteende, riskperception.

Abstract

This study examines the impact of sky-bridges, as an egress component, on total evacuation of a high-rise building by using an evacuation model named Pathfinder. Five scenarios, with different combination of aspects such as height of the building, number of sky-bridges (and the subsequent inter-distance between them), and people allocation have been simulated. The comparison between the results from the simulations indicates that sky-bridges significantly shorten the total evacuation time if used by all occupants above or at each refuge floor. Furthermore the comparison between the scenarios with different heights and the same inter-distance between the sky-bridges shows that the total evacuation time is approximately the same, as the buildings are divided in zones containing equal number of floors. However the comparison between two buildings with the same height but different inter-distance between the sky-bridges point out that the total evacuation time increases with increased inter-distance between the sky-bridges and vice versa.

© Copyright: Brandteknik och Riskhantering, Lunds tekniska högskola, Lunds universitet, Lund 2013.

Brandteknik och Riskhantering
Lunds tekniska högskola
Lunds universitet
Box 118
221 00 Lund

brand@brand.lth.se
<http://www.brand.lth.se>

Telefon: 046 - 222 73 60
Telefax: 046 - 222 46 12

Department of Fire Safety Engineering
and Systems Safety
Lund University
P.O. Box 118
SE-221 00 Lund, Sweden

brand@brand.lth.se
<http://www.brand.lth.se/english>

Telephone: +46 46 222 73 60
Fax: +46 46 222 46 12

Acknowledgements

This study is a master thesis at Risk Management and Safety Engineering (M.Sc.) programme and Fire Safety Engineering (B.Sc.) programme within the Department of Fire Safety Engineering and System Safety, at the Faculty of Engineering, at Lund University (LTH), Sweden.

There have been a lot of people helping me during this thesis. Without your help this thesis would have been very hard to conduct. First of all I want to thank God for my parents who have been a huge support during this journey. Then I want to thank my eminent supervisor *Enrico Ronchi*, the man himself, who has guided me throughout this thesis. Furthermore I want to thank my examiner *Daniel Nilsson* for proposing the idea of this thesis.

Many thanks to my brother, my friend and fellow gym mate, *Zoubeir El-Sabli*, for all hours spent proofreading the thesis. Furthermore I want to thank *Waleed Shoaib* for both proofreading and computer power. Also *Niklas Emond* and *Olov Holmstedt* deserves a huge thank for helping me with computer power for the simulations.

Thank you *Ida Svensson* and *Jenny Gramenius* for a good opposition with great feed-back.

Thanks to *Bryan Klein* and *Charlie Thornton* from Thunderhead Engineering for providing the educational licenses of the model Pathfinder.

There are many more who in various ways helped me to conduct this study and to name all of you within a limited amount of space is unfortunately impossible. Regardless I want to thank all who in any way were involved in the work of this study. Without you, this work would never have become what it is.

Lund, 31 December 2013

Egzon Haliti

Summary

To respond to the growing population, high-rise buildings are becoming more common in cities all over the world. With the growing number of high-rise buildings, new threats are introduced and therefore new appropriate evacuation strategies have to be designed. With the collapse of the World Trade Centre on September 11, 2001, leaving some occupants trapped with no evacuation option, the concept of using sky-bridges as egress components was suggested. The idea of linking two buildings with a sky-bridge is not new and there are modern buildings incorporating sky-bridges, such as the Petronas Twin Towers. Nevertheless, there is a lack of knowledge on the effectiveness of sky-bridges during an evacuation.

The aim of this study is to investigate the effectiveness of sky-bridges during an evacuation by examining different combination of aspects such as the height of a building, number of sky-bridges installed (and the subsequent inter-distance between them), and the allocation of people to the sky-bridges.

The study was conducted by simulating five hypothetical scenarios by using a continuous model named Pathfinder. The model case study is represented by two identical twin towers with either 50 or 95 stories. The towers are linked with several sky-bridges, 2, 3 or 5 of them, and the allocation of people using the sky-bridges are varied between 100%, 50% or 15%, depending on the scenario. The evacuation strategy under consideration is the total evacuation of a single tower.

By comparing the scenarios where the allocation of people to each sky-bridge varied, with all other parameters identical, it could be observed that the evacuation efficiency relies mainly on the percentage of people using sky-bridges to exit the building. If the sky-bridges are used by 100% of the people above or at each refuge floor the total evacuation time is significantly shortened. A refuge floor is a floor plane that is empty, i.e. with no inflammable materials, and it has strengthened fire resistance measures to safely accommodate occupants in emergency situations. However if not all occupants use the sky-bridges to evacuate out of the building, the total evacuation time increases considerably due to congestion on stairs from the people using them to evacuate the building.

The comparison between the scenarios with different building heights (95 storey vs. 50 storey), where all occupants (100%) are using the sky-bridges and the inter-distance between the sky-bridges is the same, indicates that the total evacuation time is approximately the same independently of the height. This, as the building is divided into zones with equal amount floors to evacuate. However when the scenarios with same height but different inter-distance between the sky-bridges were compared it was seen that the total evacuation time increased when the inter-distance between the sky-bridges increased.

To summarize, the use of each sky-bridges above or at each refuge floor by all occupants implies that the vertical evacuation route is shortened to the inter-distance between two sky-bridges instead of the whole building height. This means in turn that the total evacuation time is significantly reduced to the time it takes to evacuate the amount of floors between two sky-bridges instead of the whole building. This due to the reason that the evacuation is considered terminated as soon as an occupant has evacuated through the sky-bridge to the unaffected building. With this in mind, the sky-bridge usage as an egress

components permits buildings to still continue growing in height while keeping them at an acceptable level of safety.

Sammanfattning

För att besvara den ökade folktillväxten i världen har höga byggnader blivit allt vanligare i städer runt om i världen. Med det växande antalet höga byggnader introduceras nya hot, och därför måste nya lämpliga utrymningsstrategier utformas. I och med kollapsen av World Trade Centre den 11 september 2001 som lämnade ett antal personer instängda utan något utrymningsalternativ, introducerades förbindelsegångar som en möjlig utrymningskomponent. Idén om att förbinda två byggnader med en förbindelsegång är inte ny och det finns moderna byggnader som är införlivade med en förbindelsegång, som exempelvis Petronas Twin Towers. Dock är forskningen kring användandet av förbindelsegångar vid utrymning begränsad.

Syftet med denna studie är därför att undersöka effektiviteten av förbindelsegångar vid utrymning genom att undersöka olika kombinationer av aspekter, som exempelvis höjden på byggnaden, antalet förbindelsegångar (samt avståndet mellan dem) och fördelningen av personer till förbindelsegångarna.

Studien genomfördes genom att simulera fem hypotetiska scenarier genom en kontinuerlig modell vid namnet Pathfinder. Fallstudien representeras av två identiska tvillingtorn med antingen 50 eller 95 våningar. Tornen är sammankopplade med flertalet förbindelsegångar, 2, 3 eller 5 stycken, och fördelningen av människors som använder förbindelsegångarna varierar mellan 100%, 50% eller 15%, beroenden på scenariot. Den utrymningsstrategi som tillämpas är samtidig utrymning av ett torn.

Vid en jämförelse av de scenarier där fördelningen av personer till varje förbindelsegång varierade, med alla andra parametrar identiska, kunde det observeras att utrymningseffektiviteten av förbindelsegångarna berodde till mestadels av det procentuella antalet personer som utnyttjade dessa vid utrymning av byggnaden. Om förbindelsegångarna användes av 100% av personerna ovanför eller vid varje skyddande våningsplan så minskar utrymningstiden märkbart. Ett skyddande våningsplan är ett våningsplan som är fri från brännbart material och med en förstärkt brandbärighet, för att i utrymningssituationer kunna ackumulera ett stort antal personer. Om däremot inte alla personer använder förbindelsegångar vid utrymning av byggnaden så ökar den totala utrymningstiden avsevärt på grund av trängsel som uppstår av de personer som istället använder trapporna att utrymma.

Jämförelsen mellan de scenarier med olika höjder på byggnaderna (95 våningar vs. 50 våningar), var alla personer (100%) använder förbindelsegångarna och där avståndet mellan förbindelsegångar är densamma, visar att den totala utrymningstiden är ungefär densamma oavsett byggnadshöjd. Detta då byggnaderna delas i zoner med lika många våningar att utrymma. Däremot visar en jämförelse mellan scenarierna med samma byggnadshöjd men olika avstånd mellan förbindelsegångarna att den totala utrymningstiden ökar med ökat avstånd mellan förbindelsegångarna.

Sammanfattningsvis innebär det att om alla personer ovanför eller vid varje skyddande våningsplan använder förbindelsegångarna så förkortas den vertikala utrymningsvägen till avståndet mellan två förbindelsegångar istället för hela byggnaden. Detta i sin tur medför att den totala utrymningstiden förkortas till den tid det tar att utrymma antalet våningar mellan två förbindelsegångar istället för hela byggnaden. Detta p.g.a. att utrymningen

anses vara avslutad så fort en person har utrymt genom förbindelsegången till den ej utsatta byggnaden. Denna slutsats innebär därför att användningen av förbindelsegångar vid utrymning tillåter byggnader växa på höjden och samtidigt bibehålla en godtagbar säkerhetsnivå.

Table of contents

1	Introduction.....	1
1.1	Background.....	1
1.2	Aim and objective.....	2
1.3	Delimitations.....	2
1.4	Limitations.....	2
1.5	Definitions.....	3
2	Methodology.....	5
2.1	Literature study.....	5
2.2	Model Case study.....	5
2.3	Result analysis.....	6
2.4	Discussion and conclusion.....	6
3	Literature study.....	7
3.1	Stairs.....	7
3.1.1	Design.....	7
3.1.2	Legislations.....	8
3.1.3	Congestion.....	8
3.1.4	Merging flows.....	9
3.1.5	Issues associated with disabled occupants.....	10
3.2	Sky-bridges.....	10
3.2.1	Implementation implication.....	11
3.2.3	Incorporation of sky-bridges.....	12
3.2.4	Benefits of sky-bridges.....	14
3.3	Egress strategies.....	15
3.3.1	Total evacuation.....	15
3.4	Risk.....	16
3.4.1	Risk management.....	17
3.4.2	Risk perception and human behaviour in fire.....	18
4	Model case study.....	23
4.1	Geometric layout and egress components.....	24
4.1.1	Configuration of the floor plans.....	24
4.1.2	Stairs.....	27
4.1.3	Refuge floors and sky-bridges.....	28
4.2	Egress modelling scenarios.....	28
	Scenario 1.....	29
	Scenario 2.....	29
	Scenario 3.....	30
	Scenario 4.....	31
	Scenario 5.....	32
4.3	Application of an evacuation model.....	33
4.3.1	Pathfinder.....	33
4.3.3	Model input calibration.....	34

5 Results.....	37
5.1 Evacuation efficiency for the different scenarios.....	38
5.2 Flows and congestion.....	40
5.2.1 Scenario 1.....	40
5.2.2 Scenario 2.....	43
5.2.3 Scenario 3.....	46
5.2.4 Scenario 4.....	48
5.2.4 Scenario 5.....	52
6 Analysis.....	55
6.1 Comparison between scenario 1, 2 and 3.....	56
6.2 Comparison between scenario 1 and 4.....	57
6.3 Comparison between scenario 4 and 5.....	58
7 Discussion.....	59
7.1 Possible errors and limitations.....	59
7.2 Views from legislations on sky-bridge usage on today’s high-rise buildings.....	60
7.3 Introduction of sky-bridges within risk management context.....	60
7.4 Reflection on risk perception and sky-bridge usage.....	60
8 Conclusion.....	63
9 Future research.....	65
10 References.....	67
Appendix A.....	73
Appendix B.....	81

1 Introduction

This master thesis is a part of Risk Management and Safety Engineering (M.Sc.) programme and Fire Safety Engineering (B.Sc.) programme within the Department of Fire Safety Engineering and System Safety, at the Faculty of Engineering at Lund University (LTH), Sweden.

In this chapter, background, aim, objective, delimitations, limitations and definitions, of the study are described.

1.1 Background

Stairs have traditionally been the main component used for evacuating buildings. Lately buildings have been growing in height to respond to the growing population in the world. With the growing number of high-rise buildings, new threats are introduced and therefore new appropriate evacuation strategies have to be designed. Studies conducted by Spearpoint and MacLennan (2012) show that fatigue during stair evacuation may be a key issue due to a less fit and aging population. In those cases people have to stop their evacuation to rest, which causes a delay in evacuation. Therefore elevators have been introduced as a possible egress component which substantially reduces the evacuation time if used by all occupants (Ronchi & Nilsson, 2013).

With the collapse of World Trade Centre on September 11, 2001, leaving some occupants trapped without evacuation options, the concept of sky-bridges was proposed (Wood, 2003). Implementing a sky-bridge introduces a horizontal evacuating path above the ground with the benefits of reducing not only the total evacuation time but also the vertical travel distance and thus improving the safety of high-rise buildings (Wood, Chow, & McGrail, 2005). However, the effectiveness of sky-bridges is linked to several aspects, some of which are examined in this study. The concept of linking buildings with sky-bridges is not new. At the end of the sixteenth century for the first time ever, Antonio Contin connected Venice's Palazzo Ducale to the adjacent prison (Wood, 2003) with a link at height. Sky-bridges have been implemented in today high-rise buildings as well, with Petronas Twin Towers in Malaysia as the most known example (Ariff, 2003).

Previous modelling (Ronchi & Nilsson, 2013) as well as experimental evacuation studies (Ariff, 2003) indicates that the use of sky-bridges in combination with a simultaneous total evacuation of a building significantly shortens the total evacuation time. It is therefore of great concern to the concept of sky-bridges to obtain more knowledge so that sky-bridges can be incorporated in future high-rise building legislations as an additional egress component. Even if sky-bridges are implemented in today's high-rise buildings there is still scarce knowledge about how people would behave in case of evacuation using a sky-bridge. As human behaviour in evacuation using sky-bridges is unknown, this study is employing an evacuation model, named Pathfinder (Thunderhead Engineering, 2013), to simulate hypothetical scenarios for evacuation using a combination of sky-bridges and stairs to see where people congestion occurs and how this can be prevented. However as long as the modeller is aware of the intrinsic limitations of models, these egress models are efficient tools to investigate evacuation situations (Tavares, 2008).

1.2 Aim and objective

The aim of this work is to study how different combinations of aspects, such as the height of a building, number of sky-bridges (and the subsequent inter-distance between them), and the allocation of occupants to a sky-bridge, affect the total evacuation in a high-rise office building through the use of an evacuation model named Pathfinder.

The objective of the study is to obtain knowledge on where people congestion occurs during a total evacuation including the use of sky-bridges, depending on the above mentioned variables, and how these problems can be solved for smoother evacuation.

Specifically, this study will attempt to answer the following questions employing egress modelling:

- What impact does the allocation of people to each sky-bridge have on total evacuation, i.e. how does the evacuation efficiency depend on the percentage of people using the sky-bridges?
- How does the height of the building affect the total evacuation keeping the inter-distance between the sky-bridges constant?
- How does a change in inter-distance between the sky-bridges affect the total evacuation time?

1.3 Delimitations

There are numerous scenarios that could have been selected for this study. In the present work, only five of the most relevant scenarios have been investigated in accordance with the above mentioned aims and objectives. Scenarios are also hypothetical and people allocation has been set up through an argumentation on possible people behaviour. Due to the scarce knowledge about actual people's behaviour, there is a need to investigate the case of a sub-optimal sky-bridge usage (i.e., the behaviour of the occupants may not correspond to the planned strategy). Therefore the possible behaviours of the occupants in terms of sky-bridge usage will be discussed and should further be validated by experimental data.

In addition, the simulations have only been done for office buildings and the results are mainly applicable for this type of building use. If applied in other contexts, the building use should be taken into account. Only stairs and sky-bridges (and the corresponding refuge floors, where the sky-bridges are connected, used to accommodate occupants) are used as egress components, i.e. elevators have therefore been excluded. Furthermore total evacuation is the only egress strategy that has been investigated in this study.

1.4 Limitations

The model case study design is a continuation of a previous study within this field carried out by Ronchi and Nilsson (2013) with some adjustments made to fit the aims and objectives of the current study. For instance, the usage of Occupant Evacuation Elevators (OEE) has been excluded. The number of people and the number and the locations of sky-bridges have also been changed in some scenarios. The model case study geometry and egress components are made in accordance with building codes such as NFPA101 (NFPA, 2012) and International Building Code (IBC) (International Code Council, 2012). Nevertheless, it should be noted that the model is not fully code compliant due to inconsistencies between the two building codes. Necessary modifications to

building code prescriptions have also been made to fit the scopes of the study. It should also be noted that a simultaneous total evacuation of only one tower has been taken into consideration, meaning that all people from one of the towers are evacuating at once.

1.5 Definitions

During the thesis some words are used interchangeably. The term “egress” and “evacuation” are used as synonyms. Furthermore “simultaneous evacuation” and “total evacuation” are also taken to mean the same thing. Total evacuation is an evacuation strategy where all occupants in the building evacuate at once.

In the report the notion “high-rise building” refers to a height above 23 meters (75 feet). This definition is made according to the maximum height a fire department vehicle can reach (NFPA, 2012).

2 Methodology

In the following chapter, the body of the research will be described. The methodology for this study is divided in three parts: literature study, model case study, analysis of the results, discussion and conclusion. These three interdependent parts will try to answer, through a discussion and conclusion, the aim and objective of the research (figure 2.1 illustrates the work process).



Figure 2.1. Flow chart over the work process.

2.1 Literature study



Initially a literature study is carried out to summarize the literature on the topic of risk management and risk perception in evacuation situations, sky-bridges and stairs. To find the literature, databases were used, such as LibHub (Lund University digital database, www.lubsearch.lub.lu.se), Google Scholar (www.scholar.google.com), Scopus (www.scopus.com), ScienceDirect (www.sciencedirect.com), Wiley online library (www.onlinelibrary.wiley.com) and Springer Link (www.link.springer.com) as well as existing regulations and literature from previous courses.

2.2 Model Case study



The methodology followed in this research will be the case-study approach using computer modelling. The model case study consists of two hypothetical twin towers with business use, configured in Pathfinder (Thunderhead Engineering, 2013). The simulations are represented by different scenarios in accordance with the aims and objectives of the study. The egress components used in this study are evacuation through a combination of stairs and sky-bridges.

Due to the scope of the thesis, the study will consist of five different scenarios with different combinations such as the height of the buildings, the number and position of sky-bridges and the allocation of occupants to the two egress components (sky-bridges and stairs) during an evacuation.

2.3 Result analysis



The results from the simulation will be presented using different types of diagrams in order to investigate where congestion may occur and to provide a basis for the analysis and conclusions. The results are visualized with the aid of common chart types.

2.4 Discussion and conclusion



Analysis of the results from the different simulations are the basis for discussion and conclusions of the current study.

3 Literature study

The literature study will be divided in three parts: 1) egress components, 2) egress strategies and 3) risk perception and human behaviour in fire.

The first part of this review deals with the design and behavioural issues associated with different egress components, i.e. sky-bridges, stairs and refuge floors. Despite the fact that the case study is mainly focused on the combination of sky-bridges and stairs, a description of refuge floors is needed since it will be an integral part of the egress scenarios under investigation.

The second part of the literature study mentions different egress strategies that can be applied in evacuation situations. The main focus will be on total evacuation (i.e., simultaneous evacuation), since this is the strategy applied in the model case study.

In the third part of the literature study, the concept of risk is described in order to better understand the risk management model. A risk management model is interesting for this study since the impact of sky-bridges is seen as a precaution toward risk reduction. Furthermore a general description of risk perception and human behaviour in fire is carried out to facilitate a reflection of sky-bridge usage, as there is scarce knowledge on perception and behaviour about sky-bridge usage in fire evacuations.

3.1 Stairs

Stairs have always been an option for evacuation of any type of building, including high-rise buildings. Indeed, all people are familiar with their use. Stairs are the most common egress component even if statistics from National Electronic Injury Surveillance Systems (NEISS, 1978) show that in the United States, 800000 stairs-related injuries occur annually that require hospital treatment. Also, 3800 fatalities result from such accidents and between 1.8 and 2.6 million stair-related injuries resulted in minor disabilities that didn't require medical attention. The question in mind is why so many accidents occur? There is no simple answer to this question but incorrect design can be the main reason resulting in accidents (Pauls, 1984). The problems that are caused by incorrect design are many but relevant to this study are congestion, issues associated with merging flows and the presence of people with disabilities (Galea, Sharp, & Lawrence, 2008; Hyun-seung, Jun-ho & Won-hwa, 2011; Koo, Kim, & Kim, 2012).

3.1.1 Design

Stair design is of great concern in high-rise buildings since the long travel distances can cause fatigue, congestion, etc. Several research studies have been carried out to make stairs a safe egress component. Two of the pioneers in the field of stairs, namely Jake Pauls and John J. Fruin have given a great contribution with their research studies. Their studies include stair design, e.g. stair width, occupant capacity on stairs (i.e. occupant load on stairs for optimal occupant flow), size of tread and raiser, slope, location in building, etc. (Fruin, 1971; Graat, Midden, & Bockholts, 1999; Pauls, 1982; Pauls, Fruin, & Zupan, 2007). Pauls (1984) states that design errors are the main causes for accidents. For instance, the highest category of stair accidents includes misjudging the location of the tread edge and misplacing the foot. Therefore Pauls (1982) suggests some recommendations regarding stair design: 1) treads should be large enough so that footing is secure, 2) stairs should be visible (easy to see), and 3) provide graspable handrails.

Climbing or descending stairs consumes ten to fifteen times more energy than walking on the same level (Kratchman, 2007). The speed with which an occupant evacuates and thereby the evacuation time are affected by several factors such as the number of steps, tread and riser dimensions, and slope and location of handrails (Peacock, Averill, & Kuligowski, 2010). According to Pauls (1982), the stair riser should be a minimum of 125 mm (5 in.) high and no higher than 180 mm (7 in.), while the treads should be at least 280 mm (11 in.) but preferably 300 mm (12 in.). These dimensions result in a maximum stair slope of 33°. Through two field studies by Graat et al. (1999), different slopes of the stairs have been tested. The conclusion is that a normal slope (30°) results in a higher occupant speed and capacity compared to a steeper slope (38°). A similar study done by Irvine, Snook and Sparshatt (1990) included 19 sets of stairways with different riser and tread dimensions. The results indicates that the optimum riser should be 183 mm (7.2 in.) and the optimum tread 279 or 300 mm (11 or 12 in.). These results are in accordance with the earlier suggestions by Pauls.

Both Pauls and Fruin have attempted to determine the optimal width of stairs that would carry the occupant load for an optimal occupant flow. The evacuation studies from high-rise buildings that were conducted by Pauls indicate a linear relationship between flow and the effective width of the stairs. Thus an increased stair width results in a growing flow rate. Therefore Pauls recommended a minimum nominal width of 1400 mm. Fruin on the other hand recommended a somewhat larger minimum width of 1520 mm. Both Pauls and Fruin account for lateral body sway in their recommendations (Blair & Milke, 2011).

3.1.2 Legislations

The 9/11 attack on World Trade Center (WTC) in New York was an eye-opening event that put building and safety code recommendations into question. The National Fire Protection Association (NFPA), adopting proposals by Pauls, introduced a new wider stair width for high-rise buildings of 1425 mm (56 in.) (Pauls et al., 2007). According to the International Building Code 2012, the minimum stair width shouldn't be less than the total occupant load serving the stair multiplied by 5.08 mm (0.2 inches) per occupant (International Code Council, 2012). IBC 2009 was considering a factor equal to 7.60 mm (0.3 inches) per occupant without the provision of sprinklers in the building. In comparison with IBC 2012, NFPA101 (2012) suggests that if the occupant load serving the stairs is greater or equal to 2000 people, the minimum width should be 1.42 m and if the occupant load is smaller than 2000 people, the minimum stair width should be 1.12 m. Legislations such as NFPA101 and IBC draw regulations on how to configure the stair width. Although tragedies in the past have highlighted that legislation is not always sufficient. Emergencies cannot be fully captured within rules and to avoid accidents as much as possible, knowledge has to be collected about the situation (Graat et al., 1999). The studies by Pauls and Fruin are decades old and people demographics have changed. Pauls et al. (2007), therefore, recommend that new research must be conducted and legislation should be modified accordingly.

3.1.3 Congestion

In general congestion means excessive crowding, which is characterized by reduced speed, longer evacuation times and increased queuing. The best illustration of congestion is motor vehicle traffic. In emergency situations such as fire, congestion that may occur is similar to vehicle traffic (Hyun-seung et al., 2011). There are several factors that cause congestion:

1. Initial evacuation delay (e.g. not hearing the fire alarm) may cause occupants to meet more occupants in the stairs which may in turn impact the speed flow negatively and therefore cause congestion.
2. Presence of fire-fighters moving in the opposite direction of the descending occupants (also called vertical counter-flows) may impede occupants or may even encourage some occupants to move more quickly.
3. Insufficient stairwell width may not allow descending occupants to evacuate side by side or the fast evacuees to go by the slow ones. (Peacock et al., 2010)
4. Evacuees from higher floors repeatedly descending stairs will physically get tired and even feel dizziness which in turn leads to congestion. What amplifies congestion in high-rise buildings is the long evacuation lines and merging flows (Hyun-seung et al., 2011).

Interviews with evacuees from the World Trade Center show that congestion, being reported by 54% of the occupants, was the most frequent cause of stoppages – causing 44% of the stoppages (Galea et al., 2008). An experimental study conducted by Choi et al. (2011) finds that no congestion occurs when single-passed participants walked through the stair landing. But when simultaneous-passed participants started walking the stair landing, congestion level increased. Choi et al. (2011) conclude that congestion decreased with time. However, the level of congestion increased as occupants descended from upper floors to the ground level.

3.1.4 Merging flows

The speed by which occupants move through floors and stairs and thereby the duration of evacuation are dependent on the merging streams between the floors and stairs. The study of merging flows is therefore of great concern for high-rise building evacuations. Galea et al. (2008) found that connecting the floor to the landing adjacent to the incoming stair will enhance the speed at which a floor is emptied onto the stair (see figure 3.1).

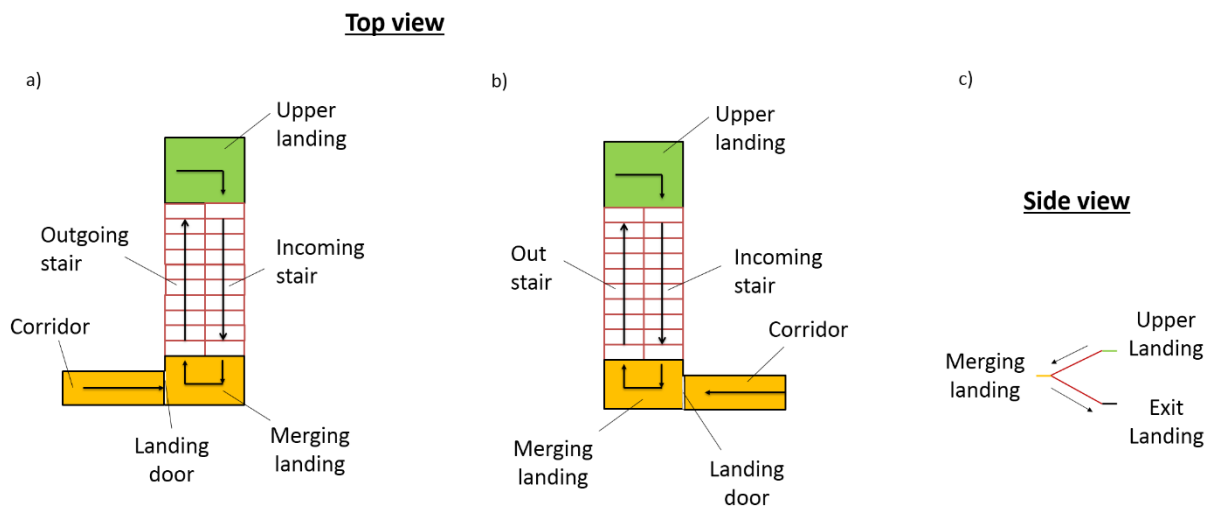

Figure 3.1. Illustration of the floor connected to the landing adjacent (a) and opposite to (b) the incoming stair, c) shows the side view of the stairs.

Beside the reduced emptying time, this configuration will also decrease the descent flow rate already on the stairs. Configuring the stairs this way is expected to have a negligible effect on the overall time to evacuate the building. However, this configuration will decrease the evacuation time for those in the lower levels at the expense of those higher up in the building. This is the opposite of

what is desired in high-rise building evacuations. Therefore, for high-rise buildings, it is suggested that the floor should be connected to the landing on the opposite side to the incoming stairs. This is consistent with other studies by others such as Takeichi et al. (2005).

Boyce, Purser and Shields (2012) did also investigate the merging flows in buildings by examining the ratio between the stair and the floor merging flows. Contrary to what is suggested by Galea et al. (2008), they suggest that the merging flow is always approximately 50:50 independent of the different geometrical locations of the door in relation to the stair and the relative stair/door width. This is also consistent with other studies such as Hokugo, Kubo and Murozaki (1985). In conjunction with congested conditions during evacuation, it was noticed that occupants descending the stairs show deference behaviours. In one case, three persons carrying small babies were allowed to join the merging stream by occupants already descending the stairs (Boyce et al., 2012). However, there are not many studies about stair merging flows and there is no definitive agreement on the expected merging ratio and the factors influencing it. Therefore, more research has to be done on the topic of merging flows in stairs.

3.1.5 Issues associated with disabled occupants

Characteristics of high-rise buildings, mainly the long vertical travel distances which in turn cause other problems such as congestion, fatigue, etc. are issues that need extra attention when there are several people with disabilities in a high-rise building. In a series of studies done by Boyce et al. (1999), some suggestions regarding people with disabilities are made: 1) in the determined escape times for a building it may be necessary to include periods of rest and time to negotiate choice of escape route, and 2) in designing the evacuation routes focus should be on real, rather than perceived needs for occupants with impairments. Another suggestion is that the level of training of staff is of great concern since this can enhance the evacuation time for people with reduced mobility (Gwynne, Purser, & Boswell, 2011).

3.2 Sky-bridges

Wood (2010) defines the term sky-bridge as: “*a primarily-enclosed space linking two (or more) buildings at height*”. The sky-bridge concept is not new and the roots go back to the sixteenth century, where Antonio Contini for the first time ever connected Venice’s Palazzo Ducale to the adjacent prison (Wood, 2003).

The World Trade Centre attacks of September 11, 2001, with the eliminated vertical egress routes and trapped occupants with no evacuation option, resulted in the largest analysis of the design of tall buildings since the birth of the high-rise building type. The 9/11 event did put into question all aspects such as response plans, evacuation procedures (Ariff, 2003), safety systems, structure, façade materials, positioning, layout etc. (Wood, 2010). One of the strategies employed in high-rise building evacuations is *phased evacuation* – evacuating a number of floors at a time while the majority of the occupants are left in place (Great Britain & Department for Communities and Local Government, 2013). With the full view of the collapse of World Trade Centre in mind, it is doubtful that occupants of high-rise buildings will feel comfortable with the strategy of phased evacuation (Barber & Van Merkesteyn, 2003). A simultaneous total evacuation, where all occupants are evacuated at once, on the other hand, requires increased number of stairs as well as increased width of stairs. The latter has an impact on floor space and it is further impossible to do those changes to existing buildings (Wood et al., 2005).

A suggested possible way of making high-rise buildings safer is the introduction of horizontal evacuation at height through the linkage of buildings by creating sky-bridges. This idea seems reasonable, especially in situations where the vertical evacuation routes are blocked or even cut off. In addition to making building safer by adding an extra egress component, sky-bridges increase the evacuation efficiency without increasing the number of stairs. This is demonstrated by the probably most well-known building that is connected by a sky-bridge, Petronas Towers in Kuala Lumpur, Malaysia. Furthermore, in Hong Kong, incorporation of sky-bridges in high-rise buildings has been suggested as a fire safety improvement (Wood et al., 2005).

The use of sky-bridges is strictly connected to the use of refuge floors. Refuge floors, an additional egress component for high rise buildings that should be installed in all new buildings exceeding 25 floors, are already implemented in the Hong Kong Fire Safety Code (Hong Kong Building Department, 1996). Refuge floors fulfil several functions: 1) serve as a rest place for evacuees, 2) serve as a refuge floor within the building for occupants at risk, 3) serve as a base for firefighting purposes, 4) serve as a place for disabled people to wait for assistance or rescue, 5) break up evacuation stairs vertically to reduce/prevent smoke spread, 6) serve as a fire barrier to cut off fire from spreading to other parts of the building. A refuge floor has to be empty, i.e. no flammable materials, and has to have strengthened fire resistance measures to safely accommodate occupants in emergency situations (Wood, 2007). By combining the advantages of a sky-bridge with those of a refuge floor, not only would the safety of the buildings improve but the empty floor would also be enriched due to commercial activities, similar to those on the ground floor (Wood et al., 2005).

3.2.1 Implementation implication

There are some challenges and issues that need to be taken into consideration when sky-bridges are incorporated between two buildings. Some of them are listed below.

- The client's brief: Will two different owners agree on sharing a sky-bridge between two buildings? Who would own the sky-bridge, pay for it, construct it and maintain it?
- Vertical placing of the sky-bridge: The sky-bridge should be placed at the centre of the population density. Placing the sky-bridge close to the ground or close to the top of the building will decrease the efficiency of the evacuation since people have to move down or up to reach the sky-bridge. The floors at which the sky-bridge is being connected will become sky-lobbies with activities similar to the ones found on the ground floor. Security service must be enhanced as people now are able to exit/enter the building at different heights.
- Planning for incorporation: A strategic planning in design and construction of a tall building has to be made so it can be incorporated with other towers in the future.
- Structure, fabric, and design: Since two adjacent buildings may not be built at the same time, structure, fabric, and design need to be made for further linkage. (Wood, 2003, 2010)

3.2.3 Incorporation of sky-bridges

Despite the challenges and issues that Wood (2003, 2010) mention, there are developed examples of incorporating sky-bridges among buildings. One example is the Hong Kong Central district which has evolved for several decades and covers an area of 450000 m², with over 20000 employees circulating on a pedestrian network without touching the ground (Wood, 2010). The other known example with great concern for this study is Petronas Twin Towers that will be looked at in more detail.

Evacuation Case Study: Petronas Twin Towers

The Petronas Twin Towers are 452 meters high and consist of 88 stories each, see figure 3.2. The sky-bridge is two stories and located at floor levels 41 and 42. These floor levels are sky-lobbies consisting of elevator change-over zone and large open spaces to facilitate the circulation of people sharing the two towers. The floors above and below the sky-bridge contain some of the communal facilities, such as conference centre, prayer room, and the executive dining room. Thus the main function of the sky-bridge in non-emergency situation is to facilitate communication between the two towers.



Figure 3.2. Petronas Twin Towers connected by a sky-bridge (Wikimedia Commons, 2013).

For evacuation events the building contains different egress components such as two stairwells running vertically down each tower, a third stairwell serving floor 43 and below, and two firefighter lifts (which are used by emergency responder and disabled people).

In emergency situations that are able to be contained on a single floor, a “Stage 1 Evacuation” is triggered where all occupants from the affected floor, the floor above and the floor below are evacuated to the three floors below, according to figure 3.3. In the evacuation floors they await further instruction from the fire authorities. The floors above and below the three affected floors are put on alert, in case of escalated emergency. The rest of the occupants in the building will not be informed about the incident. If the emergency is contained, all occupants will return to their usual floors.

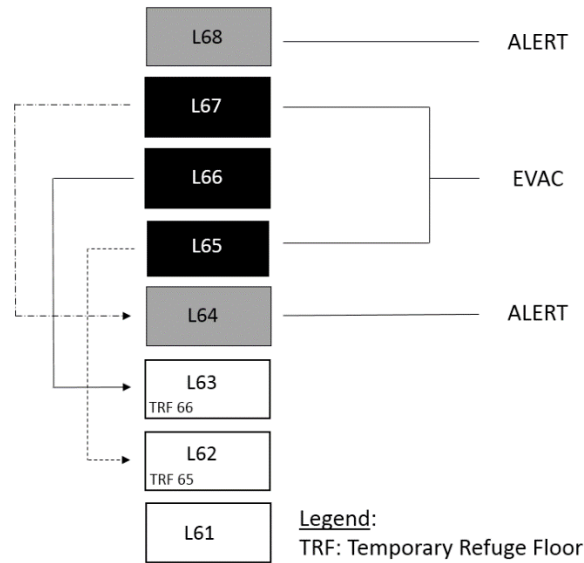

Figure 3.3. The concept of the Stage 1 Evacuation (Ariff, 2003).

If a “Stage 1 Evacuation” fails, a “Stage 2 Evacuation” is mobilized where the whole tower is evacuated. The evacuation procedure divides the building in four zones, as figure 3.4 illustrates.

- Low Zone (Level Ground to 37): occupants have to evacuate through the fire stairs to the ground level to exit the building.
- Middle Zone (Level 40 – 60): occupants travel down/up the stairs to level 41, cross through the sky-bridge to the safe tower and then use the shuttle elevators to the ground level and exit the building.
- High Zone (Level 61 – 77): occupants evacuate through the fire stairs to level 42, cross through the sky-bridge to the safe tower and then use shuttle elevators to the ground level to exit the building.
- Top Zone (Level 78 to 86): same as High Zone.

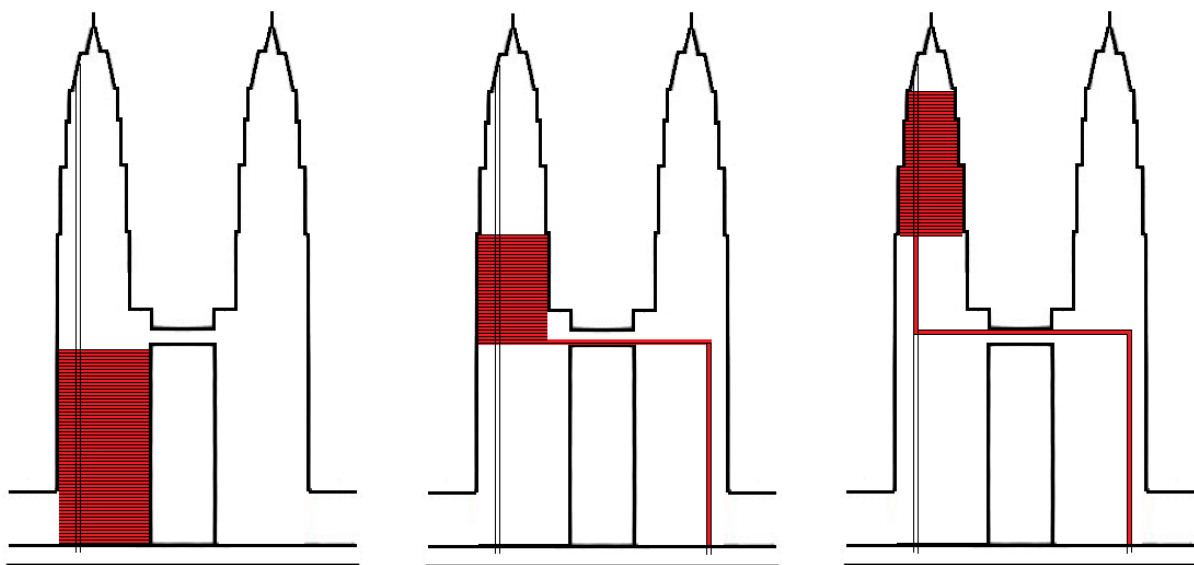

Figure 3.4. Use of the sky-bridge for the different zones of the building in case of total evacuation of a single tower a) low zone, b) middle zone and c) high zone (Wood, 2010).

In a “Stage 2 Evacuation” the sky-bridge becomes an alternative fire escape route for approximately 50% of the occupants in the upper part of the building (Wood, 2010).

Shortly after 9/11 there was a bomb call to the Petronas Twin Towers, but it was not specified in which building. Therefore the authorities decided to evacuate both of the towers simultaneously, which resulted in chaos for the upper half of the towers. Above the sky-bridge, occupants from Tower 1 wanted to pass through the sky-bridge while at the same time occupants from Tower 2 did the same thing resulting in people getting stuck. This jam took several hours to resolve. The evacuation of the bottom half of the building on the other hand went as planned. The immediate knowledge of this event made the use of sky-bridges worthless in total evacuation of two buildings at the same time. Therefore in a simultaneous evacuation of both towers the occupants below the sky-bridge uses the stairs while occupants at or above the sky-bridge uses the shuttle elevators to evacuate the building (Bukowski, 2010).

3.2.4 Benefits of sky-bridges

There are many benefits from the incorporation of sky-bridges. Some of the benefits are summarized below:

Alternative evacuation options

A sky-bridge would offer improved evacuation efficiency and the option for multiple emergency evacuation strategies (Wood, 2003). The presence of only one sky-bridge located in the centre of the mass population of the building would significantly reduce accumulative evacuation through mainly two factors:

1. If evacuating horizontally through a sky-bridge, the travel distance will be shortened and the evacuation of the occupants will speed up using the stairs due to less congestion (on the stairs).
2. Since the occupants crossing the sky-bridge would be in a safe tower, they would be able to use all means of egress (e.g. elevators) to evacuate the building and thus reduce the evacuation time. (Wood, 2007)

The need for mass evacuation preparedness

Since the September 11 attacks on WTC it is now doubtful that occupants will feel comfortable with remaining in tall buildings, as required in a phased-evacuation strategy, in similar extreme events (Wood, 2007). This resulting scenario is a simultaneous evacuation, which is something that most tall buildings today are not prepared for (Wood, 2007). Stairs and refuge floor are designed to accommodate a certain number of people, and thus congestion and occupant injuries may occur. For existing buildings, the change of stair width is impossible. Incorporating a sky-bridge could be a solution for implementing simultaneous evacuation (Wood, 2007). For future buildings it is possible to make stairs wider but as Kuligowski and Bukowski (2004) say: “*It is speculated that if future buildings were required to be designed for simultaneous evacuations under current egress design practises, there will be a building height beyond which stairs would occupy such a large portion of the floor area that such buildings would be impractical*”. Therefore, joining two buildings with a sky-bridge would enhance the evacuation efficiency and have a positive impact on the financial aspect (Wood, 2007).

Improved emergency responder access

Firefighters would be able to use elevators in the adjoining tower and then access the building in an emergency situation through the sky-bridge. Thus improving the emergency responder (Wood, 2007).

Other benefits

From the Petronas Twin Towers, the main positive effect of incorporating a sky-bridge beside improved evacuation efficiency for the evacuation of the whole tower is that an additional fire stair that would have been needed in each tower could be excluded resulting in a financial gain (Wood, 2007).

Incorporating a sky-bridge in buildings that already contain refuge floors could also result in a financial gain through commercial use in the otherwise empty space (Wood, 2010). Furthermore, a sky-bridge in comparison to a refuge floor provides an increased level of life safety. When using a refuge floor, people will remain in the same building where the emergency situation occurs while with a sky-bridge people have the opportunity to escape the danger by evacuating to the safe building (Wood et al., 2005).

3.3 Egress strategies

High-rise buildings are of great concern to life safety of occupants due to factors such as elevated height and thereby extended vertical evacuation travel distance (Luo & Wong, 2006). The design of egress components in combination with appropriate relocation strategies provide an enhanced level of high-rise building safety (Tubbs & Meacham, 2009). There are in general four categories of egress strategies:

- 1) Total evacuation – all occupants of the building are evacuated at once (Hartmann, 2005).
- 2) Phased-evacuation – the occupant floor in danger and the floors nearby are prioritised to evacuate first with the aim of decreasing queuing in stairs.
- 3) Defend in place evacuation – occupants are suggested to stay in their rooms, close the doors, seal the cracks and call for help (e.g. phone call) (Luo & Wong, 2006).
- 4) Delayed evacuation – occupants are waiting in dedicated areas, such as refuge floors, to be rescued (Ronchi & Nilsson, 2012).

Total evacuation is the egress strategy under investigation in this study and will therefore be examined in more detail. The reason why this strategy is interesting for this study is that sky-bridge usage is deemed to reduce the congestion on stairs (which may occur more frequently in the case of total evacuation) and therefore facilitate the maximum stair usage which otherwise may not be possible.

3.3.1 Total evacuation

Total evacuation is an evacuation strategy which is easy to implement. When the fire alarm triggers, all occupants in the building are expected to evacuate at once. Total evacuation is widely implemented in today's low-rise buildings. However, in high-rise buildings with a large number of people, implementing such a strategy can be problematic due to queuing before reaching the stairs and also congestion on the stairs. Furthermore for super tall buildings, i.e. buildings with height over 200 metres (Pang & Chow, 2011), descending from the top floors through stairs can take hour(s) due to ascending fire-fighters but also due to fatigue, dizziness etc. (Luo & Wong, 2006).

3.4 Risk

This section begins with defining the term risk and goes over to clarify the concept of risk management which is of interest for this study since the sky-bridge concept is seen as a precaution towards enhanced safety in tall buildings. After this, a general description of risk perception and human behaviour in fires is provided to facilitate a discussion in the field of sky-bridge usage.

In general it can be said that risk is divided in two main approaches: *the social constructivist perspective* and *the technical realistic perspective*. The difference between the two is that experts and public participants have different views on risk (Nilsson, 2003; Renn, 1998; Slovic, 2001).

The technical approach of risk is illustrated by a combination of the *probability* that an event will occur and the (negative) *consequences* of that event. Kaplan (1997) argues that risk is the answer to three question:

- What can happen (what scenario, S, can occur)?
- How likely is that (frequent likelihood, L)?
- What are the consequences (what consequences, X, that scenario, S, can result in)?

The answer to these three question can be summarized in a “risk triplet” according to $R = \{<S_i, L_i, X_i>\}_c^1$. Thus risk is equal to the sum of all scenarios, the likelihood that those occur, and the consequences that arise. Within the technical approach, no consideration is taken to the public participant’s subjective perception on risk. Instead the analysis are made of people with qualification in that field, which are free from subjective perception (Nilsson, 2003).

The technical approach is straight forward and gives a non-complicated picture of the risk problem. Followers of the social constructivist approach criticize the technical approach for not taking into consideration important social, psychological, and cultural aspects (Nilsson, 2003). Renn (1998) says that the technical approach has several flaws:

- Experts and the public participant’s views on risk are different and there must be a consideration of both, and not only the views of the experts.
- It is hard to catch all aspects of an event in the “risk triplet” – risk is more complex than just probability and consequences of an event.
- Within the technical approach the analysis is done by experts and their subjective values must therefore be part of it.

Therefore Renn (1998) gives his own definition of risk as “*the possibility that human actions or events lead to consequences that have an impact on what humans value*”. According to this definition, risk is not always seen as negative. The reason for this is that it depends on who gets to decide if the risk is negative or positive. There is a phenomena called “desired risk” for example in extreme sports activities where some people try to experience a special thrill, while other people would find that risky in a negative way. If the risk level is reduced by a safety precaution, people tend to adjust their behaviour in accordance to keep the same risk level as before the precaution. For example, if

¹ _i stands for a specific scenario while _c stands for complete, i.e. the sum of all scenarios, their likelihood and their consequences.

studded tires reduce the risk for skid during winter people adjust the risk level to the same as before by driving faster (Enander, 2005; Wilde, 2001).

As mentioned above, there are different views on the risk approach and there is no wrong or right. What is common for both the technical and social approach is that risk is the probability of negative consequences due to a certain event (Nilsson, 2003).

3.4.1 Risk management

The standard definition of "risk management" given by International Electrotechnical Commission (IEC), is the entire process from identifying risks and risk sources till the decision making of prevention solutions or not. Risk management can be divided into three parts, namely: A) risk analysis, B) risk evaluation, and C) risk reduction/control, as shown in figure 3.5 (Nilsson, 2003).

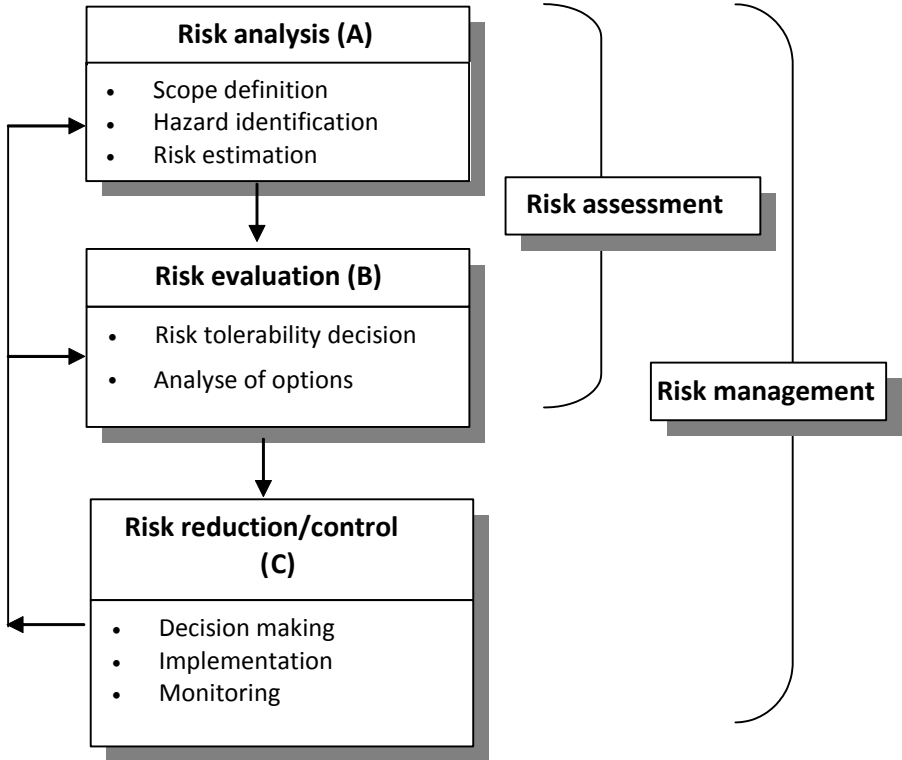

Figure 3.5. Risk management model (Nilsson, 2003).

Risk analysis can be described as a structured process in which the likelihood and the extent of the adverse events that can arise are estimated. Afterwards, a *risk evaluation* of the risk is made. Together the risk analysis and the risk evaluation represent the risk assessment whereby it is decided whether the identified risk/risks are acceptable or not. The subsequent step, *risk reduction/control*, is carried out if the risk is considered unacceptable. In this part, decision, implementation and monitoring of the required action is taken to prevent the risk (Akselsson, 2011).

In the risk management process, this study is placed within the risk reduction/control part as the objective is to investigate where in a high-rise building congestion occurs. Reducing congestion and providing an extra egress route through the sky-bridge and thereby reducing the total evacuation time for the evacuees in this study is seen as a risk reducing action.

3.4.2 Risk perception and human behaviour in fire

To select appropriate design of the egress components and to apply the right evacuation strategy for high-rise buildings, it is important to obtain knowledge on risk perception and human behaviour in fires.

Research shows that there are different views on risk perception depending on demographics such as gender and age. Enander (2005) argues that women tend to have a higher risk perception than men, and therefore, women are more concerned about safety and security. Men on the other hand believe that they are more aware of the risks and think they can handle them themselves. The differences in gender have also been studied by Savage (1993) where he gives the same conclusions. Furthermore Enander (2005) saw a relationship where safety precautions increase with increasing age. People between 36 and 55 years old show the highest risk perception for accidents while older people between 56 and 75 years old say they are not able to affect their own safety as in the case of the young.

Differences in risk perception also depend on other factors such as individual experience with risk. Wood (1972) mentioned that if people are aware that an escape route exists, they are less likely to leave because they feel less threatened by the fire. Similarly, people with previous experiences with fire accidents are more likely to leave. Only the presence of smoke or a direct threat would heighten the risk perception for this type of individuals.

Thus, perception of risk is very individual. Two people who have been through the same accident can have different perceptions. Enander (2005) illustrates this through an example where two people have been in a car accident. One of them draws the conclusion that driving a car today is very dangerous while the other one says that having a good car and wearing the belt reduce the risk of injuries or death. Why risk perception is individual has also been highlighted by Renn (1998) who argued that risk perception is connected to the outcome. Thus risk can be seen as positive or negative, depending on the individual and the type of risk. For instance there is risk of injuries related to traffic accidents, however the majority of the people are willing to take that risk because of the benefits gained. Similarly, smoking cigarettes has a negative impact on health but some people are willing to take that risk for the satisfaction gained.

In events of fire, several aspects to human behaviour have been noticed: 1) gather personal items, 2) finish or continue working, 3) attempt to make phone calls, 4) move towards familiar people and places 5) confront the hazard, 6) receive/provide assistance, 7) extreme behaviour such as “panic” (Blake, Galea, Westeng, & Dixon, 2004; Sherman, Peyrot, Magda, & Gershon, 2011; Sime, 1985).

Sime (1985) did study human behaviour during emergency situations and explained it through the “affiliative model”. He argues that people are likely to move towards familiar persons and places during potential entrapment situations. The affiliative model behaviour is noticed in other studies as well. Proulx (1995) noticed that during evacuation people moved in groups, mostly consisting of family members. Further people tend to move towards familiar exits and not always to the closest exit.

Canter and Tong (1985) address in their study that the affiliative behaviour made lone individuals to respond quicker to the unclear cues, while family groups did not respond until a clear sign of

threat appeared. This behaviour is consistent with earlier studies by Latané and Darley (1970) where students were exposed by artificial smoke. In the cases where students were alone, they reported the smoke more quickly than those in groups. Thus it seems that in the presence of other (i.e. social influence) delayed the response. This can be explained by the *normative social influence*, i.e. people fear to stand out or make a fool of oneself. People use instead the so called *informational social influence*, i.e. try to gain information about the situation by observing others (Nilsson & Johansson, 2009).

Enander (2005) believes that situations where panic can arise are characterized by two factors: 1) people thinking that they are in immediate life danger and 2) people thinking there is a chance to escape the hazard but the chance will decrease rapidly. In a panic situation it is thought that people behave in a non-rational way and therefore through their acts hurt others physically (Bengtson, Jönsson, & Frantzich, 2005). Sime (1980) did study the concept of panic and believes that it rarely occurs. From the World Trade Centre studies the characteristics of panic couldn't be seen. People remained calm and showed altruistic behaviours, where occupants with disabilities were helped by their colleagues for example (Proulx & Fahy, 2003; Sherman et al., 2011).

During a fire, it has been observed, that most people behave according to their social identity, i.e. fire fighter tries to confront the hazard or help people (Enander, 2005; Pan, Han, Dauber, & Law, 2007). During the Kentucky Supper Club fire there was a close relationship between the costumers and the waitresses who served them. The waitresses guided the same costumers she had served prior to the fire, to the exits (Tong & Canter, 1985). Even Proulx (1995) noticed that people during evacuation obeyed the guidance from the firefighters, the so called role-rule model. It seems that people are more able to obey orders from authorities when the knowledge about the situation is small (Enander, 2005). The role-rule model can have disadvantages as well. Bengtsson et al. (2005) demonstrate this by an example where the fire alarm triggered in a class room with students during a lecture. The lecturer didn't stop and the student didn't interrupt which delayed the evacuation. The reason for this behaviour can be explained that people with authority are expected to take command. However, to initiate a fast evacuation during an emergency situation, good education of both staff and employs is required (Proulx, 2007).

Kuligowski (2009) did an extensive study on evacuation associated with human behaviour in fire. The study suggests a model containing the human behavioural process divided in four phases (figure 3.6):

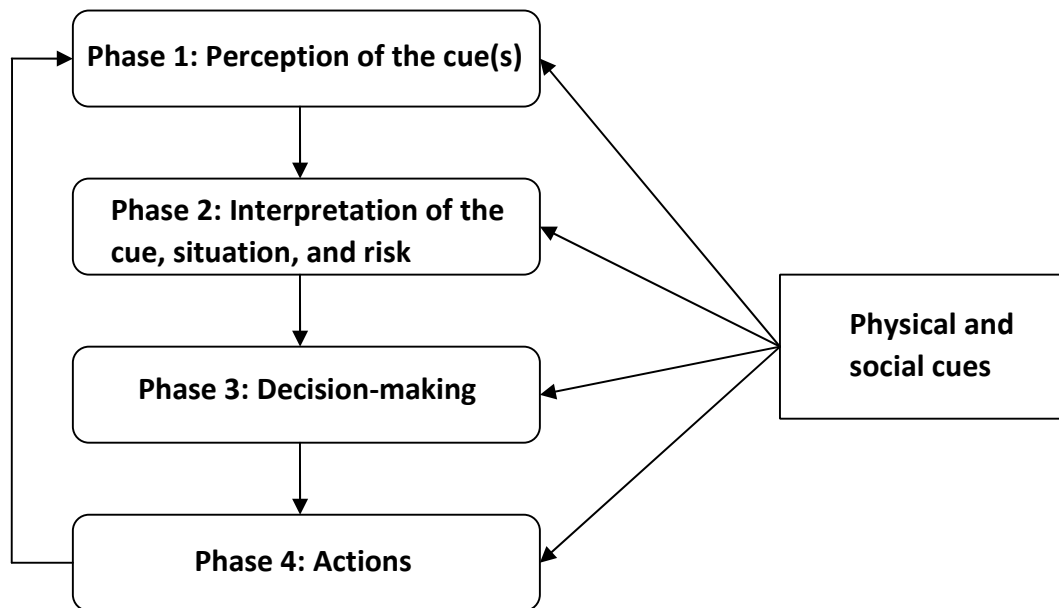

Figure 3.6. Schematic representation of the model of human behaviour in fires presented by Kuligowski (2009).

Phase 1: Occupants perceiving or receiving external physical (e.g. flames, smoke, alarm) and social (e.g. authorities giving warnings, population taking actions) cues from environment.

Phase 2: Occupants or groups interpreting the cue(s), the situation, and the risk.

Phase 3: Occupants or groups making decision based on interpretation from phase 2.

Phase 4: Occupants or groups performing the action based on decision-making from phase 3. If new information is provided before an action is performed, then the action is cancelled and the behaviour process will start from the beginning again. (Kuligowski, 2009)

People interpret a situation based on their sensory impression and experience. This is, as earlier mentioned, why two people can interpret a situation differently. Fredholm and Göransson (2006) explains a model where risk perception is affected by two experience dimensions (figure 3.7). The first dimension has to do with the subjective level of clarity or comprehensibility of a situation. The less clear a situations is perceived, the harder it becomes to control it. Therefore new or unknown threats are perceived as dangerous. The other dimension has to do with the possibility to manage a situation and how the subjective level of controllability is affected. The level of stress seems to be reduced if one seems to be able to affect the situation. In an emergency situation the aim is to reach the “A”-area in figure 3.7, where a person experience both clearness and control over the situation.

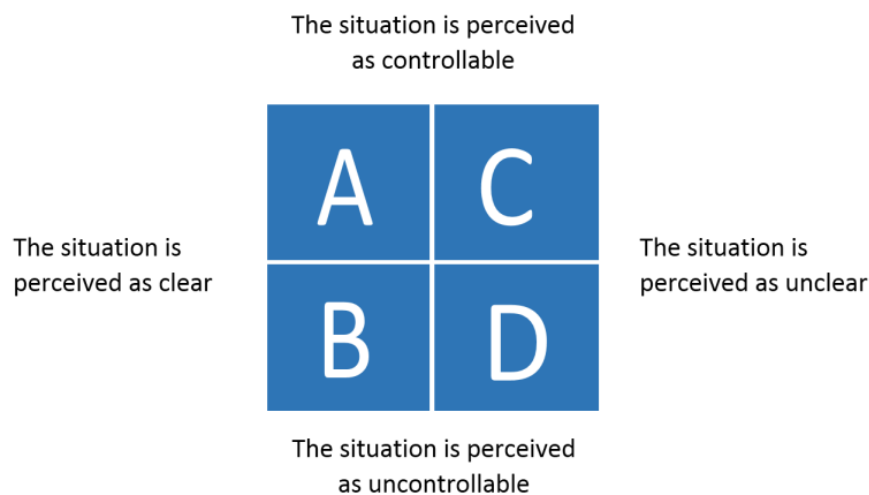

Figure 3.7. A situation can be divided into four categories dependent on how clear and controllable the situation is perceived (Göransson et al., 2006).

4 Model case study

This chapter provides a description of the geometric layout and egress components for the five scenarios under consideration. Furthermore the egress modelling of the different scenarios is illustrated. At the end of this chapter there is a section about the application of the evacuation model where model inputs are shown. The building geometry is a modified continuing version of the model case study developed by Ronchi and Nilsson (2013).

Five scenarios that consist of twin towers, with 50 and 95 floors each, represent this model case study. The first 50-floor tower has a total height of 207 metres while the second 95-floor building is 381 metres. The buildings are used for business purposes, putting them in the office-building category. The 50-storey building consists of a lobby (floor 1), 46 floors for office use (floor 3 – floor 48) and the rest of the floors are used for mechanical, electrical and plumbing equipment (MEP floors). The 95-storey building is designed in a similar way with the difference of having 90 floors for office use (floor 3 – floor 93).

The twin towers are connected with several sky-bridges on different floors, depending on what scenario is being studied. The sky-bridge length is 30 m and a schematic representation of the buildings is seen in figure 4.1.

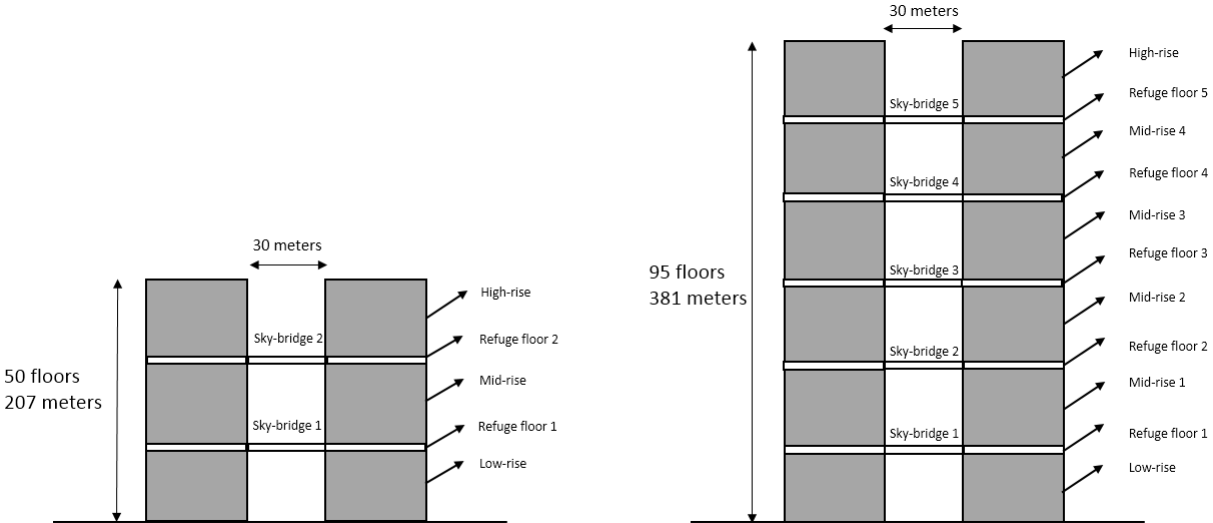

Figure 4.1. Schematic representation of the twin towers for the model case study, representing a) the 50 storey building and b) the 95 storey building.

Since this study is a continuation of a study done by Ronchi and Nilsson (2013), the floor plans keep the same dimensions of the study it is based on. Every floor plan is represented by a plate with the length of 42.7 m and the width of 65.5 m. This gives a total area for every floor to approximately 2797 m². In the middle of every floor there is a core (see figure 4.2) with a length of 37 m and a width of 13.7 m, which contains all egress components available. In this study the core contains only stairs as egress components (the exact dimensions of the core changes with the height of the building used).

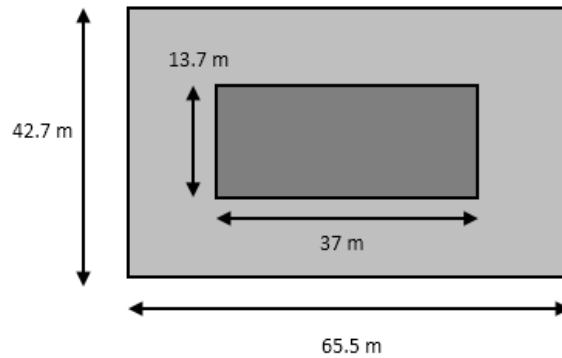

Figure 4.2. Top view of a typical floor plan.

A set of assumptions have been made to facilitate the simulation of this model case study (Ronchi and Nilsson, 2013):

1. Mechanical floors are required for these type of buildings but as their impact on the egress is small, they are excluded from this study.
2. The basements would usually consist of loading docks and underground parking. Since these floors are served by other egress components that are separated from those above the ground floor, they do not have an impact on the evacuation and are therefore excluded from this study.
3. Assembly areas (e.g., a conference centre on floor 2) are not considered in this study and therefore excluded.
4. The inter-distance between the lobby and the first floor designed for office use (i.e. floor 3) is approximately 12.2 metres, which makes the lobby into an atrium.

A summary of the geometric characteristics for the different floors (floor-to-floor heights etc.) and floor use, for every scenario can be found in *Appendix A*.

4.1 Geometric layout and egress components

This section provides information about all possible means of egress available in the buildings. The building is provided with two stairs and several sky-bridges (2, 3 or 5 of them), depending on which scenario is being simulated.

Depending on the number of sky-bridges installed, the buildings can be divided into several zones, e.g. low-rise zone, mid-rise zone, and a high-rise zone if there are two sky-bridges connected between the twin towers (figure 4.1 a).

4.1.1 Configuration of the floor plans

To facilitate the understanding of the configuration for the different floors, this section represents scenario 1 (for a detailed description of all scenarios, see section 4.2 *Egress modelling scenarios*). This scenario includes two stairs, and two sky-bridges connected at floor 18 and 33, which divides the building into three zones (i.e. low-rise, mid-rise, and high-rise zone).

Figure 4.3 represents the lobby core with all its available means of egress, i.e. stairs (S1=stair 1, located at the left side in the building core, and S2=stair 2, located at the right side of the building core) in grey.



Figure 4.3. Representation of the lobby core with stair 1 and 2 as available egress components. The core includes the different elevator banks for the different zones of the building, which are only used for regular circulation (not during evacuation).

Additional egress components include refuge floors and sky-bridges located at floor level 18 (refuge floor 1 and sky-bridge 1) and 33 (refuge floor 2 and sky-bridge 2).

Figures 4.4-4.9 provides a schematic representation of the egress components included in the floor plans, i.e. the lobby (figure 4.4), typical floor in low-rise zone (figure 4.5), refuge floor 1 (figure 4.6), typical floor in mid-rise zone (figure 4.7), refuge floor 2 (Figure 4.8), and a typical floor in high-rise zone (figure 4.9). Figure 4.6 and figure 4.8 are the floors at which the sky-bridge is located (the dotted lines represents the sky-bridge path) to the left in the boundary of the floor plans.

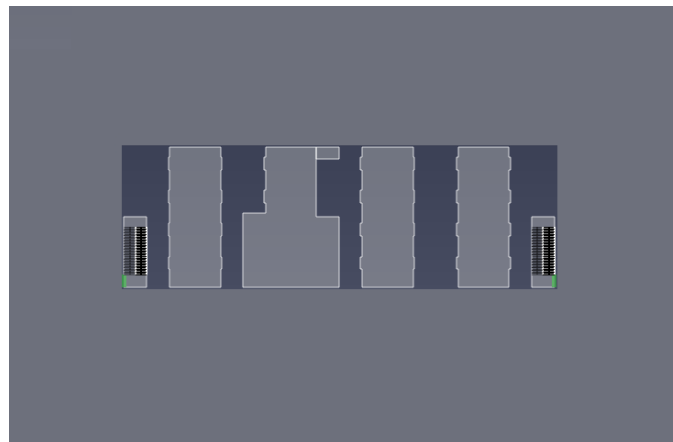

Figure 4.4. Schematic representation of the lobby.

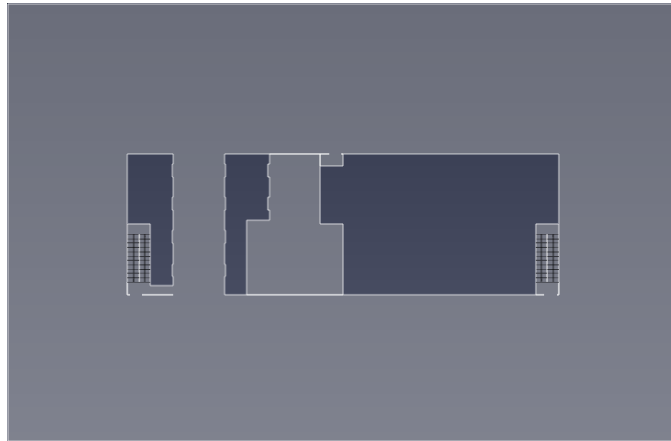

Figure 4.5. Schematic representation of a typical low-rise zone floor plan.

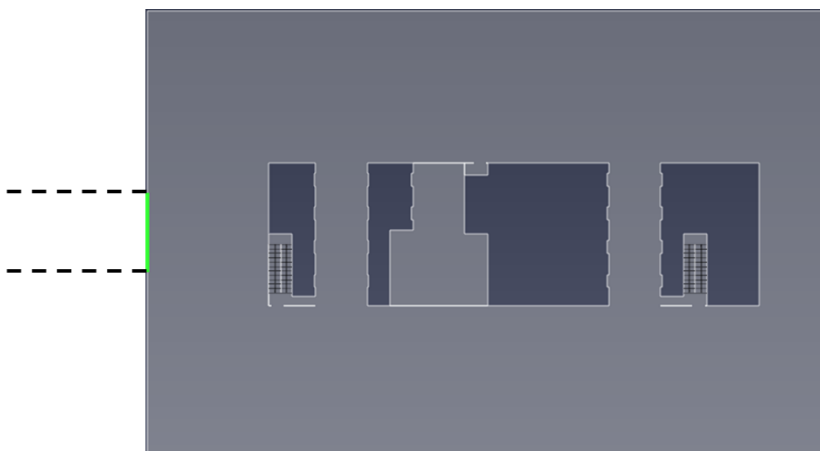

Figure 4.6. Schematic representation of floor 18, the refuge floor (1) between low-rise zone and mid-rise zone of the building. At this floor, sky-bridge 1 is located (dotted lines).

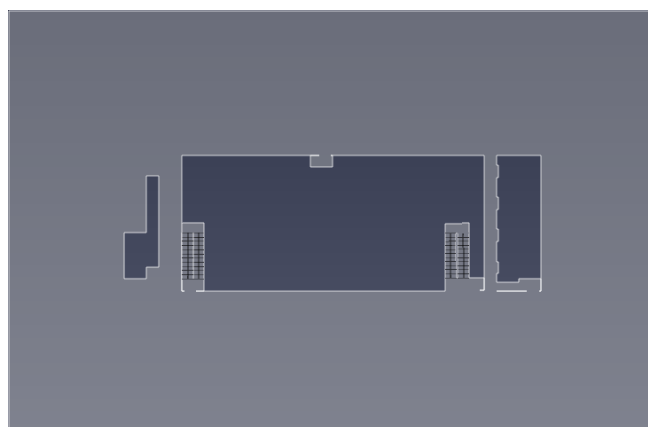

Figure 4.7. Schematic representation of a typical mid-rise zone floor plan.

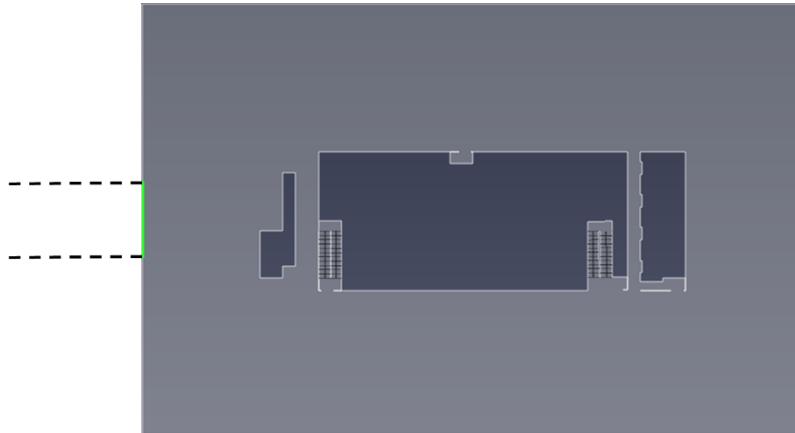

Figure 4.8. Schematic representation of floor 33, the refuge floor (2) between low-rise zone and mid-rise zone of the building. At this floor, sky-bridge 2 is located (dotted lines).

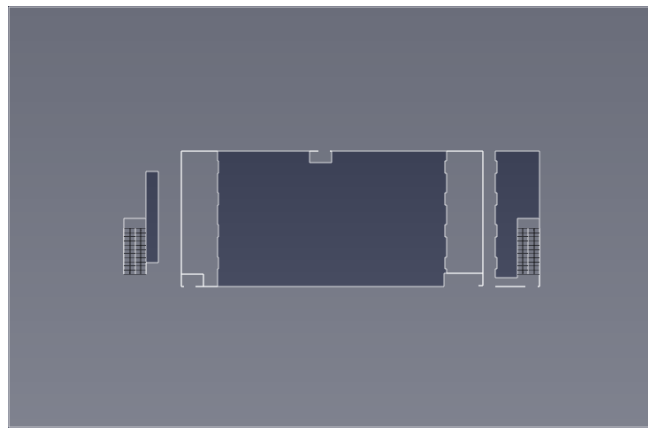

Figure 4.9. Schematic representation of a typical high-rise zone floor plan.

For the scenarios including more than two sky-bridges, the configuration of the floors is made in accordance with scenario 1 (see figure 4.11), changing the location of the stairs (with the idea of hindering smoke spread) in the same manner for every additional refuge floor.

4.1.2 Stairs

The characteristics of the stairs are made in accordance with the suggestions from NFPA101 (NFPA, 2012). The configuration of the stairs (table 4.1) consist of a minimum stair width, i.e., 1120 mm (44 in), the minimum depth, i.e., 280 mm (11 in), and the maximum raiser height, i.e., 180 mm (7 in). Despite the requirement of NFPA101, section 7.2.2.2.1.2 (NFPA, 2012), for 1420 mm (56 in) wide stairs to be used when the stairs have a cumulative occupant load of 2,000 or more occupants, has not been considered in this study.

Table 4.1. Configuration of the stairs

Stair configuration	
Nominal width	1120 mm (44 in)
Tread depth	280 mm (11 in)
Riser height	180 mm (7 in)

4.1.3 Refuge floors and sky-bridges

Several sky-bridges (2, 3 or 5 of them) are placed depending on the scenario (figure 4.10 presents the location of the sky-bridges for scenario 1-3). The floor at which the sky-bridge is connected is made into a refuge floor, which may accommodate a high amount of occupants. Therefore the refuge floor has a function of allowing occupant gathering and it permits them to use the sky-bridge.

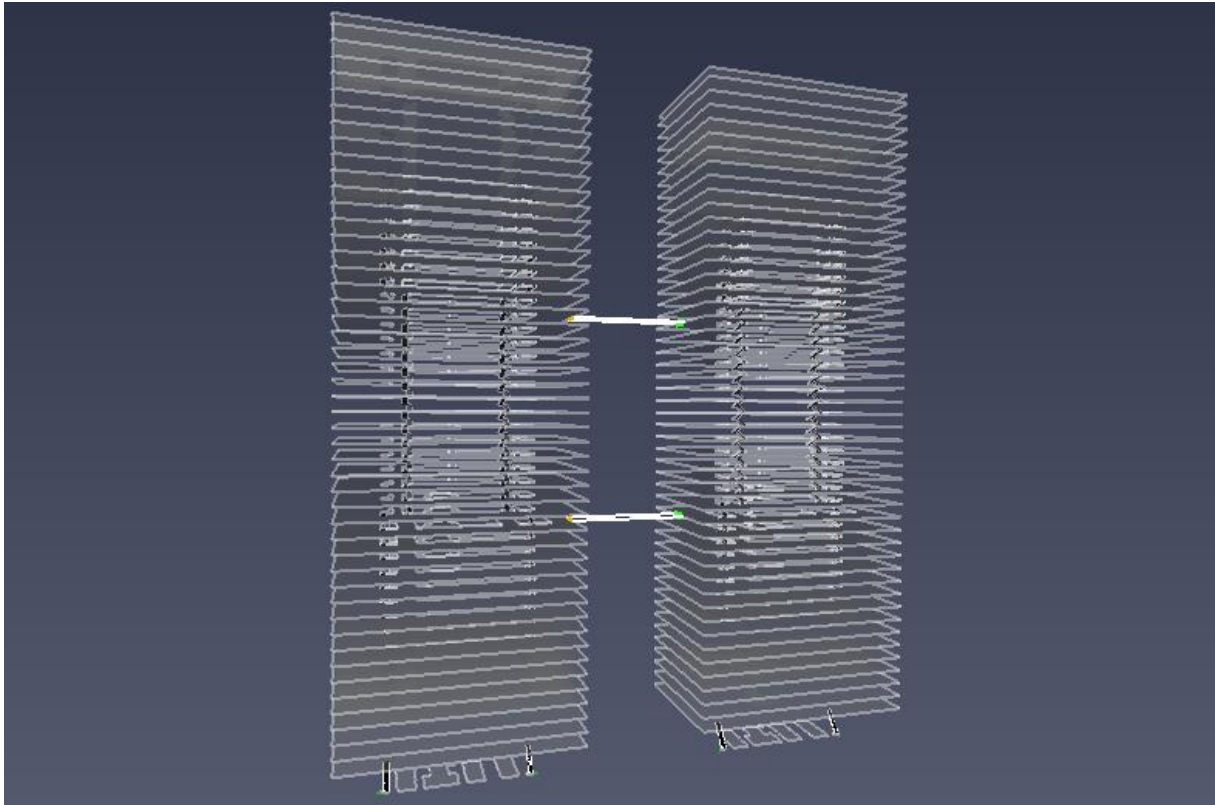

Figure 4.10. 3D model of the twin towers for scenario 1-3, where the sky-bridges are illustrated.

4.2 Egress modelling scenarios

This section illustrates the different egress modelling scenarios, in accordance with the aim and objectives of the study. The scenarios include a simultaneous total evacuation of one tower, using stairs (S1 and S2) and sky-bridges (2, 3 or 5 of them) as means of egress to escape the danger.

The study consists of five different scenarios with different combinations of aspects such as building heights, number and position of sky-bridges, and the allocation of occupants to the two available egress components, i.e. sky-bridges and stairs, during an evacuation. In all scenarios the sky-bridge permits the split of the occupants into several groups (3, 4 or 6 groups): occupants evacuating through the different sky-bridges, and occupants evacuating through the stairs to the ground level. The evacuation is considered terminated as soon as the occupants enter the sky-bridges or evacuate through the ground floor exits.

Scenario 1

Floors [n]	People using the sky-bridges* [%]	Sky-bridges [n]	Sky-bridge inter-distance [floors]
50	100	2	15/16

In this scenario (figure 4.11) the building is made of 50-floors per tower and it includes two sky-bridges and two stairs per tower (S1 and S2), as egress components. The building can be divided into three zones: low-rise zone, mid-rise zone and high-rise zone. The sky-bridges are located at the two refuge floors (floor 18 and 33), with an inter-distance of 15 floors for low-rise zone and mid-rise zone and 16 floors for high-rise zone. In this scenario it is assumed that all occupants (100%) above each sky-bridge evacuate down the stairs (S1 or S2) to the closest refuge floor and use the sky-bridge to get to the safe building, where they are able to safely use all the egress components. The occupants below refuge floor 1 (sky-bridge 1) use the stairs (S1 and S2) to the ground floor and evacuate through the exits.

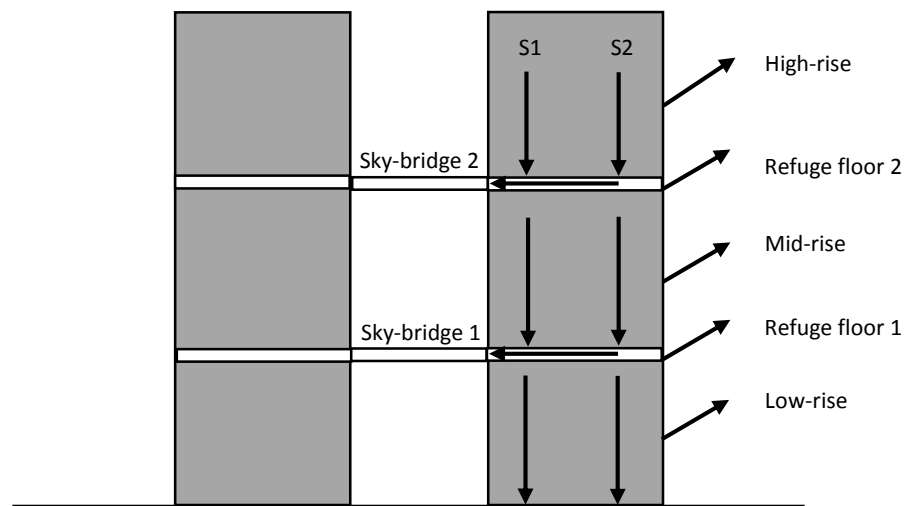

Figure 4.11. Schematic representation of scenario 1-3.

*Percentage (%) of people using the sky-bridge. The remaining percentage of the people are using the stairs.

Scenario 2

Floors [n]	People using the sky-bridges* [%]	Sky-bridges [n]	Sky-bridge inter-distance [floors]
50	50	2	15

This scenario (figure 4.11) is consistent with scenario 1, with the difference of the people allocation to the egress components. In this scenario 50% of the occupants above every sky-bridge evacuate down the stairs (S1 or S2) to the closest refuge floor and evacuate to its correspondent sky-bridge to the safe building. The rest of the occupants (50%) that do not use the sky-bridge as their egress, instead use stairs (S1 or S2) to evacuate the building.

*Percentage (%) of people using the sky-bridge. The remaining percentage of the people are using the stairs.

Scenario 3

Floors [n]	People using the sky-bridges* [%]	Sky-bridges [n]	Sky-bridge inter-distance [floors]
50	15	2	15

This scenario (figure 4.11) is consistent with scenario 1 and 2, with the difference of the people allocation to the egress components. In this scenario, a more realistic percentage of the people using the sky-bridge is chosen. It is therefore assumed that 15% of the occupants above every sky-bridge evacuate down the stairs (S1 or S2) to the closest refuge floor and evacuate to its correspondent sky-bridge to the safe building. The rest of the occupants (85%) that do not use the sky-bridges, instead use stairs (S1 or S2) as their egress route to evacuate the building.

*Percentage (%) of people using the sky-bridge. The remaining percentage of the people are using the stairs.

Scenario 4

Floors [n]	People using the sky-bridge* [%]	Sky-bridges [n]	Sky-bridge inter-distance [floors]
95	100	5	15/16

In this scenario (figure 4.12), the building is made of 95-floor per tower and it includes five sky-bridges and two stairs per tower (S1 and S2), as egress components. The building can be divided into six zones: low-rise zone, mid-rise zone 1, mid-rise zone 2, mid-rise zone 3, mid-rise zone 4, and high-rise zone. The sky-bridges are located at five available refuge floors (floor 18, 33, 48, 63, 78), with an inter-distance of 15 floors for all zones, except of high-rise zone which contain 16 floors. In this scenario it is assumed that all occupants (100%) above each sky-bridge evacuate down the stairs (S1 or S2) to the closest refuge floor and use the sky-bridge to get to the safe building, where they are able to safely use all the egress components. The occupants below refuge floor 1 (sky-bridge 1) use the stairs (S1 and S2) to the ground floor and evacuate through the exits.

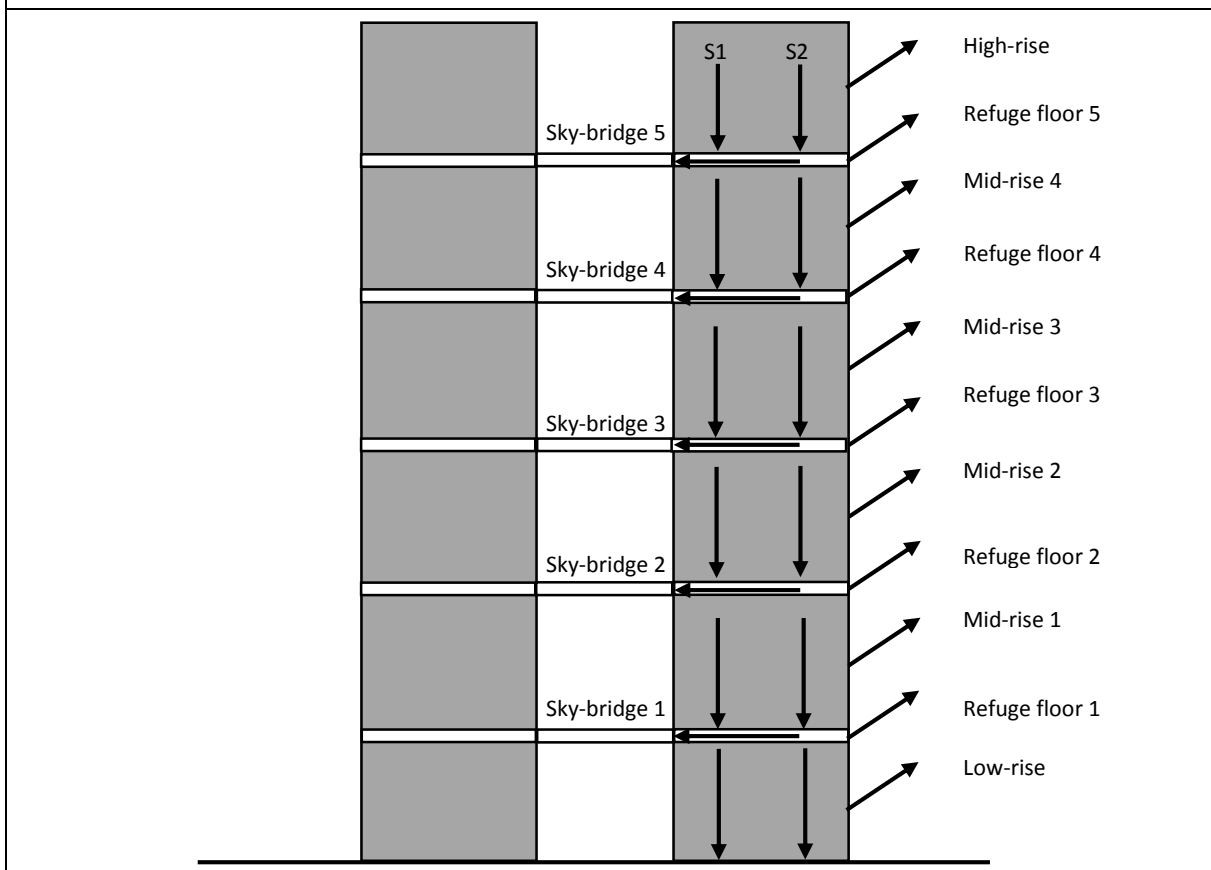

Figure 4.12. Schematic representation of scenario 4.

*Percentage (%) of people using the sky-bridge. The remaining percentage of the people are using the stairs.

Scenario 5

Floors [n]	People using the sky-bridge* [%]	Sky-bridges [n]	Sky-bridge inter-distance [m]
95	100	3	22/23

In this scenario (figure 4.13), the building is made of 95-floor per tower and it includes three sky-bridges and two stairs per tower (S1 and S2), as egress components. The building can be divided into four zones: low-rise zone, mid-rise zone 1, mid-rise zone 2, and high-rise zone. The sky-bridges are located at three available refuge floors (floor 26, 49, 71). The inter-distance is 23 floors for all zones except of mid-rise 2 zone which is 22 floors. In this scenario it is assumed that all occupants (100%) above the sky-bridge evacuate down the stairs (S1 or S2) to the closest refuge floor and use the sky-bridge to get to the safe building, where they are able to safely use all the egress components. The occupants below the refuge floor 1 (sky-bridge 1) use the stairs (S1 and S2) to the ground floor and evacuate through the exits.

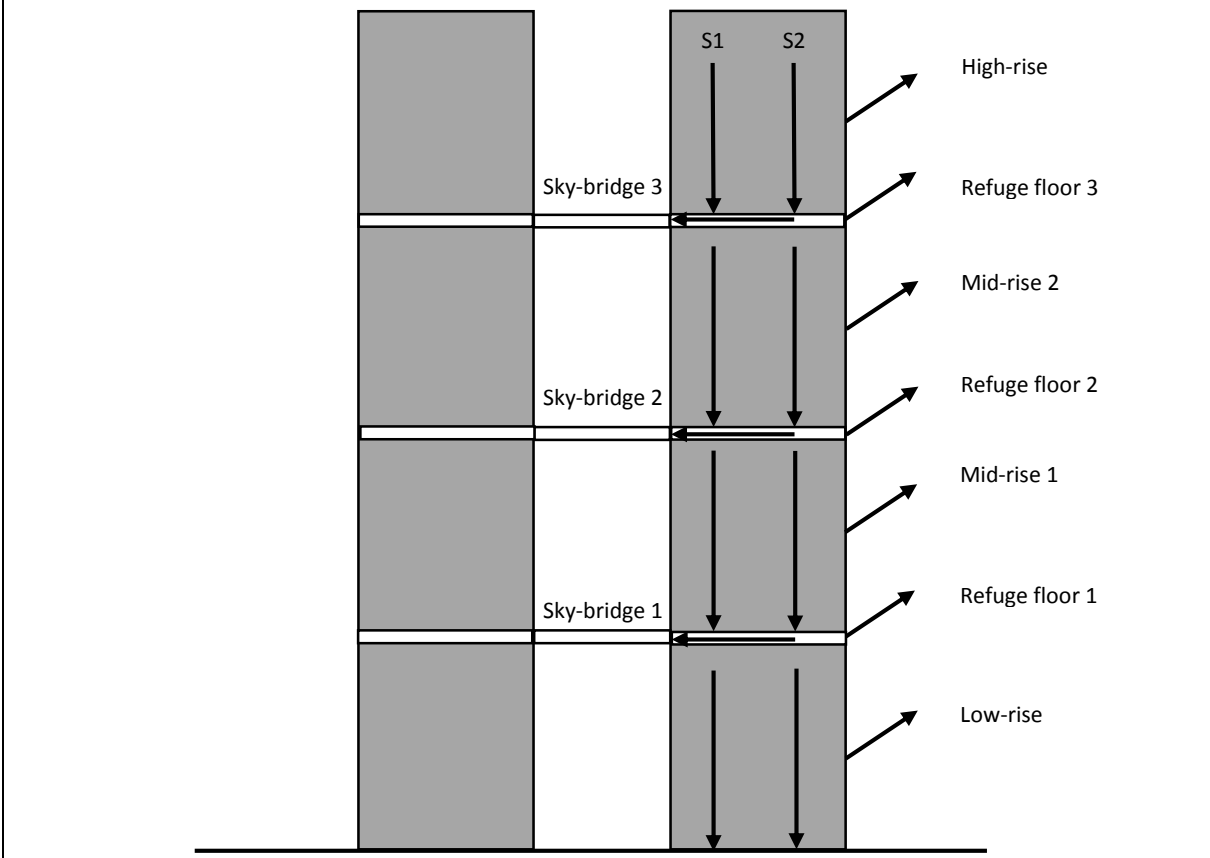

Figure 4.13. Schematic representation of scenario 5.

*Percentage (%) of people using the sky-bridge. The remaining percentage of the people are using the stairs.

A comparison between the different scenarios is made to answer the aim and objectives of this study. Scenario 1-3 are compared with each other with the aim of obtaining an understanding on what impact the allocation of people have on the total evacuation time. Furthermore, scenario 1 and scenario 4 are compared to each other to get an understanding on how the height of the building affects the congestion and evacuation time. Lastly scenario 4 and 5 are compared to observe how the sky-bridge inter-distance affects the results.

4.3 Application of an evacuation model

Ronchi and Nilsson (2013) showed in a cross validation study between two egress models, Pathfinder (Thunderhead Engineering, 2013) and STEPS (Mott MacDonald, 2012), that both of them may be successfully employed for high-rise building simulations. In this study, only one model (Pathfinder) has been used to simulate the evacuation scenarios as a continuation of the study by Ronchi and Nilsson (2013). This section presents the application of Pathfinder (Thunderhead Engineering, 2013) for the five scenarios described in the previous section. The input calibration in the model has been made in accordance with the description of the different scenarios.

4.3.1 Pathfinder

Pathfinder 2013 (version 2013.1.0925) is a commercial continuous model developed by the company Thunderhead Engineering (Thunderhead Engineering, 2013). Agent movement can be simulated in the model, using two different methods: 1) the hydraulic model, and 2) the agent-based model. The hydraulic model is provided in the Society of Fire Protection Engineering Handbook (Gwynne & Rosenbaum, 2008). The agent-based method relies on Reynolds (1999) steering model that was later refined by Amor et al. (2006). In this study, the agent-based model is employed to simulate the agent movement.

Stairs

In Pathfinder, stairs are represented through a straight-run of steps. The model requires characteristics such as a riser, tread and width (see figure 4.14). Furthermore the simulation is not dependent on the geometric slope of the stairs, but instead on the specified tread rise and run, which are the factors considered in the calculations.

Name: <input type="text" value="Stair 1"/>	<input checked="" type="checkbox"/> Color: <input type="text"/>	Riser: <input type="text" value="17,78 cm"/>	Width: <input type="text" value="111,76 cm"/>
<input checked="" type="checkbox"/> Visible	Opacity: <input type="text" value="40,0 %"/>	Tread: <input type="text" value="27,94 cm"/>	Top Door: Edit
		Length: <input type="text" value="5,05999 m"/>	Bottom Door: Edit

Figure 4.14. Screenshot of the stairway input in Pathfinder.

The velocity (v) at which an occupant moves with is dependent on several factors such as the specified occupant maximum velocity (v_{max}), the type of terrain being travelled on, speed modifiers and constants related to the terrain, and occupant density in the current room.

The occupant's base speed, $v(D)$, is the unmodified speed, i.e. the speed before applying speed modifiers and constants. If the occupant density in a room is smaller than 0.55 person/m², the base speed is calculated using equation 1:

$$v(D) = v_{max} * \frac{85*k}{1,19} \quad \text{Equation 1 (Thunderhead Engineering, 2013)}$$

However, if the density is higher than 0.55 person/m², the base speed is determined using equation 2:

$$v(D) = v_{max} * \frac{k-0.266*k*D}{1,19} \quad \text{Equation 2 (Thunderhead Engineering, 2013)}$$

In both equation 1 and 2, D is the density and k is the evacuation speed constant that depends on the terrain being travelled on. For stairs, the k -value (see table 4.2) depends on the slope of the stairway.

Table 4.2. The k -value for stairways movement in Pathfinder.

Stair Raiser (meters)	Stairs Tread (meters)	k
0.191	0.254	1.00
0.178	0.279	1.08
0.165	0.305	1.16
0.165	0.330	1.23

4.3.3 Model input calibration

This section presents the input calibration for stair modelling, and agent and behavioural modelling in the model Pathfinder. The geometry (figure 4.15) represented in the model is in line with the description of the different scenarios from previous sections.

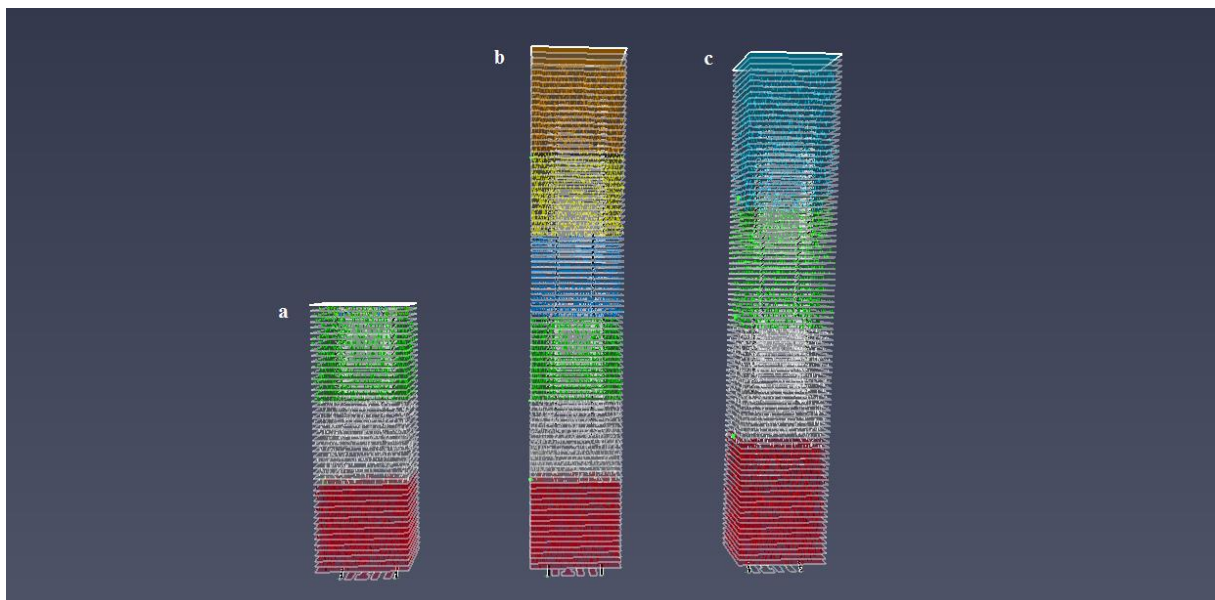

Figure 4.15. Building geometry of the different scenario in Pathfinder: a) scenario 1-3, b) scenario 4 and c) scenario 5.

Stair modelling

Stairs have been represented in Pathfinder in accordance with the description in 4.2 *Egress modelling scenarios*. Geometric characteristics such as riser, tread, and width, which are required for the model to calculate the speeds and flows of the agents travelling on the stairs are made in accordance with Gwynne & Rosenbaum (2008). The merging flows in stairs, i.e. the conflict between agents walking on the stairs and agents walking on the landing to the stairs, is solved by an incorporated mechanism in Pathfinder. When an agent faces conflict in its desired route, it can obtain a *free pass* during its movement. Free pass means that an agent will avoid unrealistic behaviour such as agents in the stairs not allowing agents in the floor landing to get into the stairs (Thunderhead Engineering, 2013).

Agent characteristics

This section provides information about the modelling assumptions made in the simulations of the agents and their behaviour. The information contain characteristics such as unimpeded walking speeds, body dimensions of the agents, behavioural modelling and response (pre-evacuation) time. In order to present as realistic scenarios as possible, real data (if possible) are used in the calibration of the model.

To be consistent with the study by Ronchi and Nilsson (2013) the building is assumed to contain 182 occupants per office used floor. The total population for the 50-story building is therefore 8372 occupants and 16562 occupants for the 95-story building. The population used in this study is lower than the suggestions from IBC 2012 (2011) and NFPA101 (2012). The assumption is made with the purpose to provide a more realistic occupant load in case of total evacuation (Muha & Park, 2012). Unimpeded walking speeds (table 4.3) of the occupants are implemented in accordance with the values provided by Gwynne and Rosenbaum (2008) in the Society of Fire Protection Engineering Handbook. In this study, it is also considered that some people may have physical impairments and may therefore have reduced horizontal and vertical speeds (table 4.3) (Boyce, Shields, & Silcock, 1999). According to Jönsson et al. (2012), 5% of the population in the building are considered to have reduced mobility. It is assumed that the people with movement disabilities are evenly distributed among the total population and furthermore they are assumed to evacuate in an evenly distributed way.

Table 4.3. Unimpeded walking speeds for Standard occupants and Occupant with disabilities.

Standard occupants			Occupants with disabilities		
Mean (m/s)	SD* (m/s)	Range (m/s)	Mean (m/s)	SD* (m/s)	Range (m/s)
1.29	1.00	0.29-2.29	0.8	0.37	0.1-1.68

* SD = standard deviation

Trying to produce as realistic results as possible, pre-evacuation times are implemented within the model. After a review of the available real data-sets from several studies (Averill et al., 2005; Fahy, 2012; Kuligowski & Mileti, 2009; McConnell et al., 2010; Sherman et al., 2011) of the World Trade Centre evacuation and suggestions from Purser and Bensilum (2001) of representing the pre-evacuation time as log-normal distributions, the values in table 4.4 are used.

Table 4.4. Pre-evacuation delays used in the simulations.

Pre-evacuation delays	
Mean	360 s
Standard deviation (SD)	120 s
Min	180 s
Max	600 s

5 Results

In the following chapter the results from the five simulated scenarios are presented. The results are presented under subheadings to facilitate the understanding. It should also be noted that only the results considered relevant for the aim and objective of the study are presented.

The results are presented using scatter plots and histograms. The values used to present the results are the average values for all the runs (15 runs) simulated for every scenario.

The evacuation model, Pathfinder, used in this study includes the use of distribution or probabilistic variables to simulate the human behaviour. In case of using random sampling methods, the model may produce different evacuation time curves for the same scenario. A single model run may not be sufficient to produce representative results and therefore several runs have to be simulated to give a representative outcome (Ronchi, Reneke, & Peacock, 2013). A convergence method, convergence in mean, is employed in this study to give representative results. Specifically the method aims to get an error between the means of two consecutive runs that is smaller than 1% for the 98% of the evacuated population (Ronchi & Nilsson, 2013). The reason why 98% of the population is used as reference evacuation time rather than 100% is to consider possible limitations associated with evacuation modelling assumptions (i.e. some agents may remain stuck in the building) (Frantzich et al., 2007).

To present representative results in this study, it has been chosen to stop the runs for a scenario when at least five consecutive runs have an error of means smaller than 1% for the 98% of the evacuees. The error smaller than 1% for five consecutive runs is achieved when at least 15 runs of a scenario are simulated (see figure 5.1). This means that an additional run would most likely change the results with less than 1%. The procedure for calculating and the separate representation of the error of mean for the different scenarios can be found in *Appendix B*.

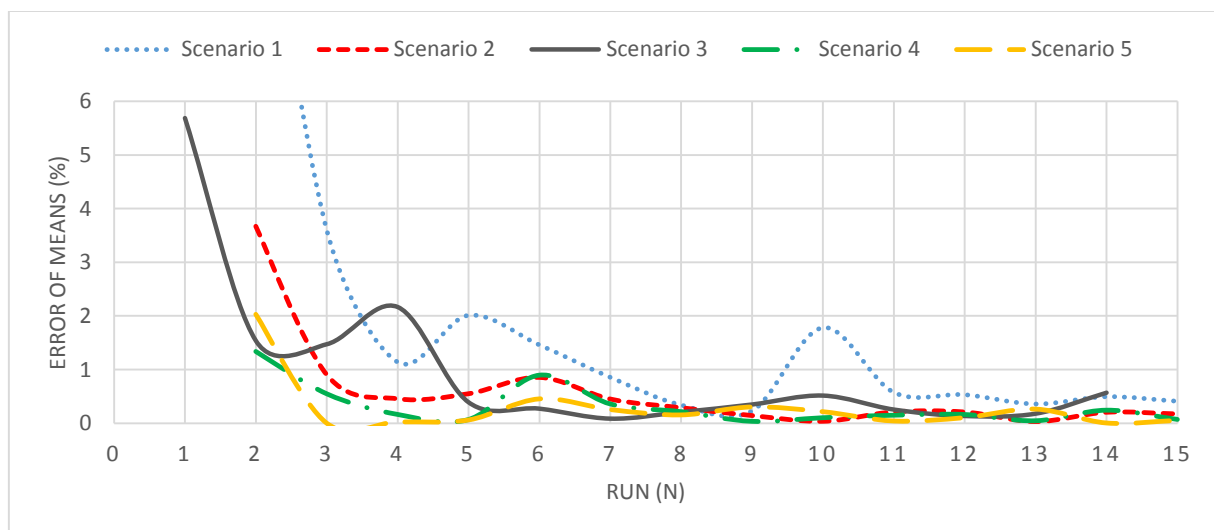

Figure 5.1. Error of means (%) against number of runs (n) for every scenario.

5.1 Evacuation efficiency for the different scenarios

The evacuation efficiency for the different scenarios is illustrated using scatter plots (figure 5.2 and 5.3) and histograms (figure 5.4). The choice of scatter plots to illustrate the results is made that they in fact facilitate the understanding of the evacuation trend. Histograms on the other hand allow for better understanding the differences between the scenarios.

Figure 5.2 presents the average percentage of the evacuees that have evacuated the building against the evacuation time for every scenario. In this scatter plot it is easy to follow the evacuation efficiency for specific points.

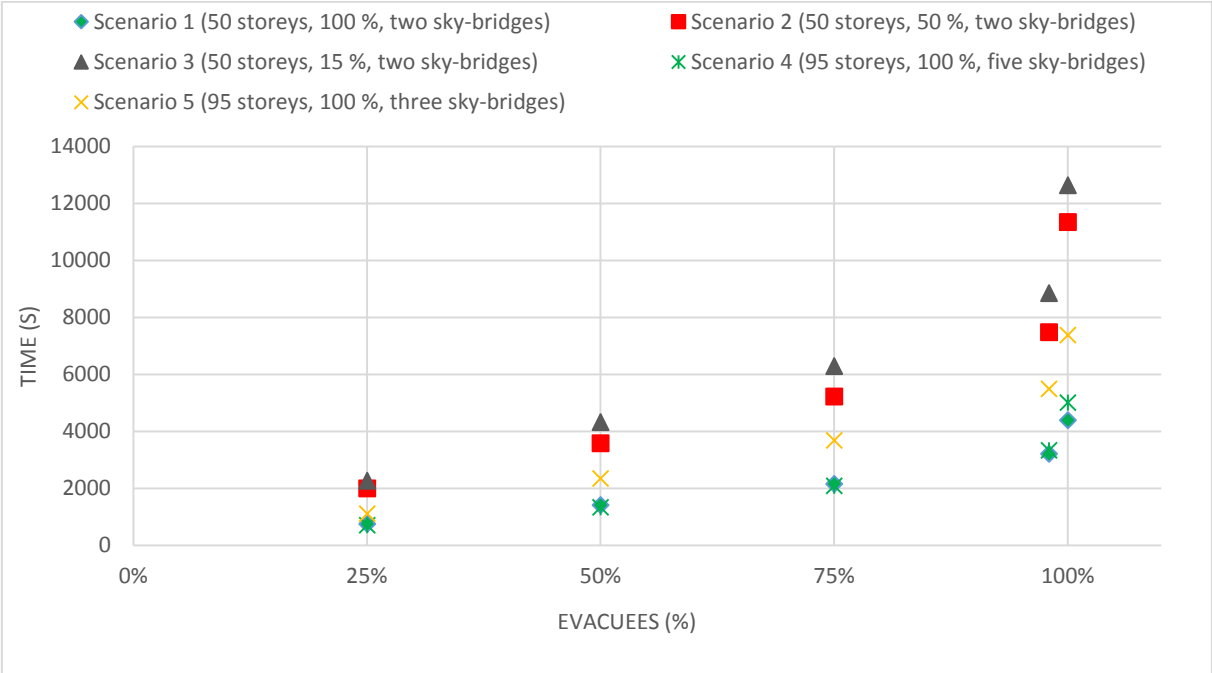

Figure 5.2. Average percentages of evacuees against timed employed by occupants for every scenario.

Figure 5.3 illustrates the average remaining occupants for each scenario plotted against time of evacuation. The advantage of this illustration is that it is possible to follow the evacuation at all time.

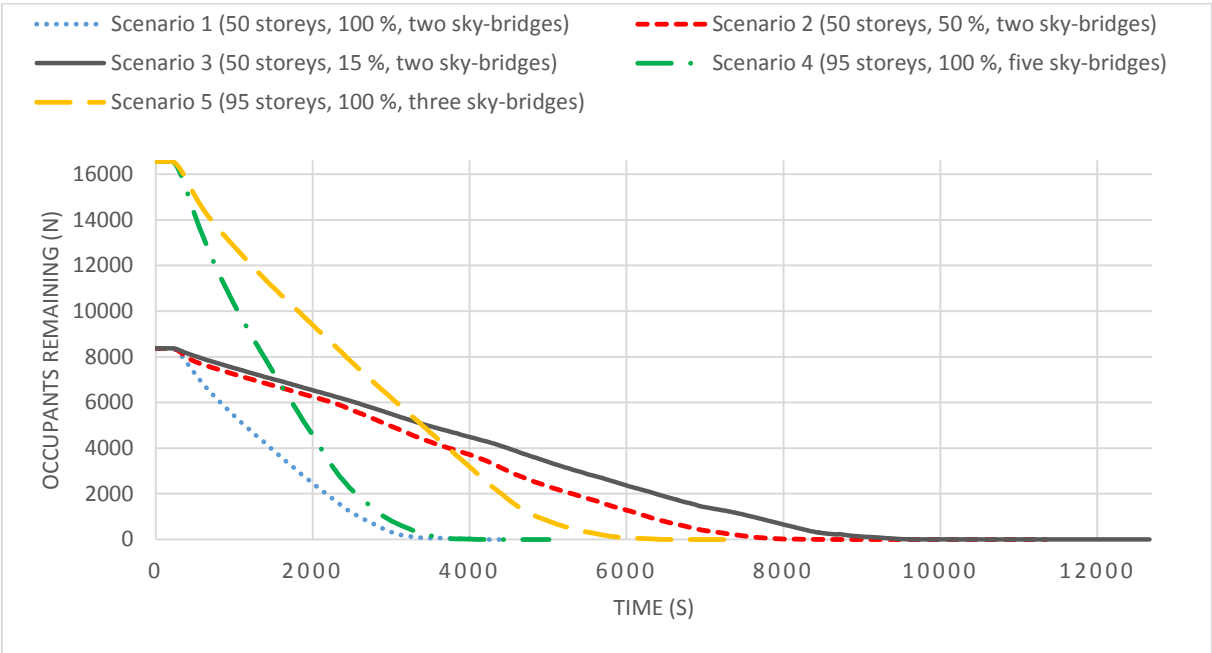

Figure 5.3. Average occupants remaining in the building against time for every scenario.

The histogram presented in figure 5.4 illustrates, in a similar way as the scatter plot in figure 5.2, the average percentage of evacuees that have left the building against the time for all scenarios. This representation allows for better understanding the differences in evacuation time (efficiency) between the scenarios.

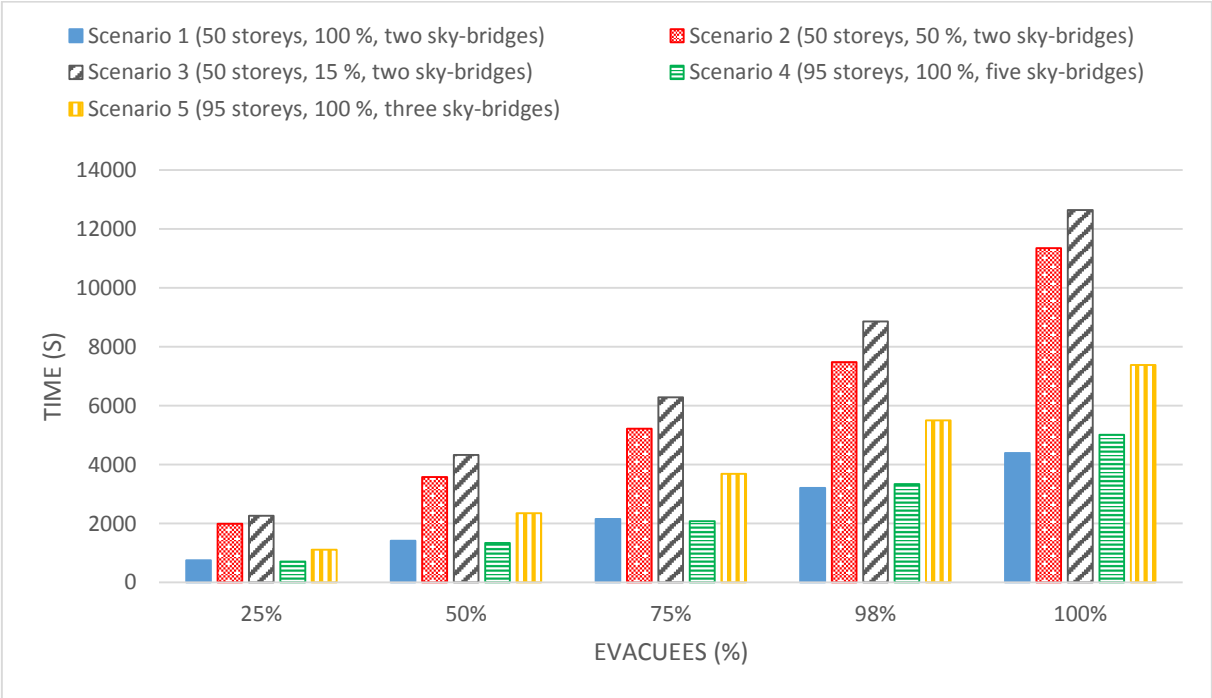

Figure 5.4. Average percentages of evacuees against time employed by occupants for every scenario.

Figures 5.2-5.4 illustrate that scenario 1 has shortest evacuation time followed by scenario 5, 4, 2 and 3. Scenario 1, 4 and 5 compared to scenario 2 and 3, are those scenarios where the sky-bridges are used by all occupants. It can be observed that the total evacuation time is significantly shorter when the sky-bridge is used by all the occupants. It can also be observed that a shorter inter-distance between the sky-bridges provides a shorter evacuation time (scenario 4 compared to scenario 5).

5.2 Flows and congestion

In this section, flows and congestion curves are presented for each scenario using scatter plots. The flow curves are illustrated for a number of chosen critical floors in the building. With critical floors, floors containing exits are intended such as the refuge floors containing sky-bridge exits and the exit stairs to the lobby. It should be highlighted prior to reading the results that the flows at the exit stairs at the lobby are added together into one flow. Furthermore the refuge floors *in all scenarios* already contain 182 occupants at the beginning of the evacuation time, and this is why the outflow is always slightly higher than the inflow. The congestion curves are presented by dividing the building (occupants) in different zones depending on the number of sky-bridges (refuge floors), e.g. six zones correspond to five sky-bridges. Congestion is then represented by a horizontal line, indicating that individuals are stuck and cannot evacuate the building, while a slope decreasing line means that people are evacuating the building.

5.2.1 Scenario 1

This scenario contains a 50 storey building with two sky-bridges (SB 2 and SB 1) located at refuge floors (RF) 33 and 18. Furthermore, 100% of the occupants above or at the sky-bridge level are using that sky-bridge as exit.

Flows at the exits

In this scenario three exits at which people can evacuate are available: sky-bridge 2, sky-bridge 1 and the exit stairs to the lobby. Figure 5.5 illustrates the flows through sky-bridge 2 (SB 2), sky-bridge 1 (SB 1) and for the lobby exits (Lobby).

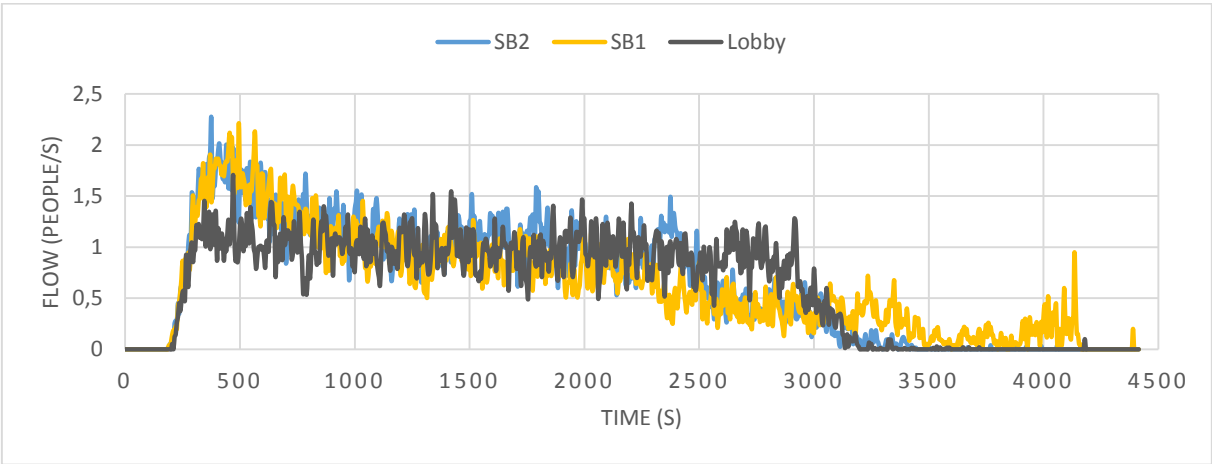

Figure 5.5. Average flow against time at the three main exits: sky-bridge 2 (SB 2), sky-bridge 1 (SB 1) and lobby exist (Lobby).

From this illustration we can see that the flows through each exit are almost the same. The flows through the sky-bridges are almost identical with slightly higher flow in general through sky-bridge

2. The reason for this is explained by the fact that high-rise zone contains 16 floors instead of 15. The flow to the lobby is on average constant and keeps this until almost all evacuees have exited.

Inflow and outflow at the refuge floors

Since 100% of the occupants above or at the refuge floors are using the corresponding sky-bridges to evacuate the building, there is an inflow to the refuge floor and an outflow through the sky-bridges. Figure 5.5 shows a general schematic representation of the inflow (white arrows) to a refuge floor and the outflow (white arrow with vertical pattern fill) through the sky-bridge.

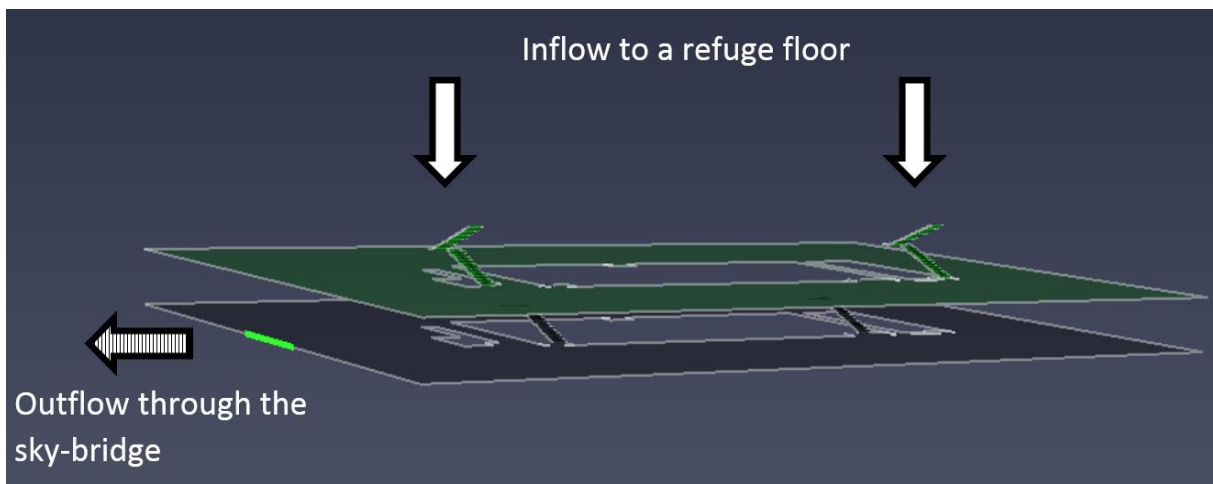

Figure 5.6. Schematic representation in general of the inflow to a refuge floor (white arrows) and the outflow through the sky-bridge (white arrow with vertical pattern fill).

The actual values for the inflow and outflow at refuge floor 33 are presented in figure 5.7, while for the refuge floor 18 the values are presented in figure 5.7.

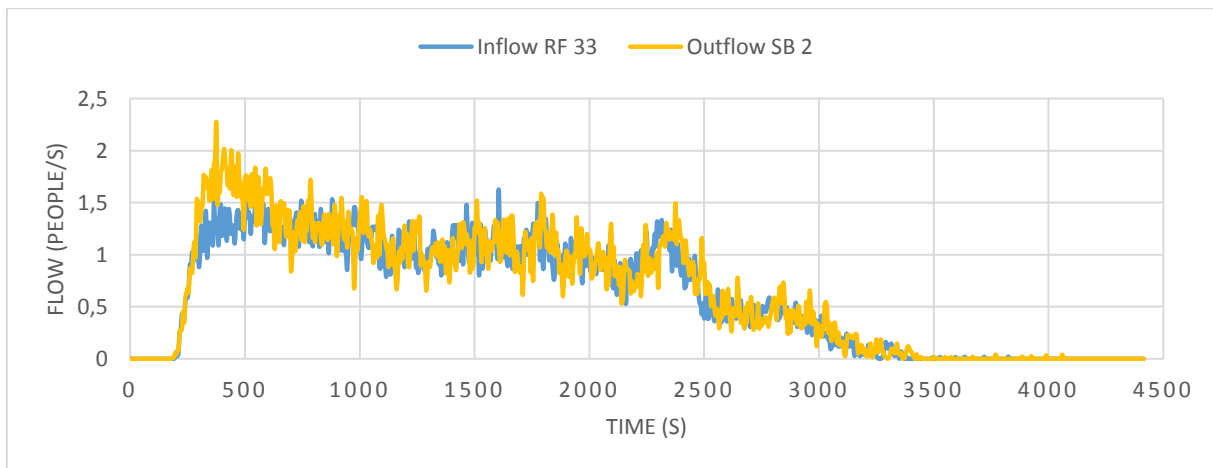

Figure 5.7. Scatter plot representing the average inflow to refuge floor 33 (RF 33) and the average outflow through the sky-bridge (SB 1).

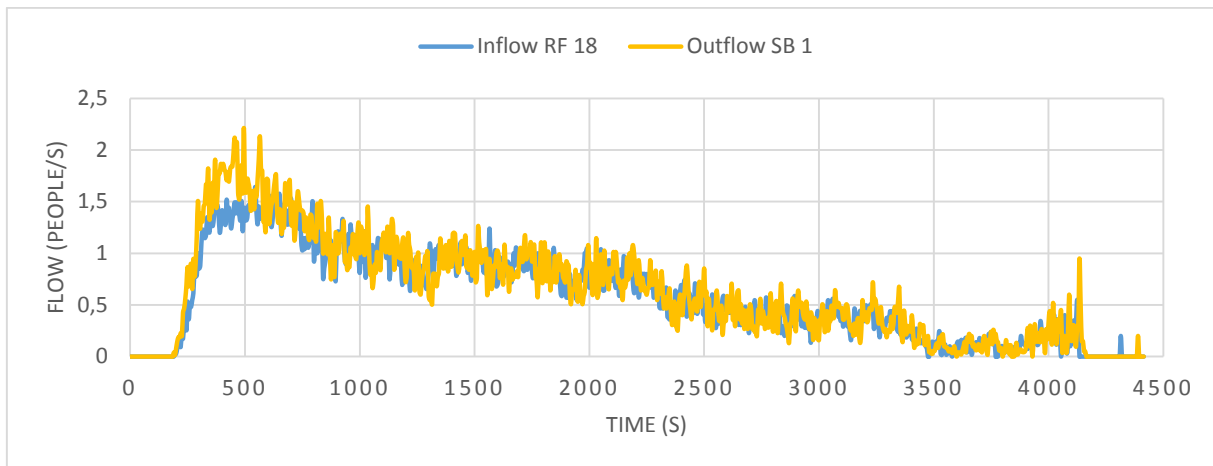

Figure 5.8. Scatter plot representing the average inflow to refuge floor 18 (RF 18) and the average outflow through the sky-bridge (SB 1).

From the scatter plot in figure 5.7 and 5.8 it can be noticed that the inflow is almost identical to the outflow with slightly higher outflow in the beginning from 250 s to 500 s due to pre-evacuation delays.

Congestion

To present the congestion in this scenario, the building is divided into three zones: high-rise zone, mid-rise zone and low-rise zone, the refuge floors being the dividing lines. By presenting the average occupant evacuation time against the occupants remaining in each zone the congestion can be visualized (figure 5.9). If congestion would appear it would be noticed with a horizontal line (see figure 5.14 and 5.15), indicating that people are stuck and no one is exiting the building.

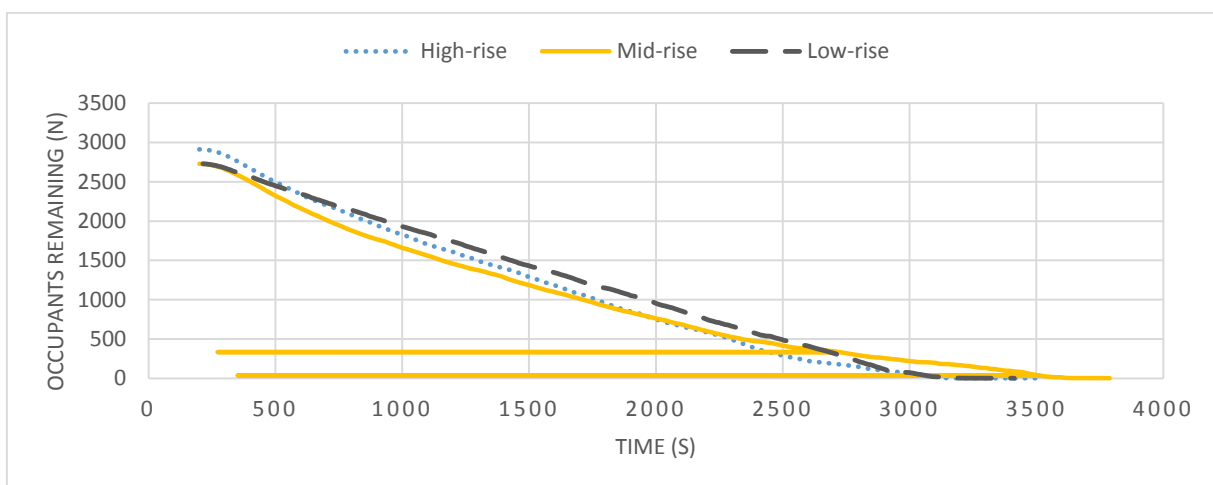

Figure 5.9. Occupants remaining in the building against average evacuation time for the different zones: high-rise zone, mid-rise zone and low-rise zone.

Figure 5.9 shows that the evacuation is smooth with no notable signs of congestion. The high-rise zone contains one additional floor (16 floors instead of 15 floors). Nevertheless, the total evacuation time is faster for the high-rise zone with approximately 3500 seconds compared to the mid-rise zone with close to 4000 seconds as total evacuation time. The lobby is the zone through which occupants evacuates fastest, exiting the building at around 3400 seconds.

5.2.2 Scenario 2

In this scenario the building is 50 storey high and there are two sky-bridges (SB 2 and SB 1) at the refuge floors 33 and 18. 50% of the occupants above or at each refuge floor evacuate through the corresponding sky-bridge while the remaining occupants evacuate through the stairs.

Flows at the exits

There are three exits available for occupants to evacuate through: sky-bridge 2 (SB 2), sky-bridge 1 (SB 1) and exit stairs to the lobby (Lobby), for which the outflows are presented in figure 5.10.

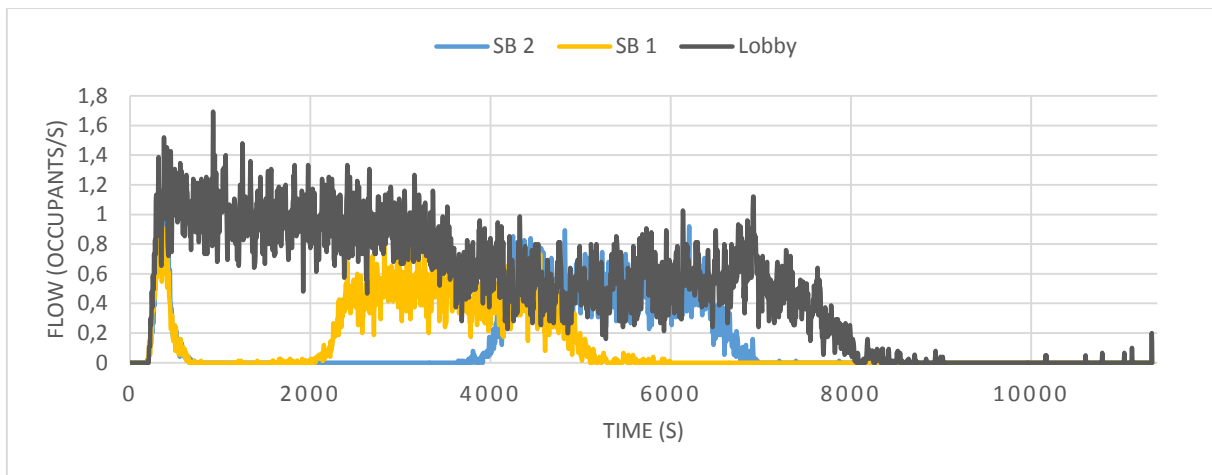

Figure 5.10. Average flow against time at the three main exits: sky-bridge 2 (SB 2), sky-bridge 1 (SB 1) and lobby exits (Lobby).

Figure 5.10 illustrates that the highest flow is through the lobby exits as those exits receive the highest number of people compared to the other exits (SB 2 and SB 1). Sky-bridge 2 and sky-bridge 1 have similar flows, with the difference of a delayed flow in sky-bridge 2 (~2000 seconds). The reason for the delayed flow through sky-bridge 2 (SB 2) is due to the congestion on stairs from the mid-rise zone occupants that are using the stairs to evacuate out of the building.

Inflow and outflow at the refuge floors

Since in this scenario only 50% of the occupants are using the sky-bridges to evacuate the building, there is one inflow and two outflows at a refuge floor. Figure 5.11 illustrates a general schematic representation of the inflow to the refuge floor (white arrows) which is equal to the sum of the outflow (white arrow with vertical pattern fill) through the sky-bridge and the outflow (white arrow with horizontal pattern fill) through the stairs from the refuge floor.

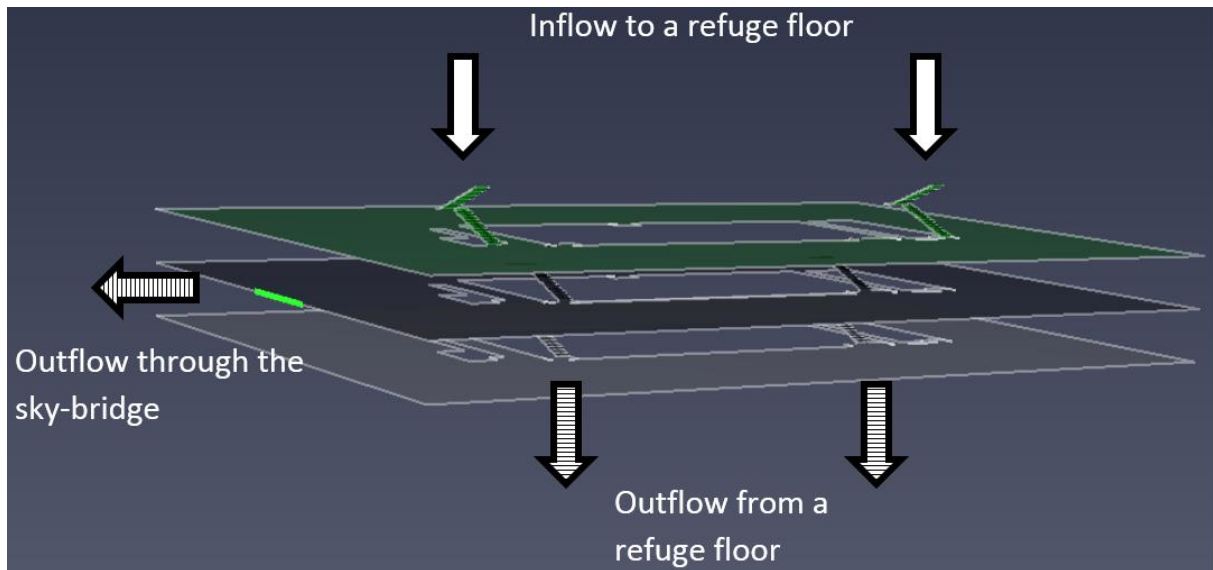
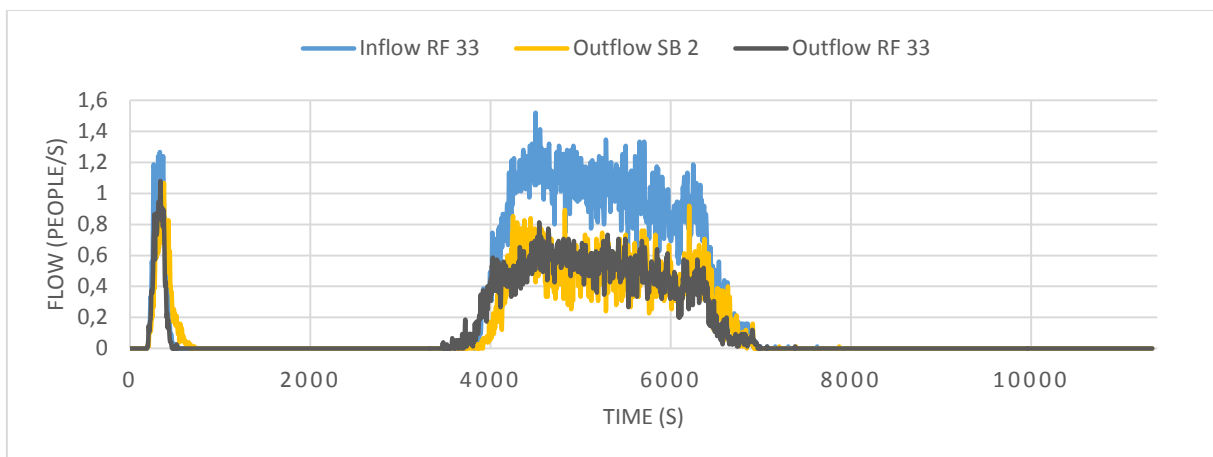

Figure 5.11. Schematic representation over the inflow to a refuge floor (white arrows) and the outflow through the sky-bridge (white arrow with vertical pattern fill) and outflow from a refuge floor (white arrow with horizontal pattern fill).

The values for the inflow and the outflows for each refuge floor are presented in figure 5.12 (refuge floor 33) and figure 5.13 (refuge floor 18).



5.12. Scatter plot representing the average inflow to refuge floor 33 (RF 33) and the average outflow through sky-bridge 2 (SB 2) and down from refuge floor 33.

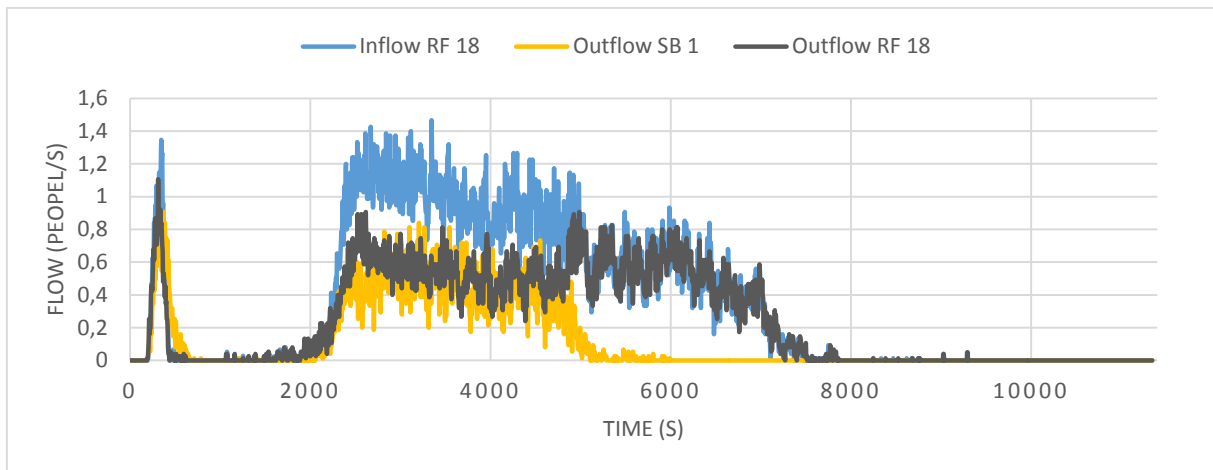

Figure 5.13. Scatter plot representing the average inflow to refuge floor 18 (RF 18) and the average outflow through sky-bridge 1 (SB 1) and down from refuge floor 18.

From figures 5.12 and 5.13 it observe that there is a longer delay in flows for refuge floor 33 compared to refuge floor 18, with the reason of congestion from mid-rise zone occupants evacuating through the stairs.

Congestion

Possible congestion is investigated by dividing the building into three zones: high-rise, mid-rise and low-rise zone at the refuge floors. Considering their initial position (i.e. the zone where they start to evacuate), the average occupant evacuation time is then plotted against the remaining occupants (figure 5.14).

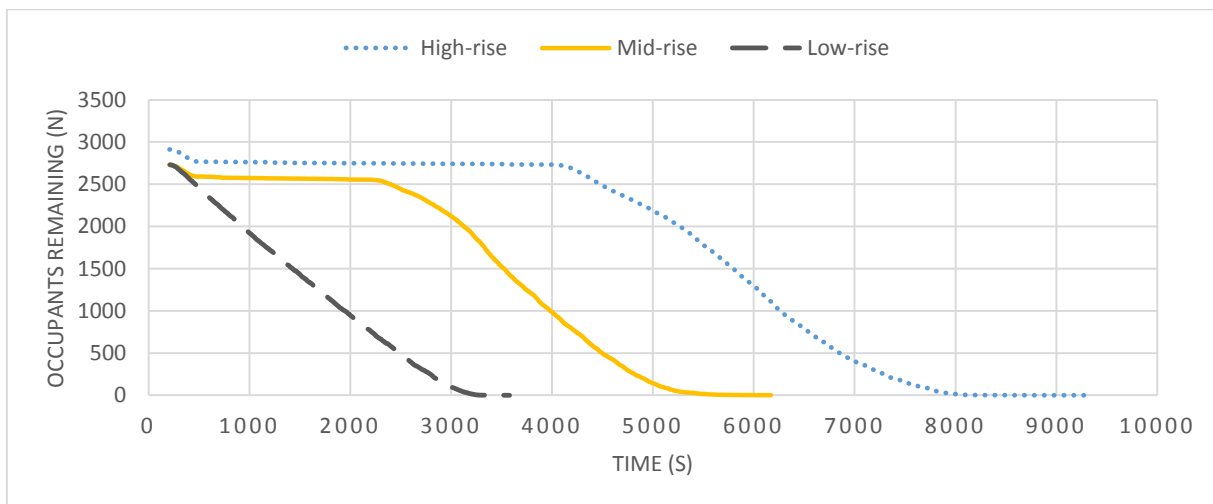

Figure 5.14. Occupants remaining in the building against average evacuation time for the different zones: high-rise zone, mid-rise zone and low-rise zone.

It can be seen that the occupants evacuating from the high-rise zone and mid-rise zone are delayed due to congestion (the almost horizontal part of the lines). The high-rise zone occupants have a congestion lasting longer than those in the mid-rise zone. In the high-rise zone the congestion starts after approximately 500 seconds and last for approximately 3500 seconds while the congestion in the mid-rise zone starts at approximately the same time and last for 2000 seconds. The high-rise zone occupants are the ones exiting the buildings last (since they have a longer travel

distance if they are assigned to exit through the lobby) with an evacuation time over 9000 seconds while the occupants belonging to the mid-rise zone evacuate in around 6000 seconds. For the low-rise zone, there are no notable signs of congestion and the occupants belonging to this part evacuate the building first in approximately 3500 seconds.

5.2.3 Scenario 3

This scenario contains a 50 storey building with two sky-bridges located at floors 33 and 18. The sky-bridges are only used by 15% of the occupants in the building, which means that the remaining 85% are using the stairs to evacuate.

Flows at the exits

Three exits are available to evacuate the building: sky-bridge 2 (SB 2), sky-bridge 1 (SB 1) and the exit stairs 1 and 2 to the lobby (Lobby). The flows through these exits are presented in figure 5.15.

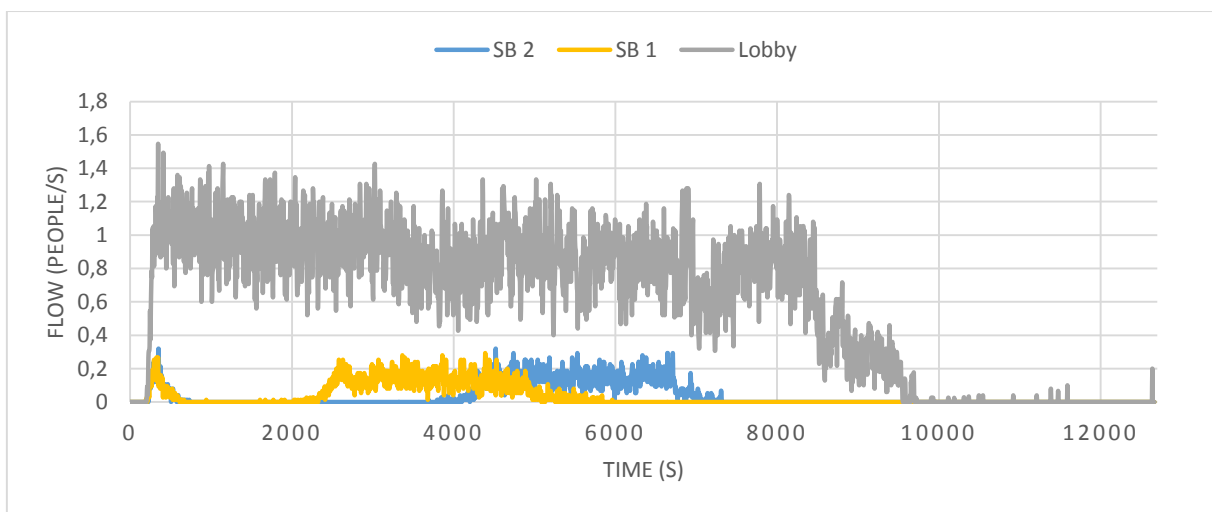

Figure 5.15. Average flow against time at the three main exits: sky-bridge 2 (SB 2), sky-bridge 1 (SB 1) and lobby exist (Lobby).

Figure 5.15 illustrates small flows through the sky-bridges as only 15% of the people use them. There is also a delay for the flow through sky-bridge 2 compared to the flow through sky-bridge 1. The flow through the lobby is far higher than the other exit flows as the majority of occupants use them to evacuate the building. The reason for the delayed flow through sky-bridge 2 (SB 2) is due to the congestion on stairs from the mid-rise zone occupants that are using the stairs to evacuate out of the building.

Inflow and outflow at the refuge floors

As there are people from all zones evacuating the building through both sky-bridges and stairs, there is one inflow to the refuge floor and two outflows, one through the corresponding sky-bridge connected at the refuge floor and another flow downstairs from the refuge floor (see figure 5.10 above for a schematic representation). The values for the flows at refuge floor 33 and 18 are presented in figures 5.16 and 5.17 respectively.

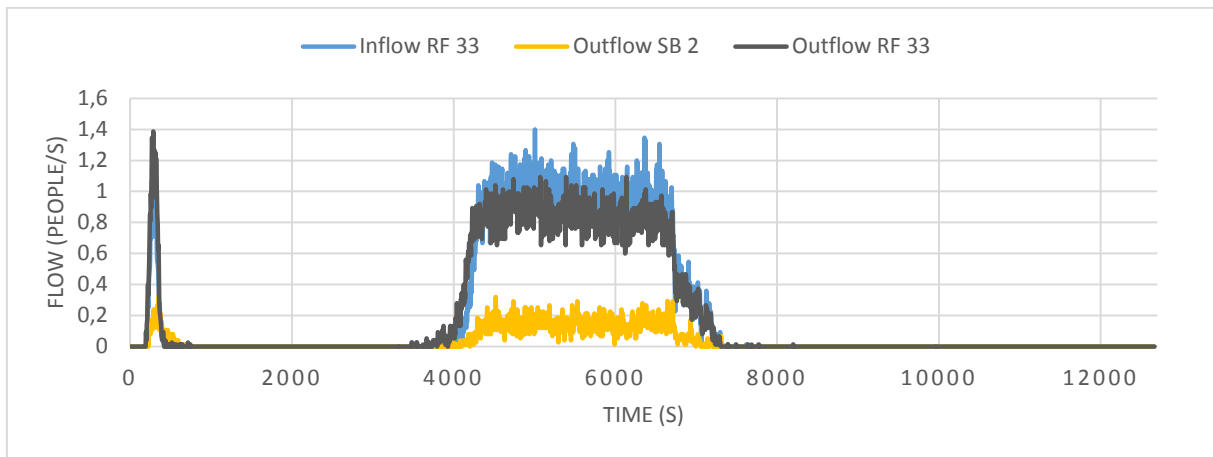

Figure 5.16. Scatter plot representing the inflow to refuge floor 33 (RF 33) and the outflows, one through sky-bridge 2 (SB 2) and the other down from refuge floor 33.

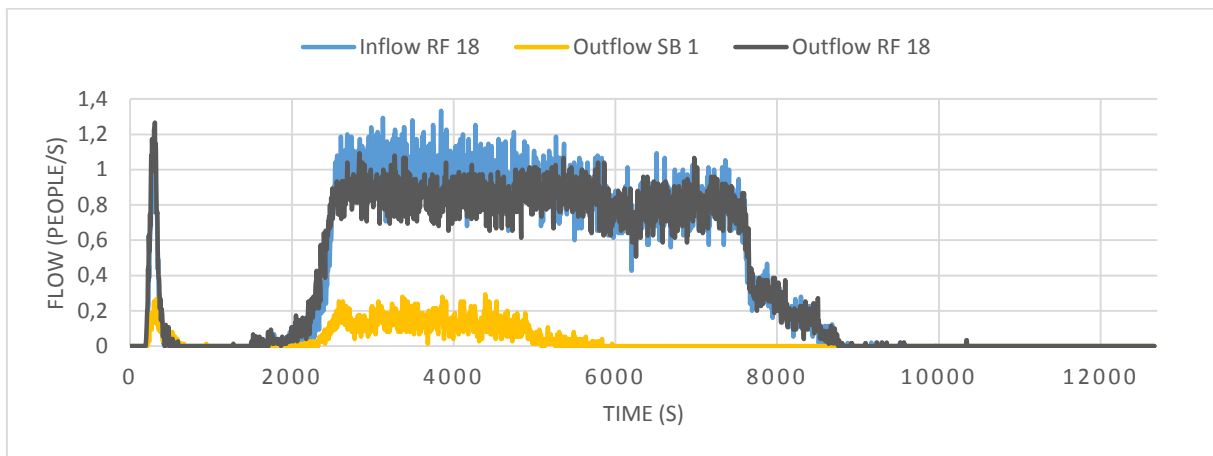

Figure 5.17. Scatter plot representing the average inflow to refuge floor 18 (RF 18) and the average outflow through sky-bridge 1 (SB 1) and down from refuge floor 18.

Figures 5.16 and 5.17 illustrate that the average inflow to the refuge floor is almost equal to the sum of the outflows through the sky-bridge and downstairs from the refuge floor. Also in this scenario, there is a delay in positive flows at the refuge floors due to congestion on stairs.

Congestion

The congestion is presented by dividing the building occupants into three zones: high-rise, mid-rise and low-rise zone with the refuge floors as the dividing lines. Congestion is then investigated by plotting the average occupant evacuation time against the remaining occupants in the building (see figure 5.18).

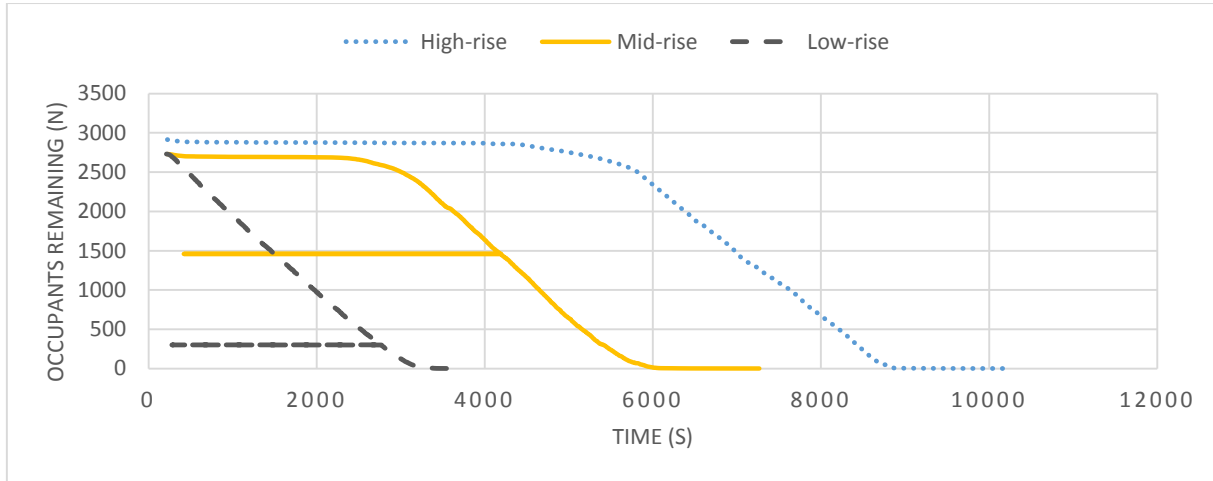

Figure 5.18. Occupants remaining against average evacuation time for the different zones: high-rise zone, mid-rise zone and low-rise zone.

Figure 5.18 illustrates that the congestion (horizontal lines) appears for high-rise and mid-rise occupants. The congestion for the occupants belonging to the high-rise zone lasts for approximately 4000 seconds. It should be noted that this zone (high-rise) contains one additional floor compared to the two other zones. The congestion for the mid-rise zone lasts half that of the high-rise zone. The congestion caused by occupants on the stairs delays the evacuation for those belonging to the high-rise zone to slightly over 10000 seconds and for the mid-rise zone to over 7000 seconds. For the occupants belonging to the low-rise zone and evacuating through the exit stairs, no congestion occurs and the evacuation time is close to 4000 seconds.

5.2.4 Scenario 4

Scenario 5 is presented by a 95-storey building with five sky-bridges, located at refuge floors 18, 33, 48, 63 and 78. 100% of the people above and at each refuge floor are using the sky-bridge to exit the building.

Flows at the exits

In this scenario there are six exits available: sky-bridge 5 (SB 5), sky-bridge 4 (SB 4), sky-bridge 3 (SB 3), sky-bridge 2 (SB 2), sky-bridge 1 (SB 1) and the exit stairs to the lobby (Lobby). The flows through the exits are presented in figure 5.19.

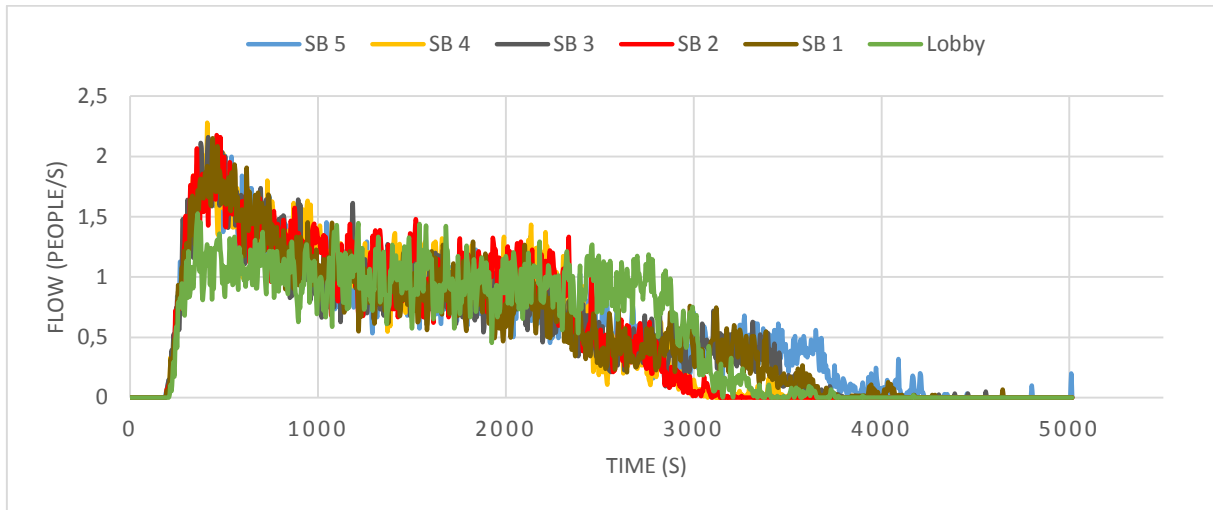

Figure 5.19. Average flow against time at the five exits: sky-bridge 5 (SB 5), sky-bridge 4 (SB 4), sky-bridge 3 (SB 3), sky-bridge 2 (SB 2), sky-bridge 1 (SB 1) and lobby exits (Lobby).

From figure 5.19, it can be observed that the flows through the sky-bridges follow almost the same pattern with slightly higher flow through sky-bridge 5 since this sky-bridge receives a larger number of people (16 floors) compared to the other zones (15 floors each). The flow at the lobby reaches a certain rate and keeps it constant during almost the whole evacuation.

Inflow and outflow at the refuge floors

As 100% of the occupants above or at the refuge floors are using the sky-bridges to exit the building, there is one inflow at the refuge floors and one outflow through the sky-bridges. The flows for refuge floors 78, 63, 48, 33, and 18 are presented in figures 5.20-5.24.

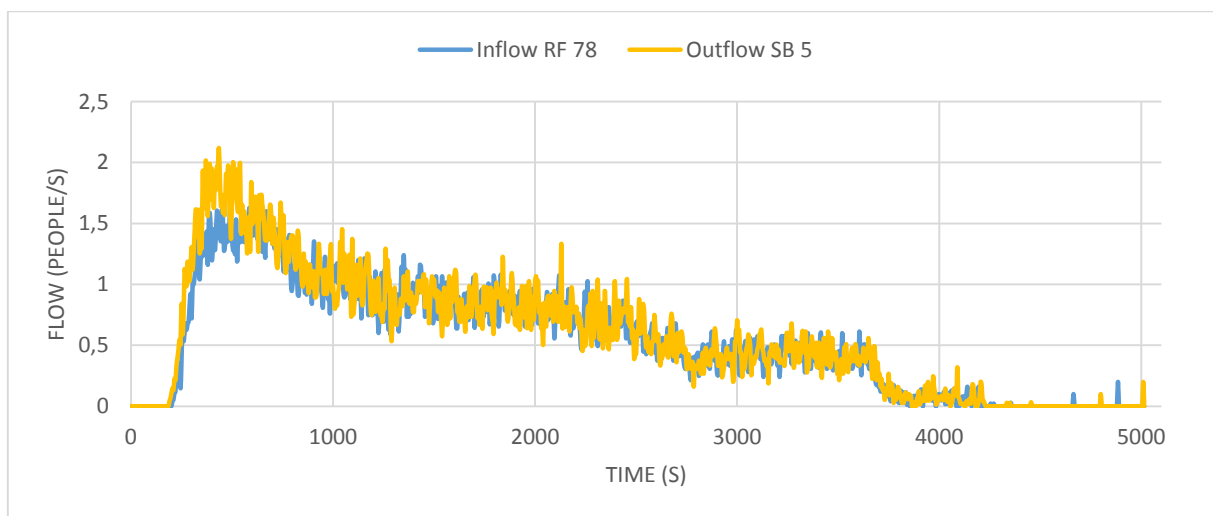

Figure 5.20. Scatter plot representing the average inflow at refuge floor 78 (RF 78) and the average outflow through the sky-bridge (SB 5).

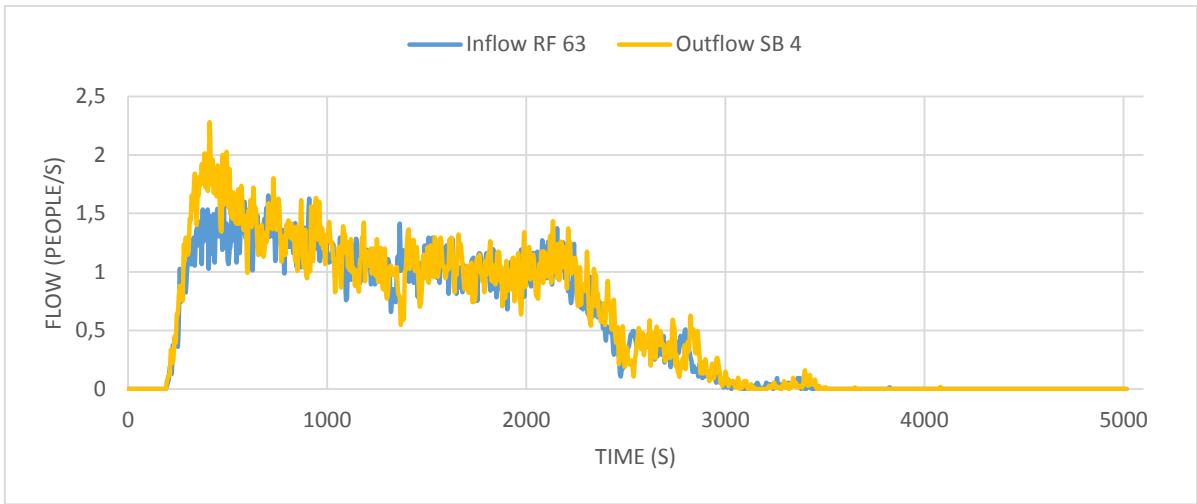

Figure 5.21. Scatter plot representing the average inflow at refuge floor 63 (RF 63) and the average outflow through the sky-bridge (SB 4).

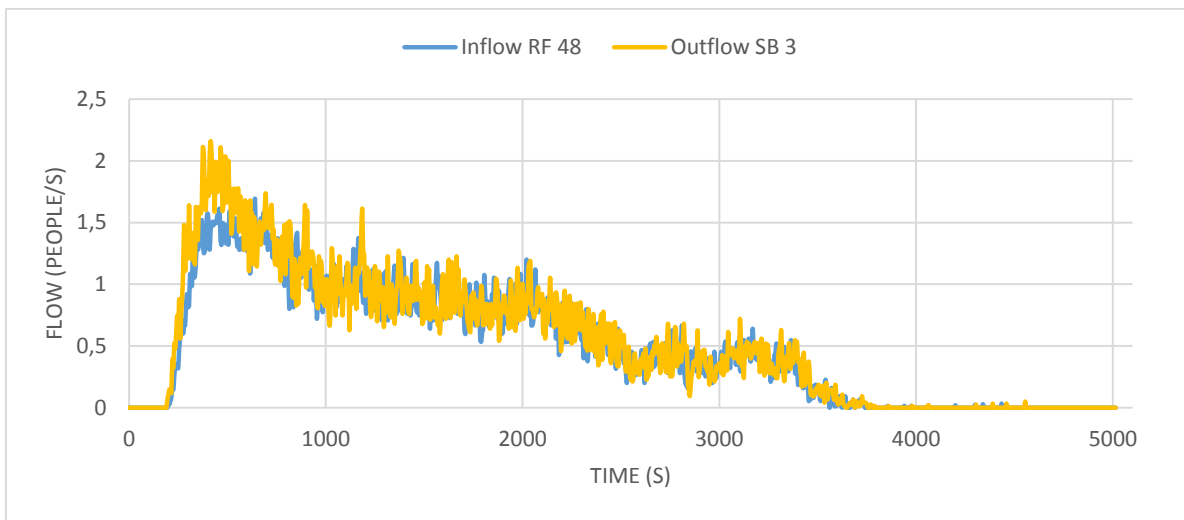

Figure 5.22. Scatter plot representing the average inflow at refuge floor 48 (RF 48) and the average outflow through the sky-bridge (SB 3).

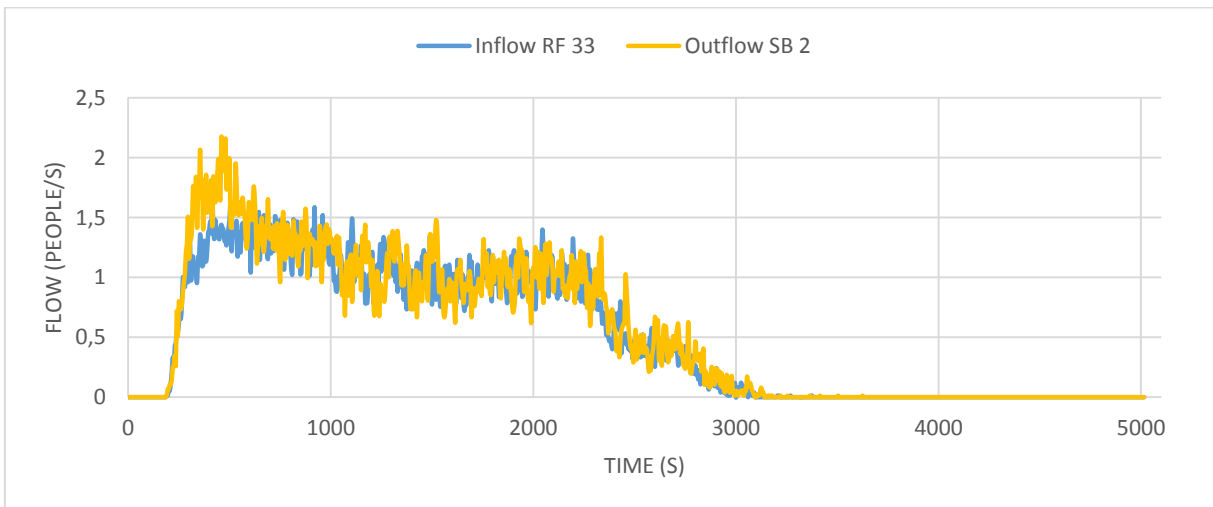

Figure 5.23. Scatter plot representing the average inflow at refuge floor 33 (RF 33) and the average outflow through the sky-bridge (SB 2).

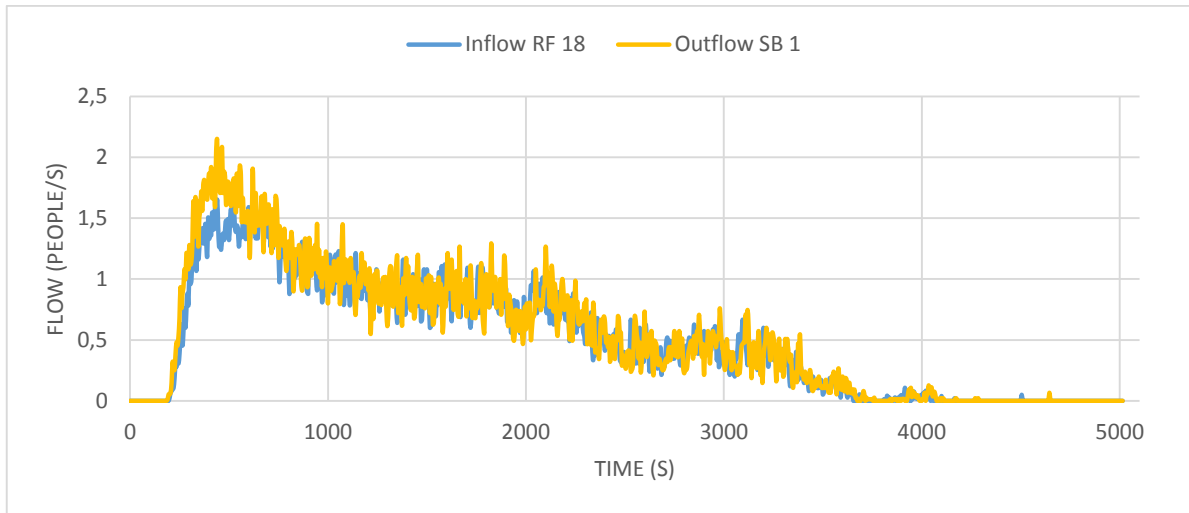

Figure 5.24. Scatter plot representing the average inflow at refuge floor 18 (RF 18) and the average outflow through the sky-bridge (SB 1).

One observes in these figures (figure 5.20-5.24) that the outflows through the sky-bridges are nearly equal to the inflows, with slightly higher outflows since the refuge floors already contains 182 occupants at the beginning of the evacuation.

Congestion

In this scenario the building is divided into six zones from the top to the bottom of the building: high-rise zone, mid-rise zone 4, mid-rise zone 3, mid-rise zone 2, mid-rise zone 1 and low-rise zone. Congestion is studied by plotting the occupants remaining for each zone against the time elapsed (see figure 5.25).

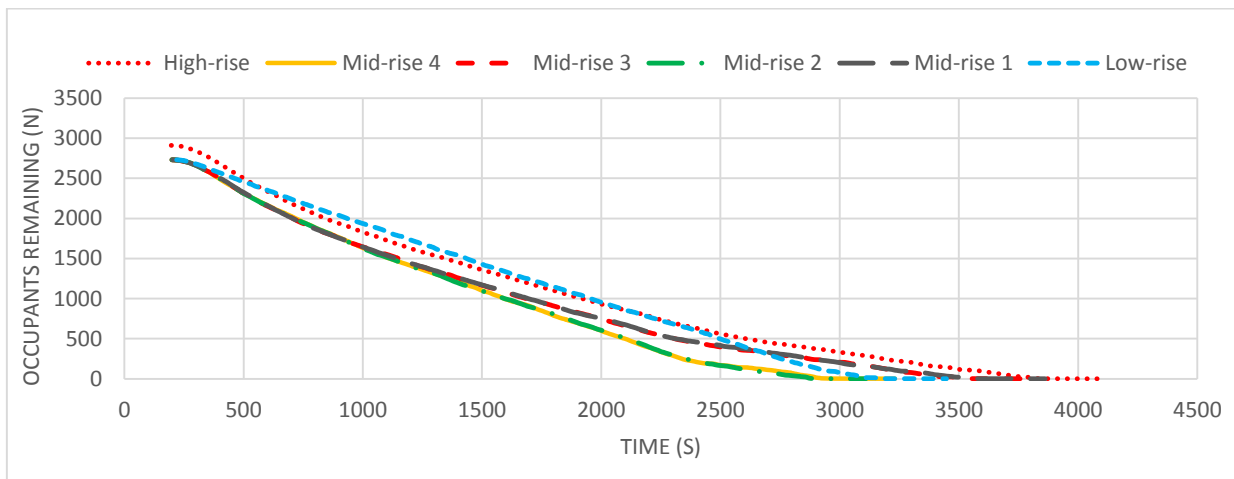

Figure 5.25. Occupants remaining in the building against average evacuation time for the different zones: high-rise zone, mid-rise zone 4, mid-rise zone 3, mid-rise zone 2, mid-rise zone 1 and low-rise.

Figure 5.25 shows no notable signs of congestion. Occupants belonging to mid-rise zone 2 are the ones evacuating the building first (~3100 s), followed by occupants from mid-rise zone 4 (~3250 s), low-rise zone (~3500 s), mid-rise zone 3 (~3750 s) and high-rise zone (~4100s).

5.2.4 Scenario 5

This scenario is presented by a 95 storey building with three sky-bridges located at refuge floor 26, 49 and 71. In this scenario, 100% of the occupants are evacuating downstairs to the closest refuge floor and evacuating through the corresponding sky-bridge.

Flows at the exits

There are four exits for the occupants to exit the building: sky-bridge 3 (SB 3), sky-bridge 2 (SB 2), sky-bridge 1 (SB 1) and the exit stairs to the lobby (Lobby). The flow for each exit is presented in figure 5.26.

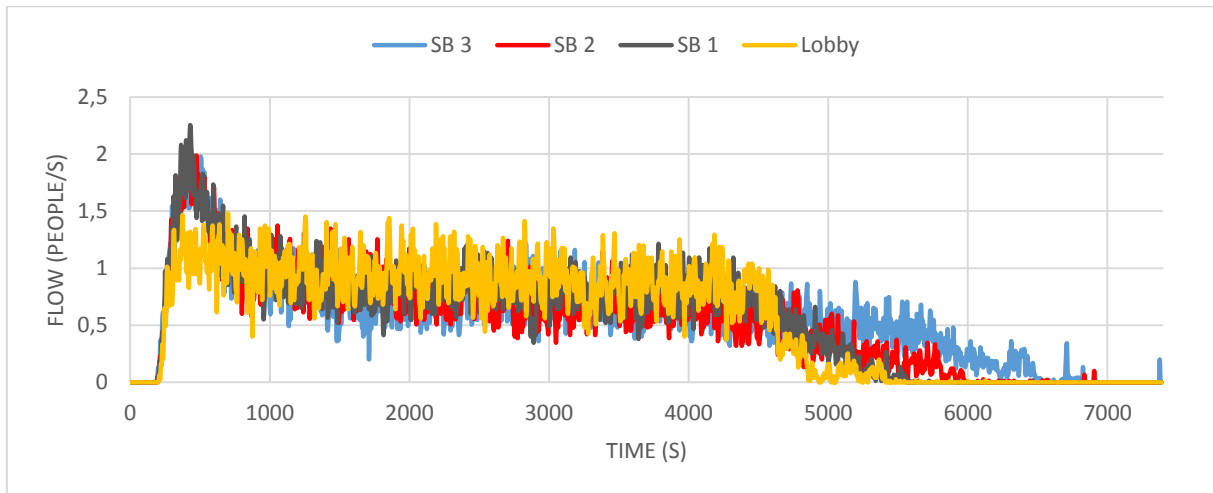

Figure 5.26. Average flow against time at the four exits: sky-bridge 3 (SB 3), sky-bridge 2 (SB 2), sky-bridge 1 (SB 1) and lobby exits (Lobby).

Figure 5.26 shows that the flows through the sky-bridge exits follows the same pattern with minor differences at the beginning and the end of the evacuation. The flow through the lobby reaches a certain rate which is kept constant during the evacuation.

Inflow and outflow at the refuge floors

Since 100% of the occupants above and at each refuge floor are using the corresponding linked sky-bridge, there is only an inflow to the refuge floor and an outflow through the exit (figure 5.5). The flows at refuge floors 71, 49 and 26 are presented in figures 5.27, 5.28 and 5.29 respectively. For all three figures it can be observed that the inflow to each refuge floor is equal to the sum of the outflows through the corresponding sky-bridge, with slightly higher outflows as the refuge floors are already loaded with 182 occupants at the start of the evacuation.

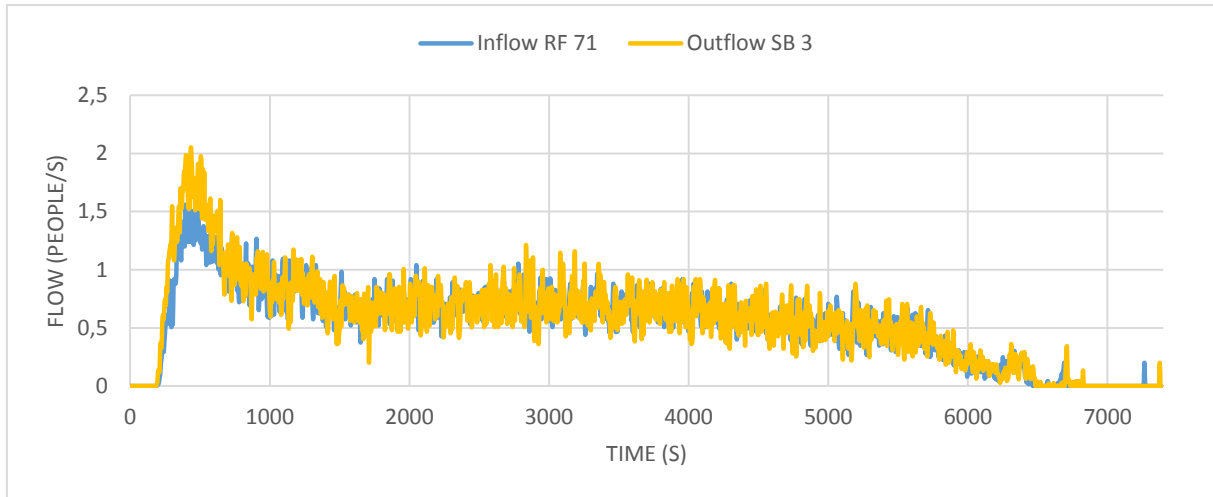

Figure 5.27. Scatter plot representing the average inflow at refuge floor 71 (RF 71) and the average outflow through the sky-bridge (SB 3).

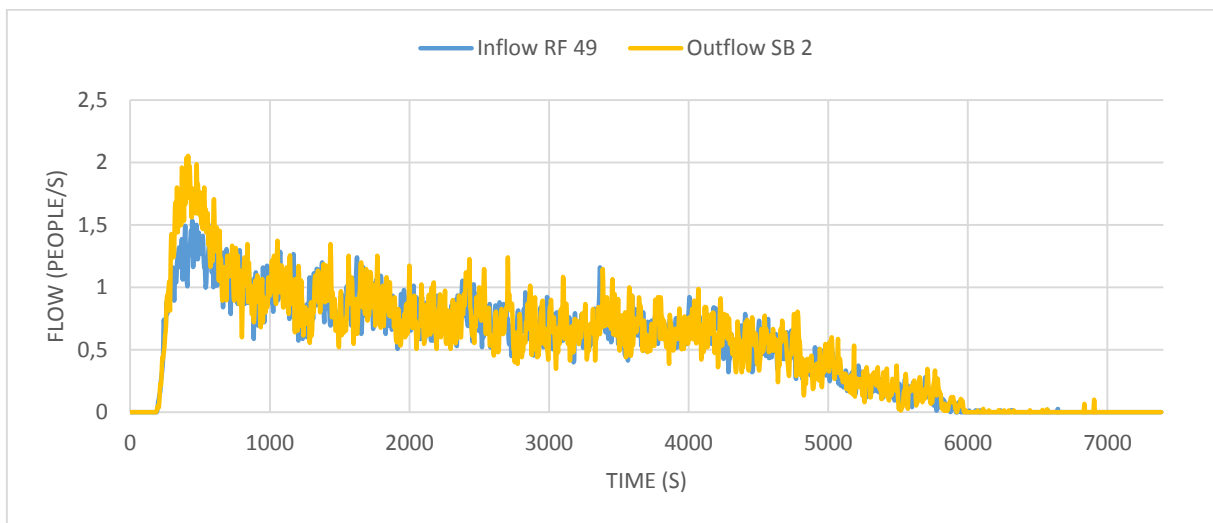

Figure 5.28. Scatter plot representing the average inflow at refuge floor 49 (RF 49) and the average outflow through sky-bridge 2 (SB 2).

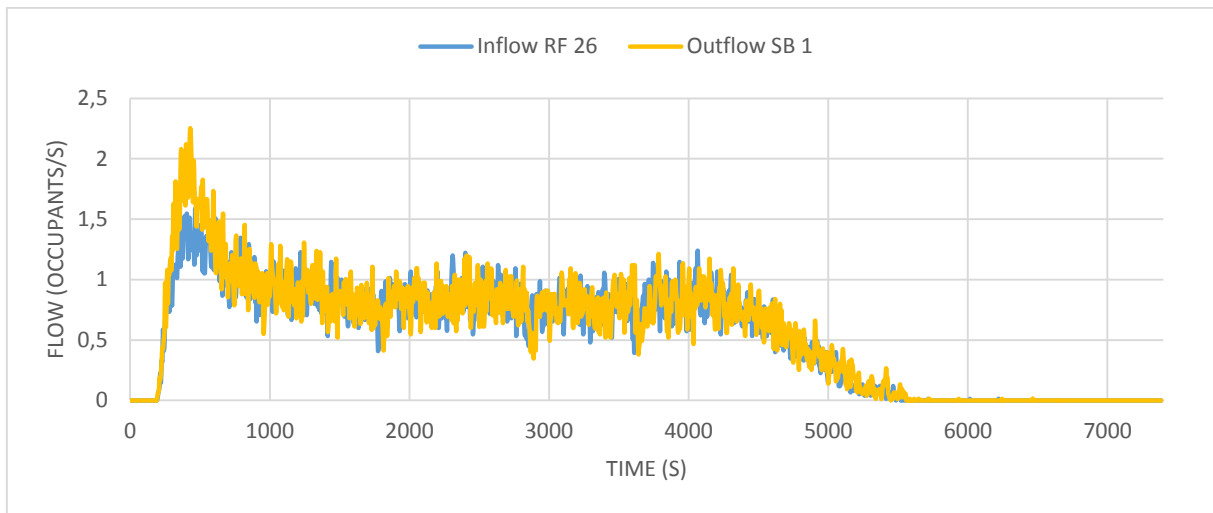

Figure 5.29. Scatter plot representing the average inflow at refuge floor 26 (RF 26) and the average outflow through sky-bridge 1 (SB 1).

Congestion

The congestion is presented by dividing the building into four zones from the top to the bottom of the building: high-rise zone, mid-rise zone 2, mid-rise zone 1 and low-rise zone and the refuge being the dividing lines. Congestion is illustrated by plotting the occupants for each zone against the time elapsed (figure 5.30).

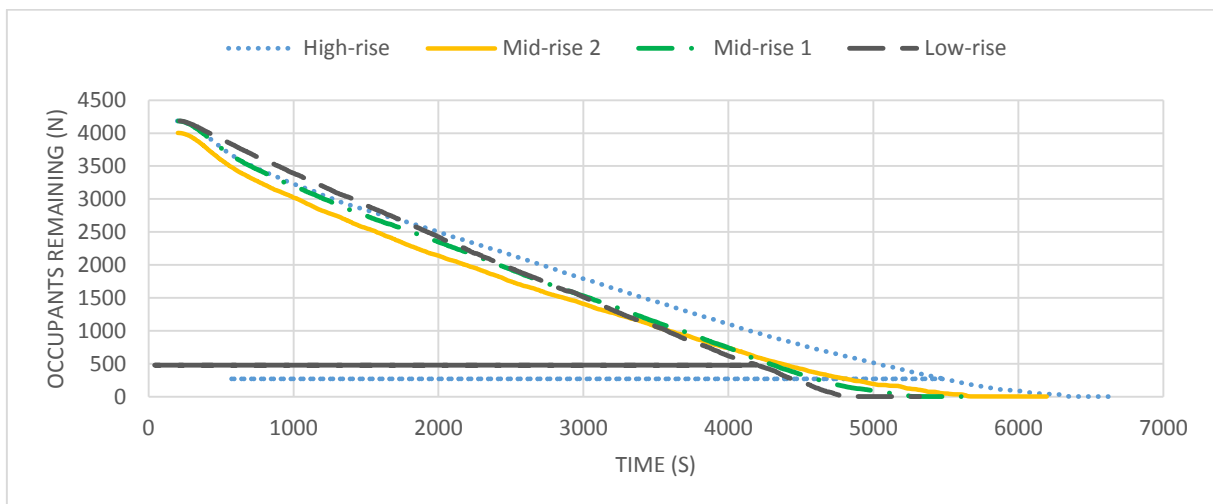

Figure 5.30. Occupants remaining in the building against average evacuation time for the different zones: high-rise zone, mid-rise zone 2, mid-rise zone 1 and low-rise.

From the curves in figure 5.30 it can be observed that there are no notable signs of congestion. The occupants belonging to the low-rise zone are the ones evacuating the building first with a total evacuation time of around 5400 seconds followed by the mid-rise zone 1 occupants with a total evacuation time of over 5500 seconds. The mid-rise zone 2 contains 182 less occupants compared to the other zones with total evacuation time of slightly over 6000 seconds. The occupants belonging to the high-rise zone are the ones with the longest evacuation time, approximately 6500 seconds.

6 Analysis

In this part the results from the model case study are analysed. A comparison between the results from different scenarios is made in consensus with the aim and objective of the study.

The differences between the scenarios that have been presented in chapter 4 are analysed in the following parts. Initially a comparison between scenarios 1, 2 and 3 is made, after which a comparison between scenarios 1 and 4 and then between scenarios 4 and 5 are made. Table 6.1 provides an overview of the different scenarios for convenience.

Table 6.1. Summary of the different scenarios under consideration. For more information about the different scenarios, the reader is referred to chapter 4.

Scenario	Floors [n]	People using the sky-bridge* [%]	Sky-bridges [n]	Sky-bridge inter-distance [floors]
1	50	100	2	15/16
2	50	50	2	15/16
3	50	15	2	15/16
4	95	100	5	15/16
5	95	100	3	22/23

*Percentage (%) of people using the sky-bridge. The remaining percentage of the people are using the stairs.

It should be noted that although an attempt to calibrate the inputs for the model has been made, there are some intrinsic limitations of evacuation models that should be considered during the analysis of evacuation model results. For instance, as described in the literature review, the study of merging flows in evacuation modelling is not fully justified by experimental data. This may affect the quantitative reliability of simulation results in which merging flows may significantly affect the results. In the present case study, when Pathfinder simulates the occupants evacuating to the sky-bridge located at the refuge floor, it may happen that the agents use the stair located closest to the sky-bridge and thereby cause a high congestion on that stair due to merging with the incoming flow from the stair. The occupants in the less congested stair can evacuate faster to the refuge floor and hinder the occupants of the congested stair to evacuate out to the floor, causing a delay in evacuation time (see figure 6.1).

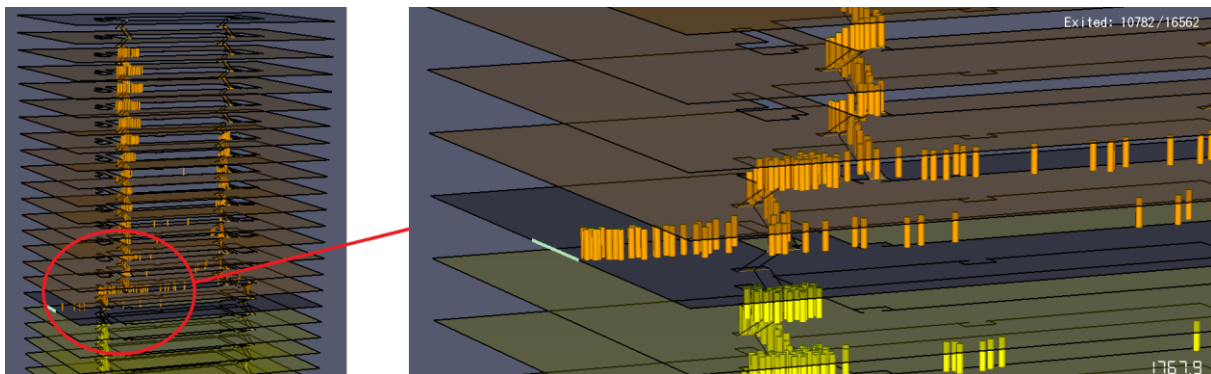

Figure 6.1. Screenshot from Pathfinder, explaining the non-deference behaviour, where occupants on the floor hinders the occupants from the stairs to enter the floor.

This means that the merging flow between the people on the refuge floor and the ones evacuating downstairs to the refuge floor may not exactly match the behaviours that may occur in a real emergency evacuation. Deference behaviour may occur in real emergencies, where people on the floor allow the ones on the stair to enter the flow. Experimental literature on the behaviour of evacuees in merging flows is scarce, thus it is not clear at this stage of experimental research how this should be simulated. Therefore the results of this study should be interpreted in a qualitative manner rather than quantitative when comparing the different scenarios.

6.1 Comparison between scenario 1, 2 and 3

The comparison between scenarios 1, 2 and 3 are made with the aim of obtaining knowledge on how the allocation of people and thereby the usage of sky-bridges affect the congestion and total evacuation time. Common for all three scenarios is that each one of them is presented by a 50 storey building with two sky-bridges (with the same inter-distance) located at refuge floors 18 and 33 and with the same amount of occupants. The difference between the scenarios in question is the percentage of people using the stairs and sky-bridges (table 6.1). In the first scenario 100% of the people are using the sky-bridge while in the second and third scenario, 50% and 15% of the occupants are using sky-bridges for evacuation respectively.

Scenario 1 provides the shortest evacuation time (see figure 5.2-5.4), followed by scenario 2 and then scenario 3. This is expected since the sky-bridge usage divides the buildings into three zones: high-rise zone, mid-rise zone and low-rise zone, thus decreasing the evacuation route for the last occupant in every zone. Figures 5.2 and 5.4 illustrate that the difference in the numbers of evacuated people increase between the scenarios with elapsed time. The reason for this is the difference in percentages of people using the sky-bridges. If the height of the building is increased and the same scenarios are simulated again with all parameters unchanged (i.e. number of people per floor, inter-distance between sky-bridges, and allocation of people using the sky-bridges), the difference in total evacuation time for the different scenarios would become even more distinct.

During the evacuation, differences regarding the flows (people/s) at each refuge floor such as flows at the exits and inflows to and outflows from the refuge floors have been noticed. Figure 5.5 illustrates the flows through the three exits available for scenario 1. The flows through the sky-bridges are almost similar with a slightly higher flow through sky-bridge 2 while the flow through sky-bridge 1 is delayed. The reason why the flow is higher through sky-bridge 2 is that the amount of occupants belonging to this zone is higher (182 more people) compared to the other zones. The delayed increase in flow for the mid-rise zone could be because of the merging flows and movement algorithm that solve congestions and thereby delay in one of the stairs. Another reason could be disabled occupants with reduced mobility who are last to evacuate or cause congestion on stairs. The flow through the lobby has an even pattern through the whole evacuation process since occupants are continuously walking downstairs towards the exits at each stair. For scenario 2 (figure 5.10) and 3 (figure 5.15) the flows at the exits are different compared to scenario 1 since not all people are using the sky-bridges to exit the building. The flow through sky-bridge 2 is delayed in both scenarios since occupants from both high-rise zone and mid-rise zone are occupying the stairs and hindering the ones from the high-rise zone evacuating downstairs to sky-bridge 2. Furthermore, the flow through the lobby exits is not even in scenario 2, with an increase in the beginning then a decrease after half of the total evacuation time and then increasing again for a short while before dropping to zero. These fluctuations can be explained by the reason that when

the occupants belonging to the low-rise zone have evacuated, the flow starts decreasing until the people from the other two zones reach the lobby exits and the flow increases once again.

The delay in total evacuation time for scenarios 2 and 3 is due to the congestion caused by the occupants evacuating through the stairs to the lobby exits (see figure 5.14 and 5.18). Since the percentage of occupants using the sky-bridges in scenario 3 is smaller compared to scenario 2, the congestion is significantly higher. In scenario 1 where all occupants are using the sky-bridges there are no signs of congestion (figure 5.9). Figure 5.9 indicates that although high-rise zone contains more occupants, the evacuation time is lower compared to the mid-rise zone. The reason for this may be associated with the modelling assumptions employed by the model to represent people movement (e.g., the methods to route choice, to solve collision avoidance and simulate congestion in merging flows). Beside the algorithm employed by Pathfinder, it is also thought that the location of the stairs has an impact on the evacuation time.

6.2 Comparison between scenario 1 and 4

The comparison between scenarios 1 and 4 is made in fact to obtain knowledge about what impact the height of the building has on congestion and total the evacuation time. Scenario 4 compared to scenario 1 has almost twice the occupant load and five sky-bridges (with same inter-distance as for scenario 1) installed, with all other parameters unchanged.

Comparing the two scenarios regarding total evacuation time, it can be observed from figures 5.2 and 5.4 that the total evacuation time for both scenarios 1 and 4 are nearly identical for all percentages of evacuees through the whole evacuation time up to 98%. At the point where 98% of the evacuees have exited the building, the evacuation time for these scenarios starts to diverge with a slightly higher evacuation time for scenario 4 towards the end.

Scenario 4 contains six exits, one at each refuge floor (five of them) and one at the lobby. The flows at the exits for scenario five are illustrated in figure 5.19 and it can be observed that these are nearly identical with the flows at the exits for scenario 1 (figure 5.5). Since 100% of the people above or at each refuge floor are using the sky-bridges to exit the building there is only one inflow to the refuge floors and one outflow through the sky-bridge (figures 5.20-5.24). In a similar way to scenario 1, the inflows to the refuge floors are almost equal to the outflows through the sky-bridges. A trend that has been observed for the flow curves in scenario 4 is that the flows at odd refuge floors (refuge floor 5, 3, 1) follow the same pattern whereas the flows in even refuge floors (refuge floor 4 and 2) follow a different pattern.

Regarding congestion, figure 5.25 illustrates that there are no notable signs of congestion for scenario 4 either. Also for the congestion curves, the odd refuge floors portray different patterns from the even refuge floors.

The reason for the trends observed for both the flow and congestion curves is thought to be the algorithm in combination with the stair location. Stairs are located in a strategic way for hindering smoke spread from one zone of the building to another. This is done by placing the stairs for odd refuge floors closer to each other and near the middle of the core of the building. The stairs for even refuge floors have longer distance between them and are placed at the outer sides of the core. From the analysis of the simulation videos it can be noted that at the odd refuge floors where the stairs are placed closer to each other, due to the movement algorithm described in the beginning

of the chapter, the stair closest to the sky-bridge is occupied by a larger amount of people. This leads the other stair to become less occupied and the occupants using it to evacuate faster to the refuge floor, which in turn hinders the other occupants using the heavily occupied stair to enter the floor. Lastly, the idea is that scenario 4 should give similar results in both flows, congestion as well in total evacuation since all parameters are the same except for the height of the building. From the analysis above, it can be noted that almost all results are similar with deviations such as evacuation time. Scenario 4 has a slightly higher total evacuation time, which is thought to be caused by disabled occupants being last to evacuate or hindering others to evacuate faster.

6.3 Comparison between scenario 4 and 5

Scenario 4 and 5 are compared with the aim of understanding what impact the inter-distance between the sky-bridges has on the congestion and total evacuation. Scenario 5 has only three sky-bridges with an inter-distance of 22/23 floors (table 6.1) whereas scenario 4 has five sky-bridges with an inter-distance of 15/16 floors, with all other parameters being the same.

With respect to scenario 5, the lower number of sky-bridges and the higher inter-distance between the different sky-bridges affects the total evacuation time in a negative way compared to scenario 4 (figures 5.2, 5.3 and 5.4). At the four exits available in scenario 5 the flow follows similar pattern as in scenario 4, however with a longer duration (figure 5.26). As for scenario 4, the inflow to the refuge floors is equal to the outflow through the sky-bridges since all people above or at the refuge floor are using the sky-bridges (figures 5.27, 5.28, and 5.29). Regarding the congestion, figure 5.30 indicates that there are no remarkable signs of congestion for scenario 5. Therefore, the total evacuation in scenario 5 is not as effective as in scenario 4.

In scenario 4, odd refuge floors portray similar flow and congestion patterns to each other while even refuge floors portray similar patterns to each other, something that cannot be observed in scenario 5. This could be because the stairs are not relocated at the refuge floors in scenario 5 as in scenario 4. Also, the movement algorithm built in the model seems may have an impact on the outcome since the occupants belonging to the mid-rise zone 1 exit the building faster than those belonging the mid-rise zone 2 (figure 5.30).

7 Discussion

In this part a general discussion about the different parts of the thesis is being argued. Possible errors and limitations of the results, views from legislations on sky-bridge usage in today's high-rise buildings, the introduction of sky-bridges within the risk management context, and a reflection on risk perception and sky-bridge usage are the things discussed here.

7.1 Possible errors and limitations

This study has been carried out by modelling different scenarios in Pathfinder in accordance with the aim and objective of the study. The decision on what scenarios should be chosen is based on hypothetical arguments on the possible behaviour of people in the context of sky-bridges. Since there is scarce knowledge on possible behaviours related to the use of sky-bridges, the scenarios chosen could be incorrect. However, it is hard to confirm the validity of the assumptions chosen for the different scenarios if no experimental data is available to compare with. Furthermore, the simulations are only done for office-buildings and the results are therefore mainly applicable for this type of building. If applied in other contexts, the results can be misleading and the user should therefore be aware of this limitation. Due to the scope of the study, only stairs and sky-bridges (and the corresponding refuge floors) are being used as egress components. If elevators were included more realistic situations would be provided since elevators are already installed in most high-rise buildings today. Total evacuation is the strategy employed in this study which usually is not very common for high-rise buildings. The reason why this strategy is not common for high-rise buildings is that that congestion may arise if all people were evacuating the building at once. However since the sky-bridge concept is being studied and the evacuation route is shorter, applying this evacuation strategy could be adequate as indicated by the results.

The modelling of the different scenarios has successfully provided information to respond to the aim of this study. However there are some limitations that need to be taken into consideration when reading the results. First, modelling assumptions used by the model may have an impact on people's movement representation. This assumption regards the representation of route choice and merging flows. What was observed in this study is that people do not always choose the route that gives shortest evacuation time but sometime choose the shortest evacuation route. Furthermore knowledge on people behaviour in the case of merging flows is relatively scarce and the inputs in the model may not be fully justified by experimental data. The second thing that has been observed from the simulations is that the location of the stairs also seems to have an impact on the process of evacuation. Stairs located close to each other cause higher congestion and therefore a longer evacuation time. However, this is just an observation from this study which was not examined in more detail and more research needs to be done to verify this observation.

The third thing that needs to be taken into consideration is that Pathfinder simulates people with disabilities in a simple way by reducing their speed compared to regular occupants. Another limitation is that fatigue, which is very common during evacuation of high-rise buildings, cannot be simulated in the model. This of course may have an impact on the total evacuation time since fatigue can be the reason to other issues during evacuation such as congestion. Therefore the results of this study have been used to rank the different simulated scenarios in a qualitative way rather than a quantitative one. It should also be noted that the limitation with people who have reduced

mobility was known prior to the simulations. A way to use this simplification and still provide realistic results is made by using the time when 98% of the evacuees have evacuated as reference time for the overall evaluation of congestions (while total evacuation times would analyse all occupants). This means that people who are stuck or the ones who are very slow are excluded from the study of congestion. Another way to go around the problem with disabled people is by introducing elevators which can be used by people with reduced mobility. Still this study shows that Pathfinder is an effective model to qualitatively rank different scenarios for high-rise buildings.

7.2 Views from legislations on sky-bridge usage on today's high-rise buildings

The results from this study indicates that the travel distance is shortened by using sky-bridges and thus the congestion and total evacuation time, which is in accordance with suggestions from other studies such as Wood et al. (2005) and Wood (2007). Legislations, such as IBC (International Code Council, 2012) and NFPA101 (NFPA, 2012), at the moment do not take into account for egress components such as sky-bridges. With the growing trend of high-rise buildings as a response to the growing population in the world, stairs are not sufficient to evacuate the building due to several factors. Therefore it is suggested that other egress components (e.g. sky-bridges, elevators, refuge floors) to be adopted in legislations. Especially if future research can confirm the effectiveness of sky-bridges, they should be adopted into building legislations. It should be highlighted that the effectiveness of the sky-bridge usage in evacuation situations is linked to the amount of people using it. If not used by a large number of occupants, the evacuation efficiency is decreased.

7.3 Introduction of sky-bridges within risk management context

As mentioned, today's buildings legislation suggests that stairs should be used to evacuate tall buildings. If a risk analysis of today's high-rise buildings is carried out, flaws will be pointed out. The attacks on September 11, 2001, for instance showed that today's high-rise buildings are not prepared for such hazards, which can occur again. This means that the risk evaluation and thus the risk assessment of risks in the context of evacuation in high-rise buildings will require control. Therefore, this study has been trying to see how the usage of sky-bridges can reduce the risks within high-rise buildings. The results from this study indicates that the usage of sky-bridge enhance the total evacuation for high-rise buildings and is therefore seen as a precaution towards increased safety for tall buildings. Nevertheless this is a simulation study and needs to be validated by experimental studies to confirm if sky-bridges really are seen as a step to increased safety for high-rise buildings.

7.4 Reflection on risk perception and sky-bridge usage

There is not a great deal of information about risk perception and human behaviour associated with sky-bridge usage. Since human behaviour and risk perception, as mentioned before, can vary depending on individuals, the best way to obtain knowledge in the field of sky-bridges is to carry out experimental studies where occupants can be followed through the whole evacuation. As this is out of the scope of this study, the above relevant collected literature about risk perception and human behaviour in fires in mind, a reflection on how risk perception and human behaviour associated with sky-bridges is presented.

It can be argued that people with no knowledge about the usage of sky-bridges are not comfortable with taking a route which they usually don't use. This action, according to the theory by Fredholm and Göransson (2006) place an individual in the "B"- or "D"-area depending on how clear a situation is. Furthermore by considering a hypothetical scenario when the alarm stops during the initial phase of the evacuation and some people are moving back to their workplace, while others are still continuing evacuation. In this situation, a person's interpretation of the situation is even more unclear which place him/her in the "D"-area. To strive towards the "A"-area, it is required to give an individual the feeling of control and clearness over the situation.

Based on the literature review, there are some ideas that can be taken into account to perform the study of sky-bridge usage: 1) affiliation theory, 2) social influence, 3) role-rule model and 4) education of both staff and employees.

By incorporating the sky-bridge in every-day activities and furthermore move similar activities as those going on, on the ground floor, to the refuge floor where the sky-bridge is linked, people will adapt a familiarity to the path. This, in accordance with the theory of affiliation increase the probability that people move towards the familiar places, which in this case would be the sky-bridge, in evacuation situations (Sime, 1985).

Another great factor that will have an impact on the selection of evacuation route is social influence. If, during an evacuation, everyone is ignoring the use of the sky-bridge as an evacuation route even the people who are familiar with it will follow the social influence and ignore it. This is due to normative social influence, i.e. people fear to do something opposite to what everyone is doing. However, there are people willing to break the trend and choose the sky-bridge to evacuate, and in this case other with the knowledge of sky-bridge as an exit route will also choose it (Nilsson & Johansson, 2009).

Furthermore, it is known from previous events that people are willing to take orders and some people even wait for orders, the so called role-rule model (Proulx, 1995). A possible implementation of the role-rule model in high-rise buildings is to assign staff on every floor the task of taking care of the other occupants during an evacuation. Those chosen individuals must be clearly marked so that other occupants understand that they should obey their orders. Using the role-rule model can therefore enhance the sky-bridge usage during evacuation. In recent years, voice alarms have become very common in many public buildings (Nilsson & Frantzich, 2010). Voice alarms telling the occupants on every floor what to do in combination with assistance from people with authority, would increase people's perception about the situation and move them towards the "A"-area in the risk perception model.

Finally, education of both staff and occupants is the key to strive towards the "A"-area where people have full control and clearness over the situation (Proulx, 2007). Educating staff and occupants for general evacuation scenarios is important since life is full of implications and unforeseeable events. A general knowledge about evacuation, instead of knowledge for a specific scenario can help people making the right decision even in new situations. For example, if a simultaneous total evacuation of two towers connected by a sky-bridge is taking place and people of both towers are trained to use the sky-bridge, congestion issues may arise if occupants of both towers use the sky-bridges at the same time. Appropriate training may instead help evacuees in

choosing the appropriate egress components which would reduce travel paths or risk exposure (Bukowski, 2010).

8 Conclusion

This chapter points out the conclusions made from the model case study simulations.

The first question concerned the evacuation efficiency depending on the allocation of people to each sky-bridge. From observations by comparing different scenarios with different allocation of people to each sky-bridge, i.e. different percentage of people using the sky-bridges, it could be seen that the evacuation efficiency using sky-bridges is mainly dependent on the amount of people using them. When all occupants above or at each refuge floor used the corresponding sky-bridge to evacuate out of the building the congestion on stairs reduced and with a decreased total evacuation time as a result. On the other hand when 50% or less people used the sky-bridges to evacuate out of the building the total evacuation time increased significantly, with more than twice the time of the scenario where all occupants used the sky-bridges to evacuate.

The second question to be answered was what impact the height of the building has on total evacuation time if the inter-distance were kept constant (same). Comparing two simulated scenarios, a 50 storey building with a 95 storey building, with the same inter-distance and the assumption that 100% of the occupants are using the sky-bridges to evacuate showed that the total evacuation time is approximately the same. The reason for this is that the buildings for the compared scenarios are divided in zones with equal height (due to the same inter-distance) which will evacuate at approximately the same time.

The third question aimed to answer what impact an increased inter-distance has on total evacuation time. The question was answered by comparing two scenarios with the same height but different inter-distance between the sky-bridges. This comparison indicates that an increased inter-distance results in zones containing more floors which in turn results in higher total evacuation time and vice versa for decreasing the inter-distance between the sky-bridges.

To summarize the conclusions above, the use of each sky-bridges above or at each refuge floor by all occupants implies that the vertical evacuation route is shortened to the inter-distance between two sky-bridges instead of the whole building height. This means in turn that the total evacuation time is significantly reduced to the time it takes to evacuate the amount of floors between two sky-bridges instead of the whole building. With this in mind, the sky-badges as an egress components permits building to still continue growing in height.

9 Future research

It is important to work proactively towards an increased safety in high-rise buildings through different sort of precautions. Since this study indicates that the use of sky-bridges as an egress component shortens the total evacuation time and thereby enhance safety in high-rise buildings it is of great concern to continue the research within this field. In this chapter some suggestions on future research are pointed out.

- **Conduct similar studies with a wider focus on the allocation of people**
Instead of focusing on different aspects, studies where only people allocation are examined in detail should be conducted. For instance, ten scenarios are carried out where the percentage of people using the sky-bridges varies from 10%-100% to obtain knowledge on how the total evacuation time varies with the percentage of people using the sky-bridges.
- **Conduct similar studies with other buildings use**
The simulations in this study have only been done for office buildings putting it in the office-building category. Therefore similar studies should be conducted for other building use verify the sky-bridge efficiency in total evacuation time.
- **Conduct similar studies where elevators also are included**
In this study the elevators have been excluded due to the time scope. However since elevators are a part of high-rise buildings around the world, a similar study taking into consideration the combination of sky-bridge, stairs and elevators as egress components should be carried out.
- **Conduct experimental studies to obtain more accurate knowledge**
This scenarios in this study are hypothetical and there is a lack of knowledge on risk perception and human behaviour in the context of sky-bridges. Therefore experimental studies should be carried out where risk perception and human behaviour are examined to validate the results from this study.

10 References

- Akselsson, R. (2011). Människa, teknik, organisation och riskhantering. Retrieved from: <http://www.lunduniversity.lu.se/o.o.i.s?id=24732&postid=3163780> [Accessed 28-11-2013].
- Ariff, A. (2003). Review of Evacuation Procedures for Petronas Twin Towers.
- Averill, J. D., Mileti, D. S., Peacock, R. D., Kuligowski, E. D., Groner, N., Proulx, G., Nelson, H. E. (2005). Final report on the collapse of the world trade center towers. *NIST NCSTAR*, 1–7.
- Barber, D., & Van Merkestein, R. (2003). Will Occupants of Tall Buildings Obey Instructions from Wardens in Staged Evacuations?—The Design Dilemma Post September 11. *CIB REPORT*, 61–70.
- Bengtson, S., Jönsson, R., & Frantzich, H. (2005). *Brandskyddshandboken: en handbok för projektering av brandskydd i byggnader*. Lunds tekniska högskola, Lunds universitet.
- Blair, A. J., & Milke, J. A. (2011). The Effect of Stair Width on Occupant Speed and Flow Rate for Egress of High Rise Buildings. I *Pedestrian and Evacuation Dynamics* (pp 747–750). Springer.
- Blake, S. J., Galea, E. R., Westeng, H., & Dixon, A. J. P. (2004). An analysis of human behaviour during the WTC disaster of 11 September 2001 based on published survivor accounts. I *Proceedings of the 3rd international symposium on human behaviour in fire*, 1–3 September 2004, Europa Hotel, Belfast, UK, pp. 181–192.
- Boyce, K. E., Purser, D. A., & Shields, T. J. (2012). Experimental studies to investigate merging behaviour in a staircase. *Fire and Materials*, 36, 383–398.
- Boyce, K. E., Shields, T. J., & Silcock, G. W. H. (1999). Toward the characterization of building occupancies for fire safety engineering: Capabilities of disabled people moving horizontally and on an incline. *Fire technology*, 35, 51–67.
- Bukowski, R. (2010). International applications of elevators for fire service access and occupant egress in fires. *CTBUH Journal (III)*, 28–584.
- Choi, J., Hwang, H., & Hong, W. (2011). Predicting the Probability of Evacuation Congestion Occurrence Relating to Elapsed Time and Vertical Section in a High-rise Building. I R. D. Peacock, E. D. Kuligowski, & J. D. Averill (Eds.), *Pedestrian and Evacuation Dynamics* (ss 37–46). Boston, MA: Springer US.
- Enander, A. (2005). *Människors förhållningssätt till risker, olyckor och kriser*. Karlstad: Räddningsverket.
- Fahy, R. F. (2012). Overview of Major Studies on the Evacuation of World Trade Center Buildings 1 and 2 on 9/11. *Fire Technology*, 49, 643–655.

- Frantzich, H., Nilsson, D., & Eriksson, O. (2007). Utvärdering och validering av utrymningsprogram. Retrieved from: <http://www.brand.lth.se/fileadmin/brandteknik/rapporter/3143.pdf> [Accessed 28-11-2013].
- Fruin, J. J. (1971). *Pedestrian planning and design*. Retrieved from: <http://trid.trb.org/view.aspx?id=114653> [Accessed 28-11-2013].
- Galea, E. R., Sharp, G., & Lawrence, P. J. (2008). Investigating the Representation of Merging Behavior at the Floor--Stair Interface in Computer Simulations of Multi-Floor Building Evacuations. *Journal of Fire Protection Engineering*, 18, 291–316.
- Göransson, A. L., Fredholm, L., & Sverige, S. räddningsverk. (2006). *Ledning av räddningsinsatser i det komplexa samhället*. Karlstad: Räddningsverket.
- Graat, E., Midden, C., & Bockholts, P. (1999). Complex evacuation; effects of motivation level and slope of stairs on emergency egress time in a sports stadium. *Safety Science*, 31, 127–141.
- Great Britain, & Department for Communities and Local Government. (2013). *The Building Regulations 2010: approved document B. Vol. 1*, [Newcastle upon Tyne]: NBS.
- Gwynne, S. M. V., Purser, D., & Boswell, D. L. (2011). Pre-Warning Staff Delay: A Forgotten Component in ASET/RSET Calculations. I R. D. Peacock, E. D. Kuligowski, & J. D. Averill (Eds.), *Pedestrian and Evacuation Dynamics* (pp 243–253). Boston, MA: Springer US.
- Gwynne, S. M. V., & Rosenbaum, E. R. (2008). Employing the hydraulic model in assessing emergency movement. *SFPE Handbook of Fire Protection Engineering*, 4th Edition. National Fire Protection Association, Quincy, MA, pp. 3-396-3-373.
- Hartmann, S. M. (2005). *A Study on Total Evacuation Versus Select Evacuation for High-rise Office Buildings*. Retrieved from: <http://drum.lib.umd.edu/handle/1903/2646> [Accessed 28-11-2013].
- Hokugo, A., Kubo, K., & Murozaki, Y. (1985). An Experimental Study on Confluence of Two Foot Traffic Flows in Staircase. *Journal of Architecture, Planning and Environmental Engineering*, 358, 37–43.
- Hong Kong Building Department. (1996). Code of Practice for Provisions of Means of Escape in Case of Fire and Allied Requirement.
- Hyun-seung, H., Jun-ho, C., & Won-hwa, H. (2011). Calculating and Verifying the Staircase-length for Evacuation Analysis. I R. D. Peacock, E. D. Kuligowski, & J. D. Averill (Eds.), *Pedestrian and Evacuation Dynamics* (pp 601–611). Boston, MA: Springer US.
- International Code Council. (2012). 2012 international building code. Country Club Hills, Ill.: ICC.
- Irvine, C. H., Snook, S. H., & Sparshatt, J. H. (1990). Stairway risers and treads: acceptable and preferred dimensions. *Applied Ergonomics*, 21, 215–225.

- Jönsson, A., Andersson, J., & Nilsson, D. (2012). A Risk Perception Analysis Of Elevator Evacuation In High-Rise Buildings.
- Kaplan, S. (1997). The Words of Risk Analysis. *Risk Analysis*, 17, 407–417.
- Koo, J., Kim, Y. S., & Kim, B.-I. (2012). Estimating the impact of residents with disabilities on the evacuation in a high-rise building: A simulation study. *Simulation Modelling Practice and Theory*, 24, 71–83.
- Kratchman, J. A. (2007). *An investigation on the effects of firefighter counterflow and human behavior in a six-story building evacuation*. Retrieved from: <http://drum.lib.umd.edu/handle/1903/6709> [Accessed 28-11-2013].
- Kuligowski, E., & Bukowski, R. W. (2004). Design of occupant egress systems for tall buildings. I *CIB World Building Congress*. Retrieved from: <http://fire.nist.gov/bfrlpubs/fire04/PDF/f04011.pdf> [Accessed 28-11-2013].
- Kuligowski, E. D. (2009). *The process of human behavior in fires*. US Department of Commerce, National Institute of Standards and Technology. Retrieved from: <http://www.drrrc.rs/nastava/nastava/UROKDIP/vanredni/tre%C4%87a%20godina/aspekti%20bezbednosti%20u%20izgradjenom%20okruzenju/THE%20PROCESS%20OF%20HUMAN%20BEHAVIOR%20IN%20FIRES.pdf> [Accessed 28-11-2013].
- Kuligowski, E. D., & Mileti, D. S. (2009). Modeling pre-evacuation delay by occupants in World Trade Center Towers 1 and 2 on September 11, 2001. *Fire Safety Journal*, 44, 487–496.
- Latané, B., & Darley, J. M. (1970). *The unresponsive bystander: why doesn't he help?* New York: Appleton-Century Crofts.
- Luo, M., & Wong, K. H. (2006). Evacuation strategy for super highrise building. I *Proceedings of 5th Annual Seminar on Tall Building Construction and Maintenance*. Hong Kong. Retrieved from: http://bst1.cityu.edu.hk/e-learning/building_info_pack/tall_building/paper_luo_ming_chun.pdf [Accessed 28-11-2013].
- McConnell, N. C., Boyce, K. E., Shields, J., Galea, E. R., Day, R. C., & Hulse, L. M. (2010). The UK 9/11 evacuation study: Analysis of survivors' recognition and response phase in WTC1. *Fire Safety Journal*, 45, 21–34.
- Mott MacDonald Simulation Group. (2012). Simulation of Transient Evacuation and Pedestrian movement STEPS User Manual 5.1 Version.
- Muha, T., & Park, O. B. (2012). Evaluating Occupant Load Factors For Business Operations. Retrieved from: <http://www.nfpa.org/assets/files/Research%20Foundation/RFEvaluatingOccupantLoadFactors.pdf> [Accessed 28-11-2013].
- National Electronic Injury Surveillance System (NEISS). (1978). *U.S. Consumer Product Safety Commission*. Retrieved from: <http://www.cpsc.gov/en/Research--Statistics/NEISS-Injury-Data/> [Accessed 28-11-2013].

- NFPA. (2012). NFPA 101 Life Safety Code.
- Nilsson, D., & Frantzich, H. (2010). Design of Voice Alarms—the Benefit of Mentioning Fire and the Use of a Synthetic Voice. I W. W. F. Klingsch, C. Rogsch, A. Schadschneider, & M. Schreckenberg (Eds.), *Pedestrian and Evacuation Dynamics 2008* (pp 135–144). Berlin, Heidelberg: Springer Berlin Heidelberg.
- Nilsson, D., & Johansson, A. (2009). Social influence during the initial phase of a fire evacuation—Analysis of evacuation experiments in a cinema theatre. *Fire Safety Journal*, *44*, 71–79.
- Nilsson, J. (2003). Introduktion till riskanalysmetoder (Report 3124). *Lund: Lund University, Department of Fire Safety Engineering and Systems Safety*.
- Pan, X., Han, C. S., Dauber, K., & Law, K. H. (2007). A multi-agent based framework for the simulation of human and social behaviors during emergency evacuations. *Ai & Society*, *22*, 113–132.
- Pang, E. C. L., & Chow, W. K. (2011). Adequacy of Safe Egress Design Codes for Supertall Buildings. *Journal of Disaster Research*.
- Pauls, J. (1984). The Movement of People in Buildings and Design Solutions for Means of Egress. Presenterad vid Ninth Australian Conference on Fire sponsored by the Australian Fire Protection Association, Sydney, September, 1983.
- Pauls, J. L. (1982). Recommendations for improving the safety of stairs. *Building Practice Note, Institute for Research in Construction, National Research Council Canada*, (35), 14.
- Pauls, J. L., Fruin, J. J., & Zupan, J. M. (2007). Minimum stair width for evacuation, overtaking movement and counterflow—technical bases and suggestions for the past, present and future. I *Pedestrian and evacuation dynamics 2005* (pp 57–69). Springer.
- Peacock, R. D., Averill, J. D., & Kuligowski, E. D. (2010). Stairwell Evacuation from Buildings: What We Know We Don't Know. I W. W. F. Klingsch, C. Rogsch, A. Schadschneider, & M. Schreckenberg (Eds.), *Pedestrian and Evacuation Dynamics 2008* (pp 55–66). Berlin, Heidelberg: Springer Berlin Heidelberg.
- Proulx, G. (1995). Evacuation time and movement in apartment buildings. *Fire Safety Journal*, *24*, 229–246.
- Proulx, G. (2007). High-rise office egress: the human factors. I *Proceedings of Symposium on High-Rise Building Egress Stairs*. New York. Retrieved from: <http://archive.nrc-cnrc.gc.ca/obj/irc/doc/pubs/nrcc49496/nrcc49496.pdf> [Accessed 28-11-2013].
- Proulx, G., & Fahy, R. F. (2003). Evacuation of the World Trade Center: what went right. *CIB REPORT*, 27–34.
- Purser, D. , & Bensilum, M. (2001). Quantification of behaviour for engineering design standards and escape time calculations. *Safety Science*, *38*, 157–182.
- Renn, O. (1998). The role of risk perception for risk management. *Reliability Engineering & System Safety*, *59*, 49–62.

- Ronchi, E., & Nilsson, D. (2012). Fire Evacuation in High-Rise Buildings: A Review on Human Behaviour and Modelling Research. Retrieved from: <http://lup.lub.lu.se/record/3914813> [Accessed 28-11-2013].
- Ronchi, E., & Nilsson, D. (2013). Modelling total evacuation strategies for high-rise buildings. *Building Simulation*, 7, 73–87.
- Ronchi, E., Reneke, P. A., & Peacock, R. D. (2013). A Method for the Analysis of Behavioural Uncertainty in Evacuation Modelling. *Fire Technology*, 1-27.
- Savage, I. (1993). Demographic Influences on Risk Perceptions. *Risk Analysis*, 13, 413–420.
- Sherman, M. F., Peyrot, M., Magda, L. A., & Gershon, R. R. M. (2011). Modeling pre-evacuation delay by evacuees in World Trade Center Towers 1 and 2 on September 11, 2001: A revisit using regression analysis. *Fire Safety Journal*, 46, 414–424.
- Sime, J. (1980). The Concept of “Panic”. In D. Cantor (Ed.), *Fires and Human Behaviour*. Chichester: John Wiley & Sons Ltd.
- Sime, J. D. (1985). Movement toward the familiar person and place affiliation in a fire entrapment setting. *Environment and Behavior*, 17, 697–724.
- Slovic, P. (2001). The risk game. *Journal of hazardous materials*, 86, 17–24.
- Spearpoint, M., & MacLennan, H. A. (2012). The effect of an ageing and less fit population on the ability of people to egress buildings. *Safety Science*, 50, 1675–1684.
- Takeichi, N., Yoshida, Y., Sano, T., Kimura, T., Watanabe, H., & Ohmiya, Y. (2005). Characteristics of merging occupants in a staircase. I *Proceedings of the Eighth International Symposium on Fire Safety Science* (pp 591–598).
- Tavares, R. M. (2008). Evacuation Processes Versus Evacuation Models: “Quo Vadimus”? *Fire Technology*, 45, 419–430.
- Thunderhead Engineering. (2013). Pathfinder 2013.1.0925 Version. Technical Reference. Retrieved from: www.thunderheadeng.com [Accessed 28-11-2013].
- Tong, D., & Canter, D. (1985). The decision to evacuate: a study of the motivations which contribute to evacuation in the event of fire. *Fire Safety Journal*, 9, 257–265.
- Tubbs, J., & Meacham, B. (2009). Selecting Appropriate Evacuation Strategies for Super Tall Buildings: Current Challenges and Needs. I *Conference Proceedings for 4th International Symposium on Human Behaviour in Fire*, Robinson College, Cambridge, 13-15 July 2009. Interscience Communications, pp. 41-50.
- Wilde, G. J. S. (2001). *Target risk 2: a new psychology of safety and health : what works? what doesn't? and why--*. Toronto: PDE Publications.
- Wood, A. (2003). Pavements in the sky: the skybridge in tall buildings. *Architectural Research Quarterly*, 7, 325–332.

- Wood, A. (2007). Alternative Forms of Tall Building evacuation. I *In Proceedings of: AEI/NIST Conference on High-Rise Building Egress*.
- Wood, A. (2010). *Tall buildings: search for a new typology*. University of Nottingham. Retrieved from: <http://etheses.nottingham.ac.uk/1486/> [Accessed 28-11-2013].
- Wood, A., Chow, W. K., & McGrail, D. (2005). The Skybridge as an Evacuation Option for Tall Buildings for Highrise Cities in the Far East. *Journal of Applied Fire Science*, 13, 113–124.
- Wood, P. G. (1972). *The behaviour of people in fires*. Fire Research Station.

Appendix A

This section contains the summary of the characteristics of the model case geometry for the different scenarios. Information regarding floor numbering, floor height and inter-distance between floors, for the different scenarios can be obtain from the tables A1-A3.

Table A1.1 Characteristics of the model case geometry for scenario 1-3. Floor description from floor 19 to roof.

Description	Floor	Height (m)	Floor to floor distance (m)
ROOF	Roof	200.9	3
MEP	50	198.4	4
MEP	49	194.5	4
Office/High	48	190.5	4
Office/High	47	186.5	4
Office/High	46	182.6	4
Office/High	45	178.6	4
Office/High	44	174.7	4
Office/High	43	170.7	4
Office/High	42	166.7	4
Office/High	41	162.8	4
Office/High	40	158.8	4
Office/High	39	154.8	4
Office/High	38	150.9	4
Office/High	37	146.9	4
Office/High	36	143	4
Office/High	35	139	4
Office/High	34	135	4
Office/Refuge M_H	33	131.1	4
Office/Mid	32	127.1	4
Office/Mid	31	123.1	4
Office/Mid	30	119.2	4
Office/Mid	29	115.2	4
Office/Mid	28	111.3	4
Office/Mid	27	107.3	4
Office/Mid	26	103.3	4
Office/Mid	25	99.4	4
Office/Mid	24	95.4	4
Office/Mid	23	91.4	4
Office/Mid	22	87.5	4
Office/Mid	21	83.5	4
Office/Mid	20	79.6	4
Office/Mid	19	75.6	4

Table A1.2 Characteristics of the model case geometry for scenario 1-3. Floor description from floor 1 to 18.

Description	Floor	Height (m)	Floor to floor distance (m)
Office/Refuge L_M	18	71.6	4
Office/Low	17	67.7	4
Office/Low	16	63.7	4
Office/Low	15	59.7	4
Office/Low	14	55.8	4
Office/Low	13	51.8	4
Office/Low	12	47.9	4
Office/Low	11	43.9	4
Office/Low	10	39.9	4
Office/Low	9	36	4
Office/Low	8	32	4
Office/Low	7	28	4
Office/Low	6	24.1	4
Office/Low	5	20.1	4
Office/Low	4	16.2	4
Office/Low	3	12.2	6
Office/Low	2	6.1	6
Lobby	1	0	0

Table A2.1. Characteristics of the model case geometry for scenario 4. Floor description from floor 78 to roof.

Description	Floor	Height (m)	Floor to floor distance (m)
ROOF	Roof	380,7	4
MEP	95	376,7	4
MEP	94	372,8	4
Office/High	93	368,8	4
Office/High	92	364,9	4
Office/High	91	360,9	4
Office/High	90	356,9	4
Office/High	89	353	4
Office/High	88	349	4
Office/High	87	345	4
Office/High	86	341,1	4
Office/High	85	337,1	4
Office/High	84	333,2	4
Office/High	83	329,2	4
Office/High	82	325,2	4
Office/High	81	321,3	4
Office/High	80	317,3	4
Office/High	79	313,3	4
Office/Refuge M4_H	78	309,4	4

Table A2.2. Characteristics of the model case geometry for scenario 4. Floor description from floor 36 to 77.

Office/Mid4	77	305,4	4
Office/Mid4	76	301,5	4
Office/Mid4	75	297,5	4
Office/Mid4	74	293,5	4
Office/Mid4	73	289,6	4
Office/Mid4	72	285,6	4
Office/Mid4	71	281,6	4
Office/Mid4	70	277,7	4
Office/Mid4	69	273,7	4
Office/Mid4	68	269,8	4
Office/Mid4	67	265,8	4
Office/Mid4	66	261,8	4
Office/Mid4	65	257,9	4
Office/Mid4	64	253,9	4
Office/Refuge M3_M4	63	250	4
Office/Mid3	62	246	4
Office/Mid3	61	242	4
Office/Mid3	60	238,1	4
Office/Mid3	59	234,1	4
Office/Mid3	58	230,1	4
Office/Mid3	57	226,2	4
Office/Mid3	56	222,2	4
Office/Mid3	55	218,2	4
Office/Mid3	54	214,3	4
Office/Mid3	53	210,3	4
Office/Mid3	52	206,4	4
Office/Mid3	51	202,4	4
Office/Mid3	50	198,4	4
Office/Mid3	49	194,5	4
Office/Refuge M2_M3	48	190,5	4
Office/Mid2	47	186,5	4
Office/Mid2	46	182,6	4
Office/Mid2	45	178,6	4
Office/Mid2	44	174,7	4
Office/Mid2	43	170,7	4
Office/Mid2	42	166,7	4
Office/Mid2	41	162,8	4
Office/Mid2	40	158,8	4
Office/Mid2	39	154,8	4
Office/Mid2	38	150,9	4
Office/Mid2	37	146,9	4
Office/Mid2	36	143	4

Table A2.3. Characteristics of the model case geometry for scenario 4. Floor description from floor 1 to 35.

Office/Mid2	35	139	4
Office/Mid2	34	135	4
Office/Refuge M1_M2	33	131,1	4
Office/Mid1	32	127,1	4
Office/Mid1	31	123,1	4
Office/Mid1	30	119,2	4
Office/Mid1	29	115,2	4
Office/Mid1	28	111,3	4
Office/Mid1	27	107,3	4
Office/Mid1	26	103,3	4
Office/Mid1	25	99,4	4
Office/Mid1	24	95,4	4
Office/Mid1	23	91,4	4
Office/Mid1	22	87,5	4
Office/Mid1	21	83,5	4
Office/Mid1	20	79,6	4
Office/Mid1	19	75,6	4
Office/Refuge L_M1	18	71,6	4
Office/Low	17	67,7	4
Office/Low	16	63,7	4
Office/Low	15	59,7	4
Office/Low	14	55,8	4
Office/Low	13	51,8	4
Office/Low	12	47,9	4
Office/Low	11	43,9	4
Office/Low	10	39,9	4
Office/Low	9	36	4
Office/Low	8	32	4
Office/Low	7	28	4
Office/Low	6	24,1	4
Office/Low	5	20,1	4
Office/Low	4	16,2	4
Office/Low	3	12,2	6
Office/Low	2	6,1	6
Lobby	1	0	0

Table A3.1. Characteristics of the model case geometry for scenario 5. Floor description from floor 56 to roof.

Description	Floor	Height (m)	Floor to floor distance (m)
ROOF	Roof	380,7	4
MEP	95	376,7	4
MEP	94	372,8	4
Office/High	93	368,8	4
Office/High	92	364,9	4
Office/High	91	360,9	4
Office/High	90	356,9	4
Office/High	89	353	4
Office/High	88	349	4
Office/High	87	345	4
Office/High	86	341,1	4
Office/High	85	337,1	4
Office/High	84	333,2	4
Office/High	83	329,2	4
Office/High	82	325,2	4
Office/High	81	321,3	4
Office/High	80	317,3	4
Office/High	79	313,3	4
Office/High	78	309,4	4
Office/High	77	305,4	4
Office/High	76	301,5	4
Office/High	75	297,5	4
Office/High	74	293,5	4
Office/High	73	289,6	4
Office/High	72	285,6	4
Office/Refuge M2_H	71	281,6	4
Office/Mid2	70	277,7	4
Office/Mid2	69	273,7	4
Office/Mid2	68	269,8	4
Office/Mid2	67	265,8	4
Office/Mid2	66	261,8	4
Office/Mid2	65	257,9	4
Office/Mid2	64	253,9	4
Office/Mid2	63	250	4
Office/Mid2	62	246	4
Office/Mid2	61	242	4
Office/Mid2	60	238,1	4
Office/Mid2	59	234,1	4
Office/Mid2	58	230,1	4
Office/Mid2	57	226,2	4
Office/Mid2	56	222,2	4

Table A3.2. Characteristics of the model case geometry for scenario 5. Floor description from floor 14 to 55.

Office/Mid2	55	218,2	4
Office/Mid2	54	214,3	4
Office/Mid2	53	210,3	4
Office/Mid2	52	206,4	4
Office/Mid2	51	202,4	4
Office/Mid2	50	198,4	4
Office/Refuge M1_M2	49	194,5	4
Office/Mid1	48	190,5	4
Office/Mid1	47	186,5	4
Office/Mid1	46	182,6	4
Office/Mid1	45	178,6	4
Office/Mid1	44	174,7	4
Office/Mid1	43	170,7	4
Office/Mid1	42	166,7	4
Office/Mid1	41	162,8	4
Office/Mid1	40	158,8	4
Office/Mid1	39	154,8	4
Office/Mid1	38	150,9	4
Office/Mid1	37	146,9	4
Office/Mid1	36	143	4
Office/Mid1	35	139	4
Office/Mid1	34	135	4
Office/Mid1	33	131,1	4
Office/Mid1	32	127,1	4
Office/Mid1	31	123,1	4
Office/Mid1	30	119,2	4
Office/Mid1	29	115,2	4
Office/Mid1	28	111,3	4
Office/Mid1	27	107,3	4
Office/Refuge L_M1	26	103,3	4
Office/Low	25	99,4	4
Office/Low	24	95,4	4
Office/Low	23	91,4	4
Office/Low	22	87,5	4
Office/Low	21	83,5	4
Office/Low	20	79,6	4
Office/Low	19	75,6	4
Office/Low	18	71,6	4
Office/Low	17	67,7	4
Office/Low	16	63,7	4
Office/Low	15	59,7	4
Office/Low	14	55,8	4

Table A3.3. Characteristics of the model case geometry for scenario 4. Floor description from floor 1 to 13.

Office/Low	13	51,8	4
Office/Low	12	47,9	4
Office/Low	11	43,9	4
Office/Low	10	39,9	4
Office/Low	9	36	4
Office/Low	8	32	4
Office/Low	7	28	4
Office/Low	6	24,1	4
Office/Low	5	20,1	4
Office/Low	4	16,2	4
Office/Low	3	12,2	6
Office/Low	2	6,1	6
Lobby	1	0	0

Legend:

ROOF	Top of the building
MEP	Mechanical, Electrical and Plumbing floor
Office/High	High-rise floor with office use
Office/Refuge M_H	Refuge floor between mid-rise zone and high-rise zone, with office use
Office/Mid	Mid-rise floor with office use
Office/Refuge L_M	Refuge floor between low-rise zone and mid-rise zone, with office use
Office/Low	Low-rise floor with office use
Lobby	Building lobby
Office/Refuge M4_H	Refuge floor between mid-rise zone 4 and high-rise zone
Office/Mid4	Mid-rise floor 4 with office use
Office/Refuge M3_M4	Refuge floor between mid-rise zone 3 and mid-rise zone 4
Office/Mid3	Mid-rise floor 3 with office use
Office/Refuge M2_M3	Refuge floor between mid-rise zone 2 and mid-rise zone 3
Office/Mid2	Mid-rise floor 2 with office use
Office/Refuge M1_M2	Refuge floor between mid-rise zone 1 and mid-rise zone 2
Office/Mid1	Mid-rise floor 1 with office use
Office/Refuge L_M1	Refuge floor between low-rise zone and mid-rise zone 1

Appendix B

In this annex the calculation of the error of means (%) is described for scenario 1. The error of means for the other scenario (scenario 2-5) is calculated in a similar manner. Furthermore, the plot over the error of means for every scenario is also represented in this chapter.

The evacuation time (EV) when 98% of the occupants have left the building for 15 runs has been selected from the simulation files. Thereafter the progressive mean (PM) for each run is being calculated by using equation 1.

$$PM = \sum_{n=0}^{15} \frac{EV_n}{n} \quad \text{Equation 1}$$

Equation 1 simply means that the progressive mean PM for a specific run i is calculated by summarizing the evacuation time when 98% of the occupants have evacuated for run 1 (EV_1) to run n (EV_n) and divide it with the specific run number n . This calculation can be seen in table B1.

Table B1. The calculated values for the progressive mean (PM) for the different scenarios.

Scenario 1	Scenario 2	Scenario 3	Scenario 4	Scenario 5
Progressive means (s)	Progressive means (s)	Progressive means (s)	Progressive means (s)	Progressive means (s)
3065	7905	8250	3325	8250
3450	7625	8748	3370	8748
3330	7557	8615	3352	8615
3293	7523	8490	3346	8490
3360	7564	8678	3344	8678
3312	7500	8644	3374	8644
3284	7466	8621	3362	8621
3273	7445	8628	3355	8628
3280	7456	8646	3356	8646
3340	7453	8616	3360	8616
3320	7469	8572	3355	8572
3303	7484	8550	3349	8550
3291	7482	8538	3348	8538
3275	7497	8523	3340	8523
3262	7484	8572	3337	8572

Subsequently a column (table B2) with the differences in progressive means (DPM) between two consecutive runs is calculated in absolute values, i.e. $[mean(n+1)] - [mean(n)]$. This column is then used to calculate the error of means (EOM).

Table B2. The calculated values for the differences in progressive means (DPM) for the different scenarios.

Scenario 1	Scenario 2	Scenario 3	Scenario 4	Scenario 5
mean n+1- mean n (abs value)	mean n+1- mean n (abs value)	mean n+1- mean n (abs value)	mean n+1- mean n (abs value)	mean n+1- mean n (abs value)
385	280	498	45	110
120	68	133	18	0
38	34	125	5	1
68	42	188	2	3
48	64	34	30	25
28	34	23	12	14
11	21	7	7	8
8	11	18	1	17
60	3	30	3	12
19	16	44	5	2
18	16	22	5	6
12	2	12	1	14
16	15	15	8	0
13	13	49	2	3

The error of means (*EOM*) is finally calculated by dividing the value for of the difference in progressive means (*DPM*) between two runs by its corresponding progressive mean (*PM*) (see table B3) according to equation 2.

$$EOM = \frac{DPM_n}{PM_n}$$

Equation 2

Table B3. The calculated values for the error of means (EOM) for the different scenarios

Scenario 1	Scenario 2	Scenario 3	Scenario 4	Scenario 5
Error of the means (%)	Error of the means (%)	Error of the means (%)	Error of the means (%)	Error of the means (%)
11.16	3.67	5.69	1.34	2.03
3.60	0.90	1.54	0.55	0.00
1.14	0.45	1.47	0.16	0.02
2.01	0.55	2.17	0.07	0.06
1.46	0.85	0.39	0.89	0.45
0.86	0.45	0.27	0.36	0.25
0.34	0.29	0.09	0.21	0.15
0.23	0.14	0.21	0.03	0.30
1.78	0.03	0.35	0.10	0.21
0.57	0.21	0.52	0.15	0.04
0.53	0.21	0.26	0.16	0.10
0.36	0.03	0.14	0.04	0.26
0.49	0.20	0.18	0.24	0.00
0.41	0.17	0.57	0.07	0.05

The error of means for every scenario (1-5) are illustrated in figure B1-B5.

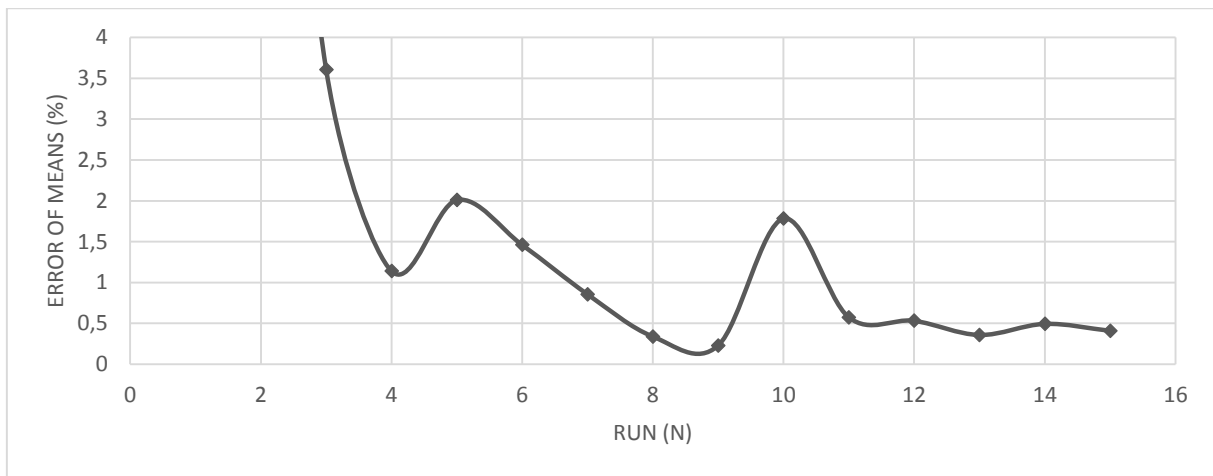

Figure B1. Error of means (%) against number of runs (n) for scenario 1.

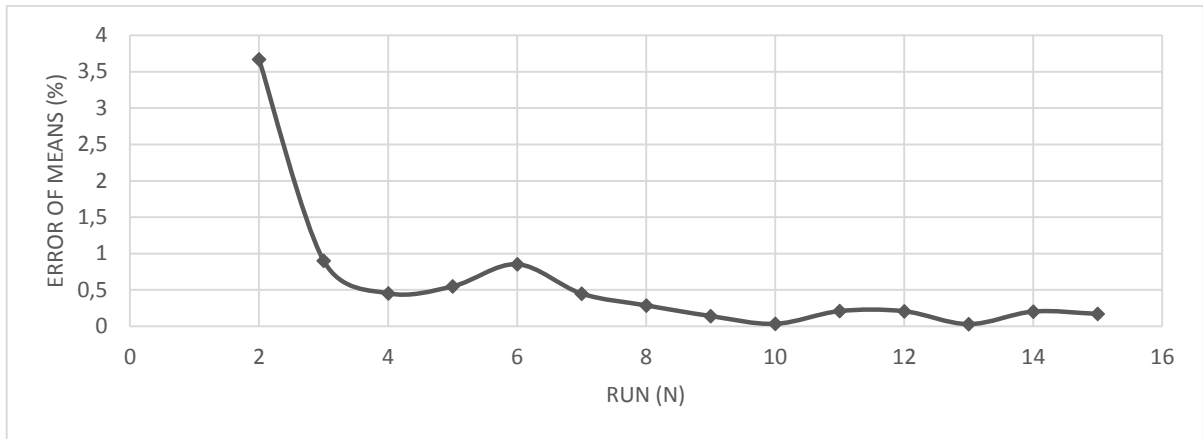

Figure B2. Error of means (%) against number of runs (n) for scenario 2.

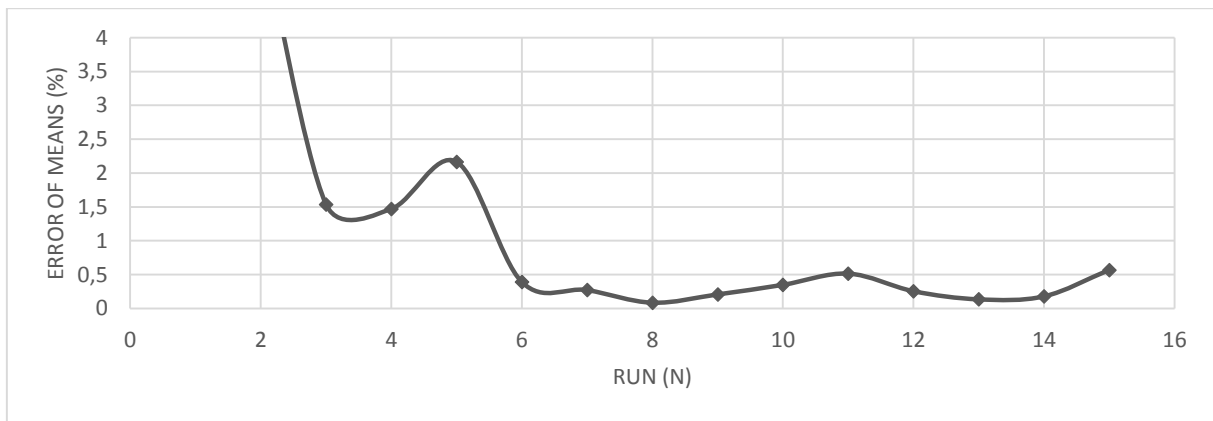

Figure B3. Error of means (%) against number of runs (n) for scenario 3.

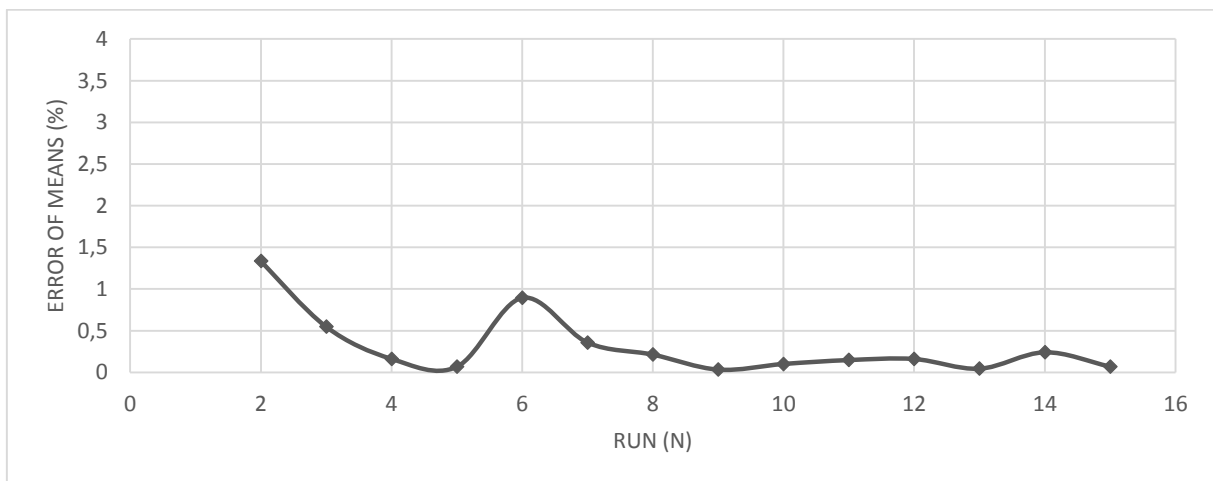

Figure B4. Error of means (%) against number of runs (n) for scenario 4.

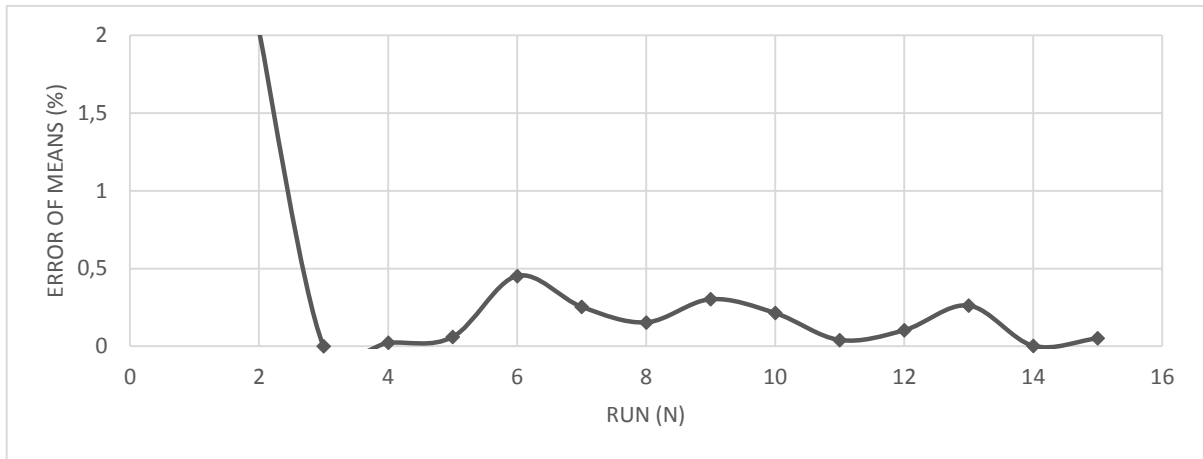

Figure B5. Error of means (%) against number of runs (n) for scenario 5.