

## General Disclaimer

### One or more of the Following Statements may affect this Document

- This document has been reproduced from the best copy furnished by the organizational source. It is being released in the interest of making available as much information as possible.
- This document may contain data, which exceeds the sheet parameters. It was furnished in this condition by the organizational source and is the best copy available.
- This document may contain tone-on-tone or color graphs, charts and/or pictures, which have been reproduced in black and white.
- This document is paginated as submitted by the original source.
- Portions of this document are not fully legible due to the historical nature of some of the material. However, it is the best reproduction available from the original submission.

07 1 125 1 3

# Hypersonic Research Facilities Study (U)

## Volume II Part 2 Phase I Preliminary Studies Flight Vehicle Synthesis

Prepared Under Contract No. NAS2-5458  
by  
Advanced Engineering  
MCDONNELL AIRCRAFT COMPANY  
for

OART - ADVANCED CONCEPTS AND MISSIONS DIVISION  
NATIONAL AERONAUTICS AND SPACE ADMINISTRATION  
Moffett Field, California 94035

CLASSIFICATION CHANGE

To UNCLASSIFIED

By authority of *[Signature]*  
Changed by *[Signature]* Date *12/17/70*  
Classified Document Master Control Station, NASA  
Scientific and Technical Information Facility

(NASA-CR-114324) HYPERSONIC RESEARCH  
FACILITIES STUDY. VOLUME 2, PART 2, PHASE  
1: PRELIMINARY STUDIES FLIGHT VEHICLE  
SYNTHESIS (U) Summary (McDonnell Aircraft  
Corp.) 2 Oct. 1970 350 p  
CSCL 14B F3/11

AVAILABLE TO U.S. GOVERNMENT AGENCIES  
AND CONTRACTORS ONLY

X71-10882

Conf  
70015

**MCDONNELL AIRCRAFT COMPANY**

**MCDONNELL DOUGLAS**



~~CONFIDENTIAL~~

MDC A0013  
2 OCTOBER 1970  
CONTROL NO. C-252000  
COPY NO. 84

NASA CR 114324

07 1 125 1 3

# Hypersonic Research Facilities Study (U)

## Volume II Part 2 Phase I Preliminary Studies Flight Vehicle Synthesis

Prepared Under Contract No. NAS2-5458  
by  
Advanced Engineering  
MCDONNELL AIRCRAFT COMPANY  
for  
OART - ADVANCED CONCEPTS AND MISSIONS DIVISION  
NATIONAL AERONAUTICS AND SPACE ADMINISTRATION  
Moffett Field, California 94035

CLASSIFIED  
BY 20204/15/77  
SUBJECT TO GENERAL DECLASSIFICATION POLICY OF  
EXECUTIVE ORDER 11652, AS AMENDED  
AT TWO YEAR INTERVALS AND DECLASSIFIED ON DECEM-  
BER 31, 1977.

This material contains information affecting the national defense of  
the United States within the meaning of the espionage laws, Title 18,  
U.S.C., sections 793 & 794, the transmission or revelation of which  
in any manner to an unauthorized person is prohibited by law.

~~GROUP 1  
DOWNGRADED AND DECLASSIFIED AT TWO YEAR INTERVALS;  
DECLASSIFIED AT 12 YEARS.  
DND DIR 8200~~

**MCDONNELL AIRCRAFT COMPANY**

Box 516, Saint Louis, Missouri 63166 - Tel. (314)232-0232

~~CONFIDENTIAL~~ MCDONNELL DOUGLAS

CORPORATION

FOREWORD

This report summarizes the results of Phase I of the Hypersonic Research Facilities Study performed from 1 July 1969 through 19 September 1969 under National Aeronautics and Space Administration Contract NAS2-5458 by McDonnell Aircraft Company (MCAIR), St. Louis, Missouri, a division of McDonnell Douglas Corporation.

The study was sponsored by the Office of Advanced Research and Technology with Mr. Richard H. Petersen as Study Monitor and Mr. Hubert Drake as alternate Study Monitor.

Mr. Charles J. Pirrello was Manager of the HYFAC project and Mr. Paul A. Czysz was Deputy Manager. The study was conducted within MCAIR Advanced Engineering, which is directed by Mr. R. H. Belt, Vice President, Aircraft Engineering. The HYFAC study team was an element of the Advanced Systems Concepts project managed by Mr. Harold D. Altis.

The support of the following engine companies in the flight vehicle synthesis is gratefully acknowledged: AiResearch Manufacturing Division of the Garrett Corporation, The General Electric Company, The Marquardt Company, and Pratt and Whitney Aircraft.

The basic task of Phase I was to establish the desirable research objectives for hypersonic flight, and to evaluate the research return available from various candidate facilities, including the impact of facility cost. The Phase I study has been conducted in accordance with the requirements and instructions of NASA RFP A-15109 (HK-81), McDonnell Technical Proposal Report G970, and OART correspondence received during the Phase I period.

This is Volume II, Part 2 of the overall HYFAC Report, which is organized as follows:

		<u>NASA CONTRACTOR REPORT NUMBER</u>
Volume I	Summary	CR 114322
Volume II	Phase I Preliminary Studies	
	Part 1 - Research Requirements and Ground Facility Synthesis	CR 114323
	Part 2 - Flight Vehicle Synthesis	CR 114324
Volume III	Phase II Parametric Studies	
	Part 1 - Research Requirements and Ground Facility Synthesis	CR 114325
	Part 2 - Flight Vehicle Synthesis	CR 114326
Volume IV	Phase III Final Studies	
	Part 1 - Flight Research Facilities	CR 114327
	Part 2 - Ground Research Facilities	CR 114328
	Part 3 - Research Requirements Analysis and Facility Potential	CR 114329
Volume V	Limited Rights Data	CR 114330
Volume VI	Operational System Characteristics	CR 114331

ACKNOWLEDGEMENTS

This work was performed by an Aircraft Advanced Engineering study team with Charles J. Pirrello as Study Manager.

The following contributed significantly to the contents of this volume:

S. Banaskavich	Weights
R. Bay	Flight Test
R. Dighton	System Analysis
L. Garner	Flight Vehicle Design
L. Hair	Propulsion
V. Pagel	Thermodynamics
D. Peters	Flight Vehicle Costs
J. Schudel	Research Requirements Evaluation
J. Sinnett	Propellants
T. Lacey	Aerodynamics and Performance
F. Slagle	Flight Vehicle Costs
K. Weber	Structures and Materials

SUMMARY

Airbreathing hypersonic aircraft employing liquid hydrogen fuel have the potential of satisfying a number of mission requirements in the 1980-2000 time period. However, major advances in the technological state of the art are necessary before such aircraft can be considered either feasible or practical. The objective of Contract NAS2-5458 was to assess the research and development requirements for hypersonic aircraft and based on these requirements, to provide the NASA with characteristics of a number of desirable hypersonic research facilities. The study is organized in three phases. Phase I is a preliminary analysis of a broad group of concepts. The purpose of Phase I was to compare the characteristics of these facilities considering research capability, versatility, adaptability, system confidence and costs and based on these comparisons select those facilities that appear most attractive for parametric study and further refinement in Phase II. This part of Volume II presents the results of the design and cost synthesis of the flight research facilities. The significant results obtained are:

1. Air breathing propulsion systems are costly to develop.
2. Staged vehicles are most economical for selective tasks, although the scope of these tasks is limited.
3. Significant size and cost differentials exist between the following launch concepts: STAGED - AIRLAUNCH - H.T.O.
4. Manned research vehicles are not significantly larger or heavier than unmanned research vehicles.
5. Wing body shape is best suited to storable propellants.
6. All body shape is best suited to cryogenic propellants.
7. Off-the-shelf rocket or turbojet acceleration engines appear feasible.
8. An air launched Mach 12 rocket powered vehicle research program cost of between 500 and 600 million dollars appears feasible.
9. A ground takeoff Mach 12 rocket powered vehicle research program cost of between 600 and 700 million dollars appears feasible.

TABLE OF CONTENTS

<u>Section</u>	<u>Title</u>	<u>Page</u>
1.	INTRODUCTION	
	(Contained in Separate Unclassified Document - Volume II, Part 1)	
2.	PHASE I ANALYSIS - PRELIMINARY STUDIES	
	(Contained in Separate Unclassified Document - Volume II, Part 1)	
3.	HYPERSONIC RESEARCH REQUIREMENTS	
	(Contained in Separate Unclassified Document - Volume II, Part 1)	
4.	FLIGHT RESEARCH VEHICLE SYNTHESIS	
4.1	Vehicle Configurations . . . . .	4-1
	4.1.1 Design Options . . . . .	4-2
	4.1.2 Concepts . . . . .	4-3
4.2	Design Criteria . . . . .	4-9
	4.2.1 Design Base . . . . .	4-9
	4.2.2 Structural . . . . .	4-12
	4.2.3 Propulsion Design . . . . .	4-14
4.3	Aerodynamics . . . . .	4-16
	4.3.1 Aerodynamic/Propulsion Force Allocation . . . . .	4-16
	4.3.2 L/D <sub>max</sub> Estimation . . . . .	4-17
	4.3.3 Lift Estimation . . . . .	4-17
	4.3.4 Drag Estimation . . . . .	4-24
	4.3.5 Stability and Control . . . . .	4-32
4.4	Propulsion . . . . .	4-36
	4.4.1 Engine Contractor Effort in Advanced Propulsion . . . . .	4-36
	4.4.2 Selected Cycles . . . . .	4-39
	4.4.3 Engine Selection and Description . . . . .	4-40
	4.4.4 Engine-Airframe Integration . . . . .	4-44
4.5	Structures . . . . .	4-53
4.6	Thermodynamics . . . . .	4-55
	4.6.1 External Surface Temperatures . . . . .	4-55
	4.6.2 Thermal Protection . . . . .	4-55

TABLE OF CONTENTS

<u>Section</u>	<u>Title</u>	<u>Page</u>
4.7	Propellant System . . . . .	4-59
4.8	Avionic Subsystems . . . . .	4-61
4.8.1	Navigation . . . . .	4-61
4.8.2	Communication . . . . .	4-64
4.8.3	Flight Sensors and Control . . . . .	4-64
4.8.4	Controls and Displays . . . . .	4-65
4.9	Vehicle Performance . . . . .	4-66
4.9.1	Performance Ground Rules . . . . .	4-66
4.9.2	Propulsion Utilization and Performance . . . . .	4-67
4.9.3	Trajectory Analyses . . . . .	4-69
4.9.4	Vehicle Sizing Technique . . . . .	4-70
4.9.5	Performance Summary . . . . .	4-81
4.10	Flight Operations and Test Requirements . . . . .	4-99
4.10.1	Flight Development Requirements . . . . .	4-99
4.10.2	Data Acquisition Requirements . . . . .	4-100
4.10.3	Mission Planning . . . . .	4-101
4.10.4	Mission Support . . . . .	4-110
4.11	Weight and Balance . . . . .	4-112
4.11.1	Basic Structure Weight Estimation Methodology . . . . .	4-114
4.11.2	Weight Estimation Methods for Structure Operating at Elevated Temperature and for Thermal Protection System . . . . .	4-135
4.11.3	Engine Weight Estimation . . . . .	4-137
4.11.4	System Weight Estimation . . . . .	4-140
4.11.5	Useful Load Estimation . . . . .	4-145
4.11.6	APU Fuel . . . . .	4-145
4.12	Flight Research Facility Costs . . . . .	4-146
4.12.1	Approach and Definitions . . . . .	4-147
4.12.2	Estimating Procedures and Program Cost Development . . . . .	4-152
4.12.3	Data Application . . . . .	4-203
4.12.4	Cost Summary . . . . .	4-211
4.13	Data Summaries . . . . .	4-215
4.13.1	Design Characteristics and Performance . . . . .	4-215
4.13.2	Weights . . . . .	4-273
4.13.3	Total System Cost Summary . . . . .	4-287



TABLE OF CONTENTS

<u>Section</u>	<u>Title</u>	<u>Page</u>
5.	FLIGHT RESEARCH VEHICLE SCREENING AND SELECTION . . . . .	5-1
5.1	Vehicle Evaluation and Screening . . . . .	5-4
5.1.1	Facility Screening . . . . .	5-19
5.1.2	Selection of Attractive Facilities . . . . .	5-24
5.1.3	Design and Operational Concept Comparisons . . . . .	5-26
5.2	Recommended Facilities for Phase II Studies . . . . .	5-39
6.	REFERENCES . . . . .	6-1

List of Pages

Title	Page
i through xxii	
4-1 through 4-288	
5-1 through 5-40	
6-1 through 6-2	

LIST OF ILLUSTRATIONS

<u>Figure</u>		<u>Page</u>
4-1	Flight Research Facility - Design Option Matrix . . . . .	4-3
4-2	Flight Research Facility - Concept Matrix . . . . .	4-5
4-3	Preliminary Structural And Thermostructural Concepts . . . . .	4-10
4-4	Phase I Propellant Volume Allocation . . . . .	4-11
4-5	Preliminary Structural Design Criteria . . . . .	4-13
4-6	Propellant Matrix . . . . .	4-15
4-7	Propellant Properties - Phase I . . . . .	4-15
4-8	Force Allocation . . . . .	4-18
4-9	(L/D) <sub>max</sub> Variation . . . . .	4-19
4-10	(L/D) <sub>max</sub> Correlation Mach 2.0 . . . . .	4-19
4-11	(L/D) <sub>max</sub> Correlation Mach 5.0 . . . . .	4-20
4-12	(L/D) <sub>max</sub> Correlation Mach 12.0. . . . .	4-20
4-13	(L/D) <sub>max</sub> Comparison Subsonic Wing Body. . . . .	4-21
4-14	(L/D) <sub>max</sub> Correlation Subsonic All Body. . . . .	4-21
4-15	Propulsive Lift/Drag Increments . . . . .	4-22
4-16	Lift Increment Due to Centrifugal Force . . . . .	4-22
4-17	Lift Increments Due to Centrifugal Force and Propulsion Lift . . . . .	4-23
4-18	Lift Curve Slope of Wing-Body Configurations . . . . .	4-25
4-19	$C_{L\alpha_0}$ and Induced Drag Factor - Wing Body Configurations. . . . .	4-26
4-20	$C_{L\alpha_0}$ and Induced Drag Factor - All Body Configurations . . . . .	4-26
4-21	Typical $C_L$ VS. $\alpha$ Variation . . . . .	4-27
4-22	Operational Lift Coefficient and Angle of Attack Levels . . . . .	4-28
4-23	Wing Body VS. All Body Drag Comparison . . . . .	4-29
4-24	Drag Rise Correlation Supersonic Configurations . . . . .	4-31
4-25	Drag Rise Correlation Hypersonic Configurations . . . . .	4-31
4-26	Leading Edge Suction Parameter Wing-Body Configurations . . . . .	4-33
4-27	Neutral Point Comparison . . . . .	4-34
4-28	Vehicle Control Systems . . . . .	4-34
4-29	Speed Brake Size and Effectiveness-Aft Fuselage Brakes-Subsonic . . . . .	4-35
4-30	Engine Configurations - Rockets and Turbojets . . . . .	4-42
4-31	Engine Configurations - Turboramjets, Ramjets, and Scramjets . . . . .	4-43
4-32	Booster Configurations . . . . .	4-45
4-33	Engine Matrix . . . . .	4-46
4-34	Engine Characteristics . . . . .	4-47
4-35	Rocket Engine Applications . . . . .	4-48
4-36	Turbojet and Turbofan Engine Applications . . . . .	4-49
4-37	Characteristics of "Off-The-Shelf" Rocket Engines . . . . .	4-49
4-38	Characteristics of "Off-The-Shelf" TJ and TF Engines . . . . .	4-50
4-39	Engine Installations . . . . .	4-52
4-40	Configuration 210 Maximum Surface Temperatures . . . . .	4-56
4-41	Configuration 257 Maximum Surface Temperatures . . . . .	4-56
4-42	Equivalent Step Input of Surface Temperature . . . . .	4-57
4-43	Comparison of Active and Passive Insulation Weights and Thicknesses . . . . .	4-58
4-44	Flight Facility Avionics . . . . .	4-62
4-45	Comparison of Rocket VS. Airbreather Acceleration - Climb Profiles. . . . .	4-67
4-46	Propulsion System Utilization for Air Vehicles With Two Propulsion Systems . . . . .	4-68

LIST OF ILLUSTRATIONS

<u>Figure</u>		<u>Page</u>
4-47	Turbojet Installation . . . . .	4-69
4-48	L/D <sub>max</sub> Equilibrium Glide Descent . . . . .	4-71
4-49	Mach 4.5 Unpowered Windup Turn N <sub>Z</sub> = 3.5g . . . . .	4-72
4-50	Mach 6.0 Unpowered Windup Turn N <sub>Z</sub> = 3.5g . . . . .	4-72
4-51	Mach 12.0 Unpowered Windup Turn N <sub>Z</sub> = 3.5g . . . . .	4-73
4-52	Drag Losses . . . . .	4-75
4-53	Gravity Rocket Boost . . . . .	4-76
4-54	Pressure and Maneuvering Losses . . . . .	4-77
4-55	Simplified Method Verified by Detail Trajectory Analysis Closed Form Solution VS. Steepest Configuration 250 . . . . .	4-79
4-56	Performance Comparison Hypersonic Research Vehicles . . . . .	4-83
4-57	Airbreathers Require Wing - Body Configurations to Achieve Transonic Acceleration . . . . .	4-85
4-58	Effect of Design Mach Number and Launch Mode on Vehicle Weight Using Rocket For Acceleration; Airbreather for Cruise . . . . .	4-86
4-59	Effect of Design Mach Number on Air Vehicle Weight Using Airbreather Propulsion . . . . .	4-87
4-60	Effect of Various Design Variables on Air Vehicle Gross Weight . . . . .	4-88
4-61	Flight Profile Mach 4.5 Airbreather Acceleration, Configuration 200 . . . . .	4-90
4-62	Flight Profile Mach 6.0, HTO Rocket VS. Airbreather Accelerator . . . . .	4-90
4-63	Flight Profile Mach 12.0, HTO Rocket VS. Airbreather Accelerator . . . . .	4-91
4-64	Effect of Design Mach No. on Gross Weight Using Two Rocket Designs Horizontal Take-Off . . . . .	4-92
4-65	Rocket Utilization Tradeoff on M=12 Air Launched Mission . . . . .	4-93
4-66	Rocket Augmentation Reduces OWE For Convertible Scramjet Vehicle . . . . .	4-94
4-67	Mission Profile - Single Base Operation Configuration 254 . . . . .	4-96
4-68	Take-Off And Landing Speed . . . . .	4-97
4-69	(L/D) <sub>max</sub> Comparison Clean Configuration (Gear Up) . . . . .	4-98
4-70	Example Minimum Range Profile . . . . .	4-102
4-71	Mission Performance and Research Aircraft Capability . . . . .	4-103
4-72	Test Range Summary . . . . .	4-104
4-73	Candidate Test Range for Rocket Accelerated Missions . . . . .	4-105
4-74	Candidate Test Range for TRJ Accelerated Mach 6 Missions . . . . .	4-105
4-75	Candidate Test Range for Airlaunched and HTO Rocket Accelerated Mach 6 Missions . . . . .	4-106
4-76	Candidate Test Range for Scramjet Accelerated Mach 12 Mission . . . . .	4-106
4-77	Alternate Candidate Test Ranges for Airlaunched/HTO Rocket Accelerated Mach 12 Missions . . . . .	4-108
4-78	Alternate Candidate Test Ranges for Airlaunched/HTO Rocket Accelerated Mach 12 Missions . . . . .	4-108
4-79	Alternate Candidate Test Ranges for Airlaunched/HTO Rocket Accelerated Mach 12 Missions . . . . .	4-109
4-80	Alternate Candidate Test Ranges for Airlaunched TRJ Accelerated Mach 6 Mission . . . . .	4-109
4-81	Relative Airframe Weight VS. Temperature . . . . .	4-113

LIST OF ILLUSTRATIONS

<u>Figure</u>		<u>Page</u>
4-82	Gross Takeoff Weight of Liquid Hydrogen Tankage Thermal Protection Systems . . . . .	4-115
4-83	MCAIR Structural Weight Estimation Method . . . . .	4-117
4-84	Ti-6Al-4V - Weight Coefficient VS. Temperature . . . . .	4-136
4-85	Titanium Wing Weight Comparison . . . . .	4-136
4-86	Composite Stabilator Weight Comparison . . . . .	4-137
4-87	Scramjet Module Weight Trends . . . . .	4-138
4-88	GE 5/JZ6C Engine Weight VS. Uninstalled Thrust . . . . .	4-139
4-89	GE 14/JZ8 Engine Weight VS. Uninstalled Thrust . . . . .	4-139
4-90	LR-129 Rocket Weight VS. Vacuum Thrust . . . . .	4-139
4-91	MIST/ARES Rocket Weight VS. Vacuum Thrust . . . . .	4-139
4-92	Hydraulic & Surface Controls Weight VS. APU Start System Weight and APU Propellant System Weight . . . . .	4-144
4-93	APU - Start System/APU Propellant VS. Electrical Power Required . . . . .	4-144
4-94	Flight Research Vehicle Cost Models . . . . .	4-146
4-95	Cost Estimating Relationships and Data Summary . . . . .	4-153
4-96	Flight Research Facility Concepts . . . . .	4-161
4-97	Airframe Characteristics and Costs . . . . .	4-163
4-98	Manhours Per Lb. VS. DCPR Weight (Total Engineering) . . . . .	4-165
4-99	Engineering Price Per Lb. VS. DCPR Weight . . . . .	4-167
4-100	Pre-delivery Flight Test Program Flight Summary . . . . .	4-169
4-101	X-15 Preliminary Flight Test Evaluation Program . . . . .	4-170
4-102	Tooling Price Per Lb. VS. DCPR Weight . . . . .	4-173
4-103	Propulsion System Characteristics and Costs . . . . .	4-174
4-104	Rocket Engine Propulsion Costs - LR-129 Class, Cryogenic Fuel . . . . .	4-179
4-105	Rocket Engine Propulsion Costs - MIST Class, Storable Fuel . . . . .	4-180
4-106	Turboramjet Propulsion Costs . . . . .	4-181
4-107	Production Price Per Lb. VS. DCPR Weight . . . . .	4-185
4-108	Scramjet Recurring Propulsion Cost . . . . .	4-189
4-109	Launch Platform Modification Cost . . . . .	4-192
4-110	Operating Cost Summary . . . . .	4-195
4-111	Flight Research Facility Mission Times (Phase I) . . . . .	4-197
4-112	Vehicle Refurbishment Cost Summary . . . . .	4-198
4-113	Propellant Cost Summary . . . . .	4-199
4-114	Flight Vehicle Transportation Cost Summary . . . . .	4-202
4-115	DCPR Weight for Configuration 250 . . . . .	4-204
4-116	Material Density for Configuration 250 . . . . .	4-205
4-117	Equipment Costs for Configuration 250 . . . . .	4-206
4-118	Production Complexity for Configuration 250 . . . . .	4-209
4-119	Material Weight Summary for Configuration 250 . . . . .	4-210
4-120	RDT&E Cost Summary (Illustrating the Effect of Propulsion Dev) . . . . .	4-212
4-121	Total System Cost Summary . . . . .	4-213
4-122	Cost Comparison Summary . . . . .	4-216
4-123	Reference Comparison Hypersonic Research Vehicles . . . . .	4-217
4-124	Configuration 200 . . . . .	4-219
4-125	Cost/Weight Summary Configuration 200. . . . .	4-220
4-126	Configuration 201 . . . . .	4-221
4-127	Configuration 204 and 205 . . . . .	4-222
4-128	Cost/Weight Summary Configuration 204. . . . .	4-223

LIST OF ILLUSTRATIONS

<u>Figure</u>		<u>Page</u>
4-129	Cost/Weight Summary Configuration 205 . . . . .	4-224
4-130	Configuration 206 . . . . .	4-225
4-131	Configuration 207 . . . . .	4-226
4-132	Cost/Weight Summary Configuration 207 . . . . .	4-227
4-133	Configuration 210 . . . . .	4-228
4-134	Cost/Weight Summary Configuration 210 . . . . .	4-229
4-135	Configuration 211 . . . . .	4-230
4-136	Configurations 212, 213 . . . . .	4-231
4-137	Cost/Weight Summary Configuration 213 . . . . .	4-232
4-138	Configuration 214 . . . . .	4-233
4-139	Cost/Weight Summary Configuration 214 . . . . .	4-234
4-140	Configurations 220 and 221 . . . . .	4-235
4-141	Cost/Weight Summary Configuration 220 . . . . .	4-236
4-142	Cost/Weight Summary Configuration 221 . . . . .	4-237
4-143	Configurations 231, 232 . . . . .	4-238
4-144	Cost/Weight Summary Configuration 232 . . . . .	4-239
4-145	Configuration 233 . . . . .	4-240
4-146	Cost/Weight Summary Configuration 233 . . . . .	4-241
4-147	Configuration 234 . . . . .	4-242
4-148	Cost/Weight Summary Configuration 234 . . . . .	4-243
4-149	Configuration 250 and 250J2S . . . . .	4-244
4-150	Cost/Weight Summary Configuration 250 . . . . .	4-245
4-151	Cost/Weight Summary Configuration 250J2S . . . . .	4-246
4-152	Configurations 251, 255, 256, and 256 H1D . . . . .	4-247
4-153	Cost/Weight Summary Configuration 251 . . . . .	4-248
4-154	Cost/Weight Summary Configuration 255 . . . . .	4-249
4-155	Cost/Weight Summary Configuration 256 . . . . .	4-250
4-156	Cost/Weight Summary Configuration 256 H1D . . . . .	4-251
4-157	Configuration 252 and 253 . . . . .	4-252
4-158	Cost/Weight Summary Configuration 252 . . . . .	4-253
4-159	Cost/Weight Summary Configuration 253 . . . . .	4-254
4-160	Configuration 254 . . . . .	4-255
4-161	Cost/Weight Summary Configuration 254 . . . . .	4-256
4-162	Configuration 257 . . . . .	4-257
4-163	Cost/Weight Summary Configuration 257 . . . . .	4-258
4-164	Configuration 270 . . . . .	4-259
4-165	Cost/Weight Summary Configuration 270 . . . . .	4-260
4-166	Configuration 271 . . . . .	4-261
4-167	Cost/Weight Summary Configuration 271 . . . . .	4-262
4-168	Configuration 280 . . . . .	4-263
4-169	Cost/Weight Summary Configuration 280 . . . . .	4-264
4-170	Configuration 281 and 282 . . . . .	4-265
4-171	Cost/Weight Summary Configuration 281 . . . . .	4-266
4-172	Cost/Weight Summary Configuration 282 . . . . .	4-267
4-173	Configuration 284 . . . . .	4-268
4-174	Cost/Weight Summary Configuration 284 . . . . .	4-269
4-175	Configuration 285 . . . . .	4-270
4-176	Cost/Weight Summary Configuration 285 . . . . .	4-271
4-177	Configurations 290, 291, 292 . . . . .	4-272
4-178	Horizontal Takeoff M = 12 Manned Configurations . . . . .	4-275

LIST OF ILLUSTRATIONS

<u>Figure</u>		<u>Page</u>
4-179	Propellant Volume VS. Wing Planform Area Trends . . . . .	4-276
4-180	M = 6.0 Manned Configurations . . . . .	4-278
4-181	M = 12.0 Manned Vertical Takeoff/Air Launched Configurations . . . . .	4-279
4-182	Unmanned Vertical Takeoff (Staged) Configurations . . . . .	4-281
4-183	M = 4.5 Manned Horizontal Takeoff Configuration . . . . .	4-282
4-184	M = 12.0 Ground Launched Vehicles O.W.E. VS. Sp . . . . .	4-283
4-185	M = 12.0 Ground Launched Vehicles TOGW VS. Sp . . . . .	4-284
4-186	Active VS. Passive Cooling Systems Concept Comparison Operating Weight Empty VS. Wing Planform Area . . . . .	4-286
4-187	Active VS. Passive Cooling Systems Concepts Comparison Propellant Volume VS. Wing Planform Areas . . . . .	4-286
4-188	Total System Cost Summary . . . . .	4-288
5-1	Flight Research Facility Concepts . . . . .	5-2
5-2	Flight Envelope Comparison . . . . .	5-3
5-3	Flight Envelope Comparison . . . . .	5-3
5-4	Performance Comparison . . . . .	5-6
5-5a thru 5-5i	Configuration Evaluation Summary . . . . .	5-8
5-6	Facility Screening Process . . . . .	5-17
5-7	Typical Weight Comparison - Manned, Unmanned . . . . .	5-26
5-8	Manned - Unmanned Comparison . . . . .	5-27
5-9	Value Comparison - Flight Vehicle Control Mode . . . . .	5-27
5-10	Propellant Comparisons . . . . .	5-28
5-11	All Body - Elliptic All Body Comparison . . . . .	5-29
5-12	All Body to Winged Body Comparisons . . . . .	5-30
5-13	Launch Mode Comparisons . . . . .	5-31
5-14	Value Comparisons - Flight Vehicle Launch Mode, Mach 12 . . . . .	5-32
5-15	Launch Mode Comparisons . . . . .	5-33
5-16	Value Comparison - Flight Vehicle Launch Mode, Mach 6 . . . . .	5-33
5-17	M = 12 Cost and Weight Comparisons (HTO) . . . . .	5-35
5-18	M = 12 Cost and Weight Comparisons (VTO and Air Launch) . . . . .	5-35
5-19	M = 4.5 and M = 6.0 Cost and Weight Comparisons (HTO and Air) . . . . .	5-36
5-20	M = 6 and M = 12 Cost and Weight Comparisons (Staged, Unmanned) . . . . .	5-36
5-21	Cost Trends . . . . .	5-36
5-22	Effect of Design Mach No. on Vehicle Weight . . . . .	5-37
5-23	Value Comparison - Propulsion Modes, M = 12 Vehicles . . . . .	5-38
5-24	Recommended Phase II Facilities . . . . .	5-39

LIST OF SYMBOLS

<u>Symbol</u>	<u>Definition</u>
a	acceleration
A	area
AR	aspect ratio
$\alpha$	angle of attack, ratio of wing span to vehicle length
$\beta$	ratio of mean aerodynamic chord to vehicle length, side slip
b	wing span
$C_D$	drag coefficient
$C_{D_0}$	zero lift drag coefficient
C	cross sectional area of wind tunnel test section
$\bar{c}$	mean aerodynamic chord
$C_R$	wing root chord
$C_T$	wing tip chord
$C_l$	balance normal force load capacity divided by balance diameter squared
$C_L$	lift coefficient
$C_{L_\alpha}$	lift curve slope
$C_{L_{\alpha_0}}$	lift curve slope at zero lift
$C_m$	pitching moment
$\gamma$	ratio of specific heats, flight path angle
d	diameter, balance diameter
D	drag
$\delta$	deflection
$\Delta$	increment between two values

LIST OF SYMBOLS (Cont)

<u>Symbol</u>	<u>Definition</u>
$\Delta t$	test time
$\Delta V$	equivalent velocity requirement
$\Delta V_i$	velocity increment due to $i^{\text{th}}$ cause
$\Delta C_{D_0}$	incremental drag at zero lift
$e$	span efficiency factor
$E_c$	compressive modulus of elasticity
$\epsilon$	nozzle expansion ratio
$F_{tu}$	ultimate tensile strength
$F_{ty}$	yield tensile strength
$F$	propulsive thrust
$f/a$	fuel to air weight ratio
$g$	acceleration due to gravity
$g_0$	acceleration due to gravity, sea level, $45^\circ$ geographic latitude = $9.80665 \text{ m/sec}^2$
$H$	geopotential pressure altitude
$h$	wind tunnel test section height, vehicle fuselage height
$H_2$	molecular hydrogen
$I_{sp}$	specific impulse
$K$	additional drag factor, ratio of model wing area to wind tunnel test section cross sectional area
$K_D$	inlet process efficiency
$l$	moment arm, length
$L'$	induced drag factor
$L$	lift, length



LIST OF SYMBOLS (Cont)

<u>Symbol</u>	<u>Definition</u>
L/D	lift to drag ratio
m	mass
M	Mach number, bending moment
$\dot{m}$	mass flow
$n_z$	flight path normal load factor
$\eta_{KE}$	inlet kinetic energy efficiency
N.F.	normal force
n	inlet height-to-width ratio
N <sub>2</sub> O <sub>4</sub>	nitrogen tetroxide
O <sub>2</sub>	molecular oxygen
o/f	oxidizer to fuel weight flow ratio
p	pressure
$\phi$	fuel equivalence ratio, ratio of actual fuel flow to stoichiometric fuel flow
$\theta$	angle between shock attachment point and cowl lip
q	dynamic pressure
R	specific gas constant
R <sub>E</sub>	mean radius of the earth 6,371,100 m
$\mathcal{R}$	universal gas constant (8.31432 joules/°K mol)
Re	Reynolds number
$\rho$	density
$\sigma, F_s$	stress
S	area
S/R	dimensionless entropy

LIST OF SYMBOLS (Cont)

<u>Symbol</u>	<u>Definition</u>
t	time
T	temperature
$T_r$	recovery temperature
$T_w$	wall temperature
V	velocity
Vol	volume
$\dot{w}$	weight flow
w	weight
$\psi$	heading angle, yaw angle
Z	geometric altitude

LIST OF SYMBOLS (Cont)

SUBSCRIPTS

Propulsion Station Designations

0	free stream
c	capture, a fixed reference area on vehicle
cowl	cowl lip
2	engine face
3	engine exit
e	nozzle exit
t	nozzle throat

General

aero	attributable to aerodynamic forces
c	chamber conditions, cruise
cent	attributable to centrifugal forces
D	drag
E	empty
e	engine exit
eff	effective
f	final
F	frontal
i	initial
$\infty$	free stream
G	associated with gravity forces, gross
I	ideal
M	maneuvering

LIST OF SYMBOLS (Cont)

<u>Symbol</u>	<u>Definition</u>
max	maximum
min	minimum
N	net
o	isentropic reservoir conditions, evaluated at zero lift
prop	attributable to propulsion system
P	associated with pressure forces, planform
R	wing root
S	structural
s	vehicle, model stagnation
t	total conditions corresponding to isentropic case
TO	takeoff
TJ	attributable to turbojet propulsion system
SJ	attributable to scramjet propulsion system
t	wing tip
test	associated with test time
wet	wetted
vac	associated with vacuum conditions
x	longitudinal direction
y	lateral direction
z	vertical direction

LIST OF ABBREVIATIONS

<u>Abbreviation</u>	<u>Definition</u>
ARC	Ames Research Center
A	ampere
A-h	Ampere-hour
AB	all body
A/D	analog to digital conversion
Alt	altitude
AM	amplitude modulation
Aero 50	Aerozine 50, a 50/50 mixutre of UDMH and Hydrazine
bp	boiling point
Btu	British thermal unit
°C	degrees Celcius (centigrade)
c.g.	center of gravity
c.p.	center of pressure
cm	centimeters
CSJ	convertible scramjet
db	decibel
D/A	digital to analog conversion
diam	diameter
eng	engine
°F	degrees Fahrenheit
FRC	Flight Research Center
ft	feet
fps	feet per second
GE	General Electric Co.

LIST OF ABBREVIATIONS (Cont)

<u>Abbreviation</u>	<u>Definition</u>
hr	hour
Hz	hertz
HF	high frequency
HTO	horizontal takeoff
HYFAC	Hypersonic Research Facilities
ILS	instrument landing system
in.	inch
inst	installed
IRFNA	inhibited red fuming nitric acid
J	joule
JP	jet propulsion fuel
°K	degrees Kelvin (absolute)
kg	kilogram
L	liquid
lb	pounds, force
LO <sub>2</sub>	liquid oxygen
LH <sub>2</sub>	liquid hydrogen
lbm	pounds, mass
mi	mile
m	meter
max	maximum
min	minimum
MCAIR	McDonnell Aircraft Company
MDAC (EAST)	McDonnell Douglas Astronautics Company (EAST)

LIST OF ABBREVIATIONS (Cont)

<u>Abbreviation</u>	<u>Definition</u>
nmi	nautical mile
N	newtons
No.	number
OWE	operational weight empty
psi	pounds per square inch
PFRT	Preliminary Flight Rating Test
P&WA	Pratt & Whitney Aircraft
°R	degrees Rankine (absolute)
R&D	research and development
RDT&E	research, development, test, and evaluation
RF	radio frequency
RJ	ramjet
RKT	rocket
RP	rocket propellant
s, sec	seconds
SJ	scramjet
smi	statute mile
TF	turbofan
TIT	turbine inlet temperature
TJ	turbojet
TMC	The Marquard Corporation
TRJ	turboramjet
TOGW	takeoff gross weight
UARL	United Aircraft Research Laboratory

LIST OF ABBREVIATIONS (Cont)

<u>Abbreviation</u>	<u>Definition</u>
UDMH	unsymmetrical dimethyl hydrazine
UHF	ultra high frequency
uninst	uninstalled
VTO	vertical takeoff
V	volt
WB	winged body
W/O	without
wt	weight
W	watt



#### 4. FLIGHT RESEARCH VEHICLE SYNTHESIS

(U) A review of the research objectives presented in Section 3 indicates a flight research aircraft can contribute significantly to the development and/or verification of the technology required for hypersonic aircraft systems. A series of flight research aircraft concepts were selected, evaluated, and compared to determine which concepts could most efficiently contribute to the required research. This section describes the candidate flight research aircraft concepts studied, their design criteria, design and performance characteristics, and related program costs.

##### 4.1 VEHICLE CONFIGURATIONS

(U) Many of the technological elements of hypersonic aircraft for commercial, military, or recoverable launch applications are remarkably common. A research vehicle concept capable of satisfying requirements for a particular class of vehicles will, in many cases, provide a major research contribution for other vehicle classes. The selection of the candidate flight research aircraft required consideration of the similarities as well as the diverse needs of each of the potential operational systems presented in Volume VI.

(U) In developing the matrix of possible candidate flight research aircraft, the parameters considered were:

- (1) Maximum design speed
- (2) Configuration/shape
- (3) Control mode
- (4) Launch mode
- (5) Acceleration propulsion concepts
- (6) Cruise propulsion concepts
- (7) Fuel type
- (8) Versatility.

(U) The primary goals in the design of a flight research vehicle are high design confidence, minimum cost, maximum versatility and maximum research capability consistent with the desired research program. To attain these goals, many combinations of aircraft configurations and component concepts were assessed and screened.

(U) In the initial phase of configuration layout, an effort was made to stabilize as many variables as possible and to maintain a consistency of design techniques. In this way small variations in performance created by variations in design options can be accurately assessed.

(U) The use of a low density fuel, such as LH<sub>2</sub>, generally creates a volume limited aircraft, whereas the dense fuels generally create weight limited designs. Based on this, the initial decision was to basically use a wing-body shape for dense fuels and an all-body shape for LH<sub>2</sub>, with three vehicles assigned to examine the alternate combinations. During Phase I it became evident that with turbo-accelerator power, the steep transonic drag rise for the all-body shape created size and weight problems. It was necessary to use wing-body shapes for these concepts in order to reduce drag and achieve an improved design.

(U) The procedure for sizing vehicles to achieve the desired 5 minute test mission consists of first drawing a vehicle that, based on previous studies, contains the design concepts needed to meet the functional requirements. From this "as drawn" vehicle, cross sectional area distribution and wetted area distribution are measured and plotted, and the operating weight empty (OWE) is estimated. Scaling techniques established for each particular class of vehicle are used to determine the vehicle volume, fuel volume, and weight trends which are plotted as a function of planform area. These trends, the calculated weights and volumes, and similar performance calculations and trends are put into a computer "sizing" program to establish the required vehicle size to meet the mission. The results of this program are then broken down into component group weights to verify that the solution is practical.

(U) To facilitate evaluation and screening of the candidate vehicles, a "design base" was established using ground rules and assumptions based on previous concepts developed by MCAIR. The individual elements of this design base do not represent an "optimum" design, but do yield performance and weight data that are responsive to variations in environment and vehicle function.

(U) In Phase I this technique operated as a gross sorting of conceptual ideas, and established the relative desirability of a specific approach to hypersonic flight research. Both the ground rules and the analysis methods used assume balanced designs.

4.1.1 (U) DESIGN OPTIONS - Figure 4-1 presents the various alternatives in design and operational parameters studied during Phase I. Combination of these alternatives into specific concepts was believed to provide a sufficiently broad study base that would encompass most all of the attractive concepts possible. Obviously a numerical evaluation of all of these combinations was not possible. A manageable group of specific concepts was selected as defined in Figure 4-2. Assessments of the potential of the remaining concepts is then possible from extrapolation of the results for the specific concepts studied.

(U) The candidate concepts were grouped in classes according to maximum design cruise speed of  $M = 0.9, 2.0, 4.5, 6.0,$  and  $12.0$ . This grouping considered subsonic flight requirements, available variable stability test equipment, materials, temperature capability, and propulsion system and fuel temperature capabilities. The upper limit on design cruise speed of Mach 12 is derived from the study requirements and appears to be a reasonable goal for airbreathing propulsion systems.

(U) FIGURE 4-1  
 FLIGHT RESEARCH FACILITY - DESIGN OPTION MATRIX

<u>Crew</u>	<u>Launch Mode</u>	<u>Configuration</u>
Manned	VTO	All Body
Unmanned	Staged	Wing Body
	HTO	
	Air Launch	

<u>Acceleration Engine</u>	<u>Hypersonic Engine</u>	<u>Propellant Type</u>
TJ	RJ	JP
Rocket	SJ	LH <sub>2</sub>
TRJ	CSJ	LOX-LH <sub>2</sub>
	Rocket	N <sub>2</sub> O <sub>4</sub> -AERO-50
		LOX-RP

(U) Much useful data can be obtained with unmanned aircraft, but experience has shown that mission success can often be achieved by pilot recognition and decision making ability. Tradeoffs of size, weight, complexity, and mission flexibility required that both control modes be investigated.

(U) Launch modes include air launch, horizontal takeoff, vertical takeoff, and vertical takeoff-staged. Air launch and staged research vehicles are generally of smaller size and the air launch technique may permit single base operation. However, both launch modes are dependent on auxiliary equipment and the attendant logistics and supply problems.

(U) Horizontal takeoff aircraft exhibit a flexibility of operation that more nearly approximates the desired operational concept. The vertical takeoff vehicle can operate independently of takeoff runway, but does require a T/W of greater than one.

(U) Aircraft body shapes considered were wing-body, MCAIR all-body, and elliptical all body cross section. Propulsion concepts considered for initial airplane acceleration are turbojet, turboramjet, and rocket.

(U) Cruise propulsion concepts considered cover a complete stable of engines. However, the only concept capable of operation from subsonic to Mach 12 is the rocket engine. Turbojets, ramjets, and scramjets each have an upper or lower Mach number limit for operation. Each cruise propulsion concept and its applicable speed range was considered in the generation of the candidate research vehicle matrix.

(U) Postulated fuels are also limited in application in most cases and flight requirements for each type of fuel became a part of the overall matrix evolution problem.

4.1.2 (U) CONCEPTS - The flight research vehicles shown in the Flight Research Facility Concepts Matrix (Figure 4-2) represent the potentially useful combinations of design options.

FLIGHT RESEARCH FACILITY CONCEPT MATRIX

Model	Control Mode		Configuration Shape		Launch Concept			Engine		Acceleration			Engine			Hypersonic			Landing Mode	Study Significance	Remarks
	Man	Un-	Wing-Body	All Body	Air	HTO	VTO	Staged	TJ	RKT	CRY	STOR	RJ	CSJ	RKT	CRY	STOR	TJ power			
200	X		X		X	X			TRJ			X	TRJ				X	TJ power	WB to BB comparison	Mach 4.5 Concepts	
201	X		X		X	X			TRJ			X	TRJ				X	TJ power	WB to BB comparison	Mach 6+ Concepts	
204	X	X	X		X				TRJ		X		TRJ			X		TJ power	TRJ to RKT accel. comparison		
206	X		X		X				TRJ		X		TRJ			X		TJ power	WB to BB comparison		
207	X		X		X				TRJ		X		TRJ			X		TJ power	TRJ to RKT accel. comparison		
210	X		X		X				TRJ		X		TRJ			X		TJ power	WB to HTO Comparison		
211	X		X		X				TRJ		X		TRJ			X		TJ power	WB to BB comparison		
212	X		X		X				TRJ		X		TRJ			X		TJ power	TRJ to TJ + RJ comparison		
213	X		X		X				X		X		X			X		TJ power	TRJ to RKT accel. comp.		
214	X		X		X				X		X		X			X		TJ power	TJ to RKT accel. comp.		
220	X		X		X								X					Parachute	Shape comparison		
221	X		X		X								X					Parachute	Vert. Launch Comparison		
231	X		X		X				X		X					X		TJ power	Shape comparison		
232	X		X		X				X		X					X		TJ power	TJ to CSJ to RKT comparison		
233	X		X		X				X		X					X		TJ power	TJ to CSJ to RKT comparison		
234	X		X		X				X		X					X		TJ power	WB to BB all RKT comparison		
250	X		X		X				X		X					X			Shape comparison (all RKT)		
251	X		X		X				X		X					X			Shape comparison (all RKT)		
252	X		X		X				X		X					X			Propellant comparison		
253	X		X		X				X		X					X			Shape comparison (CSJ vehicles)		
254	X		X		X				X		X					X			Shape comparison (CSJ vehicles)		
255	X		X		X				X		X					X			Shape comparison (CSJ vehicles)		
256	X		X		X				X		X					X			Shape comparison (CSJ vehicles)		
257	X		X		X				X		X					X			Shape comparison (CSJ vehicles)		
270	X		X		X				X		X					X			RKT to CSJ comparison		
271	X		X		X				X		X					X			RKT to CSJ comparison		
280	X		X		X				X		X					X			RKT to CSJ comparison		
281	X		X		X				X		X					X			RKT to CSJ comparison		
282	X		X		X				X		X					X			RKT to CSJ comparison		
284	X		X		X				X		X					X			RKT to CSJ comparison		
285	X		X		X				X		X					X			RKT to CSJ comparison		
290	X		X		X				X		X					X			RKT to CSJ comparison		
291	X		X		X				X		X					X			RKT to CSJ comparison		
292	X		X		X				X		X					X			RKT to CSJ comparison		

CODE: Air = Air launch  
HTO = Horizontal takeoff  
VTO = Vertical takeoff  
TJ = Turbojet  
RJ = Ramjet  
TRJ = Turboramjet  
CSJ = Convertible scramjet  
RKT = Rocket  
CRY = Cryogenic  
STOR = Storable

(U) The preponderance of all-body configurations assists in the stabilization of a portion of the variables and provides a more clear cut assessment of the difference in other design options. Direct shape comparisons are indicated for selected propulsion concepts which also provided definitive data points for other comparisons.

(U) For the Mach 0 to 0.9 speed range, low speed handling, takeoff and landing qualities will require investigation, especially for the all-body configurations. A research vehicle capable of operating in this flight regime can be of conventional aluminum construction and powered with any of a wide choice of subsonic turbojet engines. Use of higher temperature metals and higher performance engines is not required and the emphasis is placed on minimum weight and cost.

(U) Mach 2.0 testing represents a minimal extension of the above investigation into the transonic and low supersonic handling characteristics and stability. Structural requirements are still of a conventional nature and only a relatively small propulsive power increase is required. Again a choice of several off-the-shelf turbojet engines appears feasible.

(U) A new Mach 4.5 research vehicle must provide a level of research data that has not been achieved through other test programs, even though some of the comparisons suggested in Figure 4-2 have already been tested in manned and unmanned programs (ASSET, X-15, GAM-72, etc.). Potential high research value can be achieved through a sustained period of flight at this speed. This goal suggests the following vehicle: Manned, Wing-Body (WB), Horizontal Takeoff (HTO), Turbojet (TJ) accelerated, Ramjet (RJ) cruise, with JP fuel. The current development programs on Turboramjet (TRJ) engines, USAF interest in AMI, and past successful RJ programs suggests a dual-mode propulsion system rather than separate engines. A parallel configuration of All Body (AB) design was thought to be of value in comparing gross effects of L/D variation at this speed, thus, configurations -200 and -201 were then placed in the Phase I matrix.

(U) Consideration of the Mach 6 regime suggests a much greater variation of research vehicle configurations. However, as in the Mach 4.5 speed class, certain propulsive concepts will not attain full range use if limited to Mach 6 and are therefore of restricted research value. For the cruise engine, only the subsonic combustion ramjet will have maximum capability at Mach 5 to 8, while the convertible scramjet will be only in its initial modes of operation. Configurations 204 through 207 and 210 through 214 provide for comparison of the TRJ, RJ, and RKT; WB vs AB and airlaunch vs HTO for the Mach 6 speed range.

(U) For the unmanned Mach 6 class, a RJ cruise engine was chosen and a comparison made between the MCAIR all-body and an elliptic cross section all-body. Configurations 220 and 221 are used for this comparison and are vertically launched vehicles, stage boosted to test Mach number.

(U) The possibility of operating a scramjet in both a subsonic and supersonic combustion mode has long been recognized as a feature which would appreciably extend the operational versatility of the scramjet. The idea of achieving this type of system through distributed fuel injection and thermal choking in a constant combustion chamber has been developed to the point that every engine manufacturer

working in the field of scramjet development has experimentally demonstrated stable and repeatable transition from one mode of combustion to the other. Further, Garrett, in the HRE program, has demonstrated that dual mode combustion can be accomplished in practical combustion chamber lengths. Therefore, because of the enhanced versatility of the convertible or dual mode scramjet over the single mode scramjet, there appears little value in considering the single mode scramjet as a separate and distinct candidate propulsion system. In view of the above considerations, the research vehicle matrix combined the scramjet and convertible scramjet into one cruise engine concept.

(U) Only unmanned booster-staged concepts were considered. Manned systems of the "Dyna Soar" type were judged inappropriate for this study particularly in view of the cost of the large manrated boosters that would be required and the complex launch and checkout facilities associated with manned operations.

(U) Vehicle versatility can be a very powerful tool in reducing overall cost in any flight research program. Continuing MCAIR studies over the past several years have consistently pointed up the cost savings to be effected with a multiple-use approach to the design effort. This is particularly true when considering the high cost of research in the hypersonic flight regime. Although previous studies have primarily assessed operational military, commercial, or logistic vehicles, the same multi-use advantages apply to a pure research effort. This multi-use concept philosophy will be applied to further refinement of the most attractive concepts retained for the Phase II parametric studies.

(U) The overall research objective is development of technologies that will lead to efficient operational configurations. These technologies can be developed with any of several of the concepts shown. Comparing this broad framework of parameters with the desired research objectives yields the matrix of flight research vehicles initially evaluated in Phase I of the HYFAC study.

## 4.2 DESIGN CRITERIA

(U) The initial screening of hypersonic flight research facilities was performed using a set of criteria created specifically for this purpose. The Phase I criteria were flexible yet responsive so that relative evaluations could be made that did not eliminate attractive vehicles because of criteria selection. During Phase III the criteria will be re-evaluated through sensitivity studies using the selected vehicles as the evaluation base. This re-evaluation will insure that the criteria selection will not drive the study results to an unnecessarily large or expensive vehicle. A discussion of the Phase I ground rules is presented in this section.

4.2.1 (U) DESIGN BASE - The configuration "design base" used in initial evaluation of the candidate flight facilities was selected on the basis of minimum cost, minimum risk, and maximum performance. The concepts listed in Figure 4-3 have been selected for the "design base". Present day materials technology has been selected for the design base and is defined as materials and fabrication methods which are referenced in MIL-HDBK-5A. This fundamental base will be more completely defined and specifically related to the selected vehicles in the Phase II effort, including definition of applicable polymeric, inorganic, and composite materials.

(U) Primary Structure - The primary structure is insulated aluminum alloys (maintained below 250°F/121°C) employing standard mechanical attachments and present day fabrication methods. Heat shields, control surfaces, tails, and leading edges are designed as hot structure and are more efficiently made of alloys such as Columbium, Rene' 41, and TD NiC. These high temperature alloys are also joined primarily by mechanical attachments.

(U) Thermal Protection System - A passive thermal protection system was used for the Mach 6 aircraft consisting of an external heat shield or shingle of honeycomb construction and a layer of Dyna-Flex (or equivalent) insulation. The heat shield is designed to protect the insulation and resist local air loads while being free to expand, thereby reducing thermal stresses. The insulation layer is packaged and supported between the heat shield and the structure. Fuel tanks have an additional layer of insulation inside which is supported by the tank wall.

(U) An active thermal protection system was used for the Mach 12 aircraft. Similar to the passive system, the active system employs an external heat shield and a layer of insulation. In addition it uses a water filled fibrous silica blanket which is attached to the structure. The selection of this system for the Mach 12 aircraft in lieu of the passive system used for the Mach 6 aircraft is based on the results of a preliminary comparative weight analysis presented in Section 4.6 which indicates the active system is lighter.

(U) Inlet Structure - The variation in speed, fuselage shape, and propulsion mode results in a large variation in the inlet structural and mechanical concepts. The materials and thermal protection concepts, however, can be categorized into three general groups relating to speed:

(U) FIGURE 4-3  
 PRELIMINARY STRUCTURAL AND THERMOSTRUCTURAL CONCEPTS

Configuration	Primary Structure	Inlet Structure	Fuel Tank	Insulation System	Control Surfaces	Leading Edge	Windshield	Nose Cap
200-201	Aluminum	Titanium, Insulated, & Rene' 41	Non-Integral & Integral-Insulated, Bladder	Dyna-flex, Radiation Shingle (Titanium & Rene' 41 or Inconel)	Hot Structure Rene' 41 or Inconel X	Hot Structure Rene' 41 or Inconel Expanding Joints	Glass	Fiberglass
205-215	Aluminum	Titanium, Insulated, Superalloy Shield	Integral Internal Insulation	Passive Insulation, Radiation Shingle (Superalloy)	Hot Structure Rene' 41 or Inconel X	T.D. NiCr Exp. Joints	Glass	T.D. NiCr, Insulated Substructure
220-21	Aluminum	Titanium, Insulated, Superalloy Shield	Integral & Internal Insulation	Passive Insulation, Radiation Shingle (Superalloy)	Hot Structure Rene' 41 or Inconel X	Hot Structure T.D. NiCr Expanding Joints	None	T.D. NiCr, Insulated Substructure
231-2 254-55-57 271	Aluminum	Regeneratively Cooled Titanium	Integral & Internal Insulation	Water Wick, Radiation Shingle	Hot Structure Columbium	Hot Structure Columbium Exp. Joints	Glass, Covered at High Speed	Ceramic
233-34-35 200-51-52-53 258-59 270	Aluminum	-	Integral & Internal Insulation	Water Wick, Radiation Shingles	Hot Structure Columbium	Hot Structure Columbium Exp. Joints	Glass, Covered at High Speed	Ceramic
280	Aluminum	Regeneratively Cooled Titanium	Integral & Internal Insulation	Water Wick, Radiation Shingles	Hot Structure Columbium	Hot Structure Exp. Joints, Cb	None	Ceramic
281-83	Aluminum	-	Integral & Internal Insulation	Water Wick, Radiation Shingles	Hot Structure Columbium	Hot Structure Exp. Joints, Cb	None	Ceramic
282	Aluminum	-	Integral & Internal Insulation	Water Wick, Radiation Shingles	Hot Structure Columbium	Hot Structure Exp. Joints, Cb	None	Ceramic
290-92	Aluminum	Aluminum	Non-Integral & Bladder	None	Aluminum	Aluminum	Glass	Aluminum



- (1) Mach .9 - 2.5 - uninsulated aluminum alloy.
- (2) Mach 4.5 - 6 - titanium structure insulated with a passive insulation and a superalloy heat shield. The titanium temperature reaches 750°F (672°K).
- (3) Mach 10 - 12 - titanium structure insulated with passive insulation and a regeneratively cooled heat exchanger shield. The titanium is maintained at a maximum of 750°F (399°C) and the heat exchanger made of a superalloy (TD NiC) is limited to about 1700°F (927°C).

(U) Fuel Tanks - The aircraft all have integral aluminum tank/fuselage structure with internal insulation and a bladder. The aircraft fueled with JP fuel have integral tanks where possible, however, some non-integral tanks will be necessary.

(U) Configuration - The fuselage and fuel tanks are standardized in two basic shapes, the wing-body and the all-body. Usable fuel volume within the tanks has been standardized for sizing purposes as shown in Figure 4-4. Other configuration ground rules are:

- o All vehicles are designed with a one man crew.

(U) FIGURE 4-4  
 PHASE I PROPELLANT VOLUME ALLOCATION

VEHICLE TYPE	FUEL	TANKAGE VOID AREAS %	ULLAGE %	TOTAL VOID %	TOTAL USABLE VOLUME %
Wing Body	JP	2 (wing)	1	3	97
		4 (fus.)	1	5	95
Blended Body All Body	Cryogen	0.5	2.5	3.0	97
Wing Body	Cryogen	2.5 (wing)	2.5	5.0	95
		.5 (fus.)	2.5	3.0	97

- o Canopy is fixed on the Mach 4.5 and 6 vehicles.
- o Canopy is a concealed pop-up design in the Mach 12 vehicles.
- o Air launched and VTO aircraft are designed with skids while the HTO vehicles have normal wheeled gear.
- o Payload is a data collection package of 1000 lb (454 kg) at a density of 25 lb/ft<sup>3</sup> (400 kg/m<sup>3</sup>).

4.2.2 (U) STRUCTURAL - The structural design criteria and basic design concepts were selected on a minimum risk and minimum cost basis. They have been categorized in a manner that permits a large number of vehicles to be quickly evaluated on a performance basis. The design criteria used for Phase I structural concept selection and weight estimation are shown in Figure 4-5.

- o Initial load factor selection was based on the assumption that no potential operational vehicle, operating at high speed and high altitude would have occasion to exceed 5.0 g maneuvering load. A 2.0 g ground load factor is standard.
- o Design dynamic pressure of 2500 psf (11.9 N/cm<sup>2</sup>) was selected for all concepts except Mach 2, since the 5.0 g maneuvering factor can result in this environment.
- o Inlet pressures are affected by maneuvering load factor, speed, and altitude, as well as propulsion mode. Vehicles employing ramjet propulsion were designed to 150 psi (103 N/cm<sup>2</sup>). Convertible scramjet propulsion requires the structure to be designed for 100 psi (68.9 N/cm<sup>2</sup>), while the turbojet propulsion design requirement is 30 psi (20.7 N/cm<sup>2</sup>).
- o Sink speed was selected at 20 feet per second (6.1 m/sec) for all vehicles except the parachute recoverable vehicles which were designed for a sink speed of 30 feet per second (9.1 m/sec).
- o The standard factor of safety of 1.5 on limit loads is considered in all the structural design and weight estimations.
- o Approach speed was estimated at 175 knots (324 km/hr) for the Mach 4.5 concepts and 200 knots (371 km/hr) for the Mach 6.0 and 12.0 vehicles. The Mach 2 concepts were designed for 200 knot (371 km/hr) approach and the parachute recovered vehicles for essentially zero.
- o The design temperatures shown in Figure 4-5 are based on previous aircraft studies of similar speed and wing loading to the research concepts.

(U) Flight Profile - A net steady state test time of 5 ± 0.5 minutes at maximum Mach was chosen as the mission time for all candidate vehicles. This assumption for Phase I of this study is based on earlier work conducted within MCAIR. This time assumes 3 minutes to stabilize flight conditions and 2 minutes for data collection.

(U) FIGURE 4-5  
 PRELIMINARY STRUCTURAL DESIGN CRITERIA

Configuration	Load Factor End of Boost	g's Taxi	Dynamic Pressure psf (N/cm <sup>2</sup> )	Design Life Hrs	Inlet Pressure psi (N/cm <sup>2</sup> )	Landing Speed Knots (km/hr)	Sink Speed fps (m/sec)	Stagnation of Temperature (°C)		Max. Tank Pressure psi (N/cm <sup>2</sup> )	Surface Temperature (°C)	
								Nose	L. Edge		Upper	Lower
200-201	5.0	2.0	2500 (11.97)	100	150 (103.4)	175 (324)	20 (6.1)	1320 (716)	1020 (549)	15 (10.3)	800 (427)	1050 (566)
205-215	5.0	2.0	2500 (11.97)	100	150 (103.4)	200 (371)	20 (6.1)	2100 (1149)	1400 (760)	10 (6.9)	800 (427)	1200 (649)
220-221	5.0	2.0	2500 (11.97)	100	150 (103.4)	NA	30 (9.1)	2100 (1149)	1400 (760)	10 (6.9)	800 (427)	1200 (649)
231-32 254-55-57 271	5.0	2.0	2500 (11.97)	100	100 (68.9)	200 (371)	20 (6.1)	3500 (1927)	2000 (1093)	10 (6.9)	1200 (649)	2000 (1093)
233-34-35 250-51-52-53 258-59-270	5.0	2.0	2500 (11.97)	100	NA	200 (371)	20 (6.1)	3500 (1927)	2000 (1093)	25 (17.2)	1200 (649)	2000 (1093)
280	5.0	2.0	2500 (11.97)	100	100 (68.9)	NA	30 (9.1)	3500 (1927)	2000 (1093)	10 (6.9)	1200 (649)	2000 (1093)
281-83	5.0	2.0	2500 (11.97)	100	NA	NA	30 (9.1)	3500 (1927)	2000 (1093)	25 (17.2)	1200 (649)	2000 (1093)
282	5.0	2.0	2500 (11.97)	100	NA	NA	30 (9.1)	3500 (1927)	2000 (1093)	15 (10.3)	1200 (649)	2000 (1093)
290-92	5.0	2.0	2000 (9.58)	4000	30 (20.7)	200 (371)	20 (6.1)	Ambient	Ambient	15 (10.3)	Ambient	Ambient

NA - NOT APPLICABLE

TP 8476-581

(U) Air launched vehicles were dropped from the carrier aircraft at Mach 0.8 and 35,000 ft (10,668 meters).

(U) The Mach 2.0 and 4.5 vehicles were considered to have single base operating capability. The Mach 6.0 and 12.0 vehicles were designed for two base operation to minimize the penalties associated with high speed turning.

4.2.3 (U) PROPULSION DESIGN - The selection of an appropriate propulsion system was based on the key requirement that fundamental technology for the engine will be available in 1975 with a normal development cycle. In the generation of engine performance data for the variety of systems shown in the Hypersonic Research Facilities Concepts matrix, certain candidate fuels of secondary potential were not considered in Phase I. This resulted in the following ground rules:

- o Turbomachinery engines were evaluated with JP and LH<sub>2</sub> fuels, and air as oxidizer.
- o Ram-compression engines were evaluated with LH<sub>2</sub> fuel, and air as oxidizer.
- o Rocket engines were evaluated for three fuel/oxidizer combinations: LO<sub>2</sub>/LH<sub>2</sub>, LO<sub>2</sub>/RP, and N<sub>2</sub>O<sub>4</sub>/Aerozine 50.

(U) Applying these ground rules to the propulsion systems of the vehicle matrix produced the propellant matrix presented in Figure 4-6. Propellant properties used are shown in Figure 4-7.

(U) All engines were assumed to be rubberized for vehicle sizing except for Configuration 257, which was performed with fixed size F100-GE-100 turbojet engines. Engine sizing criteria were as follows:

- o Rocket engines were sized for  $T_{vac}/TOGW = 1.5$ . This value is consistent with the results of previous parametric studies and is judged as a good first order value, subject to the results of the Phase II parametric studies.
- o Turbojet and TRJ engines were sized for uninstalled sea level thrust equal to 95% of TOGW. While this value is reasonable for quick reaction military aircraft, it was found to be too high for a research aircraft and results in some penalty to the airbreathers.
- o Convertible scramjet engines were sized as the largest engine that can be installed on the vehicle, within the constraint of capturing the high pressure air needed for engine operation. Wing sweep and inlet design point (Mach no., angle of attack) define this maximum size. This criteria resulted in capture area equal to 4.5% of  $S_p$  on the all-body vehicles, and 4.0% of  $S_p$  on the wing-body vehicles.

(U) FIGURE 4-6  
 PROPELLANT MATRIX

Engine	Storable Propellants		Cryogenic Propellants	
	Fuel	Oxidizer	Fuel	Oxidizer
Turbojet, Turbofan	JP	Air	LH <sub>2</sub>	Air
Turboramjet	JP	Air	LH <sub>2</sub>	Air
Ramjet	N.A.	N.A.	LH <sub>2</sub>	Air
Convertible Scramjet	N.A.	N.A.	LH <sub>2</sub>	Air
Rocket	Aerozine 50	N <sub>2</sub> O <sub>4</sub>	LH <sub>2</sub>	LO <sub>2</sub>
	RP			LO <sub>2</sub>

(U) Figure 4-7  
 Propellant Properties - Phase I

Propellant	JP-5	LH <sub>2</sub>	AERO-50	N <sub>2</sub> O <sub>4</sub>	LO <sub>2</sub>
Density (1) lbm/ft <sup>3</sup> (Kg/m <sup>3</sup> )	51.8 (829)	4.42 (71)	56.3 (902)	90.1 (1441)	71.27 (1140)
Temp. NBP °F (°C)	359/498 (182/259)	-423.0 (-253)	158.0 (70.0)	70.07 (21.1)	-297.3 (-182.5)
Vapor Pressure (1) psia (N/cm <sup>2</sup> )	0.0145 (0.01)	14.7 (10.13)	2.1 (1.45)	14.6 (10.06)	14.7 (10.13)
Tank Pressure psia (N/cm <sup>2</sup> )	2.0 (1.38)	16.7 (11.5)	4.0 (2.76)	16.7 (11.5)	16.7 (11.5)
Thermal Conductivity (1) Btu/hr-ft-°F (J/sec-m-°C)	.079 (.137)	.069 (.120)	.151 (.262)	.077 (.134)	.087 (.151)
Specific Heat (1) Btu/lbm-°F (J/g-°C)	.47 (.197)	2.31 (.967)	.69 (.288)	.37 (.155)	.41 (.172)
Viscosity (1) Centipois (N/sec/cm <sup>2</sup> )	114.0 (1140.0)	.0135 (.135)	.87 (8.7)	.41 (4.1)	.19 (1.9)
Heat Vaporization Btu/lbm @ 1Atm (J/g)	115.0 (268.0)	192.0 (447.0)	425.8 (990.0)	178.2 (415.0)	91.7 (213.0)
Average Net Heating Value Btu/lbm (J/g) Btu/ft <sup>3</sup> (J/cm <sup>3</sup> )	18,500 (43,000) 960,000 (35,600)	51,545 (120,000) 228,000 (8,480)	10,300 (24,000) 577,000 (21,600)	N/A N/A	N/A N/A
Ullage Required % Pressurization Gas	1.0 GN <sub>2</sub>	2.5 GH <sub>2</sub>	1.0 GN <sub>2</sub>	1.0 NO <sub>2</sub>	2.5 GH <sub>2</sub>

(1) Property @ NBP for LH<sub>2</sub>, LO<sub>2</sub>; @ 70°F for others.

#### 4.3 AERODYNAMICS

(U) The primary aerodynamic emphasis during Phase I was applied to the determination of vehicle performance for a variety of configuration concepts. In view of the large number of configurations for which performance was required, a simplified approach was employed to determine the necessary aerodynamic characteristics. Briefly, the approach consisted of:

- o Estimation of maximum lift-to-drag ratio,  $(L/D)_{\max}$
- o Estimation of lift curve slope,  $C_{L\alpha}$
- o Estimation of induced drag factor,  $L'$
- o Determination of zero lift drag coefficient,  $C_{D_0}$

$$C_{D_0} = \frac{1}{4 L' (L/D)_{\max}^2}$$

based on an assumed parabolic drag variation described by

$$C_D = C_{D_0} + L' C_L^2$$

In Phase II more refined techniques will be employed.

(U) Although the lift and drag have, for the most part, been obtained by means of simplified correlations with vehicle geometry, each configuration was evaluated independently, and, in the case of the airbreather accelerators, rather detailed drag analyses were employed to obtain realistic transonic accelerations. A discussion of the methods and techniques employed is presented in the following sections. The allocation of forces between external aerodynamics and those due to propulsion are discussed first.

4.3.1 (U) AERODYNAMIC/PROPULSION FORCE ALLOCATION - All forces acting on the integrated vehicle have been allocated to either aerodynamic lift and drag components in the stability axis reference system or to propulsive forces produced by the propulsion system. The allocation of forces depends on whether the engine is operative or inoperative as follows:

- o Power-Off Condition - This condition denotes "airbreathing propulsion system inoperative". All forces acting on the external surfaces of the integrated vehicle are resolved into aerodynamic lift and drag.
- o Power-On Condition - This condition denotes "airbreathing propulsion system operative". All external forces, with the exception of propulsive forces acting on the expansion nozzle of ramjets or scramjets, have been resolved into aerodynamic lift and drag. This includes all forward fuselage forces on configurations where the forebody also provides inlet compression. Forces from additional inlet compression surfaces which project beyond the basic forebody moldline have been included in the propulsive force accounting together with the forces acting on surfaces wetted by the internal

propulsion flow and the wetted exhaust nozzle surface. This is illustrated in Figure 4-8. These propulsive forces have been resolved into stability axis components. Propulsive lift, expressed as  $\Delta L/D_{prop}$  consists of the propulsive lift divided by net thrust. During cruise when net thrust equals drag,  $\Delta L/D_{prop}$  may be added directly to the aerodynamic L/D.

4.3.2 (U) (L/D)<sub>max</sub> ESTIMATION

(U) Supersonic (L/D)<sub>max</sub> - Figure 4-9 shows the variation of  $(L/D)_{max}$  with the vehicle geometric parameter  $(VOL)^{2/3}/Sp$  which was used to derive the supersonic  $(L/D)_{max}$  of the vehicles in Phase I. Figures 4-10 through 4-12 show the data employed to derive the curves shown in Figure 4-9. These plots include published experimental data and point design estimates at full scale flight conditions. The estimates are based on component build-up methods employing hypersonic theory and empirical data representative of current technology. Trimmed experimental data were used where possible. It will be noted that in general all-body designs tend to have little variation in  $(L/D)_{max}$  with Mach number and that wing-body vehicles show a higher  $(L/D)_{max}$  at low supersonic speeds than do the all-body vehicles. The wing-body designs were favored at the lower Mach numbers in arriving at the curves of Figure 4-9 because the best low Mach number designs tend to be wing-body rather than all-body configurations.

(U) Subsonic (L/D)<sub>max</sub> - At subsonic speeds  $(L/D)_{max}$  for the wing-body vehicle is estimated using the correlation with  $b^2/S_{WET}$  shown in Figure 4-13. A value of 280 for the parameter  $e^2/C_{DF}$  is considered attainable for these designs and, therefore, was used in the drag analysis. The all-body subsonic  $(L/D)_{max}$  is based on the correlation with  $(VOL)^{2/3}/Sp$  shown in Figure 4-14. Trimmed vehicle data are used here also. The effect of trim on the FDL-7 has been shown as well as the increase in  $(L/D)$  due to the deployment of a small variable sweep lifting surface, at zero sweep angle.

4.3.3 (U) LIFT ESTIMATION - The lift of the HYFAC vehicles is defined by:

$$L = L_{aero} + L_{prop} + L_{cent}$$

where:  $L_{aero}$  = aerodynamic lift =  $C_L q Sp$

$L_{prop}$  = increase in lift due to propulsion =  $\Delta(L/D)_{prop}(Fn)$

$$L_{cent} = \text{centrifugal lift} = \frac{W}{g} \left[ \frac{V^2}{R_E + Z} \right]$$

$\Delta(L/D)_{prop}$  is found in Figure 4-15 and is used for scramjet and convertible scramjet vehicles.

(U) The increase in lift due to propulsion and centrifugal effects at high Mach number can be expressed as an increase in effective  $C_L$  as is shown graphically in Figures 4-16 and 4-17 for design Mach numbers of 6 and 12 respectively.

(U) FIGURE 4-8  
FORCE ALLOCATION

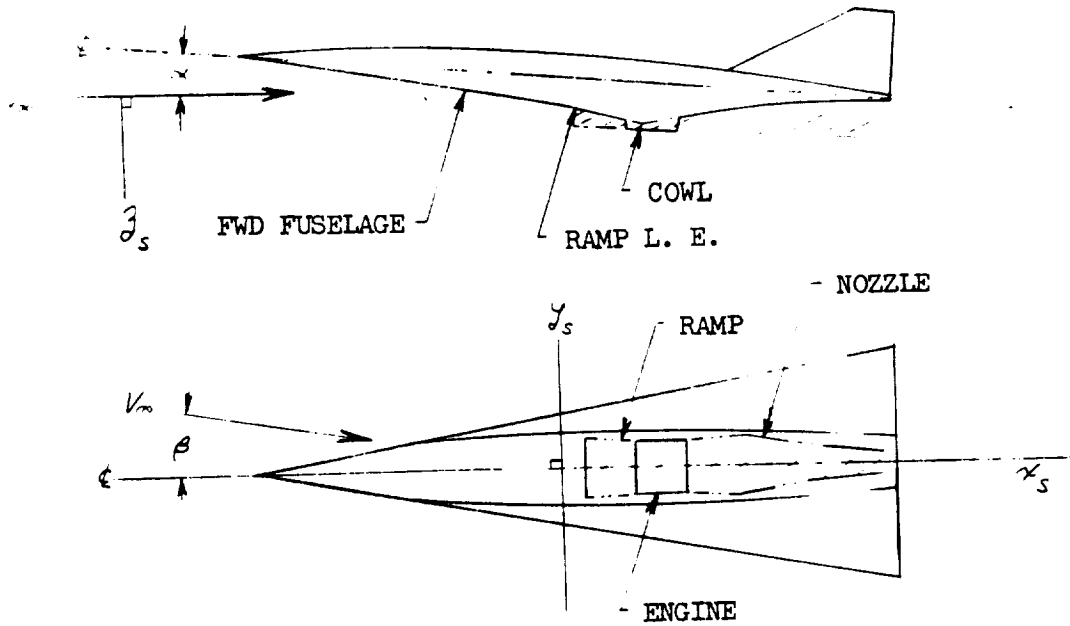

SHADED AREA ATTRIBUTABLE TO NET THRUST EXCEPT FOR EXTERNAL COWL DRAG (JUST AFT OF COWL LEADING EDGE TO TRAILING EDGE). ALL OTHER AREA IS INCLUDED IN AERODYNAMIC FORCE CATEGORY.



(U) FIGURE 4-9  
 (L/D)<sub>MAX</sub> VARIATION

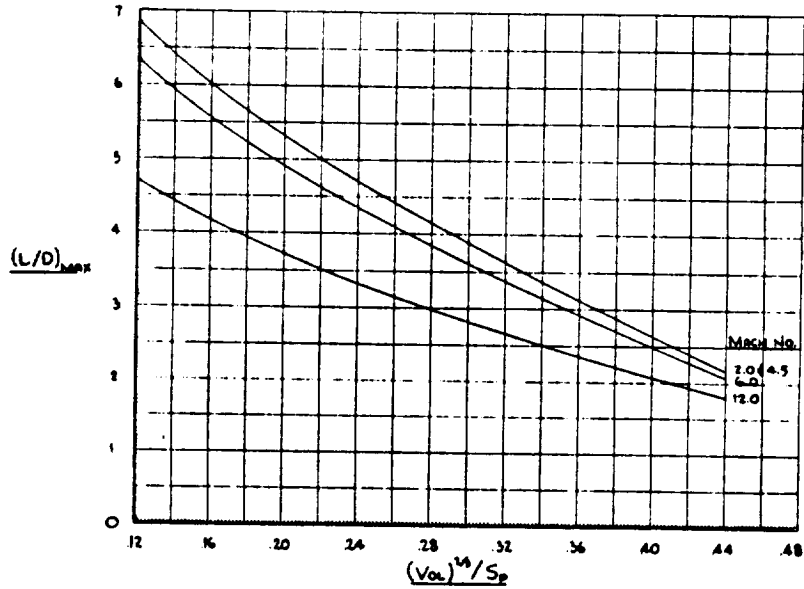

(U) FIGURE 4-10  
 (L/D)<sub>MAX</sub> CORRELATION

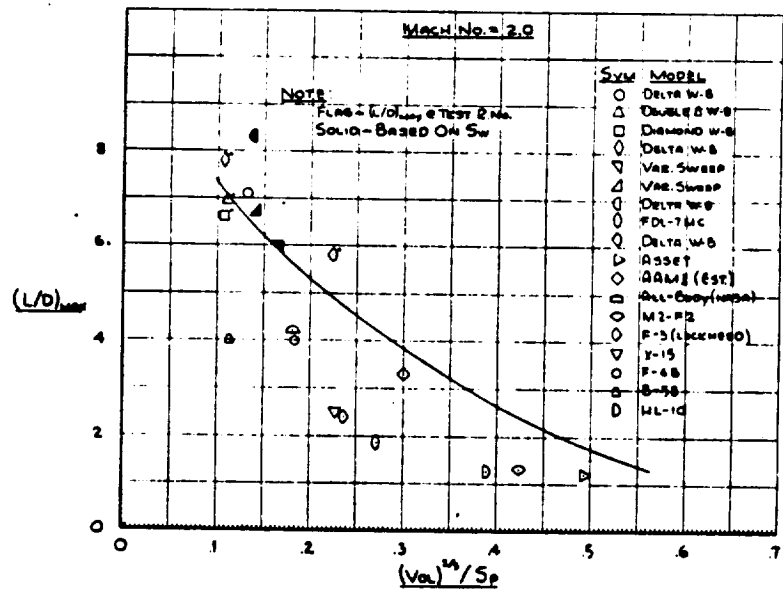

(U) FIGURE 4-11  
 (L/D)<sub>MAX</sub> CORRELATION

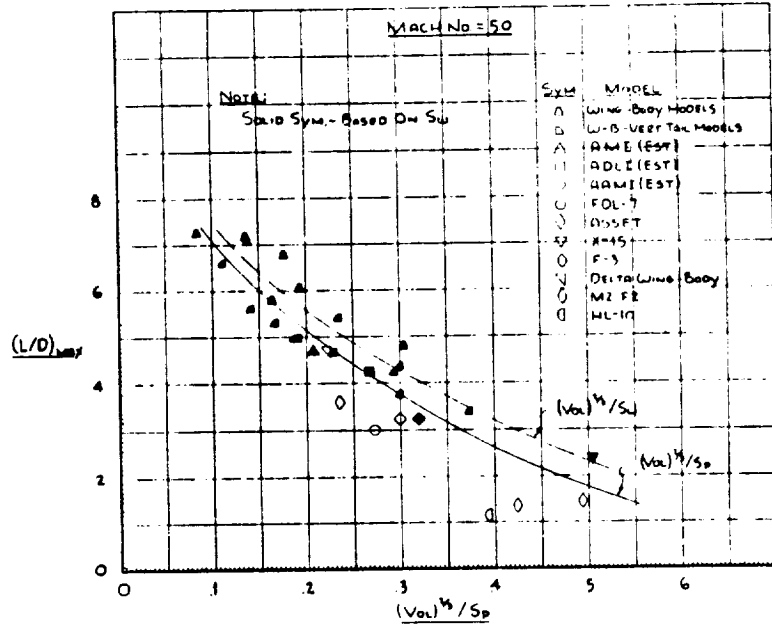

(U) FIGURE 4-12  
 (L/D)<sub>MAX</sub> CORRELATION

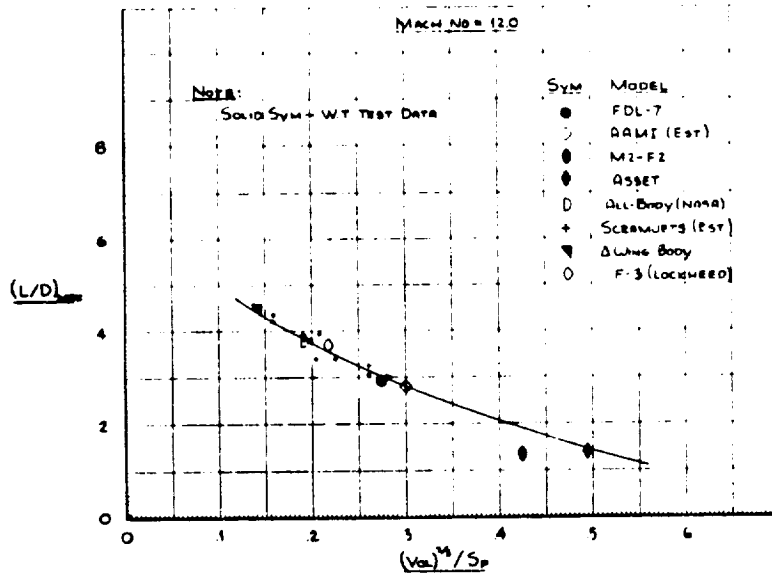

(U) FIGURE 4-13  
 (L/D)<sub>MAX</sub> COMPARISON

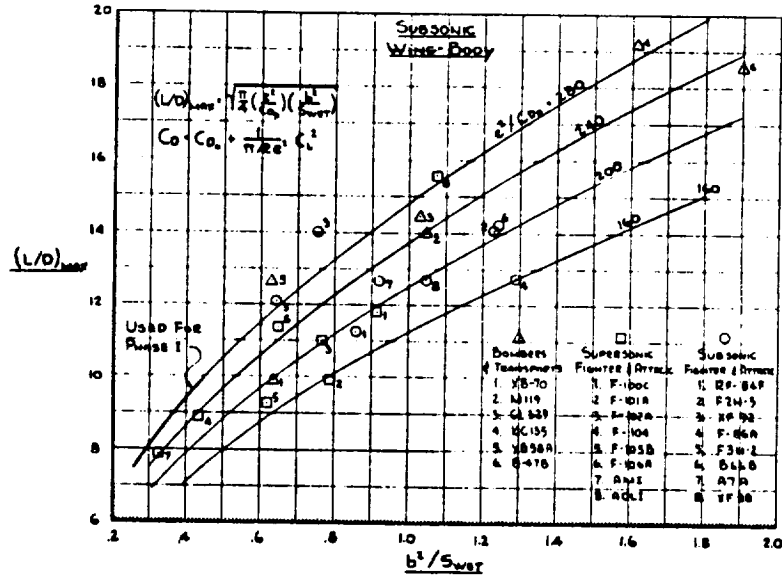

(U) FIGURE 4-14  
 (L/D)<sub>MAX</sub> CORRELATION

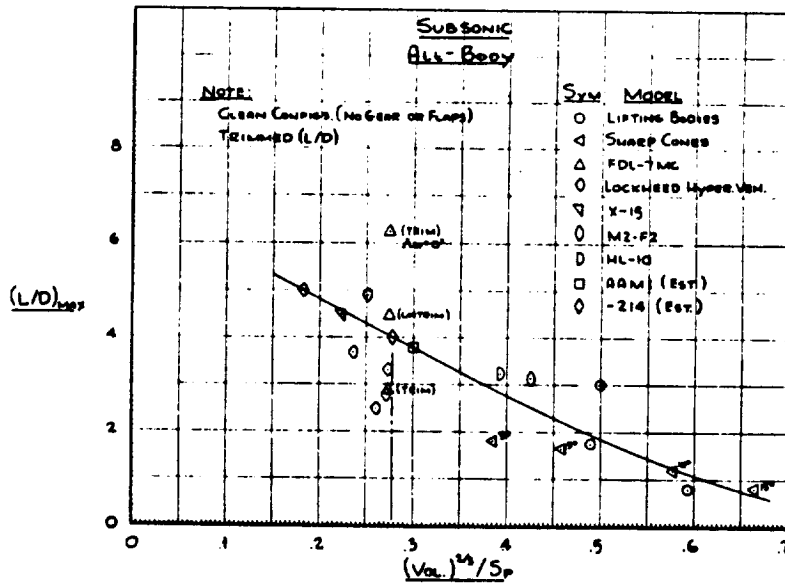

(U) FIGURE 4-15  
 PROPULSIVE LIFT/DRAG INCREMENTS

( $\psi = 1$ , THRUST = DRAG)

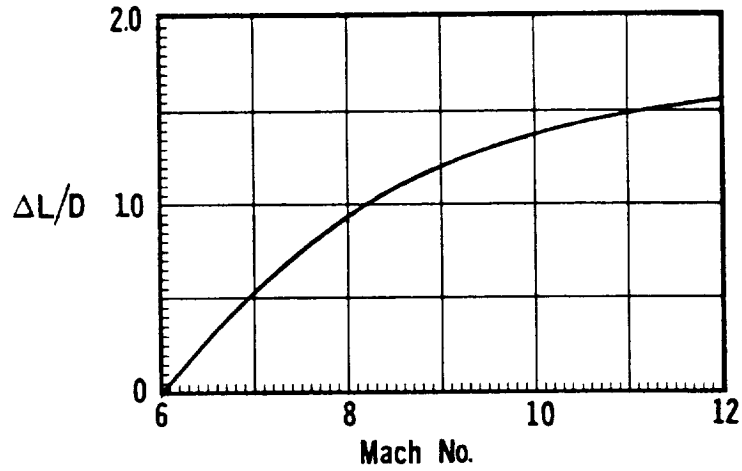

(U) FIGURE 4-16  
 LIFT INCREMENT DUE TO CENTRIFUGAL FORCE

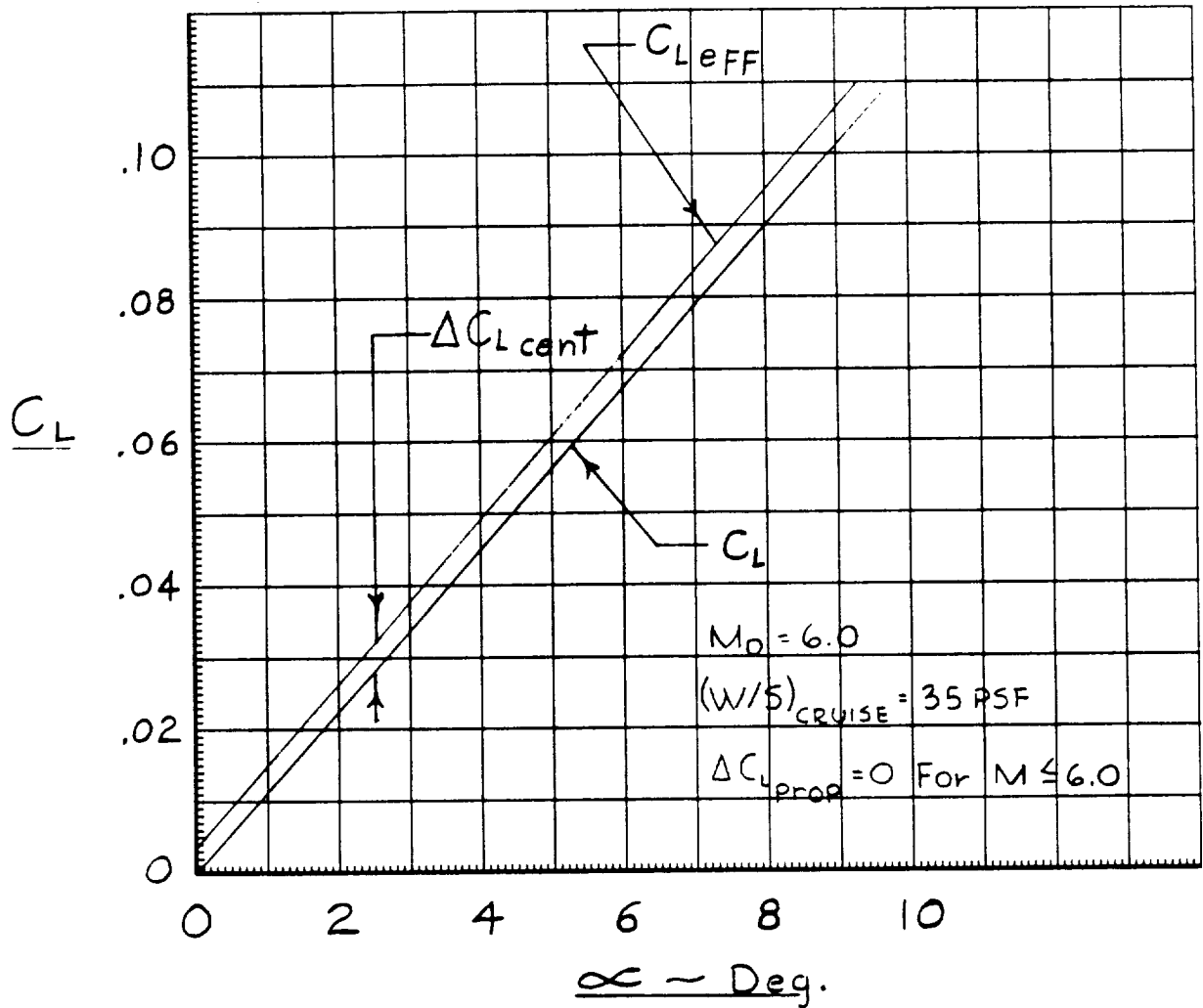

(U) FIGURE 4-17  
LIFT INCREMENTS DUE TO CENTRIFUGAL FORCE AND PROPULSION LIFT

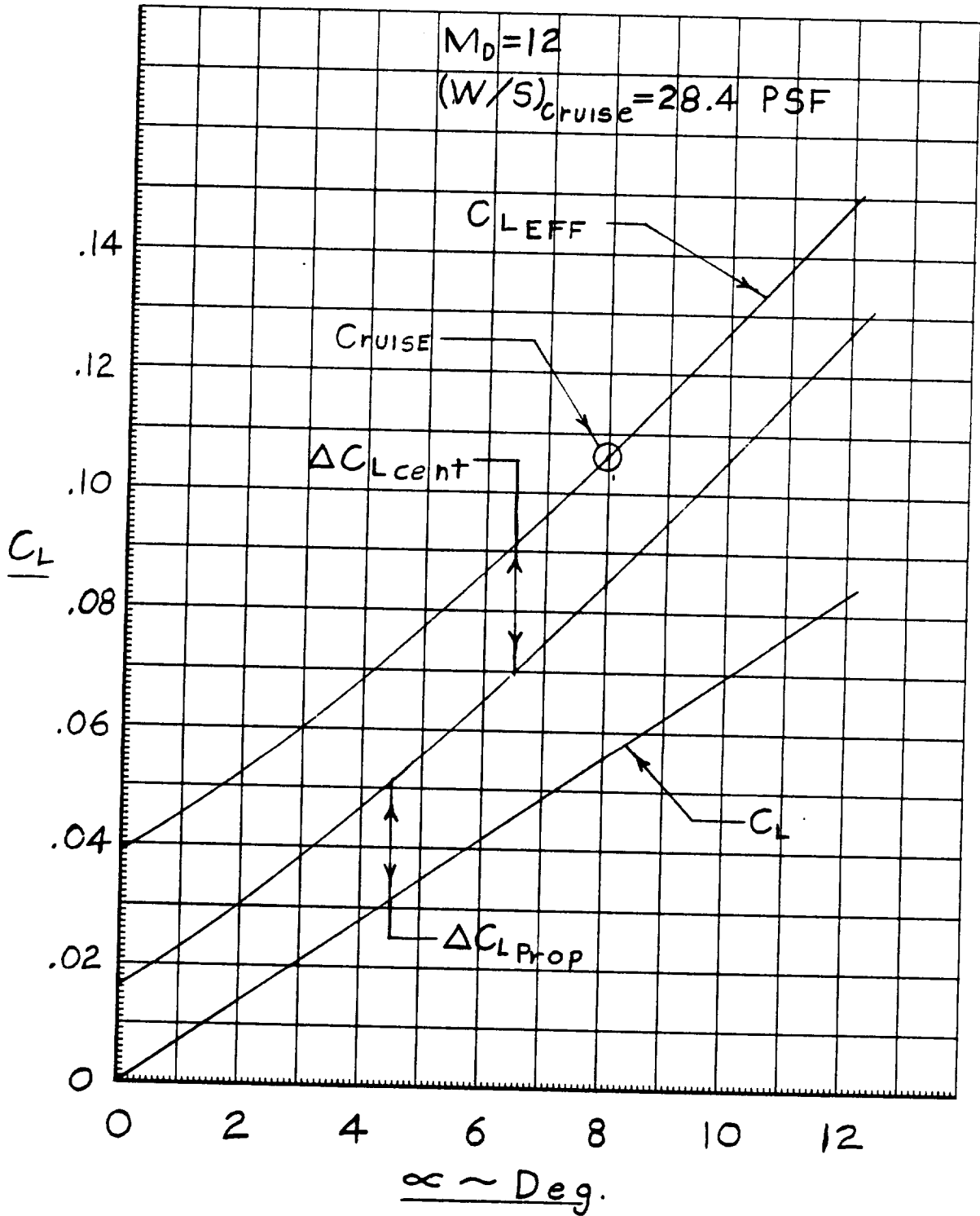

(U) Supersonic Aerodynamic Lift - The supersonic and hypersonic lift curve slopes were obtained from the correlation of data on delta wing configurations shown in Figure 4-18. For wing-body vehicles  $C_L$  is determined as a function of the ratio of body diameter to wing span ( $d/b$ ), the wing leading edge sweep angle ( $\Lambda_{LE}$ ), and the Mach number. Because of the similarity of the wing-body vehicle shapes studied, a  $d/b$  of .3 was selected as representative and used for all wing-body aircraft. For all-body configurations an equivalent  $d/b$  ratio was used, where  $b$  is the overall span of the vehicle and  $d$  is the equivalent diameter of the vehicle, based on its maximum cross-sectional area. Typical variations of lift curve slope with Mach number are shown in Figures 4-19 and 4-20 for a wing-body and an all-body design.

(U) Figure 4-21 which is based on experimental data, shows a typical variation of aerodynamic lift coefficient,  $C_L$ , with angle-of-attack for the vehicles under consideration. While the variation of lift with angle-of-attack is non-linear at high Mach numbers, for simplicity in the Phase I studies the lift curve slope is assumed to be linear throughout the Mach range. Figure 4-22 shows the estimated upper levels of  $C_L$  and  $\alpha$  required to obtain a normal load factor of 3.5 g's at hypersonic cruise altitudes. The band shown represents the variation due to cruise altitude differences among the various test vehicles.

(U) Subsonic Aerodynamic Lift - The subsonic aerodynamic lift curve slopes for all-body and wing-body configurations were determined using the method of Reference 1. This method determines  $C_{L\alpha}$  as a function of mid chord sweep angle and aspect ratio. An area weighted technique was employed to determine an effective value of the mid chord sweep angle.

4.3.4 (U) DRAG ESTIMATION - The drag coefficients of the HYFAC vehicles are computed using the simplified form:

$$C_D = C_{D_0} + L' C_L^2$$

where:  $C_{D_0}$  = zero lift drag coefficient

$$L' C_L^2 = \text{drag due to lift}$$

Each HYFAC vehicle is classified as either an all-body or a wing-body configuration and a slightly different approach is used for each class of vehicle. A comparison of typical  $C_{D_0}$  values is shown as a function of Mach number in Figure 4-23. It should be noted that the zero lift drag coefficients shown do not include drag due to the airbreather propulsion system during engine-on operation. The propulsion system drag, consisting of ram drag, spill drag, bleed drag and leakage drag, are accounted for as a reduction of gross propulsive thrust. Section 4.4.1 discusses the methodology for analyzing the propulsion system drag.

(U) Subsonic Aerodynamic Drag - For wing-body aircraft the subsonic value for  $C_{D_0}$  is obtained by the following relationship:

$$C_{D_0} = \frac{1}{4 L' (L/D)_{\max}^2}$$

$(L/D)_{\max}$  is read from Figure 4-13. The drag due to lift factor,  $L'$ , is defined by:

(U) FIGURE 4-18  
 LIFT CURVE SLOPE OF WING-BODY COMBINATIONS

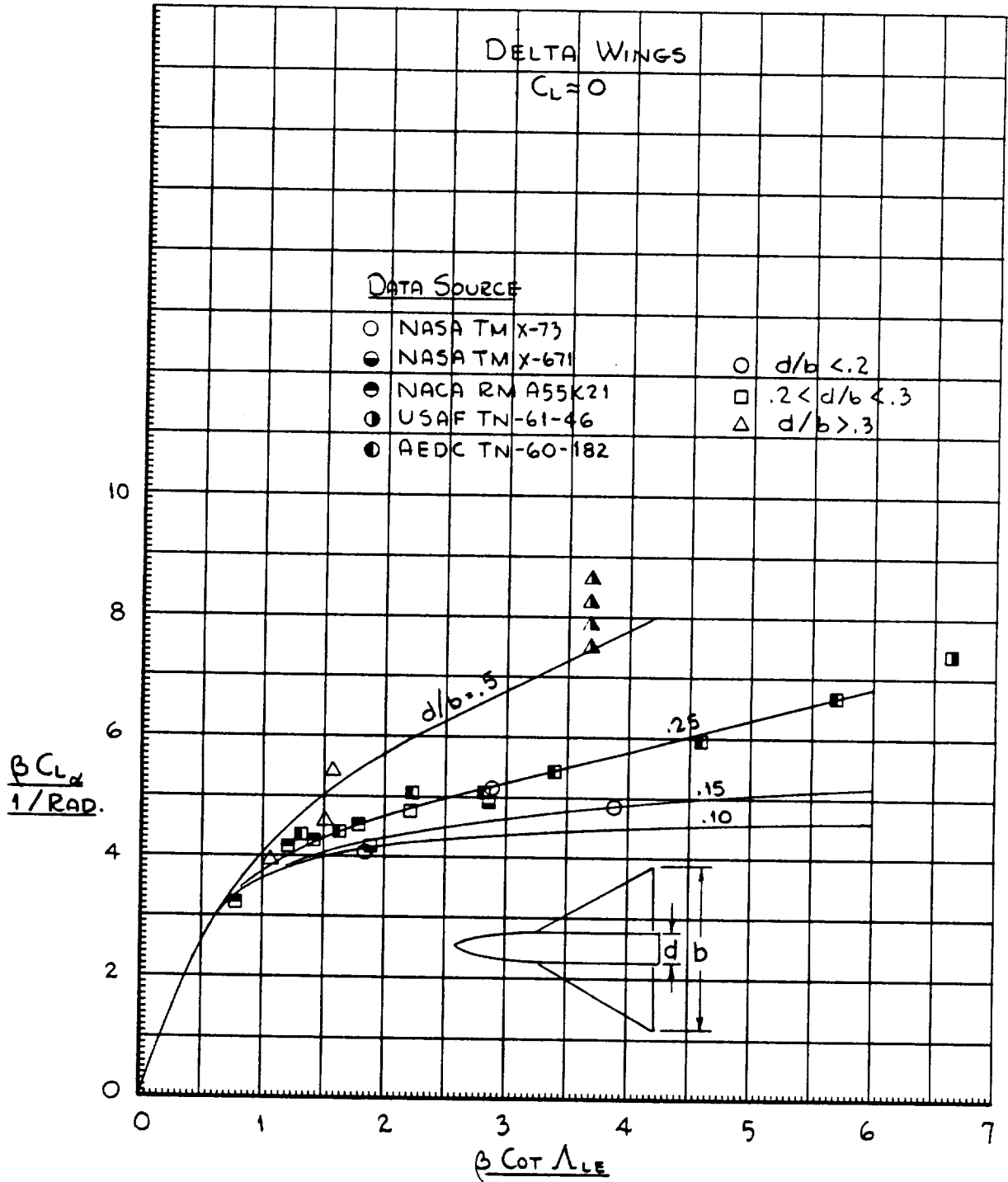

(U) FIGURE 4-19  
 $C_{L\alpha_0}$  AND INDUCED DRAG FACTOR - WING BODY CONFIGURATIONS

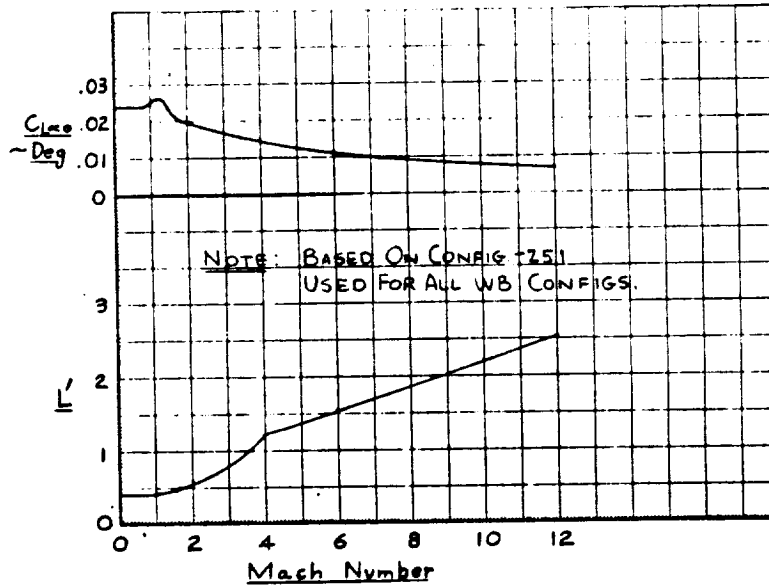

(U) FIGURE 4-20  
 $C_{L\alpha_0}$  AND INDUCED DRAG FACTOR - ALL BODY CONFIGURATIONS

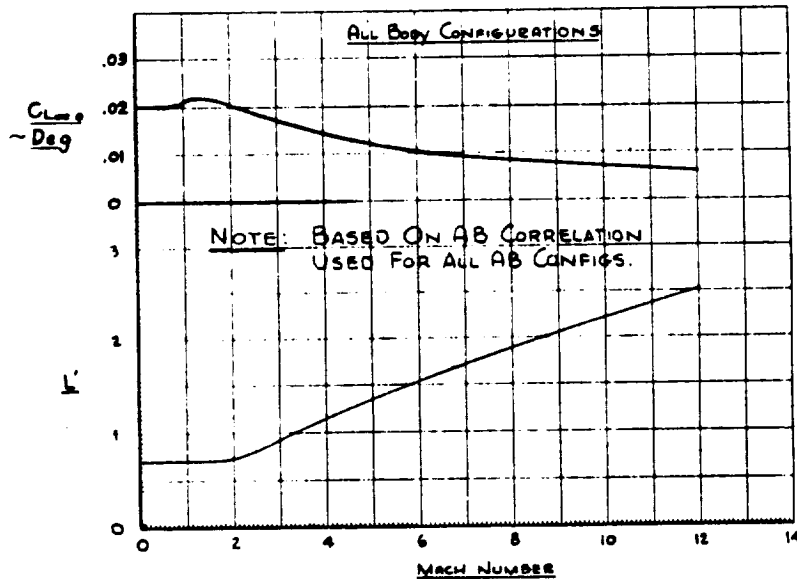



(U) FIGURE 4-21  
TYPICAL  $C_L$  vs  $\alpha$  VARIATION

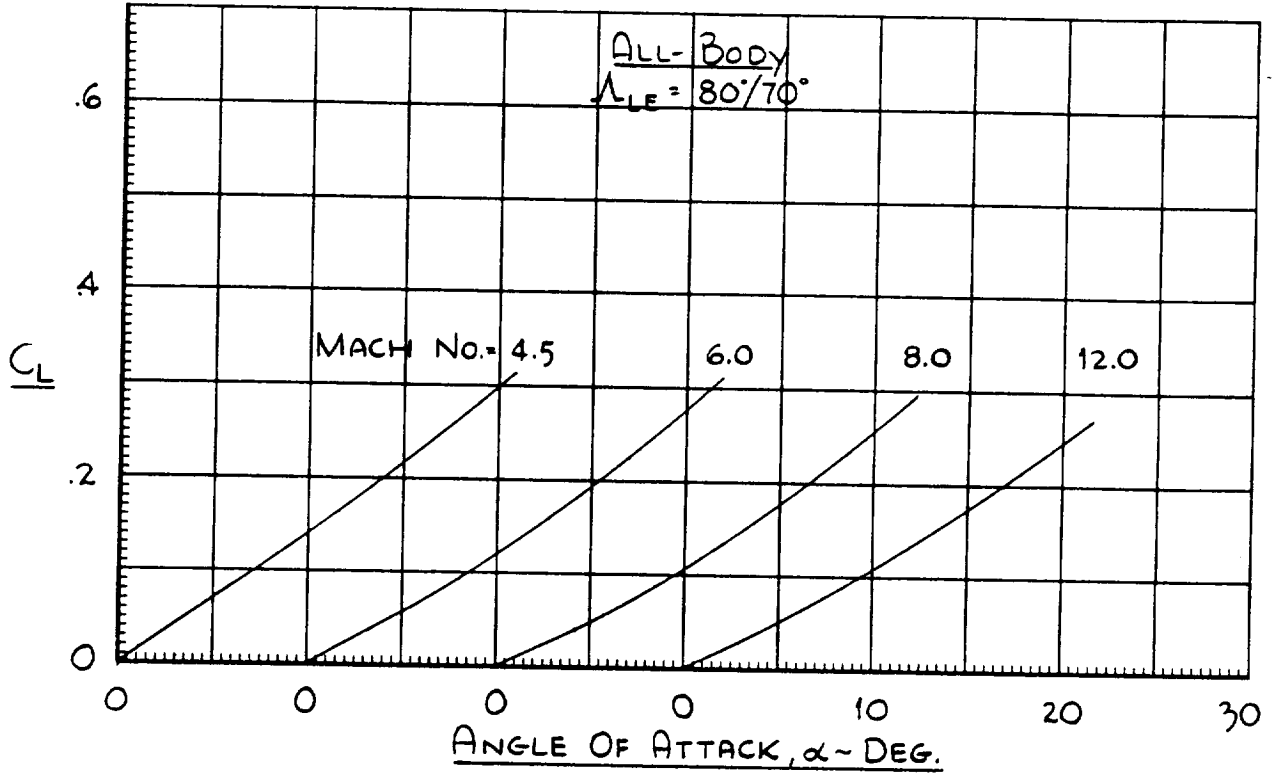

(U) FIGURE 4-22  
OPERATIONAL LIFT COEFFICIENT AND ANGLE OF ATTACK LEVELS

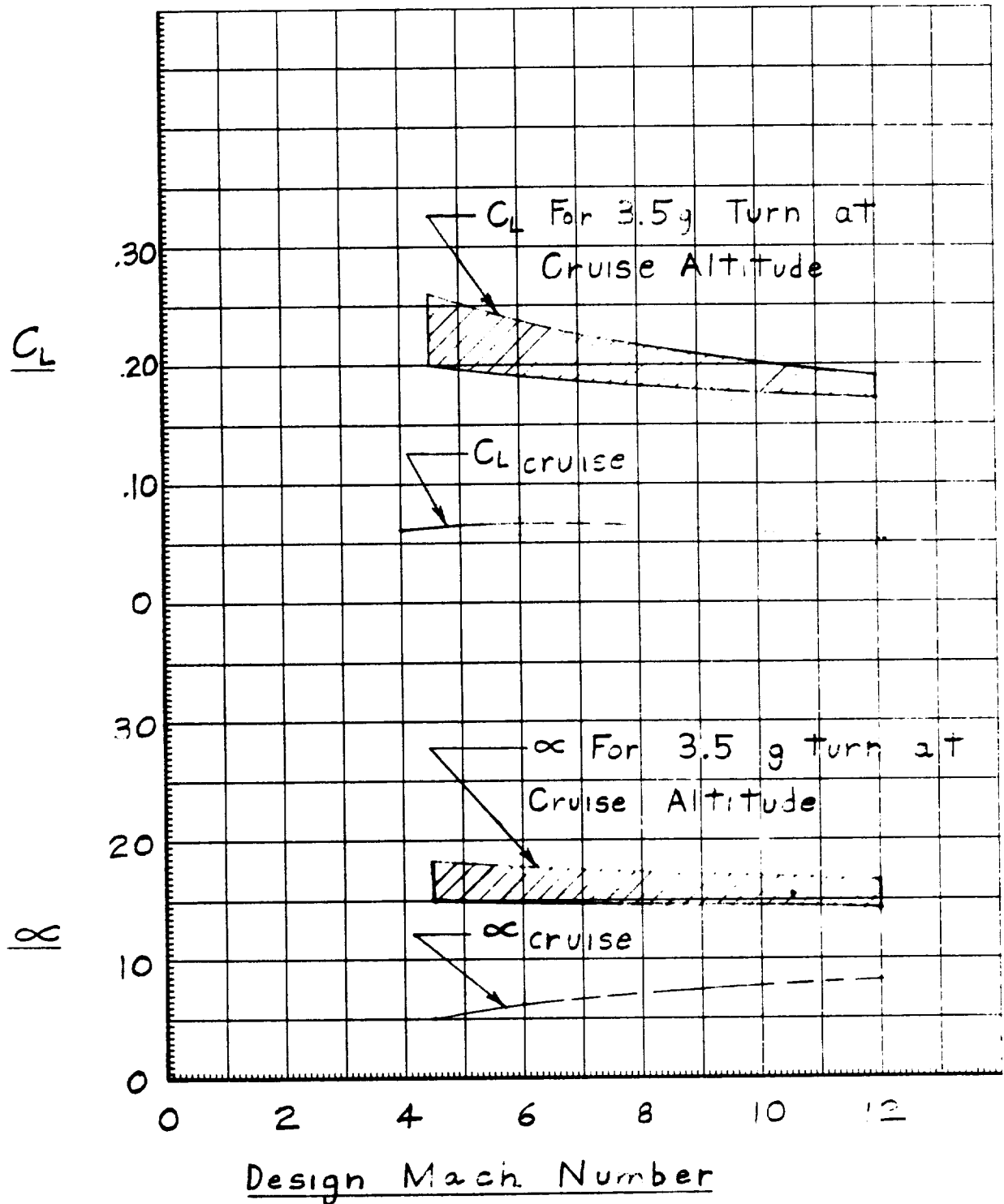

(U) FIGURE 4-23  
WING BODY vs ALL BODY DRAG COMPARISON

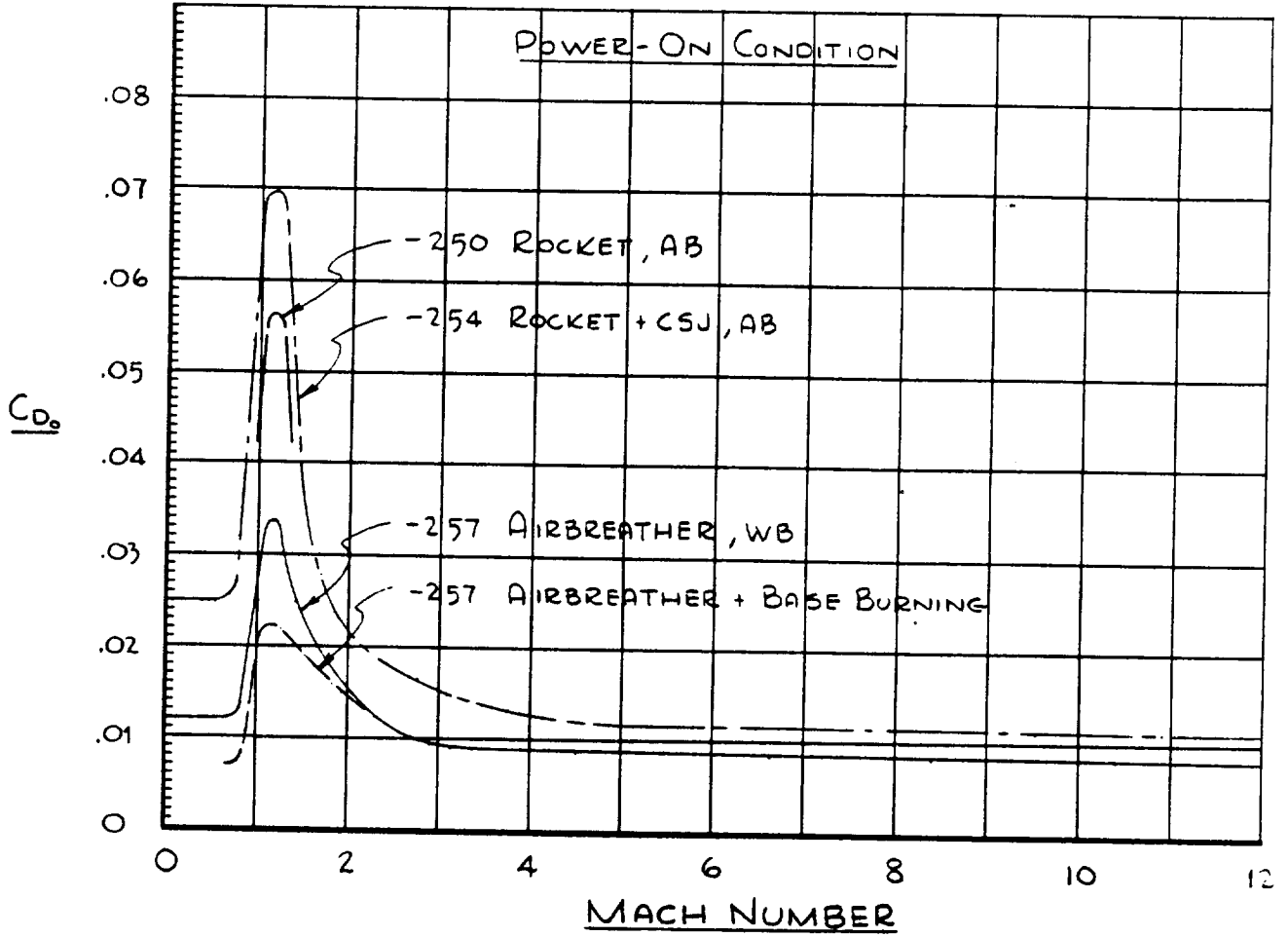

$$L' = N + K$$

where:  $N = \text{theoretical induced drag factor} = \frac{1}{.98 \pi AR}$

$K = \text{additional induced drag factor} \approx .10.$

A typical variation of  $L'$  with Mach number for wing-body configurations is shown in Figure 4-19.

(U) For all-body aircraft the same relationship is used to determine  $C_{D_0}$ , but  $(L/D)_{\max}$  is determined from Figure 4-14. The values for  $L'$  used for the all-body vehicle are based on data from a number of typical all-body designs. The average variation with Mach number based on these data is shown in Figure 4-20.

(U) Transonic Aerodynamic Drag - The zero lift drag coefficient at Mach 1.2 is based on the drag rise correlation given by Figures 4-24 and 4-25 as a function of vehicle cross-sectional area and length ( $S_F/L^2$ ). The drag coefficient at  $M = 1.2$  is determined by:

$$C_{D_0_{1.2}} = C_{D_0_{\text{subsonic}}} + \Delta C_{D_P} \left( \frac{S_F}{S_P} \right)$$

(U) For vehicles with scramjet engines the cross-sectional area was defined by:

$$S_F = A_{\max} - A_P$$

where:  $A_{\max} = \text{maximum cross-sectional area of theoretical vehicle}$

$A_P = \text{cross-sectional area attributable to the propulsion system}$

In this case the drag coefficient is defined by:

$$C_{D_0_{1.2}} = C_{D_0_{\text{subsonic}}} + \Delta C_{D_P} \left( \frac{S_F}{S_P} \right) + \Delta C_{D_0_{\text{prop}}}$$

where:  $\Delta C_{D_0_{\text{prop}}} = \frac{-F_n}{q S_P}$  (Scramjet Thrust Coefficient)

In the equation above values of  $q$  and  $F_n$  at Mach 1.2 and twenty thousand feet are used.  $F_n/A_c$  is read from Figure 2-9 in Volume V. Note that  $F_n$  is negative at these conditions and thus results in an additive drag term.

(U) Supersonic Aerodynamic Drag - Values of  $C_{D_0}$  at supersonic and hypersonic speed are calculated by using:

$$C_{D_0} = \frac{1}{4 L' (L/D)_{\max}^2}$$

$(L/D)_{\max}$  is read as a function of Mach number and  $(VOL)^{2/3}/S_P$  from Figure 4-9 for both wing-body and all-body configurations.

(U) FIGURE 4-24  
 DRAG RISE CORRELATION SUPERSONIC CONFIGURATIONS

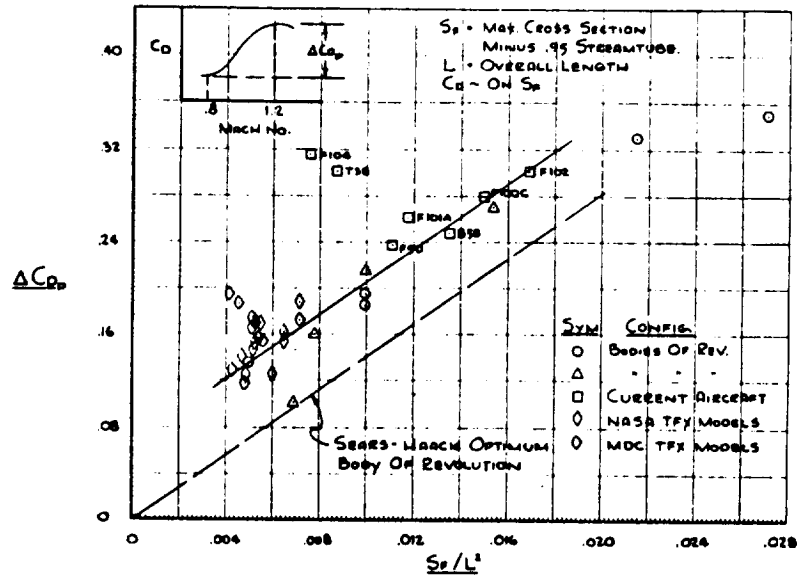

(U) FIGURE 4-25  
 DRAG RISE CORRELATION HYPERSONIC CONFIGURATIONS

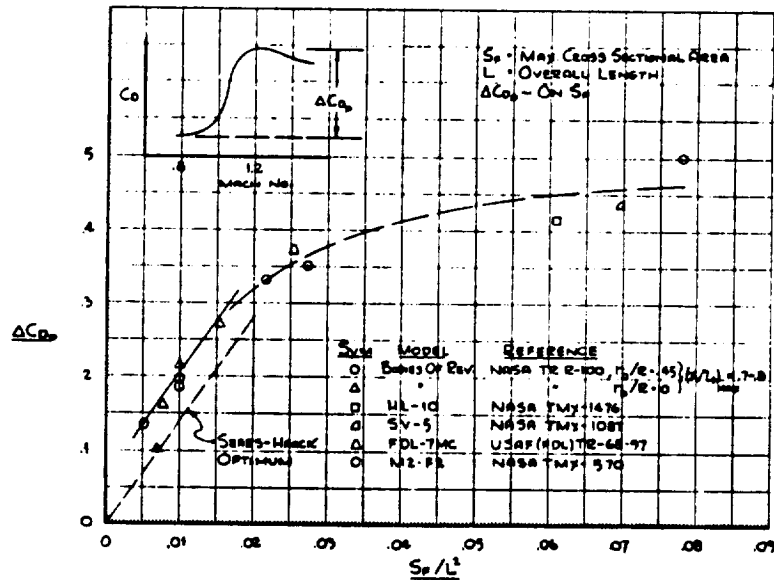

(U) Values of  $L'$  for wing-body configurations are calculated by using:

$$L' = 1/C_{L\alpha} - \Delta L'$$

where:  $\Delta L' = \bar{\Delta} [1/C_{L\alpha} - L']_{\text{subsonic}}$

$\bar{\Delta}$  is read from Figure 4-26.

The results of this calculation are shown in Figure 4-19. Since the variation in  $L'$  from one wing-body design to another was found to be quite small, the results shown in Figure 4-19 were employed for all wing-body designs.

(U) Values of  $L'$  for all-body configurations are read from Figure 4-20. This variation of  $L'$  with Mach number is based on data for a number of all-body vehicles and represents an average curve through the data.

4.3.5 (U) STABILITY AND CONTROL - The stability and control characteristics of each vehicle have not been evaluated in depth during Phase I. The designs have been configured, however, with consideration toward achieving adequate stability characteristics at all speeds. Figure 4-27 shows the neutral point location for a number of hypersonic vehicles. Also shown is the anticipated center of gravity range for the HYFAC vehicles. This cg variation is felt to be realistic and attainable by the proper location of equipment within the aircraft and by designing to provide adequate fuselage area forward of the effective wing apex. The cg range can be maintained by utilizing fuel management. A control augmentation system is anticipated in order to assure desirable handling qualities and precise flight path control.

(U) For rocket equipped vehicles, the engine is canted so that the thrust vector acts through the center of gravity. Scramjet engines must be placed below the fuselage in order to use the underside of the fuselage as part of the inlet and exit systems. Large negative pitching moments can result when the scramjet is initiated. The negative moment contribution of the scramjet can be used to help trim the basic aircraft. When the scramjet is not being operated, a nozzle flap is extended at hypersonic speeds to help reduce the pitching moment difference between scramjet power-on and off.

(U) Figure 4-28 shows the HYFAC vehicle external control systems. Wing tip control panels are used for pitch and roll control, as they are more effective at negative control deflection angles (trailing-edge-up) than elevons, since they operate in essentially free-stream conditions at all control deflections and angles of attack. Elevons would tend to lose effectiveness due to the separated flow field of the wing-body upper surface at hypersonic speeds and moderate angles of attack. The vehicle vertical fins have been toed-in to increase their effectiveness at low angles of sideslip. Rudders of the plain flap type are incorporated at the trailing edge of the vertical tails for directional control. The location at the aft extremity of the vehicle provides maximum tail length for directional control and the vertical location is consistent with minimizing rolling moment due to rudder deflection.

(U) Speed brakes will be provided for range compression and glide path control on landing approach. These can be in the form of separate speed brake panels, as shown in Figure 4-28, or unsymmetric deflection of the rudders can be employed.

(U) FIGURE 4-26  
LEADING EDGE SUCTION PARAMETER WING-BODY CONFIGURATIONS

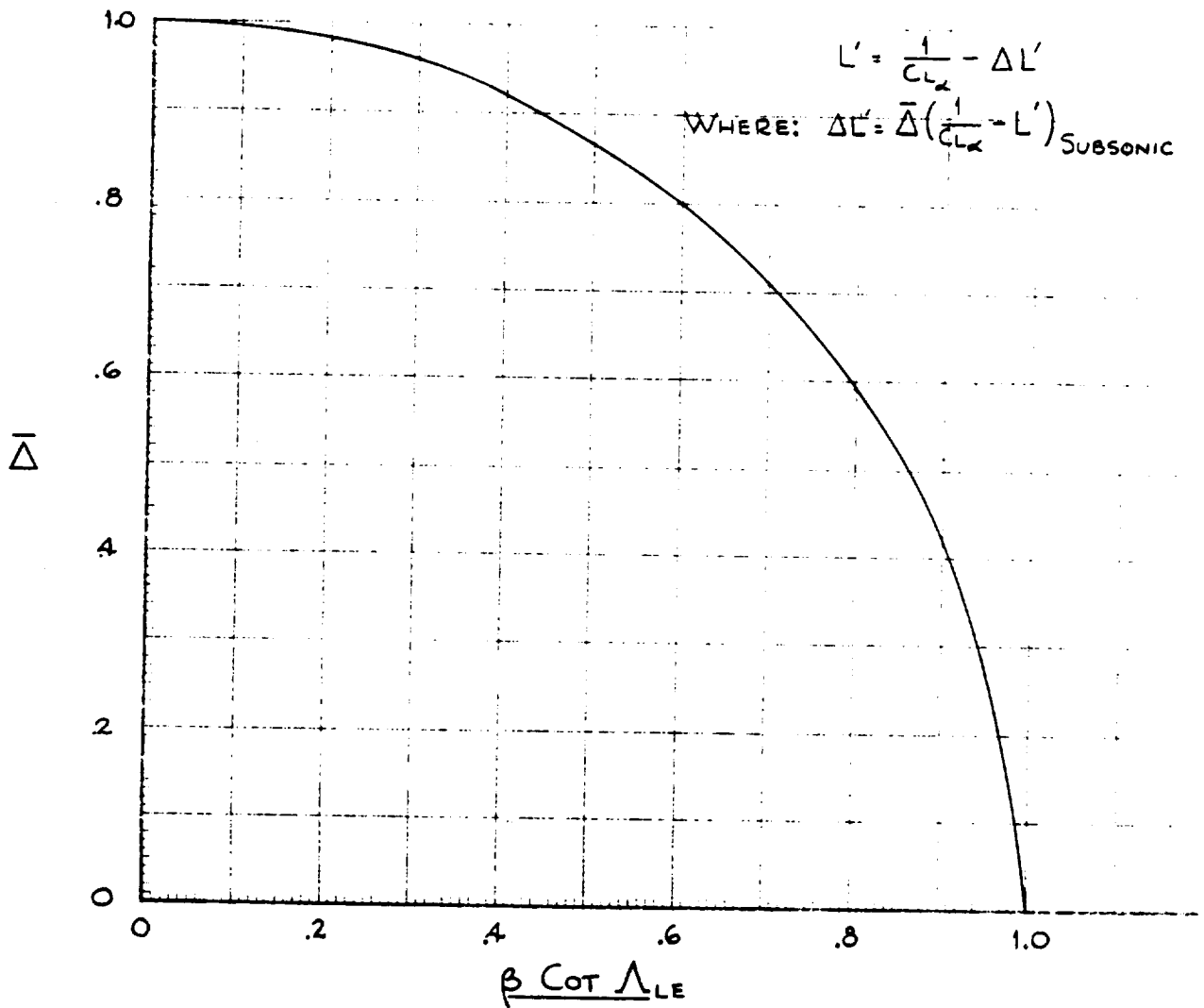

(U) FIGURE 4-27  
 NEUTRAL POINT COMPARISON

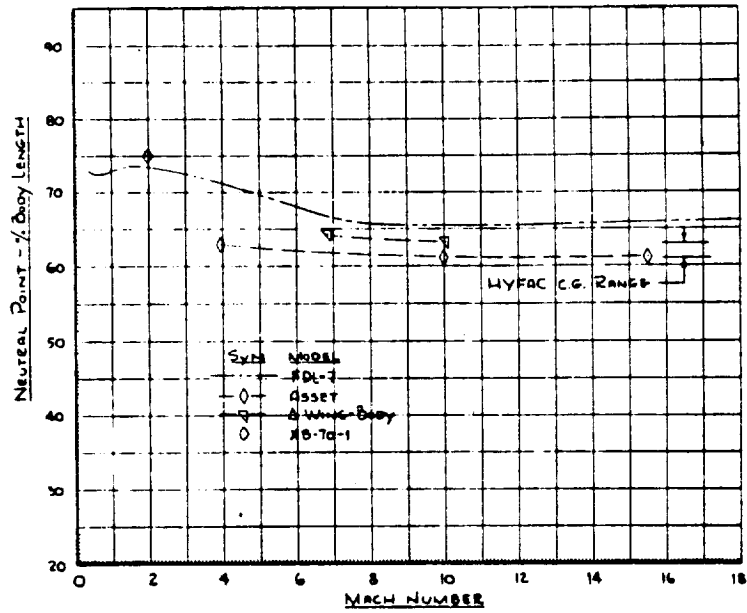

(U) FIGURE 4-28  
 VEHICLE CONTROL SYSTEMS

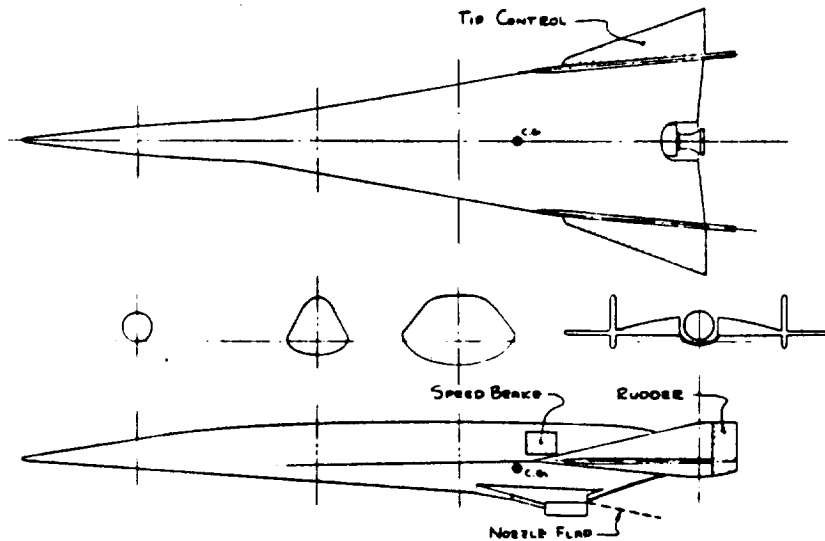



This Page Unclassified

Figure 4-29 shows the variation of speed brake area to planform area ratio with  $(VOL)^{2/3}/S_p$  for three levels of speed brake effectiveness. These values have been computed at subsonic speeds for a typical aft fuselage mounted brake.

(U) FIGURE 4-29

SPEED BRAKE SIZE AND EFFECTIVENESS - AFT FUSELAGE BRAKES - SUBSONIC

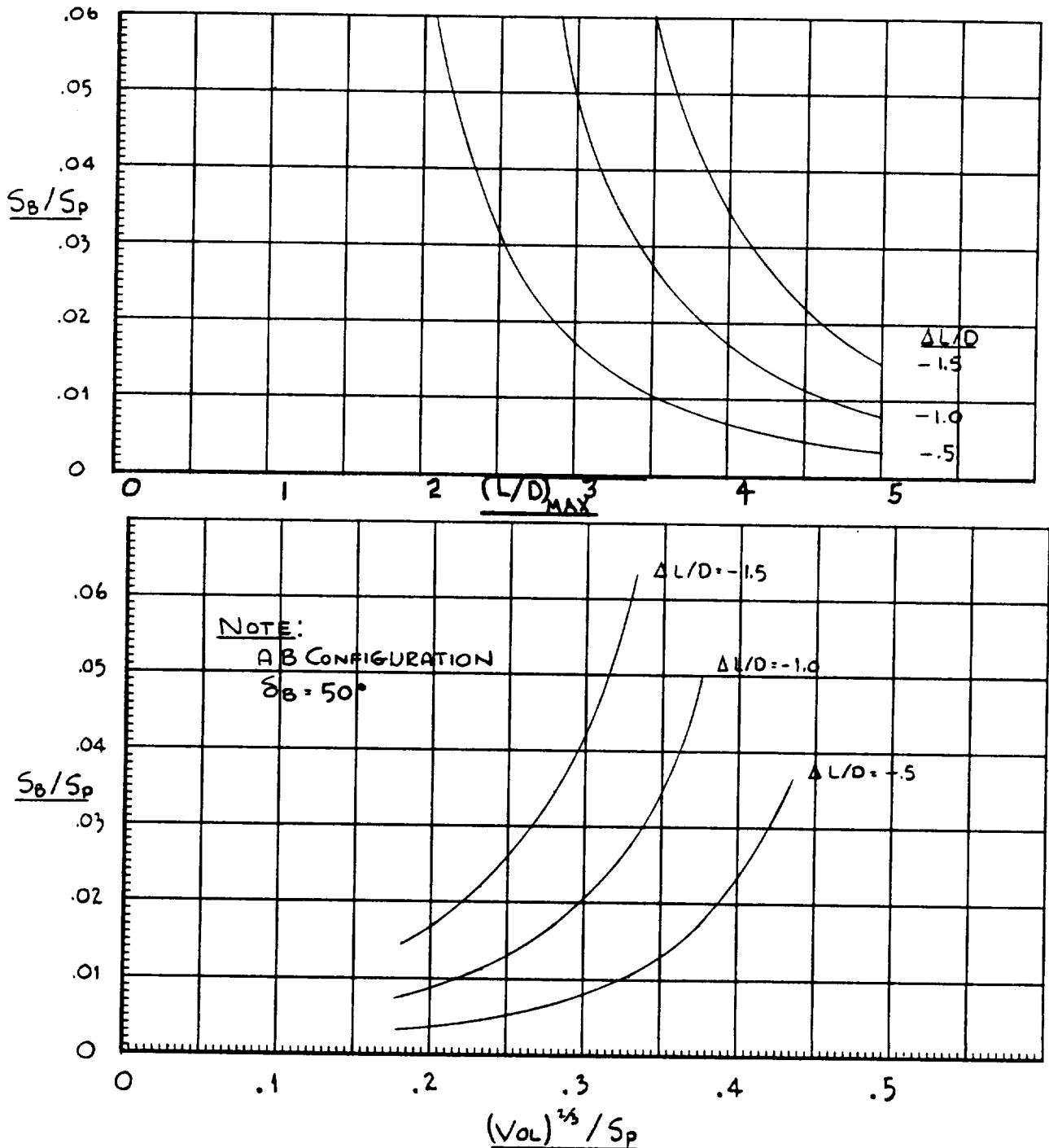

#### 4.4 PROPULSION

(U) The fundamental propulsion goal of Phase I was to select appropriate engines to satisfy the flight facility matrix of Figure 4-2. After selecting the engines, suitable installation in the various vehicles was achieved, followed by analysis of installed performance. This section describes the selection process which was accomplished within the design criteria of Section 4.2, and also particularizes the procedures used to determine installed performance. The actual engine performance contains considerable data proprietary to the respective engine manufacturers, and is presented in Volume V, to permit widest distribution of this volume.

4.4.1 (C) Engine Contractor Effort in Advanced Propulsion - The first effort undertaken in selecting propulsion systems for the candidate flight test vehicles was to contact several propulsion contractors for three purposes: (1) to obtain a current knowledge of applicable propulsion contractor programs, (2) to obtain data on current engines which might have application to the flight test vehicles, and (3) to acquaint the propulsion contractors with the HYFAC study and the assistance desired from them. Contained in this section is a description of the principle results of these meetings and a preliminary assessment of the applicability of the findings to the HYFAC program.

4.4.1.1 (C) Rocket Engine Programs - Visits were made to Rocketdyne, Pratt and Whitney Aircraft and Aerojet General in the area of rocket propulsion systems. Of interest to the HYFAC studies is the advanced design work being carried out by Rocketdyne and Aerojet in the area of essentially two dimensional exhaust nozzle installations. Aerojet's approach incorporates a series of rocket motor combustion chambers situated around the periphery of an oval or rectangular-shaped aft end of a vehicle. Such configurations may allow more freedom to the vehicle designer in integrating the rocket propulsion unit into the aft end of the vehicle than is available with conventional bell nozzles. At a point downstream of the rocket nozzle throat where the pressures have diminished such that cylindrical sections are no longer required to minimize weight, the nozzle cross section makes a transition from a circular to a rectangular cross section in such a way that at the nozzle exit plane, exhaust over an essentially two dimensional spike configuration is obtained. Flaps located at the end of the two dimensional spike have been proposed as a means of thrust vector and roll control. Aerojet reported that they have demonstrated that the transition from circular cross section can be made with negligible decreases in performance and increases in weight, compared to conventional bell nozzle configurations.

(C) Rocketdyne's approach to the same vehicle base integration problem is to employ a segmented torroidal aerospike engine to achieve the same two dimensional aft end nozzle configurations. The spike nozzle configuration, when installed on a lifting vehicle, experiences unsymmetric pressure loads on the spike. These loads result in thrust alignment changes which may effect the vehicle control requirements. These effects have not yet been investigated. An additional advanced configuration discussed by Rocketdyne employed an axisymmetric torroidal engine in which the interior region of the truncated spike was used to house the exhaust nozzle of an air-breathing propulsion unit.

(U) P&WA has reported no comparable effort to the two-dimensional exhaust nozzle efforts of Rocketdyne and Aerojet. Instead, concentration is being placed on the LR-129 high chamber pressure  $LO_2/LH_2$  engine currently under development and scheduled for PFRT by mid 1974.

(C) Of primary interest to the HYFAC program is the throttleability of the rocket engines since possible configurations may employ the same rocket engines for both boost and sustain operation. All contractors visited indicated that a 10:1 throttleability ratio is achievable with the engines they are currently investigating. It is interesting to note, however, that for the LR-129 demonstration program only a 5:1 ratio is specified. On the J2-S program no throttling is currently specified in the contract, although the contractor indicates that the engine is being developed to have throttling capability. The AMPS, Advanced Maneuvering Propulsion System, rocket motor being developed by Rocketdyne will have an 80:1 throttling ratio. This is achieved by the use of two concentric motors, one toroidal and one conventional bell nozzle motor; each has a 9:1 throttling ratio. The maximum thrust of the inner, conventional bell-nozzle motor is equal to one ninth (1/9) the maximum thrust of the toroidal motor. Multiple motor installations, of course, can be used with any engine type to achieve a wide throttling range. The Aerojet MIST engine is reported to have a goal of 10:1 throttling range with a 9:1 ratio already demonstrated.

4.4.1.2 (C) Turbomachinery Programs - Primary emphasis in current turbomachinery development for supersonic propulsion is centered on component improvement. With the exception of the engine programs for the F-15 aircraft and the SST, there is little effort on assembling such advanced components into a workable system. All of this effort involves only JP-type fuels. Improved compressor development aimed at greater compactness via higher stage loading and higher air velocities through the stages, is in progress at P&WA, GE, and Allison. Combustors operating stoichiometrically have been demonstrated by the above three contractors, at combustion efficiencies near 90%. Increased turbine inlet temperature and decreased cooling losses are being sought by use of advanced materials and cooling techniques. Advanced materials include superalloys. Fabrication techniques to produce porous structures for transpiration cooling are being developed. At GE and P&WA emphasis is on single-stage turbines, while at Allison both single-stage and two stage designs are in development. Ramburner research has proceeded to the point that straightforward design and normal development could be undertaken; P&WA has demonstrated considerable competence in this area as a result of their J58 and JTF17 (candidate SST engine, a duct-burning turbofan) efforts. Nozzle designs adequate for the needs of turbojets and turboramjets are available, but light weight mechanization still needs development. Nozzle cooling and performance are available now and only modest development is in progress.

4.4.1.3 (C) Ramjet/Scramjet Programs - The engine contractors contacted in the area of ramjet and scramjet technology were General Electric, Marquardt, Garrett and the United Aircraft Research Laboratories. At the Evendale facilities of GE the CIM, (Component Integration Model), I, II and III, programs were reviewed. In these programs, an axisymmetric spike, podded, hydrogen fueled, dual-mode-combustion scramjet configuration is being developed as part of the USAF-GE Contributing Engineering Program AF33(657)-14478. Tests have been run under the CIM II program on a water cooled engine. When heat loss corrections are made to the measured data,

attractive specific fuel impulse levels have been obtained. In the dual mode combustor of the CIM II configuration stable combustion has been demonstrated throughout two modes of combustion, as well as in the transition from one mode to the other. The CIM III program, currently in model design stage, will include tests on a fuel cooled dual mode combustor configuration designed to operate over the Mach number range from 4-7. As with the CIM II program, these tests will be conducted at a Mach number of 7. Throughout this program particular attention has been paid to the materials problem as well as the structural and fabrication problem. At the energy levels associated with Mach 7 flight, structural technology appears to be progressing at a rate compatible with fuel injection and combustor technology development. Although GE has placed major emphasis on H<sub>2</sub> fueled engines, some effort has been placed on the use of ethylene and methane as fuels. Little experimental effort has thus far been devoted to angle of attack effects on the performance.

(C) Following a series of Mach 5 tests of a hydrogen fueled, variable geometry ramjet/scramjet in the 1967-1968 time period, emphasis at the United Aircraft Research Laboratories has been placed on the hydrocarbon scramjets. Emphasis in scramjet development for military systems has shifted to volume-limited system applications such as tactical missiles. UARL is pursuing a thorough stepwise component development program, which essentially attempts to construct a systematic base of information and procedures for future hydrocarbon scramjet designs, (AF Contract AF33(615)-5153). Again, the configurations on which major emphasis have been placed thus far at UARL have been axisymmetric podded installations.

(C) The HRE program being conducted by the Garrett Corporation (Contract NAS1-6666) is concerned currently with the ground testing of an axisymmetric podded configuration. The dual mode hydrogen fueled engine operates in the subsonic combustion mode over the Mach number range from 3-6 and in the supersonic combustion mode over the range of Mach numbers from 6-8. A translating inlet is used in the engine starting and stopping process. A component development program has been successfully completed for all major components. The program has included the following technology developments: fuel control, fuel distribution, materials, structures, and fabrication. This program is unique in the importance placed on the fuel control aspects and the results achieved. The effects of a limited angle of attack range on engine performance can be minimized by suitable adjustments in fuel distribution effected by the fuel control system corresponding to entering flow asymmetries resulting from the angle of attack. Stable combustion in both modes has been demonstrated as well as in the transition from one mode to the other. Current plans call for testing a complete water cooled engine in the Plumbrook Facility in June 1970.

(C) Past scramjet programs at Marquardt have demonstrated the feasibility of supersonic combustion and the possibility of stable transition from a subsonic combustion mode to a supersonic combustion mode in a dual mode scramjet engine. A flight test demonstration program was terminated prior to actual flight test presumably because the possibility of achieving adequate thrust-drag margins was not demonstrated by ground testing within the time allowed for such ground test demonstration. As with UARL, Marquardt's current efforts in the scramjet propulsion area consists primarily in efforts in the direction of volume-limited systems applications. In the gas-generator-fueled scramjet program currently underway, the feasibility of burning boron efficiently in a scramjet combustor is being investigated.

This is a relatively fundamental program to study the mixing and combustion of the boron fuel-rich exhaust products of a gas generator. In this fuel supply system hot boron particles are exhausted from the gas generator for subsequent combustion in a scramjet combustion chamber. A hydrocarbon-fueled scramjet feasibility program is also being conducted (AF33(615)-5152) in which piloting and injection techniques are being studied experimentally in the direct connect and free jet test modes. Marquardt has recently completed a program investigating structural concepts, performance, component cooling capabilities and control concepts for a hydrogen fueled ramjet capable of operating over the Mach number range from 3 to 8. Multiple cycle, long duration run capability has been demonstrated with flight weight hardware. Run times up to 23 minutes at wall temperatures up to 2300°R (1280°K) have been demonstrated.

4.4.1.4 (C) Summary - Although rocket engine hardware is under development which has attractive vacuum specific impulses (storable = 330 sec, cryogenics = 430-460 sec) there is, pending further results of the HYFAC studies, insufficient emphasis currently being placed on the throttleability of these engines. Attractive installation configurations achievable with the Rocketdyne and Aerojet base integration concepts may give the vehicle designer more flexibility than heretofore available. However, much work remains to be done before these configurations are satisfactorily demonstrated.

(U) The current emphasis on turbomachinery component development without similar effort on assembling a compatible engine, means that the availability of a suitable turbine engine for a hypersonic research vehicle cannot be anticipated unless such development is undertaken specifically for the test vehicle. Adaptation of an existing or currently-in-development engine, such as the F100, may be accomplished to fill this need.

(U) Much of the scramjet engine development effort currently in progress is directed toward axisymmetric podded installations. This is in rather notable contrast to the configurations considered by airframe manufacturers to be attractive in the Mach 8-12 regime. Application studies, such as those from which the potential operational systems were derived, have indicated that the most attractive scramjet installations are those which are highly integrated with the overall vehicle. Such configurations attempt to use the vehicle forebody for favorable compression surfaces and the vehicle afterbody as nozzle expansion surfaces. The technologies related to fuel control, cooling, materials, and structures developed from axisymmetric configurations will have application to highly integrated configurations. However, the full scope of the problems associated with asymmetric, highly integrated airbreathing propulsion units has to date not been approached experimentally.

4.4.2 (U) Selected Cycles - Review of the engine contractors' current efforts, combined with the basic flight facility criteria that technology be state-of-the-art in 1970-1975, indicated that only a few of the possible propulsion cycles would be appropriate for HYFAC. In this discussion the word "cycle" is taken in its broad use of differentiating between, for instance, rocket engines and turbojet engines, rather than in the narrow sense of the differentiating between a gas-generator-fed rocket and a preburner type rocket. With this definition, three primary cycles were chosen: (1) rockets (RKT), (2) turbojet (TJ) airbreathers, and (3) ramjet (RJ) airbreathers.

(U) In addition to these basic cycles two modifications and several composite arrangements were considered. The turbofanjet (TF) cycle (F100-GE-100) was considered, where part of the compressed air is bypassed around the primary burner and turbine, going directly to the afterburner and nozzle. The scramjet (SJ) variation of the ramjet cycle was also included, where the air is decelerated only slightly, maintaining supersonic velocities throughout the engine. In considering composites, the potential improvements in installation and structural efficiency available by having multifunction components were the desired result. Of the various possible composites, those involving combining the rocket cycle with an airbreathing cycle were judged to involve technology beyond the study limit. This condition occurs because various engine application studies conducted by MCAIR and others have consistently found other composite engines such as the turboramjet to be more attractive, and their development in the absence of an attractive application is unlikely. However, the turboramjet (TRJ) combining the TJ and RJ does exhibit desirable features using technology consistent with the study criteria, as discussed, for example, in Reference (2). One further composite was considered, the convertible scramjet (CSJ), which provides for subsonic and supersonic combustion with a single inlet-combustor-nozzle design. Due to the wider speed range available with the CSJ relative to the SJ, with no loss in maximum speed, the CSJ was used throughout Phase I for those applications which might have used an SJ.

(U) Thus for Phase I five types of engines were selected: rockets, turbojets and turbofans, turboramjets, ramjets, and convertible scramjets. Combinations of these engines were required in some instances to satisfy the complete flight profile of the candidate flight facilities. The turboramjets and rockets can satisfy both acceleration and cruise functions; turbojets, ramjets and scramjets must be used in combination with other cycles to fulfill the mission propulsion requirements.

4.4.3 (U) Engine Selection and Description - A variety of possible engine candidates exist within the cycles specified above. Selection among these, first for applicability to HYFAC missions and then for appropriateness to the airbreathing Phase I criteria, is described in this section. The airbreathing engines must operate along the airbreather flight profiles for test vehicles shown in Figure 4-45. Rocket engines must be able to operate along both the rocket and airbreather flight profiles, except the cruise rocket engines on the staged vehicles which need operate only at cruise altitude.

4.4.3.1 (U) Rocket Engines - In selecting rocket engines for Phase I, a variety of off-the-shelf and developmental engines were available to fulfill the test vehicle flight requirements. Designs of conceptual status (that is, not currently in active development) were not considered because adequate capability was found in more near term engines. Nozzle configurations such as the Rocketdyne Aerospike and the Aerojet two-dimensional cluster were not judged appropriate to Phase I because in-depth studies beyond the Phase I scope must be performed to determine the possibility of significant improvements in vehicle performance from using such designs. The use of bell nozzles provided performance representative of the rocket engines appropriate to the time period involved and to the study phase.

(U) Off-the-shelf rockets consistent with the propellant restrictions of Section 4.2 include numerous hydrazine-blend fueled engines ranging from 2,000 to 215,000 pounds (8,900 to 956,000 N) thrust. However, only two hydrogen-fueled engines are currently available; furthermore, developmental hydrogen-fueled engines are

expected to be developed at thrust levels considerably above that appropriate to HYFAC test vehicles. For these reasons it is not feasible to postulate a set of "off-the-shelf-in-1975" cryogenic rocket engines properly sized for the HYFAC vehicles. Since most of the candidate flight facilities use cryogenic rockets it was decided to use a rubberized study engine based on developmental technology of the LR-129, Reference (3). For study consistency and comparison with the advanced cryogenic technology represented by the LR-129, it was decided to use a similar rubberized study engine based on MIST/ARES developmental technology for the storable-propellant rocket (Reference (4)). For the staged vehicle configurations 281 and 282, the LR-129 and MIST scaling limits did not permit the use of small engines, on the order of 5000 lb (2200 N) thrust. Another Pratt and Whitney rubberized study engine was used for the cryogenic rocket engine, Reference (5), thus being consistent with the large engine technology. No similar study was available to meet the need for a storable propellant engine on the -282 vehicle. An existing engine, the Bell 8258, Reference (6), was considered. However, the -282 vehicle did not appear attractive, thus refinement of this small storable engine was not needed. Thus four rocket engine concepts were selected for Phase I: LR-129, MIST, Bell 8258, and P&WA PDS-2687 parametric study engine family. As a consequence the two large-thrust engines are based on equivalent advanced technology, but the small-thrust engines have a disparity in that the Bell 8258 is current technology while the P&WA PDS-2687 engine is based on somewhat advanced technology. This inconsistency is a second order effect and should not effect the final screening results.

(C) The LR-129 is a high chamber pressure (3000 psia, 2070 N/cm<sup>2</sup>), LO<sub>2</sub>/LH<sub>2</sub> rocket using a preburner (staged combustion) cycle. Propellants are turbopump fed, and the chambers and nozzle are regeneratively cooled. A fixed nozzle design was selected using the P&WA baseline nozzle contour; an expansion ratio of 75 was chosen as the largest size for which data were readily available and which would not encounter separated flow at sea level conditions.

(C) The MIST/ARES (Multipurpose In-Space Throtttable/Advanced Rocket Engine Storable) study engine is also a high chamber pressure (2800 psia, 1930 N/cm<sup>2</sup>) engine using a preburner cycle, with N<sub>2</sub>O<sub>4</sub>/Aerozine 50 propellants, which are turbopump fed. The secondary combustion chamber and the basic nozzle are transpiration cooled while the nozzle extension is radiatively cooled. A nozzle expansion ratio of 50 was chosen as the largest value for which performance data were available and which will not have separated flow at sea level.

(C) The Bell 8258 is a low chamber pressure (120 psia, 83 N/cm<sup>2</sup>) engine with pressure fed N<sub>2</sub>O<sub>4</sub>/Aerozine 50 propellants. All components are ablatively cooled; the nozzle expansion ratio is 40.

(U) The P&WA PDS-2687 study engine is based on RL-10 technology: LO<sub>2</sub>/LH<sub>2</sub> with chamber pressure of approximately 500 psia (345 N/cm<sup>2</sup>), regeneratively cooled, with a modified expander cycle to drive the turbopumps. A nozzle expansion ratio of 100 was selected for Phase I; since for use on the -281 vehicle, rocket operation is not needed below 140,000 ft (42.7 km) altitude, a high expansion ratio can be used without encountering separation.

(U) For all of these rockets, throttling capability was assumed to be available as needed to meet the test vehicle flight profile. Figure 4-30 depicts these rocket engine configurations.

(U) FIGURE 4-30  
ENGINE CONFIGURATIONS - ROCKETS AND TURBOJET

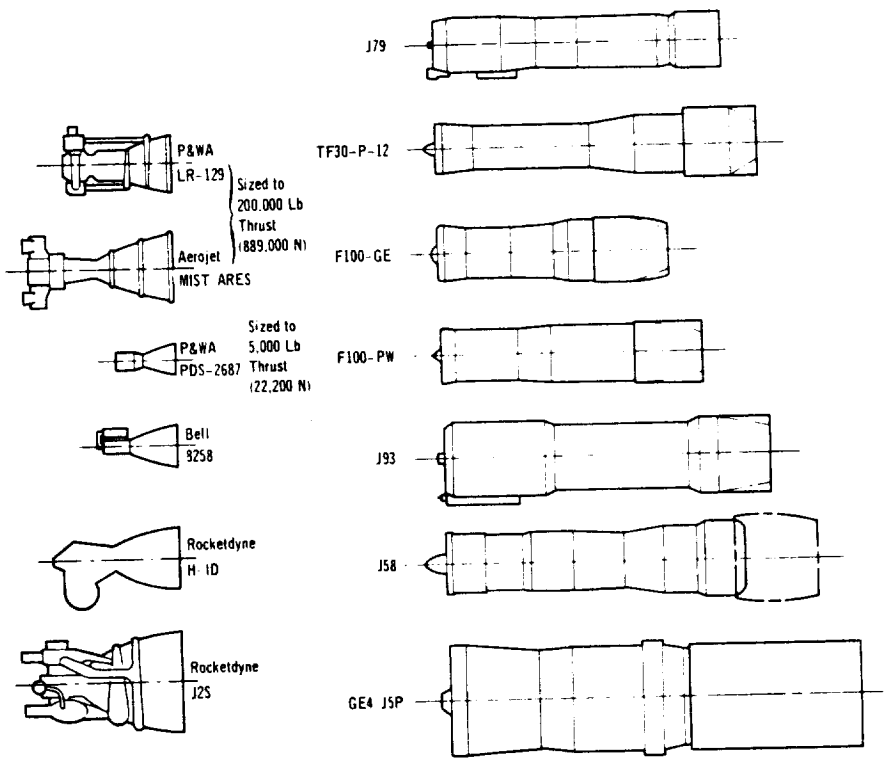

4.4.3.2 (C) Turbojets and Turbofans - In selecting turbojets/turbofans for Phase I it was decided that they should operate on hydrogen fuel, since all of the test vehicles using TJ/TF acceleration engines have hydrogen-fueled cruise engines. Thus separate tankage would not be required. However, it was realized that the development cost of a new, stoichiometric hydrogen turbojet could not be justified for the HYFAC acceleration function. Therefore, it was decided to use the performance of existing and developmental TJ/TF if operated with hydrogen to a turbine inlet temperature of 2200°F (650°C) and a stoichiometric afterburner. Such modifications of seven engines were considered: The J79-17, YJ93-3, J58, and GE4/J5P turbojets, and the TF30-P-12, F100-GE-100, and F100-PW-100 turbofans; see Figure 4-30.

(U) The basic J79-17 is an afterburning turbojet with a compressor pressure ratio of 12, used in the F4 and A5 series aircraft. Other versions of the engine have been used in the B58 and F104 aircraft; the engine was developed for JP4 and JP5 fuels, and has been operated to Mach 2+. The basic YJ93-3 is an afterburning turbojet with compressor pressure ratio of 9 and has been used in the B70 aircraft with JP5 and JP6 fuels, to Mach 3. The basic J58 is an afterburning turbojet with a compressor pressure ratio of 8 and has a complex inlet bypass/engine bleed installation on the YF12 aircraft. JP7 fuel is used, and it has operated in excess of Mach 3. The basic GE4/J5P is an afterburning turbojet being developed for the supersonic transport at Mach 2.7 with growth to Mach 3.0. The fuel is similar to JP5, and the compressor pressure ratio is 12.



(C) The basic TF30-P-12 is an afterburning turbofan having a bypass ratio of 1.0 with a compressor pressure ratio of 17; it is used in the F111 aircraft with JP4 and JP5 fuels, to Mach 2+. The basic F100-GE-100 and F100-PW-100 are afterburning turbofans with bypass ratios at .9 and .7, respectively, and compressor pressure ratios of 24 and 21, respectively. Design maximum Mach number is 2.5 for standard day conditions. All of the turbojets and turbofans described are equipped with variable geometry exhaust nozzles for efficient operation across a wide speed range; however, the J58 and TF30 nozzles as currently configured use blow-in-door ejector nozzles. For proper operation of these designs, considerable compromise in vehicle configuration may be required in the vicinity of these nozzles, so that their applicability to HYFAC is limited.

4.4.3.3 (C) Turboramjets - In selecting turboramjets, none are anticipated to be "off-the-shelf in 1975", but the necessary basic technology is expected to be available then. From the various proposed engines resulting from the several studies performed in the past few years, two designs were selected as representing the field of candidates. For the speed range up to Mach 4.5, using JP-type fuel, the General Electric GE14/JZ8, Reference (7), was chosen. For the speed range up to Mach 5-8, using LH<sub>2</sub>, the General Electric GE5/JZ6C, Reference (8), was chosen. Both of these are wraparound TRJs, with the annular RJ concentric to the central TJ. Both use separate but concentric nozzles for RJ and TJ. The engines operate the TJ to it maximum allowable speed per the engine specification: Mach 3.5 for the JZ8 and Mach 3.75 for the JZ6C. The RJ is operated from Mach 1.0 to cruise speed. The JZ8 is air-cooled throughout, while the JZ6C is fuel-cooled. Figure 4-31 depicts the TRJ designs.

(C) FIGURE 4-31  
ENGINE CONFIGURATIONS - TURBORAMJETS, RAMJETS, AND SCRAMJETS

GE14/JZ8 TRJ

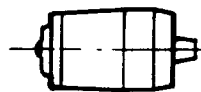

GE5/JZ6C TRJ



MA-145 Ramjet

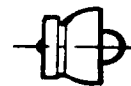

MA-188 Scramjet

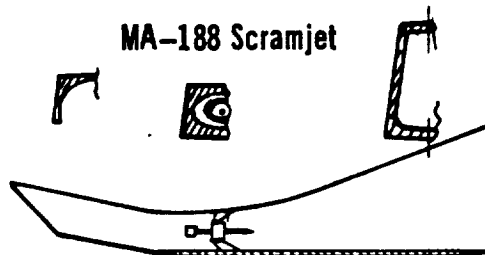

This Page Unclassified

4.4.3.4 (U) Ramjets and Scramjets - In selecting ramjets and scramjets, only a small number of proposed designs are available. Of these, none will be available in 1975 unless a development program were undertaken now; however, the fundamental technology is expected to be available then. Only one simple ramjet design is now available, the Marquardt MA145, Reference (9). This ramjet design is hydrogen fueled, stoichiometric, and fuel cooled with cooling adequate to permit significant throttling at Mach 6 cruise. An axisymmetric configuration is used with a translating-plug nozzle. Currently, scramjet designs proposed by engine manufacturers are almost exclusively axisymmetric designs, intended for podded installation. Considerable effort previous to the HYFAC study has been devoted to finding an efficient vehicle using podded scramjet, but with little success. It has been found that a highly integrated configuration is necessary. As a consequence during a previous MCAIR study for USAF, considerable coordination between MCAIR and Marquardt resulted in a scramjet concept suitable for a highly-integrated vehicle, the MA188, Reference (10). With this as a basis the requisite vehicle underbody contours were developed for efficient inlet and nozzle operation, producing the vehicles of Reference (11). For Phase I of the current study, the integrated convertible scramjet vehicle of Reference (11) was used. The convertible scramjet was selected over a possible point-design scramjet in order to provide wider operational flexibility. This greater flexibility of the CSJ is available for no cost in specific impulse or engine weight; a 40 psf (.2 N/cm<sup>2</sup>) loss in specific thrust ( $F_N/A_c$ ) at cruise is overcome by increasing the capture area of the CSJ. The CSJ inlet starts at Mach 3.5 at which point the transition from external compression to mixed compression occurs. The CSJ is then ignited and operates in ramjet mode from Mach 3.5 to 6.0. Transition to scramjet mode is accomplished at Mach 6.0 and supersonic combustion is maintained from Mach 6 to 12. The CSJ is also operated during transonic acceleration from Mach 1.0 to 1.8, with the inlet unstarted, as a means of pressurizing the base region and thus reduce transonic drag. Allocation of vehicle load as either aerodynamic forces or propulsion forces is described in Section 4.3. Figure 4-31 depicts the RJ and CSJ configurations.

4.4.3.5 (U) Boosters - In selecting boosters for the staged vehicles, data were gathered for six candidates: Little Joe, Thor, Poseidon, Minuteman, Atlas, and Titan, Figure 4-32. Comparing these various systems to the requirements of the flight facility matrix, it was determined that the Thor could boost the Mach 6 cruise vehicles as desired, and the Atlas could boost the Mach 12 cruise vehicles.

4.4.3.6 (U) Pairing Engines to Flight Facilities - In comparing the propulsion requirements of the various flight facilities to the capabilities of Section 4.9.1, the pairings presented in Figure 4-33 were chosen. Salient characteristics of the selected engines are presented in Figure 4-34. These pairings were maintained throughout Phase I. Additionally, some attention was directed at determining the utility of incorporating off-the-shelf rockets and off-the-shelf JP-fueled turbojets, wherever possible. The potential list of those currently-available engines paired to the appropriate flight facility is given in Figures 4-35 and 4-36. Characteristics of the engines are presented in Figures 4-37 and 4-38.

4.4.4 (U) Engine-Airframe Integration - Efficient integration of the selected engines with the airframe configuration is necessary to develop attractive vehicles. For the rocket powered vehicles, installation at the aft end with unimpeded exhaust

(U) FIGURE 4-32  
BOOSTER CONFIGURATIONS

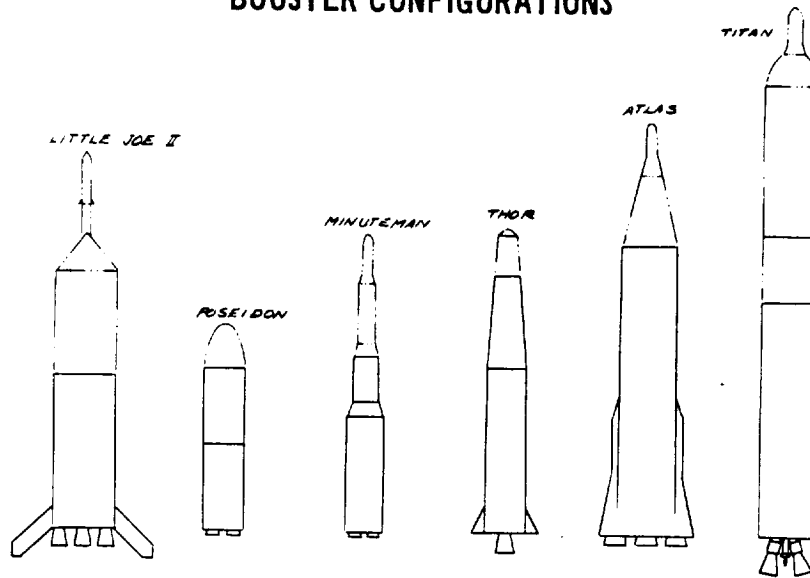

area is the primary requirement for rocket performance. This has been satisfied in all Phase I flight facilities while maintaining alignment of the rocket thrust vector close to the vehicle center of gravity, keeping control requirements small.

4.4.4.1 (U) Airbreather Engine Location - For all of the airbreathing configurations previous studies indicate that significant utilization of the vehicle pressure field will lead to the most attractive vehicles by increasing inlet recovery and air mass flow capturing capability. Maximum benefit of this pressure field generally is obtained by installing the engine beneath the vehicle at approximately half to two-thirds of the vehicle length aft of the nose. Locating the engine in the fuselage belly region then offers several specific advantages:

- o Maximum use of forebody pressure field to improve inlet recovery and capture capability
- o Use of afterbody base surface as nozzle exhaust expansion area
- o Longitudinal vehicle center of gravity (c.g.) control

Care must be exercised to insure that the vertical offset between engine thrust and vehicle c.g. does not become excessive; the engine weight itself helps meet this criteria by causing the c.g. to be relatively low.

(U) FIGURE 4-33  
ENGINE MATRIX

VEHICLE	ACCELERATION				CRUISE			
	TJ	TRJ	RKT	BOOSTER	TRJ	RJ	CSJ	RKT
-200	-	JZ8	-	-	JZ8	-	-	-
-201	-	JZ8	-	-	JZ8	-	-	-
-205	-	JZ6C	-	-	JZ6C	-	-	-
-206	-	JZ6C	-	-	JZ6C	-	-	-
-207	-	-	LR-129	-	-	MA145	-	-
-210	-	JZ6C	-	-	JZ6C	-	-	-
-211	-	JZ6C	-	-	JZ6C	-	-	-
-212	MOD.F100	-	-	-	-	MA145	-	-
-213	-	-	LR-129	-	-	MA145	-	-
-214	-	-	LR-129	-	-	-	-	LR-129
-220	-	-	-	THOR	-	MA145	-	-
-221	-	-	-	THOR	-	MA145	-	-
-231	MOD.YJ93	-	-	-	-	-	(1)	-
-232	-	-	LR-129	-	-	-	(1)	-
-233	-	-	LR-129	-	-	-	-	LR-129
-234	-	-	LR-129	-	-	-	-	LR-129
-250	-	-	LR-129, J2S	-	-	-	-	LR-129, J2S
-251	-	-	LR-129	-	-	-	-	LR-129
-252	-	-	LR-129	-	-	-	-	LR-129
-253	-	-	MIST	-	-	-	-	MIST
-254	-	-	LR-129	-	-	-	(1)	-
-255	-	-	LR-129	-	-	-	(1)	-
-256	-	-	MIST, H1D	-	-	-	-	MIST, H1D
-257	MOD.F100	-	-	-	-	-	(1)	-
-270	-	-	LR-129	-	-	-	-	LR-129
-271	-	-	LR-129	-	-	-	(1)	-
-280	-	-	-	ATLAS	-	-	(1)	-
-281	-	-	-	ATLAS	-	-	-	PDS-2687
-282	-	-	-	ATLAS	-	-	-	BELL 8258
-284	-	-	LR-129	-	-	-	-	LR-129
-285	-	-	LR-129	-	-	-	-	LR-129

(1) MCAIR design based on previous study, Reference (13).

(C) FIGURE 4-34  
ENGINE CHARACTERISTICS

Cycle	Designation	Source	Fuel	Other					Remarks	
				Oxidizer	P <sub>c</sub>		C	Scalable Thrust (Vac)		
	psia	(N/cm <sup>2</sup> )			klb	(kN)				
Rockets	LR-129	PWA	H <sub>2</sub>	O <sub>2</sub>	3000	(2070)	75	50-1000	(222-4450)	A parametric study engine  Pressure-fed
	PDS-2687	PWA	H <sub>2</sub>	O <sub>2</sub>	500	(345)	100	1-50	(4.4-222)	
	MIST	Aerojet	Aerozine 50	N <sub>2</sub> O <sub>4</sub>	2800	(1930)	50	25-600	(111-2670)	
	BELL 8258	Bell	Aerozine 50	N <sub>2</sub> O <sub>4</sub>	120	(83)	40	3.5	(15.5)	
Turbojets	F100-GE-100 YJ93	GE GE	H <sub>2</sub> H <sub>2</sub>	SLS Thrust 27 klb (120 kN) 32 klb (142 kN)			Application F15 Engine B70 Engine		Modified to H <sub>2</sub> fuel w/o weight penalty; TIT = 2200°F, (650°C), stoichiometric afterburner	
Turboramjets	GE14/JZ8 GE5/JZ6C	GE GE	JP H <sub>2</sub>	(100%) SLS Thrust 46 klb (205 kN) 53 klb (236 kN)		(100%) A <sub>c</sub> 27.6 sq ft (2.53 sq m) 19.7 sq ft (1.83 sq m)				
Ramjet	MA-145-XCA	Marquardt	H <sub>2</sub>	(100%) A <sub>c</sub> =15 sq ft (1.39 sq m) per engine						
Convertible Scramjet	---	McDonnell	H <sub>2</sub>	(100%) A <sub>c</sub> =50 sq ft (4.65 sq m) per module					As generated from previous study	
Boosters	Atlas	GD	LO <sub>2</sub> /RP	390 klb SLS thrust (1780 kN)					Stage-and-a-half	
	Thor	McDonnell Douglas	LO <sub>2</sub> /RP	170 klb SLS thrust (757 kN)					Single stage	

(C) FIGURE 4-35  
ROCKET ENGINE APPLICATIONS

CONFIG.	PHASE I STUDY BASIS		POTENTIAL "OFF-THE-SHELF" ENGINES				
	SCALED ENGINE	TVAC REQUIRED		NO.	NAME	TOTAL TVAC	
		KLB	(KN)			KLB	(KN)
-207	LR-129	64.5	(286.9)	3	RL10A	67.5	(300.3)
-213	LR-129	94.4	(433.3)	5	RL10A	111.5	(496.0)
-214	LR-129	68.9	(306.5)	4	RL10A	90	(400.3)
				3	RL10A	67.5	(300.3)
-232	LR-129	104.5	(464.8)	5	RL10A	111.5	(496.0)
				4	RL10A	90	(400.3)
-233	LR-129	112.2	(499.1)	6	RL10A	135	(600.5)
				5	RL10A	111.5	(496.0)
-234	LR-129	144	(640.5)	7	RL10A	157.5	(700.6)
-250	LR-129	195	(867.4)	9	RL10A	202.5	(900.8)
				1	J2	230	(1023.1)
				1	J2S	230	(1023.1)
-251	LR-129	222.6	(990.2)	10	RL10A	225	(1000.8)
				1	J2	230	(1023.1)
				1	J2S	230	(1023.1)
-252	LR-129	199	(885.2)	9	RL10A	202.5	(900.8)
				1	J2	230	(1023.1)
				1	J2S	230	(1023.1)
-253	MIST	473	(2104.0)	5	LR-91	500	(2224.1)
				3	LR-87-3	450	(2001.7)
-254	LR-129	202.8	(902.1)	9	RL10A	202.5	(900.8)
				1	J2	230	(1023.1)
				1	J2S	230	(1023.1)
-255	LR-129	264.5	(1176.6)	12	RL10A	270	(1201.0)
				1	J2S	265	(1178.8)
-256	LR-129	374	(1663.6)	4	LR-91	400	(1179.3)
				3	LR-87-3	450	(2001.7)
				2	LR-87-5	430	(1912.7)
				2	H1D	410	(1823.7)
-270	LR-129	217	(965.3)	1	J2	230	(1023.1)
				1	J2S	230	(1023.1)
-271	LR-129	248	(1103.2)	1	J2S	265	(1178.8)
-281 (VTO Boost)	PWA PDS-2687	6.2	(27.6)	--	--	--	--
-282 (VTO Boost)	Bell-8258	5.1	(22.7)	2	Bell-8258	7	(31.1)
-284	LR-129	111	(493.8)	5	RL10A	111.5	(496.0)
-285	LR-129	193	(858.5)	9	RL10A	202.5	(900.8)
				1	J2	230	(1023.1)
				1	J2S	230	(1023.1)

(C) FIGURE 4-36  
TURBOJET AND TURBOFAN ENGINE APPLICATIONS

CONFIG.	F <sub>N</sub> , SLS, uninst, req'd		NO. ENGINES	ENG. NAME	TOTAL F <sub>N</sub> AVAIL.		FUEL
	k lb	(kN)			k lb	(kN)	
-212	33.6*	(149.5)	2	J79-17	35.8	(159.2)	JP
-231	56*	(249.1)	2	YJ93	56.0	(249.1)	JP
-257	64.1	(285.1)	1	GE4/J5P	67.0	(298.0)	JP
			2	J58**	63.2	(281.1)	JP
Conversions of available J-P fueled engines							
-212	33.6*	(149.5)	1	J58	36.6	(162.8)	H <sub>2</sub>
-231	56*	(249.1)	2	YJ93	64.4	(286.5)	H <sub>2</sub>
			2	F100-FW-100	54.8	(243.8)	H <sub>2</sub>
			2	F100-GE-100	53.6	(238.4)	H <sub>2</sub>
			2	J79-17	41.6	(185.0)	H <sub>2</sub>
-257	64.1	(285.1)	2	YJ93	64.4	(286.5)	H <sub>2</sub>

\* Estimated  
\*\* F<sub>N</sub> < F<sub>N</sub> (req'd)

(C) FIGURE 4-37  
CHARACTERISTICS OF "OFF-THE-SHELF" ROCKET ENGINES

ENGINE	T <sub>VAC</sub> lb (N)	PROPELLANTS	D max in (cm)	L in (cm)	WT DRY/WET lb (kg)	€	Isp(VAC) sec	O/F
J2	230K (1023K)	O <sub>2</sub> /H <sub>2</sub>	80 (203.2)	116 (294.6)	3492/3653 (1584/1657)	27.5	426	5.5
J2S	230K, 265K (1023K, 1179K)	O <sub>2</sub> /H <sub>2</sub>	80 (203.2)	116 (294.6)	4050/4227 (1837/1917)	40	431	5.5
RL-10A-3-8	22.5K (100.1K)	O <sub>2</sub> /H <sub>2</sub>	39.7 (100.8)	70.2 (178.3)	350/N.A. (159)	57	444	5.0
LR-87-3	150K (667K)	N <sub>2</sub> O <sub>4</sub> /Hydrazine	43.1 (109.5)	76.1 (193.3)	1290/1548 (585/702)	8	245	2.25
LR-87-5	215K (956K)	N <sub>2</sub> O <sub>4</sub> /Hydrazine	43.1 (109.5)	74.3 (188.7)	1378/1672 (625/758)	8	287	1.93
LR-91-5	100K (445K)	N <sub>2</sub> O <sub>4</sub> /Hydrazine	66.2 (168.1)	110.1 (279.7)	1102/1238 (500/562)	13-49.2	308	1.8
XM-GM-52	45K (200K)	IRFNA	16/22.0 (40.6/55.9)	19.5/127.8 (49.5/324.6)	*	4.15	225	3.4
AJ-10-137	21.5K (95.6K)	N <sub>2</sub> O <sub>4</sub> /Hydrazine	98.4 (249.9)		777/823 (352/373)	6-62.5	311	2.0
LR-81-11	16.0K (71.2K)	IRFNA	32.5 (82.6)	83.0 (210.8)	296/308 (134/140)	45	293	2.57
8258	3.5K (15.6K)	N <sub>2</sub> O <sub>4</sub> /Hydrazine	31.3 (79.5)	51.0 (129.5)	202/N.A. (92)	40	306	1.6
H1D	205K (912K)	O <sub>2</sub> /H <sub>2</sub>	50 (127)	102 (259.1)	1997/2217 (909/1006)	8	296	2.23

\* Engine: 148 lb (67.1 kg)  
Propulsion System: Dry 672.5; Wet 2131 lb  
(305.2) (966) kg  
N.A. = not available

(C) FIGURE 4-38  
CHARACTERISTICS OF "OFF THE SHELF" TJ AND TF ENGINES

ENGINE	TYPE	THRUST F <sub>N</sub> (SLS)		FUEL	MAX. DIA.		LENGTH		WEIGHT	
		lb	(N)		in	(cm)	in	(cm)	lb	(kg)
J79-17	TJ	17,900	(79,623)	JP	39.06	(99.21)	208.7	(530.1)	3835	(1740)
		*20,800	(92,523)	H <sub>2</sub>						
TF30-P-12	TF	20,150	(89,632)	JP	49.6	(126.0)	234.2	(594.9)	3967	(1799)
		*23,400	(104,088)	H <sub>2</sub>						
YJ93-3	TJ	28,000	(124,550)	JP	55.9	(142.0)	237	(602.0)	5220	(2368)
		*32,200	(143,233)	H <sub>2</sub>						
J58	TJ	31,600	(140,564)	JP	70	(177.8)	286.4	(727.5)	7200	(3266)
		*36,600	(162,805)	H <sub>2</sub>						
GE4/J5P	TJ	67,000	(298,031)	JP	90	(228.6)	308	(782.3)	11303	(5127)
		*77,200	(343,403)	H <sub>2</sub>						
F100-GE-100	TF	22,650	(100,752)	JP	45.6	(115.8)	166.8	(423.7)	2693	(1222)
		*26,800	(119,212)	H <sub>2</sub>						
F100-PW-100	TF	22,954	(102,104)	JP	45.0	(114.3)	190.3	(483.4)	2711	(1230)
		*27,400	(121,881)	H <sub>2</sub>						

\* Estimated thrust of hydrogen-fueled conversions of available JP-fueled engines.

(U) The turbojet installation presents a slightly more complex condition since, although the preceding discussion could provide a suitable turbojet installation beneath the basic vehicle lines, the need for a cruise engine in addition to the TJ causes a belly space installation problem. This was resolved by placing the cruise engine in the belly position and burying the TJ within the vehicle. The turbojet inlet operates satisfactorily without significant forebody effect. The cruise engine inlet, which operating at the higher Mach number has the greater need for beneficial forebody influence, receives the full forebody benefit after TJ shutdown.

4.4.4.2 (U) Inlet Installation - The best combination of inlet recovery, overall installed weight, drag, shock interactions, landing gear design, etc., is achieved by two-dimensional inlet design, as has been shown by several previous studies, for example, References (2) and (12). Overhead ramp and back-to-back vertical ramp designs have been considered with the overhead ramp being selected because of less shock interactions and good recovery for a wide range of pitch angles. For test vehicles which are usually single engined, the horizontal ramp does not entail a bifurcated inlet design. For Phase I a fixed capture area, overhead ramp inlet design developed for an earlier turboramjet study was used for all TRJ systems. This inlet design employs mixed compression, with a maximum geometric contraction ratio of 9:1 including a maximum internal contraction ratio of 4.8:1. For ramjets a similar inlet was employed. For turbojets a two-dimensional ramp was used, mounted so that it moves to close off the TJ duct at speeds above TJ shutdown; this design has variable capture area capability. Both of these designs have variable throat area capability achieved by positioning the duct ramps. Figure 4-39 shows these inlet installations schematically.



(U) The scramjet inlet is highly integrated with the vehicle in that most of the vehicle forebody lower surface is used as compression surface, Figure 4-39. However, forebody geometry cannot be significantly varied without serious detriment to vehicle aerodynamics and volumetric efficiency. Therefore, second and third ramp incidence and location, and cowl lip location, are the primary variables used to achieve inlet recovery and capture area.

4.4.4.3 (U) Nozzle Installation - For the turbojets, nozzle installation is primarily aimed at providing sufficient exhaust area for TJ operation while not compromising cruise engine operation. This has been achieved by use of a moveable panel in the aft body surface which closes the TJ exhaust duct after TJ shutdown to provide a large, smooth expansion surface for the RJ or SJ cruise engine, Figure 4-39. Turboramjet nozzles used are those provided by the engine manufacturer: axisymmetric, with no provision for use of the vehicle aft surface as expansion area, due to the difficulty of doing so within practical weight allowances. The scramjet nozzle comprises the entire vehicle aft undersurface for expansion area, as the SJ is two-dimensional and a favorable integration can be achieved with only modest weight increase.

4.4.4.4 (U) Engine Performance - For the various engines used in the flight facilities, Figure 4-2, the installed engine performance was determined. However, some of these data are proprietary to the respective engine manufacturers. To permit this volume the widest possible distribution and simultaneously keep the propulsion performance data united, all of the actual engine performance data and its development are presented in Section 2 of Volume V.

4.4.4.5 (C) Significant Propulsion Results - Appropriate engines were selected for all of the candidate flight facilities, and installed performance of these engines was determined. The selected engines satisfy the basic Phase I premise that propulsion for the flight facilities be commensurate with the 1975 state-of-the-art. Six rocket engines, two turbojets, two turboramjets, one ramjet, one scramjet, and two boosters were selected:

- o Rockets: LR-129, MIST/ARES, Bell 8258, P&WA PDS-2687, J2S, H1D
- o Turbojets: YJ93-3, F100-GE-100 (modified to H<sub>2</sub> fuel)
- o Turboramjets: GE14/JZ8 (JP fuel), GE5/JZ6C (H<sub>2</sub> fuel)
- o Ramjet: MA145-XCA
- o Convertible scramjet: (MCAIR)
- o Boosters: Thor, Atlas

Selection and installation of these engines was accomplished in a manner to permit an objective evaluation of the various flight facilities. The engine selection was accomplished after extensive consultation with engine contractors to determine current status and future efforts in advanced propulsion, which assured selecting propulsion systems representative of the available candidates.

(U) Figure 4-39  
Engine Installations

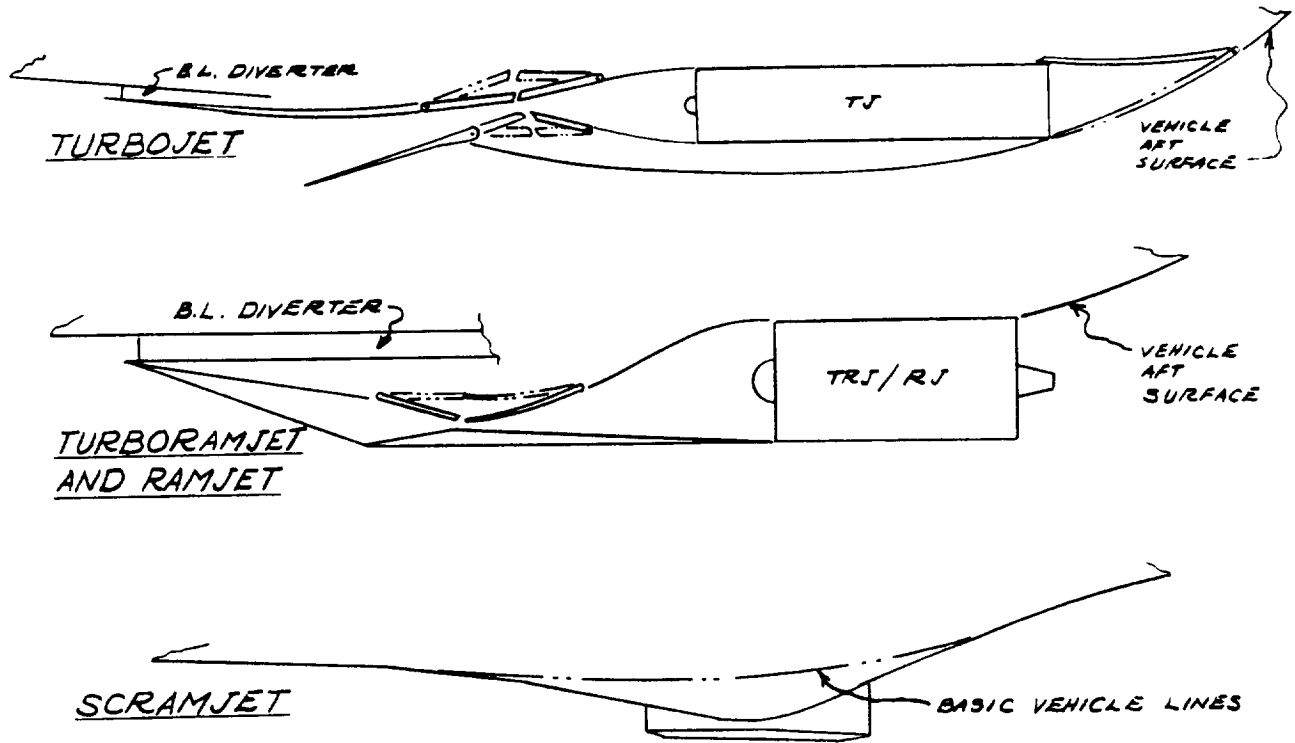

#### 4.5 STRUCTURES

(U) The objective of the structures effort during Phase I of this study was to select representative structural design concepts for evaluation in the vehicle design/cost synthesis process. To do this, the results of many previous studies have been used as aids.

(U) The initial concepts for the Phase I vehicles were selected with the primary consideration being "minimum risk" which is defined as the least amount of uncertainty consistent with low cost and high performance materials and methods. The concepts used in Phase I for initial facility screening are described herein:

(U) Primary Structure The primary structure in all aircraft is considered to be aluminum, skin-stringer construction. This is not to say that every piece is made of aluminum but that the entire primary structure is made of the most efficient flight quality material available at the current time. This includes aluminum, titanium, steel, and some superalloys.

(U) The use of advanced materials and fabrication techniques will be studied later in the program. This will result in an assessment of the required development and the value of such development on the research vehicles. The materials that will be considered include fiber reinforced composites and some advanced superalloys, e.g. AF2-1DA, Haynes Alloy 188. Fabrication techniques including welding, brazing and diffusion bonding will be studied to show the impact on the research facility.

(U) Inlet Structure The inlet structure is made of titanium alloy because of its attractive combination of low weight and high temperature capability. The inlet structure is insulated from the thermal environment of the Mach 4.5-6 aircraft by a passive insulation and a superalloy shield and is insulated from the Mach 12 environment by an active cooling system using the fuel as the coolant.

(U) Control Surfaces Studies have shown that the control surfaces are more efficiently designed as hot structure since the thickness of the insulation system significantly reduces the structural depth or increases the aerodynamic drag producing an adverse effect on the vehicle performance. The control surfaces on the Mach 4.5-6 aircraft are constructed of superalloys while the Mach 12 vehicles will have a refractory metal construction.

(U) Leading Edges The leading edges, like the control surfaces are made of hot structure, superalloy for the Mach 4.5-6 aircraft and refractory metals for the Mach 12 aircraft. The leading edges are constructed in a stiffened sheet form with built-in capability for relative expansion.

(U) Thermal Protection System The thermal protection system consists of a passive insulation and an external heat shield for the Mach 4.5-6 aircraft with internal insulation in the propellant tanks. The Mach 12 vehicles have two options that are adaptable; 1) passive insulation and heat shield combination, 2) a combination of passive insulation and water wick along with a heat shield. Either option utilizes internal insulation for propellant tanks.

(U) Studies as to the desirability and type of thermal protection system have been performed for many different vehicles (both operational and test vehicles). The results are affected by several factors, the most significant of which are speed-altitude and time. For this reason, recommendations on thermal/structural concepts will not be made until the final test vehicles have been selected. Several concepts will be considered throughout the study including passive, active and no insulation.

(U) Fuel Tank - Integral fuel tank and fuselage structure is used in all the aircraft with the exception of Models 200, 201, 290, 291, and 292. These aircraft are designed to use JP type fuels and will have a combination of integral and non-integral tanks. Internal insulation is used in all vehicles except 290, 291, and 292 which have a low temperature environment. All cryogenic fuel tanks incorporate a bladder of a material such as Kapton-H or H-Film to prevent leakage into the insulation.

(U) Windshield and Nose Cap These items constitute a minor part of the aircraft weight; however, their development and design is necessary for each of the high speed aircraft. No windshield is required in the unmanned aircraft.

#### 4.6 THERMODYNAMICS

4.6.1 (U) EXTERNAL SURFACE TEMPERATURES - Preliminary isotherms for a typical Mach 6 and Mach 12 research vehicle are presented in Figures 4-40 and 4-41 respectively. As noted on these figures, upper surface temperatures are representative of an end-of-boost condition where the vehicle angle of attack is zero, whereas, lower surface temperatures are representative of a 3.5 g maneuver condition. For the Mach 6 aircraft, upper surface temperatures are generally less than 1100°F (866°K), the maximum allowable temperature of titanium shingles. During Mach 6 operation with maneuver load factors up to about 3.5 g's, the lower surface can be adequately protected with Rene'41 shingles. Past studies have shown that a large portion of the upper surface of a Mach 12 operational aircraft, 200-300 ft (61-91.5m) in length, can be protected with titanium shingles. However, due to the shorter lengths, about 100 ft (30.5m), of a Mach 12 research aircraft, only about 1/3 of the upper fuselage surface can utilize titanium shingles, the remainder being composed of a temperature resistant superalloy. With the exception of engine inlet ramps and areas adjacent to stagnation regions, lower surface temperatures during the 3.5 g maneuver at Mach 12 are less than 2800°F (1811°K), the maximum allowable temperature for columbium.

4.6.2 (U) THERMAL PROTECTION - The following paragraphs present the approach used to determine thermal protection requirements and considerations which lead to the selection of an active (water wick) system for the Mach 12 class of aircraft. Research aircraft in the Mach 4.5 to 6 range are all configured with a passive system.

(U) Thermal protection requirements were determined based upon a step input of surface temperature and an effective flight time as graphically illustrated in Figure 4-42. Radiation equilibrium, based upon turbulent heating conditions and a surface emissivity of 0.8, was used to determine surface temperatures. The aerodynamic heating environment experienced during a typical Mach 12 airbreather accelerator flight (see Figure 4-42) results in an equivalent temperature pulse of 2100°F (1422°K) for 25.6 minutes, and 1110°F (872°K) for 33.4 minutes, on the aircraft's lower and upper surface respectively. These same temperature pulses were also used in sizing the thermal protection system for rocket boosted configurations, since the shorter boost time associated with a rocket does not significantly reduce the total heat input for the mission.

(U) Based upon the above defined step input of temperature, passive thermal protection requirements were determined per Schneider's two-layer plate solution for one-dimensional heat conduction (Reference 25). Insulation thicknesses in non-fuel areas were sized based upon a maximum backside plate (2 PSF, 9.8 Kg/m<sup>2</sup>, of aluminum structure) temperature of 300°F (422°K). Passive insulation requirements in LH<sub>2</sub> fuel tank areas were sized to limit integral tank wall temperatures to 250°F (394°K), dictated by maximum temperature capabilities of the internal cryogenic foam insulation, and an acceptable heat leak to the LH<sub>2</sub> fuel of 100 BTU/ft<sup>2</sup> hr (31.5 watts/m<sup>2</sup>).

(U) FIGURE 4-40  
 CONFIGURATION 210 MAXIMUM SURFACE TEMPERATURES

MACH 6 AT 94,000 FEET (28,700 METERS)  
 UPPER SURFACE  $\alpha = 0^\circ$   
 LOWER SURFACE  $\alpha = 20^\circ$  (0.35 RADIAN)

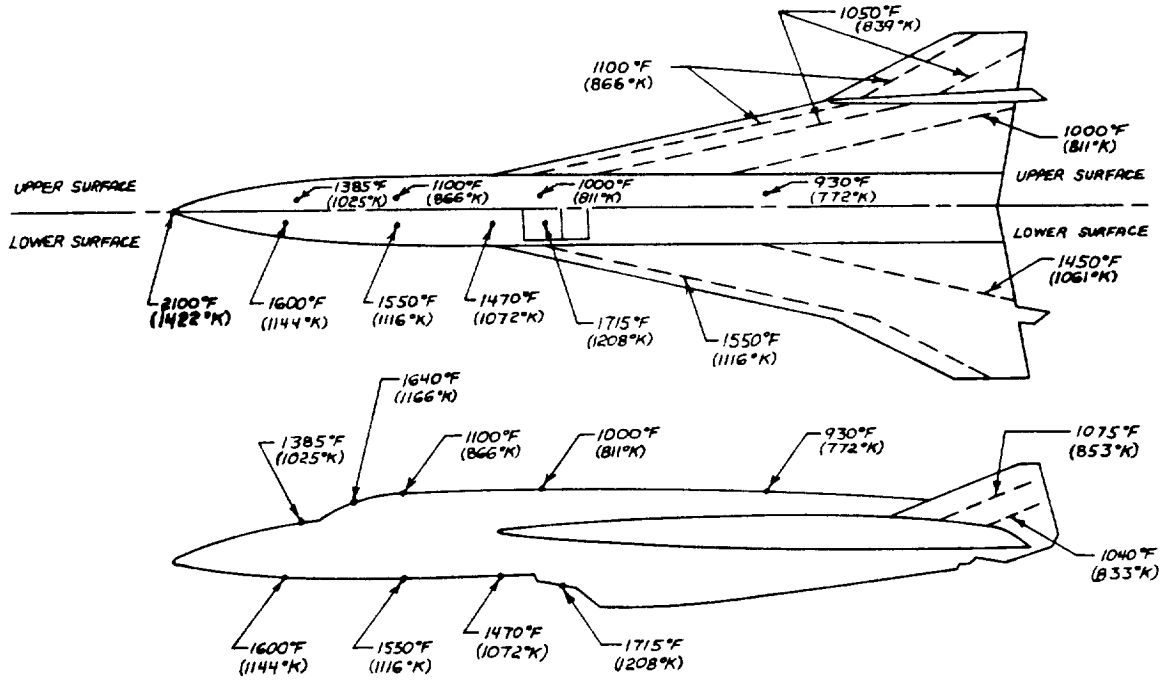

(U) FIGURE 4-41  
 CONFIGURATION 257 MAXIMUM SURFACE TEMPERATURES

MACH 12 AT 140,000 FEET (42,700 METERS)  
 UPPER SURFACE  $\alpha = 0^\circ$   
 LOWER SURFACE  $\alpha = 22^\circ$  (0.38 RADIAN)

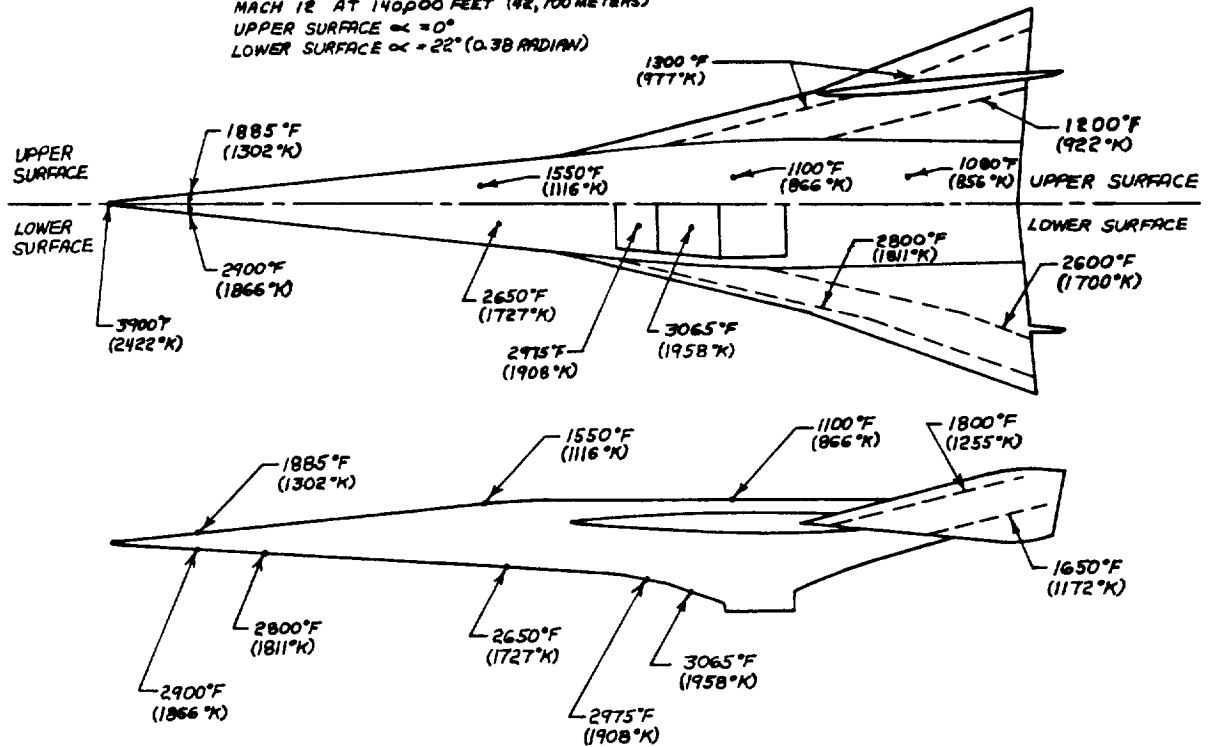

(U) FIGURE 4-42  
 EQUIVALENT STEP INPUT OF SURFACE TEMPERATURE

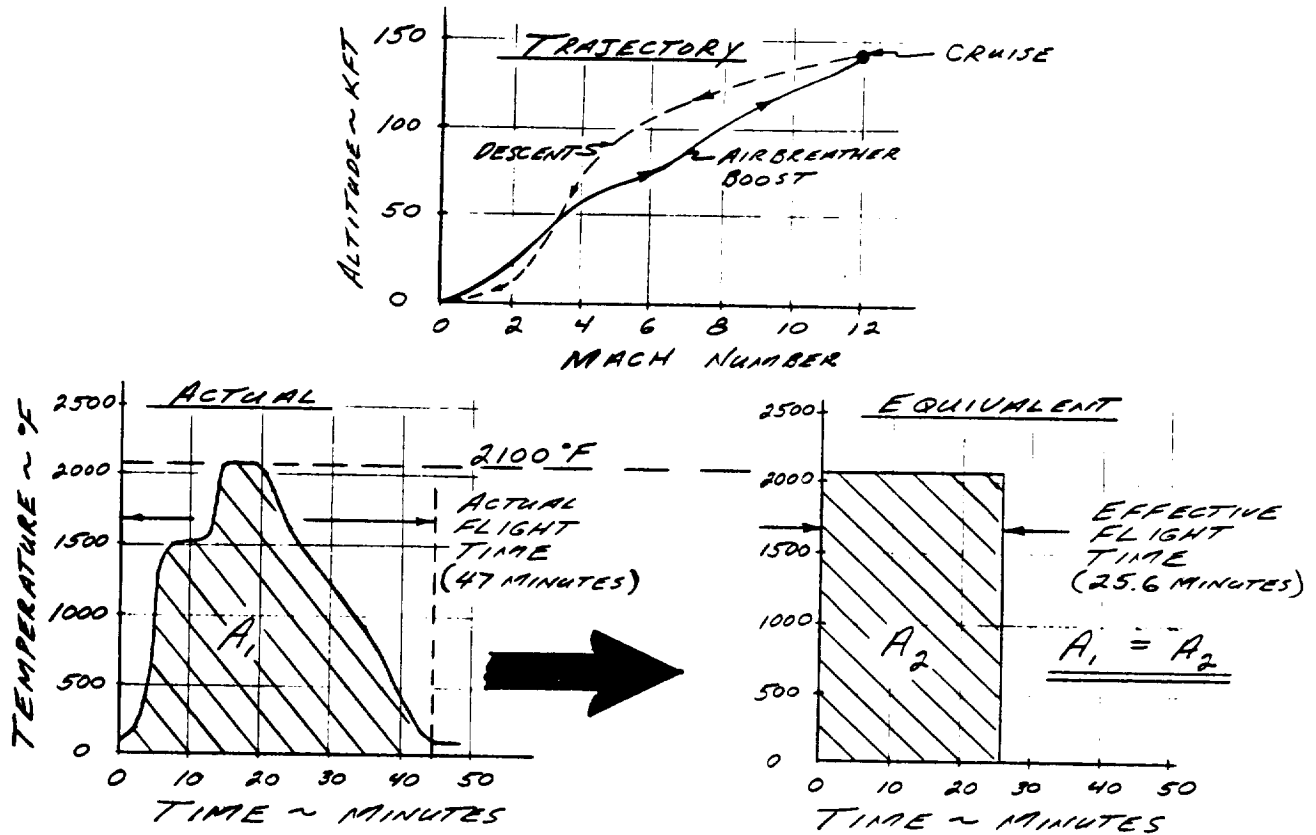

(U) Active (water wick) thermal protection requirements were determined based upon steady state conditions and the previously defined step inputs of surface temperature. With the water wick concept the structure and LH<sub>2</sub> tank wall are nearly isothermal throughout the mission such that structural heat sink effects are negligible. As with the passive concept, active TPS requirements for the fuel tank were again based upon an average heat leak to the LH<sub>2</sub> fuel of 100 BTU/ft<sup>2</sup>hr (31.5 watts/m<sup>2</sup>).

(U) For a typical Mach 12 research aircraft, thermal protection weights and thicknesses for an active (water wick) and two passive systems are presented in Figure 4-43. These initial results indicate that the active system is superior, both on a unit weight and unit thickness basis, to either of the passive approaches. The resultant saving in TOGW (estimated to be in the order of 10% to 15%), suggests the use of a water wick thermal protection system for all Mach 12 research aircraft.

(U) FIGURE 4-43  
**COMPARISON OF ACTIVE AND PASSIVE INSULATION WEIGHTS AND THICKNESSES**  
 (257 - Mach 12 Research Aircraft)

ACTIVE SYSTEM

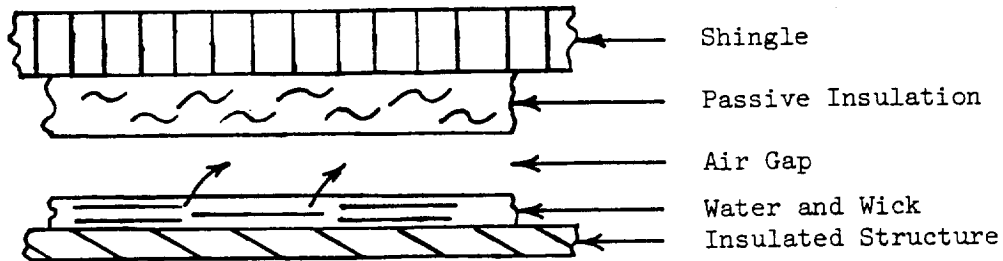

PARAMETER	INSULATION	AIR GAP	WATER & WICK	TOTAL
Weight - PSF (Kgm/m <sup>2</sup> )				
o Lower	0.25 (1.22)	-	0.50 (2.44)	0.75 (3.66)
o Upper	0.10 (0.49)	-	0.25 (1.22)	0.35 (1.71)
o Average	-	-	-	0.55 (2.69)
Thickness - In.(CM)				
o Lower	0.65 (1.65)	0.25 (0.635)	0.10 (0.255)	1.00 (2.54)
o Upper	0.25 (0.635)	0.25 (0.635)	0.05 (0.13)	0.55 (1.40)
o Average	-	-	-	0.78 (1.98)

PASSIVE SYSTEM

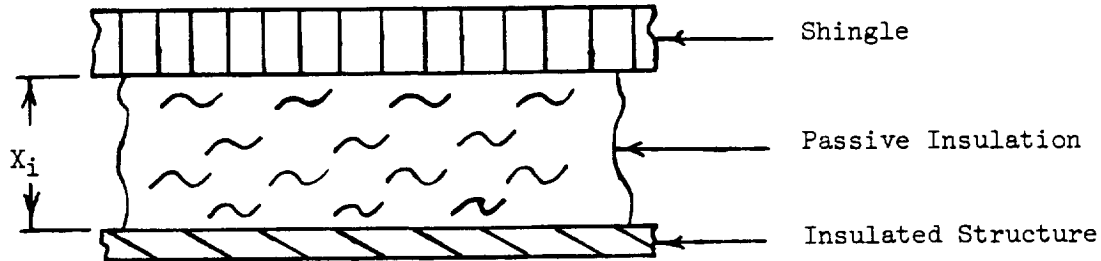

PARAMETER	*PASSIVE 1	*PASSIVE 2
Weight - PSF (Kgm/m <sup>2</sup> )		
o Lower	1.04 (5.09)	2.10 (10.25)
o Upper	0.55 (2.69)	1.15 (5.61)
o Average	0.80 (3.90)	1.63 (7.95)
Thickness (X <sub>i</sub> ) - In.(CM)		
o Lower	4.15 (10.53)	2.10 (5.33)
o Upper	2.20 (5.60)	0.86 (2.18)
o Average	3.18 (8.10)	1.48 (3.75)

\* System 1 and 2 sized to provide near minimum weight & thickness, respectively.



#### 4.7 PROPELLANT SYSTEM

(U) The Phase I flight facility propellant system study effort included selection of baseline fuels, fuel properties and design criteria as listed in Figure 4-7. The fuel selection was based on investigation of a typical hydrocarbon (JP-5), storable rocket propellant combination (N<sub>2</sub>O<sub>4</sub>/AERO-50) and cryogenic propellant combination (LO<sub>2</sub>/LH<sub>2</sub>). Propellants were considered to be at their normal boiling point for cryogenics and 70°F for storables to provide maximum use of available experience and minimize operational requirements. This also provides greater operational flexibility as an aircraft fuel system designed for NBP operation can utilize subcooled fuel with little or no modifications. The impact of fuel loading temperature on the flight vehicle is reflected in the areas of tank pressure, minimum attainable ullage, propellant mass loaded, and vehicle performance.

(U) The internal tank pressure level must be sufficiently higher than the fuel vapor pressure to inhibit excessive fuel vapor loss and provide adequate head pressure to effect the transfer of the propellant. With NBP propellants the minimum pressure at takeoff is approximately 16.7 psia (11.5N/cm<sup>2</sup>) which provides a net 2 psi (1.38N/cm<sup>2</sup>) margin over the vapor pressure. At the end of cruise the pressure will increase to account for bulk heating of the fluid. For ground pre-flight conditions, the tank pressure is relatively insensitive to fuel vapor pressure since a pressure greater than 14.7 psia (10.1 N/cm<sup>2</sup>) must be maintained to prevent potential structural damage resulting from negative pressure differentials. At cruise altitude an internal tank pressure of 16.7 psia (11.5N/cm<sup>2</sup>) results in essentially a 16.7 psi (11.5N/cm<sup>2</sup>) pressure gradient across the tank wall. For large vehicles, minimum gage materials can be used for internal pressures to approximately 10 psig (6.89 N/cm<sup>2</sup>). Maximum tank pressure levels for minimum gage construction for the research vehicles will be greater due to their smaller overall size and resulting smaller tank radius, potentially allowing use of NBP with little or no weight increase due to pressure. Tankage void volumes as listed in Figure 4-4 account for fuel volume loss due to installation of lines, pumps, baffles, and other hardware mounted inside the tankage. The values chosen were based upon analysis of similar tankage situations. Ullage requirements reflect the thermodynamic condition of the fuel and vapor space. For JP systems where the fuel temperature upon loading is considerably below the boiling point temperature, ullage values of 1% can be realized. When considering propellant at their NBP an additional factor must be included in the minimum attainable ullage to account for bubble entrainment in the bulk fluid. In typical NBP cryogenic tankage this bubble entrainment accounts for an increase in ullage volume of approximately 1.5% giving a total ullage of 2.5%.

(U) During Phase II, design criteria for subcooled propellants will be developed, vehicle performance as a function of propellant density determined, and critical subsystem requirements as affected by the use of subcooled propellants identified. In addition to reduced internal tankage pressure levels and possible reduction in tank wall material thickness, advantages are to be gained in reduced ullage, higher fuel density, and longer unattended ground hold, which result in increased overall vehicle performance. Performance improvements can be reflected in either increased range and test time or reduced vehicle size. The effects of varying fuel density in a fixed volume will be used to establish sensitivities for both an

NBP and subcooled design. In this way the performance can be thoroughly evaluated as a function of density allowing selection of the more versatile and cost effective design. A similar point design analysis for the potential operational system M2, showed a range increase of 16% in changing from NBP density of 4.42 lbm/ft<sup>3</sup> (70.9 Kg/M<sup>3</sup>) to a subcooled fuel density of 4.66 lbm/ft<sup>3</sup> (74.7 Kg/M<sup>3</sup>) for a constant volume/constant payload design.

(U) Subsystem design and operational requirements which are affected by the use of subcooled fuel include the necessity for active pressurization during ground hold to prevent loss of positive tank pressure, ground support systems to maintain the subcooled state, and propellant delivery equipment.

#### 4.8 AVIONIC SUBSYSTEMS

(U) Synthesis of the flight research vehicles developed during the Phase I study effort included definition of avionic subsystems applicable to these vehicles. The state-of-the-art utilized is commensurate with initiation of the vehicle development in the 1970-1975 time period. A primary source of applicable avionic state-of-the-art data has been avionic vendor interfaces with MCAIR during recent extensive avionic definition studies for the F-14 and F-15 programs. Figure 4-44 illustrates the baseline avionic complement defined for the manned flight research vehicle candidates. These subsystems may be characterized as low risk, the majority being either fully developed or well along the development cycle. Areas requiring special attention are the development of high temperature antennas suitable for flush mounting and air data measurement techniques compatible with M12 flight. Experience gained in such test vehicle programs as the ASSET and the X-15 indicates low risk design solutions to the aforementioned areas are possible. Unmanned flight research vehicles being studied require a general augmentation of the avionic complement. The major impact involves increased digital computer capability; deleted voice communication, displays and manual controls; augmented autopilot and data link; navigation system redundancy; and inclusion of interface conversion equipment for automation.

4.8.1 (C) NAVIGATION - The primary test vehicle navigation function is served by an inertial navigation system. Typical position accuracy of this type system when used in subsonic and supersonic vehicles is 1 nm/hr (1.8 kilometers/hr). This reflects the usual time dependent gyro drift impact upon the position error, which increases with navigation time regardless of the distance covered. When used at the hypersonic velocities of study test vehicles operating up to Mach 12, the inertial system position error is more appropriately described as a percentage of distance traveled. The reduced flight time and increased flight distance makes the inertial heading alignment errors dominate over the time dependent gyro drift errors. For these high velocity conditions, a position accuracy of 0.15 percent of distance traveled results. Velocity data is also developed by the inertial system, typically to an accuracy of 3 feet per second (9.1 meters/sec).

(U) The integrated Inertial Flight Data System (IFDS) in the X-15 was used primarily for measurement of velocity, attitude, and altitude. Compared to current inertial navigators it represents a somewhat austere mechanization. Representative of 1956-1957 state-of-the-art the analog mechanization relied upon B-52 doppler radar for initial velocity inputs and upon the B-52 compass system for initial heading. No gyrocompassing capability was included, although a later digital version derivative from the X-20 program provided ground based gyrocompassing. Velocity error specification for downrange and crossrange was 50 feet per second (15.2 meters/sec), more than an order of magnitude greater than current state-of-the-art. Position accuracy was not emphasized since the pilot primarily monitored velocity and altitude to meet the desired flight profile.

(U) Energy management and flight director functions are served for the HYFAC test vehicles by digital computer mechanization for vertical trajectory control and horizontal footprint prediction. TACAN provides position updating data to the inertial navigator. It is capable of range determination to the cooperating station to an accuracy of 1.5 nm (2.8 kilometers).

(U) FIGURE 4-44  
FLIGHT FACILITY AVIONICS

FUNCTION	EQUIPMENT
Navigation	<u>Inertial Navigator</u> Heading: $0.01^\circ/\text{hr}$ - Position: $1 \frac{\text{nm}}{\text{hr}}$ ( $1.8 \frac{\text{km}}{\text{hr}}$ ) or $0.15\%$ Roll, Pitch: 10 arc sec - Velocity $3 \text{ fps}$ ( $9.1 \frac{\text{met}}{\text{sec}}$ )
	<u>Energy Management/Flight Director</u> Digital computer - Vertical trajectory control - Horizontal footprint prediction
	<u>Tacan</u> Range accuracy: 1.5 nm (2.8 km) out to 300 nm (560 km) Bearing accuracy: $0.5^\circ$ to $1.5^\circ$ Acquisition time: 3 sec
Communication	<u>UHF Communication</u> 250 nm (460 km) line-of-sight voice/data system 3500 channels; 225-400 MHz
	<u>HF Communication</u> Beyond line-of-sight voice/data system Solid state tuning 2-30 MHz in 100 Hz steps AM single sideband; frequency shift keying
	<u>Data Link</u> Two way link for control/reply messages D/A and A/D conversion for avionics interface
	<u>Beacons</u> X and K <sub>a</sub> band systems to augment radar skin track
	<u>Antennas</u> Flush antennas compatible with; Tacan                      ILS                      UHF Communication Altimeter                  Beacons                  HF Communication
	<u>Attitude and Heading Reference</u> Backup for inertial navigator Directional gyro - free or slaved to compass Vertical gyro - slaved to accelerometer sensors All attitude - effective Schuler computation
Flight Sensors and Control	<u>Air Data</u> Nose tip comparative orifice technique for angle of attack, side slip, and dynamic pressure.

(U) FIGURE 4-44 (Continued)  
 FLIGHT FACILITY AVIONICS

FUNCTION	EQUIPMENT																
Flight sensors and Control (continued)	<u>Radar Altimeter</u> Pulsed radar - leading edge tracking Static accuracy - 0.2% Dynamic accuracy - static + 1.5% altitude rate																
	<u>ILS</u> Localizer receiver - 108.1 to 111.9 MHz Glide slope receiver - 329.3 to 335.0 MHz Marker beacon receiver - 75.0 MHz																
	<u>Autopilot</u> Three axis stability augment - Triple redundant First failure operational - Second fail-soft																
Controls and Displays	<u>Control Panels</u> <table border="0" style="width: 100%;"> <tr> <td style="width: 33%;">Inertial</td> <td style="width: 33%;">UHF Communication</td> <td style="width: 33%;">Attitude/Heading</td> </tr> <tr> <td>Autopilot</td> <td>HF Communication</td> <td>Data Link</td> </tr> <tr> <td>Tacan</td> <td>Beacon</td> <td>Built In Test</td> </tr> </table>			Inertial	UHF Communication	Attitude/Heading	Autopilot	HF Communication	Data Link	Tacan	Beacon	Built In Test					
	Inertial	UHF Communication	Attitude/Heading														
Autopilot	HF Communication	Data Link															
Tacan	Beacon	Built In Test															
<u>Indicators</u> <table border="0" style="width: 100%;"> <tr> <td style="width: 33%;">Altitude</td> <td style="width: 33%;">Energy Management</td> <td style="width: 33%;">Flight Path Angle</td> </tr> <tr> <td>Velocity</td> <td>Horizontal Situation</td> <td>Angle of Attack</td> </tr> <tr> <td>Acceleration</td> <td>Attitude/Director</td> <td>Dynamic Pressure</td> </tr> <tr> <td>Airspeed</td> <td>Comm. Frequency</td> <td>Mach Number</td> </tr> <tr> <td>Compass</td> <td>Digital Data</td> <td>Vertical Velocity</td> </tr> </table>			Altitude	Energy Management	Flight Path Angle	Velocity	Horizontal Situation	Angle of Attack	Acceleration	Attitude/Director	Dynamic Pressure	Airspeed	Comm. Frequency	Mach Number	Compass	Digital Data	Vertical Velocity
Altitude	Energy Management	Flight Path Angle															
Velocity	Horizontal Situation	Angle of Attack															
Acceleration	Attitude/Director	Dynamic Pressure															
Airspeed	Comm. Frequency	Mach Number															
Compass	Digital Data	Vertical Velocity															

(U) The X-15, operating over a relatively short 300 nm (556 kilometers) test range, did not require precision flight director or energy management mechanizations. Rogers Dry Lake, 11 nm (20 kilometers) long and 5 nm (9 kilometers) wide, is easily discernible at 160 nm (296 kilometers) range while flying Mach 6 at 100,000 ft altitude (30,500 meters). Therefore, visual cues to the landing point were available shortly after the end of the 80 sec boost profile.

4.8.2 (U) COMMUNICATION - The UHF subsystem for the HYFAC test vehicle provides voice and data communication in the 225-400 MHz frequency band. It is utilized for line of sight transmissions out to approximately 250 nm (464 kilometers). Long range communication beyond the line of sight limitation is achieved by the HF subsystem, working in the 2-30 MHz frequency band. The data link subsystem, utilizing communication equipment for automatic data transmission, contains the circuitry for control messages to the aircraft, reply messages from the aircraft, and D/A A/D converters for interface with other avionic subsystems. Beacon transponders are also included to augment ground based radar tracking of the test vehicle, particularly during the glide landing phase of the flight. All of the RF transmitting/receiving subsystems require antennas compatible with the test vehicle. A Mach 12 flight environment will not allow sharp protrusions such as antennas beyond the mold line. Therefore, flush antennas capable of elevated temperature operation are included for UHF Communication, HF Communication, Beacons, ILS, TACAN and Radar Altimeter subsystems.

(U) The X-15 communication functions were achieved with an avionic state-of-the-art approximately 15 years behind that for the study test vehicles. Over this period transitions have developed from vacuum tubes to transistors, transistors to integrated circuits, and integrated circuits to large scale integration. The X-15 UHF equipment for voice communication with the ground and SSB high frequency equipment for communication with support aircraft represent functions similar to those for the study test vehicles. They will be achieved, however, at reduced weight and volume penalties and increased reliability due to progress in the state-of-the-art.

4.8.3 (U) FLIGHT SENSORS AND CONTROL - The HYFAC test vehicles utilize an attitude and heading reference subsystem to sense aircraft orientation in earth referenced coordinates. This data is redundant with and serves as a backup to similar orientation data obtained from the inertial navigator. Air data is obtained with a nose tip located orifice array. Comparison of orifice pressure measurements yields angle of attack and sideslip data, while dynamic pressure is derived from total pressure measurements. Barometric altitude data may be obtained in the high velocity regime by combination of dynamic pressure data with inertially measured velocity to determine air density.

(U) The X-15 air data system was very similar, using a 6.5 inch (16.5 cm) diameter null seeking nose sphere to measure angles of attack and sideslip. Pressures measured with this system enabled derivation of airspeed and Mach number data. Altitude data, conventionally obtained on lower speed vehicles with static pressure measurements, could not be obtained in this fashion on the X-15. Instead, altitude was obtained from the inertial system by double integration of the vertically oriented accelerometer data. Early analog mechanizations produced 14,000 ft (4270 meters) errors by the end of typical 500 second flights. Later redesigned analog and digital mechanizations reduced the altitude error to within 4000 ft

(1220 meters). The longer flight times associated with the HYFAC test vehicles reduce the attractiveness of the open loop inertial technique of integration to obtain altitude. Instead, the dynamic pressure/inertial velocity technique previously described will provide a time independent solution for altitude.

(U) The X-15 pilot relied primarily upon visual cues to accomplish the descent and landing phases of flight. With Rogers Dry Lake in view for the major portion of the glide phase, he would seek a high key altitude above the landing area. Depending upon his velocity at the key point, he would perform a predetermined descending turn leading to a correct landing approach. The mechanization for the HYFAC test vehicles reduces this dependency upon flight skill and visual cues. The greater distance and increased velocity of these vehicles support a philosophy of command guidance during the critical let down and landing phases. A radar altimeter and ILS system provide data necessary for onboard automatic computation of guidance commands. The radar altimeter provides tape line altitude above the terrain, utilizing pulse radar techniques with leading edge tracking of the reflected signals. ILS localizer, glide slope and marker beacon functions further define the final approach geometry.

(U) The major function of an autopilot in hypersonic vehicles such as the X-15 is in stability augmentation. In many flight conditions these vehicles are difficult to control without the aid of an automatic system. Two of the X-15 vehicles used simple damper systems, while a third was used to test a redundant autopilot system with adaptive automatic gain control. This system also closed attitude, heading, and angle of attack hold outer autopilot loops around the basic stability augmentation inner loop. An additional feature, probably not required for the HYFAC test vehicles, was capability for a smooth transition between aerodynamic control and reaction control. The autopilot included in the HYFAC test vehicles mechanizes stability augmentation in all three axes of control. It uses three redundant channels to provide normal operation following a first failure and fail-safe action after a second failure. Outer loops may also be closed about the stability augmentation system to provide automatic control to a specified flight profile.

4.8.4 (U) CONTROLS AND DISPLAYS - The X-15 program used a concept of displaying to the pilot his current flight conditions so that he could determine the control action required. Flight experience has shown that pilots generally missed the planned maximum altitude by less than 5000 ft (1520 meters). This was acceptable for X-15 operations, where the flight plan simply specified a desired peak altitude. However, capability for closer control of the entire mission profile is desired for the HYFAC test vehicles. For this a command guidance concept is included in the display configuration. Control panels have been included providing all necessary pilot interface for control of the avionic subsystems. Similarly, indicators for conventional functions such as horizontal situation, attitude/director, and air data have been provided. Additional indicators unique to the flight profile of this type test vehicle have also been provided. They include display of inertially derived parameters such as true velocity and flight path angle; and energy management type display of achievable footprint for the glide phase of flight. An energy management display of this type was tested during the X-15 program, but was not considered a requirement for successful X-15 performance.

#### 4.9 VEHICLE PERFORMANCE

4.9.1 (U) PERFORMANCE GROUND RULES - Performance ground rules were established early in the study for the sizing of the various category test aircraft. Mission definition, propulsive system sizing, and aerodynamic assessment are the main factors considered in establishing these ground rules.

##### Mission Definition

- o Two base mission operation is assumed.
- o Accelerate and climb to constant test Mach number at  $(L/D)_{\max}$  equilibrium altitude.
- o Cruise at test Mach number for 5 minutes.
- o Descend with zero fuel usage.  
Reserve:  $I_{sp}$  is reduced by 5% throughout mission to provide for differences between estimated air vehicle performance and flight test operational performance.

Configurations using rockets for acceleration and climb follow the flight path for minimum fuel. Configurations using airbreathers for acceleration and climb follow a prescribed flight path which provides the highest dynamic pressure consistent with several structural and thermodynamic constraints. These flight paths are compared in Figure 4-45. All air drop missions are initiated at Mach number 0.8 and 35,000 ft (10.68 kilometers) altitude.

##### Propulsive System Sizing (Ref. Section 4.2)

- o All aircraft engines are rubberized except where designated.
- o For rubberized rocket engines, vacuum thrust to takeoff gross weight ratio is 1.5.
- o For rubberized airbreather engines sea level static uninstalled thrust to takeoff gross weight ratio is 0.942.
- o For ramjets the installed thrust is equal to the drag at start of cruise.
- o For convertible scramjets the capture area is = .045  $S_p$  for all-bodies  
= .040  $S_p$  for wing bodies

##### Aerodynamic Assessments

- o  $(L/D)_{\max}$  at cruise altitude is considered to be a function solely of  $(VOL)^{2/3}/S_p$  and Mach number.
- o Rocket thrust inclination effect on L/D is neglected.



(U) FIGURE 4-45  
 COMPARISON OF ROCKET VS AIRBREATHER ACCELERATION - CLIMB PROFILES

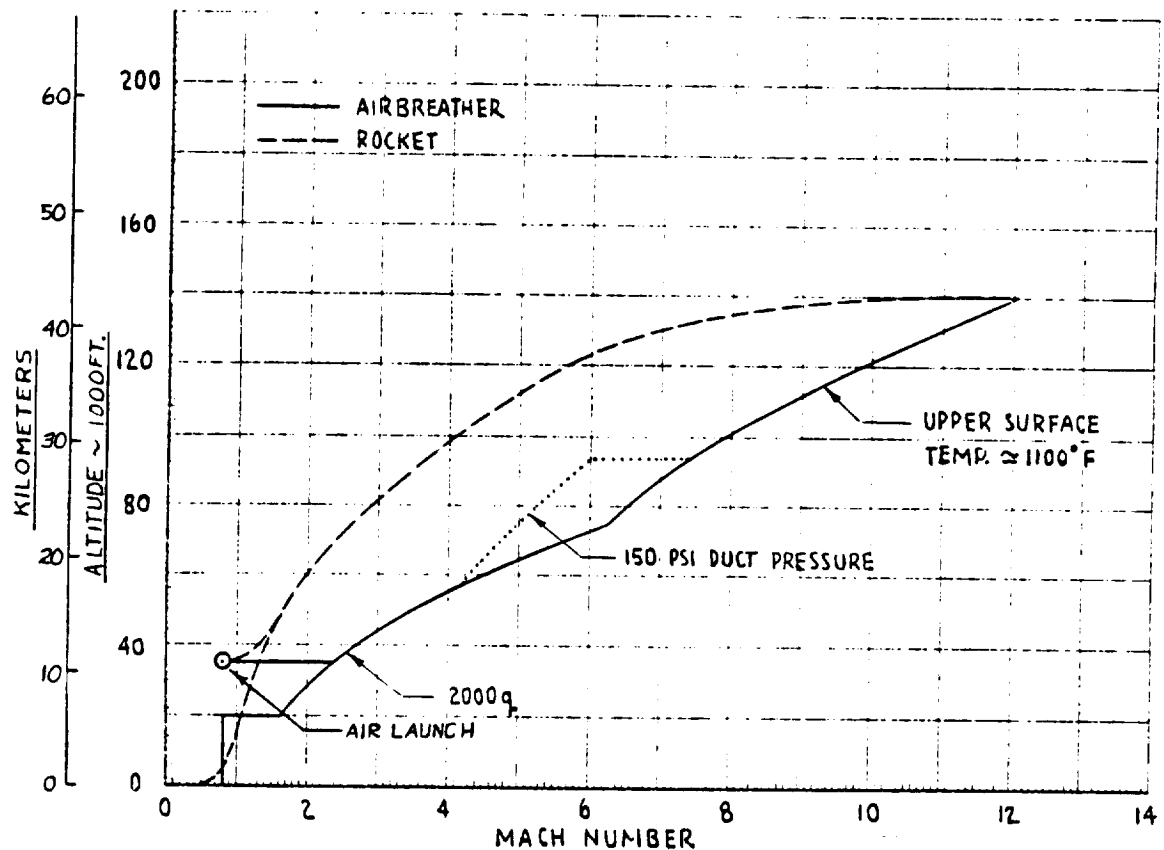

- o Expansive lift contribution of scramjets is considered during the cruise.
- o For rocket aircraft, accel-climb velocity drag losses are assessed from a closed form correlation based on initial vacuum thrust to weight ratio, initial wing loading, zero lift drag and induced drag factor at Mach 1.2.
- o For airbreather accel-climbs, aerodynamic variations with Mach number and angle of attack are considered; (non-linear effects on lift are not considered).

4.9.2 (U) PROPULSION UTILIZATION & PERFORMANCE - During Phase I, both airbreather and rocket propulsion systems were evaluated. The propulsive airbreather systems used are: turbojet (TJ), ramjet (RJ), turboramjet (TRJ), and convertible scramjet (CSJ). The rocket systems used are either integrated into the aircraft design (RKT) or are a separate system, utilized as a launch vehicle (STAGED) for the air vehicle. Some of the air vehicles are designed with combinations of propulsive systems which are utilized for either the acceleration-climb or cruise phase of flight. The propulsion system used for each flight phase is designated for all air vehicles on the performance comparison chart, Figure 4-56.

(U) For aircraft using two propulsion systems, an engine operational Mach range is established. This operational Mach range is shown on the propulsion system utilization chart, Figure 4-46, showing the manner in which each engine is utilized.

(U) FIGURE 4-46

PROPULSION SYSTEM UTILIZATION FOR AIR VEHICLES WITH TWO PROPULSION SYSTEMS

M <sub>D</sub>	PROPULSION SYSTEM		OPERATIONAL MACH NUMBER	
	ACCEL. & CLIMB	CRUISE	ACCEL. & CLIMB	CRUISE
6.0 ↓	TRJ	RJ	0 → 3.75 (TJ) 1.0 → 6.0 (RJ)	6.0 (RJ)
	RKT	RJ	0 → 6.0 (RKT)	6.0 (RJ)
	STAGED	RJ	0 → 6.0 (STAGED)	6.0 (RJ)
12.0 ↓	TJ & CSJ	CSJ	0 → 3.5 (TJ) 1.0 → 1.8 (CSJ SUBSONIC OPERATION) 3.5 → 6.0 (CSJ SUBSONIC OPERATION) 6.0 → 12.0 (CSJ SUPERSONIC OPERATION)	12.0 (CSJ)
	RKT	CSJ	0 → 12.0 (RKT)	12.0 (CSJ)
	STAGED	CSJ	0 → 12.0 (STAGED)	12.0 (CSJ)
	STAGED	RKT	0 → 12.0 (STAGED)	12.0 (RKT)

For the turboramjet-powered vehicle the TJ is operated up to Mach 3.75, which is the TJ limit according to engine specifications. The RJ is operated from Mach 1.0, the lower specification limit of the RJ, to Mach 6.0. For the turbojet-accelerated vehicles, the TJ is used as the sole thruster up to Mach 3.5, which is assumed to be the TJ limit. Above 3.5 the cruise engine, either a ramjet or convertible scramjet, is used as the sole thruster. The ramjet thus operates from Mach 3.5 to 6.0. Similarly, the convertible scramjet operates from Mach 3.5 to 12.0. The subsonic combustion mode is employed from Mach 3.5 to 6.0, and the supersonic combustion mode from Mach 6.0 to 12.0. Converting from subsonic to supersonic combustion mode at Mach 6 maintains near-maximum thrust. In addition to the operation just described, the CSJ is also operated in the transonic flight region (Mach 1.0 to 1.8). In this region the inlet is unstarted and net thrust is negative, but the exhaust serves to fill the scramjet nozzle and thus improve acceleration by reducing base drag. A schematic is shown in Figure 4-47 which illustrates the turbojet - convertible scramjet installation. During turbojet operation the turbojet inlet door is extended, causing air to pass through a variable capture area, variable contraction ratio, inlet into the turbojet. The scramjet is retracted at this time. During scramjet operation the turbojet inlet is retracted and the exit is closed, causing air to enter into the scramjet in its extended position and providing an efficient expansion surface for the exhaust. For the transonic flight region where both engines operate simultaneously, the TJ inlet door is extended and the scramjet module is extended.

(U) The installed engine performance was determined for the various engines used in the flight facilities study. However, the majority of these data are proprietary to the respective engine manufacturers. To permit this volume the widest possible distribution and simultaneously keep the propulsion performance data

(U) FIGURE 4-47  
TURBOJET INSTALLATION

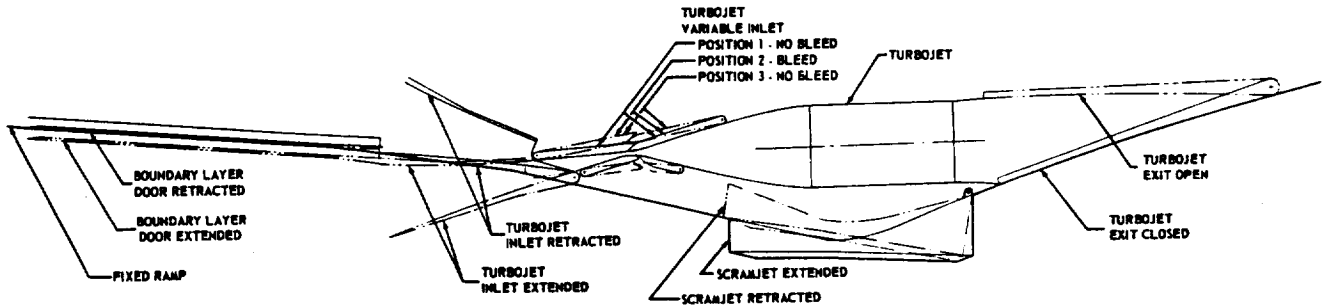

united, all of the actual engine performance data and its development are presented in Section 2 of Volume V.

4.9.3 (U) TRAJECTORY ANALYSES - The trajectory analyses performed during the Phase I studies are described in this section. The design mission consists of the acceleration-climb, five minute cruise, and the descent phases together with maneuvers utilized to obtain minimum range. Each phase is discussed in turn.

#### Acceleration-Climb Phase

(U) For the acceleration-climb phase of flight, four different methods of launch were considered: horizontal takeoff, vertical takeoff, staged vertical takeoff and air launch.

(U) The vehicles using the horizontal takeoff launch method were performed using two different climb profiles. The rocket accelerator vehicles used the climb profile for minimum fuel usage. For airbreathers, the climb was performed with fixed Mach-altitude profiles. The two types of profiles are compared in Figure 4-45. The airbreather profile consists of a takeoff and dash at sea level to 0.8 Mach number, a climb at 0.8 Mach number to an altitude of 20,000 feet (6.1 kilometers), an acceleration through the transonic regime at this altitude to a dynamic pressure of 2000 lb/ft<sup>2</sup> (9.576 x 10<sup>4</sup> N/m<sup>2</sup>). (The structural design of the airplane is based on a dynamic pressure of 2500 psf (11.97 x 10<sup>4</sup> N/m<sup>2</sup>.) From this point the Mach-altitude profile varied according to engine characteristics and test Mach number. For turboramjets, the 2000 q limit is flown until the 150 psi (1.034 x 10<sup>6</sup> newtons/meter<sup>2</sup>) engine duct pressure limit is reached; flight continues utilizing this limit. For convertible scramjets, the 2000 q limit is flown until the upper surface temperature limit of 1100°F (593°C) is reached; flight is then continued along this limit.

(U) The vertical takeoff configurations utilize rocket power. These vehicles are flown vertically until a velocity of 170 knots (315 kilometers/hr) is attained. From this point, climb performance is determined using the correlations based on minimum fuel climb trajectories.

(U) The staged vertical takeoff configurations are performed using the Thor launch vehicle for Mach 6 test vehicles and the Atlas launch vehicle for Mach 12 test vehicles.

(U) The air launched vehicles used either the B-52 or C-5A as the carrier aircraft. Initial launch altitude and Mach number are 35,000 ft (10.68 kilometers) and 0.8 respectively. The air launch climbs for rocket powered vehicles are performed using correlations based on minimum fuel climb trajectories. For air-breathers the air launch climb is performed using the fixed Mach-altitude profile shown in Figure 4-45. The air launch climb consists of an acceleration at 35,000 feet (10.68 kilometers) altitude through the transonic regime to the 2000 q limit. From this point the same Mach-altitude profile as flown by the horizontal takeoff airbreather is followed.

#### Five Minute Cruise Phase

(U) The cruise phase of flight for all vehicles is performed holding Mach number constant for five minutes at  $(L/D)_{\max}$  equilibrium altitude.

#### Descent Phase

(U) For the descent phase of flight the data shown in Figure 4-48 are used for all configurations. Time, altitude, and distance are presented as a function of velocity for various wing loadings. The descent phase was performed unpowered at  $(L/D)_{\max}$ . These data reflect the maximum glide range potential of the aircraft.

#### Minimum Range Maneuver

(U) Typical minimum range profile maneuvers for Mach 4.5, 6.0, and 12 missions are presented in Figures 4-49 through 4-51 (altitude and crossrange vs downrange). These profiles are performed assuming 3.5g power-off wind-up-turns, limited by angle of attack at high altitudes. A 180 degree heading change defined turn completion. Altitude, Mach number, and heading variation with time for these maneuvers are also presented in these figures. At turn completion the remainder of flight is unpowered, at  $(L/D)_{\max}$ .

4.9.4 (U) VEHICLE SIZING TECHNIQUE - The techniques employed in sizing the vehicles for the design mission described in Section 4.9.3 are presented herein. Basically, the sizing approach requires matching the total propellant volume required to complete the design mission with the total propellant volume available in a given configuration. Different methods of accomplishing this were employed depending upon the mode of acceleration - rocket or airbreather.

#### Sizing Techniques - Rocket Accelerators

(U) A closed form solution was used to size rocket accelerators for the given mission requirements. This solution enabled larger number of aircraft to be evaluated in the performance matrix. The closed form solution was found to be quite adequate for sizing the vehicles when compared to a point mass trajectory solution.

(U) FIGURE 4-48  
 L/D<sub>MAX</sub> EQUILIBRIUM GLIDE DESCENT

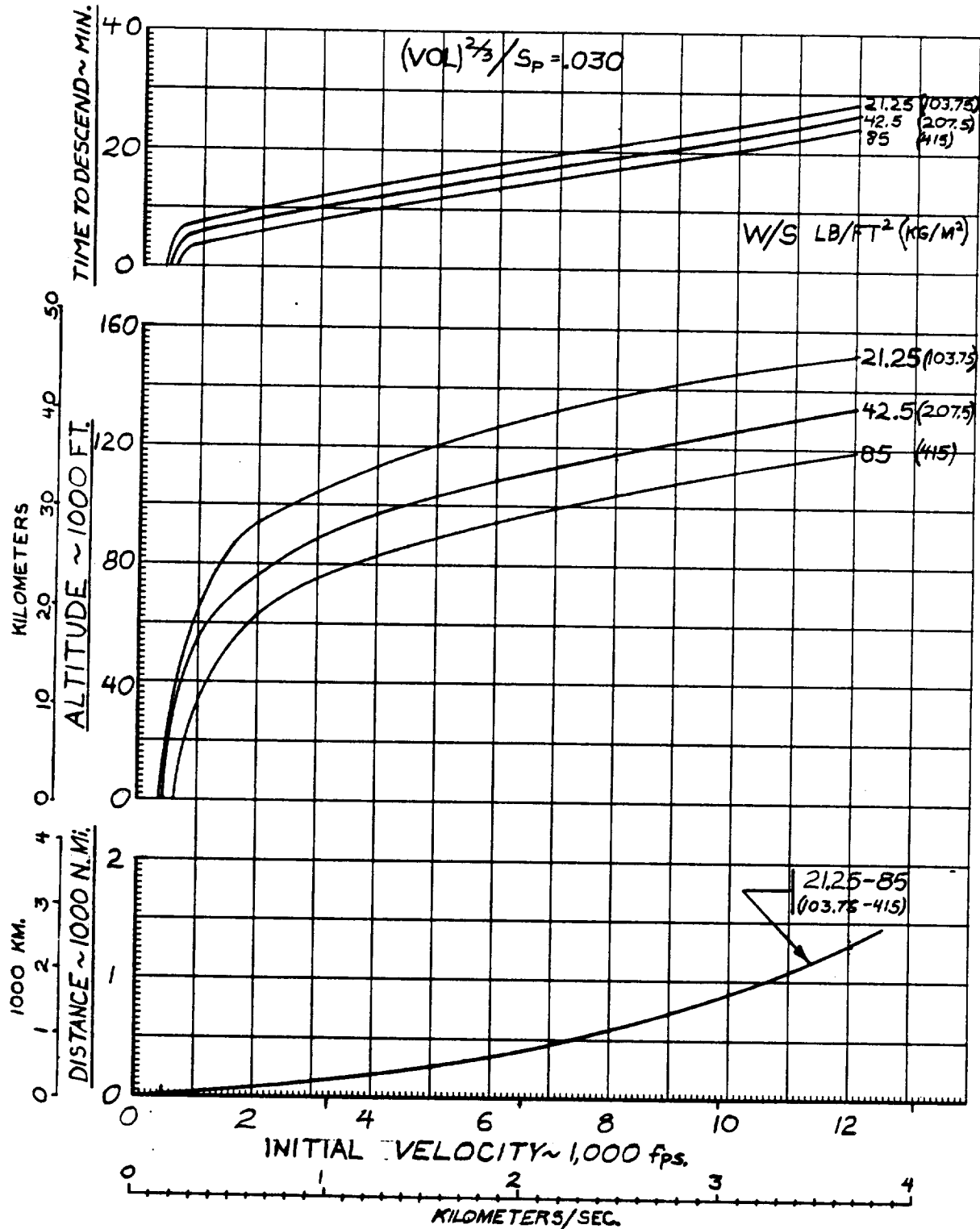

(U) FIGURE 4-49

MACH 4.5 UNPOWERED WINDUP TURN  $N_z = 3.5 g$

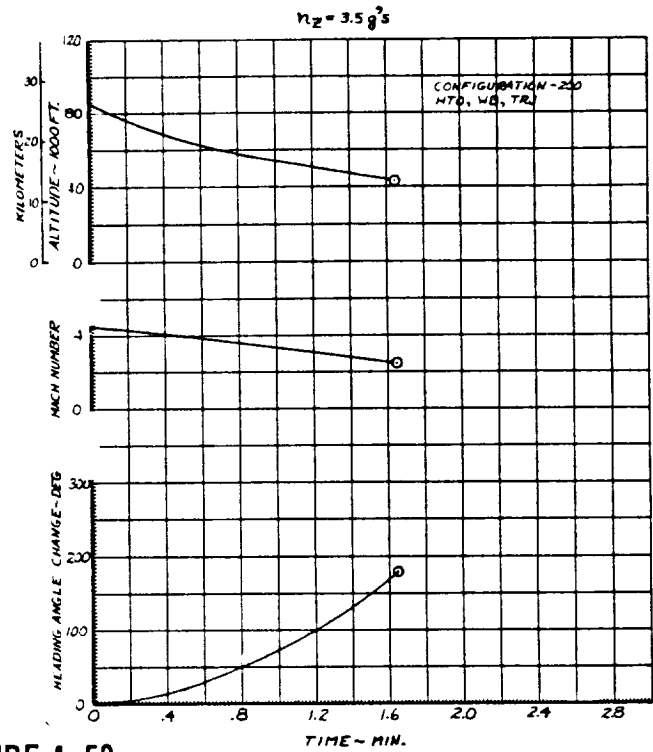
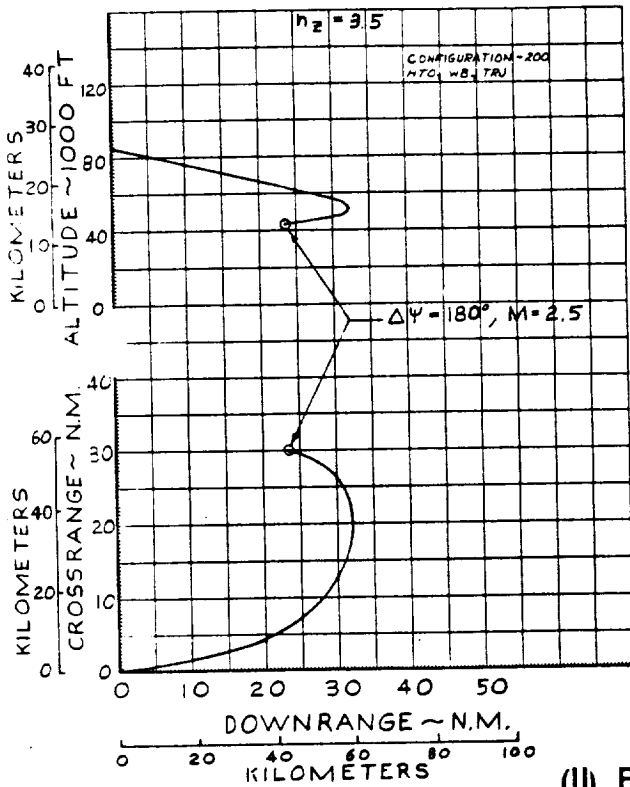

(U) FIGURE 4-50

MACH 6.0 UNPOWERED WINDUP TURN  $N_z = 3.5 g$

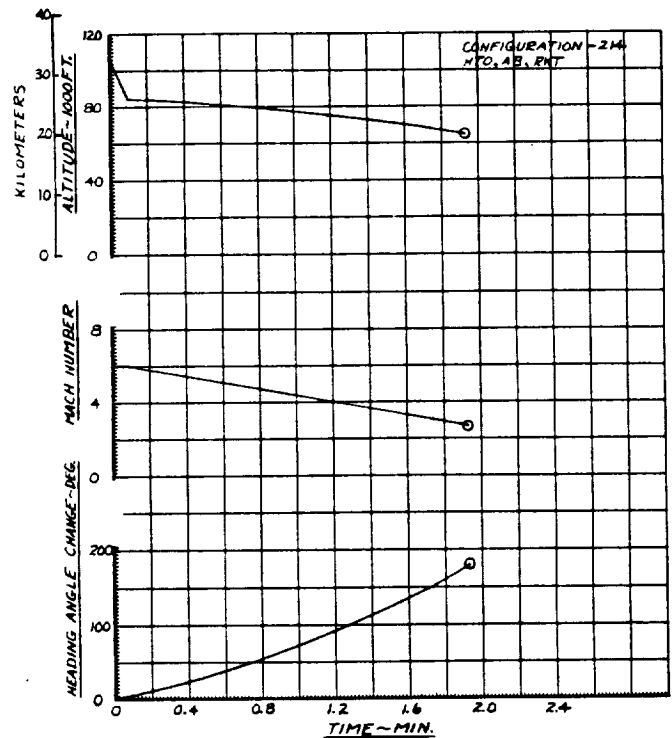
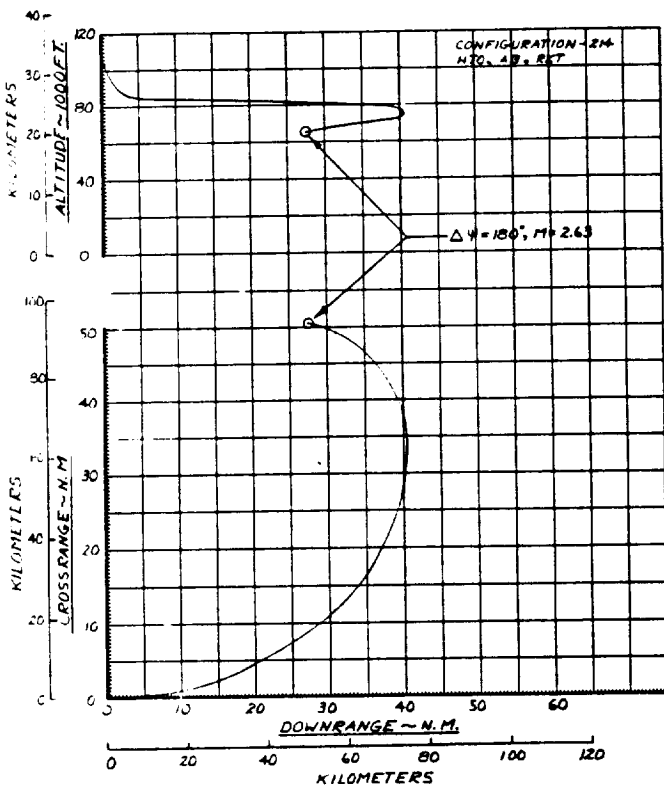

(U) FIGURE 4-51  
 MACH 12.0 UNPOWERED WINDUP TURN  $N_Z = 3.5 g$

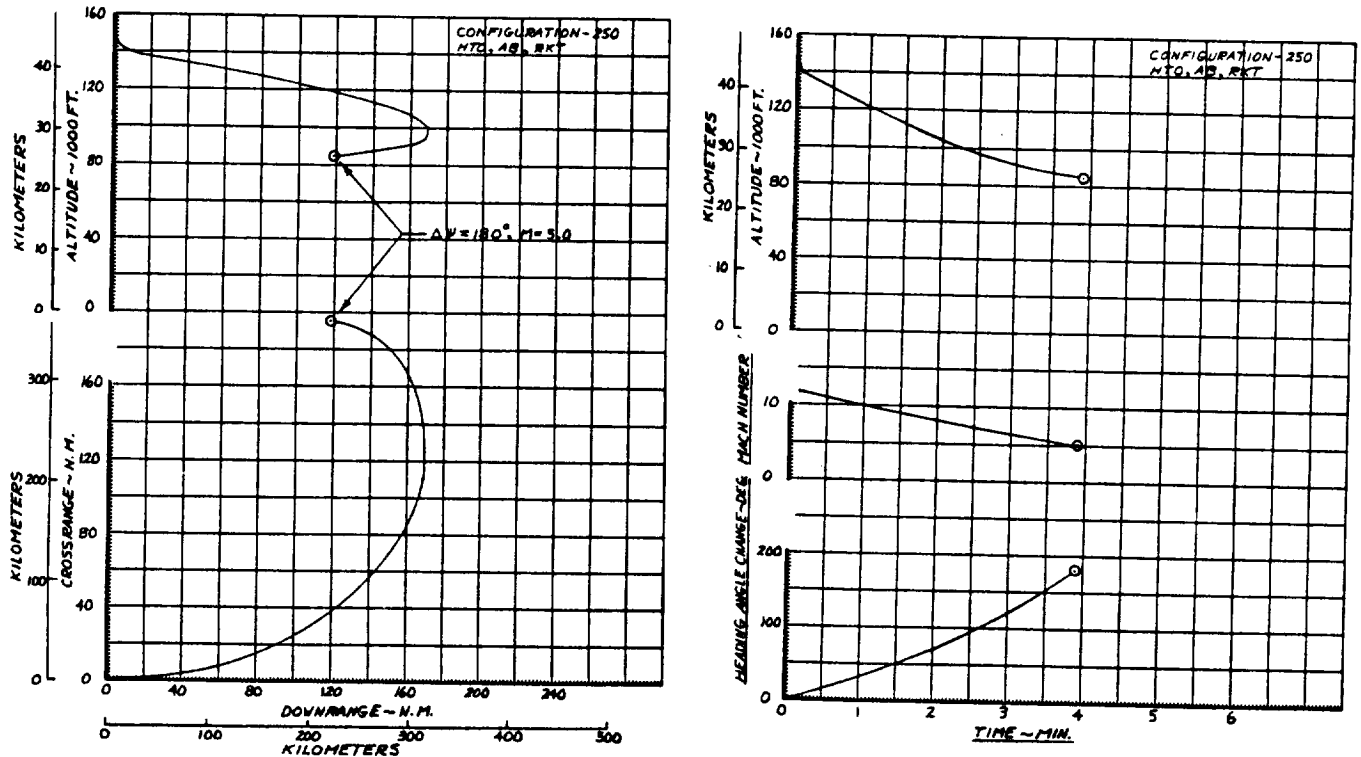

(a) Assume Weight Empty, OWE

(b) Solve for Cruise Weight Fraction,  $W_c/OWE$ , using the Brequet range equation

$$\ln \frac{W_c}{OWE} = \frac{\Delta t \text{ Test}}{(L/D)_{\max} I_{sp}} \left\{ \frac{1}{1 - \left[ \frac{V^2}{\sqrt{(R_E + Z)g}} \right]^2} \right\}$$

where  $\Delta t \text{ Test} = 5 \text{ min} = 300 \text{ sec}$

$(L/D)_{\max}$  = cruise maximum lift to drag ratio

$I_{sp}$  = specific impulse

$V$  = actual test velocity at  $(L/D)_{\max}$  equilibrium altitude

$R_E$  = radius of Earth

$Z = (L/D)_{\max}$  equilibrium altitude

$g$  = local acceleration of gravity

(c) Solve for initial Cruise Weight,  $W_c$

$$W_c = \frac{W_c}{OWE} OWE$$

(d) Determine velocity losses during acceleration and climb assuming initial takeoff gross weight, TOGW, from correlations, Figures 4-52 through 4-54.

where Drag loss  $\Delta V_D = \int_{t_1}^{t_2} \frac{D}{m} dt$

Gravity loss  $\Delta V_G = \int_{t_1}^{t_2} g \sin \alpha dt$

Pressure loss  $\Delta V_P = \int_{t_1}^{t_2} \frac{PA_e}{m} dt$

Maneuvering loss  $\Delta V_M = \int_{t_1}^{t_2} \left( \frac{T_{vac} - PA_e}{m} \right) (\cos \alpha - 1) dt$

These correlations are based on approximately 50 acceleration-climb profiles for minimum fuel usage obtained by a steepest descent trajectory optimization program. The correlations were developed from previous studies wherein T/W and W/S were in the same range as those of this study. In the development of the correlations, values of performance parameters affecting the velocity losses were obtained. These parameters were then curve-fitted to the trajectory data.

(e) Determine ideal velocity requirement

$$V_{Ideal} = V + \Delta V_D + \Delta V_G + \Delta V_P + \Delta V_M$$

$V_{initial}$ , used for air launch vehicles, is equal to 778 ft/sec

(238.65 m/sec)

(f) Determine acceleration and climb Weight Fraction, TOGW/ $W_C$  from the classical rocket equation.

$$\ln \frac{TOGW}{W_C} = \frac{V_{Ideal}}{g I_{sp}}$$

$$TOGW = \frac{TOGW}{W_C} W_C$$



(U) FIGURE 4-52  
 DRAG LOSSES

Rocket Boost

- |  |  |
|--|--|
| $\Delta V_d$ - Drag Loss - Fps                 | $C_{d_0}$ - Zero Lift Drag Coeff at Mach = 1.2 |
| T - Vacuum Thrust - Lb                         | $L'$ - Induced Drag Factor                     |
| W - Initial Weight - Lb                        | $\Delta C_d / \Delta C_L^2$ at M = 1.2         |
| $I_{sp_{vac}}$ - Vacuum Specific Impulse - Sec | S - Reference Area                             |
| $\dot{w}$ - Propellant Flow - Lb/Sec           |  |

AIR LAUNCH

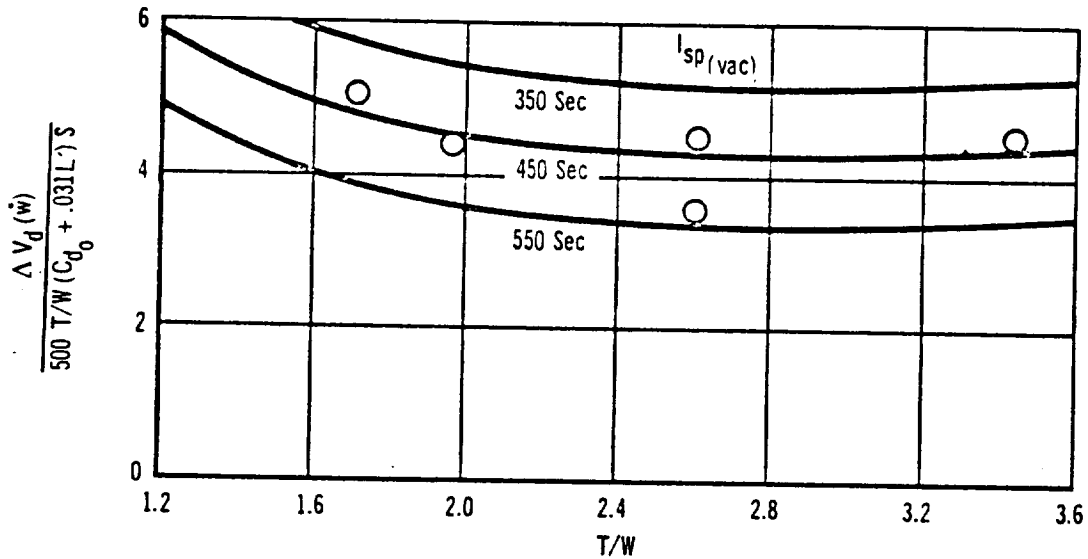

GROUND TAKEOFF

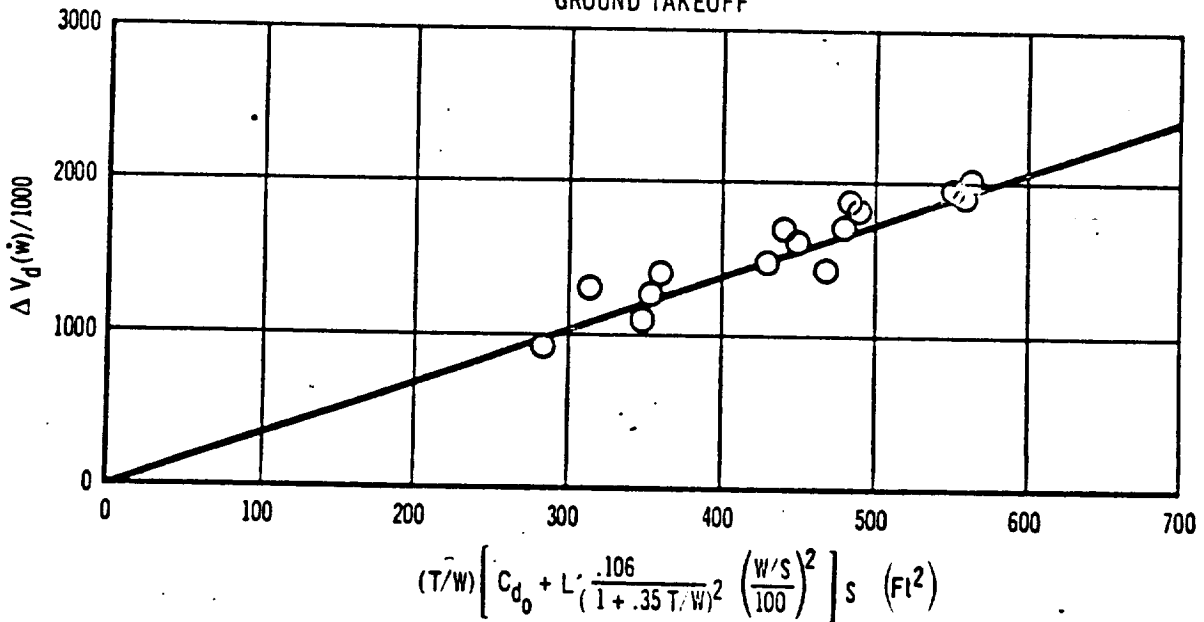

(U) FIGURE 4-53  
 GRAVITY ROCKET BOOST

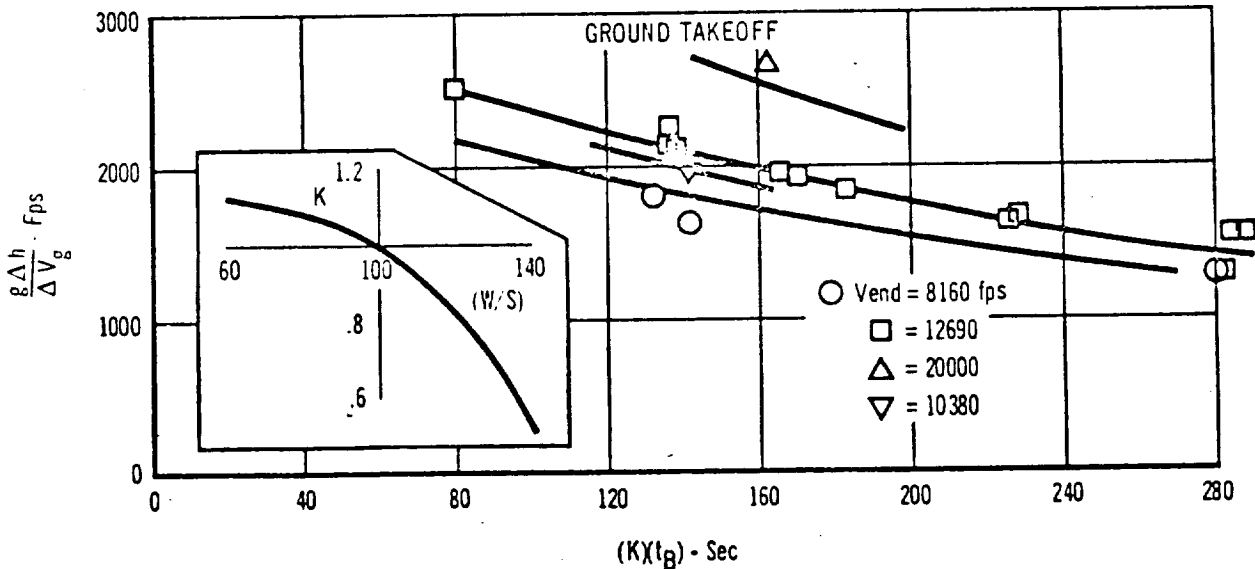
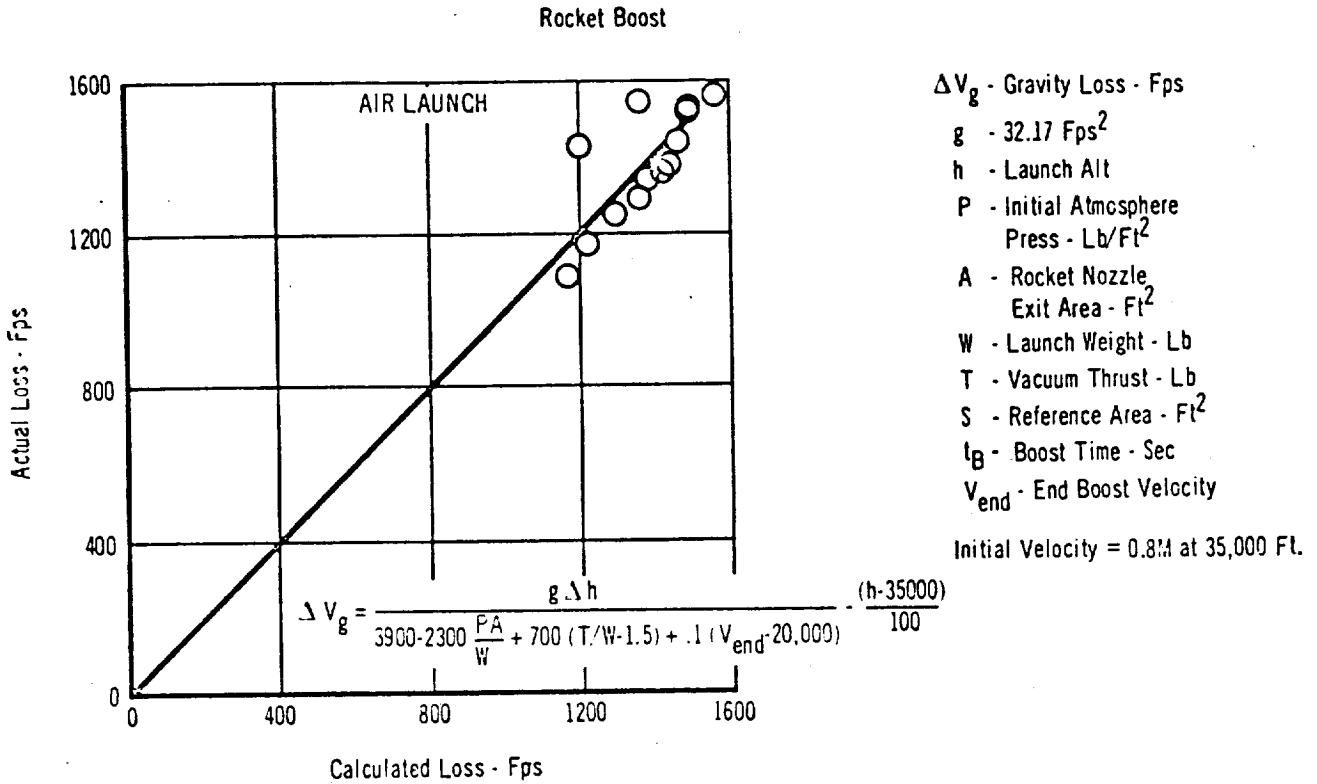

(U) FIGURE 4-54  
 PRESSURE AND MANEUVERING LOSSES

Rocket Boost

$\Delta V_p$  - Pressure Losses - Fps

$\Delta V_m$  - Maneuver Losses - Fps

$A_e$  - Rocket Nozzle Exit Area - Ft<sup>2</sup>

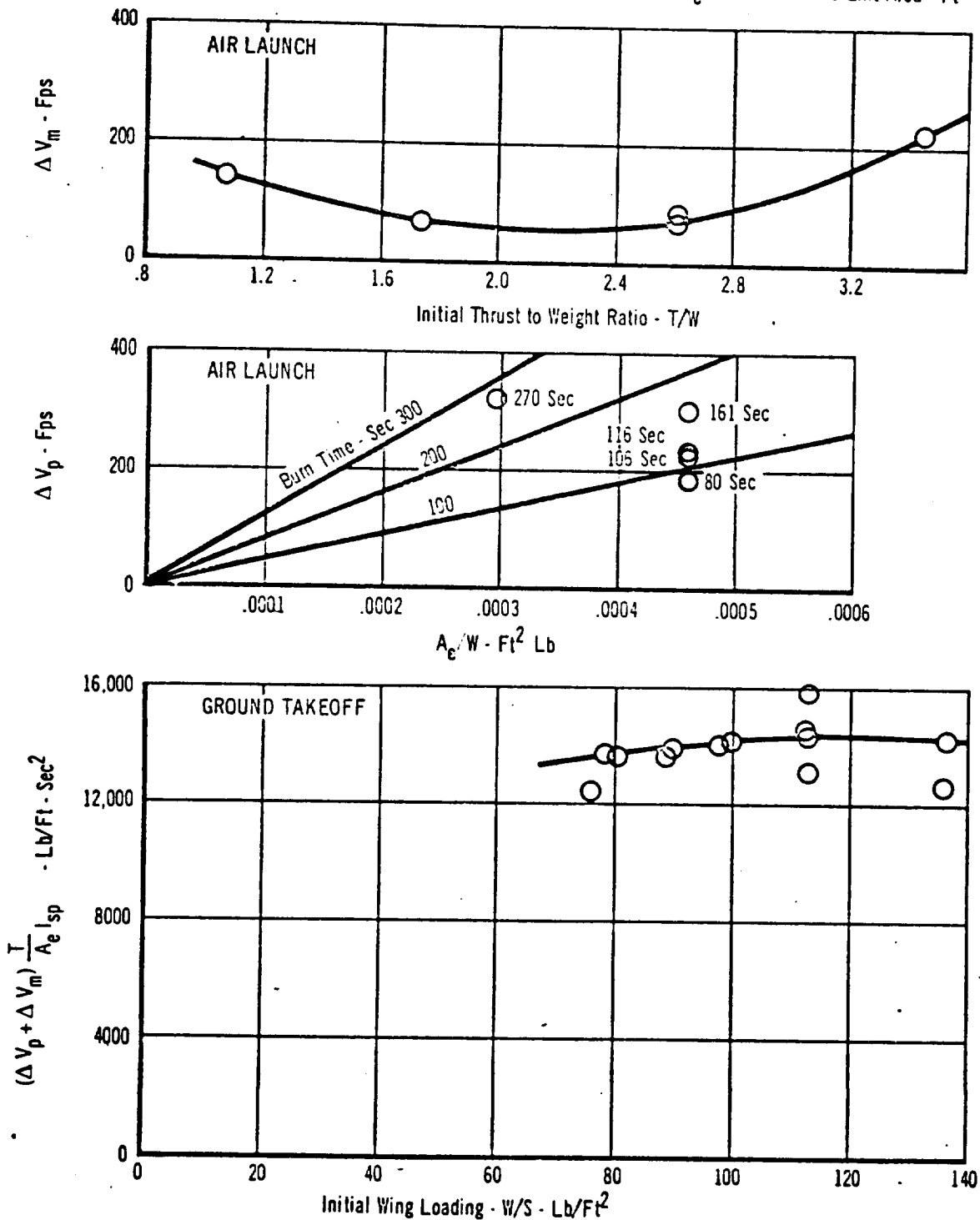

(g) Steps c thru f are then iterated until the assumed TOGW and  $W_{\text{FUEL}}$  are consistent with the assumed OWE, i.e.,

$$\text{TOGW} = \text{OWE} + W_{\text{FUEL}}$$

$$(\text{VOL})_{\text{FUEL}} = W_{\text{FUEL}} / \rho_{\text{FUEL}}$$

(h) Obtain Fuel Volume available from design and weights charts



(i) Plot the Fuel Volume Required Point calculated in Steps a through g and draw a straight line \* from this point through origin. The Required Empty Weight and Fuel Volume are found at intersection of this line and the Volume-Available Curve.

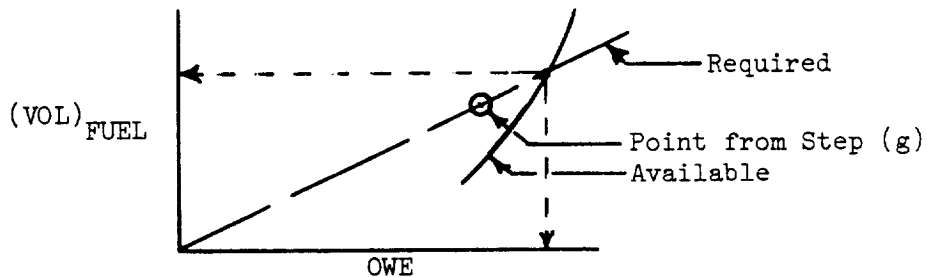

Takeoff Gross Weight is then found by converting fuel volume to fuel weight and adding to OWE.

(U) A comparison of the velocity losses obtained by the closed form solution and steepest descent optimum solution is presented in Figure 4-55 for a Mach 12 All Body, Rocket Configuration -250. Other parameters of interest are shown in the following tabulation:

	<u>Closed Form Solution</u>	<u>Steepest Descent Optimum Solution</u>
Velocity ~ ft/sec	12,975	12,720
Altitude ~ ft	142,900	143,645
Time ~ sec	206	202
Cruise Weight ~ lb	37,045	38,375

It is seen that the correlation between the two methods of calculation is very good.

\* NOTE: This simplification is possible for approximate calculations using rocket thrust since the specific impulse,  $I_{sp}$ , can be assumed to be essentially constant.

(U) FIGURE 4-55  
SIMPLIFIED METHOD VERIFIED BY DETAILED TRAJECTORY ANALYSIS  
CLOSED FORM SOLUTION vs STEEPEST DESCENT OPTIMUM SOLUTION

Configuration -250  
(Mach 12, All Body, HTO, Rocket)

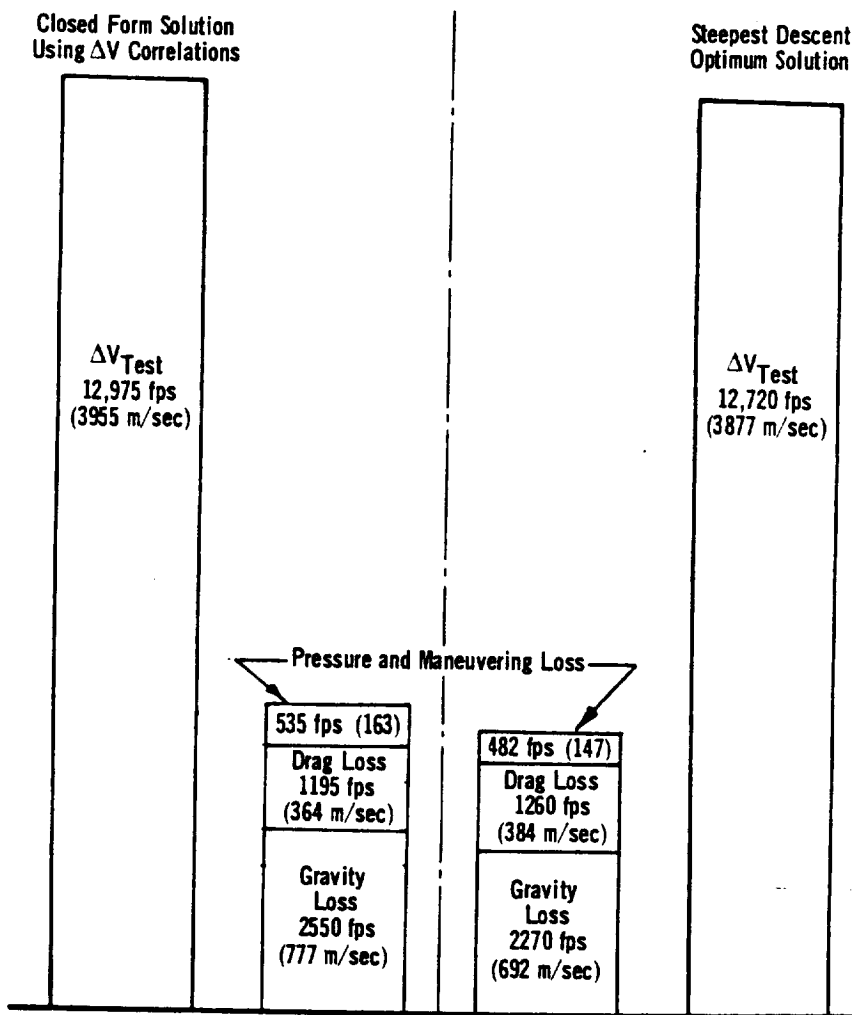

Sizing Technique - Airbreather Accelerators

(U) A closed form iterative computer program trajectory solution was used in the sizing of airbreather accelerators for the given mission requirement. The program solution utilizes the energy method for the determination of trajectory parameters and assumes small angle approximations. The basic input along with vehicle characteristics is a fixed altitude-Mach profile. Small increments along the profile are specified and the incremental energy difference  $\Delta E$  is determined.

$$E = Z + \frac{V^2}{2g}$$

$$\Delta E = E_2 - E_1$$

An acceleration is then determined assuming a weight differential  $\Delta W_1$

$$a = \frac{T_{AVG} - D_{AVG}}{W_{AVG}}$$

The time differential of energy is then

$$\dot{E} = V_{AVG} \left( \frac{a}{g} \right)$$

and the incremental time between energy levels is

$$\Delta t = \frac{\Delta E}{\dot{E}}$$

A new weight differential is then determined

$$\Delta W_2 = \dot{W} \Delta t$$

The program then compares  $\Delta W_2$  to  $\Delta W_1$ ; if the difference is within 10 lb (4.536 kg) the program accepts a solution and continues; if the difference is greater the program iterates until the test conditions are satisfied.

(U) The sizing technique for airbreather accelerators is outlined below:

(a) Determine Climb Profile

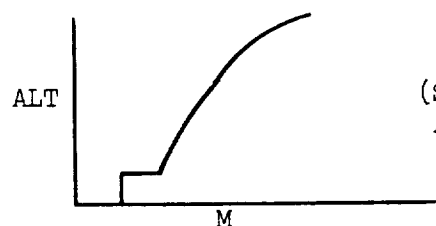

(See Section 4.9.3 on Climb Acceleration Phase)

(b) For 3 different size vehicles (scaled from a point design aircraft) calculate the takeoff gross weight using:

$$TOGW = OWE + V_f \rho_f$$

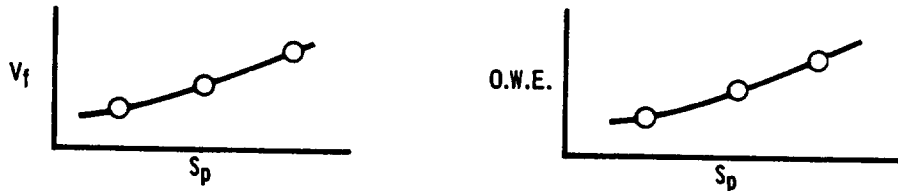

(c) Using aerodynamic and propulsion data for each configuration find the fuel weight required for acceleration and climb for each takeoff gross weight using the closed form iterative trajectory solution.

(d) Solve for cruise weight fraction ( $W_f = W_c/OWE$ ) using Brequet range equation in the same manner as used in step (b) for rocket propulsion.

(e) Use the results of steps (c) and (d) to find required fuel volume:

$$V_f = \frac{W_{f \text{ climb}} + W_{f \text{ cruise}}}{\rho_f}$$

(f) The Intersection of the volume required curve and volume available is the proper vehicle size.

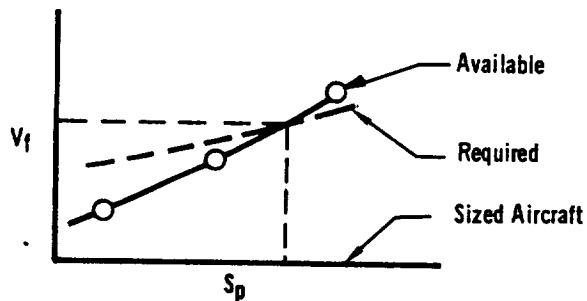

4.9.5 (U) PERFORMANCE SUMMARY - A summary of the sizing results together with some typical mission profiles obtained during HYPAC Phase I air vehicle performance studies is presented in this section. In addition, the results of several preliminary tradeoff studies are presented. These studies include the effect of changing the design Mach number, the effect of using an off-the-shelf rocket, the effect of changing the phasing sequence between rocket and scramjet engine utilization, and the effect on test Mach number of limiting flight testing to single-base operation. Preliminary data are also presented on the takeoff and landing characteristics of the air vehicles.

(U) Sizing Results - The geometric and physical characteristics of the various research aircraft, when sized to meet the design mission, are tabulated in Figure 4-56. It is noted that no data are presented for several of the designs investigated, namely Configurations -201, -206, -211, -212, and -231. These particular vehicles have insufficient thrust to overcome the transonic drag rise associated with the body shape and flight profile employed. Therefore they cannot accomplish the design mission, as presently configured. However, this is not to say that all-body airbreathing accelerators cannot be employed, since engines with greater T.W and/or flight profiles involving dive maneuvers to overcome the transonic drag rise can be utilized. The all-body shape selected in the design of these vehicles was chosen because it represents the most efficient means of providing the large fuel volume required for cryogenic fuel. However, the transonic drag rise associated with these shapes is high compared with that of wing-body vehicles, as is shown in Figure 4-23. This of little consequence when the thrust available is sufficiently large, as, for example, when rocket engines are employed to accelerate the vehicle. However, when airbreathing accelerators, of the size selected in this study ( $T/W = .942$ ), are utilized, as in the case of the subject configurations, the wing-body shape with its greater aerodynamic efficiency appears to be a better choice. This is illustrated in Figure 4-57. For these reasons, Configuration -257, originally an all-body, HTO, Mach 12, air-breather design, was changed to a wing-body shape incorporating the F100 turbojet engines with a design T/W of 1.0.

(U) Wing-body configurations were also found to have an advantage over the all-body shapes when storable propellants were employed rather than cryogenic fuel. This is not too surprising since the all-body shape was derived from the standpoint of volumetric efficiency to provide the large volume required by cryogenic fuel. When storable propellants, with their increased density, are utilized in an all-body design, excessively high wing loadings result, as for example in Configuration -253. For this reason Configuration -256, a wing-body design, was included in the concept matrix. This resulted in a reduced wing loading, but one that is still quite high, as is evident in Figure 4-56.

(U) The effect of design Mach number on the vehicle size is shown in Figure 4-58 for both air launched and horizontal takeoff vehicles. The configurations listed in this figure use rocket propulsion in the acceleration and climb and airbreather propulsion in cruise.

(U) When airbreather accelerators are used, the variation of air vehicle size with design Mach number appears to be quite different as indicated in Figure 4-59. The shape of the fairing shown may not be valid, since the  $M_D = 4.5$  design uses JP fuel whereas the  $M_D = 6.0$  and 12 designs use  $LH_2$  fuel. More visibility on the effect of design Mach number will be forthcoming in Phase II.

(U) The effect of several design alternatives on both takeoff gross weight and operating weight empty is illustrated in Figure 4-60. It is seen that although airbreather propulsion systems result in lower takeoff gross weights at  $M_D = 12$ , the OWE is substantially higher than with rocket accelerators; the airplane size is appreciably lower with air launched vehicles than HTO vehicles; the all-body design is preferable to wing body design if rocket accelerators are used; storable propellants are not competitive with cryogenic hydrogen from an aircraft weight and size standpoint; there is little weight difference between HTO and VTO vehicles; and, finally, there is very little difference in size between manned and unmanned vehicles.



FOLDOUT FRAME 2

FOLDOUT FRAME 1

(C) FIGURE 4-56  
 PERFORMANCE COMPARISON HYPERSONIC RESEARCH VEHICLES

CONFIGURATION	DESIGN MACH NUMBER	LAUNCH CONCEPT	TYPE OF CONFIGURATION	PROPULSION SYS.		BODY LENGTH FT.	VOL TOT FT. <sup>3</sup>	VOL F FT. <sup>3</sup>	(Vol) <sup>1/3</sup> /Sp	Isp SEC	OWE LBS.	TOGM LBS.	PROPELLANT WT. LBS.		Wf/Wto	(Wf/Wto) <sup>1/2</sup>	REMARKS
				ACCEL	CRUISE								ACCEL	CRUISE			
200	4.5	HTO	WB	TRJ	468	56.3	1,217	219	370	19,922	25,503	4,553	1,028	.219	.54	OPT. 4800 LBS. FREE	
201	6.0	AIR	AB	TRJ	605	55.6	1,740	605	3120	22,400	25,079	2,180	499	.0668	.42	THRUST REQ. UNAVAILABLE	
204			WB		615	56.4	1,790	620	3120	23,000	25,740	2,230	510	.1075	.42	UNMANNED	
205			AB		520	62.2	1,800	930	452/650	24,800	43,000	17,500	700	.424	.83	THRUST REQ. UNAVAILABLE	
207				RKT													
210	6.0	HTO	WB	TRJ	895	68.9	3,220	1,130	3,120	36,450	41,450	4,180	820	.121	.46		
211			AB														
212				TJ													
213				RKT													
214				RKT													
220	6.0	STAGED	AB		167	33.8	425	973	2910	12,800	13,230	-	430	.0324	.77	THRUST REQ. UNAVAILABLE	
221					174	34.5	439	99.5	2950	13,000	13,530	-	440	.0325	.78	THRUST REQ. UNAVAILABLE	
231	12.0	AIR	AB	TJ	850	79.6	3,906	2,171	452/650	23,900	69,700	45,000	800	.657	.82	THRUST REQ. UNAVAILABLE	
232				RKT	892	81.4	4,000	2,342	452	21,980	74,780	48,455	4,545	.706	.84		
233			WB		1,415	84.2	5,550	3,020	452	27,900	76,050	63,600	4,550	.71	.88	ELLIPTICAL CROSS-SECTION	
234				RKT													
250	12.0	HTO	AB	RKT	1,289	95.5	7,120	4,385	452	31,000	130,040	92,995	6,045	.760	.91		
251			WB		1,880	113.0	7,950	4,910	452	37,840	148,640	104,900	5,900	.745	.99		
252			AB		1,340	97.4	7,330	4,440	452	31,700	132,380	94,500	6,180	.76	.99		
253				CSJ	1,100	88.5	5,650	3,440	316	50,200	314,900	250,000	14,700	.841	.286		
254				CSJ	1,328	97.1	7,740	4,600	452/650	36,460	135,180	97,500	1,220	.73	.92		
255			WB		2,190	123.0	11,040	5,944	452/650	48,000	176,400	127,000	1,400	.728	.81		
256				RKT	1,318	94.6	4,750	2,700	316	41,420	238,420	197,170	9,830	.833	.89		
257				CSJ	2,000	116.1	10,300	4,800	449/650	53,000	90,200	20,470	1,730	.277	.40		
255-025			AB	TJ	1,809	113.0	11,950	7,060	288	42,580	194,280	142,800	8,900	.780	.97	(1) 0.25 ROCKET	
255-HID			WB	RKT	1,923	114.1	8,370	5,110	296	55,600	378,100	308,370	14,110	.854	.96	(2) H-ID ROCKETS	
270	12.0	VTD	AB	RKT	1,405	106.2	8,160	5,010	452	31,600	144,500	106,640	6,260	.781	.93		
271				CSJ	1,530	113.8	9,840	5,780	452/650	41,280	165,360	122,700	1,380	.75	.98		
280		STAGED	AB		165	29.6	355	94.7	1650	12,410	12,830	-	420	.0327	.78		
281				RKT	168	29.8	364	95	452	10,880	13,020	-	2,140	.164	.78		
282				CSJ	136	26.5	265	51.5	316	13,360	17,310	-	3,950	.228	.127		
284	12.0	AIR	AB	RKT	885	81.3	3,910	2,315	452	21,680	79,780	47,820	4,280	.708	.83	UNMANNED	
285		HTO			1,280	95.3	7,010	4,340	452	30,700	128,700	91,940	6,060	.762	.90		

CONFIDENTIAL

FOLDOUT FRAME 1

FOLDOUT FRAME 2

(C) FIGURE 4-56 (Continued)  
PERFORMANCE COMPARISON HYPERSONIC RESEARCH VEHICLES  
(INTERNATIONAL SYSTEM OF UNITS)

MODEL	DESIGN MACH NUMBER	LAUNCH CONCEPT	TYPE OF CONFIGURATION	PROPULSION SYS. ACCEL. & CLIMB	FUEL	SP	BODY LENGTH	VOL <sub>TO</sub>		(L/D) <sub>MAX</sub> CRUISE	I <sub>SP</sub> SEC	OWE KG	TOGW KG	PROPELLANT W.T.		W/W <sub>HTO</sub> (%S)	REMARKS
								M <sup>3</sup>	M <sup>3</sup>					ACCEL. CLIMB KG	CRUISE KG		
200	4.5	HTO	WB	TRJ	STOR	43.5	17.2	34.4	6.2	5.0	1370	9036	11,508	2065	406	.219	OFF LOADED FUEL FOR RE
201	6.0	AIR	WB	TRJ	CRY	54.2	16.9	49.2	17.1	4.35	3,120	10,160	11,316	989	226	.068	THRUST REQD UNAVAILABLE
204			WB			57.1	17.2	50.1	17.5	4.35	3,120	10,433	11,615	1012	231	.10715	UNMANNED
205			AB														THRUST REQD UNAVAILABLE
206			AB														THRUST REQD UNAVAILABLE
207			AB			48.3	19.0	50.9	26.3	3.78	1527/1500	11,249	19,504	7938	318	.424	
210	6.0	HTO	WB	TRJ	CRY	83.1	21.0	91.1	32.0	4.22	3,120	16,533	18,801	1896	372	.121	
211			AB	TJ													THRUST REQD UNAVAILABLE
212				RKT		67.4	22.0	110.4	48.4	3.10	452/400	13,144	29,420	15,195	481	.533	THRUST REQD UNAVAILABLE
213				RKT		58.5	20.4	65.1	34.2	3.86	452	9391	20,797	10,795	1610	.598	
214				RKT													
220	6.0	STAGED	AB		CRY	15.5	10.3	12.0	2.8	3.15	2950	5806	6001	-	195	.0924	ELECTRICAL
221						14.2	10.5	12.4	2.8	3.22	2950	5937	6137	-	200	.0925	THRUST REQD UNAVAILABLE
231	12.0	AIR	AB	TJ	CRY		24.3	110.5	61.4	2.92	452/1500	10,841	31,615	20,412	363	.657	
232				RKT		82.9	24.8	113.2	66.3	2.94	452	9970	33,919	21,979	1971	706	
233				RKT		31.5	25.7	157.1	85.5	3.45	452	12,655	43,567	26,846	2064	.71	
234				RKT													
250	12.0	HTO	AB	RKT	CRY	119.7	29.1	201.5	124.1	2.88	452	14,061	58,984	42,182	2142	.760	
251			WB			14.7	34.4	225.8	139.0	2.12	452	17,164	67,422	47,582	2676	.745	
252			AB			124.5	29.7	208.0	126.2	2.95	452	14,379	60,046	42,644	2803	.76	
253				CSJ	STOR	102.2	27.0	159.9	97.9	2.88	316	22,770	142,835	113,398	6668	.841	ELLIPTICAL
254				CRY		123.4	29.6	219.0	136.2	2.95	452/1500	16,538	61,316	44,225	553	.73	POST-BURN
255			WB			203.5	37.5	312.4	168.2	2.28	452/1650	21,772	80,018	57,606	635	.728	
256				RKT	STOR	122.4	28.8	134.4	76.4	3.44	316	18,788	112,481	89,434	4459	.833	
257				CSJ	CRY	185.8	35.4	291.5	135.8	3.35	449/1650	24,308	36,378	9285	785	.277	
258			AB	RKT	CRY	168.0	34.5	338.0	199.9	2.88	451	19,314	88,423	64,773	4037	.780	(1) J25 ROCKET
259			WB		STOR	178.8	34.8	236.5	144.6	2.14	2316	23,220	171,502	139,883	6400	.854	(2) H-ID ROCKETS
270	12.0	YTO	AB	RKT	CRY	130.5	32.4	230.9	141.8	2.88	452	14,535	65,544	48,371	2839	.781	
271				CSJ		142.1	34.7	278.5	163.0	2.81	1627/1650	18,124	75,006	55,655	626	.75	
280	12.0	STAGED	AB		CRY	15.3	9.0	10.0	2.7	2.79	1650	5629	5820	-	191	.0327	
281				RKT		15.6	9.1	10.3	2.7	2.79	452	4935	5906	-	971	.164	
282				STOR		12.6	8.1	7.5	1.5	2.80	316	6060	7052	-	1192	.228	
284	12.0	AIR	AB	RKT	CRY	82.2	24.8	110.7	65.5	2.82	452	9834	33,466	21,691	1941	.708	UNMANNED
285		HTO				118.9	29.0	198.4	122.8	2.91	452	13,925	58,371	41,703	2149	.762	

(U) FIGURE 4-57  
AIRBREATHERS REQUIRE WING-BODY CONFIGURATIONS  
TO ACHIEVE TRANSONIC ACCELERATION

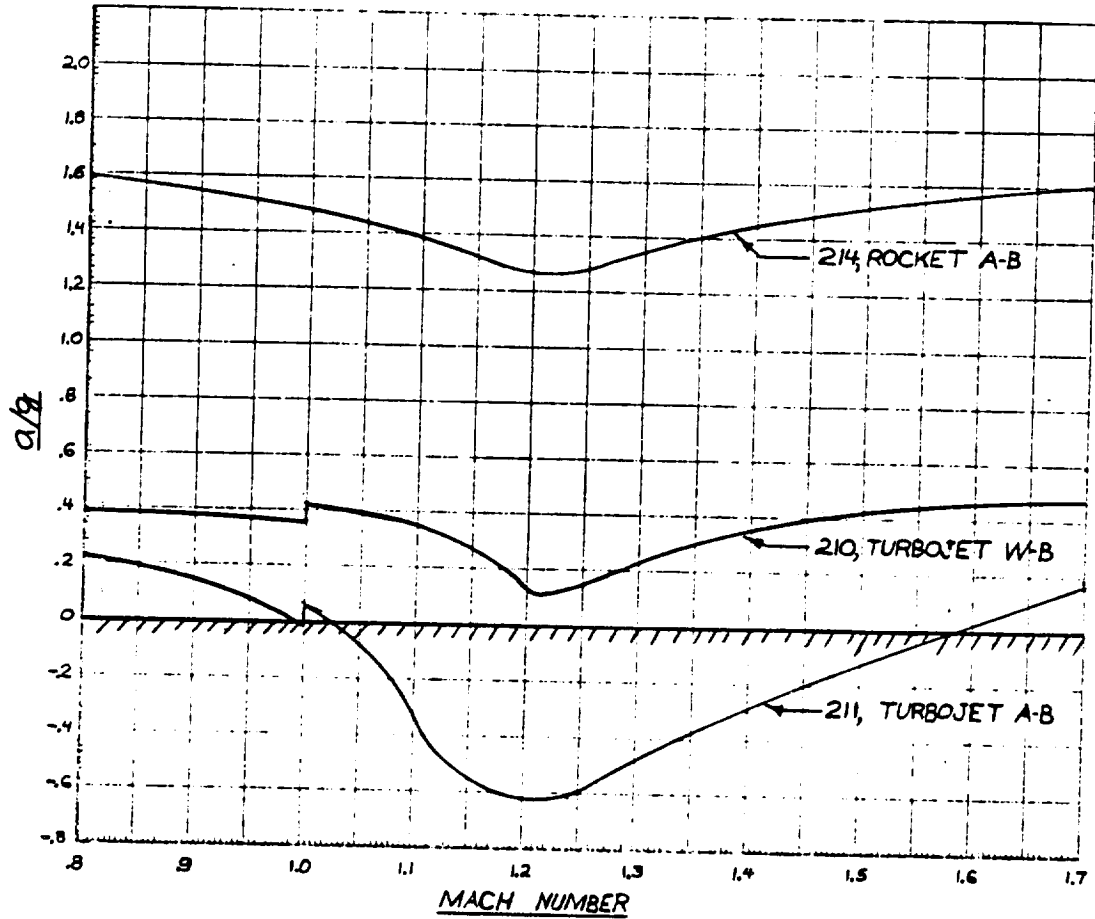

(U) FIGURE 4-58  
EFFECT OF DESIGN MACH NUMBER AND LAUNCH MODE ON VEHICLE WEIGHT  
USING ROCKET FOR ACCELERATION; AIRBREATHING FOR CRUISE

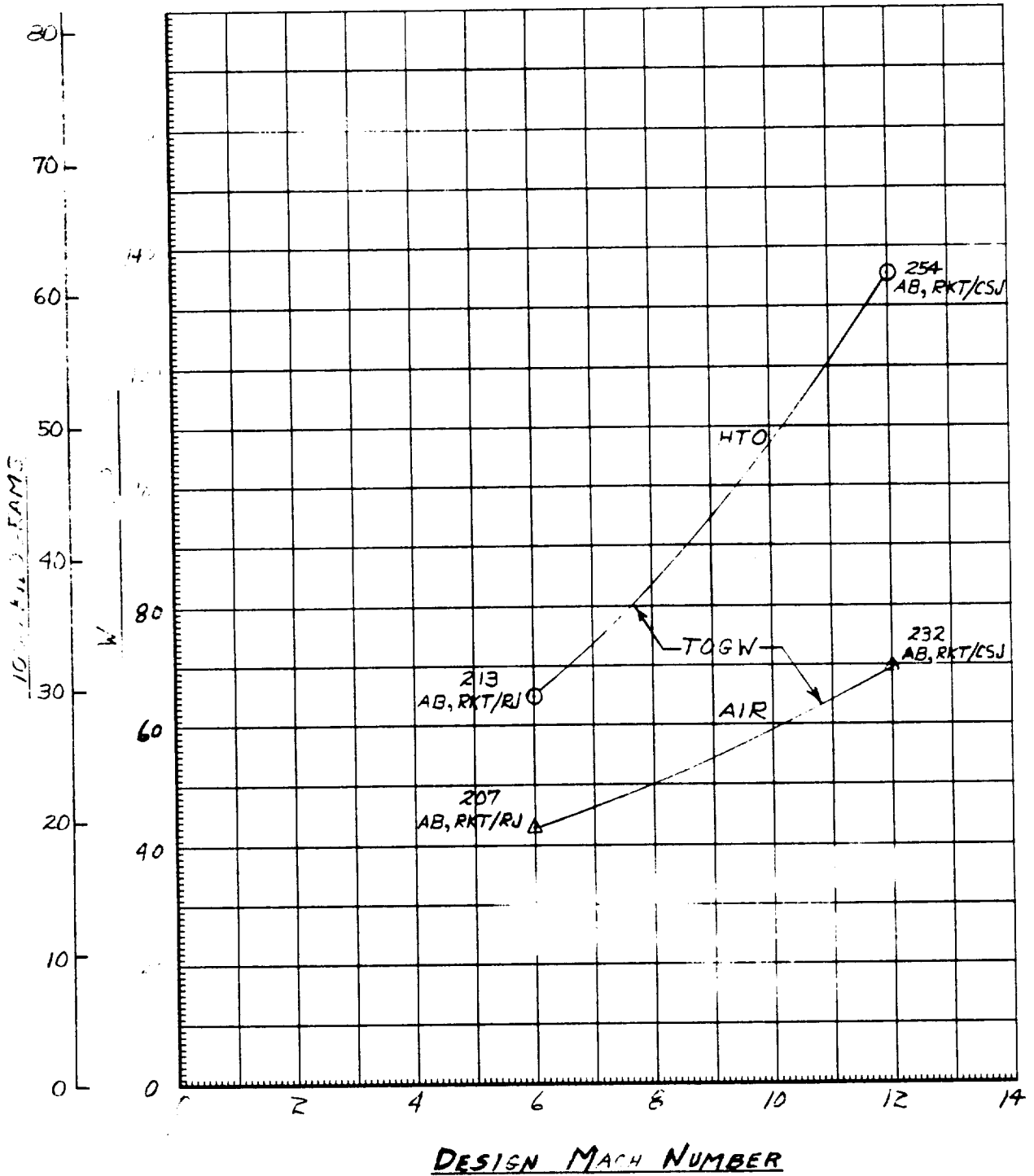

(U) FIGURE 4-59  
EFFECT OF DESIGN MACH NUMBER ON AIR VEHICLE WEIGHT  
USING AIRBREATHING PROPULSION

Launch Mode: HTO

Config. Type: WB

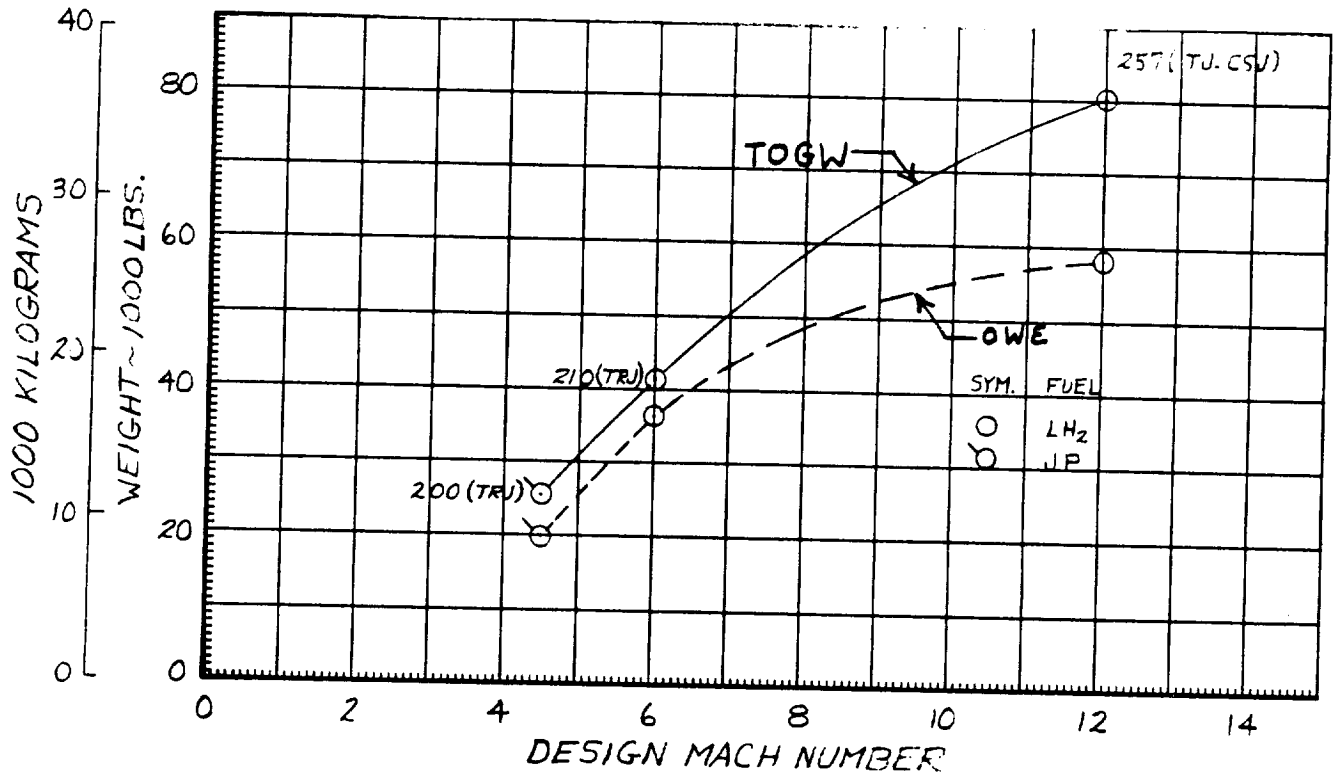

(U) FIGURE 4-60  
 EFFECT OF VARIOUS DESIGN VARIABLES ON AIR VEHICLE GROSS WEIGHT

$M_D = 12.0$

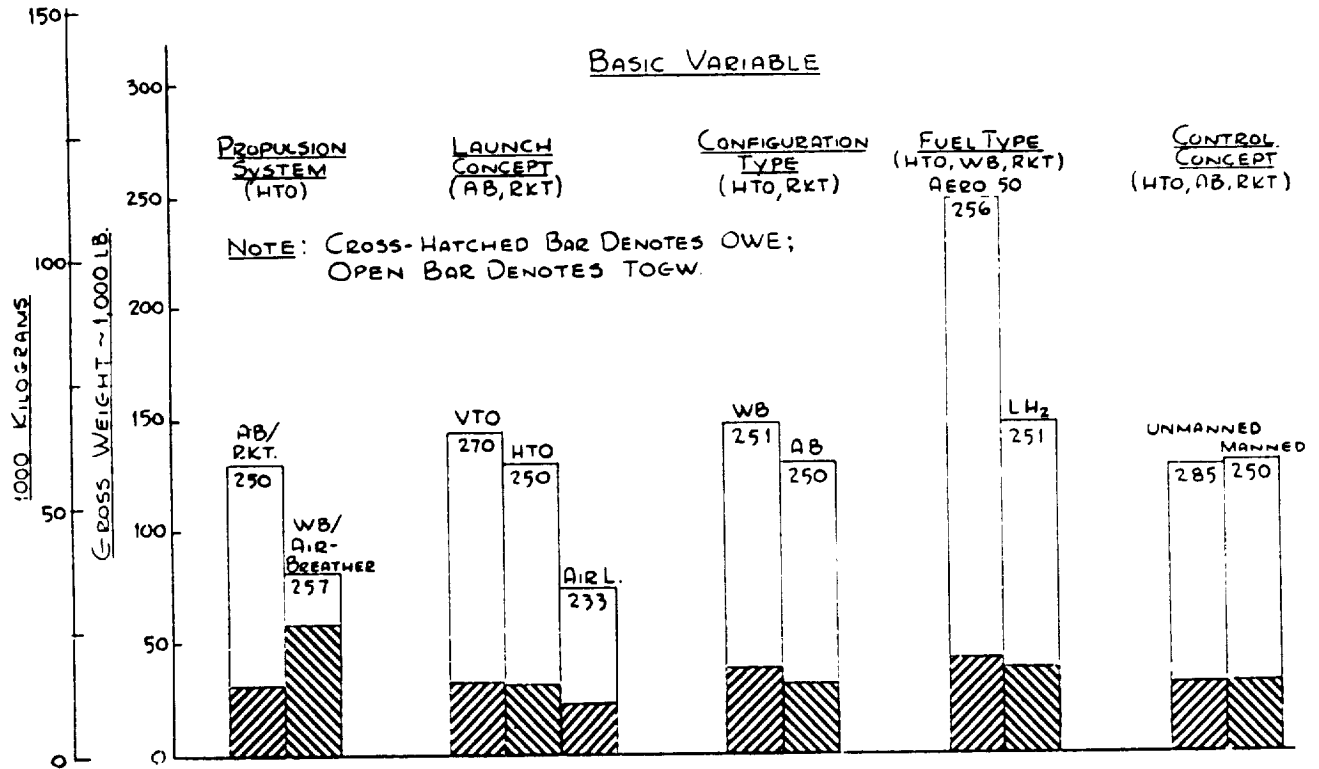

(U) Mission Profiles - Typical mission profiles for Mach 4.5, 6, and 12 test aircraft are presented in Figures 4-61 through 4-63. A comparison of the rocket and airbreather configuration mission profiles is included for the Mach 6 and 12 design aircraft. Trajectory parameters presented are altitude, Mach number, distance, angle of attack, flight path angle, and gross weight as a function of time.

(U) Tradeoffs - Although many tradeoff studies will follow in Phase II, a few preliminary studies were conducted in Phase I in order to provide better direction in certain areas.

(U) Figure 4-64 shows the effect on aircraft size of switching from a rubberized IR-129 rocket to an "off-the-shelf" J2S rocket. It is seen that the penalty for this substitution is rather severe at  $M = 12$ ; however, no size increase is incurred if the test Mach number is reduced from 12.0 to 10.75. The primary factors involved in the performance differential are a reduced specific impulse due to lower chamber pressure in the J2S; a 1690 lb (765 kilogram) engine weight increase; and an off-the-shelf fixed size engine rather than an engine sized for the specific mission.

(U) A trade study was conducted to determine the best utilization of a rocket/convertible scramjet (RKT/CSJ) engine combination during the acceleration-climb portion of flight. Configuration -232 was utilized for this investigation. The effect on vehicle OWE and TOGW was determined for the following engine schedules employed in boosting the vehicle to Mach 12 cruise conditions:

- o Single engine operation, rocket only.
- o Individual engine operation, RKT or CSJ, with mode switching at Mach 3.5, 8.0 and 12.0.
- o Dual engine operation, RKT and CSJ, with CSJ ignition at Mach 3, 8, and 12.

The results of the study are tabulated in Figure 4-65 and presented graphically in Figure 4-66. Initially, the airbreather climb profile of Figure 4-45 was employed for all cases except the baseline, rocket-only, operation. Since this flight path is not optimum for rocket operation, an additional case of dual engine operation was performed. Here, the rocket climb profile was employed for a rocket boost to Mach 8, followed by CSJ ignition and dual engine acceleration, at constant altitude, to the airbreather flight path, and hence on to Mach 12 cruise conditions. The results indicate that the lowest vehicle OWE is achieved with a rocket-only boost along the rocket climb profile shown in Figure 4-45. Dual engine operation with CSJ ignition occurring at Mach numbers greater than 8.0, followed by a constant altitude transition from the rocket flight path to that of the airbreather, results in nearly the same OWE and TOGW as the single engine rocket-only boost. The lowest TOGW values are obtained when individual engine operation is employed for boosts along the airbreather flight path and rocket engine usage is limited to Mach numbers less than 7.0. The more limited the rocket usage, the lower the TOGW.

(U) FIGURE 4-61

FLIGHT PROFILE MACH 4.5 AIRBREATHING ACCELERATOR, CONFIGURATION -200

(U)

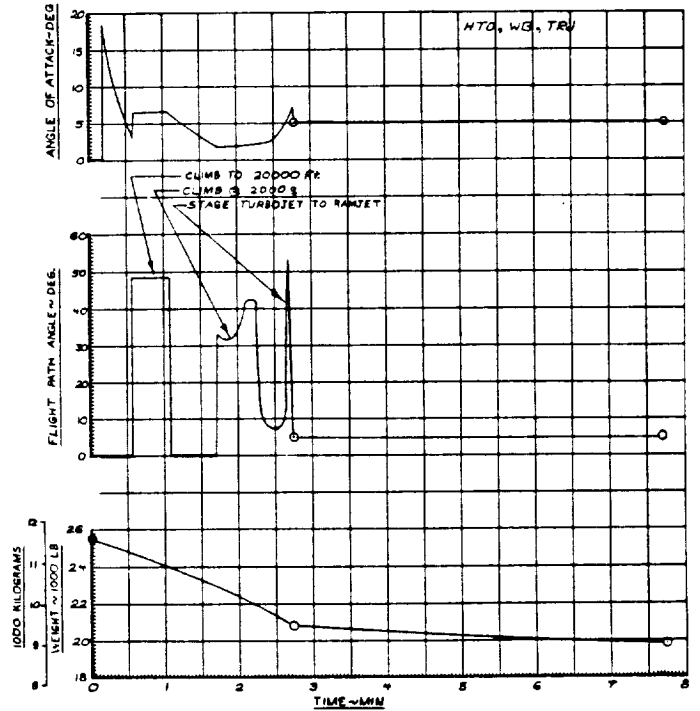
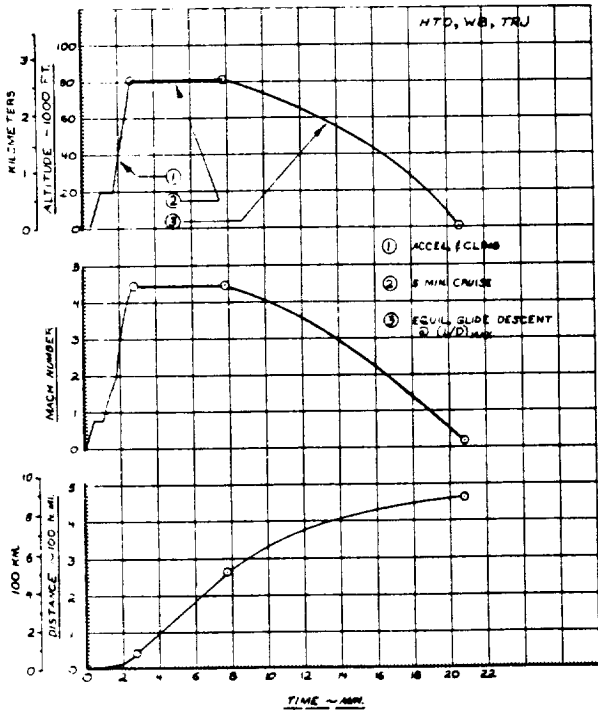

(U) FIGURE 4-62

FLIGHT PROFILE MACH 6.0, HTO ROCKET vs AIRBREATHING ACCELERATOR

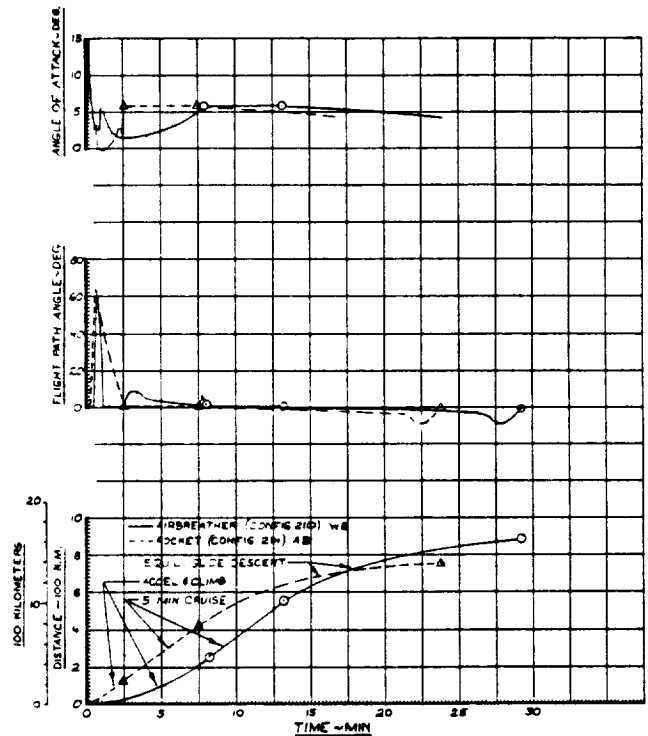
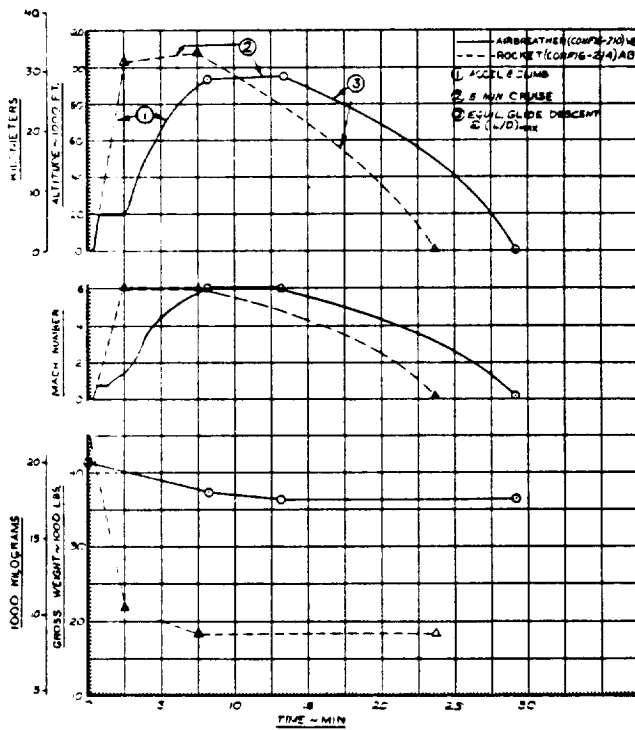



(U) FIGURE 4-63  
 FLIGHT PROFILE MACH 12.0, HTO ROCKET vs AIRBREATHING ACCELERATOR

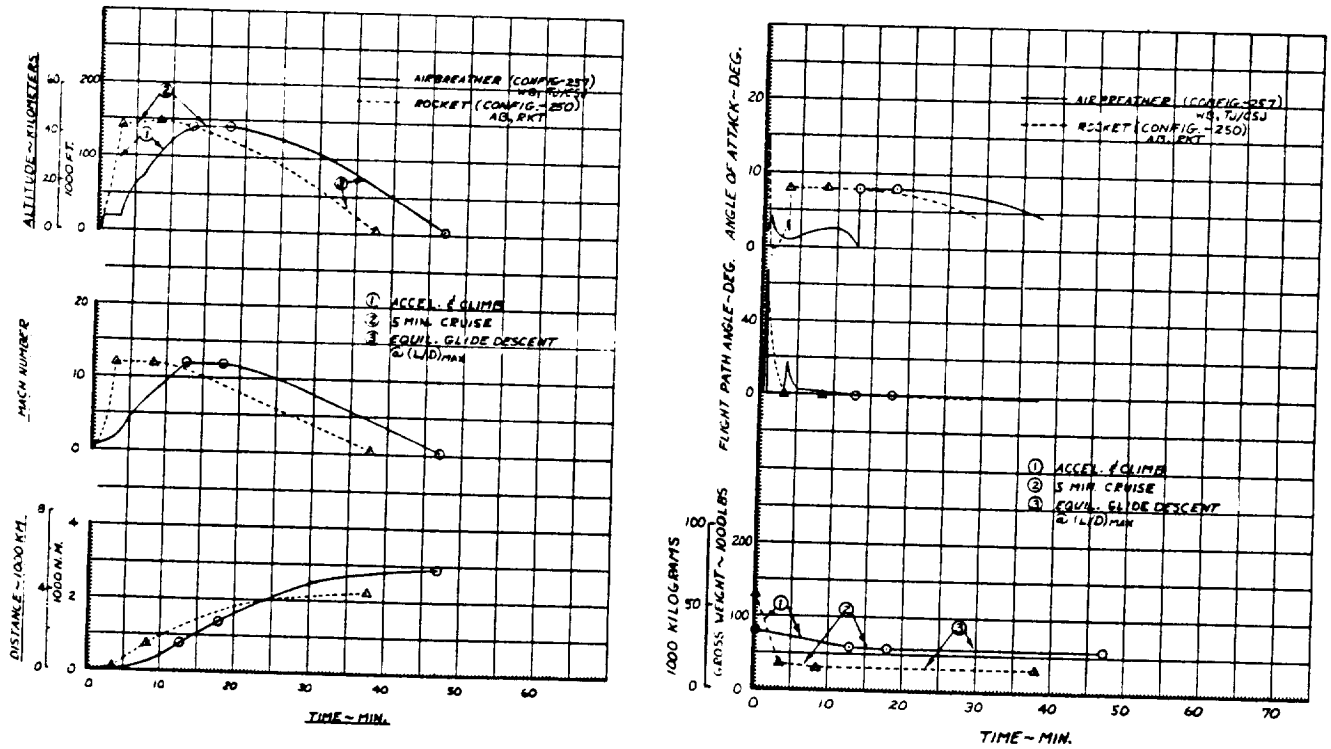

(U) FIGURE 4-64  
EFFECT OF DESIGN MACH NO. ON GROSS WEIGHT  
USING TWO ROCKET DESIGNS HORIZONTAL TAKEOFF

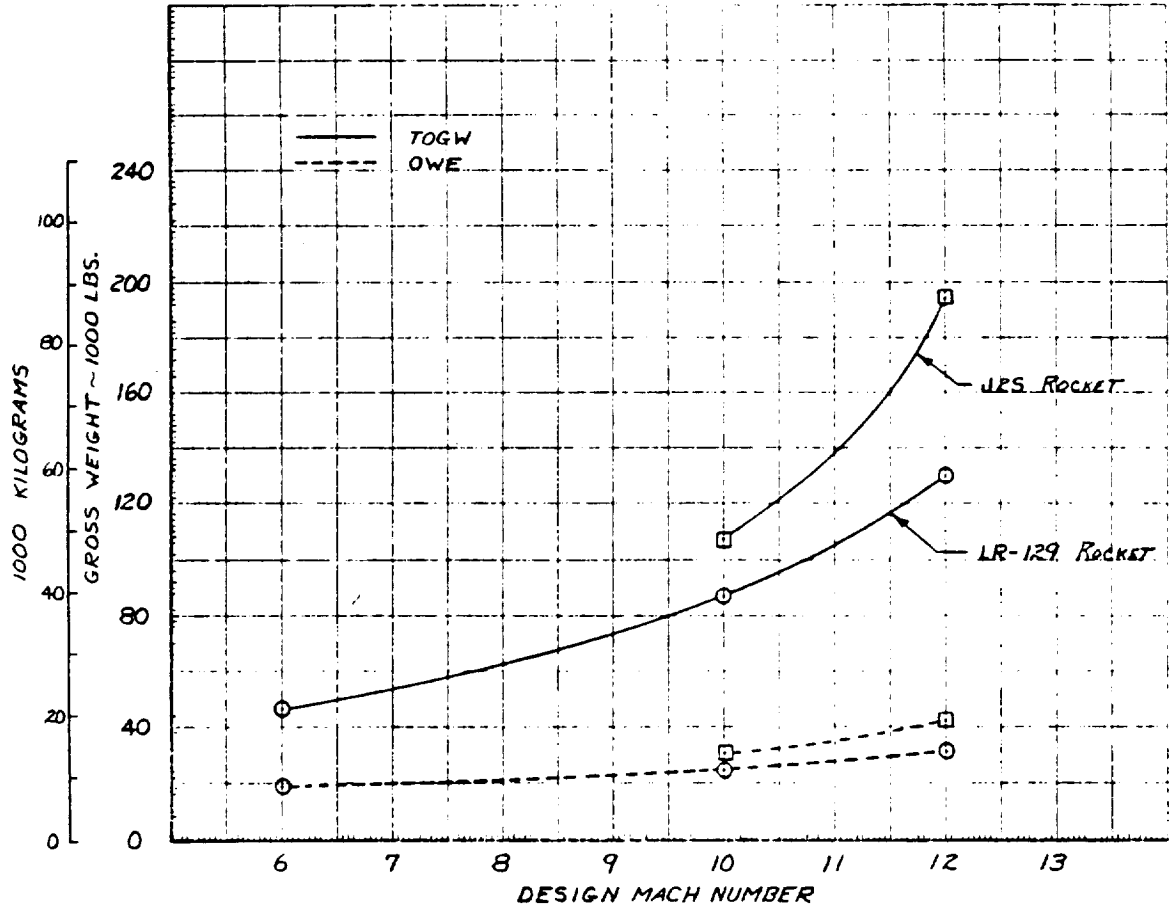

(C) FIGURE 4-65a  
ROCKET UTILIZATION TRADEOFF ON M = 12 AIR LAUNCHED MISSION  
(Configuration -232)

Rocket Utilization	CSJ Utilization	Accel. & Climb Flight Path	Sp Ft <sup>2</sup>	OWE Lb	TOGW Lb	W <sub>TO</sub> /S <sub>P</sub> Lb/Ft <sup>2</sup>	Climb Time Min	Climb Fuel-Lb.		Cruise Fuel Lb
								LOX	LH <sub>2</sub>	
M = 0.8-12	M = 12	Rocket	850	23,900	69,700	81.7	3.1	39,000	6,500	800
M = 0.8-12	M = 12	Airbreather	950	25,350	81,000	95.4	3.2	46,900	7,900	850
M = 0.8-3.5	M = 3.5-12	Airbreather	1,240	31,200	63,000	50.8	18.2	14,650	14,750	1,040
M = 0.8-8.0	M = 8.0-12	Airbreather	990	26,400	70,700	71.5	7.8	34,100	10,200	882
M = 0.8-12	M = 3.0-12	Airbreather	970	26,000	72,500	74.7	2.8	37,000	8,710	870
M = 0.8-12	M = 8.0-12	Airbreather	910	24,900	74,500	82.0	3.1	41,600	7,200	830
M = 0.8-12	M = 8.0-12	Rocket, M=0.8 - 8 Airbreather, M = 8-12	860	24,000	69,140	80.5	3.1	37,800	6,540	800

(C) FIGURE 4-65b  
ROCKET UTILIZATION TRADEOFF ON M = 12 AIR LAUNCHED MISSION  
(Configuration -232)

Rocket Utilization	CSJ Utilization	Accel. & Climb Flight Path	Sp M <sup>2</sup>	OWE kg.	TOGW kg.	W <sub>TO</sub> /S <sub>P</sub> kg/M <sup>2</sup>	Climb Time Min	CLIMB FUEL-kg		Cruise Fuel kg.
								LOX	LH <sub>2</sub>	
M = 0.8-12	M = 12	Rocket	79.0	10841	31615	400.0	3.1	17690	2948	363
M = 0.8-12	M = 12	Airbreather	88.3	11499	36741	465.8	3.2	21273	3583	386
M = 0.8-3.5	M = 3.5-12	Airbreather	115.2	14152	28576	248.0	18.2	6645	6690	472
M = 0.8-8.0	M = 8.0-12	Airbreather	92.0	11975	32069	349.1	7.8	15467	4627	400
M = 0.8-12	M = 3.0-12	Airbreather	90.1	11793	32885	364.7	2.8	16783	3951	395
M = 0.8-12	M = 8.0-12	Airbreather	84.5	11294	33792	400.4	3.1	18869	3266	376
M = 0.8-12	M = 8.0-12	Rocket, M=0.8-8 Airbreather; M = 8-12	79.0	10886	31361	393.0	3.1	17146	2966	363

3 ⊕

This Page Unclassified

(U) FIGURE 4-66  
ROCKET AUGMENTATION REDUCES OWE FOR CONVERTIBLE SCRAMJET VEHICLE

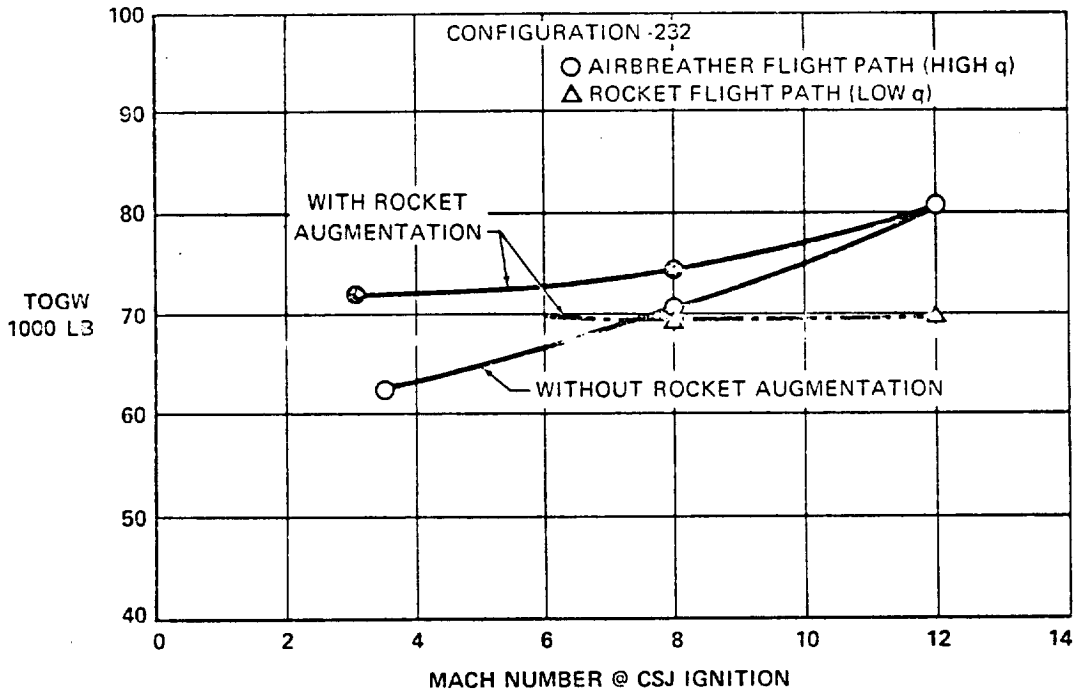
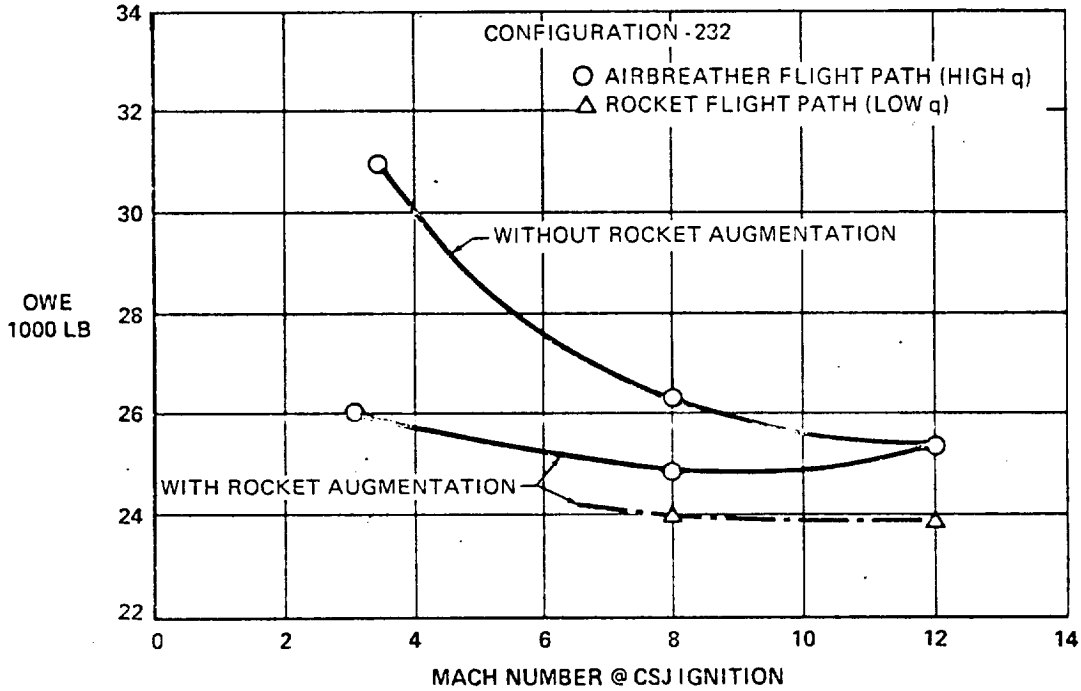

(U) The effect on test Mach number of limiting flights to single base operation was investigated using Configuration -254; a Mach 12 design with a rocket engine for acceleration and a convertible scramjet for cruise. For the study, the same total fuel volume required for two base operation was assumed for single base operation. Test Mach number was then lessened until the fuel required to perform single base missions was equal to the total fuel available. The trajectory data of Figure 4-67 show that a Mach 12 design with a convertible scramjet can be flight tested to a Mach number of 8.8 using a single-base operation if the test run is made on the outbound leg of the mission. A description of the single base maneuver is given on the trajectory plot. Pertinent weight data comparing single base operation to two base operation is tabulated below:

	OWE	TOGW	ROCKET CLIMB. FUEL TO TEST MACH	CSJ FUEL
Single base operation (Test Mach = 8.8)	36,460 lb (16,538 kg)	112,080 lb (51,030 kg)	69,060 lb (31,325 kg)	6,560 lb (2,967 kg)
Two base operation (Test Mach = 12)	36,460 lb (16,538 kg)	135,180 lb (61,316 kg)	97,500 lb (44,225 kg)	1,220 lb (553 kg)

It is interesting to note the TOGW for single base operation is 23,100 lb (10,286 kg) lighter than the two base operation TOGW. The lighter TOGW results because a portion of the propellant volume normally used for liquid oxygen (LOX) in the two base operation (required for rocket climb from Mach 8.8 to 12) is used to carry liquid hydrogen (LH<sub>2</sub>) for the CSJ return to base maneuver.

(U) Takeoff and Landing - Figure 4-68 shows preliminary takeoff or landing speed data on the HYFAC vehicles. The speeds are based on a takeoff or landing angle of attack of 15° with a corresponding C<sub>L</sub> of .40. The curve does not include any thrust effects. Further analysis of the takeoff characteristics of these vehicles will be performed.

(U) Figure 4-69 shows a comparison between the estimated landing approach (L/D)<sub>max</sub> of the all-body HYFAC vehicles and that of several research aircraft. This chart indicates that landing (L/D)<sub>max</sub> of the HYFAC vehicles should be at least as good as that of the current lifting body research vehicles.

(U) FIGURE 4-67  
**MISSION PROFILE - SINGLE BASE OPERATION**  
 Config. -254;  $M_D = 12$ ; Test Mach = 8.8

HTO All Body RKT/CSJ

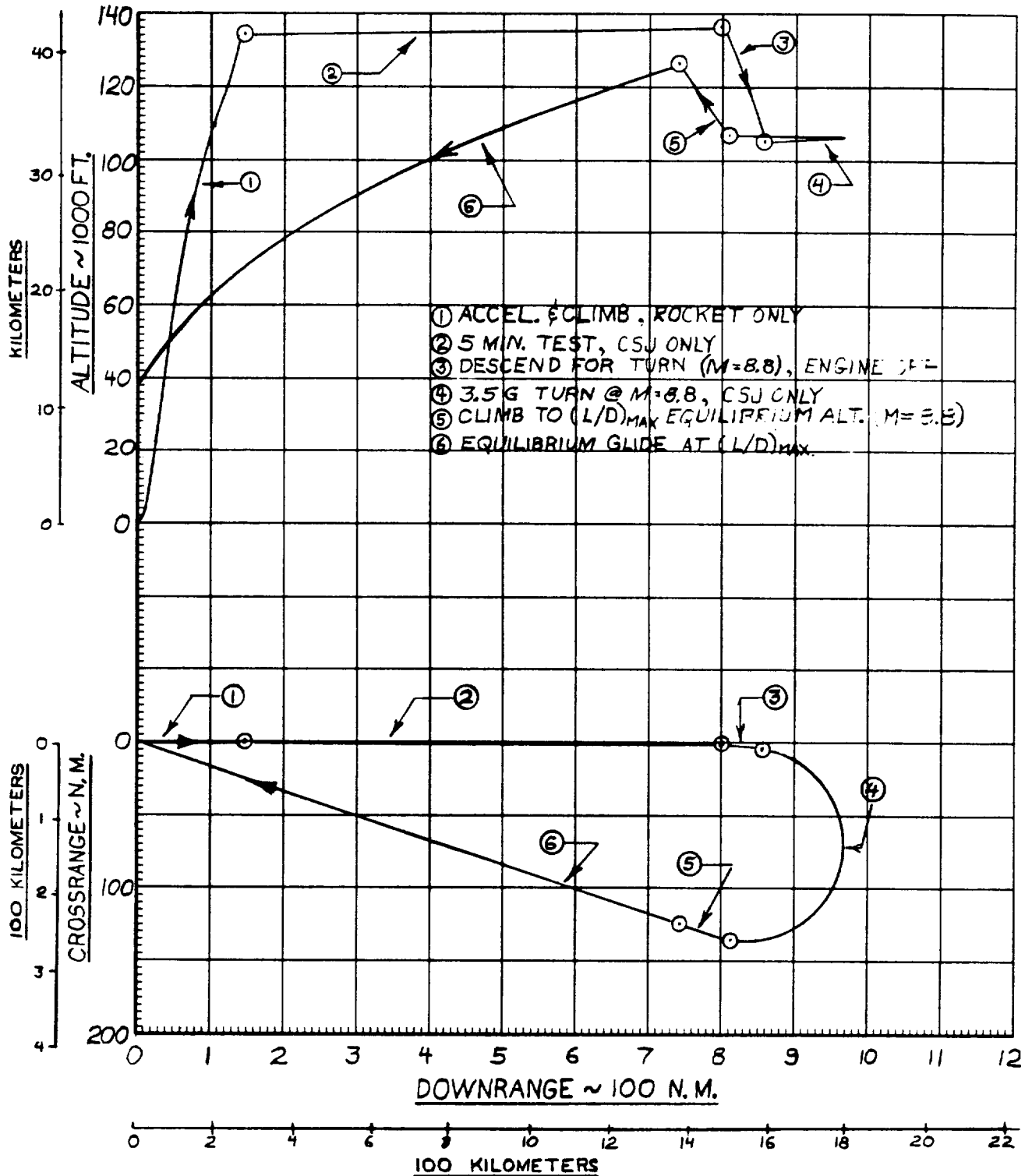

(U) FIGURE 4-68  
 TAKEOFF AND LANDING SPEED

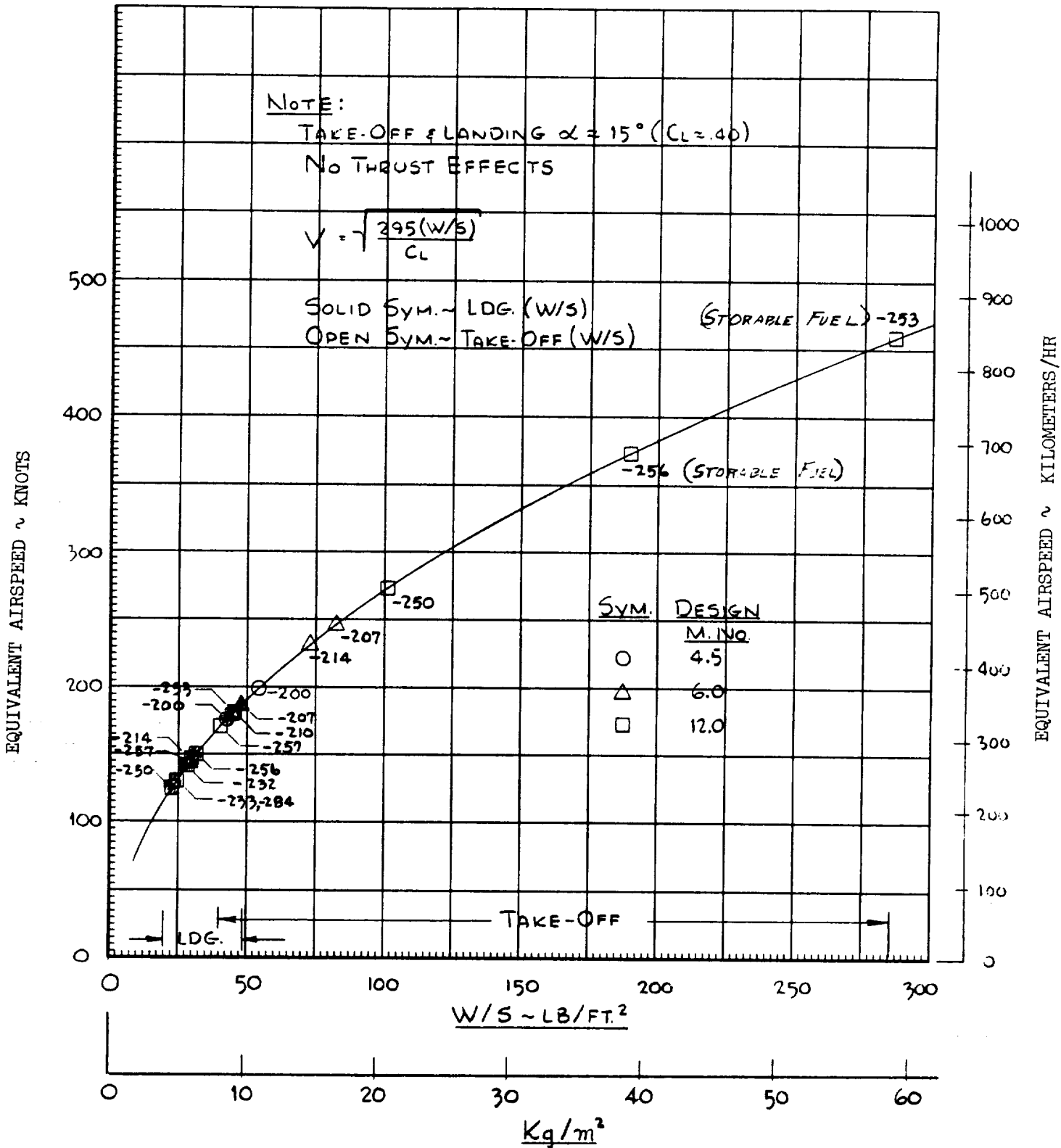

(U) FIGURE 4-69  
(L/D)<sub>MAX</sub> COMPARISON CLEAN CONFIGURATION (GEAR UP)

All-Body  
Subsonic

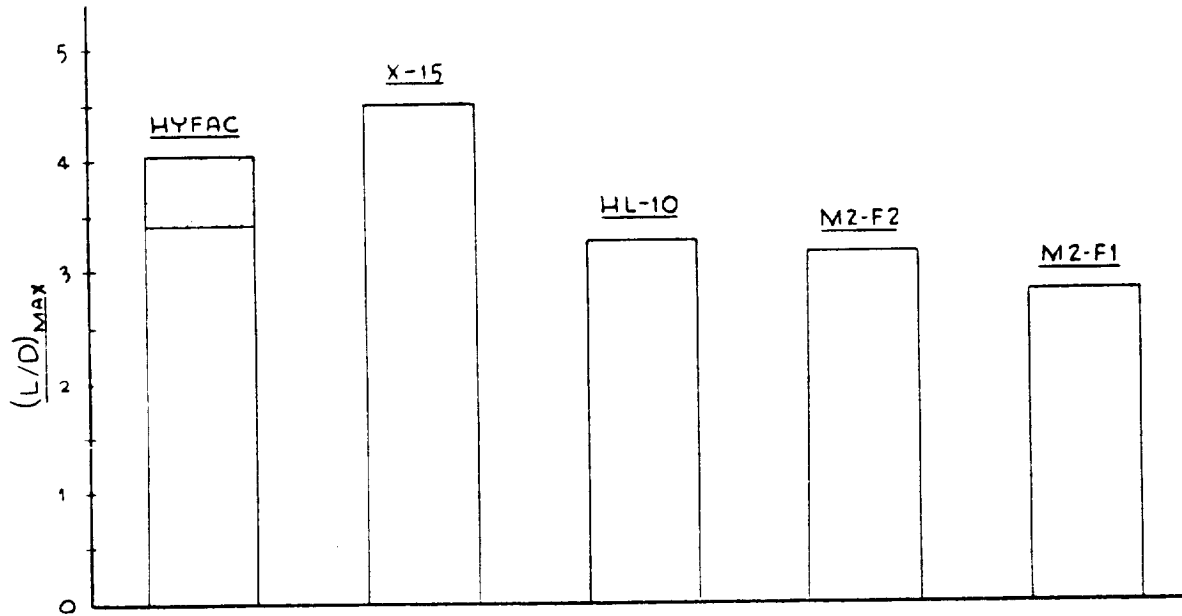



#### 4.10 FLIGHT OPERATIONS AND TEST REQUIREMENTS

(U) Examination of the research objectives defined in Section 3 indicates that a flight research aircraft can provide a significant contribution to the development of future hypersonic aircraft. Such a vehicle must itself be subjected to some pre-flight development flight testing prior to delivery for research testing. The research program will require both broad program and detail flight planning. This will consist of pre-flight development mission and data acquisition planning. The following paragraphs describe some of the requirements that will be imposed on the flight research aircraft.

4.10.1 (U) Flight Development Requirements - Before the design mission flight profile can be flown, it will be necessary to undergo a period of flight development with the test vehicles. These development requirements are dictated by:

- o The use of new or novel designs and devices
- o New flight regimes
- o Inability to completely predict scale effects
- o Integration of components
- o Full scale integrated performance evaluation
- o Unexpected problem areas
- o The necessity to develop operating procedures.

Development testing will involve both the vehicle contractor and the Government. The magnitude of their respective development efforts would vary depending on which flight facility concept is employed. This selection would have a strong influence in defining that amount of testing needed to provide confidence in the system performance prior to initiating the research flights in consideration of system reliability and costs involved. Manned vehicles would probably be subjected to more development flights than the unmanned vehicles with the staged unmanned craft being subjected to the least number of development test flights.

4.10.1.1 (U) Contractor Development Requirements - A contractor flight development program is anticipated when a manned flight facility is employed. The development efforts would be directed toward verifying air worthiness; developing the vehicle and establishing reliability of its systems to achieve the design mission; and defining operating procedures and piloting techniques. The flight envelope would be expanded only to that degree necessary to meet these objectives. Specific test categories are:

- o Airframe - structural integrity  
- aerodynamic performance
- o Propulsion - engine installation, systems, and operation  
- fuel system  
- inlet performance (for airbreathers)

- o Secondary Power Systems - electrical
  - hydraulic
  - pneumatic
- o Flight Control Systems - manual
  - automatic
- o Aircrew Stations - instruments
  - environmental system
  - crew equipment
  - emergency egress
- o Mission and Traffic Control - communications
  - navigation
  - flight director
  - antennas

4.10.1.2 (U) Government Development Requirements - The government development effort would primarily be concerned with expanding the flight envelope to the design mission limits by incremental increases in performance. Associated with the envelope expansion would be the development of:

- o Additional piloting techniques and pilot training
- o Additional reliability of the vehicle and vehicle systems.

4.10.2 (U) Data Acquisition Requirements - One of the primary objectives of a flight research facility will be the acquisition of quantitative data. These data will provide:

- o Information on the operational environments and problems associated with sustained hypersonic flight.
- o Information relative to the design of operational hypersonic systems.
- o Information to detect and solve problem areas during the development test phase.
- o Information necessary to perform the flight missions.
- o Information essential to the safety of the vehicle and crew.

(U) Research and development flight programs employing a limited number of test vehicles usually involve a relatively low number of total test flights (in comparison with development of operational aircraft). It will therefore be necessary to provide an instrumentation system with the following design considerations:

- o Sufficient quantity of measurements to provide a high data return per flight.

- o High degree of reliability to insure minimum loss of data through malfunctions or design deficiencies.
- o Qualification of components considering the extreme environments to which they may be exposed.
- o Packaging density compatible with the weight and space limitations of the vehicle.
- o Compatibility with automatic data reduction methods to permit rapid assessment of test results.
- o Capability of providing real-time data to the ground during flight.
- o Redundancy for critical parameters.
- o Maintenance and rapid turnaround time.

4.10.3 (U) Mission Planning - Phase I mission planning involved definition of the mission profiles for the research flights and identification of suitable test ranges. This planning allowed early evaluation of the gross applicability of the flight vehicles to contribute to the accomplishment of the research objectives.

(U) All candidate flight research vehicles were designed for 5 minutes of cruise time at design Mach numbers of 4.5, 6.0, or 12.0. Maximum and minimum range profiles were defined for each type of flight vehicle utilizing the Phase I ground rules presented in Section 4.2. Initially, both single-base and dual-base operations were investigated. Single-base operations appeared to require an appreciable increase in vehicle size, weight, and cost for all Mach 12 vehicles and the Mach 6 rocket powered vehicles; therefore, for the initial evaluations dual-base operation was assumed. During Phase II, vehicle sensitivities will be more accurately evaluated at which time single-base operations may prove feasible for the design mission of some systems as well as intermediate missions for all systems during the development phase. A preliminary survey of possible test ranges has been completed. Suitability of these test ranges was based on presently available flight vehicle performance and generalized criteria such as airbase facilities, test range features, and availability of test support equipment.

4.10.3.1 (U) Mission Profiles - The mission profiles were composed of three basic segments which defined the total mission profile for each flight research vehicle.

- o Acceleration and climb to cruise altitude and Mach number
- o Cruise distance based on 5 minutes at cruise Mach number
- o Descent to touchdown

(U) The maximum range profiles were determined by considering a straight line descent based on a maximum L/D flight path. The minimum range profiles were obtained by considering 3.5 g power-off wind-up turn to landing. The minimum range profile is illustrated in Figure 4-70 in which minimum range is defined as the third side

of the triangle formed by a straight line consisting of the acceleration and climb plus cruise distance and a line from the end of cruise to the point at which the aircraft would contact the ground at the end of the 3.5 g wind-up turn.

(U) FIGURE 4-70  
EXAMPLE MINIMUM RANGE PROFILE

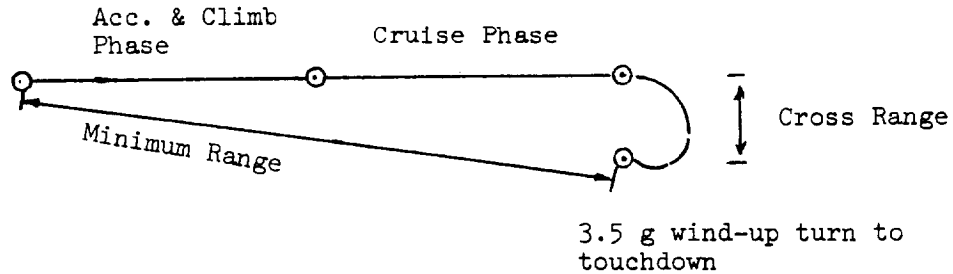

(U) Several generalized mission ground rules were assumed. First, the distance required for acceleration and climb is equal for HTO and VTO type takeoffs, provided the test vehicles have the same Mach number and engine type. Second, the air-dropped vehicles are launched at "zero" ground track distance from the takeoff base. Third, the missions for Mach 0.9, Mach 2.0, and Mach 4.5, and variable stability flight vehicles are single-base operations from Edwards AFB since these missions are similar to present day test operations and require no unique analyses. A summary of the mission performance and research aircraft capability for maximum and minimum range profiles of the Phase I candidate flight vehicles is presented in Figure 4-71.

4.10.3.2 (U) Candidate Test Ranges - Investigation of possible test ranges was conducted as part of mission planning to assure that flight mission performance was compatible with continental U.S. (CONUS) test facilities. Several test ranges were investigated for the Mach 6.0 and 12.0 flight vehicles considered in this study. The Mach 0.9, Mach 2.0, Mach 4.5, and Variable Stability vehicles are assumed to operate from Edwards Air Force Base.

(U) Edwards Air Force Base was considered as the center of operations and the landing site. This approach was adopted primarily because of flight safety considerations. Also, Edwards is currently equipped with many of the support facilities required to handle this type of program. Using Edwards as the landing site is feasible for all the candidates except the staged Mach 6 vehicles.

(U) The test range selections were based on the following criteria.

- o Existing facilities
  - (1) Runway length and load capacity
  - (2) Adaptability for vertical launch systems
  - (3) Fuel storage facilities
  - (4) Personnel facilities and equipment
  - (5) Security requirements

(U) FIGURE 4-71  
 MISSION PERFORMANCE AND RESEARCH AIRCRAFT CAPABILITY

Test Mach	Type of Launch	Accel & Climb Type Pwr.	Climb nm/km	Cruise Dist. nm/km	Max. L/D Descent Dist. nm/km	Max. Range nm/km	Min. Range* nm/km	Cross Range* nm/km
4.5	HTO	TRJ	40/74	225/417	200/370	465/860	265/490	30/56
6.0	AIR	TRJ	260/480	295/546	325/602	880/1645	555/1028	46/85
6.0	AIR	RKT	130/240	295/546	325/602	750/1390	425/785	46/85
6.0	HTO	TRJ	260/480	295/546	325/602	880/1645	555/1028	46/85
6.0	HTO	RKT	130/240	295/546	325/602	750/1390	425/785	46/85
6.0	Staged	RKT	130/240	295/546	325/602	750/1390	425/785	46/85
12.0	AIR	RKT	130/240	595/1102	1450/2680	2175/4020	725/1340	340/630
12.0	HTO/VTO	RKT	130/240	595/1102	1450/2680	2175/4020	725/1340	340/630
12.0	HTO/VTO	TJ/CSJ	800/1480	595/1102	1450/2680	2845/5260	1395/2580	340/630
12.0	VTO	RKT	130/240	595/1102	1450/2680	2175/4020	725/1340	340/630
12.0	Staged	RKT	130/240	595/1102	1450/2680	2175/4020	725/1340	340/630

HTO = Horizontal Takeoff  
 AIR = Air Dropped  
 VTO = Vertical Takeoff  
 TRJ = Turboramjet  
 RKT = Rocket  
 TJ = Turbojet  
 CSJ = Convertible Scramjet

\* 3.5 g wind-up turn

o Test range features

- (1) Availability of suitable emergency landing sites downrange
- (2) Availability of tracking station
- (3) Population density and land/water interfaces
- (4) Expected weather conditions
- (5) Restricted areas and designated airways
- (6) Altitude above sea level of air bases
- (7) Landing foot-print for rocket launch vehicles

o Support equipment

- (1) Necessary facilities and equipment for mother aircraft for air-dropped vehicles
- (2) Necessary equipment to support launch operations of vertical boosted systems

(U) Candidate test ranges resulting from the Phase I survey are summarized in Figure 4-72 and the test range recommended for each class of flight research vehicles are identified. Further definition of these ranges is contained in the U.S. maps of Figures 4-73 through 4-76. Test sites selected as candidates for flight operations (identified on the maps) are those military bases with at least a 10,000 foot (3048 meters) runway capable of supporting 300,000 pound (136,077 kg) aircraft equipped with twin-tandem landing gear.

(U) FIGURE 4-72  
 TEST RANGE SUMMARY

TEST RANGES	MISSION CLASS	MACH 4.5 HTO TRJ	MACH 6		MACH 12		MACH 0.9 & 2.0
			Airlaunched and HTO		Airlaunched and HTO		
			TRJ	Rocket	Rocket	Scramjet	
Homestead to Edwards (primary)					X		
Subranges of the primary range							
(1) Dyess to Edwards			X				
(2) Cannon to Edwards				X			
(3) Cape Kennedy to Edwards							X
(4) Cape Kennedy to Barksdale				X			
Loring to Edwards						X	
Edwards Operations		X					X

(U) FIGURE 4-73  
CANDIDATE TEST RANGES FOR ROCKET ACCELERATED MISSIONS

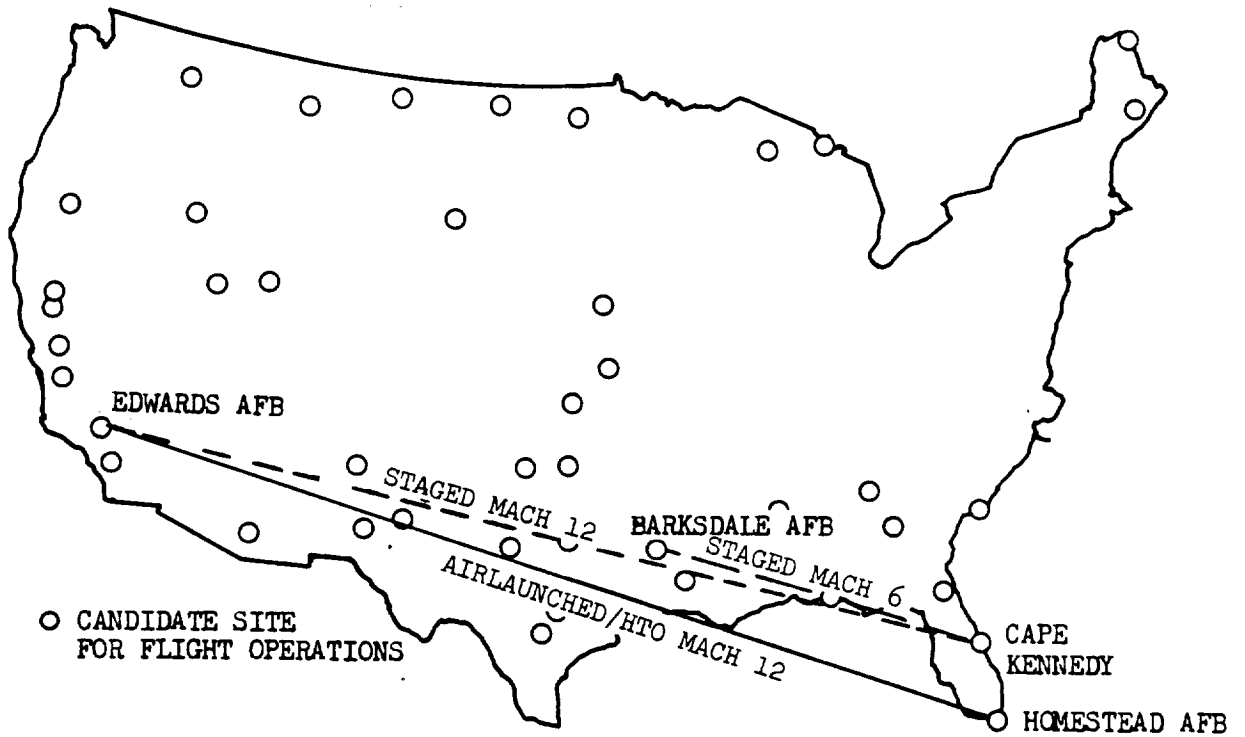

(U) FIGURE 4-74  
CANDIDATE TEST RANGE FOR TRJ ACCELERATED MACH 6 MISSIONS

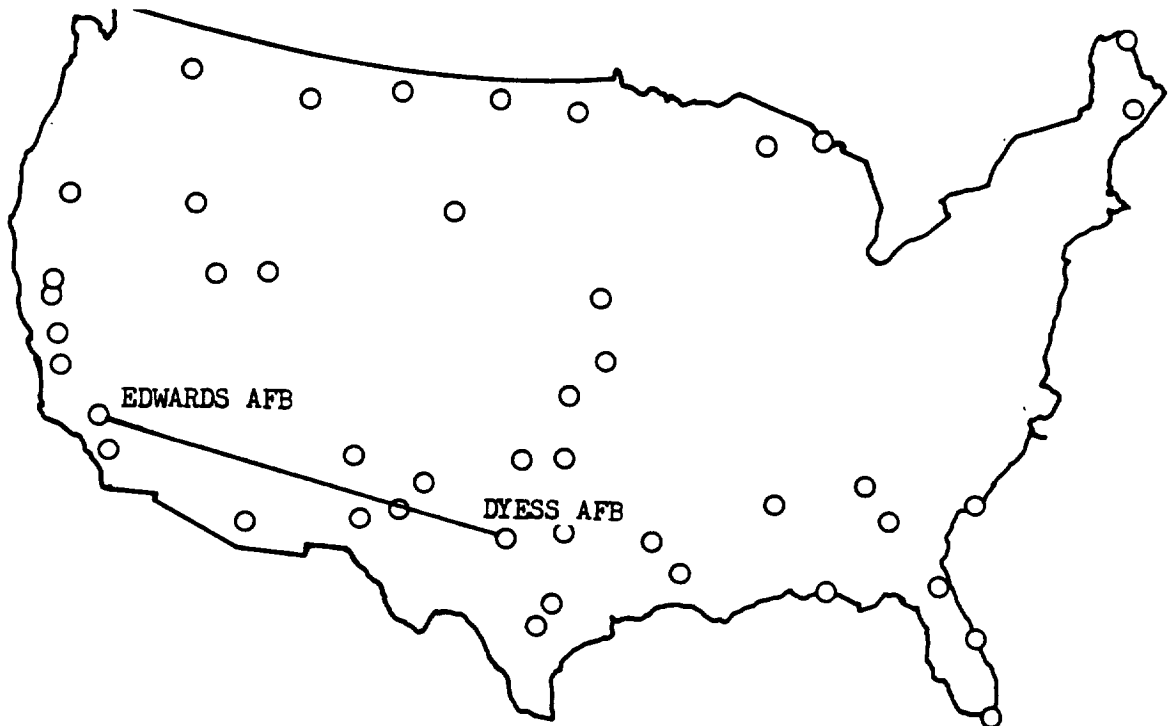

(U) FIGURE 4-75  
CANDIDATE TEST RANGE FOR AIRLAUNCHED AND HTO ROCKET  
ACCELERATED MACH 6 MISSIONS

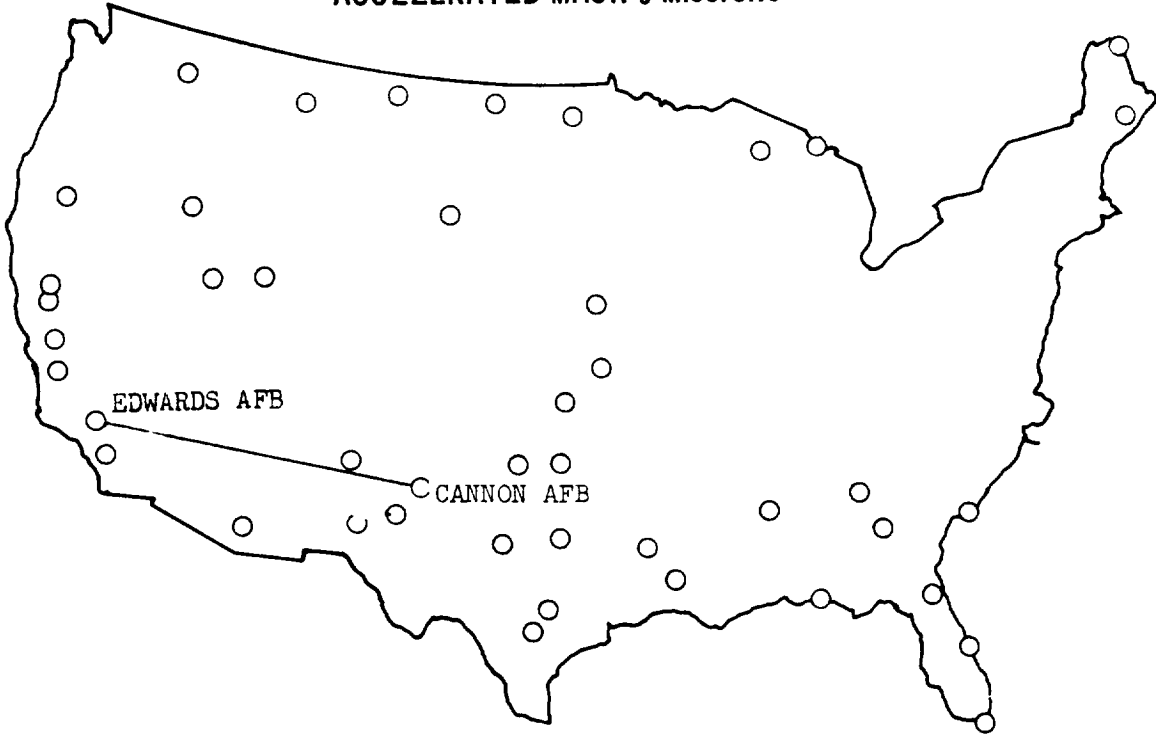

(U) FIGURE 4-76  
CANDIDATE TEST RANGE FOR SCRAMJET ACCELERATED MACH 12 MISSION

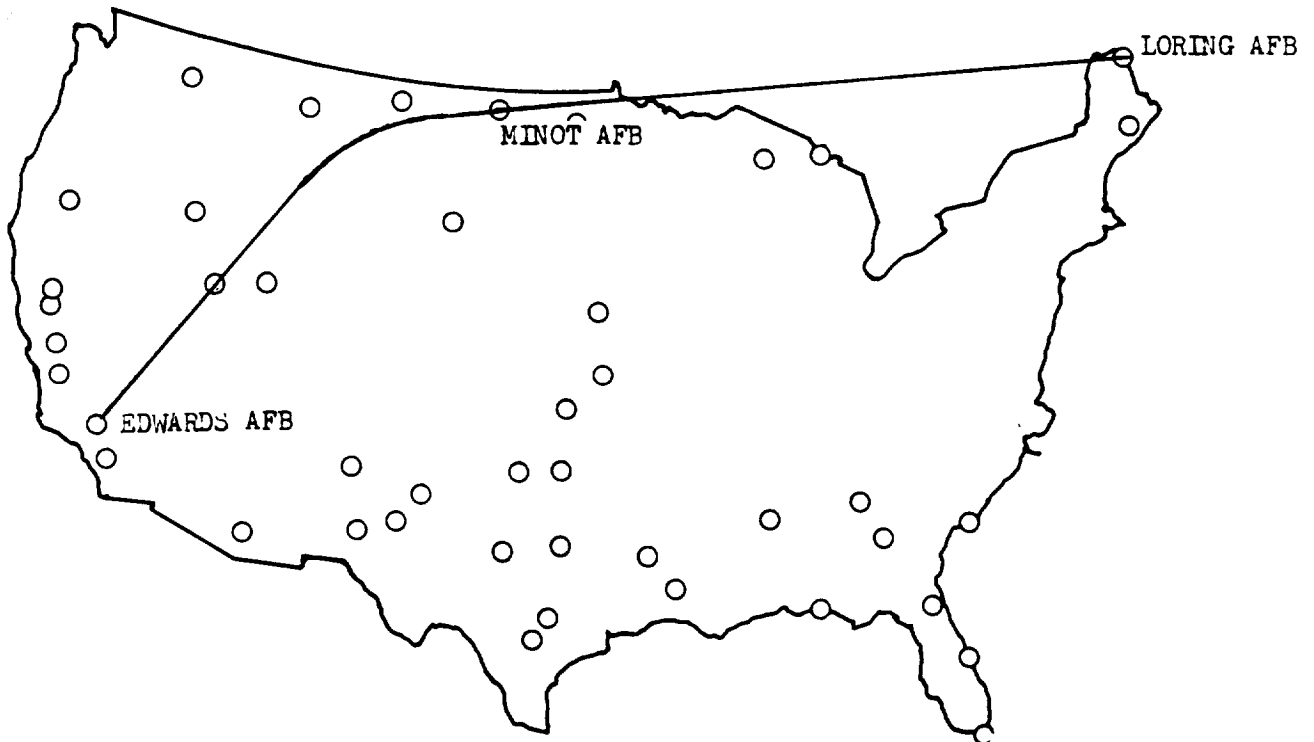



(U) A primary test range was established from Homestead Air Force Base to Edwards Air Force Base, shown in Figure 4-73, which is capable of supporting missions of at least 2050 nm (3797 km) in length. Therefore, air-launched and HTO rocket accelerated Mach 12 missions can be flown over this range. Definition of this primary test range allows other shorter missions to be flown utilizing bases along the range. Dyess Air Force Base is 25 nm (46 km) north of the range at a distance of 915 nm (1695 km) from Edwards Air Force Base. This distance is suitable for air-launched and HTO turbojet accelerator Mach 6 missions, as shown in Figure 4-74. Cannon Air Force Base lies 80 nmi (150 km) north of the primary range at a distance of 720 nm (1330 km) from Edwards Air Force Base. Therefore, it is possible to fly both air-launch and HTO, rocket accelerator Mach 6 missions over this sub-range, as illustrated in Figure 4-75.

(U) Major reasons for selecting this primary range are as follows:

- o Flights are over less densely populated land areas or the Gulf of Mexico, although not far offshore.
- o Many possible landing sites.
- o Suitable for different mission lengths.
- o Good access to facilities because of many suitable military installations along the range.
- o Good weather most of the year.

(U) Staged and VTO missions can be launched westerly from Cape Kennedy. The staged Mach 12 mission covers 2100 nm (3889 km) and the flight vehicle can be recovered at Edwards Air Force Base. The staged Mach 6 mission is 670 nm (1241 km) in length and Barksdale Air Force Base in Louisiana is suitable for recovery. This allows the booster to land in the Gulf of Mexico and still ground-recover the flight test vehicle. In addition, the tracking facilities of the primary range can be utilized. The other principal test facility presently used for large vertical boosters is Vandenberg Air Force Base. However, launch from Vandenberg necessitates water recovery of the vehicles because they must be launched westerly over the Pacific and the vehicles do not have the capability to return to the launch point. A promising alternate range for this mission is the former Matador/Mace corridor from White Sands to Wendover Air Force Base.

(U) The HTO Mach 12 airbreather accelerated mission is a special case because of its extreme length of 2845 nm (5260 km). It is possible to fly a variation of this mission from Loring AFB to Edwards AFB, provided a turn is made over Minot AFB in North Dakota. This test range, illustrated in Figure 4-76, would require flight over Canada. Weather could also be a major problem for winter operations.

(U) Only straight line flights are considered over the primary test ranges except for the Mach 12 airbreather accelerated vehicle. Straight line flights are preferred because turns do not generally result in any additional desirable test ranges. Major problems generated by making a turn are illustrated in Figures 4-77 through 4-80. A requirement for CONUS landing for the air-launched and HTO Mach 12 rocket accelerated missions results in a 200 to 400 nm (370 to 740 km) penetration

(U) FIGURE 4-77  
ALTERNATE CANDIDATE TEST RANGES FOR AIRLAUNCHED/  
HTO ROCKET ACCELERATED MACH 12 MISSIONS

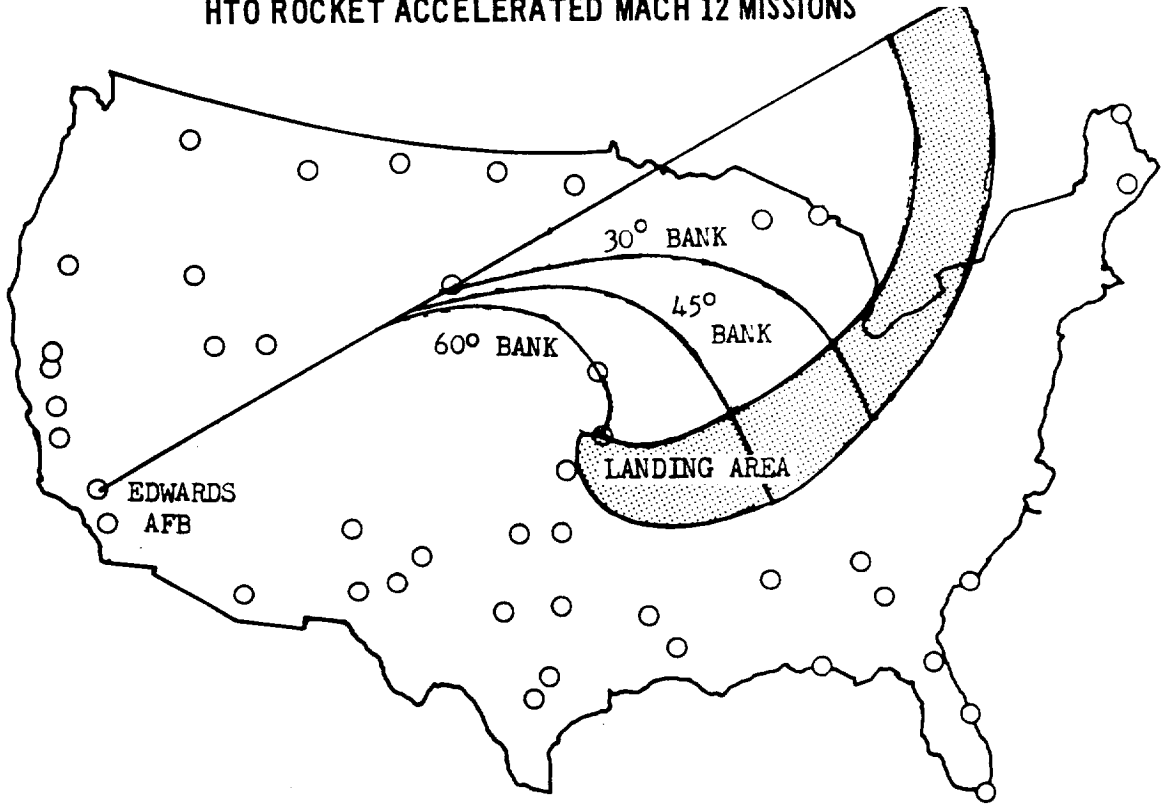

(U) FIGURE 4-78  
ALTERNATE CANDIDATE TEST RANGES FOR AIRLAUNCHED/  
HTO ROCKET ACCELERATED MACH 12 MISSIONS

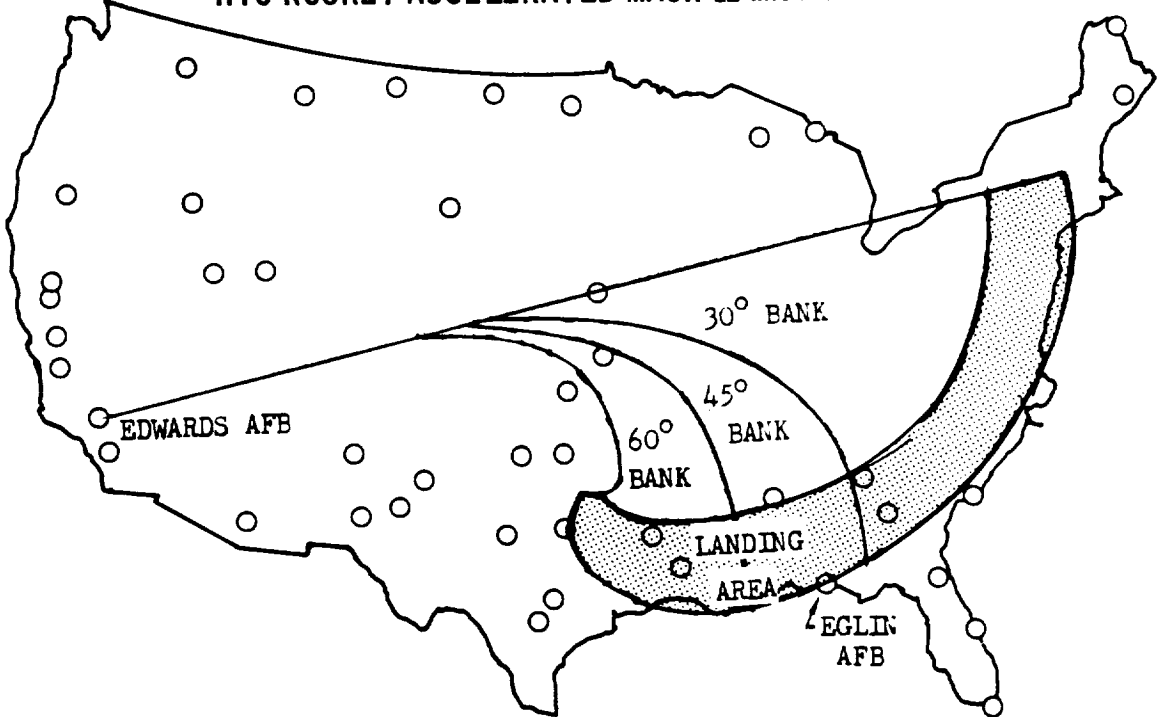

(U) FIGURE 4-79  
ALTERNATE CANDIDATE TEST RANGES FOR AIRLAUNCHED/  
HTO ROCKET ACCELERATED MACH 12 MISSIONS

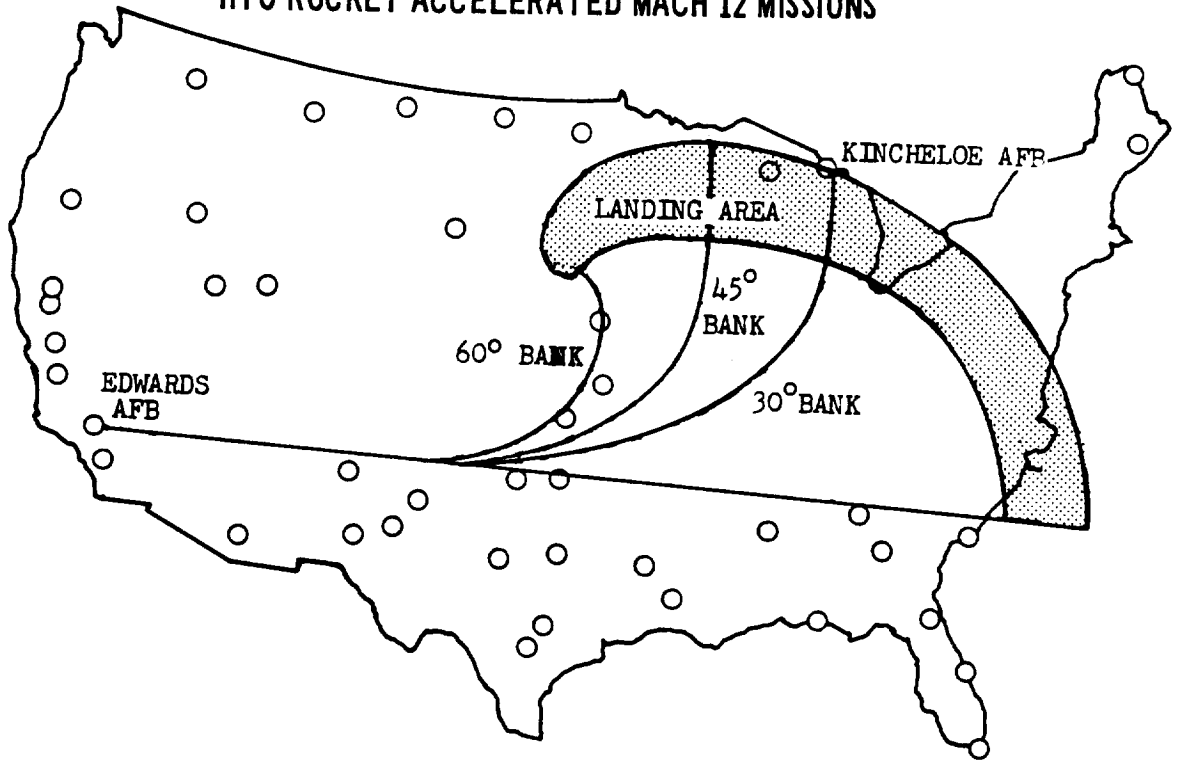

(U) FIGURE 4-80  
ALTERNATE CANDIDATE TEST RANGES FOR AIRLAUNCHED TRJ  
ACCELERATED MACH 6 MISSION

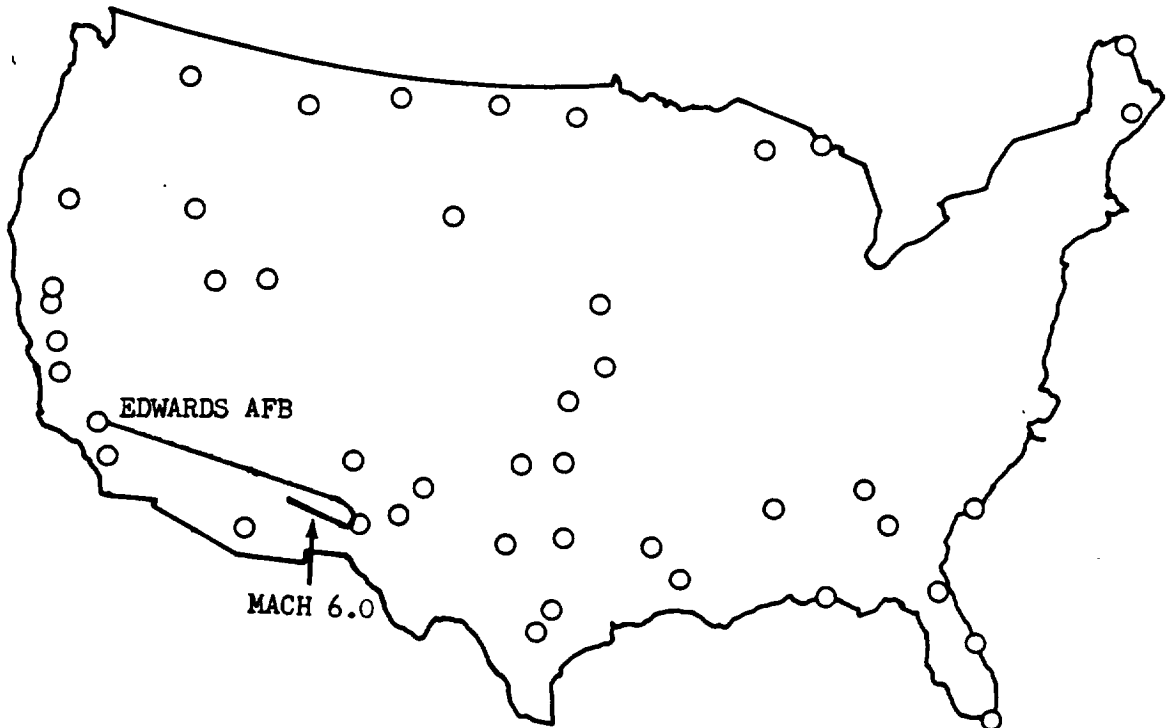

of Canada unless a turn is made, as shown in Figure 4-77. The mission depicted is a takeoff from Edwards AFB, five minutes steady state at Mach 12, and a landing in the area shaded. A more easterly launch path results in the landing area outlined in Figure 4-78, with Eglin AFB as a prime recovery base candidate. The main problem with this range is that the flight vehicle must overfly densely populated areas. Figure 4-79 shows the same mission as the two previously discussed except turns are made to the left. This mission is designated to provide a landing area that includes Kincheloe AFB; however, this flight profile also overflies densely populated areas.

(U) Figure 4-80 illustrates that even Mach 6 flight vehicles cannot easily return to their launch base. Therefore, all hypersonic flight vehicle profiles described for Phase I are based on dual-base operations except the Mach 0.9, Mach 2.0, Mach 4.5, and variable stability flight vehicles which operate single-base.

(U) Another test range considered was the X-15 test range; however, to accommodate the Mach 12 vehicles the range would have to be extended to the north and require a turn. Several problems are associated with this approach. The facilities already existing are not at suitable distances from Edwards AFB to allow use of the horizontal takeoff mode. The weather becomes more of a problem the farther north the range is extended. And finally, this range would be unsuitable for the staged type of vehicles because of the safety factors created by overland staging.

4.10.4 (U) MISSION SUPPORT - The following paragraphs describe the major areas of support which have been identified for the Phase I flight facility missions.

4.10.4.1 (U) Vehicle Transportation - The operational basing concept recommended as the baseline operation for this study considered Edwards Air Force Base as the center of operations and the landing site. Therefore, use of a C-5 aircraft to transport the vehicle from Edwards to the launch site is included in the operational plan. Additional reasons dictating the need for a C-5 are to transport the vehicle from the point of manufacture to the test site, and to retrieve the vehicle from an intermediate field in the event of an emergency landing. The personnel and support equipment required to launch the test vehicle can also be carried by the C-5. The air launched vehicles are designed to be carried by the C-5 so no size problem should be encountered for the air launched vehicles or smaller horizontal takeoff test vehicles. Some of the larger horizontal takeoff vehicles may require a special pylon on the C-5 to allow them to be canted in roll attitude from a horizontal position, and others may be too large to be transported intact by the C-5. Further analysis of the transportation problems will be performed during Phases II and III only if these large vehicles survive the elimination process.

4.10.4.2 (U) Ground-Monitor and Tracking System - A ground monitoring system will perform an important role in support of flight operations. The ground stations will utilize voice communications, radar data for space positioning, and selected channels of telemetered data from the test vehicle in order to perform the following functions:

- o Monitor the airframe and subsystems operation during flight.
- o Advise the pilot of heading/altitude corrections and position during the flight.

- o Monitor and evaluate stability and control parameters.
- o Monitor the pilot's physiological environment.
- o Provide the pilot with assistance and information in the event of an emergency or problem.
- o Direct air search and rescue operations in the event of an emergency.

(U) The primary test range between Homestead AFB, Florida and Edwards AFB, California may not have the necessary facilities along the flight path to meet the support requirements assumed for Phase I. These requirements are:

- o To maintain tracking, voice communications, and telemetry coverage on the test vehicle from lift-off to touch-down, including landings at intermediate points in the event of an emergency.
- o To provide these data in real time to the operations center at Edwards AFB.

(U) A preliminary survey indicates that existing radar facilities may be adequate to meet the mission requirements for tracking. Existing telemetry receiving facilities at Edwards AFB, Fort Huachuca, Holloman AFB, Houston Spacecraft Center, and Eglin AFB can cover the mission once the test vehicle has reached high altitude and during the let-down and landing at Edwards. It would be necessary to install a receiving station at the launch site to cover the mission during the takeoff phase. If UHF or VHF telemetry is employed, a minimum of five (5) receiving stations would be required assuming a 350 mile (560 km) radius of coverage for each station. An alternate approach would be to employ high frequency (HF) telemetry with a receiving range of up to 1000 miles (1609 km), thereby reducing the minimum stations to three (3) and possibly two (2). There are several candidate methods of transmitting the real-time data to Edwards. These include:

- o A micro-wave relay network setup between the receiving stations.
- o A hardline system from the receiving stations.
- o Airborne relay system.
- o Relay via satellite.

Additional studies will be conducted during Phase II and III to define the optimum ground tracking and data system considering both effectiveness and costs. Also, maintenance facilities including LH<sub>2</sub> availability and support equipment will be studied during Phase II and III.

#### 4.11 WEIGHT AND BALANCE

(U) Evaluation of a matrix of vehicle configurations, power plants, propellants, structural concepts, etc., requires that each individual weight estimate be correct in order that the right combination of parameters can be synthesized into the optimum vehicle. Within a given class of designs it is sufficient to have only the correct weight trend so that the minimum weight points can be determined. However, when different classes of vehicles are compared together, such as "all body" compared to "wing body" or "protected structure" compared to "unprotected structure", it is necessary that the absolute weight be correct so that the more attractive class can be selected with confidence.

(U) The feasibility of sustained hypersonic cruise aircraft is directly related to weights in terms of physical size and economic impact. For these reasons MCAIR has made numerous independent weight studies to determine the lightest practical structural concepts for vehicles subjected to aerodynamic heating. These studies covered flight speeds ranging from Mach No. 3 to Mach No. 12, as well as orbital velocity. Additional unpublished studies were conducted by the weight department in conjunction with other appropriate technical groups to determine minimum weight concepts for environmental control systems, power generating and transmission systems, propulsion systems for acceleration as well as cruise, and flight path schedules.

(U) Figure 4-81 illustrates vehicle structural weight variation with temperature. Aluminum structure is generally lighter than titanium structure below 400°F (260°C) because its lower strength and density results in a better match between strength and stability than does titanium. There are particular cases where titanium is lighter than aluminum, such as fatigue critical components or highly loaded tension structures with little or no load reversal. Above 400°F (260°C), depending upon the individual components, titanium structure becomes lighter because of the rapid reduction in weight to strength ratio of aluminum with increasing temperature. Titanium remains the lightest structural material up to 900°F (260°C) at which point the metallurgical stability limit is reached and titanium is unattractive. Some titanium alloys have been developed for use above 900°F (260°C), but are not considered state-of-the-art at this time. The next lightest material is Rene' 41, a nickel alloy, that can be used to 1550°F (840°C). Use of Rene' 41 above this temperature is not recommended because of intergranular corrosion. Alloys for use above 1550°F (840°C) are limited to L-605, a cobalt alloy, T. D. nickel-chrome, and refractory metals such as columbium. Either T. D. Ni-Cr or L-605 will result in a significant weight penalty. For example, structure made of these alloys is nearly double the weight of Rene' 41 and will be almost four times the weight of a similar aluminum structure designed at room temperature. Columbium, as well as other refractory metals, requires a disilicide type coating over all exposed areas to prevent oxidation. Coating life is presently limited which means the primary structure would have to be dismantled and recoated periodically. Therefore, the use of Columbium is limited to easily replaced items such as shingles and liners in the inlet as well as non-load-carrying structure such as leading edges of wing and control surfaces.

(U) The shaded band in Figure 4-81 shows the relative weight trend of protected structure. The structural temperature is maintained between 70°F (180°C) and approximately 300°F (149°C) by a thermal protection system (TPS). The TPS can

(U) FIGURE 4-81  
RELATIVE AIRFRAME WEIGHT vs TEMPERATURE

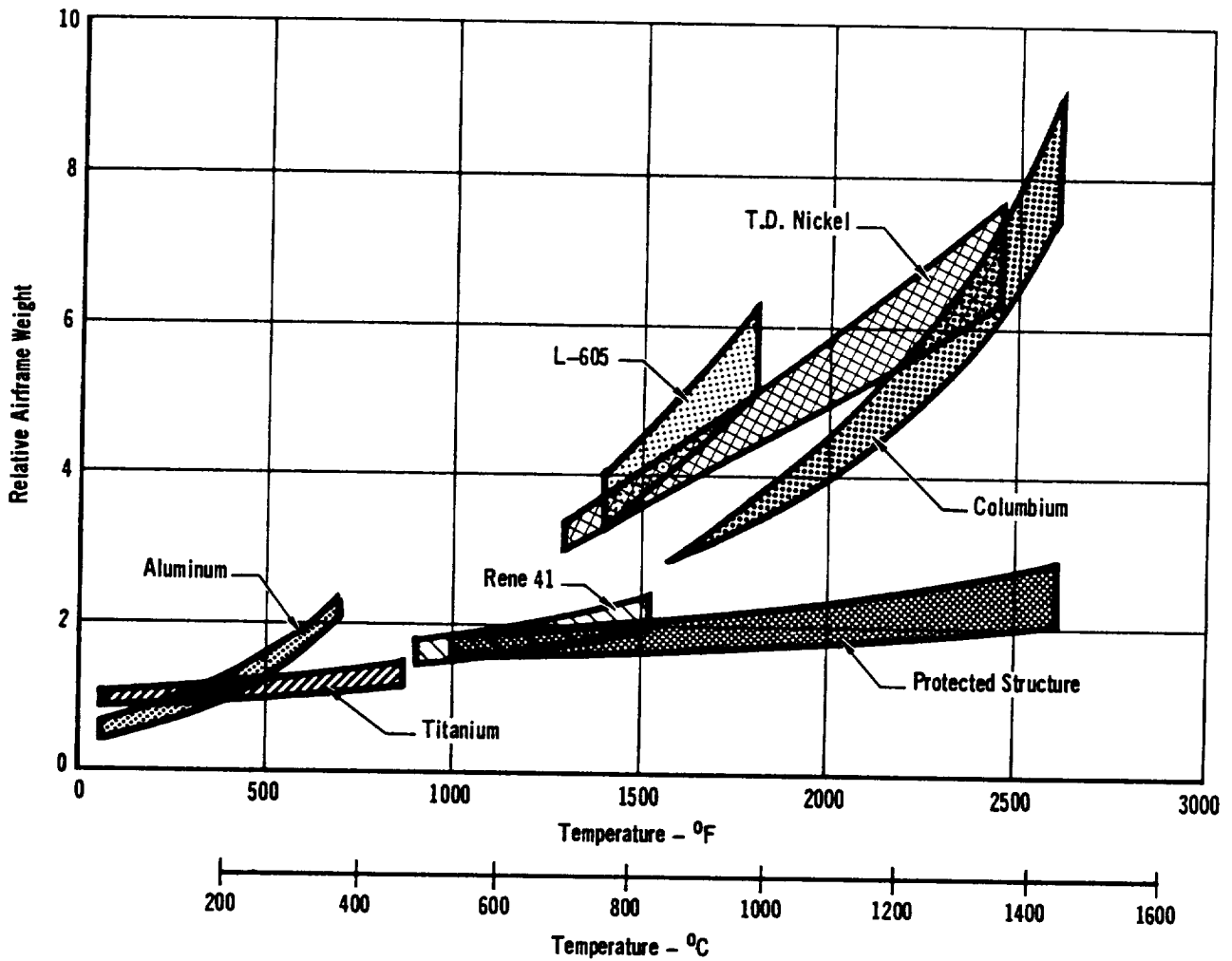

TP 8476-855

be either an active system which absorbs heat through phase changes, such as boiling water, or a passive system using insulation to lower the temperature from the mold-line to the structure. A high emissivity shingle is used to protect the insulation and cooling medium and to reradiate 95% of the incident heat back into the atmosphere. Figure 4-82 is a comparison of the unit weights for 8 different thermal protection systems. The additional weight of the thermal protection system is about equal to the weight of the primary structure. However, this concept is competitive weightwise with unprotected structure in the 1000°F (537°C) range and is definitely lighter beyond 1550°F (840°C) - 1600°F (868°C).

(U) The protected structural concept has several other inherent features which contribute to minimum weight designs, such as:

- o Internal vehicle temperatures are maintained at reasonable levels so that additional insulation is not required in the fuel bays, cabin, and equipment compartments. Hydraulic, electrical, avionics, etc., systems operate within existing state-of-the-art levels and no additional weight is required for high temperature operation capability.
- o Thermal stresses in the primary structure are minimal. Airframe distortions which result from temperature gradients from the windward to the leeward sides are precluded when the protected structure concept is used. Weight penalties for creep design or oxidation resistance are not required.

(U) However, there are areas where protected structure cannot be used, such as leading edges, vertical and horizontal tails, and control surfaces, because of their limited depth. The thermal protection system (shingle, insulation, etc.) thickness is a minimum of 1.45 inches per side. Control surface loads are generally higher during low speeds when the surface is cool than they are at high speeds when the surface is hot. This results in the control surface weight being established by maximum load with the surface near room temperature.

4.11.1 (U) BASIC STRUCTURE WEIGHT ESTIMATION METHODOLOGY - The structural weight estimation methods used in this study to determine the weight of the wing, tails, fuselage, landing gear, air induction, and engine section are a modified statistical type, as opposed to analytical or comparative methods. These estimation methods were developed independently by MCAIR and are documented in Reference (13).

(U) Our weight estimation equations were developed by setting up a mathematical model of an idealized structure for each component, i.e., wing, horizontal tail, vertical tail, etc., and then adding weight penalties for cutouts, control surfaces, wing folds, and so on. As an example, the wing was assumed to be a cantilevered box beam which reacted the applied bending moments, torques, and shears. An equation was then written which described the material required to react the load as a function of the torque box span, depth, taper ratio, sweep back angle, and planform area. This same type of approach was first offered by Shanley, and a more thorough discussion can be found in Reference (14). The weight of the theoretical box beam thus derived was then compared to an actual one of identical dimensions and loads to determine how much additional weight was required for fasteners, joints, splices, access doors, minimum gage material, and other non-optimum design features. By correlating the mathematical torque box model to many actual torque box weights, it was possible to develop a weight estimation equation that yielded a realistic weight and



(U) FIGURE 4-82  
**GROSS TAKEOFF WEIGHT OF LIQUID  
 HYDROGEN TANKAGE THERMAL PROTECTION SYSTEMS**  
 Mach 8 Cruise at 88,000 Ft 1500°F for 1.5 Hours  
 (26,822 M) (815°C)

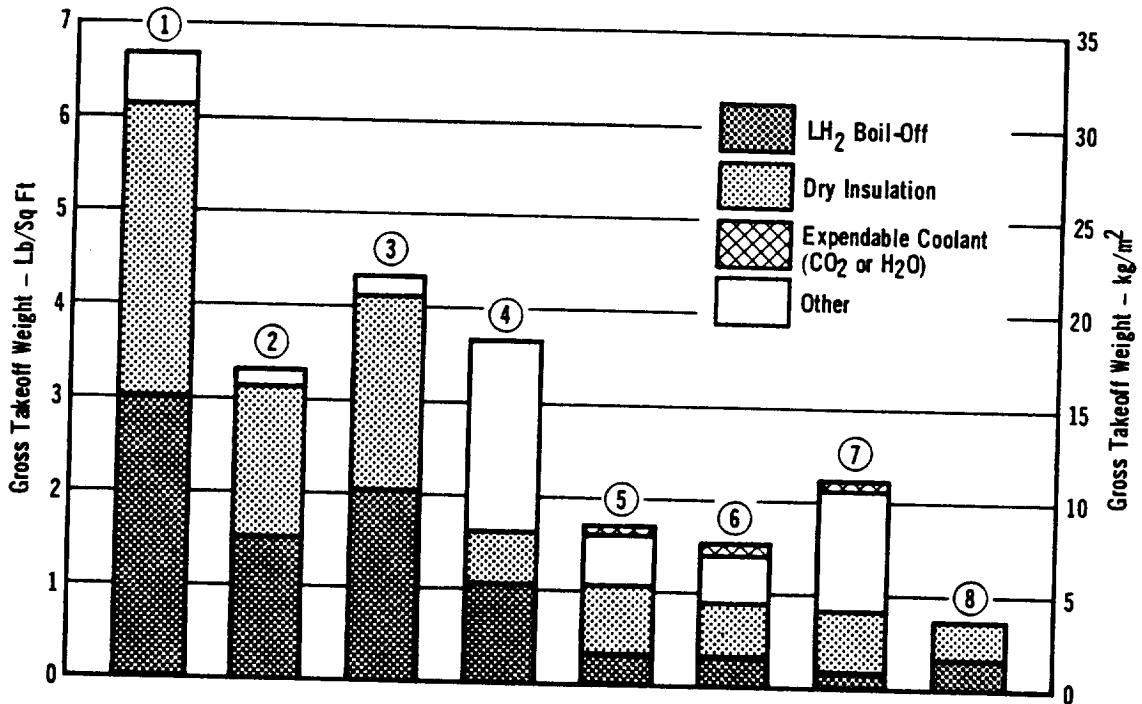

- Insulation Concepts
- ① Helium Purged Q-Felt System
  - ② Coevacuated Foam Plastic System
  - ③ Evacuated Metal Foil System
  - ④ Carbon Dioxide Frost System
  - ⑤ MAC Water/Transpiration System
  - ⑥ MAC Radiation Gap/Water Wick System
  - ⑦ MAC Modified Carbon Dioxide Frost System
  - ⑧ Idealized High Temperature Evacuated Super Insulation System

responded correctly to changes in loads, geometry, and size. The same modeling technique was used to develop equations for the remaining items that make up the wing weight such as:

- o Leading and trailing edge structure
- o Leading and trailing edge control surfaces and support structure
- o Landing gear well and back-up structure
- o Fuel system provisions
- o Wing fold structure
- o Air induction cavity structure
- o Engine cavity structure
- o Bending relief - engines
  - landing gear
  - fuel

(U) There are 27 equations involving 67 different parameters used to estimate the wing basic structure weight, excluding heat protection. The other structural components, i.e. tail, fuselage, etc., are estimated with the same depth of analysis and with equations derived in the manner previously discussed. In total, the structural weight estimates require 93 equations which contain 253 parameters. However, the depth of the analysis is rewarded by its accuracy which has been computed to be within -3.35% to 3.81% for  $l\sigma$  with 50% confidence, as illustrated in Figure 4-83.

(U) The general equations listed below are those used by MCAIR to estimate the primary structure weight of the wing, tails, fuselage, landing gear, engine section and air induction. Thermal protection system weight, high temperature structure and other supplemental structural weight items are accounted for by a separate analysis.

(U) FIGURE 4-83  
 MCAIR STRUCTURAL WEIGHT ESTIMATION METHOD

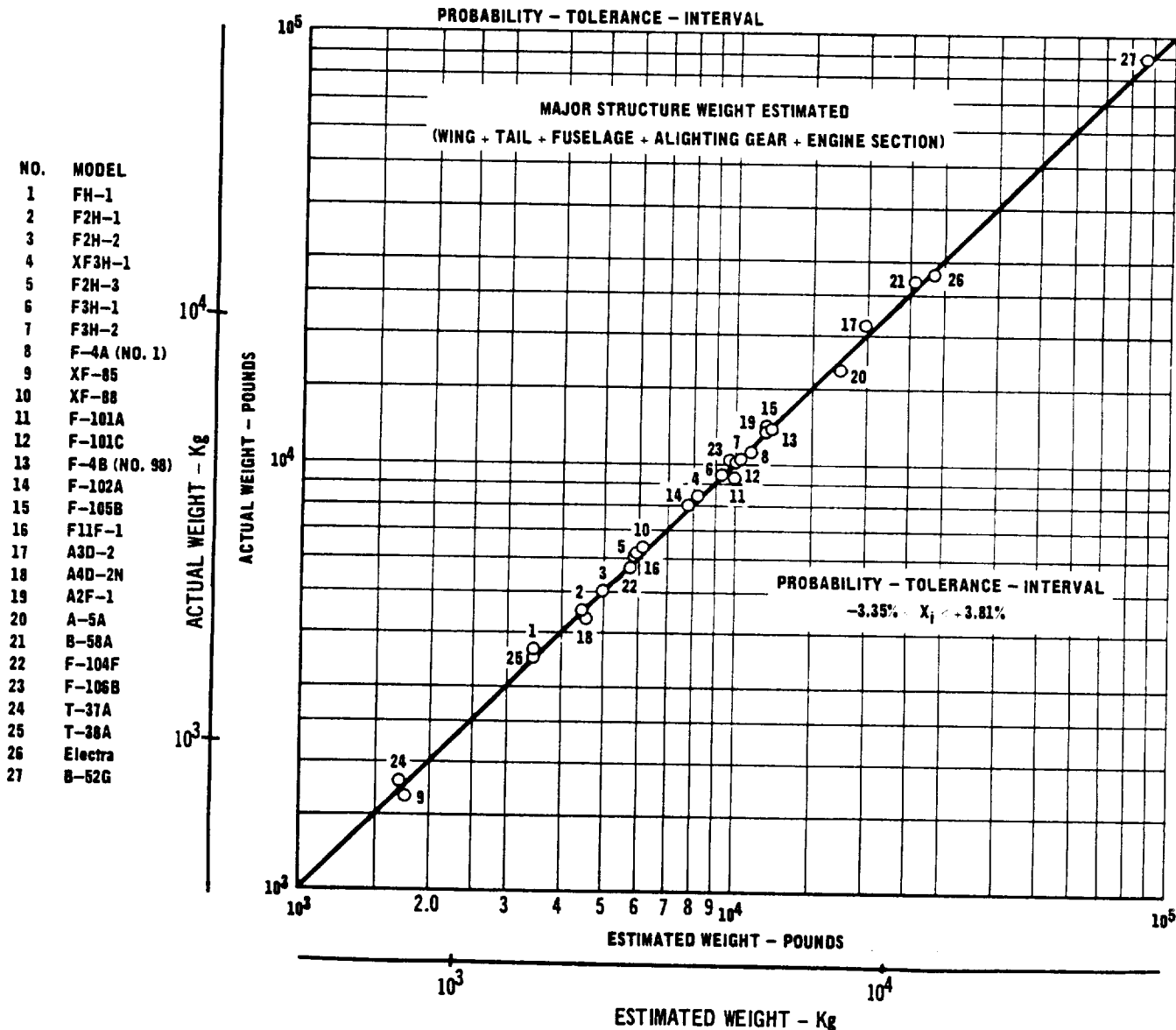

4.11.1.1 (U) Wing Group Weight Estimation Equations -

$$\text{Estimated Weight} = \sum_{i=1}^{13} \gamma_i$$

$$\gamma_1 \text{ Basic Shell} = \gamma_{1e} + \gamma_{tb} + \gamma_{te}$$

$$\gamma_{1e} \text{ (Leading Edge)} = k (W_g n_z / S_g)^n (S_{1e})$$

$$\gamma_{tb} \text{ (Torque Box)} = k (S_{tb})$$

$$\gamma_{te} \text{ (Trailing Edge)} = k (W_g n_z / S_g)^n (S_{te})$$

$$\gamma_2 \text{ Bending Material and Misc} = \gamma_{bm} + \gamma_{rl} + \gamma_{re} + \gamma_{rf}$$

$$\gamma_{bm} \text{ (Bending Material)}$$

$$= k \left[ \frac{(W_g - W_w) n_z \pm L_n}{t_r} \right]^n (b / \cos \theta)^n (1 + \lambda)^n (S_{tb})^n$$

$$\gamma_{rl} \text{ (Bending Relief-Landing Gear)} = -k (W_{lg} n_z) / t_r (b_l / \cos \theta)^n$$

$$\gamma_{re} \text{ (Bending Relief-Engine)} = -k (W_e n_z) / t_r (b_e / \cos \theta)^n$$

$$\gamma_{rf} \text{ (Bending Relief-Fuel)} = -k (W_f n_z) / t_r (b_f / \cos \theta)^n$$

$$\gamma_3 \text{ Duct Provisions} = k (N_1) (L_d) \left[ \frac{C_1 + C_2}{2} \right]^n (P)^n$$

$$\begin{aligned} \gamma_4 \text{ Engine Provisions (Submerged)} \\ = k (T)^n (N_1) + k (L_1 D)^n (N_1) \end{aligned}$$

$$\gamma_5 \text{ Fuel System Provisions} = K_1 (G/N_2)^n (N_2)$$

$$\gamma_6 \text{ Main Landing Gear Provisions} = k (q)^n (S_1) + k (F_g L_2)^n$$

$$\gamma_7 \text{ Expanded Root Thickness} = -k (W_g n_z b / \cos \theta)^n (t_a/t_r)^n (b_r / \cos \theta)^n$$

$\gamma_8$  Wing Fold Provisions

$$= k \left[ \frac{W_g n_z S_{op} b_o / \cos \theta}{t_f S_g} \right]^n + K_2 \left[ \frac{b_o}{\cos \theta} (k W_o + W_t) \right]$$

$$\gamma_9 \text{ Catapult Back-up} = \gamma_{hp} + \gamma_{tp}$$

$$\gamma_{hp} \text{ (Holdback Provisions)} = k (W_c) (n_x)$$

$$\gamma_{tp} \text{ (Tow Provisions)} = k (W_c) (n_x)$$

$$\gamma_{10} \text{ Control Surface Provisions} = \gamma_a + \gamma_t + \gamma_l + \gamma_{sl} + \gamma_{sb} + \gamma_{sp}$$

$$\gamma_a \text{ (Aileron and Actuator Provisions)} = k W_a + k (L_a)^n$$

$$\gamma_t \text{ (T.E. Flap and Actuator Provisions)} = k (W_{ft})^n$$

$$\gamma_l \text{ (L.E. Flap and Actuator Provisions)} = k (W_{fl})^n$$

$$\gamma_{sl} \text{ (Slat Provisions)} = k (W_s)^n$$

$$\gamma_{sb} \text{ (Speed Brake Provisions)} = k (S_b)$$

$$\gamma_{sp} \text{ (Spoiler Provisions)} = k (S_s)$$

$$\gamma_{11} \text{ Sweepback "Kick" Load} = k \left[ \frac{W_g n_z S_o \sin \theta (b_s / \cos \theta)}{t_b S_g} \right]^n$$

$$\gamma_{12} \text{ Trailing Edge Surfaces} = \gamma_{bs} + \gamma_b + \gamma_h + \gamma_s + \gamma_e$$

$$\gamma_{bs} \text{ (Basic Shell)} = k (S_{cs}) + k (S_{hc}) + k (S_{hs}) N_3$$

$$\gamma_b \text{ (Drive Ribs and Chord Wise Bending)} = K_3 (HM/t_m)^n (C_m) N_3$$

$$\gamma_h \text{ (Hinges and Front Beam)} = K (HM)^n (b_a) N_3$$

$$\gamma_s \text{ (Supports)} = K_4 (\gamma_{bs} + \gamma_b + \gamma_h)$$

$$\gamma_e \text{ (Special Increment)} = \text{Balance Weights, B.L.C., etc.}$$

$$\gamma_{13} \text{ Leading Edge Surfaces} = \gamma_f + \gamma_s + \gamma_e$$

$$\gamma_f \text{ (Flap Structure)} = k (W_g n_z / S_g)^n (b_a) (C_m)^n$$

$$\gamma_s \text{ (Hinges and Supports)} = K_f \gamma_s$$

$$\gamma_e \text{ (Special Installations)} = \text{B.L.C., etc.}$$

Symbols, Wing

- b Span, Wing - Ft.
- b<sub>a</sub> Span, Hinge Line, Per Surface - Ft.
- b/cos θ Span, Structural, Along Maximum Thickness Line - Ft.
- b<sub>e</sub>/cos θ Span, C<sub>L</sub> to C.G. of Engine - Ft.
- b<sub>f</sub>/cos θ Span, C<sub>L</sub> to C.G. of Fuel - Ft.
- b<sub>l</sub>/cos θ Span, C<sub>L</sub> to C.G. of Landing Gear - Ft.
- b<sub>o</sub>/cos θ Span, Outer Wing Structural, Along Maximum Thickness Line - Ft.
- b<sub>r</sub>/cos θ Span, Expanded Root Section - Ft.

REPORT MDC A0013 • 2 OCTOBER 1970  
VOLUME II • PART 2

$b_s/\cos \theta$	Span, Structural, Outboard of Sweep Break Along Maximum Thickness Line - Ft.
$C_1$	Circumference, Duct-Fwd - Ft.
$C_2$	Circumference, Duct-Aft - Ft.
$C_m$	Chord, Mean Surface - Ft.
$D_c$	Diameter, Engine Compartment - Ft.
$F_g$	Load, Maximum Ultimate Vertical/Strut - Lb x $10^{-3}$
$G$	Wing Fuel Capacity - Gallons
$HM$	Hinge Moment, Ult. - In. Lb x $10^{-3}$
$k$	Constant of Proportionality (these values differ for each equation)
$K_1$	Constant, Fuel Storage = 0.6, Fuel Cells = 0.3, Integral Tanks
$K_2$	Constant, Wing Fold Actuation = 31.2, Hydraulic = 45.5, Electric
$K_3$	Constant, Control Surface Actuation Point = 0.46, Actuated @ $H_L$ = 0.23, Actuated @ Approximately .5 C. = 1.50, Actuated @ $H_L$ and one end of surface. = 1.00, Actuated @ $H_L$ and both ends of surface.
$K_4$	Constant, Control Surface Supports = 0.18, Ailerons, Speed Brakes and Spoilers = 0.20, Flaps
$L_a$	Load, Ultimate Actuator - Lb x $10^{-3}$
$L_d$	Length, Duct Along $C_L$ - Ft.
$L_h$	Load, Ultimate Horizontal Tail - Balancing - Lb x $10^{-3}$
$L_1$	Length, Engine Compartment - Ft.
$L_2$	Length, Main Gear Extended - In.
$n$	Exponent (these values differ for each equation)
$n_z$	Load Factor, Ultimate Vertical

$n_x$	Load Factor, Ultimate Catapult
$N_1$	Number of Engines
$N_2$	Number of Fuel Tanks/Aircraft
$N_3$	Number of Control Surfaces
$P$	Pressure, Ultimate Duct - psi
$P_a$	Load, Axial @ Root - Lb x $10^{-3}$
$q$	Maximum Dynamic Pressure - psf
$S_b$	Area, Speed Brake/Aircraft - Ft. <sup>2</sup>
$S_{cs}$	Area, Conventional Structure/Surface - Ft. <sup>2</sup>
$S_g$	Area, Gross Wing - Ft. <sup>2</sup>
$S_{hc}$	Area, Honeycomb Structure/Surface - Ft. <sup>2</sup>
$S_{hs}$	Area, Half Shell Structure/Surface - Ft. <sup>2</sup>
$S_l$	Area, Main Landing Gear Door/Aircraft - Ft. <sup>2</sup>
$S_{le}$	Area, Fixed Leading Edge/Aircraft - Ft. <sup>2</sup>
$S_o$	Area, Gross Outboard of Sweep Break - Ft. <sup>2</sup>
$S_{op}$	Area, Outer Wing/Panel - Ft. <sup>2</sup>
$S_s$	Area, Spoiler/Aircraft - Ft. <sup>2</sup>
$S_{tb}$	Area, Torque Box/Aircraft - Ft. <sup>2</sup>
$S_{te}$	Area, Fixed Trailing Edge/Aircraft - Ft. <sup>2</sup>
$t_a$	Thickness, Actual Root (Expanded Root) - Ft.
$t_b$	Thickness, Sweep Break - Ft.
$t_f$	Thickness, Wing Fold Line - Ft.
$t_m$	Thickness, Mean Hinge Line - In.
$t_r$	Thickness, Root - Ft.
$T$	Thrust/Engine - Lb x $10^{-3}$



$W_a$	Weight, Aileron Structure, Less Balance Wts. - Lb
$W_c$	Weight, Catapult Gross - Lb x $10^{-3}$
$W_e$	Weight, Engine, Per Aircraft - Lb x $10^{-3}$
$W_f$	Weight, Wing Fuel, Per Aircraft - Lb x $10^{-3}$
$W_{fl}$	Weight, Leading Edge Flap, Per Aircraft - Lb
$W_{ft}$	Weight, Trailing Edge Flap, Per Aircraft - Lb
$W_g$	Weight, Design Gross - Lb x $10^{-3}$
$W_{lg}$	Weight, Landing Gear, Per Aircraft - Lb x $10^{-3}$
$W_o$	Weight, Outer Panel, Per Aircraft - Lb x $10^{-3}$
$W_s$	Weight, Slat, Per Aircraft - Lb
$W_t$	Weight, Tip Tank, Including Trapped Fuel/Aircraft - Lb x $10^{-3}$
$W_w$	Weight, Wing Structure, Per Aircraft - Lb x $10^{-3}$
$\lambda$	Taper Ratio (Tip Chord/Root Chord)
$\theta$	Sweep Back Angle of Maximum Thickness Line
$\gamma$	Weight, Estimated - Lb

4.11.1.2 (U) Horizontal Tail Group Weight Estimation Equation

$$\text{Estimated weight} = \sum_{i=1}^5 \gamma_i$$

$$\gamma_1 \text{ Basic Shell Structure} = \gamma_{le} + \gamma_{tb} + \gamma_{te}$$

$$\gamma_{le} \text{ (Leading Edge)} = k (L_h K/S_h)^n (S_{le})$$

$$\gamma_{tb} \text{ (Torque Box)} = k (S_{tb})$$

$$\gamma_{te} \text{ (Trailing Edge)} = k (L_h K/S_h)^n (S_{te})$$

$$\gamma_2 \text{ Bending Material \& Misc.}$$

$$= k \left[ \frac{KL_h + W_h n_z}{t_r} \right]^n (b/\cos \theta)^n (1 + \lambda)^n (S_{tb})^n$$

$$\gamma_3 \text{ Sweepback "Kick" Load} = k \left[ \frac{L_h K S_o \sin\theta (b_s/\cos\theta)}{t_b S_h} \right]$$

$$\gamma_4 \text{ Elevator Back-up} = k W_e$$

$$\gamma_5 \text{ Hinges and Actuator Support Fitting} = k (L_a)^n$$

Symbols, Horizontal Tail

$b/\cos\theta$  Span, Structural, Along Maximum Thickness Line - Ft.

$b_s/\cos\theta$  Span, Structural, Outboard of Sweepbreak Along Maximum Thickness Line - Ft.

$k$  Constant of Proportionality (these values differ for each equation)

$K$  Factor, Unsymmetrical  
 = 1.5 Along Buffet or Stall Line of  $V - n_z$  Diagram, 1.15 Elsewhere<sup>2</sup>

$L_a$  Load, Ultimate Actuator -  $Lb \times 10^{-3}$

$L_h$  Load, Ultimate Horizontal Tail - Design -  $Lb \times 10^{-3}$

$n$  Exponent (these values differ for each equation)

$n_z$  Load Factor, Ultimate Vertical

$S_h$  Area, Gross Horizontal Tail -  $Ft.^2$

$S_{le}$  Area, Leading Edge -  $Ft.^2$

$S_o$  Area, Gross Outboard of Sweepbreak -  $Ft.^2$

$S_{tb}$  Area, Torque Box -  $Ft.^2$

$S_{te}$  Area, Trailing Edge -  $Ft.^2$

$t_b$  Thickness, Sweepbreak - Ft.

$t_r$  Thickness, Root - Ft.

$W_e$  Weight, Elevator (Less Balance Wts) - Lb

$W_h$  Weight, Horizontal Tail -  $Lb \times 10^{-3}$

$\lambda$  Taper Ratio

- $\theta$  Sweepback Angle of Maximum Thickness Line.  
 $\gamma$  Weight, Estimated - Lb

4.11.1.3 (U) Vertical Tail Group Weight Estimation Equations

6

$$\text{Estimated Weight} = \sum_{i=1} \gamma_i$$

$$\gamma_1 \text{ Basic Shell Structure} = \gamma_{1e} + \gamma_{tb} + \gamma_{te}$$

$$\gamma_{1e} \text{ (Leading Edge)} = k (L_v/S_v)^n (S_{1e})$$

$$\gamma_{tb} \text{ (Torque Box)} = k (S_{tb})$$

$$\gamma_{te} \text{ (Trailing Edge)} = k (L_v/S_v)^n (S_{te})$$

$$\gamma_2 \text{ Bending Material and Misc.} = k (L_v/t_r)^n (b/\cos \theta)^n (1 + \lambda)^n (S_{tb})^n$$

$$\gamma_3 \text{ Sweepback "Kick" Load} = k \left[ \frac{L_v S_o (b_s/\cos \theta) \sin \theta}{t_b S_v} \right]^n$$

$$\gamma_4 \text{ Vertical Tail Fold} = k \left[ \frac{L_v (b_o/\cos \theta) S_{op}}{t_f S_v} \right]^n + \frac{K}{2} (k W_o b_o/\cos \theta)^n$$

$$\gamma_5 \text{ Rudder Back-Up} = .25 (W_r)$$

$$\gamma_6 \text{ Rudder} = \gamma_{bs} + \gamma_b + \gamma_h + \gamma_e$$

$$\gamma_{bs} \text{ (Basic Shell)} = k (S_{cs}) + k (S_{hc}) + k (S_{hs}) N$$

$$\gamma_b \text{ (Drive Ribs \& Chordwise Bending)} = K_1 (HM/t_m)^n (C_m)N$$

$$\gamma_h \text{ (Hinges and Front Beam)} = k (HM)^n (b) N$$

$$\gamma_c \text{ (Special Increments)} = \text{Balance Weights, Dampers, etc.}$$

Symbols, Vertical Tail

$b$  Span, Rudder Hinge Line - Ft.

$b/\cos \theta$  Span, Structural, Along Maximum Thickness Line - Ft.

$b_o/\cos \theta$  Span, Structural, Outboard of Fold Along Maximum Thickness Line - Ft.

$b_s/\cos \theta$  Span, Structural, Outboard of Sweep Break Along Maximum Thickness Line - Ft.

REPORT MDC A0013 • 2 OCTOBER 1970  
VOLUME II • PART 2

$C_m$	Chord, Mean Control Surface - Ft.
HM	Hinge Moment - In. Lb x $10^{-3}$
k	Constant of Proportionality (these values differ for each equation)
K	Constant, Actuation = 31.2 - Hydraulic Actuation = 41.5 - Electric Actuation
$K_1$	Constant, Rudder Actuation Point = .46 Actuated @ HL = .23 Actuated @ Approximately .5C = 1.50 Actuated @ HL and @ One End of Surface = 1.00 Actuated @ HL and @ Both Ends of Surface
$L_v$	Load, Ultimate Vertical Tail - Lb x $10^{-3}$
n	Exponent (these values differ for each equation)
N	Number of Control Surfaces
$S_{cc}$	Area, Conventional Structures - Ft. <sup>2</sup>
$S_{hc}$	Area, Honeycomb Structure - Ft. <sup>2</sup>
$S_{hs}$	Area, Half-Shell Structure - Ft. <sup>2</sup>
$S_{le}$	Area, Leading Edge - Ft. <sup>2</sup>
$S_o$	Area, Outboard of Fold - Ft. <sup>2</sup>
$S_{op}$	Area, Outboard of Fold - Ft. <sup>2</sup>
$S_{tb}$	Area, Torque Box - Ft. <sup>2</sup>
$S_{te}$	Area, Trailing Edge - Ft. <sup>2</sup>
$S_v$	Area, Total Vertical Tail - Ft. <sup>2</sup>
$t_b$	Thickness, Sweepbreak - Ft.
$t_f$	Thickness, Fold - Ft.
$t_m$	Thickness, Mean Hinge Line - In.
$t_r$	Thickness, Root - Ft.
$W_o$	Weight, Folding Panel - Lb x $10^{-3}$
$W_r$	Weight, Rudder (Less Balance Weights) - Lb
$\lambda$	Taper Ratio
$\sigma$	Sweepback Angle of Maximum Thickness Line

**MCDONNELL AIRCRAFT**

Y Weight, Estimated - Lb

4.11.1.4 (U) Fuselage Group Weight Estimation Equations

15

$$\text{Estimated Weight} = \sum_{i=1}^{15} Y_i$$

- Y<sub>1</sub> Shell = k (q)<sup>n</sup> (S<sub>f</sub>)
- Y<sub>2</sub> Cockpit Provisions = k (V<sub>c</sub>)<sup>n</sup> (1 + P<sub>c</sub>)<sup>n</sup>
- Y<sub>3</sub> Bending Material = Y<sub>fV</sub> + Y<sub>fS</sub> + Y<sub>ah</sub> + Y<sub>av</sub> + Y<sub>ae</sub> + Y<sub>as</sub>  
 Y<sub>fV</sub> (Fwd - Vertical Bending) = k (L<sub>1</sub><sup>2</sup>/d<sub>1</sub>) (W<sub>f</sub>) (n<sub>z</sub>)  
 Y<sub>fS</sub> (Fwd - Side Bending) = k (L<sub>1</sub> x L<sub>2</sub>/d<sub>3</sub>) (L<sub>v</sub>)  
 Y<sub>ah</sub> (Aft - Horizontal Tail Bending) = k (L<sub>2</sub><sup>2</sup>/d<sub>2</sub>) (L<sub>h</sub>)  
 Y<sub>av</sub> (Aft - Vertical Bending) = k (L<sub>2</sub><sup>2</sup>/d<sub>2</sub>) (W<sub>a</sub>) (n<sub>z</sub>)  
 Y<sub>ae</sub> (Aft - Engine Bending) = k (L<sub>3</sub><sup>2</sup>/d<sub>2</sub>) (W<sub>e</sub>) (n<sub>z</sub>)  
 Y<sub>as</sub> (Aft - Side Bending) = k (L<sub>2</sub><sup>2</sup>/d<sub>3</sub>) (L<sub>v</sub>)
- Y<sub>4</sub> Nose Landing Gear Provisions = k (q)<sup>n</sup> (S<sub>nd</sub>) + k (F<sub>n</sub> L<sub>4</sub>)<sup>n</sup>
- Y<sub>5</sub> Main Landing Gear Provisions = k (q)<sup>n</sup> (S<sub>md</sub>) + k (F<sub>m</sub> L<sub>5</sub>)<sup>n</sup>
- Y<sub>6</sub> Wing Reaction = k (W<sub>g</sub> n<sub>z</sub> b/cos θ)
- Y<sub>7</sub> Fuel System Provisions = K<sub>1</sub> (G<sub>f</sub>/N<sub>1</sub>)<sup>n</sup> (N<sub>1</sub>)
- Y<sub>8</sub> Air Induction Provisions = k (N<sub>5</sub>) (L<sub>6</sub>)  $\left[ \frac{C_1 + C_2}{2} \right]^n (P_d)^n$
- Y<sub>9</sub> Engine Provisions - Submerged = Y<sub>m</sub> + Y<sub>c</sub> + Y<sub>b</sub>  
 Y<sub>m</sub> (Thrust Reaction) = k (T)<sup>n</sup> (N<sub>2</sub>)  
 Y<sub>c</sub> (Cavity Prov.) = k (L<sub>7</sub> D<sub>c</sub> N<sub>3</sub>)<sup>n</sup>  
 Y<sub>b</sub> (Blast Area - Exhaust) = k (S<sub>b</sub>)
- Y<sub>10</sub> Tail Provisions = k (L<sub>A</sub>)<sup>n</sup>
- Y<sub>11</sub> Arresting Gear Provisions = k (D<sub>a</sub>)

- Y<sub>12</sub>      Catapult Back-Up =  $\gamma_{hp} + \gamma_{tp}$   
 $\gamma_{hp}$  (Holdback Provisions) =  $k (W_c) (n_x)$   
 $\gamma_{tp}$  (Tow Provisions) =  $k (W_c) (n_x)$
- Y<sub>13</sub>      External Store Provisions =  $K_2 (W_s)^n (N_4)$
- Y<sub>14</sub>      Windshield, Canopy and Mech. =  $k (S_c)^n (1 + P_c)^n$
- Y<sub>15</sub>      Speed Brakes and Supports =  $k (S_{sb})^n (L_b)^n (N_6)$

Symbols, Fuselage

- b          Span, Wing - Ft.
- C<sub>1</sub>        Circumference, Duct - Fwd - Ft.
- C<sub>2</sub>        Circumference, Duct - Aft - Ft.
- D<sub>a</sub>        Drag, Ultimate Arresting Component - Lb x 10<sup>-3</sup>
- D<sub>c</sub>        Diameter, Engine Cavity - Ft.
- d<sub>1</sub>        Depth @ Main Spar, Effective - Fwd Fuselage - Ft.
- d<sub>2</sub>        Depth @ Main Spar, Effective - Aft Fuselage - Ft.
- d<sub>3</sub>        Width @ Main Spar, Fuselage - Ft.
- F<sub>n</sub>        Vertical Load Per Strut, Nose Gear - (Max. Ult.) - Lb x 10<sup>-3</sup>
- F<sub>m</sub>        Vertical Load Per Strut, Main Gear - (Max. Ult.) - Lb x 10<sup>-3</sup>
- G<sub>f</sub>        Capacity, Fuel - Fuselage - Gals.
- k          Constant of Proportionality (these values differ for each equation)
- K<sub>1</sub>        Constant, Fuel Tank:  
           Tray Supported = 0.40  
           Fus. Supported, Air Force = 0.75; Navy = 0.95
- K<sub>2</sub>        Constant, External Store:  
           Air Force = 8.5  
           Navy = 12.6
- L<sub>1</sub>        Length, Fwd Longeron - (Main Spar to Nose) - Ft.
- L<sub>2</sub>        Length, Aft Longeron - (Main Spar to Tail Pivot) - Ft.
- L<sub>3</sub>        Length - (Main Spar to Engine C.G.) - Ft.
- L<sub>4</sub>        Length Per Strut, Nose Gear - (Extended) - In.

REPORT MDC A0013 • 2 OCTOBER 1970  
VOLUME II • PART 2

$L_5$	Length Per Strut, Main Gear - (Extended) - In.
$L_6$	Length, Air Intake Duct - Ft.
$L_7$	Length, Engine Compartment - Ft.
$L_A$	Load, Tail - Applicable - Lb x $10^{-3}$
$L_h$	Load, Horizontal Tail - (Ult.) - Lb x $10^{-3}$
$L_v$	Load, Vertical Tail - (Ult.) - Lb x $10^{-3}$
$L_b$	Load Per Speed Brake - (Limit) - Lb x $10^{-3}$
$n$	Exponent (these values differ for each equation)
$n_x$	Load Factor, Catapult - (Ult.)
$n_z$	Load Factor, Vertical - (Ult.)
$N_1$	Number of Fuselage Fuel Tanks
$N_2$	Number of Fuselage Mounted Engines
$N_3$	Number of Engine Cavities
$N_4$	Number of Fuselage Store Stations
$N_5$	Number of Air Intake Ducts
$N_6$	Number of Fuselage Speed Brakes
$P_c$	Pressure, Differential - Cockpit - (Ult.) - psi
$P_d$	Pressure, Air Intake Duct - (Ult.) - psi
$q$	Pressure, Dynamic - (Maximum) - psf
$S_b$	Area, Blast - Engine Exhaust - (Gross) - Ft. <sup>2</sup>
$S_c$	Area, Canopy - (Gross) - Ft. <sup>2</sup>
$S_f$	Area, Wetted - Fuselage - (Less Canopies) - Ft. <sup>2</sup>
$S_{md}$	Area, Main Landing Gear Doors - (Total) - Ft. <sup>2</sup>
$S_{nd}$	Area, Nose Landing Gear Doors - (Total) - Ft. <sup>2</sup>
$S_{sb}$	Area Per Speed Brake - Ft. <sup>2</sup>
$T$	Thrust Per Engine - (Maximum) - Lb x $10^{-3}$
$V_c$	Volume, Cockpit - Ft. <sup>3</sup>

$W_a$	Weight, Aft of Main Spar - (Less Fuel & Engines) - Lb x $10^{-3}$
$W_c$	Weight, Catapult - Design Gross - Lb x $10^{-3}$
$W_e$	Weight, Engines - (Total) - Lb x $10^{-3}$
$W_f$	Weight, Fwd of Main Spar - (Less Fuel) - Lb x $10^{-3}$
$W_g$	Weight, Design Gross - Lb x $10^{-3}$
$W_s$	Weight, External Store - Design - (Per Station) - Lb x $10^{-3}$
$\theta$	Sweepback Angle @ 50% Chord Line
$\gamma$	Weight, Estimated - Lb

4.11.1.5 (U) Alighting Gear Group Weight Estimation Equations

$$\text{Estimated Weight} = \sum_{i=1}^7 \gamma_i$$

Main Gear

$\gamma_1$  Structure =  $\gamma_s + \gamma_{bb} + \gamma_a + \gamma_f$

$\gamma_s$  (Struts) =  $k (L_1 + k_4)^n (R_B)^n (E F_g)^n (K_m) (N)$

$\gamma_{bb}$  (Bogey Beams) =  $k (D_t)^n (F_g)^n (N)$

$\gamma_a$  (Axles) =  $k (W_t)^n (F_g)^n (N)$

$\gamma_f$  (Attach Ftgs) =  $k (\gamma_s)^n$

$\gamma_2$  Running Gear =  $\gamma_w + \gamma_t + \gamma_{as}$

$\gamma_w$  (Wheels) =  $k (F/N_w)^n (D_w)^n (W_f)^n (N_w)$

$\gamma_b$  (Brakes) =  $K_b (KE)^{nb}$

$\gamma_t$  (Tires)

Tubeless =  $k (D_t + D_w)^n (W_t + D_t - D_w)^n (F_o)^n (N_t)$

Low Profile =  $k (D_t + D_w)^n (W_t + D_t - D_w)^n (F_o)^n (N_t)$

Air Weight - Estimated

$\gamma_{as}$  (Anti-Skid Device) = Estimated

$\gamma_3$  Controls =  $k (\gamma_1 + \gamma_2)^n$



Nose Gear

$\gamma_4$  Structure =  $\gamma_s + \gamma_f$

$\gamma_s$  (Struts) =  $k (L_1 + .3L_4)^n (R_B)^n (E F_g)^n (K_m) (N)$

$\gamma_f$  (Attach Ftg) =  $k (\gamma_s)^n$

$\gamma_5$  Running Gear =  $\gamma_w + \gamma_t$

$\gamma_w$  (Wheels) =  $k (F/N_w)^n (D_w)^n (W_f)^n (N_w)$

$\gamma_t$  (Tires)

Tubeless =  $k (D_t + D_w)^n (W_t + D_t - D_w)^n (F_o)^n (N_t) \times 10^{-3}$

Low Profile =  $k (D_t + D_w)^n (W_t + D_t - D_w)^n (F_o)^n \times 10^{-4}$

Air Weight = Estimated

$\gamma_6$  Controls =  $(\gamma_4 + \gamma_5)^n$

Special Weight Increments

$\gamma_7$  Miscellaneous

(Special Attachment Gear, Tip Skids, Tail Bumper, etc.)

Alighting Gear Symbols

$D_t$  Diameter, Tire - (Max. Outside) - In.

$D_w$  Diameter, Wheel Bead Ledge - In.

$E$  Efficiency, Material = (Mat'l Density/Mat'l Allow.) - In.  $^{-1} \times 10^6$

$F$  Load, Total Wheel - (Maximum Ult.):

=  $W_L n_L - \text{Lb} \times 10^{-3}$

=  $W_m n_t - \text{Lb} \times 10^{-3}$

$F_g$  Vertical Load per Gear - (Maximum Ult.):

Ground Condition -  $\text{Lb} \times 10^{-3}$

Landing Condition -  $\text{Lb} \times 10^{-3}$

$F_o$  Operating Load/Tire - (Maximum) - Lb.

$k$  Constant of Proportionality (these values differ for each equation)

$K_b$  Constant, Brake:

Air Force = 4.6

Navy = 11.8

REPORT MDC A0013 • 2 OCTOBER 1970  
VOLUME II • PART 2

$K_c$  Constant, Nose Gear Controls:  
Air Force = 1.20  
Navy = 0.53

$K_m$  Material Factor, Outer Barrel:  
Steel = 1.00  
Alum. = 0.82

$KE$  Kinetic Energy, Landing - (Design) - Ft.-Lb  $\times 10^{-6}$   
= 58.7 Ft/Knot<sup>2</sup> ( $W_L$ ) ( $V_{SL}$ )<sup>2</sup> @ Stall Speed OR  
= 44.3 Ft/Knot<sup>2</sup> ( $W_L$ ) ( $V_{TD}$ )<sup>2</sup> @ Touchdown Speed

$L_1$  Length, Extended Gear - (Trunnion to Axle) - In.

$L_2$  Length, Collapsed Gear - (Trunnion to Axle) - In.

$L_3$  Length, Brace Distance - (Trunnion to Drag Brace Ftg.) - In.

$L_4$  Length, Strut Above Trunnion - In.

$n$  Exponent (these values differ for each equation)

$n_b$  Exponent, Brake:  
Air Force = 1.176  
Navy = 0.91

$n_L$  Load Factor, Landing - (Ult.)

$n_t$  Load Factor, Taxi - (Ult.)

$N$  Number of Struts/Aircraft

$N_t$  Number of Tires/Aircraft

$N_w$  Number of Wheels/Aircraft

$R_B$  Drag Brace Ratio:  
Ground Condition =  $L_2 / (L_2 + L_3)$   
Landing Condition =  $(L_1 - .5S) / (L_1 + L_3 - .5S)$

$S$  Stroke, Total Gear - In.

$V_{SL}$  Speed, Stall - (Power-Off) - Knots

$V_{TD}$  Speed, Touchdown - Knots

$W_f$  Width, Wheel Flange - In.

$W_L$  Weight, Landing Gross - Lb  $\times 10^{-3}$

$W_m$  Weight, Maximum Gross - Lb x  $10^{-3}$   
 $W_t$  Width, Tire, Maximum Section - In.  
 $\gamma$  Weight, Estimated - Lb

4.11.1.6 (U) Engine Section or Nacelle Group Estimation Equations

6

$$\text{Estimated Weight} = \sum_{i=1}^6 \gamma_i$$

$\gamma_1$  Mounts-Thrust Reaction =  $k (W_e)^n (T)^n (N_e)$   
 $\gamma_2$  Tracks =  $k (W_e)^n (L_t) (N_e)^n$   
 $\gamma_3$  Nacelle Shell =  $k (q)^2 (N_n) (S_n)$   
 $\gamma_4$  Air Induction Provisions =  $k (N_n) (L_6) \left[ \frac{C_1 + C_2}{2} \right]^n (P_d)^n$   
 $\gamma_5$  Cavity Provisions =  $k (D_c L_7 N_n)^n$   
 $\gamma_6$  Pylon & Provisions =  $k (q)^2 (S_p N_p) + k \left( \frac{W_h}{T_p} \right)^n \left( \frac{H_p}{\text{Cos}\theta} \right)^n (S_p)^n (N_p)$

Symbols-Engine Section or Nacelle Group

$C_1$  Circumference, Fwd Duct Face - Ft.  
 $C_2$  Circumference, Aft Duct Face - Ft.  
 $D_c$  Diameter, Engine Compartment - Ft.  
 $H_p$  Height, Pylon (Wing/Fuselage to Nacelle)  
 $k$  Constant of Proportionality (these values differ for each equation)  
 $L_p$  Length, Pylon - Ft.  
 $L_6$  Length, Air Induction Duct - Ft.  
 $L_7$  Length, Engine Cavity - Ft.  
 $L_t$  Length, Engine Removal Track - Ft.  
 $n$  Exponent (these values differ for each equation)  
 $N_e$  Number, Engines  
 $N_n$  Number, Nacelles  
 $\gamma$  Weight, Estimated - Lb

4.11.1.7 (U) Air Induction Group Weight Estimation Equations

$$\text{Estimated Weight} = \sum_{i=1}^8 \gamma_i$$

- $\gamma_1$  Inlet Lip =  $k(C_1)(N)K_T$
- $\gamma_2$  Duct Liner =  $k(S_1)$
- $\gamma_3$  Duct Structure =  $k(L_1)(C_1)^n(P_1)^n(K_{VR})(N)(K_T)$
- $\gamma_4$  External Ramps =  $k(S_2)(P_2)^n(N)(K_T)$
- $\gamma_5$  Internal Ramps =  $k(S_3)(P_3)^n(N)(K_T)$
- $\gamma_5$  Actuation & Mechanism =  $k(8_5)$
- $\gamma_6$  Duct Liner Insulation =  $K_1(S_1)N$
- $\gamma_7$  Auxiliary Air Doors =  $k(N)(K_T)$
- $\gamma_8$  Bellmouth and Controls =  $k(C_2)(P_1)^{n+K}$

Symbols, Air Induction

- C Circumference, Inlet - Ft.
- $C_1$  Circumference, Duct - Average - Ft.
- $C_2$  Circumference, Engine Face - Ft.
- k Constant of Proportionality (these values differ for each equation)
- $K_1$  Constant, Duct Liner  
 = 1.00 when  $M_\infty = 3.0$   
 = 3.15 when  $M_\infty > 3.0$
- $K_T$  Constant, Material, Temperature, and Failure Mode Distribution
- $K_{VR}$  Constant, Ramp Displacement
- $L_1$  Length, Duct Structure - Ft.
- n Exponent (these values differ for each equation)
- N Number of Ducts
- $P_1$  Pressure, Maximum, Duct (Ultimate) - psi
- $P_2$  Pressure, Maximum, External Ramp (Ultimate) - psi

$P_3$	Pressure, Maximum, Internal Ramp (Ultimate) - psi
$S_1$	Area, Duct Liner - Ft. <sup>2</sup>
$S_2$	Area, External Ramp - Ft. <sup>2</sup>
$S_2$	Area, Internal Ramp - Ft. <sup>2</sup>
$N_p$	Number, Pylons
$P_d$	Pressure, Air Intake Duct - (Ult) - psi
$q$	Pressure, Dynamic (Maximum) - psf
$S_n$	Wetted Area, Nacelle - Ft. <sup>2</sup>
$S_p$	Planform Area, Pylon - Ft. <sup>2</sup>
$T$	Thrust, Maximum Static Sea Level (Uncorrected) - Lb x 10 <sup>-3</sup>
$T_p$	Thickness, Pylon (At Frontal View) - Ft.
$W_e$	Weight, Engine - Lb x 10 <sup>-3</sup>
$W_h$	Weight, Engine(s) plus Thrust Reverser(s) Hanging From Pylon - Lbs/1000
$\theta$	Forward Sweep Angle of Pylon at 50% Span
$\gamma$	Weight, Estimated - Lb

4.11.2 (U) WEIGHT ESTIMATION METHODS FOR STRUCTURE OPERATING AT ELEVATED TEMPERATURE AND FOR THERMAL PROTECTION SYSTEM - No statistical weight information is available for sustained cruise aircraft in the Mach 4 to Mach 12 range. Therefore, our statistical weight estimation methods were modified by the method of Reference 14 to account for the weight penalties associated with structural components operating at elevated temperatures. By using proven statistical weights estimation methods and then modifying the results to account for temperatures, materials, and structural arrangements, we feel that the accuracy of the basic method is retained in the final estimate. The procedure outlined in Reference 15 develops a weight coefficient for various materials as a function of equilibrium temperature and a failure mode distribution which is representative of the particular structural item being investigated. Application of the weight coefficient to the basic estimate (which is predicated on aluminum structure designed at room temperature) results in a weight which reflects the appropriate material and design conditions.

(U) Figure 4-84 shows a typical weight coefficient plot for Ti-6Al-4V at various temperatures. The failure mode distribution has a significant effect on the coefficient. Therefore, failure modes were determined for various structural components such as wing, vertical tail, horizontal tail, fuselage, and so on, as indicated on the graph. Distribution of the failure mode percentages was based on the parameters that normally design each item. The failure mode distribution can be altered by changing the structural concepts which in turn has a significant weight effect.

(U) FIGURE 4-84  
 Ti-6Al-4V - WEIGHT COEFFICIENT vs TEMPERATURE

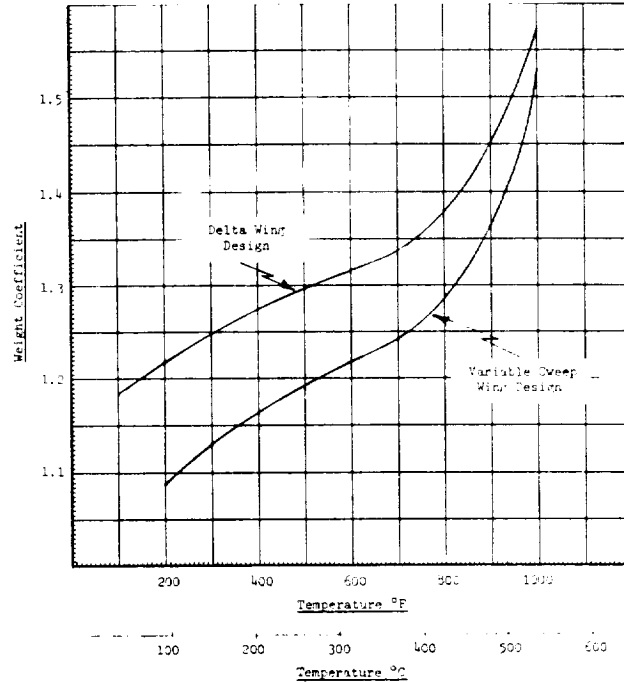

(U) This method was used to estimate the weight savings for using titanium in the carry through and lower torque box skin of a variable sweep wing and a boron composite stabilator. These items were then fabricated and weighted as part of a MCAIR advanced structures program.

(U) Figure 4-85 is a comparison of the estimated weight using 7075-T765 aluminum and Ti 6Al-6V-2Sn ANN which shows a weight savings of 258 lbs. The third column is the actual weight, which shows that our estimated weight was within 20 lbs of the actual weight. The aluminum weight was determined by the estimation equations presented in Section 4.11.1. These weights were then modified by the methods previously described to arrive at an equivalent titanium weight.

(U) FIGURE 4-85  
 TITANIUM WING WEIGHT COMPARISON

<u>Component</u>	<u>Aluminum</u> <u>lb (Kg)</u>	<u>Titanium</u> <u>lb (Kg)</u>	<u>Actual</u> <u>lb (Kg)</u>
Carry Through Assembly	804 (365.0)	615 (279.0)	630 (285.5)
Outer Wing Assembly	787 (357.0)	718 (326.0)	700 (317.5)
Pin and Bushing	58 (26.3)	58 (26.3)	41 (18.6)
Total	1649 (749.0)	1391 (632.0)	1371 (622.0)

(U) A boron/epoxy composite stabilator was built under the advanced structures program and demonstrated significant weight improvement over a comparable aluminum structure. Figure 4-86 presents the estimated stabilator weights for aluminum skin-stringer and for Boron/Epoxy full depth honeycomb structure.

(U) **FIGURE 4-86**  
**COMPOSITE STABILATOR WEIGHT COMPARISON**

<u>Weight Status</u>	<u>Torque Box Weight - LB (kg)</u>
Aluminum	383 (173.5)
Boron/Epoxy Estimate	275 (124.8)
Boron/Epoxy Actual	289 (131.0)

4.11.3 (U) ENGINE WEIGHT ESTIMATION - Through vendor cooperation, data has been obtained to enable MCAIR to perform accurate engine weight estimation. Various types of engines are used in this phase of the HYFAC study. Engine weights have basically been obtained from quotes or curves derived from the various vendors. Analytical or statistical modifications for installation and thrust vector control actuation not included in vendor weights have been made where necessary.

4.11.3.1 (U) Convertible Scramjets - Figure 4-87 depicts convertible scramjet module weight as a function of the maximum pressure in the combustor section and module width. The inlet and nozzle sections are designed by their respective pressures which are considerably lower than that of the combustor section, but their weight is included in the module weight. This estimation procedure, with each module estimated separately, was developed from our experience in the HSVS study, Reference (16). By summing the modules required for given thrust, the total weight of the convertible scramjet is obtained. Besides accounting for scramjet structure this estimation includes a regenerative cooling system, fuel injectors, and ramp mechanism. The back-up and mounting structure is estimated with the body, while trapped fluids appear in the useful loads.

4.11.3.2 (U) Turbojets - The weight for the installed turbojet was obtained directly from the vendor. A weight of 2300 lb (1043.3 kg) was used for the installed F100-GE-100.

4.11.3.3 (U) Turboramjets - The weight for the GE 5/JZ6C and GE 14/JZ8 turboramjets were derived as a function of uninstalled thrust as depicted in Figure 4-88, and Figure 4-89. The vehicles in this phase were sized for an uninstalled thrust to weight ratio at takeoff of .942. The weight quoted is the complete installed engine weight.

4.11.3.4 (C) Rockets - The rocket weight for LR-129 and MIST/ARES rockets are derived as a function of vacuum thrust. Rockets were sized for the vehicles at a T/W ratio at takeoff of 1.5. Figure 4-90 depicts the LR-129 rocket weight versus vacuum thrust. Figure 4-91 shows a similar curve of engine weight versus vacuum thrust for MIST/ARES rocket. The weights for these rockets include the installed engine with trapped propellants, the necessary wire harnesses, instrumentation, spin-up system and thrust vector control situation. Additional engine instrumentation is carried with the instrument group.

This Page Unclassified

(U) FIGURE 4-87  
SCRAMJET MODULE WEIGHT TRENDS

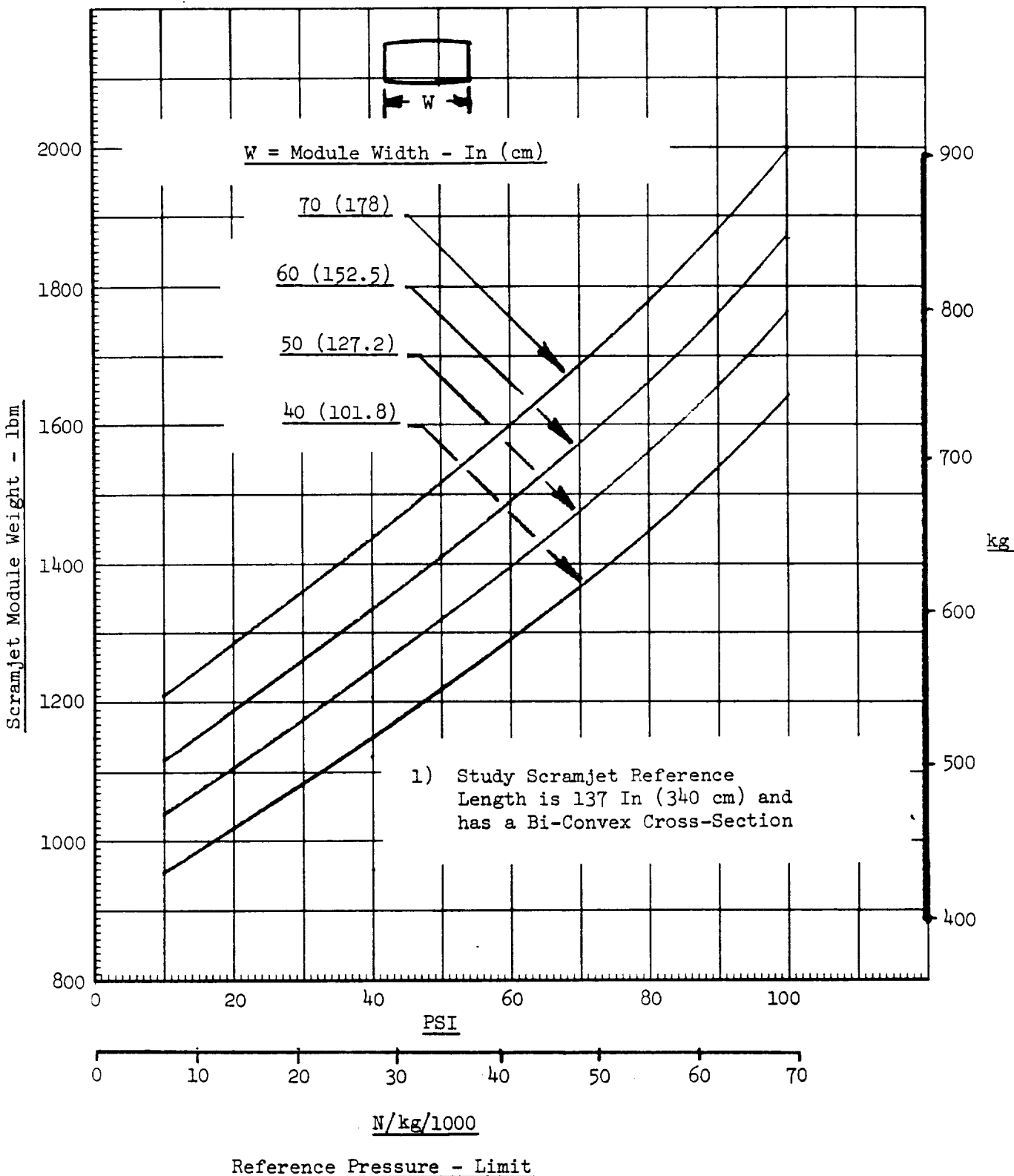



(U) FIGURE 4-88  
 GE 5/JZ6C ENGINE WEIGHT vs  
 UNINSTALLED THRUST

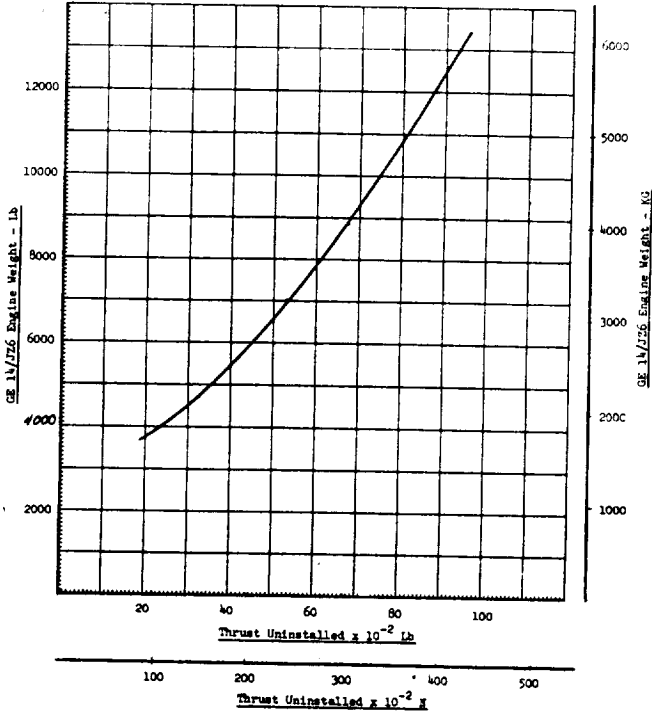

(U) FIGURE 4-89  
 GE 14/JZ8 ENGINE WEIGHT vs  
 UNINSTALLED THRUST

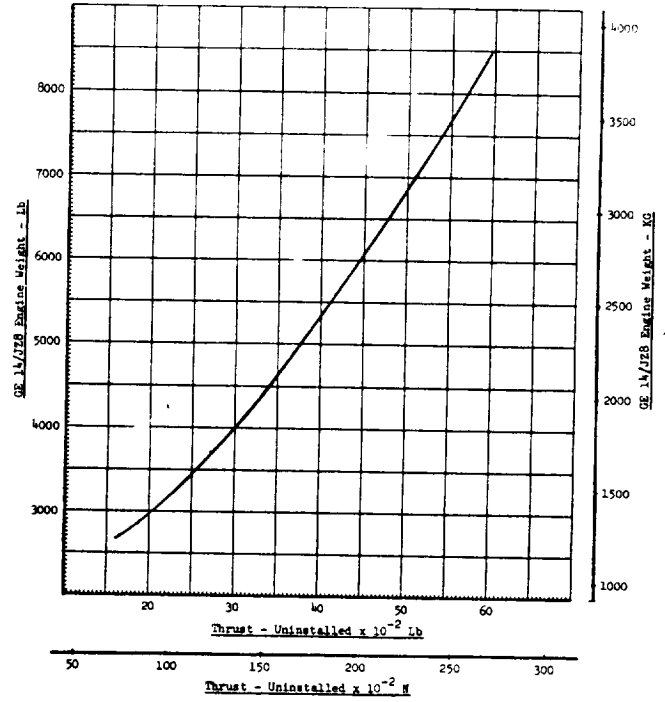

(U) FIGURE 4-90  
 LR-129 ROCKET WEIGHT vs  
 VACUUM THRUST

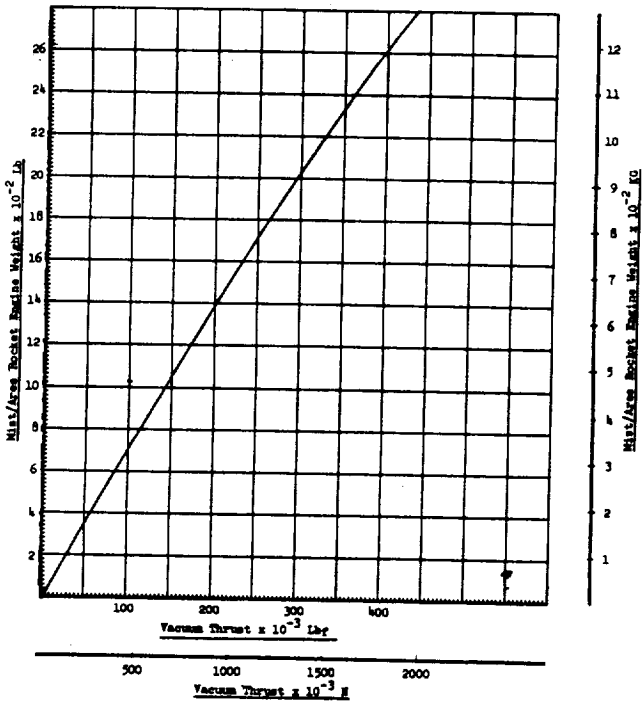

(U) FIGURE 4-91  
 MIST/ARES ROCKET WEIGHT vs  
 VACUUM THRUST

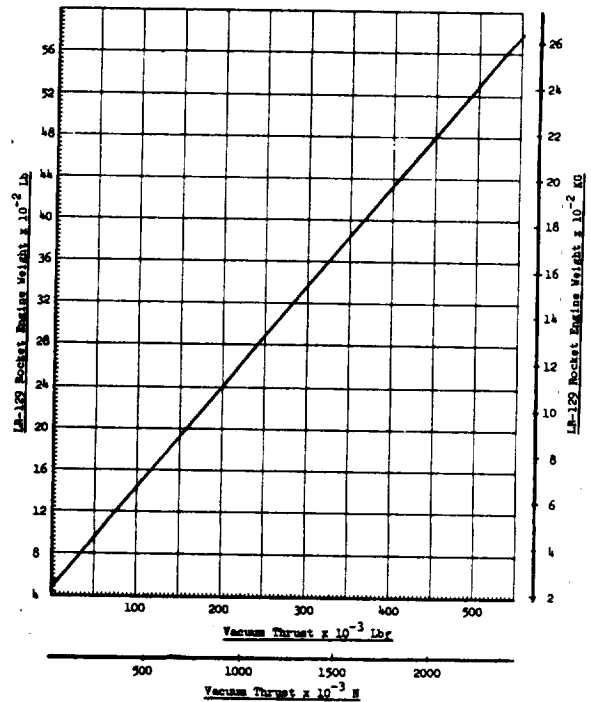

(U) The weight of the J2S engine is fixed for all configurations. The following breakdown was obtained for this engine:

	<u>Weight - lb</u>	<u>(kg)</u>
Rocket Engine	3235	(1461.4)
Accessories	565	(256.3)
Restart Accessories	<u>250</u>	<u>(113.4)</u>
	4050	(1837.1)

4.11.4 (U) SYSTEM WEIGHT ESTIMATION - System weight estimates were based primarily on statistical methods because the systems were not thoroughly defined during this phase. Our system estimation methods reflect weights based upon generalized terms such as basic takeoff and flight design gross weights, wing area, dynamic pressure and ultimate load factor. Fixed weights were used for instruments, electrical, electronics, environmental control system and furnishings due to their invariance between configurations.

4.11.4.1 (U) Fuel System Group Weight Estimation - The fuel system group estimation was divided in three basic components, distribution system, propellant supply system, and helium pressurization provisions. Included in the distribution system are boost pumps, vent and pressurization and dump and drain subsystems as well as ground fueling points, valves and ducting. The propellant supply system includes lines and valves for propellant supply, while the turbo pumps are included in the engine weights. The number of tanks, fuel ducting length, numbers of engines and takeoff gross weight are the sizing parameters for the distribution system while the propellant supply system is sized primarily by the maximum fuel flow rate. The following are the equations used for the fuel system estimation for Phase I HYFAC study. Helium pressurization provisions include the helium bottle, heater and controls with an external shell to insulate the helium keeping the temperature of helium constant as liquid hydrogen is used in the tank. Reference (17) equations for uniform internal pressure in a spherical shell and external pressure on a spherical shell were used for estimating thicknesses of the helium bottle and the external shell for insulation, respectively. The following equations were used in fuel system estimation:

$$\text{Estimated Weight} = \sum_{i=1}^3 \gamma_i$$

$$\gamma_1 \text{ Distribution System} = \gamma_{bp} + \gamma_{sd} + \gamma_{cv} + \gamma_{gf} + \gamma_{vp} + \gamma_{dd}$$

$$\gamma_{bp} \text{ (Boost Pumps)} = W_{TO} (N_T + K_1)$$

$$\gamma_{sd} \text{ (Fuel System Ducts)} = k (N_T + N_E) + k (L_D)$$

$$\gamma_{cv} \text{ (Control Valves)} = k (W_{TO}) + k (N_T)$$

$$\gamma_{vp} \text{ (Vent and Pressurization)} = k (W_{TO} + K_2) L_D + k (N_T)$$

$$\gamma_{dd} \text{ (Dump and Drain)} = k (W_{TO} + K_3) L_D + k (N_D)$$

$$\gamma_2 \text{ Propellant Supply System} = \gamma_l + \gamma_v$$

$$\gamma_l \text{ (Lines)} = K_4 + k (F)$$

$$\gamma_v \text{ (Valves)} = K_5 + k (F)$$

$$\gamma_3 \text{ Helium Pressurization Provisions} = \gamma_{nb} + \gamma_{nc} + \gamma_s$$

$$\gamma_{nb} \text{ (Helium Bottle)} = k \rho_1 4\pi r_1^2 t_1$$

$$\gamma_{nc} \text{ (Heaters and Controls)} = 25 \text{ lb/11.3 kg}$$

$$\gamma_s \text{ (External Shell for Insulation)} = k \rho_2 4\pi r_2^2 t_2$$

Symbols, Fuel System

F	Maximum Fuel Flow Rate - lb/sec	$N_T$	Number of Fuel Cells
k	Constant of Proportionality (these values differ for each equation)	$P_1$	Burst Pressure, Helium Bottle - psi
$K_1$	Constant, Boost Pumps	$P_2$	Pressure, External Shell - psi
$K_2$	Constant, Vent and Pressurization	$r_1$	Radius, Helium Bottle - in.
$K_3$	Constant, Dump and Drain	$r_2$	Radius, External Shell - in.
$K_4$	Constant, Propellant Supply Lines	$t_1$	Thickness, Helium Bottle - in.
$K_5$	Constant, Propellant Supply Valves	$t_2$	Thickness, External Shell - in.
$L_D$	Length of Fuel Ducting - ft	$W_{TO}$	Weight, Takeoff Gross
$N_D$	Number of Drains	$\gamma$	Weight, Estimated - lb
$N_E$	Number of Engines		

4.11.4.2 (U) Hydraulic System Estimation Equations - The hydraulic system for the HYFAC study in Phase I was sized primarily by theoretical wing areas, design gross weight and maximum dynamic pressure. The following equation was used:

$$\gamma = k (S_w)^n (W_g)^n (q)^n$$

Symbols, Hydraulic System

k	Constant of Proportionality	$S_w$	Area, Theoretical Wing - ft <sup>2</sup>
n	Exponent	$W_g$	Weight, Flight Design Gross - lb x 10 <sup>-3</sup>
q	Maximum Dynamic Pressure - psf	$\gamma$	Weight, Estimated - lb

4.11.4.3 (U) Surface Control System Estimation Equations - The surface control system for the Phase I HYFAC study was sized by parameters similar to the hydraulic system. The control system weight is derived as a function of wing area, design gross weight, load factor, and maximum dynamic pressure, as shown in the following equation:

$$\gamma = k (S_w)^n (W_g)^n (N_z) (q)^n$$

Symbols, Surface Controls System

- k Constant of Proportionality
- n Exponent
- N<sub>z</sub> Load Factor, Ultimate Vertical
- q Maximum Dynamic Pressure - psf
- S<sub>w</sub> Area, Theoretical Wing - ft<sup>2</sup>
- W<sub>g</sub> Weight, Flight Design Gross - lb x 10<sup>-3</sup>
- γ Weight, Estimated - lb

4.11.4.4 (U) Electronics Group Weight Estimation - The component list for the electronic group was compiled by MCAIR on the basis of mission and payload requirements for the HYFAC vehicle. The following is the electronic group weight used for Phase I of the HYFAC study.

<u>SUBSYSTEM</u>	<u>Weight - lb</u>	<u>(kg)</u>
Inertial Navigation	76	(34.5)
Attitude & Heading Reference	35	(15.9)
Energy Management/Flight Director	61	(27.7)
Air Data Computer	36	(16.3)
TACAN	25	(11.3)
UHF Comm.	21	(9.5)
HF Comm.	58	(26.3)
Radar Altimeter	13	(5.9)
Data Link	47	(21.3)
Beacons	9	(4.0)
Antennas	27	(12.2)
ILS	8	(3.6)
Autopilot	54	(24.5)
Controls	36	(16.3)
Displays	60	(27.2)
Wiring and Racks, etc.	<u>149</u>	<u>(67.7)</u>
TOTAL	715	(324.2)

4.11.4.5 (U) Electrical Group Weight Estimation - Electrical system weights include the generator(s), transformer/rectifier, and main bus. Distribution wiring weights is accounted for in the electronics group weights. Based on the given electrical loads, a weight of 300 lb (136.0 kg) was allocated for the electrical system for all vehicles in Phase I.

4.11.4.6 (U) APU-Starting System Estimation - The APU system is derived in two separate increments. Figure 4-92 shows an increment for APU-start system based on the combined weight of hydraulics and surface controls. Figure 4-93 depicts another increment for APU-start system based on the electrical power requirements of the HYFAC vehicle. The weights for APU-start system include a dual liquid hydrogen fueled unit including combustor, turbine and power takeoff shafts and liquid oxygen tanks and installation.

4.11.4.7 (U) Instruments Group Estimation - The weights for instruments were derived from the X-15 report, Reference (18). One exception is the air data computer which is included in the electronic group.

	<u>Weight - lb</u>	<u>(kg)</u>
Flight System	79	(35.8)
Cabin System	7	(3.2)
Propulsion	57	(25.9)
APU System	15	(6.8)
Pitot System	4	(1.8)
Installation	<u>13</u>	<u>(5.9)</u>
TOTAL	175	(79.4)

4.11.4.8 (U) Furnishings Group Estimation - The weight for all furnishings is taken directly from the X-15 report, Reference (18). The fire detection system is accounted for in the fuel system.

	<u>Weight - lb</u>	<u>(kg)</u>
Seat & Installation	300	(136.0)
Pressure Suit PROV.	8	(3.6)
Oxygen Installation	18	(8.2)
Thermal Installation & Trim	54	(24.5)
Instrument Boards, Consoles, Control Stands	20	(9.1)
TOTAL	<u>400</u>	<u>(181.4)</u>

(U) FIGURE 4-92  
 HYDRAULIC & SURFACE CONTROLS WEIGHT vs APU START  
 SYSTEM WEIGHT AND APU PROPELLANT SYSTEM WEIGHT

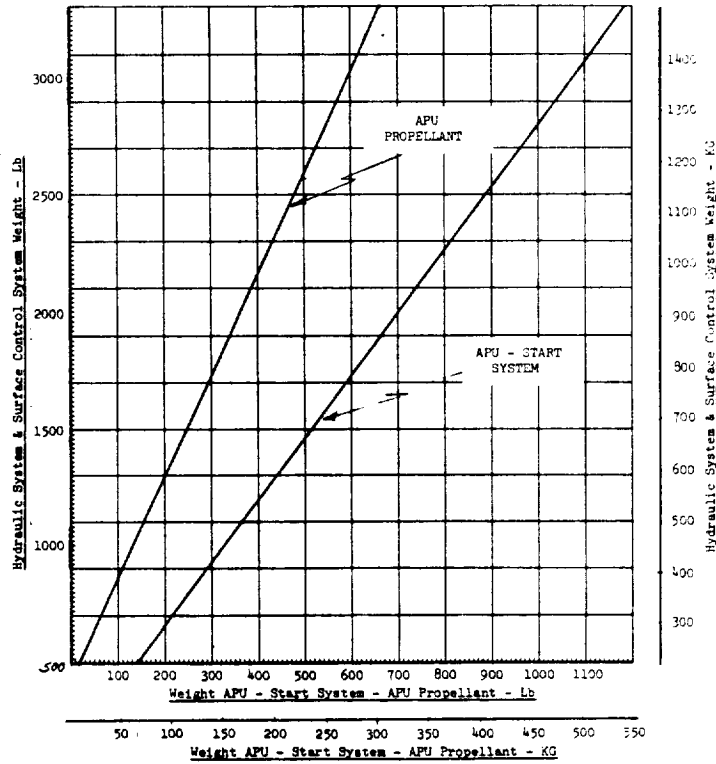

(U) FIGURE 4-93  
 APU - START SYSTEM/APU PROPELLANT vs  
 ELECTRICAL POWER REQUIRED

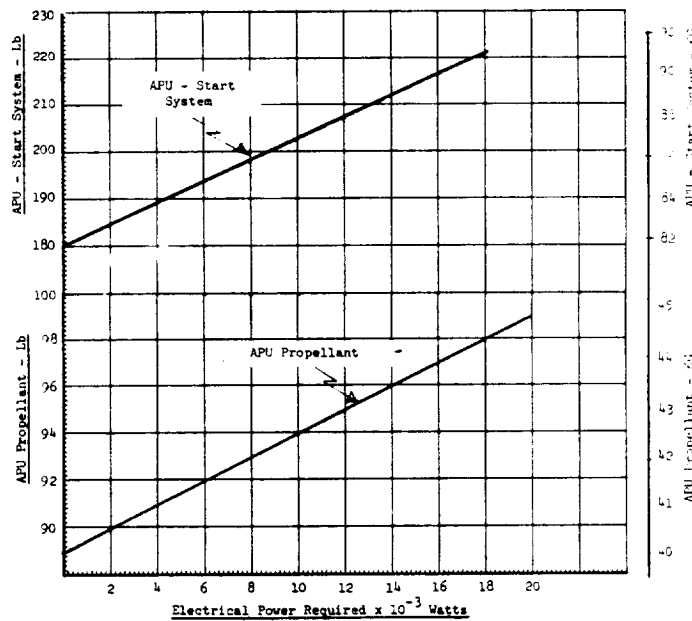

4.11.4.9 (U) Environmental Control System - From information available in the X-15 report and previous studies at MCAIR, an ECS weight of 250 lb (113.4 kg) has been developed. This weight includes nitrogen and helium tankage, pressure regulators and sealing, ducting, plumbing, controls and supports.

4.11.5 (U) USEFUL LOAD ESTIMATION - Weights for useful load items were based on fixed amounts derived for the HYFAC mission. One exception is vented trapped fuel which is varied as a function of LOX for rocket aircraft or LH<sub>2</sub> for airbreathing vehicles. The helium was sized by the total volume of propellant at takeoff.

4.11.5.1 (U) Crew Equipment - Based on the HYFAC mission and previous studies for a one man crew flying in this environment indicates a weight of 240 lb (108.9 kg). Included in this weight is the man and his provisions.

4.11.5.2 (U) Payload - A fixed weight of 1000 lb (453.6 kg) was allocated for payload for all HYFAC vehicles. The 1000 lb (453.6 kg) includes electronic gear to perform the desired research of the HYFAC mission.

4.11.5.3 (U) Vent Propellant - This is the amount of fuel which in the gaseous state is vented in order to maintain pressure equalization in the tanks. The following estimation was allocated for vented propellant:

$$\text{Rockets (LH}_2\text{/LOX)} = .005(W_{T\text{LOX}})$$

$$\text{Airbreathing (LH}_2\text{ only) Vehicles} = .02(W_{T\text{LH}_2})$$

4.11.5.4 (U) Helium Pressurization - This is the helium to pressurize and inert the propellant tanks. The helium is stored at 5 psi ( $3.347 \times 10^4 \frac{\text{N}}{\text{m}^2}$ ) at a temperature of 40°R (22.22°K). The following gas equation is used to determine the weight of the helium necessary:

$$N = \frac{PV}{ZRT}$$

where: P = 720 lb/ft<sup>2</sup> ( $3.347 \times 10^4 \frac{\text{N}}{\text{m}^2}$ )  
 V = Volume of Propellant - ft<sup>3</sup> (m<sup>3</sup>)  
 Z = 1.0 (compressibility factor)  
 R =  $386.2 \frac{\text{ft-lb}_f}{\text{lbm-R}^\circ}$  ( $2080 \frac{\text{m-N}}{\text{kg-}^\circ\text{K}}$ )  
 T = 40°R (22.22°K)  
 N = weight helium - lb (kg)

4.11.6 (U) APU FUEL - The APU fuel required is derived from the same sizing curves which sized the APU start system, see Figures 4-92 and 4-93. Two parameters were considered for sizing the amount of APU fuel needed. One increment is based on the electrical power required.

#### 4.12 FLIGHT RESEARCH FACILITY COSTS

(U) The development of total program costs for each flight research vehicle considered in Phase I are presented in the following sections:

(U) Six cost models were used for the flight research vehicle cost analysis, in order to distinguish between the operational differences of the vehicles. These differences are; control mode, launch concept, and recovery mode, as summarized in Figure 4-94.

(U) **FIGURE 4-94**  
**FLIGHT RESEARCH VEHICLE COST MODELS**

<u>Cost Model</u>	<u>Control Mode</u>	<u>Launch Concept</u>	<u>Recovery Mode</u>
(1)	Manned	HTO	Land Recovery
(2)	Manned	Air Launch	Land Recovery
(3)	Manned	VTO	Land Recovery
(4)	Unmanned	HTO	Land Recovery
(5)	Unmanned	Air Launch	Land Recovery
(6)	Unmanned	Staged	Land/Water Recovery

(U) All program costs are presented in a standardized format patterned after the formats presented in References 19 and 20 employing three major categories: RDT&E (Research, Development, Test, and Evaluation), Investment and Operating Costs. The RDT&E category covers the basic development of a flight research vehicle using a minimum cost-to-fly approach. The investment category contains the costs involved in production of the aircraft (usually 3 vehicles) and ancillary equipment for the flight research program. Finally, the operating category includes all costs involved in conducting the flight research program.

(U) The cost-estimating task of Phase I has provided some insight into the driving cost elements of a flight research program. A number of the significant factors contributing to the program costs are identified as:

(a) Air frame DCPR weight - A majority of the cost estimating relationships employed in the RDT&E and Investment cost categories are a direct function of the research vehicle DCPR weight. DCPR weight is defined as the empty weight of the airplane less (1) wheels, brakes, tires and tubes, (2) engines, (3) starter, (4) cooling fluid, (5) rubber or nylon fuel cells, (6) instruments, (7) batteries and electrical power supply and conversion equipment, (8) electronic equipment, (9) air conditioning units and fluid, (10) auxiliary power plant unit and, (11) trapped fuel and oil.

(b) Percentage of advanced materials used in the airframe - Advanced materials are approximately ten times more expensive than conventional materials and have a major effect on the cost of the thermal protection system. However, when employed



in the airframe structure the improved strength-to-weight properties of these advanced materials can result in reduced airframe size and weight and, possibly, a lower investment cost.

(c) Type of propulsion system employed - Rocket and ramjet propulsion systems are of lower cost than turbojet, turboramjet, scramjet and convertible scramjet propulsion systems. Engine development costs form a large part of the total program cost.

(d) Control mode - Unmanned vehicles in general are lighter in weight than corresponding manned vehicles. This weight decrease results in decreased airframe and miscellaneous subsystem costs. However, the cost of the additional avionic equipment required for unmanned vehicles tends to negate the effect.

4.12.1 (U) APPROACH AND DEFINITIONS - A cost format was selected which provides visibility to the significant program cost elements. Although the costs must be considered preliminary, the results are sufficiently accurate to assure valid comparisons of the candidate flight research vehicles. Program cost ground rules and assumptions, a summary of the historical cost background data used and definition of the cost format elements are discussed in the following sections.

4.12.1.1 (U) Costing Ground Rules and Assumptions - Program cost ground rules and assumptions were selected to effect economy while retaining reasonable design confidence, and to establish a basis for deriving the investment and operating costs. The ground rules and assumptions selected appear reasonable and consistent with past flight research programs.

(U) Ground Rules - Basic cost estimating ground rules adhered to throughout the HYFAC Phase I study are as follows:

- (a) Minimum cost-to-fly program (experimental shop approach similar to ASSET program).
- (b) Soft tooling.
- (c) Static and fatigue testing limited to element tests rather than full scale models.
- (d) Limited reliability program.
- (e) "Zero Defects" program not employed.
- (f) Limited pre-delivery flight test program.
- (g) Maximum use of existing equipment.
- (h) Maximum use of existing facilities.
- (i) Three flight research test vehicles in the program (similar to the X-15).
- (j) A separate flight hardware airframe is provided for structural testing.

- (k) Seven spare propulsion systems for each configuration (similar to X-15).
- (l) Five-year flight research program (similar to the X-15) for all configurations except the staged configurations. These configurations are allocated a two-year program.
- (m) HTO vehicle programs are allocated 225 total flights, with each vehicle performing 15 flights per year.
- (n) Air launched and VTO vehicle programs are allocated 180 total flights with each vehicle performing 12 flights per year. This assumes a lower utilization rate for these launch modes.
- (o) Staged vehicle programs are allocated 8 total flights distributed between the 3 vehicles.
- (p) All costs are in 1970 dollars and include allowance for prime contractor earnings of 10 percent.
- (U) Costing Assumptions - The following assumptions were used in the development of the program costs.
  - (a) For the VTO concepts, an additional vehicle would be required to be used in the pre-delivery flight test program for system verification and man rating. The vehicle would not be used in the operational test program and was priced at two-thirds of the investment cost of the manned vehicle.
  - (b) All flight research vehicles would be transported by air from the recovery sites to the launch sites.
  - (c) Edwards AFB would be the recovery site for all configurations with the exception of the Mach 6 staged configurations. Barksdale AFB would be the recovery site for these vehicles.
  - (d) The B-52 is used to launch the Mach 6 configurations while the C-5A is used to launch the Mach 12 configurations.
  - (e) SAC bases or Cape Kennedy would be used as launch sites for all configurations.
  - (f) Flight tests in the pre-delivery flight test program were not provided for the unmanned staged configurations.
  - (g) All vehicles would use their total propellant including reserves, during each mission.
  - (h) All vehicles would be refurbished at Edwards with the exception of the Mach 6 staged vehicles, which would be refurbished at Cape Kennedy.
  - (i) Thor launch vehicles would be used to launch the Mach 6 staged configurations while Atlas launch vehicles would be used to launch the Mach 12 staged configurations.

(j) Existing Thor and Atlas launch facilities at Cape Kennedy would be used for launching the Mach 6 and 12 staged configurations.

(k) Two launch aircraft would be provided for all air launch configurations.

4.12.1.2 (U) Historical Cost Background - Both MCAIR and external historical cost background data sources were used in the cost analysis study. MCAIR historical background sources included the F-4, XF-85, XF-88, XF-2H, XF-3H, XFD-1, Model 119, ASSET, BGRV, Mercury, and Gemini programs while the external sources include the X-15, HL-10, PRIME and DYNASOAR programs. Of the four external sources used, the X-15 program provided the most applicable type of information. Two X-15 reports (References 20 and 21) proved extremely helpful in the cost analysis, especially in the development of operating costs. In addition to this historical cost data, cost background data was obtained from applicable MCAIR and external studies (References 22, 23 and 24). Also, cost data obtained from GE, Pratt & Whitney, Marquardt and North American Rocketdyne was used in the development of propulsion RDT&E and investment costs.

4.12.1.3 (U) Definition of Cost Model Categories and Elements - Program costs are divided into three cost categories each containing a number of elements as follows: (1) RDT&E, (Research, Development, Test, and Evaluation), (2) Investment, and (3) Operating.

(U) The RDT&E cost category consists of 6 cost elements: (1) Airframe Design and Development, (2) Tooling, (3) Avionics Development, (4) Propulsion Development, (5) Support Equipment Design and Systems Integration, and (6) Ground Test Facilities. The Airframe Design and Development cost element consists of 5 sub-elements: (A) Airframe Design, (B) Miscellaneous Subsystems Design and Development, (C) Development Tests (including wind tunnel), (D) Test Hardware, and (E) Pre-Delivery Flight Test.

(U) The Investment cost category consists of 4 cost elements: (1) Flight Vehicles, (2) Support Costs, (3) Launch Platform Costs and (4) Launch Vehicle Costs. The Flight Vehicle element is broken down into 4 sub-elements: (A) Airframe, (B) Miscellaneous Subsystems, (C) Propulsion and (D) Avionics. Support costs include AGE, Training Equipment, Initial Stocks, Initial Training and Initial Transportation.

(U) The Operating cost category consists of 10 cost elements: (1) Range User Costs, (2) Escort Aircraft and Logistics, (3) Vehicle Refurbishment Costs, (4) Propellant Costs, (5) AGE Maintenance, (6) General Purpose Maintenance Support (7) Transportation Costs, (8) Pilot Pay and Support Personnel Pay, (9) Launch Platform Operating Costs and (10) Launch Service Costs.

4.12.1.3.1 (U) RDT&E Cost Elements and Definitions

(1) Airframe Design and Development - Includes: airframe design, miscellaneous subsystem design and development, development tests, test hardware and pre-delivery flight test costs.

- (A) Airframe Design - Includes the cost of the design engineering effort for the basic structure and for the integration of the following associated items: landing gear, secondary power, environmental control, crew escape, propulsion and flight control equipment, furnishings, flight control equipment, furnishings and equipment and other airborne equipment.
- (B) Miscellaneous Subsystem Design and Development - Includes the vendor and contractor development costs for propellant distribution and pressurization, power supply, hydraulic, electrical, auxiliary power, cockpit furnishings, flight controls and environmental control system.
- (C) Development Tests (Includes Wind Tunnel) - Includes the cost of low speed, polysonic and hypersonic wind tunnel tests conducted and the associated material and labor costs. Also, the following ground tests are included:
- o Structural static test of the entire aircraft (structural test vehicle included in cost of this test element)
  - o Pressurization fatigue test of the cockpit section
  - o Fuel system tests
  - o Structural and material development tests
  - o Bench tests and other miscellaneous tests
  - o Dynamic tests
- (D) Test Hardware - Includes the experimental construction effort required for the fabrication of test hardware and associated material cost.
- (E) Pre-Delivery Flight Tests - Includes engineering and technician labor cost, travel and per diem allowances, pilot compensation, material costs, propellant costs, vehicle transportation costs and launch platform operating costs. Flight checkout will be sufficient to determine air worthiness of the aircraft.
- (2) Tooling - Includes the labor and material costs associated with the soft tooling required to build the flight test research vehicle airframe. Also, includes the tooling required for the launcher where applicable.
- (3) Avionics Development - Includes the cost of design, development hardware, and tooling required to integrate the guidance, navigation, communication, and flight instrument systems in the research vehicle.
- (4) Propulsion Development - Includes the cost of design engineering testing hardware, materials, fuels, and tooling required for a new propulsion system. For off-the-shelf propulsion systems, only the cost of integrating the propulsion system(s) into the airframe are considered.

(5) Support Equipment Design and Systems Integration - Includes the design costs of the equipment used in the maintenance shops, the ground handling equipment, and the system checkout equipment. Also includes the cost of integrating the research instrumentation package with the flight research vehicle and safety studies.

(6) Ground Test Facilities - Includes the modification of existing facilities and the cost of new facilities required for the flight test research vehicle. Wind tunnels, propulsion test facilities and structural test facilities are included in this category. It was found that the only facilities required for the HYFAC program were those associated with the propulsion system development.

#### 4.12.1.3.2 (U) Investment Cost Elements and Definitions

(1) Flight Vehicles - Includes the cost of liaison engineering, manufacturing labor, materials, quality control and procurement and installation costs associated with contractor GFE and subcontracted items for the following subsystems:

- (A) Airframe
- (B) Miscellaneous Subsystems - Includes the auxiliary power unit, instruments, hydraulic systems, electrical system, cockpit furnishings, air conditioning, nose landing gear, main landing gear, fuel system and engine controls.
- (C) Propulsion
- (D) Avionics

(2) Support Costs - Includes the cost of soft tooling, liaison engineering, manufacturing labor, materials, quality control and procurement and installation costs associated with GFE and subcontracted items for the following categories:

- (A) AGE
- (B) Training Equipment
- (C) Initial Stocks - Includes spare engines and AGE spares.
- (D) Initial Training - Includes training costs associated with the test pilots.
- (E) Initial Transportation - Includes the transportation costs associated with transporting the vehicle refurbishment material, propellants, AGE, AGE spares, training equipment and engine spares from the point of manufacture to the flight test center or launch area.

(3) Launch Platform Costs - Includes the cost to modify the launch vehicle(s) (aircraft, booster, pad, etc.) required to launch the flight research vehicles.

(4) Launch Vehicle Cost - Includes the cost of the Thor and Atlas launch vehicles required for the staged VTO configurations.

4.12.1.3.3 (U) Operating Cost Elements and Definitions

(1) Range User Cost - Includes the range operating cost and the base engineering and fire protection costs.

(2) Escort Aircraft and Logistics - Includes the Petroleum, Oil, and Lubricants (POL), maintenance and crew costs incurred for the chase, search and rescue aircraft required to support the flight research program.

(3) Vehicle Refurbishment - Includes the labor and material cost associated with the refurbishment of the flight test research vehicles.

(4) Propellant Cost - Includes the cost of the fuels and oxidizers required to support the flight research test program.

(5) AGE Maintenance - Includes the labor cost to maintain the AGE.

(6) General Purpose Maintenance Support - Includes the pro rata share of the labor and material costs associated with the maintenance of the flight test research center facilities.

(7) Transportation Costs - Includes the cost to transport the flight research test vehicles from the recovery site to the launch site.

(8) Pilot Pay and Support Personnel Pay - Includes the pay of the flight research test pilots and the support personnel. Support personnel includes the research, data system, quality assurance, administrative and biomedical personnel at the flight research center.

(9) Launch Platform Operating Cost - Includes the launch aircraft operating costs, namely, POL and maintenance.

(10) Launch Service Cost - Includes the cost to assemble, check out, fuel and launch the launch vehicles (Thor and Atlas) and the flight research vehicles at the launch site.

4.12.2 (U) ESTIMATING PROCEDURES AND PROGRAM COST DEVELOPMENT - Cost estimating relationships (CERS) together with the cost data and parameters used to develop the total program costs are summarized in Figure 4-95. The ground rules and assumptions presented in Section 4.12.1.1 were used as a basis for the generation of the data presented in Figure 4-95. The "configurations" notation shown in Figure 4-95 refers to a particular research vehicle considered in Phase I. A summary description of each vehicle is presented in Figure 4-96 for ease of reference.

(U) The following sections present the methods of applying the CERS and cost data in developing the cost elements for each vehicle along with the costs resulting from the application of these methods. The cost elements are consolidated to obtain total program costs and are summarized in Section 4.12.4.

COST ESTIMATING RELATIONSHIPS AND DATA SUMMARY

Cost Categories and Cost Elements	Cost Estimating Relationships and Data Employed		La 20 25 25	
	Launch Mode Control Mode Recovery Mode	Relationships and Data Used		Figures Used and Comments ①
	Configurations			
<b>I. RDT&amp;E Costs</b>				
<b>1. Airframe Des. &amp; Dev.</b>				
<b>A. Airframe Des. (Engr.)</b>				
		Total DCPR Weight, \$/Lb., Mach No., Material Density	Fig. 4-99. Engr. Price Per Lb. vs DCPR Weight	
<b>B. Misc. Subsystem Des. &amp; Dev.</b>				
<b>a. Subsystem Des. (Engr.)</b>				
Combined with Airframe Engr. and Computed in Total				
<b>b. Equipment Development</b>				
		Eq. Wt. x \$/Lb. x Rate Factors	Fig. CFE Cost Summary	
<b>C. Development Testing</b>				
Combined with Airframe Engr. and Misc. Subsystem Engr. and Computed in Total				
<b>D. Test Hardware</b>				
<b>E. Pre-Delivery Flight Test</b>				
<b>a. Engineering</b>				
		\$/Man hr x No. of Man hr. Required	Man hr. Based on F-4 Experience	
<b>b. Production</b>				
		\$/Man hr. x No. of Man hr. Required	Man hr. Based on F-4 Experience	
<b>c. Material</b>				
		F-4 Matl x Ratio of Total \$/Lb to Base \$/Lb. x Proc. Exp. Factor x G&A Factor	None G&A Factor = 1.138	
<b>d. Travel &amp; Per Diem</b>				
		F-4 Dollars x Econ. Adj. Factor x G&A Factor	None Econ. Adj. Factor = 1.710 G&A Factor = 1.138	
<b>e. Pilot's Salary</b>				
		F-4 Dollars x Econ. Adj. Factor x G&A Factor	None Econ. Adj. Factor = 1.710 G&A Factor = 1.138	
<b>f. Propellants</b>				
		\$/Lb x Lb/Flt x No. of Flts	None	

① Figures not numbered are not shown in the report, but are contained in the work substantiation notebook.

✓ Indicates applicable

- Indicates not applicable

Abbreviations: TOGW - Takeoff Gross Weight      Flt - Flight      CSJ - Convertible Scramjet      G&A - General and Av  
 OWE - Operational Weight Empty      LPM - Launches Per Month      OX - Oxidizer      NMPR - Number of Main  
 Rkt - Rocket      Ref - Reference      Veh - Vehicle      Dol - Dollars  
 No. - Number      Yr - Year      Hr - Hours      Engr - Engineering  
 F-4 - Phantom Actt.

Cost Models					
1	2	3	4	5	6
HTO anned Recovery	Air Manned Land Recovery	VTO Manned Land Recovery	HTO Unmanned Land Recovery	Air Unmanned Land Recovery	Staged VTO Unmanned Land/ Water Recovery
10,213,214, 50J2S,251 33,254,255, 56,257	205, 207, 232, 233, 234	270, 271	285	204, 284	220, 221, 280, 281, 282
√	√	√	√	√	√
√	√	√	√	√	√
√	√	√	√	√	√
√	√	√	√	√	√
√	√	√	√	√	√
√	√	√	√	√	√
√	√	√	√	√	√
√	√	√	√	√	√
√	√	√	√	√	√
√	√	√	√	√ (Carrier Acft Only)	√
√	√	√	√	√	√

6
Staged VTO Unmanned Land/ Water Recovery
220, 221, 280, 281, 282
√
√
√
-
-
√ Config. 280 Only
-
-
√ Config. 282 Only
√ Configs. 220 & 221 Only
√
-

Administrative  
Finance Personnel

Proc - Procurement  
K - Thousand  
Inv - Investment  
CFE - Contractor Furnished Equipment

Config - Configuration  
Rd - Round  
DCPR - Defense Contractor Progress Report  
Eq - Equipment  
M - Million

Contractor Progress Report



FOLDOUT FRAME 1

(U) FIGURE 4-95 (Continued)  
 COST ESTIMATING RELATIONSHIPS AND DATA SUMMARY

Cost Categories and Cost Elements	Cost Estimating Relationships and Data Employed			1 HT Manr Land Re 200,210. 250,250. 252,253. 256
	Launch Mode Control Mode Recovery Mode	Relationships and Data Used	Figures Used and Comments ①	
	Configurations			
I. RDT&E Costs (Continued)				
B. Ramjet		\$8,000,000	Obtained from MDC GED Facilities Personnel	✓ Config.
C. CSJ/SJ		\$50,000,000		✓/Config 255 & 2
D. Turboramjet (LH <sub>2</sub> )		\$5,000,000		✓/Config 210 C
E. Rocket		None		-
II. Investment Costs				
1. Flight Vehicles				
A. Airframe				
a. Labor		Total DCPR Wt \$/Lb Weighted Complexity	Fig. 4-107. Production Price/Lb vs DCPR Weight	✓
b. Material		Total DCPR Wt x Matl Cost (\$/Lb) by Material Type	None	✓
B. Misc Subsystems				
a. Labor		Combined with Airframe Labor and Computed as a Total Labor Cost		✓
b. Material		Combined with Airframe Material and Computed as a Total Material Cost		✓
c. Equipment		\$/Lb x Eq. Wt. x Rate Factors	Fig. 4-117. Equip. Cost Summary Used as Example.	✓
C. Propulsion				
a. J2S Rocket		\$2,500,000	N.A. Rocketdyme Estimate	✓/Conf 250J2S
b. Turboramjet		\$/Lb of Sea Level Thrust	Fig. 4-106. Turboramjet Prop. Costs	✓/Conf 200 & 21

① Figures not numbered are not shown in the report, but are contained in the work substantiation notebook.

- ✓ Indicates applicable
- Indicates not applicable

Abbreviations: TOGW - Takeoff Gross Weight  
 OWE - Operational Weight Empty  
 Rkt - Rocket  
 No. - Number  
 F-4 - Phantom Acft.

Flt - Flight  
 LPM - Launches Per Month  
 Ref - Reference  
 Yr - Year

CSJ - Convertible Scramjet  
 OX - Oxidizer  
 Veh - Vehicle  
 Hr - Hours

G&A - General and Admin  
 NMPR - Number of Mainten  
 Dol - Dollars  
 Engr - Engineering

FOLDOUT FRAME 2

Cost Models					
	2	3	4	5	6
Category	Air Manned Land Recovery	VTO Manned Land Recovery	HTO Unmanned Land Recovery	Air Unmanned Land Recovery	Staged VTO Unmanned Land/Water Recovery
3,214, 3,251, 4,255, 4,257	205, 207, 232, 233, 234	270, 271	285	204, 284	220, 221, 280, 281, 282
13 Only	√ Config. 207 Only	-	-	-	√ Configs. 220 & 221 Only
254,	√ Config. 232 Only	√ Config. 271 Only	-	-	√ Config. 280 Only
ly	√ Config. 205 Only	-	-	√ Config. 204 Only	-
	-	-	-	-	-
	√	√ Manned Config.	√	√	√
	√		√	√	√
	√	√ Manned Config.	√	√	√
	√		√	√	√
	√		√	√	√
only	-	-	-	-	-
Only	√ Config. 205 Only	-	-	-	-

	6
Category	Staged VTO Unmanned Land/Water Recovery
284	220, 221, 280, 281, 282
	√ Config. 280 Only
	-
4 Only	-
	√ Config. 282 Only
	√ Configs. 220 & 221 Only
	√
	√
	√
	√
	√
	√
	√

Administrative Personnel

Proc - Procurement  
K - Thousand  
Inv - Investment  
CFE - Contractor Furnished Equipment

Config - Configuration  
Rd - Round  
DCPR - Defense Contractor Progress Report  
Eq. - Equipment  
M - Million

ration

Contractor Progress Report  
ent  
s

FOLDOUT FRAME I

(U) FIGURE 4-95 (Continued)  
COST ESTIMATING RELATIONSHIPS AND DATA SUMMARY

Cost Categories and Cost Elements	Cost Estimating Relationships and Data Employed		La 200 250 251 255	
	Launch Mode Control Mode Recovery Mode	Relationships and Data Used		Figures Used and Comments ①
	Configurations			
II. Investment Cost (Continued) E. Initial Transportation		2% x Σ AGE, AGE Spares, Eng. Spares, Refurb. Mat., Propellant and Training Eq. Costs.	2% Factor Obtained from Rpt. MAC F666, Vol. 10.	
3. Launch Platform Cost A. C-5A/B-52 Pod Installation		\$75/Lb x Flt Vehicle (TOGW)	Based on B-52 Mod. for X-15 Program	
B. VTO Launcher		\$1,000,000 Per Launcher	Based on Internal Est. & NA Rpt. 67-789, Vol. 9	
4. Launch Vehicle Cost A. Thor		0.5M Dol. x No. of Thors	Based on Douglas Estimate	
B. SLV-3		1.65M Dol. x No. of SLV-3's	Based on GD Estimate	
III. Operating Costs				
1. Range User Cost				
A. Range Operating Cost		21.5K Dol./Flt. x No. of Flts.	Based on X-15 Program and Escalated to 1970 Econ.	
B. Base Engr. Support		No. of Yr. x 25.31K Dol./Yr.		
2. Escort Act & Logistics		11.5K Dol./Flt. x No. of Flts.		
3. Vehicle Refurbishment Cost		1.5%-2.5% x Flt. Veh. Inv. Cost	1.5% (Mach 4.5), 2.0% (Mach 6.0), 2.5% (Mach 12.0)	
4. Propellant Cost A. LH <sub>2</sub>		\$0.1385/Lb. x 1.5 (Utilization Factor) x Lb. of Fuel Req./Flt. x No. of Flts.	Based on Internal Data Ref. Inter-Office Memo, Memo No. 69-529, 5 Aug. '69.	

① Figures not numbered are not shown in the report, but are contained in the work substantiation notebook.

- ✓ Indicates applicable
- Indicates not applicable

Abbreviations: TOGW - Takeoff Gross Weight      Flt - Flight      CSJ - Convertible Scramjet      G&A - General and A  
 OWE - Operational Weight Empty      LPM - Launches Per Month      OX - Oxidizer      NMPR - Number of Ma  
 Rkt - Rocket      Ref - Reference      Veh - Vehicle      Dol - Dollars  
 No. - Number      Yr - Year      Hr - Hours      Engr - Engineering  
 F-4 - Phantom Actt.

FOLDOUT FRAME 2

FRAME 2

Cost Models					
1	2	3	4	5	6
HTO Manned Land Recovery	Air Manned Land Recovery	VTO Manned Land Recovery	HTO Unmanned Land Recovery	Air Unmanned Land Recovery	Staged VTO Unmanned Land/Water Recovery
10,213,214 50J2S, 52,253,254, 56,257	205, 207, 232, 233, 234	270, 271	285	204, 284	220, 221, 280, 281, 282
√	√	√	√	√ Less Training Eq.	√
-	√	-	-	√	-
-	-	√	-	-	-
-	-	-	-	-	√ Configs. 220 & 221 Only
-	-	-	-	-	√ Configs. 280, 281 & 282
√	√	√	√	√	√
√	√	√	√	√	√
√	√	√	√	√	√
√	√	√	√	√	√
fig. 210, 213, 50,250J2S, 52,254, and 257	√	√	√	√	√

6
Staged VTO Unmanned Land/Water Recovery
220, 221, 280, 281, 282
√ Config. 281 Only
-
√ Config. 282 Only
√ Config. 282 Only
√
√
-
-
√ Configs. 220 & 221 Only
-
-
√ Configs. 280, 281, & 282

Administrative  
Maintenance Personnel

Proc - Procurement  
K - Thousand  
Inv - Investment  
CFE - Contractor Furnished Equipment

Config - Configuration  
Rd - Round  
DCPR - Defense Contractor Progress Report  
Eq. - Equipment  
M - Million

Contractor Progress Report

(U) FIGURE 4-95 (Continued)  
COST ESTIMATING RELATIONSHIPS AND DATA SUMMARY

Cost Categories and Cost Elements	Cost Estimating Relationships and Data Employed		Lar 200 250 252	
	Launch Mode Control Mode Recovery Mode	Relationships and Data Used		Figures Used and Comments ①
	Configurations			
III. Operating Costs (Continued)				
8. Pilot Pay and Support Per Pay				
A. Pilot Pay		4 Pilots Per Yr. x 50K Dol./ Pilot x 5 Yrs.	No. of Pilots Per Yr Based on X-15 Program. Pilot Pay Based on Lockheed Rpt. LR-21042.	
B. Support Per Pay		2 NMPR x 20K Dol./Yr. x No. 11 NMPR = (50 + 20 LPM) (TPGW/344,000) <sup>0.33</sup>	Based on Lockheed Rpt. LR-21042 and X-15 Program.	
9. Launch Platform Op. Cost				
A. C-5A		\$12,700/Fit. x No. of Flts.	Based on \$1284 Fly. Hr. Obtained from AFM-172-3	
B. B-52		\$13,800/Fit. x No. of Flts.	Based on \$1396 Fly. Hr. Obtained from AFM-172-3	
C. VTO Launcher		5% x Launcher Inv. Cost x No. of Yr.	Based on Rand Rpt. RM-630	
10. Launch Service Cost				
A. Thor		0.195K Dol. x No. of Flts.	Based on Douglas Estimate	
B. SLV-3		0.2479K Dol. x No. of Flts.	Based on GD Estimate	

① Figures not numbered are not shown in the report, but are contained in the work substantiation notebook.

✓ Indicates applicable

- Indicates not applicable

Abbreviations: TOGW - Takeoff Gross Weight  
OWE - Operational Weight Empty  
Rkt - Rocket  
No. - Number  
F-4 - Phantom Acft.

Flt - Flight  
LPM - Launches Per Month  
Ref - Reference  
Yr - Year

CSJ - Convertible Scramjet  
OX - Oxidizer  
Veh - Vehicle  
Hr - Hours

G&A - General and  
NMPR - Number of Ma  
Dol - Dollars  
Engr - Engineering

## FOLDOUT FRAME 2

Cost Models					
1	2	3	4	5	6
HTO anned Recovery	Air Manned Land Recovery	VTO Manned Land Recovery	HTO Unmanned Land Recovery	Air Unmanned Land Recovery	Staged VTO Unmanned Land/ Water Recovery
10,213,214, 50J2S,251, 53,254,255, 56,257	205, 207, 232, 233, 234	270, 271	285	204, 284	220, 221, 280, 281, 282
√	√	√	√	-	√
√	√	√	√	√	√
-	√ Configs. 232,233,234	-	√	-	-
-	√ Configs. 205 & 207 Only	-	-	√ Config. 204 Only	-
-	-	√	-	-	-
-	-	-	-	-	√ Configs. 220 & 221 Only
-	-	-	-	-	√ Configs. 280, 281 & 282

Administrative  
Personnel

Proc - Procurement  
K - Thousand  
Inv - Investment  
CFE - Contractor Furnished Equipment

Config - Configuration  
Rd - Round  
DCPR - Defense Contractor Progress Report  
Eq. - Equipment  
M - Millions

(U) FIGURE 4-96  
 FLIGHT RESEARCH FACILITY CONCEPTS

MANNED					
Design mach	Launch mode	Propulsion type	Fuel	Configuration	
				Wing Body	All Body
.9	HTO	TJ	JP		-291
2.0	HTO	TJ	JP	-290(VST)	-292
4.5	HTO	TRJ	JP	-200	-201
6+	AIR	TRJ RKT/RJ	LH <sub>2</sub> LH <sub>2</sub>	-205	-206 -207
	HTO	TRJ TJ/RJ RKT/RJ RKT	LH <sub>2</sub> LH <sub>2</sub> LH <sub>2</sub> LH <sub>2</sub>	-210 -212	-211 -213 -214
12	AIR	TJ/CSJ RKT/CSJ RKT	LH <sub>2</sub> LH <sub>2</sub> LH <sub>2</sub>	-234	-231 -232 -233
	HTO	RKT RKT RKT RKT/CSJ TJ/CSJ	LH <sub>2</sub> AERO 50 RP LH <sub>2</sub> LH <sub>2</sub>	-251 -256 -256H1D -255 -257	-250,-252,250(J2S) -253 -254
	VTO	RKT RKT/CSJ	LH <sub>2</sub> LH <sub>2</sub>		-270 -271
UNMANNED					
6+	STAGED AIR	RH TRJ	LH <sub>2</sub> LH <sub>2</sub>	-204	-220,-221
12	STAGED	CSJ RKT RKT	LH <sub>2</sub> LH <sub>2</sub> AERO 50		-280 -281 -282
	AIR HTO	RKT RKT	LH <sub>2</sub> LH <sub>2</sub>		-284 -285

4.12.2.1 (U) RDT&E Cost Development - A detailed explanation of the methods used to develop the program RDT&E cost elements is presented in the following sections. Costs have been developed applying the appropriate MCAIR labor and overhead rates for the 1969 time period and adding earnings. These 1969 dollars were then adjusted to 1970 economics. Propulsion equipment is assumed to be GF&E or supplied by an associate contractor; thus general and administrative expense, procurement expense and profit for the prime contractor are not applied to the costs. Figure 4-97 summarizes the RDT&E costs associated with the airframe and miscellaneous subsystems for the Phase I flight research vehicles.

4.12.2.1.1 (U) Airframe Design and Development - The airframe design and development cost consists of the following elements:

- (A) Airframe Design
- (B) Miscellaneous Subsystem Design
- (C) Development Tests
- (D) Test Hardware
- (E) Pre-Delivery Flight Test

Elements A, B and C were combined in Phase I and estimated in total.

(U) DCPR weight and material distribution as shown in Figure 4-95 were used to develop the airframe and miscellaneous subsystems design and development costs. Materials were divided into two categories: (1) advanced, and (2) conventional. Advanced materials include: Cb, TD N<sub>i</sub> C<sub>r</sub>, Rene' 41, Ti and ablative materials. Conventional materials include: aluminum, steel and insulation.

(U) Airframe Design and Development Tests - Figure 4-98 was used in the development of the engineering manhours per pound required for the design and development of the HYFAC airframe configurations.

(U) Parallel lines were fitted to the data generated for the various vehicle Mach number categories shown in Figure 4-98 and the vertical distance between any two lines is defined as the increased engineering complexity created by higher speeds. The hard point data used to develop these curves is contained in Figure 2-10 of Volume V. The manhours per lb versus speed reference line was used to generate the parallel lines shown in Figure 4-98. For example, the Mach .8 line was generated by projecting vertically up from the 609 m.p.h. (980 km/hr) horizontal speed scale to the manhours per lb versus speed reference line. At the point of intersection, a line is drawn parallel to the abscissa to the point of intersection of a line drawn vertically from the 10,000 lb (4,536 kgs) DCPR weight point on the horizontal scale. A straight line is then drawn through the point of intersection using a 70% slope. The lines for the remaining Mach numbers shown were computed in a similar fashion. With the addition of provisions for carry-on engineering and manufacturing support of engineering, these curves were converted to cost per pound in Figure 4-99. A material density of 0.110 lb/in.<sup>3</sup> (.003 kg/cm<sup>3</sup>) is assumed as a representative average for the subsonic experimental aircraft data point and is judged to be representative for the research vehicles being studied, in view of the large use of aluminum employed in their structural design. Thus, the orbital/sub-orbital data points shown in Figure 2-10 were adjusted to a 0.110 material density. This was accomplished by dividing the vehicle's actual density by the 0.110 density and multiplying the actual engineering manhours/lb data points by this factor.



FOLDOUT FRAME 1

FOLDOUT FRAME 2

(U) FIGURE 4-97  
AIRFRAME CHARACTERISTICS AND COSTS

Config- uration No.	Type of Configuration	Launch Mode	Control Mode	Mach No.	Basic Structure					Shingles				Nose Cone Weight (Lb)	Insulation Weight (Lb)	Foam Weight (Lb)	Wick Weight (Lb)	Equipment Weight (Lb)		Total Empty Weight (Lb)	DCPR Weight (Lb)	OWE (Lb)	TOGW (Lb)	Airframe and Misc. Subsystem Cost (Millions of Dollars)	
					Material Weight (Lb)					Material Weight (Lb)								Fixed	Variable					RDT&E	Investment
					Alum.	Steel	Titanium	Cb	Other	Titanium	Rene-41	TD-N-CR	Cb												
200	Wing Body	HTO	Manned	4.5	4,837	2,257	3,205	-	120	273	-	-	50	241	-	-	1,980	5,195	18,139	14,313	19,922	25,503	64,288	9,880	
204	Wing Body	Air	Unmanned	6.0	3,532	3,779	1,400	1,900	201	650	735	-	80	904	480	-	1,710	5,494	20,925	16,097	22,400	25,079	62,847	17,113	
205	Wing Body	Air	Manned	6.0	3,577	3,779	1,400	1,900	201	650	735	-	80	904	480	-	1,825	5,494	21,085	16,590	23,000	25,740	64,888	18,544	
207	All Body	Air	Manned	6.0	2,874	3,167	3,500	2,760	210	1,135	264	-	80	1,140	170	-	1,755	5,885	22,920	18,682	24,800	43,000	71,165	17,166	
210	Wing Body	HTO	Manned	6.0	6,767	3,490	5,546	4,670	828	970	780	-	80	1,290	710	-	1,825	7,772	34,728	28,882	36,450	41,450	90,228	24,289	
213	All Body	HTO	Manned	6.0	5,406	2,827	2,860	3,995	859	820	970	-	80	1,050	560	-	1,825	7,218	28,470	23,060	30,300	64,860	83,621	19,488	
214	All Body	HTO	Manned	6.0	5,040	2,066	966	-	728	770	903	-	80	745	403	-	1,755	3,329	16,790	14,802	18,500	45,850	76,189	12,261	
220	All Body	Boost VTO	Unmanned	6.0	2,551	1,693	900	970	43	234	216	-	80	570	128	-	1,005	3,040	11,430	9,437	12,800	13,230	54,676	8,343	
221	All Body	Boost VTO	Unmanned	6.0	2,804	1,700	900	970	43	244	236	-	80	570	128	-	1,005	3,040	11,720	9,727	13,090	13,530	55,915	8,532	
232	All Body	Air	Manned	12.0	5,270	4,351	570	-	210	473	183	302	1,340	150	368	501	64	1,755	5,888	21,430	17,370	23,900	69,700	111,974	16,653
233	All Body	Air	Manned	12.0	5,259	3,619	584	-	212	483	197	312	1,390	150	382	501	72	1,755	4,499	19,415	16,808	21,980	74,780	110,070	16,787
234	Wing Body	Air	Manned	12.0	6,727	5,237	830	-	204	575	260	395	2,315	150	585	825	101	1,755	4,871	24,830	22,058	27,900	96,050	121,140	22,430
250	All Body	HTO	Manned	12.0	7,249	5,326	750	-	1,357	714	282	435	2,065	150	569	781	110	1,755	6,447	27,990	24,353	31,000	130,040	133,616	21,550
250J2S	All Body	HTO	Manned	12.0	11,338	7,285	910	-	1,670	880	335	520	2,480	150	680	930	120	1,755	9,147	38,180	33,364	42,580	194,280	157,143	26,669
251	Wing Body	HTO	Manned	12.0	10,174	6,712	966	-	1,527	670	300	460	2,720	150	675	965	130	1,755	7,176	34,370	30,839	37,840	148,640	149,216	25,296
252	All Body	HTO	Manned	12.0	6,443	5,946	940	-	1,420	677	282	435	2,190	150	582	273	101	1,755	6,924	28,118	24,453	31,700	132,380	128,871	22,542
253	All Body	HTO	Manned	12.0	11,005	10,468	2,640	-	2,548	200	600	280	2,500	200	855	940	160	1,505	12,029	45,930	38,876	50,200	314,900	167,362	29,637
254	All Body	HTO	Manned	12.0	7,542	7,746	780	-	1,397	725	286	442	2,100	150	575	800	100	1,775	9,027	33,445	27,287	36,400	135,180	138,242	22,702
255	Wing Body	HTO	Manned	12.0	10,965	10,224	950	-	1,750	745	322	503	2,960	150	740	600	130	1,325	12,536	43,900	35,373	48,000	176,400	155,597	27,291
256	Wing Body	HTO	Manned	12.0	11,038	6,750	1,020	-	3,004	580	252	390	2,300	150	660	415	130	1,775	8,436	36,900	32,647	41,420	248,420	164,631	22,753
257	Wing Body	HTO	Manned	12.0	12,922	15,010	1,515	-	1,135	730	330	505	2,980	150	1,350	1,050	125	1,705	14,793	54,305	41,810	58,000	80,200	168,060	28,115
270	All Body	VTO	Manned	12.0	8,412	5,525	888	-	221	740	280	450	2,140	150	590	290	115	1,755	6,839	28,395	24,698	31,600	144,500	131,579	22,536
271	All Body	VTO	Manned	12.0	9,104	8,868	1,020	-	1,539	780	306	475	2,260	150	620	845	110	1,755	10,203	38,035	31,123	41,280	165,360	148,057	24,549
280	All Body	Boost VTO	Unmanned	12.0	2,525	2,212	170	-	27	54	114	175	537	150	135	95	24	975	3,612	10,805	8,322	12,410	12,830	77,473	8,638
281	All Body	Boost VTO	Unmanned	12.0	2,501	1,461	170	-	26	50	110	175	535	150	130	93	24	975	2,875	9,275	7,866	10,880	13,020	78,470	8,504
282	All Body	Boost VTO	Unmanned	12.0	4,226	1,562	240	-	32	30	90	200	570	150	170	115	28	725	3,517	11,655	9,771	13,360	17,310	93,927	8,671
284	All Body	Air	Unmanned	12.0	5,145	3,606	580	-	61	480	195	310	1,385	150	380	500	70	1,305	5,323	19,490	16,565	21,680	73,780	108,850	16,910
285	All Body	HTO	Unmanned	12.0	7,417	5,266	740	-	1,206	700	280	432	2,060	150	560	770	97	1,060	7,247	27,935	24,032	30,700	128,700	131,850	21,918

① Does not include 450 lb of ballast.

FOLDOUT FRAME 1

FOLDOUT FRAME 2

(U) FIGURE 4-97 (Continued)  
AIRFRAME CHARACTERISTICS AND COSTS  
(INTERNATIONAL SYSTEM OF UNITS)

Configuration	Type of Configuration	Launch Mode	Control Mode	Mach No.	Basic Structure					Shingles				Nose Cone Weight (kg)	Insulation Weight (kg)	Foam Weight (kg)	Wick Weight (kg)	Equipment Weight (kg)		Total Empty Weight (kg)	DCPR Weight (kg)	OWE (kg)	TOGW (kg)	Airframe and Misc. Subsystems Cost (Millions of Dollars)	
					Material Weight (kg)					Material Weight (kg)								Fixed	Variable					RDT&E	Investment
					Alum.	Steel	Titanium	Cb	Other	Titanium	Rene 41	TD-N-CR	Cb												
200	Wing Body	HTO	Manned	4.5	2,194	1,024	1,454	-	54	124	-	-	23	109	-	-	889	2,357	8,228	6,492	9,036	11,568	64,288	9,880	
204	Wing Body	Air	Unmanned	6.0	1,602	1,714	662	862	91	295	333	-	36	410	218	-	776	2,492	9,491	7,302	10,160	11,376	62,847	17,113	
205	Wing Body	Air	Manned	6.0	1,623	1,714	662	862	91	295	333	-	36	410	218	-	828	2,492	9,564	7,525	10,433	11,675	64,888	18,544	
207	All Body	Air	Manned	6.0	1,304	1,437	1,588	1,252	95	515	120	-	36	517	77	-	796	2,660	10,396	8,474	11,249	19,504	71,166	17,166	
210	Wing Body	HTO	Manned	6.0	3,059	1,583	2,516	2,118	376	440	354	-	36	585	322	-	828	3,525	15,752	13,101	16,533	18,801	90,228	24,289	
213	All Body	HTO	Manned	6.0	2,452	1,282	1,297	1,812	390	372	440	-	36	476	254	-	828	3,274	10,460	13,744	29,420	29,420	83,621	19,488	
214	All Body	HTO	Manned	6.0	2,286	937	438	-	330	349	412	-	36	338	183	-	796	1,510	7,616	6,714	8,391	20,797	76,189	12,261	
220	All Body	BoostVTO	Unmanned	6.0	1,157	768	408	440	20	106	98	-	36	259	58	-	456	1,379	5,185	4,281	5,806	6,001	54,676	8,343	
221	All Body	BoostVTO	Unmanned	6.0	1,272	771	408	440	20	111	107	-	36	259	58	-	456	1,379	5,316	4,412	5,938	6,137	55,915	8,532	
232	All Body	Air	Manned	12.0	2,390	1,974	259	-	95	215	85	137	608	68	167	227	29	796	2,671	9,720	7,879	10,841	31,615	111,974	16,653
233	All Body	Air	Manned	12.0	2,385	1,642	265	-	96	219	89	142	630	68	173	227	33	796	2,814	8,807	7,624	9,970	33,920	110,070	16,787
234	Wing Body	Air	Manned	12.0	3,051	2,376	377	-	93	261	118	179	1,050	68	265	374	46	796	2,209	11,263	10,006	12,655	43,568	121,140	22,430
250	All Body	HTO	Manned	12.0	3,288	2,416	340	-	616	324	128	197	987	68	258	354	50	796	2,924	12,696	11,047	14,061	58,985	133,616	21,550
250J2S	All Body	HTO	Manned	12.0	5,143	3,304	413	-	758	390	152	236	1,125	68	308	422	54	796	4,149	17,318	15,134	19,314	88,124	157,143	26,669
251	Wing Body	HTO	Manned	12.0	4,615	3,044	438	-	693	304	136	209	1,234	68	306	433	59	796	3,255	15,590	13,989	16,164	67,422	149,216	25,296
252	All Body	HTO	Manned	12.0	2,922	2,697	426	-	644	307	128	197	993	68	264	124	446	796	3,141	12,754	11,092	14,379	60,047	128,871	22,542
253	All Body	HTO	Manned	12.0	4,992	4,748	1,197	-	1,156	91	272	127	1,134	91	388	426	73	683	5,456	20,834	17,634	22,770	142,836	167,362	29,637
254	All Body	HTO	Manned	12.0	3,421	3,514	354	-	634	329	130	200	952	68	261	363	45	805	4,094	15,170	12,377	16,511	61,317	138,242	22,702
255	Wing Body	HTO	Manned	12.0	4,974	4,637	431	-	794	338	146	228	1,343	68	336	272	59	601	5,686	19,913	16,045	21,772	80,014	155,597	27,291
256	Wing Body	HTO	Manned	12.0	5,007	3,062	463	-	1,363	263	114	177	1,043	68	299	188	59	805	3,827	16,738	14,809	18,788	112,682	164,631	22,753
257	Wing Body	HTO	Manned	12.0	5,862	6,808	687	-	515	331	150	229	1,352	68	612	476	57	773	6,712	24,632	18,965	26,308	36,378	168,060	28,115
270	All Body	VTO	Manned	12.0	3,815	2,506	403	-	100	336	127	204	971	68	268	132	52	796	3,102	12,880	11,203	14,334	65,544	131,579	22,536
271	All Body	VTO	Manned	12.0	4,130	4,022	463	-	698	354	139	215	1,025	68	281	383	50	796	4,628	17,252	14,117	18,724	75,006	148,057	24,549
280	All Body	BoostVTO	Unmanned	12.0	1,145	1,003	77	-	12	25	52	79	244	68	61	43	11	442	1,638	4,901	3,775	5,629	5,820	77,473	8,638
281	All Body	BoostVTO	Unmanned	12.0	1,134	663	77	-	12	23	50	79	243	68	59	42	11	442	1,304	4,207	3,568	4,935	5,908	78,470	8,504
282	All Body	BoostVTO	Unmanned	12.0	1,917	709	109	-	14	14	41	91	258	68	77	52	13	329	1,595	5,287	4,432	6,060	7,852	93,927	8,671
284	All Body	Air	Unmanned	12.0	2,334	1,636	263	-	28	218	88	141	628	68	172	227	32	592	2,414	8,841	7,514	9,834	33,466	108,850	16,910
285	All Body	HTO	Unmanned	12.0	3,364	2,389	336	-	547	318	127	196	934	68	254	349	44	481	3,287	12,694	10,901	13,925	58,377	131,850	21,918

① Does not include 204 kilograms of ballast.

(U) FIGURE 4-98  
MANHOURS PER LB (KG) vs DCPR WEIGHT (TOTAL ENGINEERING)

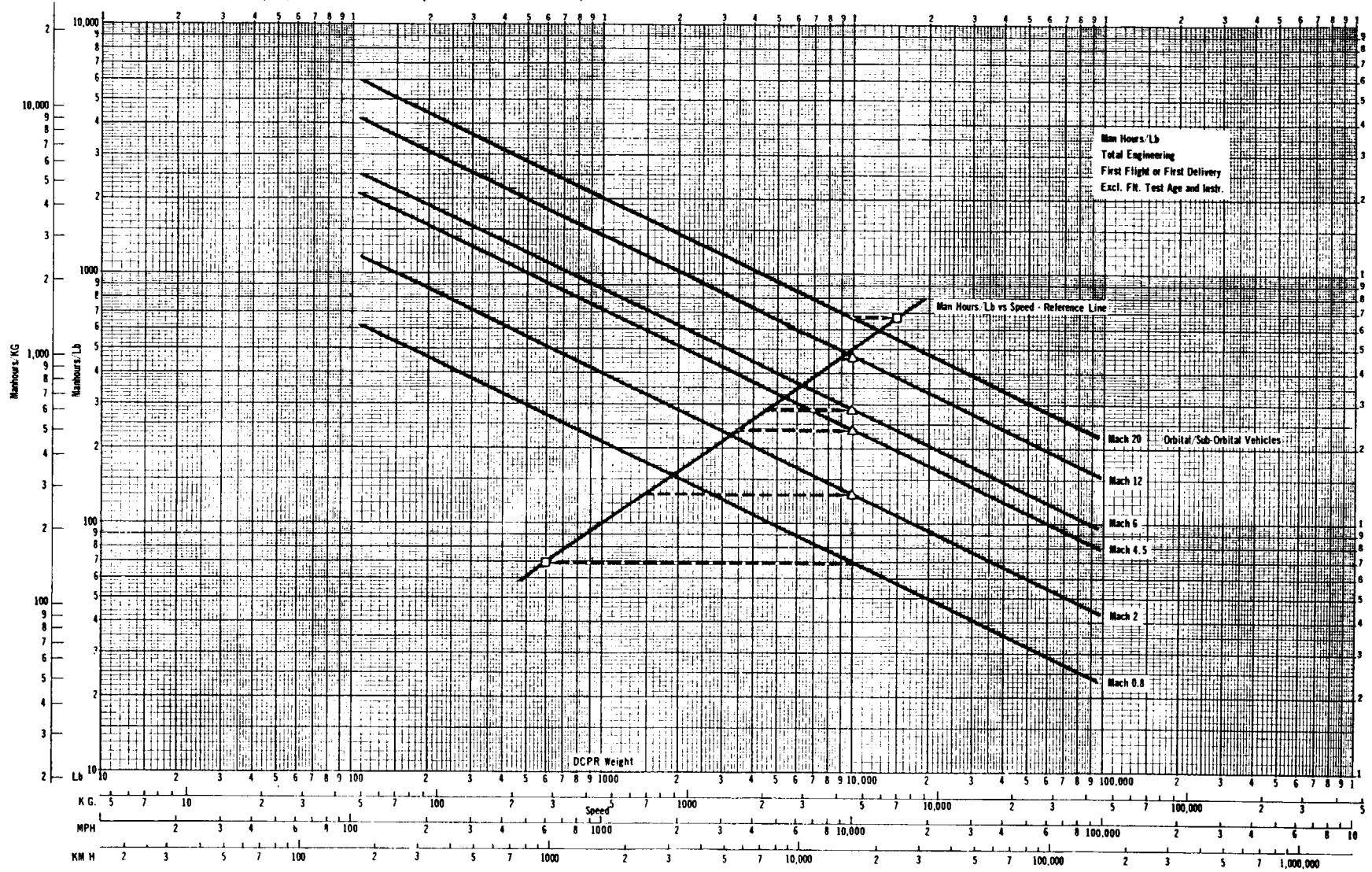

(U) FIGURE 4-99  
 ENGINEERING PRICE PER POUND (Kg) vs DCPR WEIGHT

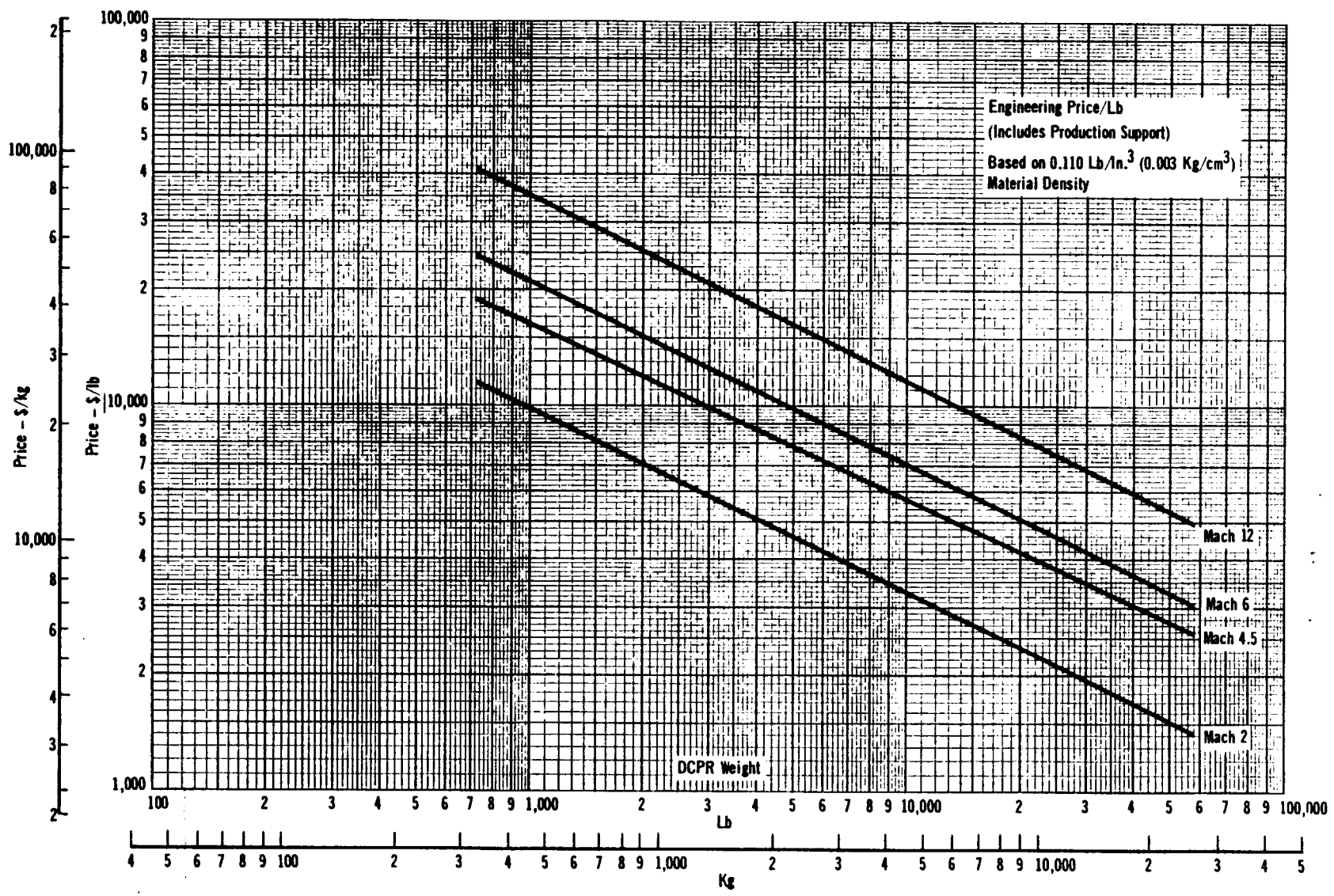

MCDONNELL AIRCRAFT  
4-167

REPORT MDC A0013 ● 2 OCTOBER 1970  
 VOLUME II ● PART 2

(U) Miscellaneous Subsystem Design and Development Tests - Development costs have been derived individually for the following elements:

- (a) Wheels, Tires and Brakes
- (b) Power Plant and Fuel System
- (c) Controls and Hydraulics
- (d) Electrical
- (e) Instruments
- (f) Furnishings and Equipment
- (g) Environmental Control System

(U) The seven elements of cost are based on a study of contractor furnished equipment (CFE) cost per pound for the F-4 aircraft. The CFE items were separated by cost and weight and the cost per pound was derived for each element.

(U) The investment cost/lb by element multiplied by the applicable weight resulted in the equipment cost with the addition of economics to reflect 1970 dollars being the only adjustment made. The development cost is then based on four times the investment cost for one ship set which assumes maximum use of items already developed.

(U) Test Hardware - Static, fatigue and miscellaneous test hardware costs have been estimated at 20% of production and material recurring costs. The 20% factor is based on internal historical cost data.

(U) Pre-Delivery Flight Test - The pre-delivery flight test program for the HYFAC flight research vehicles varies in duration from 9 to 18 months. Upon completion of the pre-delivery flight test program, the flight research vehicles are turned over to the customer for flight research. For the manned, rocket powered HTO configurations, a 12 month pre-delivery flight test program was used. The pre-delivery flight test program for the VTO configurations was lengthened to 18 months. For the air launched vehicles, the pre-delivery flight test program varied from 12 to 18 months duration depending on the type of propulsion system used. The F-4 flight test program cost was used as a basis for estimating the pre-delivery flight test program costs for the HYFAC flight research vehicles. For the unmanned vehicles, the pre-delivery flight test program cost was reduced by a factor of 25% which reflects the reduced testing attendant to unmanned vehicles. Figure 4-100 shows the pre-delivery flight test programs assumed for the HYFAC flight research vehicles and may be compared with the X-15 program using Figure 4-101. Only two of the three flight research vehicles are used in the HYFAC pre-delivery flight test program.

(U) In the X-15 program (See Figure 4-101), the first vehicle was turned over to NASA 12 months after the start of the preliminary flight test evaluation program, while the second vehicle was turned over to NASA 24 months after the start of the preliminary flight test evaluation program.

(U) FIGURE 4-100  
PRE-DELIVERY FLIGHT TEST PROGRAM FLIGHT SUMMARY

FLIGHT FACILITY IDENTIFICATION					PRE-DELIVERY FLIGHT TESTS				
MODEL NO.	LAUNCH MODE	CONTROL MODE	PROP SYSTEM(S)	MACH NO.	TAXI TESTS NO.	CAPTIVE FLIGHT TESTS NO. <sup>△</sup>	DROP/GLIDE TEST NO.	FLIGHT TESTS NO. <sup>△</sup>	UNMANNED LAUNCHES NO. <sup>△</sup>
200	HTO	MANNED	TRJ	4.5	2	-	-	18	-
204	AIR	UNMANNED	TRJ	6	-	2	2	-	-
205	AIR	MANNED	TRJ	6	-	3	2	17	-
207	AIR	MANNED	RKT & RJ	6	-	3	2	14	-
210	HTO	MANNED	TRJ	6	3	-	-	18	-
213	HTO	MANNED	RKT & RJ	6	3	-	-	18	-
214	HTO	MANNED	RKT & RJ	6	-	-	-	18	-
220	Boost VTO	UNMANNED	Booster & RJ	6	-	-	-	18	-
221	Boost VTO	UNMANNED	Booster & RJ	6	-	-	-	-	-
232	AIR	MANNED	RKT & CSJ	12	-	-	-	-	-
233	AIR	MANNED	RKT	12	-	3	2	21	-
234	AIR	MANNED	RKT	12	-	3	2	15	-
250	HTO	MANNED	RKT	12	-	3	2	15	-
250	J2S HTO	MANNED	RKT	12	4	-	-	17	-
251	HTO	MANNED	RKT	12	4	-	-	17	-
252	HTO	MANNED	RKT	12	4	-	-	17	-
253	HTO	MANNED	RKT	12	4	-	-	17	-
254	HTO	MANNED	RKT & CSJ	12	4	-	-	17	-
255	HTO	MANNED	RKT & CSJ	12	4	-	-	22	-
256	HTO	MANNED	RKT	12	4	-	-	22	-
257	HTO	MANNED	TJ & CSJ	12	4	-	-	17	-
270	VTO	MANNED	RKT	12	-	-	-	27	-
271	VTO	MANNED	RKT & CSJ	12	-	-	-	26 <sup>△2</sup>	-
280	Boost VTO	UNMANNED	Booster & CSJ	12	-	-	-	33 <sup>△2</sup>	-
281	Boost VTO	UNMANNED	Booster & RKT	12	-	-	-	-	-
282	Boost VTO	UNMANNED	Booster & RKT	12	-	-	-	-	-
284	AIR	UNMANNED	RKT	12	-	2	-	-	-
285	HTO	UNMANNED	RKT	12	4	-	2	-	-

MCDONNELL AIRCRAFT  
4-169

REPORT MDC A0013 • 2 OCTOBER 1970  
VOLUME II • PART 2

- <sup>△</sup> Includes 1 flight on A/C #2
- <sup>△2</sup> Vectored by 1.5 to allow for development of VTO and transition to horiz. flight. One A/C will require conventional landing gear to evaluate low airspeed flight characteristics.
- <sup>△</sup> Only Two aircraft are used in the pre-delivery flight test program.

(U) FIGURE 4-101  
**X-15 PRELIMINARY FLIGHT TEST EVALUATION PROGRAM**

1958	+1st Mission												× 1st NASA Mission												♦ 1st XLR-99 Mission												‡ 1st Flight												1961					1962																																																																	
	1959												1960												1961												1961					1962																																																																													
N	D	J	F	M	A	M	J	J	A	S	O	N	D	J	F	M	A	M	J	J	A	S	O	N	D	J	F	M	A	M	J	J	A	S	O	N	D	J	F	M	A	M	J	F	M	A	M																																																																								
A/C Fit Mos.	1	2	3	4	5	6	7	8	9	10	11	12	13	14	15	16	17	18	19	20	21	22	23	24	25	26	27	28	29	30	31	32	33	34	35	36	37	38	39																																																																																
Accum Days	21	51	82	112	143	174	204	235	265	301	332	361	392	422	453	483	514	545	757	788	818	849	880	908	939	969	1000	1030	1061	1092	1122	1153	1183	1214	1245	1274	1305	1335	1360																																																																																
A/C No. 1 Prep. for First Mission	+ NAA 1 Captive 1 Glide 3 Aborts 5 Total												† Lay-Up Reasons Unknown												(*) NAA NASA Flights 1 6 Aborts 1 3 Total 2 9												L/U Prep. for Envel. Exp.												NASA 13 Flights 7 Aborts 20 Total												Lay-Up XLR-99 Instl.												NASA 3 Flights 4 Aborts 7 Total												Lay-Up												Lay-Up Following Emergency Landing												NASA 2 2 2 4										
A/C No. 2	+ NAA 1 Captive 3 Flights 5 Aborts 9 Total												† Lay-Up Landing Damage Repair												(*) NAA NASA Flights 3 5 Aborts 2 5 Total 5 10												Lay-Up XLR 99 Instl.												Lay-Up Repair												NASA 4 Flights 4 Total												Lay-Up Repair Damage from Max Fit & Incomp Mods																																														
A/C No. 3	1st Flight Scheduled												Prep. for First Mission												Air and Grd Run												Lay-Up Repair A/C Damage Resulting from Explosion During XLR 99 Ground Run												NASA 4 Flights 4 Aborts 8 Total																																																																						
Program Summary	Fretiminary Evaluation and Devel. Phase -21 Mos.												NASA Devl. 6 Flights 3 Aborts 9 Total Missions												NASA LR-11 Envel. Expansion 13 Flights 7 Aborts 20 Total Missions												NAA XLR-99 Eval 2 Aborts 3 Flights 5 Total Missions												Envelope Expansion Phase -21 Mos.												NASA XLR99 Envel. Expansion 19 Flts 17 Aborts 36 Total Missions																																																										
	NAA Devel. 2 Captive 1 Glide 25 Total Missions												LR-11 Eng. 10 Flights 12 Aborts																																																																																																										
	34 Missions in 16.75 Calendar Mo. = 2 Missions/Mo. in 514 Days = 15 Days/Mission												34 Missions in 29 A/C Mo. = 1.2 Missions/Mo.												34 Missions in 16 A/C Mo. Avail. = 2.1 Missions/Mo.												61 Missions in 21 Cal. Mo. = 2.9 Missions/Mo.												61 Missions in 852 Days = 14 Day/Mission												61 Missions in 46.5 A/C Mo. = 1.3 Missions/Mo.												61 Missions in 23.5 A/C Avail. Mo. = 2.6 Missions/Mo.												35 Flights in 46.5 A/C Mo. = 0.75 Flights/Mo.												Mach No. Expansion Complete 80 Missions												Altitude Expansion Complete 95 Missions										

MCDONNELL AIRCRAFT  
4-170

REPORT MDC A0013 • 2 OCTOBER 1970  
VOLUME II • PART 2

(U) The pre-delivery flight test program cost consists of the following seven cost elements:

- (a) Engineering
- (b) Production
- (c) Material
- (d) Travel and Pre Diem
- (e) Pilot Compensation
- (f) Transportation
- (g) Propellants

4.12.2.1.2 (U) Tooling - MCAIR experience from previous experimental aircraft programs for total manhours/lb has been plotted versus the DCPR weight of the aircraft. Based on these data points, an 85% weight correction slope has been established. By the application of 1969 labor and overhead rates and tooling material costs, this curve was converted to price per pound as shown in Figure 4-102.

(U) The data established above represents soft tooling requirements for a vehicle composed primarily of aluminum with some steel construction. An analysis of tooling experience on sub-orbital vehicles shows tooling hours/lb that are 7.5 times higher than were experienced on experimental aircraft. Comparison of actual data points for the sub-orbital vehicles and the experimental aircraft is shown in Figure 2-11 in Volume V. The additional complexity results from the fact that the sub-orbital vehicles were manufactured primarily from advanced materials that require additional tooling.

(U) In order to establish tooling hours for the vehicles estimated in this study, consideration is given to the additional complexity introduced by the use of advanced materials. By determining the percentage of advanced materials included in the DCPR weight of the vehicle, a weighted average calculation is made as follows:

	<u>%</u>	<u>Complexity Factor</u>
Advanced Material	7.5	=
Normal Material	1.0	=
	100.00	Weighted Complexity

4.12.2.1.3 (U) Avionics Development - Current costs for electronic equipment indicate recurring cost of \$1000/lb and a development cost of 50 times the cost for one unit. These two relationships include many advanced and complex electronic items. Since the development of new electronic equipment for the vehicles in this study was held to a minimum, the recurring cost has been reduced to \$500/lb and the development cost estimated at 10 times the recurring cost.

4.12.2.1.4 (U) Propulsion Development - The various engine type studies include:

- (a) Rocket Systems
- (b) Turboramjet Systems
- (c) Turbojet System
- (d) Scramjet Systems
- (e) Ramjet Systems

(U) Figure 4-103 shows the propulsion system costs developed for the cost analysis study. The following discussion relates the details and mechanics of their development.



FOLDOUT FRAME 1

FOLDOUT FRAME 2

(U) FIGURE 4-102  
TOOLING PRICE PER POUND (KG) vs DCPR WEIGHT

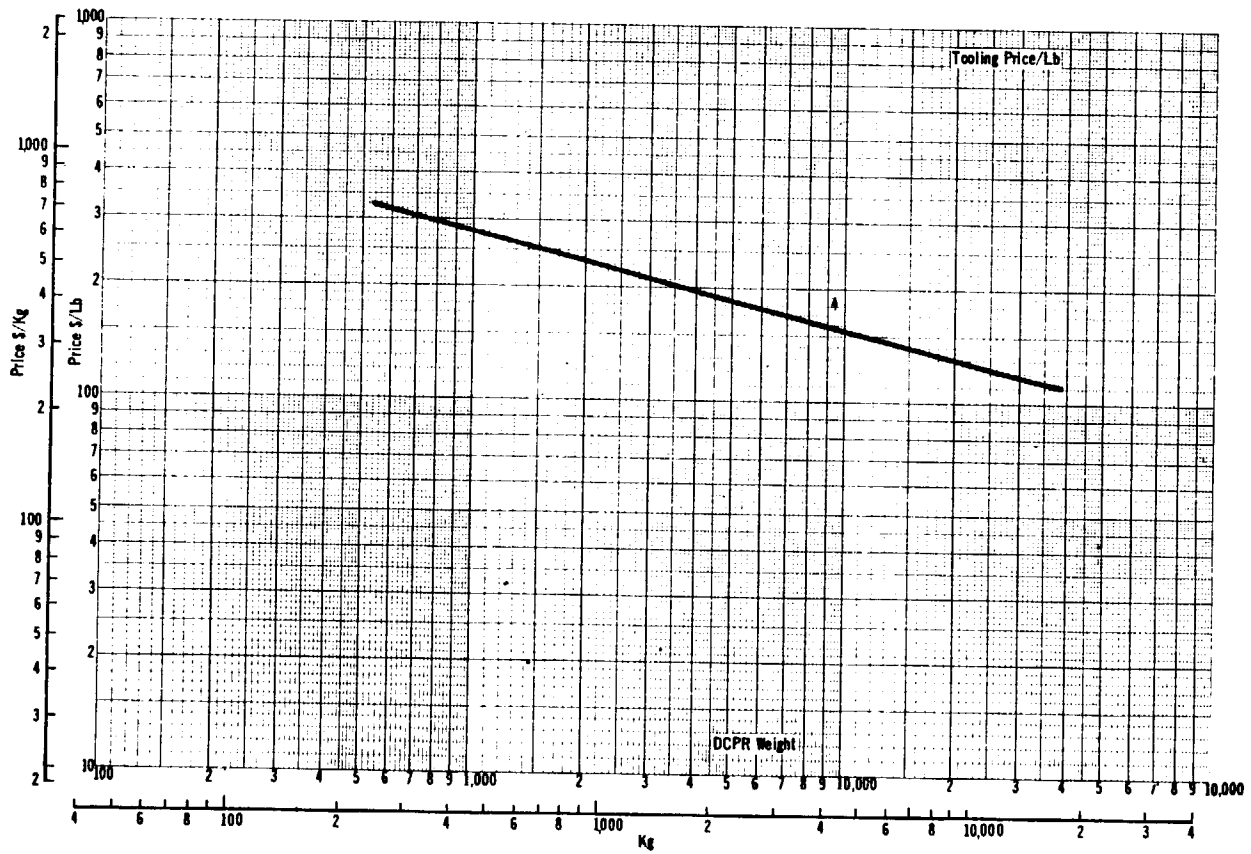

FOLDOUT FRAME 1

FOLDOUT FRAME 2

(U) FIGURE 4-103  
PROPULSION SYSTEM CHARACTERISTICS AND COSTS  
(INTERNATIONAL SYSTEM OF UNITS)

Config. No.	Type of Engine		Operating Mach No.		Thrust/Eng. (Lbs) ①		Thrust Conditions	Propellant				RDT&E Costs (\$) ③			Investment Costs (\$) ③			Prop. Sys. Cr Test Fac. Cost (\$)
	Accel. & Climb	Cruise	Accel. & Climb	Cruise	Accel. & Climb	Cruise		Fuel		Oxidizer		Accel. & Climb Eng.	Cruise Eng.	Total	Accel. & Climb Eng.	Cruise Eng.	Total	
								Type	(Lb)	Type	(Lb)							
200	TRJ	Same	0-4.5	4.5	18,600	Same	S.L.S.U.	JP	5,581	-	-	259,698	-	259,698	7,579	-	7,579	3,500
204	TRJ	Same	0-6.0	6.0	20,050	Same	S.L.S.U.	LH <sub>2</sub>	2,680	-	-	389,550	-	389,550	8,395	-	8,395	5,000
205	TRJ	Same	0-6.0	6.0	20,600	Same	S.L.S.U.	LH <sub>2</sub>	2,740	-	-	397,500	-	397,500	8,454	-	8,454	5,000
207	RKT	RJ	0-6.0	6.0	64,500	6,750	TVAC/M-6.0	LH <sub>2</sub>	3,200	LOX	15,000	81,620	170,000	251,620	943	1,312	2,255	8,000
210	TRJ	TRJ	0-6.0	6.0	33,200	Same	S.L.S.U.	LH <sub>2</sub>	5,000	LOX	-	556,500	-	556,500	11,952	-	11,952	5,000
213	RKT	RJ	0-6.0	6.0	97,200	10,000	TVAC/M-6.0	LH <sub>2</sub>	5,890	LOX	28,670	113,420	170,000	283,420	1,208	1,661	2,869	8,000
214	RKT	Same	0-6.0	6.0	68,700	Same	TVAC	LH <sub>2</sub>	3,905	LOX	23,445	84,800	-	84,800	0,981	-	0,981	-
220	Booster	RJ	-	6.0	-	4,200	M-6.0	LH <sub>2</sub>	430	-	-	-	170,000	170,000	0,525	-	0,525	8,000
221	Booster	RJ	-	6.0	-	4,200	M-6.0	LH <sub>2</sub>	440	-	-	-	170,000	170,000	0,525	-	0,525	8,000
232	RKT	CSJ	0-12	12.0	104,300	11,450	TVAC/M-12.0	LH <sub>2</sub>	7,200	LOX	38,600	118,720	265,000	383,717	1,246	1,241	2,487	50,000
233	RKT	Same	0-12	12.0	112,000	Same	TVAC	LH <sub>2</sub>	11,345	LOX	41,455	127,199	-	127,199	1,299	-	1,299	-
234	RKT	Same	0-12	12.0	144,000	Same	TVAC	LH <sub>2</sub>	9,750	LOX	58,400	138,329	-	138,329	1,426	-	1,426	-
250	RKT	Same	0-12	12.0	195,000	Same	TVAC	LH <sub>2</sub>	14,150	LOX	84,890	169,599	-	169,599	1,643	-	1,643	-
250J2S	RKT	Same	0-12	12.0	265,000	Same	TVAC	LH <sub>2</sub>	23,400	LOX	128,300	10,000	-	10,000	2,500	-	2,500	-
251	RKT	Same	0-12	12.0	223,000	Same	TVAC	LH <sub>2</sub>	15,900	LOX	94,900	182,319	-	182,319	1,749	-	1,749	-
252	RKT	Same	0-12	12.0	199,000	Same	TVAC	LH <sub>2</sub>	19,630	LOX	81,050	171,720	-	171,720	1,654	-	1,654	-
253	RKT	Same	0-12	12.0	472,000	Same	TVAC	Aero-50	78,000	N <sub>2</sub> O <sub>4</sub>	186,700	163,240	-	163,240	0,467	-	0,467	-
254	RKT	CSJ	0-12	12.0	203,000	17,900	TVAC/M-12.0	LH <sub>2</sub>	15,070	LOX	83,650	172,780	265,000	437,777	1,598	2,306	3,903	50,000
255	RKT	CSJ	0-12	12.0	263,000	26,300	TVAC/M-12.0	LH <sub>2</sub>	19,500	LOX	108,900	203,520	265,000	468,516	1,919	1,887	3,805	50,000
256	RKT	Same	0-12	12.0	372,000	Same	TVAC	Aero-50	60,800	N <sub>2</sub> O <sub>4</sub>	146,380	143,099	-	143,099	0,437	-	0,437	-
257	TJ	CSJ	0-3.5	3.5-12.0	21,300	24,000	S.L.S.U.	LH <sub>2</sub>	22,200	-	-	- <sup>②</sup>	265,000	265,000	2,772	2,671	5,443	50,000
270	RKT	Same	0-12	12.0	216,000	Same	TVAC	LH <sub>2</sub>	16,100	LOX	96,800	180,199	-	180,199	1,814	-	1,814	-
271	RKT	CSJ	0-12	12.0	248,000	20,600	TVAC/M-12.0	LH <sub>2</sub>	18,880	LOX	105,200	196,100	265,000	461,096	1,959	2,306	4,265	50,000
280	Booster	CSJ	-	12.0	-	2,230	M-12.0	LH <sub>2</sub>	420	-	-	264,998	-	264,998	1,044	-	1,044	50,000
281	Booster	RKT	-	12.0	-	4,670	TVAC	LH <sub>2</sub>	305	LOX	1,835	-	21,200	21,200	0,371	-	0,371	-
282	Booster	RKT	-	12.0	-	6,190	TVAC	Aero-50	1,160	N <sub>2</sub> O <sub>4</sub>	2,790	-	42,824	42,824	0,244	-	0,244	-
284	RKT	Same	0-12	12.0	110,000	Same	TVAC	LH <sub>2</sub>	11,130	LOX	40,970	118,522	-	118,522	1,272	-	1,272	-
285	RKT	Same	0-12	12.0	193,000	Same	TVAC	LH <sub>2</sub>	14,000	LOX	84,000	168,435	-	168,435	1,638	-	1,638	-

- ① Required Thrust
- ② TJ RDT&E Cost of 249 Million Dollars Previously Paid Thru DOD Fighter Development
- ③ Costs in Millions of Dollars (1970)

FOLDOUT FRAME 1

FOLDOUT FRAME 2

(U) FIGURE 4-103 (Continued)  
PROPULSION SYSTEM CHARACTERISTICS AND COSTS  
(INTERNATIONAL SYSTEM OF UNITS)

Config. No.	Type of Engine		Operating Mach No.		Thrust/Eng. Newtons <sup>①</sup>		Thrust Conditions	Propellant				RDT&E Costs (\$) <sup>③</sup>			Investment Costs (\$) <sup>③</sup>			Prop. Sys. Gr Test Fac. Cost (\$)
	Accel. & Climb	Cruise	Accel. & Climb	Cruise	Accel. & Climb	Cruise		Fuel		Oxidizer		Accel. & Climb Eng.	Cruise Eng.	Total	Accel. & Climb Eng.	Cruise Eng.	Total	
								Type	(kg)	Type	(kg)							
200	TRJ	Same	0-4.5	4.5	82,737	Same	S.L.S.U.	JP	1,532	-	-	259,698	-	259,698	7,579	-	7,579	3,500
204	TRJ	Same	0-6.0	6.0	89,187	Same	S.L.S.U.	LH <sub>2</sub>	1,216	-	-	389,550	-	389,550	8,395	-	8,395	5,000
205	TRJ	Same	0-6.0	6.0	91,633	Same	S.L.S.U.	LH <sub>2</sub>	1,243	-	-	397,500	-	397,500	8,454	-	8,454	5,000
207	RKT	RJ	0-6.0	6.0	286,910	30,025	TVAC M-6.0	LH <sub>2</sub>	1,451	LOX	6,804	81,620	170,000	251,620	.943	1,312	2,255	8,000
210	TRJ	TRJ	0-6.0	6.0	147,681	Same	S.L.S.U.	LH <sub>2</sub>	2,268	LOX	-	556,500	-	556,500	11,952	-	11,952	5,000
213	RKT	RJ	0-6.0	6.0	432,367	44,482	TVAC M-6.0	LH <sub>2</sub>	2,672	LOX	13,005	113,420	170,000	283,420	1,208	1,661	2,869	8,000
214	RKT	Same	0-6.0	6.0	305,593	Same	TVAC	LH <sub>2</sub>	1,771	LOX	10,634	84,800	-	84,800	0.981	-	0.981	-
220	Booster	RJ	-	6.0	-	18,683	M-6.0	LH <sub>2</sub>	195	-	-	-	170,000	170,000	0.525	-	0.525	8,000
221	Booster	RJ	-	6.0	-	18,683	M-6.0	LH <sub>2</sub>	200	-	-	-	170,000	170,000	0.525	-	0.525	8,000
232	RKT	CSJ	0-12	12.0	463,949	50,932	TVAC M-12.0	LH <sub>2</sub>	3,266	LOX	17,509	118,720	265,000	383,717	1,246	1,241	2,487	50,000
233	RKT	Same	0-12	12.0	498,201	Same	TVAC	LH <sub>2</sub>	5,146	LOX	18,804	127,199	-	127,199	1,299	-	1,299	-
234	RKT	Same	0-12	12.0	640,545	Same	TVAC	LH <sub>2</sub>	4,423	LOX	26,490	138,329	-	138,329	1,426	-	1,426	-
250	RKT	Same	0-12	12.0	867,403	Same	TVAC	LH <sub>2</sub>	6,418	LOX	38,506	169,599	-	169,599	1,643	-	1,643	-
250J2S	RKT	Same	0-12	12.0	1,178,778	Same	TVAC	LH <sub>2</sub>	10,614	LOX	58,196	10,000	-	10,000	2,500	-	2,500	-
251	RKT	Same	0-12	12.0	991,953	Same	TVAC	LH <sub>2</sub>	7,212	LOX	43,046	182,319	-	182,319	1,749	-	1,749	-
252	RKT	Same	0-12	12.0	885,196	Same	TVAC	LH <sub>2</sub>	8,904	LOX	36,764	171,720	-	171,720	1,654	-	1,654	-
253	RKT	Same	0-12	12.0	2,099,560	Same	TVAC	Aero-50	35,380	N <sub>2</sub> O <sub>4</sub>	84,686	163,240	-	163,240	0.467	-	0.467	-
254	RKT	CSJ	0-12	12.0	902,987	79,623	TVAC M-12.0	LH <sub>2</sub>	6,836	LOX	37,943	172,780	265,000	437,777	1,598	2,306	3,903	50,000
255	RKT	CSJ	0-12	12.0	1,169,882	116,988	TVAC/M 12.0	LH <sub>2</sub>	8,845	LOX	49,396	203,520	265,000	468,516	1,919	1,887	3,805	50,000
256	RKT	Same	0-12	12.0	1,654,738	Same	TVAC	Aero-50	27,578	N <sub>2</sub> O <sub>4</sub>	66,397	143,099	-	143,099	0.437	-	0.437	-
257	TJ	CSJ	0-3.5	3.5-12.0	94,747	106,747	S.L.S.U.	LH <sub>2</sub>	10,070	-	-	- <sup>②</sup>	265,000	265,000	2,772	2,671	5,443	50,000
270	RKT	Same	0-12	12.0	960,816	Same	TVAC	LH <sub>2</sub>	7,303	LOX	43,908	180,199	-	180,199	1,814	-	1,814	-
271	RKT	CSJ	0-12	12.0	1,103,159	91,633	TVAC M-12.0	LH <sub>2</sub>	8,564	LOX	47,718	196,100	265,000	461,096	1,959	2,306	4,265	50,000
280	Booster	CSJ	-	12.0	-	9,920	M-12.0	LH <sub>2</sub>	191	-	-	264,998	-	264,998	1,044	-	1,044	50,000
281	Booster	RKT	-	12.0	-	20,773	TVAC	LH <sub>2</sub>	138	LOX	832	-	21,200	21,200	0.371	-	0.371	-
282	Booster	RKT	-	12.0	-	27,534	TVAC	Aero-50	526	N <sub>2</sub> O <sub>4</sub>	1,266	-	42,824	42,824	0.244	-	0.244	-
284	RKT	Same	0-12	12.0	489,304	Same	TVAC	LH <sub>2</sub>	5,048	LOX	18,584	118,522	-	118,522	1,272	-	1,272	-
285	RKT	Same	0-12	12.0	858,506	Same	TVAC	LH <sub>2</sub>	6,350	LOX	38,102	168,435	-	168,435	1,638	-	1,638	-

- ① Required Thrust
- ② TJ RDT&E Cost of 249 Million Dollars Previously Paid Thru DOD Fighter Development
- ③ Costs in Millions of Dollars (1970)

(U) Rocket Systems - Development costs for all rocket acceleration engines are based on vacuum thrust requirements, which are calculated from the gross takeoff weight of each model according to the following formula:

Sea level thrust = 1.5 x takeoff gross weight  
Vacuum thrust = 1.07 x sea level thrust (for staged configurations)  
Vacuum thrust = 1.1 x sea level thrust (for all other configurations)

(U) The majority of the models that employ a rocket engine configuration are designed to use a cryogenic fuel rocket of the LR-129 class. Development costs are determined from vacuum thrust using Figure 4-104. The remaining rocket engine configurations are of the storable fuel MIST (Multi-Purpose In-Space Throttleable) rocket class. Data for the ARES (Advanced Rocket Engine Storable) series of MIST rockets, based on vacuum thrust requirements, is used to determine development costs for this class (Figure 4-105).

(U) Turboramjet Systems - Turboramjet development costs are related to the sea level thrust requirements of each engine, which are found by converting takeoff gross weight according to the following formula:

Sea level thrust = .942 x takeoff gross weight

(U) Development costs were taken from Figure 4-106 which are based on GE planning estimates for the GE14 JZ8 turboramjet engine. Development costs shown in Figure 4-106 are for JP fueled turboramjet engines. A factor of 1.5 was applied to obtain the development costs for LH<sub>2</sub> fueled turboramjet engines.

(U) Turbojet Systems - The turbojet development cost was assumed to be written off in current DOD programs, hence, the HYFAC program was not charged with the turbojet development cost.

(U) Scramjet Systems - Scramjet development cost is based on a propulsion engineering comparison of two scramjet engines: (1) an engine module of 10 square feet of engine effective area and (2) a module of 25 square feet of engine effective area. The engine effective area is calculated from inlet capture area specified on the aircraft drawing according to the following formula:

Engine Effective Area = .7 inlet capture area (Refer to Figure 4-108)

The comparison demonstrated that considerable economic advantages would result by developing the smaller engine size and using a greater number of modules per aircraft than by developing one engine large enough to deliver the thrust required for a particular vehicle. The conclusion has been to use a cost of \$250,000,000 (1969 dollars) for the development cost of a module with an effective area of 10 square feet as standard for all configurations.

(U) Ramjet Systems - Ramjet development costs for all models are estimated at \$160,000,000 (1969 dollars) based on planning estimates received from engine manufacturers.

(U) Booster Rocket (Staged) Systems - Thrust requirements for the rocket cruise engines in configurations 281, and 282 are determined according to the following formula:

Vacuum thrust = .25 x takeoff gross weight.

FOLDOUT FRAME 1

FOLDOUT FRAME 2

(U) FIGURE 4-104  
ROCKET ENGINE PROPULSION COSTS - LR-129 CLASS, CRYOGENIC FUEL

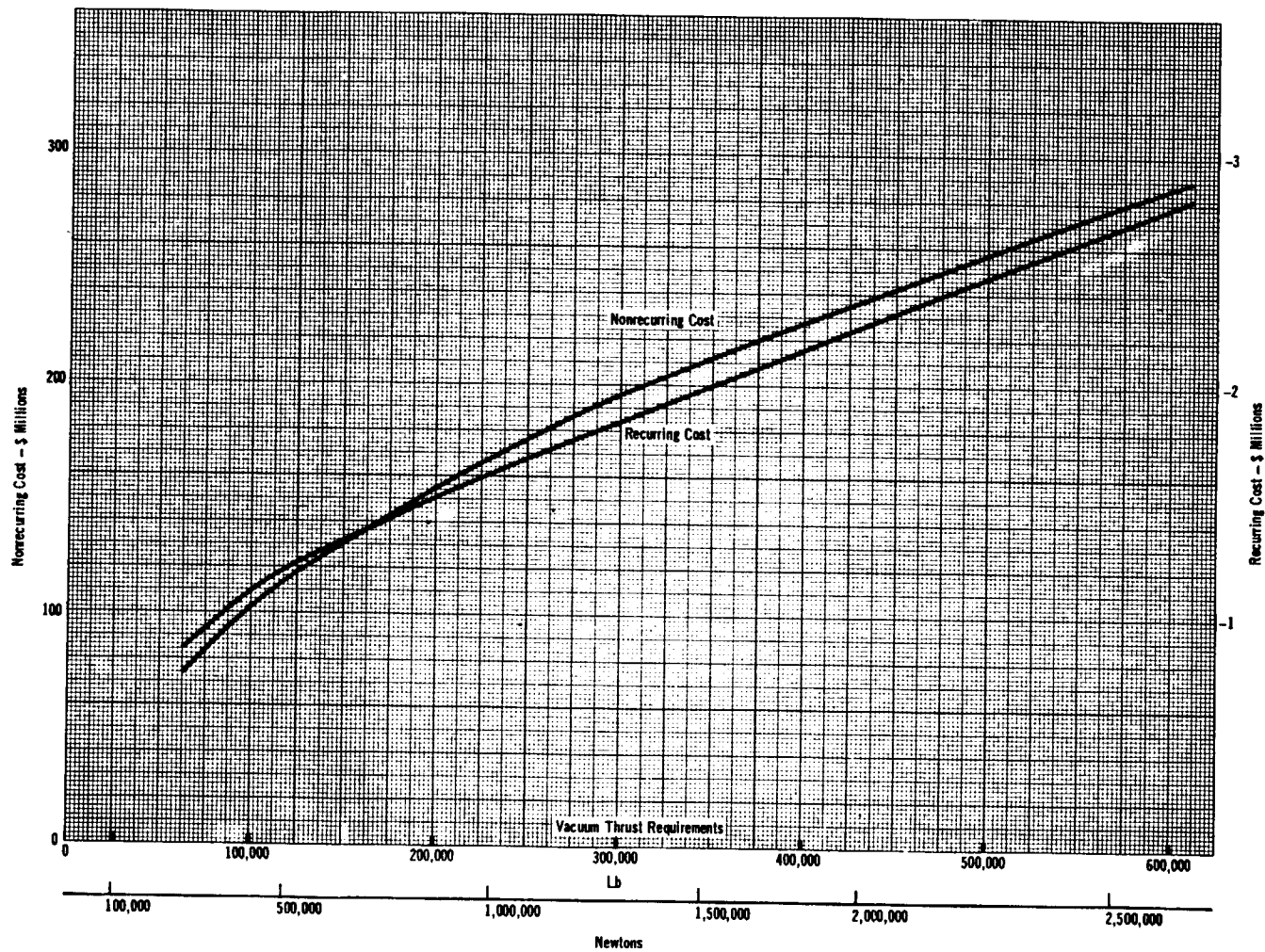

FOLDOUT FRAME 2

FOLDOUT FRAME 1

(U) FIGURE 4-105  
ROCKET ENGINE PROPULSION COSTS - MIST CLASS, STORABLE FUEL

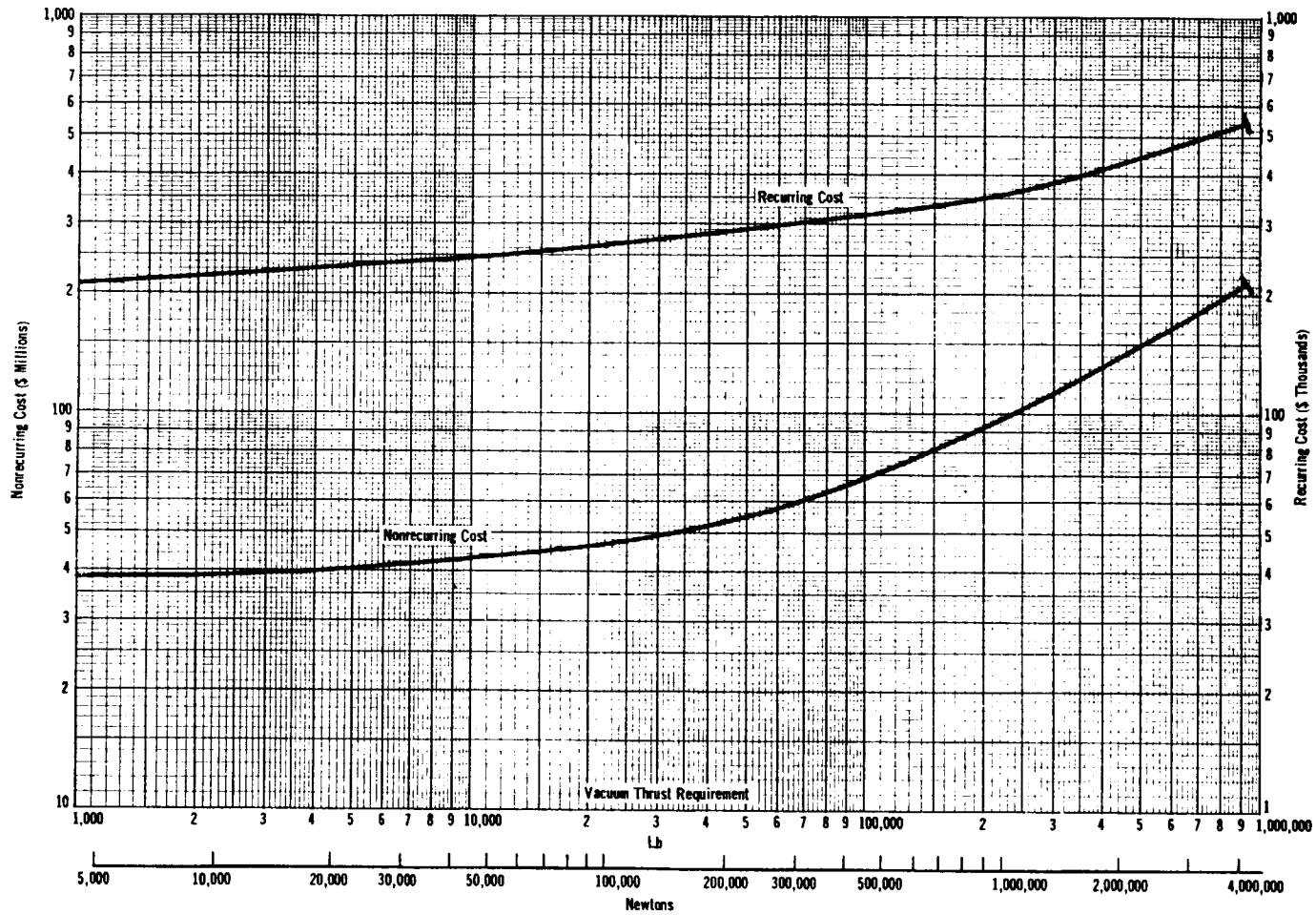

### TURBORAMJET PROPULSION COSTS

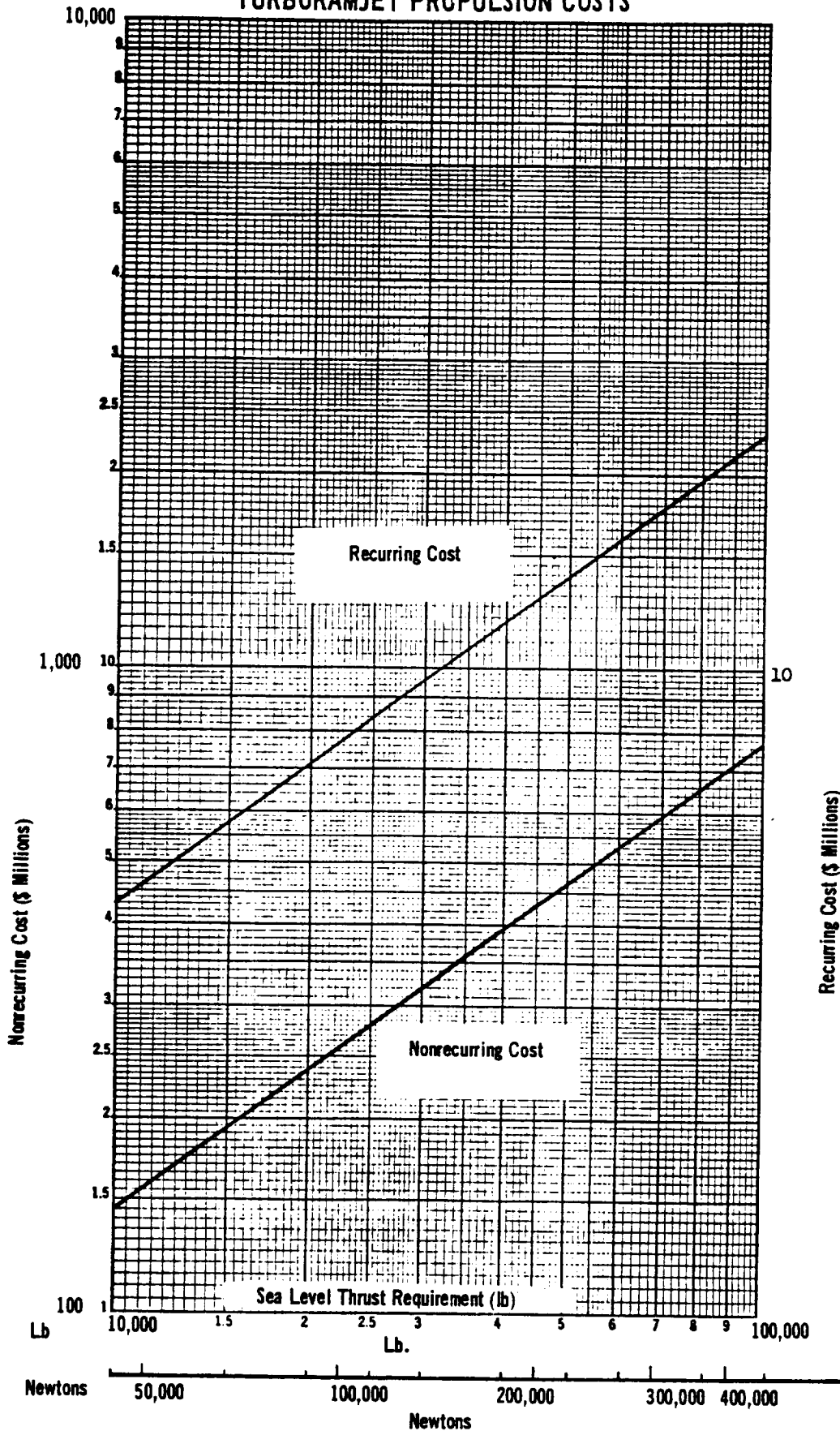

(U) Development cost for the configuration 281 rocket engine is based on cost data for the RL-10 rocket class. Costs for the configuration 282 engine are based on the ARES data, shown in Figure 4-105.

4.12.2.1.5 (U) Support Equipment Design and Systems Integration - The following CER (Cost Estimating Relationship) was used to derive this cost element:

$$\text{SED\&SI} = .047 (\text{OWE})^{.59} \times 10^6 \text{ dollars}$$

where: OWE = Operational Empty Weight of Vehicle.

(U) The CER was obtained from Reference 19.

4.12.2.1.6 (U) Ground Test Facilities - It was found that the only ground test facilities required were for the new (rubberized) propulsion systems specially developed for the research program. The following propulsion ground test facilities costs were used:

- (a) Turboramjet (JP) - 3.5 M Dollars (modification cost of an existing facility)
- (b) Turboramjet (LH<sub>2</sub>) - 5.0 M Dollars (modification cost of an existing facility)
- (c) Rocket - None
- (d) Ramjet - 8.0 M Dollars (modification cost of an existing facility)
- (e) Convertible Scramjet - 50 M Dollars (new facility cost)

4.12.2.2 (U) Investment Cost Development - Investment costs include: (1) flight vehicle costs, (2) support costs, (3) launch platform costs and (4) launch vehicle costs. The investment costs for the airframe and miscellaneous subsystems developed for the Phase I vehicles are summarized in Figure 4-97.

4.12.2.2.1 (U) Flight Vehicle Investment Cost - The flight vehicle investment cost consists of the following elements:

- (A) Airframe
- (B) Miscellaneous subsystems
- (C) Propulsion
- (D) Avionics

Parameters for the airframe investment costs have been developed based on relating hours per pound and dollars per pound to the DCPR weight of the flight research vehicle. Further consideration has been given to the speeds and construction materials peculiar to the hypersonic vehicles.

(U) The investment costs associated with the airframe and miscellaneous subsystems for the Phase I HYFAC flight research vehicles were combined and are



shown in total in Figure 4-97. These costs include: (1) airframe material and labor costs (2) miscellaneous subsystem material and labor costs.

(U) All relationships except propulsion have been converted to the price level by applying the appropriate MCAIR labor and overhead rates for the 1969 time period and adding appropriate earnings. These 1969 dollars were then adjusted to 1970 economics consistent with the HYFAC work statement. Propulsion dollars exclude MCAIR loadings since they will be furnished by the government or an associate contractor.

(U) Airframe and Miscellaneous Subsystems - These combined elements consist of production labor, material and equipment costs.

(a) Production Labor - Production manhours per pound for previously built experimental aircraft have been plotted versus the DCPR weight of the aircraft and an 80% weight correction slope has been established from these data points. (See Figure 2-12 in Volume V.)

(U) The slope established above is representative of a vehicle consisting primarily of aluminum with some steel construction. The data requires adjustment by a factor which provides for the manufacturing complexities of materials that are considered advanced during the 1970-1975 time frame. Following is a list of the materials used in this study and the format used to derive construction complexities:

<u>Material</u>	<u>%</u>	<u>Complexity</u>	
Columbium	x	4.0	=
T. D. Nickel	x	11.0	=
Rene 41	x	7.5	=
Titanium	x	4.5	=
Nose Cone - Mach 4.5 and 6	x	1.25	=
Nose Cone - Mach 12	x	4.0	=
Insulation	x	1.0	=
Aluminum	x	1.0	=
Steel	x	1.0	=
Systems	x	1.0	=
Other	x	1.0	=
	<u>100.0</u>		<u>Weight Complexity</u>

Manufacturing complexities are based on relationship to aluminum. Experimental construction manhours per pound were converted to dollars to give the production price per pound shown in Figure 4-107.

(b) Material - Distinction has been made in this study between conventional materials and advanced materials with the following grouping made:

<u>Conventional Materials</u>	<u>Advanced Materials</u>
Aluminum	Columbium
Steel	T. D. Nickel
Insulation	Rene 41
Systems	Titanium
Other	Nose Cone

FOLDOUT FRAME 1

FOLDOUT FRAME 2

(U) FIGURE 4-107  
PRODUCTION PRICE PER LB (KG) vs DCPR WEIGHT

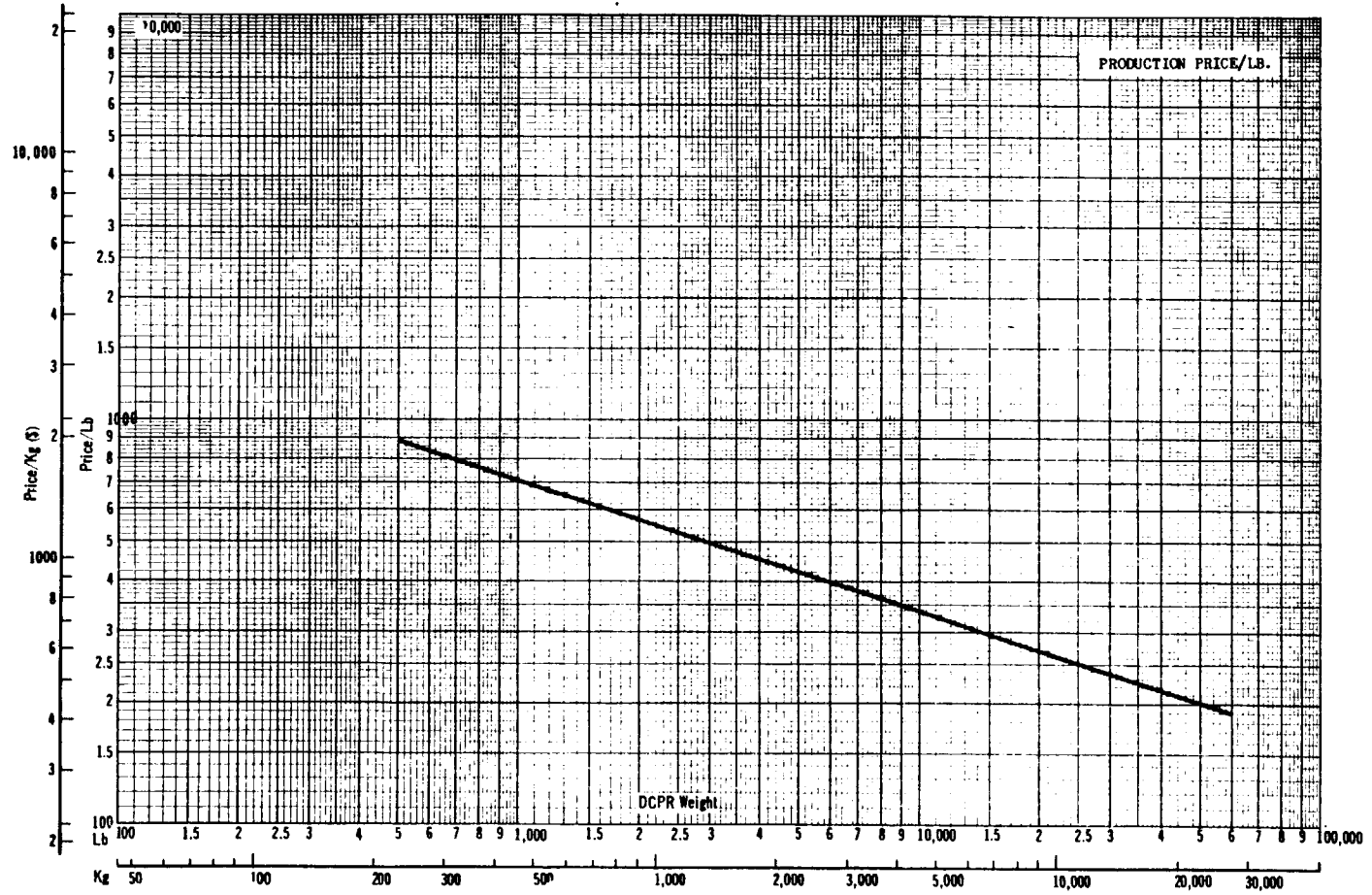

MCAIR experience has been used to derive material cost/lb for the conventional materials.

(U) Material dollars/lb for the advanced materials are based on the following:

<u>Material</u>	<u>Cost/Lb.</u>	<u>Cost/Kilogram</u>
Columbium	\$600	\$1323
T. D. Nickel	75	165
Rene 41	50	110
Titanium	50	110
Ablative Material		
Nose Cone (Mach 12)	600	1323
Nose Cone (Mach	150	331

These costs were obtained from Ref. (23) and other internal sources.

(c) Equipment - The method used to derive the investment cost of the equipment was presented in Section 4.12.2.1.1 and is illustrated in Figure 4-117.

(U) Propulsion - Recurring propulsion costs for the various engine types are based on the following parameters:

- (a) Rocket Systems - Vacuum Thrust Requirement
- (b) Turboramjet Systems - Sea Level Thrust Requirement
- (c) Scramjet Systems - Engine Effective Area
- (d) Ramjet Systems - Dry Engine Weight

(1) Rocket Systems - Recurring costs for all rocket engines are based on vacuum thrust requirements, which are calculated from the take-off gross weight of each configuration according to the following formulae:

Sea Level Thrust - 1.5 take-off gross weight

Vacuum Thrust = 1.07 x sea level thrust (for staged configurations)

Vacuum Thrust - 1.1 x sea level thrust (for all other configurations)

The majority of the configurations that employ a rocket engine are designed to use a cryogenic fuel rocket of the LR-129 class. The LR-129 data for production costs of 100, 200 and 500 units versus engine vacuum thrust has been extrapolated back to the first unit to obtain recurring rocket propulsion costs. (See Figure 4-104.) The remaining rocket engine configurations are of the storable fuel MIST (Multi-purpose In-Space Throtttable) rocket class. Data for the ARES series of MIST rockets, based on vacuum thrust requirements, is used to determine investment costs for this class. (See Figure 4-105.)

(2) Turboramjet Systems - Turboramjet costs are related to the sea level thrust requirements of each engine, which are found by converting take-off gross weight according to the following formula:

$$\text{Sea Level Thrust} = .942 \times \text{take-off gross weight}$$

Recurring costs are taken from Figure 4-106.

(3) Scramjet Systems - Scramjet investment costs are based on engine effective area, which is calculated from inlet capture area specified on the aircraft drawing according to the following formula:

$$\text{Engine Effective Area} = .7 \times \text{inlet capture area (Ref. Figure 4-108)}$$

To facilitate the development of scramjet engine costs, a basic scramjet engine module with an effective area of 10 square feet has been used.

(U) In order to calculate scramjet investment costs, the total engine effective area required for a vehicle is expressed as the number of modules of 10 square feet of effective engine area that are needed. The number of modules required per flight vehicle is then multiplied by three (3 vehicles required in program) to give a total order quantity. Figure 4-108, relating delivered costs per module to number of modules manufactured, is derived from propulsion manufacturers' data. Cost per module was read from this graph at the total number of modules required, and then multiplied by the number of modules per vehicle to give a recurring propulsion cost per ship set.

(4) Ramjet Systems - Ramjet recurring engine cost has been estimated at \$550 per pound of dry engine weight.

(5) Staged Systems - Thrust requirements for the rocket cruise engines in configurations 281 and 282 are determined according to the following formula:

$$\text{Vacuum Thrust} = .25 \times \text{take-off gross weight}$$

The recurring cost for the configuration 281 rocket engine is based on cost data for the RL-10 rocket class while the recurring cost for the configuration 282 engine is based on the ARES data (Figure 4-105). Configurations 220 and 280 are also staged systems. The cruise engine for configuration 220 is a ramjet and is costed by dry engine weight in the same manner as other ramjet systems. Configuration 280 is a scramjet configuration and is costed on the basis of the engine effective area consistent with other scramjet systems. Smaller thrust requirements for these models result in reduced engine size or weight. Costs therefore can be determined directly from the applicable figures without making further adjustments.

(6) Turbojet Systems - An investment cost of \$924,000 per engine was used for the turbojet engine employed.

(U) Avionics - Current costs for electronic equipment indicate recurring costs of \$1,000/lb (\$2,205/kg). This includes many advanced and complex electronic items. Since the development of new electronics for the vehicles in this study will be held at a minimum and items already developed used when available, the recurring costs have been reduced to \$500/lb (\$1,102/kg).

~~CONFIDENTIAL~~

FOLDOUT FRAME 1

FOLDOUT FRAME 2

(C) FIGURE 4-108  
SCRAMJET RECURRING PROPULSION COST

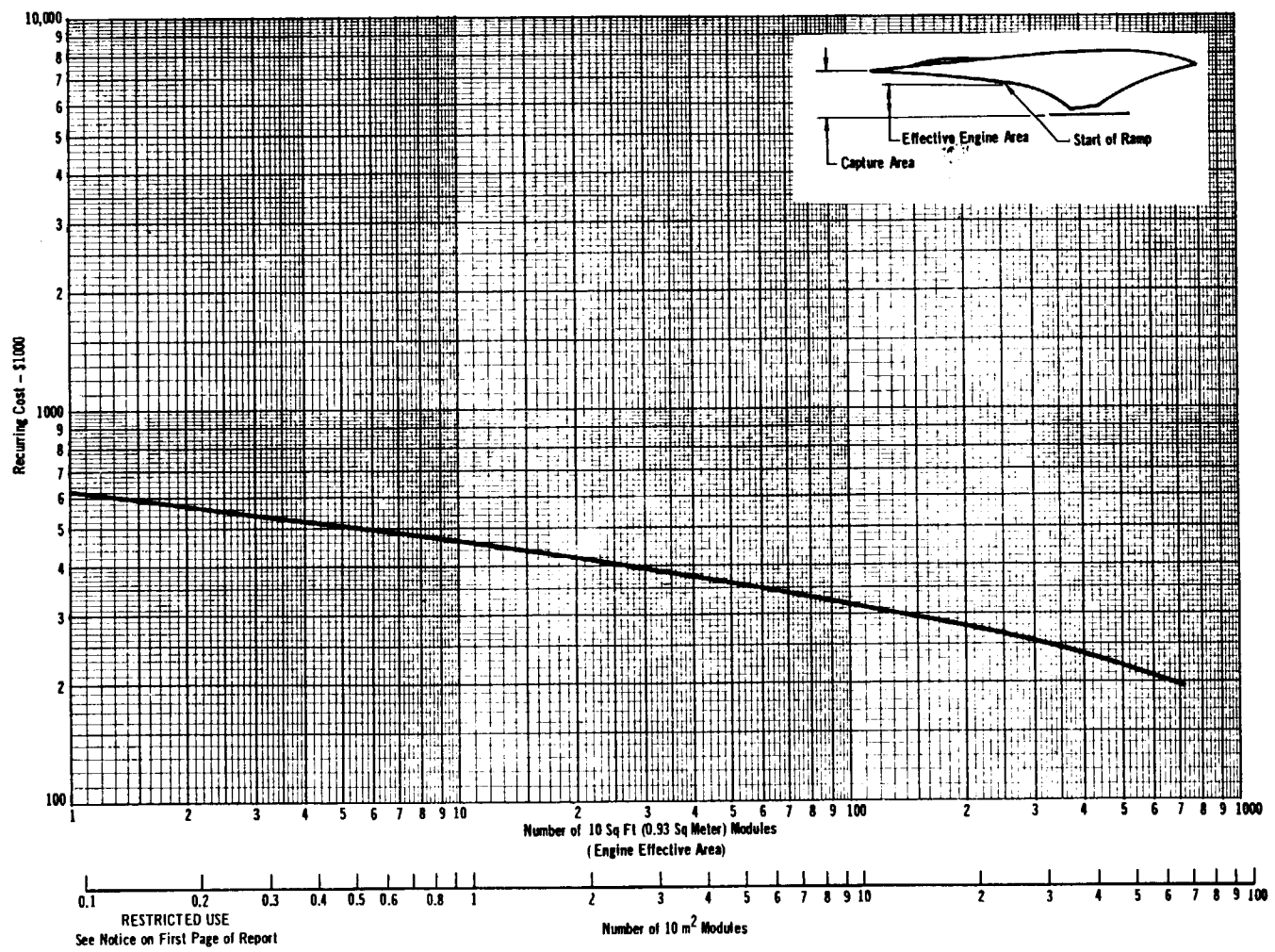

RESTRICTED USE  
See Notice on First Page of Report

MCDONNELL AIRCRAFT

~~CONFIDENTIAL~~

4.12.2.2.2 (U) Support Costs - Includes AGE, training equipment, initial stocks and initial transportation investment costs.

(U) AGE Costs - AGE costs were generated by multiplying the total flight vehicle investment cost by a factor of 15 percent.

(U) Training Equipment - Training equipment is applicable to the manned flight vehicles only and was estimated to be \$5 million dollars which is the cost of a dynamic type simulator. Ref. (16) was used as a basis for this estimate.

(U) Initial Stocks - Initial stocks consist of the cost of 7 spare propulsion systems and AGE spares. AGE spares are estimated by multiplying the AGE investment cost by a factor of 10 percent.

(U) Initial Training - Includes the costs required to train the test pilots and was computed by multiplying the number of test pilots assigned to the program (20) by the training cost per pilot (\$50,000).

(U) Initial Transportation - The initial transportation cost was computed by summing the AGE, AGE spares, training equipment, engine spares, propellants, and vehicle refurbishment material costs and multiplying the sum by a factor of 2 percent.

4.12.2.2.3 (U) Launch Platform Costs - Launch platform costs consists of the cost to modify the launch aircraft to carry the air launched vehicles and the cost of the launcher required to launch the VTO configurations. Launch aircraft modification costs are shown in Figure 4-109 and were computed by multiplying the TOGW of the air launched flight vehicles by \$75 which was generated from X-15 cost data. Launchers required for the VTO configurations were estimated to cost \$1 million dollars per launcher. Two launchers are required for the VTO configurations.

4.12.2.2.4 (U) Launch Vehicle Cost - This cost consists of the investment cost of the Thor and Atlas launch vehicles required to launch the Mach 6 and 12 staged configurations. The Thor was priced at \$500,000 per booster while the Atlas was priced at \$1,647,000 per booster. It was assumed that the design and development cost associated with mating the flight research vehicle to the launch vehicle was negligible. Therefore no cost allowance was made for this item.

4.12.2.3 (U) Operating Cost and Development - Operating costs are those costs associated with the maintenance and operation of the facilities and the flight and support equipment associated with the flight research program and are divided into two categories; namely, (1) those that vary with the number of flights and (2) those that vary with program duration.

The operating costs that vary with the number of flights are:

- o Range Operating Cost (first part of the range user cost)
- o Escort Aircraft and Logistics
- o Vehicle Refurbishment Cost
- o Propellant Cost

(U) FIGURE 4-109  
LAUNCH PLATFORM MODIFICATION COST

MODEL NO.	FLT. VEH. TOGW		MOD. COST		MOD. COST ONE ACFT \$	MOD. COST TWO ACFT \$
	(LB)	kg	\$/LB	\$/kg		
204	25,079	11,376	75	165.35	1,880,925	3,761,850
205	25,740	11,675	75	165.35	1,930,500	3,861,000
207	43,000	19,504	75	165.35	3,225,000	6,450,000
232	69,700	31,615	75	165.35	5,227,500	10,455,000
233	74,780	33,920	75	165.35	5,608,500	11,207,000
234	96,050	43,568	75	165.35	7,203,750	14,407,500
284	73,780	33,466	75	165.35	5,533,500	11,067,000

(1) Based on cost to modify B-52 for X-15 program.

Launch Platform Operating Cost

MODEL NO.	LAUNCH ACFT.	LAUNCH ACFT. COST PER FLT. (\$)	NO. OF FLIGHTS	TOTAL (\$)
204	B-52	13,800 (1)	180	2,484,000
205	B-52	13,800 (1)	180	2,484,000
207	B-52	13,800 (1)	180	2,484,000
232	C-5A	12,700 (2)	180	2,286,000
233	C-5A	12,700 (2)	180	2,286,000
234	C-5A	12,700 (2)	180	2,286,000
284	C-5A	12,700 (2)	180	2,286,000

(1) Based on B-52 operating cost incurred for X-15 program.

(2) Based on ratio of C-5A and the B-52 POL and maint. cost per flying hr. x B-52 cost per flight.

- o Transportation Cost
- o Launch Platform Operating Cost
- o Launch Service Cost

Operating costs that vary with program duration are:

- o Range Support Cost - includes base engineering and fire protection costs (second part of the range user cost)
- o AGE Maintenance
- o General Purpose Maintenance Support
- o Pilot Pay and Support Personnel Pay

(U) A summary of the operating costs developed for the flight research vehicle configurations is presented in Figure 4-110. The data pertaining to the number of flights and program duration was obtained from Figure 4-111 which presents the mission times, the flight frequency and the test times for each flight research facility. The refurbishment cost is the largest of all the operating cost elements; consequently, this cost element drives the operating costs.

4.12.2.3.1 (U) Range User Costs - Range user costs consist of the range operating cost which was obtained by multiplying \$21,500 per flight times the number of flights and the base engineering and fire protection cost which was obtained by multiplying \$253,000 per year times the program duration. Both of these factors were generated from the X-15 cost and operations data and escalated to 1970 dollars.

4.12.2.3.2 (U) Escort Aircraft and Logistics - This cost element was derived on the basis of \$11,000 per flight and was taken from X-15 cost and operations data and escalated to 1970 economics.

4.12.2.3.3 (U) Vehicle Refurbishment Cost - Figure 4-112 presents the vehicle refurbishment costs. Essentially, the vehicle refurbishment cost is the product of the refurbishment percentage parameter (1.5 to 2.5%), the vehicle investment cost and the number of flights.

4.12.2.3.4 (U) Propellant Cost - The propellant costs are presented in Figure 4-113. The propellant cost is the product of the propellant cost per flight and the number of flights. Utilization factors were applied to the propellant requirements to account for propellants purchased but not used due to boil-off, spillage, line loss, contamination, sub-cooling, etc.

4.12.2.3.5 (U) AGE Maintenance - AGE maintenance costs were generated by multiplying the AGE investment cost by a factor of 3% per year times the program duration. The 3% factor was obtained from Ref. (19).

4.12.2.3.6 (U) General Purpose Maintenance Support - General purpose maintenance support costs were obtained by multiplying the program duration by a factor of



FOLDOUT FRAME 1

(U) FIGURE 4-110  
OPERATING COST SUMMARY

FOLDOUT FRAME 2

Operating Costs	Configurations													
	200	204	205	207	210	213	214	220	221	232	233	234	250	250J2S
	Flight Research Program Duration - Years													
	5	5	5	5	5	5	5	2	2	5	5	5	5	5
	No. of Flights													
	225	180	180	180	225	225	225	8	8	180	180	180	225	225
	Costs - Millions of 1970 Dollars													
1. Range User Cost	6.103	5.136	5.136	5.136	6.103	6.103	6.103	0.678	0.678	5.136	5.136	5.136	6.103	6.103
2. Escort Aircraft & Logistics	2.498	1.998	1.998	1.998	2.498	2.498	2.498	0.089	0.089	1.998	1.998	1.998	2.498	2.498
3. Vehicle Relubrication Cost	62.363	96.512	100.847	73.570	167.652	105.174	64.157	1.627	1.657	90.698	85.954	111.920	136.170	169.785
4. Propellant Cost	0.021	0.100	0.102	0.145	0.234	0.336	0.232	0.010	0.010	0.335	0.494	0.463	0.841	1.365
5. AGE Maintenance (Laboratory)	1.247	1.810	1.891	1.380	2.515	1.578	0.362	0.274	0.280	1.360	1.290	1.679	1.634	2.037
6. General Purpose Maint. Support	0.500	0.500	0.500	0.500	0.500	0.500	0.500	0.200	0.200	0.500	0.500	0.500	0.500	0.500
7. Transportation Cost (Vehicle)	0.558	1.428	0.447	0.447	0.774	0.774	0.774	0.041	0.041	1.428	1.428	1.428	1.785	1.785
8. Pilot Pay & Sup. per Day	17.400	15.800	16.200	17.000	18.400	19.600	18.000	4.160	4.160	18.000	18.000	18.800	21.800	23.400
9. Launch Platform Operating Cost	-	2.484	2.484	2.484	-	-	-	-	-	2.286	2.286	2.286	-	-
10. Launch Service Cost	-	-	-	-	-	-	-	1.560(1)	1.560(1)	-	-	-	-	-
<b>Total</b>	<b>90.690</b>	<b>124.968</b>	<b>129.605</b>	<b>102.660</b>	<b>198.676</b>	<b>136.963</b>	<b>99.226</b>	<b>8.639</b>	<b>8.675</b>	<b>121.741</b>	<b>117.286</b>	<b>144.210</b>	<b>171.331</b>	<b>207.473</b>

Operating Costs	Configurations														
	251	252	253	254	255	256	257	270	271	280	281	282	284	285	
	Flight Research Program Duration - Years														
	5	5	5	5	5	5	5	5	5	5	2	2	2	5	5
	No. of Flights														
	225	225	225	225	225	225	225	180	180	8	8	8	180	225	
	Costs - Millions of 1970 Dollars														
1. Range User Cost	6.103	6.103	6.103	6.103	6.103	6.103	6.103	5.136	5.136	0.678	0.678	0.678	5.136	6.103	
2. Escort Aircraft & Logistics	2.498	2.498	2.498	2.498	2.498	2.498	2.498	1.998	1.998	0.089	0.089	0.089	1.998	2.498	
3. Vehicle Relubrication Cost	157.838	141.811	175.044	155.363	166.449	136.153	194.473	114.593	134.281	2.197	2.035	2.043	87.674	139.821	
4. Propellant Cost	0.944	0.851	14.618	0.881	1.142	11.420	1.038	0.766	0.884	0.023	0.023	0.030	0.485	0.832	
5. AGE Maintenance (Labor Only)	1.894	1.702	2.101	1.864	2.167	1.634	2.334	1.719	2.020	0.297	0.275	0.276	1.315	1.678	
6. General Purpose Maint. Support	0.500	0.500	0.500	0.500	0.500	0.500	0.500	0.500	0.500	0.200	0.200	0.200	0.500	0.500	
7. Transportation Cost (Vehicles)	1.785	1.785	1.785	1.785	1.785	1.785	2.799	1.392	1.392	0.102	0.102	0.102	1.428	1.785	
8. Pilot Pay & Sup. per Day	22.400	22.000	25.600	22.000	23.000	24.000	20.200	20.000	20.400	4.160	4.160	4.240	17.200	20.800	
9. Launch Platform Operating Cost	-	-	-	-	-	-	-	0.500	0.500	-	-	-	2.286	-	
10. Launch Service Cost	-	-	-	-	-	-	-	-	-	1.983(2)	1.983(2)	1.983(2)	-	-	
<b>Total</b>	<b>199.962</b>	<b>177.250</b>	<b>228.249</b>	<b>190.994</b>	<b>203.644</b>	<b>184.093</b>	<b>229.945</b>	<b>146.604</b>	<b>167.511</b>	<b>9.729</b>	<b>9.545</b>	<b>9.641</b>	<b>118.022</b>	<b>174.017</b>	

Notes:

(1) The cost of the Thor launch vehicles (\$500K per vehicle) is excluded here and included in the investment cost category designated launch vehicle cost.

(2) The cost of the Atlas SLV-3 launch vehicles (\$1,647K per vehicle) is excluded here and included in the investment cost category designated launch vehicle cost.

(Page 4-196 is Blank)

(U) FIGURE 4-111  
 FLIGHT RESEARCH FACILITY MISSION TIMES (PHASE 1)

Flight Facility Identification					Flight Test Mission Profiles			Test Program Life (Yrs)	Flight Frequency		Flight Time (Min.) ①	Total Cruise Test Time (Hr)	Total Flight Time (Hr)
Config. No.	Launch Mode	Control Mode	Prop. System(s)	Mach. No.	Phase				Flts Yr (3 Veh.)	Total Flts			
					Acc. & Climb to Cruise Time (Min.)	Cruise Time (Min.)	Descent Time (Min.)						
200	HTO	Manned	TRJ	4.5	2.81	5.00	13.00	5	45	225	20.81	18.75	78.04
204	Air	Unmanned	TRJ	6+	8.23	5.00	16.00	5	36	180	29.23	15.00	87.69
205	Air	Manned	TRJ	6+	8.23	5.00	16.00	5	36	180	29.23	15.00	87.69
207	Air	Manned	RKT & RJ	6+	1.94	5.00	15.50	5	36	180	22.44	15.00	67.32
210	HTO	Manned	TRJ	6+	8.26	5.00	16.00	5	45	225	29.26	18.75	109.73
213	HTO	Manned	RKT & RJ	6+	2.47	5.00	15.50	5	45	225	22.97	18.75	86.14
214	HTO	Manned	TRJ & RKT	6+	2.48	5.00	17.50	5	45	225	24.98	18.75	93.68
220	Boost VTO	Unmanned	Booster & RKT	6+	2.00	5.00	13.00	2	4	8	20.00	.667	2.67
221	Boost VTO	Unmanned	Booster & RJ	6+	2.00	5.00	13.00	5	4	8	20.00	.667	2.67
232	Air	Manned	RKT & CSJ	12	3.08	5.00	30.00	5	36	180	38.08	15.00	114.24
233	Air	Manned	RKT	12	3.09	5.00	30.50	5	36	180	38.59	15.00	115.77
234	Air	Manned	RKT	12	3.16	5.00	31.50	5	36	180	39.66	15.00	118.98
250	HTO	Manned	RKT	12	3.41	5.00	30.50	5	45	225	38.91	18.75	145.91
250 J2S	HTO	Manned	RKT	12	3.68	5.00	30.60	5	45	225	39.28	18.75	147.30
251	HTO	Manned	RKT	12	3.37	5.00	31.00	5	45	225	39.37	18.75	147.64
252	HTO	Manned	RKT	12	3.40	5.00	30.50	5	45	225	38.90	18.75	145.88
253	HTO	Manned	RKT	12	2.64	5.00	28.00	5	45	225	35.64	18.75	141.15
254	HTO	Manned	RKT & CSJ	12	3.44	5.00	29.50	5	45	225	37.94	18.75	142.28
255	HTO	Manned	RKT & CSJ	12	3.44	5.00	31.00	5	45	225	39.44	18.75	147.90
256	HTO	Manned	RKT	12	2.54	5.00	30.00	5	45	225	37.64	18.75	131.15
257	HTO	Manned	TJ & CSJ	12	13.00	5.00	30.00	5	45	225	48.00	18.75	180.00
270	VTO	Manned	RKT	12	3.52	5.00	31.00	5	36	180	39.52	15.00	118.56
271	VTO	Manned	RKT & CSJ	12	3.54	5.00	29.50	5	36	180	38.04	15.00	114.12
280	Boost VTO	Unmanned	Booster & CSJ	12	2.12	5.00	26.00	2	4	8	33.12	.667	4.42
281	Boost VTO	Unmanned	Booster & RKT	12	2.13	5.00	27.00	2	4	8	34.13	.667	4.55
282	Boost VTO	Unmanned	Booster & RKT	12	2.48	5.00	25.00	2	4	8	32.48	.667	4.33
284	Air	Unmanned	RKT	12	3.09	5.00	30.50	5	36	180	38.59	15.00	115.77
285	HTO	Unmanned	RKT	12	3.40	5.00	30.50	5	45	225	38.90	18.75	145.88

① Flight time = Acc. & climb to cruise time + cruise time + descent time

MCDONNELL AIRCRAFT  
4-197

REPORT MDC A0013 ● 2 OCTOBER 1970  
VOLUME II ● PART 2

(U) FIGURE 4-112  
VEHICLE REFURBISHMENT COST SUMMARY

CONFIG. NO.	VEH. INV. COST (\$)	VEHICLE REFURBISHMENT COST (\$)			REFURB. % (3)	NO. OF FLIGHTS	REFURBISHMENT COST TOTAL (\$)		
		LABOR (1)	MATERIAL (2)	TOTAL			LABOR	MATERIAL	TOTAL
200	18,478,000	166,302	110,868	277,170	1.5	225	37,417,950	24,945,300	62,363,250
204	26,809,000	321,708	214,472	536,180	2.0	180	57,907,440	38,604,960	96,512,400
205	28,013,000	336,156	224,104	560,260	2.0	180	60,508,080	40,338,720	100,846,800
207	20,436,000	245,232	163,488	408,720	2.0	180	44,141,760	29,427,840	73,569,600
210	37,256,000	447,072	298,048	745,120	2.0	225	100,591,200	67,060,800	167,652,000
213	23,372,000	280,464	186,976	467,440	2.0	225	63,104,400	42,069,600	105,174,000
214	14,257,000	171,084	114,056	285,140	2.0	225	38,493,900	25,662,600	64,156,500
220	10,169,000	122,028	81,352	203,380	2.0	8	976,224	650,816	1,627,040
221	10,358,000	124,296	82,864	207,160	2.0	8	994,368	662,912	1,657,280
232	20,155,000	302,325	201,550	503,875	2.5	180	54,418,500	36,279,000	90,697,500
233	19,101,000	286,515	191,010	477,525	2.5	180	51,572,700	34,381,800	85,954,500
234	24,871,000	373,065	248,710	621,775	2.5	180	67,151,700	44,767,800	111,919,500
250	24,208,000	363,120	242,080	605,200	2.5	225	81,702,000	54,468,000	136,170,000
250 J2S	30,184,000	452,760	301,840	754,600	2.5	225	101,871,000	67,914,000	169,785,000
251	28,060,000	420,900	280,600	701,500	2.5	225	94,702,500	63,135,000	157,837,500
252	25,211,000	370,165	252,110	630,275	2.5	225	85,087,125	56,724,750	141,811,875
253	31,119,000	466,785	311,190	777,975	2.5	225	105,026,625	70,017,750	175,044,375
254	27,620,000	414,300	276,200	690,500	2.5	225	93,217,500	62,145,000	155,362,500
255	32,111,000	418,665	321,110	802,775	2.5	225	94,199,625	72,249,750	166,449,375
256	24,205,000	363,075	242,050	605,125	2.5	225	81,691,875	54,461,250	136,153,125
257	34,573,000	518,595	345,730	864,325	2.5	225	116,683,875	77,789,250	194,473,125
270	25,465,000	381,975	254,650	636,625	2.5	180	68,755,500	45,837,000	114,592,500
271	29,784,000	446,760	297,840	744,600	2.5	180	80,416,800	53,611,200	134,028,000
280	10,983,000	164,745	109,830	274,575	2.5	8	1,317,960	878,640	2,196,600
281	10,176,000	152,640	101,760	254,400	2.5	8	1,221,120	814,080	2,035,200
282	10,216,000	153,240	102,160	255,400	2.5	8	1,225,920	817,280	2,043,200
284	19,483,000	292,245	194,830	487,075	2.5	180	52,604,100	35,069,400	87,673,500
285	24,857,000	372,855	248,570	621,425	2.5	225	83,892,375	55,928,250	139,820,625

- ① 60% of Total Refurbishment Cost
- ② 40% of Total Refurbishment Cost
- ③ % of Flight Vehicle Investment Cost

(U) FIGURE 4-113  
PROPELLANT COST SUMMARY

Configuration Number	Propellants (lb)		Utilization Factor <sup>③</sup>		Adjusted Propellants (lb)		No. of Trips	Propellant Requirements (lb)		Propellant Cost/lb (\$/lb)		Propellant Costs (\$)				
	Fuel	Oxidizer	Fuel	Oxidizer	Fuel	Oxidizer		Fuel	Oxidizer	Fuel	Oxidizer	Fuel	Oxidizer	Fuel	Oxidizer	Total
200	5,581 JP	-	1.1	-	6,139 JP	-	225	1,381,275	-	0.015	-	20,719	-	20,719		
204	2,680 LH <sub>2</sub>	-	1.5	-	4,020 LH <sub>2</sub>	-	180	723,600	-	0.1385	-	100,219	-	100,219		
205	2,740 LH <sub>2</sub>	-	1.5	-	4,110 LH <sub>2</sub>	-	180	739,800	-	0.1385	-	102,462	-	102,462		
207	3,200 LH <sub>2</sub>	15,000 LOX	1.5	1.54	4,800 LH <sub>2</sub>	23,100 LOX	180	864,000	4,158,000	0.1385	0.0061	119,664	25,364	145,028		
210	5,000 LH <sub>2</sub>	-	1.5	-	7,500 LH <sub>2</sub>	-	225	1,687,500	-	0.1385	-	233,719	-	233,719		
213	5,890 LH <sub>2</sub>	28,670 LOX	1.5	1.54	8,835 LH <sub>2</sub>	44,152 LOX	225	1,987,875	9,934,200	0.1385	0.0061	275,321	60,599	335,920		
214	3,905 LH <sub>2</sub>	23,445 LOX	1.5	1.54	5,858 LH <sub>2</sub>	36,105 LOX	225	1,318,050	8,123,625	0.1385	0.0061	182,550	49,554	232,104		
220 <sup>①</sup>	430 LH <sub>2</sub>	-	1.5	-	645 LH <sub>2</sub>	-	8	5,160	-	0.1385	-	715	-	715		
221 <sup>①</sup>	440 LH <sub>2</sub>	-	1.5	-	660 LH <sub>2</sub>	-	8	5,280	-	0.1385	-	731	-	731		
232	7,200 LH <sub>2</sub>	38,600 LOX	1.5	1.54	10,800 LH <sub>2</sub>	59,444 LOX	180	1,944,000	10,699,920	0.1385	0.0061	269,244	65,270	334,514		
233	11,345 LH <sub>2</sub>	41,455 LOX	1.5	1.54	17,018 LH <sub>2</sub>	63,841 LOX	180	3,063,240	11,491,380	0.1385	0.0061	424,259	70,097	494,356		
234	9,750 LH <sub>2</sub>	58,400 LOX	1.5	1.54	14,625 LH <sub>2</sub>	89,936 LOX	180	2,632,500	16,188,480	0.1385	0.0061	364,601	98,750	463,351		
250	14,150 LH <sub>2</sub>	84,890 LOX	1.5	1.54	31,225 LH <sub>2</sub>	130,731 LOX	225	4,775,625	29,414,475	0.1385	0.0061	661,424	179,428	840,852		
250J2S	23,400 LH <sub>2</sub>	128,300 LOX	1.5	1.54	35,100 LH <sub>2</sub>	197,582 LOX	225	7,897,500	44,455,950	0.1385	0.0061	1,093,804	271,181	1,364,985		
251	15,900 LH <sub>2</sub>	94,900 LOX	1.5	1.54	23,850 LH <sub>2</sub>	146,146 LOX	225	5,366,250	32,882,850	0.1385	0.0061	743,226	200,585	943,811		
252	14,300 LH <sub>2</sub>	86,300 LOX	1.5	1.54	21,450 LH <sub>2</sub>	132,902 LOX	225	4,826,250	29,902,950	0.1385	0.0061	668,536	182,408	850,944		
253	78,000 Aero 50	186,700 N <sub>2</sub> O <sub>4</sub>	1.1	1.1	85,800 Aero 50	205,370 LOX	225	19,305,000	46,208,250	0.4700	0.1200	9,073,350	5,544,990	14,618,340		
254	15,070 LH <sub>2</sub>	83,650 LOX	1.5	1.54	22,605 LH <sub>2</sub>	128,821 LOX	225	5,086,125	28,984,725	0.1385	0.0061	704,428	176,807	881,235		
255	19,500 LH <sub>2</sub>	108,900 LOX	1.5	1.54	29,250 LH <sub>2</sub>	167,706 LOX	225	6,581,250	37,733,850	0.1385	0.0061	911,503	230,176	1,141,679		
256	68,800 Aero 50	146,380 N <sub>2</sub> O <sub>4</sub>	1.1	1.1	66,880 Aero 50	161,018 N <sub>2</sub> O <sub>4</sub>	225	15,048,000	36,229,050	0.4700	0.1200	7,072,560	4,347,486	11,420,046		
257	22,200 LH <sub>2</sub>	-	1.5	-	33,300 LH <sub>2</sub>	-	225	7,492,500	-	0.1385	-	1,037,711	-	1,037,711		
270	16,100 LH <sub>2</sub>	96,800 LOX	1.5	1.54	24,150 LH <sub>2</sub>	149,070 LOX	180	4,347,000	26,832,960	0.1385	0.0061	602,060	163,681	765,741		
271	18,880 LH <sub>2</sub>	105,200 LOX	1.5	1.54	28,320 LH <sub>2</sub>	162,008 LOX	180	5,097,600	29,161,440	0.1385	0.0061	706,018	177,885	883,903		
280 <sup>②</sup>	420 LH <sub>2</sub>	-	1.5	-	630 LH <sub>2</sub>	-	8	5,040	-	0.1385	-	698	-	698		
281 <sup>②</sup>	305 LH <sub>2</sub>	1,835 LOX	1.5	1.54	458 LH <sub>2</sub>	2,826 LOX	8	3,664	22,608	0.1385	0.0061	507	138	645		
282 <sup>②</sup>	1,160 Aero 50	2,790 N <sub>2</sub> O <sub>4</sub>	1.1	1.1	1,276 Aero 50	3,069 H <sub>2</sub> O <sub>4</sub>	8	10,208	24,552	0.4700	0.1200	4,798	2,946	7,744		
284	11,130 LH <sub>2</sub>	40,370 LOX	1.5	1.54	16,695 LH <sub>2</sub>	63,094 LOX	180	3,005,100	11,356,920	0.1385	0.0061	516,206	69,277	485,483		
285	14,000 LH <sub>2</sub>	84,000 LOX	1.5	1.54	21,000 LH <sub>2</sub>	129,360 LOX	225	4,725,000	29,106,000	0.1385	0.0061	654,413	177,547	831,960		
Thor Booster	28,857 RP-1	72,143 LOX	1.1	1.54	31,743 RP-1	111,100 LOX	8	253,944	888,800	0.015	0.0061	3,809	5,422	9,231		
SLV-3 Booster	70,286 RP-1	175,714 LOX	1.1	1.54	77,315 RP-1	270,600 LOX	8	618,520	2,164,800	0.015	0.0061	9,278	13,205	22,483		

- ① Thor booster used to launch vehicle.  
 ② SLV-3 booster used to launch vehicle.  
 ③ To account for propellants purchased but not used due to boil-off, spillage, line loss, contamination, sub-cooling, etc.

(U) FIGURE 4-113  
**PROPELLANT COST SUMMARY**  
 (INTERNATIONAL SYSTEM OF UNITS)

Configuration Number	Propellants (kg)		Utilization Factor <sup>(3)</sup>		Adjusted Propellants (kg)		No. of Trips	Propellant Requirements (kg)		Propellant Cost/lb (\$/kg)		Propellant Costs (\$)		
	Fuel	Oxidizer	Fuel	Oxidizer	Fuel	Oxidizer		Fuel	Oxidizer	Fuel	Oxidizer	Fuel	Oxidizer	Total
200	2,532 JP	-	1.1	-	2,785 JP	-	225	626,537	-	0.03307	-	20,719	-	20,719
204	1,216 LH <sub>2</sub>	-	1.5	-	1,823 LH <sub>2</sub>	-	180	328,220	-	0.30534	-	100,219	-	100,219
205	1,243 LH <sub>2</sub>	-	1.5	-	1,864 LH <sub>2</sub>	-	180	335,568	-	0.30534	-	102,462	-	102,462
207	1,451 LH <sub>2</sub>	6,804 LOX	1.5	1.54	2,177 LH <sub>2</sub>	10,433 LOX	180	391,904	1,886,040	0.30534	0.01345	119,664	25,364	145,028
210	2,260 LH <sub>2</sub>	-	1.5	-	3,402 LH <sub>2</sub>	-	225	765,438	-	0.30534	-	233,719	-	233,719
213	2,672 LH <sub>2</sub>	13,005 LOX	1.5	1.54	4,007 LH <sub>2</sub>	20,027 LOX	225	901,686	4,506,084	0.30534	0.01345	275,321	60,599	335,920
214	1,771 LH <sub>2</sub>	10,634 LOX	1.5	1.54	2,657 LH <sub>2</sub>	16,377 LOX	225	597,858	3,684,819	0.30534	0.01345	182,550	49,554	232,104
220 <sup>(1)</sup>	195 LH <sub>2</sub>	-	1.5	-	293 LH <sub>2</sub>	-	8	2,341	-	0.30534	-	715	-	715
221 <sup>(1)</sup>	200 LH <sub>2</sub>	-	1.5	-	299 LH <sub>2</sub>	-	8	2,395	-	0.30534	-	731	-	731
232	3,266 LH <sub>2</sub>	17,509 LOX	1.5	1.54	4,899 LH <sub>2</sub>	26,963 LOX	180	881,785	4,853,409	0.30534	0.01345	269,244	65,270	334,514
233	5,146 LH <sub>2</sub>	18,804 LOX	1.5	1.54	7,719 LH <sub>2</sub>	28,958 LOX	180	1,389,464	5,212,410	0.30534	0.01345	424,259	70,097	494,356
234	4,423 LH <sub>2</sub>	26,490 LOX	1.5	1.54	6,634 LH <sub>2</sub>	40,794 LOX	180	1,194,084	7,342,981	0.30534	0.01345	364,601	98,750	463,351
250	6,418 LH <sub>2</sub>	38,506 LOX	1.5	1.54	14,163 LH <sub>2</sub>	59,299 LOX	225	2,166,190	13,342,200	0.30534	0.01345	661,424	179,428	840,852
250J2S	10,614 LH <sub>2</sub>	58,196 LOX	1.5	1.54	15,921 LH <sub>2</sub>	89,622 LOX	225	3,582,251	20,164,908	0.30534	0.01345	1,093,804	271,181	1,364,985
251	7,212 LH <sub>2</sub>	43,046 LOX	1.5	1.54	10,818 LH <sub>2</sub>	66,291 LOX	225	2,434,093	14,915,431	0.30534	0.01345	743,226	200,585	943,811
252	6,486 LH <sub>2</sub>	39,145 LOX	1.5	1.54	9,730 LH <sub>2</sub>	60,283 LOX	225	2,189,153	13,563,769	0.30534	0.01345	668,536	182,408	850,944
253	35,380 Aero 50	84,686 N <sub>2</sub> O <sub>4</sub>	1.1	1.1	38,918 Aero 50	93,154 LOX	225	8,756,613	20,959,739	1.03617	0.26455	9,073,350	5,544,990	14,618,340
254	6,836 LH <sub>2</sub>	37,943 LOX	1.5	1.54	10,253 LH <sub>2</sub>	58,432 LOX	225	2,307,031	13,147,268	0.30534	0.01345	704,428	176,807	881,235
255	8,845 LH <sub>2</sub>	49,396 LOX	1.5	1.54	13,268 LH <sub>2</sub>	76,070 LOX	225	2,985,209	17,115,810	0.30534	0.01345	911,503	230,176	1,141,679
256	27,578 Aero 50	66,397 N <sub>2</sub> O <sub>4</sub>	1.1	1.1	30,336 Aero 50	73,037 N <sub>2</sub> O <sub>4</sub>	225	6,825,667	16,433,243	1.03617	0.26455	7,072,560	4,347,486	11,420,046
257	10,070 LH <sub>2</sub>	-	1.5	-	15,105 LH <sub>2</sub>	-	225	3,398,546	-	0.30534	-	1,037,711	-	1,037,711
270	7,303 LH <sub>2</sub>	43,908 LOX	1.5	1.54	10,954 LH <sub>2</sub>	67,617 LOX	180	1,971,769	12,171,243	0.30534	0.01345	602,060	163,681	765,741
271	8,528 LH <sub>2</sub>	47,718 LOX	1.5	1.54	12,846 LH <sub>2</sub>	73,486 LOX	180	2,312,236	13,227,425	0.30534	0.01345	706,018	177,885	883,903
280 <sup>(2)</sup>	191 LH <sub>2</sub>	-	1.5	-	286 LH <sub>2</sub>	-	8	2,286	-	0.30534	-	698	-	698
281 <sup>(2)</sup>	138 LH <sub>2</sub>	832 LOX	1.5	1.54	208 LH <sub>2</sub>	1,282 LOX	8	1,662	10,255	0.30534	0.01345	507	138	645
282 <sup>(2)</sup>	526 Aero 50	1,266 N <sub>2</sub> O <sub>4</sub>	1.1	1.1	579 Aero 50	1,392 N <sub>2</sub> O <sub>4</sub>	8	4,630	11,137	1.03617	0.26455	4,798	2,946	7,744
284	505 LH <sub>2</sub>	18,584 LOX	1.5	1.54	7,573 LH <sub>2</sub>	28,619 LOX	180	1,363,092	5,151,419	0.30534	0.01345	516,206	69,277	485,483
285	635 LH <sub>2</sub>	38,102 LOX	1.5	1.54	9,525 LH <sub>2</sub>	58,677 LOX	225	2,143,227	13,202,278	0.30534	0.01345	654,413	177,547	831,960
Thor Booster	13,089 RP-1	32,724 LOX	1.1	1.54	14,398 RP-1	50,394 LOX	8	115,187	403,153	0.03307	0.01345	3,809	5,422	9,231
SLV-3 Booster	31,881 RP-1	79,703 LOX	1.1	1.54	35,070 RP-1	122,742 LOX	8	280,556	981,938	0.03307	0.01345	9,278	13,205	22,483

<sup>(1)</sup> Thor booster used to launch vehicle.

<sup>(2)</sup> SLV-3 booster used to launch vehicle.

<sup>(3)</sup> To account for propellants purchased but not used due to boil-off, spillage, line loss, contamination, sub-cooling, etc.

\$100,000 per year. This factor was generated from X-15 cost and operation data and escalated to 1970 economics.

4.12.2.3.7 (U) Transportation Cost - Transportation costs are shown in Figure 4-114. It was assumed that the C-5A transport would transport the flight vehicle from the recovery sites to the launch site(s). The cost per flying hour (\$811) used for the C-5A was obtained from Ref. (24) and is the charge quoted for the MATS airlift industrial fund concept. The long range cruise speed used for the C-5A aircraft was 440 knots. The following criteria was used in the development of the transportation time from the recovery sites to the launch sites:

- (a) Edwards to Walker AFB - 670 nm/440 Knots (1,241KM/814KM/HR) = 1.53 hrs.
- (b) Edwards to Dyess AFB - 930 nm/440 Knots (1,722KM/814KM/HR) = 2.12 hrs.
- (c) Barksdale AFB to Cape Kennedy - 700 nm/440 Knots (1,296KM/814KM/HR) = 1.59 hrs.
- (d) Edwards to Homestead AFB - 2,150 nm/440 Knots (3,982KM/814KM/HR) = 4.89 hrs.
- (e) Edwards to Loring AFB - 3,375 nm/440 Knots (6,251KM/814KM/HR) = 7.67 hrs.
- (f) Edwards to Kennedy AFB - 2,100 nm/440 Knots (3,889KM/814KM/HR) = 4.77 hrs.

(U) The transportation costs shown in Figure 4-114 represents the round trip costs as it was assumed that the C-5A flies back to the recovery site after delivery of the flight research vehicle to the respective launch site.

4.12.2.3.8 (U) Pilot Pay and Support Personnel Pay - Pilot pay was generated by multiplying the pilot pay (\$50,000/yr) times the number of pilots in the program per year (4) times the program duration which is 5 years for all the manned vehicle configurations. Support personnel requirements were generated from the following CER (Cost Estimating Relationship):

$$SP = [2 (50 \times 20 (LPM) \times (TOGW/344,000) \cdot 33]$$

where: LPM = launches per month

TOGW = Vehicle take-off gross weight in pounds

(U) The CER was obtained from Ref. (19) and adjusted using X-15 data. Support personnel were priced at \$20,000 per year. Hence, support personnel costs were obtained by multiplying the number of support personnel required times the support personnel pay per year times the program duration.

4.12.2.3.9 (U) Launch Platform Operating Cost - Launch platform operating costs consist of the operating costs associated with the launch aircraft and VTO launchers. The launch platform aircraft operating costs are shown in Figure 4-109. Operating costs associated with the VTO launchers were computed by multiplying the investment cost of the launcher by a factor of 5% for each year of operation.

(U) FIGURE 4-114  
**FLIGHT VEHICLE TRANSPORTATION COST SUMMARY**

MCDONNELL AIRCRAFT  
4-202

REPORT MDC A0013 ● 2 OCTOBER 1970  
 VOLUME II ● PART 2

CONFIG. NO.	ORIGIN/DESTINATION	DISTANCE		COST PER RD. TRIP (\$)	NO. OF TRIPS	FLT. VEH. TRANS. COST (\$)	LAUNCH VEH. TRANS. COST (\$)	TOTAL TRANS. COST (\$)
		NM	KM					
200	Edwards/Walker AFB	670	1,241	2,482	225	558,450	---	558,450
204	Edwards/Homestead AFB	2,150	3,982	7,932	180	1,427,760	---	1,427,760
205	Edwards/Walker AFB	670	1,241	2,482	180	446,760	---	446,760
207	Edwards/Walker AFB	670	1,241	2,482	180	446,760	---	446,760
210	Edwards/Dyess AFB	930	1,722	3,438	225	773,550	---	773,550
213	Edwards/Dyess AFB	930	1,722	3,438	225	773,550	---	773,550
214	Edwards/Dyess AFB	930	1,722	3,438	225	773,550	---	773,550
220	Barksdale AFB Kennedy	700	1,296	2,578	8	20,624	20,000 ①	40,624
221	Barksdale AFB/Kennedy	700	1,296	2,578	8	20,624	20,000 ②	40,624
232	Edwards/Homestead AFB	2,150	3,982	7,932	180	1,427,760	---	1,427,760
233	Edwards/Homestead AFB	2,150	3,982	7,932	180	1,427,760	---	1,427,760
234	Edwards/Homestead AFB	2,150	3,982	7,932	180	1,427,760	---	1,427,760
250	Edwards/Homestead AFB	2,150	3,982	7,932	225	1,784,700	---	1,784,700
250 J2S	Edwards/Homestead AFB	2,150	3,982	7,932	225	1,784,700	---	1,784,700
251	Edwards/Homestead AFB	2,150	3,982	7,932	225	1,784,700	---	1,784,700
252	Edwards/Homestead AFB	2,150	3,982	7,932	225	1,784,700	---	1,784,700
253	Edwards/Homestead AFB	2,150	3,982	7,932	225	1,784,700	---	1,784,700
254	Edwards/Homestead AFB	2,150	3,982	7,932	225	1,784,700	---	1,784,700
255	Edwards/Homestead AFB	2,150	3,982	7,932	225	1,784,700	---	1,784,700
256	Edwards/Homestead AFB	2,150	3,982	7,932	225	1,784,700	---	1,784,700
257	Edwards/Loring AFB	3,375	6,251	12,440	225	2,799,000	---	2,799,000
270	Edwards/Kennedy	2,100	3,889	7,736	180	1,392,480	---	1,392,480
271	Edwards/Kennedy	2,100	3,889	7,736	180	1,392,480	---	1,392,480
280	Edwards/Kennedy	2,100	3,889	7,736	8	61,888	40,000 ②	101,888
281	Edwards/Kennedy	2,100	3,889	7,736	8	61,888	40,000 ②	101,888
282	Edwards/Kennedy	2,100	3,889	7,736	8	61,888	40,000 ①	101,888
284	Edwards/Homestead AFB	2,150	3,982	7,932	180	1,427,760	---	1,427,760
285	Edwards/Homestead AFB	2,150	3,982	7,932	225	1,784,700	---	1,784,700

① Cost to ship 8 Thors Launch Vehicles to Cape Kennedy from West Coast by MATS Cargo Aircraft  
 ② Cost to ship 9 Atlas Launch Vehicles to Cape Kennedy from West Coast by MATS Cargo Aircraft

4.12.2.3.10 (U) Launch Service Cost - The launch service cost is the cost associated with the assembly, check-out, fueling and launching the Thor and Atlas launch vehicles from Cape Kennedy. A launch service cost of \$195,000 per launch was used for the Thor launch vehicles while a launch service cost of \$247,900 per launch was used for the Atlas launch vehicles. These costs were generated from Douglas and General Dynamics data and adjusted for quantity.

4.12.3 (U) DATA APPLICATION - In order to demonstrate the application of the costing data derived in Sections 4.12.2.1 and 4.12.2.2, calculation of the estimated costs for the Air Launched, Mach 12, Rocket, manned vehicle (Configuration 250) is presented in the following example. Frequent reference is made to data derivations and methodology in Sections 4.12.2.1 and 4.12.2.2, and those sections should be consulted for the origin of methods employed in this example. All prices are calculated in 1969 economics and then adjusted to 1970 economics.

4.12.3.1 (U) RDT&E Cost Development Application - The following discussion shows the development of the RDT&E cost for configuration 250. The RDT&E costs associated with support equipment design and systems integration and test facilities are not shown here; however, their development is shown in Figure 4-95.

(1) Airframe Design and Development - The airframe design and development test costs were computed in total for configuration 250 and are included in the airframe engineering cost.

(A) Airframe Engineering - Figure 4-115 is a summary of material and equipment weights for the configuration 250. Deductions applicable to this model are made from the empty weight of the configuration in order to arrive at the DCPR weight of 24,253 pounds (11,046 kg). The engineering price per pound is taken from Figure 4-97 in Section 4.12.2.1.1 at the DCPR weight of 24,353 pounds and specified velocity of Mach 12. The engineering price for this configuration is \$7,550 per pound (\$16,645/kg). The price per pound or kg times the DCPR weight of 24,353 pounds or 11,046 kg is \$183,865,000. This price is based on the 0.110 lbs./in.<sup>3</sup> (.003 kg/cm<sup>3</sup>) material density shown in Figure 4-99, and must be adjusted to the material density of the configuration 250.

Figure 4-116 derives the material density of 0.164 lbs./in.<sup>3</sup> (.0045 kg/cm<sup>3</sup>) for this configuration and a density adjustment factor of 0.67. The \$183,865,000 x 0.67 yields the adjusted engineering price of \$123,190,000. This price when adjusted to 1970 economics is \$130,000,000.

(B) Miscellaneous Subsystem Development - Figure 4-117, summarizes the equipment weights for this configuration. Recurring equipment price is \$745,000. This price multiplied by a factor of four as determined in Section 4.12.2.1.1 gives a development price of \$2,980,000. This equipment design and development price is \$3,159,000 when adjusted for 1970 economics.



(U) FIGURE 4-115  
 DCPR WEIGHT FOR CONFIGURATION 250

	Weight Empty		DCPR Deductions		DCPR Weight	
	lb	kg	lb	kg	lb	kg
<u>Structure</u>						
Aluminum	7249	3288				
Steel	1466	665				
Titanium	1464	664				
Rene 41	4142	1879				
T.D. Nickel	435	197				
Columbium	2065	937				
Nose Cone	150	68				
Insulation	1460	662				
Other	1357	616				
Subtotal Structure Weight	19788	8976			19788	8976
<u>Equipment</u>						
NLG Wheels Tires and Brakes	58	26	58	26	0	0
MLG Wheels Tires and Brakes	254	115	254	115	0	0
Power Plant and Fuel System	3700	1678	2380	1080	1320	598
Controls and Hydraulics	1825	828	0	0	1825	828
Electrical	1210	549	396	180	814	369
Instruments	175	79	105	48	70	31
Furnishings and Equipment	280	127	0	0	280	127
Electronics	450	204	369	167	81	37
Environmental Control System	250	114	75	34	175	80
Total Systems Weight	8202	3720			4565	2070
Total Weight	27990	12696	3637	1650	24353	11046

<u>DCPR Deductions</u>		lb	kg
NLG Wheels Tires and Brakes		58	26
MLG Wheels Tires and Brakes		254	115
Engines		2380	1080
Power Source	660 lb x .60 (299 kg x .60)	396	180
Instruments	175 lb x .60* (79 kg x .60*)	105	48
Electronics	450 lb x .82 (204 kg x .82)	369	167
ECS	250 lb x .30* (114 kg x .30)	75	34
Total DCPR Deductions			

\*Based on F-4 Weight Data

(U) FIGURE 4-116  
 MATERIAL DENSITY FOR CONFIGURATION 250

Material	DCPR Weight		Percent Of DCPR Weight	Material Density	Weighted Density x 100
	lb	kg			
Columbium	2065	937	8.48	.326	2.764
T. D. Nickel	435	197	1.79	.322	.576
Rene 41	4142	1879	17.01	.298	5.069
Titanium	1464	664	6.01	.160	.962
Nose Cone	150	68	.62	.200	.124
Subtotal	8256	3745	33.91		9.495
Advanced Material					
Insulation	1460	662	6.00	.001	.006
Aluminum	7249	3288	29.76	.100	2.976
Other	1357	616	5.57	.110	.613
Steel	1466	665	6.02	.213	1.262
Systems	4565	2071	18.74	.110	2.061
Subtotal	16097	7302	66.09		6.938
Normal Material					
Total DCPR Weight	24353	11047			①

① Weighted Density =  $\frac{16.433}{100} = .164$

Material Density Adjustment Factor =  $\frac{.110}{.164} = .67$

② Includes:

Controls and Hydraulics	- 1825 lbs.	(828 kg)
Furnishings & Equipment	- 280 lbs.	(127 kg)
Fuel System	- 1320 lbs.	(599 kg)
Electrical System	- 550 lbs.	(250 kg)
ECS	- 175 lbs.	(79 kg)
Electronics	- 81 lbs.	(37 kg)
Instruments	- 70 lbs.	(32 kg)
Power Source	- 264 lbs.	(120 kg)
Total	4565 lbs.	2072 kg

(U) FIGURE 4-117  
 EQUIPMENT COSTS FOR CONFIGURATION 250

	Cost		Weight		Investment Cost	Development Cost
	\$/lb	\$/kg	lb	kg		
Wheels, Tires, Brakes	\$ 16.50	\$ 36.25	312	142	\$ 5,148	\$ 20,592
Power Plant and Fuel System	81.00	178.50	1320	599	106,920	427,680
Controls and Hydraulics	75.75	166.96	1825	828	138,244	552,976
Electrical	156.00	343.83	1210	549	188,760	755,040
Instruments	267.00	591.45	175	79	46,725	186,900
Furnishings and Equipment	41.70	92.15	137	62	5,713	22,852
Ejection Seat			143	65	38,865 <sup>(3)</sup>	139,460
Environmental Control System	148.00	324.57	250	114	37,000	148,000
Subtotal					\$563,375	\$2,253,500
					<u>1.322</u> <sup>Ⓛ</sup>	<u>1.322</u> <sup>Ⓛ</sup>
Total Price					<u>\$744,800</u>	<u>\$2,979,000</u>

Ⓛ Factor which is made up of the following costs:

- (1) Procurement expense
- (2) General and administrative costs
- (3) Earnings

- (C) Test Hardware - As explained in Section 4.12.2.1.1, the test hardware is 20% of production labor (\$18,156,000 from Section 4.12.3.2 (a)) plus material, \$4,604,000 from Section 4.12.3.2 (b)) or \$4,152,000. Since production and material are already in 1970 dollars, this figure requires no further adjustment.
- (D) Pre-delivery Flight Test - The following computations involve compilation of flight test costs as explained in Section 4.12.2.1.1.

Engineering	125,870 hrs x \$13.40/hr (Engr. Rate) =	\$1,686,658
Production	54,237 hrs x \$13.53/hr (Prod. Rate) =	733,827
Material	\$22,310 x 2.49 (Mat. Adj. Factor) x 1.202 (Proc. Factor) =	66,774
Travel and Per Diem	\$157,498 x 1.710 (Econ. Factor) x 1.138 (G&A Factor) =	269,322
Pilot Compensation	\$17,165 x 1.710 (Econ. Factor) x 1.138 (G&A Factor) =	<u>33,403</u>
		\$2,827,000*

\*Transportation and propellant costs not shown in example. These costs add \$230,000 to the adjusted total cost.

(U) Costs remain constant, with the exception of material, for all configurations. The factor of 2.49 used to adjust material dollars is the ratio of \$91.74 per pound (\$202/kg) of material for this configuration (from Section 4.12.3.2) to \$36.79 per pound (\$81/kg) of basic material. Factors have been applied for procurement and general and administrative expenses. Allowing earnings of 10% and an economic factor for 1970 dollars, the price for predelivery flight test is \$3,297,000. The basic hours and dollars used were obtained from the F-4 program and adjusted for the HYFAC program.

(2) Tooling - The tooling price of \$3,166,000 is equal to the DCPR weight of 24,353 lbs. (11,046 kg) times the tooling price of \$130 per lb (\$287/kg) obtained from Figure 4-102 developed in Section 4.12.2.1.2.

(U) The average weighted tooling complexity is found in the following manner; using material factors from MCAIR historical data.

	<u>Fraction</u>		<u>Tooling Complexity Factor</u>		<u>Weighted Complexity Factor</u>
Advanced Material	.3391	x	7.5	=	2.543
Conventional Material	.6609	x	1.0	=	<u>0.661</u>
Weighted Complexity				=	3.204

This weighted factor of 3.2 times the tooling price of \$3,166,000 is \$10,100,000 and becomes \$10,700,000 when adjusted to 1970 dollars.

(3) Avionics Development - Electronics equipment weight times \$500 per pound (\$1,102/kg) as explained in Section 4.12.2.1.3 is \$225,000. Avionics development cost is ten times the unit cost or \$2,225,000. Adding procurement expense, general and administrative expense and earnings, the price is \$2,976,000. When adjusted to 1970 dollars, the price is \$3,155,000.

(4) Propulsion Development - The take-off gross weight for the configuration 250 is 130,040 pounds (58,985 kg). By using the formula specified in Section 4.12.2.1.4, the vacuum thrust requirement for the rocket engine to be used in this model is 214,566 pounds (954,437 Newtons). Development cost of this engine is then determined directly from Figure 4-104. As explained in Section 4.12.2.1, propulsion is assumed to be GFAE or supplied by an associate contractor; therefore, no MCAIR loadings have been applied. Propulsion development is \$160,000,000 in 1969 dollars or \$169,599,000 in 1970 dollars.

(U) Development Cost Summary - The following is a summary of configuration 250 development costs which have been calculated in Section 4.12.3.1

Airframe Design and Development

Engineering Design and Development	\$130,457,000
Equipment Development	<u>3,159,000</u>
Subtotal	\$133,616,000
Predelivery Flight Test	3,297,000
Test Hardware	4,152,000
Tooling	<u>10,724,000</u>
Total Airframe	\$151,789,000
Avionics Development	3,155,000
Propulsion Development	<u>169,600,000</u>
Total Development Cost Less Support Equipment Design and Systems Integration and Ground Test Facilities Costs	\$324,544,000

4.12.3.2 (U) Investment Cost Development Application - The investment cost for configuration 250 is shown in the following discussion. Frequent reference is made to data derivations and methodology in Section 4.12.2.2, and this section should be consulted for the origin of methods employed in this example. All prices are calculated in 1969 economics and then adjusted to 1970 economics.

(A) Airframe

(a) Production Labor - Figure 4-107 developed in Section 4.12.2.2.1 is used to determine the production labor price estimate. For 24,353 lb (11,046 kg) DCPR weight, price of \$253 per pound is read and then multiplied by the DCPR weight to give a production labor price estimate of \$6,161,000 based on aluminum structure.

(U) Figure 4-118 summarizes materials from Figure 4-115 as percentages of DCPR weight. These percentages are multiplied by the individual production complexities to give a weighted production complexity of 2.78 for this configuration. This factor times the base price of \$6,161,000 equals \$17,128,000. Adjusted to 1970 economics, this price is \$18,156,000.

(U) FIGURE 4-118  
**PRODUCTION COMPLEXITY FOR CONFIGURATION 250**

Material	%	Complexity	Weighted Complexity
Columbium	8.48	4.0	33.92
T. D. Nickel	1.79	11.5	20.59
Rene 41	17.01	7.5	127.58
Titanium	6.01	4.5	27.05
Nose Cone	.62	4.0	2.48
Subtotal Advanced Material	33.91		211.62
Insulation	6.00	1.0	6.00
Aluminum	29.76	1.0	29.76
Other	5.57	1.0	5.57
Steel	6.02	1.0	6.02
Systems	18.74	1.0	18.74
Subtotal Conventional Material	66.09		66.09
Total	<u>100.00</u>		<u>277.71</u>

$$\text{Average Weighted Complexity} = \frac{277.71}{100} = 2.78$$

(b) Material - Material weights are summarized from Figure 4-115 and multiplied by their respective costs per pound from Section 4.12.2.2.1 to obtain total material cost as follows (Figure 4-119):

(U) FIGURE 4-119  
MATERIAL WEIGHT SUMMARY FOR CONFIGURATION 250

	Wt. From Figure 4-115		Dollars		Unit
	(lb)	(kg)	Per Pound	Per kg	Dollars
Basic Material (Including Systems)	16,097	7,301	36.79	81.09	\$ 592,000
Columbium	2,065	937	600.00	1322.31	1,239,000
T. D. Nickel	435	197	75.00	167.51	33,000
Rene' 41	4,142	1,879	50.00	110.10	207,000
Titanium	1,464	664	50.00	110.10	73,000
Nose Cone	<u>150</u>	<u>68</u>	<u>600.00</u>	<u>1323.54</u>	<u>90,000</u>
Subtotal	24,353	11,046	91.73	202.25	
Total Material Cost					<u>\$2,234,000</u>

Allowing 10% earnings and adjusting to 1970 economics, the material price is \$2,604,000.

(B) Miscellaneous Subsystems - The recurring equipment price of \$745,000 obtained from Figure 4-117, and adjusted for 1970 economics is \$790,000.

(C) Propulsion - Vacuum thrust requirement for the engine is 214,566 lb, (954,437 N) (see Section 4.12.2.2.1). Recurring cost is \$1,550,000 taken from Figure 4-104. As explained in Section 4.12.3.1, propulsion is assumed to be GFAE or supplied by an associate contractor; therefore, no further factors are applied. The investment propulsion cost is \$1,643,000 in 1970 dollars.

(D) Avionics - The recurring avionics price was estimated on the basis described in Section 4.12.2.2.1 and is \$958,000, adjusted for 1970 economics, the price is \$1,015,000. The payload instrumentation weight of 1000 lbs (454 kgs) was added to the electronics weight of 450 lbs (204 kgs) and the recurring cost was computed on the basis of \$500/lb x 1450 lbs. Loading and economic adjustment factors were then applied to obtain the recurring cost of \$1,015,000.

(E) Investment Cost Summary - The following is a summary of the configuration 250 estimated recurring prices which have been calculated in Section 4.12.3.2.

Airframe and Subsystems

Production Labor	\$18,156,000
Material	2,604,000
Equipment	<u>790,000</u>
Total	\$21,550,000
Avionics	1,015,000
Propulsion	<u>1,643,000</u>
Total Unit Price	<u>\$24,208,000</u>

4.12.4 (U) COST SUMMARY - This section presents the results of the cost study summarized for the flight research vehicles studied in the Phase I study.

(U) The RDT&E cost summary is presented in Figure 4-120. RDT&E costs are presented with and without propulsion development costs to show the cost impact of the propulsion systems' development costs on the total RDT&E costs. It can readily be seen from Figure 4-120 that propulsion development costs are a major portion of the total RDT&E cost.

(U) The total program cost for each flight research vehicle configuration is presented in Figure 4-121. Each of the cost elements are presented together with their respective costs to allow for cost comparisons and to show those costs which drive the total system costs.

(U) In addition to the flight vehicle costs presented in Figure 4-121, total program costs were derived for configurations 290, 291, 292 and 256 HID and are 30 M, 50 M, 75 M, and 660 M dollars respectively. Costs for configurations 290, 291, 292 and 256 HID were based on available data for the HL-10, X-24, F-106X and HYFAC configuration 256 and adjusted to reflect changes in the size, shape and systems requirements.



**(U) FIGURE 4-120**  
**RDT&E - COST SUMMARY (ILLUSTRATING THE EFFECT OF PROPULSION DEVELOPMENT)**

(Millions of Dollars)  
 (1970 Economics)

COST CATEGORIES	MODEL NOS.													
	200	204	205	207	210	213	214	220	221	232	233	234	250	251
<b>RDT&amp;E</b>														
AIRFRAME	69.470	69.508	72.025	78.464	98.407	90.820	81.883	57.109	58.348	118.768	116.843	129.055	141.295	157.649
PROPULSION	259.698	389.550	397.500	251.620	556.500	283.420	84.800	170.000	170.000	383.717	127.199	138.329	169.599	182.319
GR. TEST FAC.	3.500	5.000	5.000	8.000	5.000	8.000	---	8.000	8.000	5.000	---	---	---	---
OTHER	25.215	32.431	29.885	31.861	40.566	35.220	24.920	22.889	23.054	29.120	28.414	33.866	34.868	39.314
TOTAL W/PROP.	357.883	496.489	504.410	369.945	700.473	417.460	191.603	257.998	259.402	581.605	272.456	301.250	345.762	379.282
TOTAL W/O PROP.	94.685	101.939	101.910	110.325	138.973	126.040	106.803	79.998	81.402	147.888	145.257	162.921	176.163	196.963

COST CATEGORIES	MODEL NOS.													
	252	253	254	255	256	257	270	271	280	281	282	284	285	250-J2 S
<b>RDT&amp;E</b>														
AIRFRAME	136.737	177.708	146.207	164.496	173.357	177.139	141.242	158.186	79.951	80.919	96.415	115.422	139.363	165.856
PROPULSION	171.720	163.240	437.777	468.516	143.099	264.998	180.199	461.096	264.998	21.200	42.824	118.522	168.435	10.000
GR. TEST FAC.	---	---	50.000	50.000	---	50.000	---	50.000	50.000	---	---	---	---	---
OTHER	35.327	46.155	37.263	43.639	38.984	47.313	38.725	43.660	22.061	21.083	22.679	31.123	37.479	41.528
TOTAL W/PROP.	343.784	387.103	671.247	726.651	355.440	539.450	360.166	712.942	417.010	123.202	161.918	265.067	345.277	217.384
TOTAL W/O PROP.	172.064	223.863	183.470	208.135	212.341	224.452	179.967	201.846	102.012	102.002	119.094	146.545	176.842	207.384

MCDONNELL AIRCRAFT

4-212

REPORT MDC A0013 • 2 OCTOBER 1970  
 VOLUME II • PART 2

FOLDOUT FRAME 1

FOLDOUT FRAME 2

(U) FIGURE 4-121  
TOTAL SYSTEM COST SUMMARY ①

Cost Categories and Elements	Configuration Model Numbers													
	200	204	205	207	210	213	214	220	221	232	233	234	250	251
<b>I RDT&amp;E Costs</b>														
1. Airframe Design & Dev (No. of FHs)	225	180	180	180	225	225	225	8	8	180	180	180	225	225
A. Airframe Design														
B. Misc. Subsystem Design	64.288	62.847	64.888	71.667	90.228	83.621	76.189	54.676	55.915	111.974	110.070	121.140	133.616	149.216
C. Dev. Tests (Incl. Wind Tunnel)														
D. Test Hardware	1.860	3.331	3.605	3.318	4.721	3.761	2.335	1.596	1.596	3.201	3.221	4.356	4.152	4.886
E. Pre-Delivery Flt. Test	3.322	3.330	3.532	3.479	3.458	3.438	3.359	.837	0.837	3.593	3.552	3.559	3.527	3.547
Sub-Total	69.470	69.508	72.025	78.464	98.407	90.820	81.883	57.109	58.348	118.768	116.843	129.065	141.295	157.649
2. Tooling	5.858	9.110	9.129	10.306	14.316	11.358	6.289	4.442	4.442	7.960	8.124	10.986	10.724	12.557
3. Avionics Development	3.189	5.992	3.154	3.154	3.154	3.154	3.154	5.992	5.992	3.154	3.154	3.154	3.154	3.154
4. Propulsion Development	259.698	389.550	397.500	251.620	556.500	283.420	84.800	170.000	170.000	383.717	127.199	138.329	169.599	182.319
5. Support Equipment Design & Sys. Int.	16.168	17.329	17.602	18.401	23.096	20.708	15.477	12.455	12.620	18.006	17.136	19.726	20.990	23.603
6. Ground Test Facilities	3.500	5.000	5.000	8.000	5.000	8.000		8.000	8.000	50.000	-	-	-	-
<b>Total</b>	<b>357.883</b>	<b>496.489</b>	<b>504.410</b>	<b>369.945</b>	<b>700.473</b>	<b>417.460</b>	<b>191.603</b>	<b>257.998</b>	<b>259.402</b>	<b>581.605</b>	<b>272.456</b>	<b>301.250</b>	<b>345.762</b>	<b>379.282</b>
<b>II Investment Costs</b>														
1. Flight Vehicles														
A. Airframe	9.880	17.113	18.544	17.166	24.289	19.488	12.261	8.343	8.532	16.653	16.787	22.430	21.550	25.296
B. Misc. Subsystems														
C. Propulsion	7.579	8.395	8.454	2.255	11.952	2.869	.981	.525	0.525	2.487	1.299	1.426	1.643	1.749
D. Avionics	1.019	1.301	1.015	1.015	1.015	1.015	1.015	1.301	1.301	1.015	1.015	1.015	1.015	1.015
Unit Cost (1) Vehicle	18.478	26.809	28.013	20.436	37.256	23.372	14.257	10.169	10.358	20.155	19.101	24.871	24.208	28.060
Unit Cost (3) Vehicles	55.434	80.427	84.039	61.308	111.768	70.116	42.771	30.507	31.074	60.465	57.303	74.613	72.624	84.180
2. Support Costs														
A. AGE	8.315	12.064	12.606	9.196	16.765	10.517	6.416	4.576	4.661	9.069	8.595	11.192	10.894	12.627
B. Training Equipment	5.000	-	5.000	5.000	5.000	5.000	5.000	-	-	5.000	5.000	5.000	5.000	5.000
C. Initial Stocks (Engs & AGE Sps)	53.885	59.971	60.439	16.705	85.341	21.135	7.509	4.133	4.141	18.316	9.953	11.101	12.590	13.506
D. Initial Training	1.000	-	1.000	1.000	1.000	1.000	1.000	-	-	1.000	1.000	1.000	1.000	1.000
E. Initial Transportation	1.843	2.215	2.370	1.209	3.488	1.581	0.896	0.187	0.190	1.380	1.168	1.450	1.676	1.904
Sub-Total	70.043	74.250	81.415	33.110	111.594	39.233	20.821	8.896	8.992	34.765	25.716	29.743	31.160	34.037
3. Launch Platform Cost	-	3.762	3.861	6.450	-	-	-	-	-	10.455	11.205	14.408	-	-
4. Launch Vehicle Cost	-	-	-	-	-	-	-	4.000	4.000	-	-	-	-	-
<b>Total</b>	<b>125.477</b>	<b>158.439</b>	<b>169.315</b>	<b>100.868</b>	<b>223.362</b>	<b>109.349</b>	<b>63.592</b>	<b>43.403</b>	<b>44.066</b>	<b>105.685</b>	<b>94.224</b>	<b>118.764</b>	<b>103.784</b>	<b>118.217</b>
<b>III Operating Cost</b>														
1. Range User Cost	6.103	5.136	5.136	5.136	6.103	6.103	6.103	0.678	0.678	5.136	5.136	5.136	6.103	6.103
2. Escort Aircraft & Logistics	2.498	1.998	1.998	1.998	2.498	2.498	2.498	0.089	0.089	1.998	1.998	1.998	2.498	2.498
3. Vehicle Refurb. Cost	62.363	96.512	100.847	73.570	167.652	105.174	64.157	1.627	1.657	90.698	85.964	111.920	136.170	157.838
4. Propellant Cost	0.021	0.100	0.102	0.145	0.234	0.336	0.232	0.010	0.010	0.335	0.494	0.463	0.841	0.944
5. AGE Maintenance (Labor Only)	1.247	1.810	1.891	1.380	2.515	1.578	0.962	0.274	0.280	1.360	1.290	1.679	1.634	1.894
6. General Purpose Maintenance Sup.	0.500	0.500	0.500	0.500	0.500	0.500	0.500	0.200	0.200	0.500	0.500	0.500	0.500	0.500
7. Transportation Cost	0.558	1.428	0.447	0.447	0.774	0.774	0.774	0.041	0.041	1.428	1.428	1.428	1.785	1.785
8. Pilot Pay & Sup. Per. Pay	17.400	15.000	16.200	17.000	18.400	19.600	18.000	4.160	4.160	18.000	18.200	18.800	21.800	22.400
9. Launch Platform Operating Cost	-	2.484	2.484	2.484	-	-	-	-	-	2.286	2.286	2.286	-	-
10. Launch Service Cost	-	-	-	-	-	-	-	1.560	1.560	-	-	-	-	-
<b>Total</b>	<b>90.690</b>	<b>124.968</b>	<b>129.605</b>	<b>102.660</b>	<b>198.676</b>	<b>136.563</b>	<b>93.226</b>	<b>8.639</b>	<b>8.675</b>	<b>121.741</b>	<b>117.286</b>	<b>144.210</b>	<b>171.331</b>	<b>193.962</b>
Grand Total W/ Prop	574.050	779.896	803.330	573.473	1,122.511	663.372	348.421	310.040	312.143	809.031	483.966	564.224	620.877	691.461
Grand Total W/O Prop.	310.852	385.346	400.830	313.853	561.011	371.952	263.621	132.040	134.143	375.314	356.767	425.895	451.278	509.142

① 1970 Costs (Millions of Dollars)

FOLDOUT FRAME 1

(U) FIGURE 4-121 (Continued)  
TOTAL SYSTEM COST SUMMARY ①

FOLDOUT FRAME 2

Cost Categories and Elements	Configuration Model Nos.													
	250J25	252	253	254	255	256	257	270	271	280	281	282	284	285
I. RDT&E Costs	No. of Flts	225	225	225	225	225	225	180	180	8	8	8	180	225
1. Airframe Design and Dev.														
A. Airframe Design														
B. Misc. Subsystem Design														
C. Dev. Tests (Incl. Wind Tunnel)	157.143	128.871	167.362	138.242	155.597	164.631	168.060	131.579	148.057	77.473	78.470	93.927	108.850	131.850
D. Test Hardware	5.157	4.318	5.720	4.381	5.284	4.362	5.483	4.341	4.737	1.653	1.624	1.651	3.254	4.236
E. Pre-Delivery Flight Test	3.556	3.548	4.626	3.584	3.615	4.364	3.596	5.322	5.392	.825	.825	.837	3.318	3.277
Sub-Total	165.856	136.737	177.708	146.207	164.496	173.357	177.139	141.242	158.186	79.951	80.919	96.415	115.422	139.363
2. Tooling	13.060	10.905	15.107	11.013	13.319	10.929	13.783	11.157	11.924	3.840	3.778	3.912	8.136	10.614
3. Avionics Development	3.154	3.154	3.154	3.154	3.154	3.154	3.154	3.154	3.154	5.992	5.992	5.992	5.992	5.992
4. Propulsion Development	10.000	171.720	163.240	437.777	468.516	143.099	264.990	180.199	461.096	264.996	21.200	42.424	118.522	168.435
5. Support Equip. Design and Sys. Int.	25.314	21.268	27.894	23.096	27.166	24.901	30.376	24.414	28.582	12.229	11.313	12.775	16.995	20.873
6. Ground Test Facilities	-	-	-	50.000	50.000	-	-	-	50.000	50.000	-	-	-	-
Total	217.384	343.784	387.103	671.247	726.651	355.440	539.450	360.166	712.942	417.010	123.202	161.918	265.067	345.277
II. Investment Costs														
1. Flight Vehicles														
A. Airframe	26.669	22.542	29.637	22.702	27.291	22.753	28.115	22.536	24.549	8.638	8.504	8.671	16.910	21.918
B. Misc. Subsystems														
C. Propulsion	2.500	1.654	.467	3.903	3.805	.437	5.443	1.814	4.265	1.044	.371	.244	1.272	1.638
D. Avionics	1.015	1.015	1.015	1.015	1.015	1.015	1.115	1.115	1.301	1.301	1.301	1.301	1.301	1.301
Unit Cost (1) Vehicle	30.184	25.211	31.119	27.620	32.111	24.205	34.573	25.465	29.929	10.983	10.176	10.216	19.483	24.857
Unit Cost (3) Vehicles	90.552	75.633	93.357	82.860	96.333	72.615	103.719	76.395	89.787	32.949	30.528	30.648	58.449	74.571
2. Support Costs								93.340	109.750					
A. AGE	13.583	11.345	14.004	12.429	14.450	10.892	15.558	11.459	13.468	4.942	4.579	4.597	8.767	11.186
B. Training Equipment	5.000	5.000	5.000	5.000	5.000	5.000	5.000	5.000	5.000	-	-	-	-	-
C. Initial Stocks (Engs & AGE Sps)	18.858	12.712	4.669	28.564	28.080	4.148	5.366	13.844	31.202	7.802	3.055	2.167	9.781	12.585
D. Initial Training	1.000	1.000	1.000	1.000	1.000	1.000	1.000	1.000	1.000	-	-	-	-	-
E. Initial Transportation	2.134	1.733	2.166	2.180	2.418	1.718	2.095	1.538	2.089	.273	.169	.152	1.082	1.611
Sub-Total	48.575	31.790	26.839	49.173	50.948	22.758	29.019	32.841	52.759	13.017	7.803	6.916	19.630	25.382
3. Launch Platform Cost	-	-	-	-	-	-	-	2.000	2.000	-	-	-	-	-
4. Launch Vehicle Cost	-	-	-	-	-	-	-	-	-	73.181	13.181	13.181	-	-
Total	131.127	107.423	120.196	132.033	147.281	95.373	132.738	128.221	164.509	59.147	51.512	50.745	89.146	99.953
III. Operating Cost														
1. Range User Cost	6.103	6.103	6.103	6.103	6.103	6.103	6.103	5.136	5.136	.678	.678	.678	5.136	6.103
2. Escort Aircraft & Logistics	2.498	2.498	2.498	2.498	2.498	2.498	2.498	1.998	1.998	.089	.089	.089	1.998	2.498
3. Vehicle Rebirthment Cost	169.785	141.811	175.044	155.363	166.449	136.153	194.473	114.593	134.281	2.197	2.035	2.043	87.674	139.821
4. Propellant Cost	1.365	.851	14.618	.881	1.142	11.420	1.038	.766	.884	.023	.023	.030	.485	.832
5. AGE Maintenance (Labor Only)	2.037	1.702	2.101	1.864	2.167	1.634	2.334	1.719	2.020	.297	.275	.276	1.315	1.678
6. General Purpose Maint. Sup.	.500	.500	.500	.500	.500	.500	.500	.500	.500	.200	.200	.200	.500	.500
7. Transportation Cost (Veh.)	1.785	1.785	1.785	1.785	1.785	1.785	1.785	1.392	1.392	1.102	1.102	1.102	1.428	1.785
8. Pilot Pay & Sup. Per Pay.	23.400	22.000	25.600	22.000	23.000	24.000	20.200	-	-	4.160	4.240	4.240	17.200	20.800
9. Launch Platform Op. Cost	-	-	-	-	-	-	-	500	500	-	-	-	2.286	-
10. Launch Service Cost	-	-	-	-	-	-	-	-	-	1.983	1.983	1.983	-	-
Total W/Prop.	207.473	177.250	228.249	190.994	203.644	184.093	229.945	146.604	167.511	9.729	9.545	9.641	118.022	174.017
Grand Total W/Prop.	555.984	628.457	735.548	994.274	1,077.676	634.906	902.133	634.991	1,044.962	485.886	184.259	222.304	472.235	619.247
Grand Total W/O Prop.	545.984	456.737	572.308	506.457	559.060	491.807	587.135	454.792	533.866	170.888	163.059	179.480	353.713	450.812

① 1970 Costs (Millions of Dollars)  
② Unmanned Vehicle Used in Pre-Delivery Flight Test Program.  
Investment Cost = 2/3 Manned Vehicle Cost.

(U) In summary, Figure 4-122 presents a cost summary comparison of configurations within the six different cost models in descending order with respect to their total system cost. The significant contributing factors that influence flight research vehicle costs are:

(a) Type of propulsion system employed - Rocket and ramjet propulsion systems are the least expensive propulsion systems while turbojets and turboramjets are the most expensive propulsion systems considered in the Phase I study.

(b) Percentage of advanced material used in the airframe - Advanced materials are approximately 10 times more expensive than conventional materials.

(c) Control mode (manned vs unmanned) - Unmanned systems in general are lighter in weight than their manned counterpart vehicles. This weight decrease is reflected in decreased airframe and miscellaneous subsystem costs. However, the cost of avionic equipment is greater for unmanned vehicles due to the fact that the electronic equipment weight is approximately twice that for the manned counterpart vehicle.

#### 4.13 DATA SUMMARIES

(U) A broad group of flight research facilities were studied during Phase I. This section presents summaries of their design characteristics and performance, their weights, and their costs.

4.13.1 (U) DESIGN CHARACTERISTICS AND PERFORMANCE - Each configuration evaluated during Phase I is described in the following section. A brief word description followed by a general arrangement three-view drawing is presented for each concept as initially drawn for the sizing process. Figure 4-123 summarizes the results of the performance calculations and lists the design characteristics of each configuration. Bar chart summaries of the weight and cost for each vehicle are presented.

(U) FIGURE 4-122  
 COST COMPARISON SUMMARY

COST MODEL	MACH NO.	CONFIGURATIONS	TOTAL SYS. COST W/PROP. (\$) (1)	CONFIGURATIONS	TOTAL SYS COST W/O PROP (\$) (1)
1. (HTO, M, LR)	4.5	200	574.050	200	310.852
	6.0	210	1,122.511	210	561.011
	6.0	213	663.372	213	371.952
	6.0	214	348.421	214	263.621
	12.0	255	1,077.576	257	587.135
	12.0	254	994.274	253	572.308
	12.0	257	902.133	255	559.060
	12.0	253	735.548	250 J2S	545.984
	12.0	251	691.461	251	509.142
	12.0	256	634.906	254	506.497
	12.0	252	628.457	256	491.807
	12.0	250	620.877	252	456.737
	12.0	250 J2S	555.984	250	451.278
2. (AIR, M, LR)	6.0	205	803.330	205	400.830
	6.0	207	573.473	207	313.853
	12.0	232	809.031	234	425.895
	12.0	234	564.224	232	375.314
	12.0	233	483.966	233	356.767
3. (VTO, M, LR)	12.0	271	1,044.962	271	533.866
	12.0	270	634.991	270	454.792
4. (HTO, UN, LR)	12.0	285	619.247	285	450.812
5. (AIR, UN, LR)	6.0	204	779.896	204	385.346
	12.0	284	472.235	284	353.713
6. (BOOST VTO, UN, LR/WR)	6.0	221	312.143	221	134.143
	6.0	220	310.040	220	132.040
	12.0	280	485.886	282	179.480
	12.0	282	222.304	280	170.888
	12.0	281	184.259	281	163.059

(1) Cost in millions of dollars (1970)  
 HTO - Horizontal take-off  
 AIR - Air Launched  
 VTO - Vertical take-off  
 Boost VTO - Booster used to launch vehicle  
 M - Manned  
 UN - Unmanned  
 LR - Land recovery  
 WR - Water recovery

~~CONFIDENTIAL~~

EGLDOUT FRAME

EGLDOUT FRAME 2

(C) FIGURE 4-123  
PERFORMANCE COMPARISON HYPERSONIC RESEARCH VEHICLES

CONFIGURATION	DESIGN MACH NUMBER	LAUNCH CONCEPT	TYPE OF CONFIGURATION	PROPULSION SYS.		FUEL	Sp	BODY LENGTH	VOL <sub>TOT</sub>	VOL <sub>F</sub>	(VOL <sub>F</sub> /Sp)	(L/D) <sub>MAX</sub>	I <sub>SP</sub>	OWE	TOGW	PROPELLANT WT.		W <sub>F</sub> /W <sub>TOT</sub>	(W <sub>F</sub> /S) <sub>TOT</sub>	REMARKS
				ACCEL. & CLIMB	CRUISE											ACCEL. & CLIMB	CRUISE			
							FT. <sup>2</sup>	FT.	FT. <sup>3</sup>	FT. <sup>3</sup>		CRUISE	SEC	LBS.	LBS.	LBS.	LBS.		LBS./FT. <sup>2</sup>	
200	4.5	HTO	WB	TRJ	TRJ	STOR	468	56.3	1,217	219	.220	5.0	1370	19,922	25,503	4,553	1,028	.219	54	OFF LOADED FUEL 1789 LBS.
201	↓	↓	AB	↓	↓	↓	↓	↓	↓	↓	↓	↓	↓	↓	↓	↓	↓	↓	↓	THRUST REQ'D UNAVAILABLE
204	6.0	AIR	WB	TRJ	TRJ	CRY	605	55.6	1,740	605	.240	4.35	3,120	22,400	25,079	2,180	499	.1068	42	UNMANNED
205	↓	↓	↓	↓	↓	↓	615	56.4	1,790	620	.240	4.35	3,120	23,000	25,740	2,230	510	.1075	42	
206	↓	↓	AB	↓	↓	↓	↓	↓	↓	↓	↓	↓	↓	↓	↓	↓	↓	↓	↓	THRUST REQ'D UNAVAILABLE
207	↓	↓	↓	RKT	RJ	↓	520	62.2	1,800	930	.284	3.78	452/1950	24,800	43,000	17,500	700	.424	83	
210	6.0	HTO	WB	TRJ	TRJ	CRY	895	68.9	3,220	1,130	.244	4.29	3,120	36,450	41,450	4,180	820	.121	46	
211	↓	↓	AB	↓	↓	↓	↓	↓	↓	↓	↓	↓	↓	↓	↓	↓	↓	↓	↓	THRUST REQ'D UNAVAILABLE
212	↓	↓	↓	TJ	RJ	↓	↓	↓	↓	↓	↓	↓	↓	↓	↓	↓	↓	↓	↓	THRUST REQ'D UNAVAILABLE
213	↓	↓	↓	RKT	RJ	↓	725	72.2	3,900	1,710	.342	3.10	452/1950	30,300	64,860	33,500	1,060	.533	89	
214	↓	↓	↓	RKT	RKT	↓	630	67.0	2,300	1,210	.277	3.86	452	18,500	45,850	23,800	3,550	.598	73	
220	6.0	STAGED	AB	-	RJ	CRY	167	33.8	425	97.3	.337	3.15	2950	12,800	13,230	-	430	.0324	79	
221	↓	↓	↓	-	↓	↓	174	34.5	439	99.5	.332	3.22	2950	13,090	13,530	-	440	.0325	78	ELLIPTICAL CROSS-SECTION
231	12.0	AIR	AB	TJ	CSJ	CRY	-	-	-	-	-	-	-	-	-	-	-	-	-	THRUST REQ'D UNAVAILABLE
232	↓	↓	↓	RKT	↓	↓	850	79.6	3,906	2,171	.292	2.87	452/1650	23,980	69,700	45,000	800	.657	82	
233	↓	↓	↓	↓	RKT	↓	892	81.4	4,000	2,342	.283	2.94	452	21,980	74,780	48,455	4,545	.706	84	
234	↓	↓	WB	↓	↓	↓	1,415	84.2	5,550	3,020	.223	3.45	452	27,900	96,050	63,600	4,550	.71	68	
250	12.0	HTO	AB	RKT	RKT	CRY	1,289	95.5	7,120	4,385	.288	2.90	452	31,000	130,040	92,995	6,045	.760	101	
251	↓	↓	WB	↓	↓	↓	1,880	113.0	7,950	4,910	.212	3.59	452	37,840	148,640	104,900	5,900	.745	79	
252	↓	↓	AB	↓	↓	↓	1,340	97.4	7,350	4,460	.280	2.95	452	31,700	132,380	94,500	6,180	.76	99	ELLIPTICAL CROSS-SECTION
253	↓	↓	↓	↓	CSJ	STOR	1,100	88.5	5,650	3,460	.288	2.90	316	50,200	314,900	250,000	14,700	.841	286	
254	↓	↓	↓	↓	↓	CRY	1,329	97.1	7,740	4,600	.295	2.85	452/1650	36,460	135,180	97,500	1,220	.73	102	
255	↓	↓	WB	↓	RKT	↓	2,190	123.0	11,040	5,944	.228	3.44	452/1650	48,000	176,400	127,000	1,400	.726	81	
256	↓	↓	↓	TJ	CSJ	STOR	1,318	94.6	4,750	2,700	.214	3.56	316	41,420	248,420	197,170	9,830	.833	189	
257	↓	↓	↓	RKT	RKT	CRY	2,000	116.1	10,300	4,800	.235	3.35	449/1650	58,000	80,200	20,470	1,730	.277	40	
250-J25	↓	↓	AB	RKT	RKT	CRY	1,809	113.0	11,950	7,060	.288	2.88	431	42,580	194,280	142,800	8,900	.780	107	(1) J25 ROCKET
256-HID	↓	↓	WB	↓	↓	STOR	1,923	114.1	8,370	5,110	.214	3.56	296	55,600	378,100	308,320	14,110	.854	196	(2) H-ID ROCKETS
270	12.0	VTD	AB	RKT	RKT	CRY	1,405	106.2	8,160	5,010	.288	2.90	452	31,600	144,500	106,640	6,260	.781	103	
271	↓	↓	↓	↓	CSJ	↓	1,530	113.8	9,840	5,760	.900	2.81	452/1650	41,280	165,360	122,700	1,380	.75	108	
280	12.0	STAGED	AB	-	CSJ	CRY	165	29.6	355	94.7	.303	2.79	1650	12,410	12,830	-	420	.0327	78	
281	↓	↓	↓	↓	RKT	↓	168	29.8	364	95	.303	2.79	452	10,880	13,020	-	2,140	.164	78	
282	↓	↓	↓	↓	↓	STOR	136	26.5	265	51.5	.302	2.80	316	13,360	17,310	-	3,950	.228	127	
284	12.0	AIR	AB	RKT	RKT	CRY	885	81.3	3,910	2,315	.282	2.95	452	21,680	73,780	47,820	4,280	.708	83	UNMANNED
285	↓	HTO	↓	↓	↓	↓	1,280	95.3	7,010	4,340	.291	2.88	452	30,700	128,700	91,940	6,060	.762	100	

CONFIDENTIAL

FOLDOUT FRAME 2

FOLDOUT FRAME 1

(C) FIGURE 4-123 (Continued)  
PERFORMANCE COMPARISON HYPERSONIC RESEARCH VEHICLES  
(INTERNATIONAL SYSTEM OF UNITS)

MODEL	DESIGN	LAUNCH	TYPE OF CONFIGURATION	PROPULSION SYS.		FUEL	Sp	BODY LENGTH	VOL <sub>TOT</sub>	VOL <sub>F</sub>	(VOL <sub>F</sub> /Sp)	(L/D) <sub>MAX</sub>	I <sub>sp</sub>	OWE	TOGW	PROPELLANT W.T.		W <sub>F</sub> /W <sub>TOT</sub>	(W <sub>F</sub> /W <sub>TOT</sub> ) <sub>TO</sub>	REMARKS
	MACH NUMBER	CONCEPT		ACCEL. CLIMB	CRUISE		M <sup>2</sup>	M								M <sup>3</sup>	M <sup>3</sup>			
200	4.5	HTD	WB	TRJ	TRJ	STOR	43.5	17.2	34.4	6.2	.220	5.0	1370	9036	11,568	2065	466	.219	266	OFF LOADED FUEL
201	↓	↓	AB	↓	↓	↓	↓	↓	↓	↓	↓	↓	↓	↓	↓	↓	↓	↓	↓	THRUST REQ UNAVAILABLE
204	6.0	AIR	WB	TRJ	TRJ	CRY	56.2	16.9	49.2	17.1	.240	4.35	3,120	10,160	11,376	989	226	.1068	203	UNMANNED
205	↓	↓	↓	↓	↓	↓	57.1	17.2	50.7	17.5	.240	4.35	3,120	10,433	11,675	1012	231	.1075	205	
206	↓	↓	AB	↓	↓	↓	↓	↓	↓	↓	↓	↓	↓	↓	↓	↓	↓	↓	↓	THRUST REQ UNAVAILABLE
207	↓	↓	↓	RKT	RJ	↓	48.3	19.0	50.9	26.8	.284	3.78	452/1650	11,249	19,504	7938	318	.124	404	
210	6.0	HTD	WB	TRJ	TRJ	CRY	83.1	21.0	91.1	32.0	.244	4.29	3,120	16,533	18,801	1896	372	.121	226	
211	↓	↓	AB	↓	↓	↓	↓	↓	↓	↓	↓	↓	↓	↓	↓	↓	↓	↓	↓	THRUST REQ UNAVAILABLE
212	↓	↓	↓	TJ	RJ	↓	↓	↓	↓	↓	↓	↓	↓	↓	↓	↓	↓	↓	↓	THRUST REQ UNAVAILABLE
213	↓	↓	↓	RKT	↓	↓	67.4	22.0	110.4	48.4	.342	3.10	452/1650	13,144	29,420	15,195	481	.533	436	
214	↓	↓	↓	RKT	RKT	↓	58.5	20.4	65.1	34.2	.277	3.86	452	8391	20,797	10,795	1610	.598	356	
220	6.0	STAGED	AB	-	RJ	CRY	15.5	10.3	12.0	2.8	.337	8.15	2950	5806	6001	-	195	.0324	387	
221	↓	↓	↓	↓	↓	↓	16.2	10.5	12.4	2.8	.332	3.22	2950	5937	6137	-	200	.0325	380	ELLIPTICAL CROSS-SECTION
231	12.0	AIR	AB	TJ	CSJ	CRY	-	-	-	-	-	-	-	-	-	-	-	-	-	THRUST REQ UNAVAILABLE
232	↓	↓	↓	RKT	↓	↓	79.0	24.3	110.5	61.4	.292	2.87	452/1650	10,841	31,615	20,412	363	.657	400	
233	↓	↓	↓	↓	RKT	↓	82.9	24.8	113.2	66.3	.283	2.94	452	9970	33,919	21,979	1971	.706	410	
234	↓	↓	WB	↓	↓	↓	131.5	25.7	157.1	85.5	.223	3.45	452	12,655	43,567	28,848	2064	.71	332	
250	12.0	HTD	AB	RKT	RKT	CRY	119.7	29.1	201.5	124.1	.288	2.90	452	14,061	58,984	42,182	2142	.760	493	
251	↓	↓	WB	↓	↓	↓	114.7	34.4	225.8	139.0	.212	3.59	452	17,164	67,422	47,982	2676	.745	386	
252	↓	↓	AB	↓	↓	↓	124.5	29.7	208.0	126.2	.280	2.95	452	14,379	60,046	42,864	2803	.76	483	ELLIPTICAL CROSS-SECTION
253	↓	↓	↓	↓	↓	STOR	102.2	27.0	159.9	97.9	.288	2.90	316	22,770	142,835	113,398	6668	.841	1396	
254	↓	↓	↓	↓	CSJ	CRY	123.4	29.6	219.0	130.2	.295	2.85	452/1650	16,538	61,316	44,225	553	.73	498	
255	↓	↓	WB	↓	↓	↓	208.5	37.5	312.4	168.2	.228	3.44	452/1650	21,772	80,018	57,606	635	.728	394	
256	↓	↓	↓	↓	RKT	STOR	122.4	28.8	134.4	76.4	.214	3.56	316	18,788	112,681	89,434	4459	.833	922	
257	↓	↓	↓	TJ	CSJ	CRY	185.8	35.4	291.5	135.8	.235	3.35	410/1650	26,308	36,378	9285	785	.277	196	
250-255	↓	↓	AB	RKT	RKT	CRY	168.0	34.5	338.0	199.9	.288	2.88	431	19,314	88,123	64,773	4037	.780	522	(1) J25 ROCKET
256-HID	↓	↓	WB	↓	↓	STOR	178.8	34.8	236.5	144.6	.214	3.56	296	25,220	171,502	139,883	6400	.854	957	(2) H-ID ROCKETS
270	12.0	VTD	AB	RKT	RKT	CRY	130.5	32.4	230.9	141.8	.288	2.90	452	14,333	65,544	48,371	2839	.781	502	
271	↓	↓	↓	↓	CSJ	↓	142.1	34.7	278.5	163.0	.300	2.81	452/1650	18,724	75,006	55,655	626	.75	527	
280	12.0	STAGED	AB	-	CSJ	CRY	15.3	9.0	10.0	2.7	.303	2.79	1650	5629	5820	-	191	.0327	380	
281	↓	↓	↓	↓	RKT	↓	15.6	9.1	10.3	2.7	.303	2.79	452	4935	5906	-	971	.164	378	
282	↓	↓	↓	↓	↓	STOR	12.6	8.1	7.5	1.5	.302	2.80	316	6060	7852	-	1792	.228	621	
284	12.0	AIR	AB	RKT	RKT	CRY	82.2	24.8	110.7	65.5	.282	2.95	452	9834	33,466	21,691	1941	.788	407	UNMANNED
285	↓	HTD	↓	↓	↓	↓	118.9	29.0	198.4	122.8	.291	2.88	452	13,925	58,377	41,703	2749	.762	488	

MCDONNELL AIRCRAFT

4-218

CONFIDENTIAL

(U) FIGURE 4-124  
CONFIGURATION -200

This is a Mach 4.5 manned, wing-body, JP fueled vehicle. It takes off horizontally using the turbojet mode of the turboramjet propulsion system. Turbojet power accelerates the vehicle to Mach 1.0 where dual mode operation is initiated with the ramjet supplying thrust to augment the turbojet thrust to Mach 3.5. At this point, the turbojet mode is shut down and the ramjet mode is the primary power accelerating the vehicle to Mach 4.5. The ramjet mode is throttled back to maintain the Mach 4.5 cruise speed for the full test period. The dual mode propulsion system incorporates an inlet air induction system with horizontal variable ramps.

The final portion of the flight is an unpowered maximum L/D glide with an unpowered approach and landing.

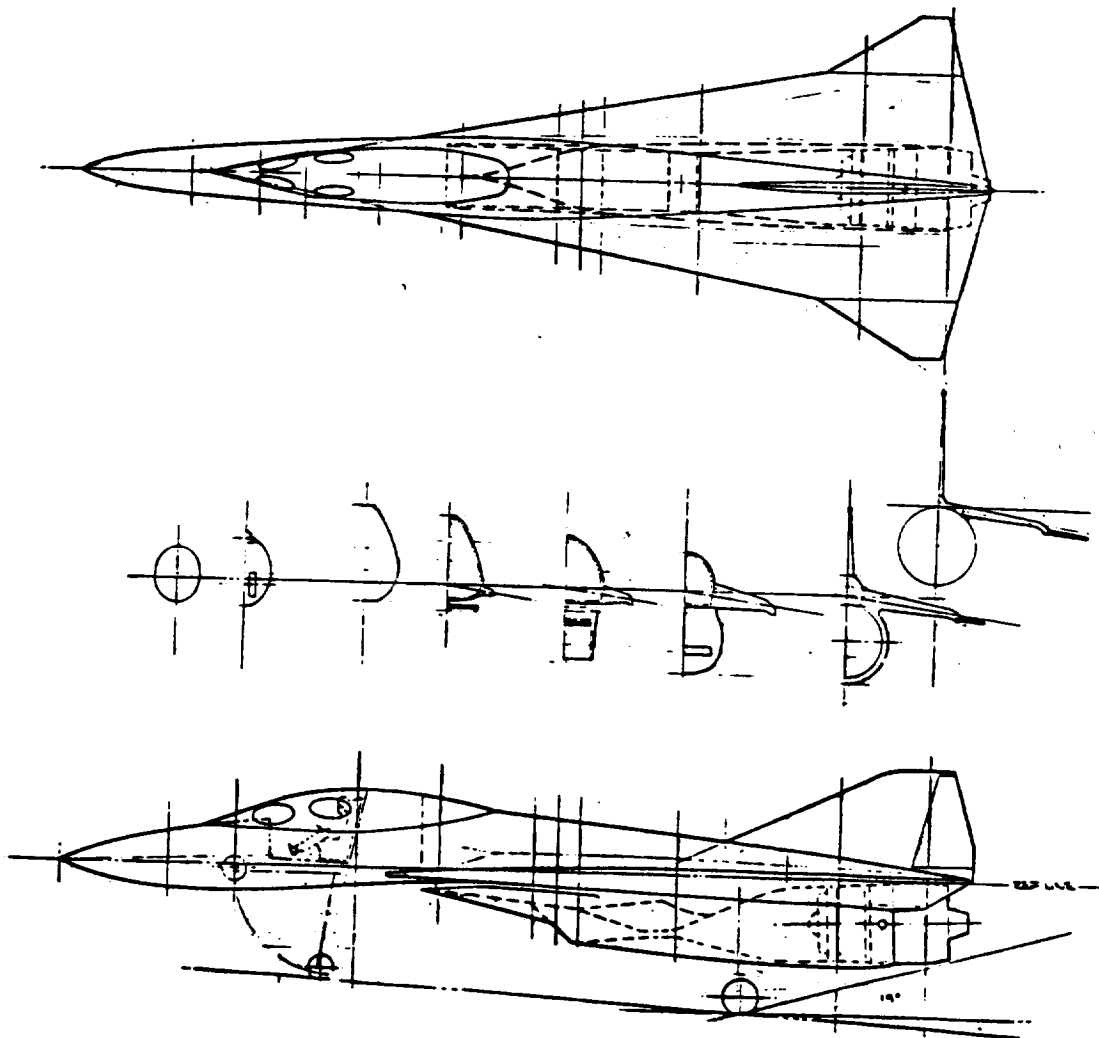



(U) FIGURE 4-125  
 COST/WEIGHT SUMMARY

<u>MACH NO. 4.5</u>	<u>WING BODY</u>	<u>CONFIGURATION NO. 200</u>	
LENGTH	56.3 ft (17.2m)	LAUNCH	HTO
S <sub>p</sub>	468 ft <sup>2</sup> (43.5m <sup>2</sup> )	CONTROL MODE	MANNED
THRUST	18,600 lb (SLSU) 82,732 N	ACCEL ENG/FUEL	TRJ/JP
THRUST	18,600 lb (SLSU) 82,732 N	CRUISE ENG/FUEL	TRJ/JP

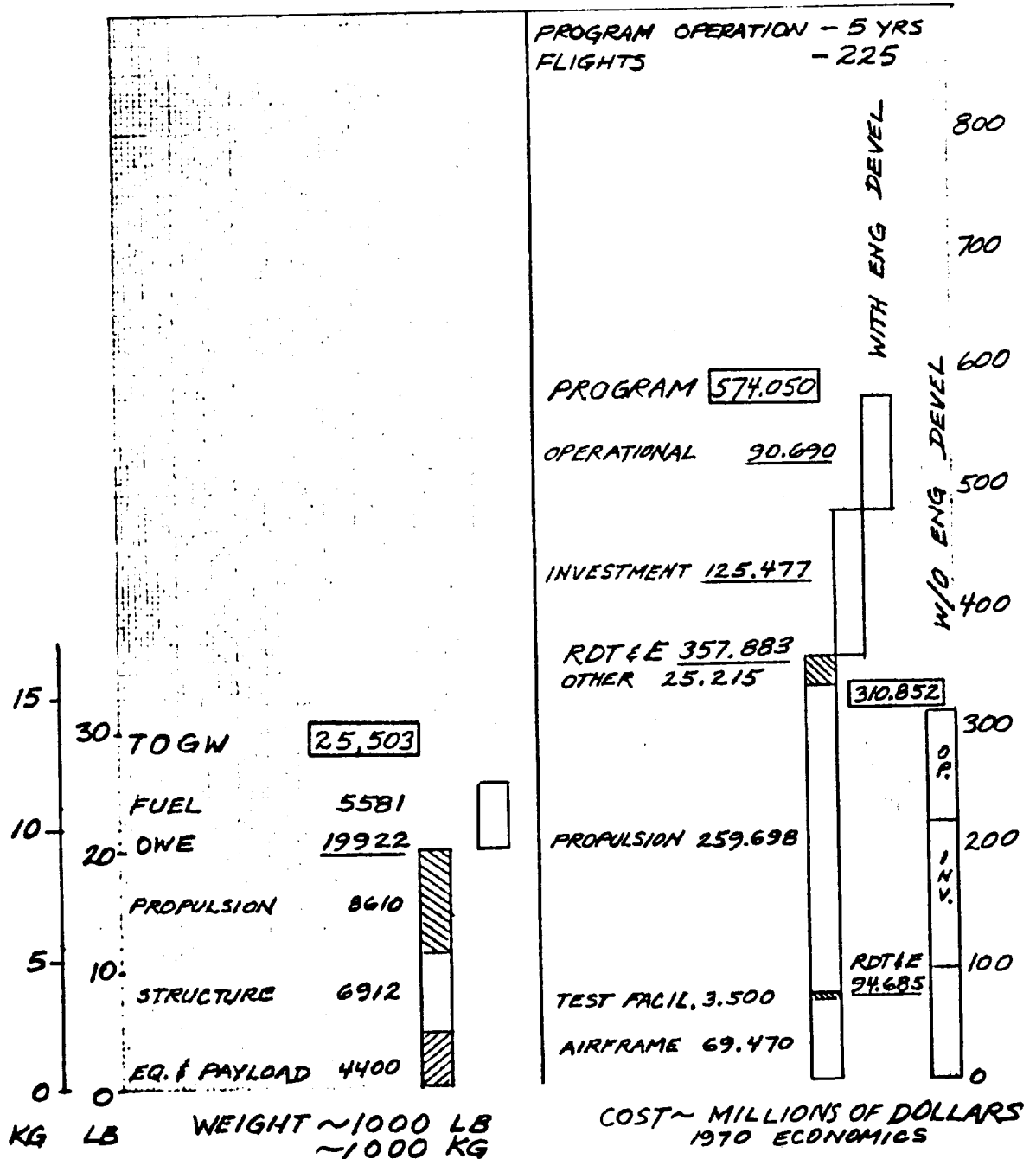

(U) FIGURE 4-126  
CONFIGURATION -201

This vehicle is a Mach 4.5, manned, all body, horizontal takeoff aircraft. A propulsion pod on the lower surface houses a JP fueled turboramjet engine with an inlet air induction system utilizing horizontal variable ramps. Engine mode operation for this configuration is the same as that noted for Configuration -200. Design convergence was not achieved for this aircraft (Ref. Section 4.9.4) so performance characteristics, weights and cost data are not shown.

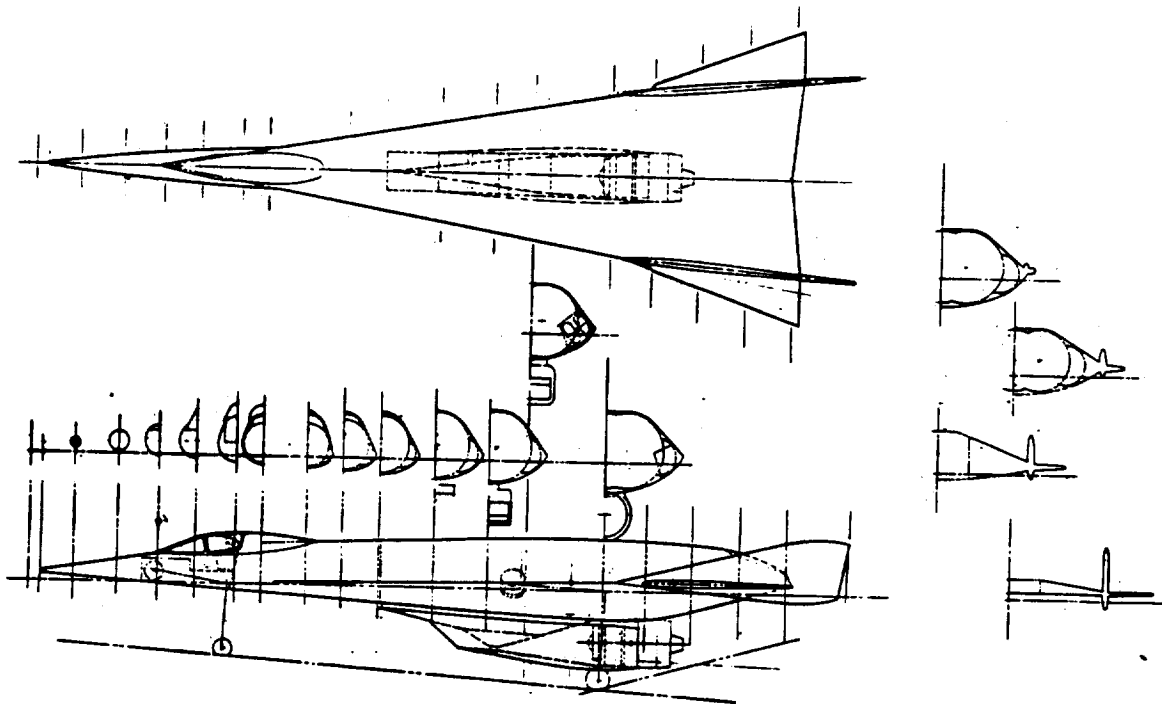

(U) FIGURE 4-127  
CONFIGURATION -204 AND -205

These two vehicles are essentially the same; Mach 6, wing body, air launched, turboramjet powered, hydrogen fueled aircraft. Both vehicles utilize horizontal variable inlet ramps for the air induction system. Configuration -205 is illustrated below and is a man controlled vehicle. Configuration -204 is unmanned and would have the same appearance except the cockpit and canopy are removed permitting a smooth upper sheer line.

The turbojet mode of the dual mode propulsion system is used to accelerate the vehicle to Mach 1.0 when the ramjet mode is ignited and its thrust augments the turbojet thrust. At Mach 3.5 the turbojet mode is shut down and the ramjet thrust continues to accelerate to Mach 6. At cruise Mach number the ramjet is throttled to provide cruise thrust for the stabilized Mach 6 cruise flight over the full test time period.

The final segment of the flight is an unpowered maximum L/D glide with an unpowered approach and landing.

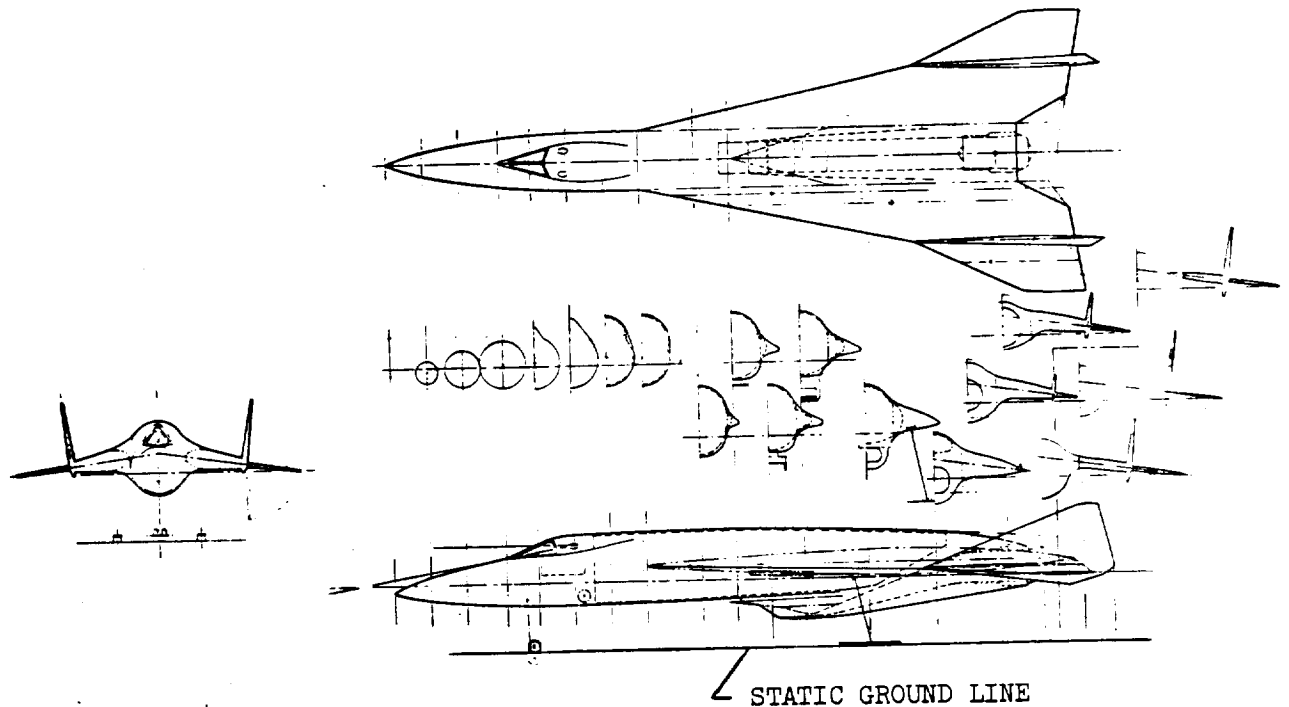

(U) FIGURE 4-128  
 COST/WEIGHT SUMMARY

MACH NO. 6.0	WING BODY	CONFIGURATION NO. 204	
LENGTH	55.6 ft (17m)	LAUNCH	AIR
S <sub>p</sub>	605 ft <sup>2</sup> (56.2m <sup>2</sup> )	CONTROL MODE	UNMANNED
THRUST	20,064 lb (SLSU) 89,247 N	ACCEL ENG/FUEL	TRJ/LH <sub>2</sub>
THRUST	20,064 lb (SLSU) 89,247 N	CRUISE ENG/FUEL	TRJ/LH <sub>2</sub>

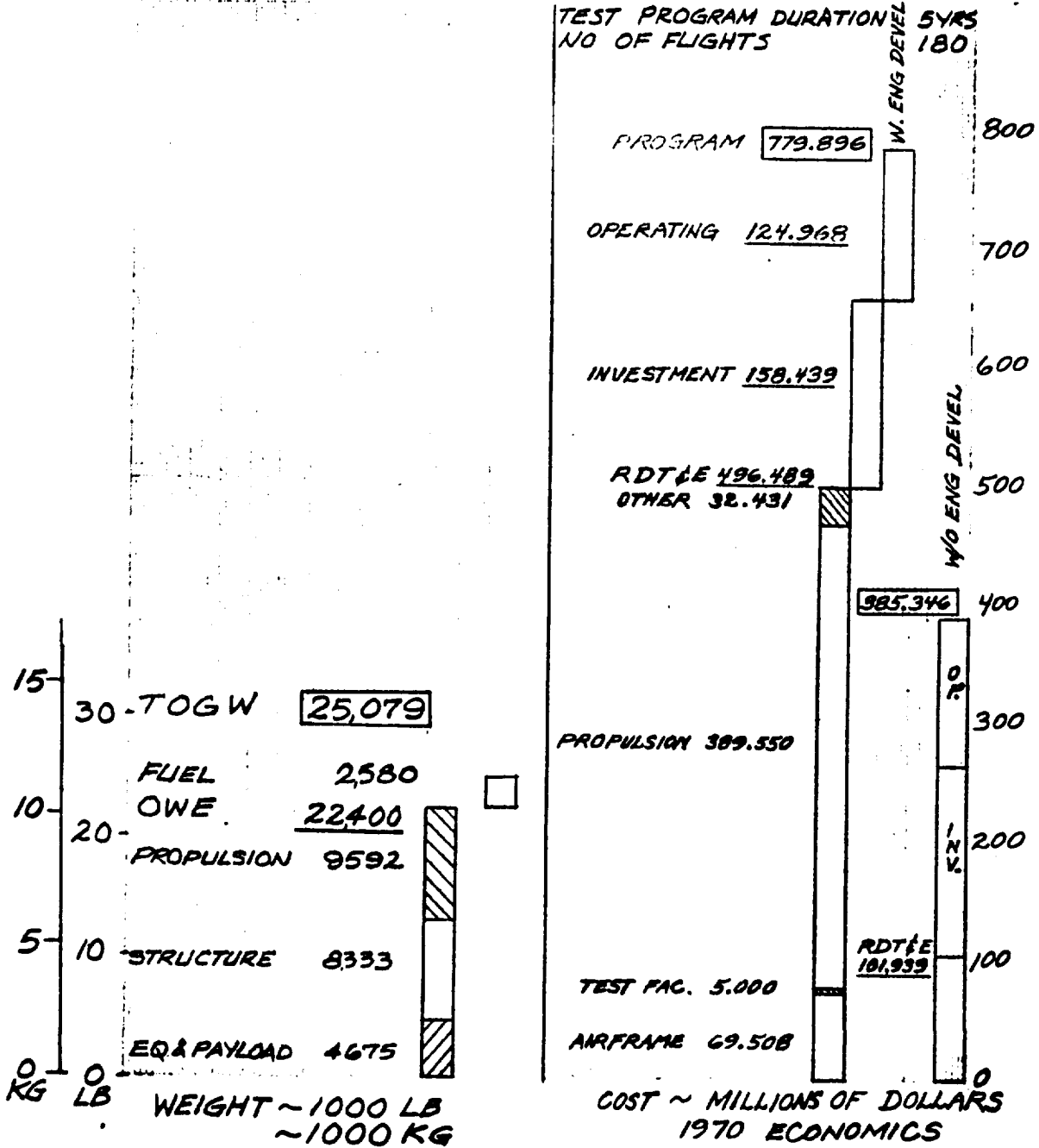

(U) FIGURE 4-129  
 COST/WEIGHT SUMMARY

MACH NO. 6.0	WING BODY	CONFIGURATION NO. 205	
LENGTH 56.4 ft (17.2m)		LAUNCH AIR	
S <sub>p</sub> 615 ft <sup>2</sup> (57.1m <sup>2</sup> )		CONTROL MODE MANNED	
THRUST 20,600 lb (SLSU) 91,629 N		ACCEL ENG/FUEL TRJ/LH <sub>2</sub>	
THRUST 20,600 lb (SLSU) 91,629 N		CRUISE ENG/FUEL TRJ/LH <sub>2</sub>	

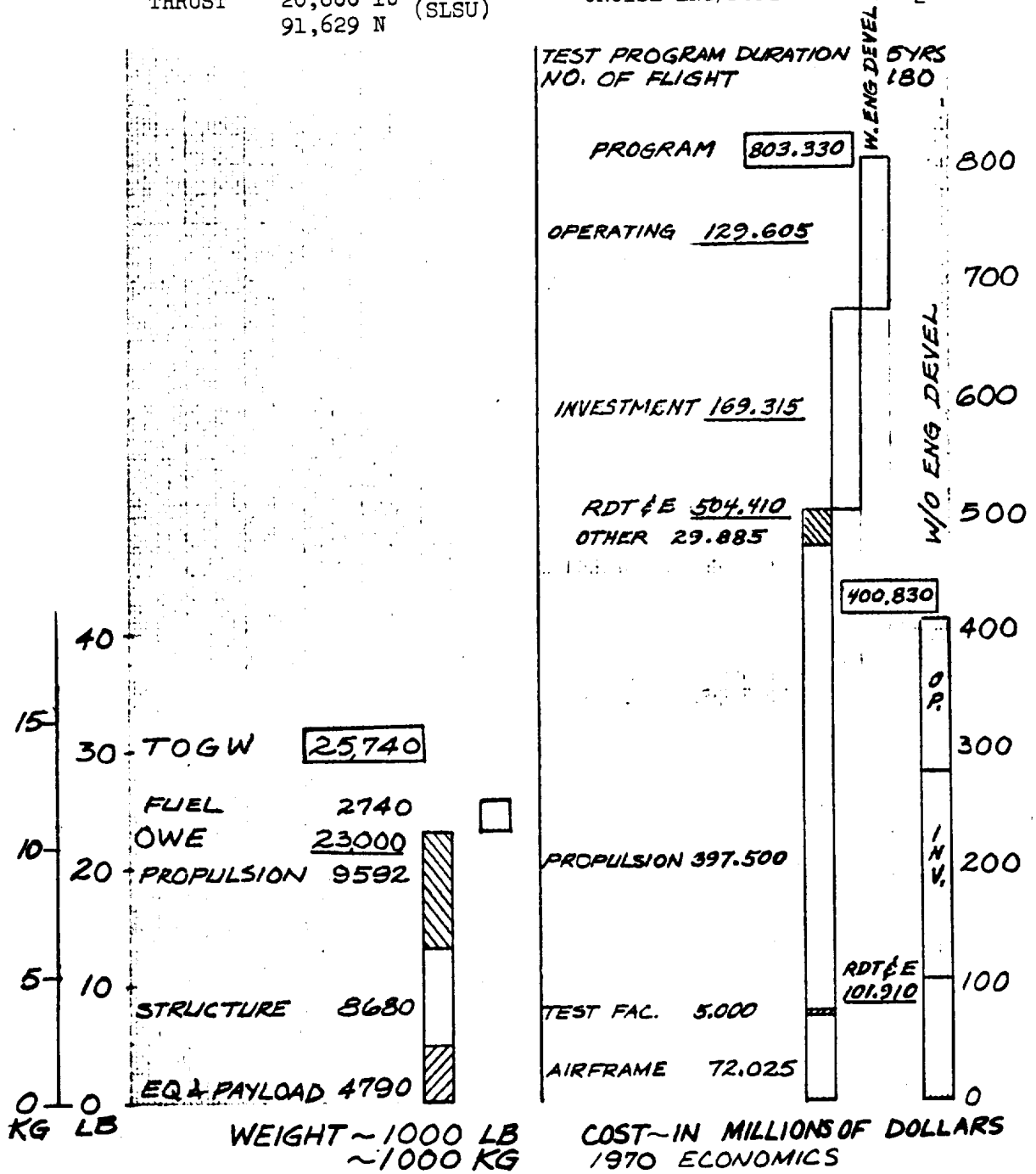

(U) FIGURE 4-130  
CONFIGURATION -206

This is a Mach 6.0, manned, all body, air launched, vehicle. The propulsion pod on the lower surface of the vehicle houses the hydrogen fueled turboramjet engine and the inlet air induction system with horizontal variable inlet ramps. The engine operation is the same as Configuration -205. Design convergence was not achieved for this vehicle (Ref. Section 4.9.4) so performance characteristics weights and cost data are not presented.

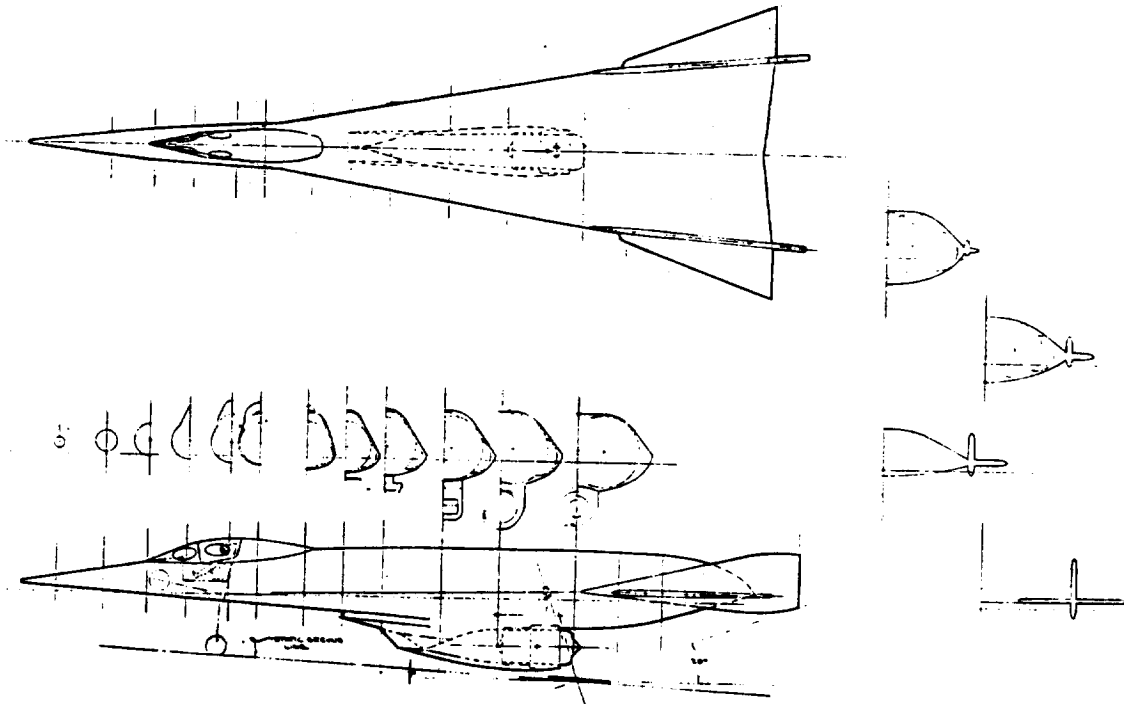

(U) FIGURE 4-131  
CONFIGURATION -207

This vehicle is a Mach 6, manned, all body, air launched aircraft. The vehicle is accelerated by rocket power and cruises on ramjet power. The liquid hydrogen fueled rocket accelerates this vehicle to Mach 6. After the hydrogen fueled ramjet engine is operating, the rocket is shut down. Stabilized cruise flight at Mach 6.0 is maintained by the ramjet engine for the full test time period. The final portion of the flight is a powerless maximum L/D glide with an unpowered approach and landing.

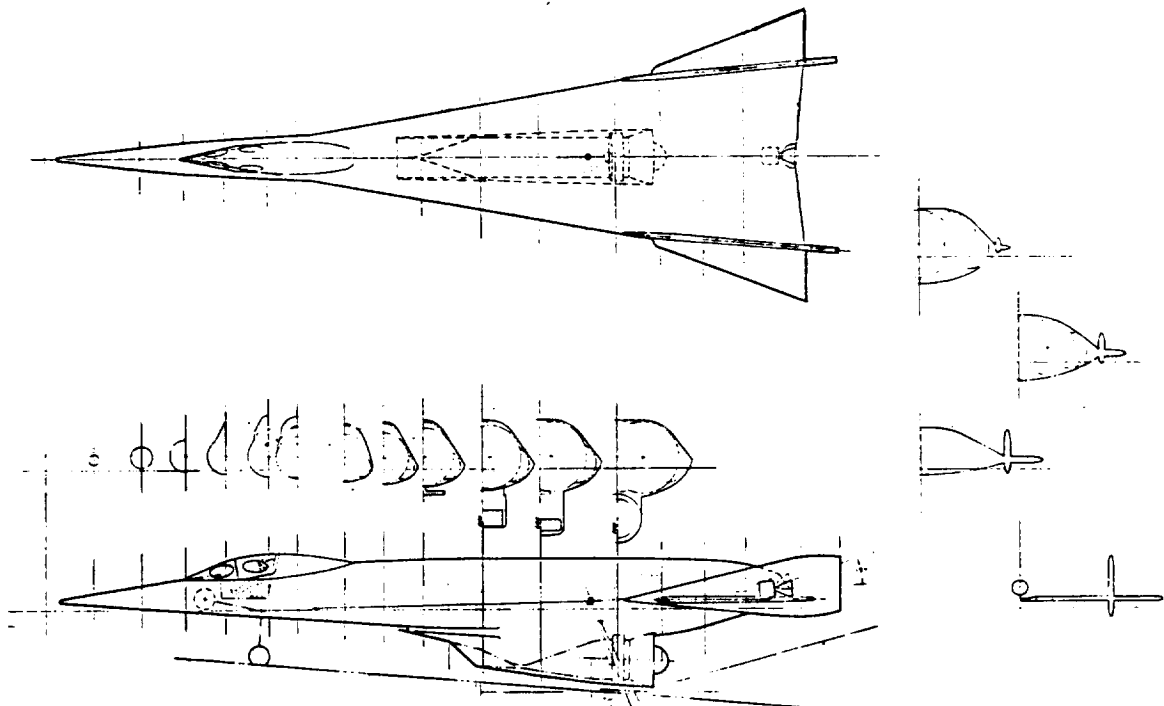

(U) FIGURE 4-132  
 COST/WEIGHT SUMMARY

<u>MACH NO. 6.0</u>	<u>ALL BODY</u>	<u>CONFIGURATION NO. 207</u>
LENGTH	62.2 ft (18.9m)	LAUNCH AIR
S <sub>p</sub>	520 ft <sup>2</sup> (48.3m <sup>2</sup> )	CONTROL MODE MANNED
THRUST	64,500 lb 286,896 N (T <sub>vac</sub> )	ACCEL ENG/FUEL RKT/LH <sub>2</sub> -LO <sub>2</sub>
THRUST	6,750 lb 30,024 N (M=6.0)	CRUISE ENG/FUEL RJ/LH <sub>2</sub>

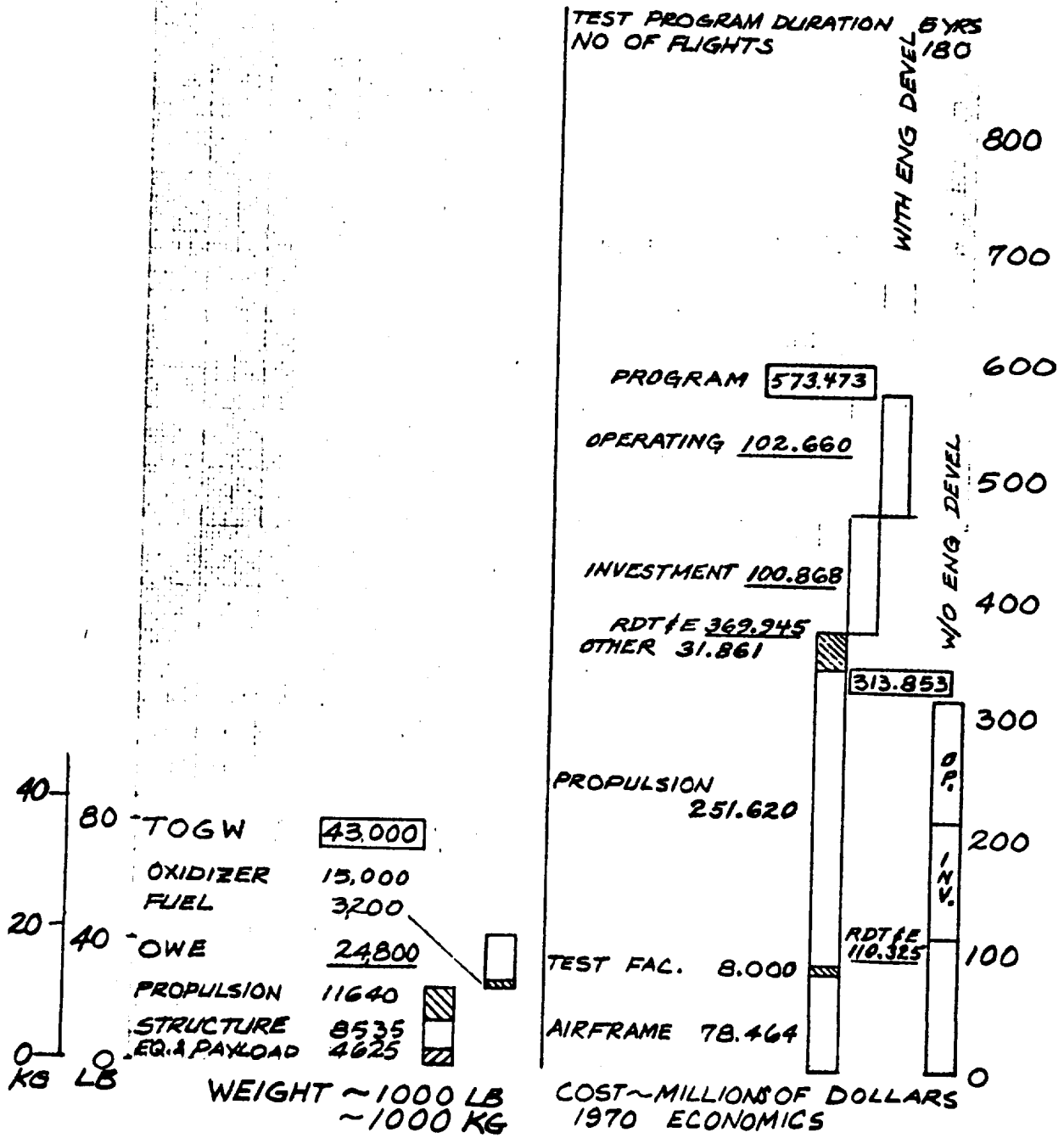



(U) FIGURE 4-133  
CONFIGURATION -210

This is a Mach 6, manned, wing body, horizontal takeoff vehicle. A turbo-ramjet engine is installed in the aft fuselage with a horizontal variable ramp air induction system on the lower surface of the vehicle. The aircraft accelerates to Mach 1.0 using the turbojet mode of the engine. The ramjet mode of operation is started at Mach 1.0 and its thrust augments the turbojet thrust. At Mach 3.5 the turbojet is shut down and the ramjet mode is used to accelerate the vehicle to Mach 6.0 and maintain this speed for the cruise flight test period. An unpowered maximum L/D glide to the destination with an unpowered approach and land completes the flight.

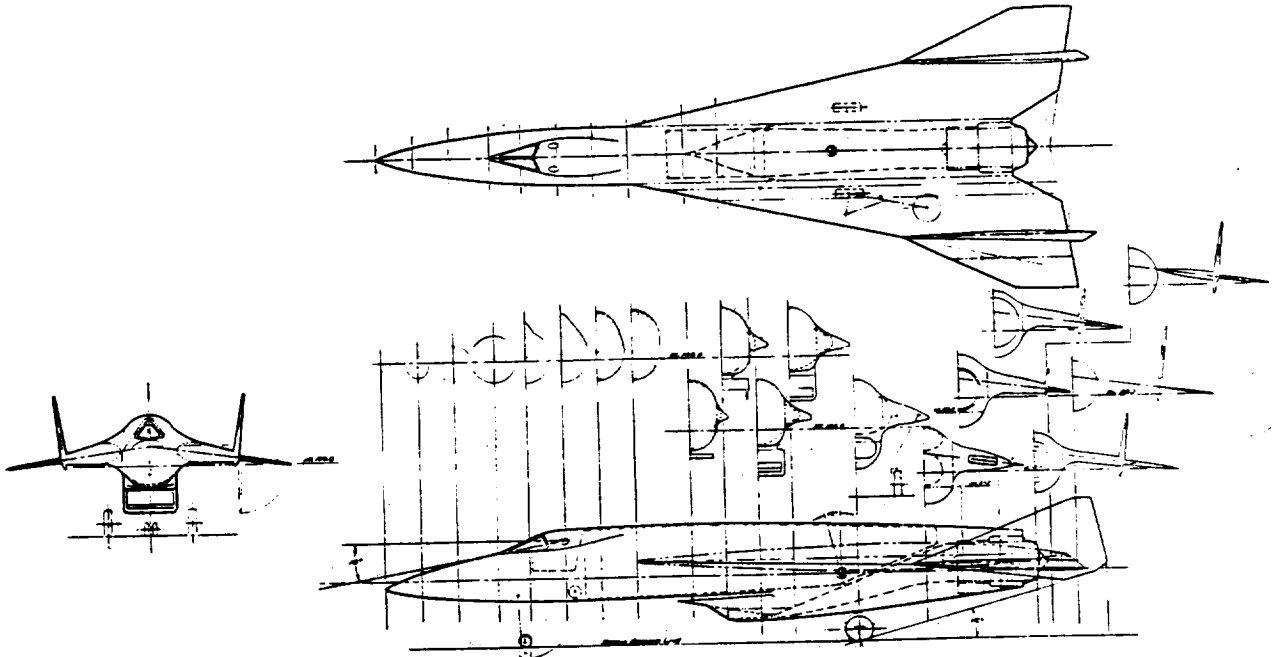

(U) FIGURE 4-134

COST/WEIGHT SUMMARY

<u>MACH NO. 6.0</u>	<u>WING BODY</u>	<u>CONFIGURATION NO. 210</u>	
LENGTH	68.9 ft (21.0m)	LAUNCH	HTO
$S_p$	895 ft <sup>2</sup> (83.2m <sup>2</sup> )	CONTROL MODE	MANNED
THRUST	33,200 lb (SLSU) 147,674 N	ACCEL ENG/FUEL	TRJ/LH <sub>2</sub>
THRUST	32,200 lb (SLSU) 147,674 N	CRUISE ENG/FUEL	TRJ/LH <sub>2</sub>

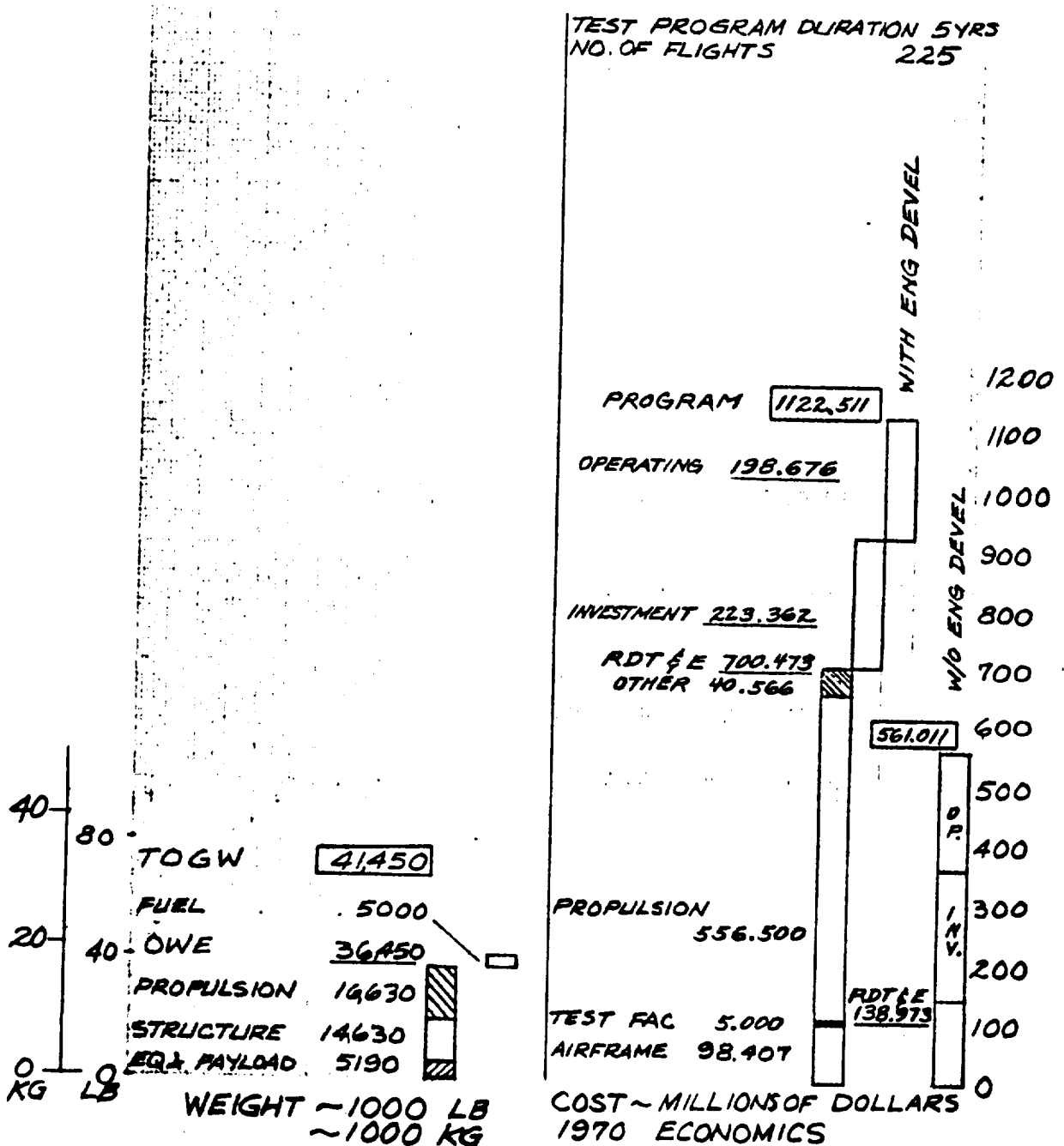

(U) FIGURE 4-135  
CONFIGURATION -211

This configuration is a Mach 6, manned, all body, horizontal takeoff vehicle using a hydrogen fueled turboramjet engine. The engine and inlet air induction system with horizontal variable ramps are housed in a pod on the lower surface of the vehicle. The turboramjet operation is the same as that used for Configuration -210. Design convergence was not achieved for this configuration (Ref. Section 4.9.4) so performance characteristics, weight and cost data are not available.

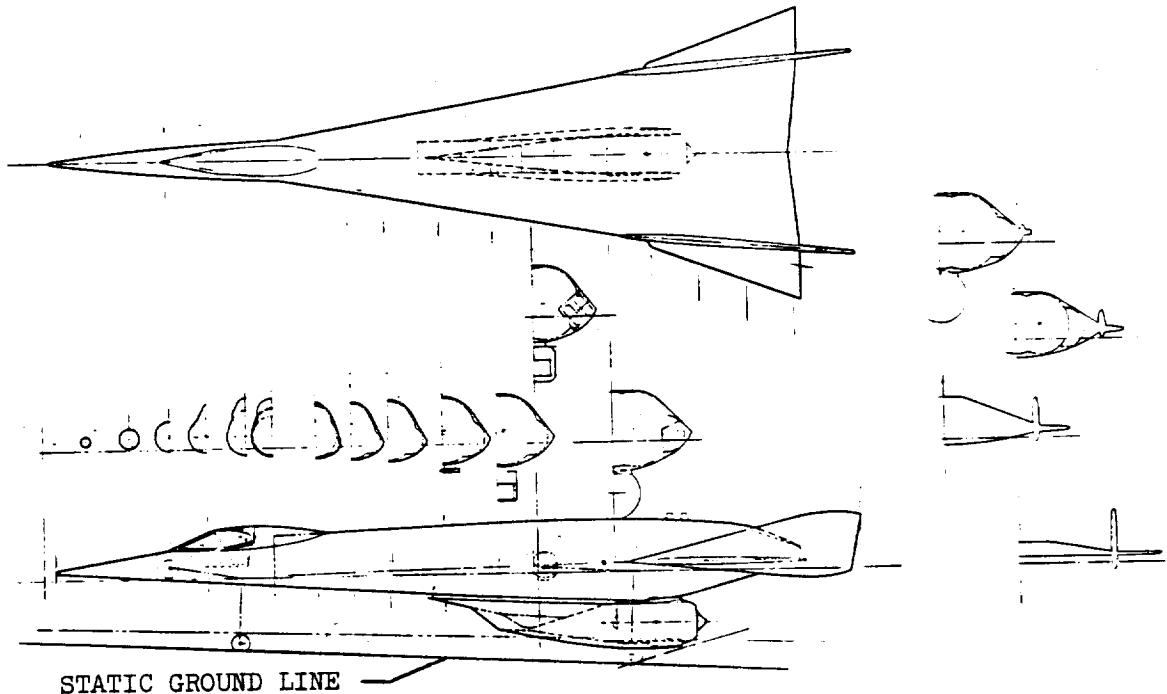

**(U) FIGURE 4-136  
CONFIGURATION -212**

This is a Mach 6.0, manned, horizontal take-off, all body vehicle utilizing a turbojet acceleration engine and a ramjet cruise engine. Design integration and convergence was not achieved with this configuration so no drawing and performance characteristics or weight and cost data are given.

Integration of this engine configuration with a wing-body shape will be attempted during the next phase of the study.

**CONFIGURATION -213**

This is a Mach 6.0, manned, all body, horizontal take-off vehicle. A hydrogen fueled ramjet engine with a horizontal variable ramp inlet air induction system is housed in a pod on the lower surface of the vehicle and is used for cruise flight at Mach 6. The hydrogen fueled rocket engine in the aft fuselage is used to accelerate the vehicle to Mach 6.0. After attaining the cruise speed of Mach 6.0, the ramjet is started and its thrust maintains cruise flight for the full test period and the rocket engine is shut down for the remainder of the flight. The final portion of the flight is an unpowered maximum L/D glide with an unpowered approach and landing.

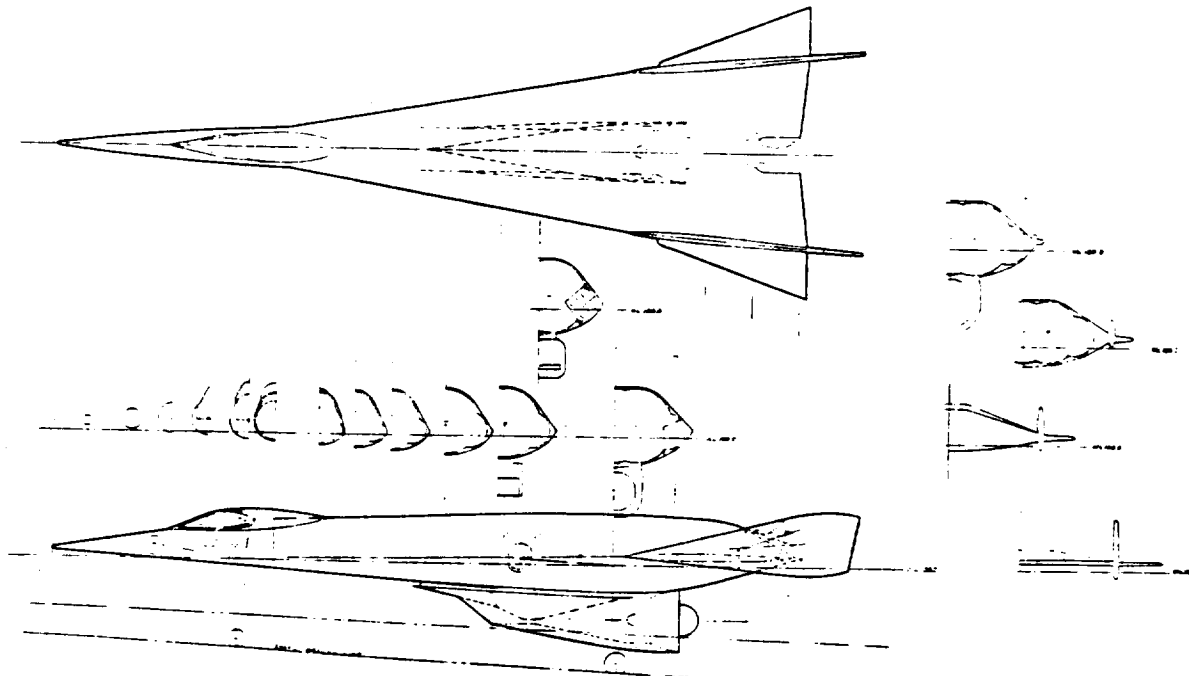

(U) FIGURE 4-137  
 COST/WEIGHT SUMMARY

<u>MACH NO. 6.0</u>	<u>ALL BODY</u>	<u>CONFIGURATION NO. 213</u>	
LENGTH	72.2 ft (22.0m)	LAUNCH	HTO
S <sub>p</sub>	725 ft <sup>2</sup> (67.4m <sup>2</sup> )	CONTROL MODE	MANNED
THRUST	97,200 lb (T <sub>vac</sub> )	ACCEL ENG/FUEL	RKT/LH <sub>2</sub> -LO <sub>2</sub>
	432,346 N		
THRUST	10,000 lb (M=6.0)	CRUISE ENG/FUEL	RJ/LH <sub>2</sub>
	44,800 N		

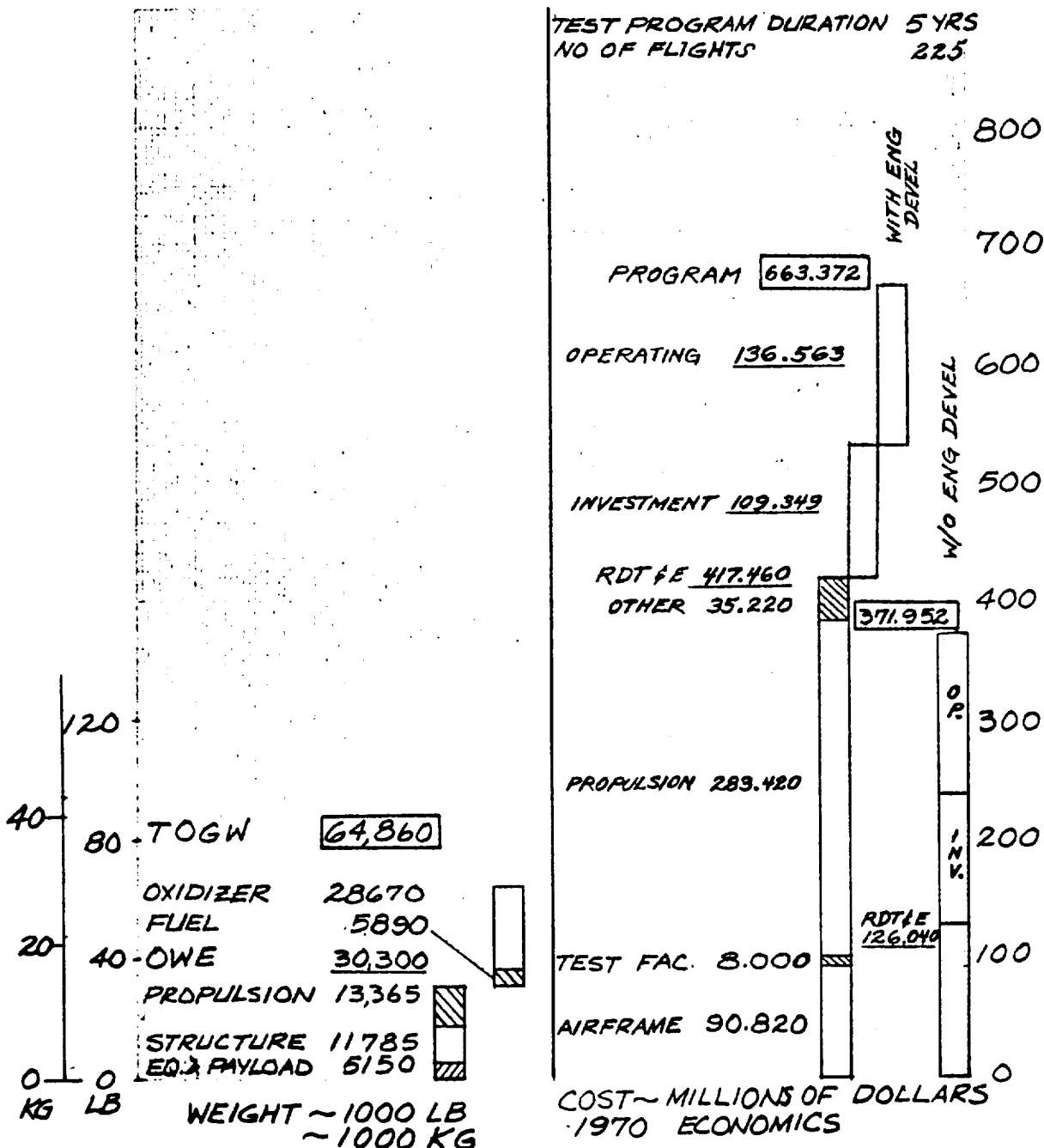

(U) FIGURE 4-138  
CONFIGURATION -214

This is a Mach 6, manned, all body, horizontal take-off vehicle. The single liquid hydrogen fueled rocket in the aft fuselage is used to accelerate the vehicle to a Mach 6.0 cruise speed and then is throttled to maintain the cruise speed for the full test time period. At the end of the test period, the rocket is out of fuel, the vehicle glides to its destination at maximum L/D, approaches and lands without power.

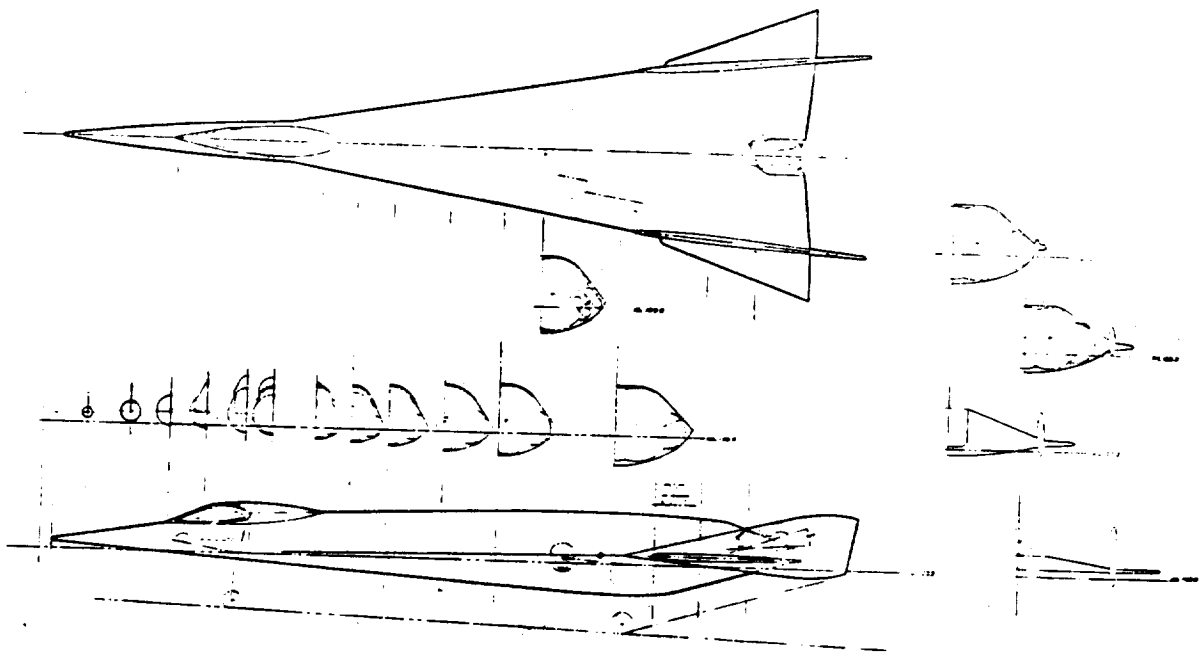

(U) FIGURE 4-139  
 COST/WEIGHT SUMMARY

<u>MACH NO. 6.0</u>	<u>ALL BODY</u>	<u>CONFIGURATION NO. 214</u>	
LENGTH	67.0 ft (20.4m)	LAUNCH	HTO
S <sub>p</sub>	630 ft <sup>2</sup> (58.5m <sup>2</sup> )	CONTROL MODE	MANNED
THRUST	68,700 lb (T <sub>vac</sub> )	ACCEL ENG/FUEL	RKT/LH <sub>2</sub> -LO <sub>2</sub>
	305,577 N		
THRUST	68,700 lb (T <sub>vac</sub> )	CRUISE ENG/FUEL	RKT/LH <sub>2</sub> -LO <sub>2</sub>
	305,577 N		

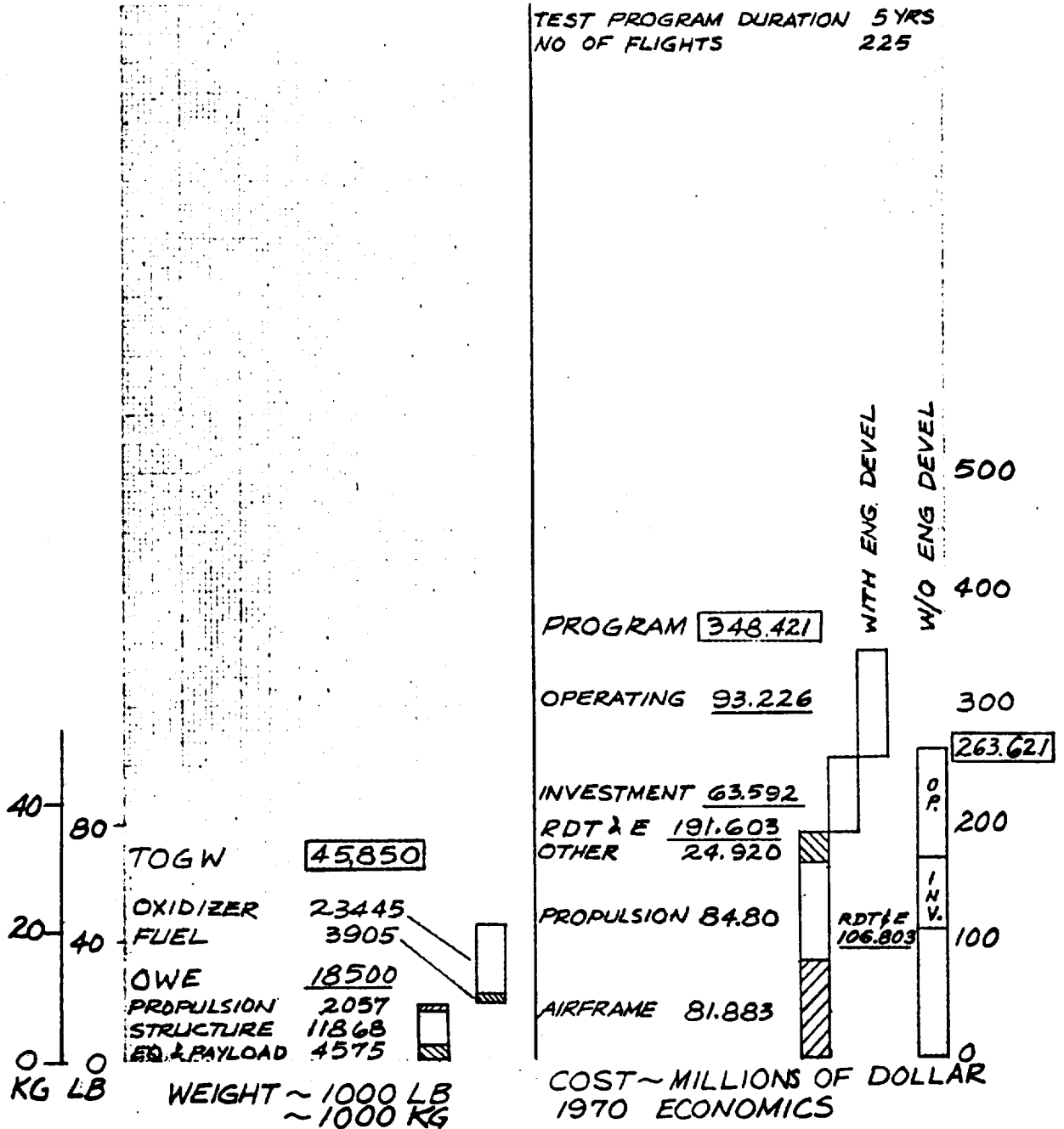

(U) FIGURE 4-140  
CONFIGURATION -220 AND -221

These configurations are both Mach 6, unmanned, all body, vertical take-off vehicles boosted to cruise Mach number by a first stage rocket. Cruise flight at Mach 6.0 is sustained by the thrust of a ramjet engine mounted on the under surface of the vehicle. The ramjet is started just prior to staging and has full thrust at staging. The only difference between the vehicles is the body shape, -220 is the MCAIR all body design as shown below and -221 is of a elliptical all body cross section. Both vehicles are recovered by remotely deployed parachute system.

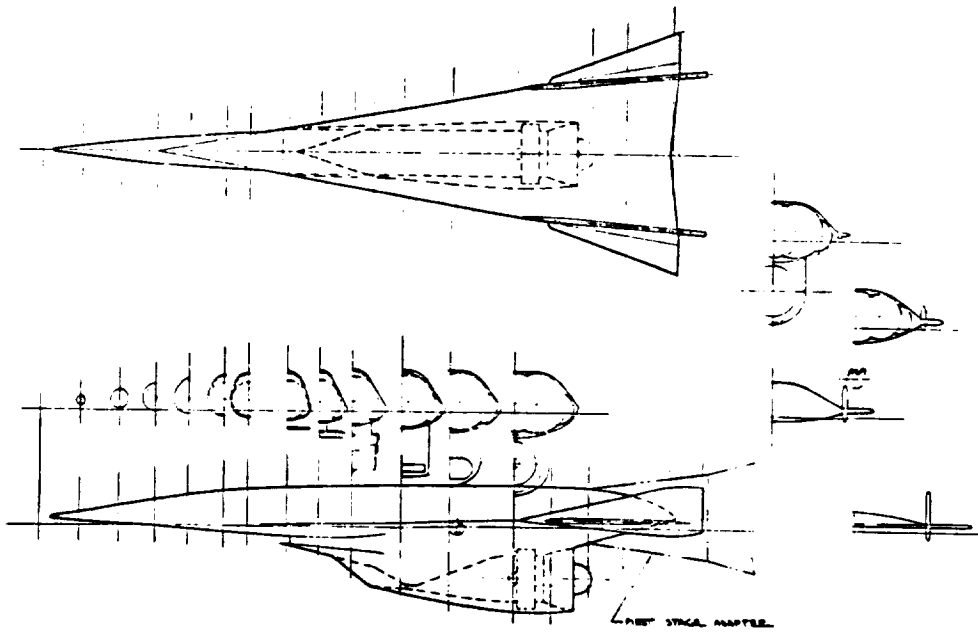



(U) FIGURE 4-141  
 COST/WEIGHT SUMMARY

<u>MACH NO. 6.0</u>	<u>ALL BODY</u>	<u>CONFIGURATION NO. 220</u>	
LENGTH	33.8 ft (10.3m)	LAUNCH	BOOST VTO
S <sub>p</sub>	167 ft <sup>2</sup> (15.5m <sup>2</sup> )	CONTROL MODE	UNMANNED
THRUST	<hr/>	ACCEL ENG/FUEL	THOR
THRUST	42,000 lb (M=6.0) 186,816 N	CRUISE ENG/FUEL	RJ/LH <sub>2</sub>

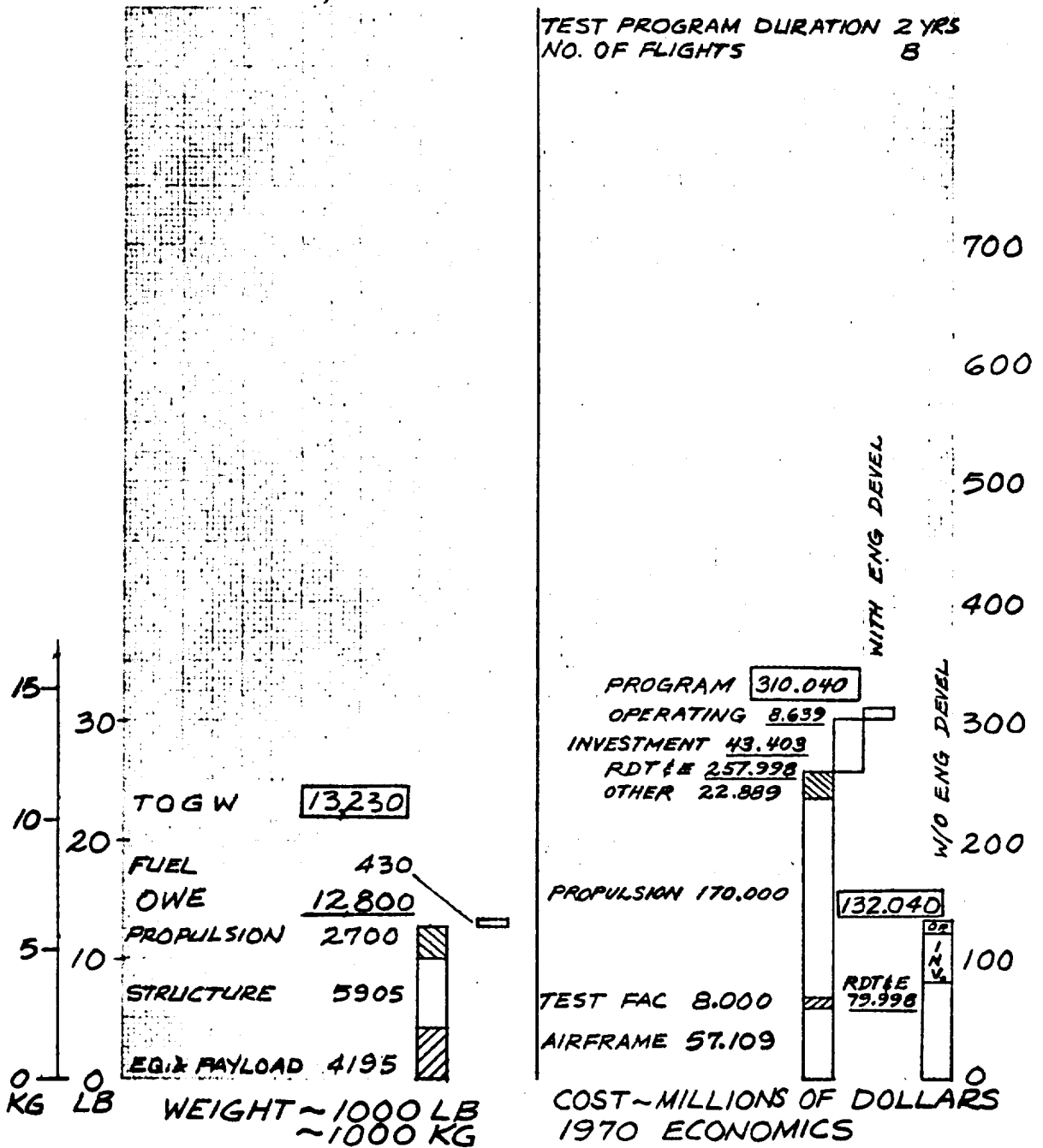

(U) FIGURE 4-142  
 COST/WEIGHT SUMMARY

<u>MACH NO. 6.1</u>	<u>ALL BODY</u> (ELLIPTICAL)	<u>CONFIGURATION NO. 221</u>	
LENGTH	34.5 ft (10.5m)	LAUNCH	BOOST VTO
S <sub>p</sub>	174 ft <sup>2</sup> (16.2m <sup>2</sup> )	CONTROL MODE	UNMANNED
THRUST	_____	ACCEL ENG/FUEL	THOR
THRUST	42,000 lb 186,816 N (SLSU)	CRUISE ENG/FUEL	RJ/LH <sub>2</sub>

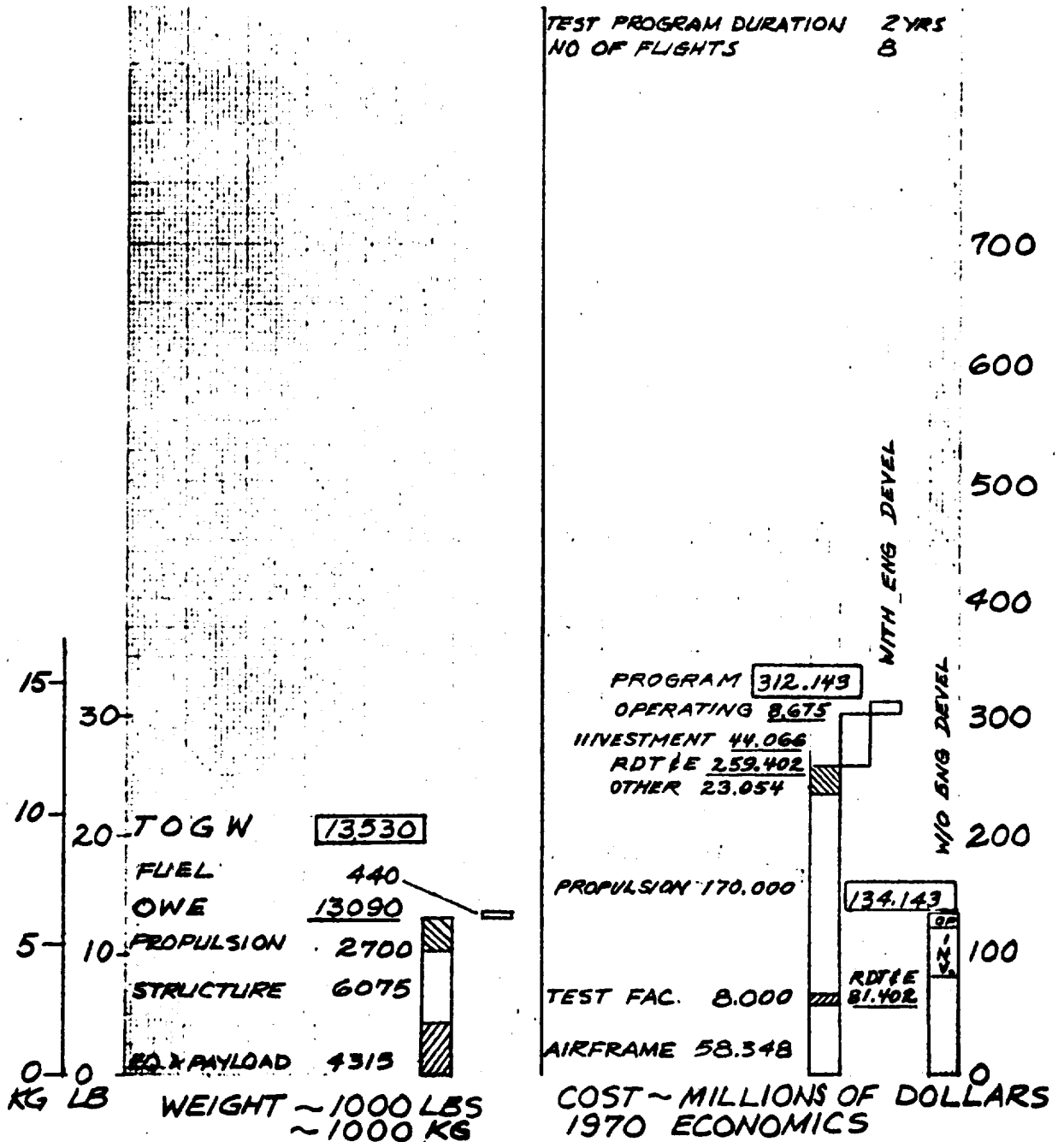

**(U) FIGURE 4-143  
CONFIGURATION - 231**

This vehicle is described as a Mach 12, air launched, all body aircraft using a cryogenic fueled turbojet engine for acceleration and a convertible scramjet engine as a cruise engine. Parametric integration and design convergence was not achieved for this design so no design and performance characteristics or weights and cost data are given for this configuration.

**CONFIGURATION - 232**

This Mach 12, manned, all body, air launched vehicle is accelerated to cruise Mach number by a hydrogen fueled rocket engine. Cruise thrust at Mach 12 is generated by a hydrogen fueled convertible scramjet that is started at Mach 12 just prior to rocket shut down. With the rocket accelerator, no convertible scramjet base burning is required for reduced drag. The last segment of the flight is an unpowered maximum L/D glide with an unpowered approach and landing.

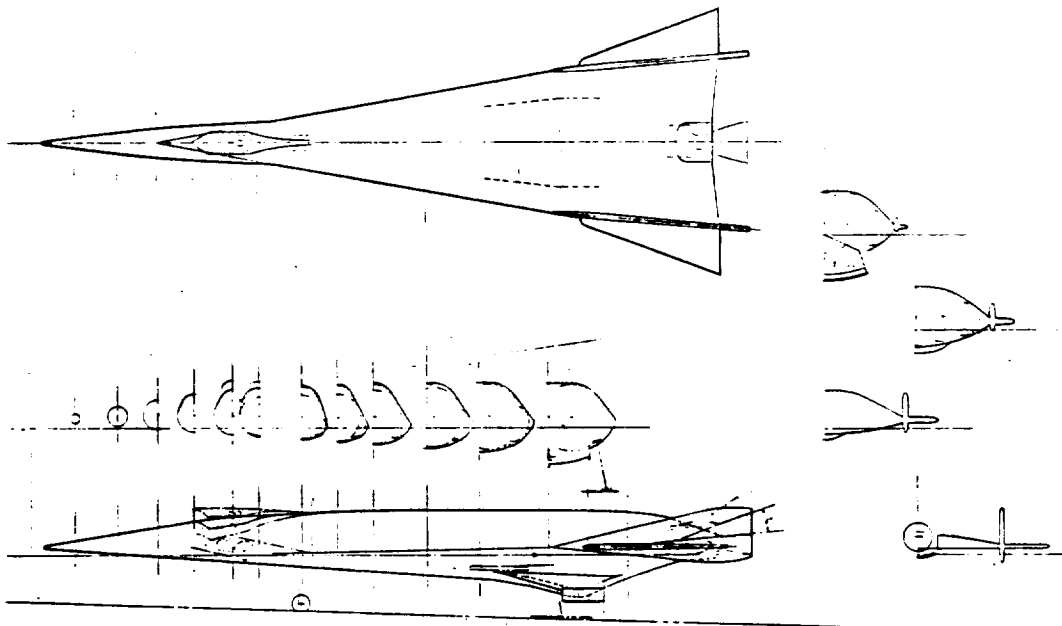

(U) FIGURE 4-144  
 COST/WEIGHT SUMMARY

<u>MACH NO.</u>	<u>12.0</u>	<u>ALL BODY</u>	<u>CONFIGURATION NO.</u>	<u>232</u>
LENGTH	79.6 ft (24.3m)	LAUNCH	AIR	
S <sub>p</sub>	850 ft <sup>2</sup> (79m <sup>2</sup> )	CONTROL MODE	MANNED	
THRUST	104,300 lb 463,926 N (T <sub>vac</sub> )	ACCEL ENG/FUEL	RKT/LH <sub>2</sub> -LO <sub>2</sub>	
THRUST	11,450 lb 50,930 N (M=12)	CRUISE ENG/FUEL	CSJ/LH <sub>2</sub>	

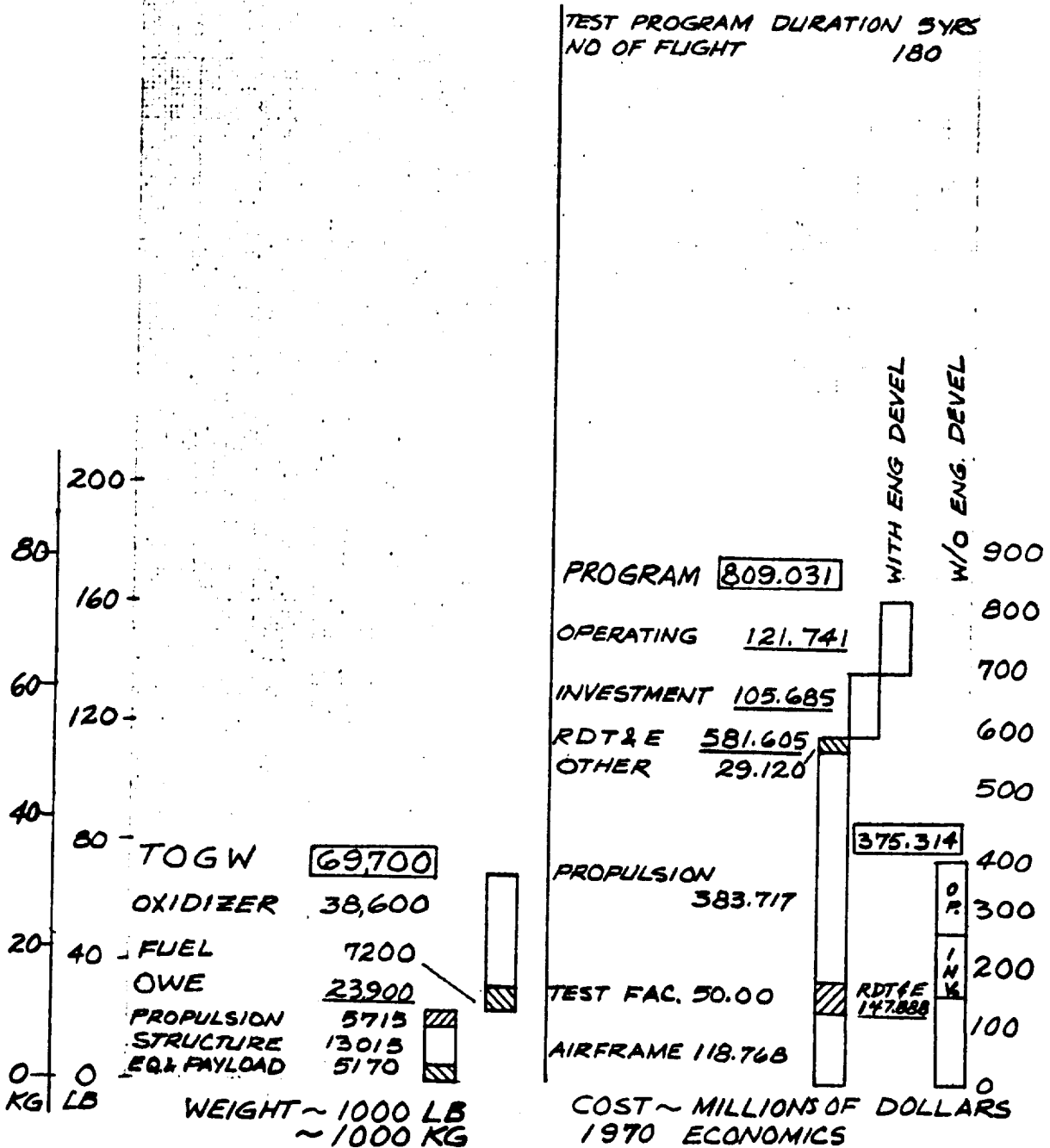

(U) FIGURE 4-145  
CONFIGURATION -233

This configuration is a Mach 12, manned, all body, air launched aircraft using a hydrogen fueled rocket engine for acceleration to cruise Mach number. The same rocket engine is throttled to maintain a Mach 12 cruise thrust for the test data acquisition time period. The last segment of the flight is an unpowered maximum L/D glide with an unpowered approach and landing.

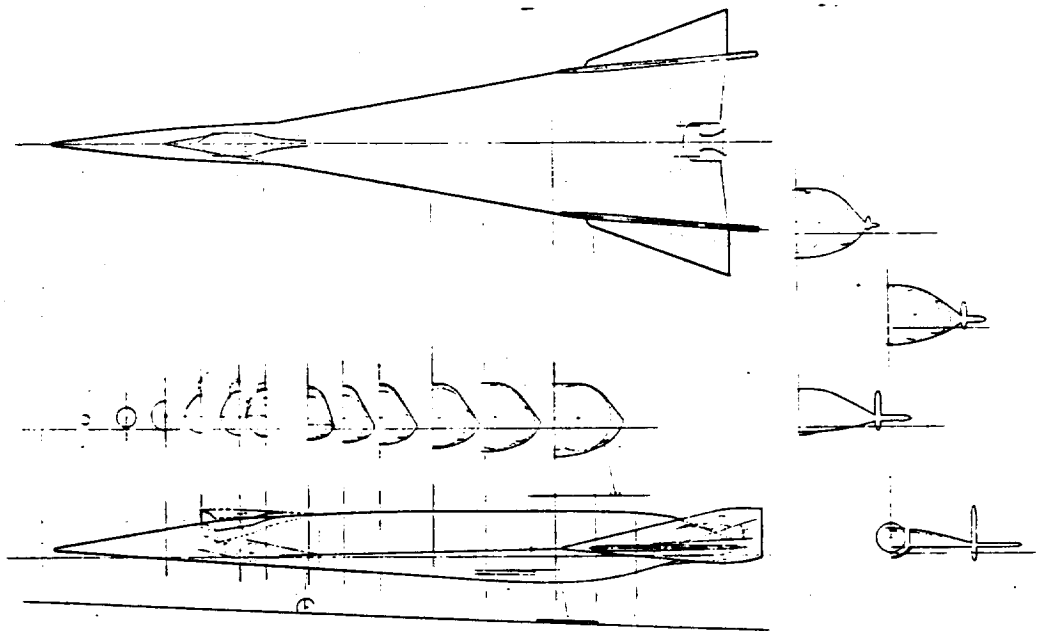

(U) FIGURE 4-146  
 COST/WEIGHT SUMMARY

MACH NO. 12.0

ALL BODY

CONFIGURATION NO. 233

LENGTH 81.4 ft (24.8m)

LAUNCH AIR

$S_p$  892 ft<sup>2</sup> (82.9m<sup>2</sup>)

CONTROL MODE MANNED

THRUST 112,000 lb (T<sub>vac</sub>)  
 498,176 N

ACCEL ENG/FUEL RKT/LH<sub>2</sub>-LO<sub>2</sub>

THRUST 112,000 lb (T<sub>vac</sub>)  
 498,176 N

CRUISE ENG/FUEL RKT/LH<sub>2</sub>-LO<sub>2</sub>

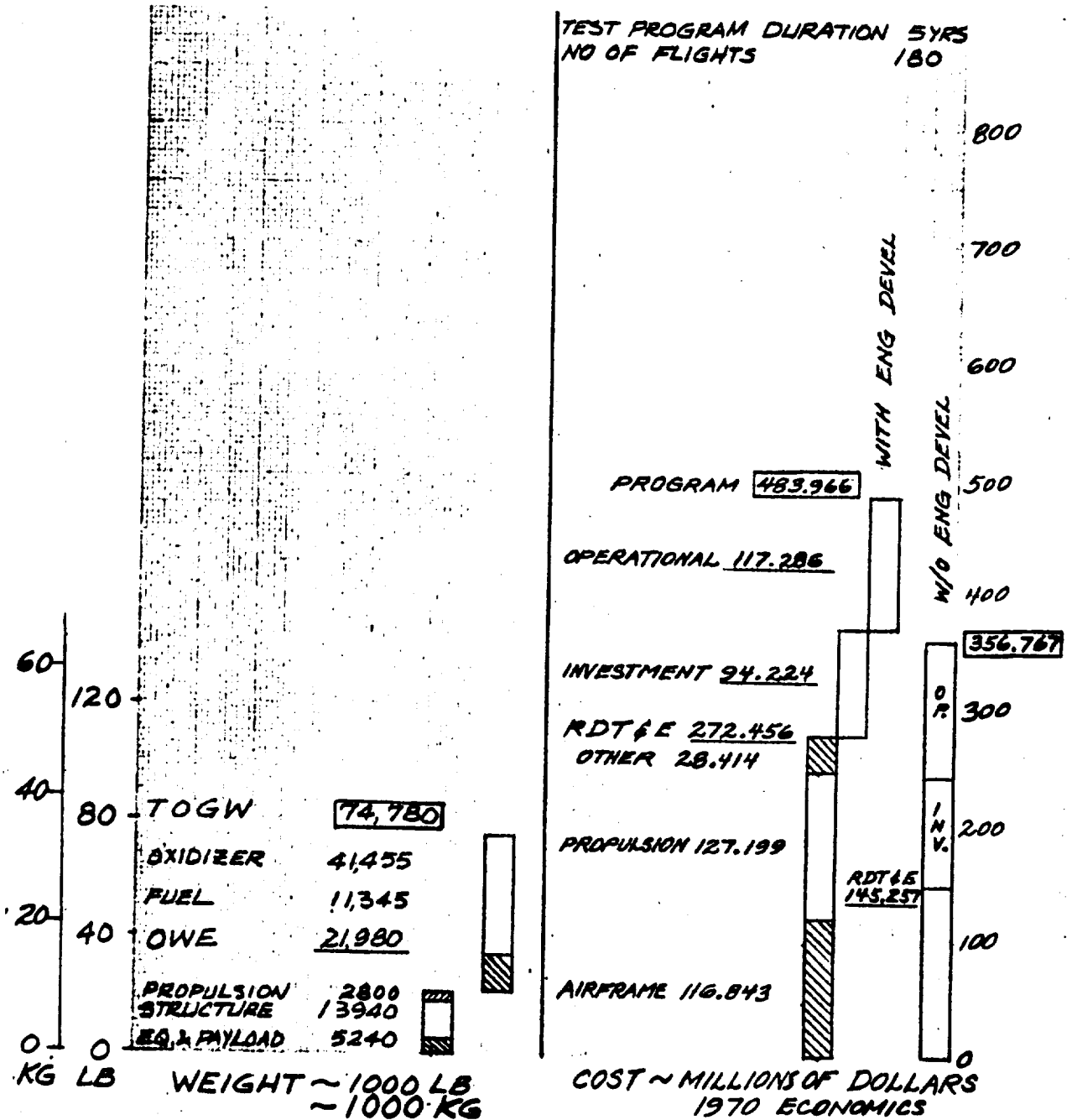

(U) FIGURE 4-147  
CONFIGURATION -234

This vehicle is a Mach 12, manned, air launched, wing body aircraft. A liquid hydrogen fueled rocket accelerates the aircraft to Mach 12. Cruise thrust is maintained by throttling the rocket engine for the test period for data acquisition. After rocket burn-out the final segment of the flight is an unpowered maximum L/D glide with an unpowered approach and landing.

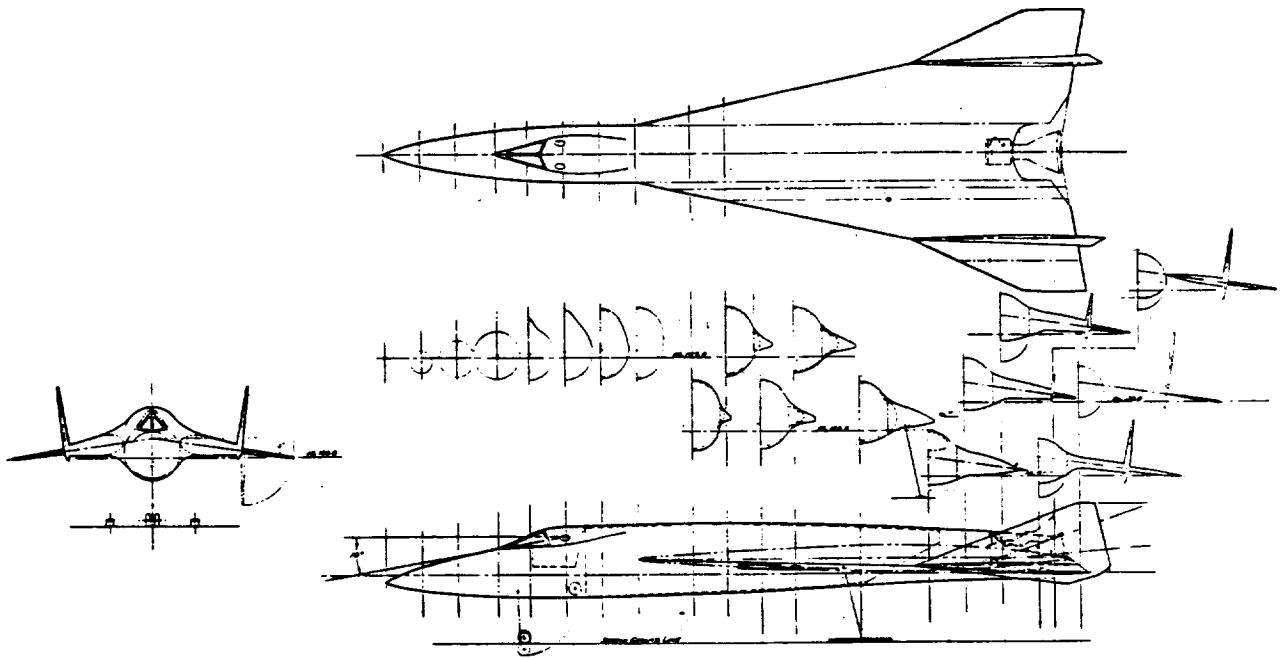

(U) FIGURE 4-148  
 COST/WEIGHT SUMMARY

<u>MACH NO. 12.0</u>	<u>WING BODY</u>	<u>CONFIGURATION NO. 234</u>	
LENGTH	84.2 ft (25.7m)	LAUNCH	AIR
Sp	1,415 ft <sup>2</sup> (131.5m <sup>2</sup> )	CONTROL MODE	MANNED
THRUST	144,000 lb (T <sub>vac</sub> ) 640,512 N	ACCEL ENG/FUEL	RKT/LH <sub>2</sub> -LO <sub>2</sub>
THRUST	144,000 lb (T <sub>vac</sub> ) 640,512 N	CRUISE ENG/FUEL	RKT/LH <sub>2</sub> -LO <sub>2</sub>

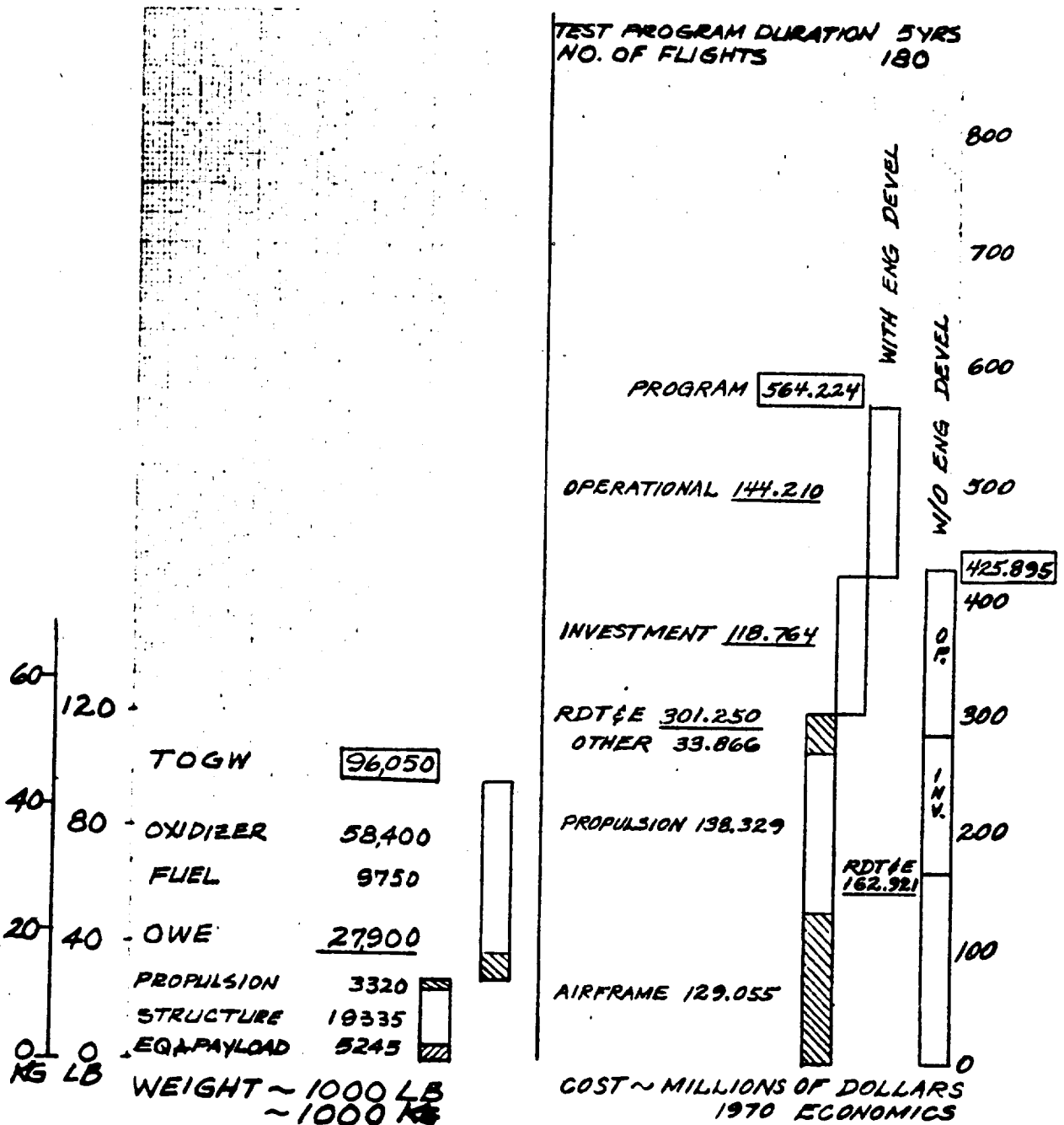



(U) FIGURE 4-149  
CONFIGURATION -250 AND -250J2S

Configuration -250 is a Mach 12, manned, horizontal take-off, all body shape aircraft. A liquid hydrogen fueled rocket is used to accelerate the vehicle to Mach 12. Cruise flight is maintained by throttling the rocket engine to the required thrust value.

Configuration -250J2S has the same design parameters as -250 except an off-the-shelf rocket engine (J-2S made by P & WA) is used. This permits the assessment of the advantages of an off-the-shelf engine versus a new engine design with its attendant development costs. Cruise thrust from J-2S engine is obtained by throttling the engine. A maximum L/D glide return flight and an unpowered approach and landing are also used for these configurations.

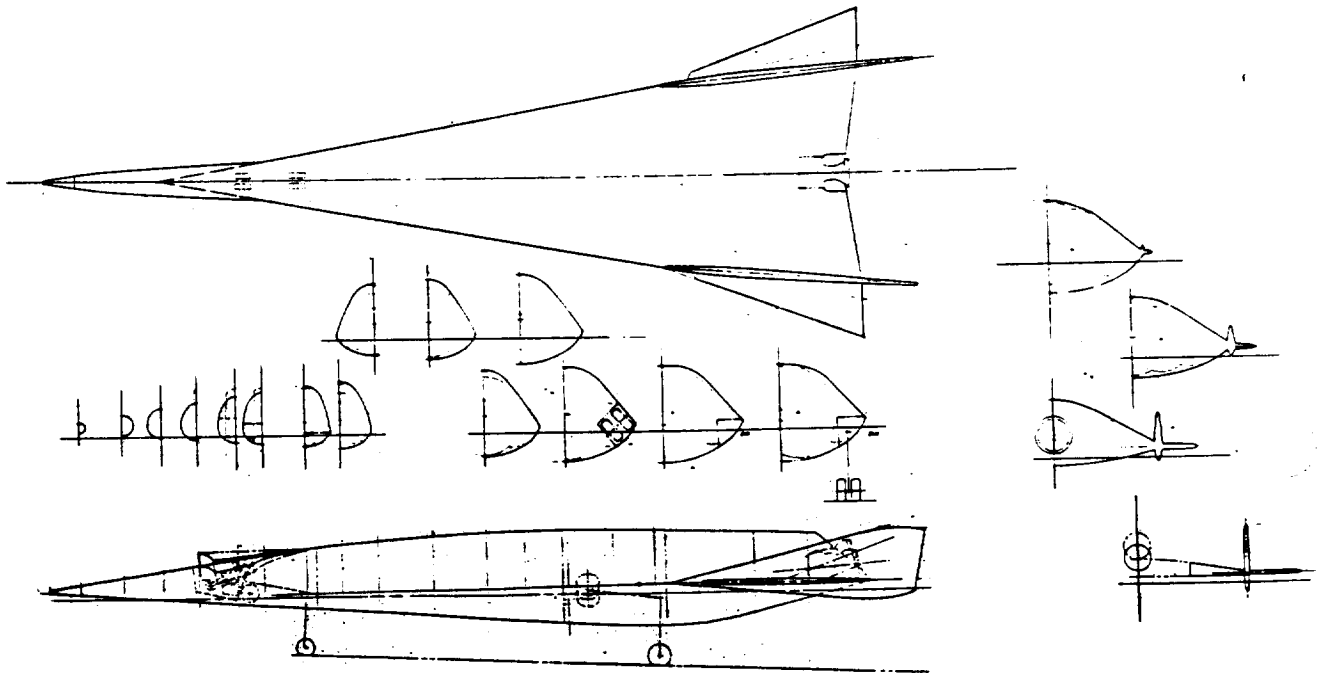

(U) FIGURE 4-150  
 COST/WEIGHT SUMMARY

<u>MACH NO. 12.0</u>	<u>ALL BODY</u>	<u>CONFIGURATION NO. 250</u>	
LENGTH	95.5 ft (29.1m)	LAUNCH	HTO
Sp	1,289 ft <sup>2</sup> (119.7m <sup>2</sup> )	CONTROL MODE	MANNED
THRUST	195,000 lb (T <sub>vac</sub> )	ACCEL ENG/FUEL	RKT/LH <sub>2</sub> -LO <sub>2</sub>
	867,360 N		
THRUST	195,000 lb (T <sub>vac</sub> )	CRUISE ENG/FUEL	RKT/LH <sub>2</sub> -LO <sub>2</sub>
	867,360 N		

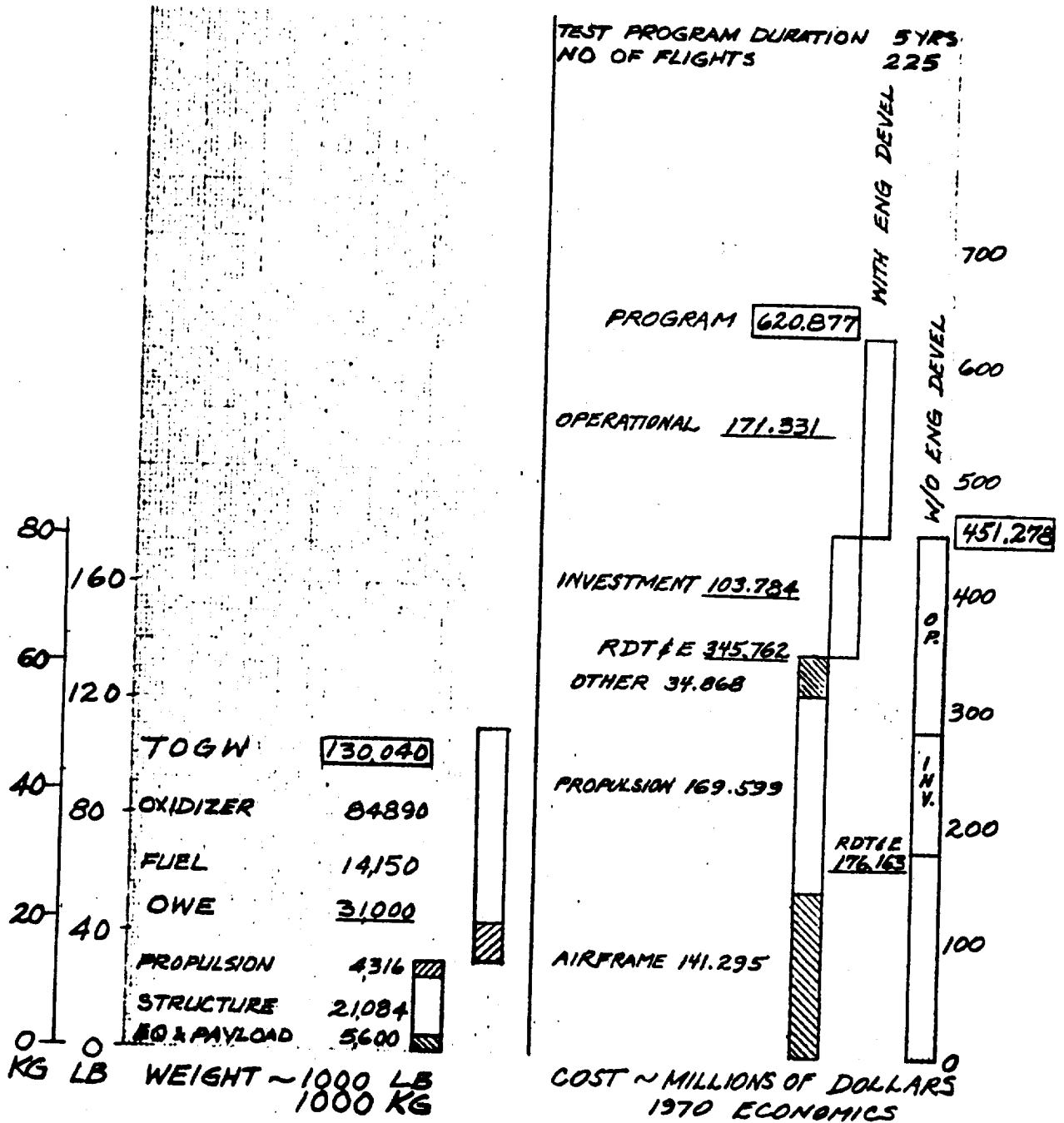

(U) FIGURE 4-151

(U) Figure COST/WEIGHT SUMMARY

<u>MACH NO. 12.0</u>	<u>ALL BODY</u>	<u>CONFIGURATION NO. 250J2S</u>	
LENGTH	95.5 ft(29.1m)	LAUNCH	HTO
Sp	1,289 ft <sup>2</sup> (119.7m <sup>2</sup> )	CONTROL MODE	MANNED
THRUST	265,000 lb (T <sub>vac</sub> ) 1,178,720 N	ACCEL ENG/FUEL	RKT/LH <sub>2</sub> -LO <sub>2</sub>
THRUST	265,000 lb (T <sub>vac</sub> ) 1,178,720 N	CRUISE ENG/FUEL	RKT/LH <sub>2</sub> -LO <sub>2</sub>

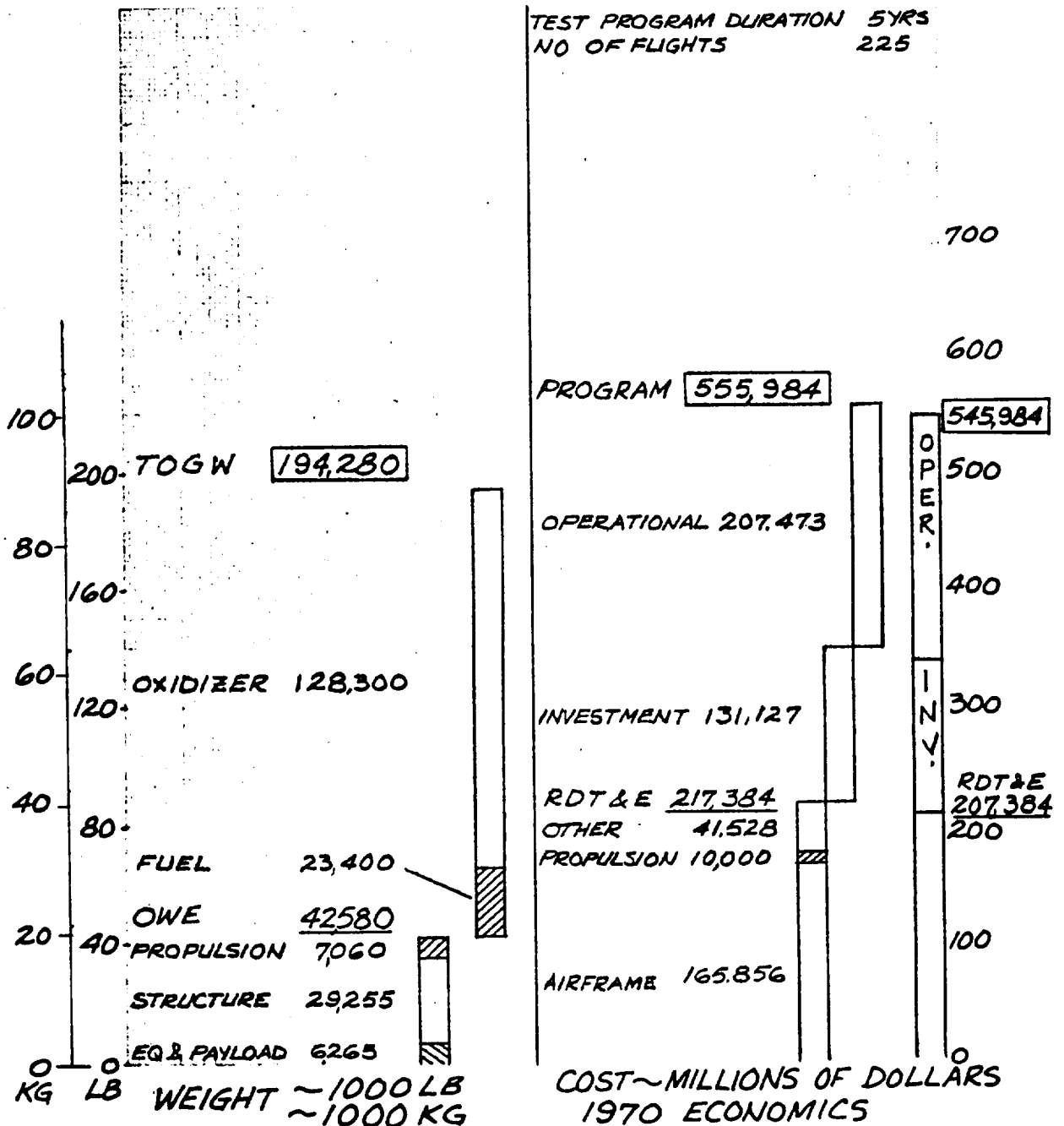

(U) FIGURE 4-152  
CONFIGURATION -251, -255, -256 AND -256H1D

All of these vehicles are Mach 12, manned, horizontal takeoff, wing body aircraft using rocket power to accelerate to cruise Mach number. Configuration -251 has a cryogenic fueled rocket while -256 utilizes a storable fuel for the rocket. Configuration -256 H1D is the same as -256 except it has an off-the-shelf H1D rocket engine and uses LOX-RP fuel. Cruise thrust is maintained by throttling the rocket engine. Configuration -255 uses a cryogenic fueled rocket engine for acceleration to cruise Mach number and then switches to a hydrogen fueled convertible scramjet engine for sustained cruise power. This configuration is illustrated below. The only difference between -255 as shown and -251, -256, and -256 H1D (not shown) is that the convertible scramjet engine is removed and a smooth lower shear is utilized. The final segment of the flight is an unpowered maximum L/D glide and an unpowered approach and landing for all these vehicles.

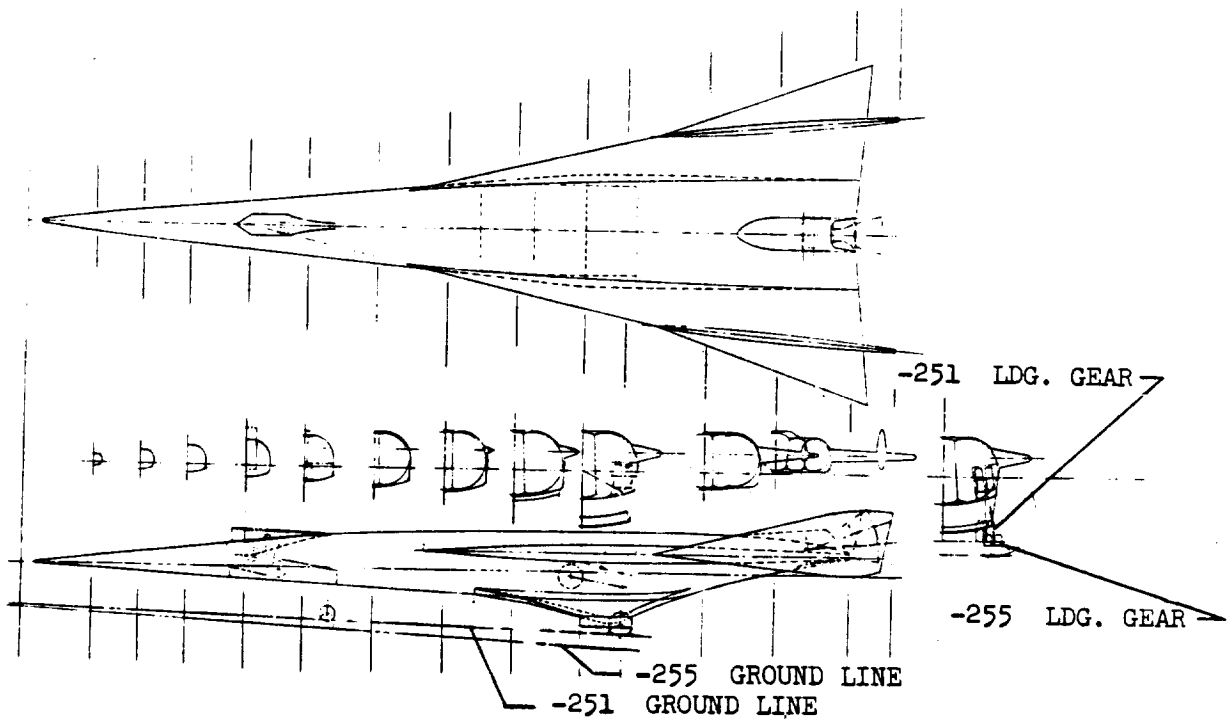

(U) FIGURE 4-153  
 COST/WEIGHT SUMMARY

<u>MACH NO. 12.0</u>	<u>WING BODY</u>	<u>CONFIGURATION NO. 251</u>	
LENGTH	113 ft (34.4m)	LAUNCH	HTO
$S_p$	1,880 ft <sup>2</sup> (174.7m <sup>2</sup> )	CONTROL MODE	MANNED
THRUST	223,000 lb (T <sub>vac</sub> ) 991,904 N	ACCEL ENG/FUEL	RKT/LH <sub>2</sub> -LO <sub>2</sub>
THRUST	223,000 lb (T <sub>vac</sub> ) 991,904 N	CRUISE ENG/FUEL	RKT/LH <sub>2</sub> -LO <sub>2</sub>

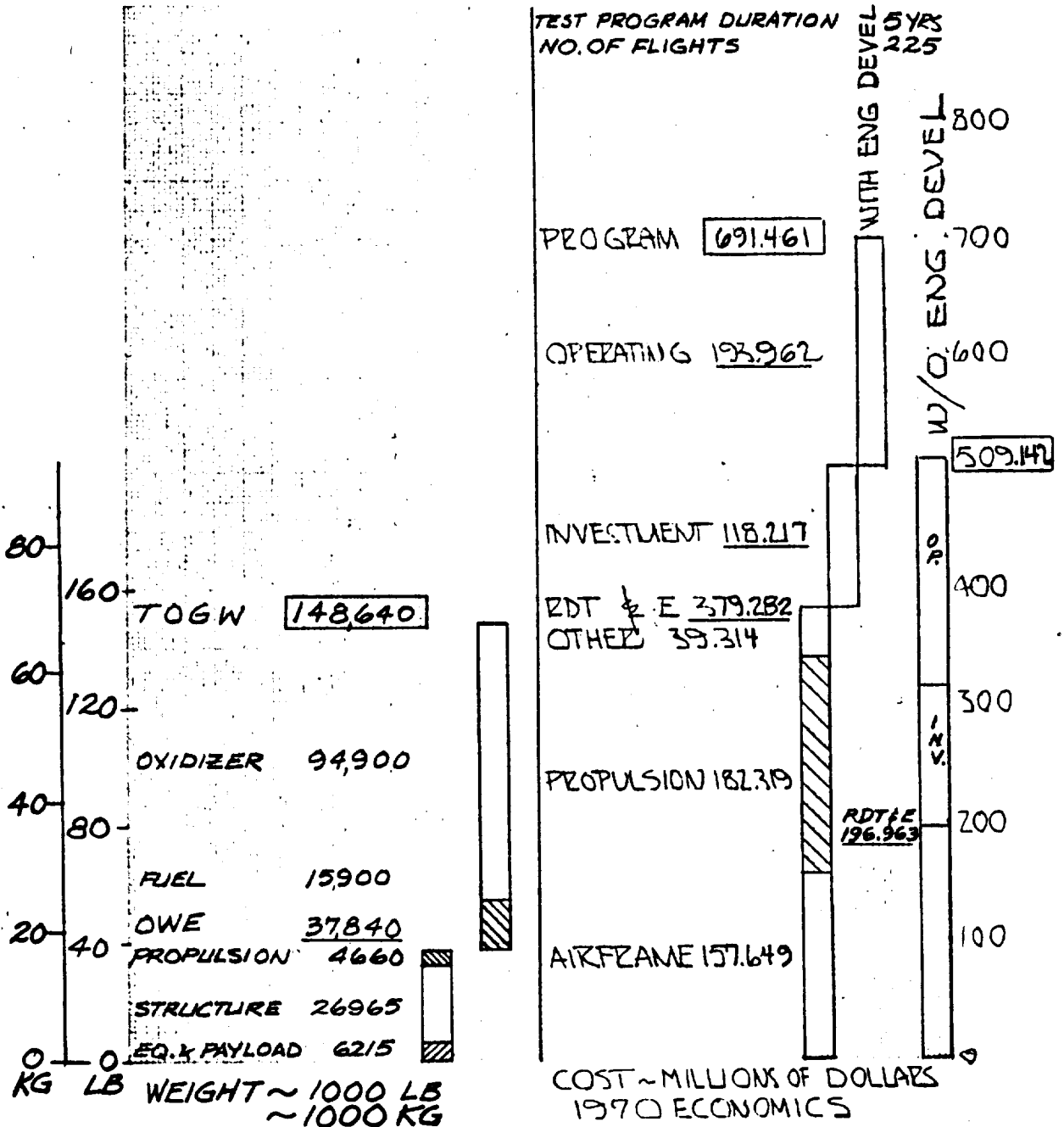

(U) FIGURE 4-154  
 COST/WEIGHT SUMMARY

MACH NO. 12.0	WING BODY	CONFIGURATION NO. 255	
LENGTH	123 ft (37.5m)	LAUNCH	HTO
$S_p$	2,190 ft <sup>2</sup> (203.5m <sup>2</sup> )	CONTROL MODE	MANNED
THRUST	263,300 lb 1,171,158 N ( $T_{vac}$ )	ACCEL ENG/FUEL	RKT/LH <sub>2</sub> -LO <sub>2</sub>
THRUST	26,300 lb 116,982 N ( $M=12$ )	CRUISE ENG/FUEL	CSJ/LH <sub>2</sub>

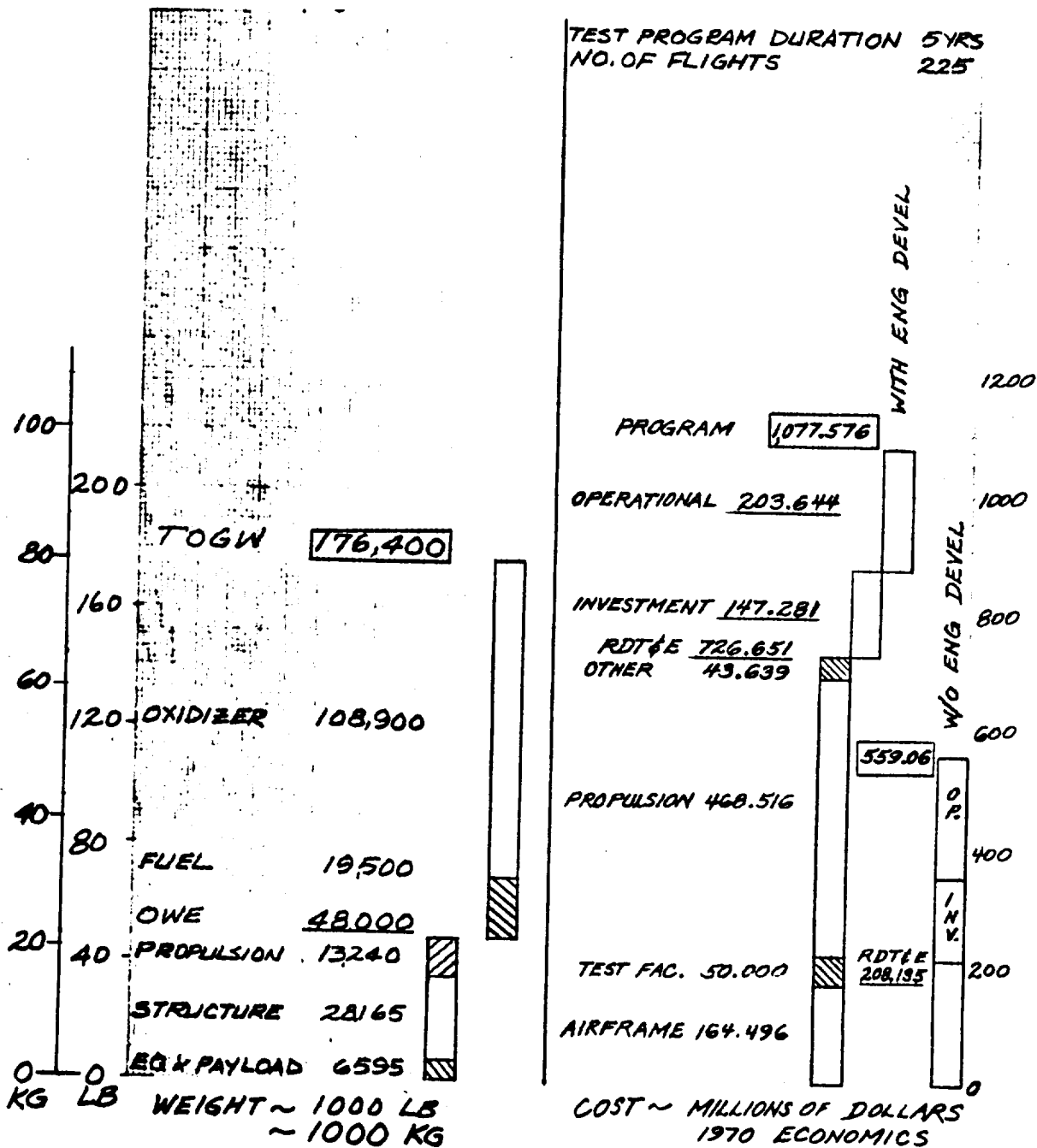

(U) FIGURE 4-155  
 COST/WEIGHT SUMMARY

<u>MACH NO. 12.0</u>	<u>WING BODY</u>	<u>CONFIGURATION NO. 256</u>	
LENGTH	94.6 ft (28.8m)	LAUNCH	HTO
$S_p$	1,318 ft <sup>2</sup> (122.4m <sup>2</sup> )	CONTROL MODE	MANNED
THRUST	372,000 lb 1,654,656 N ( $T_{vac}$ )	ACCEL ENG/FUEL	RKT/AERO 50 N <sub>2</sub> O <sub>4</sub>
THRUST	372,000 lb 1,654,656 N ( $T_{vac}$ )	CRUISE ENG/FUEL	RKT/AERO 50 N <sub>2</sub> O <sub>4</sub>

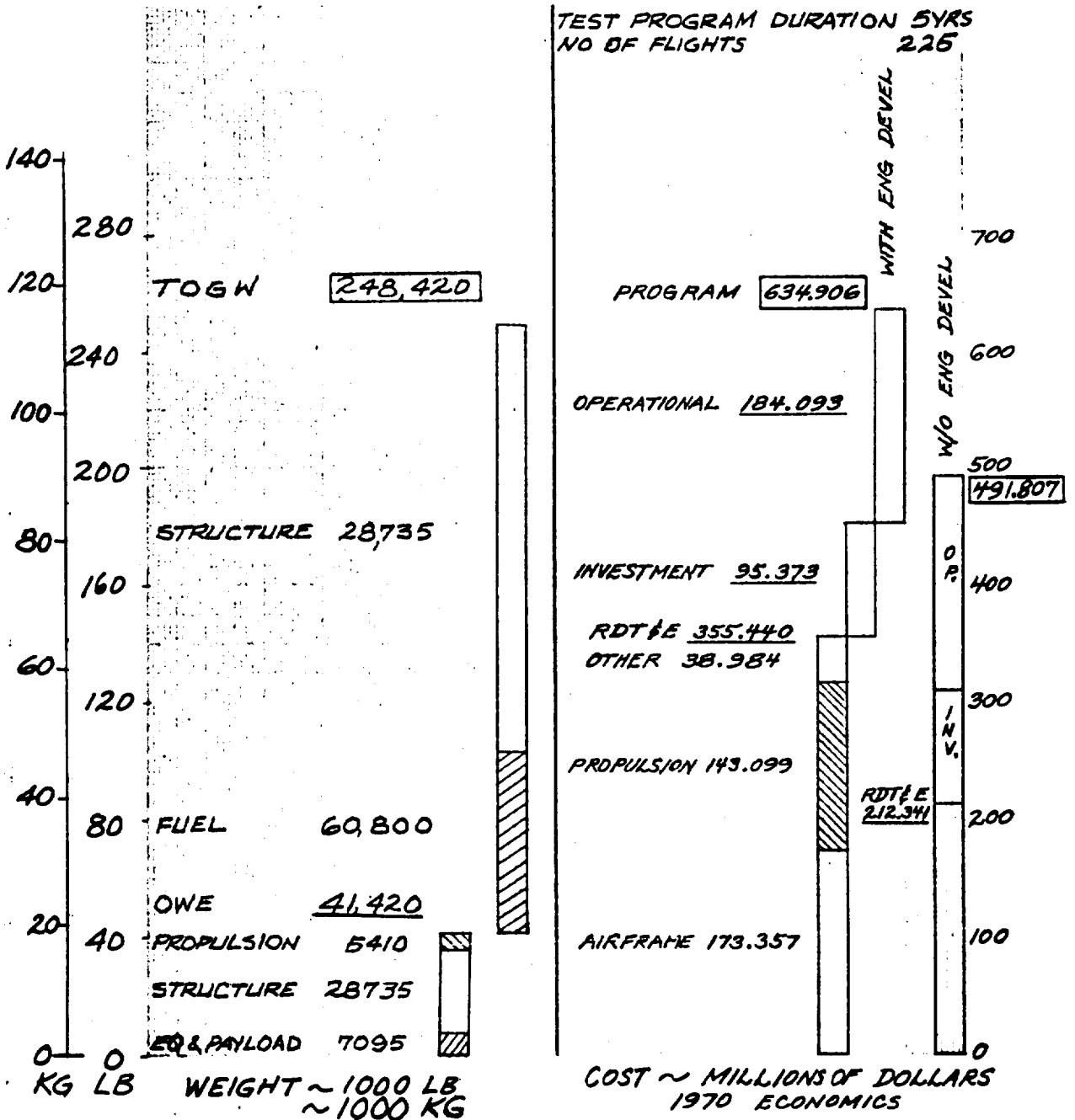

(U) FIGURE 4-156  
 COST/WEIGHT SUMMARY

<u>MACH NO. 12.0</u>	<u>ALL BODY</u>	<u>CONFIGURATION NO. 256 HLD</u>
LENGTH	114.3 ft (34.8m)	LAUNCH HTO
Sp	1,923 ft <sup>2</sup> (178.6m <sup>2</sup> )	CONTROL MODE MANNED
THRUST	230,000 lb (T <sub>vac</sub> ) 1,023,040 N	ACCEL ENG/FUEL RKT/RP-LO <sub>2</sub>
THRUST	230,000 lb (T <sub>vac</sub> ) 1,023,040 N	CRUISE ENG/FUEL RKT/RP-LO <sub>2</sub>

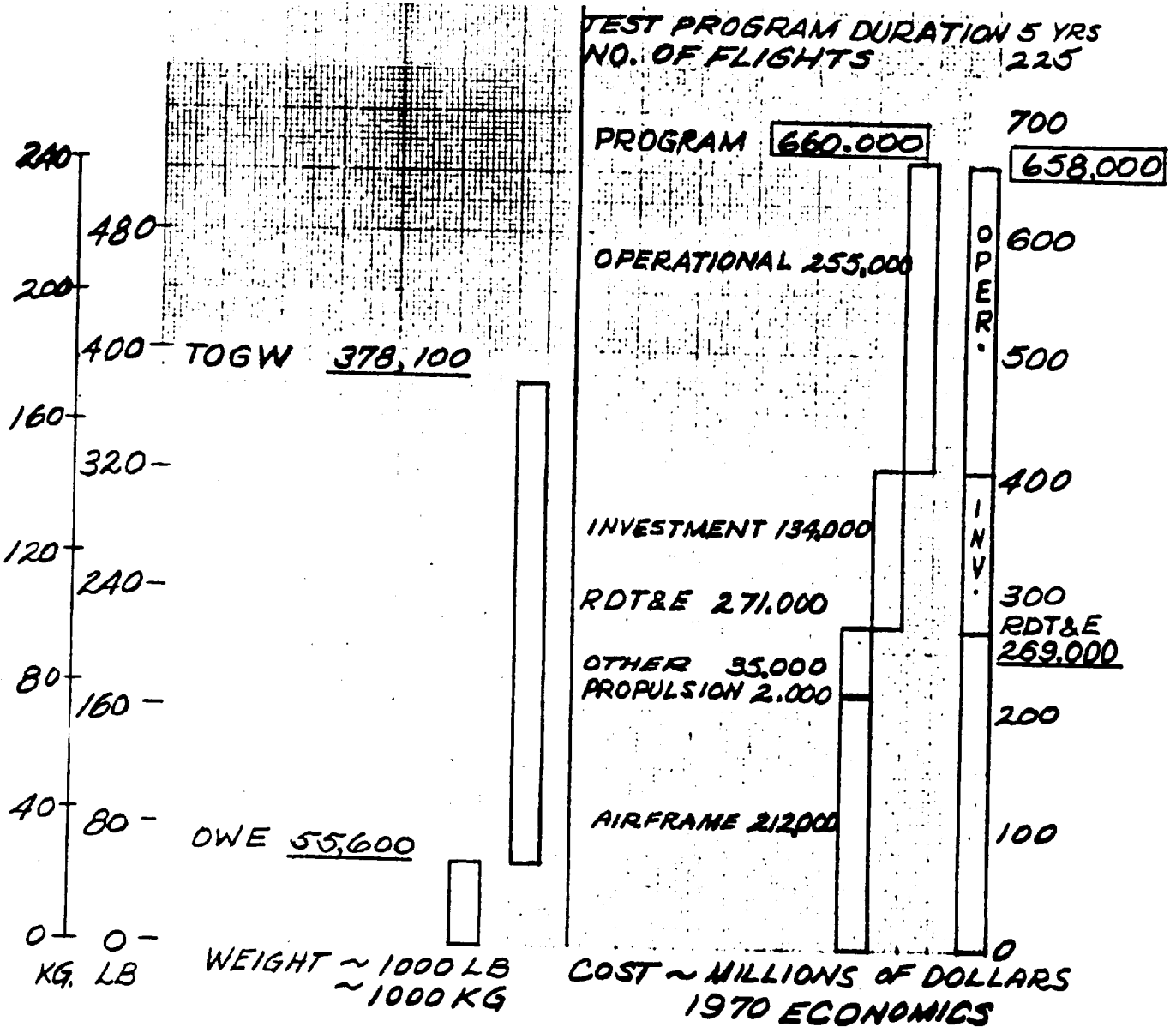



(U) FIGURE 4-157  
CONFIGURATION -252 AND -253

These vehicles are Mach 12, manned, horizontal takeoff aircraft. Both aircraft use rocket engines to accelerate and cruise at Mach 12. Configuration -252 is an elliptical all body shape with cryogenic fuel and is illustrated below. Configuration -253 is pictorially the same as -252 except the cross sectional shape is the MCAIR all body shape and uses storable rocket fuel.

A comparison between configuration -250 and -252 can be made with the fuselage cross sectional shape as the only variable. A comparison between configuration -250 and -253 can be made with the fuel as the only variable.

The final segment of the flight of both vehicles is an unpowered maximum L/D glide and unpowered approach and landing.

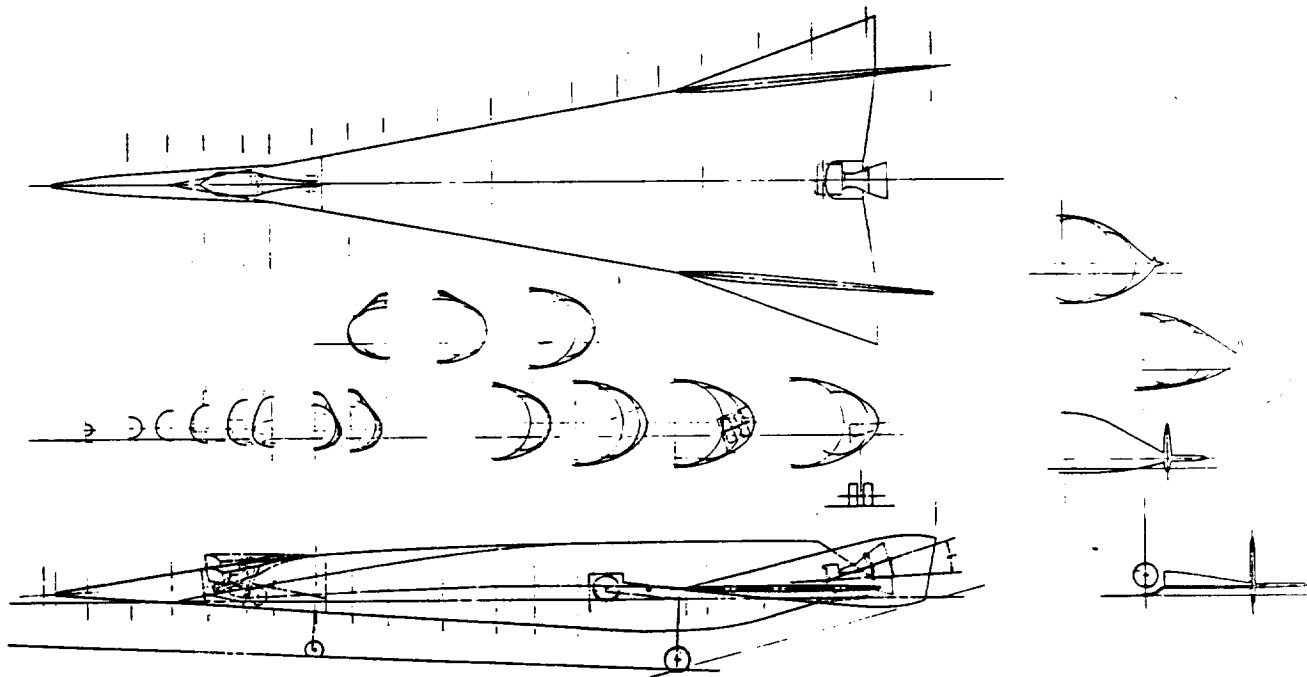

(U) FIGURE 4-158  
 COST/WEIGHT SUMMARY

MACH NO. 12.0      ALL BODY (ELLIPTICAL)      CONFIGURATION NO. 252

LENGTH	97.4 ft (29.7m)	LAUNCH	HTO
$S_p$	1,340 ft <sup>2</sup> (124.5m <sup>2</sup> )	CONTROL MODE	MAINED
THRUST	199,000 lb (T <sub>vac</sub> )	ACCEL ENG/FUEL	RKT/LH <sub>2</sub> -LO <sub>2</sub>
	885,152 N		
THRUST	199,000 lb (T <sub>vac</sub> )	CRUISE ENG/FUEL	RKT/LH <sub>2</sub> -LO <sub>2</sub>
	885,152 N		

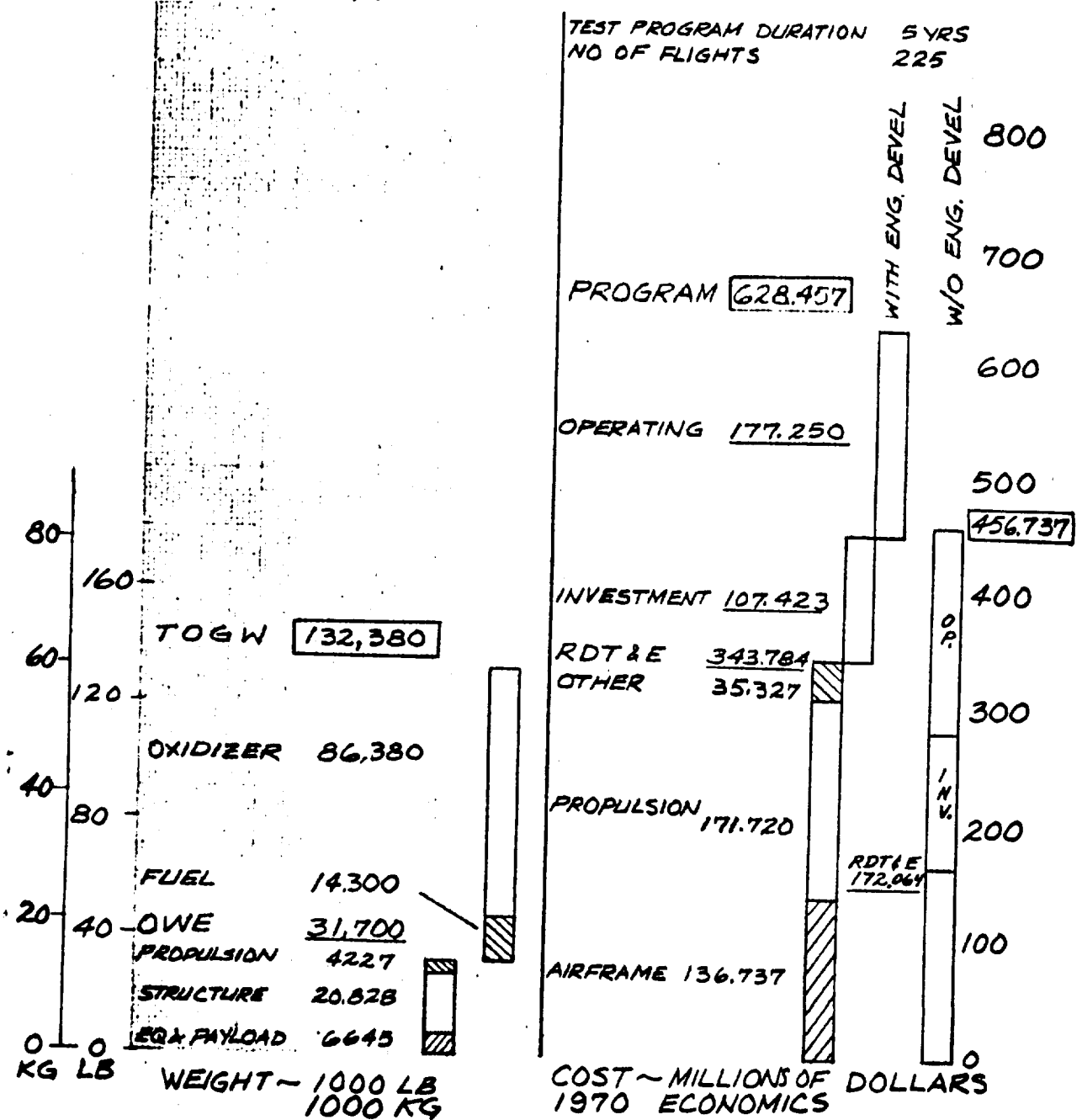

(U) FIGURE 4-159  
 COST/WEIGHT SUMMARY

<u>MACH NO. 12.0</u>	<u>ALL BODY</u>	<u>CONFIGURATION NO. 253</u>	
LENGTH	88.5 ft (27m)	LAUNCH	HTO
Sp	1,100 ft <sup>2</sup> (102.2m <sup>2</sup> )	CONTROL MODE	MANNED
THRUST	472,000 lb (T <sub>vac</sub> )	ACCEL ENG/FUEL	RKT/AERO 50-N <sub>2</sub> O <sub>4</sub>
	2,099,456 N		
THRUST	472,000 lb (T <sub>vac</sub> )	CRUISE ENG/FUEL	RKT/AERO 50-N <sub>2</sub> O <sub>4</sub>
	2,099,456 N		

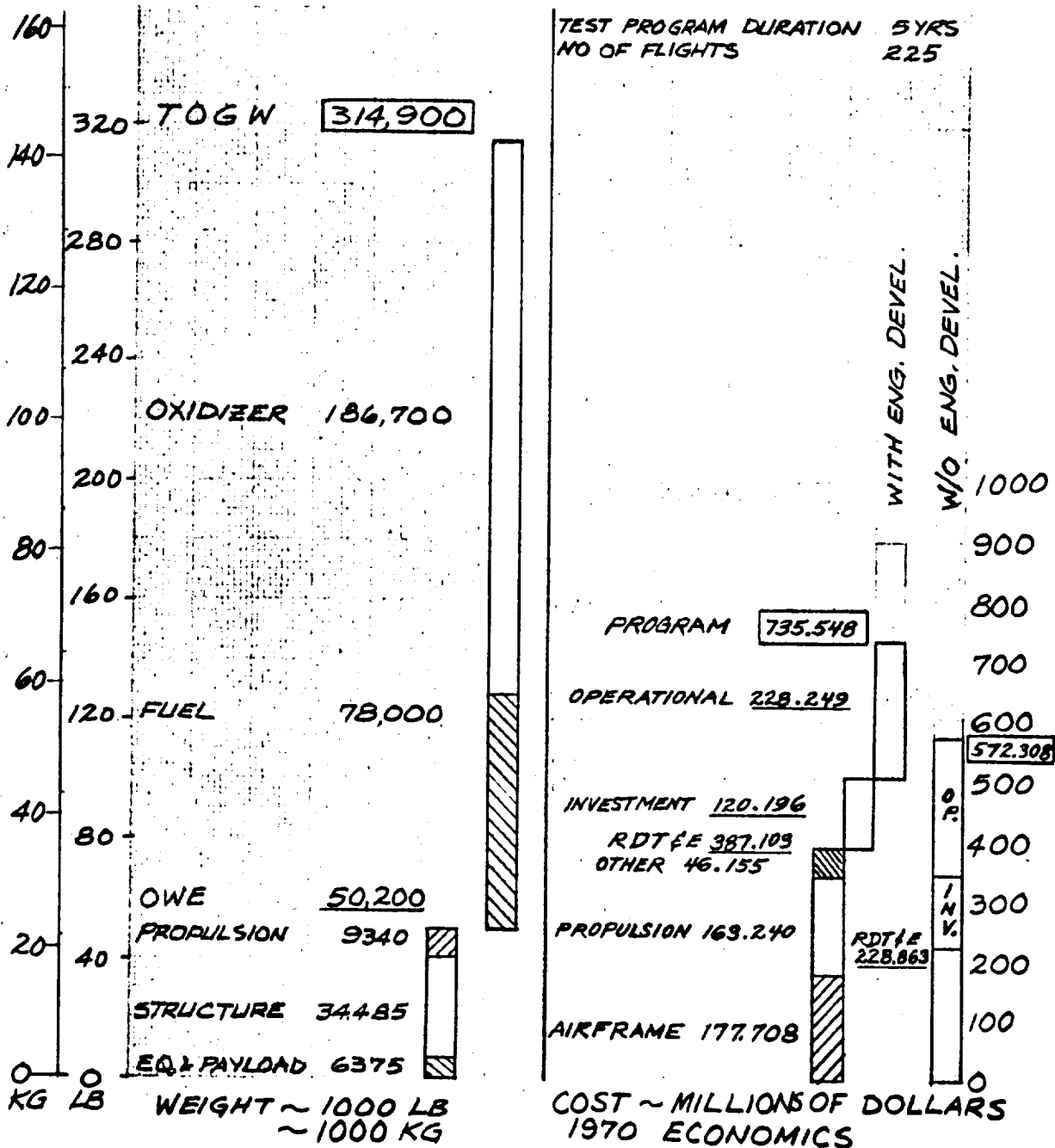

(U) FIGURE 4-160  
CONFIGURATION -254

This is a Mach 12, manned, horizontal takeoff, all body aircraft with a hydrogen fueled rocket engine for acceleration and convertible scramjet engine for cruise power. The rocket accelerates the aircraft to Mach 12 where the convertible scramjet engine is started and cruise flight is sustained for acquisition of data over the test time period. No convertible scramjet base burning is required for drag reduction when rocket engine is used to accelerate the aircraft. Return flight is an unpowered maximum L/D glide and unpowered approach and landing.

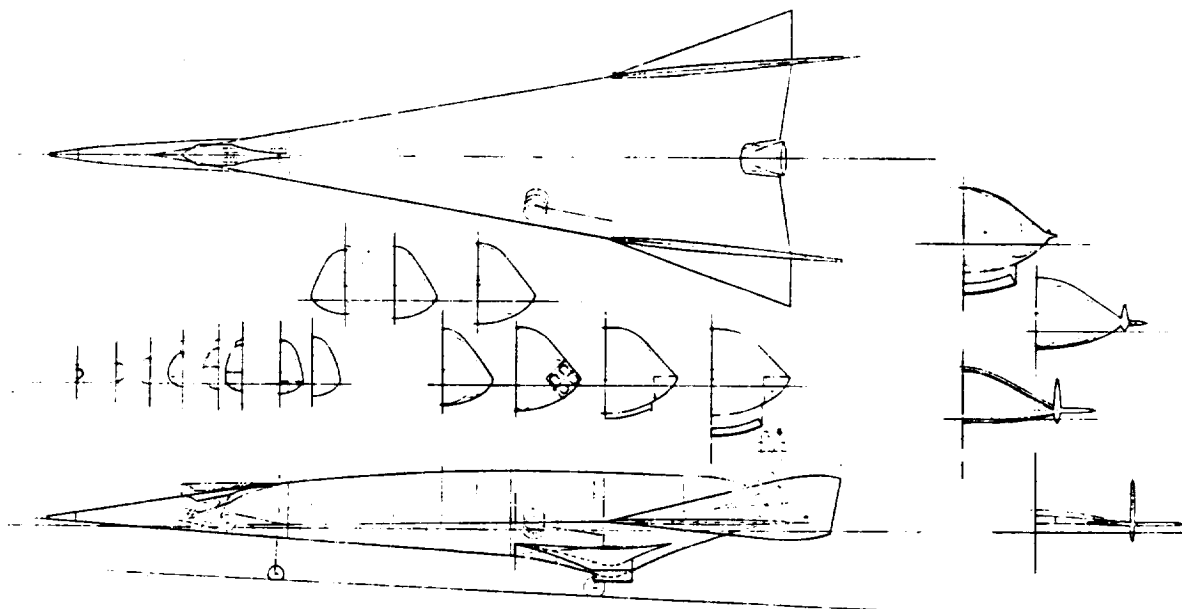

(U) FIGURE 4-161

**COST/WEIGHT SUMMARY**

<u>MACH NO. 12.0</u>	<u>ALL BODY</u>	<u>CONFIGURATION NO. 254</u>	
LENGTH	97.1 ft (29.6m)	LAUNCH	HTO
S <sub>p</sub>	1,328 ft <sup>2</sup> (123.4m <sup>2</sup> )	CONTROL MODE	MANNED
THRUST	203,000 lb (T <sub>vac</sub> ) 902,944 N	ACCEL ENG/FUEL	RKT/LH <sub>2</sub> -LO <sub>2</sub>
THRUST	17,900 lb (M=12) 79,619 N	CRUISE ENG/FUEL	CSJ/LH <sub>2</sub>

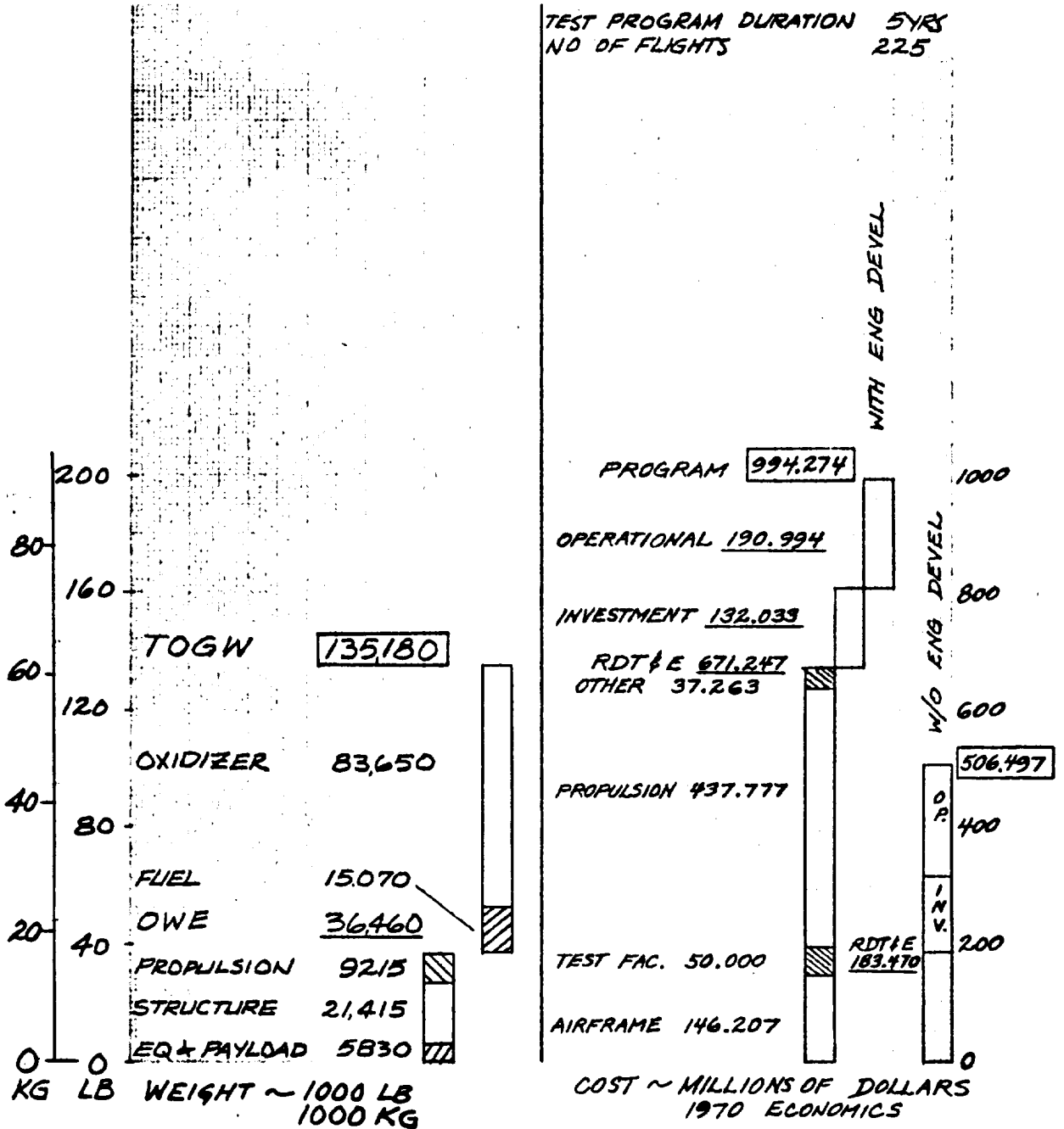

(U) FIGURE 4-162  
CONFIGURATION -257

This is a Mach 12, manned, horizontal takeoff, wing body shaped aircraft. Hydrogen fueled turbojet acceleration engines accelerate the aircraft to Mach 1.0 when the hydrogen fueled convertible scramjet is started. Initially, the base burning of the scramjet is used to reduce aircraft drag and at Mach 3.0 to 3.5 the scramjet thrust is sufficient to accelerate the vehicle on to Mach 12. The turbojet engines are shut down in the Mach 3.0 to 3.5 range.

The turbojet air induction system consists of an inlet scoop with integral internal horizontal variable ramps mounted on the lower surface of the vehicle and is retracted after turbojet shut down. A boundary layer diverter is also retractable into the lower surface of the vehicle and is mounted forward of the airscoop to provide the first inlet ramp during the turbojet operation. When the turbojet inlet scoop and boundary layer diverter are retracted, they form the first and second inlet ramp of the convertible scramjet for improved high Mach number operation

The final segment of the flight is an unpowered maximum L/D glide with an unpowered approach and landing.

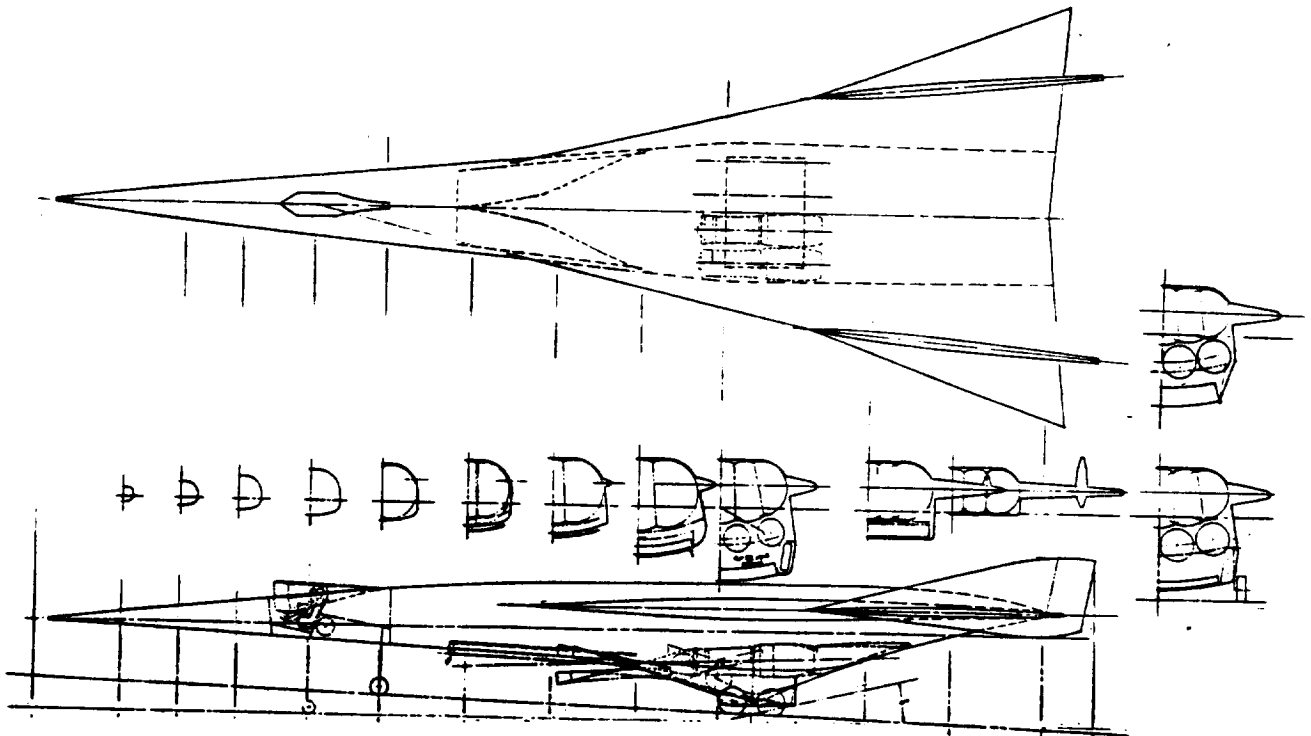

(U) FIGURE 4-163  
 COST/WEIGHT SUMMARY

MACH NO. 12.0	WING BODY	CONFIGURATION NO. 257	
LENGTH	116.1 ft (35.4m)	LAUNCH	HTO
S <sub>p</sub>	2,000 ft <sup>2</sup> (185.8m <sup>2</sup> )	CONTROL MODE	MANNED
THRUST	21,300 lb (94,742 N) (SLSU)	ACCEL ENG/FUEL	TJ/LH <sub>2</sub>
THRUST	24,000 lb (106,752 N) (M=12)	CRUISE ENG/FUEL	CSJ/LH <sub>2</sub>

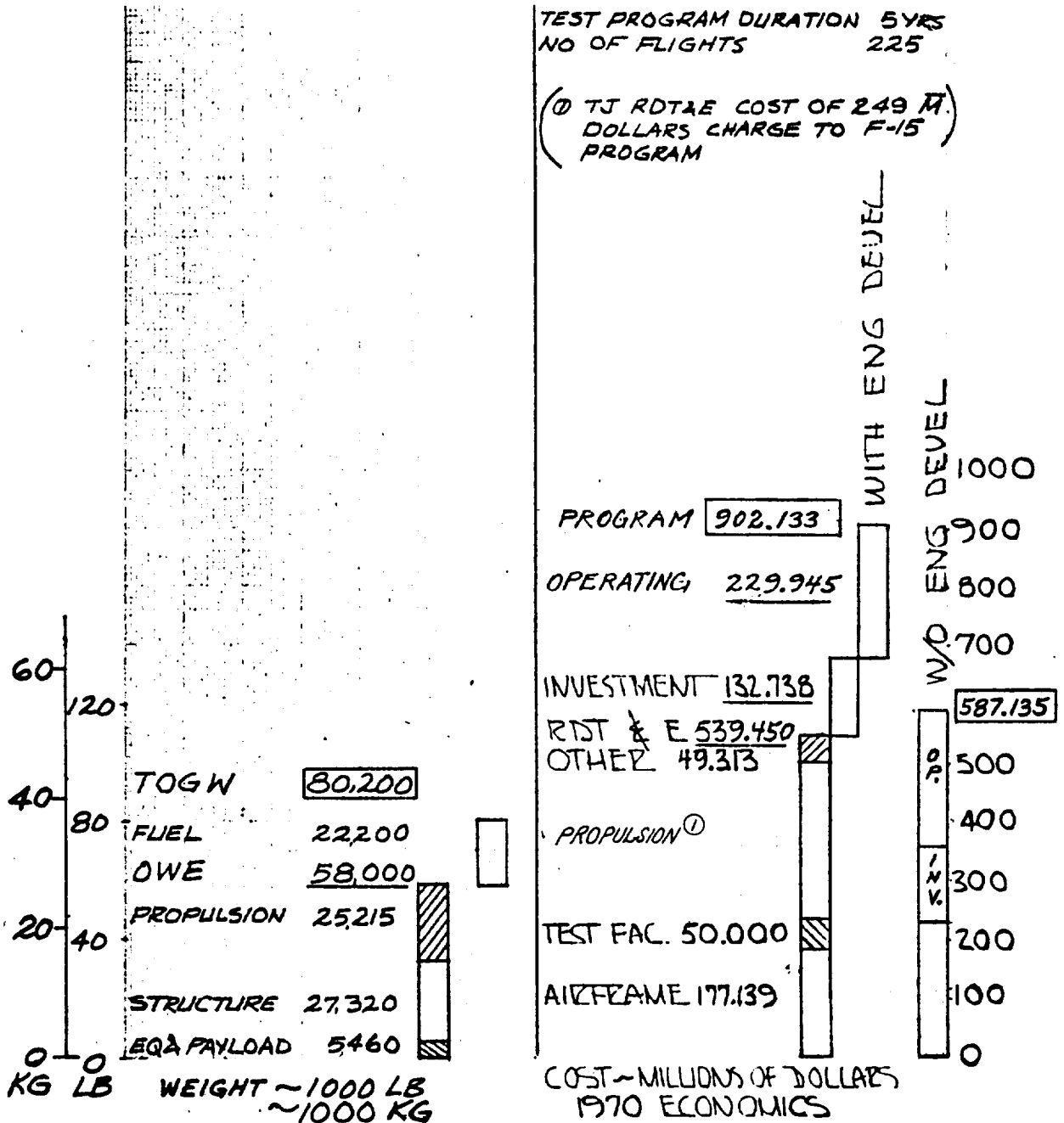

6 ⊕

(U) FIGURE 4-164  
CONFIGURATION -270

This is a Mach 12, manned, all body, vertical takeoff vehicle using a liquid hydrogen fueled rocket for acceleration to cruise Mach number. Cruise thrust is maintained by throttling the rocket engine during the test period for data acquisition. Return leg of the flight is a maximum L/D glide with a unpowered approach and landing.

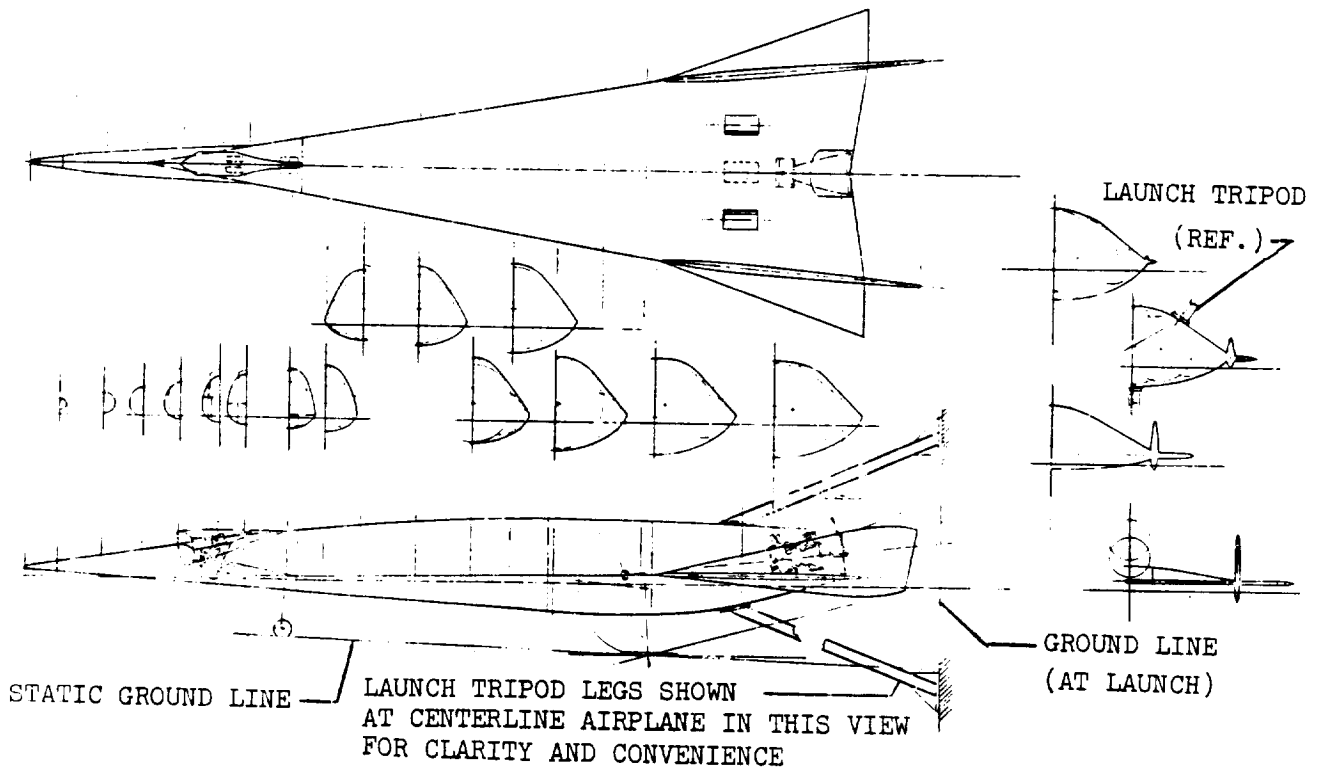



(U) FIGURE 4-165  
 COST/WEIGHT SUMMARY

MACH NO. 12.0	ALL BODY	CONFIGURATION NO. 270	
LENGTH	106.2 ft (32.4m)	LAUNCH	VTO
$S_p$	1,405 ft <sup>2</sup> (130.5m <sup>2</sup> )	CONTROL MODE	MANNED
THRUST	216,000 lb (T <sub>vac</sub> ) 960,768 N	ACCEL ENG/FUEL	RKT/LH <sub>2</sub> -LO <sub>2</sub>
THRUST	216,000 lb (T <sub>vac</sub> ) 960,768 N	CRUISE ENG/FUEL	RKT/LH <sub>2</sub> -LO <sub>2</sub>

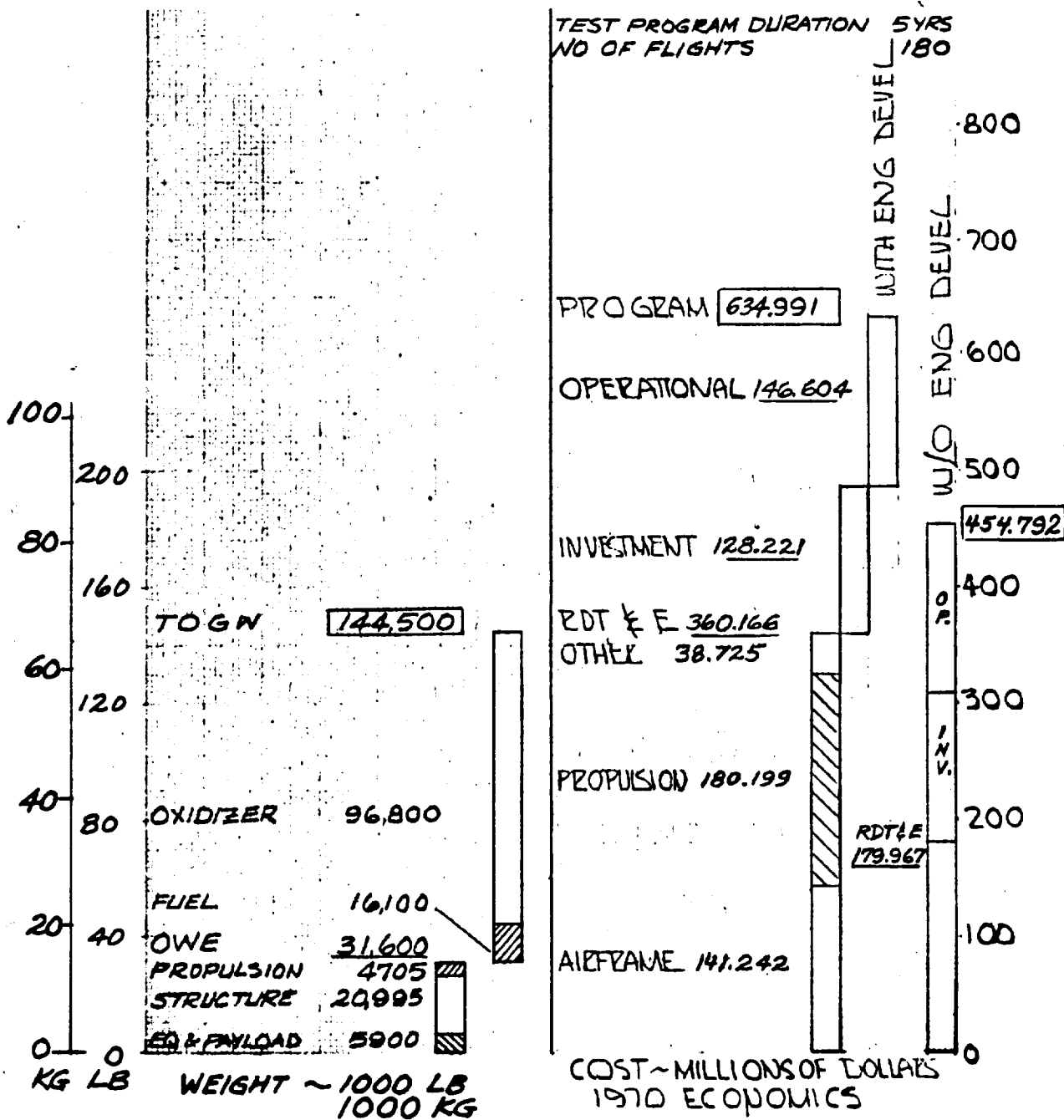

(U) FIGURE 4-166  
CONFIGURATION -271

This vehicle is a Mach 12, manned, all body, vertical takeoff aircraft. A hydrogen fueled rocket engine accelerates the aircraft to cruise Mach number where a hydrogen fueled convertible scramjet takes over and supplies the cruise thrust for the data acquisition time period. Return to base is a maximum L/D glide with a unpowered approach and landing.

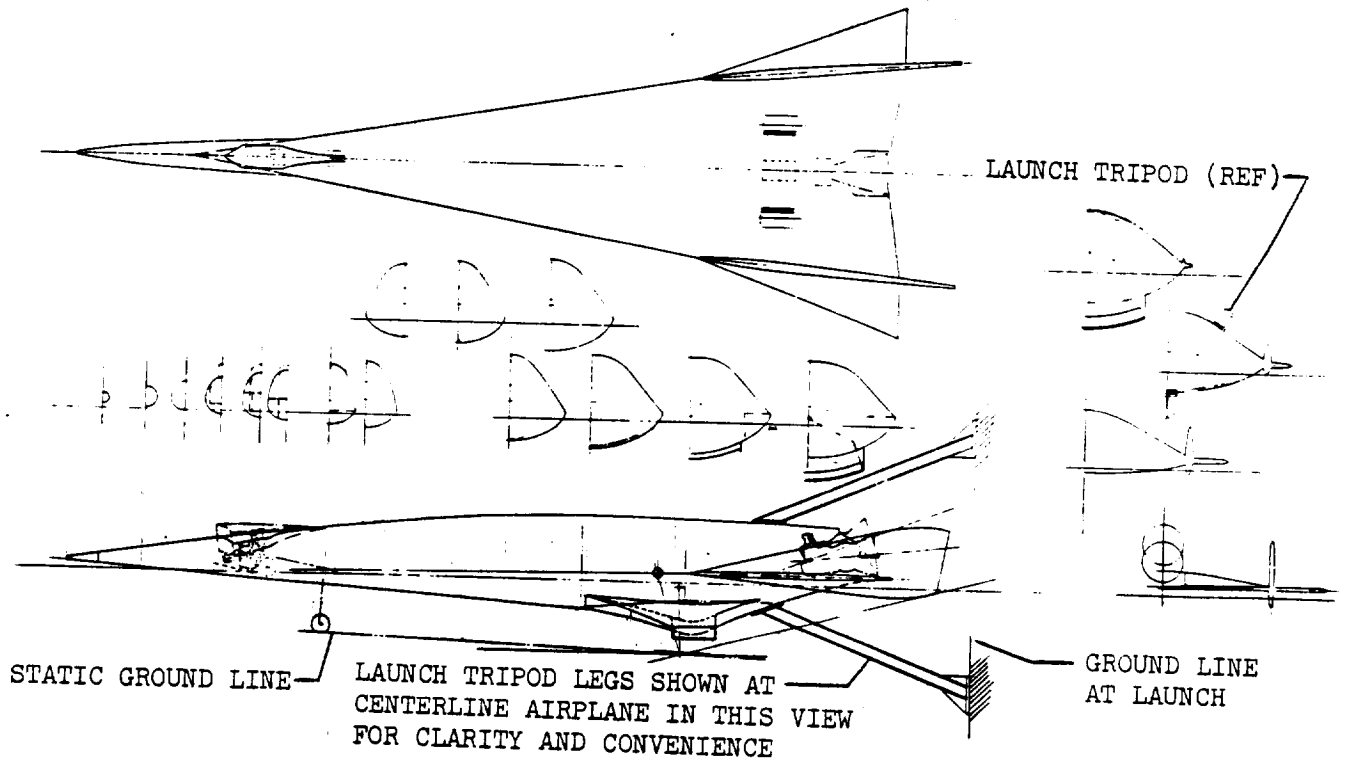

(U) FIGURE 4-167  
 COST/WEIGHT SUMMARY

MACH NO. 12.0	ALL BODY	CONFIGURATION NO. 271	
LENGTH	113.8 ft (34.7m)	LAUNCH	VTO
$S_p$	1,530 ft <sup>2</sup> (142.1m <sup>2</sup> )	CONTROL MODE	MANNED
THRUST	248,000 lb (T <sub>vac</sub> ) 1,103,104 N	ACCEL ENG/FUEL	RKT/LH <sub>2</sub> -LO <sub>2</sub>
THRUST	20,000 lb (M=12) 88,900 N	CRUISE ENG/FUEL	CSJ/LH <sub>2</sub>

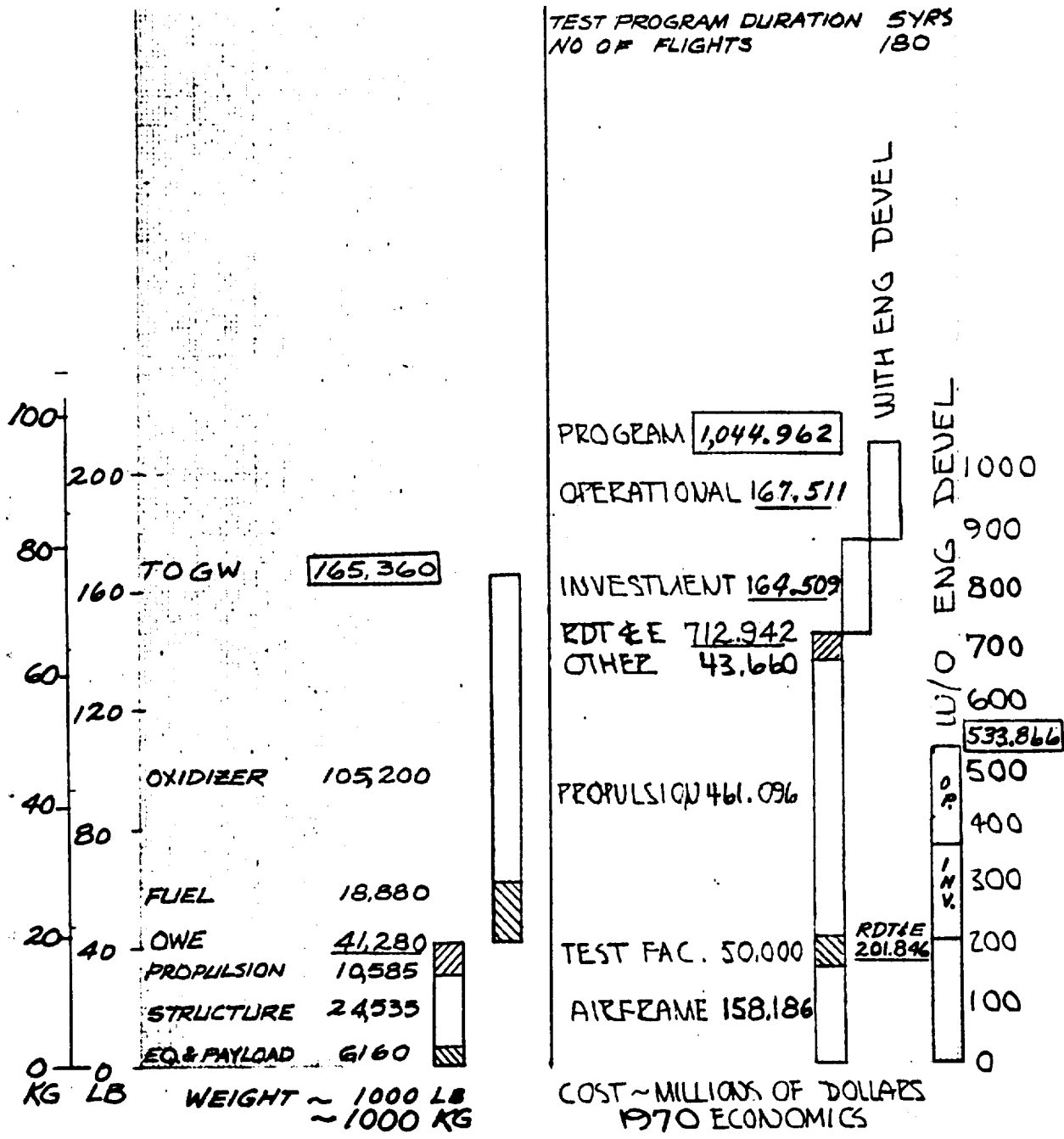

(U) FIGURE 4-168  
CONFIGURATION -280

This vehicle is a Mach 12, unmanned, all body, vertical takeoff aircraft boosted to cruise Mach number by a staged boost rocket. Cruise flight is sustained by a hydrogen fueled convertible scramjet engine for the test data acquisition period. After fuel depletion, the vehicle utilizes a programmed parachute deployment recovery system for return and recovery.

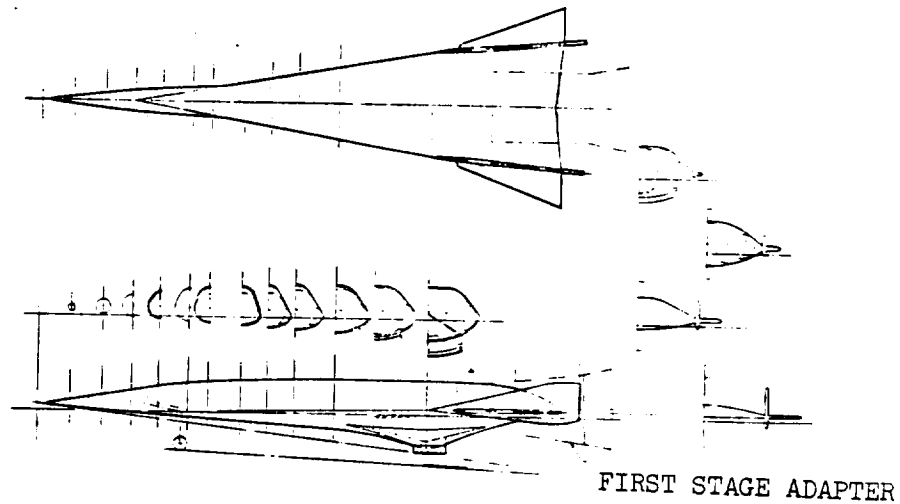

(U) FIGURE 4-169  
 COST/WEIGHT SUMMARY

<u>MACH NO. 12.0</u>	<u>ALL BODY</u>	<u>CONFIGURATION NO. 280</u>	
LENGTH	29.6 ft (9.0m)	LAUNCH	BOOST VTO
S <sub>p</sub>	165 ft <sup>2</sup> (15.3m <sup>2</sup> )	CONTROL MODE	UNMANNED
THRUST	_____	ACCEL ENG/FUEL	ATLAS
THRUST	2,230 lb (M=12) 9,919 N	CRUISE ENG/FUEL	CSJ/LH <sub>2</sub>

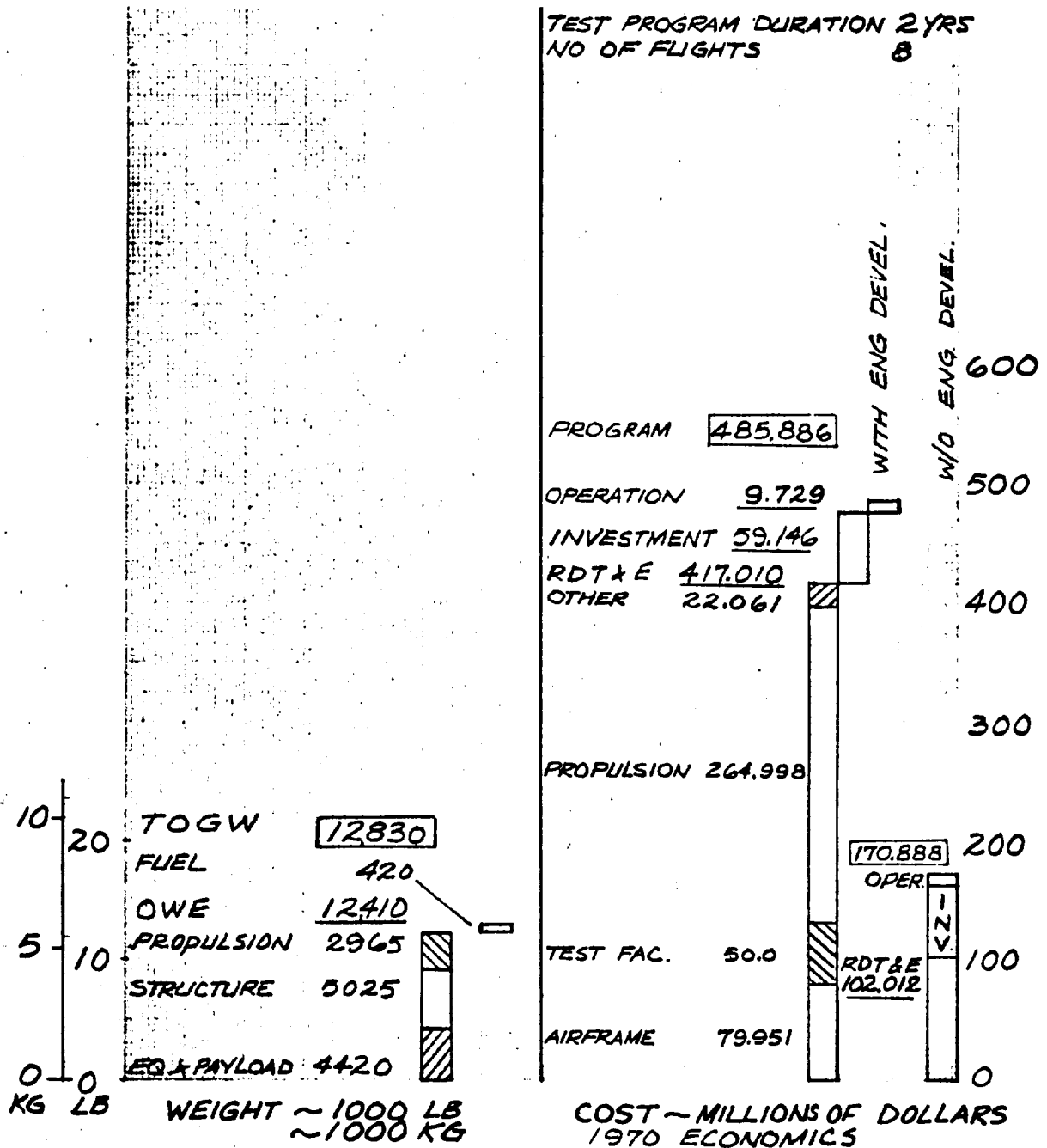

(U) FIGURE 4-170  
CONFIGURATION -281 AND -282

Both of these vehicles are Mach 12, unmanned, all body shaped aircraft that are boosted to cruise Mach number by a first stage booster rocket. These aircraft maintain cruise Mach number thrust with an on-board rocket engine. Enough fuel is carried to complete the required test period. Configuration -281 uses liquid hydrogen fuel with liquid oxygen as the oxidizer. Configuration -282 uses a storable fuel, aeroxine 50, with  $N_2O_4$  as the oxidizer. Both vehicles have remotely deployed parachutes for descent and vehicle recovery.

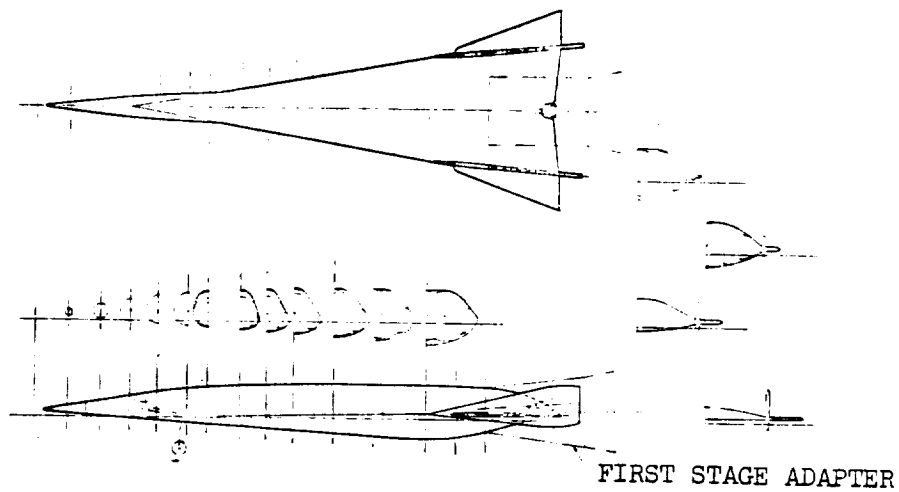

(U) FIGURE 4-171  
 COST/WEIGHT SUMMARY

<u>MACH NO. 12.0</u>	<u>ALL BODY</u>	<u>CONFIGURATION NO. 281</u>	
LENGTH	29.8 ft (9.1m)	LAUNCH	BOOST VTO
S <sub>p</sub>	168 ft <sup>2</sup> (15.6m <sup>2</sup> )	CONTROL MODE	UNMANNED
THRUST	_____	ACCEL ENG/FUEL	ATLAS
THRUST	4,670 lb (SLSU) 20,772 N	CRUISE ENG/FUEL	RKT/LH <sub>2</sub> -LO <sub>2</sub>

TEST PROGRAM DURATION 2 YRS  
 NO OF FLIGHTS 8

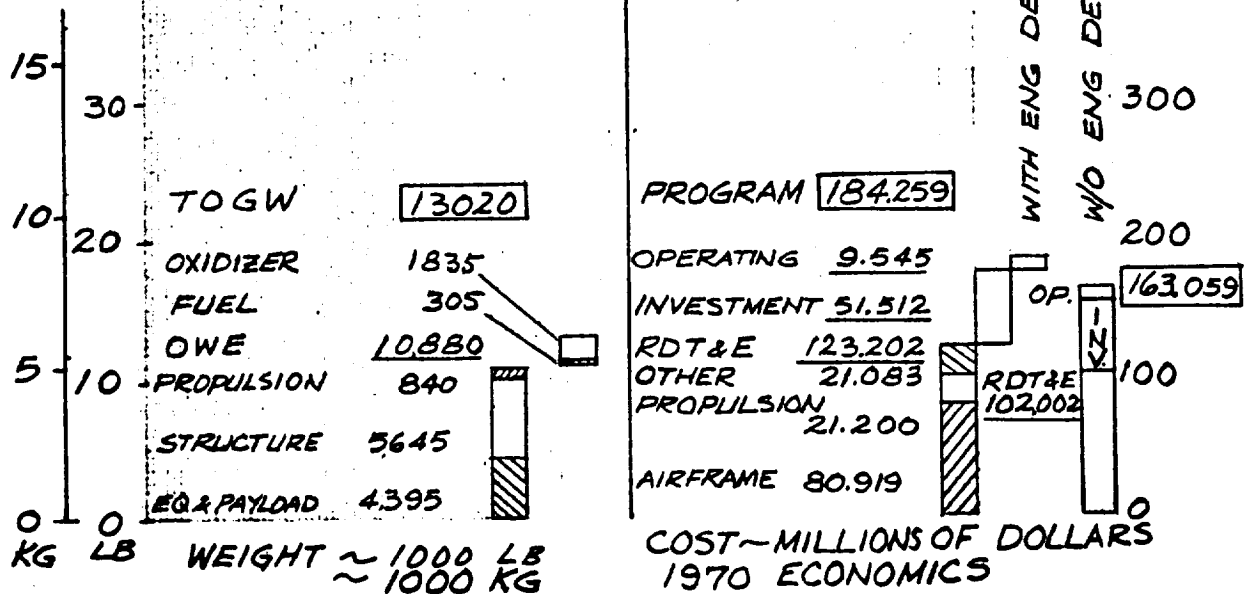

(U) FIGURE 4-172  
 COST/WEIGHT SUMMARY

MACH NO. 12.0	ALL BODY	CONFIGURATION NO. 282	
LENGTH	26.5 ft (8.1m)	LAUNCH	BOOST VTO
S <sub>p</sub>	136 ft <sup>2</sup> (12.6m <sup>2</sup> )	CONTROL MODE	UNMANNED
THRUST	_____	ACCEL ENG/FUEL	ATLAS
THRUST	6,190 lb (SLSU) 27,533 N	CRUISE ENG/FUEL	RKT/AERO 50-N <sub>2</sub> O <sub>4</sub>

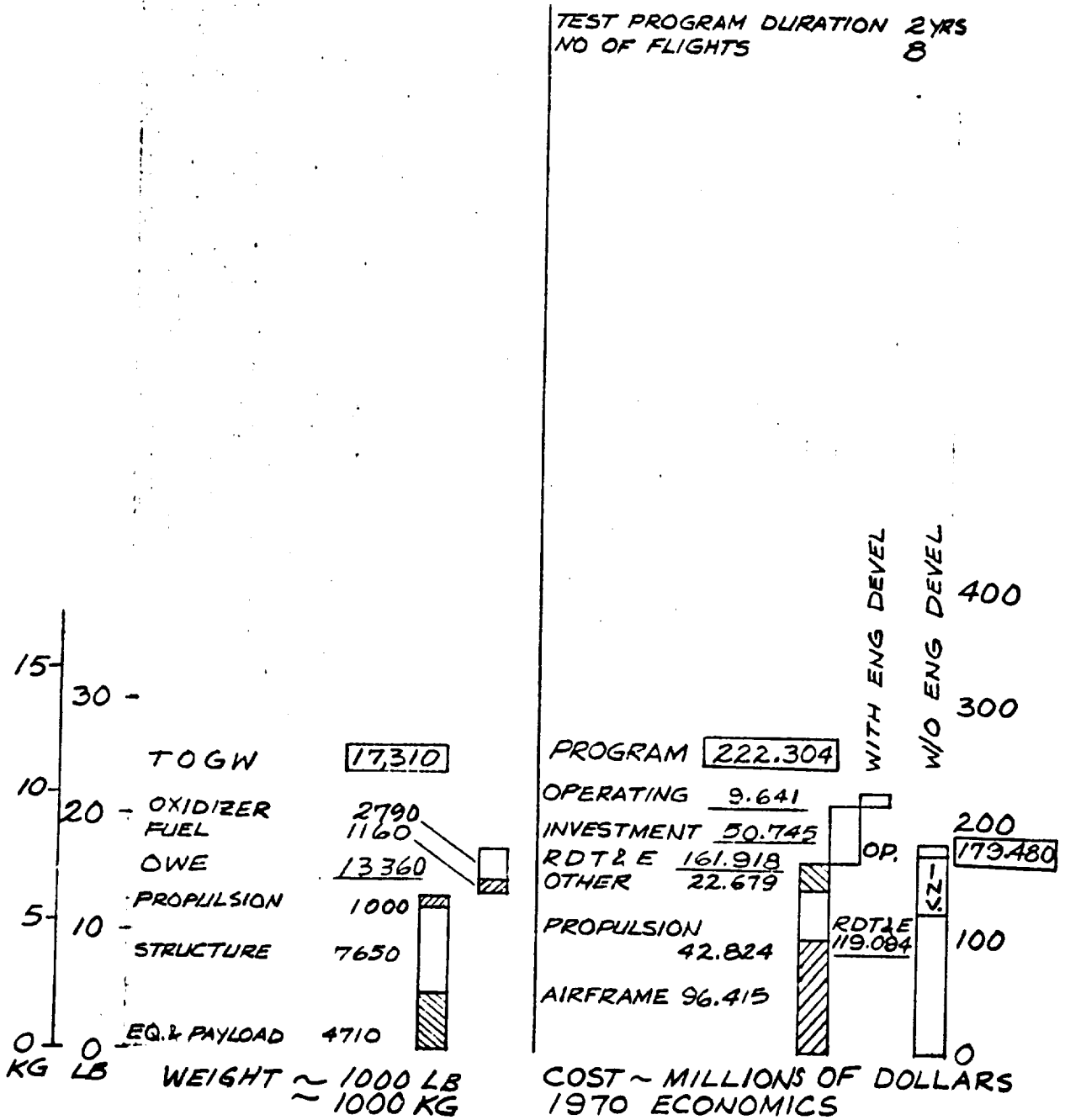



(U) FIGURE 4-173  
CONFIGURATION -284

This vehicle is a Mach 12, unmanned, air launched, all body, aircraft using a hydrogen fueled rocket for acceleration to cruise Mach number. Cruise conditions are maintained by throttling the rocket during the data gathering test period of stabilized flight. Recovery is accomplished by a programmed parachute deployment and descent over a specified area.

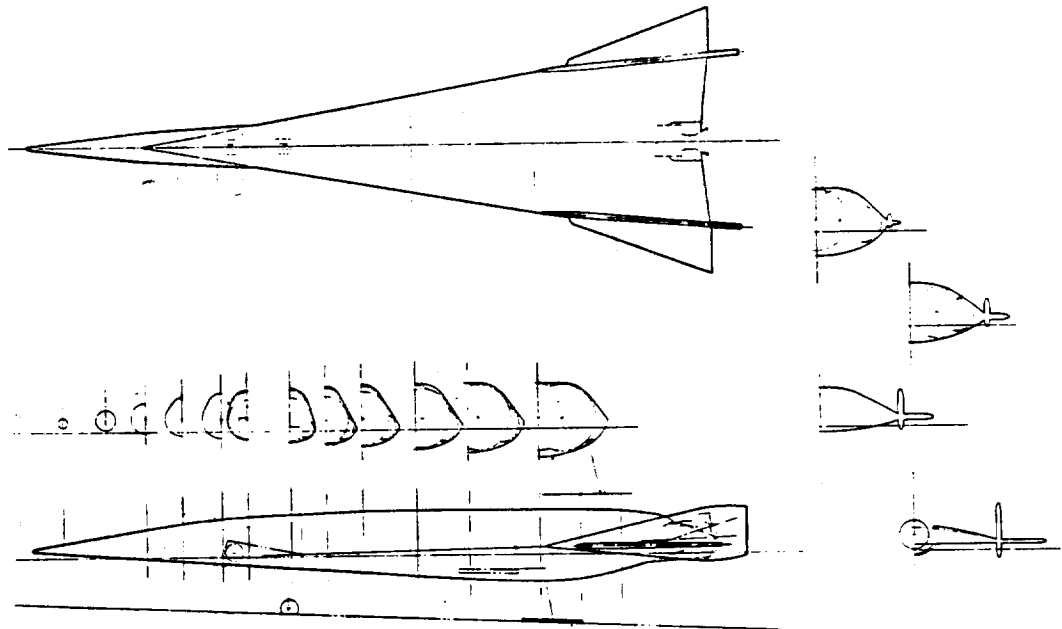

(U) FIGURE 4-174  
 COST/WEIGHT SUMMARY

MACH NO. 12.0	ALL BODY	CONFIGURATION NO. 284	
LENGTH	81.3 ft (24.8m)	LAUNCH	AIR
S <sub>p</sub>	885 ft <sup>2</sup> (82.2m <sup>2</sup> )	CONTROL MODE	UNMANNED
THRUST	110,000 lb (T <sub>vac</sub> ) 489,280 N	ACCEL ENG/FUEL	RKT/LH <sub>2</sub> -LO <sub>2</sub>
THRUST	110,000 lb (T <sub>vac</sub> ) 489,280 N	CRUISE ENG/FUEL	RKT/LH <sub>2</sub> -LO <sub>2</sub>

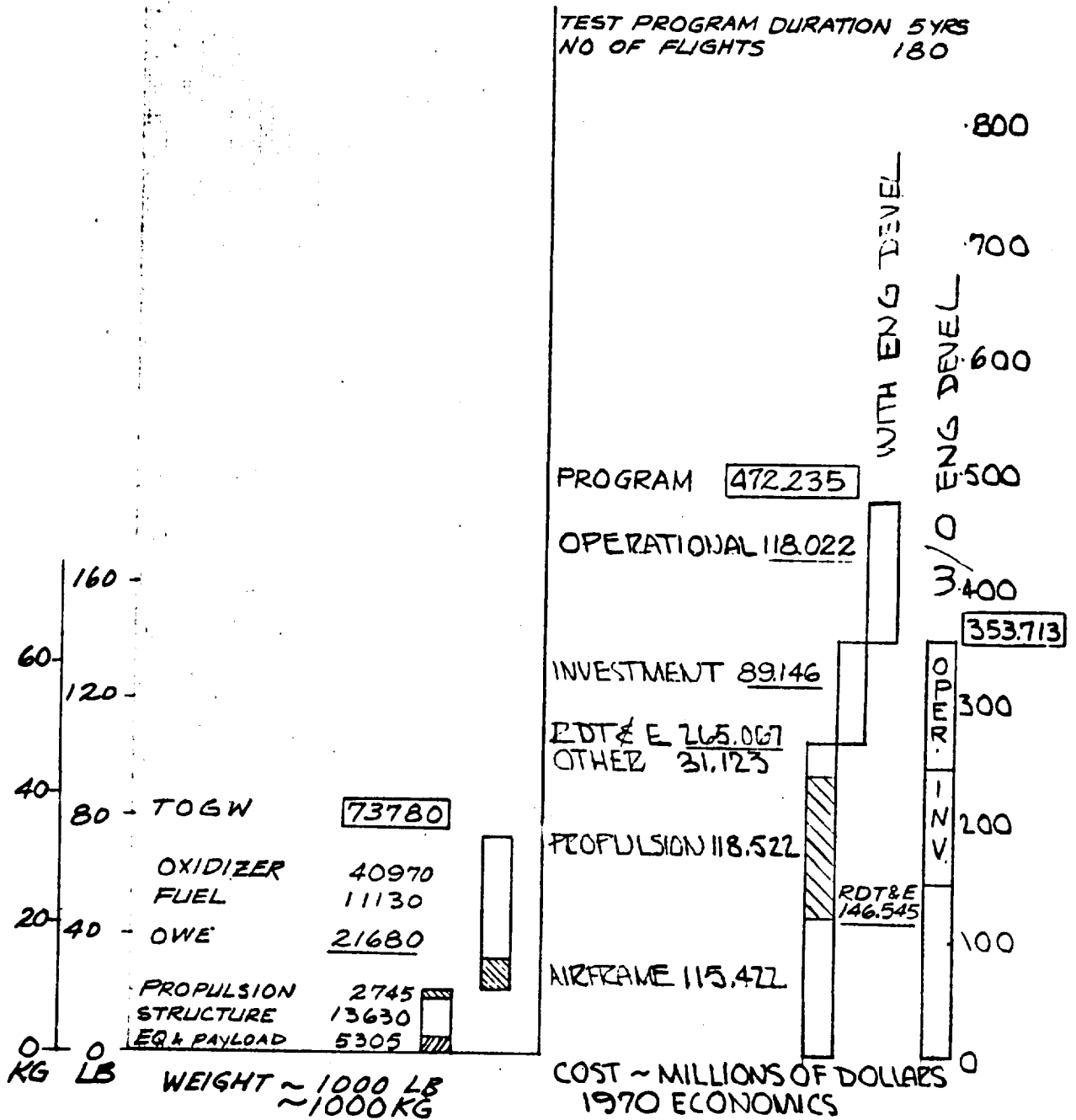

(U) FIGURE 4-175  
CONFIGURATION -285

This aircraft is a Mach 12, unmanned, horizontal takeoff vehicle. A hydrogen fueled rocket accelerates the vehicle to cruise Mach number and is then throttled to sustain stabilized cruise conditions during test data acquisition time period. Remote landing procedures are used for recovery operation.

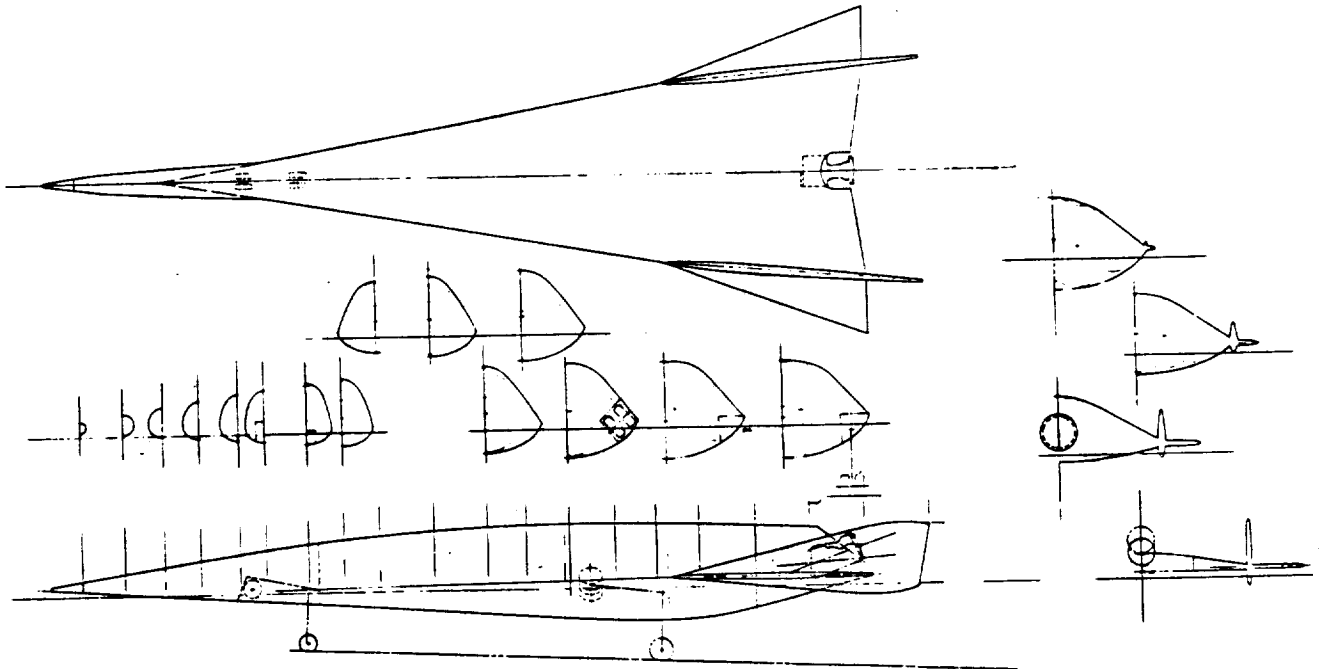

(U) FIGURE 4-176  
 COST/WEIGHT SUMMARY

MACH NO. 12.0	ALL BODY	CONFIGURATION NO. 285	
LENGTH	95.3 ft (29.0m)	LAUNCH	HTO
$S_p$	1,280 ft <sup>2</sup> (118.9m <sup>2</sup> )	CONTROL MODE	UNMANNED
THRUST	193,000 lb 858,464 N ( $T_{vac}$ )	ACCEL ENG/FUEL	RKT/LH <sub>2</sub> -LO <sub>2</sub>
THRUST	193,000 lb 858,464 N ( $T_{vac}$ )	CRUISE ENG/FUEL	RKT/LH <sub>2</sub> -LO <sub>2</sub>

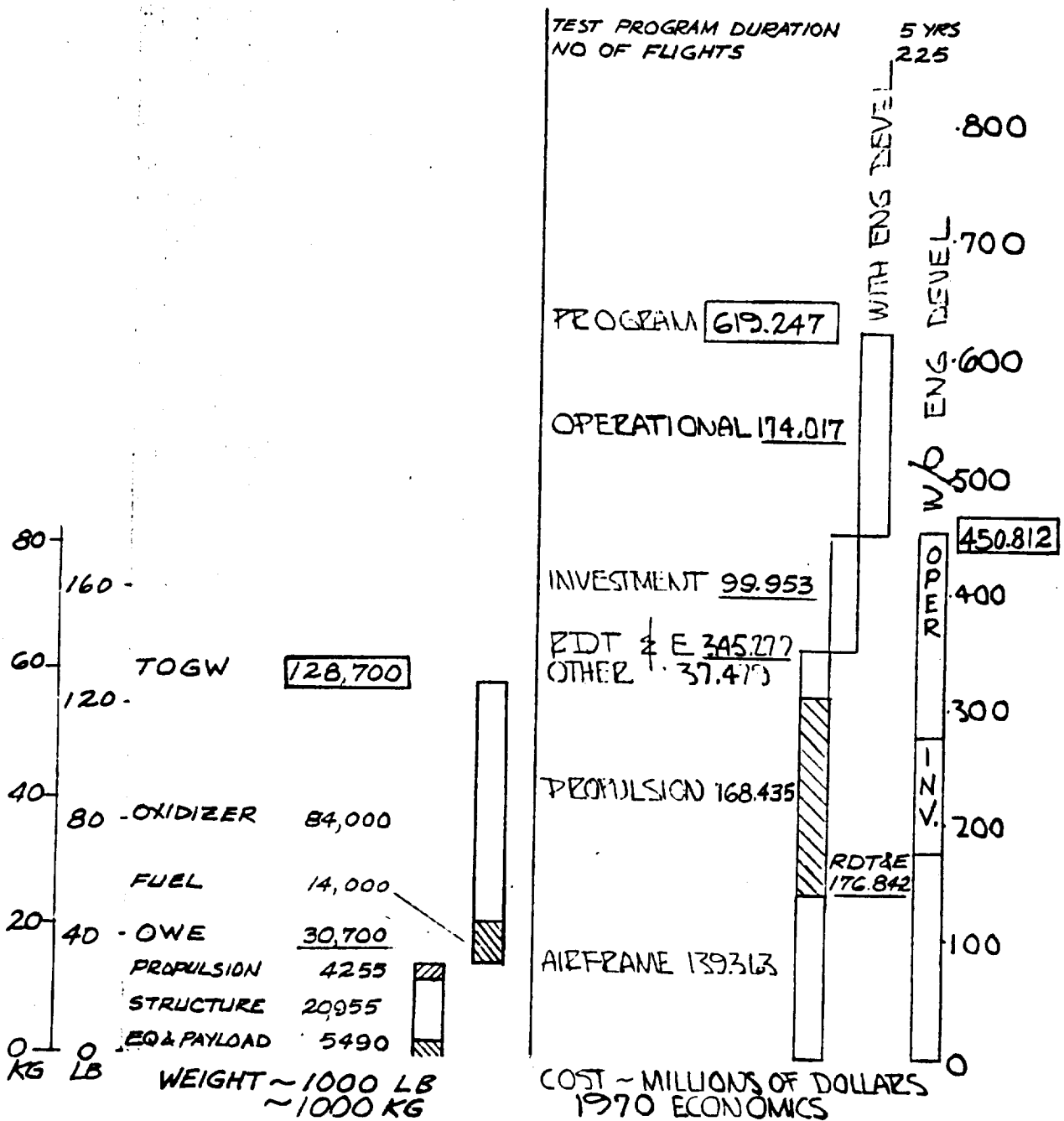

**(U) FIGURE 4-177  
CONFIGURATION -290**

This vehicle is a Mach 2.0, manned, wing body aircraft of conventional aluminum structure and off-the-shelf engines. The unique feature required by this vehicle is variable stability over the supersonic and high subsonic speed range. As a trainer, this aircraft would develop techniques for use with hypersonic aircraft during the critical low speed approach and landing phase of the flight for wing body vehicles.

Since this aircraft is considered a trainer necessary for the hypersonic flight program and of normal aluminum structure with only the stability variability as unique, no design or performance is presented in this report for this vehicle.

**CONFIGURATION -291**

This Mach .9 vehicle is a manned, all body shaped aircraft of conventional aluminum structure and off-the-shelf engine and will be another trainer in the hypersonic flight program. This aircraft will explore the subsonic handling characteristics of an all body shaped aircraft during takeoff and landing flight conditions.

As a trainer, this study recognized but did not elaborate on this phase of the flight program and no design and performance characteristics are presented.

**CONFIGURATION -292**

The logical extension of configuration -291 is to explore the transonic and low supersonic flight characteristics of the all body aircraft. This is accomplished with Configuration -292 which is a Mach 2.0, manned, all body aircraft of conventional aluminum construction and off-the-shelf engine. The aircraft would be capable of testing and exploring the characteristics of the all body shape from subsonic speeds up to Mach 2.

Again, the need of such a trainer is recognized, but no design is presented in this study for such a vehicle.

4.13.2 (U) Weights - This section is concerned with examining weight trends for the Phase I HYFAC vehicles.

(U) The majority of studies in Phase I vehicles were developed for Mach 12 vehicles. Hence, these will be discussed in detail. Fewer studies were conducted for Mach 6 vehicles while but two Mach 4.5 vehicles were performed. Results of studies on Mach 12, 6, and 4.5 vehicles, respectively, will be discussed in their order of impact upon this study.

(U) Figure 4-178 compares the group of M = 12.0 horizontal takeoff vehicles. An inspection of the figure shows two primary weight breakdowns via bar graphs. The lower left hand bar depicts operating weight empty. The upper right hand bar shows the propellant weight added to the operating weight empty and the resulting takeoff gross weight. The OWE bar has a secondary weight breakdown of structure, equipment plus payload, and propulsion system. The right hand bar shows the breakdown of the fuel and oxidizer. Each configuration illustrated on Figure 4-178 has been aerodynamically sized to complete a similar mission.

(C) All the configurations on Figure 4-178 are manned except configuration -285. A comparison between -285 and -250 shows only a small weight difference. Deleting the pilot, his seat, and cockpit is partially offset by the additional avionics required to control the aircraft. Configurations -250, -252, and -251 essentially compare body shape. The wing sweep angle is fixed for all these configurations. As the body depth is decreased from the all-body (-250) to the elliptical all-body (-252) to the wing-body, the cross-sectional area is reduced. This results in an increase in wing area to maintain propellant volume. The following is a comparison for three Mach 12 vehicles.

<u>Configuration</u>	<u>Sp (Ft<sup>2</sup>/M<sup>2</sup>)</u>	<u>(L/D) Max</u>	<u>OWE (lb/kg)</u>	<u>TOGW (lb/kg)</u>
-250 (A/B)	1289/119.75	2.90	31000/14061	130040/58984
-252 (EA/B)	1340/124.49	2.95	31700/14379	132380/60046
-251 (W/B)	1880/174.65	3.59	37840/17164	148640/67422

(U) The effect of increased L/D is shown in the growth of the aircraft. Thus, as the aerodynamic shape becomes more efficient, less propellant volume is available per given wing area which causes a growth in wing planform area to maintain constant performance.

(U) The preceding configurations used "rubberized" LR-129 rocket engines. If an "off-the-shelf" J2S rocket was used on the -250 configuration, a weight penalty will be incurred to install the heavier engine (including ballast to maintain vehicle balance). This added weight will cause a vehicle size "growth effect" requiring more propellant. Due to reduced engine performance and a lower propellant mixture ratio of the J2S an additional "growth effect" results. A comparison of these parameters is:

<u>Configuration</u>	<u>Isp</u>	<u>O/F</u>	<u>SP (Ft<sup>2</sup>/M<sup>2</sup>)</u>	<u>OWE (lb/kg)</u>	<u>TOGW (lb/kg)</u>
-250 (LR-129)	452.0	6.0/1.0	1289/119.75	31000/14061	130040/58834
-250 (J2S)	431.0	5.5/1.0	1809/168.06	59040/26780	194280/88123

(U) A breakdown of the weight increase due to the above is:

	<u>Lb</u>	<u>Kg</u>
ΔEngine Weight	1690	766.6
Ballast	420	190.5
ΔSize Growth for Above (Incl. Strength)	3390	1537.7
ΔPropellant for Above	16460	7466.3
ΔReduced Engine Performance (Vehicle Size)	6080	2757.9
ΔPropellant for Above	<u>36200</u>	<u>16420.3</u>
ΔTOGW	64240	29139.3

(C) Mach 12 Configurations -253 and -256 use storable propellants (N<sub>2</sub>O<sub>4</sub> and Aero 50). The storable propellant is more dense (76.7 lb/ft<sup>3</sup> vs 22.55 lb/ft<sup>3</sup>) (1228.7 Kg/M<sup>3</sup> vs 361.2 Kg/M<sup>3</sup>) than the cryogenic propellants. This results in smaller vehicles as shown in the following comparison:

<u>Configuration</u>	<u>Engine/Propellant</u>	<u>Sp (Ft<sup>2</sup>/M<sup>2</sup>)</u>	<u>OWE (lb/kg)</u>	<u>TOGW (lb/kg)</u>
-250 (A/B)	LR-129/Cryogenic	1289/119.75	31000/14061	130040/38984
-253 (A/B)	Mist/Storable	1100/102.19	50200/22770	314900/142835
-251 (W/B)	LR-129/Cryogenic	1880/174.65	37840/17164	148640/67422
-256 (W/B)	Mist/Storable	1318/122.44	41420/18788	248420/112681

(U) An inspection of the above vehicles size comparison indicates that the storable propellant vehicles would result in lighter structural weights. However, Figure 4-178 shows that the structure is heavier. This is due to the large increase in takeoff gross weight resulting from the less efficient propellant mixture ratio (6.0/1.0 vs 5.5/1.0) and lower I<sub>sp</sub> of the MIST rocket (452.0 vs 316.0). Figure 4-179 shows a comparison of the four vehicles that are sized for equal performance, superimposed with the vehicle sizing propellant volume trend vs the wing planform area. The structural weight increase for the storable propellant vehicles is primarily in the landing gear (and back-up structure) and structure affected by maneuver loads (rotating tips, vertical tails, etc.). It should be noted that the W/B (wing body) has less weight growth (-251 vs -256) than the A/B (all body) (-250 vs -253). This is due to the difference in volumetric efficiency as indicated on Figure 4-179.

(U) Configurations -254 and -255 use a rocket for the boost mode and a convertible scramjet for the cruise mode. The all body configuration shows only a modest weight change (-250 vs -254). The weight increase is primarily in the

(U) FIGURE 4-178  
HORIZONTAL TAKEOFF M = 12.0 MANNED CONFIGURATIONS

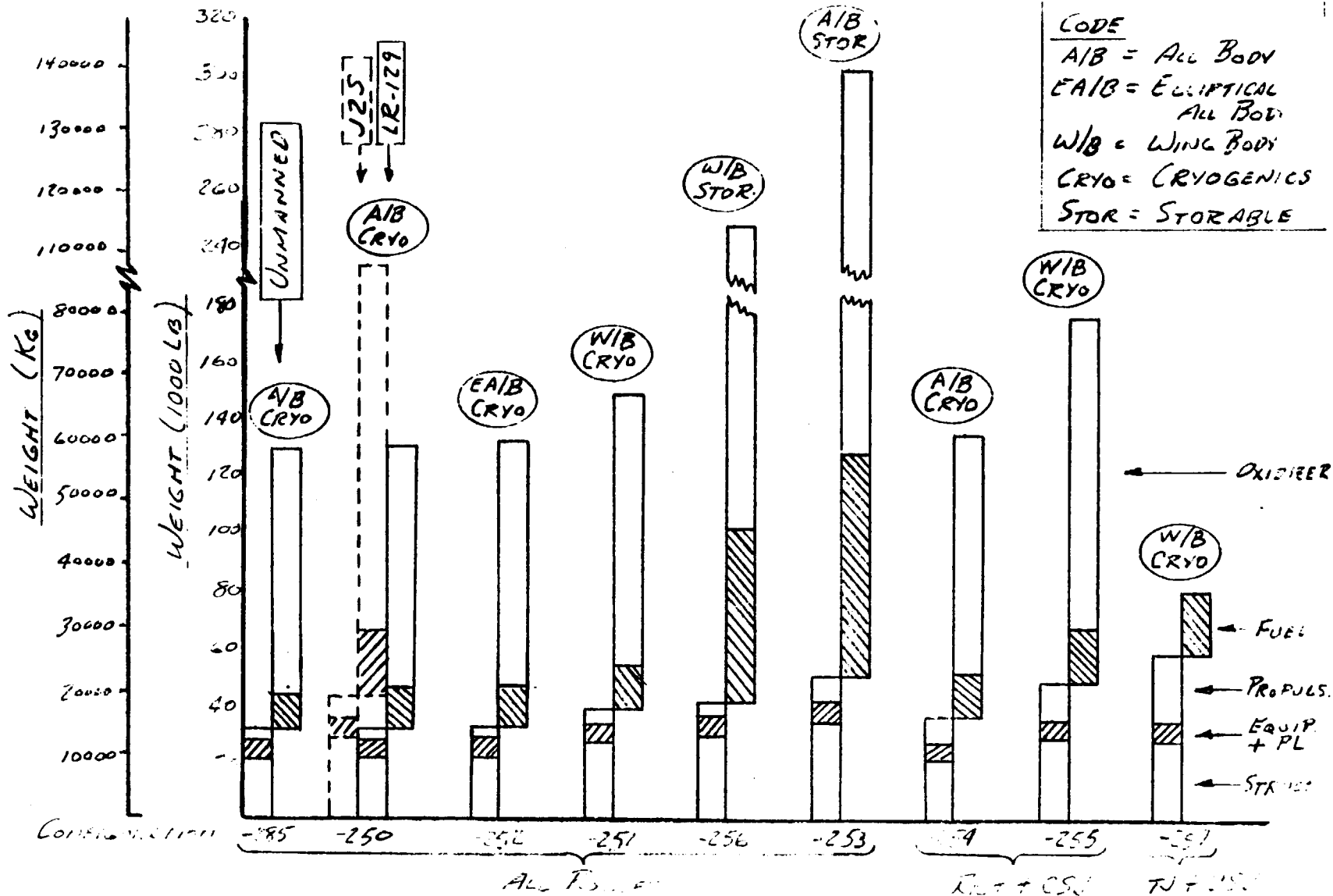

McDONNELL AIRCRAFT  
4-275

CONFIDENTIAL



(C) FIGURE 4-179  
PROPELLANT VOLUME vs WING PLANFORM AREA TRENDS

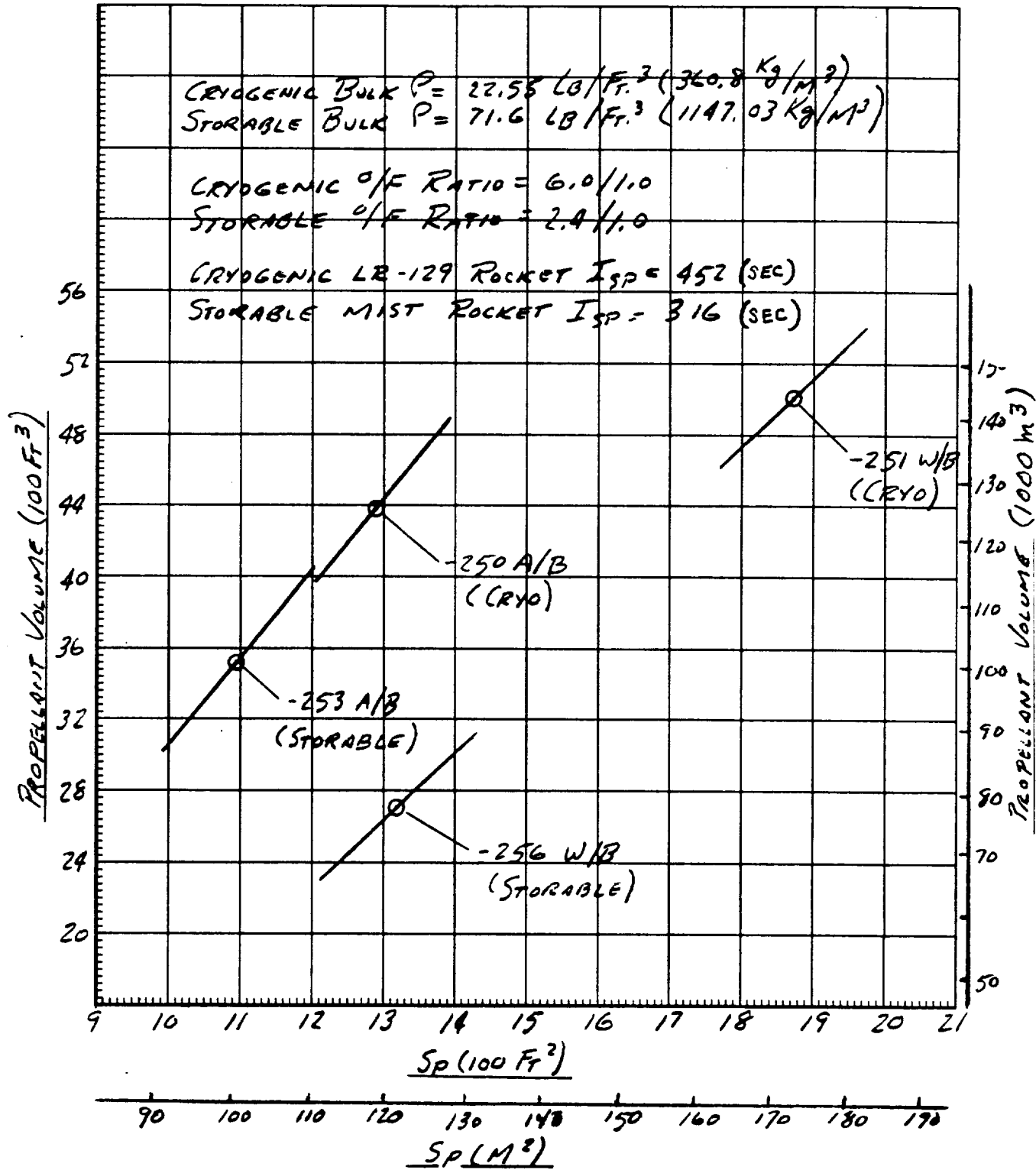

propulsion group, due to adding the convertible scramjet. The -254 configuration is a somewhat larger vehicle ( $Sp = 1328 \text{ ft}^2/123.38 \text{ M}^2$ ) than the -250 configuration ( $1289 \text{ ft}^2/119.75 \text{ M}^2$ ). However, the higher cruise  $I_{sp}$  of the convertible scramjet (1650 vs 452) partially offsets the propulsion/structural weight increase. The wing body configuration (-251 vs -255) does not integrate as well with the convertible scramjet ( $L/D_{max} = 3.59$  vs  $L/D_{max} = 3.44$ ) and results in a somewhat larger weight change. This is due to a larger increase in wing planform area ( $Sp = 1880 \text{ ft}^2$  vs  $Sp = 2190 \text{ ft}^2$ ) ( $Sp = 174.65 \text{ M}^2$  vs  $203.45 \text{ M}^2$ ).

(U) The final configuration on Figure 4-178 is an all airbreather and has the lightest takeoff gross weight. It is the largest vehicle ( $Sp = 2000 \text{ ft}^2$   $185.9 \text{ M}^2$ ) with the heaviest propulsion system resulting in the largest operating weight empty. The propulsion system weight is due to a heavy engine plus an inlet system with some additional engine cavity penalty due to burying the engine in the body.

(U) Two additional comments may be made on Figure 4-178. The fallacy of using structural mass fraction ( $WS/W_{TOGW}$ ) comparison is indicated. Configuration -253 has the lowest structural fraction but highest gross weight. Configuration -251 has the highest structural fraction but lowest gross weight. The -250/-250 J2S configurations have equal structural efficiency but the structural fractions vary significantly. The second comment is the fallacy of comparing vehicles at equal takeoff gross weight or equal wing planform area. From the preceding comments, it is reasonable to conclude that vehicles should be compared on a constant mission basis. This is especially true where total system cost is used as an evaluation tool.

(U) Figure 4-180 compares the  $M = 6.0$  horizontal takeoff vehicles to air launched vehicles in a similar manner as the  $M = 12.0$  vehicles compared on Figure 4-175. All vehicles are sized for the same mission except the X-15, which is shown as a relative comparison. Due to the high transonic drag, configurations -211 and -206 would not meet the mission. These vehicles were performed on the same flight trajectory as configurations -210 and -204. Additional work to seek a suitable trajectory will be performed at a future date. Generally speaking, the same comments made on Figure 4-178 apply to Figure 4-180, except the  $M = 6.0$  vehicles are smaller in size.

(U) Figure 4-181 compares  $M = 12.0$  vertical takeoff and air launched vehicles. These vehicles meet the same performance criteria as the  $M = 12$  horizontal takeoff vehicles compared on Figure 4-178. The difference in weight is essentially due to the difference in vehicle size. To illustrate:

<u>Configuration</u>	<u>Sp (Ft<sup>2</sup>/M<sup>2</sup>)</u>	<u>OWE (lb/kg)</u>	<u>TOGW (lb/kg)</u>
-250 (HTO)	1289/119.75	31000/14061	130040/58984
-270 (VTO)	1405/13052	31600/14333	144500/65544
-233 (AIR)	892/82.87	21980/9970	74780/33919

The different flight trajectory results in the difference in size of the -250 and -270 configurations. The staging effect of using an air carrier (B-52/C-5)

(U) FIGURE 4-180  
M = 6.0 MANNED CONFIGURATIONS

CODE  
A/B = ALL BODY  
W/B = WING BODY  
CRYO = CRYOGENICS

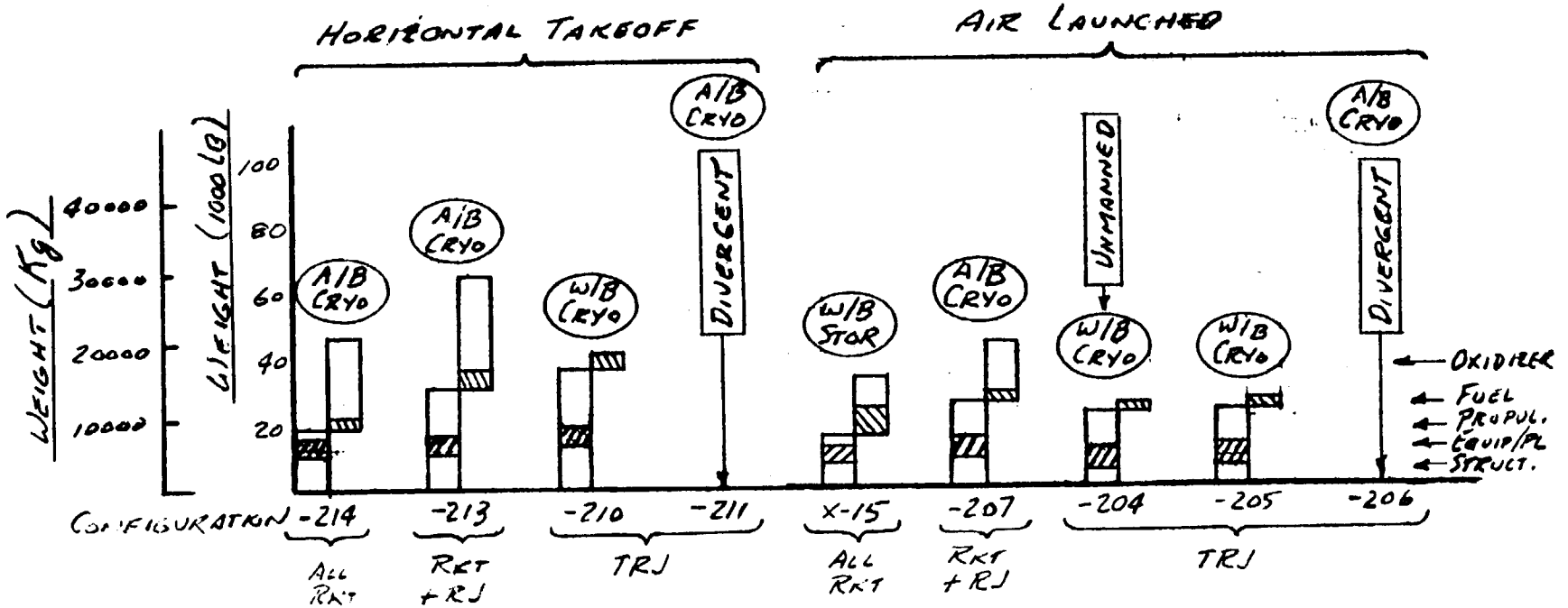

(U) FIGURE 4-181

M = 12.0 MANNED VERTICAL TAKEOFF/AIR LAUNCHED CONFIGURATIONS

**CODE**  
 A/B = ALL BODY  
 W/B = WING BODY  
 CRYO = CRYOGENICS

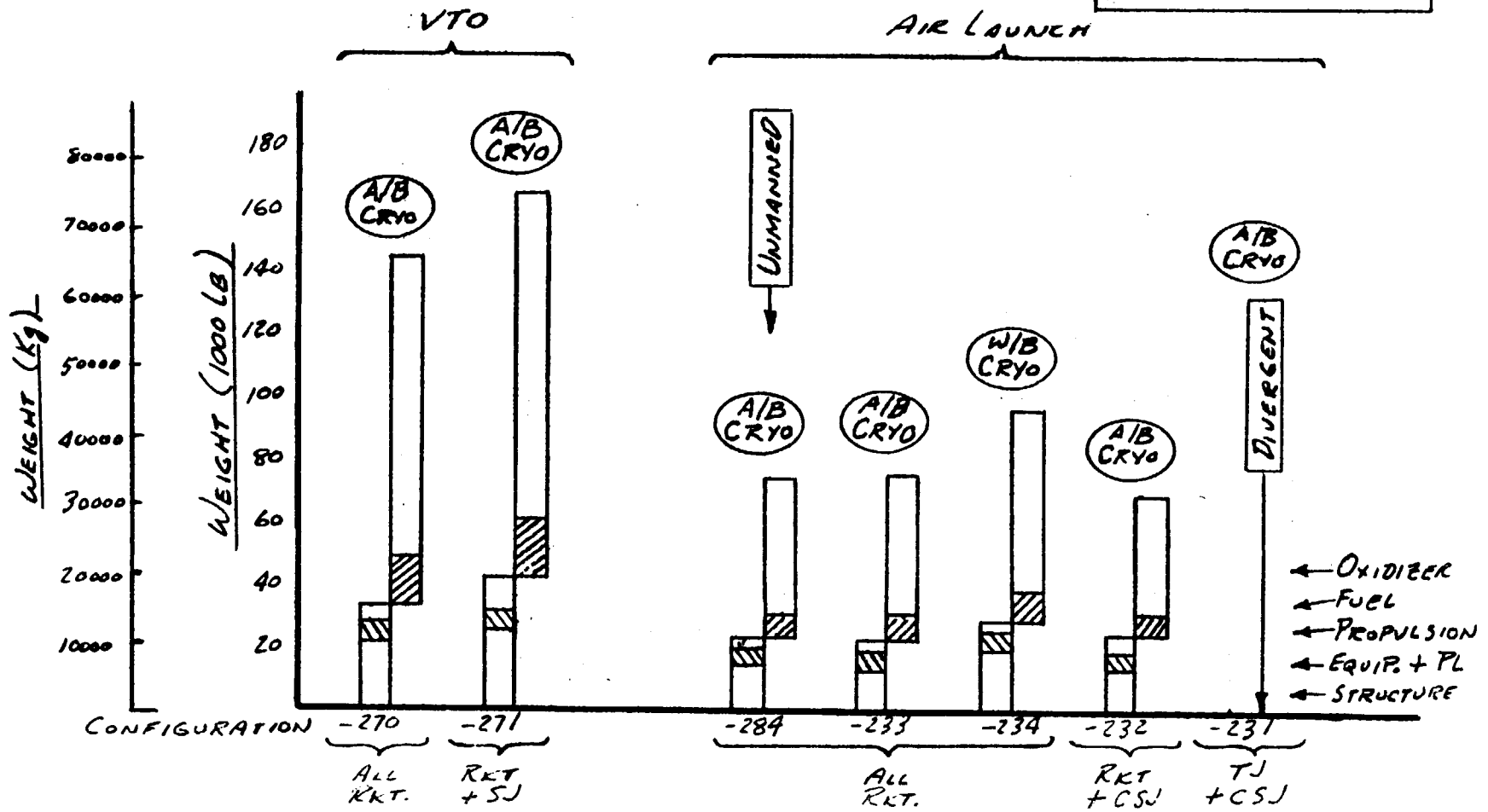

reduces the size of the -233 configuration (-250 vs -233). The structural concepts are the same for the vehicles illustrated on Figures 4-178 and 4-181 except for the landing gear. The horizontal takeoff vehicles (Figure 4-178) are weighed with conventional wheels/tires and brakes and are designed for takeoff gross weight loads. The vertical takeoff and air launched vehicles (Figure 4-181) use conventional nose wheels, but have skids (X-15 type) for the main gear and are designed to sink speeds at landing weights. This simpler landing system is significantly lighter.

(U) Figure 4-182 compares the weight of the staged unmanned configurations for both  $M = 6.0$  and  $M = 12.0$ . Weight of the pilot and provisions has been deleted and additional electronic weight was added. Weight for a ring sail parachute system was included in each configuration. An oleo type shock strut with skids is used. To minimize the parachute system size and weight the design sink speed has been increased from 20 fps (6.11 m/sec) to 30 fps (9.17 m/sec.) Local strengthening for booster loads is included, but the booster adapter is not included in the vehicle weight. No attempt was made to ascertain the strength capability of the booster to carry a winged body. It is strongly recommended that if the VTO (staged) vehicles become contenders in Phase II that the possibility of booster strengthening be investigated. The vehicles compared on Figure 4-182 are sized to the same cruise mission as the preceding configurations.

(U) Figure 4-183 shows the M-4.5 configurations which were analyzed. Based upon previous studies the GE 14/JZ8 turboramjet (47.25%) engine was the most feasible, Mach 4.5 engine. Weight of all-body configuration was found to be divergent. The high drag of this configuration required more fuel which increased the weight to such an extent that the vehicle could not meet the required performance. The wing-body configuration, with a LH<sub>2</sub> fueled GE 14/JZ8 turboramjet (47.25%), did perform the mission. However, minimizing the wing loading at cruise while maintaining the required thrust loading for acceleration, resulted in a wing planform of 468 ft<sup>2</sup> (43.48 M<sup>2</sup>). Fuel requirements were small, due to the higher Isp of 1370 sec and L/D<sub>max</sub> of 5.0. The weight shown in Figure 4-183 is for an off-loaded fuel condition to provide 5 minutes of cruise time. However, at this planform wing area sufficient fuel volume is available for 33 minutes cruise time.

(U) Figure 4-184 illustrates the  $M = 12.0$  horizontal launch vehicles operating weight empty compared to wing planform area. The weight trend slopes are superimposed on the vehicle weight. The -253 configuration exhibits the steepest slope. This is due to its high volumetric efficiency and dense fuel. The -251 and -257 slopes are the shallowest slopes. This shows that the poor volumetric efficiency of the wing-body shape increases wing planform area at a faster rate to enclose the necessary propellant volume. The -256 configuration (remaining wing body on the illustration) takes advantage of the poor volumetric efficiency with the dense (storable propellant). The all body shapes have similar slopes.

(U) Figure 4-185 compares the takeoff gross weight vs the wing planform area superimposed with the weight trend slopes of the  $M = 12.0$  horizontal takeoff configurations. Inspection of the figure shows that the -257 configuration has the

(U) FIGURE 4-182  
 UNMANNED VERTICAL TAKEOFF (STAGED) CONFIGURATIONS

CODE  
 A/B = ALL BODY  
 EA/B = ELLIPTICAL ALL BODY  
 CRYO = CRYOGENICS  
 STOR = STORABLE

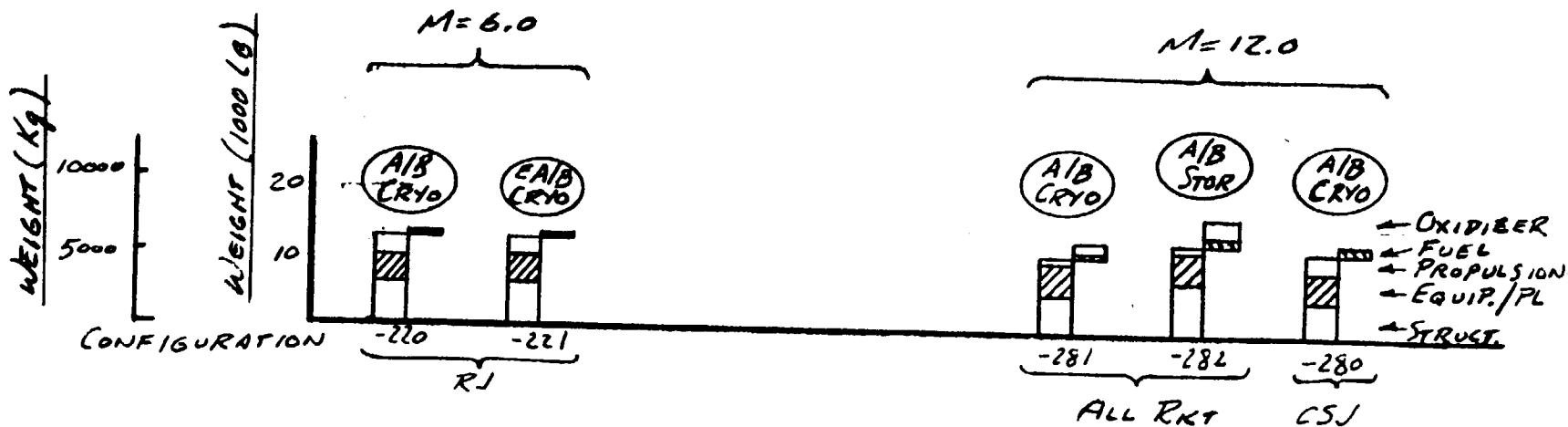

(U) FIGURE 4-183

M = 4.5 MANNED HORIZONTAL TAKEOFF CONFIGURATION

CODE	
W/B	= WING BODY
A/B	= ALL BODY
STOR	= STORABLE

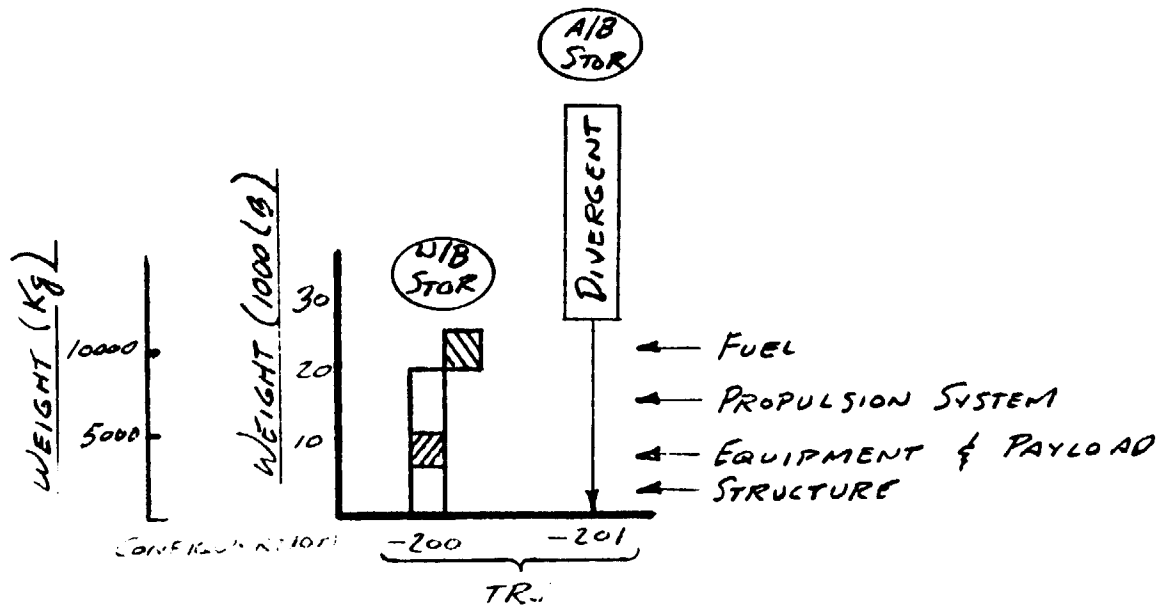

(U) FIGURE 4-184

M = 12.0 GROUND LAUNCHED VEHICLES O.W.E. vs SP

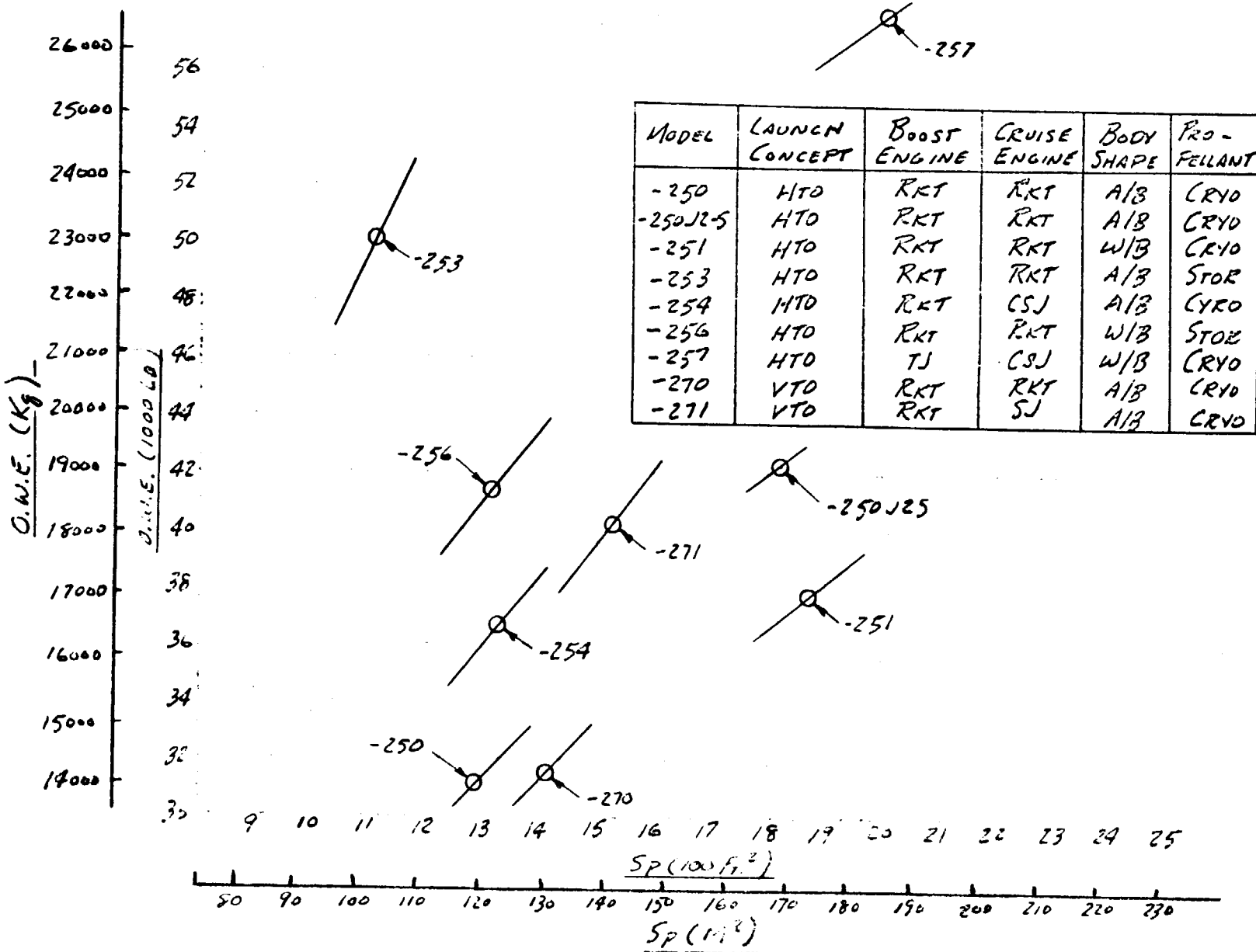

4-283  
MCDONNELL AIRCRAFT



(U) FIGURE 4-185  
M = 12.0 GROUND LAUNCHED VEHICLES TOGW vs SP

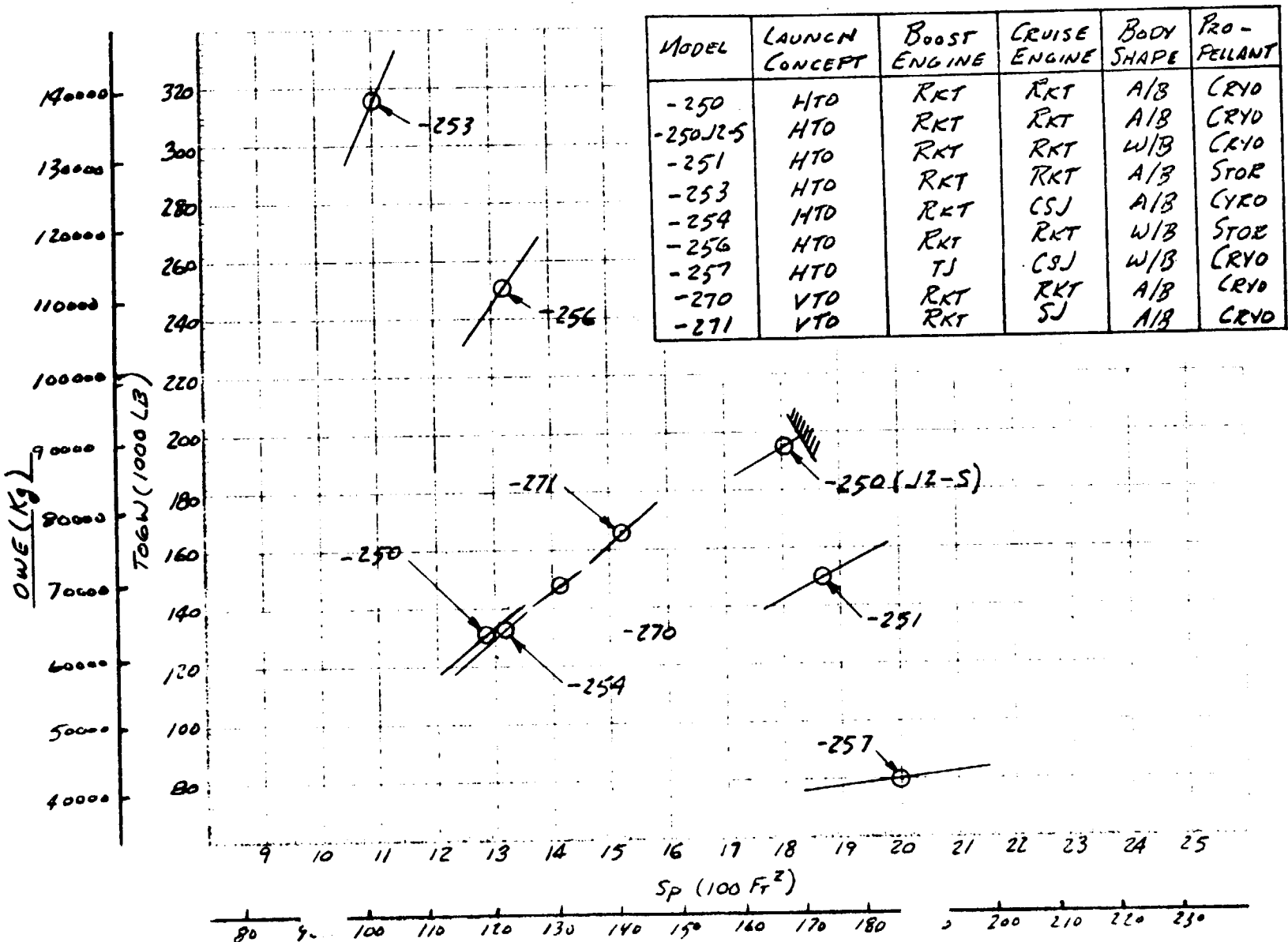

MCDONNELL AIRCRAFT  
4-284

lightest gross weight and the most shallow weight trend slope. This configuration is an all airbreather and does not require an oxidizer. The low density LH<sub>2</sub> (4.42 lb/ft<sup>3</sup>/70.81 Kg/M<sup>3</sup>) imposes a high volume requirement. However, the -257 wing body configuration has a low volumetric efficiency. Coupled together these requirements make the wing planform area a sensitive parameter. The -253 configuration uses a storable propellant (N<sub>2</sub>O<sub>4</sub>/Aero 50) with a high bulk density (76.7 lb/ft<sup>3</sup>) (1227.13 Kg/M<sup>3</sup>). The -253 configuration utilizes an all body shape with a high volumetric efficiency. Therefore, the -253 configuration exhibits a steeper slope, less sensitive to wing planform area change. The large differences in takeoff gross weight between -253 and -257 were discussed earlier. An examination of the weight trend slope of the -256 configuration shows the influence of the dense storable propellant packaged in the more efficient wing body shape (-253 vs -256). The -251 configuration has a shallow slope due to the relatively low volumetric efficiency of its wing body shape. The slope of the -250 J2S configuration tends to become more shallow than the -250 configuration. This is due to the fixed engine weight of the J2S configuration. It should be emphasized that the -250 J2S configuration with the current ground rules cannot tolerate a weight increase to maintain the current mission. As discussed previously, a relatively small weight increase in dead weight will result in a large increase in takeoff gross weight due to the fixed thrust of the J2S. The trend data for the remaining configurations is similar to those previously discussed and a further discussion would be repetitious. Discussions on weight estimation methodology are presented in Section 4.11.

(U) The M = 4.5 and M = 6.5 configurations have been weighed with a passive insulation heat protection system. The M = 12.0 configurations were weighed with an active cooled (water wick) heat protection system. A tradeoff study was performed on the -250 configuration to substitute a passive insulation system. Two concepts were studied and are discussed in the thermodynamic Section 4.6. The first concept used thick, low density insulation (to minimize insulation weight); but resulted in a significant loss in propellant volume. The second concept used less efficient, higher density insulation, but resulted in a propellant volume loss which was but 30% of that of the first concept. Figures 4-186 and 4-187 illustrate the change in operating weight empty and propellant volume for the two passive insulation concepts as compared to the active cooled concept.

(U) Figure 4-186 illustrates that for a given planform area the active system results in the lowest operating weight empty of the three systems studied. Of the two passive concepts the minimum thickness concept, which results in minimum fuel volume lost, has the heavier OWE for a given wing planform area. An examination of Figure 4-187 shows that the two passive concepts have less propellant volume per given planform area than the active concept. This results in an increase in wing planform area to maintain the original propellant volume required for the pressure cooled (-250) configuration. The increased wing planform area adds weight and requires additional propellant at a reduced volumetric efficiency. The following is a comparison for thermal protection concepts for the 250 aircraft.

<u>Concept</u>	<u>OWE (lb/kg)</u>	<u>TOGW (lb/kg)</u>
Active Cooled (Water Wick)	31000/14061	130040/58984
Passive Insulation (Minimum Insulation Weight)	40100/18190	167800/76114
Passive Insulation (Minimum Volume Loss)	41250/18711	174250/79040

(U) FIGURE 4-186  
 ACTIVE vs PASSIVE COOLING SYSTEMS CONCEPT COMPARISON  
 OPERATING WEIGHT EMPTY vs WING PLANFORM AREA

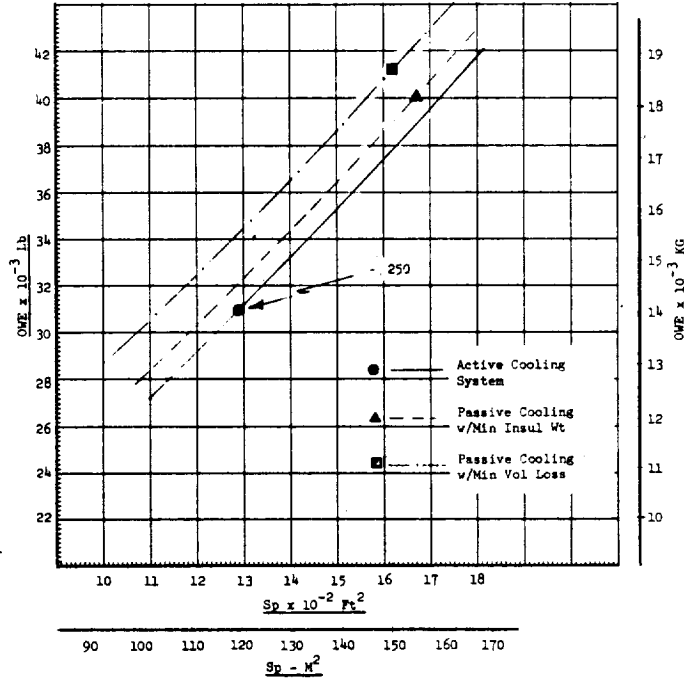

(U) FIGURE 4-187  
 ACTIVE vs PASSIVE COOLING SYSTEMS CONCEPTS COMPARISON  
 PROPELLANT VOLUME vs WING PLANFORM AREA

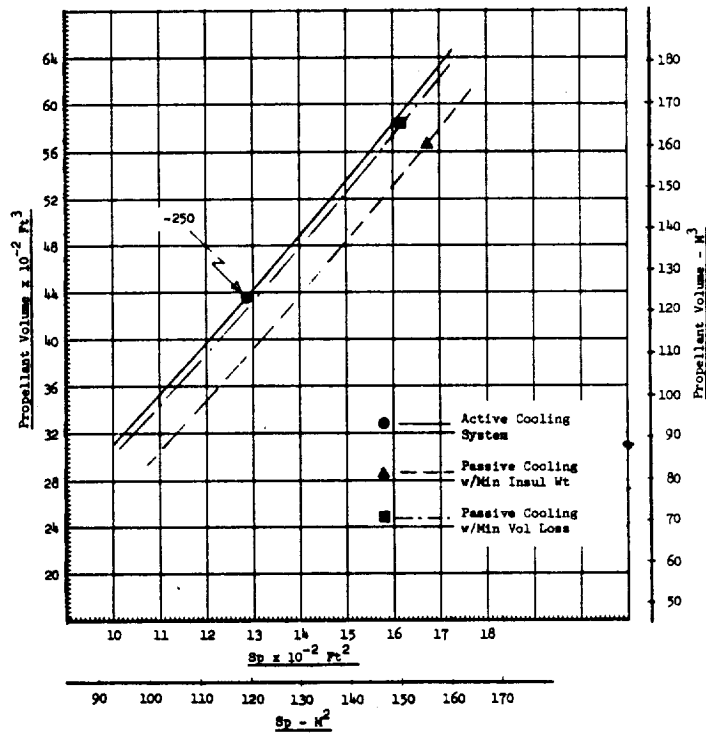

4.13.3 (U) Total System Cost Summary - Total system program costs are shown in Figure 4-188 for the 32 configurations costed in the Phase I study. Twenty-eight of the configurations were estimated in accordance with the cost format presented in Figure 4-119 of Volume II, while the remaining four configurations (290, 291, 292 and 256 H1D) were estimated in total using available cost data for the HL-10, X-24, F-106X and HYFAC configuration 256 and adjusted to reflect changes in size, shape and systems requirements.

(U) Total systems costs presented in Figure 4-188 are separated into the three basic categories of costs: namely, (1) RDT&E, (2) investment and (3) operating.

(U) The flight research programs for configurations 290, 291 and 292 were assumed to be 2 years in duration and the number of flights were assumed to be 180. The flight research program for configuration 265 H1D was assumed to be 5 years in duration and the number of flights were assumed to be 225.

(U) The HTO (horizontal takeoff) configurations were allocated 15 flights per year per vehicle, while the air launched and VTO (vertical takeoff) configurations were allocated 12 flights per year per vehicle. The staged VTO vehicles were allocated 4 flights per year for 3 vehicles. The test program life for all flight vehicle configurations is 5 years with the exception of the boost VTO configurations, which were allocated a two-year test program life. The ASSET and PRIME programs were used as a basis for developing the flight frequency and test program duration for the staged VTO configurations.

**(U) FIGURE 4-188**  
**TOTAL SYSTEM COST SUMMARY**  
(MILLIONS OF DOLLARS)  
(1970 ECONOMICS)

COST CATEGORIES	CONFIGURATION NOS. ②													
	200	204	205	207	210	213	214	220	221	232	233	234	250	251
RDT&E (W/PROP.)	357.883	496.489	504.410	369.945	700.473	417.460	191.603	257.998	259.402	581.605	272.456	301.250	345.762	379.282
INVESTMENT	215.477	158.439	169.315	100.868	223.362	109.349	63.592	43.403	44.066	105.685	94.224	118.764	103.784	118.217
OPERATING ①	90.690	124.968	129.605	102.660	198.676	136.563	93.226	8.638	8.675	121.741	117.286	144.210	171.331	193.962
TOTAL W/PROP.	574.050	779.896	803.330	573.473	1122.511	663.372	348.421	310.040	312.143	809.031	483.966	564.224	620.877	691.461

COST CATEGORIES	CONFIGURATION NOS. ②													
	252	253	254	255	256	257	270	271	280	281	282	284	285	250-J2 S
RDT&E (W/PROP.)	343.784	287.103	671.247	726.651	355.440	539.450	360.166	712.942	417.010	123.202	161.918	265.067	345.277	217.384
INVESTMENT	107.423	120.196	132.033	147.281	95.373	132.738	128.221	164.509	59.147	51.512	50.745	89.146	99.953	131.127
OPERATING ①	177.250	228.249	190.994	203.644	184.093	229.945	146.604	167.511	9.729	9.545	9.641	118.022	174.017	207.473
TOTAL W/PROP.	628.457	735.548	994.274	1077.576	634.906	902.133	634.991	1044.692	485.886	184.259	222.304	472.235	619.247	555.984

① 2 year program for configurations 220, 221, 280, 281, and 282; 5 year program for remaining 23 configurations.

② Total system costs for configuration nos. 256 HID, 290, 291 and 292 areas follow: 660 M̄, 30 M̄, 50 and 75 M̄ dollars respectively.

## 5. FLIGHT RESEARCH VEHICLE SCREENING AND SELECTION

(U) The flight research facility concepts which were studied during Phase I are summarized in Figure 5-1. Concepts were chosen so as to provide a broad data base on the design and operational options available for a research vehicle. Particular options studied were:

- o Maximum Design Speed
- o Flight Control - Manned and Unmanned
- o Vehicle Configurations (Shape)
- o Launch Modes
- o Propulsion Systems
- o Propellant Type

(U) The candidate flight research aircraft provide the capability to duplicate steady state flight environmental conditions for the potential operational systems as illustrated in Figure 5-2. In addition, the transient environment for a typical Space Shuttle vehicle can be partially duplicated within an alternate (transient) flight envelope.

(U) The HYFAC flight research aircraft being studied will provide a significant extension of technology as compared to previous flight research vehicles. This is illustrated in Figure 5-3 by the comparison of flight environments. It is seen that the flight environment up to approximately Mach 6 is not more severe than the X-15. However, the HYFAC aircraft in this regime provide the capability to explore airbreathing propulsion systems, a capability which was not used on the X-15.

(U) The design and cost synthesis process discussed in Section 4 provided configuration design, weight and cost data. The research requirements analysis presented in Section 3 provided research value data. These data were used in comparing and evaluating the candidate flight vehicles. The following sections present the comparisons and evaluation of these flight vehicles along with selection of the most attractive vehicles and recommendations for the Phase II parametric studies.

(U) FIGURE 5-1  
 FLIGHT RESEARCH FACILITY CONCEPTS

MANNED					
Design mach	Launch mode	Propulsion type	Fuel	Configuration	
				Wing Body	All Body
.9	HTO	TJ	JP		-291
2.0	HTO	TJ	JP	-290(VST)	-292
4.5	HTO	TRJ	JP	-200	-201
6+	AIR	TRJ RKT/RJ	LH <sub>2</sub> LH <sub>2</sub>	-205	-206 -207
	HTO	TRJ TJ/RJ RKT/RJ RKT	LH <sub>2</sub> LH <sub>2</sub> LH <sub>2</sub> LH <sub>2</sub>	-210 -212	-211 -213 -214
12	AIR	TJ/CSJ RKT/CSJ RKT	LH <sub>2</sub> LH <sub>2</sub> LH <sub>2</sub>	-234	-231 -232 -233
	HTO	RKT RKT RKT RKT/CSJ TJ/CSJ	LH <sub>2</sub> AERO 50 RP LH <sub>2</sub> LH <sub>2</sub>	-251 -256 -256H1D -255 -257	-250,-252,250(J2S) -253 -254
	VTO	RKT RKT/CSJ	LH <sub>2</sub> LH <sub>2</sub>		-270 -271
UNMANNED					
6+	STAGED AIR	RH TRJ	LH <sub>2</sub> LH <sub>2</sub>	-204	-220,-221
12	STAGED	CSJ RKT RKT	LH <sub>2</sub> LH <sub>2</sub> AERO 50		-280 -281 -282
	AIR HTO	RKT RKT	LH <sub>2</sub> LH <sub>2</sub>		-284 -285

(C) FIGURE 5-2  
FLIGHT ENVELOPE COMPARISON  
HYFAC Research Vehicles – Potential Operational Systems

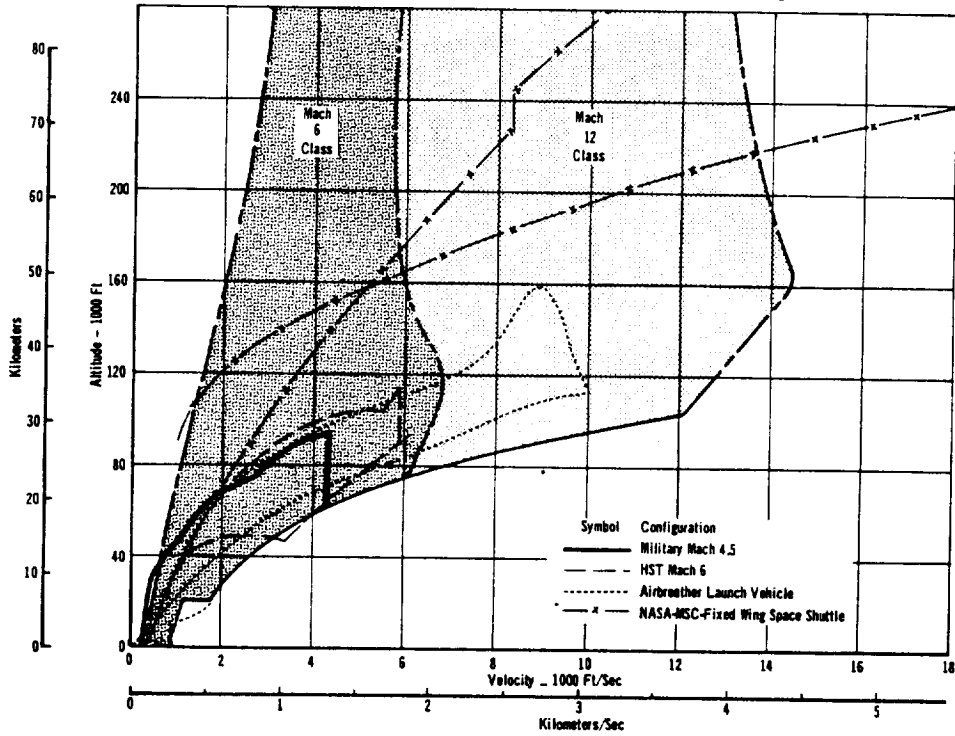

(U) FIGURE 5-3  
FLIGHT ENVELOPE COMPARISON  
HYFAC Research Vehicles – Previous Research Vehicles

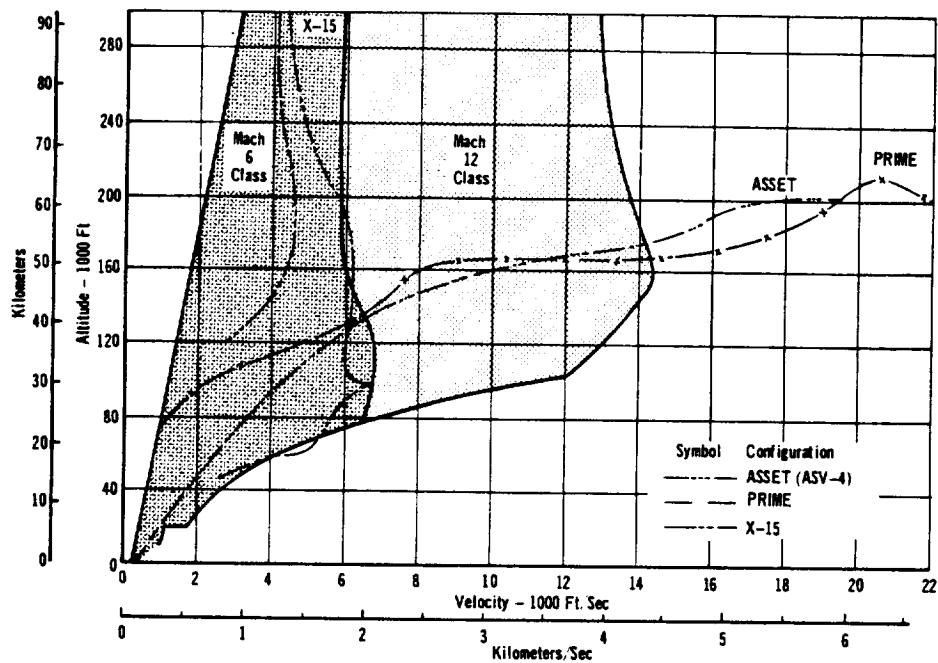



This Page Unclassified

## 5.1 VEHICLE EVALUATION AND SCREENING

(U) In order to objectively screen the thirty-seven (37) vehicle concepts studied in Phase I a consistent systematic process was needed. It was judged that a process wherein two configurations at a time were compared, preferably with only a single design or operational parameter being varied, and a choice was then made of one of the configurations (go-no-go) would provide the desired consistency. This approach was used and resulted in the elimination of twenty-three (23) configurations. In seven (7) cases such direct comparisons were not available and a more general evaluation was employed, wherein a large number of variables were considered in making the evaluation.

(U) While much quantified data was available from the synthesis process, it was recognized that due to the preliminary nature of these data it would be advisable to also include a subjective engineering judgement evaluation in the screening process. In applying any subjective evaluation one must be careful not to replace sound engineering judgement with a predetermined biased judgement. This is an alternative one must accept and such judgements form an essential element of many engineering analyses. A four level screening process was employed wherein comparisons of vehicles were made within three speed classes, namely Mach 0.9 to 2, Mach 4.5 to 6 and Mach 12, in consideration of the following:

(1) Mission Performance - A number of the configurations employing turbojet engines for initial acceleration did not meet the mission requirements when analyzed using the same performance ground rules and comparably sized vehicles as other competitive vehicles. It was apparent that increasing the vehicle size as well as modifying the performance ground rules (such as engine thrust to weight ratio) would result in these vehicles being substantially bigger and more costly than those compared. Thus, further analysis was not continued and size, weight and costs for these vehicles were not determined. Five (5) configurations were eliminated on this basis.

(2) Vehicle Cost for fixed mission performance as defined by design cruise speed and test time, wherein the research value was lower at either the same or higher cost, or the research value was the same at higher cost. Eleven (11) configurations were eliminated on this basis.

(3) Research value and cost for fixed mission performance as defined by design cruise speed and test time, wherein both research value and cost increased or both research value and cost decreased which required basing the choice on the amount of research accomplished for the cost involved in accomplishing the research. Seven (7) configurations were eliminated on this basis.

(4) Research Potential - The research value and cost, and a subjective evaluation of the vehicle versatility, growth potential and development confidence, were considered, thus defining the ability of the vehicle to provide research information of a broad nature, particularly in areas of interest to NASA. Seven (7) configurations were eliminated on this basis.

(U) Figure 5-4 summarizes the research value and program cost for each of the flight research aircraft concepts studied. Maximum and minimum research values are shown along with the applicable potential operational system. This variation in research value reflects the configurational and operational differences between the flight research aircraft and the various study potential operational systems. The more nearly the flight research aircraft simulates the size, shape, structural concept, propulsion system and operational approach of the potential operational system, the higher the research value and vice versa. It should be recognized that the intrinsic research values developed in this study do not represent absolute values, but are a valid representation of relative value. As previously discussed in Section 4.9, five of the configurations did not meet the mission performance. Therefore, the characteristics of these configurations (i.e., 201, 206, 211, 212 and 231) are not shown in Figure 5-4.

(U) The subjective evaluation of the vehicle versatility, adaptability and design confidence, along with costs and research value are presented in tabular form in Figure 5-5.

(U) It is very important to keep in mind that the trends and conclusions drawn as a result of the following comparison are valid for the problem being studied and may not be valid for other applications. Specifically, i.e., the results are valid for flight research aircraft designed under the ground rules stated in this section. For different ground rules, or different operational missions the results may be significantly different.

(U) Two fundamental issues of importance for the research vehicle are the maximum design speed and the type of propulsion system used. These issues have a major impact on the program cost and research value. Thus, the screening process in Phase I was not intended to converge on a given speed class or propulsion system, but rather to narrow down the numerous candidates within the categories to those which appeared most attractive.

(U) The evaluation and selection of the attractive facilities and a comparison of the effect of design and operational concepts on the vehicle capability are presented in the following sections.

(U) FIGURE 5-4  
 PERFORMANCE COMPARISON  
 FLIGHT RESEARCH VEHICLES

Configuration	Design Mach Number	Launch Concept	Type of Configuration	Propulsion System			Sp (Sq Ft)	Body Length (Ft)	OWE (Lb)	TOGW (Lb)	Program Cost (\$ x 10 <sup>-6</sup> )	Research Value			
				Accelerate and Climb	Cruise	Fuel						Maximum Value	Associated Operational System	Minimum Value	Associated Operational System
-200	4.5	HTO	WB	TRJ	TRJ	STOR	468	56.3	19,922	25,503	574	1505	M1	1065	M2
-201	4.5	HTO	AB	TRJ	TRJ	STOR	-	-	-	-	-	-	-	-	-
-204	6.0	AIR	WB	TRJ	TRJ	CRY	605	55.6	22,400	25,079	780	1637	C1	1163	M2
-205	6.0	AIR	WB	TRJ	TRJ	CRY	615	56.4	23,000	25,740	803	1891	C1	1391	M2
-206	6.0	AIR	AB	TRJ	TRJ	CRY	-	-	-	-	-	-	-	-	-
-207	6.0	AIR	AB	RKT	RJ	CRY	520	62.2	24,800	43,000	573	1769	C1	1385	M1
-210	6.0	HTO	WB	TRJ	TRJ	CRY	895	68.9	36,450	41,450	1123	1960	C1	1458	M2
-211	6.0	HTO	AB	TRJ	TRJ	CRY	-	-	-	-	-	-	-	-	-
-212	6.0	HTO	AB	TJ	RJ	CRY	-	-	-	-	-	-	-	-	-
-213	6.0	HTO	AB	RKT	RJ	CRY	725	72.2	30,300	64,860	663	1870	C1	1439	M1
-214	6.0	HTO	AB	RKT	RKT	CRY	630	67.0	18,500	45,850	348	1607	C1	1321	M1
-220	6.0	Staged VTO	AB	RKT	RJ	CRY	167	33.8	12,800	13,230	310	1443	C1	1052	M1
-221	6.0	Staged VTO	EAB	RKT	RJ	CRY	174	34.5	13,090	13,530	312	1443	C1	1052	M1
-231	12.0	AIR	AB	TJ	CSJ	CRY	-	-	-	-	-	-	-	-	-
-232	12.0	AIR	AB	RKT	CSJ	CRY	850	79.6	23,900	69,700	809	2228	L4	1504	M1
-233	12.0	AIR	AB	RKT	RKT	CRY	892	81.4	21,980	74,780	484	1786	L3	1309	M1
-234	12.0	AIR	WB	RKT	RKT	CRY	1,415	84.2	27,900	96,050	564	1786	L3	1309	M1
-250	12.0	HTO	AB	RKT	RKT	CRY	1,289	95.5	31,000	130,040	621	1816	L3	1335	M1
-250 J2S	12.0	HTO	AB	RKT	RKT	CRY	1,809	113.0	42,500	194,280	556	1816	L3	1335	M1
-251	12.0	HTO	WB	RKT	RKT	CRY	1,880	113.0	37,840	148,640	691	1816	L3	1335	M1
-252	12.0	HTO	EAB	RKT	RKT	CRY	1,340	97.4	31,700	132,380	628	1816	L3	1335	M1
-253	12.0	HTO	AB	RKT	RKT	STOR	1,100	88.5	50,200	314,900	736	1639	L3	1335	M1
-254	12.0	HTO	AB	RKT	CSJ	CRY	1,328	97.1	36,460	135,180	994	2258	L4	1583	M1
-255	12.0	HTO	WB	RKT	CSJ	CRY	2,190	123.0	48,000	176,400	1078	2258	L4	1583	M1
-256	12.0	HTO	WB	RKT	RKT	STOR	1,318	94.6	41,420	248,420	635	1727	L3	1416	M1
-256 H1D	12.0	HTO	WB	RKT	RKT	STOR	1,923	114.1	55,600	378,100	660	1727	L3	1416	M1
-257	12.0	HTO	WB	TJ+CSJ	CSJ	CRY	2,000	116.1	58,000	80,200	902	2231	L4	1599	M1
-270	12.0	VTO	AB	RKT	RKT	CRY	1,405	106.2	31,600	144,500	635	1745	L4	1332	M1
-271	12.0	VTO	AB	RKT	CSJ	CRY	1,530	113.8	41,280	165,360	1045	2276	L4	1580	M1
-280	12.0	Staged VTO	AB	RKT	CSJ	CRY	165	29.6	12,410	12,830	486	1820	L4	1262	M1
-281	12.0	Staged VTO	AB	RKT	RKT	CRY	168	29.8	10,880	13,020	184	1366	L2	1076	M1
-282	12.0	Staged VTO	AB	RKT	RKT	STOR	136	26.5	13,360	17,310	222	1222	L2	1076	M1
-284	12.0	AIR	AB	RKT	RKT	CRY	885	81.3	21,680	73,780	472	1420	L2	1088	M1
-285	12.0	HTO	AB	RKT	RKT	CRY	1,280	95.3	30,700	128,700	619	1488	L3	1095	M1
-290	2.0	HTO	WB	TJ	TJ	STOR	-	-	-	-	30	262	L3	156	C2
-291	0.9	HTO	AB	TJ	TJ	STOR	-	-	-	-	50	228	L3	225	M1
-292	2.0	HTO	AB	TJ	TJ	STOR	-	-	-	-	75	406	L3	301	C2

MCDONNELL AIRCRAFT

5-6

REPORT MDC A0013 • 2 OCTOBER 1970  
 VOLUME II • PART 2

(U) FIGURE 5-4 (Continued)  
**PERFORMANCE COMPARISON**  
 FLIGHT RESEARCH VEHICLES  
 (INTERNATIONAL SYSTEM OF UNITS)

Configuration	Design Mach Number	Launch Concept	Type of Configuration	Propulsion System		Fuel	Sp m <sup>2</sup>	Body Length (m)	OWE (kg)	TOGW (kg)	Program Cost (\$ x 10 <sup>-6</sup> )	Research Value			
				Accelerate and Climb	Cruise							Maximum Value	Associated Operational System	Minimum Value	Associated Operational System
-200	4.5	r TO	WB	TRJ	TRJ	STOR	43.5	17.2	9,036	11,568	574	1505			
-201	4.5	n TO	AB	TRJ	TRJ	STOR	-	-	-	-	-	-			
-204	6.0	AIR	WB	TRJ	TRJ	CRY	56.2	16.9	10,160	11,376	780	1637	C1	1065	M2
-205	6.0	AIR	WB	TRJ	TRJ	CRY	57.1	17.2	10,433	11,675	803	1891	C1	1163	M2
-206	6.0	AIR	AB	TRJ	TRJ	CRY	-	-	-	-	-	-			
-207	6.0	AIR	AB	RKT	RKT	CRY	48.3	19.0	11,249	19,504	573	1769	C1	1391	M2
-210	6.0	HTO	WB	TRJ	TRJ	CRY	83.1	21.0	16,533	18,801	1123	1960	C1	1385	M1
-211	6.0	HTO	AB	TRJ	TRJ	CRY	-	-	-	-	-	-			
-212	6.0	HTO	AB	TJ	RJ	CRY	-	-	-	-	-	-			
-213	6.0	HTO	AB	RKT	RJ	CRY	67.4	22.0	13,744	29,420	663	1870	C1	1458	M2
-214	6.0	HTO	AB	RKT	RKT	CRY	58.5	20.4	8,391	20,797	348	1607	C1	1439	M1
-220	6.0	Staged VTO	AB	RKT	RJ	CRY	15.5	10.3	5,806	6,001	310	1443	C1	1321	M1
-221	6.0	Staged VTO	EAB	RKT	RJ	CRY	16.2	10.5	5,937	6,137	312	1443	C1	1052	M1
-231	12.0	AIR	AB	TJ	CSJ	CRY	-	-	-	-	-	-			
-232	12.0	AIR	AB	RKT	CSJ	CRY	79.0	24.3	10,841	31,615	809	-			
-233	12.0	AIR	AB	RKT	RKT	CRY	82.9	24.8	9,970	33,919	484	2228	L4	1504	M1
-234	12.0	AIR	WB	RKT	RKT	CRY	131.5	25.7	12,655	43,567	564	1786	L3	1309	M1
-250	12.0	HTO	AB	RKT	RKT	CRY	119.7	29.1	14,061	58,984	631	1816	L3	1309	M1
-250J2S	12.0	HTO	AB	RKT	RKT	CRY	168.0	34.5	19,714	88,123	556	1816	L3	1335	M1
-251	12.0	HTO	WB	RKT	RKT	CRY	174.7	34.4	17,164	67,422	691	1816	L3	1335	M1
-252	12.0	HTO	EAB	RKT	RKT	CRY	124.5	29.7	14,379	60,046	628	1816	L3	1335	M1
-253	12.0	HTO	AB	RKT	RKT	STOR	102.2	27.0	22,770	142,835	736	1816	L3	1335	M1
-254	12.0	HTO	AB	RKT	CSJ	CRY	123.4	29.6	16,538	61,316	994	1639	L3	1335	M1
-255	12.0	HTO	WB	RKT	CSJ	CRY	203.5	37.5	21,772	80,013	1078	2258	L4	1583	M1
-256	12.0	HTO	WB	RKT	RKT	STOR	122.4	28.8	18,788	112,681	635	2258	L4	1583	M1
-256 H1D	12.0	HTO	WB	RKT	RKT	STOR	178.8	34.8	25,220	171,502	660	1727	L3	1416	M1
-257	12.0	HTO	WB	TJ · CSJ	CSJ	CRY	185.8	35.4	26,308	36,378	902	1727	L3	1416	M1
-270	12.0	VTO	AB	RKT	RKT	CRY	130.5	32.4	14,333	65,544	635	2231	L4	1599	M1
-271	12.0	VTO	AB	RKT	CSJ	CRY	142.1	34.7	18,724	75,006	1045	1745	L4	1332	M1
-280	12.0	Staged VTO	AB	RKT	CSJ	CRY	15.3	9.0	5,629	5,820	486	2276	L4	1580	M1
-281	12.0	Staged VTO	AB	RKT	RKT	CRY	15.6	9.1	4,935	5,906	184	1820	L4	1262	M1
-282	12.0	Staged VTO	AB	RKT	RKT	STOR	12.6	8.1	6,060	7,852	222	1366	L2	1076	M1
-284	12.0	AIR	AB	RKT	RKT	CRY	82.2	24.8	9,834	33,466	472	1222	L2	1076	M1
-285	12.0	HTO	AB	RKT	RKT	CRY	118.9	29.0	13,925	58,377	619	1420	L2	1088	M1
-290	2.0	HTO	WB	TJ	TJ	STOR	-	-	-	-	30	1488	L3	1095	M1
-291	0.9	HTO	AB	TJ	TJ	STOR	-	-	-	-	50	262	L3	156	C2
-292	2.0	HTO	AB	TJ	TJ	STOR	-	-	-	-	75	228	L3	225	M1
												406	L3	301	C2

(U) FIGURE 5-5a  
 CONFIGURATION EVALUATION SUMMARY

Facility Identification	Description	* Cost		Research Value (Average)	Subjective Evaluations			
		With Engine Development	Without Engine Development		Versatility	Growth Capability	Design Confidence	Limitations
-200	M = 4.5, WB, HTO Manned TRJ(JZ8) JP	574	311	1270	<ol style="list-style-type: none"> <li>1. Shingle type heat shield allows full range of material testing.</li> <li>2. Inlet modifications can assist in air induction testing and development.</li> <li>3. Can flight demonstrate advanced TJ/TRJ engines.</li> <li>4. Additional propulsion limited to rocket.</li> </ol>	<ol style="list-style-type: none"> <li>1. Oversize engine is consistent with anticipated development. Test time can be over 30 minutes.</li> <li>2. Inlet structure not capable of large growth in speed or pressures.</li> </ol>	<ol style="list-style-type: none"> <li>1. Basic aluminum airframe is S.O.A.</li> <li>2. Heat shields and T.P.S have been flown on ASSET.</li> <li>3. TRJ in advanced development.</li> <li>4. Subsystems are S.O.A.</li> <li>5. Inlets for composite engines not proven.</li> <li>6. Nozzle efficiency not proven.</li> <li>7. Cooling problems not completely solved.</li> </ol>	<ol style="list-style-type: none"> <li>1. No value to research in cryogenics.</li> <li>2. Low value in Aero/Thermal research due to Mach limitation.</li> </ol>
-201	M = 4.5, AB, HTO Manned TRJ, JP				This concept did not meet the required performance due to the large power requirement for transonic drag rise. Flight path analyzed was a normal high "q" airbreather climb trajectory and did not employ diving techniques. Study of body shape modifications and applicability of transonic rocket assist necessary for an improved design.			
-204	M = 6, WB, Air Launch, Unmanned, TRJ(JZ6C), LH <sub>2</sub>	780	385	1321	<ol style="list-style-type: none"> <li>1. Capable of testing metals at all temperatures anticipated in hypersonic cruise.</li> <li>2. Difficult to integrate additional propulsion except for rocket.</li> <li>3. Additional air-breathing propulsion would need to assist for transonic operation.</li> </ol>	<ol style="list-style-type: none"> <li>1. Growth limited by material capability at elevated temperatures.</li> <li>2. Significant thrust increase requires major structural changes.</li> <li>3. Inlets must be scaled up for larger engines.</li> <li>4. Inlet temperature most limiting feature of concept.</li> </ol>	<ol style="list-style-type: none"> <li>1. Inlet structure is high risk at current S.O.A.</li> <li>2. Turbomachinery well developed.</li> <li>3. LH<sub>2</sub> fuel reasonably well demonstrated.</li> <li>4. Regen cooled panels developed but not proven on large areas.</li> <li>5. Inlets for composite engines not developed.</li> <li>6. Nozzle efficiency not proven.</li> <li>7. Most components in advanced development stages but not integrated into operational engine.</li> </ol>	<ol style="list-style-type: none"> <li>1. Research limited to low end of hypersonic flight regime.</li> <li>2. No ability to vary mission during flight.</li> <li>3. No evaluation of handling qualities possible.</li> </ol>

\*Note: Cost is in millions of 1970 dollars.  
 S.O.A. = State-of-Art  
 T.P.S. = Thermal Protection System

(U) FIGURE 5-5b  
CONFIGURATION EVALUATION SUMMARY

Facility Identification	Description	Cost		Research Value (Average)	Subjective Evaluations			
		With Engine Development	Without Engine Development		Versatility	Growth Capability	Design Confidence	Limitations
-205	M = 6, WB, Air Launch, Manned, TRJ(JZ6C), LH <sub>2</sub>	803	401	158i	<ol style="list-style-type: none"> <li>1. Capable of testing metals at all temperatures anticipated in hypersonic cruise.</li> <li>2. Difficult to integrate additional propulsion except for rocket.</li> <li>3. Additional air-breathing propulsion would need to assist for transonic operation.</li> </ol>	<ol style="list-style-type: none"> <li>1. Growth limited by material capability at elevated temperatures.</li> <li>2. Significant thrust increase requires major structural changes.</li> <li>3. Inlets must be scaled up for larger engines.</li> <li>4. Inlet temperature most limiting feature of concept.</li> </ol>	<ol style="list-style-type: none"> <li>1. Inlet structure is high risk at current S.O.A.</li> <li>2. Turbomachinery well developed.</li> <li>3. LH<sub>2</sub> fuel reasonably well demonstrated.</li> <li>4. Regen cooled panels developed but not proven on large areas.</li> <li>5. Inlets for composite engines not developed.</li> <li>6. Nozzle efficiency not proven.</li> <li>7. Most components in advanced development stages but not integrated into operational engine.</li> </ol>	<ol style="list-style-type: none"> <li>1. Research limited to low end of hypersonic flight regime.</li> <li>2. Not a quantum advance over X-15.</li> </ol>
-206	M = 6, AB, Air Launch, Manned, TRJ(JZ6C), LH <sub>2</sub>				<ol style="list-style-type: none"> <li>1. Capable of testing metals at all temperatures anticipated in hypersonic cruise.</li> <li>2. Difficult to integrate additional propulsion except for rocket.</li> <li>3. Additional air-breathing propulsion would need to assist for transonic operation.</li> </ol>	<ol style="list-style-type: none"> <li>1. Growth limited by material capability at elevated temperatures.</li> <li>2. Significant thrust increase requires major structural changes.</li> <li>3. Inlets must be scaled up for larger engines.</li> <li>4. Inlet temperature most limiting feature of concept.</li> </ol>	<ol style="list-style-type: none"> <li>1. Inlet structure is high risk at current S.O.A.</li> <li>2. Turbomachinery well developed.</li> <li>3. LH<sub>2</sub> fuel reasonably well demonstrated.</li> <li>4. Regen cooled panels developed but not proven on large areas.</li> <li>5. Inlets for composite engines not developed.</li> <li>6. Nozzle efficiency not proven.</li> <li>7. Most components in advanced development stages but not integrated into operational engine.</li> </ol>	<p>Did not meet mission performance requirements similar to Configuration 201</p>

(U) FIGURE 5-5c  
CONFIGURATION EVALUATION SUMMARY

Facility Identification	Description	Cost		Research Value (Average)	Subjective Evaluations			
		With Engine Development	Without Engine Development		Versatility	Growth Capability	Design Confidence	Limitations
-207	M-6, AB, Air Launch, Manned, Rocket + RJ, LH <sub>2</sub>	573	314	1559	<ol style="list-style-type: none"> <li>1. Capable of testing metals at all temperatures anticipated in hypersonic cruise.</li> <li>2. Capable of testing various air-breathing engine concepts through use of pod mounting.</li> <li>3. Low end of SJ/CSJ testing possible.</li> </ol>	<ol style="list-style-type: none"> <li>1. Growth limited by material capability at elevated temperatures.</li> <li>2. Improved inlet and nozzle efficiency can contribute in increased thrust.</li> <li>3. Inlets can scale up for larger engines.</li> <li>4. Inlet temperature most limiting feature of concept.</li> </ol>	<ol style="list-style-type: none"> <li>1. Inlet structure is high risk at current S.O.A.</li> <li>2. TPS for primary structure not proven in practice.</li> <li>3. RJ developed to M = 3.0 to 3.5.</li> <li>4. Nozzle efficiency not proven.</li> <li>5. Cooling at low throttle settings not demonstrated.</li> </ol>	<ol style="list-style-type: none"> <li>1. Requires better integration of propulsion system to correct thrust line for eccentricity.</li> <li>2. Will probably show weight and size increase with solution of No. 1 above.</li> </ol>
-210	M-6, WB, HTO, Manned, TRJ(JZ6C), LH <sub>2</sub>	1123	561	1649	<ol style="list-style-type: none"> <li>1. Capable of testing metals at all temperatures anticipated in hypersonic cruise.</li> <li>2. Difficult to integrate additional propulsion except for rocket.</li> <li>3. Additional air-breathing propulsion would need to assist for transonic operation.</li> </ol>	<ol style="list-style-type: none"> <li>1. Growth limited by material capability at elevated temperatures.</li> <li>2. Significant thrust increase requires major structural changes.</li> <li>3. Inlets must be scaled up for larger engines.</li> <li>4. Inlet temperature most limiting feature of concept.</li> </ol>	<ol style="list-style-type: none"> <li>1. Inlet structure is high risk at current S.O.A.</li> <li>2. Turbomachinery well developed.</li> <li>3. LH<sub>2</sub> fuel reasonably well demonstrated.</li> <li>4. Regen cooled panels developed but not proven on large areas.</li> <li>5. Inlets for composite engines not developed.</li> <li>6. Nozzle efficiency not proven.</li> <li>7. Most components in advanced development stages but not integrated into operational engine.</li> </ol>	<ol style="list-style-type: none"> <li>1. Research limited to low end of hypersonic flight regime.</li> <li>2. Not a quantum advance over X-15.</li> </ol>
-211	M-6, AB, HTO, Manned, TRJ(JZ6C) LH <sub>2</sub>				This concept did not meet the required performance due to the large power requirement for transonic drag rise. Flight path analyzed was a normal high "q" airbreather climb trajectory and did not employ diving techniques. Study of body shape modifications and applicability of transonic rocket assist necessary for an improved design.			
-212	M-6, AB, HTO Manned, TJ (F-100 Mod.) Plus RJ (MA-145), LH <sub>2</sub>				<ol style="list-style-type: none"> <li>1. Axisymmetric ramjet integrates poorly with all body design.</li> <li>2. High transonic drag rise same as -201.</li> </ol>			
-213	M-6, AB, HTO, Manned, Rocket (LR129) Plus RJ (MA145), LH <sub>2</sub>	663	372	1634	<ol style="list-style-type: none"> <li>1. Capable of testing metals at all temperatures anticipated in hypersonic cruise.</li> <li>2. Capable of testing various air-breathing engine concepts through use of pod mounting.</li> <li>3. Low end of SJ/CSJ testing possible.</li> </ol>	<ol style="list-style-type: none"> <li>1. Growth limited by material capability at elevated temperatures.</li> <li>2. Improved inlet and nozzle efficiency can contribute increased thrust.</li> <li>3. Inlets can scale up for larger engines.</li> <li>4. Inlet temperature most limiting feature of concept.</li> </ol>	<ol style="list-style-type: none"> <li>1. Inlet structure is high risk at current S.O.A.</li> <li>2. TPS for primary structure not proven in practice.</li> <li>3. RJ developed to M = 3.0 to 3.5.</li> <li>4. Nozzle efficiency not proven.</li> <li>5. Cooling at low throttle settings not demonstrated.</li> </ol>	<ol style="list-style-type: none"> <li>1. Requires better integration of propulsion system to correct thrust line for eccentricity.</li> <li>2. Will probably show weight and size increase with solution of No. 1 above.</li> </ol>

5-10  
MCDONNELL AIRCRAFT

REPORT MDC A0013 • 2 OCTOBER 1970  
VOLUME II • PART 2

(U) FIGURE 5-5d  
CONFIGURATION EVALUATION SUMMARY

Facility Identification	Description	Cost		Research Value (Average)	Subjective Evaluations			
		With Engine Development	Without Engine Development		Versatility	Growth Capability	Design Confidence	Limitations
-214	M - 6, AB, HTO, Manned, Rocket (LR129), LH <sub>2</sub>	348	264	1482	<ol style="list-style-type: none"> <li>1. Capable of testing metals at all temperatures anticipated in hypersonic cruise.</li> <li>2. Capable of testing various air-breathing engine concepts through use of pod mounting.</li> <li>3. Low end of SJ/CSJ testing possible.</li> </ol>	<ol style="list-style-type: none"> <li>1. Growth limited by material capability at elevated temperatures.</li> <li>2. Rocket can be scaled up for greater thrust.</li> </ol>	<ol style="list-style-type: none"> <li>1. TPS for primary structure not proven in practice.</li> <li>2. Throttle ratios greater than 10 to 1 not demonstrated.</li> </ol>	
-220	M - 6, AB, Staged, Unmanned, Thor Booster, RJ (MA145), LH <sub>2</sub>	310	132	1184	<ol style="list-style-type: none"> <li>1. Capable of testing metals at all temperatures anticipated in hypersonic cruise.</li> <li>2. Capable of testing various air-breathing engine concepts through use of pod mounting.</li> <li>3. Low end of SJ/CSJ testing possible.</li> <li>4. Useful for cruise propulsion testing only.</li> </ol>	<ol style="list-style-type: none"> <li>1. Growth limited by material capability at elevated temperatures.</li> <li>2. Improved inlet and nozzle efficiency can contribute increased thrust.</li> <li>3. Inlets can scale up for larger engines.</li> <li>4. Inlet temperature most limiting feature of concept.</li> </ol>	<ol style="list-style-type: none"> <li>1. Inlet structure is high risk at current S.O.A.</li> <li>2. TPS for primary structure not proven in practice.</li> <li>3. RJ developed to M = 3.0 to 3.5.</li> <li>4. Nozzle efficiency not proven.</li> <li>5. Cooling at low throttle settings not demonstrated.</li> </ol>	<ol style="list-style-type: none"> <li>1. Limited to specifically identified research</li> <li>2. Low productivity, would require increased launch rate and quantity for improvement.</li> </ol>
-221	M - 6, AB(EHp.), HTO, Staged, Unmanned, Thor Booster, RJ(MA145), LH <sub>2</sub>	312	134	1184	<ol style="list-style-type: none"> <li>1. Capable of testing metals at all temperatures anticipated in hypersonic cruise.</li> <li>2. Capable of testing various air-breathing engine concepts through use of pod mounting.</li> <li>3. Low end of SJ/CSJ testing possible.</li> <li>4. Useful for cruise propulsion testing only.</li> </ol>	<ol style="list-style-type: none"> <li>1. Growth limited by material capability at elevated temperatures.</li> <li>2. Improved inlet and nozzle efficiency can contribute increased thrust.</li> <li>3. Inlets can scale up for larger engines.</li> <li>4. Inlet temperature most limiting feature of concept.</li> </ol>	<ol style="list-style-type: none"> <li>1. Inlet structure is high risk at current S.O.A.</li> <li>2. TPS for primary structure not proven in practice.</li> <li>3. RJ developed to M = 3.0 to 3.5.</li> <li>4. Nozzle efficiency not proven.</li> <li>5. Cooling at low throttle settings not demonstrated.</li> </ol>	
-231	M - 12, AB, Air Launch, Manned, TJYJ93 Mod.) Plus CSJ, LH <sub>2</sub>				This concept did not meet the required performance due to the large power requirement for transonic drag rise. Flight path analyzed was a normal high "q" airbreather climb trajectory and did not employ diving techniques. Study of body shape modifications and applicability of transonic rocket assist necessary for an improved design.			
-232	M - 12, AB, Air Launch, Manned, Rocket (LR-129) Plus SJ, LH <sub>2</sub>	809	375	1921	<ol style="list-style-type: none"> <li>1. All current structural concepts can be tested and demonstrated.</li> <li>2. Provision for various TPS concepts can be incorporated.</li> <li>3. Capable of testing all current air-breathing propulsion concepts in pod mounted form, if SJ package is removed.</li> <li>4. Capable of longer flight times at lower Mach number dependent on propellant ratios and loading concepts.</li> </ol>	<ol style="list-style-type: none"> <li>1. Speed increase limited to small excursion above M=12 through elimination of cruise fuel.</li> <li>2. Size limited by Sp that will fit on carrier A/C.</li> </ol>	<ol style="list-style-type: none"> <li>1. Regen cooled panels developed but not proven on large areas.</li> <li>2. TPS for primary structure not proven in practice.</li> <li>3. SJ under development on ground, but not in flight test.</li> <li>4. Propulsion system scaling laws and component sizes not sufficiently established for design confidence.</li> <li>5. Aluminum substructure within S.O.A.</li> </ol>	

5-11 MCDONNELL AIRCRAFT

REPORT MDC A0013 • 2 OCTOBER 1970  
VOLUME II • PART 2



(U) FIGURE 5-5e  
CONFIGURATION EVALUATION SUMMARY

Facility Identification	Description	Cost		Research Value (Average)	Subjective Evaluations			
		With Engine Development	Without Engine Development		Versatility	Growth Capability	Design Confidence	Limitations
-233	M 12, AB, Air Launch, Manned, Rocket (LR129), LH <sub>2</sub>	484	357	1598	<ol style="list-style-type: none"> <li>1. All current structural concepts can be tested and demonstrated.</li> <li>2. Provision for various TPS concepts can be incorporated.</li> <li>3. Capable of testing all current airbreathing propulsion concepts in pod mounted form.</li> <li>4. Capable of longer flight times at lower Mach number dependent on propellant ratios and loading concepts.</li> </ol>	<ol style="list-style-type: none"> <li>1. Speed increase limited to small excursion above M 12 through elimination of cruise fuel.</li> <li>2. Size limited by S<sub>0</sub> that will fit on carrier A C.</li> </ol>	<ol style="list-style-type: none"> <li>1. Regen cooled panels developed but not proven on large areas.</li> <li>2. TPS for primary structure not proven in practice.</li> <li>3. Aluminum substructure within S.O.A.</li> </ol>	
-234	M 12, WB, Air Launch, Manned, Rocket (LR129), LH <sub>2</sub>	564	426	1598	<ol style="list-style-type: none"> <li>1. All current structural concepts can be tested and demonstrated.</li> <li>2. Provision for various TPS concepts can be incorporated.</li> <li>3. Capable of testing all current airbreathing propulsion concepts in pod mounted form.</li> <li>4. Capable of longer flight times at lower Mach number dependent on propellant ratios and loading concepts.</li> </ol>	<ol style="list-style-type: none"> <li>1. Speed increase limited to small excursion above M 12 through elimination of cruise fuel.</li> <li>2. Size limited by S<sub>0</sub> that will fit on carrier A C.</li> </ol>	<ol style="list-style-type: none"> <li>1. Regen cooled panels developed but not proven on large areas.</li> <li>2. TPS for primary structure not proven in practice.</li> <li>3. Aluminum substructure within S.O.A.</li> </ol>	Vehicle size not compatible with carrier A C.
-250	M 12, AB, HTO, Manned, Rocket (LR129), LH <sub>2</sub>	621	451	1626	<ol style="list-style-type: none"> <li>1. All current structural concepts can be tested and demonstrated.</li> <li>2. Provision for various TPS concepts can be incorporated.</li> <li>3. Capable of longer flight times at lower Mach number dependent on propellant ratios and loading concepts.</li> <li>4. Addition of longer MLG will allow airbreathing propulsion package to be tested.</li> </ol>	<ol style="list-style-type: none"> <li>1. Speed increase limited to small excursion above M 12 through elimination of cruise fuel.</li> </ol>	<ol style="list-style-type: none"> <li>1. Regen cooled panels developed but not proven on large areas.</li> <li>2. TPS for primary structure not proven in practice.</li> <li>3. Aluminum substructure within S.O.A.</li> </ol>	

(U) FIGURE 5-5f  
CONFIGURATION EVALUATION SUMMARY

Facility Identification	Description	Cost		Research Value (Average)	Subjective Evaluations			
		With Engine Development	Without Engine Development		Versatility	Growth Capability	Design Confidence	Limitations
-251	M = 12, WB, HTO, Manned, Rocket (LR129), LH <sub>2</sub>	691	509	1626	<ol style="list-style-type: none"> <li>1. All current structural concepts can be tested and demonstrated.</li> <li>2. Provisions for various TPS concepts can be incorporated.</li> <li>3. Capable of longer flight times at lower Mach number dependent on propellant ratios and loading concepts.</li> <li>4. Addition of longer MLG will allow airbreathing propulsion package to be tested.</li> </ol>	<ol style="list-style-type: none"> <li>1. Speed increase limited to small excursion above M=12 through elimination of cruise fuel.</li> </ol>	<ol style="list-style-type: none"> <li>1. Regen cooled panels developed but not proven on large areas.</li> <li>2. TPS for primary structure not proven in practice.</li> <li>3. Aluminum substructure within S.O.A.</li> </ol>	
-252	M = 12, AB (Ellip.), HTO, Manned, Rocket (LR129), LH <sub>2</sub>	628	457	1626	<ol style="list-style-type: none"> <li>1. All current structural concepts can be tested and demonstrated.</li> <li>2. Provision for various TPS concepts can be incorporated.</li> <li>3. Capable of longer flight times at lower Mach number dependent on propellant ratios and loading concepts.</li> <li>4. Addition of longer MLG will allow airbreathing propulsion package to be tested.</li> </ol>	<ol style="list-style-type: none"> <li>1. Speed increase limited to small excursion above M=12 through elimination of cruise fuel.</li> </ol>	<ol style="list-style-type: none"> <li>1. Regen cooled panels developed but not proven on large areas.</li> <li>2. TPS for primary structure not proven in practice.</li> <li>3. Aluminum substructure within S.O.A.</li> </ol>	
-253	M = 12, AB, HTO, Manned, Rocket (Mist), Aero 50/N <sub>2</sub> O <sub>4</sub>	736	572	1478	<ol style="list-style-type: none"> <li>1. All current structural concepts can be tested and demonstrated.</li> <li>2. Provision for various TPS concepts can be incorporated.</li> <li>3. Capable of longer flight times at lower Mach number dependent on propellant ratios and loading concepts.</li> </ol>	<ol style="list-style-type: none"> <li>1. Speed increase limited to small excursion above M=12 through elimination of cruise fuel.</li> </ol>	<ol style="list-style-type: none"> <li>1. Regen cooled panels developed but not proven on large areas.</li> <li>2. TPS for primary structure not proven in practice.</li> <li>3. Aluminum substructure within S.O.A.</li> </ol>	<ol style="list-style-type: none"> <li>1. Airbreathing propulsion would require LH<sub>2</sub> tankage and contribute to size and weight increase.</li> </ol>
-254	M = 12, AB, HTO, Manned, Rocket (LR129), Plus CSJ, LH <sub>2</sub>	994	506	1958	<ol style="list-style-type: none"> <li>1. All current structural concepts can be tested and demonstrated.</li> <li>2. Provision for various TPS concepts can be incorporated.</li> <li>3. Capable of testing all current airbreathing propulsion concepts in pod mounted form, if CSJ package is removed.</li> <li>4. Capable of longer flight times at lower Mach number dependent on propellant ratios and loading concepts.</li> </ol>	<ol style="list-style-type: none"> <li>1. Speed increase limited to small excursion above M=12 through elimination of cruise fuel.</li> </ol>	<ol style="list-style-type: none"> <li>1. Regen cooled panels developed but not proven on large areas.</li> <li>2. TPS for primary structure not proven in practice.</li> <li>3. CSJ under development on ground, but not in flight test.</li> <li>4. Propulsion system scaling laws and component sizes not sufficiently established for design confidence.</li> <li>5. Aluminum substructure within S.O.A.</li> </ol>	

(U) FIGURE 5-5g  
**CONFIGURATION EVALUATION SUMMARY**

Facility Identification	Description	Cost		Research Value (Average)	Subjective Evaluations			
		With Engine Development	Without Engine Development		Versatility	Growth Capability	Design Confidence	Limitations
-255	M = 12, WB, HTO, Manned, Rocket LR129) Plus CSJ, LH <sub>2</sub>	1078	559	1958	<ol style="list-style-type: none"> <li>All current structural concepts can be tested and demonstrated.</li> <li>Provision for various TPS concepts can be incorporated.</li> <li>Capable of testing all current airbreathing propulsion concepts in pod mounted form, if CSJ package is removed.</li> <li>Capable of longer flight times at lower Mach number dependent on propellant ratios and loading concepts.</li> </ol>	<ol style="list-style-type: none"> <li>Speed increase limited to small excursion above M=12 through elimination of cruise fuel.</li> </ol>	<ol style="list-style-type: none"> <li>Regen cooled panels developed but not proven on large areas.</li> <li>TPS for primary structure not proven in practice.</li> <li>CSJ under development on ground, but not in flight test.</li> <li>Propulsion system scaling laws and component sizes not sufficiently established for design confidence.</li> <li>Aluminum substructure within S.O.A.</li> </ol>	
-256	M = 12, WB, HTO, Manned, Rocket (Mist), Aero50/N <sub>2</sub> O <sub>4</sub>	635	492	1563	<ol style="list-style-type: none"> <li>All current structural concepts can be tested and demonstrated.</li> <li>Provision for various TPS concepts can be incorporated.</li> <li>Capable of longer flight times at lower Mach number dependent on propellant ratios and loading concepts.</li> </ol>	<ol style="list-style-type: none"> <li>Speed increase limited to small excursion above M=12 through elimination of cruise fuel.</li> </ol>	<ol style="list-style-type: none"> <li>Regen cooled panels developed but not proven on large areas.</li> <li>TPS for primary structure not proven in practice.</li> <li>Aluminum substructure within S.O.A.</li> </ol>	<ol style="list-style-type: none"> <li>Airbreathing propulsion would require LH<sub>2</sub> tankage and contribute to size and weight increase.</li> </ol>
-257	M = 12, WB, HTO, Manned, TJ (F100 Mod.) Plus CSJ, LH <sub>2</sub>	902	587	1963	<ol style="list-style-type: none"> <li>All current structural concepts can be tested and demonstrated.</li> <li>Provision for various TPS concepts can be incorporated.</li> <li>Capable of testing all current airbreathing propulsion concepts in pod mounted form, if CSJ package is removed.</li> <li>Capable of longer flight times at lower Mach number dependent on propellant ratios and loading concepts.</li> </ol>	<ol style="list-style-type: none"> <li>Speed increase limited to small excursion above M=12 through elimination of cruise fuel.</li> </ol>	<ol style="list-style-type: none"> <li>Regen cooled panels developed but not proven on large areas.</li> <li>TPS for primary structure not proven in practice.</li> <li>CSJ under development on ground, but not in flight test.</li> <li>Propulsion system scaling laws and component sizes not sufficiently established for design confidence.</li> <li>Aluminum substructure within S.O.A.</li> </ol>	

MCDONNELL AIRCRAFT  
 5-14

(U) FIGURE 5-5h

## CONFIGURATION EVALUATION SUMMARY

Facility Identification	Description	Cost		Research Value (Average)	Subjective Evaluations			
		With Engine Development	Without Engine Development		Versatility	Growth Capability	Design Confidence	Limitations
-270	M = 12, AB, VTO, Manned, Rocket (LR129), LH <sub>2</sub>	635	455	1601	<ol style="list-style-type: none"> <li>All current structural concepts can be tested and demonstrated.</li> <li>Provision for various TPS concepts can be incorporated.</li> <li>Capable of longer flight times at lower Mach number dependent on propellant ratios and loading concepts.</li> <li>Addition of longer MLG will allow airbreathing propulsion package to be tested.</li> </ol>	<ol style="list-style-type: none"> <li>Speed increase limited to small excursion above M=12 through elimination of cruise fuel.</li> </ol>	<ol style="list-style-type: none"> <li>Regen cooled panels developed but not proven on large areas.</li> <li>TPS for primary structure not proven in practice.</li> <li>Aluminum substructure within S.O.A.</li> </ol>	<ol style="list-style-type: none"> <li>Requires better integration of propulsion system to correct thrust line for eccentricity.</li> <li>Will probably show weight and size increase with solution of No. 1 above.</li> </ol>
-271	M = 12, AB, VTO, Manned, Rocket (LR129), Plus CSJ, LH <sub>2</sub>	1045	534	1900	<ol style="list-style-type: none"> <li>All current structural concepts can be tested and demonstrated.</li> <li>Provision for various TPS concepts can be incorporated.</li> <li>Capable of testing all current airbreathing propulsion concepts in pod mounted form, if CSJ package is removed.</li> <li>Capable of longer flight times at lower Mach number dependent on propellant ratios and loading concepts.</li> </ol>	<ol style="list-style-type: none"> <li>Speed increase limited to small excursion above M=12 through elimination of cruise fuel.</li> </ol>	<ol style="list-style-type: none"> <li>Regen cooled panels developed but not proven on large areas.</li> <li>TPS for primary structure not proven in practice.</li> <li>CSJ under development on ground, but not in flight test.</li> <li>Propulsion system scaling laws and component sizes not sufficiently established for design confidence.</li> <li>Aluminum substructure within S.O.A.</li> </ol>	<ol style="list-style-type: none"> <li>Requires better integration of propulsion system to correct thrust line for eccentricity.</li> <li>Will probably show weight and size increase with solution of No. 1 above.</li> </ol>
-280	M = 12, AB, Staged, Unmanned, Atlas Booster, CSJ, LH <sub>2</sub>	486	171	1575	<ol style="list-style-type: none"> <li>All current structural concepts can be tested and demonstrated.</li> <li>Provision for various TPS concepts can be incorporated.</li> <li>Capable of longer flight times at lower Mach number dependent on propellant ratios and loading concepts.</li> <li>Useful for cruise propulsion testing only.</li> </ol>	<ol style="list-style-type: none"> <li>Speed increase limited to small excursion above M=12 through elimination of cruise fuel.</li> <li>Size limited by booster capability.</li> </ol>	<ol style="list-style-type: none"> <li>Regen cooled panels developed but not proven on large areas.</li> <li>TPS for primary structure not proven in practice.</li> <li>CSJ under development on ground, but not in flight test.</li> <li>Propulsion system scaling laws and component sizes not sufficiently established for design confidence.</li> <li>Aluminum substructure within S.O.A.</li> </ol>	<ol style="list-style-type: none"> <li>Limited to specifically identified research</li> <li>Low productivity, would require increased launch rate and quantity for improvement.</li> </ol>
-281	M = 12, AB, Staged Unmanned, Atlas Booster, Rocket (Parametric), LH <sub>2</sub>	184	163	1256	<ol style="list-style-type: none"> <li>All current structural concepts can be tested and demonstrated.</li> <li>Provision for various TPS concepts can be incorporated.</li> <li>Capable of longer flight times at lower Mach number dependent on propellant ratios and loading concepts.</li> </ol>	<ol style="list-style-type: none"> <li>Speed increase limited to small excursion above M=12 through elimination of cruise fuel.</li> <li>Size limited by booster capability.</li> </ol>	<ol style="list-style-type: none"> <li>Regen cooled panels developed but not proven on large areas.</li> <li>TPS for primary structure not proven in practice.</li> <li>Aluminum substructure within S.O.A.</li> </ol>	

(U) FIGURE 5-5i  
CONFIGURATION EVALUATION SUMMARY

Facility Identification	Description	Cost		Research Value (Average)	Subjective Evaluations			
		With Engine Development	Without Engine Development		Versatility	Growth Capability	Design Confidence	Limitations
-282	M = 12, AB, Staged, Unmanned, Atlas Booster, Rocket (Bell 8258), Aero 50/N <sub>2</sub> O <sub>4</sub>	222	180	1136	<ol style="list-style-type: none"> <li>All current structural concepts can be tested and demonstrated.</li> <li>Provision for various TPS concepts can be incorporated.</li> <li>Capable of longer flight times at lower Mach number dependent on propellant ratios and loading concepts.</li> </ol>	<ol style="list-style-type: none"> <li>Speed increase limited to small excursion above M=12 through elimination of cruise fuel.</li> <li>Size limited by booster capability.</li> </ol>	<ol style="list-style-type: none"> <li>Regen cooled panels developed but not proven on large areas.</li> <li>TPS for primary structure not proven in practice.</li> <li>Aluminum substructure within S.O.A.</li> </ol>	<ol style="list-style-type: none"> <li>Limited to specifically identified research</li> <li>Low productivity, would require increased launch rate and quantity for improvement.</li> </ol>
-284	M = 12, AB, Air Launch, Unmanned, Rocket (LR129), LH <sub>2</sub>	472	354	1312	<ol style="list-style-type: none"> <li>All current structural concepts can be tested and demonstrated.</li> <li>Provision for various TPS concepts can be incorporated.</li> <li>Capable of testing all current airbreathing propulsion concepts in pod mounted form, if CSJ package is removed.</li> <li>Capable of longer flight times at lower Mach number dependent on propellant ratios and loading concepts.</li> </ol>	<ol style="list-style-type: none"> <li>Speed increase limited to small excursion above M=12 through elimination of cruise fuel.</li> <li>Size limited by S<sub>p</sub> that will fit on carrier A. C.</li> </ol>	<ol style="list-style-type: none"> <li>Regen cooled panels developed but not proven on large areas.</li> <li>TPS for primary structure not proven in practice.</li> <li>CSJ under development on ground, but not in flight test.</li> <li>Propulsion system scaling laws and component sizes not sufficiently established for design confidence.</li> <li>Aluminum substructure within S.O.A.</li> </ol>	
-285	M = 12, AB, HTO, Unmanned, Rocket (LR129), LH <sub>2</sub>	619	451	1338	<ol style="list-style-type: none"> <li>All current structural concepts can be tested and demonstrated.</li> <li>Provision for various TPS concepts can be incorporated.</li> <li>Capable of longer flight times at lower Mach number dependent on propellant ratios and loading concepts.</li> <li>Addition of longer MLG will allow airbreathing propulsion package to be tested.</li> </ol>	<ol style="list-style-type: none"> <li>Speed increase limited to small excursion above M=12 through elimination of cruise fuel.</li> </ol>	<ol style="list-style-type: none"> <li>Regen cooled panels developed but not proven on large areas.</li> <li>TPS for primary structure not proven in practice.</li> <li>Aluminum substructure within S.O.A.</li> </ol>	
-290	M = 2 Variable Stability (F106)	30		200	Adaptable to stability characteristics of all Hypersonic vehicles	N/A	Current S.O.A., Avionics and Adaptive Controls	1. Limited to specifically identified research
-291	M = 0.9, HTO, Manned TJ, JP	50		226	<ol style="list-style-type: none"> <li>Low speed handling qualities</li> <li>Approach and landing techniques</li> </ol>	N/A	Current S.O.A., Structure and propulsion	
-292	M = 2.0, HTO, Manned TJ, JP	75		347	<ol style="list-style-type: none"> <li>Low speed handling qualities</li> <li>Approach and landing techniques</li> </ol>	N/A	Current S.O.A., Structure and propulsion	

**FOLDOUT FRAME**

(U) FIGURE 5-6  
FACILITY SCREENING PROCESS

Vehicle Characteristics						Configuration Number	Design/0		
Mach No.	Shape	Propulsion	Launch Mode	Control Mode	Propellants		Body Shape	Propellants	Pro and
0.9	AB	TJ	HTO	MAN	STOR	291			
2	WB	TJ	HTO	MAN	STOR	290			
2	AB	TJ	HTO	MAN	STOR	292			
4.5	WB	TRJ	HTO	MAN	STOR	200			
4.5	AB	TRJ	HTO	MAN	STOR	201	X Lower Performance		
6	WB	TRJ	AIR	UNMAN	CRY	204			
6	WB	TRJ	AIR	MAN	CRY	205			
6	AB	TRJ	AIR	MAN	CRY	206	X Lower Performance		
6	WB	TRJ	HTO	MAN	CRY	210			
6	AB	TRJ	HTO	MAN	CRY	211	X Lower Performance		
6	AB	RKT/RJ	AIR	MAN	CRY	207			
6	AB	RKT/RJ	HTO	MAN	CRY	213			
6	AB	TJ/RJ	HTO	MAN	CRY	212			
6	AB	RKT	HTO	MAN	CRY	214			
6	AB	RJ	STAGED	UNMAN	CRY	220			
6	EAB	RJ	STAGED	UNMAN	CRY	221	X Higher Cost		
12	AB	RKT	AIR	MAN	CRY	233			
12	WB	RKT	AIR	MAN	CRY	234	X Higher Cost		
12	AB	TJ/CSJ	AIR	MAN	CRY	231			
12	AB	RKT/CSJ	AIR	MAN	CRY	232			
12	AB	RKT/CSJ	HTO	MAN	CRY	254			
12	WB	RKT/CSJ	HTO	MAN	CRY	255	X Higher Cost		
12	AB	RKT/CSJ	VTO	MAN	CRY	271			
12	AB	RKT	HTO	MAN	STOR	253	X Higher Cost		
12	WB	RKT	HTO	MAN	STOR	256			X H
12	WB	RKT	HTO	MAN	STOR	256(H1D)		X Higher Cost	
12	AB	RKT	HTO	MAN	CRY	250			
12	WB	RKT	HTO	MAN	CRY	251	X Higher Cost		
12	EAB	RKT	HTO	MAN	CRY	252		X Higher Cost	
12	AB	RKT	HTO	MAN	CRY	250(J2S)			
12	AB	RKT	VTO	MAN	CRY	270			
12	WB	TJ/CSJ	HTO	MAN	CRY	257			
12	AB	CSJ	STAGED	UNMAN	CRY	280			
12	AB	RKT	STAGED	UNMAN	CRY	281			
12	AB	RKT	STAGED	UNMAN	STOR	282		X Higher Cost	
12	AB	RKT	AIR	UNMAN	CRY	284			
12	AB	RKT	HTO	UNMAN	CRY	285			

(Reference Section)

———— Go

———— X No Go - For Reason Stated

# FOLDOUT FRAME 2

rational Variable in Comparison				Research Potential Screening	Retained for Phase II
Orbit Shape	Control Mode	Launch Mode	Propulsion		
				X Limited	
				X Limited	
				X Limited	
				X Lower Research Value (Same Cost)	
				X Lower Research Value (Lower Cost)	
				X Higher Cost (Higher Research Value)	
				X Higher Cost (Higher Research Value)	
				X Higher Cost (Higher Research Value)	✓ Retain
				X Higher Cost (Higher Research Value)	✓ Retain in WB Config.
				X Lower Performance	
				X Limited	
				X Limited	
					✓ Retain
				X Lower Performance	
					✓ Retain
				X Higher Cost (Higher Research Value)	
				X Higher Cost (Higher Research Value)	
Higher Cost				X Higher Cost	
					✓ Retain and Combine
					✓ Retain
				X Limited	
				X Limited	
					✓ Retain for Further Control Mode Evaluation
				X Higher Cost (Higher Research Value)	

5.1.1 (U) FACILITY SCREENING - The facility screening process is illustrated in Figure 5-6. Each flight research vehicle concept studied in Phase I is listed and its disposition indicated either by a check (✓) indicating retention for Phase II study or a cross (X) indicating that it was not selected as one of the more attractive facilities. The design or operational concept variable in the direct comparison between the two vehicles is noted along with the primary reason for elimination of one of the vehicles. Secondary considerations, where applicable, are noted in brackets. In general, evaluation was made on the basis of variation of only a single parameter between the two facilities being compared. However, to complete the evaluation of all of the facilities in some cases it was necessary to make selections by consideration of a number of variables. The following sections discuss the detail basis of the evaluation.

5.1.1.1 (U) Body Shape - Body shape was selected as the initial comparison variable. Nine such comparisons were made. Shapes compared were wing body (WB), all body (AB) and elliptic all body (EAB). Configuration number designations are shown in brackets, RV = maximum Research Value, and Cost = total program costs in millions of dollars.

ITEM	COMPARISON	ELIMINATE	RETAIN	BASIS
1	WB to AB Mach 4.5, TRJ HTO, STOR, Manned	AB RV - Cost -	WB 1505 574	Mission performance was not achieved for the all body configuration. To achieve mission performance would require that the engine size be increased and would result in a higher weight and cost aircraft.
		(201)	(200)	
2	WB to AB Mach 6, TRJ AIR, CRYO, Manned	AB RV - Cost -	WB 1891 803	(Same as 1)
		(206)	(205)	
3	WB to AB Mach 6, TRJ HTO, CRYO, Manned	AB RV - Cost -	WB 1960 1123	(Same as 1)
		(211)	(210)	
4	WB to AB Mach 12, RKT/CSJ HTO, CRYO, Manned	WB RV 2258 Cost 1078	AB 2258 994	The all body configuration results in lower weight and cost with no change in research value
		(255)	(254)	
5	WB to AB Mach 12, RKT HTO, STOR, Manned	AB RV 1639 Cost 736	WB 1727 635	The wing body configuration results in lower weight and cost and an increase in research value.
		(253)	(256)	



REPORT MDC A0013 • 2 OCTOBER 1970  
VOLUME II • PART 2

ITEM	COMPARISON	ELIMINATE	RETAIN	BASIS
6	WB to AB Mach 12, RKT HTO, CRYO, Manned	WB RV 1816 Cost 691 (251)	AB 1816 621 (250)	The all body configuration results in lower weight and cost with no change in research value.
7	EAB to AB Mach 12, RKT HTO, CRYO, Manned	EAB RV 1816 Cost 628 (252)	AB 1816 621 (250)	(Same as 6)
8	EAB to AB Mach 6, RKT/RJ Staged, CRYO, Unmanned	EAB RV 1443 Cost 312 (221)	AB 1443 310 (220)	(Same as 6)
9	WB to AB Mach 12, RKT AIR, CRYO, Manned	WB RV 1786 Cost 564 (234)	AB 1786 484 (233)	(Same as 6)

5.1.1.2 (U) Propellants - Propellant comparisons were used to eliminate two additional configurations.

ITEM	COMPARISON	ELIMINATE	RETAIN	BASIS
1	LO <sub>2</sub> /RP to N <sub>2</sub> O <sub>4</sub> / Aero 50 Mach 12, RKT HTO, WB, Manned	LO <sub>2</sub> /RP RV 1727 Cost 660 (256 -H1D)	N <sub>2</sub> O <sub>4</sub> /Aero 50 1727 635 (256)	The N <sub>2</sub> O <sub>4</sub> /Aero 50 configuration is lower weight and cost with no change in research value.
2	N <sub>2</sub> O <sub>4</sub> /Aero 50 to LH <sub>2</sub> Mach 12, RKT Staged, AB, Unmanned	N <sub>2</sub> O <sub>4</sub> /Aero 50 RV 1222 Cost 222 (282)	LO <sub>2</sub> /LH <sub>2</sub> 1366 184 (281)	The LO <sub>2</sub> /LH <sub>2</sub> configuration results in lower weight and cost and an increase in research value.

5.1.1.3 (U) Propellants and Body Shape - Selection between the alternates of an all body vehicle using cryogenic propellants and a wing body vehicle using storable propellants is not straight forward. For an operational system operational procedures, maintenance and costs of the propellant system are important considerations. These factors are not as significant for a research airplane and the choice is driven more by the type of research which has been defined for the potential operational system than by the costs.

COMPARISON	ELIMINATE	RETAIN	BASIS
LO <sub>2</sub> /LH <sub>2</sub> All Body to N <sub>2</sub> O <sub>4</sub> /Aero 50 Wing Body Mach 12, RKT HTO, Manned	N <sub>2</sub> O <sub>4</sub> /Aero 50 Wing Body RV 1727 Cost 635  (256)	LO <sub>2</sub> /LH <sub>2</sub> All Body 1816 621  (250)	The LO <sub>2</sub> /LH <sub>2</sub> all body re- sults in lower weight and cost and an increase in research value.

5.1.1.4 (U) Control Mode - While there are three comparisons of configurations identical in all regards except for control mode, elimination of only one configuration was made on this basis.

COMPARISON	ELIMINATE	RETAIN	BASIS
Unmanned to Manned Mach 6, TRJ HTO, CRYO, WB	Unmanned RV 1637 Cost 780  (204)	Manned 1891 803  (205)	The weight and cost for the unmanned configuration is slightly lower, however this is offset by the increased research value for the manned configura- tion.

5.1.1.5 (U) Launch Mode - The air launch approach for a research aircraft appeared quite attractive. Launch mode comparisons resulted in elimination of five configurations.

ITEM	COMPARISON	ELIMINATE	RETAIN	BASIS
1	AIR to HTO Mach 6, TRJ WB, CRYO, Manned	HTO RV 1960 Cost 1123  (210)	AIR 1891 803  (205)	While the HTO configuration pro- vides more research value, the program costs are significantly reduced for the AIR configura- tion. On the basis of cost the AIR configuration is retained.
2	AIR to HTO Mach 6, RKT/RJ AB, CRYO, Manned	HTO RV 1870 Cost 663 (213)	AIR 1769 573 (207)	(Same as 1)
3	AIR to HTO Mach 12, RKT/CSJ AB, CRYO, Manned	HTO RV 2258 Cost 994 (254)	AIR 2228 809 (232)	(Same as 1)

ITEM	COMPARISON	ELIMINATE	RETAIN	BASIS
4	AIR to VTO Mach 12, RKT/CSJ AB, CRYO, Manned	VTO RV 2276 Cost 1045	AIR 2228 809	While the VTO configuration provides more research value the program costs are significantly reduced for the AIR configuration. On the basis of cost the AIR configuration is retained.
		(271)	(232)	
5	AIR to HTO Mach 12, RKT AB, CRYO, Unmanned	HTO RV 1488 Cost 619	AIR 1420 472	(Same as 1)
		(285)	(284)	

5.1.1.6 (U) Propulsion System - The previous comparisons have been rather straight forward since for all but one case only a single parameter was varied in making the evaluation. In the following comparison five additional concepts are eliminated predominantly on the basis of propulsion concept comparisons. However, in some cases factors other than propulsion system differences have a strong influence on the facility potential and resulting evaluation.

ITEM	COMPARISON	ELIMINATE	RETAIN	BASIS
1	Mach 4.5, WB, TRJ HTO, STOR, Manned to Mach 6, AB, RKT/RJ AIR, CRYO, Manned	TRJ RV 1505 Cost 574	RKT/RJ 1769 573	The total program cost for both vehicles are essentially identical. However the research value is 25% greater for configuration 207 than for configuration 200, and on this basis configuration 207 is retained.
		(200)	(207)	
2	Wing Body TRJ to All Body RKT/RJ Mach 6, AIR, CRYO Manned	TRJ RV 1891 Cost 803	RKT/RJ 1769 573	While the research value for the turboramjet configuration is slightly higher the cost is substantially higher. On the basis of the lower program cost the RKT/RJ configuration is retained.
		(205)	(207)	
3	TJ/RJ HTO to RKT/RJ AIR Mach 6, AB, CRYO Manned	TJ/RJ RV - Cost -	RKT/RJ 1769 573	Mission performance was not achieved for the turbojet accelerated all body, configuration 212. To achieve mission performance would require that the engine size be increased and would result in a higher weight and cost aircraft. Use of a wing body shape would be more suitable for the TJ/RJ configuration thus it is recommended that such a configuration be studied in Phase II.
		(212)	(207)	

ITEM	COMPARISON	ELIMINATE	RETAIN	BASIS
4	TJ/CSJ to RKT/CJS Mach 12, AB, AIR CRYO, Manned	TJ/CSJ RV - Cost -	RKT/CSJ 2228 809	Mission performance was not achieved for the turbojet accelerated all body, configuration 231. To achieve mission performance would require that the engine size be increased and would result in a higher weight and cost aircraft. This concept would be improved if a wing body shape were employed. Configuration 257 is such an aircraft employing HTO. It is felt that the study would provide more useful information by evaluating the HTO configuration in Phase II rather than the AIR configuration, thus configuration 232 is retained, and configuration 231 eliminated.
		(231)	(232)	
5	Off Shelf RKT(J2S) to Rubberized RKT (LR129) Mach 12, RKT, AB HTO, CRYO, Manned	Rubberized RKT RV 1816 Cost 621	Off Shelf RKT RKT 1816 556	Research value for these two configurations are identical. The lower program cost for the off shelf rocket appears attractive and the off shelf rocket is therefore retained.
		(250)	(250J2S)	

5.1.1.7 (U) Research Potential - Seven flight research vehicle concepts were eliminated on the basis of research potential as indicated in Figure 5-6. The staged vehicle concepts configurations 200, 280 and 281 are quite attractive. These vehicles do an excellent job for specifically identified research problems; however, they do not provide the broad research capability desired. To increase their capability, the number of vehicles would have to be increased many fold, which would result in a corresponding cost increase. Only eight flights, reusing each of the three flight vehicles, were assumed for the total program. The capability of these vehicles to conduct structural and thermal protection system research is excellent, however, the operational life and reusability aspects would be severely limited. While much aerodynamic and thermodynamic data throughout the flight regime could be obtained these vehicles would have little value in contributing to landing characteristics and man machine problems. It is the area of propulsion research where these vehicles are most severely limited. While the number of flights could be increased to provide the necessary flight test data (at the cost of a new booster and launch complex support for each additional flight) the calendar span time would be unreasonable. While this class of research vehicle is an extremely useful tool for specialized research they do not appear either sufficiently versatile or adaptable to accomplish the broad research program desired and are therefore not retained for further study.

(U) Similar to the staged vehicles, the variable stability airplane (Configuration 290) and low speed, flying qualities aircraft (Configuration 291 and Configuration 292) are low cost research vehicles and are very effective tools for obtaining specialized research. These vehicles are recommended for specialized

research programs, but do not provide the broad research capability desired for further HYFAC study and are therefore not retained for Phase II. Configuration 214 is a Mach 6, manned, all body, horizontal take-off, LOX-LH<sub>2</sub> rocket powered vehicle and provides high research value at a reasonable cost. Based on other applicable study comparisons such a vehicle in an air launched configuration would probably appear even more attractive. However, this concept is not judged to provide a big enough step over the X-15 program, and it is more desirable to expend further study effort on concepts in this speed class which employ airbreathing propulsion systems. Thus, while this concept has been determined to be a very attractive research tool it is not retained for Phase II refinement primarily because concepts of broader capability are of more interest for HYFAC study.

5.1.2 (U) SELECTION OF ATTRACTIVE FACILITIES - Those facilities appearing most attractive for retention in Phase II are indicated in Figure 5-6.

(U) In the Mach 6 class of vehicles, two configurations are retained, both of which are manned. The manned vehicles, while more costly, provide a higher research capability, as well as the desired flexibility and versatility for a broad research program. However, to further substantiate this result, an unmanned version of a M = 12 vehicle (Configuration 284) is retained for direct comparison with a manned version (Configuration 233).

(U) AIR and HTO configurations were chosen, for the Mach 6 vehicles. Turbojet, ramjet, and rocket propulsion options are retained to provide further information on these options in the Phase II parametric studies.

(U) Five Mach 12 class of vehicles are retained for Phase II. To the AIR and HTO options the added option of a vehicle having the capability of either horizontal or vertical takeoff is added. This configuration was selected since it provides a means of obtaining a direct comparison of operational factors for HTO and VTO, and could provide much useful data for future space shuttle vehicles. Turbojet, scramjet, convertible scramjet, and rocket propulsion options are also retained on the M = 12 vehicles to provide further information on these options in Phase II. Following is a discussion of each vehicle selected for retention in Phase II.

(U) Configuration -207 is a Mach 6, manned, all-body, air launched, LH<sub>2</sub> rocket accelerated, ramjet cruise concept which received a relatively high rating in research value at a moderate cost.

(U) Able to conduct a wide variety of research and exhibiting good versatility and growth capability, this concept can add much to the current level of research knowledge.

(U) The initial use of rocket propulsion provides a low development risk and would contribute to an early return of data. Ramjet development to Mach 3.5 is relatively complete and is not deemed to require a major effort in extending operation to Mach 6 and above.

(U) Substitution of other advanced air breathing propulsion for the ramjet would provide a major contribution to further development of turboramjet, scramjet and convertible scramjet technology.

(U) Configuration -212 is a Mach 6, manned, all-body, horizontal takeoff, turbojet accelerated, ramjet cruise, LH<sub>2</sub> fueled vehicle. Initial efforts to inte-

grate an axisymmetric ramjet with turbojet accelerators into the all-body shape of Configuration -212 created rather unwieldy configurations. The large inlet area needed by the ramjet engine at the required thrust level did not integrate well with the inlet requirements of the turbojets. In addition, the high transonic drag rise requires high thrust, thus large size engines resulting in a noncompetitive vehicle.

(U) However, the resulting low cost and risk associated with a vehicle employing an off-the-shelf turbojet as the accelerator engine suggests that further investigation of this option is desirable. Thus a combination of turbojet engines with ramjets in a wing body appears attractive. In a HTO configuration the research value is enhanced and in Phase II a design effort combining these attractive features will be initiated.

(U) Configuration -232 is a Mach 12, manned, all-body air-launched, rocket accelerated, convertible scramjet cruise, LH<sub>2</sub> fueled vehicle. It is one of the higher valued concepts in providing research capability although the program cost is high. The versatility of this vehicle and high research potential make it attractive for retention in Phase II.

(U) Configuration -233 is a Mach 12, manned, all-body, air-launched, rocket accelerated and cruise, LH<sub>2</sub> fueled vehicle. It is the lowest cost manned Mach 12 vehicle and provides good research potential. It is highly versatile and provides good growth capability as well as a high development confidence, thus making it one of the more attractive vehicles retained for Phase II.

(U) Configuration -250, a Mach 12, manned, all-body, horizontal takeoff, LH<sub>2</sub> rocket powered vehicle, was among the higher research value vehicles. An extremely versatile design with relatively good growth capability, it also shows a fairly low development risk. By assessing the impact of a passive thermal protection system and incorporation of HTO/VTO capability, direct comparison of these parameters can be made in Phase II.

(U) Use of an "off-the-shelf" rocket such as the J2S will result in lower program costs. Such an approach has been found feasible and will be incorporated in the Phase II analyses.

(U) Showing a good research return at moderate cost, this concept can be improved even more by combining it with the VTO concept, Configuration -270, allowing a more direct comparison of operational factors.

(U) Configuration -257, a Mach 12, manned, wing-body, horizontal takeoff, turbojet accelerated convertible scramjet cruise, hydrogen fueled concept, utilizing off-the-shelf (F100) primary propulsion, and with the versatility of testing all current air breathing propulsion concepts, this configuration attained a high research value. Although costly to develop, it provides research capability in a number of areas of interest.

(U) Configuration -257 is of rather large size compared to equivalent rocket powered vehicles, but has direct application to several of the potential operational vehicles of Section 3.

(U) Configuration -284, a Mach 12, unmanned, all-body, air launched LH<sub>2</sub> rocket powered vehicle, is being retained for further refinement studies during Phase II to provide a more complete assessment of the advantages and/or disadvantages of unmanned testing concepts.

5.1.3 (U) DESIGN AND OPERATIONAL CONCEPT COMPARISONS - The direct comparison (go no-go) approach is rather straight forward and assures consistent judgements. However, if these were the only comparisons made the evaluation would lose sight of those design and operational concept options which drive the results. Therefore, it is desirable to examine these influences. The following sections examine the results of the design and operational options on the flight research aircraft weights, costs and research value in order to develop trend information.

5.1.3.1 (U) Manned-Unmanned Comparisons - While unmanned systems do not provide the flexibility and versatility desired for a broad research program, this comparison was made to examine the weight and cost differences and assess their significance.

(U) Figure 5-7 shows the weight comparisons for a typical manned and unmanned vehicle. Using an average overall packaging density of 20lb/ft<sup>3</sup> (32 kg/M<sup>3</sup>), which is representative for these class of vehicles, results in a volume increment of approximately 25 ft<sup>3</sup> (.7 M<sup>3</sup>) for a manned vehicle over an unmanned vehicle. Incorporation of this weight and volume increase in the vehicle design results in a weight and cost increase for the configurations studied, as shown in Figure 5-8. The weight and size differences are small which reflects the fact that the volumetric and therefore size requirement is driven by the volumetric requirement for the low density LH<sub>2</sub>, and not by the equipment and furnishing requirement. This is further evident by examining the percentage weight increase between the configurations studied. It is seen that the smaller the vehicle the greater the percentage increase, verifying that as the fuel volume is increased the more negligible is the effect of furnishing differences.

(U) As expected the research value for the unmanned configuration was lower in all cases. This is illustrated in Figure 5-9. The costing analysis conducted in Phase I was not very sophisticated and did not reflect differences in the reliability of manned and unmanned aircraft. It is expected that these differences may be significant and would result in increased cost for the unmanned system when properly accounted for. Thus, a further manned-unmanned comparison appears warranted for Phase II study.

(U) FIGURE 5-7  
 TYPICAL WEIGHT COMPARISON - MANNED, UNMANNED

	WEIGHT lb (Kg)	
	MANNED	UNMANNED
o COCKPIT STRUCTURE CANOPY AND WINDSHIELD	526 (239)	
o EQUIPMENT BAY STRUCTURE		150 (68)
o EQUIPMENT	805 (365)	1210 (599)
o MAN	240 (109)	
o SEAT, CONSOLE	280 (127)	
TOTAL	1851 (840)	1360 (617)
DIFFERENCE	Δ = 491 (223)	

(U) FIGURE 5-8  
 MANNED-UNMANNED COMPARISON

Vehicle Class	Type	Configuration Number	TOGW Lb/(kg)	ΔTOGW Lb/(Kg)	Cost (\$ x 10 <sup>-6</sup> )	ΔCost (\$ x 10 <sup>-6</sup> )
M = 12 Rocket HTO All Body Cryogenic	M	250	130,040 (58,985)	+ 1,340 (+ 608)	620.9	+ 1.7
	U	285	128,700 (58,377)		619.2	
M = 12 Rocket Air Launch All Body Cryogenic	M	233	74,780 (33,919)	+ 1,000 (+ 454)	484	+ 11.8
	U	284	73,780 (33,466)		472.2	
M = 6 TRJ Air Launch Wing Body Cryogenic	M	205	25,740 (11,675)	+ 661 (+ 300)	803.3	+ 23.3
	U	204	25,079 (11,376)		779.9	

(U) FIGURE 5-9  
 VALUE COMPARISON - FLIGHT VEHICLE CONTROL MODE

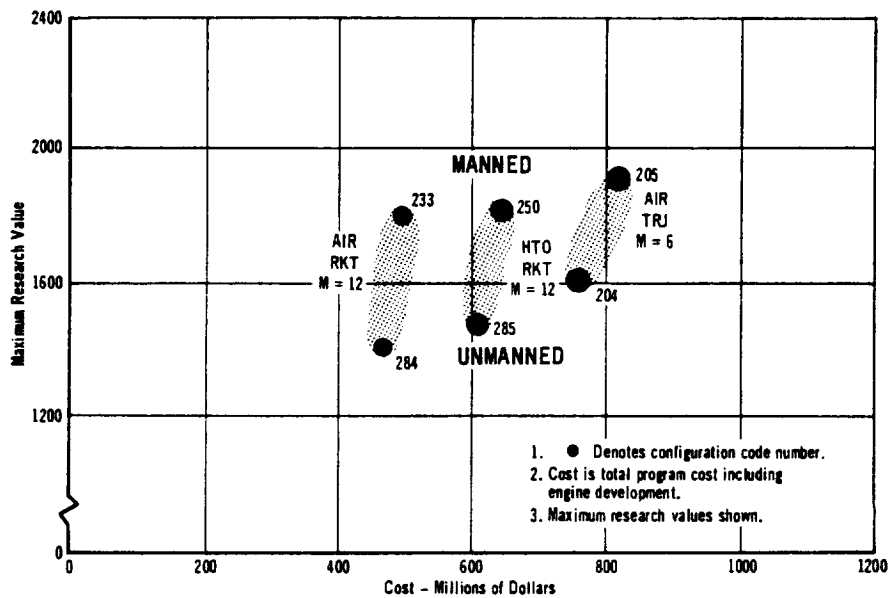



5.1.3.2 (U) Propellant Type - Comparisons - For the Phase I study the fuel for the airbreather systems was taken as LH<sub>2</sub> for all vehicles except for the M = 4.5 turbo-ramjet vehicles which utilizes JP. However, for the rocket systems cryogenic propellant systems utilizing LOX/LH<sub>2</sub>, storable systems using N<sub>2</sub>O<sub>4</sub>/AERO 50 and a LOX/RP system were studied. A comparison of weights and costs is given in Figure 5-10.

(U) From the comparison of the storable propellant configuration (256) to the LOX/RP (256-H1D) it is seen that the N<sub>2</sub>O<sub>4</sub>/AERO 50 vehicle is smaller, lighter and of lower total program cost, and is certainly the better choice of propellants.

(U) Three comparisons of storables and cryogenic propellant configurations are shown in Figure 5-10. It is seen that when this comparison is made in a Wing Body shape the storable propellant vehicle, while smaller in size, is heavier in OWE and TOGW, particularly TOGW, but lower in program cost. The heavier weight is due to significantly lower (30%) specific impulse of the storable fueled rocket. The major factor contributing to the lower cost is the significantly lower development cost for the storable rocket when compared to the cryogenic rocket, however, this is somewhat offset by the increased propellant cost for the storable vehicle.

(U) FIGURE 5-10  
 PROPELLANT COMPARISONS

	Type	Configuration Number	TOGW/OWE Lb/(Kg)	ΔTOGW/ΔOWE Lb/(Kg)	Cost (\$ x 10 <sup>-6</sup> )	ΔCost (\$ x 10 <sup>-6</sup> )
M = 12 Rocket HTO Wing Body Manned	S	256	248,420/41,420 (112,681/18,788)		634.9	
	S	256 -H1D	378,100/55,600 (171,000/25,200)	+129,680/+14,180 (+58,800/+6430)	660	+25.1
M = 12 Rocket HTO Wing Body Manned	C	251	148,640/37,840 (67,422/107,822)		691.5	
	S	256	248,420/41,420 (112,681/18,788)	+99,780/3580 (+45,529/+1624)	634.9	-56.6
M = 12 Rocket HTO All Body Manned	C	250	130,040/31,000 (58,985/14,061)		620.9	
	S	253	314,900/50,200 (142,835/22,700)	+184,860/+19,200 (+83,851/+8709)	735.5	+115.4
M = 12 Rocket Staged All Body Unmanned	C	281	13,020/10,880 (5906/4935)		184.3	
	S	282	17,310/13,360 (7852/6060)	+4290/+3480 (+1946/+1578)	222.3	+38

(U) When the same comparison is made in all all-body shape, it is seen that volumetric efficiency of the all-body shape lends itself to the large volume requirements of the LH<sub>2</sub> vehicle. The vehicle size difference between the all-body and wing-body is decreased which results in a significant weight advantage for the all-body configuration and a significantly lower program cost, even though the engine development costs are high.

(U) Wing loadings for the storable configurations, in particular configuration 253, are high. Typical values for the potential operational systems range between 50 to 80 lb/ft<sup>2</sup> (2394 to 3830 N/M<sup>2</sup>). Also to be considered is that the comparisons are based on vehicles having a cruise propellant requirement of only five minutes. Thus, propellant costs are not a major factor as they could be for an operational system.

(U) Comparison of the cryogenic all-body vehicle with the storable wing-body vehicle for identical system capability (configuration No. 250 to 256 comparison) shows a slight improvement for the all-body. However, the differences are too small to be conclusive, and further choice must be based on other considerations. As previously noted, a change in ground rules could change the results for an operational system.

5.1.3.3 (U) Vehicle Shape Comparisons - Vehicle body shape comparisons are shown in Figures 5-11 and 5-12. It is seen that there is not a distinguishable difference between the all-body and elliptical all-body configurations studied. All-body to wing-body comparisons shown in Figure 5-12 show conclusively that for cryogenic propellants all-body configurations are the most effective. Wing-body configurations appear most suitable for the use of high density propellants.

(U) FIGURE 5-11  
 ALL BODY-ELLIPTIC ALL BODY COMPARISONS

Vehicle Class	Type	Configuration Number	TOGW Lb/(Kg)	ΔTOGW Lb/(Kg)	Cost (\$ x 10 <sup>-6</sup> )	Δ Cost (\$ x 10 <sup>-6</sup> )
M = 12 Rocket HTO Cryogenic Manned	AB	250	130,040 ( 58,985)		620.9	
	E-AB	252	132,380 ( 60,046)	+ 2,340 (+ 1,061)	628.5	+ 7.6
M = 12 RJ Staged Cryogenic Unmanned	AB	220	13,230 ( 6,001)		310.	
	E-AB	221	13,530 ( 6,137)	+300 (+136)	312.1	+ 2.1



(U) FIGURE 5-12  
 ALL BODY TO WINGED BODY COMPARISONS

Vehicle Class	Type	Configuration Number	TOGW Lb/(Kg)	ΔTOGW Lb/(Kg)	Cost (\$ x 10 <sup>-6</sup> )	Δ Cost (\$ x 10 <sup>-6</sup> )
M = 12 Rocket HTO Cryogenic Manned	AB	250	130,040 ( 58,985)		620.9	
	WB	251	148,640 ( 67,422)	+18,640 (+ 8,455)	691.5	+ 70.6
M = 12 Rocket HTO Storable Manned	AB	253	314,900 (142,835)		735.5	
	WB	256	248,420 (112,681)	-66,480 (-30,155)	634.9	-100.6
M = 12 Rocket + CSJ HTO Cryogenic Manned	AB	254	135,180 ( 61,316)		994.3	
	WB	255	176,400 ( 80,013)	+41,220 (+18,697)	1077.6	+ 13.3
M = 12 Rocket Air Launch Cryogenic Manned	AB	233	74,780 (33,919)		484	
	WB	234	96,050 (43,567)	+21,270 ( +9,648)	564.2	+ 80.2

5.1.3.4 (U) Launch Mode Comparison - Three different launch modes were examined for manned vehicles in Phase I. These include (1) conventional horizontal takeoff (HTO) vehicles, (2) B-52 or C-5A launched (AIR) vehicles similar to the X-15 and HL-10 and (3) vertical takeoff (VTO) vehicles having conventional landing capability (i.e., launch-tail sitting, land-horizontal).

(U) Figures 5-13 through 5-16 show comparisons of vehicle, volume, weight, program costs and research value for a number of manned M - 12 and M - 6 vehicles. Distinct trends are evident, independent of the vehicle speed class or propulsion concept.

(U) In considering the M = 12 vehicles, a small increment in weight and cost is evident from comparison of horizontal takeoff to vertical takeoff. The VTO and HTO vehicles are both designed using T/W = 1.5 rockets; however, the lift capability of the HTO essentially reduces the gravity losses when compared to the VTO vehicles thus resulting in a slightly smaller vehicle. The HTO vehicles were designed using wheel type gear for takeoff and landing while the VTO vehicle was designed using a skid type gear for landing. This difference results in a small weight increase in landing gear weight for the HTO vehicle. This weight difference is somewhat offset by the weight increase required in the aft end of the VTO vehicle when beefed up to provide tail sitting capability. The overall comparison shows a surprisingly small incremental difference in the HTO and VTO vehicles. Considering research values and costs, clearly the air-launched approach appears most attractive. Similar results are found for the M = 6 vehicles.

(U) FIGURE 5-13  
 LAUNCH MODE COMPARISONS

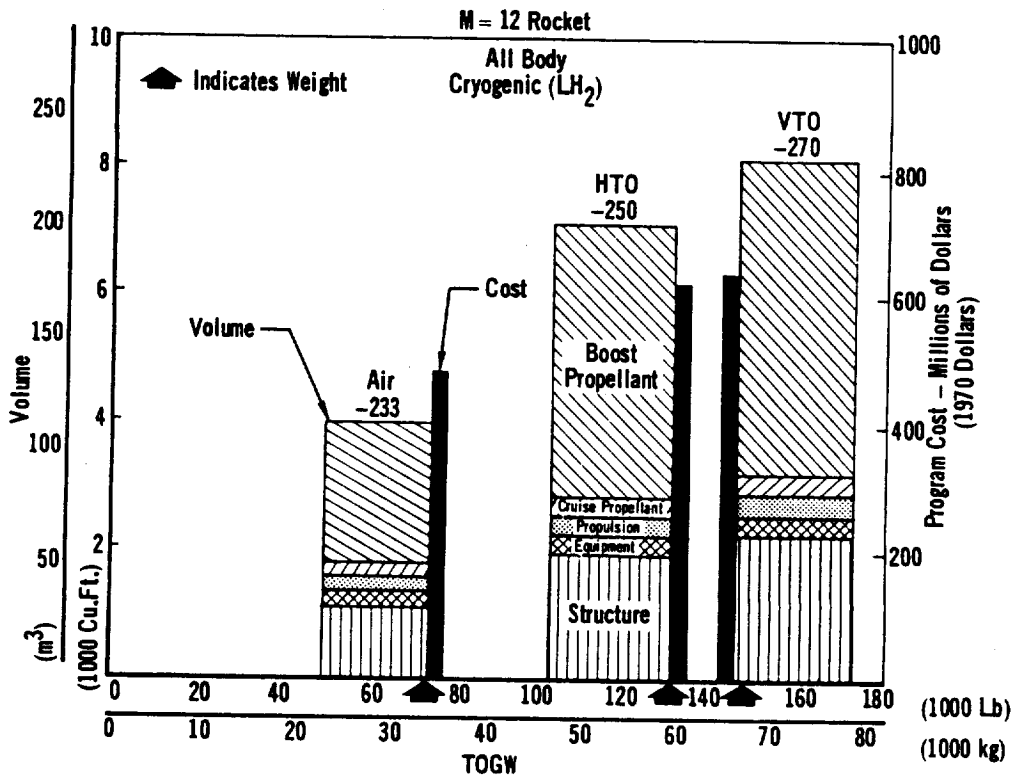

MCDONNELL AIRCRAFT

(U) FIGURE 5-14  
VALUE COMPARISONS - FLIGHT VEHICLE LAUNCH MODE, MACH 12

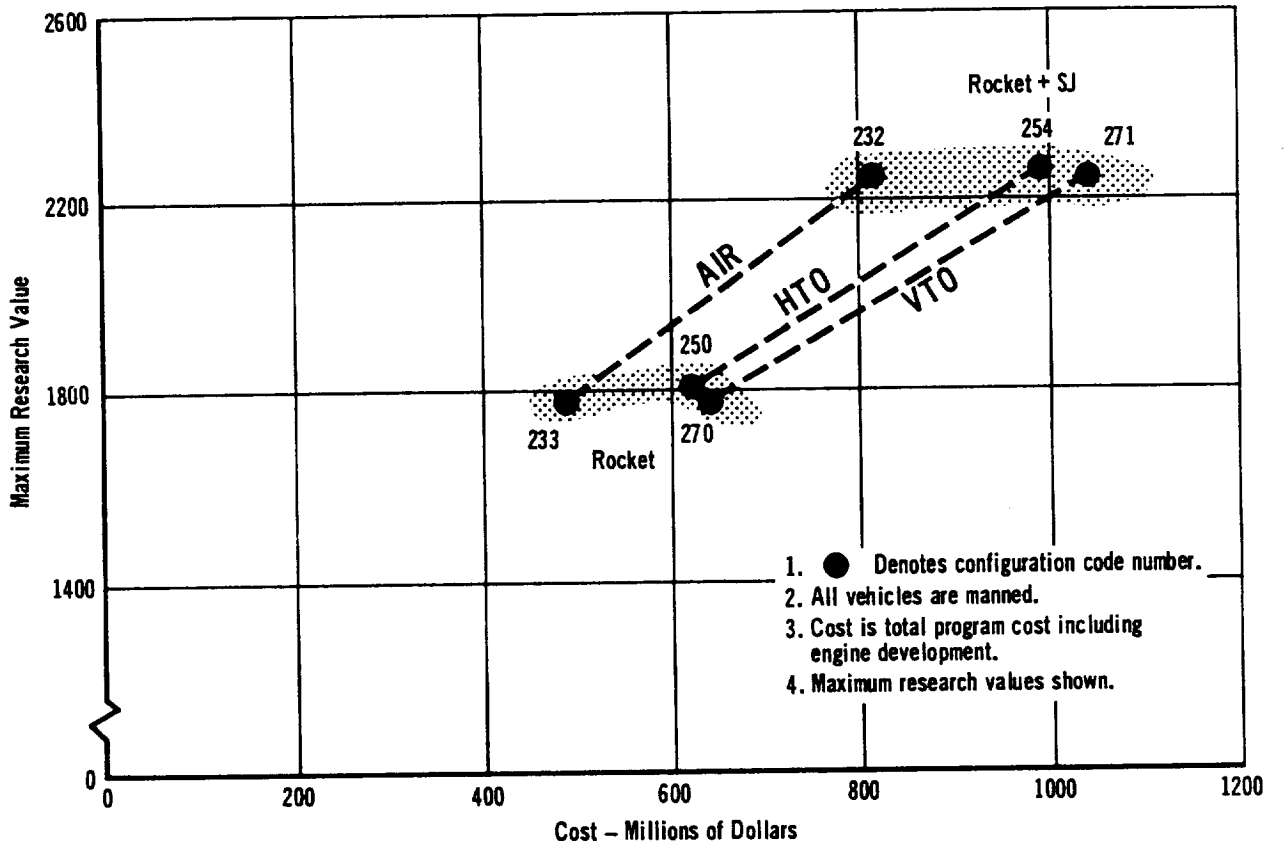

This Page Unclassified

(U) FIGURE 5-15  
LAUNCH MODE COMPARISONS

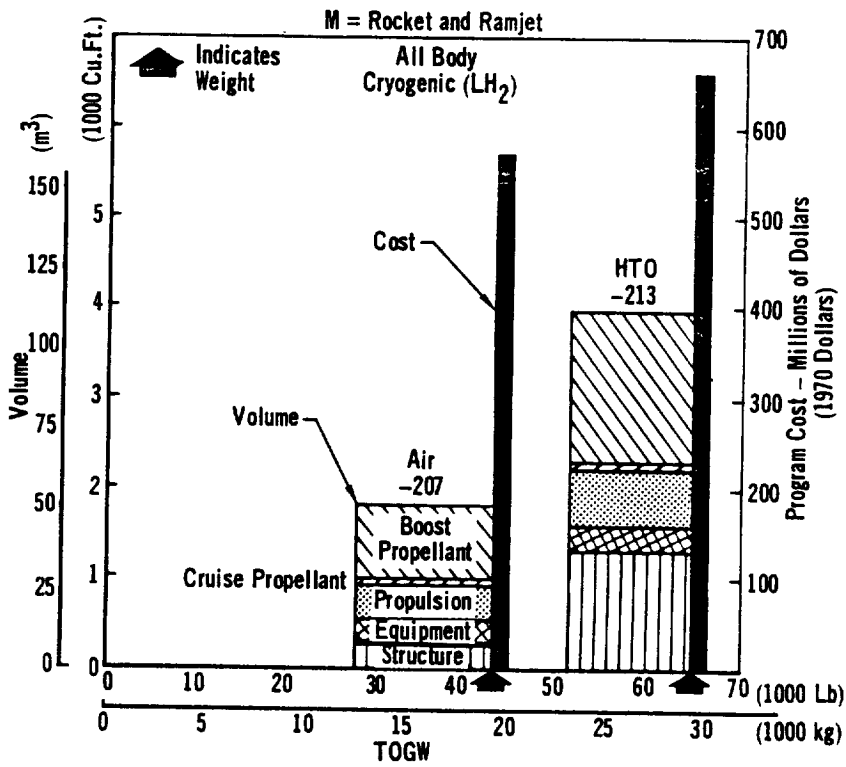

(U) FIGURE 5-16  
VALUE COMPARISON - FLIGHT VEHICLE LAUNCH MODE, MACH 6

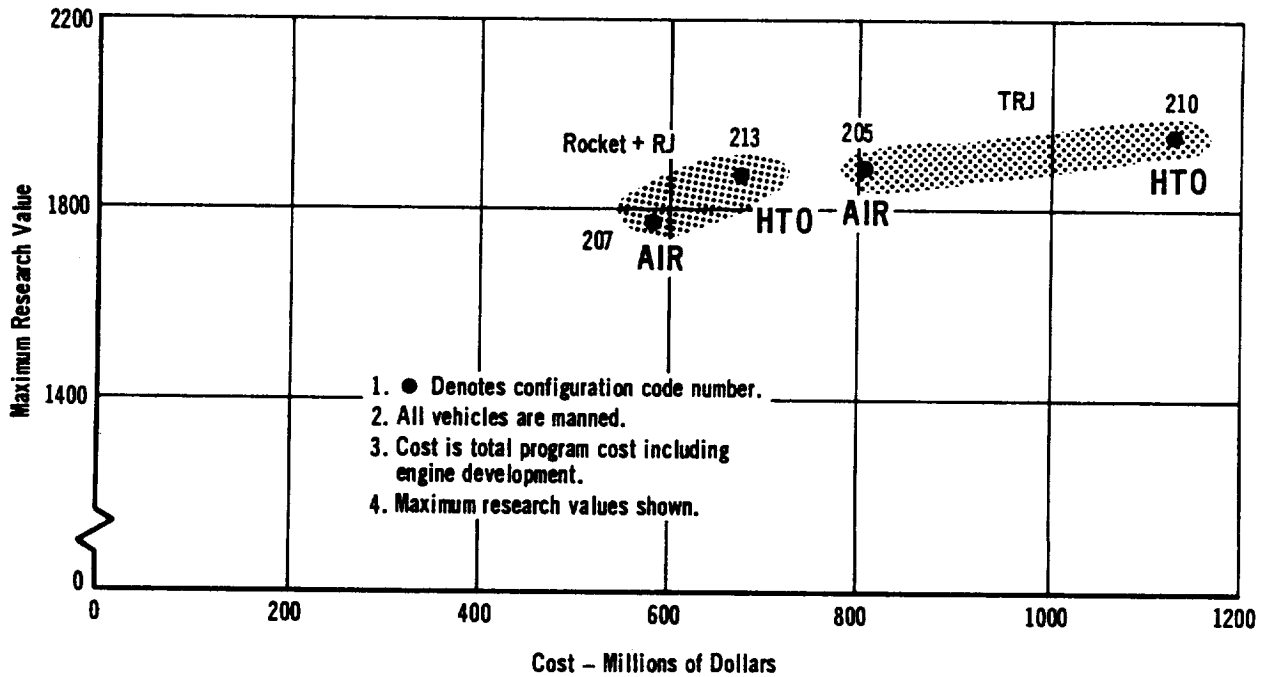

5.1.3.5 (U) Maximum Design Speed and Propulsion System Comparisons - Two fundamental issues of importance for the research vehicle are the maximum design speed and the type of propulsion system used. These issues have a major impact on the vehicle weight, program cost and research value. Figures 5-17, 5-18, 5-19 and 5-20 show weight and cost summaries for the candidate systems studied in Phase I.

(U) Figure 5-21 shows the cost comparisons for a number of the study vehicles. A number of definite cost trends are apparent. As expected, increasing speed capability increases the program cost. A straight line has been used to connect the design points merely to illustrate trends. It is well known that these trend lines are non-linear and are strongly influenced by the propulsion system specific impulse.

(U) Propulsion system influences on program costs are also shown. Systems employing only rockets are significantly more economical than those employing combined propulsion systems. Addition of airbreathing propulsion to a rocket propulsion system increases the program cost significantly. Changing the initial acceleration mode from rocket to turbojet with ram airbreathers as the hypersonic engine also introduces a significant cost increase. It appears that TJ + CSJ (configuration No. 257) does not show the same general trends when compared with TJ + RJ or more precisely TRJ (configuration No. 210). However, configuration 257 costs do not include the cost of developing the turbojet engine (approximately 250 million dollars) which has been assumed to be absorbed in developing this engine for a military program. If this cost is added to the costs of configuration 257 the TJ + (RJ/CSJ) trend line appears consistent with the other systems.

(C) To assess the program cost effect of using "off-the-shelf" engines a comparison of an all-rocket  $M = 12$  vehicle was made using a rubberized LR-129 rocket (configuration No. 250) and an "off-the-shelf" J2S rocket (configuration No. 250 J2S) engine, their  $I_{sp}$  being 452 sec and 431 sec respectively. Figure 5-17 shows the weight and cost comparison and indicates that while heavier, due to the  $I_{sp}$  differences, the program costs are reduced for the J2S configuration. A performance comparison of these configurations is shown in Figure 5-22. It is seen that at a slightly reduced design speed  $M = 10.8$  the J2S vehicle would be of comparable weight with the LR-129 vehicle. This design point would reflect a significant program cost reduction over the  $M = 12$  LR-129 vehicle, approximately 200 million dollar reduction (i.e., 400 compared to 600 million dollars).

(U) A further assessment of existing off-the-shelf combinations of RL-10 engines appears to have potential application for other configurations. Also "off-the-shelf" turbojets appear feasible. The exceptions are turboramjets, ramjets, and scramjets none of which are expected to be "off-the-shelf" in the near future. In view of the appreciable cost reduction potential for "off-the-shelf" engines the Phase II effort for the recommended vehicles will initially be evaluated with "off-the-shelf" engines.

(U) Figure 5-23 compares research value and cost for a number of configurations studied. The high interest in airbreather propulsion systems is evident by the high research value attributed to those systems which employ airbreather propulsion, however there is an associated significant cost difference.

(U) FIGURE 5-17  
 M = 12 - COST AND WEIGHT COMPARISONS (HTO)

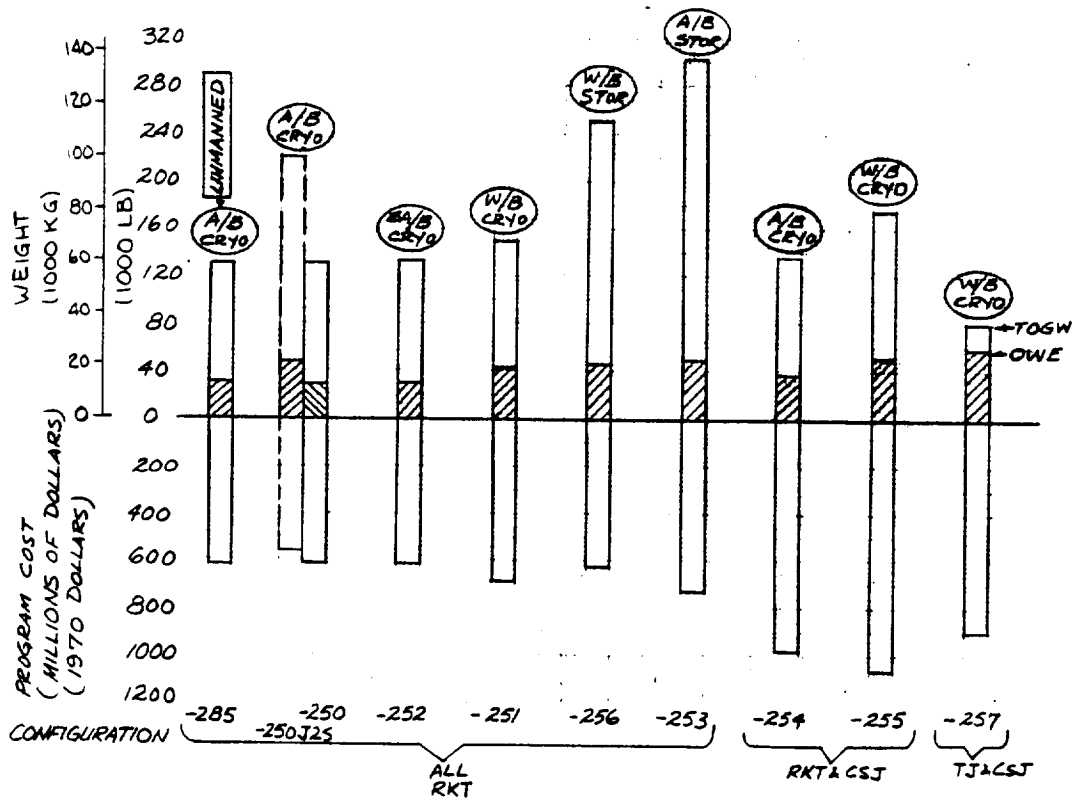

(U) FIGURE 5-18  
 M = 12 COST AND WEIGHT COMPARISONS (VTO & AIR LAUNCH)

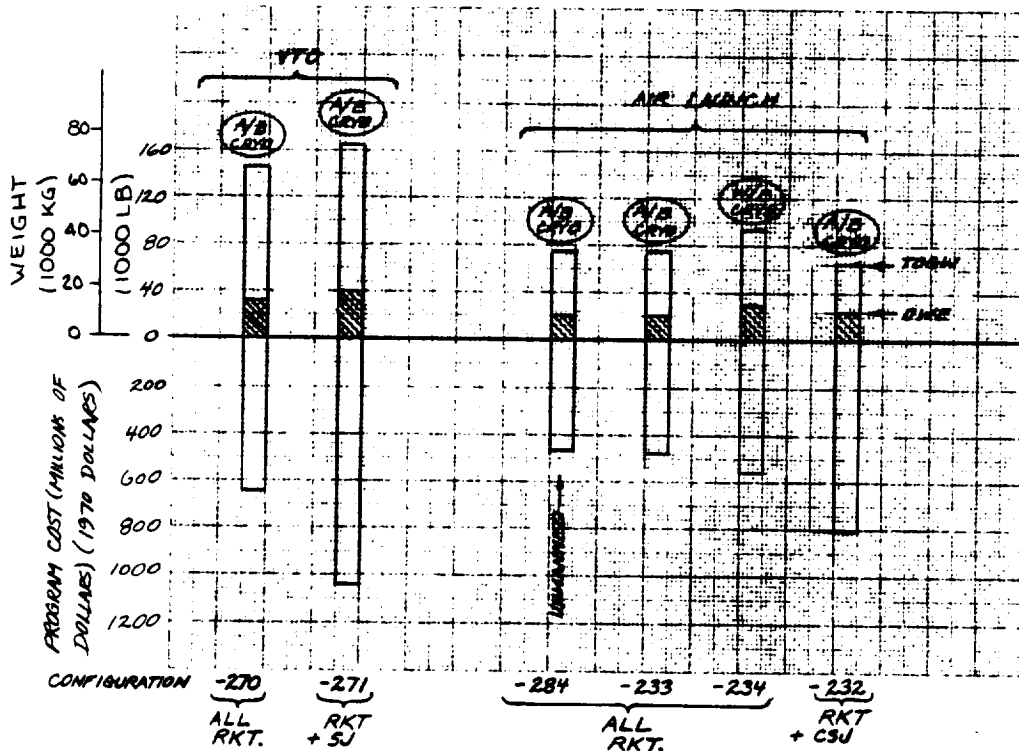



(U) FIGURE 5-19

M = 4.5 AND M = 6.0 - COST AND WEIGHT COMPARISONS (HTO AND AIR)

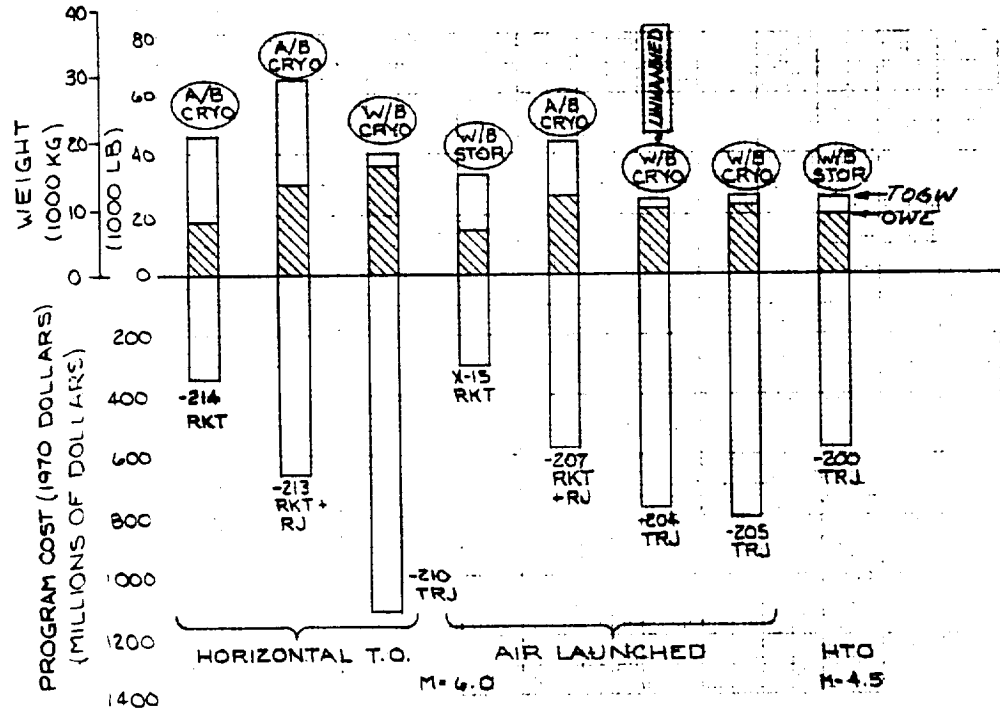

(U) FIGURE 5-20

M = 6 AND M = 12 COST AND WEIGHT COMPARISONS (STAGED, UNMANNED)

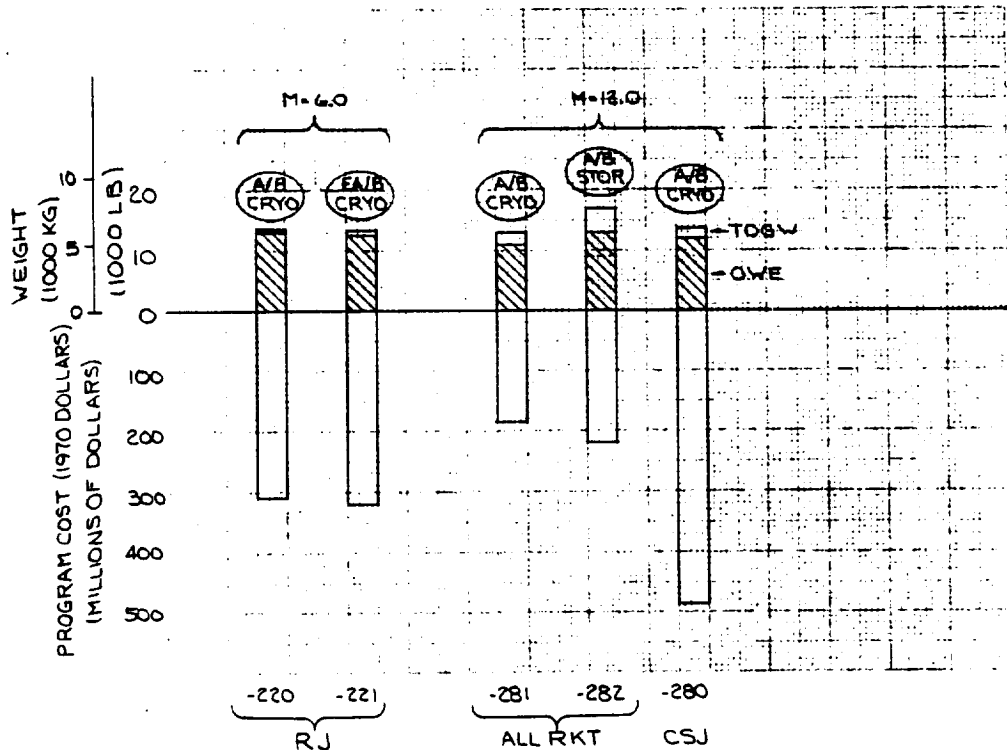

(U) FIGURE 5-21  
 COST TRENDS  
 (Including Engine Development)

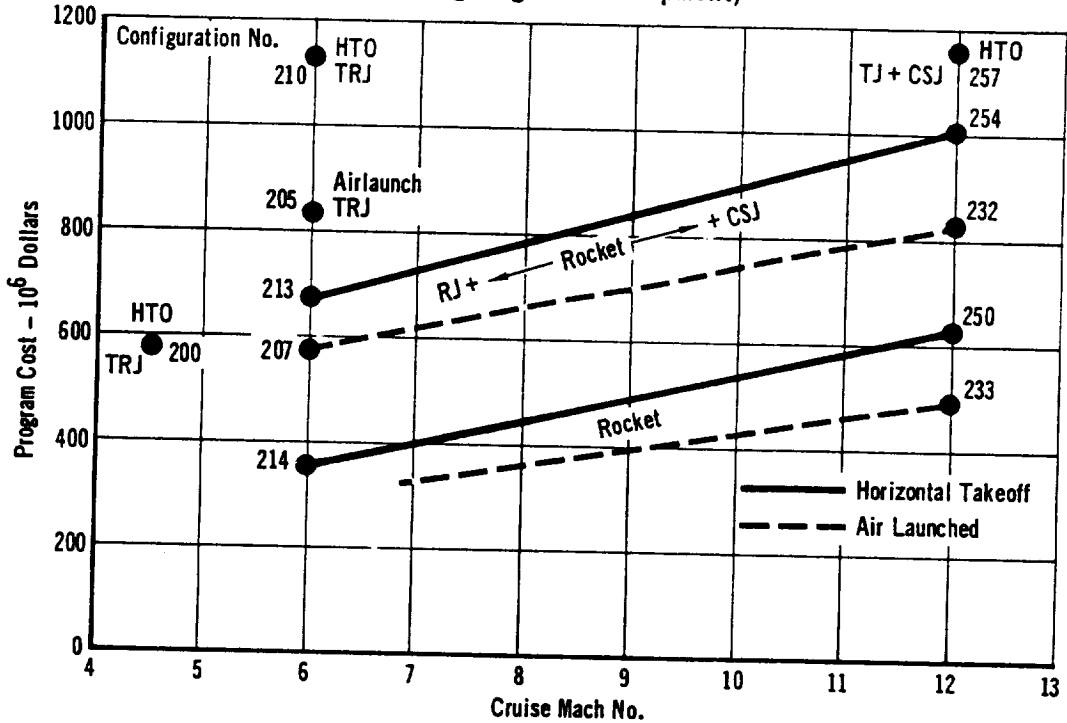

(U) FIGURE 5-22  
 EFFECT OF DESIGN MACH NO. ON VEHICLE WEIGHT

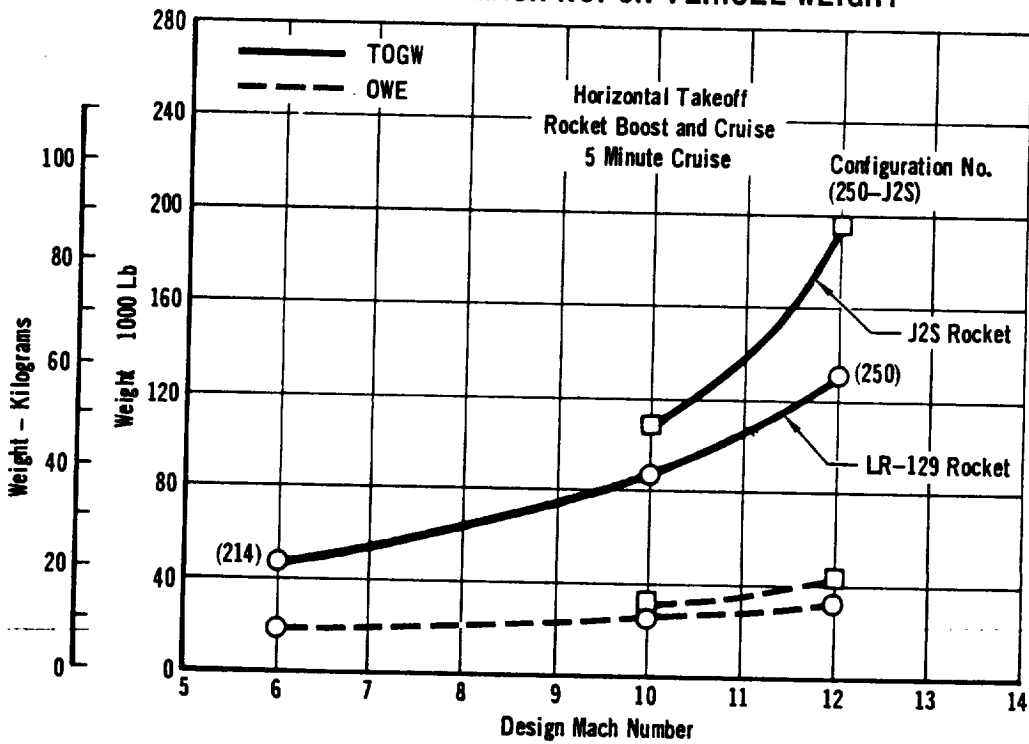

(U) FIGURE 5-23  
VALUE COMPARISON - PROPULSION MODES, M = 12 VEHICLES

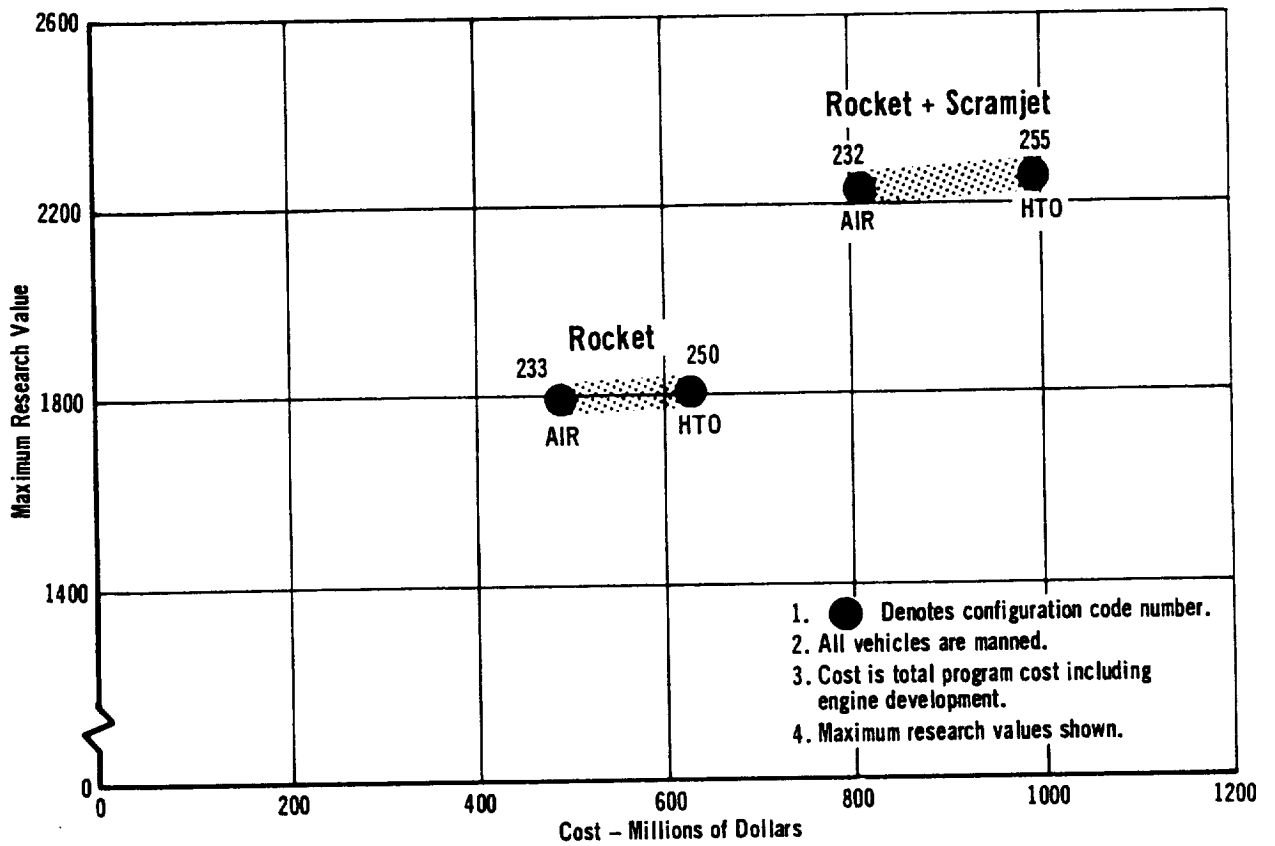

5.2 (U) RECOMMENDED FACILITIES FOR PHASE II STUDIES

(U) As a result of the evaluation and selection process previously discussed in Section 5.1.1 and 5.1.2 and the trend information developed in Section 5.1.3, the vehicle concepts listed in Figure 5-24 are recommended for retention for Phase II parametric study and refinement.

(U) The group selected will provide further assessment of different speed classes, launch modes, control modes and propulsion systems. Since the Phase I studies of body shape and propellant type provided some very definite trends, it does not appear that further extensive studies are warranted. Therefore, studies will be limited to design refinement of the options selected for the attractive vehicles.

(U) **FIGURE 5-24**  
**RECOMMENDED PHASE II FACILITIES**

FLIGHT RESEARCH VEHICLES			
MACH NO.	LAUNCH MODE	PROPULSION	DESCRIPTION
6	Air	RKT + RJ	Manned, All Body, LH <sub>2</sub>
	HTO	TJ + RJ	Manned, Wing Body, LH <sub>2</sub>
12	Air	RKT + SJ	Manned, All Body, LH <sub>2</sub>
	Air	RKT	Manned, All Body, LH <sub>2</sub>
	Air	RKT	Unmanned, All Body, LH <sub>2</sub>
	HTO	TJ + CSJ	Manned, Wing Body, JP/LH <sub>2</sub>
	HTO/VTO	RKT	Manned, All Body, LH <sub>2</sub>

6. REFERENCES

1. Spencer, Bernard Jr., "A Simplified Method For Estimating Subsonic Lift-Curve Slope at Low Angles of Attack for Irregular Planform Wing", NASA TMS-525, May 1961, (CONFIDENTIAL).
2. "Comparative Propulsion Systems Concepts Study (U)", MCAIR Report to be released as USAF AFAPL-TR-69-91, 8 September 1969, (SECRET).
3. "Air Force Reuseable Rocket Engine Program XLR129-P-1 Engine Program, (U)" April 1969, AFRPS-TR-69-19, (CONFIDENTIAL).
4. "Throttling and Scaling Study for Advanced Storable Engine, Part 2 of Two Parts, Appendix I, ARES Size Scaling Data, (U)" January 1968, AFRPL-TR-68-2 Part 2, (CONFIDENTIAL).
5. "Oxygen/Hydrogen and Flourine/Hydrogen Rocket Engine Parametric Data," 19 January 1968, Pratt and Whitney Aircraft PDS-2687.
6. "Liquid Propellant Engine Manual, (U)" CPIA Manual M5, (CONFIDENTIAL).
7. "Variable Cycle Turboramjet GE14/JZ8, Preliminary Performance and Installation Manual, (U)", GE Report, USAF Contract AF33615-69-6-1245, September 1969, (CONFIDENTIAL).
8. "GE5/JZ6 Study C, Wrap-Around Turboramjet, Turbo-Accelerator Propulsion System Study Data, (U)", GE Report SS-65-2, 1 December 1965, (CONFIDENTIAL).
9. "Hypersonic Ramjet Propulsion Program, Engine Performance, (U)", Marquardt Report 6112, 8 August 1966, (CONFIDENTIAL).
10. MA188-XAB Baseline Dual Mode Scramjet for the McDonnell/Douglas Reusable Launch Vehicle Application, (U)", Marquardt letter to MCAIR 1966, (CONFIDENTIAL).
11. Hypersonic Scramjet Vehicle Study (U)", MCAIR Report F666, 15 October 1967, (SECRET).
12. "Inlet/Engine/Nozzle Installation, F-15 Contract Definition (U)" MCAIR Proposal H100, 29 June 1969, (SECRET).
13. MCAIR Report 747, Volume I, Structural Weight Estimation.
14. Shanley, F. R., Weight Strength Analysis of Aircraft Structures, 1 July 1952, Bond Corporation.
15. Taylor, R. J., "High Temperature Airframe Weight Estimation," May 1965, S.A.W.E. Technical Paper No. 479.
16. Structures and Weights, Volume VII, Hypersonic Scramjet Vehicle Study, MAC Report F666, McDonnell Douglas Corporation, October 1967, (SECRET).

17. Roark, R. J., "Formulas for Stress and Strain", 1954, McGraw-Hill Book Company.
18. Detail Weight Statement, Actual Weight and Balance Report for X-15, System 60SA Airplane, Report No. NA59-1464, North American Aviation, Inc., July 1959.
19. Lockheed Report IR 21042, "A Study of Advanced Airbreathing Launch Vehicles With Cruise Capability", Volume V; Economics Model.
20. NASA Report TND 3732, "Survey of Operation and Cost Experience of the X-15 Airplane as a Reusable Space Vehicle", November 1966.
21. TAE Paper, "Operational Experience of the X-15 Airplane as a Reusable Vehicle System", May 9 - 11, 1967.
22. MAC Report F666, Volume 10, "Hypersonic Scramjet Vehicle Study", 15 October 1967.
23. MDAC East Report G975, "Optimized Cost/Performance Design Methodology", 15 April 1969.
24. AFM 172-3, "Peacetime Planning Factors Manual", 27 April 1969.
25. Schneider, P. J., "Temperature Response Charts," John Wiley and Sons, Inc.