

Digital Fabrication Approaches for the Design and Development of Shape-Changing Displays

By Aluna Everitt



This dissertation is submitted for the degree of
Doctor of Philosophy

February 2020

School of Computing and Communications
Lancaster University

| Declaration

This thesis has not been submitted in support of an application for another degree at this or any other university. It is the result of my own work and includes nothing that is the outcome of work done in collaboration except where specifically indicated. Many of the ideas in this thesis were the product of discussion with my supervisor, Dr. Jason Alexander.

Excerpts of this thesis have been published in the following conference manuscripts and academic publications.

Published Papers:

Everitt, Aluna, Faisal Taher, and Jason Alexander. "ShapeCanvas: An exploration of shape-changing content generation by members of the public." In Proceedings of the 2016 CHI Conference on Human Factors in Computing Systems, pp. 2778-2782. ACM, 2016.

Everitt, Aluna, and Jason Alexander. "PolySurface: a design approach for rapid prototyping of shape-changing displays using semi-solid surfaces." In Proceedings of the 2017 Conference on Designing Interactive Systems, pp. 1283-1294. ACM, 2017.

Nabil, Sara, **Aluna Everitt**, Miriam Sturdee, Jason Alexander, Simon Bowen, Peter Wright, and David Kirk. "ActuEating: Designing, Studying and Exploring Actuating Decorative Artefacts." In Proceedings of the 2018 on Designing Interactive Systems Conference 2018, pp. 327-339. ACM, 2018.

Everitt, Aluna, and Jason Alexander. "3D Printed Deformable Surfaces for Shape-Changing Displays." *Frontiers in Robotics and AI* - Vol. 6 (2019): 80.

Papers in progress:

Everitt, Aluna, Alexander K Eady, and Audrey Girouard. "Multi-Material 3D Printing for Rapid Prototyping of Deformable and Interactive Wearables" In progress for submission.

Aluna Everitt, BSc (Hons)
Lancaster University, UK

| Acknowledgements

A huge thank you to my PhD supervisor Dr. Jason Alexander. The work contained within this thesis was supported by departmental funding from the School of Computing and Communications at Lancaster University. It was partially supported by GHOST, a project funded by the European Commission's 7th Framework Programme - FETOpen scheme (Grant #309191) and the EPSRC's MORPHED project (grant #EP/M016528/1). Part of this work was also conducted at CIL: Creative Interactions Lab, Carleton University, Canada. Thank you also to the Friend's programme Research Travel Conference Fund.

| Dedication

I dedicate this thesis to my mum and dad.

Thank you both so much for being amazing.

| Abstract

Interactive shape-changing displays enable dynamic representations of data and information through physically reconfigurable geometry. The actuated physical deformations of these displays can be utilised in a wide range of new application areas, such as dynamic landscape and topographical modelling, architectural design, physical telepresence and object manipulation.

Traditionally, shape-changing displays have a high development cost in mechanical complexity, technical skills and time/finances required for fabrication. There is still a limited number of robust shape-changing displays that go beyond one-off prototypes. Specifically, there is limited focus on low-cost/accessible design and development approaches involving digital fabrication (e.g. 3D printing). To address this challenge, this thesis presents accessible digital fabrication approaches that support the development of shape-changing displays with a range of application examples – such as physical terrain modelling and interior design artefacts. Both laser cutting and 3D printing methods have been explored to ensure generalisability and accessibility for a range of potential users.

The first design-led content generation explorations show that novice users, from the general public, can successfully design and present their own application ideas using the physical animation features of the display. By engaging with domain experts in designing shape-changing content to represent data specific to their work domains the thesis was able to demonstrate the utility of shape-changing displays beyond novel systems and describe practical use-case scenarios and applications through rapid prototyping methods. This thesis then demonstrates new ways of designing and building shape-changing displays that goes beyond current implementation examples available (e.g. pin arrays and continuous surface shape-changing displays). To achieve this, the thesis demonstrates how laser cutting and 3D printing can be utilised to rapidly fabricate deformable surfaces for shape-changing displays with embedded electronics. This thesis is concluded with a discussion of research implications and future direction for this work.

| Table of Contents

List of Figures.....	xii
List of Tables	xiv
1 Introduction.....	1
1.1 Motivations, Challenges, and Approaches	5
1.2 Methodology	11
1.2.1 Methodology Breakdown.....	12
1.3 Contributions	19
1.4 Thesis Structure.....	21
2 Literature Review	22
2.1 Shape-Changing Displays Definition.....	23
2.2 Tangible Interfaces	23
2.2.1 Physical User Interfaces.....	24
2.2.2 Data Physicalizations	26
2.2.3 Deformable User Interfaces (DUIs).....	30
2.3 Research Challenges in the Field	31
2.3.1 Challenges Faced by the Field	31
2.4 Overview of Shape-Changing Displays	36
2.4.1 Shape-Changing Displays.....	37
2.4.2 Interaction with Shape-Changing Displays.....	37
2.5 Technical Implementations of Shape-Changing Displays	42
2.5.1 Elastic Deformable Displays.....	43
2.5.2 Mechanical Pin-Actuation Displays	43
2.5.3 Shape-Memory Alloy (SMA) Actuation	46
2.5.4 Actuation Techniques from Robotics	47
2.5.5 Other Actuation Mechanisms	49
2.5.6 Summary of Subsection	49
2.6 Kinetic Art.....	50
2.6.1 Public Installations.....	50
2.7 Digital Fabrication Approaches	51
2.7.1 Laser Cutting Fabrication Methods	52
2.7.2 Semi-Solid Surface Design	53
2.7.3 3D Printing.....	53
2.7.4 4D Printing.....	55
2.8 Content Generation and Ideation Methodologies.....	56
2.9 Summary of Related Work.....	57

3	 Exploring Novice Content Generation.....	59
3.1	System Design.....	60
3.2	User Study.....	61
3.2.1	Study Format.....	61
3.2.2	Participant Demographics.....	62
3.2.3	Reactions to the Demo Applications.....	62
3.2.4	ShapeCanvas Application Ideas.....	62
3.2.5	Low-Level Interactions with ShapeCanvas.....	62
3.3	Physical Animations.....	63
3.3.1	General User Perceptions.....	65
3.4	Chapter Discussion.....	66
3.4.1	Physical Animations.....	66
3.4.2	Interaction Patterns.....	66
3.4.3	Limitations and Generalizability.....	67
3.5	Chapter Conclusion.....	67
4	 Engaging Domain Experts in Designing Shape-Changing Displays	69
4.1	Design and Fabrication Approach.....	71
4.1.1	Conceptual Approach.....	72
4.1.2	PolySurface: Implementation of Approach.....	72
4.2	Design Session Methodology.....	76
4.2.1	Meeting One: Design.....	77
4.2.2	Meeting Two: Evaluation.....	78
4.2.3	Display Showcase.....	78
4.3	PolySurface Design Sessions.....	78
4.3.1	Demographic Background.....	78
4.3.2	Participant 1.....	79
4.3.3	Participant 2.....	81
4.3.4	Participant 3.....	85
4.4	Additional Case-Studies.....	88
4.4.1	Interior Designer - Case Study.....	89
4.4.2	Sociologist - Case Study.....	93
4.5	Discussion of Studies.....	94
4.5.1	Simplification of Complex Data.....	94
4.5.2	Insights Gained.....	94
4.5.3	Input Data Types.....	95
4.5.4	Generalizability.....	95
4.5.5	Levels of Participation.....	95
4.5.6	Reflection on Approach.....	96
4.5.7	Limitations.....	96
4.6	Implications for Design and Fabrication.....	97
4.6.1	Data Representation and Temporality.....	97
4.6.2	Designing for Complex Geometry.....	99
4.6.3	Alternative Approaches for Fabrication.....	100

4.7	Chapter Conclusion	100
5	 Fabricating Shape-Changing Surfaces Using 3D Printed Interlinks.....	103
5.1	Fabrication Approach	105
5.1.1	Surface Scaling Based on 3D Printing Approaches.....	106
5.1.2	Actuation Explorations	107
5.1.3	Visualization Technique	108
5.1.4	Embedding Interaction.....	109
5.1.5	Surface Design Explorations.....	109
5.2	Surface Applications	113
5.2.1	Surface Applied to Existing State-of-the-Art	115
5.2.2	3D Printed Surface as a Stand-Alone Display	116
5.3	Chapter Discussion.....	118
5.3.1	Reflection on Contributions and Limitations.....	118
5.4	Chapter Conclusion	121
6	 Embedding Electronics for Deformable 3D Printed Surfaces.....	124
6.1	Design and Fabrication Approach.....	126
6.1.1	Core Concept of Approach	127
6.1.2	Technical Details of Implementation.....	127
6.1.3	3D Modelling Deformable Interfaces	127
6.2	Design Explorations	129
6.3	Use-Case Example - FlexiWear	132
6.3.1	Interaction Capabilities	133
6.3.2	Summary of Prototype Implementation.....	135
6.3.3	Ideation Workshop.....	136
6.4	Use-Case Example – Flexible Pixel Display.....	138
6.4.1	Design and Fabrication of Prototype	138
6.4.2	Application Ideas	139
6.5	Chapter Discussion.....	140
6.5.1	Design and Fabrication Considerations	140
6.5.2	Workshop Feedback.....	143
6.6	Chapter Conclusion	143
7	 Research Implications and Discussion.....	146
7.1	Summary of Thesis.....	146
7.2	Research Implications	147
7.2.1	Implications for Designers	147
7.2.2	Implications of Design Processes	149
7.2.3	Implications of Fabrication Processes	154
7.2.4	Addressing Technical Challenges.....	156
7.2.5	Visualisation and Interaction Techniques	158
7.2.6	Generalization	161
7.3	Research Methodology and Approach	162

7.3.1	Reflection on Research Methodology.....	163
7.3.2	Validation and Evaluations	164
7.3.3	Future Work and Limitations.....	166
7.4	Addressing the Research Questions	169
8	 Conclusion	173
	References	177
	Appendix A.....	195
	Documentation for Studies	195
	ShapeCanvas Study (Chapter 3)	195
	PolySurface (Chapter 4).....	200
	Workshop (Chapter 6)	212

| List of Figures

Figure 1: Breakdown of the research questions addressed in the thesis.	3
Figure 2: Examples of prototypes developed based on proposed fabrication approaches presented in each chapter of this thesis. Moving from traditional pin-array in Chapter 3, to a semi-solid laser cut two-layer surface in Chapter 4 that uses fewer linear actuators, to a single layer 3D printed deformable surface in Chapter 5, to finally a multi-material deformable surface that has embedded interaction and visualisation capabilities in Chapter 6.....	14
Figure 3: Standardised interaction model for GUIs (A) and TUIs (B) proposed initially by Ullmer and Ishii (2000).....	25
Figure 4: Examples of Data Physicalizations.....	28
Figure 5: Examples of shape-changing displays. Pin-arrays (A-D), continuous fabric (E), and elastic shape display (F).....	36
Figure 6: An original illustration of pin-screen [39] (A), pin impression toy (B), and side-view implantation of shapeShift, a mobile pin-array shape-changing display [156] (C).	44
Figure 7: ShapeCanvas, a 4x4 grid of height and colour actuating pixels (left) with touchscreen controls (right).	60
Figure 8: Height (left) and colour (right) interaction density (average number of interactions per participant) heat maps.	63
Figure 9: Assortment of animation frames created by participants. Photographs described inline.	64
Figure 10: Interactive shape-changing displays developed with PolySurface: A) a physical terrain model used for design session demos; B) physical bar-chart interface designed by P1; C) physical volcano modelling by P2; (D) interactive physical display to model eye tracking data by P3.	70
Figure 11: Breakdown of the conceptual approach.....	72
Figure 12: Segmentation process of a contour map.	73
Figure 13: (A) Laser cutting polypropylene sheet (0.8mm depth) and (B) fabricated polygonal surface. Securing shapes on the surface (C); Removing spacing guides (D); Gluing surface to Spandex (E); Removing tape (F).....	74
Figure 14: Map projection onto the surface (A) and frame from volcano vocalization (B).	75
Figure 15: Actuators in specific positions on an 8x6 grid above the flat monitor (A); Height control webpage underneath (B).	76
Figure 16: Hover interaction for shape selection (A); Interactive buttons on the surface (B); Button on side of display enclosure (C).	76
Figure 17: Example physical bar charts showing the distribution of None-EU (A) and male (B) students across six colleges.....	80

Figure 18: Physical state transition of volcano structure 95,000 years ago (A) and morphology with glacier overlay (B).....	81
Figure 19: Comparison of the same aerial photo of Bláhnúkur volcano. is rotated 180 degrees. (Imagery ©2016 Google, DigitalGlobe, Map data ©2016).....	82
Figure 20: Image from academic paper provided by participant(A-B). P2 showing the none-geologist sampling points on volcano (C) Contour map (D).....	84
Figure 21: Difference represented between target and gaze on point on a line (A) and a corner (B) from the square data sample.	85
Figure 22: P3’s colleague comparing elevation difference between circle frame 12 (A) and frame 8 (B).	87
Figure 23: Designing and making of ActuEater1. (1) Ideation and Sketching. (2) Prototyping the software and hardware. (3) Designing the pattern. (4) Creating the actuation. (5) ActuEater is ready and ‘dinner is served’.....	90
Figure 24: Designing and making of Actuator2. 1) Designing the pattern. 2) Making the colour-changing parts. 3) Stitching, crimping and sewing. 4) Creating the actuation. 5) ActuEater2.	91
Figure 25: Fabrication of a physical terrain map of Lancaster.	93
Figure 26: Basic 3D model (A) and 3D print (B) of interlinked panels, and fabricated shape-changing displays examples (C-E).	104
Figure 27: Bottom side of the surfaces. Interlinked triangular panels 3D printed (FDM) with red filament - Panel 21×19mm and interlink width 4mm (A); SLA with clear resin - Panel 20×17mm and interlink width 3mm (B). 3D model source [105].	106
Figure 28: Horizontal uniformed force on 1 side of the surface (A); for an elevated arch (B); Surface deformation without actuator support (C); and curved when the surface is slightly raised (D).	108
Figure 29: Visualization examples using over the surface (A) and under the surface (B) projection.	108
Figure 30: Two fine copper wires are interwoven through the surface for capacitive sensing.....	109
Figure 31: Initial 3D printed link designs for triangular (Left) and square panels (Right).	111
Figure 32: Interlink CAD design (triangular) with a limited angle for restricted movement on a triangular panel; and interlink design (curved) for more movement on a square panel.....	111
Figure 33: Examples of cylindrical and ovoid shape-output when links are on top and convex shape-output when links face down.	112
Figure 34: Optimal panel (15×15×2mm) & interlink (width=1mm) designed, with space between panels=2mm.....	113
Figure 35: Surface (280x280x8mm) with 2 actuators attached to 1 side. Interlinks on top with shape-output only on the far side (A), increased width of cylindrical shape	

when two actuators push areas used (B), and flat panels on top of the surface for “pointed” shape elevation (C).114

Figure 36: Interlinked surface over linear pin-array (A-C).115

Figure 37: Shape-Changing display set-up with under-the-surface projection to eliminate occlusion, 3 actuators on one side of display (A); Wave simulation application with 3 linear actuators (B); User manipulating surface with a tunnel (C); Temperature simulator for reef topography (D); Surface rendering 2.5D cylindrical form – banana (E).117

Figure 38: Comparison of actuators required using traditional pin-array shape-displays (Left) and using an interlinked 3D printed surfaces to achieve the same deformation with horizontal actuation force (Right).118

Figure 39: Prototype with copositive touch sensing and integrated LED electronics. Demonstrating interaction techniques for pressing (A), bending (B), stretching (C) on the hand and integrated into a pair of jeans, and user-deformed interaction.125

Figure 40: Final prototype tile and link 3D model design close-up that is merged in aggregate to create a deformable device.128

Figure 41: Initial tile design explorations with square (A), triangular (B), and hexagonal (C) polygons.129

Figure 42: Link design explorations; Wider vertical link design (A), thinner vertical link (B), final horizontal curved link (C).130

Figure 43: Circuit diagram of the layout of 3D printed surface, showing conductive connections (yellow) and LED connected with conductive thread (blue).131

Figure 44: Prototype (195x95x2mm) on hand (A) with light (B) and hard (C) pressing, integrated with a pair of jeans (D), pressing on a bent knee (E) and stretched on bend knee (F).132

Figure 45: Range of force when user continuously presses on four different rows of prototype recorded via Arduino Serial output (including noise).134

Figure 46: Small scale flexible and foldable pixel display. The surface is fully foldable (A-D), self-supporting (E-F), and retains its form once deformed (F). It can fit into a smaller bag by folding it (A). Users can deform and fold the display with their hands to change its form factors (B/D).139

Figure 47: Progression of prototypes, as the number of actuators reduces the surface structure moves away from physical pixels into a continuous surface with embedded interaction and visualisation capabilities.149

| List of Tables

Table 1: Participants’ demographic information.79

1 | Introduction

Shape-changing displays are emerging as a new generation of devices that can dynamically change their surface shape to represent data/information as well as support tangible interaction techniques, that go beyond that of conventional flat screen displays [6]. Shape-changing displays add dynamic interactive capabilities to tangible interfaces through the development of reconfigurable and actuated surfaces. Such interfaces have been used to represent a wide range of information as well as enhance communication capabilities. These physically deformable displays can be utilized in a wide range of new application areas, such as dynamic landscape and topographical modelling, architectural design, physical telepresence and object manipulation [138, 170]. Shape-changing displays predominately consist of mechanical actuators that support deformations of the display's surface. Essentially, they physically map digital input data into physical output representations that can dynamically morph and create new surface shape deformations [143].

These hardware systems enable dynamic data physicalizations, which can be defined as physical artefacts whose geometry or material properties encode data. In this thesis, I focus on dynamic physicalizations that encode data or information through their physical form. Tangibility is a key aspect of data physicalization and the form of the physical artefact is often perceptible by touch. These physical data representations often encourage direct interaction to create an engaging user experience.

This thesis focuses on interactive shape-changing displays and how they can support dynamic data physicalizations. Particularly, how to design and build shape-changing displays using novel yet accessible digital fabrication approaches. This thesis also explores how other people, both novice and experts, can design and build their own shape-changing displays and data physicalizations using the design and fabrication approaches that I propose.

Over recent years, the HCI research community has proposed numerous prototype systems that have explored a variety of shapes, forms, interactions, and implementation techniques. Despite the potential for enhancing information communication capabilities, there is still challenges faced by the field. Specifically, more understanding

is required as to how shape-changing displays can enhance user engagement with applications, from different domains, with their dynamic ability to represent data and information using physically reconfigurable geometry. Additionally, there is also the challenge of encouraging non-HCI experts to engage with shape-changing displays and interfaces. Research presented in this thesis aims to support people design and develop shape-changing displays for applications specific to their functional requirements. As a core contribution, this thesis presents digital fabrication techniques, using both accessible and low-cost approaches, that support rapid development with applications from different domains.

The overarching research question this thesis addresses is: *how can digital fabrication support the design and development of shape-changing displays across diverse application domains?* As an overarching contribution, this thesis presents: *novel approaches to fabrication that support the rapid development of shape-changing displays for diverse application domains.* Specifically, this work focuses on commercially available digital fabrication tools such as laser cutters and 3D printers to create deformable semi-solid surfaces for building shape-changing displays with computer-aided design (CAD). These digital fabrication approaches aim to be accessible, both in terms of cost, technical simplicity, and build time.

To address the overarching research question of this thesis, four research projects were conducted that each address an area of the main contribution by designing, building, and evaluating interactive shape-changing displays with various input and output capabilities. See **Figure 1** for the breakdown of the four research questions that this thesis addresses as listed below:

1. How do people approach and react to the task of generating content for shape-changing displays?
(Addressed in Chapter 3)
2. How can experts be engaged in designing shape-changing content to represent data specific to their work domains?
(Addressed in Chapter 4)
3. How can assembly requirements be reduced to make the fabrication of shape-changing displays more efficient?
(Addressed in Chapter 5)
4. How can interaction and visualisation be better integrated within a single deformable surface?
(Addressed in Chapter 6)

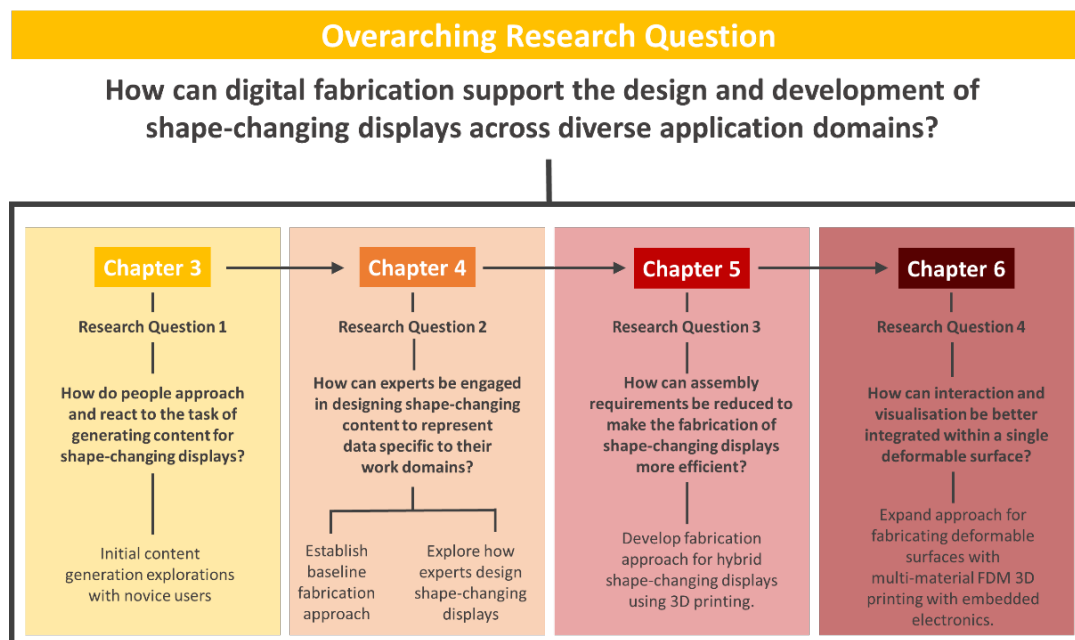

Figure 1: Breakdown of the research questions addressed in the thesis.

This thesis firstly focuses on the design of shape-changing display content and applications (chapters 3 and 4). By adopting qualitative evaluations and explorations this first step is key to establish design implications that directly inform the technical challenges currently faced by the field. The observations and insights gained identify key design requirements, limitations, and research challenges for developing shape-changing displays.

These insights and their implications further extend the design space for interactive shape-changing displays. Based on these insights, this thesis then addresses the technical challenges (chapters 5 and 6) that were uncovered from the design focused explorations on content generation. Specifically, expanding the design space for development by supporting the need for fabrication approaches that reduce technical complexity enables more accessible and rapid implementations of shape-changing displays. This is achieved by exploring and describing novel and innovative laser cutting and 3D printing techniques that can reduce the technical barriers for the development of shape-changing displays by going beyond traditional implementations e.g. pin-arrays.

1.1 Motivations, Challenges, and Approaches

Accessible Fabrication

Current examples of shape-changing displays consist of complex hardware systems that are both economically and technically high-cost. Traditional examples of shape-changing displays consist of actuated pin-arrays [42, 72, 168], these displays are often cumbersome and can rarely be replicated by others – limiting the generalisability of these hardware systems beyond lab demonstrations. To encourage the wider adoption of shape-changing displays beyond novel demonstration prototypes, this thesis aims to create more accessible approaches for building shape-changing displays that does not require such high-cost hardware equipment and technical knowledge. To ensure accessible fabrication, this work focused on re-useable parts (e.g. modular actuators) with easy implementation (e.g. simplistic hardware that can be used by non-experts) that encourage others to design and build their own prototypes. One of the core motivations of this thesis was to focus on creating accessible fabrication approaches that allow more people, both novice and experts, to design and develop their own shape-changing displays.

Simplifying Data

To understand the future potential of shape-changing displays/interfaces, the research community needs to understand what types of data and information is best represented using these novel hardware systems. Through content generation studies, with both domain experts and novice users, this thesis begins to establish the types of data (e.g. Geographic Information Systems - GIS data) and applications (e.g. terrain modelling) that are best suited for shape-changing displays. By understanding if shape-changing displays can be used to simplify complex data through their dynamic tangible properties the research communities can better understand the place and purpose of shape-changing displays within the wider spectrum of display technologies [6] (e.g. are they more engaging to users than flat screen displays when presenting topographical data?). The content generation explorations conducted for this thesis establish an initial understanding of how experts present data and understand how end-users view data using shape-changing displays.

Practical Applications

As it currently stands, the majority of shape-changing displays developed are still in early prototype stages where they are used as preliminary demonstration hardware systems [137]. The core focus of shape-changing displays currently comes from their novelty rather than practical use-cases [169]. There is greater focus within the research community for technical advances for shape-changing displays but little research into establishing practical use-cases and applications for this new range of technology [168]. To establish and secure the place of shape-changing displays in the future of technologies, it is important to understand what types of applications are best suited for and represented using their reconfigurable tangible 3D surfaces [6]. This is achieved through a range of content explorations, with both novice and expert users, a better understanding of key areas of interest and applications can start to emerge. This understanding is essential for taking shape-changing displays from being just a novel technology into a practical technology where its full potential can be realised. This may come from a more context dependent applications and implementations for this new technology. This also comes from understanding user interaction behaviour.

Research Questions Breakdown

Over recent years, the research community has proposed numerous prototype systems [138] that have explored a variety of shape outputs, interaction methods, and implementation techniques. Despite the potential for enhancing information communication capabilities, there are still a number of challenges faced by the field. The primary high-level challenges that motivate this research focus on content generation, design processes, digital fabrication approaches, and implementations for shape-changing displays. More specifically these challenges, motivations, and research approaches are described below.

Research Question 1: How do people approach and react to the task of generating content for shape-changing displays?

Motivation 1: Shape-changing displays' physical dynamicity exploits users' rich visual and tactile senses. This new generation of displays offers an additional information channel – the physical channel - opening up new application areas [138]. However, this additional channel comes with additional complexity in content design: visual output must now be accompanied by shape-

information. Content generation explorations are essential to providing novel opportunities for experiencing, creating and manipulating 3D content in the physical world.

Challenge 1: The current lack of fundamental understanding of even the most basic user interactions for shape-changing displays and corresponding use case scenarios limits the adoption of this new generation of displays in a diverse range of application domains. As with any new ‘hosting’ platform, content, and therefore its generation, will be key to its future success. However, the relative immaturity of the shape-change field currently means that content generation remains largely unexplored. This is because the deployment of robust shape-changing displays is still limited due to the highly complex technical requirements for creating displays of a high enough resolution to support a diverse range of data and applications.

Research Approach 1: My early research focused on addressing this limitation by developing a shape-changing display that supports content generation for novice users. I focused on designing and developing low-cost hardware systems that can be easily reproduced, are portable, and scalable. ShapeCanvas, a 4x4 grid of large actuated pixels, combined with simple interactions, explored novice user behaviour and interactions for shape-change content design through a qualitative user study.

Research Question 2: How can experts be engaged in designing shape-changing content to represent data specific to their work domains?

Motivation 2: To ensure the success of this new and novel technology, the research community must encourage the adoption of shape-changing displays across a diverse range of application domains. Exploring why domain experts might want to author shape-changing displays is currently limited but these insights are key to expanding the design-space. Practically, domain experts need to be able to engage audiences when presenting their datasets. However, data representations are often limited to 2D virtual spaces that lack novel engagement factors, such as tangibility. Working with experts from different domains can provide insights as to how shape-change can engage novice end-users and

encourage group discussion for large datasets and temporal data. In-depth content generation explorations can also provide valuable insights to uncover potential end-user groups and optimal data types for representation that have not yet been identified. This can be achieved by better supporting and understanding how experts from different domains design content for shape-changing interfaces to represent their own data.

Challenge 2: There is a limited number of tools and methods to enable domain experts, with minimal resources, to directly author physically reconfigurable interfaces [57, 176]. As a result, there is a lack of low-cost and robust shape-changing displays and data physicalizations that are deployed for real-world applications and are technically accessible to novices. Currently, domain experts cannot engage with novel physical representations of their data as they do not have the necessary tools or skillsets to directly design and create shape-changing displays based on their specifications. The low number of qualitative user evaluations also limits insights into the engagement impact of dynamic physical data representations.

Research Approach 2: This work aims to enable domain experts to design and construct interactive shape-changing displays based on their own input data. This approach demonstrates generalizability by allowing experts, from different domains, to design interactive shape-changing displays based on datasets from their own work and demonstrate them to either novices or other domain colleagues. The combination of mapping data to physical surface reconfiguration, interaction features, and visualization shows enhanced user engagement and understanding of complex data trends and information. This work also explores potential end-user groups that are yet to be established within the current literature.

Research Question 3: How can assembly requirements be reduced to make the fabrication of shape-changing displays more efficient?

Motivation 3: The majority of current shape-changing displays are one-off prototypes that are either restricted to linear pin-based [42, 72, 97, 132] or continuous surface outputs [28, 147, 185]. They are often cumbersome and limit the forms of data and information encoded within them due to the lack of

resolution and dynamicity in the surface configurations. Complex polygonal structures, meshes, or curved contours are difficult to construct as they require complex and time-consuming assembly and production requirements. By establishing alternative fabrication approaches, that go beyond that of current implementations (e.g. pin-arrays), the design space can be further expanded for developing these hardware systems across a diverse range of application domains.

Challenge 3: Scaling for higher resolution output further increases the cost of assembly and technical complexity, as the number of mechanical actuators also increases. Currently, even with commercially available actuators, there is high technical complexity for controlling, setting up and building actuated and deformable surfaces for shape-changing displays.

Research Approach 3: Developing an approach for fabricating hybrid shape displays that combine the benefits of pin arrays and cloth, specifically using stereolithography (SLA) 3D printing. By establishing a generalizable approach for design and fabrication with low implementation and assembly costs, rather than presenting a singular instance of a hardware system, the proposed deformable surfaces aim to expand the design space for shape-changing displays. Due to the dynamic nature of the 3D printed surfaces, they can represent more complex physical structures in comparison to traditional pin-array displays with reduced production requirements. The 3D printed deformable surfaces described and developed support reduced assembly and production requirements. Fewer actuators are also used to represent more complex geometries than traditional continuous fabric shape-changing displays.

Research Question 4: How can interaction and visualisation be better integrated within a single deformable surface?

Motivation 4: Current fabrication techniques for shape-changing displays are limited by cumbersome electronics and mechanical surface rigidity. To further support the design and development of shape-changing displays across diverse application domains, including portable and wearable devices, these displays must integrate interaction and visualisation capabilities. Specifically, embedded

within a single deformable surface without the need for external components such as projectors.

Challenge 4: Work on embedded interactive and visual components using digital fabrication techniques, especially for 3D printed interfaces, is prominent [16, 148]. However, most approaches for embedding electronics for digitally fabricated interfaces is limited to flat or static objects. It is difficult to embed electronics within a deformable interface, especially one that is mechanically actuated, as the surface has to dynamically reconfigure its shape. Current electronic components are limited by rigidity to be easily situated within the thin surface and also dynamically accommodate deformations of their enclosure. The technical skills required to build robust shape-changing surfaces is often limited to the field of mechanical hardware and robotics. Designers and developers often lack the technical skills, accessible equipment, and electronic components required to build fully integrated robust shape-changing displays.

Research Approach 4: Multi-material 3D printing has already been utilized in other areas to rapidly fabricate interfaces with integrated interactive capabilities. Specifically, using commercially available and widely adopted Fused Deposition Modelling (FDM) printers that support multi-material extrusion. This work demonstrates the rapid fabrication of low-cost interactive surfaces with embedded interaction and visualisation features. Using flexible and electroconductive filament materials simultaneously during the printing process produces stretchable and deformable interfaces. The integrated 3D printed circuitry can support capacitive touch sensing as well as embedded surface mount LEDs for visualisation. These deformable surfaces are specifically designed to support embedded electronic components and can easily adapt and deform to various shapes. A technical evaluation also provides key insights into how the produced prototypes can further expand the current design space as well as look at future adoption of these hardware systems. This fabrication approach aims to support and encourage the community to develop and explore a wider range of design alternatives for shape-changing displays.

1.2 Methodology

This thesis follows a research-through-design methodology, originally proposed by Frayling [44]. He initially defined “research through art and design” as a mix of materials research, development work, and action research. Essentially Frayling summarised research-through-design as a process of iteratively designing artefacts as a creative way of investigating what a potential future might be. This approach is reflected within the main research chapters of this thesis that progressively refine the design of deformable surfaces for shape-changing displays. This is achieved by utilising three different digital fabrication processes such as laser cutting and multi-material 3D printing with the goal of establishing a place for shape-changing displays as a future technology.

Within the context of Human-Computer Interaction, the methodology of this thesis follows more closely the research-through-design approach re-established by Zimmerman et al. [210]. Their reflective approach aims to generate knowledge through the creation of artefacts to create stronger connections between the design iterations presented (e.g. chapters 4, 5, and 6). Zimmerman et al. [210] propose the use of iterative problem solving as part of their model for enhancing interaction design within the HCI community. Essentially, their methodological model focuses on the iterative design and development of artefacts and prototypes to solve problems defined by the research community through anthropological insights gained during user focused explorations. This can be seen as a cross-disciplinary approach that takes into account the iterative prototyping of design and engineering together with the user insights gained from more qualitative anthropological evaluation processes. Below is a summary of how the main themes of the methodology for research-through-design are linked to this thesis.

Process: Each of the processes for designing and developing shape-changing displays presented in this thesis is documented and can be considered as individual contributions. In addition, each data chapter also provides a clear rationale for the selection of the specific methods employed (e.g. laser cutting or 3D printing).

Invention: Each of the fabrication approaches proposed in this thesis also comes with additional details for the technical opportunities for engineers in the HCI research

community, providing them with guidance on what to build and how to build it effectively (e.g. application examples in chapter 4).

Relevance: As well as ensuring that the work from this thesis is documented in such a way that peers can reproduce the results (e.g. step by step instructions for reproducibility), the core data chapters also document the preferred state the design attempts to achieve (e.g. the future vision of shape-changing displays) and provide support for why the community should consider this state to be preferred. Specifically, the preferred state this thesis aims to achieve is moving away from pin-array actuated shape-changing displays and moving towards embedded deformable surfaces that support visualisation and interaction capabilities without the need for cumbersome hardware (e.g. mechanical stepper motors).

Extensibility: Extensibility is defined as the ability to build on the resulting outcomes of the interaction design research: either employing the process in a future design process or understanding and leveraging the knowledge created by the resulting artefacts. The design and fabrication approaches presented in this thesis (e.g. chapter 3, 4, 5 and 6) follow a progressive approach, where each iteration of the fabrication approaches builds from the last through optimization (e.g. reducing assembly).

1.2.1 Methodology Breakdown

As mentioned above, this thesis uses a cross-disciplinary methodology that begins with design explorations for shape-changing displays and subsequently proposes a technical approach for addressing the overarching research question. Based on insights gained and design implications discussed in chapters 3 and 4 a range of digital fabrication approaches are detailed to further advance implementations of shape-changing displays. Based on Zimmerman et al.'s [210] methodology for research-through-design five key aspects that connect the progression of this thesis are detailed below.

1. This methodology encourages the HCI research community to engage with “wicked” problems that cannot be easily addressed through science and engineering methods. Chapter 3 focuses on creative design explorations for content generation to gain a better understanding of what kinds of problems and challenges emerge based on traditional shape-changing displays.

2. The research-through-design approach ensures that technological opportunities are highlighted to both engineers as well as uncovering new insights from a design and anthropological perspective to motivate new research. Research conducted thorough this thesis aims to inform both technical and design researchers.
3. This work aimed to support the creation of useable systems rather than just prototype demos. Though the wider adoption of the fabrication approaches described in this thesis, by both the HCI community and with engagement from experts in different domains, this thesis provides a new approach for transferring knowledge produced in the HCI research to other practice communities (e.g. volcanology and interior design). Particularly by looking at new application areas and new fabrication approaches.
4. By utilising more generalized and accessible fabrication tools (e.g. 3D printer and laser cutters), this thesis aimed to make it easier for HCI researchers and designers to create their own artefact and prototypes. Research-through-design also allows interaction designers to make research contributions that take advantage of the real skills designers possess by reframing the problems through a process of making the right thing.

Methodological Overview of Thesis

This methodology also motivates the HCI community to discuss preferred states and to reflect on the potential impacts research might have on the work and for the future directs of the research.

Based on research-through-design methodology – the first part of the research focused on establishing current issues with not being able to have any practical applications for shape-changing displays – the design and construction of the original hardware system (chapter 3) also uncovered a range of technical issues with scaling when developing more traditional shape-changing displays (e.g. pin-arrays). Chapter 4 then attempted to develop an alternative approach for designing and building shape-changing displays that requires less complex hardware and minimal time for construction. A qualitative evaluation was then performed with a range of experts from different domains to ensure the new fabrication approach is suitable for a range of applications and can be reproduced with more ease (e.g. within two days). Based on the success of the laser cutting fabrication approach, an optimised version of the fabrication approach was designed that uses 3D printing to reduce the need for multi-layer assembly (chapter 5).

This new 3D printing approach for developing deformable surfaces for shape-changing displays also proposes alternative interaction and visualisation techniques that have previously been a problem to implement within the HCI shape-changing displays community (e.g. embedded interaction and under-the-surface projected visualisation). Following this updated fabrication approach, another optimization is then followed that incorporates multi-material 3D printing to further optimise the fabrication process for embedded interaction and visualisation (chapter 6).

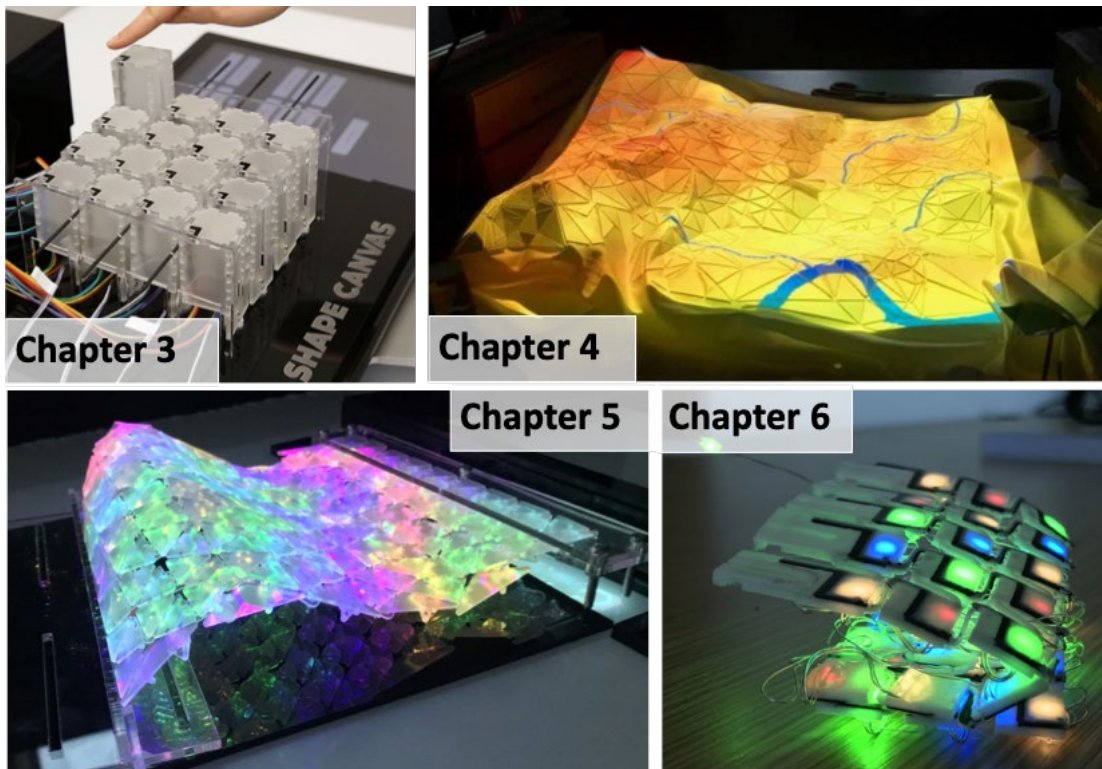

Figure 2: Examples of prototypes developed based on proposed fabrication approaches presented in each chapter of this thesis. Moving from traditional pin-array in Chapter 3, to a semi-solid laser cut two-layer surface in Chapter 4 that uses fewer linear actuators, to a single layer 3D printed deformable surface in Chapter 5, to finally a multi-material deformable surface that has embedded interaction and visualisation capabilities in Chapter 6.

Figure 2 demonstrates this methodological process of optimising the design and fabrication approach for developing shape-changing displays using the four key prototypes systems developed as examples to demonstrate the utility of each approach.

The core premise of this research is to build a comprehensive understanding of how to support the design and development of shape-changing displays across diverse

application domains. To achieve this, an initial understanding of how people design shape-changing displays needs to be addressed. By building initial prototypes and involving end users in the design and evaluation of shape-changing displays and their applications, a set of design implications emerged. The design implications discussed in chapter 4 uncover technical limitations for the current development of shape-changing displays that are not discussed in current literature. Chapter 5 and 6 then go into technical detail of how to address these limitations with a focus on digital fabrication approaches. This is achieved by adopting commercially available 3D printing as a method for fabricating deformable surfaces that advance the design space for shape-changing display development. These deformable surfaces are also able to render complex polygonal structures, cylindrical meshes, and curved contours that go beyond the capabilities of current technologies (e.g. pin-arrays).

Addressing Research Question 1

The methodology used for the initial research question focused on the deployment of a prototype in a public setting to encourage novice users, from a diverse demographic, to interact and engage with a novel technology. This methodology closely follows an Inductive Model [101], where there are no preconceived ideas of the findings from the study. Instead, this study provides an opportunity to explore an open design space that encourages the participants to think freely and creatively about the content they design and generate. As shape-changing is a relatively new area of research, an initial prototype (*Design of Artefact*) had to be built in order to facilitate the content generation tasks. This initial prototype can be considered as an ideation tool [30] to facilitate content generation. The qualitative results and *observations* build the fundamental framework of insights (*theory*) that could not be achieved without the interaction of a wider range of users. A participatory design session to inform the design of the initial prototype, would not have provided sufficient guidance outside of current literature and this was not the main focus. An open-ended design revealed aspects of the design process that specific tasks would fail to expose.

Addressing Research Question 2

The next step in the methodology also begins with the *design of artefacts* by creating a new approach for the design and development of shape-changing prototypes. Chapter 4 builds on the insights gained from the initial content generation study and explores how to engage experts from different domains in designing shape-changing displays, using

data specific to their work areas. A set of in-depth design sessions were conducted with a range of experts to develop shape-changing displays specific to their needs. These early prototypes expand the design space and enhance the understanding of how the research community can further support the development of shape-changing displays. This methodology follows closely with the “Design of Artefacts” approach described by Mackay and Fayard [102]. As the field of HCI studies the interaction between people and computer systems, it is key to understand how people design such interactive systems.

Observations from the design focused studies also followed an Inductive Model [101], to a degree, but with more focus on the specific domains that content was generated for. The initial fabrication approach utilised the accessible and low-cost nature of laser cutters. The study combines qualitative insights gained from the design sessions, user evaluations, and demonstrations to develop a set of design implications that influenced the technical contribution detailed in chapters 5 and 6. The theory base design implications discussed highlight the need for more dynamic deformable surface for shape-changing displays. Specifically, those that can be rapidly fabricated at a low-cost, both in terms of time and technical simplicity.

The work in chapter 4 builds on design *theory* by supporting domain experts to directly design high-fidelity shape-changing display using their own specifications and data. To enable significant depth in the design sessions and analysis, each case study was split into two or three sessions over the course of a week. Each participant provided detailed feedback and evaluations of their experience in designing content for shape change and tangible physicalizations.

By directly involving people in the design and development process, more explicit implications emerged around technical challenges for developing shape-changing displays. Though current literature begins to explore these challenges [6], this is often isolated to theory without sufficient observations for validity. Alternatively, simply conducting an individual quantitative empirical evaluation on a prototype, where a study has a set of specific tasks and outputs, would limit the diversity of results outside of current literature. The multiple research approaches used support the emergence of a wider range of strengths and limitations when designing for shape-change and physical representations of data. This methodological triangulation approach [102] used for this

work is essential to the adoption of this new generation of displays across a diverse range of domains.

Addressing Research Question 3

To ensure that shape-changing displays can be more widely adoptable, the design implications from the previous chapter highlight that assembly and production requirements need to be reduced. Chapter 5 follows a similar methodology to previous chapters by first establishing the *Design of Artefacts*. In this case, a new fabrication approach for creating deformable surfaces using 3D printing. The core focus on this work is on addressing the technical limitations that emerged from the explorative design studies detailed in the previous chapter. These limitations also relate to technical challenges described by current literature [6].

Domain experts from the previous study highlight that the technical complexity of implementations is one of the largest barriers when attempting to adopt shape-changing displays across a diverse range of application domains. Based on the premise of “semi-solid” surfaces described in the previous chapter, the design of the deformable surfaces for chapter 5 focuses on utilising 3D printing technologies. The fabrication approach designed for this work focuses on minimal production requirements by 3D printing a single layer deformable surface for shape output. Alternative actuation methods, that go beyond traditional pin-arrays, were also explored and tested.

The technical evaluation in chapter 5 focuses on the 3D printed deformable surfaces, rather than focusing on empirical users testing. The *observations* from the technical evaluation of the deformable surfaces and their fabrication approach are aimed to further streamline the production and design. As this work is an initial concept, in early development stages, a formal user evaluation would not produce conclusive empirical results on usability. Further iterations of the prototypes and fabrication approach are needed, based on technical evaluations, before a formal empirical user study is to be conducted. In terms of *theory*, to further enhance the design process for fabrication, chapter 5 also defines technical limitations.

Addressing Research Question 4

The technical methodology of chapter 6 highlights how interaction and visualisation can be better integrated within a single deformable surface. By creating an integrated single deformable surface eliminates the need for cumbersome external electronic

components commonly found on traditional implementations of shape-changing displays. Much like in the previous chapters, the research approach here follows a similar structure mixed methodological triangulation [102]. The initial work presents a refined fabrication approach and the *design of a new artefact* (e.g. the interactive 3D printed deformable surface). This refined fabrication approach is based on the technical evaluation described in chapter 5. *Observations* from the design workshop provide key insights as to how the refined fabrication approach can be generalised beyond the scope of shape-changing displays and within other domains (e.g. wearables). In terms of *theory*, the work is concluded with a discussion of the fabrication approaches described throughout this thesis and how they expand the current design space. The design and fabrication approach utilizes multi-material 3D printing for developing thin and stretchable surfaces. The surfaces are designed to support embedded electronics and can easily adapt to various shapes.

A workshop focused evaluation of the interaction techniques supported by the prototype further supports generalisation with a wider range of domains, such as wearables. The technical evaluation of the approach also demonstrates how multi-material printing can further reduce assembly requirements for shape-changing display development. The technical methodology of chapter 6 aims to support and encourage the community to develop and explore a wider range of design alternatives that can adapt to a range of shapes. As this is still an emerging technological approach, a more formal empirical evaluation is not fully utilized, and this was not the focus of the research question chapter 6 was addressing. Much like in more established fields in HCI and computing, quantitative analysis provides more valuable insights once the technology and its purpose are more established.

This thesis is concluded by discussing and reviewing current challenges faced by the field and how the fabrication approaches proposed in this work can further support solutions. The design implications defined also uncover additional technical challenges that are yet to be discussed in current literature. The design focused methodology of chapters 3 and 4 support the technical limitations that are addressed in chapters 5 and 6. The range of design and technical evaluations also support an enhanced understanding for future directions of the field and research endeavours.

1.3 Contributions

The main contribution this thesis presents is a range of fabrication approaches for developing thin form-factor shape-changing displays using laser cutting and 3D printing techniques. The progressive nature of the design iterations is illustrated through each of the main chapters (e.g. from low resolution pin-array shape-display in chapter 3 to a thin form factor deformable surfaces that have embedded visualisation and interaction in chapter 6). To highlight this progressive and iterative methodology, this thesis moves away from adopting pin-array shape-changing displays and creating thin form factor shape-changing surfaces. Figure 2 illustrates this prototype evolution by building upon the findings and contribution from each chapter retrospectively. By working closely with experts from different domains a range of context-dependent shape-changing display prototypes and applications were also developed to show the utility of this new technology. Below is a collective breakdown of the work presented in this thesis on a chapter by chapter basis:

1. Exploring Content Generation with Novice Users:

To address research question 1, chapter 3 presents: (1) ShapeCanvas, a small, but robust shape-changing display (2), a 2.5 day deployment of ShapeCanvas in a public environment to understand how novices generate content (3), a thematic categorization of generated content, empirical report of interaction, and discussion on future approaches. To summarise, chapter 3 contributes an initial understanding of content generation and application possibilities for shape-changing displays from the perspective of the general public.

2. Engaging Domain Experts in Designing Shape-Changing Displays:

To address research question 2, chapter 4 presents: (1) A conceptual approach for designing and developing shape-changing displays using dynamic polygonal surface structures. (2) PolySurface as a low-cost implementation method for rapid high-fidelity prototyping of shape-changing displays and interactive interfaces. (3) Three case studies where participants, from different domains, generated interactive shape-changing displays based on datasets provided from their work. (4) Discussion of design sessions and observations identify key design requirements, limitations, and research challenges for designing and fabricating shape-changing displays and interfaces. To summarise, this chapter contributes a set of more refined context-

based shape-changing displays that demonstrate the utility of this new technology for a set of specific applications (e.g. displays for volcano modelling). These are the first forms of “semi-solid” surfaces that are a hybrid between pin-arrays and continuous surface shape-changing displays.

3. Semi-Solid 3D Printed Deformable Surfaces:

To address research question 3, chapter 5 presents the application of 3D printed ‘fabrics’ as a novel approach to further the development of shape-changing displays. The 3D printed interlinked surfaces fabricated show: (1) A reduced number of actuators needed for dynamic surface deformations, with horizontal force actuation. (2) Opportunities for under-the-surface visualization and embedding interactive components into the surface. (3) Retained fluidity and rigidity whilst rendering cylindrical, oval, and tunnel forms. To summarise, this chapter contributes a refined approach for fabricating semi-solid and deformable shape-changing displays that require less assembly than the previous approach using laser cutting.

4. Multi-Material 3D Printed Deformable Surfaces with Embedded Interaction and Visualisation:

To address research question 4, chapter 6 presents: (1) A design and fabrication approach for developing thin, stretchable, and deformable surfaces for shape-changing interfaces using multi-material 3D printing. (2) Interaction techniques (e.g. pressing, bending, and stretching) supported by this approach. (3) Discussion and design considerations to understand how the approach can better support the design and development of interactive shape-changing interfaces with embedded electronics. To summarise, this chapter contributes a novel form of deformable 3D printed surfaces that support embedded visualisation and interaction capabilities based on the iterative refinement of the original fabrication approaches presented in chapters 4 and 5.

1.4 Thesis Structure

This thesis is structured as below:

Chapter 2: *Related Work* that describes and discusses current implementations of shape-changing displays, data physicalization, and Deformable User Interfaces (DUIs), current challenges faced by the field, and digital fabrication approaches that supported the development of work conducted in this thesis.

Chapters 3-6: *Presents core research* that focus on exploring novice content generation and understanding how to engage domain experts in designing shape-changing displays. This thesis also presents a set of digital fabrication approaches using both laser cut, and 3D printed deformable surfaces that are specifically designed for developing shape-changing displays for a range of applications.

Chapters 7-8: *This thesis is concluded with a set of research implications and a discussion* of the benefits and limitations of the digital fabrication approaches presented. The future direction of shape-changing displays is also discussed based on the insights gained through multiple evaluations of applications and prototypes developed.

2 | Literature Review

Shape-changing displays are an emerging technology that enables active shape input and output. The dynamic movement of the display's surface enables new forms of data representations, such as active elevated physical topography, and novel tangible interactions, such as physical sculpting, that are beyond the capabilities of conventional flat-screen 2D displays [6]. This chapter discusses current state-of-the-art for shape-changing displays and interfaces. After an initial definition of shape-changing displays, this chapter discusses Tangible User Interfaces [71] and Data Physicalizations [81] that have influenced the development of these dynamic hardware systems. Current work also provides an overview of challenges within the research domain of shape-changing displays and interfaces, in the context of human-computer interaction. This chapter highlights the need for a wider range of accessible fabrication techniques for designing, prototyping, and implementing shape-changing displays that go beyond one-off prototypes. Current digital fabrication techniques, such as laser cutting and additive manufacturing methods (e.g. 3D printing) that have influenced fabrication approaches proposed in this thesis are also discussed. To motivate the qualitative analysis methodology used throughout this PhD work, this chapter also discusses current approaches for content generation and applications for emerging and novel technologies.

To summarise, this chapter provides a discussion of current work on:

1. Shape-Changing Displays Definition
2. Tangible Interfaces, Data Physicalizations, & Deformable User Interfaces
3. Research Challenges in the Field
4. Overview of Shape-Changing Displays and Interfaces
5. Technical Implementations of Shape-Changing Displays
6. Digital Fabrication Approaches
7. Content Generation and Ideation Methodologies

2.1 Shape-Changing Displays Definition

The core concept for a shape-changing display or interface is an interactive computational device that can dynamically transform into a range of shapes or materiality relevant to the context of use [6]. Sutherland's Ultimate Display [172] describes such a device as a computer that can "control the existence of matter". Shape-changing displays [42] have developed from TUIs, they additionally allow dynamic physical surface reconfigurations to support a wider range of modalities. These physical computational systems provide enhanced sensory abilities such as haptic feedback, physical affordance, scalable form-factors, and physical three-dimensional interactions [24, 138].

2.2 Tangible Interfaces

Tangible User Interfaces (TUIs) utilize physical modalities for enhanced interactive user experience and give physical form to digital data and information. They embody physical artefacts both as representations and controls for computational media [188]. Data physicalizations [81] also extended from TUIs. They offer a physical three-dimensional representation of digital data and information coupled with tangible interaction capabilities, that are not possible on flat 2D interfaces. Similarly, Organic User Interfaces (OUIs) is defined as a user interface with a non-flat display that can be manually deformed if required [195].

Shape-changing displays extend the notion of TUIs by supporting dynamic physical form reconfigurations and movement through computational control of a non-flat display. Tangible interfaces are becoming the new generation of technology to offer additional interaction capabilities that exploit users' natural dexterity. Below current work on TUIs, data physicalizations, and deformable user interfaces (DUIs) is discussed.

2.2.1 Physical User Interfaces

Ishii et al. [71] highlight the limitation of generic Graphical User Interfaces (GUIs) as they only allow users to see data and interact with digital information using a flat 2D screen. Tangible interfaces, on the other hand, are physical artefacts and dynamic surfaces that enable users to interact with digital information [188] in physical 3D form. Buxton [19] highlighted in early work how interface design was biased towards graphical output at the expense of input from the real world. Since then, the field has progressed significantly by presenting a range of models and prototypes for TUI implementation [70, 128, 133, 187]. However, there is still limited low-level understanding of how the physical modalities of TUIs affect interaction and engagement with users [81, 155].

TUIs build on users' dexterity by embodying digital information in physical space. Tangible interfaces are defined by Ishii et al. [71] as physical manifestations of computation, allowing users to interact directly with the portion of the interface that is made tangible. Tangible design expands the affordance of physical objects, so they can support direct engagement with the digital world [69, 74]. Initially, Tangible Bits [74] allowed users to grasp and manipulate physical "bits" of a user interface. The main goal of Tangible Bits was to bridge the gaps between both cyberspace and the physical environment. The interaction with GUIs is separated from the physical environment within which people live and interact on a daily basis. Ishii and Ullmer [74] highlighted that interaction between users and the cyberspace have largely been confined to traditional Graphical User Interfaces.

There are various interaction practices for processing information through a range of modalities in the physical world. Specifically, using haptic interaction with physical objects such as writing with a pen on paper or using peripheral senses, such as becoming aware of weather changes through ambient light. These practices are often neglected when users interact with digital devices because of the lack of diversity in the input and output media when designing user interfaces. Current work presents many approaches for coupling physical artefacts with digital information [91]. The main focus often being how information is perceived or embodied in physical form [143]. Low-level empirical performance data for user interaction with such systems have, however, been limited.

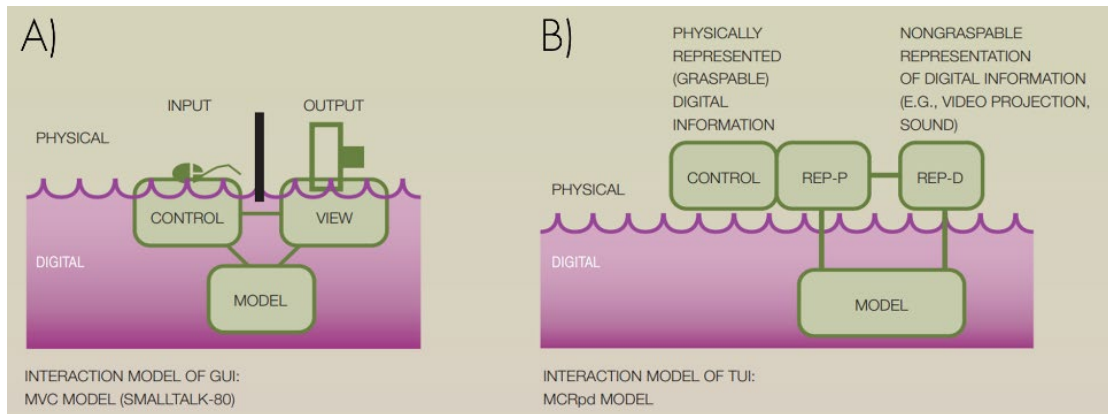

Figure 3: Standardised interaction model for GUIs (A) and TUIs (B) proposed initially by Ullmer and Ishii (2000).

Figure 3 compares the standardised “model-view-controller” (MVC) interface archetype [92] for GUIs with Ullmer and Ishii’s initial interaction model for TUIs. Their interaction model is specifically designed to utilise physical space and map data into interactive physical form. Though the mouse and screen are predominant physical mediums for interaction with GUIs, they are tightly coupled with the digital environment. For tangible interfaces, both the control and data representations are removed from the digital and moved into the physical environment to enable direct interaction and engagement with data physically. For both static and dynamic attributes, I aim to gain an initial low-level understanding of how physical forms and dimensions affects user interaction.

By combining the capabilities of computer technology with the richness of physical interaction, TUIs have been adopted as an appealing alternative to traditional screen-based computer interaction. Application examples for TUIs include, but are not limited to, education and learning [63], remote communication and awareness [201], entertainment [157], information storage, retrieval, and manipulation [189], and information visualization [60]. These example application areas all utilize physical objects as controls, though the data representation itself is typically visualised on a screen [190] or top-projected [131, 193]. In comparison, when designing data physicalizations there is an emphasis on using the physical object’s characteristics to map given data intuitively. There is also an emphasis on data exploration and analysis tasks using the tangible object. When developing shape-changing displays both the design of the controls and dynamic and adaptive data representations have to be considered.

Sylla et al. [174] highlight the learning potential of a tangible interface in comparison to standard GUIs. Their tangible interface aims to promote stronger and long-lasting involvement and having a greater potential to engage children, potentially promoting learning. Similarly, Horn et al. [61] designed and deployed a tangible computer programming exhibit for engaging children at a science museum. Their “passive tangible interface” consisted of a collection of unpowered physical components with a non-continuous link to a digital system. This approach addresses issues involving tangible interaction in public settings.

TUIs is a diverse area of research where the hardware systems are taking many shapes and morphologies where current state-of-the-art promotes a diverse range of applications. The fundamental design considerations of physical interactive techniques for these displays, such as height between features and dimensions, remain unexplored [35, 170]. Tangible User Interfaces (TUIs) can be described as either static (e.g. most data physicalizations) or dynamic (e.g. shape-changing displays and deformable user interfaces). Dynamic TUIs are able to actively reconfigure their physical structure and surface for a range of uses and data input/output. Next, I discuss data physicalizations as a derivative of tangible interfaces, with the specific purpose of representing data in physical rather than just visual form factors.

2.2.2 Data Physicalizations

Data physicalization evolved from areas such as visualization [22] and tangible user interfaces [71, 74] as a form of data analysis in physical form. They embody physical artefacts whose geometry or material properties encode data [3, 81]. Calvert et al. [21] highlight that humans have evolved a highly complex sensory system that allows them to efficiently extract information from the physical world. Representing data through interactive physical objects enhances the identification and interpretation of sensory information beyond the capabilities of flat displays.

Encoding data into physical artefacts where geometry or material properties convey meaning or represent data patterns has long-standing practice and tradition in both scientific and design communities [31]. From the early Mesopotamian Clay Tokens (5500 BC) [31] to Durrell Bishop’s first tangible user interface (1992) the Marble Answering Machine [74]. With the recent convergence of digital fabrication, tangible

interfaces, and shape-changing displays the emergence of data physicalization as an independent area is becoming increasingly clear [3, 81].

Computer-supported physical data representation enhances the understanding, exploration, and communication of data [80]. As a result, comprehensive and engaging user experience is available. This is beyond the capabilities of conventional applications of flat, rigid, and static surfaces. Physicalizations enable people to perceive data by leveraging their internal sense of physical space and ability to manipulate objects. They utilise spatial perception, where physical objects can provide enhanced cues of shape and volume to represent data in a 3D form, ensuring the data can be perceived with less effort and more accuracy than on a computer display [81], even stereoscopic displays [80].

There is an opportunity to develop a wide range of novel interaction capabilities from new forms of data representations. With current innovation and development of shape-changing displays, complex data analysis tasks performed by existing desktop computers could also soon be enhanced through data physicalization systems. The representation of data through physical artefacts has also potential to be extended beyond traditional visualisations of numeric data and bar charts [80, 81]. The representation of data as physical artefacts also supports cognitive and sensory stimuli [31].

Although the majority of physicalizations developed currently are static, they can still offer perceptual, cognitive, and communicative stimuli as well as enhance user experience value which could not be possible through desktop computers. Current work has already established processes for composing and creating one-off static physicalizations, using fabrication technologies [171, 173]. Dynamic physicalizations in comparison require additional computer driven control of physical geometry or material properties. A wider range of techniques for actuation has been explored and implemented for controlling physical geometry both for data physicalizations and shape-changing interfaces [138, 143].

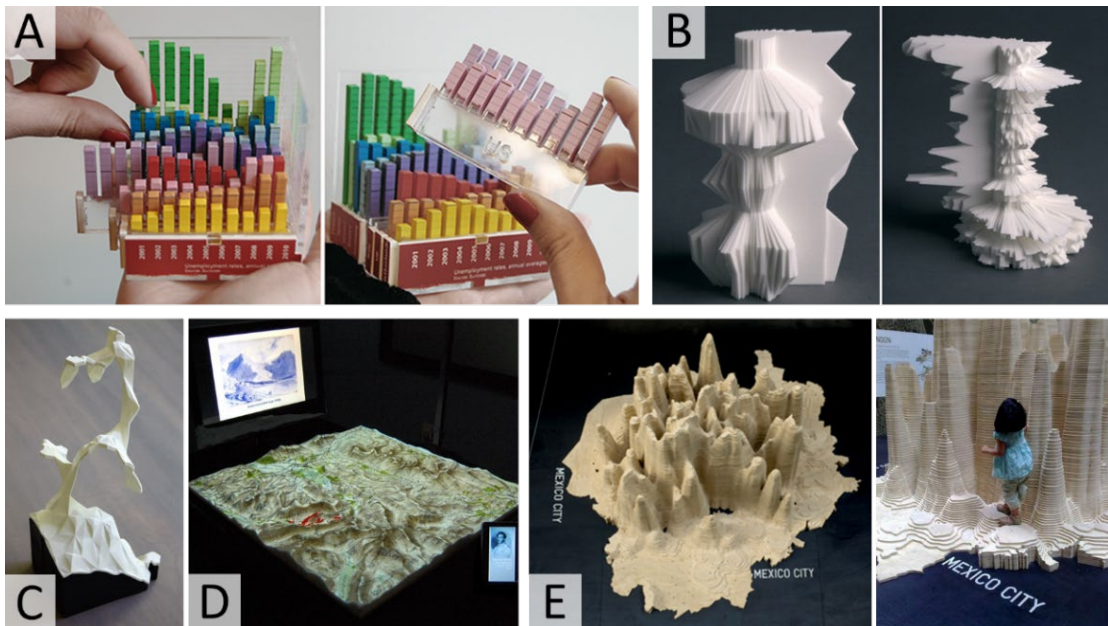

Figure 4: Examples of Data Physicalizations.

Data physicalizations come in many forms as seen in **Figure 4**. Jansen et al. [80] show 3D physical bar charts where datasets can be switched by hand (**Figure 4A**). Cylinder by Andy Huntington and Drew Allan [66] is an early example of digitally-fabricated sound sculptures (**Figure 4B**). Physicalizations can also represent data in more abstract and artful forms. Work by data artist Doug McCune [105] depicts a 3D printed map of housing prices in San Francisco **Figure 4C** in abstract form. The height of each area represents the average price per square foot for recent home sales. A more realistic physical representation of topographical data can be seen by Pristnall et al. [134]. The PRAM system is a static physical relief model is augmented with top projection to display landscape details and to overlay with additional data visualizations **Figure 4D**. Work by Richard Burdett [17] demonstrates larger scale data physicalizations to represent density models where plywood forms embody the populations of 12 of the world’s major urban centres (**Figure 4E**).

Many physicalizations focus on a direct mapping between the data and representations. Specifically, when exploring and evaluating engagement with users’ personal data. Physikit [64] is a toolkit and technology probe [67] that maps users’ data about their home energy consumption into physical data representations in the form of tangible cubes. This work encourages end-user to programme their own physical data representations in the realm of the internet of things (IoT). Ananthanarayan et al. [8] have also proposed a novel approach to represent personal health by using paper cherry

blossom leaves, flowers, or felt and Velcro stick-objects. From personal quantitative data to qualitative emotional data representations, Emoballoon [116] is a soft social-touchable interface that can monitor human intentions or emotions based on touch interaction. These interactions include hugging, rubbing, and slapping using a series of sensors within a balloon. Visually communicating emotion has thus far been predominately studied in colour theory [124]. Initial work within HCI [163] evaluates how physical shape configurations are used to represent emotionality for users. These explorations of information representations through physical forms [4, 176] enhance understanding of which data is best conveyed through the representation of shapes to users in a range of contexts.

Jansen et al. [81] highlight the need to better support interaction with physical forms. Their initial review encourages the development of techniques for the empirical evaluation of data physicalizations. They also emphasize that more generalised approaches for the design and fabrication of data physicalizations must emerge to ensure wider range applications can be supported. Empirical evaluation techniques could also highlight the trade-offs between cost and utility. Currently, projects within the field of data physicalizations are isolated within specified domains. However, by developing a generalizable evaluation framework results can become comparable. These evaluations need to be comparable across a wide range of systems. As the field is still immature, no generalised empirical evaluation methodology has been considered comprehensively. This is in part due to the majority of current work focusing on isolated instances and as a result, there is a lack of a broad overview of data physicalization. A similar paradigm is also lacking in the domain of shape-changing displays. This could be partially due to the limited generalisability of tangible systems that go beyond singular sentences, an issue this thesis aims to address. By contrast, in other domains such as digital signage [7] or web usability [117-119] evaluation challenges are well understood.

Given the recent increase in research interest addressing this topic, it is anticipated that there will be a need to perform evaluations of the effectiveness of communicating data, aesthetics, and efficiency to establish fundamental guidelines of designing and developing data physicalizations. In terms of technical capabilities with existing and impending advances in digital fabrication, shape-changing displays [57, 138], tangible user interfaces [155], and programmable materials [71, 74] it is now possible to create

data physicalizations faster, cheaper, and more effectively than before by utilising existing tools [57]. However, this stands more towards static applications for data physicalizations that at best can only be manually deformed. The fabrication of dynamic materials and surfaces to support physical movement and form reconfigurations for displays is still limited. The need to create more dynamic display surfaces that can be computationally reconfigured is still a technical challenge that requires high costs [6]. As it stands with current applications, it must be considered if the benefits of creating data physicalizations outweigh the cost of design and fabrication.

2.2.3 Deformable User Interfaces (DUIs)

Current work on Deformable User Interfaces (DUIs) [87] shows how these adaptive technologies can support the development of deformable interactive surfaces. DUIs offer users novel interact opportunities with objects with a high degree of flexibility. DUIs can be deformed as a means of interaction through physical actions like squeezing, bending, and stretching [87]. The interaction techniques that are supported by DUIs can be also mapped to shape-changing displays, especially when evaluating preference for direct user manipulation of surfaces such as bending and pinching. By exploring how users directly manipulate deformable displays, new implications for interactions techniques emerge that can support both designers and engineers working on future technologies [95].

The shape-deformations for user input are often focused on handheld devices [129], though work on evaluating shape changes on larger scale implementations is also explored [163]. Specifically, Strohmeier et al. [163] explore how shape changes and dynamic deformations can be used for conveying emotion. These preliminary explorations are important for understanding how shape-output can be conveyed to users for various purposes and how the physical properties of the interface material influence complex commands in deformation based interaction. These initial explorations for DUIs offer a promising direction for the future adoption of this novel technology for a wide range of applications.

In terms of technical challenges, however, there is still a lack of deformable displays that can dynamically change into complex physical forms whilst supporting higher resolution visualisation output, without the need to external projections. Integrating embedded visualisation within a singular deformable surface is also a limitation with

current shape-changing displays. As they also traditionally rely on external projectors for visualisation. Though with shape-changing displays there is also the additional challenge supporting computationally control actuation mechanisms that go beyond the manual deformations of DUIs.

DUIs provide a diverse range of tangible interaction capabilities through their flexibility and malleability [152, 196, 202]. By adapting to various geometries they can fit dynamic organic shapes, such as the human body—making them ideal to support the development of deformable wearable devices [125, 180]. Gummi [152] presented an initial exploration of deformation-based interaction techniques, bending, with a flexible display. Schwesig et al. [152] highlight that the deformable form factors of DUIs also promote context-dependent functionality.

2.3 Research Challenges in the Field

Interactive shape-changing displays enable the dynamic representation of data and information through physically reconfigurable geometry. Over recent years, the research community has proposed numerous prototype systems [138] that have explored a variety of shapes, forms, interactions, and implementation techniques. Despite the potential for enhancing the capabilities of information representation, there are still accessibility challenges faced by the field.

2.3.1 Challenges Faced by the Field

Alexander et al. [6] highlight the need for progression from single prototypes and individual design explorations to a more generalised approach for designing and developing shape-changing displays and interfaces. Current grand challenges for developing shape-changing displays and interfaces can be summarised by three main areas of technological, user behavioural, and design challenges.

Technical Challenges

In terms of technological challenges, *developing toolkits* that support prototyping of shape-changing interfaces still remains as a limited area of research. Practically, because prototyping these hardware systems requires knowledge of electronic and mechanical engineering that goes beyond that typically required in other areas of interactive computing – such as software programming.

Increasing the number of accessible toolkits available for shape-changing displays will dramatically lower the implementation barrier. The overarching goal of the field currently is to reduce the implementation effort of classic interfaces such as pin-array based displays [42] or more abstract PinWheels [73]. Work in this thesis aims to reduce the implementation efforts for shape-changing displays by adopting novel digital fabrication approaches that reduce assembly requirements during development. Particularly, by reducing the need for pin-array actuation as seen in chapters 5 and 6.

Scaling the device form factors and ensuring high-resolution shape-output is another technical challenge currently faced by the field [6]. The availability of small actuators with minimal weight is still limited and comes to a high cost [178]. Chapter 5 begins to address this limitation by exploring alternative actuation methods using horizontal force as opposed to traditional vertical linear force with pin-arrays. To ensure generalisability, shape-changing interfaces are beginning to move beyond stationary to mobile and wearable forms [78, 103]. Integrating and scaling of electronic components for singular instances of deformable surfaces needs to be considered when designing this new generation of hardware systems. Chapter 6 proposes a rapid fabrication approach with the use of 3D printed circuitry to support the integration of embedded electronics within a singular deformable shape-changing display. This work also supports generalisability by adopting the fabrication approach for developing wearable deformable interfaces.

Increasingly, shape-changing interfaces are also transiting from rigid forms to flexible and stretchable, and even floating shapes [52, 113, 122, 123]. To support this transition to more complex form factors, chapter 6 explores the use of flexible materials to fabricate stretchable surfaces that are both durable and can be scaled.

User Experience Challenges

There is still limited work on understanding the *user experience when interacting* with shape-changing interfaces. Current research in shape-changing interfaces is limited by the complexity of hardware required. This results in many devices being fragile, hard to replicate, and not suitably robust for long term use. As a result, evaluations of shape-changing interfaces with real tasks are limited but do exist [54, 127]. These types of evaluations help to establish suitable contexts of use and uncover possible issues that may emerge with various user groups. Chapters 3 and 4 begin to address these limitations with qualitative content generation studies. There also needs to be a better

understanding of the benefits and drawbacks of shape-changing interfaces in comparison to existing modalities for interaction. This has been done with TUIs and comparatively with GUIs [186, 211] and has proven to be insightful for their progression and advancement in interaction techniques and development.

Replication of work on shape-change is also rarely conducted. The research community tends to focus on novelty and one-off prototypes. The cost of rebuilding current systems [72] prevents independent replication studies to be performed. The value of replication is well established and documented both within and outside the HCI community [62, 159]. The core focus of this thesis is to go beyond one-off prototypes and increase the adoption of shape-changing displays within a diverse range of domains. This is achieved by developing accessible fabrication approaches that encourage others to develop their own bespoke shape-changing displays.

The core challenge when building theory for shape-changing displays is integrating and backing up empirical findings with a theory based rationale that can inform future directions of use cases for these dynamic interfaces. As benefits, the research community can generalise and predict user experience and usefulness of specific examples of shape-change. To achieve this several questions must be addressed including; an overarching definition of what shape-change is, why it works, what experience it can enhance, and when is it useful.

Design Challenges

Integrating movement and geometric transformations through actuation based on direct user input is unique to shape-changing interfaces. The responsiveness of this new generation of displays affects the design and forms of the hardware systems and their dynamic qualities. Alexander et al. [6] highlight three key design challenges currently faced by the field. (1) Designing for temporality. (2) Integrating artefacts and interaction. (3) Applications and content design.

Shape-change requires *temporal design*. Currently, there is a challenge in translating behavioural sketches and functional transitions of systems' behaviour into actual designs. While static prototypes provide tangible representations that can be comparable by users, the dynamic form has temporal aspects that are difficult to compare in practice. The direct interaction a user has with a shape-changing interface is yet to be supported with a generalised set of definitions for material properties and

experiences. Work in chapters 3 and 4 begins to address this by exploring how people design shape-changing displays with temporality in mind.

Roudaut et al. [143] propose the term shape-resolution that extends the definition of display resolution to shape-changing interfaces. Based on the mathematical model of Non-Uniform Rational B-splines (NURBS), it has ten features that can classify shape-changing prototypes from previous work based on given metrics. A key goal is to build on these classifications and develop techniques that allow the design, construction, and comparison between temporal forms for shape-change.

Integrating physical artefacts with embodied interaction is also a current challenge faced by the field. Specifically, designers are challenged to develop devices that are satisfying both in form and interaction [142]. Alexander et al. [6] highlight a core aim for the research community is to design shape-changing materials that engage both the body as well as the mind, in terms of physical and cognitive stimuli in conjunction with each other. There is a need for the development of design tools that can integrate physical dynamic form with interaction capabilities with no added complexity [162].

From a technical perspective, work in chapter 6 proposes technical approaches for integrating interactive capabilities within a singular instance of a deformable shape-changing display. The interaction techniques presented in chapter 6 support a more diversified user experience as demonstrated from a user workshop.

Exploring *applications and content design* for shape-change is also a current challenge. Recent work begins to explore a wider range of applications in large scale public events [72], sharing prototypes with the broader public [170] and developing speculative scenarios and designs [33, 169]. Though understanding when the best opportunities are to utilize shape-change and in which context is limited. Alexander et al. [6] suggest the development of frameworks and design principles that describe when shape-change is best suited to represent, when it provides enhanced interaction, and when traditional interfaces are more suitable. Chapter 3 and 4 provide in-depth content and interaction design explorations to uncover the best opportunities is to utilize shape-changing interfaces.

Sturdee et al. [170] identify categories of applications for shape-changing applications. They allow people to explore and test the current design space. The research community should aim to further expand and identify key application domains comprehensively. Particularly, to provide clear benefits and drawbacks for specific end-user engagement. Much like work on Data Physicalizations [81], there needs to be more focused and targeted applications established for shape-changing interfaces. Design sessions in chapter 4 focus on specific use-cases and data types to further expand the design space.

Toolkits that facilitate content generation on any size, shape, or form-factor interface can address content design limitations currently faced by the field. Recent work has already begun to explore possible areas for non-traditional display formats such as spherical and volumetric displays [153, 154]. It needs to be taken into consideration that content design for shape-changing interfaces addresses both the visual and physical configurations of the display and user input.

2.4 Overview of Shape-Changing Displays

This subsection provides an overarching review of the current state-of-the-art and technical implementations that motivated this work. Also reviewed are various digital fabrication techniques and content generation/ideation methodologies adopted throughout this thesis.

Several people have surveyed the field from different angles. Rasmussen et al. [138] identify eight types of shape-change for interfaces. Coelho and Zigelbaum [24] surveys the design space for shape-changing materials. Poupyrev et al. [133] present an overview of actuation styles, including new interaction scenarios from dynamic shape output.

Rasmussen et al. [138] highlight that current design and construction techniques need to be further expanded. Support for interaction design must also be enhanced, as shape-changing interfaces further exploit the perceptual-motor skills beyond the capabilities of current flat-screen displays and ridged interfaces [6]. As this new generation of displays take advantage of haptic and kinaesthetic senses, the instinctive perception of physical 3D forms, and provide inherent support for multi-user interaction – the demand for shape-changing displays to be adopted for a range of applications is increasing [168].

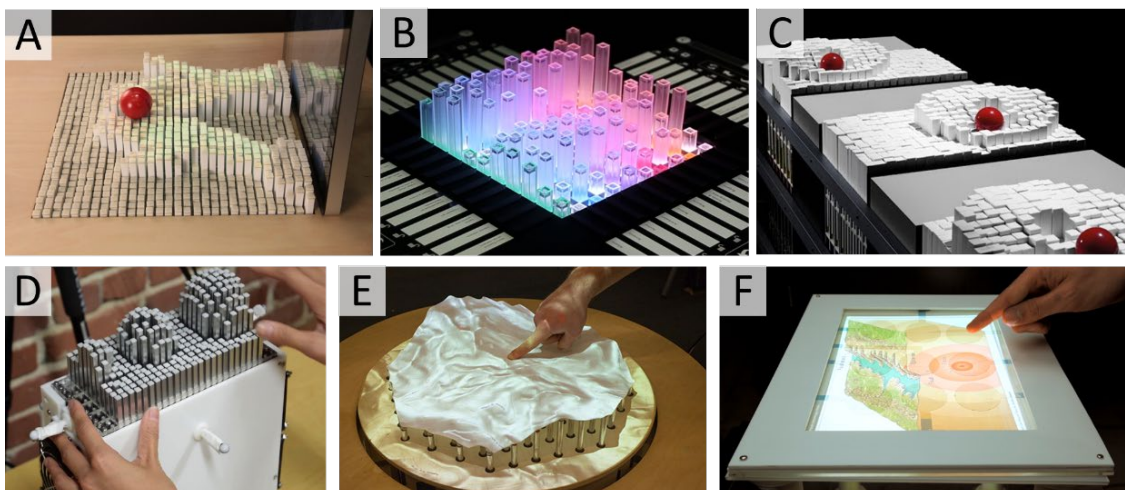

Figure 5: Examples of shape-changing displays. Pin-arrays (A-D), continuous fabric (E), and elastic shape display (F).

Shape-changing displays dynamically change their physical form to visualize data and information. They are becoming more dynamic and scalable and can be used for both static and dynamic physical information visualizations [42, 97]. Commonly shape-changing displays use motorised pin-arrays for actuation [42, 72, 158, 176] (**Figure 5A-D**). Cloth can be added to pin-arrays to create a continuous deformable surface [97] (**Figure 5E**). New forms of actuation are beginning to emerge such as electrostatically deformed displays that use electrodes mounted on its top or underside [147] (**Figure 5F**).

2.4.1 Shape-Changing Displays

An early example of a shape-changing display is FEELEX [75] which combines haptic sensations with computer graphics. The Actuated Workbench [126] is a table-top surface with integrated object tracking, physical actuation, and projected video. Objects on the surface can be both directly manipulated as well as self-actuated. These early displays explore actuation techniques for mechanically reconfigure tangible components of an interface. Similarly, Ylirisku et al. [208] explore connected tangible components through the Manhattan prototype. They show contextual data around a household using actuated blocks. Harrison and Hudson [58] developed a simpler implantation of a shape-changing interface using a touchscreen interface with deformable buttons that do not require dedicated actuators or complex circuitry.

These early examples of shape-changing displays are considered as one-off prototypes that are limited in application scenarios and show no verified empirical validation on user experience. Most current explorations focus on a single application output [170, 176, 198]. Though, modular toolkits are beginning to emerge for supporting the design of shape-changing interfaces [57]. Kinetic Tiles [88] is another example of modular construction units for kinetic animations that use present movements, design via animation toolkit, and direct input. Work in this thesis further expands this notion by exploring how these systems can be used to let users generate their own content through accessible and modular fabrication approaches.

2.4.2 Interaction with Shape-Changing Displays

Shape-changing and deformable displays are still a relatively new area of exploration and the community is still building an understanding of user interaction. Current

research [13, 42, 98] explores the combined use of freehand gestures, direct touch to resolve input ambiguities, and direct data input through an external interface [75, 79]. Rasmussen et al. [138] also describe three approaches to shape-changing interaction: no interaction, indirect interaction, and direct interaction.

Direct Interaction

Most commonly, direct interaction techniques have been explored and evaluated within the field. This is where the user physically contacts the deformable surface of the display with their hands to provide input. For pin-array displays, initial quantitative studies show it is more effective to allow users to directly interact with individual pixels using their hands [176]. Early work focused on establishing direct interaction techniques for manipulating shape-changing surfaces [28, 40].

Dand and Hemsley [28] describe a range of interaction techniques to directly deform an elastic surface. The prototype system combines a linear actuator display with the freedom of interaction enabled by an elastic surface. The user can reach in and manipulate the shape of the topography and navigate various data layers. The elastic nature of the top layer shows height changes of the display and enables gesture explorations through two types of linear actuators; individual actuators represent single point features (1), and movable base plane enables uniform surface deformation (2). The user is able to intrude or extrude the display by pushing or grasping the surface directly with their hands and fingers. Though this system could support multi-user interaction there is still limited work on multi-person interactions for shape-changing displays.

Previously interaction has been limited to buttons [133] or button-like behaviour [76]. Many initial examples of interaction techniques with tangible and actuated interfaces focus on touching the surface acting like a mouse click in traditional graphical user interfaces (GUI). Poupyrev et al. [133] proposed interactions that explore behaviours similar to a touch screen that enable users to swipe their hand above the surface for interaction. These initially proposed interaction techniques being to support the diverse range of tangible modalities enabled by shape-changing interfaces. However, current work lacks empirical evaluations of usability. Quantitative analyses evaluating interaction techniques are yet to be fully established and are generally limited [6]. Most

recent work on the quantitative empirical analysis of shape-changing displays focuses on pin-array interfaces rather than deformable surfaces [98, 176, 177].

Direct and Gestural Interaction with Tangible Data

Shape-changing displays can facilitate data exploration tasks such as sorting and navigating data sets that exceed the fixed two dimensions of traditional flat-screen displays. EMERGE [176] is a shape-changing display consisting of a 10x10 pin-array of linear actuators that begins to explore interactions with physically dynamic bar charts. Gestural interactions were compared to physical interaction techniques. These interactions included directly touching the data points and gestures such as swiping to manipulate data. No clear difference in user preference was found between directly touching data bars and using gestures. Specifically, strength and weakness were found for both direct and gestural interaction techniques based on the context of use.

For precise interactions, users preferred to directly press a bar for annotation of a data point, rather than use gestures. In contrast, large scale data manipulation, large gestures for row organisation show more beneficial for users. Participants were able to successfully use multiple physical interaction techniques for manipulating a given data set. These insights supported designers by encouraging more freedom to integrate different types of gestures when developing interaction techniques.

Taher et al. [177] provide a quantitative evaluation with dynamic physical bar charts for data explorations. Specifically, they analyse and explore users' body movements and hand-gestures to understand how people approach and react to dynamic physicalizations and how they interact with the physical data directly. Users were able to confidently initiate physical interaction with the bars. Users also pressed and pulled most frequently bars around the edges of the display. It was suggested that edge bars are best used as a control mechanism on future implementations of pin-array displays. Participants were, however, hesitant when attempting to carry out concurrent bar presses to hide data.

Interaction with Physical Objects

The physical reconfigurable nature of shape-changing displays enables new and novel interaction techniques that go beyond the capabilities of traditional flat-screen static displays. Specifically, these deformable surfaces enable object manipulation either directly through user interaction or to represent data more dynamically. inForm [42] support interaction and manipulation of external physical objects.

The adoption of physical telepresence with a depth camera enables mapping of a physical object's geometry to the actuated deformable surface. TRANSFORM [72] incorporates motion design to manipulate physical objects situated on the actuated surface of the display. The Escher mode demonstrates “inter-material interactions” through the “dance” with inert passive materials (red balls). The large-scale shape display can also move an object, such as a mobile phone, closer to the user without the need to direct contact from them. AnimaStage [114] uses a pin-based shape-changing display as a stage for physical animation. These examples of novel interaction with external physical objects demonstrate the utility of shape-changing displays. Though no empirical evaluations of usability are presented there is an opportunity for object manipulation as an interaction technique to be adopted for a wider range of applications.

Gestural Interaction

Gestural interaction within this context is referred to as mid-air gestures that are performed above the surface of the display. Usually, tracked by an external infrared camera. Leithinger et al. [98] explore gestural interactions with a pin-array shape-changing display, Relief [97]. Their work begins to establish fundamental guidelines for interaction with shape-changing displays. They highlight current limitations of touch and deformation as input on 2.5D shape displays. Specifically, the problem of reaching when the shape of the interface surface may hinder direct touch. They propose the use of above the surface gestural interaction to overcome this limitation.

Leithinger et al. [98] also present interaction techniques which extend manipulation through touch with freehand gestures. They identify a set of common interactions for viewing and manipulating content on shape displays and propose hands-free gestures to enable; selecting, translating, rotating, and scaling areas of the deformable actuated surface. deForm [40] is a novel input device that supports 2.5D touch gestures, tangible tools, and arbitrary objects, as well as real-time structured light scanning of a malleable surface for interaction. The system supports touch interaction as well as more complex hand interactions due to its depth. This technique is combined with IR projection allows for invisible hand capture, which provides an opportunity for collocated visual feedback on the deformable surface.

Touch interaction on the top of the surface can also be performed where the reconstructed 2D texture image of the gel surface can be used to do basic diffuse IR multi-touch sensing. Capacitive sensing is also used within the system to distinguish between touch and tools. The above examples focus mainly on qualitative analysis, there is limited work focused on developing more general models of quantitatively performance analysis.

Eliciting User Input to Design Interaction

Content generation from a novice user's perspective is becoming a novel approach for allowing a wider demographic of users to interact with shape-changing displays as well as begin designing applications specifically for their use. This technique allows researchers to gain creative input on the design process [27] and new suggestions for designing direct interactions and gestures [198]. This technique has already been applied to the shape-change arena: by sampling a public user-base [170] new application ideas have already emerged that go beyond those documented by the research community. This shows the effectiveness of public involvement and allows researchers to compare and contrast ideas in existing literature.

2.5 Technical Implementations of Shape-Changing Displays

This subsection reviews techniques for building shape-changing displays from a technical perspective. Actuation techniques from the field of robotics that have influenced work in this thesis are also discussed.

The majority of shape-changing displays can either be user-deformed or self-actuated and are mainly used as input or output for data representation [138]. Poupyrev et al. [133] present an overview of actuation mechanisms and techniques for physically reconfigurable user interfaces. They define an actuated interface as: *when physical components move in a way that can be detected by the use*. They explore various parameters of mechanical actuation such as; changes in the spatial position of components, the speed of motion, surface texture reconfigurations, and force of direct user interaction.

Coelho et al. [24] survey smart-materials used for shape displays. They review properties of shape-changing materials, such as shape memory alloys (SMAs), to establish how each material can affect the behaviour of shape-changing objects. They detail; deformation strength and power requirement, speed and resolution of configurations, number of memory shapes, transition quality, trainability of the materials, as well as consistency in transitions.

Taher et al. [178] also examine current implementations techniques of motorized, pneumatic, hydraulic, magnetic, and shape-memory actuators within the field of shape-changing displays. The majority of existing shape-changing displays consist of an array of solid actuation pins [42, 72, 78, 96, 97, 132] or deformable surface material [28, 147, 185, 206]. These hardware systems can limit the physical representations of complex polygonal structures, meshes, or curved contours due to lack of resolution and dynamicity in surface configurations. HypoSurface [32] combines a flexible surface with solid elements to reduce the actuation requirement and provides polygonal structure rendering. However, this system does not attempt to reduce the barrier to adoption outside HCI.

2.5.1 Elastic Deformable Displays

Troiano et al. [184] explore interaction scenarios and gestures for elastic user-deformable surfaces without actuation. They list a range of user-deformable devices with haptic feedback in addition to materials and gestures used for applications such as multi-layered data visualizations [110] and 3D modelling. Kammer et al. [84] provide a task and interaction focused taxonomy for elastic displays to further insights for designers and developers of promising applications for this new technology. The large visualization and interaction area these displays offer can be utilized to represent large scale data-set representations.

These displays also enable simultaneous visual and haptic feedback by using a transparent flexible sheet in front of an LCD [58] or using rear-projection [199]. Users can also explore multi-dimensional data using ElaScreen [209]. A depth-sensing camera captures the depth variance once a user deforms an elastic screen. The data captured by the depth camera is then used for navigating data visualisations on an external flat-screen display. This hardware system consists of three core elements; an elastic touch screen and a depth camera for interaction, and a flat-screen display for visualisation. Though these components can be commercially purchased, they are all external to the primary elastic surface.

Within the domain of shape-changing displays, there is limited work on an integrated deformable surface that embed integration and visualisation within them [168]. TableHop [147] presents a new actuation approach for creating a dynamic surface display that combines the advantages of user-deformable and self-actuated fabric displays. Similar to most existing deformable elastic surfaces, it requires an external projector for visualisation. Though in the case of TableHop, the projector is situated under the elastic surface to provide under-the-surface projected visualisations to minimise occlusion that is a common issue with traditional shape-changing displays that use projection for visualisation.

2.5.2 Mechanical Pin-Actuation Displays

Pin-array linear actuators are the most common approach for constructing shape-changing displays [178]. These hardware systems provide sensory abilities such as haptic feedback, dynamic physical affordance, scalable form-factors, and three-

dimensional interactions. Mechanical pin-array actuated shape-changing displays work on a similar principle as a pin-screen [39] or a pin impression toy (see **Figure 6 A-B**). With a pin screen, each pin in a 2D array in aggregate can create a dynamic surface deformation. The pins are vertically movable much like each motorised linear actuator in a pin-array shape-changing display.

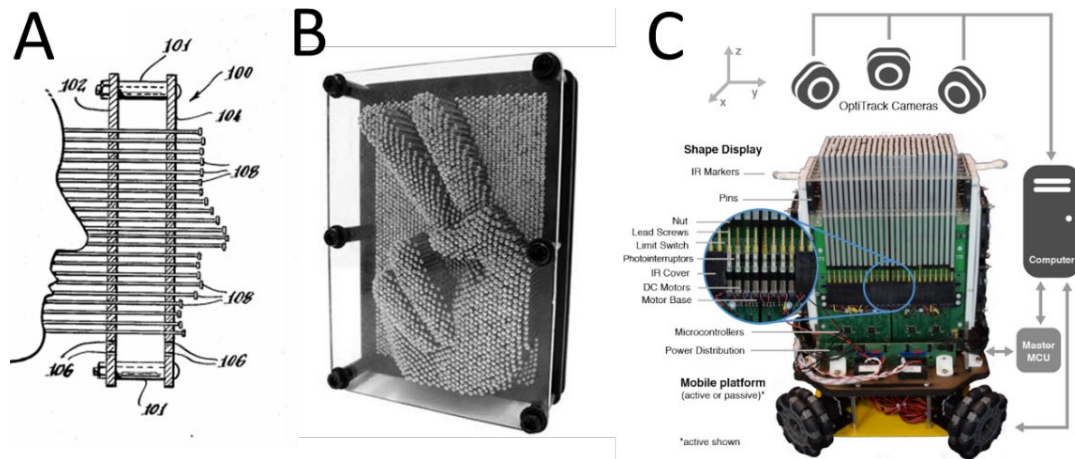

Figure 6: An original illustration of pin-screen [39] (A), pin impression toy (B), and side-view implantation of shapeShift, a mobile pin-array shape-changing display [158] (C).

FEELEX [75] was one of the earliest shape-displays that combined haptic sensations with computer graphics on a table-top. They proposed the use of an array of vertical actuators that consist of a rod, DC motor, a linear guide, and a rod that can move up and down based on computer control. In combination, the linear actuators are used to create fluid shape movement. Their original 6X6 linear actuator array could be set under an elastic screen to create continuous surface deformations. External projection above the surface was used for visualisation. This implementation approach has become the baseline method for constructing the majority of shape-changing displays over the duration of the last three decades. The mechanical design for the actuators has stayed the same and has been implemented through the field on numerous prototype examples.

Figure 6C shows an implementation of a traditional pin-array shape-changing display with vertical linear actuators [158]. shapeShift attempts to increase the freedom of movement by using four wheels to make the display mobile, by this increases the technical complexity of the implementation.

Relief [97] and Sublimate [96] are similar actuated table top displays that support gestural interaction whilst rendering dynamic 3D surfaces. Relief is actuated by a 12x12 array of 120 commercially available motorized actuators with 130mm vertical travel. These pins can be covered with a Lycra cloth material to create a continuous smooth surface. Using over-the-surface projection for visualisation it becomes an elastically deformable display. Sublimate consists of 120 motorised pins arranged in a 12x12 array with 38.6mm spacing between them. Each linear actuator on Sublimate has 100mm vertical travel. For data visualisation and interaction, the shape display includes a stereoscopic screen, a half-silvered mirror, above the head projection, a table, and infra-red tracking equipment. As seen by both Relief and Sublimate, pin-array shape-changing displays often require additional external electronic components and equipment to support visualisation and interaction with the display. Though the pin actuators can provide shape-deformation of a surface, additional external equipment such as projectors or depth cameras are needed to support visualisation and interaction. These additional external components can further complexify the design of the shape display and increase the cumbersome hardware set-up that already consists of at least 120 mechanical actuators.

inForm [42] is another table-top pin-array display. The hardware system consists of a larger 30x30 grid of motorized pins for height actuation and provides visualisation with an overhead projection. A depth-camera positioned at the top of the display enables interaction. Using external components for visualisation and interaction are a common implementation for pin-array shape-changing displays. TRANSFORM [72] combines 3 embedded inForm displays, each consists of a 24x16 grid of motorized pins (total 1,152 pins). Though TRANSFORM does not use any projections visualisations, the hardware system is considered more like a piece of furniture due to its large scale. Unlike the pin-array displays described above interaction is integrated within the display through slide potentiometers.

Taher et al. [176] developed EMERGE to generate dynamic physical bar charts on a table-top. 10x10 array of motorized sliders are used to explore new direct interaction techniques. Each motor is attached to a plastic rod. Visualisation is integrated within the display as each linear actuator has a dedicated colour LED for visualization without occlusion. Though this approach for visualisation limits the resolution and interaction detection is still supported through an external depth camera tracking. Currently, pin-

array shape-changing displays struggle to integrate both visualisation and interaction within their surfaces without the need for external electronic components such as projectors or depth cameras.

For small scale low-fidelity pin-array implementation, ShapeClips [57] enable rapid prototyping of physical shape displays with minimal programming skill. Combined with an LCD screen, ShapeClips can create 3D displays with dynamic physical forms. The open source modular nature of ShapeClips can be utilised to allow users to place actuators anywhere below a screen to create a shape-changing display that requires height elevation. Each ShapeClip linear actuator can be considered as a building block for creating a diverse range of shape-changing displays. An RGB LED is embedded on top of each ShapeClip to support visualisation, though on a low-resolution level. However, integrated interaction capabilities are supported with ShapeClips and external electronics are needed for user interaction.

Array-based shape-changing displays are beginning to be adopted for a range of scales. In terms of miniature scale actuation, Jang et al. [78] present Haptic Edge Display for mobile tactile interaction. This hardware system consists of a linear array of miniature piezoelectric actuators to enable novel input and output techniques for mobile devices. Takie et al. [179] on the other hand presents large-scale actuators that have the ability to extend up to 25 times the human height (3,000mm top elevation / 120mm minimum).

2.5.3 Shape-Memory Alloy (SMA) Actuation

For alternative actuation, Coelho and Zigelbaum [24] explore properties and limitations of current materials, primarily Shape Memory Alloys (SMA), used for shape-changing user interfaces. They fabricate four design probes to further understand parametric design and motion transitions using SMA for actuation. MimicTiles [115] is a small scale deformable user interface for mobile devices with variable stiffness to provide users with a range of interaction techniques for a small mobile device. The implementation only uses SMA wires for both actuation and external input sensors. Qi and Buechley [136] present examples of SMA self-actuated paper/origami for physical notification output and physical animation.

For deformable mobile user interfaces, MorePhone [51] consists of a thin E-ink display where the SMA is attached to a flexible surface. Morphees [143] are flexible mobile

devices that adapt their shape on-demand to depending on an application scenario. SMA wires are used together with a flexible touchscreen. Coelho and Zigelbaum [24] explore the properties and limitations of Shape Memory Alloys (SMA). They fabricate four design probes to further understand parametric design and motion transitions using SMA for shape-changing interfaces. Qi and Buechley [136] present examples of SMA self-actuated paper/origami for physical notification output and animation. Morphees [143] are flexible mobile devices that adapt their shape on-demand to depending on an application scenario. The majority of current SMA implementations focus on small scale deformable user interfaces. SMA has the potential for adoption in larger scale table top shape-changing displays but has yet to be fully utilized within the domain due to the energy demands of SMA for deformation on large scale.

2.5.4 Actuation Techniques from Robotics

There is an increasing interest in developing reconfigurable surfaces in the field of robotics. The cross-disciplinary contributions of this work aim to extend the utility and accessibility of tangible robotic interfaces for future applications within a range of domains. A variety of actuation techniques, that go beyond mechanical linear motorised actuators, have been developed within the field of soft robotics that begins to address technical challenges faced when developing shape-changing displays. Many pin-array shape-changing devices utilize large numbers of actuated physical pixels to produce three-dimensional contours and surface deformations. One of the current technical challenges addressed by the soft robotics field is integrating many actuators in close proximity and configurations. By utilising alternative forms of actuation, such as vacuum power, the limited degree-of-freedom, resolution, and performance with existing devices can be overcome.

Modular Actuators

Robertson et al. [139] address current technical challenges with pin-arrays by developing a compact modular soft surface with reconfigurable shapes and stiffness. By utilizing vacuum power and soft material actuators they present a soft reconfigurable surface with multimodal control. The hardware system comprising of a square grid array of linear vacuum-powered soft pneumatic actuators, built into plug-and-play modules. They enable the arrangement, consolidation, and control of multiple degrees-of-freedom. Much like ShapeClips [57], this architecture facilitates the construction of

customized assemblies with compact form factors. Though unlike traditional linear actuators used for shape-changing displays, Robertson et al. [139] present a new reconfigurable surface concept based on a new type of modular linear Vacuum-Powered Soft Pneumatic Actuator (V-SPA), which is capable of operating in position, force, as well as stiffness control modes. This additional variable surface stiffness control supports higher degrees-of-freedom manipulation, expanding the interaction design space and affordances compared to the capabilities of traditional linear actuators used.

Origami Robotics

Modular origami robots can also be used to generate reconfigurable surfaces. Mori [12] consists of single entities in the shape of equilateral triangles that combined form a modular reconfigurable surface. These self-folding robotic systems support modularity, origami-folding, mobility, and versatility in the shape output possibilities that go beyond traditional HCI implementations. One of the core limitations with modular self-folding robots is insufficient torque that may lead to inaccurate movements and even transformation failures. To further optimize the adoption and robustness of modular self-folding robots, Yao et al. [207] present a methodology for optimized reconfiguration with torque limitation in modular self-folding robots.

These modular origami style robots can be easily adopted for shape-changing displays. Micro-robots are already beginning to be applied as an alternative technical implementation for developing data physicalizations and shape-displays [94]. Though current work within the HCI field also focuses on more of a technical approach for combining modular robotic components. Zooids [50] are custom-designed wheeled micro-robots each 2.6 cm in diameter. In combination with a radio base station, a highspeed DLP structured light projector for optical tracking, and a software framework for application development and control, these micro-robots can create swarm based interfaces. These examples of robotics adapted for interfaces show promising future direction within the field of HCI, however, no substantial work has yet been conducted on their usability with users.

Actuated Surfaces

Flexible fabric actuators [46] are also an emerging alternative for developing deformable surfaces without cumbersome electronics. These fabric actuators consist of lightweight and flexible artificial muscles that use electro-pneumatic regulators to

create thin artificial muscles on a flexible rubber swath. The continuous surface system can control the fabric actuator smoothly, and control methods to realize six basic movements. An external depth camera can be used for supporting gestural user interaction capabilities with the actuated fabric surface. This particular hardware system has a lot of potential for adoption in the field of shape-changing displays due to its streamlined and thin nature.

2.5.5 Other Actuation Mechanisms

Harrison and Hudson's [58] visual display elevates deformable physical buttons and other interface areas with pneumatic actuation. An infrared camera behind the display enables multi-touch input and visualization through rear projection. Stevenson et al. [160] present an inflatable hemispherical multi-touch display where curvature changes dynamically from flat to dome. Follmer et al. [41] explore the jamming of granular particles applied to malleable and flexible interfaces. Yao et al. [206] present a range of shape-changing interfaces that actuate by pneumatic soft composite materials. Direction and angle of deformation are controlled by constraints through pre-programmed material structures.

2.5.6 Summary of Subsection

To summarise, the majority of current shape-changing displays are one-off prototypes that require significant expertise in electrical engineering, mechanical engineering, and materials science to construct [126, 176, 185, 198]. As a result, building robust shape-changing displays comes at a high cost in terms of time, technical complexity, and economic investment. The need to create more accessible approaches and tools for fabricating shape-changing displays is highlighted in current research [36, 170]. Particularly with high interest for modular actuators [57].

Current technologies adopted by the HCI community for building shape-changing displays are limited in terms of scaling and reproducibility. To render high-resolution shape changes with pin-arrays require thousands of actuators that are interconnected, making for complex and high-cost circuitry and electronics. SMAs require time for training and are limited in consistent shape reconfigurations. Elastic displays offer a diverse range of interaction capabilities though often lack computationally controlled actuation. Work from the robotics community, particularly soft robotics, shows more

promising actuation technologies that overcome the limitations listed above. For example, vacuum powered modular actuators can provide more degrees of freedom. Origami inspired micro-robots self fold to create more complex geometric structures that go beyond 2.5D surfaces. Work in this thesis supports a cross-disciplinary approach that is influenced by the robotics field to create integrated actuated surfaces.

2.6 Kinetic Art

In the domain of art, kinetic sculptures reflect the core principles of shape-changing displays by also providing physical movement and shape change output forms. Specifically, their movements are used to evoke artistic expression through material or object movement. Kinetic art is defined as any art form that contains movement perceivable by the viewer or relies on motion for effect [161]. Motion driven artwork provides apparent physical movement, most often through mathematical principles that are paramount to the dynamic shape-changes of the artwork. Kinetic artwork is formed from a diverse range of material, from wood or LED lights and can be powered electronically or using natural elements such as wind or water even. Kinetic art sculptures by artists such as Alexander Calder [20] focused on using motorised or hand driven mechanisms to create dynamic physical movements. To achieve more organic movements natural elements such as air and wind power are also used to propel motion in the sculptures [65].

2.6.1 Public Installations

Most commonly kinetic sculptures are used in large-scale public installations. Patrick Shearn of Poetic Kinetics [156] uses air and wind power to create large scale organic kinetic sculptures made of holographic mylar and monofilament. This art installation can physically represent wind speed and patterns to the public and in turn, can be considered as a large-scale abstract information display. The use of natural elements, in this case wind, for organic surface shape deformations embodies a novel approach for shape-change actuation techniques. Specifically, using natural elements to achieve shape reconfigurations that dynamically also represent data about wind. In terms of scale, the piece spans 15,000 sq. ft. and is comprised of two layers that rise from 15 feet off the ground to 115 feet in the air.

Alternatively, mechanical parts automated through computational programming can be used to force movement [183]. David Cerny created the mechanically powered “Metalmorphosis” [23] as a 30-ft tall giant head made of horizontally sliced stainless steel plate layers that rotate in various patterns. The kinetic sculpture consists of 42 independently driven layers with max revolving speed of each layer 6 RPM. Though the art piece has no formal data it is representing, the large scale mechanical implementations shows dynamic shape movements and deformations for artistic expression. More complex computational kinetics are developed by design studio ART+COM [166]. They utilize the physical properties of objects and materials to provide novel communication platforms that move away from flat screens in public settings. Their new dynamic interfaces, such as the original BMW Kinetic Sculpture [165], represents three-dimensional forms. In a six-square-metre area, 714 metal spheres are suspended from the ceiling on thin steel wires and animated with the help of mechanics, electronics and code.

Though kinetic artwork is not significantly documented in HCI research, these examples of shape-changing installations provide technical and user engagement insights. Specifically, the use of organic and natural elements for actuation and shape deformations is a unique technical contribution that is yet to be fully utilized within the field of shape-changing displays and organic deformable interfaces. These works of kinetic art have also been successfully deployed in public environments.

To further the adoption of shape-changing displays in public environments more studies of how the kinetic sculptures are perceived could perhaps provide insightful findings on user engagement and interaction.

2.7 Digital Fabrication Approaches

When looking at technical development opportunities for shape-changing displays, digital fabrication approaches show the most promising avenue for adoption for both designers and developers. Digital fabrication is the design and development of physical artefacts from digital data, usually using Computer Aided Design (CAD), most commonly solid static objects, prototypes, and enclosures. In the context of implementation for shape-changing displays, digital fabrication techniques are used to create dynamic non-static surfaces that can reconfigure in shape and form on demand.

Two core approaches to fabrication are subsumed under this term: additive manufacturing - where material is added to form an object - and subtractive manufacturing - where material is removed to the same end. Both approaches can be implemented through different processes, each offering unique benefits and disadvantages., such as cost and timing for fabricating. While a full survey of these approaches and technology is outside of the scope of this thesis, for an in-depth analysis for additive manufacturing and rapid prototyping techniques please refer to Core's review [25], Bourell et al. [15], and Kruth et al. [93].

This sub-section reviews current digital fabrication approaches that can further advance the design and development of shape-changing displays, Specifically, focusing on 3D printing and laser cutting as these are most commercially available and accessible techniques.

2.7.1 Laser Cutting Fabrication Methods

When designing and building shape-changing displays, the cost of fabrication must be considered, in terms of both time and technical complexity. As these hardware systems are often bespoke and require to be built from scratch, accessible fabrication approaches are essential for their wider adoption. Though additive fabrication methods, such as 3D printing, offer freedom with the variety of shape they can produce, the time constraint for fabrication is often limited by the scale of the object [109]. Traditionally, laser cutters offer rapid fabrication though this comes at a cost of being limited to producing only 2D parts. These 2D cut sheets of material can be used to create 3D objects, such as enclosures, however, this then requires manual assembly and mapping 3D designs to 2D layers of parts. Using joints, such as finger joints, allows for pieces of laser cut sheet material to be manually assembled to create 3D objects and enclosures. Though this approach requires extra time and assembly requirements.

Within the context of HCI, to support faster fabrication using laser cutters, Mueller et al. [108] present a rapid prototyping system that produces 3D objects using a laser cutter. Unlike traditional laser cutting, the resulting 3D objects require no manual assembly and are fabricated substantially faster compared to FDM 3D printing. Umaphathi et al. [191] present a stacking approach where layers of laser cut sheet materials are automatically generated to be stacked together to enable rapid assembly of 3D objects for a range of use cases.

From the human-computer interaction perspective, it is still a challenge to map designs from 3D to 2D. In order to build a 3D object, there must first be a decompose of the 3D design into a layout of 2D parts. In terms of accessibility as a fabrication approach, despite its widespread use in maker communities, laser cutting is still a niche skill that the majority of the population would not be confident to conduct independently. As a possible solution, Coros et al. [26] support the design of mechanical characters by simply drawing the desired output motion. Another challenge faced with laser cut fabrication approaches, with the field of HCI, is how to support people in creating more complex objects without the need for necessary technical knowledge [107].

2.7.2 Semi-Solid Surface Design

3D fabrics combine light elastic textiles with more rigid support to form more dynamic three-dimensional structures. Mika Barr's "3D Fabrics" [11] enable folding and fracturing of a flat textile pattern into a three-dimensional structure. Light and elastic textiles are hand-dyed and then screen printed with an inflexible material that supports the fabric's movement, creating a new, three-dimensional textile structure. The technique has been transferred into industrial production. Similarly, Elisa Stozzyk designed "Wooden Fabric" [164], a material that is half-wood half-textile. Small pieces of wood are laser cut and manually glued to a thin layer of fabric to allow for movement. These dynamic wooden surfaces can be manipulated by touch due to their semi-solid material properties. These design techniques can be extended to rapidly fabricate semi-solid polygonal surfaces that can actively deform for shape-changing displays.

2.7.3 3D Printing

Wong and Hernandez [205] review the current additive manufacturing processes for 3D printing. Stereolithography (STL) and Fused Deposition Modelling (FDM) are the most common commercially available methods for 3D printing. As interest for 3D printing widens, maker communities such as MakerBot's Thingiverse [104] and MyMiniFactory [2] support users to share, collaborate and further evolve new and pre-existing work.

3D Printing on Fabrics

Recent research [130, 146, 181] combines 3D printed polymers with textile materials to show new application opportunities, such as adaptive wearables. Users in maker

communities have further developed these methods of 3D printing on fabrics to create flexible surfaces with more accessible methods [192]. 3D printing solid elements onto textiles offer opportunities to develop new materials that mimic fluid and ridged characteristics. However, uniform fabric lacks control designed interlinks provide.

3D Printed Interlinked Fabrics

3D printing interlinked cloth-like materials is an emerging applying area [141]. Nervous System (2013), a design studio led by Jessica Rosenkrantz developed Kinematics [140], a system for 4D printing that creates complex, foldable forms composed of articulated modules. The system provides a way to turn a three-dimensional shape into a flexible structure using 3D printing by modelling triangles and then interlinking the individual parts together with hinges. This work reflects Kinematics' use of 3D printed articulated modules interlinked to construct a dynamic mechanical structure, but this technique is yet to be applied specifically for shape-changing displays. Recent research [203] also shows electrospinning (Electroloom) as an approach for 3D printing custom 3D fabrics and textiles. As this technology remains in a prototyping phase, this thesis focuses on more accessible approaches for 3D printing fabrics using SLA and FDM machines. The initial explorations are based on current design work for 3D printing fabric-like surfaces [82, 106], that can be accessible to researchers and designers.

3D Printing with Embedded Electronics

With the recent development of multi-material 3D printers, there is now an increase in construction of customisable interfaces with interactive capability [149]. This introduces great potential for low cost and lead time device fabrication. Wills et al. [204] describe an approach to 3D printing customizable interactive devices categorised as Printed Optics. Functioning devices are designed within a digital 3D modelling editor and realized into a single physical form through optical 3D printing. Active components and optical quality elements are embedded into the device as part of the fabrication process.

Savage et al. [148] describe a fabrication approach for designing and developing interactive interfaces with embedded optical light tubes within the interiors of 3D printed objects. Electronic sensors or actuation components are manually embedded into the interior of 3D printed objects. Subtractive processes are implemented through

an algorithmic approach to generate space within 3D models for the insertion of active components and electronics. Through manual insertion, electronic sensors or actuation mechanisms are situated within 3D printed objects to enable interactivity.

2.7.4 4D Printing

4D printing is a relatively new area of additive manufacturing that includes time as the additional 4th dimension. Specifically, the transformation of the material and its shape over time that is mathematically incorporated during the 3D printing process [86]. In relation to the field of shape-changing displays, the additional shapeshifting capability of 4D printed objects provides novel fabrication methods that go beyond other additive manufacturing approaches. By incorporating shape changes and movement within objects, directly during the printing process, provides new avenues of design and fabrication for deformable surfaces.

The self-assembly programmable materials and adaptive technologies that 4D printing supports can reduce the mechanical and electronic components required for actuation. 4D printing utilizes advances in material science to fabricate physical objects that can transform themselves based on external stimuli. Khan et al. [86] review current work on shape-shifting materials used in 4D printing, for both single and multi-material additive manufacturing techniques.

Ultimately, 4D printing enables physical shape changes of an object fabricated using smart materials that react to stimuli or an interaction mechanism embedded during the printing process. Specifically, Leo [99] defines smart materials as “those materials which convert thermal energy into mechanical work”. Qamar et al. [135] highlight the need to incorporate and utilize multi-disciplinary collaborations with material sciences to further advance the design and fabrication of shape-changing displays and interfaces. Skylar Tibbits’s Self-Assembly Lab at the Massachusetts Institute of Technology (MIT) [182] has also focused on the development of self-assembly, programmable materials and adaptive technologies.

Embedding Active Capabilities for 4D Printing

The shape-shifting behaviour of parts, material structures and response to various stimuli are all considered to define 4D printed applications. These active capabilities are simulated through mathematical modelling of the 4D printing process. There are

two categories for recently developed 4D printing materials: single and multiple materials/composites. 4D printing of single material can support self-adaptability, self-sensing, shape memory and multiple functionalities are the qualities that are sought of smart materials [14, 83, 194]. Active origami is an example of 4D printed multi-material. Qi et al. [49] demonstrate the use of multi-material technology to create printed active parts and check their ability is one of the useful achievements in 4D printing of active origami. These examples of 4D printing capabilities can be utilized for designing and fabricating streamline shape-changing displays that can support embedded interaction and actuation capabilities.

2.8 Content Generation and Ideation Methodologies

Shape-changing displays are still a relatively new area in computer science and the research community is still building an understanding of which applications are best suited to support this new generation of displays [168]. Content generation explorations are essential for understanding what types of data and information are best represented using the dynamic and physical modalities [4] that encompass shape-changing displays [6].

Exploring content generation from a novice user's perspective is a technique that allows researchers to gain creative input on the design process [27] and new suggestions for designing direct interactions and gestures [198]. Employing mixed methodologies such as sketching user scenarios and creating design fictions to inform the field is becoming more widely adopted for content generation explorations [167]. Whilst public facing workshops allow for fresh perspectives on future design and use cases [170].

These techniques have already been applied to shape-changing displays and interfaces. Sturdee et al. [170] explore ideation for shape-changing content generation by sampling a public user-base for new application ideas. Their work shows the effectiveness of public involvement and allows researchers to compare and contrast ideas in existing literature. This qualitative analysis work is key for the methodology for uncovering application case studies for shape-changing displays. Design fiction has also been increasingly adopted within the HCI community to investigate potential applications for this new generation of dynamic displays, by creating and analysing artefacts relating to future use-scenarios for shape-change [169].

2.9 Summary of Related Work

To summarise, shape-changing displays support the tangible characteristics of TUIs and data physicalizations, with the added quality of computer-controlled actuation for dynamic surface movement and reconfigurations. The interaction capabilities for these displays are starting to be explored but there is still limited understanding of user experience impact due to lack of quantitative evaluation. Current work in the field of HCI has focused on singular implementations that are of high cost, both in terms of technical complexity and economic value. Particularly with pin-array displays that are both cumbersome and lack mobility. The high cost of fabrication is a major barrier for the adoption of this new and novel technology outside the research field. Work in this thesis aims to address this technical barrier by proposing accessible design and fabrication approaches for the rapid development of shape-changing displays across a diverse range of domains.

This literature review also explored work from fields outside of HCI. Current work from the fields of textile design, robotics, kinetic art, and additive manufacturing processes have all influenced and motivated the various digital fabrication approaches established within this thesis. Textile design of 3D fabrics motivated work in chapter 4. Using a laser cutter enables the creation of dynamic surfaces that support organic movement whilst changing shapes. The alternative actuation techniques proposed in chapter 5 were influenced by the varied range of integrated mechanisms that are established in the field of robotics. Various techniques for 3D printing were used in chapters 5 and 6 to explore alternative approaches for designing and fabricating novel surfaces for shape-changing displays. This work supports new methods of actuation and embedded interaction and visualisation capabilities.

3 | Exploring Novice Content Generation

As stated in the related work chapter, there is a current lack of fundamental understanding of even the most basic user interactions for shape-changing displays and corresponding use case scenarios. This is essential in providing novel opportunities for experiencing, creating, and manipulating 3D content in the physical world. Shape-changing displays' physical dynamicity exploits users' rich visual and tactile senses. As with any new 'hosting' platform, content, and therefore its generation, will be key to its future success. However, the relative immaturity of the shape-change field currently means that content generation remains largely unexplored. This chapter aims to address the initial research question:

How do people approach and react to the task of generating content for shape-changing displays?

Content design must incorporate visual elements, physical surface shape, react to user input, and adapt these parameters over time. The addition of the 'shape channel' significantly increases the complexity of content design but provides a powerful platform for novel physical design, animations, and physicalizations. For this initial work, a small but robust shape-changing display was developed as a 4×4 grid of large actuated pixels, ShapeCanvas. Together with simple interactions, ShapeCanvas was used to explore novice user behaviour and interactions for shape-change content design. ShapeCanvas was deployed in a café for two and a half days where participants generated 21 physical animations. These were categorized into seven categories and eight directly derived from people's personal interest. This chapter describes these experiences, the generated animations, and provides initial insights into shape-changing content design.

To summarize, this chapter contributes: (1) ShapeCanvas, a small, but robust shape-changing display, (2) a two-and-a-half-day deployment of ShapeCanvas into a public environment to understand how novices generate content, and (3) a thematic categorization of generated content, empirical report of interaction, and discussion on future approaches.

3.1 System Design

ShapeCanvas (**Figure 7 - left**) is a 4x4 grid of actuators, each of which has user configurable height and colour. To observe ‘pixel level’ interaction, the display was designed to be a small size. ShapeClips [57] were augmented with laser-cut frosted acrylic cases, attached LDR light sensors to the top left corner to sense user interactions, and utilized ShapeClip’s built-in LED for the display. Each physical pixel has a top surface area of 35×35mm and actuates 100mm. The ShapeClips were placed onto an 18” touchscreen that, along with custom-built software, was used to control the ShapeClips, run demonstrations, and facilitate user configuration of physical animations (**Figure 7 - right**). The system automatically logged all user interactions.

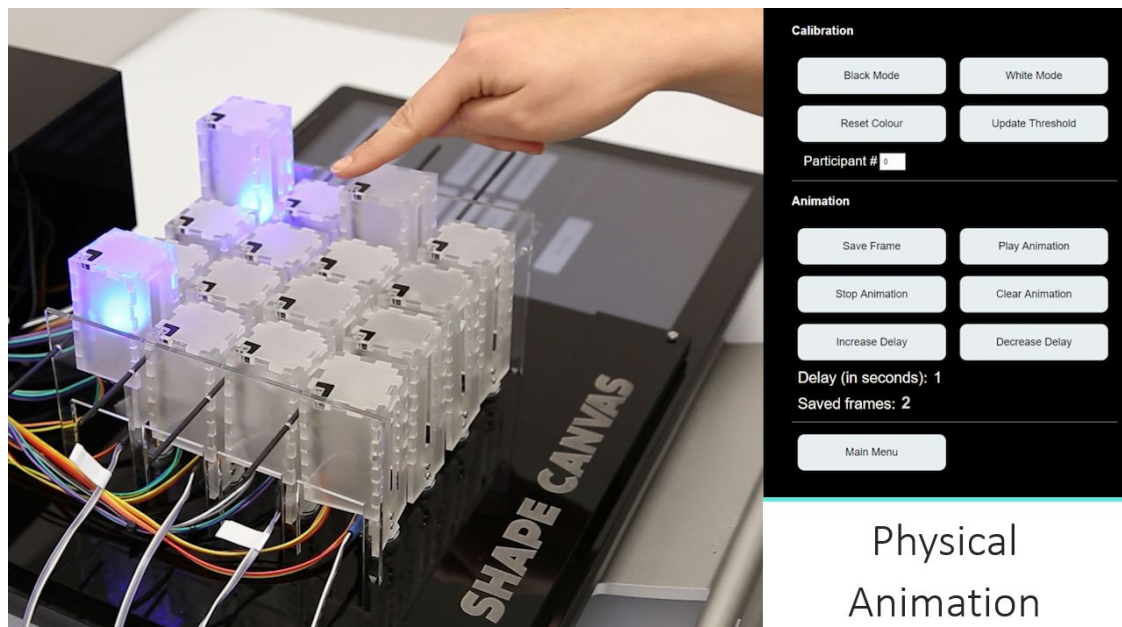

Figure 7: ShapeCanvas, a 4x4 grid of height and colour actuating pixels (left) with touchscreen controls (right).

Interaction Design

Simple interactions were designed that allowed users to configure each physical pixel’s height and colour. Animation sequences were compiled using the touchscreen (**Figure 7 - right**).

Physical Pixel Height

Height control follows a ‘mimic’ approach (as observed by Alexander et al. [5]) using the LDR for input detection. To activate a physical pixel, the user first taps the top panel

of the pixel (over the LDR). To move a pixel up, the user moves their finger vertically: the physical pixel follows. To move a pixel down, the user presses their finger on top of the physical pixel: again, it follows, the user releases their finger when the desired height is reached.

Physical Pixel Colour

A visual representation was used to control pixel colour: shining a small light source (torch) onto a physical pixel triggers the built-in LED to iterate through the six secondary colours at two-second intervals. Removing the light source stops rotation and the colour is selected. The torch was used as a “paintbrush” to maximize physical interaction.

Shape-Changing Animation

Once the height and colours are configured, users can save the frame as part of an animation sequence (**Figure 7** - right). Once multiple frames are saved, the timing between the frames can be adjusted to modify actuation speed; the system will then generate a looped animation.

3.2 User Study

In order to gain initial insight into how novice users would generate physical animations using a shape-changing display, the pixel canvas was deployed in a busy café. Novice users (rather than trained groups) ensured insights into initial interactions and reactions, potential content design domains, and ideas for future applications. Please see Appendix A for documentation related to this study.

3.2.1 Study Format

ShapeCanvas was set up in a busy café for two and a half days and used by 21 participants. A large display advertised the study in the café, which allowed participants to be self-selected by approaching the researcher. Participants were seated in front of a low table which supported ShapeCanvas. Each study was divided into three phases: (PH1) demonstration phase using a weather forecasting application with static and dynamic physical examples, (PH2) interaction training phase to allow users to understand the height and colour controls, (PH3) content design phase where participants were asked to create their own physical animations.

3.2.2 Participant Demographics

The study consisted of 21 participants (6 females) with age ranging from 18 up to 45+ years. Occupational backgrounds ranged from Policy Adviser, Chef, Systems Developer, Barista, Chemist, and Student. In total, 18 participants had experience with graphical software but lacked experience in animation (10 participants either never used animation software or only a few times a year). The average time spent performing the study was approximately 21 minutes.

3.2.3 Reactions to the Demo Applications

Each participant was shown three static physical weather frames (“Clear Sky”, “Few Clouds”, and “Many Clouds”) and two motion animations (“Rain Animation”, and “Current Wind Direction”). Participants found dynamic heights a useful indicator of weather conditions. They expressed the greatest interest in the wind and rain animations, with four participants wanting to see a larger, higher resolution version. Several participants put their hand on the display to feel the wind motion and said it would be a useful way for visually impaired users to have a more engaging experience. P7 stated that the dynamic height changes “adds an extra level of dimension and makes people pay more attention to it.... bringing the outside indoors”.

3.2.4 ShapeCanvas Application Ideas

Throughout the study participants were encouraged to think of future applications for the display [170]. A diverse range of possible application areas emerged: landscape and terrain modelling (7), dynamic board game layouts (3), modelling physical artefacts such as pizza sizes (2) or commercial products (3), displaying complex structures such as cloud formations (P3) and forest canopy layers (P15). P17 described using ShapeCanvas as a tool for modelling prototypes and products, to scale, to demonstrate physical models to overseas stakeholders. Participants pursued these ideas, along with others, during the content design phase.

3.2.5 Low-Level Interactions with ShapeCanvas

Participants initially performed interactions using their dominant hand (right = 16; left = 5) and one participant used their index finger for controlling height. Participants initially interacted with the pixels on the row closest to them and reached over to the

ones further back in the later stages. For single colour-changes participants used the torch with their non-dominant hand but swapped to the dominant hand to perform canvas-wide colour changes.

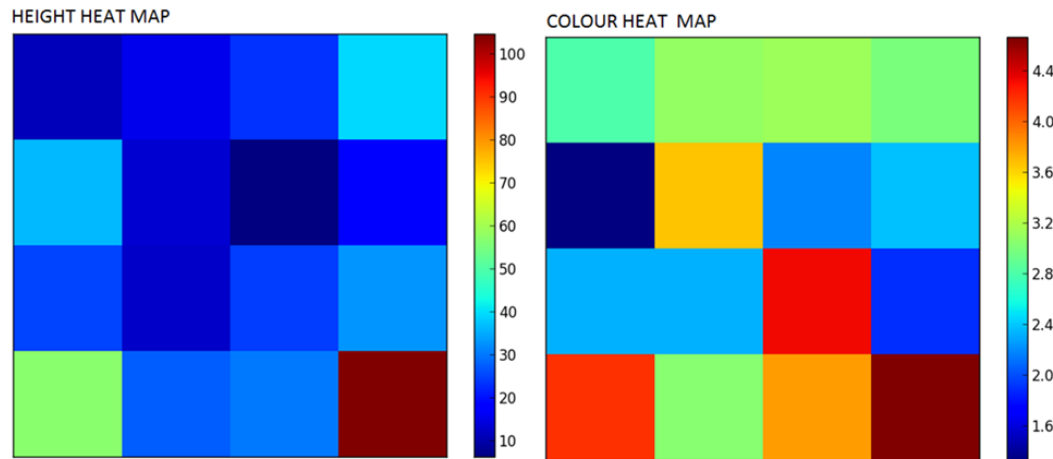

Figure 8: Height (left) and colour (right) interaction density (average number of interactions per participant) heat maps.

During the animation phase, it was noted that participants used bimanual interaction: their left hand was used to control pixel height on the left side of the display and their right hand on the right side. **Figure 8** shows a summary of where canvas interactions were performed; edges and close corners were the most popular. These observations showed that participants quickly learned to efficiently use the spatial position of their body for design; however, the hard-to-reach pixels received less attention.

3.3 Physical Animations

Each participant made at least one frame, with the longest animation containing 24 frames (mean: 5 frames). Interaction time varied depending on the complexity of the participants' design approach. Those who used fewer pixels per frame generally had shorter interaction time (e.g. P4 generated 24 frames in 9:58 minutes whereas P6 generated 6 frames in 24:31 minutes).

Animations can be categorized as artistic expressions (6), structured recreations (3), physical typography (3), face illustrations (3), landscape modelling (2), symbols and signs (2), and game simulation (2). Each participant walked through their design once completed.

Artistic Expression

Six of the participants used the system for artistic expression. They explored height and colour interactions of the 4×4 grid, activating individual pixels in no particular order. They used it “*just for fun*” (P3, P7, P14) and “*just to see what happens*” (P7, P8). These artistic animations ranged from 3 to 12 frames. **Figure 9E** is an example of a frame created by P3.

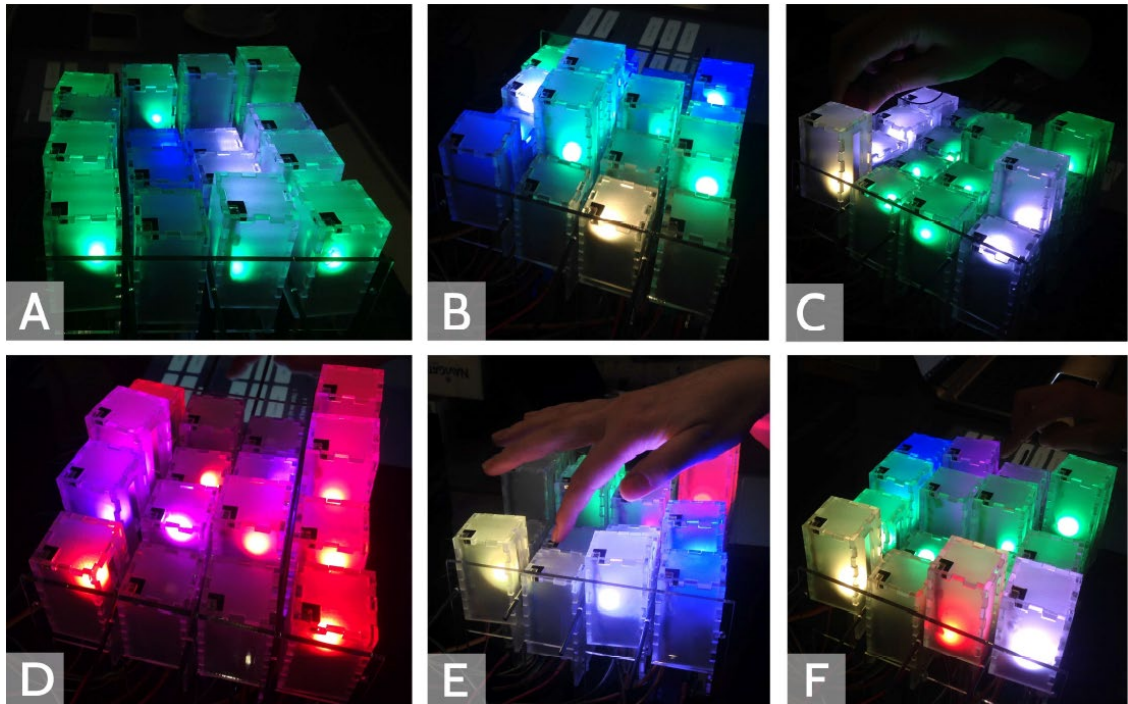

Figure 9: Assortment of animation frames created by participants. Photographs described inline.

Structured Recreations

After initial explorations, three participants recreated physical environments. P2 created the “Las Vegas Strip” (2 frames). P10 visualized a rainbow effect by selecting specific colours and heights for each animation frame (8 frames). Similarly, P21 explored a physical wave pattern that changed colour (14 frames), stating that the system could be applied in mathematics to “*physically represent the wave equation*”.

Physical Typography

Three participants created animations that spell out their name (**Figure 9D** showing the letter “I”). Participants wanted to create content personal to them and stated that “*it seems like a simple thing to show on a low-resolution display*” (P6).

Face Illustrations

P13 and P20 created simple “face” icons. P13 made a sad face to represent their mood at the time (3 frames). Similarly, P20 made a “smiley face” where the mouth moved to change expression (2 frames). P17 came from an artistic background and created a partial profile of a face which emerged from the display (3 frames). They used the height of each pixel to show the contours of the nose, eyebrow, and eye.

Landscape Modelling

Two of the participants used the system to create landscapes. P4 generated a terrain map (24 frames) that visualized a path (green pixels) through a set of mountains (red pixels that were raised higher which represented danger areas, **Figure 9F**). Their aim was to visualize suitable walking paths in mountainous areas. P15 modelled a forest canopy (2 frames) growing and dying over time (e.g. **Figure 9A** shows a gap in the centre representing dead trees). P15 used the system to “show the forest moving over time as it is difficult to represent the patterns in 2D”.

Symbols and Signs

P11 created a single frame that showed a hazard sign. The height of the red pixels on the outside represented how severe a hazard can be. The four pixels in the centre had a range of colours that mapped to a particular threat.

Game Simulation

Two participants generated game simulations. P1 made a simple game for their cat (6 frames). Each pixel represented a mouse which goes up and down at random stages of the animation to attract the attention of the cat. P9 based their animation on the strategy board game “Risk” (**Figure 9C**). They used the grid to generate a dynamic environment for gameplay (6 frames). The animation simulates a plane (blue pixel) flying over the landscape (green pixels) to a target (yellow pixel). When the plane reaches the target, the yellow pixel turns red to show the target has been eliminated.

3.3.1 General User Perceptions

In general, participants enjoyed the intuitive nature of the height and colour controls. P18 stated that the pixels followed their finger “like a pet”. P16 felt the height control allowed them to be “connected” with the display. The majority of participants wanted

to see a system of a larger scale and higher resolution (e.g. 100×100 pixels). Participants also suggested faster response times for colour and height changes.

3.4 Chapter Discussion

The majority of current shape-changing displays are one-off prototypes that require significant expertise in design, electrical engineering, mechanical engineering, and materials science to construct [126, 176, 185, 198]. The community's focus on resource-intensive technical demands limits the number of qualitative user evaluations on how people engage with shape-changing displays. There are a limited number of tools and methods to enable users, with minimal resources, to directly author physically reconfigurable interfaces [57, 176]. The need to create more accessible approaches and tools for fabricating shape-changing displays and interfaces is highlighted in current research [143, 168, 170]. This early research focused on addressing this limitation by developing a shape-changing display that supports content generation for novice users.

The core focus here was on designing and developing low-cost hardware systems that can be easily reproduced, are portable, and scalable. ShapeCanvas, a 4x4 grid of large actuated pixels, combined with simple interactions, explored novice user behaviour and interactions for shape-change content design.

3.4.1 Physical Animations

Participants successfully used ShapeCanvas to design a range of physical animations. Several participants designed content directly applicable to themselves (Physical Typography – all participants visualized their name) or their personal interests (P4, walking trail; P9, dynamic board game), and occupation-related visualizations (P15).

3.4.2 Interaction Patterns

Bimanual interaction emerged as the dominant interaction pattern. Video analysis and observations participants quickly learning to efficiently use both of their hands for direct interaction. Future design environments should try to take advantage of the direct physical interaction possible with such displays (rather than trapping users in desktop environments). P3 described the interaction as “playing the piano where you use both hands for better control of particular keys”. The tap and hover interaction for increasing

the height of a pixel was well received by users. Future iterations of ShapeCanvas will aim to increase the parallel use of both hands.

3.4.3 Limitations and Generalizability

A small (4×4-pixel grid) display was initially used, with simple interactions for novice user content design. This demonstrated that users were able to use low-level configuration to build physical animations. However, such interaction methods would need adapting to scale for large physical pixel displays. I also observed a diverse range of application areas. The choice of applications was likely influenced by the capabilities of the display, but in all cases, would only improve in quality on high-resolution displays. Larger scale content creation can be enhanced by enabling adjustable actuation speed, and concurrent multi-pixel interaction and colour selection.

3.5 Chapter Conclusion

The key objective of this work was to allow users to directly interact with a shape-changing display to generate their own content. This chapter demonstrated how novice users can create physical animations using low-level interactions for controlling the height and colour of individual pixels. The key findings from this exploration are: (1) Simple, small shape-displays are useful for informing interaction design and discovering novel application areas, (2) Novice users successfully designed a diverse range of physical animations, suitable for informing future design environments, and (3) users quickly learned to take advantage of the spatial affordances of the shape-display. These findings provide a starting point for the construction and evaluation of content design environments for shape-changing displays.

Based on the insights gained from this initial exploration of content generation for shape-changing displays, the next step is to develop prototypes that provide dedicated support for specific applications. Content generation explorations in this chapter explored more generalised uses of shape-changing displays with no particular datasets represented. The development of application-specific shape-changing displays in the next chapter is more focused on distinct datasets and establishing a platform with a variety of functions in different domains. To better understand what applications are most suited for shape-changing displays, domain experts from a range of areas were asked to design and develop shape-changing displays specific to their own work.

4 | Engaging Domain Experts in Designing Shape-Changing Displays

After an initial exploration of content generation and application ideas, this chapter begins to establish a process that facilitates the production of a range of applications for shape-changing displays. Currently, there is a limited number of tools and methods to enable domain experts, with minimal resources or technical skills, to directly author physically reconfigurable interfaces. This limits the ability to reliably design interactive shape-changing displays that utilise the dynamic physical affordances of such systems. Currently, domain experts cannot engage with novel physical representations of their data as they do not have the necessary tools or skillsets to directly design and create shape-changing displays based on their requirements. The need to create more accessible approaches and tools for fabricating shape-changing displays is highlighted in current research [6, 170]. Furthermore, there is currently a lack of understanding of the engagement impact on users of dynamic data physicalizations. This chapter aims to address the initial research question:

How can experts be engaged in designing shape-changing content to represent data specific to their work domains?

To address the research question above, this chapter presents a design approach for the rapid fabrication of high-fidelity interactive shape-changing displays using bespoke semi-solid surfaces (see **Figure 10**). This is achieved by segmenting virtual representations of the given data and mapping it to a dynamic physical polygonal surface.

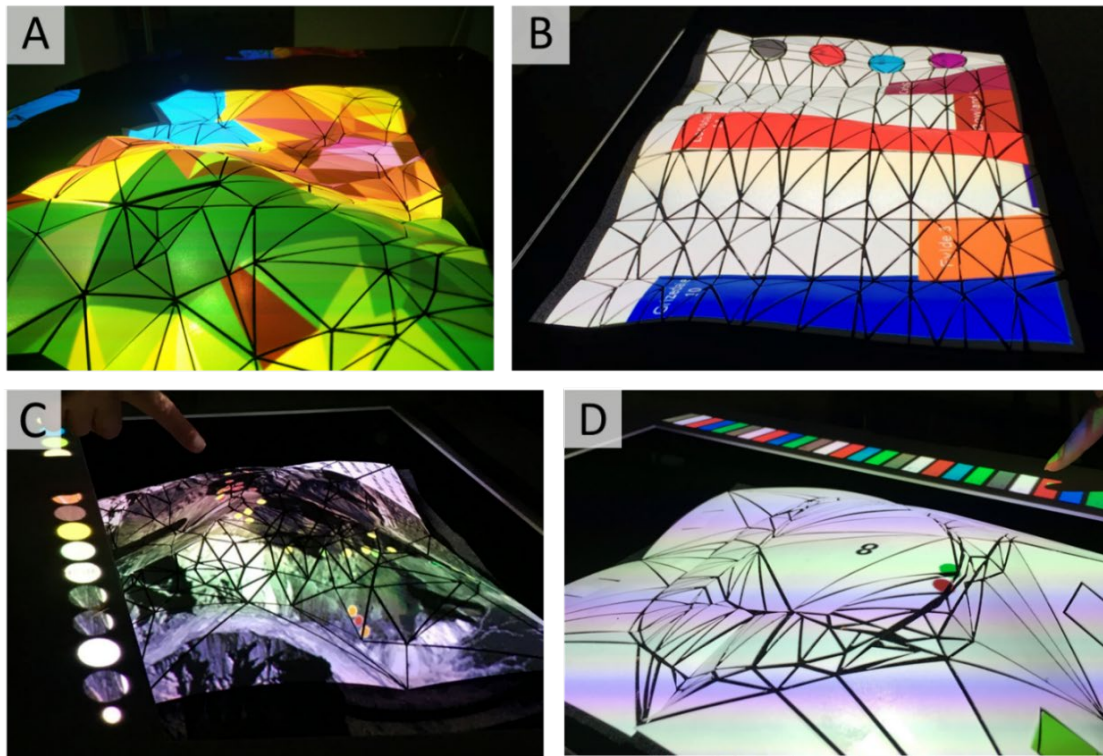

Figure 10: Interactive shape-changing displays developed with PolySurface: A) a physical terrain model used for design session demos; B) physical bar-chart interface designed by P1; C) physical volcano modelling by P2; (D) interactive physical display to model eye tracking data by P3.

The majority of current shape-changing displays are one-off prototypes that are either restricted to linear pin-based [42, 72, 97, 132] or continuous surface outputs [28, 147, 185]. These hardware systems limit the forms of data and information encoded within them due to the lack of resolution and dynamicity in the surface configurations, for both static and motion-based representations. Complex polygonal structures, meshes, or curved contours are difficult to construct. The low-cost implementation method, PolySurface, combines the benefits of pin arrays and cloth. The combined flat solid surfaces and elastic material used in PolySurface enhances the design space for shape-changing displays due to its capability to represent more complex physical structures, such as curved contours, in comparison to traditional shape-changing displays.

First, this work establishes the design and fabrication approach, PolySurface, for generating semi-solid reconfigurable surfaces. Secondly, the generalizability of this approach is demonstrated by presenting design sessions using datasets provided by experts from a diverse range of domains. Thirdly, user engagement is evaluated with the prototype hardware systems that are built. All participants, all of whom had no

previous interaction with shape-changing displays, were able to successfully design interactive hardware systems that physically represent data specific to their work. Finally, a reflection on the content generated was used to understand if the approach is effective at representing the intended output based on a set of user-defined functionality requirements.

The PolySurface approach consists of six steps: (1) Data Segmentation: input data and interface designs are digitally segmented to generate a polygonal mesh of the semi-solid surface; (2) Fabrication: the polygonal mesh is laser cut on a thin solid material such as polypropylene; (3) Assembly: the polygonal mesh is attached to durable spandex to allow elasticity; (4) Visualization Design: establish visual interface features. (5) Height Design: identify variables from the data to represent surface movement and position actuators below the display; (6) Interaction Control: implement interactive features of the display (e.g. buttons, hover control, gesture recognition).

This approach enables users from a range of domains to design and construct shape-changing displays based on their own input data. This can take many forms: photographs, graphics, Comma Separated Values (CSVs), topographic models etc. The approach decreases the number of actuators needed whilst showing more complex content and structures than pin-based or continuous fabric displays.

To summarize, the primary contributions of this chapter; (1) Conceptual approach for designing and developing shape-changing displays using dynamic polygonal surface structures. (2) PolySurface as a low-cost implementation method for rapid high-fidelity prototyping of shape-changing displays and interactive interfaces. (3) Three case studies where participants, from different domains, generated interactive shape-changing displays based on datasets provided from their work. (4) Discussion of design sessions observations that identify key design requirements, limitations, and research challenges for designing and fabricating shape-changing displays.

4.1 Design and Fabrication Approach

The overarching goal of this work is to develop an approach for rapid prototyping high-fidelity dynamic shape-changing displays with interactive capabilities. In order to develop a more generalizable contribution, I focused on reducing the design and construction time and technical requirements needed to design and generate these

dynamic physically reconfigurable hardware systems. the approach utilizes both actuated pixels, where each actuator keeps to a flat solid state, and an elastic material that extrudes smoothly from the surface of the shape-display.

4.1.1 Conceptual Approach

To facilitate engagement with end-users the approach has two key design features: (1) Allow end-users to generate dynamic display surfaces using a diverse range of input data; (2) Reduce display construction and implementation complexity by using pre-existing toolkits and minimal hardware. A six-step process was developed (**Figure 11**) that incorporates these design features. This process is based around the idea of semi-solid surfaces: surfaces that consist of solid components (laser cut polypropylene) fused onto a flexible sub-surface (spandex). By correctly segmenting input data, templates can be produced that maximize continuous surfaces (to reduce the required number of actuators) and provide sufficient flexibility to allow height control where required.



Figure 11: Breakdown of the conceptual approach.

This approach has three key advantages for shape-changing displays: (1) Only areas that require height elevation are segmented and cut, significantly reducing the number of actuators required; (2) It can produce areas of continuous surface not currently possible with pin-arrays; (3) Development time is significantly reduced for high-fidelity prototyping. The key trade-off is the reduced generalizability of the shape-changing surface if the initial input data is coarse. To validate the conceptual approach, PolySurface was developed as an implementation of the design and fabrication of semi-solid surfaces.

4.1.2 PolySurface: Implementation of Approach

The developed approach for fabricating semi-solid surfaces that consist of laser-cut flat polygonal meshes that are attached to a durable spandex material. A minimal number of actuators are placed below the semi-solid surface to enable elevation of selected polygonal areas. The proposed design and fabrication process enables rapid creation of

more complex shape-changing representations and greater accessibility to nontechnical users.

Step 1: Data Segmentation

This process outlines all of the vertices necessary to allow actuation. Firstly, the users' data or interface designs are directly mapped onto a polygonal segmented surface ready for fabrication. To do this, I capitalize on the wide range of segmentation algorithms already available. Image data can be segmented using a number of geometric algorithms (e.g. General Triangulation [47], Straight Skeleton [37], Voronoi Diagrams [9]) which are available open source and via online web applications [38]. For numerical data (x , y), the Delaunay Triangulation [144] segmentation algorithm is used to generate polygonal meshes. This algorithm ensures each data point is a vertex on the mesh plane of the semi-solid surface. For outline designs, such as interfaces or architectural plans, plane segmentation is generated in an illustrator vector graphics software (**Figure 12**).



Figure 12: Segmentation process of a contour map.

Step 2: Fabrication

Secondly, a physical representation of the segmented surface (**Figure 13B**) must be produced. Once the digital surface is designed (Step 1), it is laser cut based on a set of guidelines detailed below. A lightweight polypropylene (0.8mm depth) is used for laser cutting the polygonal mesh. It is recommended that any small polygons (less than 10mm diameter) are merged into adjacent larger polygons to ensure anything smaller than 10mm is not deformed by the laser cutter as polypropylene material has a low melting point. A gap of at least 1mm between each polygon is advised as it ensures fluid flex and fold motion of the surface. This mesh is then attached to black bidirectional (x and y -axis stretchable) spandex for fluidity and elastic support (**Figure 13C-F**).

Step 3: Assembly

To ensure that all of the polygons stay intact and in the right position, strips of tape are overlaid on the mesh before removing it from the laser cutter bed (**Figure 13C**). This ensures no parts are lost or move position. The cut outline surrounding the mesh (**Figure 13D**) is then removed and super glue the entire surface as onto stretchable spandex (**Figure 13E**) to provide the flexible sub-surface. To reduce the visibility of lines on the surface it is recommended to use the same colour material for both the Spandex and the solid segments. **Figure 13F** Shows the tape overlay removed once the surface is secured. The surface is then inserted into an enclosure (750 x 450 x 210mm) which also contains actuators and horizontal screen.

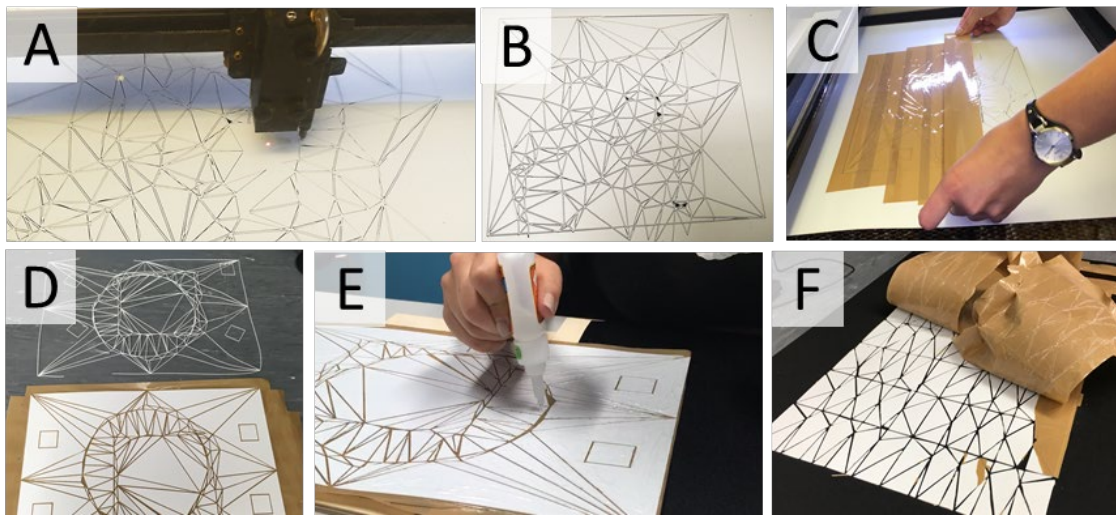

Figure 13: (A) Laser cutting polypropylene sheet (0.8mm depth) and (B) fabricated polygonal surface. Securing shapes on the surface (C); Removing spacing guides (D); Gluing surface to Spandex (E); Removing tape (F).

Step 4: Visualization Design

The correct position of visualizations is established by projection mapping the basic digital outline of the surface design onto the physical semi-solid surface (**Figure 14A**). Interactive visualizations are implemented using HTML webpages and are not restricted in diversity. **Figure 14B** shows an example of volcano visualizations.

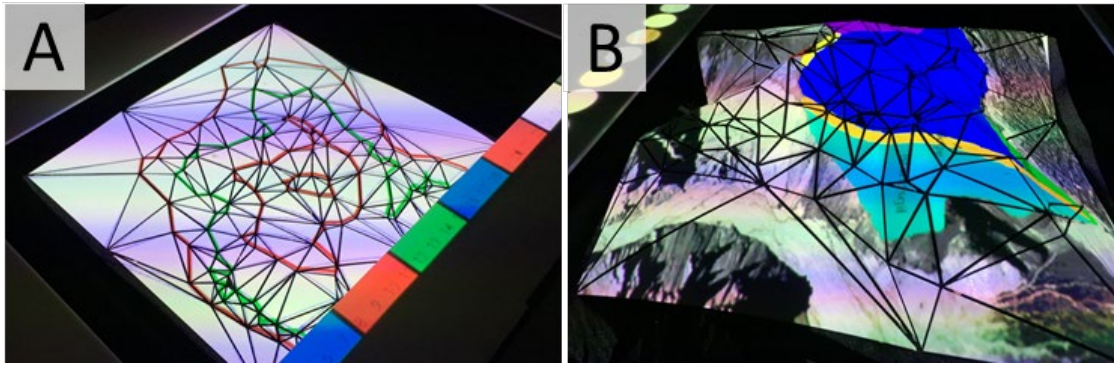

Figure 14: Map projection onto the surface (A) and frame from volcano vocalization (B).

Step 5: Height Design

Physical reconfigurations of PolySurface were generated by mapping variables, such as numeric variances, from the given data to represent elevation states. ShapeClip modules [57] are used for height actuation as they are cheap and easy to control, with the light-intensity output from the monitor directly regulating actuator height above (**Figure 15A**). ShapeClip placement is customizable, depending on the input data, and is not limited to a grid. The monitor, underneath the actuators, shows an HTML webpage that uses Bitmap greyscale animation frames for elevation control (**Figure 15B**). To determine accurate actuator position, it is recommended to observe where the greatest white and grey light-intensity variance occurs on the monitor. These areas directly map to the highest frequency of movement on the physical display. Positioning the actuators on these areas of the monitor guarantees most accurate height elevation on the semi-solid surface above.

Using custom JavaScript functions, a user can design a set of Bitmap frames where the colour of each pixel directly corresponds to movement for a designated actuator. Elevation controls are translated directly from the user's input data. Custom data is automatically scaled to grayscale RGB values (0-255).

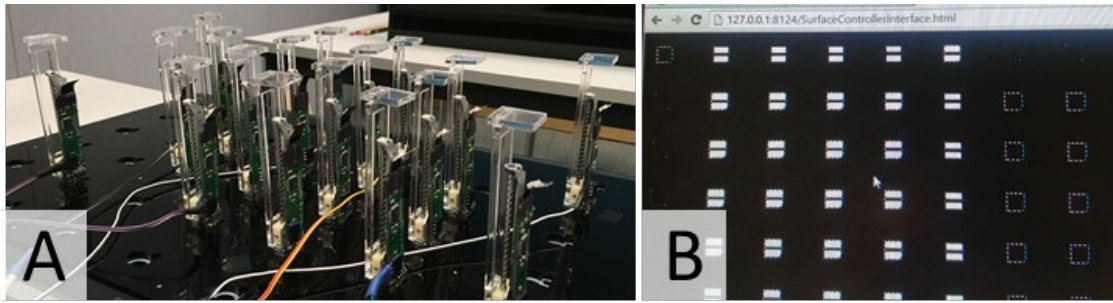

Figure 15: Actuators in specific positions on an 8x6 grid above the flat monitor (A); Height control webpage underneath (B).

Step 6: Interaction Control

To enhance engagement with the display users can add interactive elements such as hover or buttons directly on the dynamic surface (**Figure 16A-B**) or on the side of the enclosure (**Figure 16C**). A wide range of interactions can be implemented by using a depth camera positioned above the surface. Pre-designed code snippets were used with an open source toolkit [56] to enable interaction with the dynamic surface and enclosure. The toolkit uses simple HTML webpages and client-server communication. Interaction is not limited to a depth camera and other forms of input, such as a keyboard, can be used.

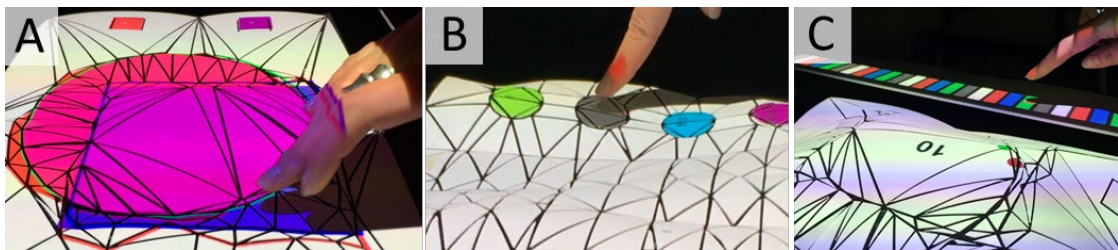

Figure 16: Hover interaction for shape selection (A); Interactive buttons on the surface (B); Button on side of display enclosure (C).

4.2 Design Session Methodology

The goal of the design sessions is to understand whether the approach for fabricating shape-changing interface design is: (1) Appropriate to engage non-expert users; (2) Able to generate surfaces suitable for use and demonstration in a variety of application domains; (3) Efficient for rapidly developing high fidelity prototypes. Please see Appendix A for documentation related to this study

Participants attended in two sessions: (1) Design: to bring along their dataset, specify requirements for the display, and design the surface, actuation, and interactions; (2) Evaluation: to assess the produced surface for its effectiveness in their domain, and where possible, to demonstrate it to other domain experts or a novice. Design sessions were conducted with three separate participants to explore content generation using the approach for fabricating shape-changing displays. This study is limited to three participants to allow us to work closely with each participant and the unique datasets they provided. Each participant was allocated a week-long slot to enable significant depth in the sessions and analysis.

4.2.1 Meeting One: Design

The first meeting was at most two hours and aimed to establish the surface design based on the participant's requirements. The participants were asked to bring along a sample of data they use in their everyday work. This could range from, but not restricted to generic (x, y) data, more complex numeric representations (x, y, z), bar charts, as well as graphics, plan designs, sketches (hand drawn or digital), interface/web designs etc.

Each participant was shown a presentation overview of the project at the start of the first meeting. Video examples of existing shape-changing displays were shown together with a live demo of two applications generated using the PolySurface approach. The first application was a video player (dynamic user interface) with interactive height and visualization control on the surface. The second example was a dynamic terrain map (**Figure 10A**). The researcher provided detailed instructions and walked the participant through the design process. This meeting consisted of the design tasks in the PolySurface approach (**Figure 11**) and listing a set of requirements the device must perform to successfully function. I used the requirements to help assess the effectiveness of the resulting display. Once the participant was satisfied with the designed surface (both physical and visual), elevation design, and height and interaction control, I laser cut and assembled the device (**Figure 13**). Participation in the fabrication, assembly, implementation of height design and interaction was optional. Contextual inquiries were performed throughout to understand each participant's thoughts and impressions.

4.2.2 Meeting Two: Evaluation

In the second meeting, each participant was asked to evaluate the success of the final device produced based on a set of requirements they specified during meeting one of the studies. To begin, the complete surface was demonstrated to the participant and they were walked through the set of interactions. Participants were then encouraged to explore their dataset and comment on the validity of the representation and any new insights, advantages, or disadvantages their shape-changing display provided. Semi-structured interviews were conducted throughout each evaluation meeting to ensure the participant's thoughts and opinions were comprehensively audio and video recorded.

4.2.3 Display Showcase

When the participant had explored the prototype display and was satisfied that the functionality met their requirements, they were encouraged to showcase their shape-changing display to a small group or individual (either domain experts or novices). An informal group presentation and a short feedback session then took place to allow us to evaluate the effectiveness and engagement of the shape-changing prototypes developed.

4.3 PolySurface Design Sessions

To demonstrate the generalizability of the approach for designing and fabricating high fidelity shape-changing displays three design sessions were conducted. Each design session consisted of a two-hour design meeting followed by a one-hour evaluation session once the final display was developed. Participants also had the opportunity to showcase their shape-changing display to either domain experts or novices.

Based on the set of requirements defined in the first design meetings all three participants successfully developed shape-changing displays specific to their domain expertise (**Figure 10B-D**). During each meeting, the participant provided information on their domain-specific data and methods they traditionally use for presenting it.

4.3.1 Demographic Background

Participants were selected from a range to domains to ensure a wide variety of data samples to demonstrate the generalizability of the approach. Summarized demographic profiles in **Table 1**.

Age	Gender	Domain	Dataset Type
35-44	F	Accommodation Manager	Numeric & Text (Spreadsheet)
25-34	F	Volcanologist	Geographic Information Systems (GIS)
25-34	M	Eye Tracking Researcher	(x, y) co-ordinates (Spreadsheet)

Table 1: Participants' demographic information.

4.3.2 Participant 1

P1 is an accommodation manager and provided a spreadsheet detailing the distribution of students in studio accommodation as well as their demographics. Their primary goal was to “make the data visually easier to understand”. Based on the data sample provided the participant designed a physical bar chart representing gender and nationality distribution across the six colleges they managed. The prototype display was then developed within two days. The primary target audience for this data representation are colleagues from the accommodation management department.

Design Session

I worked with the participant to establish which variable in the data sample would be best to represent using height and elevation variants. At first, P1 struggled with brainstorming ideas. I suggested examples of a physical bar-chart, a map of the accommodation, or a world heightmap showing the international distribution of students. P1 stated that the information provided is minimal in terms of creativity due to only a small data sample provided. The participant settled on the physical bar-chart as they were familiar with this style of representation.

Initially, P1 showed apprehension in the exploration of creative ideas for the display. When asked to sketch their design concept they indicated that they would prefer the researcher to do it for them. P1 became more comfortable once the bar-chart concept was established and then took over the sketching process. P1 did not initially think interaction with the display was necessary, but further discussion revealed the necessity of buttons to change datasets. I attribute this apprehension to the novelty of the display

modality and highlight the need for better methodologies to expose users to the potential of such displays (see chapter Discussion).

Shape-Changing Display Description

The developed PolySurface is 355mm × 215mm and consisted of six vertical rectangles to represent each college membership and four circles on the right side for buttons (see **Figure 17B**). 14 actuators were positioned at various locations underneath the surface for elevation control. The full process, from design to implementation, had taken two days. A user can press one of the four buttons to activate a physical bar-chart that represents either gender or continental distribution (female, male, EU, or None-EU) of students across six colleges in studio accommodation. In the height transition between each bar chart, elevation of the surface drops to minimal height and rises to appropriate levels to ensure the transition changes are obvious. The high and low levels of the surface correlate to the number of people for each bar. The more data variation, the more significant dips would be. In this example, physical height is a direct representation of the visual display.

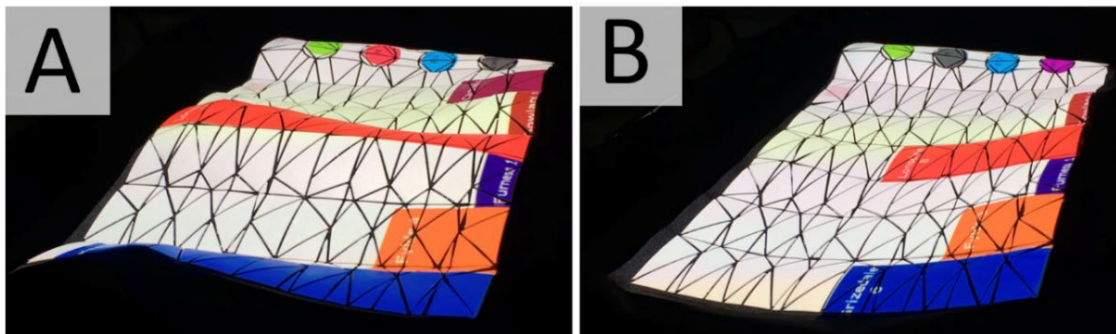

Figure 17: Example physical bar charts showing the distribution of None-EU (A) and male (B) students across six colleges.

Evaluation Meeting

The display was presented to P1, who said that this information is easier to see and “play around with as it is more visible than going through a lot of spreadsheets”. They stated that this representation would be easier to market as it was more visually appealing and interactive than traditional bar charts. They considered the display to be suitable for showing a ‘snap-shot’ of the data and its trends that can enhance audience engagement. They provide the example of using this for marketing purposes where complex data trends would be a lot easier to interpret and display rather than people going through figures and percentages. However, P1 commented that for their day-to-

day work, this system is more sophisticated than needed. P1 did not showcase their display, they requested a video to show to colleagues.

Summary

P1 successfully designed a physical representation of their dataset. While the representation is familiar (a bar chart), this emphasized the need to help users think ‘outside the box’. P1 appreciated the display for its communication and engagement potential to convey a ‘snap-shot’ of overall trends to senior management, in a public space and for educational purposes.

4.3.3 Participant 2

P2 is a Senior Teaching Associate (Environmental Science) specializing in volcanology. Their research looks into glacial volcanoes in Iceland from around 95,000 years ago. Their primary goal was to “accurately and clearly represent the volcanic edifices and paleo-ice conditions in 3D”. P2 provided a paper from fieldwork conducted at Bláhnúkur (Torfajökull, Iceland). Their shape-changing display represents the predicted structure of the volcano before its eruption (95,000 years ago) (**Figure 18**) and the current morphology. The primary use of this data representation was for demonstrations to colleagues and novices.

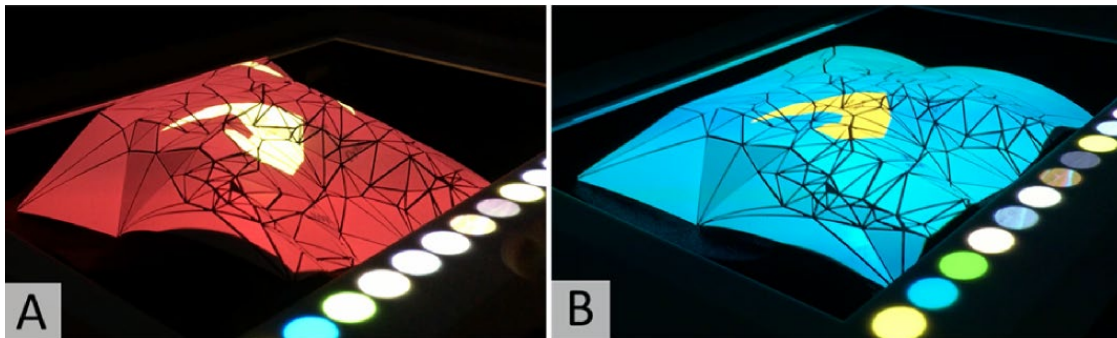

Figure 18: Physical state transition of volcano structure 95,000 years ago (A) and morphology with glacier overlay (B).

Design Session

Due to the complexity of their research, P2 came to two design sessions. The first meeting helped to develop an insight into the participant’s domain and overall concept for the display design. Initially, P2 provided us with two papers with separate volcano models. I established Bláhnúkur as the volcano P2 was interested to recreate in physical form and outlined main functionality requirements. During the second design meeting,

I verified an accurate model of the PolySurface based on data from the Bláhnúkur paper. For visualization, P2 provided us with aerial photos, satellite images, contour map, and geological maps from geographic websites [1]. 2D images for structural representation was proven to be a limitation in P2's field: *"I cannot show everything in just one image which is problem... it is impossible to get a photograph where you can see everything"*

A contour map of the volcano was used as input for the PolySurface segmentation. P2 specified they wanted multiple images projected on their surface as this would help the audience differentiate between areas of the volcano through colour as well as elevation. For interaction, I designed a simple button interface to transition between images provided by P2. During the design session, I established two limitations for 2D image analysis in P2's domain. The participant demonstrated this difficulty (**Figure 19**) to interpret data correctly from 2D images: *"I struggle with this image because optically when looking from the south, there is a valley, but actually it is wrong"*

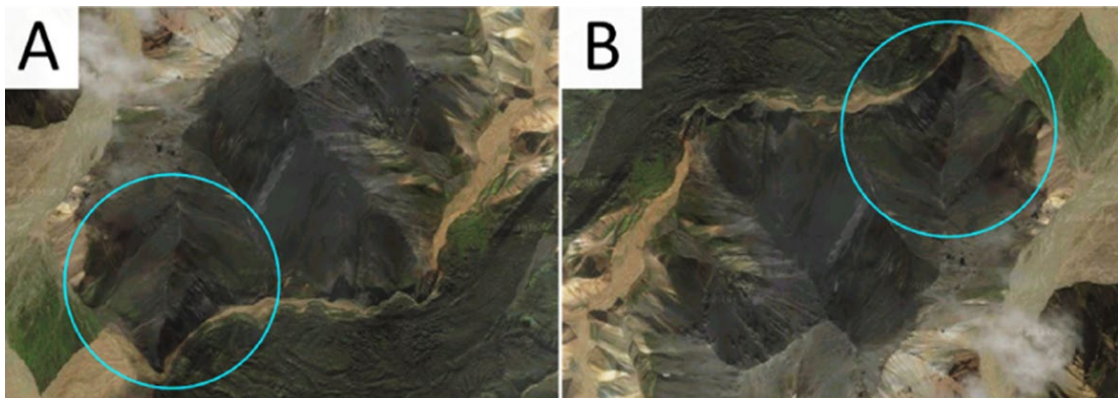

Figure 19: Comparison of the same aerial photo of Bláhnúkur volcano. is rotated 180 degrees. (Imagery ©2016 Google, DigitalGlobe, Map data ©2016)

Two limitations have emerged from P2's design sessions:

1. With aerial images, there is an optical illusion depending on viewpoint angle.
2. With photographs of the side view of the volcano, it is impossible to see every angle of the volcano.

For height design, three main states were established: (state 1) morphology before eruption, (state 2) morphology before eruption with glacier elevation, (state 3) current morphology of the volcano. Water sample data from their field work was used for height design and to physically represent the volcano model 95,000 years ago.

Shape-Changing Display Description

The assembled PolySurface is 310 x 273mm in size with 16 actuators situated below that control the elevation of three physical states. The full construction process, including fabrication, assembly, visualization and interaction control also took two days. Interaction controls consist of 15 buttons that are projected on the top of the enclosure box. The first three buttons control height changes representing three morphologies of the volcano in the last 95,000 years. The other 12 buttons transition between visualizations on the PolySurface. These visuals include; aerial photographs, satellite images, contour and topographic maps, and sampling location areas on the volcano surface.

Evaluation Meeting

For all three physical state changes, P2 found PolySurface provided an accurate representation of the volcano's morphology. The semi-solid mesh surface clearly represented valleys and ridges to scale, and these were also easier to differentiate compared to photo analysis. The participant expressed interest in using this display for research presentations. P2 stated that using a shape display like this provides a better representation of a volcano: *"You can turn your head and see the whole morphology and you cannot see all of the angles in a 2D image"*.

Display Showcase

P2 was asked to present their interactive shape-changing display to a non-geologist. P2 walked through the display functionality whilst explaining to the non-geologist each physical state change with different visual backdrops. The non-geologist was able to clearly understand the main concept explained within 5 minutes and stated: *"For a non-geologist, a shape-changing representation is much better to communicate and picture the whole thing"*

The direct interaction with the volcano structure and visualization also made it easier for P2 to explain their research. They felt this display is most appropriate for communicating their research to the general public. P2 and the non-geologist agreed that the added interactive features enhanced engagement with complex information.

Summary

P2 successfully designed a high-fidelity reconstruction of a volcano by mapping pre-existing topography using a bespoke PolySurface. For P2 it is impossible to accurately visualize volcanos in 2D space. The dynamic polygonal mesh of PolySurface enabled a physical 3D representation of a range of angular structures comprising the volcano's valleys and ridges. Two practical limitations were established within P2's domain. Firstly, aerial terrain analysis is limited due to optical illusions based on the rotation of images. Secondly, geologists are unable to represent a full model of terrain using solely 2D space. The representation facilitated analysis by providing an additional (physical) information channel, reducing the confusion of optical illusions and overlaying additional (visual) data onto a physical terrain map. P2 showcased the display to a non-geologist who understood a complex research concept in a 5-minute demonstration. The non-geologist stated: *"This display summaries thousands of years of history in just a few buttons"*

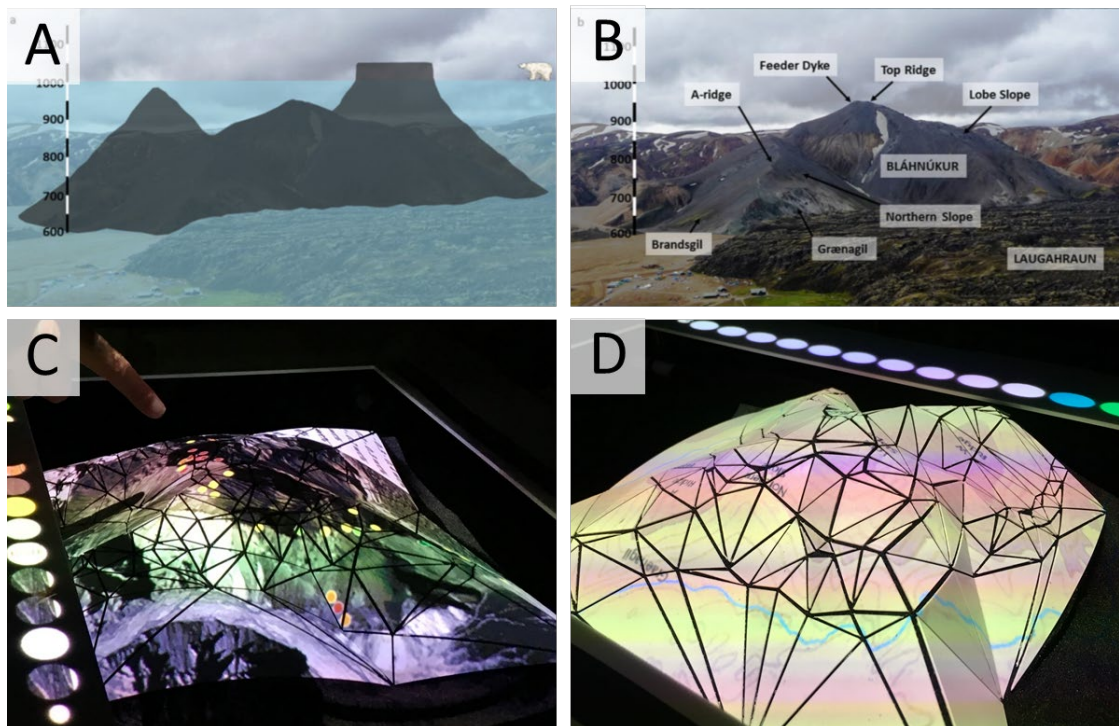

Figure 20: Image from academic paper provided by participant(A-B). P2 showing the none-geologist sampling points on volcano (C) Contour map (D).

4.3.4 Participant 3

P3 is a PhD researcher specializing in eye-tracking calibration. They provided data from their own study that compares eye tracking calibration effectiveness with a range of shapes. They wanted to show the comparison between two variables (target eye coordinates and actual gaze coordinates) through surface elevation on a timeline. Based on the data sample provided a shape-changing display was developed that physically represents this comparison variable using two interaction techniques (see **Figure 21**). P3 showcased their PolySurface display to a group of five colleagues (**Figure 22**) to gain insight into how the technology can be used to enhance data analysis and demonstrations.

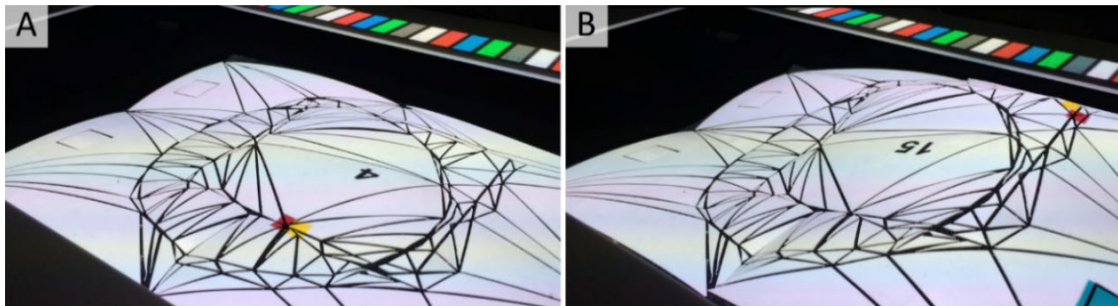

Figure 21: Difference represented between target and gaze on point on a line (A) and a corner (B) from the square data sample.

Design Session

The spreadsheet supplied by P3 contained (x, y) coordinates for target eye location, actual eye gaze location, and the difference between them for a square and a circle sample. 30 samples were used from both the circle and square datasets. P3 traditionally uses 2D graphics, graphs and plots to represent their data. To enhance their current representation methods, they wanted to include interaction and visual features in their display. P3 emphasized that the most important variable to represent was the offset between the target and actual gaze coordinates. It was agreed to use surface elevation to show this offset. P3 had the idea of using a slider to go through a timeframe to show “evolution of that movement” for their specific shapes. P3 had the most comprehensive list of requirements.

To be functionally successful their PolySurface display must: (1) Play the animation to see the different positions of both target and gaze coordinates; (2) See the difference (positive and negative) between coordinates using height; (3) Navigate around the

animation; (4) Select on the animation line which points of the data set to activate; (5) Visualization must have different colours for target and gaze points.

Shape-Changing Display Description

This PolySurface is 350 x 240mm in size and used 16 actuators. The display was designed and constructed within one week due to the high specification of functionality requirements listed. Two interaction techniques were established. Firstly, data from the square sample was represented using a chronological physical animation sequence when a user pressed the blue square on the bottom right of the surface (**Figure 21**). Secondly, sample data from the circle example was shown through individual frames.

A user can hover or press one of the 30 buttons projected on top of the display enclosure to select a specific indexed frame (see **Figure 22** and **Figure 16C**). For height control, P3's data was automatically scaled to fit ShapeClip's grayscale RGB input values (0-255).

Evaluation Meeting

The display was presented to P3, who noticed there was sharp variation in height at the corners (**Figure 21B**) of the square whilst on the main lines (**Figure 21A**) were flatter. Both interaction features enhanced understanding of the preliminary data trends. Based on these observations P3 stated that this dynamic physicalization helped to verify their hypothesis regardless of the relativity small data sample: *“Now I know for sure from this square example that corners are problematic and in the circle example I can check that there are not that many changes.”*

P3 noted that the segmented polygonal structure of PolySurface enhances slopes for each height actuation. Initially, the additional visualization of the data sample points aided differentiating between the square and circle examples. Individual frame selection enabled easy comparison between points on the timeline. The chronological animation sequence enabled clear insight into the overall trend of the data sample.

Group Showcase

P3 invited five colleagues from the eye-tracking research domain along to a showcase of their interactive shape-changing display. P3 showcased their PolySurface display, explaining the data representation and interactive features. P3 went into detail about the data trends that emerged from these representations (e.g. greater height variation in

corners of the square). All group members were able to distinguish variation in height and conclude that corners are where the gaze is lost due to sharp angles. One member questioned why the distance of the gaze points was represented by height. P3 replied that eye-gaze offset is the most important variable in their data they thought it was the most appropriate to represent through elevation. Another colleague asked why the distance between target and gaze points is not just visualized using the projector.

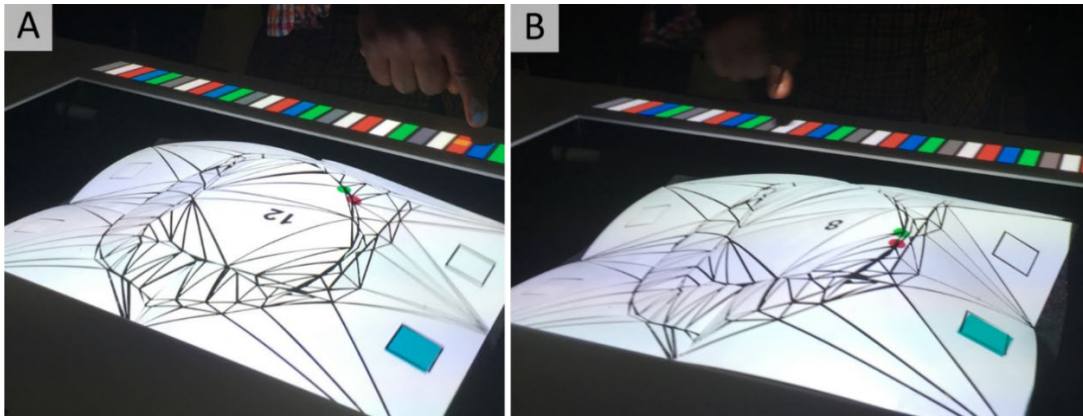

Figure 22: P3’s colleague comparing elevation difference between circle frame 12 (A) and frame 8 (B).

P3 stated that having just the visualization does not clearly show positive and negative variation. Another member inquired about the possibility of adapting the display to show real-time data. This functionality could be implemented using visualization toolkits.

Summary

P3 successfully designed a shape-changing display which enables physical comparison between target and gaze position in an animated circle and square based on a timestamped log. Two interactive features were incorporated to physically represent two separate data samples. Firstly, a user can play the full sequence of data points through a chronological animation (**Figure 21**). Secondly, show each data point through individual timeline frames. A user simply selects a specific frame by hovering or tapping their finger the top of the display enclosure (**Figure 22**). The participant showcased their display to five colleagues. All group members were able to distinguish the greatest height variation on the corners of the square example which verifies P3’s research hypothesis. P3 described his shape-changing display as a tool for “proving hypothesis and data trends”.

4.4 Additional Case-Studies

After the initial study, the PolySurface design approach was used with two further experts from separate domains. The first was an interior designer and HCI researcher and the second was a sociologist. The interior designer was aiming to construct an actuated decorative artefact that can dynamically change shape and provide users with an interactive dining experience. Their core motivation for designing and developing “ActuEating” was to understand how an actuating artefact can be simultaneously a resource for social engagement and an interactive decorative. Using the PolySurface semi-solid geometry and material characteristics, they were able to explore design opportunities for situating novel interactive materials in everyday settings, taking the leap into a new generation of interactive spaces, and critically considering new aesthetic possibilities.

The sociologist was aiming to find new approaches to represent data and information, from their work on data flow models, in a novel way that can involve tangible interaction. They initially wanted to gain a better understanding of current technical implementations of shape-changing displays that could be used for designing and showing data visualisations. After an initial consultancy regarding possible technical approaches for building novel data representations using physicalizations and shape-change, PolySurface was recommended as a rapid fabrication approach based on their design requirements. The data physicalization developed with the sociologist was for a workshop. Their aim was to engage the general public (in a public library) with their own research into data flows. The subsections below describe the design, development, and deployment of the shape-changing display built by the interior designer (see **Figure 23**) and the physical terrain map designed by the sociologist (see **Figure 25**) using PolySurface.

4.4.1 Interior Designer - Case Study

After the first study, an interior designer and HCI researcher independently designed and developed two prototype shape-changing artefacts based on the PolySurface approach. Please refer to Nabil et al. [111] for more detail on this work. Actuating, dynamic materials offer substantial potential to enhance interior designs but there are currently few examples of how they might be utilised or impact user experiences. Both prototypes were used for explorative studies, the second prototype deviates from the original linear actuators for shape-deformation and instead uses muscle-wire to reduce hardware requirements. As part of a design-led exploration, the participant prototyped an actuating, dining table runner (ActuEater1), and then developed a fully interactive fabric version that both changes shape and colour (ActuEater2). The results of the ‘ActuEating’ studies provide evidence for how an actuating artefact can be simultaneously a resource for social engagement and an interactive decorative. The designer explored opportunities for situating novel interactive materials in everyday settings.

Designing ActuEater1

Inspired by PolySurface, the designer re-purposed ShapeClips [57] to build a dynamic and customizable shape-changing prototype that fits on a dining table as a traditional table runner. As ShapeClips vary between 8 and 18 cm in height, they were embedded within the table. After the software was re-programmed and the hardware electronic components were re-structured in the desired arrangements, a full-length table runner was made (see **Figure 23**).

The prototype was designed from stretchable Spandex and a uniform custom-designed pattern laser-cut on 0.8 mm thin polypropylene sheets to give it a controlled semi-flexible moving capability. The final runner was 930 × 350 mm consisting of 10 ShapeClips in a 2×5 grid to control its inner body. The actuation performed by ActuEater1 were in a live Wizard of Oz study. The experimenter responded to emerging interactions and developed the following pattern of responses to users: when one participant was engaged with ActuEater1 or touched it, it vibrated (low actuation) the part in front of them by moving up and down in a small scale with limited height.

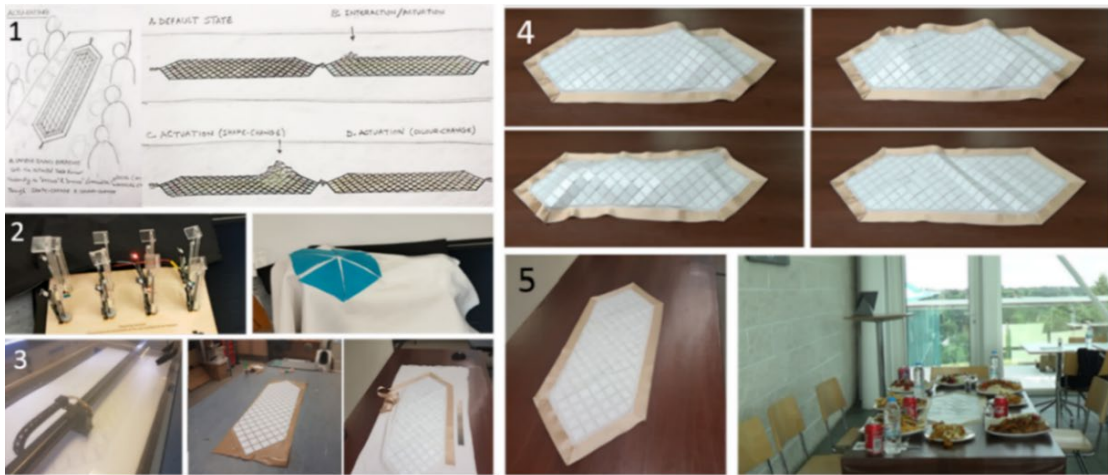

Figure 23: Designing and making of ActuEater1. (1) Ideation and Sketching. (2) Prototyping the software and hardware. (3) Designing the pattern. (4) Creating the actuation. (5) ActuEater is ready and ‘dinner is served’.

When two participants were both engaged with it by talking about it with each other, it would vibrate in front of both of them. If two people touched it with their hands or used an object, it rose all up. Then if they tapped it, it went all down. If two or more people kept touching it, it animated in an organic wave motion going up and down from one end to the other. Actuations were improvised at some points to initiate interactions with one (or more) of the participants to explore the effects of this on their reactions to ActuEater1 and interactions with each other.

Designing ActuEater2

A second prototype was developed, ActuEater2, to have more organic movement (rather than mechanical actuation), direct physical interactions (rather than a Wizard of Oz approach), and richer capabilities (colour-change as well as shape-change). The redesign also shifted away from using linear mechanical actuators. ActuEater2 was intended to not be a radical departure from the design of ActuEater1 but build upon what the designer had learnt in terms of both design and user experience. ActuEater2 presented an organically actuating soft decorative object which could be used to further study how multi-aesthetic interactions from a shape-changing decorative could impact people’s dining experience.

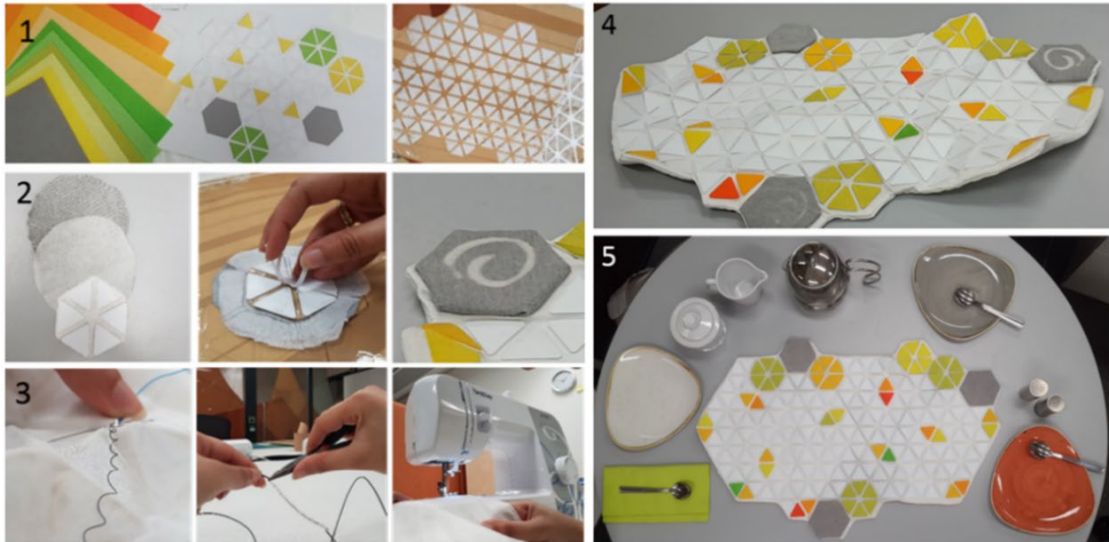

Figure 24: Designing and making of Actuator2. 1) Designing the pattern. 2) Making the colour-changing parts. 3) Stitching, crimping and sewing. 4) Creating the actuation. 5) ActuEater2.

ActuEater2 (see **Figure 24**) is a 60×40 cm fabric envelope, with a stretchable spandex top holding the deformable pattern, both sandwiching a silicon rubber layer in between, holding a set of SMA (Shape Memory Alloy) wires. This layering technique was inspired by the HotFlex [53] technique for making interactive printed objects. The layering acted as an insulating cover for the SMA (a useful safety feature). The 9 SMAs used were each 1-inch pre-trained shape-changing ‘nitinol’ shape-memory springs from Kelloggs Research Labs that actuate at ‘standard temperature’ (45°C) or equivalent 5V and 0.7A drawn from a MOSFET transistor, pulling it back to its 1-inch spring shape from any malleable form. ActuEater2 had capacitive sensing parts (green flowers) using 10×10 cm concealed knit conductive fabric to enable soft touch and proximity sensing through 1MΩ resistors. Similar to ActuEater1, the second prototype was designed with a uniform custom-designed pattern laser-cut on 0.8 mm thin polypropylene sheets to give it a controlled semi-flexible moving capability. This time the designer optimized the pattern into triangular tessellation (instead of squares) to allow more organic deformations in different orientations. ActuEater2 was also designed to be more colourful. Thermochromic ‘grey’ fabric was used in some parts to add the capability of colour-change. By embedding a heating wire underneath, the thermochromic fabric was controlled to reveal a hidden pattern as an ambient display and means of richer interactivity.

ActuEater2 changes shape more subtly, slowly and silently than ActuEater1, making it appear far more organic and less mechanical. Different parts of ActuEater2 behaved in different ways according to the affordance, stiffness and weight of the material at differing points i.e. edges deformed more freely than the centre. Touch-sensitive ‘green’ parts acted as ubiquitous sensing that triggered actuation of parts beside it. Agency was also enabled in the algorithm of ActuEater2 to display autonomous actuation.

Discussion of Implementation

The challenges the designer faced was to conceal technology within an everyday fabric artefact ubiquitously, they aimed at experimenting how hidden interactivity in objects (that blend into the space design) could be of value, meaning and significance to space occupants over an in-situ social event (in a restaurant or at home). They emphasize on how weaving technology into real-world objects, specifically decorative ones, can deliver a rather richer ‘spatial experience’ in a given contextual setting. By taking previous work on PolySurface further, they were able to explore new territories of this design space. However, the design constraints they set included studying only actuating table runners in dining settings. Although ActuEaters were designed as non-functional artefacts, their aesthetic qualities as decorative objects are rather useful as they do not need constant attention, which aligns well with slow and calm technology concepts [120].

ActuEater aimed to advance research by the HistoryTableCloth [48] and coMotion [54] around shape-changing interfaces and interactive spaces, furniture and everyday objects. Its failure to interact at any time will not lead to a crisis of affordance [48], as it remains a decorative aesthetic artefact in its own right. PolySurface in this case study evolved to further facilitate the requirements of the designer. The rapid nature of the fabrication approach enabled the design and deployment of Actuater1 within 5 days. This supports PolySurface as a fast implementation approach. However, mechanical actuators used in the first prototype hindered the user experience through the noisy and cumbersome nature of ShapeClips. Actuater2 also utilised a semi-solid surface in their design, though diverged from mechanical linear actuators to SMAs for creating more organic shape transitions.

4.4.2 Sociologist - Case Study

To demonstrate the generalisability of PolySurface as a fabrication approach, it was used to rapidly create a table-top high-resolution data physicalization. This additional case study focused on working with a Sociologist whose research draws on the social sciences, humanities, arts and natural sciences to explore the changing relationship between humans, environment and technology. A table-top data physicalization was used to support their work on exploring and presenting drift as a planetary phenomenon [175].

After an initial design session with the Sociologist, a set of functional requirements were defined together with a detailed discussion of the dataset that needs to be represented on the static data physicalization. They designed the topographical physical representations needed for their own workshop in a public library. A contour map of Lancaster, provided by the Sociologist, was used to design and fabricate a semi-solid surface in two days. **Figure 25** shows the completed data physicalization. Though the surface was static, animations were used above the surface with a projector to help people engage with the tangible display.

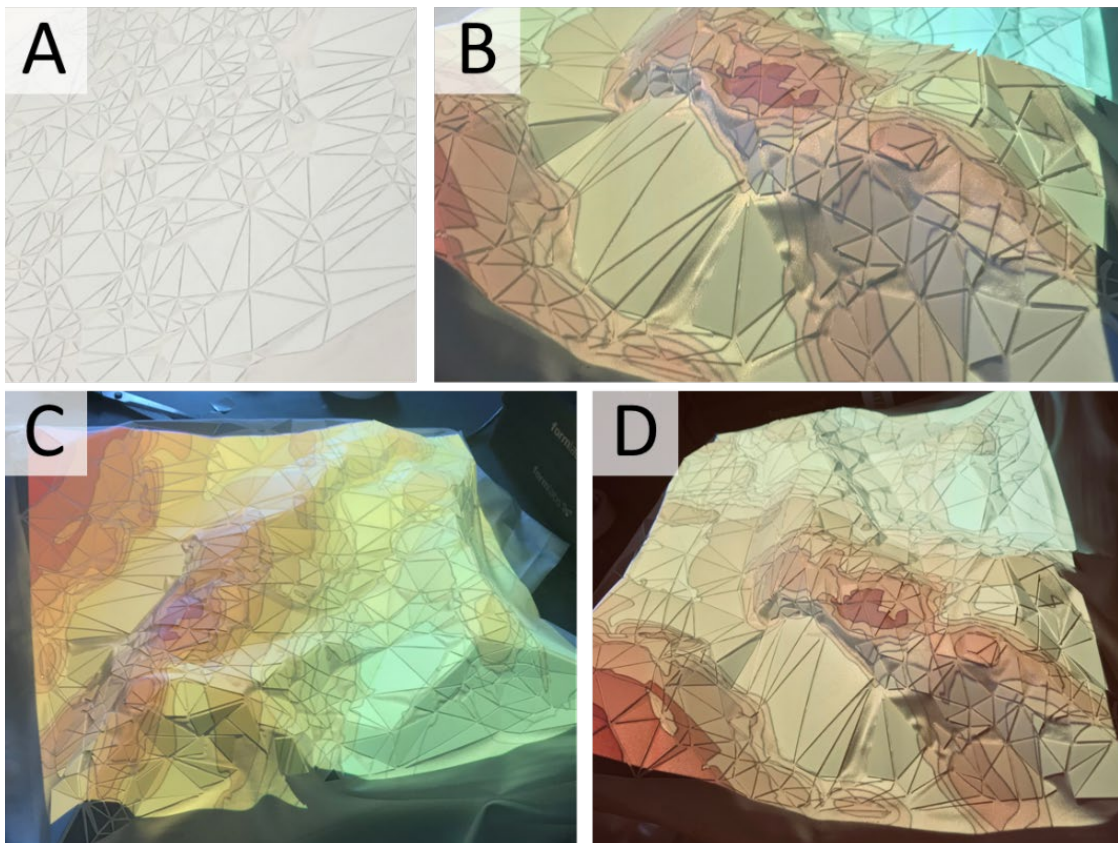

Figure 25: Fabrication of a physical terrain map of Lancaster.

4.5 Discussion of Studies

The design session observations show that PolySurface enhances the rapid prototyping of high-fidelity interactive shape-changing display with minimal hardware requirements. From the evaluation meetings and showcases, it was shown that all participants were able to successfully design shape-changing displays which were then constructed using the PolySurface approach. I identify and discuss key findings and limitations below.

4.5.1 Simplification of Complex Data

During the design sessions, trends in designing minimal visual aids or labels were observed. It was highlighted that all participants applied some form of data simplification when designing their shape-changing display. P3 wanted to see if the focus group could perceive data trends represented by their display without a comprehensive explanation. P2 explained the underlining representation to the non-geologist. Both the non-geologist and focus group members were able to understand the underlining concepts after an initial explanation. P2 also highlighted that experts from their domain focus on low-level data specifics.

Similarly, P1 noticed that they did not add axis labels to all four physical bar-charts. It was established that additional visual aids are necessary to represent complex information and data. The novelty of designing shape-changing and elevated features for displays resulted in a lack of focus on visualizations. Further investigation is needed to understand if it is the medium that encourages data simplification or the toolset. It is suggested that during the visualization design step, users are encouraged to carefully consider how they should use visual aids and labels in their design.

4.5.2 Insights Gained

The novelty of physically representing eye-tracking data encouraged focus group participants to think about their work from a new perspective. Pleasingly, the physicalization helped P3 to verify previously unknown areas of focus in his dataset (the corners of square targets). The novel approach for data representation helped to expose new insights.

4.5.3 Input Data Types

All participants used spreadsheets, databases, tables, plots or graphics to represent their data traditionally. Both P1 and P3 provided spreadsheets. P1 supplied a basic table containing numeric and text data. P3 normalized their numeric data into CSV format, which was used for segmentation and mapping elevation controls. P2 provided a copy of their paper and multiple images, photos, figures, and graphs to aid in communicating their data. The combination of numeric data, aerial photographs, contour maps and topographical images aided the design and construction of their display. This wide range of data types shows that the approach facilitates the conversion of a variety of input data into shape displays.

4.5.4 Generalizability

Based on the observations, PolySurface has the greatest impact on low-frequency and contour-based geometric transformations. Landscapes and novel interfaces (P3) with curved and rounded outlines are best emphasized using the semi-solid characteristics of PolySurface – where small solid segments and dynamic folds emphasize more complex geometry. For high-frequency geometric transformations such as bar charts, bare pin actuators may be more appropriate, but this does increase hardware requirements.

4.5.5 Levels of Participation

Participation levels varied depending on confidence with technical capability and creative engagement with the data. P1 initially felt inadequate designing a shape display due to their unfamiliarity with this type of technology. As P1 became more comfortable with the design process they took over sketching. With guidance and support, P1 was able to develop a simple physical bar chart representation. I observed that P2 and P3 were more engaged in the design process. Although their data samples were more complex, the additional time spent establishing their designs enhanced their engagement with the approach. To increase creative engagement in the design process, I propose developing a library of templates with adjustable features for numeric data types as an example. This would allow users to visualize their prototypes more clearly and adjust features as they see fit.

4.5.6 Reflection on Approach

The aim of this work was to develop an approach that reduced the technical entry-point for developing shape displays. Participants were able to efficiently design their own shape displays and showcase them to both colleagues within their domain and non-experts. All participants designed novel applications with practical uses that were engaging to users.

While participants were fully involved in the design sessions, none stayed to help with the fabrication step. Despite its widespread use in maker communities, laser cutting is still a niche skill that the majority of the population would not be confident to conduct independently. Further, while height design was conducted by participants, interactive elements were implemented by a researcher. Even with toolkits, code snippets (and in future, drag-and-drop coding), this task cannot be performed independently by a non-technical user. More work is needed to bring the accessibility of interactive elements in these displays closer to non-technical users. The design sessions described in this chapter aimed to demonstrate examples of possible applications using a wide range of data from different domains.

4.5.7 Limitations

While the approach provides non-technical users with a route into shape-changing display design, it does suffer from some limitations. First, the approach still requires some technical input. The key area for improvement is in interaction design, where code-snippets need to be integrated into the system to easily implement buttons and other interactions.

Second, PolySurface is not as generic as large pin-arrays. This is a trade-off in implementation cost – the reduced engineering complexity results in reducing the generalizability of the display. While users can input several datasets to design a complex semi-solid surface, this does not necessarily mean the surface can physically represent all datasets. Until generic shape-changing displays mature (both in terms of cost and accessibility), for most uses (public displays e.g.), PolySurface users will be happy with this generalizability trade-off. Currently, PolySurface actuator position is determined by the variance in height between frames.

4.6 Implications for Design and Fabrication

This sub-section focuses on defining the design implications based on insights gained from the initial explorational studies conducted. These design case studies highlight the limitations of current technology and fabrication techniques for developing shape-changing displays. Insights presented above help to further expand the design space for supporting the implementation of shape-changing displays in a wider range of application domains.

Chapter 3 and 4 focus specifically on the design and content generation for shape-changing displays. Insights and implications from these qualitative explorations begin to support and realise the potential of shape-changing interfaces in future use case scenarios for a wider range of application domains.

To further advance the design space for this new generation of displays both the design and fabrication methods need to be expanded and become more widely used and accessible. The case study with the Sociologist demonstrated PolySurface as a generalised approach through a developed data physicalization. The surfaces can be dynamically used for both static representations as well as actuated shape-changing displays. The aim of this work was to engage with the public and talk to them about data flows. The case study used the physical version of the Lancaster terrain would be effective at helping people engage with the research conducted by the sociologist.

The sub-section below discusses the transition between the insights from the first two core chapters, that focus on design and content for shape-changing displays, and how these design-based findings can influence implications for the fabrication of a new range of shape-changing displays that can be considered as “hybrid” shape-changing displays [168].

4.6.1 Data Representation and Temporality

Findings from the initial explorations show that experts from a range of areas can adapt and translate the representations of their data from traditional 2D representations into more tangible 3D forms. The core premise of the shape-changing displays presented in this chapter demonstrates that data, of varied forms, can be dynamically presented using shape-changing displays to further engage users. The volcanologist example

(Participant 2) demonstrates this engagement with a novice user. There is a clear gap between designing displays that show physical forms of data representations in static form and designing for literal shape-change to represent data or information. The dynamic nature of shape-changing displays can enable the adaptive transition of physical forms to represent temporality in data. Yet the design explorations conducted for this work show that participants did not fully consider or take full advantage of designing their data representations with temporality.

Use Case Examples

The example of Participant 2 (volcanologist), show that the initial focus of the design sessions were the physical static forms of the volcano morphology. The implications of how the changes in the shape affect the user's view of the represented data came at a later stage during the demo. The novice user pointed out how land erosion was represented by the surface shape changes. They also noted how the reduction in landmass has an impact on how they perceived the original visualisations projected on the surface. The implications of how a user might perceive the data when the display's surface changes shape was not explicitly discussed with Participant 2 during their design session. Evidently, the design for temporality in shape-change needs to be taken into consideration when initially designing the various data representations as the surface's physical movement can be used to represent data and information in more novel and explicit manner than traditional 2D flat screen displays.

During the design sessions, the majority of attention was on how the different surface's shape configurations can be used to represent data and interface features whilst the surface is static. It needs to be highlighted that less focus was taken on the design of the transition between different shape states of the display surface. From the final demonstrations of each display, it was highlighted that it is the transitions between shape states that also affect the user's perception of data and their interaction with the display. Designing for temporality and considering how the transitions between different surface shape configurations affect the user's interaction and perception with an interface needs to be more explicitly addressed.

Temporality in design is more explicitly demonstrated with Participant 3's case study. They support the analysis of data dynamically through the surface's dynamic form changes as they enable a user to navigate through a numeric dataset. The notion of

temporality for the design of shape-changing displays is demonstrated here. The interactions between the user the represented dataset and the elevations of the display surface directly correspond to each other. As the surface moves and certain points elevate, the transition between data points is clearly evident. This is demonstrated in the group showcase of Participant 3's display. Users can clearly distinguish how the shape changes in the surface represent the disparity between data points in a given dataset.

Implications for Temporality Design

The speed at which surface configurations transition is just one of the design parameters that need to be taken into consideration when developing an application for a shape-changing display. Current actuation methods for shape-changing interfaces are limited in their ability to provide a wide enough range of speeds and degrees of freedom mechanically [178]. This technical issue limits the design space and types of content shape-changing display can represent. Work in this chapter proposed the use of semi-solid reconfigurable surfaces that can dynamically deform with minimal technical requirements needed in comparison to traditional pin-array based shape-changing displays. Chapter 5 focuses more on the technical limitations of current technology to further support the development of these displays.

4.6.2 Designing for Complex Geometry

The content design explorations described in this chapter demonstrate the utility of shape-changing displays for a diverse range of application domains. Much like data physicalizations have been able to directly map and represent a diverse range of data, shape-changing displays design for this work can also support and communicate a multitude of data types. To ensure that shape-changing displays can be adopted for a diverse range of applications, their design and technical implementation must be able to support diverse and complex geometry for mapping different data types, in both numeric and more abstract forms. Deformable surfaces for shape-changing displays must be able to represent complex bespoke shapes and geometries. Specifically, for morphologies and environmental science-based representations. Based on interviews conducted with participants in this chapter, there is a need for more organic shapes to be represented by shape-changing displays. This need is highlighted in current work [89, 143], though it still remains a challenge to combine high shape resolution with high display and touch resolution.

4.6.3 Alternative Approaches for Fabrication

From the design and evaluation sessions detailed in this chapter, it was highlighted that new physically dynamic surfaces need to be developed. As stated in the discussion above, deformable surfaces need to support the technical requirements for representing more complex geometry representations for shape-changing displays. These surfaces must go beyond the limited resolution of current technologies (e.g. pin-array shape-changing displays) whilst also supporting high-resolution visuals and interactive capabilities. This work proposes the adoption of hybrid shape-changing displays [168] using deformable surfaces that can be easily fabricated using existing and accessible additive manufacturing technologies. In order to keep engaging novice shape-change developers the tools they use for fabrication must be accessible, hence the hybrid 3D printing (e.g. SLA and FDM 3D printing) that also reduces production and assembly requirements.

4.7 Chapter Conclusion

This chapter presents PolySurface, a low-cost digital fabrication approach for rapid high-fidelity prototyping of interactive shape-changing displays. The design approach combines characteristics of solid actuation pins with the elasticity of cloth material to enable a more dynamic form of the polygonal shape-changing surface. Generalizability is demonstrated by allowing users, from different domains, to design interactive shape displays based on datasets from their own work. The combination of mapping data to physical surface reconfiguration, interaction features, and visualization enhances user engagement and understanding of complex data trends and information.

This initial fabrication approach used laser cutters, which can be easily accessible in maker spaces and fab labs, to build high-fidelity shape-changing display prototyping. PolySurface demonstrates that semi-solid surfaces can be utilised for developing shape-changing displays for various applications. As an approach, a PolySurface consists of two layers; (1) a solid laser cut laser and (2) a fabric material layer. Though this approach is low-cost in terms of materials and time to laser cut, it requires manual assembly.

The implications discussed above are used to drive the development process in the next chapter as there is a need to reduce the assembly requirements of developing shape-changing surfaces. Additionally, maintaining high-resolution shape output and visualisation/interaction capabilities must also be addressed. Work in the next chapter achieves this by utilizing 3D printing techniques for interlinking segments of a deformable surface. Each segment of the surface is interlinked during the printing process to reduce assembly requirements. The core concept of 3D printed fabrics aims to support the development of deformable surfaces that can be adapted for geometric physical reconfigurations that can be used for dynamic data physicalizations with minimal assembly and manual development requirements.

5 | Fabricating Shape-Changing Surfaces Using 3D Printed Interlinks

The last chapter began to support the development of shape-changing displays that go beyond one-off prototypes through a low-cost fabrication approach using laser cut semi-solid surfaces. PolySurface presented the notion of semi-solid surfaces that consist of solid components (laser cut polypropylene) fused onto a flexible sub-surface (spandex). These semi-solid surfaces can support more complex polygonal structures, meshes, or curved contours that are difficult to render using traditional pin-arrays. The research in the previous chapter focused on developing an approach for fabricating hybrid shape-changing displays that combine the benefits of pin arrays and cloth with minimal assembly and production requirements.

This chapter builds on the knowledge gained in chapter 4 to support the physical representation of shape-output with diverse and complex geometries. The previous chapter established that complex geometries can be represented with semi-solid surfaces with reduced actuators, this chapter aims to further optimize the fabrication process. Fundamentally, this chapter focuses on establishing a generalizable approach for designing and developing shape-changing displays with low implementation costs, rather than a one-off prototype of a hardware system. Stereolithography (SLA) 3D printing is used as part of a fabrication approach with fewer actuators whilst showing more complex content and structures than continuous fabric displays. This chapter aims to address the initial research question:

How can assembly requirements be reduced to make the fabrication of shape-changing displays more efficient?

3D printed fabrics and textiles are becoming an emergent application area in digital fabrication [141]. The core fabrication concept for this chapter is to use 3D printed panels, that are interlinked (see **Figure 26A/B**) during the printing process, to create deformable continuous surfaces, specifically for shape-changing displays (**Figure 26C/D**). By mimicking interlinking textile structures, such as chainmail, these 3D printed fabrics combine the qualities of flexibility and rigidity for moving shape forms (**Figure 26C/D**). They can also adapt in scale and resolution via computer-aided design (CAD) for diverse uses, from small scale wearables to larger scale installations whilst supporting deformation using both vertical and horizontal actuation. This chapter describes the general design and fabrication approach, the impact of varying surface design parameters (e.g. interlink and panel dimensions), and a demonstration of two possible application examples.

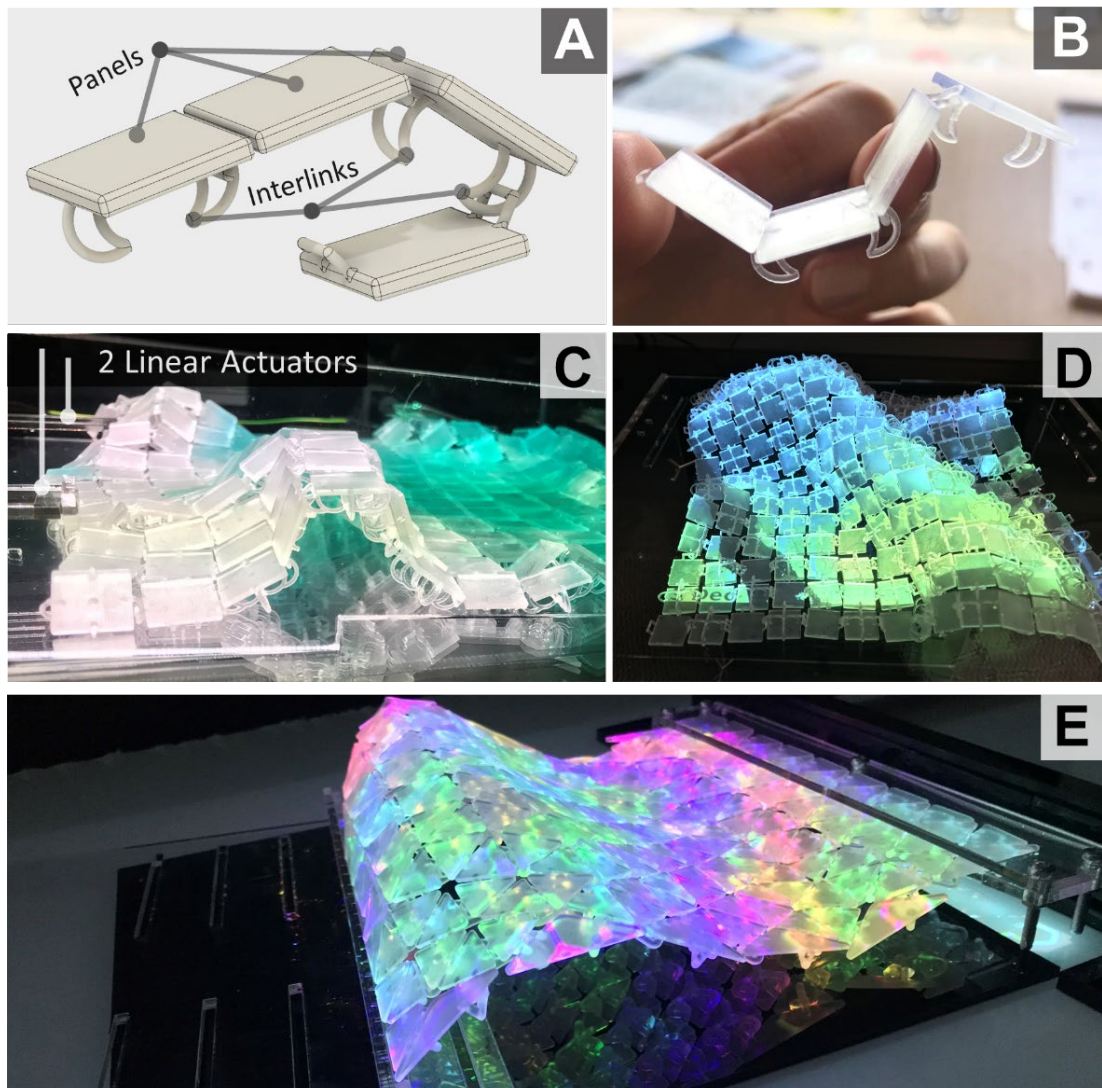

Figure 26: Basic 3D model (A) and 3D print (B) of interlinked panels, and fabricated shape-changing displays examples (C-E).

In terms of technical detail, each 3D printed panel is rigid, but in aggregate they behave as a continuous surface. Unlike cloth and fabrics, previously used for shape displays, these surfaces can adapt in fluidity or rigidity based on their designs. By enabling direct manipulation of surface properties, during the design stages, this fabrication approach will further enhance the design and development of shape-changing displays. Using new (e.g. horizontal force) and existing actuation technologies (e.g. pin-arrays), show how this fabrication technique can be adopted to shape-changing displays. Scalability and the technical opportunities these surfaces offer, such as horizontal actuation for surface deformations, are also demonstrated and discussed. Vertical actuation was also tested with a pre-existing shape-changing display [176] to demonstrate generalizability. Finally, limitations and possible applications are discussed.

In summary, this chapter contributes the application of 3D printed ‘fabrics’ as a novel approach to further the development of shape-changing displays. The 3D printed interlinked surfaces fabricated show:

1. A reduced number of actuators needed for dynamic surface deformations, with horizontal force actuation.
2. Opportunities for under-the-surface visualization and embedding interactive components into the surface.
3. Retained fluidity and rigidity whilst rendering cylindrical, oval, and tunnel forms.

5.1 Fabrication Approach

This chapter presents an overview of the fabrication approach that demonstrates: (1) 3D printing complete and partial segments of interlinked surfaces with no additional support structures to reduce material consumption; (2) continuous and curving 3D printed interlinked surfaces; (3) with a reduced number of actuators that still create complex surface deformations; (4) using horizontal force to render tunnels and 2.5D cylindrical/oval forms; (5) under the surface projection as a form of visualization; and (6) embedding conductive materials as part of the surface for capacitive touch sensing.

The core premise of the fabrication approach is to use continuous 3D-printed surfaces, comprising of panels that are interlinked (**Figure 26A**), to create shape-changing surfaces that can be actuated with horizontal force. The following subsections explore design parameters to establish the utility of this fabrication approach. Scaling factors were tested to find the most error-free 3D printing approach. Actuation explorations established that horizontal force can be used to achieve a range of surface deformations and elevations. Visualisation explorations adopted under-the-surface projection to reduce occlusion and embedded interaction capabilities reduced the need for external depth cameras for touch detection on the surface.

5.1.1 Surface Scaling Based on 3D Printing Approaches

To establish which additive manufacturing techniques produces fewest print errors and highest resolution, scaling CAD parameters were explored. Stereolithography (SLA) 3D printing, using liquid resin (print resolution = 0.05mm) achieved fewest errors with smaller scale factors. Clear resin also supports optical clarity for visualisation opportunities with both projections and LEDs. To reduce material waste during fabrication, the surface was printed directly on the build plate with no support structures. Fused Deposition Modelling (FDM), was also tested (MakerBot Replicator2) to ensure the approach can be generalized. **Figure 27A** shows an FDM test surface (print resolution = 0.2mm). In comparison to the SLA test surfaces (**Figure 27B**), dimensions of individual panels and interlinks using FDM are scaled up to ensure interlinks are strong enough for robust movement.

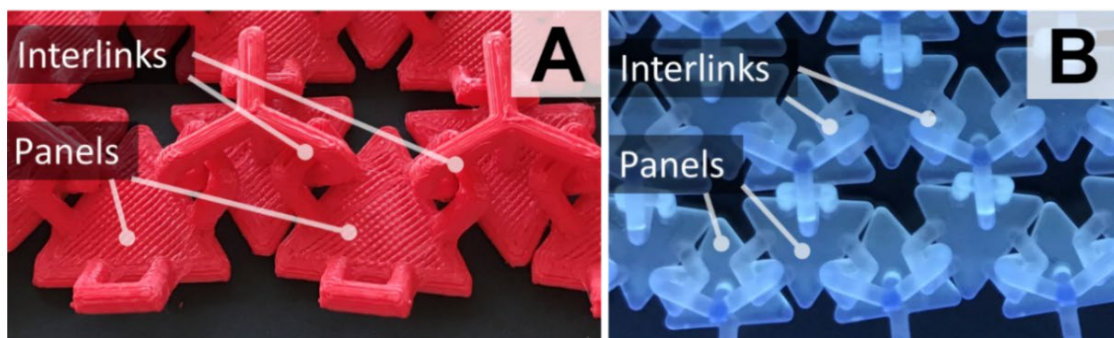

Figure 27: Bottom side of the surfaces. Interlinked triangular panels 3D printed (FDM) with red filament - Panel 21×19mm and interlink width 4mm (A); SLA with clear resin - Panel 20×17mm and interlink width 3mm (B). 3D model source [106].

A multitude of panel shapes were tested during the initial surface design explorations including triangular (**Figure 27**) and square (**Figure 29A**). It is recommended that interlinks should be at least 3mm width with FDM printing, as initial tests with smaller panels and interlinks resulted in increased print fails and inconsistencies. For larger scale surfaces, FDM could be used. Using clear or white filament/material supports projection. A greater number of panels and interlinks creates more detailed surface deformations and more fluid movement. Scale must be increased with FDM to ensure interlinks are properly formed without print faults. With SLA, I recommend interlink width of 2mm for robustness.

5.1.2 Actuation Explorations

The aim of this exploration was to explore an alternative actuation approach for surface deformations and elevations that go beyond traditional linear vertical pin-arrays. The goal was to use even fewer actuators than detailed in chapter 4 whilst maintaining high shape-output deformations.

In initial tests, horizontal force was used for surface actuation as opposed to vertical force, commonly applied with pin-array shape displays. The actuator consisted of two continuous servos, and two Micro-Bits [43] (one for servo control, one for user input). For early-stage testing, I explored the effects of continuous horizontal motion on surface deformation without fixed actuators. The test surface dimensions are 185×150×17mm. Each triangular panel was 14×12×2mm with interlink width of 2mm.

A hexagonal design, with alternate linkages, was also tested [82]. It generated a uniform arch using the whole surface. Four forms of surface deformations and movements were achieved with horizontal force actuation. (1) **Figure 28A/B** shows continuous elevated movement from a flat surface to a high arc. (2) Once the actuator is paused, the surface stays in place without continuous force applied by the actuator. (3) When curving one side of the surface under itself the surface retains ridged form without any support required from the actuator (**Figure 28C**). (4) A wave shape form can be achieved when one side of the surface is higher (**Figure 28D**).

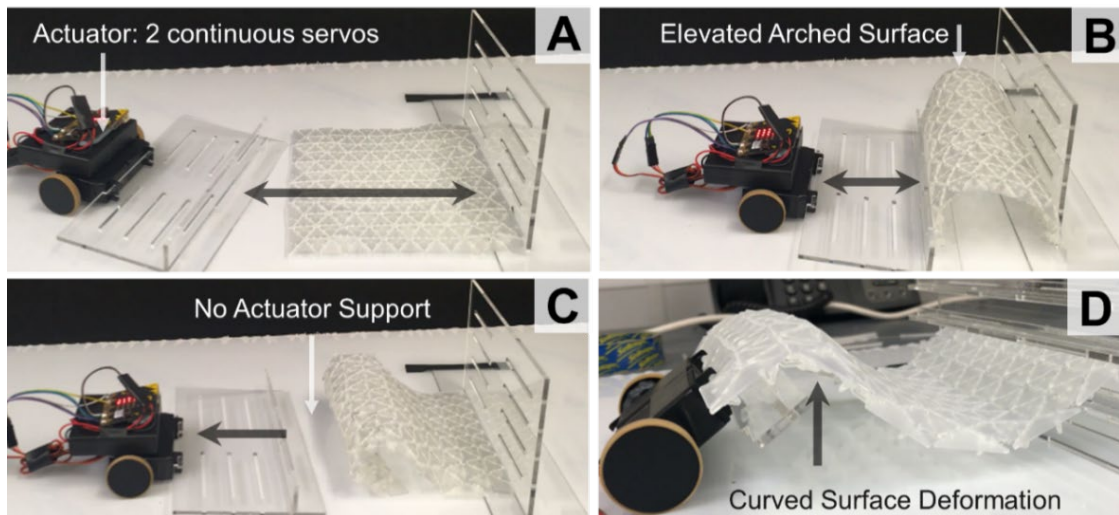

Figure 28: Horizontal uniformed force on 1 side of the surface (A); for an elevated arch (B); Surface deformation without actuator support (C); and curved when the surface is slightly raised (D).

5.1.3 Visualization Technique

The aim of the visualisation explorations was to reduce the issue of occlusion whilst maintain high-resolution visual output on the surface. **Figure 29** shows two possible visualization approaches, using a projector. **Figure 29A** shows over-the-surface projection suffering from occlusion. Under the surface projection, using a table with a gap cut into it eliminated occlusion (**Figure 29B**). Though more space is required under the surface, no occlusion occurs when users interact with the display, creating a more impactful user experience.

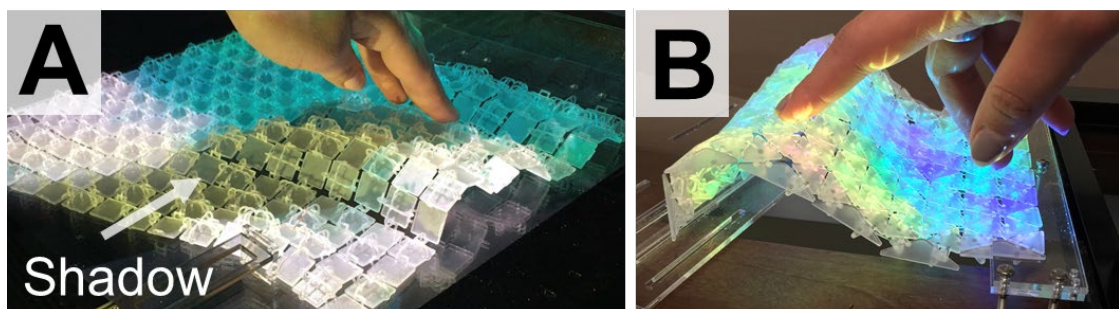

Figure 29: Visualization examples using over the surface (A) and under the surface (B) projection.

5.1.4 Embedding Interaction

Exploring opportunities for embedded interaction capabilities within a surface aimed to reduce the need for external depth cameras for touch detection. **Figure 30** demonstrates how capacitive touch can be embedded into the interlinked surface for controlling actuation. Two 0.1mm copper wires were interwoven through the surface and connected to a 2nd MicroBit for capacitive touch sensing (**Figure 30C**). When touch is detected, the continuous surface would actively deform under the finger. Though a novel interaction experience, accurate control of the surface movements was limited. Conductive Silver Ink and ITO (Indium Tin Oxide) coated film can also be used for capacitive touch sensing on the surface, as a second layer of material. With FDM printing, conductive filament can be used to print sensing directly into the surface.

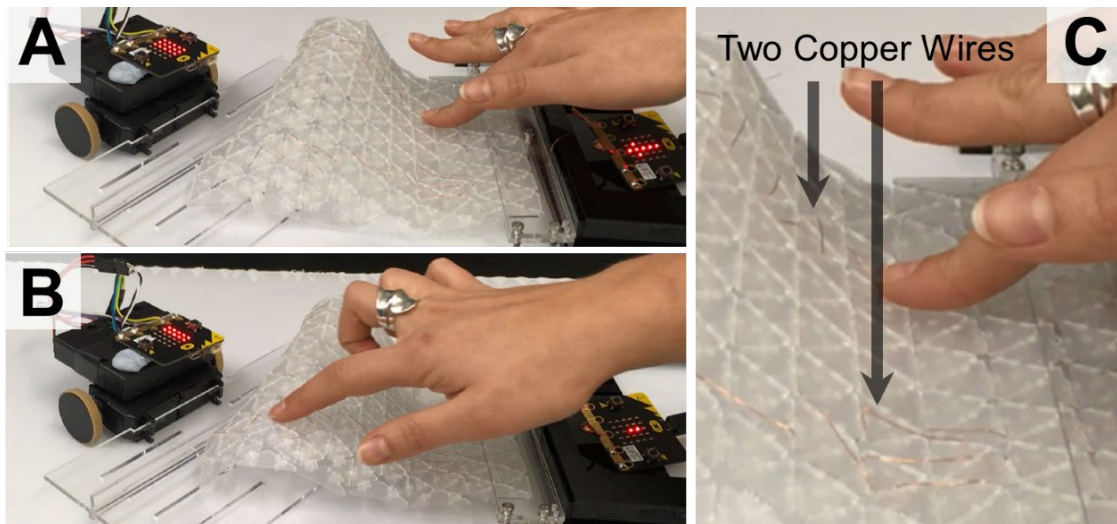

Figure 30: Two fine copper wires are interwoven through the surface for capacitive sensing.

5.1.5 Surface Design Explorations

A range of geometries were explored to understand how the shape of each link and place can affect the movement and deformations of the surface as a whole. This is key for establishing what kinds of shape-output the surface can achieve during reconfigurations. The impact of varying panel and interlink (**Figure 26**) dimensions that influence surface motion and rigidity was also explored as part of this work. Fusion360 motion studies informed design choices for optimal interlink and panel design for fluid movement.

Panel Design

Figure 34 and **Figure 31** show interlinks and panels. Thinner panels ($<3\text{mm}$) with rounded edges allow more fluid (e.g. smoother and unhindered) movement during elevation and horizontal deformations. This is because each of the plates in aggregate creates uniformed movement. Downscaling interlink width ($\leq 1\text{mm}$) provides less under-the-surface protrusion but increases fragility. To overcome this, resin that simulates ABS (Acrylonitrile Butadiene Styrene) injection moulded components is used for tougher material properties to mitigate fragility with thinner interlinks. However, the blue tint of the resin decreased optical clarity for visualization. Thicker panels ($>3\text{mm}$) with smaller spacing between interlinks (**Figure 34**) provide rigidity and robust support when the surface is deformed.

However, scaling up panel dimensions in the Y axis results in courser geometry and limited movement flow, especially when interlinks are tightly coupled. Triangular, square, and hexagonal panels were designed and fabricated to understand how panel shape can affect surface deformations. Size of panels and interlinks has a greater impact on surface movement, as these parameters affect individual plate rotation and movement.

Interlink Motion Explorations

Motion studies were performed on two initial interlink designs. A planar joint was used to test freedom of movement with each interlink design. Constraints were set to ensure only motion inside the interlink was rendered. Reduced space within the link, see **Figure 31** (approx. $\leq 1\text{mm}$) limits the movement. Too much space within interlinks ($\geq 3\text{mm}$) creates very lose panel movement, resulting in loss of fluidity in motion and the continuous surface shape. As seen in **Figure 31**, triangular links have a much more limited angle of movement (34°) in comparison to curved links (139°). Approximately 2mm space for interlinks gaps (see **Figure 31** green and orange shaded areas) is recommended to ensure panels create fluid motion but are not too loose.

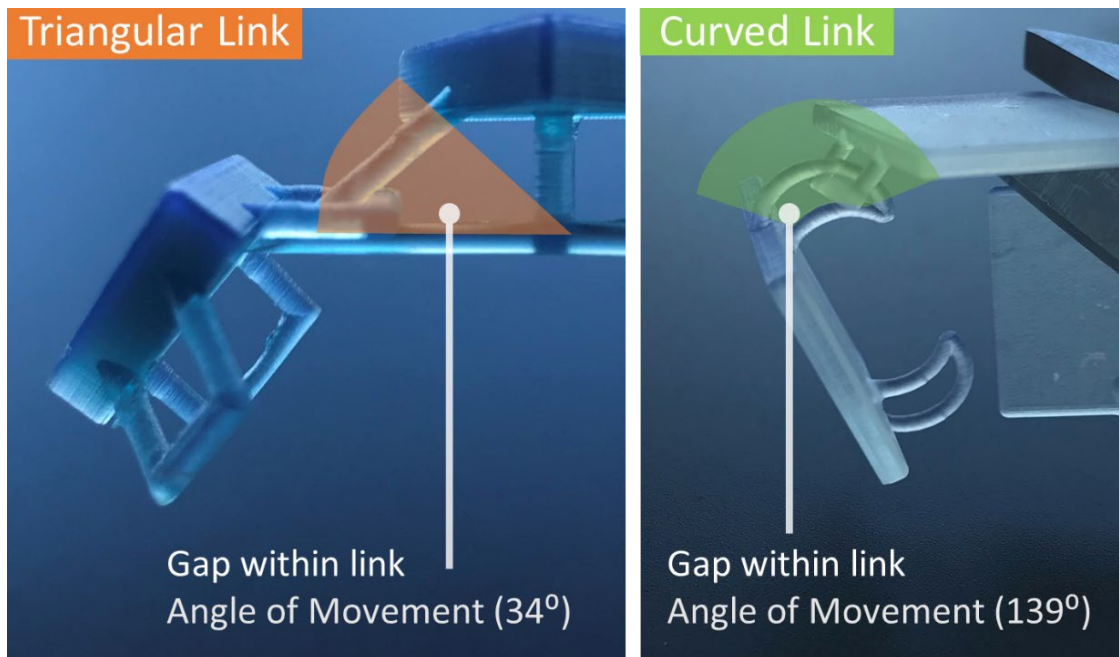

Figure 31: Initial 3D printed link designs for triangular (Left) and square panels (Right).

The triangular interlink design (**Figure 32** left), shows that the angle for movement is limited to 34° due to the nose of the interlink (**Figure 32** left). This type of interlink could be used in specific areas of a display to create more ridged deformations. A curved interlink (**Figure 32** right) provides a 139° angle for panel motion. Curved interlinks allow a set of panels to drape, like cloth, whereas a triangular interlinks support rigidity and self-support for surface deformations. Self-support for triangular shaped links occurs due to the link nose limiting the bending of the connected link (**Figure 32** left) and in aggregate this effect is propagated to create a self-supporting surface.

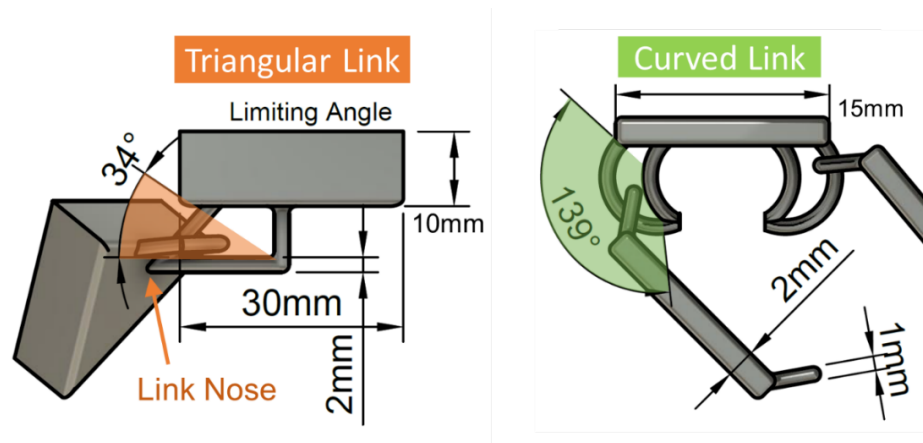

Figure 32: Interlink CAD design (triangular) with a limited angle for restricted movement on a triangular panel; and interlink design (curved) for more movement on a square panel.

Horizontal Actuation and Shape-Output Control

For cylindrical/ovoid and triangular shape-output (**Figure 33**) accuracy and control, speed and force of actuation are key factors. To control shape position, the more force and speed propagated through the surface, the further away surface elevation occurs from the actuator. To control shape-output scale, a greater “push” area of an actuator increases the width of the shape. **Figure 35A** shows a cylindrical shape with one actuator. When two actuators increase the “push area” (**Figure 35B**), with the same force at the same speed, the shape-output width is increased across the surface.

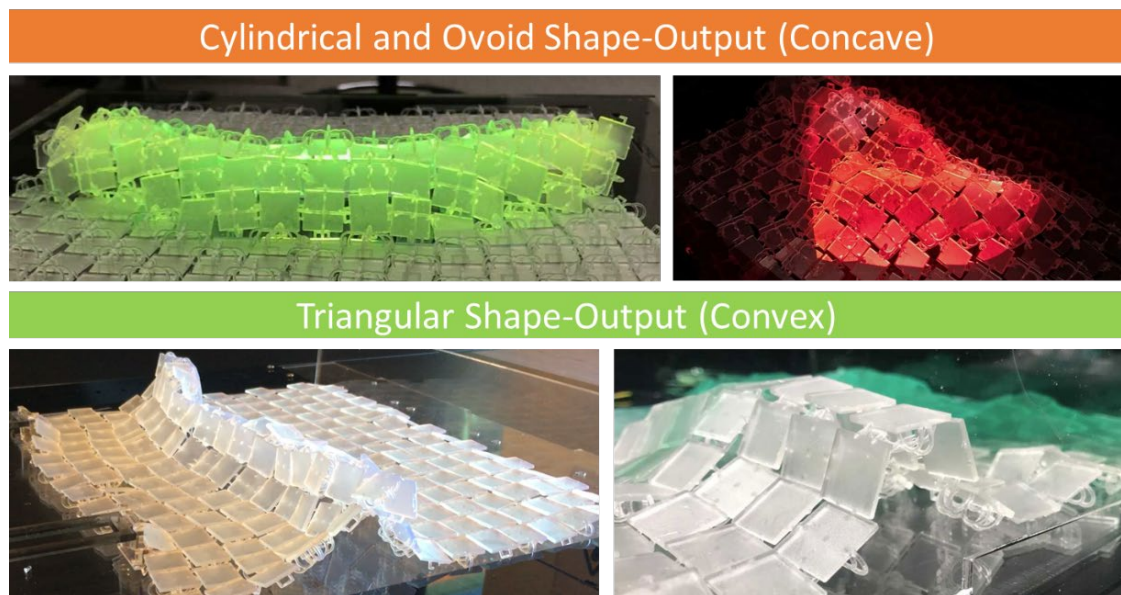

Figure 33: Examples of cylindrical and ovoid shape-output when links are on top and convex shape-output when links face down.

Each side of the surface has specific shape output characteristics based on the freedom of the angle of movement. To render oval/ovoid and curved 3D forms, the surface needs to have the links facing up (see **Figure 33** and **Figure 35A-B**). As the angle of movement is restricted by adjacent panels’ edges, the surface in aggregate bends in an oval fashion and can render tunnel oval like structures (**Figure 33** and **Figure 35B**). The curvature continuity of the surface when links are facing up enables physical 2.5D renderings of spheres, cones, and cylinders (**Figure 33**). To physically render 3D shapes with sharper corners and edges it is best to have the surface links facing down as this creates a more “pointed” shape elevation (**Figure 33** and **Figure 35C**).

Having the surface positioned where the links are facing down, enables more freedom in the angle of movement between each panel. As a result, the panels in aggregate can be bent to much greater angles without the limit of touching the other panel edges. When

the surface links are facing down (**Figure 33**) shapes such as triangular pyramids, square based pyramids, and triangular prisms can be rendered. To achieve these shape-outputs using horizontal actuation, the actuators need to be driven at different speeds and force.

5.2 Surface Applications

The proof-of-concept surface combines under the surface projection for visualizations and linear motors for horizontal actuation in two applications. **Figure 34** shows the square panel and interlink design chosen for fabricating a larger 280×280mm display surface. I reduced the interlink width to 1mm. Though this allows for finer aesthetic, the surface becomes more fragile, prone to breaks and fractures. An interlink width of 2mm is optimal for a robust surface that can withstand excess force and deformations.

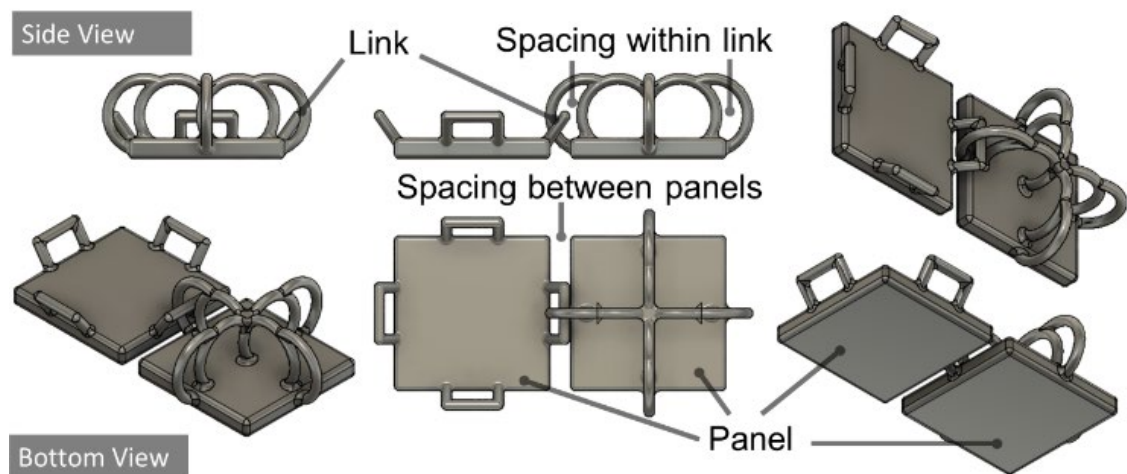

Figure 34: Optimal panel (15×15×2mm) & interlink (width=1mm) designed, with space between panels=2mm.

Due to the limited build platform space on the Form2 (145x145mm), four interlinked surfaces were 3D printed separately (140x140x8mm) and “welded” together, using a glue gun, to create a larger surface (280x280x8mm), see **Figure 35**. Each surface consisted of two panel/interlink designs, seen in **Figure 34**, iterated to create an 8x8 grid (140x140x8mm).

Total print time for a 280x280x8mm surface was 15 hours, and 1 hour 20 mins for post-processing (20 mins per print). Both sides of the surface have specific characteristic deformations. Sharper surface forms are rendered when interlinks of the surface face

down (see **Figure 35C**), as each panel has a greater angle of movement. When interlinks are facing up, a curved form is elevated (**Figure 35A**) due to the limited angle of movement for each panel.

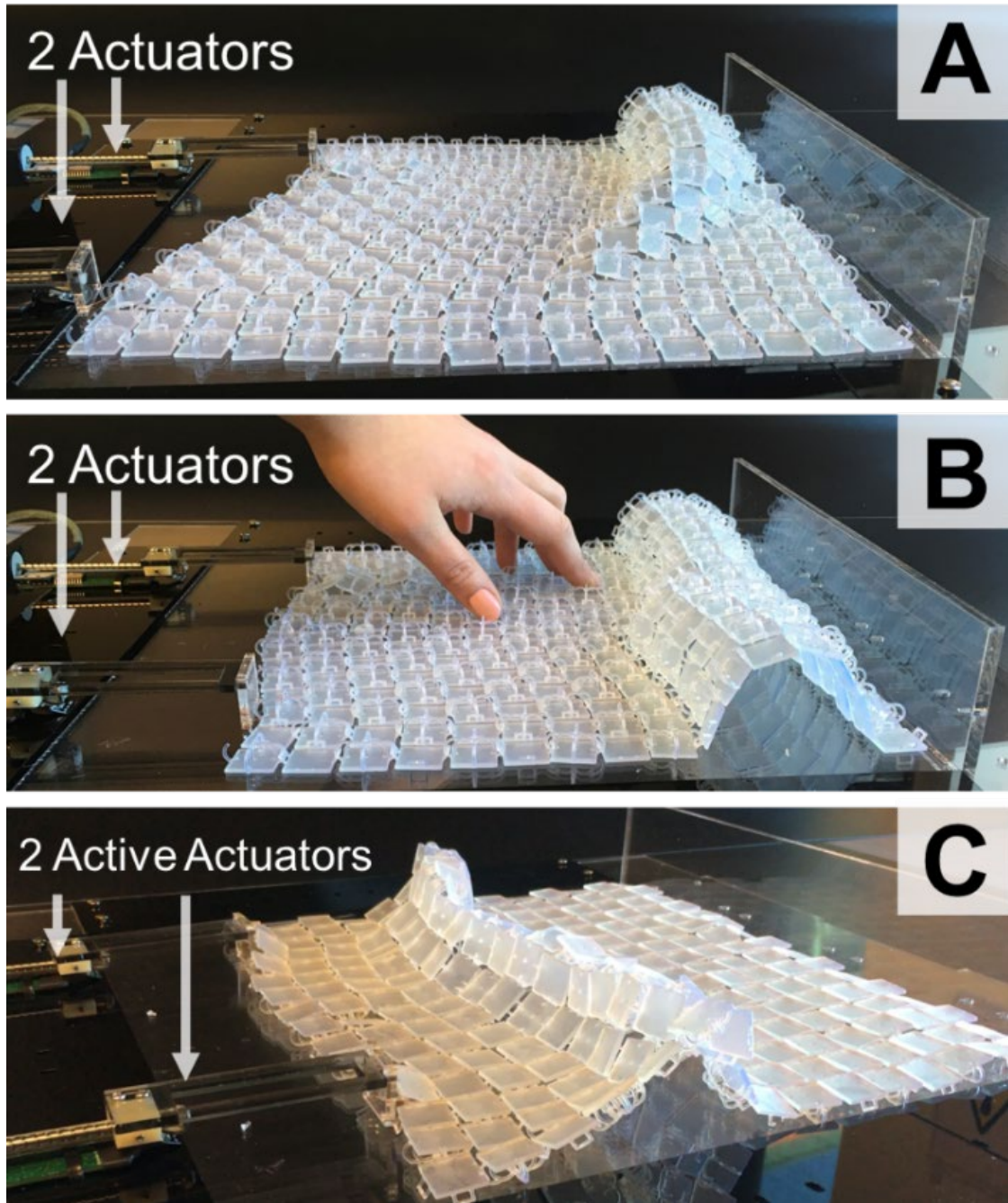

Figure 35: Surface (280x280x8mm) with 2 actuators attached to 1 side. Interlinks on top with shape-output only on the far side (A), increased width of cylindrical shape when two actuators push areas used (B), and flat panels on top of the surface for “pointed” shape elevation (C).

5.2.1 Surface Applied to Existing State-of-the-Art

To demonstrate generalizability with existing technologies, the surface was used to transform large scale vertically-actuated pin-arrays into continuous surface shape-changing displays. EMERGE [176], a 10x10 array of actuated pins, was selected for this as it supports under-the-surface visualization. **Figure 36** shows that the surface creates a continuous display. When actuators are spread further apart the surface renders continuous shape-forms. Translucent panels release light from LEDs in each pin actuator to create diffused visualization. The surface required no attachments to pins and rendered an organic fluid movement during actuation, which could better represent continuous mathematical functions or topography without the need for a cloth layer.

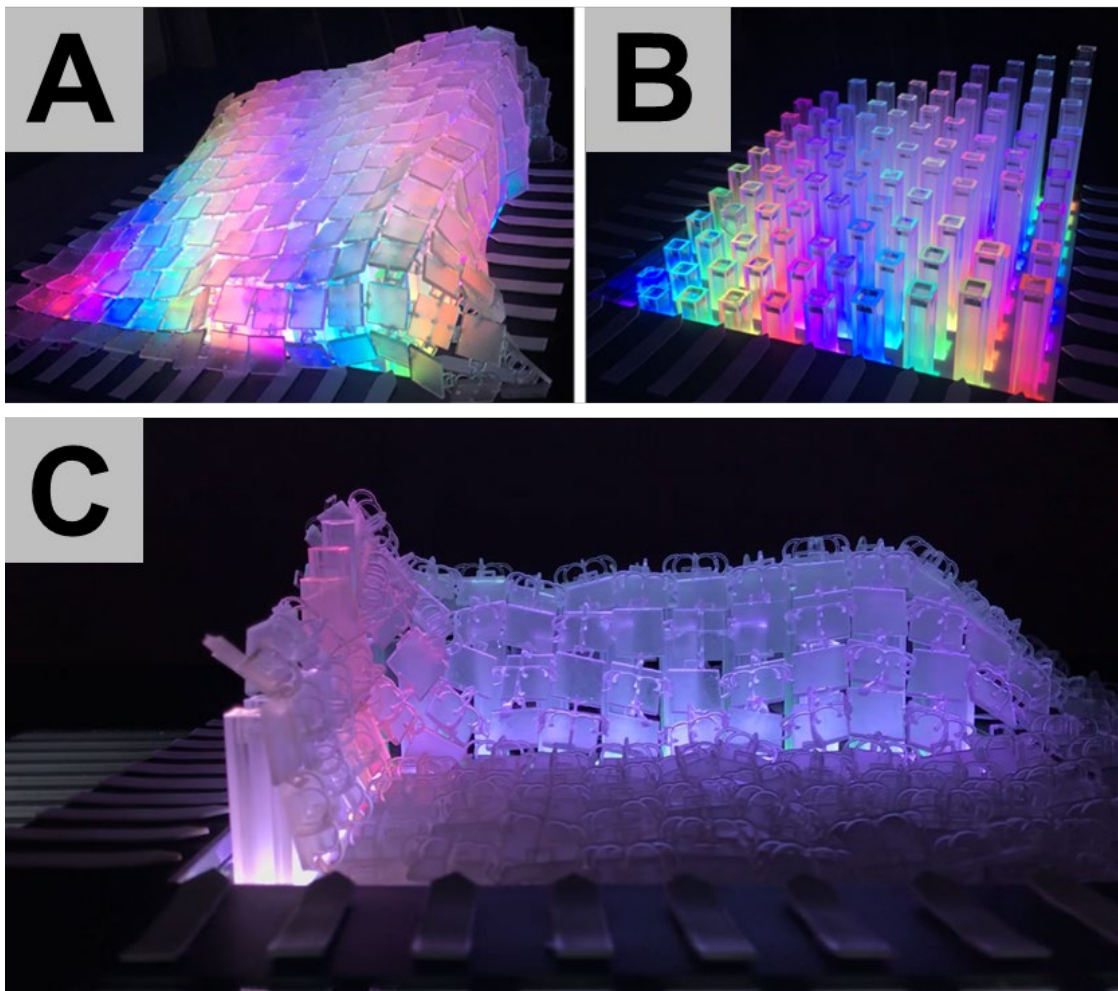

Figure 36: Interlinked surface over linear pin-array (A-C).

5.2.2 3D Printed Surface as a Stand-Alone Display

Figure 37A shows a shape-changing display with rear-projection that uses three actuators. A layer of clear laser-cut Perspex is used to secure actuators on the sides and also ensures the fabric-like surface does not droop. The use of horizontal force as an actuator eliminates the need for electronics under the surface and also deforms in both the X and Y axis, as seen in **Figure 37B**. The display also renders under-the-surface ‘tunnels’ **Figure 37C** whilst a laser-cut clear ‘wall’ is used on one side of the display to ensure the surface elevates when an actuator pushes it.

2.5D Oval and Cylindrical Object Rendering

The surface was first used with the links facing up to physically render cylindrical and oval forms. When designing possible content for this first shape-changing display, multiple examples of cylindrical and oval shape-forms were considered for rendering in 2.5D.

Based on insights from the initial content generation study (Chapter 3), physically showing the scale of various food items was selected as an application scenario to explore. The design focus of this initial shape-changing display was to demonstrate to users the physical scale of food items at a restaurant (e.g. pizza size or banana). **Figure 37E** shows an example of a 2.5D banana form with rear-projection for imagery. Users could physically see the size of a certain food at a restaurant before they order it. Two actuators, on one side of the display, elevated areas of the surface as seen in **Figure 35**. A user can further refine the oval and cylindrical shape-outputs by controlling the distance an actuator pushes the surface backwards or forwards, or by manipulating the surface deformations by hand as seen in **Figure 37C**. This set-up could also be used in an architectural context to render tunnels.

Physical Flow Simulations

Figure 37B/D show the surface as a display to simulate ‘flowing’ visualizations with physical shape-output. A physical wave motion simulation (**Figure 37B**) was used as an example to show natural flowing movement throughout the continuous surface. Two linear actuators were used on a single side of the surface and another one on the perpendicular side.

The actuators act as mechanical paddles which move back and forth either simultaneously or individually to create different types of wave scenarios based on horizontal actuation speed and force. **Figure 26C** shows a close-up of surface deformation during the actuation for simulating wave shaped forms. **Figure 37D** shows the topography of a reef that gradually changes shape as the visualization, and water temperature varies.

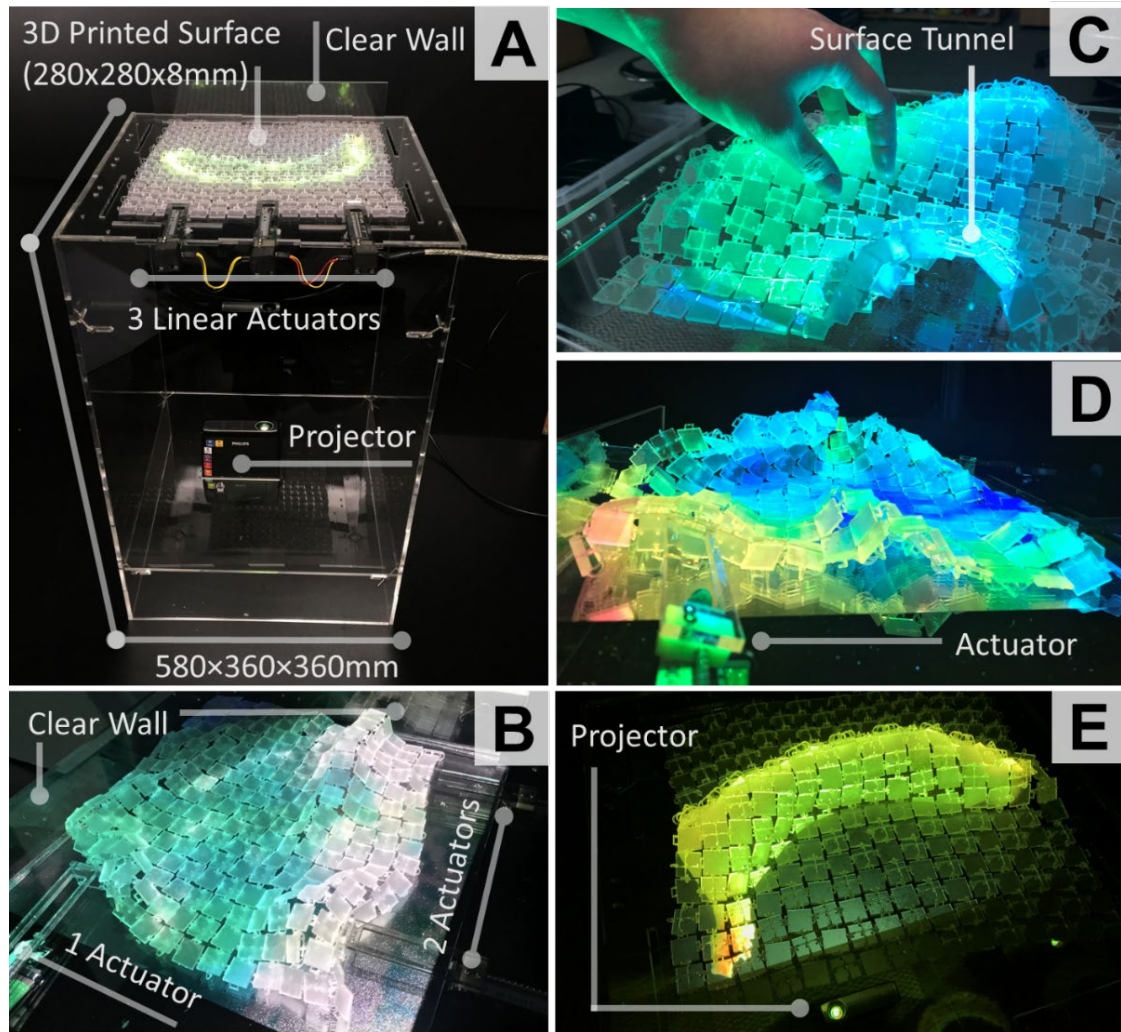

Figure 37: Shape-Changing display set-up with under-the-surface projection to eliminate occlusion, 3 actuators on one side of display (A); Wave simulation application with 3 linear actuators (B); User manipulating surface with a tunnel (C); Temperature simulator for reef topography (D); Surface rendering 2.5D cylindrical form – banana (E).

5.3 Chapter Discussion

This chapter presents an initial exploration of 3D printed interlinked panels to fabricate dynamic surfaces for shape-changing displays. These surfaces can be scaled by combining multiple prints as a ‘patchwork’ to create larger surfaces. The fluidity of continuous surface movement with added rigidity enables cylindrical, oval, and tunnel shape-forms. Clear resin, used during fabrication, enables visualizations with no occlusion. To demonstrate alternative actuation opportunities, horizontal force was used with a reduced number of actuators for surface deformations in both X and Y axes.

5.3.1 Reflection on Contributions and Limitations

The work in this chapter aimed to achieve three core objectives; (1) to reduce the number of actuators needed for dynamic shape-output, (2) support opportunities for under-the-surface visualization and embedded electronics, and (3) enable shape-output that can retain fluidity and rigidity whilst rendering cylindrical, oval, and tunnel shapes.

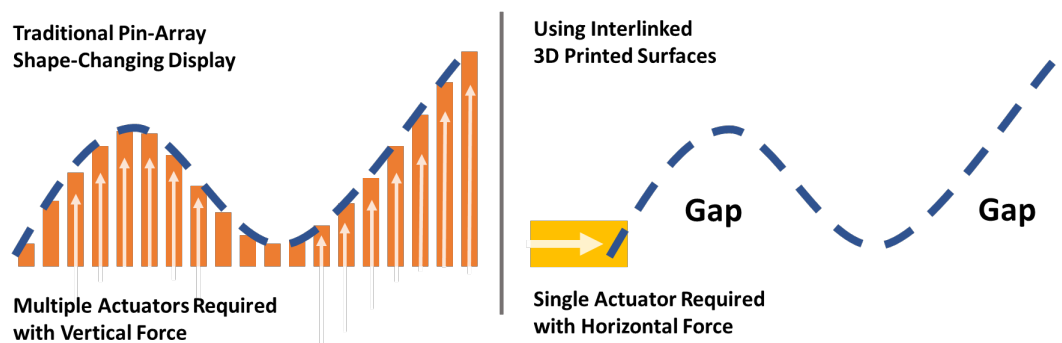

Figure 38: Comparison of actuators required using traditional pin-array shape-displays (Left) and using an interlinked 3D printed surfaces to achieve the same deformation with horizontal actuation force (Right).

The initial explorations into actuation opportunities highlight the use of horizontal force to achieve shape deformations without the need for linear actuators to be positioned below the surface. As seen in **Figure 38**, using horizontal force can provide the same curvature of surface deformation as a traditional pin-array display (**Figure 38** - Left), but with a significantly reduced number of actuators (**Figure 38** - Right).

Unlike with traditional pin-array shape-changing displays, which use vertical linear force, having the linear actuators positioned on the sides of the deformable surfaces also

allows for additional opportunities for visualisation, such as under-the-surface projection. By reducing the area needed to be covered for shape deformations, fewer actuators are needed to be positioned on the outside edges of the display in comparison to uniform pin-arrays that are currently used. However, the level of control required for shape deformations is limited with horizontal force for actuation.

The granularity of shape-out, defined by Kim et al. [89] as the density of physical actuation points, is limited with horizontal force as the actuation in the initial exploration conducted for this work is focused on uniformed force that is applied to one whole side of a 3D printed surface. With the larger example of the shape-changing display prototypes developed (**Figure 37**), three actuators are positioned to apply horizontal force on more specific areas of the surface edge. Based on the surfaces' layout, it can demonstrate retained fluidity and rigidity whilst rendering cylindrical, oval, and tunnel forms as seen in **Figure 37**. Though granularity is increased with the number of physically actuated points on the surface, the level of control for actuating each specific point on the surface is still not accurate in terms of modelling precise deformation and elevation. This especially applies to areas at the centre of the display, where the propagated horizontal force is not as focused.

As mentioned earlier, there is a trade-off between shape resolution and number of actuators. This is a scaling matter, for both surface dimensions and actuation mechanism used. A larger surface requires more actuators to move different areas of the surface. The accuracy of shape elevation when using linear force is determined by the actuator's capabilities to: (1) control its speed and force applied to the surface, (2) the "push" area of the actuator, and (3) its actuated extension length. To increase the number of oval/cylindrical shapes rendered across a larger display requires the actuators to be more spread across the edge of the surface.

The work in this chapter provides an initial step towards reducing the need for complex electronics and mechanical actuators to create shape-changing surfaces, especially when creating curved and oval 2.5D shapes. The next development for this work is to be able to establish a greater level of control when applying horizontal force to the interlinked 3D printed surface with more complex and granular shapes as dynamic output. This chapter demonstrates; (A) how horizontal uniformed force on one side of the surface, (B) for an elevated arch, (C) surface deformation without actuator support,

and (D) curved shape-output when the surface is slightly raised. These initial primitive shape elevations begin to establish a space for supporting a new generation of deformable displays that do not require a large pin-array of actuators to render dynamic shape-output.

The initial surface design (with a continuous pattern) shows how ovals and cylindrical shapes are rendered. A quantitative analysis for shape geometry that also explores mixed design pattern surfaces is needed to further diversify the design space for the fabrication technique. With the current surface design, tunnels can also be rendered where users look at the space under the surface – this is a novel shape representation that is not possible with the current linear actuated state-of-the-art. Exploring actuation beyond linear-actuators, such as muscle wire embedded into the surface, can also support a diverse range of movement and deformations. The next step is to simulate physical motion for the whole surface and placement of actuators to optimize shape-output before fabrication. The current surface design renders oval, cylindrical, and tunnel forms. A parametric design system needs to be developed that generates 3D models specific to users' needs and surface properties.

Using horizontal force for actuation supports opportunities for under-the-surface visualisation. Particularly, when using translucent or clear resin and FDM filaments when 3D printing these interlinked surfaces, the use of projection for visualisation can go beyond the generic over the surface implementation that traditional shape-displays use. The gap beneath the surface (see **Figure 38** - Right) does not just enable tunnel-based shape-output to be elevated but also supports the use of projection from under the surface. A user can also put their hands under the surface and interact with the underside of the display as an additional interaction opportunity. The overarching goal of these 3D printed surfaces would be to eliminate the need for external visualisation equipment (e.g. projectors) and develop a fully functioning deformable surface that has a visual display build within it. To achieve this, embedding electronics such as LEDs into the surface is the next logical step in the fabrication process for these displays.

As each surface is designed in a CAD environment, areas for embedded electronics is initially explored for prototyping these deformable surfaces. The initial use of conductive wire interweaved throughout the interlinked surfaces, post-printing, provides an initial stepping stone for integrating interaction within the surface without

excessively complex electronic components. The capacitive touch sensing circuits that these deformable surfaces support provides initial opportunities for compact and integrated shape-changing displays. Though using projectors for visualisation provides higher resolution imagery on the surface, by embedding smaller LEDs within each of the panels further reduces the need for additional components that are situated away from the original display surface. Integrating electronic components for both visualisation and interaction within these 3D printed deformable surface for shape-changing displays is the next step in this research.

5.4 Chapter Conclusion

This chapter explores the use of 3D printed surfaces as a fabrication technique for shape-changing displays. I described the general fabrication approach that demonstrates opportunities for under-the-surface visualization and embedding interactive components into the surface. By varying surface design parameters, the surface can retain fluidity and rigidity whilst rendering cylindrical, oval, and tunnel forms with a reduced number of actuators, and horizontal force actuation. Two possible application scenarios of the surface are shown based on current shape-outputs possible with the initial surface design. This fabrication technique aims to further enhance the design of shape-changing display by supporting dynamic deformations through a balance of ridged and fluid material characteristics.

By specifically focusing on 3D printing as the core fabrication method, each surface can be custom designed and developed in CAD environments based on the design requirements of the application. This second fabrication approach further re-enforces the utility of semi-solid and deformable surfaces as a technique for shape-changing display development. Though this 3D printing approach for fabricating semi-solid surface reduces the need for manual assembly, in comparison to laser cutting with PolySurface, the next chapter aims to further optimize the fabrication of deformable and semi-solid surfaces by enhancing utility, through embedding electronic components within each surface.

Current fabrication techniques for developing shape-changing displays and dynamic surfaces are limited by the thickness of electronics and mechanical surface rigidity. Rendering complex polygonal structures, cylindrical meshes, or curved contours is also

limited due to lack of dynamicity in surface configurations with pre-existing systems. The next chapter explores how deformable surfaces can be fabricated for shape-changing displays with embedded electronics for interactive capabilities. By utilizing multi-material 3D printing the next chapter aims to develop thin and stretchable surfaces with interactive capabilities embedded.

These dynamic surfaces are specifically designed to support embedded electronic components and can easily adapt to various shapes. Enabling multi-material 3D printing with conductive filaments further reduces assembly requirements and enhances iterative prototyping of shape-changing displays with interactive capabilities. The next chapter also explores the use of alternative visualisation techniques that do not require projection. These fabrication approaches aim to support and encourage the community to develop and explore a wider range of design alternatives for shape-changing displays.

6 | Embedding Electronics for Deformable 3D Printed Surfaces

Work in the previous chapter supported the rendering of complex polygonal structures, cylindrical meshes, or curved contours using a 3D printed deformable surface. However, that approach is still limited as it does not fully support integrated electronic components within a deformable surface. This chapter explores how interaction and visualisation capabilities can be better integrated within a single deformable surface. The exploration of multi-material 3D printed surfaces builds on work on semi-solid surfaces from previous chapters to develop deformable and flexible 3D printed interactive surfaces that can also support embedded visualisation.

Current fabrication techniques for developing shape-changing displays and dynamic surfaces are often limited by the bulkiness of electronics and mechanical surface rigidity [90]. Alexander et al. [6] highlight the need for more flexible/elastic displays and sensors to further the design space for shape-changing displays and interfaces. The core focus of this chapter is on integrating both visualisation and interaction capabilities within a deformable surface that also has a thin form-factor. The fabrication approach described enables shape change with a more diverse shape output and a portable, non-obtrusive form factor. The use of multi-material FDM 3D printing supports the development of flexible surfaces that are interactive, deformable, and provide at-a-glance feedback.

The research question this chapter addresses is:

How can interaction and visualisation be better integrated within a single deformable surface?

As demand continues to grow for flexible devices [18, 121], with visualization and interaction capabilities, new design challenges are raised for developing deformable devices that can easily change shape. Though e-textiles are commonly adopted for smart deformable devices [77, 85], these techniques have yet to be established for customizable material properties, e.g. stretchiness and bendability. Computer-aided design (CAD) was utilized with commercial multi-material 3D printing to design and rapidly fabricate low-cost interactive and flexible surfaces with a range of scale form-factors and embedded interactive features. Supporting fast and accessible fabrication increases opportunities for research as Lo and Girouard [100] argue with a rapid prototyping method for deformable mobile devices.

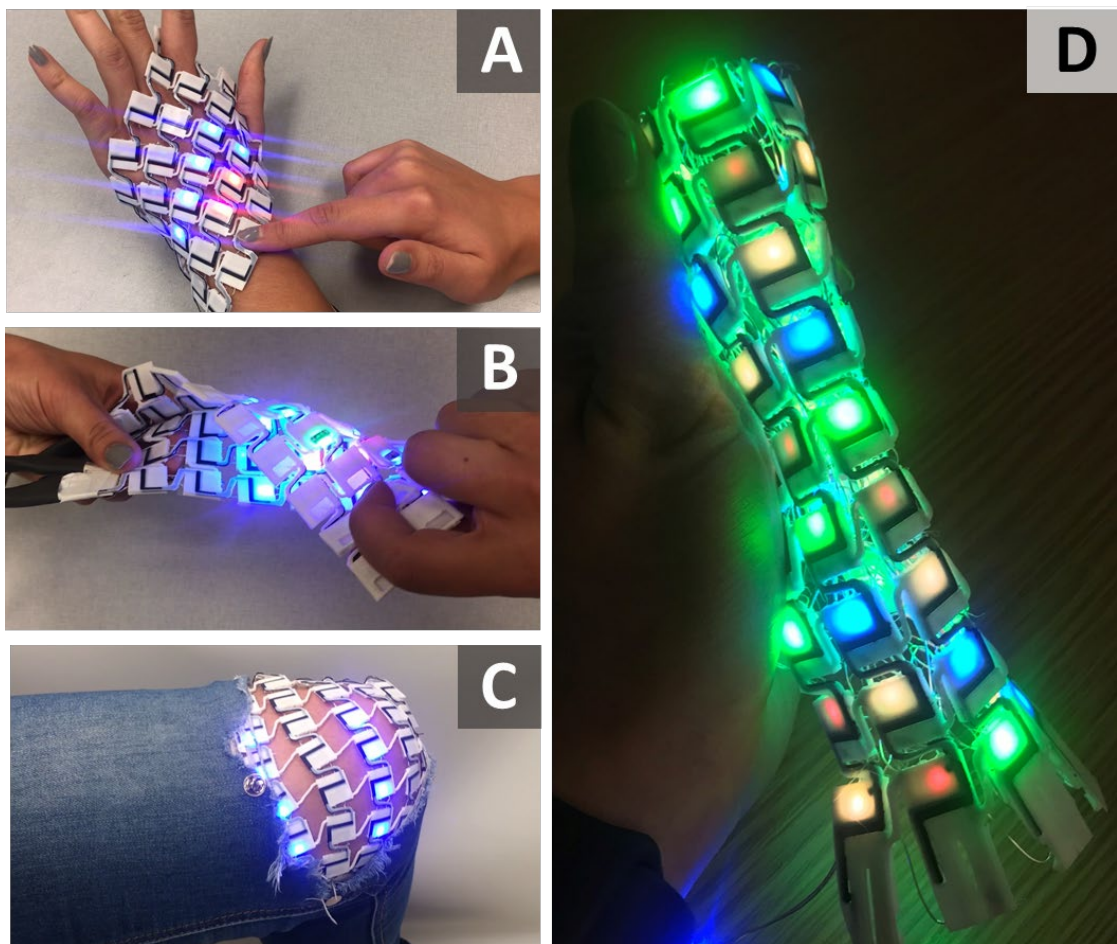

Figure 39: Prototype with copositive touch sensing and integrated LED electronics. Demonstrating interaction techniques for pressing (A), bending (B), stretching (C) on the hand and integrated into a pair of jeans, and user-deformed interaction.

This chapter describes the core design concept and fabrication approach, presents insights from design explorations and 3D modelling, provides technical detail for embedding interactive and visual components, and finally presented a set of case studies with a design focused workshop to validate the approach. The core motivation of this work is to enable the research and design community to develop a wider range of portable, thin-form factor displays and interfaces (**Figure 39**). Specifically, with minimal cost and assembly requirements. User-deformed displays rather than self-actuated shape-change were used to demonstrate the utility of embedded interaction and visualisation capabilities of 3D printed surfaces. The core contributions of this chapter are:

- (1) Design and fabrication approach for developing thin, stretchable, and interactive display surfaces using multi-material 3D printing. Integrating flexible and conductive materials simultaneously during printing can rapidly create customizable interactive surfaces that support additional embedded electronics.
- (2) The low-cost proof of concept prototypes that are interactive, customizable, and flexible display surfaces. The interaction techniques supported insights from a design workshop to provide an initial understanding of how to expand the design space for flexible interfaces.

6.1 Design and Fabrication Approach

The core premise of the proposed fabrication approach is to use multi-material 3D-printed surfaces, comprising tiles (sizes 10–15 mm – similar to panels 3D printed in the previous chapter) that are linked to create deformable surfaces that are easily adapted into shapes using both self-actuation or user deformations. These surfaces can be further modified, as illustrated in **Figure 40**, in anticipation of additional electronic components, which can reduce the difficulty and time of assembly. This fabrication approach demonstrates: (1) a design method for developing custom deformable surfaces with interactive sections and areas for embedding electronics. (2) Multi-material 3D printing with flexible and conductive filaments to produce flexible surfaces with integrated capacitive touch sensing. (3) Techniques for embedding electronic components (conductive materials as part of the surface for capacitive touch sensing).

6.1.1 Core Concept of Approach

The core motivation of this fabrication approach is to support the development of shape-changing surfaces with thin form-factor and integrated visualisation and interactive capabilities. To achieve this, 3D printed interconnected panels are used to provide flexibility and stretchable surfaces. Within those panels, conductive material is used to support embedded electronics for providing additional functionality in terms of interaction and visualisation capabilities. Multi-material Fused Deposition Modeling (FDM) 3D printing is utilized where; (1) flexible filament is used to fabricate deformable and stretchable surfaces, and, simultaneously (2) conductive filament is used to create capacitive touch circuits with interactive areas within the stretchable surfaces. Small scale LEDs are embedded within the 3D printed flexible surfaces to support visual feedback.

6.1.2 Technical Details of Implementation

Multi-material 3D printing is utilized to fabricate flexible and stretchable surfaces with interactive capabilities. Commercially available Flexible Polyurethane Material [38] was used for fabricating a flexible 2D array of tiles that are linked together to create a stretchable surface (**Figure 39**). Conductive Polylactic Acid (PLA) [144] material was also used to print capacitive touch sensors within the flexible surfaces [150]. Though conductive PLA is not a flexible filament, when used in small quantity (one or two 0.2 mm layers), it can behave as such.

6.1.3 3D Modelling Deformable Interfaces

Fusion360 is used to model a range of tile and link designs for fluid movement. Each tile is linked together in aggregate to behave as a continuous flexible surface. **Figure 40** shows the final 3D model design used for the demonstration prototypes for the design workshop. For the first prototype, the tile dimensions were limited to 15x15x2 mm to ensure the deformable surface can accommodate miniature electronics (e.g. surface mount LEDs) whilst maintaining thin and lightweight device properties. A gap of 5 mm between tiles, where a curved link connects each tile, ensures the surface is stretchable. For interaction, a layer of conductive filament (0.5 mm depth) is embedded during the printing process on each tile and is connected through the links (**Figure 40A**).

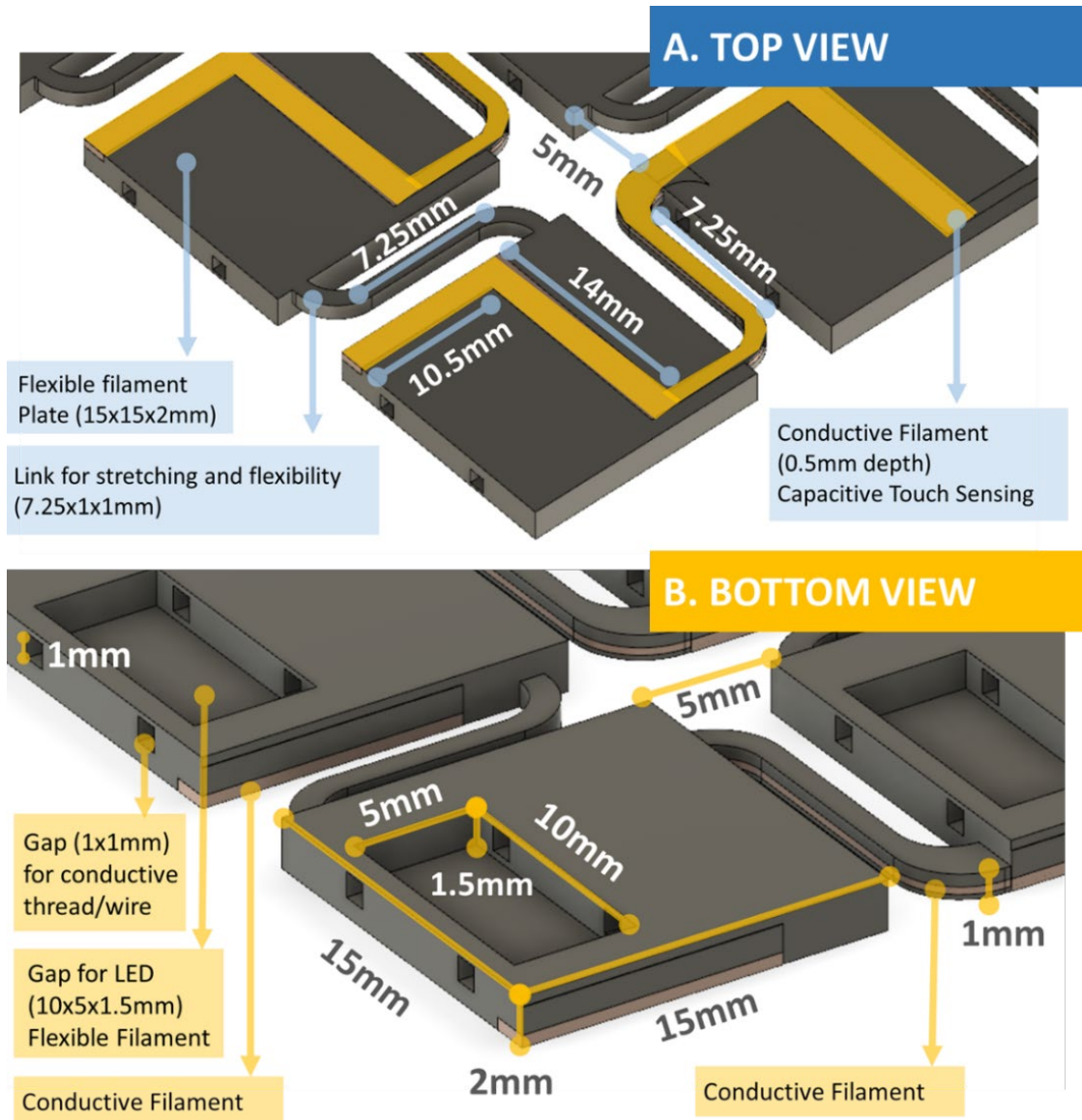

Figure 40: Final prototype tile and link 3D model design close-up that is merged in aggregate to create a deformable device.

Surface-mount LEDs were used for their miniature size to ensure the overall design is compact. A gap of 5x10x1.5 mm in each tile can situate an individual LED. Flexible white 3D printing material was used, which also served to diffuse light from the LEDs throughout each tile, making them more like large pixels in a display. The number of tiles and LEDs reflects the resolution of the wearable. With more tiles, more complex visualizations can be created. In the initial prototype design, two gaps (1x1 mm each) were included in every tile that allows conductive thread or insulated electromagnetic wire (0.5 mm) to be easily threaded through the prototype and provide current and data for the LEDs (**Figure 40B**).

6.2 Design Explorations

Below describes the design iterations explored for both tile and link design and how their geometry affects bendability, stretching, and conductivity properties.

Tile Design

The goal here was to establish which tile shapes and dimensions best support the most dynamic and flexible shape change. To achieve this, a range of tile shapes were designed and printed in an array to test how much they bend and deform. First, the impact of varying tile link dimensions and shapes was explored to support bending of the surface (**Figure 41**). The bending capabilities for each surface are affected by both the number of sides and the arrangement of the tiles. Though a triangular configuration (**Figure 41B**) allows for 60-degree bends, the deformation would occur on a slanted angle that is paralleled to the triangle sides. This limited the bending capabilities of the surface to slanted bends. For the final prototype square tiles were used as they enable a direct 90-degree bend in four directions without any obstructions. The depth of each tile model was limited to 2 mm maximum to ensure the design is as streamline and lightweight as possible. This also reduces printing time and material required for fabrication.

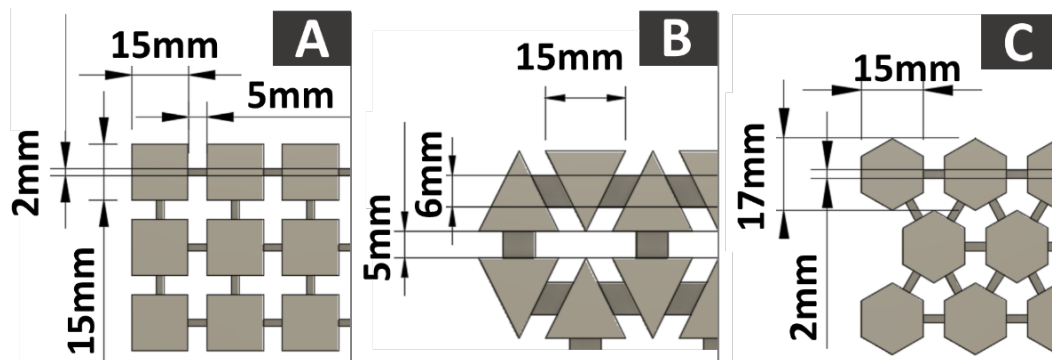

Figure 41: Initial tile design explorations with square (A), triangular (B), and hexagonal (C) polygons.

Link Design

The goal of these explorations was to establish which link designs achieved the most stretch and bend whilst retaining robust surface deformations. To achieve this, a range of link designs were tested to see which enabled most durable stretching. The stretch was measured using the same technique for measuring the stretch of most fabrics [34].

The surface with the links was placed on a ruler and expanded until resistance was felt. The stretch was calculated based on how far the surface extended. The link design was inspired by the design of 3D printed spring mechanisms [59] where stretching is affected by the length of the “S” shape link joint that is curved. Flexible filament ensured that the stretchable links have elastic properties to ensure tiles can go back to their original shape after deformation.

Bending properties is affected by the width and thickness of the link. A simple straight line was used for the initial link design to connect each tile and understand how width and depth of the flexible material affect bending in aggregate. Though the original link designs were 2 mm width (Figure 41A/C), a link width of 1 mm with the depth of 1 mm is recommended for maximum flexibility and durability. A wider link (Figure 42A) reduces bending abilities and creates a more rigid form. Thinner links (Figure 42B) bend easily and with less force needed for deformation. Stretching is affected by length of the “S” shape of the link (Figure 42C).

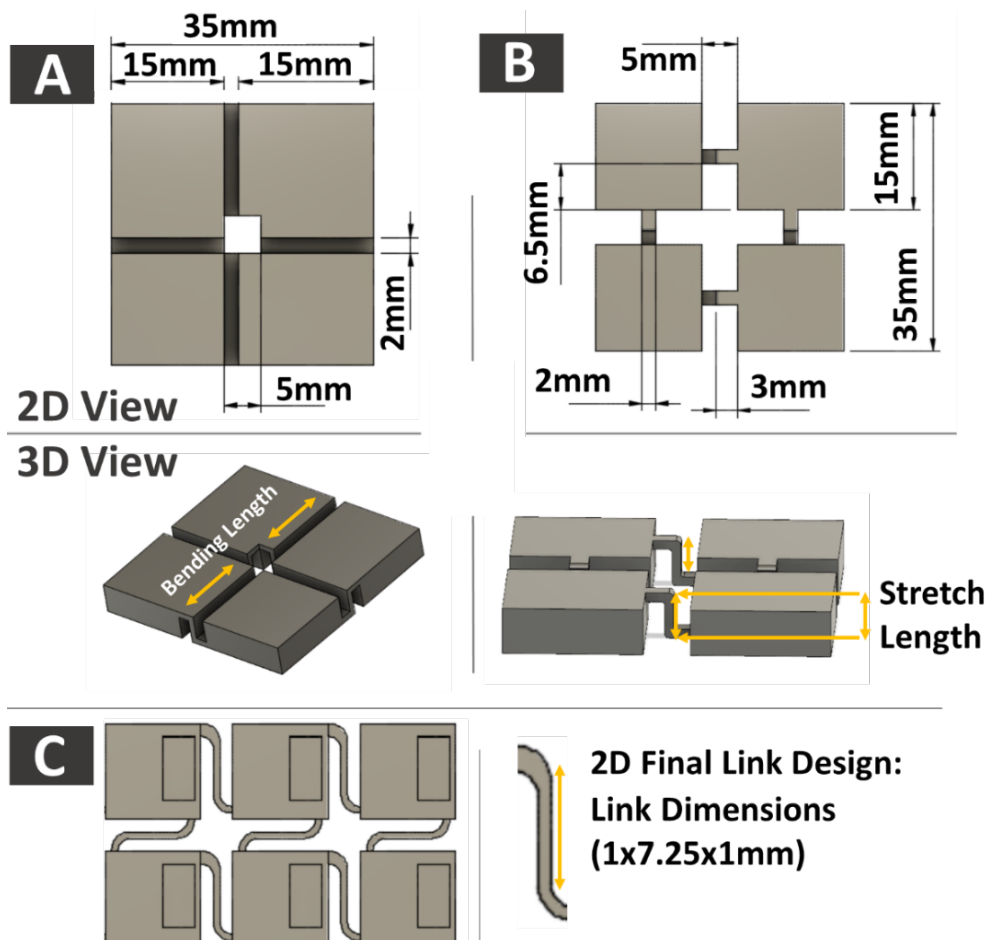

Figure 42: Link design explorations; Wider vertical link design (A), thinner vertical link (B), final horizontal curved link (C).

Embedding Electronics and Sensors

Conductive filament (**Figure 40A**) can create a sensor for touch input or connect electronic components such as LEDs. The initial prototype uses conductive filament specifically for capacitive touch sensing. **Figure 43** shows the circuit diagram details. To incorporate conductive filament for LEDs, two more links must be added to each tile side (for power and ground input). This requires a more complex 3D model with multiple links connecting each side of the tile.

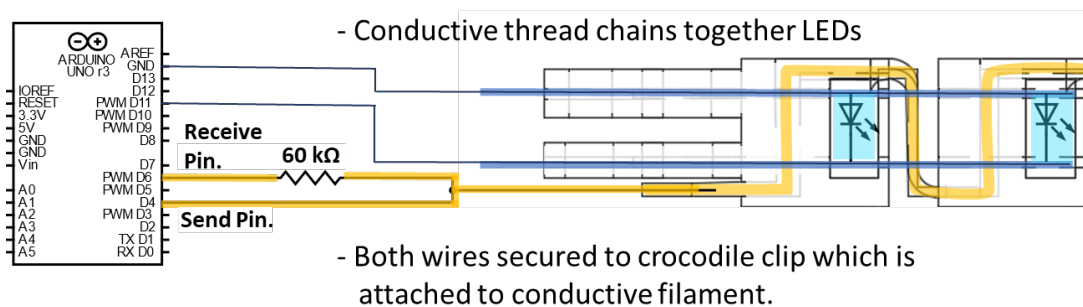

Figure 43: Circuit diagram of the layout of 3D printed surface, showing conductive connections (yellow) and LED connected with conductive thread (blue).

Conductive thread connects the LEDs in the prototype as it fully supports flexible surface deformation. An LED is embedded in each tile and connected in a circuit using two pieces of conductive thread (**Figure 43**). Two 1 mm gaps are included in the tiles to hold the thread (**Figure 40B**) and speed assembly. Using a square gap, rather than circular, is recommended as keeping the gap walls straight reduces the risk of print deformities or blockages at small scale. A short-circuit can occur if both the positive and negative threads cross during large deformations, like twisting. To mitigate this, spray paint can be used to insulate exposed areas of each thread piece. Alternatives, like liquid rubber, can also work.

Insulated electromagnetic wire (0.5 mm) was implemented on a smaller scale version of the prototype (with tile dimensions 10x10x1.8 mm). The wire holds the deformed shape unlike with thread, where the surface goes back to a neutral position. As the wire is 0.5 mm thin, this increases fragility with repetitive twisting and bending. To mitigate the risk of wire breaking, soldering directly on the wire is recommended to burn off the insulation coating to expose the conductive copper and strengthen the wire.

To demonstrate the utility of this fabrication approach, the subsections below explore how the prototypes developed can be adopted to domains outside of shape-changing displays. Specifically, how the thin form-factors with integrated visualisation and interaction capabilities can be utilised for both user deformed and self-actuated shape-changing surfaces. The first prototype use-case explores the adoption of the thin and stretchable surface as a user-deformable wearable device to demonstrate generalizability. The second use-case example demonstrates utility by presenting a small-scale user-deformed mobile flexible pixel display.

6.3 Use-Case Example - FlexiWear

This prototype demonstrates the interactive capabilities supported by the fabrication approach this chapter proposes. The initial prototype (**Figure 44**) is a flexible 2D array of 8x5 tiles (15x15x2mm and 5mm apart), each connected with a curved link (13x1x1mm). The prototype here is referred to as a FlexiWear device. An extension of 20 mm is added to the end of each row of tiles to connect wires for the conductive filament and thread to an Arduino Uno. For touch sensing a 30 OHM resistor is connected to the conductive filament in conjunction with the Arduino Capacitive Sensing Library [10]. Two pieces of conductive thread are used for each row of LEDs, situated inside a designated gap within a tile (**Figure 40B**).

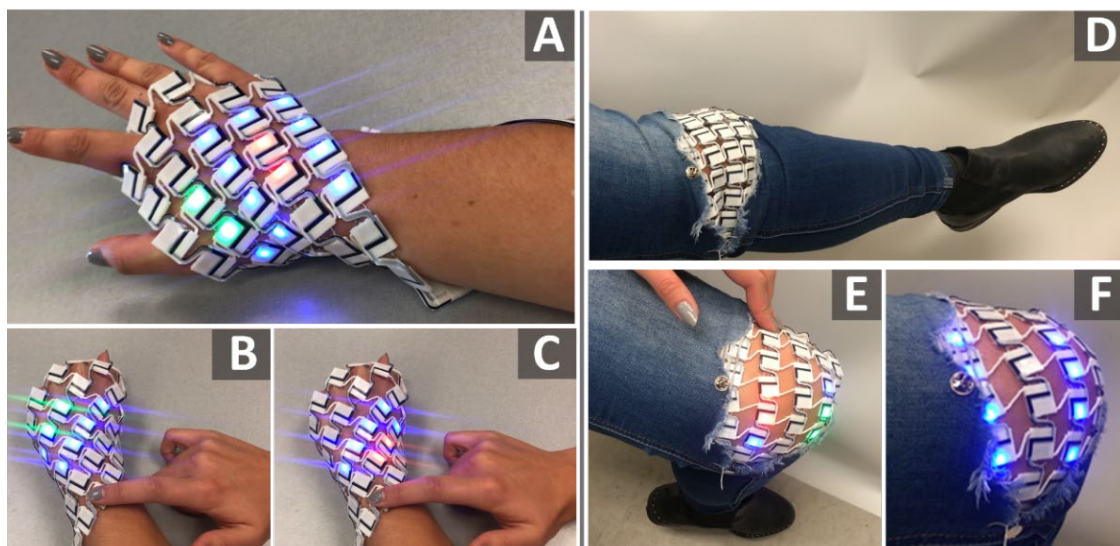

Figure 44: Prototype (195x95x2mm) on hand (A) with light (B) and hard (C) pressing, integrated with a pair of jeans (D), pressing on a bent knee (E) and stretched on bend knee (F).

The prototypes presented in this chapter support a low-cost approach through rapid fabrication and minimal print material requirements, as the 3D models are required to be thin (2 mm depth max) and do not require any additional support during the printing process. This also reduces printing time significantly and supports rapid iterative prototyping. The initial prototype (195x95x2 mm) took 3h 45min to 3D print. A smaller-scale version (dimensions 145x70x1.8 mm) took 1h 45 min to print, using both flexible and conductive filaments simultaneously.

6.3.1 Interaction Capabilities

This prototype use-case example moved from self-actuation to human-actuation in an attempt to demonstrate the generalisability and utility of the core design and fabrication approach. Based on insights and design implications discussed in chapter 4, direct interaction techniques were the core focus for this work. Specifically, three core interaction techniques that are supported by this prototype (**Figure 39** and **Figure 44**) are: (1) Pressure based touch and pressing, (2) bend detection on human skin, and (3) stretching of the surface to support natural shape output and movement. Capacitive readings from the conductive filament also can detect when the device is touched or picked up by a user and when it is dormant—e.g. contacting skin or lying on a table. Interaction techniques described below are based on capacitive sensing.

Device Body Placement

These interaction techniques are demonstrated using two body placement application examples. **Figure 44A-C** shows the prototype as a hand worn device. This demonstrates generalizability with commercially available wearables, as arm and hand worn devices. **Figure 44D-F** shows the prototype with a more novel application, integrated into a pair of ripped jeans to detect knee bends. These interactions are described below.

Pressure Based Pressing

The prototype surface can detect the force a user presses a tile using capacitive sensing thresholds with the Arduino Uno. Each of the black lines on the tile is conductive filament situated across an array of flexible white tiles. The change in voltage is measured for capacitive touch sensing to determine how hard a user is pressing a tile.

Figure 45 shows varied force (measured as capacitance in arbitrary units [10]) applied to four different rows of tiles by a user's finger. **Figure 44A** shows green LEDs activated when a user lightly presses on a tile (e.g. reading between 2000 and 3000 units). **Figure 44B** shows red LEDs light up when a user presses harder on a tile, as the capacitance reading increases (e.g. above 4000 units).

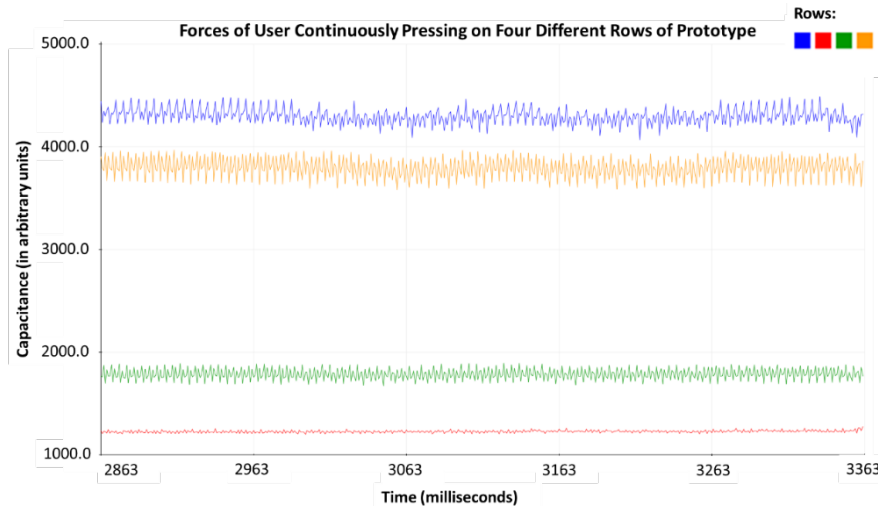

Figure 45: Range of force when user continuously presses on four different rows of prototype recorded via Arduino Serial output (including noise).

This capability to distinguish between light and hard presses can be used in multiple applications such as music control. For example, to pause a song, a user can lightly touch a tile. When they want to skip a track, they can press harder on the tile. This eliminates the need for both single and double presses, that most music controllers use for distinguishing between pausing and skipping tracks.

Bend Detection and Stretch Deformation

In the context of wearables, it is important for the device to be able to adapt to the user's body. For this prototype, the device does not only deform as the user body shape accordingly but also detects when they move and bend their body part. **Figure 44D-F** shows the prototype adapting to bend and stretch with electronic circuits (e.g. chain of LEDs) embedded within the deformable surface. Using capacitive input from the conductive material, the prototype can detect human limb flexing and bending based on the amount of contact made with human skin. When the knee is extended the LEDs are deactivated and the deformable surface is withdrawn to adapt its shape for a straightened knee (**Figure 44D**). When the knee is at 90 degrees, blue LEDs are active (**Figure 44F**) to detect the bend.

For pressing interaction, when touch is detected a higher capacitive reading occurs, resulting in LED colour change **Figure 44E**). Bend over the knee is only detected based on the amount of contact the surface makes with the skin once it is stretched. The more the knee is bent, the greater the contact of the conductive material on the skin, resulting in a higher resistance input reading. 3D printed flexible surfaces can also stretch based on the interconnected link designs as demonstrated by Schumacher et al. [151]. Generic stretch sensors can also be incorporated to measure stretch when no skin contact is made with the surface. These personally fabricate bend sensors open up opportunities for customisation without being limited to the length and dimensions of commercially available bend sensors.

User Aware Interaction

Using the capacitive sensing through the Arduino can also detect when the deformable surface is not being picked up by a user. When the prototype is placed on the table the resistance reading is at its lowest (e.g. below 1000 units). Once the deformable surface is being touched or held by the user, there is an increase in capacitance from the conductive filament making close contact to the skin. This interaction capability could enable the device to distinguish between active and dormant states and go into power saving mode when it detects it is not being actively touched by a user.

6.3.2 Summary of Prototype Implementation

This wearable prototype presents a surface with a thin form-factor with integrated visualisation and interaction capabilities embedded during the 3D printing process. Multi-material 3D printing is utilised where flexible filament provides deformable and stretchable surfaces and, simultaneously, conductive filament is embedded to create interactive areas, through capacitive touch circuits, within the stretchable surfaces; all in a single print. LEDs are embedded within the 3D printed flexible surfaces to support at a glance feedback. Based on the capacitive sensing capabilities of the conductive filament three initial interaction techniques emerged for both direct user interaction with their hands and also bend detection for body placement. Though this prototype focuses on use-deformations only, it does present a more generalisable example of adoption for the core fabrication approach outside of self-actuated displays.

6.3.3 Ideation Workshop

An ideation workshop was conducted that focused on understanding how people can design wearable technology for a range of applications based on the fabrication approach. The main goal was to explore applications for wearable technology using interaction techniques supported by FlexiWear. Please see Appendix A for documentation related to this workshop

Six participants were recruited for the workshop, 4 females and 2 males with ages ranging from 18 to 44. The smaller sample size ensured a focused group discussion and ideation session. Participants' experience with wearables ranged from none to owning multiple wearable devices, specifically smartwatches for self-tracking and notifications. As two participants never owned a wearable device, this encouraged an alternative perspective for discussion. One participant owned a Snapchat Spectacles [48], the only wearable that was not wrist worn. The workshop consisted of four equal phases and lasted two hours. A coffee break was also included for participants.

Phase 1 - Background and Video Demo: To familiarize participants with a range of wearables, they were shown examples of commercially available wearables and technology currently in research development such as the Levi Smart Jacket [53] and The Sound Shirt [120]. FlexiWear interaction techniques were also showcased.

Phase 2 - Group Discussion: This discussion aimed to uncover general trends for functional user requirements that go beyond current literature, such as body placement of wearables.

Phase 3 - Ideation and Sketching: Each participant designed and sketched 3 wearable devices: (1) one with input capabilities (e.g. user interaction); (2) one with output capabilities (e.g. visualizations); and (3) one device with both input and output capabilities (wearable with both input and output). This phase aimed to explore application ideas for wearables that utilize the core fabrication approach.

Phase 4 – Presentations: Participants presented their designs to the group and discuss their rationale. These presentations encouraged members to provide constructive feedback for each idea.

Workshop Application Ideas

Below reports on insights gained based on the group ideation session with regards to FlexiWear application areas.

Impact Monitoring Sports Clothing: P1 designed a smart shirt that can visualize levels impact or pain during a sports activity. For visualization, colour heat map changes indicate where on the body impact had occurred after a collision (e.g. during a dodgeball game). The purpose of the device is to show other people where impact or pain is coming from. Colour changes based on the level of impact can indicate to a coach or parent how hard a child has been injured during sports. P1 also suggested integrating FlexiWear into a smart helmet, which monitors impact and concussion during cycling etc. As FlexiWear uses capacitive sensing, the prototype can utilize capacitance readings during impact with another human to detect how hard a user has been hit. RGB LEDs embedded into FlexiWear can visualize a coloured heat map to indicate force of the impact on the body.

Smart Anklet: P3 proposed a customizable smart ankle bracelet. This is a personal design as they had experienced issues with pain during exercise on the leg and joints. As input, the device would measure minor changes in muscle movement. If any inconsistencies are detected, the anklet will contract and apply pressure to specific muscle for pain relief. P3 describes it as a “personal massage therapist that is non-intrusive”. The bending and stretching interaction supported by FlexiWear can be used to detect muscle spasms during strenuous exercise. By incorporating actuators, such as muscle wire, within the 3D printed surface can support actuation to help apply pressure to areas for relieving pain.

Wearable Smart Wristbands or Headbands: P6 designed wearable smart wristbands or headbands that notify parents if their child is having an issue, much like a baby monitor but a mobile wearable. It would incorporate haptics and vibrations. This additional multi-sensory feedback is aimed to help parents monitor the baby and know when it is awake during “loud” activities. For example, when a parent is putting a child to sleep and does not want the loud noise of other children crying on a monitor to wake up the others. For this application, a wrist-worn FlexiWear device could incorporate small embedded electronics to produce haptic output.

They also suggested a weighted comfort blanket with sensors, connected to a wearable bracelet/accessory hat knows when it is being used, as a context-aware application. When a user is inside the blanket, sensors could notify an app or wearable device (e.g., bracelet or ring) to let loved ones know when the comfort blanket is being used. The context-aware interaction capability of FlexiWear can be utilized on a large-scale, to create a comfort blanket that can distinguish when the blank is on the body of a user.

6.4 Use-Case Example – Flexible Pixel Display

The second use-case example (see **Figure 46**) demonstrates the utility of the thin form-factor shape-change with embedded components through visualisation capabilities on a small-scale user-deformed mobile pixel display that can be foldable. Though this prototype is user-deformed, horizontal force (as described in chapter 5) can also be used to create a self-actuated version of the flexible display.

6.4.1 Design and Fabrication of Prototype

This second prototype follows a similar CAD design to the previous version, but with even smaller tiles (each 10x10x2mm) and is also fully self-supported using insulated wire instead of conductive thread. The 5x9 array (dimensions 70x145x2mm) has embedded micro LEDs interwoven throughout. The prototype display is fully flexible and can be deformed by the user whilst retaining visualisation capabilities of the pixel display as seen in **Figure 46**. Though the resolution of the display is low in terms of the pixels used, the surface is mobile and can be folded away whilst stored in small spaces (**Figure 46A**). Using insulated wires (0.2mm diameter) instead of conductive thread ensures the display can be self-supporting and retain its form once deformed or folded by the user. The length of wire between each LED is 50mm and is U-shaped to facilitate sufficient stretching, bending, and folding. The wire used should not degrade over time and the self-supported surface will retain its shape until pressure or weight is applied. In light of these visualisation integrations, this prototype also aims to support capabilities of self-actuated flexible devices as detailed by Roudaut et al. [143]. For actuated self-folding, the surface can incorporate modular origami robots [12] for example.

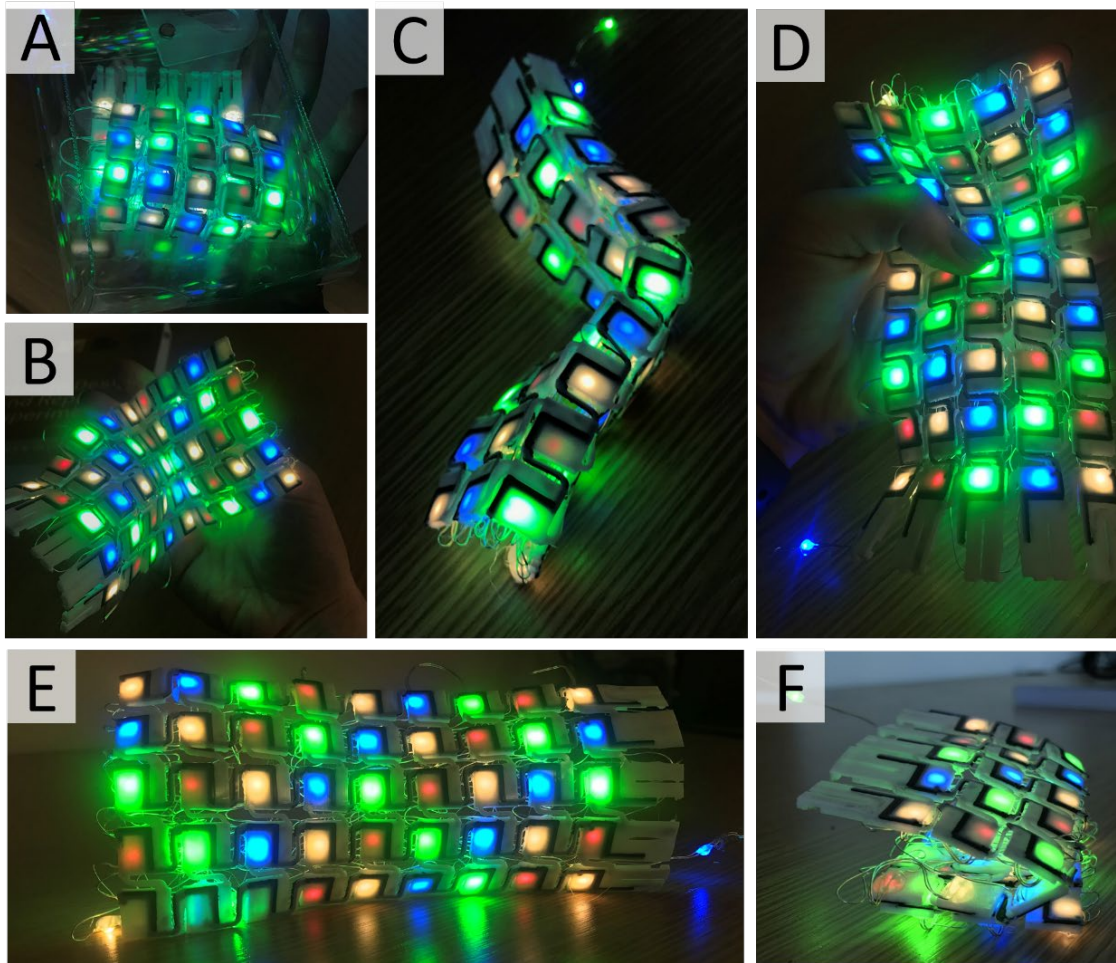

Figure 46: Small scale flexible and foldable pixel display. The surface is fully foldable (A-D), self-supporting (E-F), and retains its form once deformed (F). It can fit into a smaller bag by folding it (A). Users can deform and fold the display with their hands to change its form factors (B/D).

6.4.2 Application Ideas

Below describes potential application examples for the foldable pixel display.

Foldable Mobile Phone: There is currently an increased interest in developing foldable phones commercially. The core premise with this use case is to develop foldable mobile phone prototypes that are both lightweight and dynamically configure to various forms. These flexible displays can be used for initial HCI usability studies for foldable phones. For example, the pixel surface can be similar to a flip phone or be rolled up to fit into a small pocket, but with a full foldable screen inside when opened. Alternatively, the handset can be shown in tablet mode, but when both sides of the device are folded inwards at two points, only the middle third of the phone on show.

Foldable Navigation Map: Pocket-sized navigation maps have been popular for tourists and those visiting new cities. With a compact and minimal design, the foldable surface can be suitable for map visualisations. The flexible properties of the surface make it ideal for repeated use and storage in a wallet or pocket. The prototype surface can be 3D printed in a variety of sizes, columns, and rows based on the scale requirements of the user. For example, single row folding (**Figure 46F**) can be expanded in one direction to reveal a larger display (**Figure 46D**).

6.5 Chapter Discussion

This subsection summarises the practical aspects of the design and fabrication approach using multi-material 3D printing, focusing on considerations for designers, and a reflection of prototypes produced. Below also discusses insights gained from participants' application ideas to inform future works and discuss feedback on current interaction techniques.

6.5.1 Design and Fabrication Considerations

The overarching goal of the fabrication approach described and presented in this chapter is to support the development of a thin form factor deformable surfaces with integrated visualisation and interaction capabilities. The approach focuses on commercially available 3D printing to rapidly fabricate low-cost interactive surfaces with embedded interactive features. FDM 3D printing was used for this approach as it supports multi-material fabrication whilst also being a relatively accessible technology for additive manufacturing. Combining flexible and conductive materials during the printing process reduces assembly requirements for embedding interactive capabilities within a deformable surface.

Conductivity and Capacitive Sensing

The conductive thread used for attaching the LEDs is not insulated and bending or folding occurs, there is a chance of short circuit if positive and negative threads make contact. Spray paint can be used on the exposed areas of the thread to mitigate chances of short-circuiting during twisting the bending the device. As an alternative to conductive thread, insulated electromagnetic wire (0.5 mm) can be used for connecting embedded electronics as the wire holds the deformed shape unlike with thread. The noise readings with capacitive touch sensing can be reduced with the integration of

additional capacitors to the circuitry design, though this would also increase the electronic components required for fabrication.

Scaling of Deformable Surfaces

During the initial 3D modelling stages, the designer only needs to create two tiles and link them together with specified dimensions in mind as recommended from the design explorations. The design of the initial two tiles and links surrounding the edges can then be duplicated to form an array that can be expanded to meet the specifications of the designer. When 3D modelling the flexible links and tiles, designers must take scale into consideration. A thicker link ensures a more robust connection, and less chance of breakage when stretched, but this limits flexibility overall as detailed in the original design explorations (see **Figure 42**). The stretching capabilities of the deformable surface also depend on where conductive filament extruded. Conductive PLA can behave as a flexible filament as a single layer (0.2mm).

When creating larger scale tiles (e.g. 50x50mm width and length) it is recommended to still use thin links (thickness of 1mm) to ensure the surface can be easily stretched and deformed. If the tiles are larger than 20mm using one link is still sufficient for connecting each of the tiles in an array. The connecting link should go from one edge of the tile to another tile and still be 1mm in depth and width, however, the length of the link should correspond to the length of stretch required by the designer. Using link dimensions with width and depth of 1mm ensures that the 3D printed array is still robust and yet flexible enough to bend and stretch. For less stretch and bending properties of the surface, thicker links (e.g. 2mm) can be used.

Stretch Factor

To increase stretch-ability, the link length needs to be increased based on how far the designer wants their surface to stretch in aggregate. The stretching factor works similar to a 2D spring coil, where the number of coils and their length affect the stretching. For example, if the link has one “coil” with a length of 10mm between two tiles, then the stretch between those two tiles will be 10mm. If the link has two coils with the length of 10mm then the stretch will be 20mm.

With a single link is 10mm in length, then the maximum stretch between an array of 4 links would be 40mm more than the original length of the non-deformed surface. A

minimal gap of 2mm between each tile should not be increased to ensure the tile array behaves as a singular surface.

Alternate Approaches to Visualisation and Interaction

This chapter aims to establish an approach to support interaction and visualisation integration within a single deformable surface. Though there are various examples of work in the spaces of space of on-skin overlays, DIY electronics, and e-textiles these often require multiple steps for manual assembly. DIY fabrication of thin and stretchable wearables and electronics [112, 200, 202] also requires multiple assembly requirements and skills with handling chemicals, liquid silicon, and conductive inks. DIY e-textiles often reply knowledge of sewing and embroidery skills, though sewing machines reduce manual labour for this [55].

Capacitive sensing and LEDs have been used extensively in HCI. This work acknowledges the use of alternative approaches in the future such as flexible printed electronics as they offer much better conductors with silver nanoparticles rather than a graphene-based filament. These also offer more versatile materials by printing translucent conductors or displays.

User-Deformed Vs Self-Actuated

This chapter details mainly user-deformed surfaces as the core focus of this research question was on integrating interaction and visual capabilities into a thin form-factor deformable surface. Additionally, there is a number of actuation techniques currently available for self-actuated flexible displays [89, 143], yet minimal work on integrating interaction and visual capabilities whilst retaining thin form-factor and flexibility [6]. Self-actuation within the surface can also be embedded in principle using flexible fabric actuators to create 3D movements [46]. Though to keep within the scope of the research question this chapter addresses, the focus was to demonstrate the integration of visualisation and interaction whilst retaining a thin form factor flexible display.

6.5.2 Workshop Feedback

During the workshop, participants highlight that bend interaction supported by the initial prototype can aid in tracking body movement non-intrusively, by being comfortable on the skin and adapting to body movement. All participants agreed the use of the device on the knee is a novel body placement. Device body placement needs to be considered when designing the interactions for the wearable device. All participants encouraged adopting the device for rehabilitation when tracking body movement. Detecting bending of joints and body parts is limited with current commercially available wearables.

The prototype can support a range of device body placement due to its flexible nature. The example of using it as a stand-alone belt on the torso (P2) or integrated into sports clothing (P1) whilst allowing the user to maintain natural body movement during physical activity. FlexiWear can also be used as a wearable for monitoring good physical form during a workout, eliminating the dependency of having a personal trainer when squatting or performing deadlifts.

6.6 Chapter Conclusion

The core focus of this chapter is on integrating both visualisation and interaction capabilities within a deformable surface that also has a thin form-factor. Specifically, with minimal cost and assembly requirements. Multi-material 3D printing is used for developing thin and stretchable surfaces with interactive capabilities. These dynamic surfaces are specifically designed to support embedded electronic components. Though current work proposes methods for embedding both visualization and interaction capabilities into deformable user interfaces, these examples use pre-existing objects and surface – the approach allows for deformable user interfaces to be fully customizable using CAD tools for designing the flexible surfaces. Compared to e-textiles, with 3D printed materials, to have more control over how the material stretches. The initial prototype demonstrates generalisability by adopting the fabrication approach for the development of low-cost, customisable user-deformable devices. The interaction techniques presented support pressing, bending, and stretching the user's body.

The case study with the wearable device was used to validate the approach. All participants from the ideation workshop agreed that bend sensing is a key feature for wearables to monitor physical muscle/body movement and that the use of the device on the knee is a novel body placement. The key contributions are; (1) a design and fabrication approach for developing interactive deformable wearables using multi-material 3D printing; (2), as a low-cost proof of concept prototype; (3) interaction techniques (e.g. pressing, bending, and stretching) supported by the initial prototype; and (4) qualitative feedback from a user workshop aided understanding of how the approach can better support the development of interactive flexible wearables.

7 | Research Implications and Discussion

Each of the previous chapters contains an individual discussion of the research conducted for specific focused research questions. This chapter provides a unified discussion of the work conducted throughout this thesis with a range of research implications. A generalised overview of how each chapter's work related to addressing the overarching research question is also detailed below. Further, I generalize the concepts and approaches developed to other domains. Implications of addressing each of the four core research questions are also covered, followed by a reflection of the research methodology employed at different stages of this thesis. The evaluation methods are also highlighted and justified for each focused research question and the broader design explorations. The effects and impact of future technological developments are also covered below.

7.1 Summary of Thesis

As an overarching contribution, this thesis presents novel approaches for fabrication that have specific properties that support the development of shape-changing displays for diverse application domains.

The work presented in this thesis firstly explores content generation for shape-changing displays to establish a wide range of possible application ideas (chapter 3). Secondly, a more focused understanding for diverse applications is established by engaging experts, from different domains, in designing content for shape-changing displays using data specific to their work domains (chapter 4). Based on insights and implications from those design explorations, the initial fabrication approach is then refined to reduce assembly requirements for building shape-changing displays (chapter 5). As a final contribution, this thesis presents an approach for integrating interaction and visualisation capabilities within a deformable surface for shape-changing displays with embedded electronics (chapter 6). The work is also generalised by adopting it for other domains (e.g. wearables). These digital fabrication approaches aim to be accessible, both in terms of cost, technical simplicity, and implementation time.

7.2 Research Implications

Shape-changing displays are still in their early development stages compared to more generalised and well-established graphical user interfaces (GUIs). The work presented here focuses on initial design-led explorations and innovative technical contributions to expand the adoption of this new technology. Current work highlights the need for adopting a cross-disciplinary approach for the design and development of shape-changing displays. A low-cost (in terms of time and technical complexity) development approach that incorporated input from both technical and design led experts can significantly increase the wider adoption of this technology.

The feedback from the user studies and workshops described in the initial design led explorations (chapters 3 and 4), show an increased awareness of how shape change can be incorporated into the design of dynamic physical data representations. As a designer of a shape-changing interface, a variety of physical parameters must be considered during the design stages. From a technical perspective, designers must also consider development limitations of current actuation technologies and the limited geometric representations with current implementations of shape-changing displays (e.g. pin-arrays). The sub-sections below detail the insights and implications, from both design and technical perspectives, that have emerged from research conducted for this thesis.

7.2.1 Implications for Designers

This thesis is focused on encouraging designers and HCI researchers to design and create new shape-changing displays that go beyond traditional implementations (e.g. pin-array). Particularly, HCI researchers who already specialise in building shape-changing interfaces should consider exploring alternative approaches for building deformable displays that utilise rapid fabrication processes for more iterative prototyping as presented in this thesis. Researchers and designers that are outside of the shape-change domain but want to incorporate deformable surface technologies within their work (e.g. for wearables or VR) should also consider the adoption of digital fabrication processes to create new forms of reconfigurable interfaces. Particularly, to further advance visualisation and interaction capabilities for users as discussed later on in this chapter. The target audience for this thesis can be considered mainly as HCI

researchers who already have expertise in shape-changing displays though this thesis also encourages readers who are not specifically specialising in shape-changing.

A range of experts from different domains were recruited to design their own shape-changing displays, however the fabrication approaches detailed in this thesis are aimed for predominantly HCI researchers and designers to help them design and build these shape-changing interfaces. As a result, the materials and electronics chosen for these fabrication approaches were specifically chosen to be accessible and commercially available to the majority of HCI researchers who have some familiarity of basic hardware (e.g. Arduinos, projectors, 3D printing, etc.). Yet, the fabrication approaches in this thesis are not limited to HCI researchers, rather, this work also encourages the maker community to potentially adopt laser-cut and 3D printed deformable surfaces to develop bespoke shape-changing interfaces for personal purposes. In terms of skills required to adopt the fabrication approaches makers would need some form of User Interface design skills to create fully functioning and interactive shape-changing displays. Specifically, designers who are able to implement interactive features for these displays using HTML and JavaScript together with depth camera and basic capacitive sensing with conductive materials.

Each of the prototypes presented in this thesis evolve from the initial physical pixel-based pin-array actuators (chapter 3) to a more refined deformable surfaces (see Figure 47). Though the prototype in chapter 4 still used linear actuators their number was decreased, and they were only placed where actuation was required rather than filling a whole pin-array. Later chapters also explored alternative methods of actuation (chapter 5 and 6) to further advance the design space. In terms of fabrication complexity, the original semi-solid surface in chapter 4 (PolySurface) was constructed using two layers of material manually super glued together. Though this deformable surface produced higher resolution shape-changing output compared to pin-array shape-change, the additional requirement for manual labour to produce such a surface made this a more tedious process. To reduce the assembly requirements for manual labour but retain high resolution shape output 3D printed deformable surfaces were produced that are fully assembled during printing.

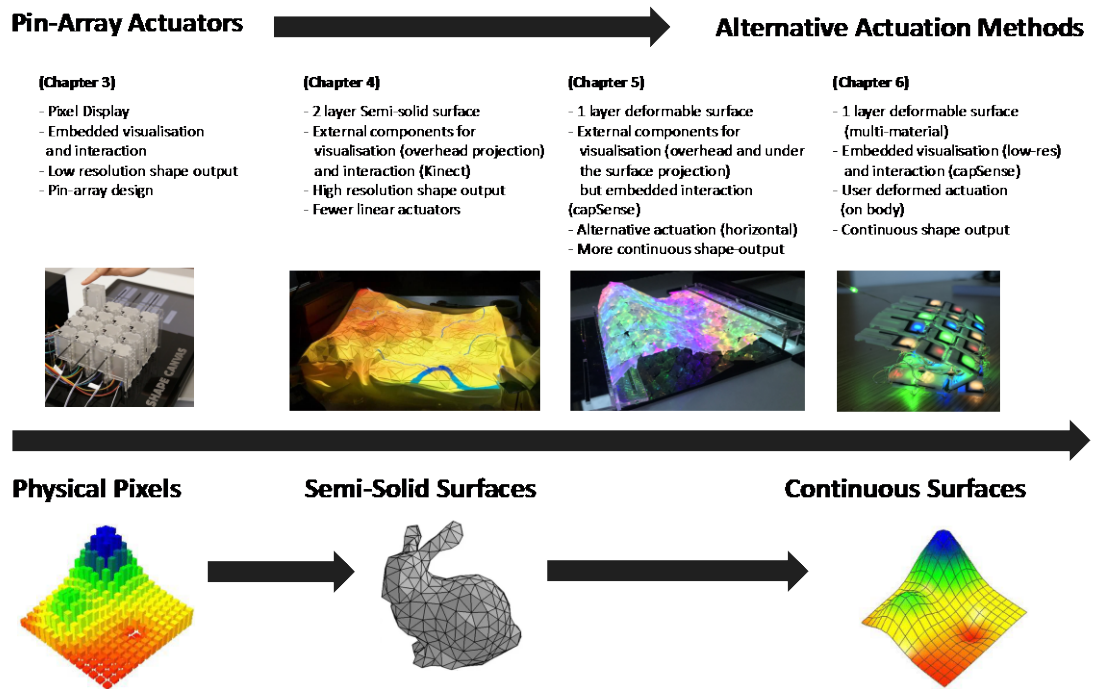

Figure 47: Progression of prototypes, as the number of actuators reduces the surface structure moves away from physical pixels into a continuous surface with embedded interaction and visualisation capabilities.

7.2.2 Implications of Design Processes

Designing shape-changing displays is still relatively high-cost for complex and high-resolution output. This is because current technology for fabricating robust and deployable displays is still relatively limiting and expensive. Additionally, the majority of current shape-changing displays are bespoke and cannot be generalised beyond one particular application. This is demonstrated in current literature with a range of one-off prototypes that are also often restricted to linear pin-based or continuous surface outputs. As a result, interaction design is also limited by the physical construction of each prototype. To address the problem of one-off prototypes, this thesis begins to establish more accessible design processes that can be generalised and adopted for a wider range of domains.

Novelty of Designing for Shape-Change

As shape-changing displays are still a novel technology, there is also apprehension when designing content for these hardware systems to represent. This was particularly observed during the initial design sessions in chapter 4. Participants who did not think they had technical skills were less inclined to think creatively during the design process

about fully utilising the physical and dynamic nature of representing their data using shape-changing displays. This could be in part due to the novelty of designing for physical 3D. The transition between designing from 2D in virtual space to realising those initial concepts to physical 3D is still challenging to most people. To increase creative engagement in the design process, it would be essential to develop a library of templates with adjustable features such as the Metamaterial Mechanisms custom editor example [68]. Designers could visualize their prototypes whilst reducing the design space to allow an easier choice of representation.

Mapping Data to Shape-Change

Mapping data, especially temporal, for representation to physically reconfigurable surfaces can be challenging as a wider range of parameters must be considered during the initial design process. For example, understanding how the end-user perceives speed of shape-movement and resolution of data presented is essential to ensure data is mapped and interpreted correctly. For high-frequency geometric transformations such as bar charts, bare pin actuators may be more appropriate, but this does increase hardware requirements.

When looking at complex datasets, such as those that incorporate temporality or multiple dimensions, shape-changing displays have the advantage of physical dynamicity compared to traditional flat-screen visual displays. From the initial design explorations with experts from different domains, it was highlighted how their complex datasets can be simplified to encompass data trends without the need to show the details of each data point. The tangible dynamicity of shape-changing displays can support temporal representations of complex datasets, particularly, with multi-dimensional data where trends can be highlighted through the dynamic shape changes of the display. Essentially, abstraction might be necessary to meet the physical capabilities of the shape-changing display.

When designing data representations for a shape-changing display, visualisations need to be considered together with the physical surface configurations. During the design sessions (chapter 4) experts were able to successfully design intuitive shape-changing data representations that can be easily interpreted. Though there were also examples of designing shape-changes with no visual cues that are too abstract for an end-user to interpret correctly. In chapter 4 for example, participant 1 noticed that they did not add

axis labels to all four physical bar-charts. Focusing too much on designing the physicalizations and shape changes can limit consideration for designing appropriate visual elements that can clearly explain what more abstract shape changes are trying to represent, such as wind speed or flood levels over time.

The design processes should also incorporate a layer of abstraction between the raw data sets and what is intended to be represented. Particularly for someone who is new to designing shape-changing displays and would struggle with the technical complexity of the hardware system. Instead, the design process should focus on the shape-output capabilities of the surface display.

Designing Interactions for Shape-Change

The tangible qualities of shape-changing displays show promise for new and engaging interaction techniques that go beyond the capabilities of traditional flat-screen displays. By utilising the tangible properties of these displays, interaction with physical representations of data has the potential to enhance user engagement, particularly for users with visual impairments. This was shown during the initial content generation explorations (chapter 3), where a colour blind user was able to directly relate the physical movement of each actuator with the movement of wind. By directly enabling users to feel the data with their hands, a more impactful user experience can emerge.

Current work begins to explore varied interaction techniques for shape-changing displays. Though during the initial content generation explorations (chapter 3) and design sessions (chapter 4) it was shown that integrating both gestural and direct user input can create the most impactful user experience scenarios. Particularly, it was observed that during interaction with ShapeCanvas users intuitively adopted bimanual interaction as their core input technique.

One participant described interacting with a shape-changing display with direct input similar to playing a piano or typing on a keyboard. The observations from chapter 3 were key to establishing how shape-changing displays can be utilised for intuitive bimanual interaction. In terms of gestural input techniques, current literature focuses on depth-camera based interaction designs, e.g. waving arms. ShapeCanvas was able to incorporate other tools (e.g. torch) to further diversify the interaction design space. This additional interaction method was able to reflect the natural experience of a person using

a tool to interact with a physical artefact. E.g. a tool that can be used for sculpting or physically moulding.

Future Interaction Considerations - Based on these observations two core aspects for future interaction design need to be considered. Firstly, future designers need to consider what level of interaction (e.g. gestural, direct, or indirect) is most appropriate given the context of deployment (e.g. personal use or public display) and the content represented by the shape-changing display. For a public display, gestural interaction would provide a more impactful experience with novice users particularly for interface navigation. For more personal use, perhaps with a mobile shape-changing display, direct interaction techniques focused on user deformations would be more appropriate. Secondly, the precision of interaction needs to also be taken into consideration when designing new input techniques.

For widespread data manipulations or navigation, gestural interaction would reduce the risk of users interfering with the physical reconfigurations of the shape-changing surface. For more precise input, direct user interaction with the surface would provide a more controlled experience for the user. Designers are also encouraged to utilise tools for interaction approaches with shape-changing displays. Traditionally tools have been used throughout history to manipulate physical artefacts to change their forms (e.g. sculpting tools). Though the use of tools for interaction with a shape-changing display is promising it has rarely been explored in current literature.

Interaction Opportunities for Shape-Changing Displays

Though this thesis mainly focuses on the fabrication approaches, based on the range of user evaluations performed throughout this body of work, important insights into interaction opportunities have emerged. This subsection discusses various interaction insights that have arisen from user-based evaluations and design sessions conducted. These interaction aspects are key features for the future development of these displays.

Reachability and spatial orientation are important aspect for consideration when designing interactive features for shape-changing interfaces. The initial interaction explorations in chapter 3 show that *spatial position of the body* impacts user interaction with a pixel pin-array shape display. Particularly, a designer should consider the location of interactive features based on where the user is sat or standing, and how far they can reach. This is because the areas that are closest to the user are the most

commonly used and interacted with. This aspect of reachability is very commonly used with more traditional table-top displays that are positioned horizontally. Similarly, the corners of the shape-changing display (Shape-Canvas) were also the second most commonly used areas for interaction. This suggests that areas around the edges of a display, that are easy to reach without covering the main segments of the display, are particularly suitable for supporting interactive features/elements such as buttons etc. This preference for interaction around the edges of the display is most possibly due to the ease of reachability around the edges in comparison reaching over elevated areas of a shape display.

In terms of *aesthetics and creating interactions*, the design of user input capabilities for each of the prototypes developed was dependent on the type of fabrication approach implemented. For example, the laser cut semi-solid surfaces in chapter 4 did not support embedded interaction directly. Instead, PolySurface used an external infrared depth camera to detect user input. This method for creating interaction was rapid and easy to implement using a pre-existing JavaScript library for web interfaces. In chapter 4 there was more focus to explore gestural interaction in mid-air as well as direct contact with the surface. Though the aesthetic of the interactions reflected more traditional GUI elements (e.g. buttons and sliders). More novel interaction design was shown in chapter 5 and 6, where 3D printed deformable surfaces had interaction capabilities embedded within them through copper wire (Chapter 5) and direct fabrication with multi-material 3D printing of conductive materials (Chapter 6). Particularly, in chapter 6 the conductive material printed directly within the deformable surface for capacitive sensing directly impacted the full aesthetic design of the surface as the black and white parts indicated which areas of the surface were interactive (black) and which were flexible (white).

Essentially, more impactful UX emerged when novel input capabilities were explored by embedding conductive materials within a deformable surface (e.g. for haptic interaction). Whereas relying on external components such as a depth camera, that is traditionally used with pin-array shape displays, more traditional UI interaction design can be achieved (e.g. buttons and sliders). Using direct touch interaction with a deformable surface also brings forward advantages of temporality. This is where the physical movement and deformation of the surface upon direct touch can reflect temporality of data and information through haptic feedback. The most obvious

example of this is shown with the weather demo in chapter 4. This is where the haptic sensation of the display imitated the passing and falling of rain drops when users put their hands on the display. From the user feedback, this provided impactful haptic sensation that would otherwise be hard to achieve on a flat-screen display.

7.2.3 Implications of Fabrication Processes

This section discusses the implications of the fabrication approaches proposed in this thesis. It also details how these approaches have been iteratively refined and adapted based on technical evaluations as well as the design process for developing behind them.

Laser Cutting

The initial fabrication approach proposed in this thesis utilised the rapid nature of laser cutters for high fidelity prototyping of shape-changing displays, PolySurface (chapter 4). Laser cutters were used for initial fabrication explorations as they are easily accessible and can be commonly found in maker-spaces, design studios, and FAB labs [29]. The initial fabrication process is based around the idea of semi-solid surfaces: surfaces that consist of solid components (laser cut polypropylene) fused onto a flexible sub-surface (spandex).

Though this fabrication approach was rapid (e.g. two days for prototype development), there were still high assembly requirements. The laser cut parts each had to be manually glued onto the Spandex material by hand. Though not highly technical, this tedious manual assembly still increases labour cost. Though technical developers have the necessary skills to operate laser cutters, those who do not have the necessary maker experience with digital fabrication would struggle initially to independently design and fabricate their own surfaces.

The key design implications of using laser cutters are focused on their utility for rapid high-fidelity prototyping of shape-changing displays. Particularly, for large scale implementations that go beyond the dimensions of a 3D printer's building plate. For rapid and iterative designing, laser cutters show a promising direction for prototyping shape-changing displays. The cheaper material costs (e.g. Perspex sheets) compared to 3D printing filaments also narrow the accessibility and adoption barrier for fabrication with laser cutters. The 2D design environments used for laser cutters (e.g. Adobe Illustrator) also simplify the initial design process compared to CAD 3D modelling.

Though there is a greater level of assembly required with the 2D pattern designs fabricated with laser cutters that is an issue for complex hardware systems.

The material properties of the sheets used for laser cutting should also be taken into consideration during the design process. Though Polypropylene (PP) 0.8mm sheets used for PolySurface (chapter 4) are thinner and more flexible than Perspex, when laser cut small segments in close proximity to each other would fuse together with PP. This meant that particularly small laser cut segments with PP were difficult to fabricate precisely compared to traditional Perspex material.

3D Printing with SLA and FDM

The high assembly requirements for the laser cutting approach might limit adoption to a wider range of domains beyond initial prototyping of shape-changing displays. From a convenience perspective, 3D printing supports personal fabrication much easier than laser cutters. Especially as most users can become skilled using 3D printers through open access content and tutorials online. Unlike with laser cutters, that use CO2 lasers, no additional supervision or health and safety precautions are usually needed with FDM printers. To reduce assembly requirements alternative fabrication approaches were established using two 3D printing methods; Stereolithography (SLA) in chapter 5 and multi-material Fused Deposition Modeling (FDM) in chapter 6.

With SLA 3D printing, the design process focused on interlinking each of the solid parts of the surface together during the printing process to reduce manual assembly. The intricate nature of the 3D printed interlinked surface CAD designs required the creation of accurate and repeatable dimensions on a small scale. This was not possible using the more commonly available Fused Deposition Modeling (FDM) machines as the scale of links caused multiple print errors with a filament extruder.

SLA 3D printers support a multitude of different resin types that have a wider range of material properties, such as flexible and clear. The clear and translucent materials used supported under the surface visualisation with a projector. The core issue with SLA is that it does not yet support multi-material 3D printing. Instead, multi-material parts have to be individually printed and can only be assembled manually after each part is printed and post-processed. This can also further complicate the design process. The interlink design could be "templated" to allow novices to simply tweak parameters (perhaps

through a GUI rather than a CAD programme) to help them design a custom-made surface.

One of the core advantages of FDM printers is their ability to support multi-material 3D printing. FDM printing was adopted (chapter 6) for refining the final fabrication approach to support 3D printing circuitry for integrated surfaces. In terms of multi-material applications, this is particularly prominent with the introduction of 4D printing. Using the same core premise of extruder based FDM processes, the smart materials used during printing can also achieve actuation as well as sensing of external stimuli. The future of shape-changing displays can fully utilize the use of smart and active materials for designing and developing a new generation of dynamic displays that can be printed as one. The reduction of electronic components and mechanical actuation, through 3D/4D printing smart dynamic surfaces, can further minimize the technical barrier of adoption for shape-changing displays. Essentially, by creating a singular actuated surface, with integrated interaction and visualisation capabilities, that can be designed and fabricated as one without the need for external mechanical actuators.

This premise is already demonstrated within the field of soft robotics and smart material sciences. The shape-changing interfaces and HCI community, as a whole, could benefit greatly with closer collaborations with these fields for technically focused developments.

7.2.4 Addressing Technical Challenges

This sub-section discusses the overarching technical challenges that are addressed by this thesis and how they can be used to further enhance the design space for shape-changing displays. As highlighted in the previous subsections, there is a trade-off between what people want to design for a shape-changing display and what is technically possible. The fabrication approaches proposed and implemented in this thesis, particularly in chapters 5 and 6, aim to address the technical challenges that are currently faced by the field. These digital fabrication approaches focus on reducing the technical requirements of developing shape-changing displays to encourage the wider adoption of this new and novel technology. Essentially, by reducing the technical barrier for development could encourage more people to design and build shape-changing displays for their own purposes.

Actuation Techniques

Traditionally shape-changing displays have focused on using vertical linear actuators for the basic up and down motion of one “physical pixel”. Though in essence this logically maps physical aspects to standard graphical user interfaces, this approach is limited in scale and resolution. To achieve a high-resolution shape-changing display with linear pin-array actuators would require thousands of individual components. The cost of implementation and increased risk of malfunctions with such an electronically complex system is great. This technical complexity and high cost can also be intimidating to those who are new to designing and building shape-changing displays. As a result, there is a technical barrier to the wider adoption of these displays beyond the research field. The shape-changes and reconfigurations are also limited by only using linear vertical movement for actuation.

Though the initial work in this thesis (chapter 4) focused on using similar linear actuators for PolySurface, there was a focus to reduce the need for a full array of actuators. Placing actuators only where needed under the surface reduced the number of electronic components and ensured the technical process remained modular. This approach to modular actuation was sufficient for exploring initial high-fidelity prototypes of shape-changing displays but is limited to bespoke applications and lacks generalisability. The modular nature of the actuators ensures they can be arranged freely and are not limited to a grid layout like traditional pin-arrays. Though, users need to decide for themselves the number of necessary actuators required underneath the surface as there is currently no software to provide feedback on where to place them. Virtual simulations can be applied to address this issue for future development of the system.

The ActuEater case study demonstrated the adoption of the PolySurface with embedded muscle wire for actuation. This alternative actuation approach implemented by the designer demonstrates the wider scope of actuation possibilities for PolySurface, beyond linear actuators. Though, to implement alternative actuation techniques for shape-changing displays requires at least moderate technical knowledge for those looking to build their own prototypes.

Modular actuators such as ShapeClips [57] can be used by more novice users but these are still limited to a single linear mechanical motion. For more dynamic actuation techniques perhaps the field of soft robotics can offer an integrated method such as the surface fabric actuators [46].

Work in chapter 5 experiments with horizontal force actuation as an alternative approach for shape deformations. The use of horizontal force can achieve some of the same shape output that can be rendered with basic pin-arrays, but with substantially fewer actuators and power required. Based on current literature, this approach for actuation is yet to be established beyond this thesis. Though, more extensive investigations need to be conducted to further solidify the physical parameters of horizontal force actuation. Physics simulations could be utilised to predict the shape deformations when a horizontal force is applied to particular 3D models of surfaces to further establish and the shape output design space using this form of actuation. However, even with virtual physics simulations to predict shape output, most commercially available, linear actuators are limited to single speed. This makes it difficult to accurately map vertical simulations to real-world practice.

One of the core motivations of chapter 5 was to demonstrate the utility of horizontal actuation as it frees the space underneath the surface display and ensures the whole hardware system is not as cumbersome as traditional shape-changing displays. Other methods of computer-controlled shape deformations are demonstrated within the robotics and engineering domains. Yet the adoption of alternative actuation approaches is rarely utilized beyond the scope of traditional pin-arrays and shape memory alloys (SMA) for 2.5D shape-changing displays. There is emerging work in the field of robotics that can expand the actuation techniques available for shape-changing displays. Flexible fabric actuators [46] can be used to create integrated single surfaces that support controlled actuation and self-folding origami robots [12] can also be used to create overhangs on shape-changing displays.

7.2.5 Visualisation and Interaction Techniques

Most common shape-changing displays consist of multiple external components for visualisation and interaction. Projectors and depth cameras are traditionally situated above an array of mechanical actuators using a metallic frame for support. Though projectors and depth cameras are widely accessible and easy to install, they are limiting

as over the surface projection increases occlusion and depth camera can currently only be positioned above or on the side of a display to recognise gestural interaction. Relying on external components for user input and visual output does not support an integrated and unified hardware system. To reduce the cumbersome design of current shape-changing displays and make them more mobile these hardware systems must be fully unified to support integrated visualisation and interaction within one singular surface. The work in this thesis attempts to address this limitation by exploring alternative approaches of fabrication that support integrated visualisations and interaction capabilities.

The visualization and interaction techniques explored in this thesis used a range of approaches from projection and depth cameras, to embedding LEDs and capacitive materials within a deformable surface. Initially, RGB LEDs were used together with photoresistor (LDR) light sensors within each of the actuated pixels in a 4x4 pin-array for ShapeCanvas. Chapter 4 adopted a baseline approach with above the surface projection and depth camera for rapid high-fidelity prototyping with PolySurface. Chapter 5 explored alternative visualisation and interaction techniques with under the surface projection and embedding capacitive touch sensing within a singular deformable surface. Chapter 6 presents a fully integrated hardware system with multi-material 3D printing using conductive materials to support integrated electronic circuits.

In terms of visualisation, using projectors can support higher resolution visuals and together with projection mapping the system can also easily adapt the visual based on the surface reconfigurations. Though projectors support high-resolution visualisation, the overall hardware system relies on cumbersome external components and over the surface projection suffers from occlusion. Under the surface projection for visual representations ensures that no occlusion occurred when users interacted with the deformable translucent display. However, the hardware system design would still rely on accommodating an external projector for visualisation. With this visualisation technique, the overall design of a shape-changing display must consider where the projector will be placed (e.g. below or above the surface of the shape-changing surface). These external components make the design of a shape-changing display more cumbersome as additional enclosures are needed around the display to support a projector. Embedding LEDs into pin-arrays and thin stretchable surfaces for visualisation eliminates occlusion and the need for external components, though at the

cost of resolution. Though the scope of possible visuals are limited with the lower resolution of embedded LEDs and this needs to be taken into consideration when designing visualisations with this approach. With the increase of mobile technologies bulky systems for shape-changing displays could be less desirable as they are heavy and not as robust.

In terms of interaction techniques, depth cameras are the most common technique for gesture tracking and input. Similar to the projector though, this approach is reliant in external components. Using embedded LDR light sensors for interaction can support dual input techniques with both the user's hands for direct and hover interaction as well as additional tools such as a light torch. This is a novel approach for dual interaction capabilities can also be integrated directly within a shape-changing surface due to the small form factor of the electronics. However, the core issue with LDR as an input sensor is sensitive to ambient light as the display would struggle with calibration in most environments. Capacitive touch sensing is more reliable for direct user interaction and using wire enables direct touch sensing with the deformable surface. Using multiple threshold readings can also support hover-based interaction. This approach presents embedded interactive components within a shape-changing surface, though as the cost of manual assembly.

7.2.6 Generalization

Generalization of fabrication approaches: From a technical perspective, the work presented in this thesis begins to demonstrate the utility of digital fabrication as a tool for developing shape-changing displays. The overarching concept of the fabrication approaches is to develop semi-solid deformable surfaces that can easily reconfigure, and change shape as required. Whether these surfaces reconfigure based on user input or passive actuation is up to the designer. The initial work with laser cutters established the baseline concept for creating semi-solid surfaces using solid pieces of plastic attached to a fabric. However, this approach does not have to involve laser cutters but for a more basic implementation, a designer can hand cut their designs for smaller scale semi-solid surface. The core concept of interlinked 3D printed surfaces aimed to mimic the structural dynamicity of interconnected textile structures such as chainmail. This approach can be generalised beyond 3D printers by manually linking solid components together with craft work. The 3D printing approaches presented can also be generalised by scaling the form factors of the 3D models during the initial design process.

Generalising areas of use for building shape-changing displays: The dynamic nature of the semi-solid and deformable surfaces produced using the fabrication approaches described support utility and generalisability. In terms of generalisability, the deformable surfaces do not have to be used as traditional displays but can also be adapted for more abstract use cases. For example, the interior design in chapter 4 integrated alternative actuation techniques within PolySurface to create a décor artefact with muscle wires. This shows great promise for taking the work further by enabling the approaches to be adapted to various user requirements. This shows that by leaving the design and fabrication approach open enough in its scope allows users to take their own initiative when developing their own shape-changing displays. The dynamic nature of the deformable surfaces developed in this thesis also shows promise for generalisability beyond one-off prototypes and bespoke systems.

Generalisation to other domains: This thesis begins to demonstrate that a range of application areas can utilise the dynamic tangible nature of shape-changing displays to represent a multitude of datasets to both expert and novice audiences. Additionally, the core fabrication approaches presented can also go further to be adopted for developing deformable interactive surfaces within other domains such as wearables. Reducing the scale of components and embedding custom micro-electronics within the deformable surfaces could support the development of more mobile shape-changing displays that can be adopted for both wearables and foldable mobile phones of the future perhaps.

The freedom to create custom geometric compositions with the PolySurface approach means that it does not need to incorporate actuation to create meaningful data physicalizations rapidly with users who are not technically knowledgeable. Multi-material 3D printed semi-solid surface can be adapted for wearables. Insights from the workshop show a promising direction for stretchable 3D printed wearable surfaces that have integrated visualisation and interactive capabilities. The varying scale factors of prototypes enabled by the 3D printing approach also demonstrates the versatility of the design and fabrication process. Wearables have already been covered as a potential domain for shape-changing as discussed by Sturdee et al. [170]. Their explorative public ideation study also introduces domains such as augmented living, architecture, and medical use that work from this thesis could now lead into.

7.3 Research Methodology and Approach

This thesis adopts a methodology that reflects a research-through-design approach, first established by Frayling [44] and then later introduced to the HCI community by Zimmerman et al. [210]. This thesis follows an iterative process of designing artefacts (e.g. deformable surfaces in chapter 4 to 6) as a creative way of investigating potential future applications (e.g. terrain modelling shape-changing displays – chapter 5). This approach greatly influences both the design and technical contributions this thesis presents and the sub-sections below reflect on approaches adopted, evaluations based on current state-of-the-art, and the impact of future technological development in regard to the contributions presented in this thesis.

7.3.1 Reflection on Research Methodology

Human-Computer Interaction research practises support a multitude of methodological approaches. Adopting one individual methodological approach for this thesis would have led to singular outcomes on the limitations and challenges addressed in this work. Below I reflect on both the adopted methodologies and alternatives such as empirical studies, one-off prototypes, and more traditional quantitative evaluations that could have been incorporated throughout this thesis.

The initial research conducted (chapters 3 and 4) followed a qualitative and design led methodology. ShapeCanvas (chapter 3) was focused on the deployment of a system in a real-world environment (e.g. cafe) to encourage a wider demographic of users. However, having a singular deployment in the wild also limited the group of users for the study to only one demographic of participant: cafe users in that area. For greater scope, multiple locations could be covered over a prolonged period of time to sufficiently expand content generation work and widen public user engagement. Nevertheless, this approach helped to establish original application ideas and content design. The deployment of the ShapeCanvas system in the wild followed a similar premise to a design probe [197] for inspiring and realising novel content generation with shape-changing displays.

The work in chapters 3 and 4 allowed users to directly interact, design, and develop their own content and applications for shape-changing displays. As an alternative approach, sample surveys could have been sent out to larger and broader online user groups to ask them what types of applications they want to see on shape-changing displays. This approach would have gathered a larger and broad spectrum of ideas for applications. Similarly, computer simulation build environments could have been used to allow users to virtually create their own high-fidelity shape-changing display prototypes. However, sample surveys and virtual simulations of shape-changing displays would have defeated the purpose of allowing users to directly interact with tangible implementations of their ideas and hence real-world deployment was chosen instead. The design explorations in chapters 3 and 4 establish a range of technical challenges and limitations that are barriers for the adoption of shape-changing displays across a wider range of application domains.

The engineering focused research detailed in chapters 5 and 6 aimed to provide practical solutions and alternative approaches to the technical limitations that emerged from the initial design led explorations. Building more complex one-off prototype systems would have limited the reproducibility and the wider adoption of this new technology. Instead, exploring alternative methods of fabrication provided a broader range of hybrid shape-changing displays [168] and deformable interfaces that can be generalised to other domains. Real world deployment of the 3D printed surface displays would have provided insights into usability and user engagement like the work in chapters 3 and 4. However, to keep within the scope of developing appropriate fabrication approaches for shape-changing displays, it was important to focus on addressing technical limitations first before looking at usability. Nevertheless, the iterative design process for improving the 3D printing fabrication approaches across chapters 5 and 6 should also be evaluated with designers and makers to ensure they are robust and met user requirements.

Adopting a solely empirical methodology for this thesis would produce narrower results that would lack generalised implications that go beyond one-off prototypes and systems. Though current literature highlights the lack of empirical evaluations within the field of shape-changing interfaces [6] a broader understanding of fundamental limitations and application domains needs to be established first. This is to ensure that the controlled empirical studies, that are to follow the work from this thesis, can be applied with a focus to specific use cases and context-dependent scenarios. Focusing on one particular application area, such as the medical sector, throughout this thesis would have given more depth the contributions but limited the broader impact and generalisability of the research conducted.

7.3.2 Validation and Evaluations

The evaluation of research conducted in this thesis began with more qualitative evaluations at the start (chapters 3 and 4). This led to more technical evaluations of the prototypes and fabrication approaches described in chapters 5 and 6. The fabrication approaches presented in this thesis were evaluated by a range of user studies, design sessions, ideation workshops, and by implementing prototype systems using key principles that emerged from technical explorations of various digital fabrication processes (e.g. laser cutting and 3D printing).

This was first achieved by allowing novice users (chapter 3) and experts from different domains (chapter 4) to directly design and develop their own shape-changing content and applications. Secondly, the utility of the fabrication approaches was demonstrated by developing alternative prototype systems with example application scenarios (chapter 5). For wider generalizability, the prototype system developed in chapter 6 aimed to be adopted to other domains such as wearables. These methods of evaluation are appropriate as they demonstrate not just the benefits, but also limitations of the fabrication approaches and the prototype systems developed. This approach to evaluation provides validation that the hardware systems can be adopted to a wider range of domains and application scenarios as well as explore different user groups, different application domains to understand issues from both the 'creation' and 'user' points of view.

The fabrication approaches presented in this thesis aimed to be low-cost and accessible (e.g. easy to reproduce and adapt based on personal specifications and requirements). This ensures wider adoption for a range of application domains, such as the wearables example in chapter 6. For validating the low-cost aspect of the approaches, all materials and electronics were purchased commercially and in terms of time for development, each PolySurface display had taken two days to design and build. To validate accessibility for wider adoption, evaluating the engagement impact whilst designing shape-changing displays with experts from different domains is key. For example, PolySurface as a fabrication approach can support specific user requirements defined by the designer whilst also supporting rapid implementation through reduced technical complexity.

The initial implementation of the high-fidelity prototype developed renders usability evaluation unsuitable at these preliminary stages. Much like with usability testing for GUIs, the core framework needs to be firmly established before conducting empirical user evaluations and analysis. This would be the next stage of this work.

7.3.3 Future Work and Limitations

The fabrication approaches presented in this thesis have been implemented for a range of prototype systems to demonstrate their utility as shape-changing displays and interfaces across a range of domains. Below I discuss the future directions of the work conducted for this thesis as a whole.

In chapter 3, the observations from the initial content generation study better support the design of larger scale system in future work by exploring application ideas that go beyond current state-of-the-art, such as shape-changing signage. The low-fidelity of ShapeCanvas (4x4 pixel pin-array) limited the resolution of each physical animation created. To fully understand content generation for shape-changing displays, examples of the physical animations from the explorative study should be realised into functional applications that are tested in terms of usability. Exploring content generation with different audiences may also derive alternative findings that have not yet been established. In terms of advancing the initial hardware system, ShapeCanvas, the addition of a colour palette on the screen interface would serve to reduce colour selection time, as would a physical “brush” similar to Ryokai et al.’s I/O Brush [145].

To understand how shape-changing displays can be adopted for wider audiences more insight needs to be gained into how participants respond to current shape-changing displays. To achieve this in future work, more shape-changing displays need to be deployed in public environments (e.g. museums, libraries, restaurants, and public information centres) and other domain environments (e.g. workplaces and FAB labs). The work in this thesis was motivated to encourage this wider adoption of shape-changing displays by supporting more accessible (e.g. in terms of low cost and technical complexity) design and development approaches through digital fabrication. This will also support formal quantitative and qualitative user evaluations to understand user engagement with shape-changing displays.

From a technical perspective, future work should explore a wider range of actuation techniques that are not limited in their degrees of freedom and go beyond those described in current state-of-the-art (e.g. mechanical pin-arrays, linear actuators, or shape memory alloys). This is beginning to be evident with work emerging on levitating shape-changing displays [45]. Though more broadly speaking the HCI community should explore research fields such as soft robotics. In terms of the next step for the 3D

printing fabrication approaches described in this thesis, utilise 4D printing methods would be the next step to achieve fully integrated shape-changing surfaces that can support embedded actuation, visualisation, and integration capabilities all without the need for manual assembly. This could also be achieved in the future with printed electronics, though the technology at the moment for this is not available at a low enough cost.

From an additive manufacturing perspective, the print resolution and repeatability are also often limited with FDM, especially with lower-end machines. The quality of the final deformable surfaces printed depended greatly on the quality of the filament materials used. Investing in a better quality flexible material ensures that the final surfaces are more robust. Though with the conductive materials used, the quality of the material was judged more on its compatibility with the printer. Experimentation with different material types still needs to be done to gain further understanding which filaments are most compatible together. Especially when using them for a reconfigurable surface that requires the materials to easily adapt, stretch, and change shape.

In terms of broader direction for future work involving shape-change, design fiction begins to explore potential use case scenarios that can now be realised this new generation of hardware technology. This work is a step forward to realising these ideas in physical and tangible form by providing the fabrication approach that allows others to author their own application ideas. In a more general sense, shape-change as a field should not be limited to just displays but should also more broadly explore potential applications within industry with examples such as augmented living spaces or large-scale reconfigurable architecture.

Impact for Future Adoption

Currently, the field of shape-changing displays and interfaces is influencing other domains such as wearables, mobile phones, virtual reality, and public displays [6, 168, 169]. The future adoption of shape-changing displays and interfaces is affected by the technological advances of fields both within and outside the HCI and wider computer science domains. For example, as Virtual Reality is becoming widely adopted for the general public as a platform for not just entertainment but also representing data and information. There is emerging work on adapting shape-changing interfaces to provide

tactile feedback for VR users [158]. Work in this thesis also demonstrates that other domains such as environmental sciences and social science can adopt shape-changing displays and similar technology for their own work [111, 175]. This is shown in the PolySurface user studies and how those participants engaged with these design displays to represent their own data.

Work in this thesis highlights that to ensure that shape-changing displays can be authored by experts in other domains, the complexity needs to be reduced. Breaking down this barrier for adoption is challenging due to the high cost of implementation and limited scalability. Additionally, understanding how complex data can be presented in a meaningful and engaging manner to novices is still in emerging stages. The related work that this thesis discusses also emphasises collaboration with other domains such as robotics to further advance the technology for shape-changing displays.

From an interactions point of view, more work with the physiological aspects of user behaviour and perception needs to be conducted to better understand the social implications and value propositions of this new and still emerging area of computer science. For example, open questions regarding the potential redundancy of shape-changing displays as a technology are yet answered or even established. Perhaps this new generation of displays is destined for obsolescence as the audience would simply see shape-changing displays as nothing more than a novelty. Therefore, it is key to establish what domains and applications can utilise the dynamic tangible aspects of this new generation of displays beyond novel and flashy gimmicks.

Limitations

Each of the main research chapters (3-6) discuss limitations specific to addressing an individual research question. This subsection focuses on the broader limitations of the thesis. The actuation techniques explored throughout this thesis predominantly focused on linear actuators with one example of shape-memory alloys (chapter 4 case study). This is still limiting factor as the degrees of freedom with mechanical linear actuators cannot be dynamically utilised to fully realise all of the required shape-changed needed to create complex shape output beyond 2.5D. Though the related work chapter of this thesis expands on alternative actuation approaches from the field of robotics, these more dynamic actuators are not yet commercially available or can be reproduced so obtaining them is not yet possible.

The initial fabrication approach, PolySurface, was evaluated with a participatory user study by allowing domain experts to directly design and author their own shape-changing displays. However, the 3D printing approaches detailed in chapters 5 and 6 focused more on technical evaluations rather than testing the utility of the fabrication approach with users. This does limit the understanding of how people will design their own shape-changing interfaces using the 3D printing approaches presented, though this is a direction for future work.

Reflecting more broadly on the limitations of the methodology, this thesis could have focused on a specific application area for one in-depth contribution and uncovered more novel devices/interfaces that would change a specific area. However, given that the field is still relatively new, compared to more established areas such as GUIs, focusing on addressing broader challenges ensures greater generalisability. Especially as this thesis aimed to present more widely adopted insights and contributions that can be utilised and adopted by many rather than few.

7.4 Addressing the Research Questions

This thesis aimed to demonstrate how digital fabrication can support the design and development of shape-changing displays across diverse application domains. As an overarching contribution, the work in this thesis offers a range of novel approaches for fabrication that support the rapid development of shape-changing displays for diverse application domains. These digital fabrication approaches aim to be accessible, both in terms of cost, technical simplicity, and implementation time.

To address the overarching research question of this thesis, four core research chapters address an area of the main contribution by designing, building, and evaluating a wide range of interactive shape-changing displays with various input and output capabilities. Below describes the core aspects of each chapter.

Chapter 3 addresses: *How do people approach and react to the task of generating content for shape-changing displays?*

Work in this chapter expands the limited understanding of content generation for shape-changing displays. A low-resolution shape-changing display was developed to explore content generation and support the design of application

ideas. The key findings from this exploration are: (1) Simple, small shape-changing displays are useful for informing interaction design and discovering novel application areas, (2) Novice users successfully designed a diverse range of physical animations, suitable for informing future design environments, and (3) users quickly learned to take advantage of the spatial affordances of the shape-display. These findings provided a starting point for the construction and evaluation of content design environments for shape-changing displays.

Chapter 4 addresses: *How can experts be engaged in designing shape-changing content to represent data specific to their work domains?*

This work aimed to support domain experts in designing and constructing interactive shape-changing displays based on their own input data. This approach demonstrates generalizability by allowing experts, from different domains, to design interactive shape-changing displays based on datasets from their own work and demonstrate them to either novices or other domain colleagues. The combination of mapping data to physical surface reconfiguration, interaction features, and visualization shows enhanced user engagement and understanding of complex data trends and information.

Chapter 5 addresses: *How can assembly requirements be reduced to make the fabrication of shape-changing displays more efficient?*

The core contribution of this work was to reduce the production and assembly requirements of deformable surfaces to reduce the time and requirements for construction. To achieve this, chapter 5 describes a general design and fabrication approach, the impact of varying surface design parameters, and a demonstration of two possible application examples. This blueprint for developing deformable surfaces begins to explore alternative methods of shape actuation to further reduce the technical demands of fabricating shape-changing displays.

Chapter 6 addresses: *How can interaction and visualisation be better integrated within a single deformable surface?*

The core focus of this chapter was on integrating both visualisation and interaction capabilities within a deformable surface that also has a thin form-factor. The fabrication approach proposed enabled user-deformed shape change with a fully flexible display that is also portable and has non-obtrusive form factors. The use of multi-material FDM 3D printing supports the development of flexible surfaces that are interactive, deformable, and provides baseline pixel resolution visualisation whilst being fully flexible.

8 | Conclusion

The overarching motivation for the work in this thesis was to address the limited number of tools and methods to enable the wider adoption of shape-changing displays. The research community's focus on resource-intensive technical demands limits the number of qualitative user evaluations on how people engage with shape-changing displays. The limited number of tools and methods to enable users, with minimal resources, to directly author physically reconfigurable interfaces discourage the wider adoption of shape-changing displays across various domains. As a result, it is also difficult to establish which applications and data are best suited to this new generation of displays. To address this overarching challenge, this thesis proposed a range of design and fabrication approaches for shape-changing displays. Specifically, fabrication approaches that focus on low costs, technical simplicity, and accessibility compared to resource intensive demands of developing existing hardware systems.

This work aims to support thin form factor shape-changing displays that are both foldable and deformable as well as are able to perform surface elevations. A display that could resemble a 3D object mesh that is translated into a physical 3D mesh that can be used in various applications, both as a table-top display and also a hand-held device in the future. Below summarises the broader take-away points this thesis contributes to the field of shape-changing displays.

Establishing Applications and Content for Shape-Changing Displays

The earlier work of this thesis (chapter 3 and 4) begin to establish new applications for shape-changing displays that support both pre-existing work on content generation [170], such as the landscape modelling, and also those that have yet to be discussed in the shape-changing community, such as interior design artefacts (chapter 5).

By working with a wider range of experts from different domains this thesis was able to demonstrate the utility of this new display technology beyond novelty. I hope this work will inspire more HCI researchers and designers to engage and collaborate with experts from different domains to work towards a designing and building more meaningful applications for shape-changing displays. Particularly, applications that can be both bespoke for specific use-cases and more generalised to a wider audience. One

of the most effective ways to achieve this is to explore content generation with a wider range of people, from novice users in chapter 3 to more advanced domain experts in chapter 4. This approach for research reflects the research-through-design methodology very closely and pushes towards more innovation in the field of shape-changing displays beyond presenting novel systems that lack purpose and impactful user experience.

Demonstrating Rapid Prototyping for Shape-Changing Displays

Digital fabrication had been utilised in this thesis to support rapid design and development of shape-changing displays. As highlighted in the related work chapter, current implementations of shape-changing displays often take a long time to produce (e.g. about 6 months for a functional prototype pin-array display) and take up a large number of mechanical and electrical hardware to realise (e.g. pin-array displays). The initial work in chapter 4 aimed to demonstrate that it is feasible to design and create high-fidelity prototypes of shape-changing displays rapidly (e.g. within 5 days) and with limited actuation requirements. Essentially, the use of digital fabrication methods such as laser-cutting and 3D printing can enable faster design and development of shape-changing display prototypes, particularly without intensive hardware requirements. This is important to further advance the design space for shape-changing interfaces as the rapid prototyping approaches detailed in this thesis can allow researchers to quickly and effectively explore and test various display implementations without resource intensive methods. The research-through-design methodology also emphasises that rapid prototyping helps researchers and designers to iteratively refine and develop new hardware systems that can meet functional requirements as well as develop more meaningful user experience.

Promoting Accessible Fabrication for Shape-Changing Displays

The fabrication approaches described in this thesis using laser cutting and 3D printing are not aimed to be just rapid but also accessible for a wider range of designers and researchers to implement. Potentially, even hobbyist and maker community members are able to recreate these fabrication approaches using commercially available materials and equipment. Particularly, by supporting accessible fabrication through the use of low-cost materials that can be purchased commercially and are widely available (e.g. spandex and FDM filament). The actuation opportunities described in chapters 4 and 5 also aim to limit the need for complex mechanical electronics (e.g. pin-array displays)

in an attempt to make it cheaper to implement elevation of shape-changing surfaces. Essentially, this thesis aims to support accessible fabrication of shape-changing displays by demonstrating that these hardware systems can be designed and build on a limited budget without the need for expensive actuators or complex electronic engineering knowledge.

Enabling the Development of Hybrid Shape-Changing Displays

The core of this thesis focuses on the development of semi-solid deformable surfaces that can be implemented for the development of shape-changing displays. These deformable surfaces help to realise physical shape deformations that a shape-changing display can achieve without the need for substantial assembly and building time requirements. Most pre-existing shape-changing display focus on the use of pin-array actuation, though this provides good control factors for shape- deformation, these systems should not be the only forms of shape-changing displays out there. Essentially, this thesis aims to promote the new ways of designing and building shape-changing displays that go beyond current implementation examples available (e.g. pin arrays and continuous surface shape-changing displays).

Concluding Statement

Research conducted for this thesis demonstrates how shape-changing displays can be adopted for a multitude of application domains. This is achieved by utilising digital fabrication methods to support the design and development of this new generation of displays and interfaces, whilst also keeping the core concepts of the approach simple enough to be both reproducible and adapted to specific needs and requirements. By reducing the barrier of technical complexity for implementation this work will hopefully help inspire more people to design and develop their own shape-changing displays and interfaces in the near future.

| References

- [1] 1997. *National Land Survey of Iceland*. 1997 [cited 2016 2 September]; Available from: <http://www.lmi.is/en/>.
- [2] 2013. *MyMiniFactory*. 2013 [cited 2018 02/03/2018]; Available from: www.myminifactory.com.
- [3] Jason Alexander, Ryan Brotman, David Holman, Audrey Younkin, Roel Vertegaal, Johan Kildal, Andrés A Lucero, Anne Roudaut, and Sriram Subramanian. 2013. Organic experiences:(re) shaping interactions with deformable displays. in *CHI'13 Extended Abstracts on Human Factors in Computing Systems*. ACM. 3171-3174 p.
- [4] Jason Alexander, Yvonne Jansen, Kasper Hornbæk, Johan Kildal, and Abhijit Karnik. 2015. Exploring the Challenges of Making Data Physical, in *Proceedings of the 33rd Annual ACM Conference Extended Abstracts on Human Factors in Computing Systems*. ACM: 2702659. Seoul, Republic of Korea. 2417-2420 p. <https://doi.org/10.1145/2702613.2702659>
- [5] Jason Alexander, Andrés Lucero, and Sriram Subramanian. 2012. Tilt displays: designing display surfaces with multi-axis tilting and actuation, in *Proceedings of the 14th international conference on Human-computer interaction with mobile devices and services*. ACM: 2371600. San Francisco, California, USA. 161-170 p. <https://doi.org/10.1145/2371574.2371600>
- [6] Jason Alexander, Anne Roudaut, Jürgen Steimle, Kasper Hornbæk, Miguel Bruns Alonso, Sean Follmer, and Timothy Merritt. 2018. Grand Challenges in Shape-Changing Interface Research, in *Proceedings of the 2018 CHI Conference on Human Factors in Computing Systems*. ACM: 3173873. Montreal QC, Canada. 1-14 p. <https://doi.org/10.1145/3173574.3173873>
- [7] Florian Alt, Stefan Schneegaß, Albrecht Schmidt, Jörg Müller, and Nemanja Memarovic. 2012. How to evaluate public displays. in *Proceedings of the 2012 International Symposium on Pervasive Displays*. ACM. 17 p.
- [8] Swamy Ananthanarayan, Nathan Lapinski, Katie Siek, and Michael Eisenberg. 2014. Towards the crafting of personal health technologies. in *Proceedings of the 2014 conference on Designing interactive systems*. ACM. 587-596 p.
- [9] Franz Aurenhammer. 1991. Voronoi Diagrams - A Survey of a Fundamental Geometric Data Structure. *ACM Comput. Surv.* 23(3): p. 345-405. <https://doi.org/10.1145/116873.116880>
- [10] Paul Badger. *Capacitive Sensing Library - Arduino Playground*. 20/07/2018; Available from: <https://playground.arduino.cc/Main/CapacitiveSensor?from=Main.CapSense>.
- [11] Mika Barr. 2016. *folding-A-part - Mika Barr*. 2016 [cited 2016 October 25]; Available from: <http://www.mikabarr.com/folding-a-part>.
- [12] C. H. Belke and J. Paik. 2017. Mori: A Modular Origami Robot. *IEEE/ASME Transactions on Mechatronics*. 22(5): p. 2153-2164. <https://doi.org/10.1109/TMECH.2017.2697310>
- [13] Matthew Blackshaw, Anthony DeVincenzi, David Lakatos, Daniel Leithinger, and Hiroshi Ishii. 2011. Recompose: direct and gestural interaction with an actuated surface, in *CHI '11 Extended Abstracts on Human Factors in Computing Systems*.

- ACM: 1979754. Vancouver, BC, Canada. 1237-1242 p.
<https://doi.org/10.1145/1979742.1979754>
- [14] Adam Blaney, Jason Mark Alexander, Nicholas Simon Dunn, Daniel Courtney Richards, Allan Edward Watson Rennie, and Jamshed Anwar. 2015. Adaptive materials: Utilising additive manufactured scaffolds to control self-organising material aggregation.
- [15] David L Bourell, Joseph J Beaman Jr, Donald Klosterman, Ian Gibson, and Amit Bandyopadhyay. 2001. Rapid Prototyping. *ASM Handbook*. 21: p. 383-7.
- [16] Eric Brockmeyer, Ivan Poupyrev, and Scott Hudson. 2013. PAPHILLON: designing curved display surfaces with printed optics, in *Proceedings of the 26th annual ACM symposium on User interface software and technology*. ACM: 2502027. St. Andrews, Scotland, United Kingdom. 457-462 p. <https://doi.org/10.1145/2501988.2502027>
- [17] Richard Burdett. 2007. *Global Cities: Elevation Maps of City Population*. 2007 [cited 2019 29/01/2019]; Available from: <http://dataphys.org/list/city-populations/>.
- [18] Jesse Burstyn, Paul Strohmeier, and Roel Vertegaal. 2015. DisplaySkin: Exploring Pose-Aware Displays on a Flexible Electrophoretic Wristband, in *Proceedings of the Ninth International Conference on Tangible, Embedded, and Embodied Interaction*. ACM: 2680596. Stanford, California, USA. 165-172 p.
<https://doi.org/10.1145/2677199.2680596>
- [19] William Buxton. 1997. Living in augmented reality: Ubiquitous media and reactive environments. *Video mediated communication*: p. 363-384.
- [20] Alexander Calder and Jean Davidson. 1966 *Calder: an autobiography with pictures*. Pantheon Books New York.
- [21] Gemma Calvert, Charles Spence, and Barry E Stein. 2004 *The handbook of multisensory processes*. MIT press.
- [22] Mackinlay Card. 1999 *Readings in information visualization: using vision to think*. Morgan Kaufmann.
- [23] David Cerny. 2014. *Metalmorphosis*. 2014 [cited 2019 20/02/2019]; Available from: <http://www.davidcerny.cz/starten.html>.
- [24] Marcelo Coelho and Jamie Zigelbaum. 2011. Shape-changing interfaces. *Personal Ubiquitous Comput.* 15(2): p. 161-173. <https://doi.org/10.1007/s00779-010-0311-y>
- [25] Bryony Core. 2018 *3D Printing 2018-2028: Technology and Market Analysis - Read more at*: <https://www.idtechex.com/research/reports/3d-printing-2018-2028-technology-and-market-analysis-000588.asp>. IDTechEx, 2018.
- [26] Stelian Coros, Bernhard Thomaszewski, Gioacchino Noris, Shinjiro Sueda, Moira Forberg, Robert W. Sumner, Wojciech Matusik, and Bernd Bickel. 2013. Computational design of mechanical characters. *ACM Trans. Graph.* 32(4): p. 1-12.
<https://doi.org/10.1145/2461912.2461953>
- [27] Andy Crabtree, Alan Chamberlain, Rebecca E. Grinter, Matt Jones, Tom Rodden, and Yvonne Rogers. 2013. Introduction to the Special Issue of "The Turn to The Wild". *ACM Trans. Comput.-Hum. Interact.* 20(3): p. 1-4.
<https://doi.org/10.1145/2491500.2491501>
- [28] Dhairya Dand and Robert Hemsley. 2013. Obake: interactions on a 2.5D elastic display, in *Proceedings of the adjunct publication of the 26th annual ACM*

- symposium on User interface software and technology. ACM: 2514734. St. Andrews, Scotland, United Kingdom. 109-110 p. <https://doi.org/10.1145/2508468.2514734>
- [29] Tomas Diez. 2012. Personal fabrication: Fab labs as platforms for citizen-based innovation, from microcontrollers to cities. *Nexus network journal*. 14(3): p. 457-468.
- [30] Tomas Dorta, Edgar Perez, and Annemarie Lesage. 2008. The ideation gap:: hybrid tools, design flow and practice. *Design studies*. 29(2): p. 121-141.
- [31] Pierre Dragicevic and Yvonne Jansen. 2012. *List of Physical Visualizations and Related Artifacts*. 2012 25/10/2018]; Available from: <http://dataphys.org/list/>.
- [32] Mark Goulthorpe; Mark Burry; Grant Dunlop. 2001. Aegis Hyposurface: The Bordering of University and Practice. In Proc. of ACADIA, 2001, Association for Computer--Aided Design in Architecture: p. pp. 344--349.
- [33] Anthony Dunne and Fiona Raby. 2013 *Speculative everything: design, fiction, and social dreaming*. MIT press.
- [34] Emilie. 2015. *HOW TO MEASURE FABRIC STRETCH*. 2015 [cited 2019 20/03/2019]; Available from: <https://jalie.com/blog/how-to-measure-fabric-stretch/>.
- [35] Aluna Everitt and Jason Alexander. 2017. PolySurface: A Design Approach for Rapid Prototyping of Shape-Changing Displays Using Semi-Solid Surfaces, in Proceedings of the 2017 Conference on Designing Interactive Systems. ACM: 3064677. Edinburgh, United Kingdom. 1283-1294 p. <https://doi.org/10.1145/3064663.3064677>
- [36] Aluna Everitt, Faisal Taher, and Jason Alexander. 2016. ShapeCanvas: An Exploration of Shape-Changing Content Generation by Members of the Public, in Proceedings of the 2016 CHI Conference on Human Factors in Computing Systems. ACM: 2858316. Santa Clara, California, USA. 2778-2782 p. <https://doi.org/10.1145/2858036.2858316>
- [37] Petr Felkel and Stepan Obdrzalek. 1998. Straight skeleton implementation. in *Proceedings of spring conference on computer graphics*. Citeseer. p.
- [38] Georg Fischer. 2013. *Image Triangulation Experiment*. 2013 [cited 2016 12 April]; Available from: <https://github.com/snorpey/triangulation>.
- [39] Ward Fleming. 1985. *Pin screen*. Google Patents.
- [40] Sean Follmer, Micah Johnson, Edward Adelson, and Hiroshi Ishii. 2011. deForm: an interactive malleable surface for capturing 2.5D arbitrary objects, tools and touch, in Proceedings of the 24th annual ACM symposium on User interface software and technology. ACM: 2047265. Santa Barbara, California, USA. 527-536 p. <https://doi.org/10.1145/2047196.2047265>
- [41] Sean Follmer, Daniel Leithinger, Alex Olwal, Nadia Cheng, and Hiroshi Ishii. 2012. Jamming user interfaces: programmable particle stiffness and sensing for malleable and shape-changing devices, in Proceedings of the 25th annual ACM symposium on User interface software and technology. ACM: 2380181. Cambridge, Massachusetts, USA. 519-528 p. <https://doi.org/10.1145/2380116.2380181>
- [42] Sean Follmer, Daniel Leithinger, Alex Olwal, Akimitsu Hogge, and Hiroshi Ishii. 2013. inFORM: dynamic physical affordances and constraints through shape and object actuation, in Proceedings of the 26th annual ACM symposium on User interface software and technology. ACM: 2502032. St. Andrews, Scotland, United Kingdom. 417-426 p. <https://doi.org/10.1145/2501988.2502032>

- [43] Micro:bit Educational Foundation. *Micro:bit* [cited 2017 27/03/2018]; Available from: <http://microbit.org/>.
- [44] Christopher Frayling. 1994. Research in art and design (Royal College of Art Research Papers, vol 1, no 1, 1993/4).
- [45] Euan Freeman, Julie R. Williamson, Praxitelis Kourtelos, and Stephen Brewster. 2018. Levitating Particle Displays with Interactive Voxels, in Proceedings of the 7th ACM International Symposium on Pervasive Displays. ACM: 3205878. Munich, Germany. 1-6 p. <https://doi.org/10.1145/3205873.3205878>
- [46] Y. Funabora. 2018. Flexible Fabric Actuator Realizing 3D Movements Like Human Body Surface for Wearable Devices. in *2018 IEEE/RSJ International Conference on Intelligent Robots and Systems (IROS)*. 6992-6997 p. <https://doi.org/10.1109/IROS.2018.8594359>
- [47] S. Ganapathy and T. G. Dennehy. 1982. A new general triangulation method for planar contours, in Proceedings of the 9th annual conference on Computer graphics and interactive techniques. ACM: 801264. Boston, Massachusetts, USA. 69-75 p. <https://doi.org/10.1145/800064.801264>
- [48] William Gaver, John Bowers, Andy Boucher, Andy Law, Sarah Pennington, and Nicholas Villar. 2006. The history tablecloth: illuminating domestic activity, in Proceedings of the 6th conference on Designing Interactive systems. ACM: 1142437. University Park, PA, USA. 199-208 p. <https://doi.org/10.1145/1142405.1142437>
- [49] Qi Ge, H Jerry Qi, and Martin L Dunn. 2013. Active materials by four-dimension printing. *Applied Physics Letters*. 103(13): p. 131901.
- [50] Mathieu Le Goc, Lawrence H. Kim, Ali Parsaei, Jean-Daniel Fekete, Pierre Dragicevic, and Sean Follmer. 2016. Zooids: Building Blocks for Swarm User Interfaces, in Proceedings of the 29th Annual Symposium on User Interface Software and Technology. ACM: 2984547. Tokyo, Japan. 97-109 p. <https://doi.org/10.1145/2984511.2984547>
- [51] Antonio Gomes, Andrea Nesbitt, and Roel Vertegaal. 2013. MorePhone: a study of actuated shape deformations for flexible thin-film smartphone notifications, in Proceedings of the SIGCHI Conference on Human Factors in Computing Systems. ACM: 2470737. Paris, France. 583-592 p. <https://doi.org/10.1145/2470654.2470737>
- [52] Antonio Gomes, Calvin Rubens, Sean Braley, and Roel Vertegaal. 2016. BitDrones: Towards Using 3D Nanocopter Displays as Interactive Self-Levitating Programmable Matter, in Proceedings of the 2016 CHI Conference on Human Factors in Computing Systems. ACM: 2858519. San Jose, California, USA. 770-780 p. <https://doi.org/10.1145/2858036.2858519>
- [53] Daniel Groeger, Elena Chong Loo, and Jürgen Steimle. 2016. HotFlex: Post-print Customization of 3D Prints Using Embedded State Change, in Proceedings of the 2016 CHI Conference on Human Factors in Computing Systems. ACM: 2858191. San Jose, California, USA. 420-432 p. <https://doi.org/10.1145/2858036.2858191>
- [54] Erik Grönvall, Sofie Kinch, Marianne Graves Petersen, and Majken K. Rasmussen. 2014. Causing commotion with a shape-changing bench: experiencing shape-changing interfaces in use, in Proceedings of the 32nd annual ACM conference on Human factors in computing systems. ACM: 2557360. Toronto, Ontario, Canada. 2559-2568 p. <https://doi.org/10.1145/2556288.2557360>

- [55] Nur Al-huda Hamdan, Simon Voelker, and Jan Borchers. 2018. Sketch&Stitch: Interactive Embroidery for E-textiles, in Proceedings of the 2018 CHI Conference on Human Factors in Computing Systems. ACM: 3173656. Montreal QC, Canada. 1-13 p. <https://doi.org/10.1145/3173574.3173656>
- [56] John Hardy and Jason Alexander. 2012. Toolkit support for interactive projected displays, in Proceedings of the 11th International Conference on Mobile and Ubiquitous Multimedia. ACM: 2406419. Ulm, Germany. 1-10 p. <https://doi.org/10.1145/2406367.2406419>
- [57] John Hardy, Christian Weichel, Faisal Taher, John Vidler, and Jason Alexander. 2015. ShapeClip: Towards Rapid Prototyping with Shape-Changing Displays for Designers, in Proceedings of the 33rd Annual ACM Conference on Human Factors in Computing Systems. ACM: 2702599. Seoul, Republic of Korea. 19-28 p. <https://doi.org/10.1145/2702123.2702599>
- [58] Chris Harrison and Scott E. Hudson. 2009. Providing dynamically changeable physical buttons on a visual display, in Proceedings of the SIGCHI Conference on Human Factors in Computing Systems. ACM: 1518749. Boston, MA, USA. 299-308 p. <https://doi.org/10.1145/1518701.1518749>
- [59] Liang He, Huaishu Peng, Joshua Land, Mark D. Fuge, and Jon E. Froehlich. 2017. Designing 3D-Printed Deformation Behaviors Using Spring-Based Structures: An Initial Investigation, in Adjunct Publication of the 30th Annual ACM Symposium on User Interface Software and Technology. ACM: 3131836. Quebec City, QC, Canada. 151-153 p. <https://doi.org/10.1145/3131785.3131836>
- [60] Kelly Bowman Heaton. 2000. *Physical pixels*. Massachusetts Institute of Technology.
- [61] Michael S. Horn, Erin Treacy Solovey, and Robert J. K. Jacob. 2008. Tangible programming and informal science learning: making TUIs work for museums, in Proceedings of the 7th international conference on Interaction design and children. ACM: 1463756. Chicago, Illinois. 194-201 p. <https://doi.org/10.1145/1463689.1463756>
- [62] Kasper Hornbæk, Søren S Sander, Javier Andrés Bargas-Avila, and Jakob Grue Simonsen. 2014. Is once enough?: on the extent and content of replications in human-computer interaction. in *Proceedings of the SIGCHI Conference on Human Factors in Computing Systems*. ACM. 3523-3532 p.
- [63] Eva Hornecker and Matthias Stifter. 2006. Learning from interactive museum installations about interaction design for public settings, in Proceedings of the 18th Australia conference on Computer-Human Interaction: Design: Activities, Artefacts and Environments. ACM: 1228201. Sydney, Australia. 135-142 p. <https://doi.org/10.1145/1228175.1228201>
- [64] Steven Houben, Connie Golsteijn, Sarah Gallacher, Rose Johnson, Saskia Bakker, Nicolai Marquardt, Licia Capra, and Yvonne Rogers. 2016. Physikit: Data Engagement Through Physical Ambient Visualizations in the Home, in Proceedings of the 2016 CHI Conference on Human Factors in Computing Systems. ACM: 2858059. San Jose, California, USA. 1608-1619 p. <https://doi.org/10.1145/2858036.2858059>
- [65] Anthony Howe. 2017. *AZLON | Kinetic Sculptures Flow Organically with the Wind*. 2017 [cited 2018 14/06/2018]; Available from: <https://www.howearth.net/azlon>.
- [66] Andy Huntington and Drew Allan. 2003. *Cylinder 2003* [cited 2019 29/01/2019]; Available from: <http://extraversion.co.uk/2003/cylinder/>.

- [67] Hilary Hutchinson, Wendy Mackay, Bo Westerlund, Benjamin B Bederson, Allison Druin, Catherine Plaisant, Michel Beaudouin-Lafon, Stéphane Conversy, Helen Evans, and Heiko Hansen. 2003. Technology probes: inspiring design for and with families. in *Proceedings of the SIGCHI conference on Human factors in computing systems*. ACM. 17-24 p.
- [68] Alexandra Ion, Johannes Frohnhofen, Ludwig Wall, Robert Kovacs, Mirela Alistar, Jack Lindsay, Pedro Lopes, Hsiang-Ting Chen, and Patrick Baudisch. 2016. Metamaterial Mechanisms, in *Proceedings of the 29th Annual Symposium on User Interface Software and Technology*. ACM: 2984540. Tokyo, Japan. 529-539 p. <https://doi.org/10.1145/2984511.2984540>
- [69] Hiroshi Ishii. 2008. Tangible bits: beyond pixels. in *Proceedings of the 2nd international conference on Tangible and embedded interaction*. ACM. xv-xxv p.
- [70] Hiroshi Ishii. 2008. The tangible user interface and its evolution. *Communications of the ACM*. 51(6): p. 32-36.
- [71] Hiroshi Ishii, Dávid Lakatos, Leonardo Bonanni, and Jean-Baptiste Labrune. 2012. Radical atoms: beyond tangible bits, toward transformable materials. *interactions*. 19(1): p. 38-51. <https://doi.org/10.1145/2065327.2065337>
- [72] Hiroshi Ishii, Daniel Leithinger, Sean Follmer, Amit Zoran, Philipp Schoessler, and Jared Counts. 2015. TRANSFORM: Embodiment of "Radical Atoms" at Milano Design Week, in *Proceedings of the 33rd Annual ACM Conference Extended Abstracts on Human Factors in Computing Systems*. ACM: 2702969. Seoul, Republic of Korea. 687-694 p. <https://doi.org/10.1145/2702613.2702969>
- [73] Hiroshi Ishii, Sandia Ren, and Phil Frei. 2001. Pinwheels: visualizing information flow in an architectural space, in *CHI '01 Extended Abstracts on Human Factors in Computing Systems*. ACM: 634135. Seattle, Washington. 111-112 p. <https://doi.org/10.1145/634067.634135>
- [74] Hiroshi Ishii and Brygg Ullmer. 1997. Tangible bits: towards seamless interfaces between people, bits and atoms. in *Proceedings of the ACM SIGCHI Conference on Human factors in computing systems*. ACM. 234-241 p.
- [75] Hiroo Iwata, Hiroaki Yano, Fumitaka Nakaizumi, and Ryo Kawamura. 2001. Project FEELEX: adding haptic surface to graphics, in *Proceedings of the 28th annual conference on Computer graphics and interactive techniques*. ACM: 383314. 469-476 p. <https://doi.org/10.1145/383259.383314>
- [76] Hiroo Iwata, Hiroaki Yano, Fumitaka Nakaizumi, and Ryo Kawamura. 2001. Project FEELEX: adding haptic surface to graphics. in *Proceedings of the 28th annual conference on Computer graphics and interactive techniques*. ACM. 469-476 p.
- [77] Margot Jacobs and Linda Worbin. 2005. Reach: dynamic textile patterns for communication and social expression, in *CHI '05 Extended Abstracts on Human Factors in Computing Systems*. ACM: 1056949. Portland, OR, USA. 1493-1496 p. <https://doi.org/10.1145/1056808.1056949>
- [78] Sungjune Jang, Lawrence H. Kim, Kesler Tanner, Hiroshi Ishii, and Sean Follmer. 2016. Haptic Edge Display for Mobile Tactile Interaction, in *Proceedings of the 2016 CHI Conference on Human Factors in Computing Systems*. ACM: 2858264. Santa Clara, California, USA. 3706-3716 p. <https://doi.org/10.1145/2858036.2858264>

- [79] Yvonne Jansen and Pierre Dragicevic. 2013. An interaction model for visualizations beyond the desktop. *IEEE Transactions on Visualization and Computer Graphics*. 19(12): p. 2396-2405.
- [80] Yvonne Jansen, Pierre Dragicevic, and Jean-Daniel Fekete. 2013. Evaluating the efficiency of physical visualizations, in *Proceedings of the SIGCHI Conference on Human Factors in Computing Systems*. ACM: 2481359. Paris, France. 2593-2602 p. <https://doi.org/10.1145/2470654.2481359>
- [81] Yvonne Jansen, Pierre Dragicevic, Petra Isenberg, Jason Alexander, Abhijit Karnik, Johan Kildal, Sriram Subramanian, and Kasper Hornbæk. 2015. Opportunities and Challenges for Data Physicalization, in *Proceedings of the 33rd Annual ACM Conference on Human Factors in Computing Systems*. ACM: 2702180. Seoul, Republic of Korea. 3227-3236 p. <https://doi.org/10.1145/2702123.2702180>
- [82] Jay Jeon. 2014. *Hex chain (scale) mail*. 2014 [cited 2017 14/12/2017]; Available from: <https://www.thingiverse.com/thing:255924>.
- [83] Susmita Kamila. 2013. Introduction, classification and applications of smart materials: an overview. *American Journal of Applied Sciences*. 10(8): p. 876.
- [84] Dietrich Kammer, Mathias Müller, Jan Wojdziak, and Ingmar S Franke. 2018. New Impressions in Interaction Design: A Task Taxonomy for Elastic Displays. *i-com*. 17(3): p. 247-255.
- [85] Viirj Kan, Katsuya Fujii, Judith Amores, Chang Long Zhu Jin, Pattie Maes, and Hiroshi Ishii. 2015. Social Textiles: Social Affordances and Icebreaking Interactions Through Wearable Social Messaging, in *Proceedings of the Ninth International Conference on Tangible, Embedded, and Embodied Interaction*. ACM: 2688816. Stanford, California, USA. 619-624 p. <https://doi.org/10.1145/2677199.2688816>
- [86] Fraz Khan, H Kursat Celik, Okan Oral, and Allan Edward Watson Rennie. 2018. A Short Review on 4D Printing.
- [87] Johan Kildal. 2012. Interacting with deformable user interfaces: effect of material stiffness and type of deformation gesture. in *International Conference on Haptic and Audio Interaction Design*. Springer. 71-80 p.
- [88] Hyunjung Kim and Woohun Lee. 2010. Kinetic tiles: modular construction units for interactive kinetic surfaces, in *Adjunct proceedings of the 23rd annual ACM symposium on User interface software and technology*. ACM: 1866256. New York, New York, USA. 431-432 p. <https://doi.org/10.1145/1866218.1866256>
- [89] Hyunyoung Kim, Celine Coutrix, and Anne Roudaut. 2018. Morphees+: Studying Everyday Reconfigurable Objects for the Design and Taxonomy of Reconfigurable UIs, in *Proceedings of the 2018 CHI Conference on Human Factors in Computing Systems*. ACM: 3174193. Montreal QC, Canada. 1-14 p. <https://doi.org/10.1145/3173574.3174193>
- [90] Jaemin Kim, Jongsu Lee, Donghee Son, Moon Kee Choi, and Dae-Hyeong Kim. 2016. Deformable devices with integrated functional nanomaterials for wearable electronics. *Nano Convergence*. 3(1): p. 4. <https://doi.org/10.1186/s40580-016-0062-1>
- [91] Borianna Koleva, Steve Benford, Kher Hui Ng, and Tom Rodden. 2003. A framework for tangible user interfaces. in *Physical Interaction (PI03) Workshop on Real World User Interfaces*. 46-50 p.

- [92] Glenn E Krasner and Stephen T Pope. 1988. A description of the model-view-controller user interface paradigm in the smalltalk-80 system. *Journal of object oriented programming*. 1(3): p. 26-49.
- [93] J-P Kruth, Ming-Chuan Leu, and Terunaga Nakagawa. 1998. Progress in additive manufacturing and rapid prototyping. *Cirp Annals*. 47(2): p. 525-540.
- [94] Mathieu Le Goc, Charles Perin, Sean Follmer, Jean-Daniel Fekete, and Pierre Dragicevic. 2019. Dynamic composite data physicalization using wheeled micro-robots. *IEEE transactions on visualization and computer graphics*. 25(1): p. 737-747.
- [95] Sang-Su Lee, Sohyun Kim, Bopil Jin, Eunji Choi, Boa Kim, Xu Jia, Daeep Kim, and Kunpyo Lee. 2010. How users manipulate deformable displays as input devices. in *Proceedings of the SIGCHI Conference on Human Factors in Computing Systems*. ACM. 1647-1656 p.
- [96] Daniel Leithinger, Sean Follmer, Alex Olwal, Samuel Luescher, Akimitsu Hogge, Jinha Lee, and Hiroshi Ishii. 2013. Sublimate: state-changing virtual and physical rendering to augment interaction with shape displays, in *Proceedings of the SIGCHI Conference on Human Factors in Computing Systems*. ACM: 2466191. Paris, France. 1441-1450 p. <https://doi.org/10.1145/2470654.2466191>
- [97] Daniel Leithinger and Hiroshi Ishii. 2010. Relief: a scalable actuated shape display, in *Proceedings of the fourth international conference on Tangible, embedded, and embodied interaction*. ACM: 1709928. Cambridge, Massachusetts, USA. 221-222 p. <https://doi.org/10.1145/1709886.1709928>
- [98] Daniel Leithinger, David Lakatos, Anthony DeVincenzi, Matthew Blackshaw, and Hiroshi Ishii. 2011. Direct and gestural interaction with relief: a 2.5D shape display, in *Proceedings of the 24th annual ACM symposium on User interface software and technology*. ACM: 2047268. Santa Barbara, California, USA. 541-548 p. <https://doi.org/10.1145/2047196.2047268>
- [99] Donald J Leo. 2007 *Engineering analysis of smart material systems*. John Wiley & Sons.
- [100] J. Lo and A. Girouard. 2014. Fabricating Bendy: Design and Development of Deformable Prototypes. *IEEE Pervasive Computing*. 13(3): p. 40-46. <https://doi.org/10.1109/MPRV.2014.47>
- [101] John Losee. 2001 *A historical introduction to the philosophy of science*. OUP Oxford.
- [102] Wendy E. Mackay and Anne-Laure Fayard. 1997. HCI, natural science and design: a framework for triangulation across disciplines, in *Proceedings of the 2nd conference on Designing interactive systems: processes, practices, methods, and techniques*. ACM: 263612. Amsterdam, The Netherlands. 223-234 p. <https://doi.org/10.1145/263552.263612>
- [103] Ahmed Al Maimani and Anne Roudaut. 2017. Frozen Suit: Designing a Changeable Stiffness Suit and its Application to Haptic Games, in *Proceedings of the 2017 CHI Conference on Human Factors in Computing Systems*. ACM: 3025655. Denver, Colorado, USA. 2440-2448 p. <https://doi.org/10.1145/3025453.3025655>
- [104] MakerBot. 2018. *MakerBot's Thingiverse*. 2018 [cited 2018 20/02/2018]; Available from: www.thingiverse.com.
- [105] Dough McCune. 2016. *Sculpture of Housing Prices Ripping San Francisco Apart*. 2016 [cited 2019 29/01/2019]; Available from:

- <http://dougmccone.com/blog/2016/07/21/sculpture-of-housing-prices-ripping-san-francisco-apart/>
- [106] Devin Montes. 2017. *Triangle Mesh Fabric*. 2017 [cited 2018 01/02/2018]; Available from: <https://www.myminifactory.com/object/3d-print-triangle-mesh-fabric-49475>.
- [107] Stefanie Mueller and Patrick Baudisch. 2015. Laser cutters: a new class of 2D output devices. *interactions*. 22(5): p. 72-74.
- [108] Stefanie Mueller, Bastian Kruck, and Patrick Baudisch. 2013. LaserOrigami: laser-cutting 3D objects, in *Proceedings of the SIGCHI Conference on Human Factors in Computing Systems*. ACM: 2481358. Paris, France. 2585-2592 p. <https://doi.org/10.1145/2470654.2481358>
- [109] Stefanie Mueller, Bastian Kruck, and Patrick Baudisch. 2014. Laser origami: laser-cutting 3D objects. *Interactions*. 21(2): p. 36-41. <https://doi.org/10.1145/2567782>
- [110] Mathias Müller, Anja Knöfel, Thomas Gründer, Ingmar Franke, and Rainer Groh. 2014. FlexiWall: Exploring Layered Data with Elastic Displays, in *Proceedings of the Ninth ACM International Conference on Interactive Tabletops and Surfaces*. ACM: 2669529. Dresden, Germany. 439-442 p. <https://doi.org/10.1145/2669485.2669529>
- [111] Sara Nabil, Aluna Everitt, Miriam Amber Sturdee, Jason Mark Alexander, Simon Bowen, Peter Wright, and David Kirk. 2018. ActuEating: Designing, Studying and Exploring Actuating Decorative Artefacts.
- [112] Steven Nagels, Raf Ramakers, Kris Luyten, and Wim Deferme. 2018. Silicone Devices: A Scalable DIY Approach for Fabricating Self-Contained Multi-Layered Soft Circuits using Microfluidics, in *Proceedings of the 2018 CHI Conference on Human Factors in Computing Systems*. ACM: 3173762. Montreal QC, Canada. 1-13 p. <https://doi.org/10.1145/3173574.3173762>
- [113] Ken Nakagaki, Artem Dementyev, Sean Follmer, Joseph A. Paradiso, and Hiroshi Ishii. 2016. ChainFORM: A Linear Integrated Modular Hardware System for Shape Changing Interfaces, in *Proceedings of the 29th Annual Symposium on User Interface Software and Technology*. ACM: 2984587. Tokyo, Japan. 87-96 p. <https://doi.org/10.1145/2984511.2984587>
- [114] Ken Nakagaki, Udayan Umapathi, Daniel Leithinger, and Hiroshi Ishii. 2017. AnimaStage: Hands-on Animated Craft on Pin-based Shape Displays, in *Proceedings of the 2017 Conference on Designing Interactive Systems*. ACM: 3064670. Edinburgh, United Kingdom. 1093-1097 p. <https://doi.org/10.1145/3064663.3064670>
- [115] Yusuke Nakagawa, Akiya Kamimura, and Yoichiro Kawaguchi. 2012. MimicTile: a variable stiffness deformable user interface for mobile devices, in *Proceedings of the SIGCHI Conference on Human Factors in Computing Systems*. ACM: 2207782. Austin, Texas, USA. 745-748 p. <https://doi.org/10.1145/2207676.2207782>
- [116] Kosuke Nakajima, Yuichi Itoh, Yusuke Hayashi, Kazuaki Ikeda, Kazuyuki Fujita, and Takao Onoye. 2013. Emoballoon, in *Advances in Computer Entertainment*. Springer. p. 182-197.
- [117] Jakob Nielsen. 1994. Enhancing the explanatory power of usability heuristics. in *Proceedings of the SIGCHI conference on Human Factors in Computing Systems*. ACM. 152-158 p.
- [118] Jakob Nielsen. 1994. Usability inspection methods. in *Conference companion on Human factors in computing systems*. ACM. 413-414 p.

- [119] Jakob Nielsen and Rolf Molich. 1990. Heuristic evaluation of user interfaces. in *Proceedings of the SIGCHI conference on Human factors in computing systems*. ACM. 249-256 p.
- [120] William Odom, Richard Banks, Abigail Durrant, David Kirk, and James Pierce. 2012. Slow technology: critical reflection and future directions, in *Proceedings of the Designing Interactive Systems Conference*. ACM: 2318088. Newcastle Upon Tyne, United Kingdom. 816-817 p. <https://doi.org/10.1145/2317956.2318088>
- [121] Simon Olberding, Kian Peen Yeo, Suranga Nanayakkara, and Jurgen Steimle. 2013. AugmentedForearm: exploring the design space of a display-enhanced forearm, in *Proceedings of the 4th Augmented Human International Conference*. ACM: 2459239. Stuttgart, Germany. 9-12 p. <https://doi.org/10.1145/2459236.2459239>
- [122] Themis Omirou, Asier Marzo, Sue Ann Seah, and Sriram Subramanian. 2015. LeviPath: Modular Acoustic Levitation for 3D Path Visualisations, in *Proceedings of the 33rd Annual ACM Conference on Human Factors in Computing Systems*. ACM: 2702333. Seoul, Republic of Korea. 309-312 p. <https://doi.org/10.1145/2702123.2702333>
- [123] Jifei Ou, Mélina Skouras, Nikolaos Vlavianos, Felix Heibeck, Chin-Yi Cheng, Jannik Peters, and Hiroshi Ishii. 2016. aeroMorph - Heat-sealing Inflatable Shape-change Materials for Interaction Design, in *Proceedings of the 29th Annual Symposium on User Interface Software and Technology*. ACM: 2984520. Tokyo, Japan. 121-132 p. <https://doi.org/10.1145/2984511.2984520>
- [124] Li-Chen Ou, M Ronnier Luo, Andrée Woodcock, and Angela Wright. 2004. A study of colour emotion and colour preference. Part I: Colour emotions for single colours. *Color Research & Application*. 29(3): p. 232-240.
- [125] Antti Oulasvirta and Gregory D Abowd. 2016. User interface design in the 21st century. *Computer*. 49(7): p. 11-13.
- [126] Gian Pangaro, Dan Maynes-Aminzade, and Hiroshi Ishii. 2002. The actuated workbench: computer-controlled actuation in tabletop tangible interfaces, in *Proceedings of the 15th annual ACM symposium on User interface software and technology*. ACM: 572011. Paris, France. 181-190 p. <https://doi.org/10.1145/571985.572011>
- [127] Young-Woo Park, Joohee Park, and Tek-Jin Nam. 2015. The Trial of Bendi in a Coffeehouse: Use of a Shape-Changing Device for a Tactile-Visual Phone Conversation, in *Proceedings of the 33rd Annual ACM Conference on Human Factors in Computing Systems*. ACM: 2702326. Seoul, Republic of Korea. 2181-2190 p. <https://doi.org/10.1145/2702123.2702326>
- [128] James Patten, Hiroshi Ishii, Jim Hines, and Gian Pangaro. 2001. Sensetable: a wireless object tracking platform for tangible user interfaces. in *Proceedings of the SIGCHI conference on Human factors in computing systems*. ACM. 253-260 p.
- [129] Esben W Pedersen, Sriram Subramanian, and Kasper Hornbæk. 2014. Is my phone alive?: a large-scale study of shape change in handheld devices using videos. in *Proceedings of the 32nd annual ACM conference on Human factors in computing systems*. ACM. 2579-2588 p.
- [130] Eujin Pei, Jinsong Shen, and Jennifer Watling. 2015. Direct 3D printing of polymers onto textiles: experimental studies and applications. *Rapid Prototyping Journal*. 21(5): p. 556-571.

- [131] Ben Piper, Carlo Ratti, and Hiroshi Ishii. 2002. Illuminating clay: a 3-D tangible interface for landscape analysis. in *Proceedings of the SIGCHI conference on Human factors in computing systems*. ACM. 355-362 p.
- [132] Ivan Poupyrev, Tatsushi Nashida, Shigeaki Maruyama, Jun Rekimoto, and Yasufumi Yamaji. 2004. Lumen: interactive visual and shape display for calm computing, in *ACM SIGGRAPH 2004 Emerging technologies*. ACM: 1186173. Los Angeles, California. 17 p. <https://doi.org/10.1145/1186155.1186173>
- [133] Ivan Poupyrev, Tatsushi Nashida, and Makoto Okabe. 2007. Actuation and tangible user interfaces: the Vaucanson duck, robots, and shape displays, in *Proceedings of the 1st international conference on Tangible and embedded interaction*. ACM: 1227012. Baton Rouge, Louisiana. 205-212 p. <https://doi.org/10.1145/1226969.1227012>
- [134] Gary Priestnall, Jeremy Gardiner, Jake Durrant, James Goulding, and Innovation Park. 2012. Projection Augmented Relief Models (PARM): tangible displays for geographic information. in *EVA*. p.
- [135] Isabel P. S. Qamar, Rainer Groh, David Holman, and Anne Roudaut. 2018. HCI meets Material Science: A Literature Review of Morphing Materials for the Design of Shape-Changing Interfaces, in *Proceedings of the 2018 CHI Conference on Human Factors in Computing Systems*. ACM: 3173948. Montreal QC, Canada. 1-23 p. <https://doi.org/10.1145/3173574.3173948>
- [136] Jie Qi and Leah Buechley. 2012. Animating paper using shape memory alloys, in *Proceedings of the SIGCHI Conference on Human Factors in Computing Systems*. ACM: 2207783. Austin, Texas, USA. 749-752 p. <https://doi.org/10.1145/2207676.2207783>
- [137] Majken K. Rasmussen, Esben W. Pedersen, Marianne G. Petersen, and Kasper Hornbaek. 2012. Shape-changing interfaces: a review of the design space and open research questions, in *Proceedings of the SIGCHI Conference on Human Factors in Computing Systems*. ACM: 2207781. Austin, Texas, USA. 735-744 p. <https://doi.org/10.1145/2207676.2207781>
- [138] Majken K. Rasmussen, Esben W. Pedersen, Marianne G. Petersen, and Kasper Hornbæk. 2012. Shape-changing interfaces: a review of the design space and open research questions, in *Proceedings of the SIGCHI Conference on Human Factors in Computing Systems*. ACM: 2207781. Austin, Texas, USA. 735-744 p. <https://doi.org/10.1145/2207676.2207781>
- [139] M. A. Robertson, M. Murakami, W. Felt, and J. Paik. 2019. A Compact Modular Soft Surface With Reconfigurable Shape and Stiffness. *IEEE/ASME Transactions on Mechatronics*. 24(1): p. 16-24. <https://doi.org/10.1109/TMECH.2018.2878621>
- [140] Jessica Rosenkrantz. 2013. *KINEMATICS*. 2013 [cited 2017 22/11/2017]; Available from: <https://n-e-r-v-o-u-s.com/projects/sets/kinematics/>.
- [141] Jessica Rosenkrantz. 2016. *Second Skin: 3D-printed textiles*. 2016 [cited 2017 02/11/2017]; Available from: <https://designobjectsinteraction.wordpress.com/2016/10/31/second-skin-3d-printed-textiles/>.
- [142] Philip R Ross and Stephan AG Wensveen. 2010. Designing aesthetics of behavior in interaction: Using aesthetic experience as a mechanism for design. *International Journal of Design*. 4(2): p. 3-13.

- [143] Anne Roudaut, Abhijit Karnik, Markus Löchtefeld, and Sriram Subramanian. 2013. Morphees: toward high "shape resolution" in self-actuated flexible mobile devices, in *Proceedings of the SIGCHI Conference on Human Factors in Computing Systems*. ACM: 2470738. Paris, France. 593-602 p. <https://doi.org/10.1145/2470654.2470738>
- [144] Jim Ruppert. 1995. A Delaunay refinement algorithm for quality 2-dimensional mesh generation. *Journal of algorithms*. 18(3): p. 548-585.
- [145] Kimiko Ryokai, Stefan Marti, and Hiroshi Ishii. 2004. I/O brush: drawing with everyday objects as ink, in *Proceedings of the SIGCHI Conference on Human Factors in Computing Systems*. ACM: 985731. Vienna, Austria. 303-310 p. <https://doi.org/10.1145/985692.985731>
- [146] Lilia Sabantina, Franziska Kinzel, Andrea Ehrmann, and Karin Finsterbusch. 2015. Combining 3D printed forms with textile structures-mechanical and geometrical properties of multi-material systems. in *IOP Conference Series: Materials Science and Engineering*. IOP Publishing. 012005 p.
- [147] Deepak Ranjan Sahoo, Kasper Hornbæk, and Sriram Subramanian. 2016. TableHop: An Actuated Fabric Display Using Transparent Electrodes, in *Proceedings of the 2016 CHI Conference on Human Factors in Computing Systems*. ACM: 2858544. Santa Clara, California, USA. 3767-3780 p. <https://doi.org/10.1145/2858036.2858544>
- [148] Valkyrie Savage, Ryan Schmidt, Tovi Grossman, George Fitzmaurice, and Björn Hartmann. 2014. A series of tubes: adding interactivity to 3D prints using internal pipes, in *Proceedings of the 27th annual ACM symposium on User interface software and technology*. ACM: 2647374. Honolulu, Hawaii, USA. 3-12 p. <https://doi.org/10.1145/2642918.2647374>
- [149] Martin Schmitz, Mohammadreza Khalilbeigi, Matthias Balwierz, Roman Lissermann, Max Mühlhäuser, and Jürgen Steimle. 2015. Capricate: A Fabrication Pipeline to Design and 3D Print Capacitive Touch Sensors for Interactive Objects, in *Proceedings of the 28th Annual ACM Symposium on User Interface Software & Technology*. ACM: 2807503. Charlotte, NC, USA. 253-258 p. <https://doi.org/10.1145/2807442.2807503>
- [150] Martin Schmitz, Jürgen Steimle, Jochen Huber, Niloofar Dezfuli, and Max Mühlhäuser. 2017. Flexibles: Deformation-Aware 3D-Printed Tangibles for Capacitive Touchscreens, in *Proceedings of the 2017 CHI Conference on Human Factors in Computing Systems*. ACM: 3025663. Denver, Colorado, USA. 1001-1014 p. <https://doi.org/10.1145/3025453.3025663>
- [151] Christian Schumacher, Steve Marschner, Markus Cross, and Bernhard Thomaszewski. 2018. Mechanical characterization of structured sheet materials - *ACM Trans. Graph.* 37(4): p. 1-15. <https://doi.org/10.1145/3197517.3201278>
- [152] Carsten Schwesig, Ivan Poupyrev, and Eijiro Mori. 2004. Gummi: a bendable computer. in *Proceedings of the SIGCHI conference on Human factors in computing systems*. ACM. 263-270 p.
- [153] Marcos Serrano, Anne Roudaut, and Pourang Irani. 2016. Investigating Text Legibility on Non-Rectangular Displays, in *Proceedings of the 2016 CHI Conference on Human Factors in Computing Systems*. ACM: 2858057. San Jose, California, USA. 498-508 p. <https://doi.org/10.1145/2858036.2858057>
- [154] Marcos Serrano, Anne Roudaut, and Pourang Irani. 2017. Visual Composition of Graphical Elements on Non-Rectangular Displays, in *Proceedings of the 2017 CHI*

- Conference on Human Factors in Computing Systems. ACM: 3025677. Denver, Colorado, USA. 4405-4416 p. <https://doi.org/10.1145/3025453.3025677>
- [155] Orit Shaer and Eva Hornecker. 2010. Tangible user interfaces: past, present, and future directions. *Foundations and Trends® in Human-Computer Interaction*. 3(1-2): p. 4-137.
- [156] Patrick Shearn. 2016. *LIQUID SHARD - Poetic Kinetics*. 2016 [cited 2019 20/02/2019]; Available from: <http://www.poetickinetics.com/liquid-shard/>.
- [157] Helen Shwe and Amy Francetic. 1999. Smarter play for smart toys: The benefits of technology-enhanced play. Zowie Entertainment White Paper. 3208.
- [158] Alexa F. Siu, Eric J. Gonzalez, Shenli Yuan, Jason B. Ginsberg, and Sean Follmer. 2018. shapeShift: 2D Spatial Manipulation and Self-Actuation of Tabletop Shape Displays for Tangible and Haptic Interaction, in *Proceedings of the 2018 CHI Conference on Human Factors in Computing Systems*. ACM: 3173865. Montreal QC, Canada. 1-13 p. <https://doi.org/10.1145/3173574.3173865>
- [159] Editorial Staff. 2016. Go forth and replicate. *Nature*. 536: p. 373.
- [160] Andrew Stevenson, Christopher Perez, and Roel Vertegaal. 2011. An inflatable hemispherical multi-touch display, in *Proceedings of the fifth international conference on Tangible, embedded, and embodied interaction*. ACM: 1935766. Funchal, Portugal. 289-292 p. <https://doi.org/10.1145/1935701.1935766>
- [161] Jessica Stewart. 2017. *Art History: The Evolution of Hypnotic Kinetic Sculptures*. 2017 [cited 2019 20/02/2019]; Available from: <https://mymodernmet.com/kinetic-sculpture-art-history/>.
- [162] Jelle Stienstra, Miguel Bruns Alonso, Stephan Wensveen, and Stoffel Kuenen. 2012. How to design for transformation of behavior through interactive materiality, in *Proceedings of the 7th Nordic Conference on Human-Computer Interaction: Making Sense Through Design*. ACM: 2399020. Copenhagen, Denmark. 21-30 p. <https://doi.org/10.1145/2399016.2399020>
- [163] Paul Strohmeier, Juan Pablo Carrascal, Bernard Cheng, Margaret Meban, and Roel Vertegaal. 2016. An Evaluation of Shape Changes for Conveying Emotions, in *Proceedings of the 2016 CHI Conference on Human Factors in Computing Systems*. ACM: 2858537. San Jose, California, USA. 3781-3792 p. <https://doi.org/10.1145/2858036.2858537>
- [164] Elisa Strozyk. 2016. *"Dyed - Wooden - Textiles" Wall - Hangings/Plaids*. 2016 [cited 2016 June 16]; Available from: <http://www.elisastrozyk.de/seite/dyedtextiles.html>.
- [165] ART+COM Studios. 2008. *KINETIC SCULPTURE — THE SHAPES OF THINGS TO COME*. 2008 [cited 2018 25/05/2018]; Available from: <https://artcom.de/en/project/kinetic-sculpture/>.
- [166] ART+COM Studios. 2019. *KINETICS 2019* [cited 2019 20/02/2019]; Available from: https://artcom.de/en/?research_focus=kinetics.
- [167] Miriam Sturdee. 2017. Drawing Design Futures for Shape-Changing Interfaces, in *Proceedings of the 2017 ACM Conference Companion Publication on Designing Interactive Systems*. ACM: 3079170. Edinburgh, United Kingdom. 399-401 p. <https://doi.org/10.1145/3064857.3079170>

- [168] Miriam Sturdee and Jason Alexander. 2018. Analysis and Classification of Shape-Changing Interfaces for Design and Application-based Research. *ACM Comput. Surv.* 51(1): p. 1-32. <https://doi.org/10.1145/3143559>
- [169] Miriam Sturdee, Paul Coulton, and Jason Alexander. 2017. Using Design Fiction to Inform Shape-Changing Interface Design and Use. *The Design Journal.* 20(sup1): p. S4146-S4157.
- [170] Miriam Sturdee, John Hardy, Nick Dunn, and Jason Alexander. 2015. A Public Ideation of Shape-Changing Applications, in *Proceedings of the 2015 International Conference on Interactive Tabletops & Surfaces.* ACM: 2817734. Madeira, Portugal. 219-228 p. <https://doi.org/10.1145/2817721.2817734>
- [171] Simon Stusak, Aurélien Tabard, Franziska Sauka, Rohit Ashok Khot, and Andreas Butz. 2014. Activity sculptures: Exploring the impact of physical visualizations on running activity. *IEEE Transactions on Visualization and Computer Graphics.* 20(12): p. 2201-2210.
- [172] Ivan E Sutherland. 1965. The ultimate display. *Multimedia: From Wagner to virtual reality:* p. 506-508.
- [173] Saiganesh Swaminathan, Conglei Shi, Yvonne Jansen, Pierre Dragicevic, Lora A Oehlberg, and Jean-Daniel Fekete. 2014. Supporting the design and fabrication of physical visualizations. in *Proceedings of the SIGCHI Conference on Human Factors in Computing Systems.* ACM. 3845-3854 p.
- [174] Cristina Sylla, Pedro Branco, Clara Coutinho, and Eduarda Coquet. 2012. TUIs vs. GUIs: comparing the learning potential with preschoolers. *Personal Ubiquitous Comput.* 16(4): p. 421-432. <https://doi.org/10.1007/s00779-011-0407-z>
- [175] Bronislaw Szerszynski. 2018. Drift as a Planetary Phenomenon. *Performance Research.* 23(7): p. 136-144. <https://doi.org/10.1080/13528165.2018.1558436>
- [176] Faisal Taher, John Hardy, Abhijit Karnik, Christian Weichel, Yvonne Jansen, Kasper Hornbæk, and Jason Alexander. 2015. Exploring Interactions with Physically Dynamic Bar Charts, in *Proceedings of the 33rd Annual ACM Conference on Human Factors in Computing Systems.* ACM: 2702604. Seoul, Republic of Korea. 3237-3246 p. <https://doi.org/10.1145/2702123.2702604>
- [177] Faisal Taher, Yvonne Jansen, Jonathan Woodruff, John Hardy, Kasper Hornbæk, and Jason Alexander. 2017. Investigating the use of a dynamic physical bar chart for data exploration and presentation. *IEEE transactions on visualization and computer graphics.* 23(1): p. 451-460.
- [178] Faisal Taher, John Vidler, and Jason Alexander. 2017. A Characterization of Actuation Techniques for Generating Movement in Shape-Changing Interfaces. *International Journal of Human-Computer Interaction.* 33(5): p. 385-398. <https://doi.org/10.1080/10447318.2016.1250372>
- [179] Shohei Takei, Makoto Iida, and Takeshi Naemura. 2011. KineReels: extension actuators for dynamic 3D shape, in *ACM SIGGRAPH 2011 Posters.* ACM: 2037810. Vancouver, British Columbia, Canada. 1-1 p. <https://doi.org/10.1145/2037715.2037810>
- [180] Aneesh P Tarun, Byron Lahey, Audrey Girouard, Winslow Burleson, and Roel Vertegaal. 2011. Snaplet: using body shape to inform function in mobile flexible display devices. in *CHI'11 Extended Abstracts on Human Factors in Computing Systems.* ACM. 329-334 p.

- [181] Tiia-Maria Tenhunen, Oldouz Moslemian, Kari Kammiovirta, Ali Harlin, Pirjo Kääriäinen, Monika Österberg, Tekla Tammelin, and Hannes Orelma. 2018. Surface tailoring and design-driven prototyping of fabrics with 3D-printing: An all-cellulose approach. *Materials & Design*. 140: p. 409-419.
- [182] Skylar Tibbits. 2014. 4D printing: multi-material shape change. *Architectural Design*. 84(1): p. 116-121.
- [183] Jennifer Townley. 2017. *Asinas II*. 2017 [cited 2019 20/02/2019]; Available from: <http://www.jennifertownley.com/asinas-ii>.
- [184] Giovanni Maria Troiano, Esben Warming Pedersen, and Kasper Hornbæk. 2014. User-defined gestures for elastic, deformable displays, in *Proceedings of the 2014 International Working Conference on Advanced Visual Interfaces*. ACM: 2598184. Como, Italy. 1-8 p. <https://doi.org/10.1145/2598153.2598184>
- [185] Jessica Tsimeris, Colin Dedman, Michael Broughton, and Tom Gedeon. 2013. ForceForm: a dynamically deformable interactive surface, in *Proceedings of the 2013 ACM international conference on Interactive tabletops and surfaces*. ACM: 2512807. St. Andrews, Scotland, United Kingdom. 175-178 p. <https://doi.org/10.1145/2512349.2512807>
- [186] Philip Tuddenham, David Kirk, and Shahram Izadi. 2010. Graspables revisited: multi-touch vs. tangible input for tabletop displays in acquisition and manipulation tasks, in *Proceedings of the SIGCHI Conference on Human Factors in Computing Systems*. ACM: 1753662. Atlanta, Georgia, USA. 2223-2232 p. <https://doi.org/10.1145/1753326.1753662>
- [187] Brygg Ullmer and Hiroshi Ishii. 1997. The metaDESK: models and prototypes for tangible user interfaces. in *Proceedings of the 10th annual ACM symposium on User interface software and technology*. ACM. 223-232 p.
- [188] Brygg Ullmer and Hiroshi Ishii. 2000. Emerging frameworks for tangible user interfaces. *IBM systems journal*. 39(3.4): p. 915-931.
- [189] Brygg Ullmer, Hiroshi Ishii, and Dylan Glas. 1998. mediaBlocks: physical containers, transports, and controls for online media, in *Proceedings of the 25th annual conference on Computer graphics and interactive techniques*. ACM: 280940. 379-386 p. <https://doi.org/10.1145/280814.280940>
- [190] Brygg Ullmer, Hiroshi Ishii, and Robert JK Jacob. 2003. Tangible query interfaces: Physically constrained tokens for manipulating database queries. in *Proc. of INTERACT*. 279-286 p.
- [191] Udayan Umapathi, Hsiang-Ting Chen, Stefanie Mueller, Ludwig Wall, Anna Seufert, and Patrick Baudisch. 2015. LaserStacker: Fabricating 3D Objects by Laser Cutting and Welding, in *Proceedings of the 28th Annual ACM Symposium on User Interface Software & Technology*. ACM: 2807512. Charlotte, NC, USA. 575-582 p. <https://doi.org/10.1145/2807442.2807512>
- [192] UncleJessy. 2018. *3D Printing on Fabric - Hexagon / Triangle Pattern Test*. 2018 [cited 2018 23/03/2018]; Available from: <https://www.thingiverse.com/thing:2787803>.
- [193] John Underkoffler and Hiroshi Ishii. 1999. Urp: a luminous-tangible workbench for urban planning and design. in *Proceedings of the SIGCHI conference on Human Factors in Computing Systems*. ACM. 386-393 p.

- [194] Vijay K Varadan, Kalarickaparambil Joseph Vinoy, and Sankaraiyer Gopalakrishnan. 2006 Smart material systems and MEMS: design and development methodologies. John Wiley & Sons.
- [195] Roel Vertegaal and Ivan Poupyrev. 2008. Organic user interfaces. *Communications of the ACM*. 51(6): p. 26-30.
- [196] Kevin Vlack, Terukazu Mizota, Naoki Kawakami, Kazuto Kamiyama, Hiroyuki Kajimoto, and Susumu Tachi. 2005. GelForce: a vision-based traction field computer interface. in *CHI'05 extended abstracts on Human factors in computing systems*. ACM. 1154-1155 p.
- [197] Jayne Wallace, John McCarthy, Peter C Wright, and Patrick Olivier. 2013. Making design probes work. in *Proceedings of the SIGCHI Conference on Human Factors in Computing Systems*. ACM. 3441-3450 p.
- [198] Jun-ichiro Watanabe, Arito Mochizuki, and Youichi Horry. 2008. Bookisheet: bendable device for browsing content using the metaphor of leafing through the pages, in *Proceedings of the 10th international conference on Ubiquitous computing*. ACM: 1409684. Seoul, Korea. 360-369 p. <https://doi.org/10.1145/1409635.1409684>
- [199] Y. Watanabe, A. Cassinelli, T. Komuro, and M. Ishikawa. 2008. The deformable workspace: A membrane between real and virtual space. in *Horizontal Interactive Human Computer Systems, 2008. TABLETOP 2008. 3rd IEEE International Workshop on*. 145-152 p. <https://doi.org/10.1109/TABLETOP.2008.4660197>
- [200] Martin Weigel, Tong Lu, Gilles Bailly, Antti Oulasvirta, Carmel Majidi, and Jürgen Steimle. 2015. Iskin: flexible, stretchable and visually customizable on-body touch sensors for mobile computing. in *Proceedings of the 33rd Annual ACM Conference on Human Factors in Computing Systems*. ACM. 2991-3000 p.
- [201] Mark Weiser and John Seely Brown. 1997. The coming age of calm technology, in *Beyond calculation*. Springer. p. 75-85.
- [202] Michael Wessely, Theophanis Tsandilas, and Wendy E Mackay. 2016. Stretchis: Fabricating highly stretchable user interfaces. in *Proceedings of the 29th Annual Symposium on User Interface Software and Technology*. ACM. 697-704 p.
- [203] Joseph White, Marcus Foley, and Aaron Rowley. 2015. A novel approach to 3D-Printed fabrics and garments. *3D Printing and Additive Manufacturing*. 2(3): p. 145-149.
- [204] Karl Willis, Eric Brockmeyer, Scott Hudson, and Ivan Poupyrev. 2012. Printed optics: 3D printing of embedded optical elements for interactive devices. in *Proceedings of the 25th annual ACM symposium on User interface software and technology*. ACM. 589-598 p.
- [205] Kaufui V Wong and Aldo Hernandez. 2012. A review of additive manufacturing. *ISRN Mechanical Engineering*. 2012.
- [206] Lining Yao, Ryuma Niiyama, Jifei Ou, Sean Follmer, Clark Della Silva, and Hiroshi Ishii. 2013. PneuUI: pneumatically actuated soft composite materials for shape changing interfaces, in *Proceedings of the 26th annual ACM symposium on User interface software and technology*. ACM: 2502037. St. Andrews, Scotland, United Kingdom. 13-22 p. <https://doi.org/10.1145/2501988.2502037>
- [207] M. Yao, H. Cui, X. Xiao, C. H. Belke, and J. Paik. 2018. Towards Peak Torque Minimization for Modular Self-Folding Robots. in *2018 IEEE/RSJ International*

- Conference on Intelligent Robots and Systems (IROS)*. 7975-7982 p.
<https://doi.org/10.1109/IROS.2018.8593648>
- [208] Salu Ylirisku, Siân Lindley, Giulio Jacucci, Richard Banks, Craig Stewart, Abigail Sellen, Richard Harper, and Tim Regan. 2013. Designing web-connected physical artefacts for the 'aesthetic' of the home, in *Proceedings of the SIGCHI Conference on Human Factors in Computing Systems*. ACM: 2466117. Paris, France. 909-918 p.
<https://doi.org/10.1145/2470654.2466117>
- [209] Kyungwon Yun, JunBong Song, Keehong Youn, Sungmin Cho, and Hyunwoo Bang. 2013. ElaScreen: exploring multi-dimensional data using elastic screen, in *CHI '13 Extended Abstracts on Human Factors in Computing Systems*. ACM: 2468590. Paris, France. 1311-1316 p. <https://doi.org/10.1145/2468356.2468590>
- [210] John Zimmerman, Jodi Forlizzi, and Shelley Evenson. 2007. Research through design as a method for interaction design research in HCI. in *Proceedings of the SIGCHI conference on Human factors in computing systems*. ACM. 493-502 p.
- [211] Oren Zuckerman and Ayelet Gal-Oz. 2013. To TUI or not to TUI: Evaluating performance and preference in tangible vs. graphical user interfaces. *International Journal of Human-Computer Studies*. 71(7-8): p. 803-820.

| Appendix A

Documentation for Studies

ShapeCanvas Study (Chapter 3)



Participant Information Sheet

Initial Explorations of Shape-Changing Content Generated By the Public

Dear Participant,

This is an invitation to a user study that explores how the public generates content for a physical shape-changing display canvas. This forms part of our research into the applications of physical visualization and shape-changing display technology, which is a relatively new and unexplored domain. We are specifically interested in how the general public interacts and generates content using a shape-changing pixel canvas, how they design content for a shape-changing display, and how they use the device to generate physical animations.

Feel free to contact us with any questions in case any of the information in this document is unclear.

Researcher:

Aluna Everitt (a.everitt@lancaster.ac.uk)

Project Leader:

Jason Alexander (j.alexander@lancaster.ac.uk)

Project Title:

Generic, highly-organic shape-changing interfaces (GHOST)

What is the purpose of this study?

We are interested in exploring how people interact and generate content for a shape-changing display (how do people consider designing for height and time, etc.), how people interact with the system to generate physical animations (do they actually understand what's going on?), and how they use the device to create their own physical animations. This will involve carrying out a study in a public environment (Café Republic) that allows people to interact and create their own physical animations using the shape-changing pixel canvas.

Why am I suitable to be a participant?

The study requires participants who are over 18 and new to shape-changing technology.

Is the participation voluntary?

Yes, it is entirely voluntary. You can also withdraw at any stage of the study. To be sure that you can participate in this study happily we advise you to read this document carefully and discuss with the researcher any questions you may have before you sign the consent form.

- You will be treated with respect and dignity at every phase of the study.
- You will be treated with honesty, integrity, openness, and straight forwardness in all phases of the research, including a guarantee that you will not unknowingly be deceived during



the course of the research.

- You should sense NO pressure, explicit or otherwise, to sign this consent form.

What does the study involve?

In brief, the study procedure is as follows:

- A short demographic questionnaire.
- A demonstration phase, where participants will be shown how to use the functionalities of the system, and they will be asked to carry out these interactions so they become familiar.
- An exploration and presentation phase, where participants will be asked to interact with the shape-changing pixel canvas and generate their own physical animations.
- A short discussion about your experiences.

Confidentiality:

Your identity will only be known to the researchers in this project. Any information provided by you will remain confidential. All the participants will be coded in the reports resulting from this study (e.g. P1, P2, P3, etc.).

Problems and Complaints:

In case any issues arise or you wish to complain about any part of the study you are involved with, feel free to contact the researcher using the e-mail address from the top of this document. If this does not satisfy you and you wish to file a formal complaint, please contact the project leader, Jason Alexander. A copy of the participant information sheet and photocopies of your signed consent forms will be available upon request for a period of 24 months.

What happens after the study?

The data collected through this study will be analysed, and the conclusions produced will allow the researchers to gain insights into how people interact with and generate content for shape-changing displays.

Thank you for your time 😊



Consent Form

Name: _____

Please tick the boxes below that apply

- I am at least 18 years old.
- I have read and understood the consent form and information document.
- I understand the nature of this study and wish to participate.
- I allow the recording of video and audio for data analysis.
- I understand that I can withdraw at any time.
- I understand that all data published from this study will be anonymous.

Participant's Signature

Date

[Demographic] - Using a Shape-Changing Canvas Display

Demographic Questionnaire

*Required

Participant Number *

Age *

- 18 - 24
- 25 - 34
- 35 - 44
- 45+
- Prefer not to say

Gender *

- Female
- Male
- Other

Current Occupation *

I am familiar with gesture recognition technology *

E.g. Xbox Kinect, Wii, etc.

1 2 3 4 5

Strongly Disagree Strongly Agree

I am familiar with shape-changing technology *

Any device that changes its physical form to present information

1 2 3 4 5

Strongly Disagree Strongly Agree

Please state how often you use graphics software *

E.g. Paint, Photoshop, GIMP, etc.

- Every day
- Weekly
- Monthly
- Few times a year
- Never

Please state how often you use animation software *

E.g. Flash, SketchBook, Blender, etc.

- Every day
- Weekly
- Monthly
- Few times a year
- Never

Submit

Never submit passwords through Google Forms.

[Post-study Questionnaire] - Using a Shape-Changing Canvas Display

Post-Study Questionnaire

*Required

Participant Number *

Your answer

I found it easy to control the height of each pixel pad *

	1	2	3	4	5	
Strongly disagree	<input type="radio"/>	<input type="radio"/>	<input type="radio"/>	<input type="radio"/>	<input type="radio"/>	Strongly agree

Comments

Did the interactions make sense? What did you find difficult? What did you find easy?

Your answer

I found it easy to control the colour of each pixel pad *

	1	2	3	4	5	
Strongly Disagree	<input type="radio"/>	<input type="radio"/>	<input type="radio"/>	<input type="radio"/>	<input type="radio"/>	Strongly Agree

Comments

What did you find difficult? What did you find easy?

Your answer

I was able to create the physical animation I wanted *

	1	2	3	4	5	
Strongly Disagree	<input type="radio"/>	<input type="radio"/>	<input type="radio"/>	<input type="radio"/>	<input type="radio"/>	Strongly Agree

Comments

Was it easy to control the height and colour of the pixels to make the animation you wanted?

Your answer

I could easily make more complex designs if more pixels were used *

If asked to create a physical animation with a 100x100 grid, would you find this easy?

	1	2	3	4	5	
Strongly Disagree	<input type="radio"/>	<input type="radio"/>	<input type="radio"/>	<input type="radio"/>	<input type="radio"/>	Strongly Agree

Comments

What would you find easy? What would you find hard?

Your answer

General Comments *

What other features would you like to see? Possible Improvements?

PolySurface (Chapter 4)

Aluna Everitt



Participant Information Sheet

I am a PhD student at Lancaster University and I would like to invite you to take part in a research study about exploring content generation using semi-solid shape-changing displays and surfaces.

Please take time to read the following information carefully before you decide whether or not you wish to take part in this case study.

What is the study about?

This study aims to explore content generation using semi-solid shape-changing displays and surfaces. Each participant will be asked to design and make their own semi-solid surface that will be used for representing data and information that is specific to them and their work. We want to understand the advantages and drawbacks of using our method of representing information compared to more traditional approaches used.

Why have I been invited?

I have approached you because I am interested in understanding how people from different professional backgrounds can use this method for designing shape-changing displays to represent data and information specific to their work domains.

I would be very grateful if you would agree to take part in this study.

What will I be asked to do if I take part?

Each participant will work closely with the researcher to design and create their own shape-changing displays. This will involve each participant spending half a day designing (using software) virtual surfaces and coming up with a set of requirements the final device must meet in order to successfully function. The researcher will then laser cut the designed surface and added onto a physical hardware system. Throughout the duration of the study each participant will be supervised by the researcher, who will also assemble the shape-changing display. We will also ask participants to showcase their prototype shape-changing display to a small focus group (2 – 8 people maximum) from their work domain (this is optional). This will allow us to evaluate the effectiveness and engagement of the shape-changing prototypes developed.

Each case study is split up into two meetings. You will also have an option of showcasing your final device at the end of the study to a group of your colleagues.

Breakdown of each meeting can be found below:

1. Meeting 1 - Design your own shape-changing display:
 - You will be designing a surface for a shape-changing display or interface that will represent data you use either at work or any other example datasets you have access to.
 - The researcher will be going through the design process with you step by step during the study.
 - You will be asked to come up with a list of requirements the final device must meet in order to successfully function.
 - This meeting should last no more than 2 hours.



Aluna Everitt

- You will have the option to come into the hardware laboratory (A34) in Infolab21 or we can arrange to meet at a place more convenient for you, if necessary.
 - You will also have the option of accompanying me in the laboratory for the fabrication and assembly of your shape-changing surface.
2. Meeting 2 - Final assembly and testing/evaluation:
- We will evaluate your final shape-changing display or interface based on the list of requirements you set during the first meeting.
 - Once you are happy with the shape-changing display you have designed and built there will be the option of showcasing it to a group of people within your work in order to explore what reaction they have to this new novel way of representing information and data.
3. Optional Demonstration:
- Once the device is successfully fabricated, you have the option of inviting a small group (between 2-8 people maximum) of colleagues to the demo room in InfoLab21 to showcase their shape-changing display.
 - Alternatively, the researcher can set up the device in the participant's workspace (office or laboratory).
 - This optional part of the study will involve an informal group presentation and a short feedback session that will allow us to evaluate the effectiveness and engagement of the shape-changing prototypes developed.
 - The researcher will provide additional consent forms for focus group members, to ensure their involvement in the study is ethically covered.

We will conduct semi-structured interviews throughout each case study to ensure the participant's thoughts and opinions are comprehensively recorded via audio and video. At the beginning of each case study we will ask the participant to pre-define a set of requirements the hardware system must meet in order to be successfully function and representing intended content.

What are the possible benefits from taking part?

You will be directly involved in creating your very own shape-changing display. If you are happy with the final shape-changing display, there is also the option of showcasing the display for your work.

Do I have to take part?

No. It is completely up to you to decide whether or not you take part. Your participation is voluntary and you are free to withdraw at any time, without giving any reason.

What if I change my mind?

As explained above, you are free to withdraw at any time and if you want to withdraw, I will extract any data you contributed to the study and destroy it. Data means the information, views, ideas, etc. that you and other participants will have shared with me. However, it is difficult and often impossible to take out data from one specific participant when it has already been anonymised or pooled together with other people's data. Therefore, you can only withdraw up to 6 weeks after taking part in the study.

We will be using anonymous questionnaires during the study, this means withdrawal may not be possible, because all data is anonymised and therefore the data provided by the person who wants to withdraw cannot be identified.



Aluna Everitt

What are the possible disadvantages and risks of taking part?

Taking part in the study would mean investing a relatively considerable amount of your time, at least two afternoon meeting (each lasting around 2 hours).

Will my data be identifiable?

After the case study, only myself, the researcher conducting this study and my supervisor (Dr. Jason Alexander) will have access to the data you shared with me. I will keep all personal information about you (e.g. your name and other information that can identify you) confidential, I will not share it with others. I will anonymise any audio recordings and hard copies of any data. This means that I will remove any personal information.

How will my data be stored?

Your data will be stored in encrypted files (that is no-one other than me, the researcher will be able to access them) and on password protected computers.

I will store hard copies of any data securely in locked cabinets in my office.

I will keep data that can identify you separately from non-personal information (e.g. your views on a specific topic).

In accordance with University guidelines, I will keep the data securely for a minimum of ten years.

How will we use the information you have shared with us and what will happen to the results of the research study?

I will use the data you have shared with only in the following ways:

- I will use it for academic purposes only. This will include, my PhD thesis and other publications, for example journal articles. I may also present the results of my study at academic conferences.
- When writing up the findings from this study, I would like to reproduce some of the views and ideas you shared with me. When doing so, I will only use anonymised quotes (e.g. from our interview with you), so that although I will use your exact words, you cannot be identified in our publications.
- If anything you tell me in the interview (or other data collection method) suggests that you or somebody else might be at risk of harm, I will be obliged to share this information with my supervisor and/or colleagues. If possible I will inform you of this breach of confidentiality.

Who has reviewed the project?

This study has been reviewed and approved by Dr. Jason Alexander (my supervisor) and the Faculty of Science and Technology's Research Ethics Committee.

What if I have a question or concern?

If you have any queries or if you are unhappy with anything that happens concerning your participation in the study, please contact myself, Aluna Everitt (a.everitt@lancaster.ac.uk) or my supervisor, Dr. Jason Alexander (j.alexander@lancaster.ac.uk).

If you have any concerns or complaints that you wish to discuss with a person who is not directly involved in the research, you can also contact:



Aluna Everitt

- Professor Jon Whittle - head of the School of Computing and Communications
j.n.whittle@lancaster.ac.uk

Thank you for considering your participation in this project.

Aluna Everitt



Semi-Structured Interview Example Questions:

Example Pre Design Phase Questions:

1. What do you traditionally use to show information and data for your work?
(*E.g. bar charts, graphs, info graphics, virtual models*)
 - a) What are the main benefits of using your method of representing data or information?
(*E.g. easy to work with, easy for other people to understand and read the data*)
 - b) What are the main drawbacks of using your method of representing data or information?
(*E.g. hard for other people to understand and interpret the data, difficult task to process the data/information*)
 - c) If possible, what improvements would you make to your current method?
(*E.g. make the data input process easier/faster, make it more visual*)
 - d) Who normally uses the output representation?
(*E.g. work colleagues, clients, researchers, students*)
2. Describe your desired application:
 - a) What task should it achieve?
 - b) List a set of requirements it must achieve in order to successfully fulfil your task:
 - c) What do you expect the advantages of using this system to be?
 - d) What do you expect the disadvantages of using this system to be?
3. Where would you use this system?
(*E.g. at work, presentations etc.*)

Example Post Design Questions:

1. Why did you choose this particular approach for segmenting your input image?
2. Do you prefer a hardware system that has multiple uses with less physical accuracy or just has one application that is more accurate?
 - a) What do you think are the advantages and drawbacks of a multi-use shape-changing system?
 - b) What do you think are the advantages and drawbacks of a single use shape-changing system?

Height and Interaction Questions:

1. What input data did you use for height control?
2. Did you find the colour corresponding to heights a useful approach for elevation input?
3. Did you choose to have direct interaction for your system?
 - If yes, why?
 - If no, why?

Aluna Everitt



Focus Group Information Sheet

I am a PhD student at Lancaster University and I would like to invite you to take part in a brief research focus group about evaluating content generated using semi-solid shape-changing displays and surfaces.

Please take time to read the following information carefully before you decide whether or not you wish to take part in this focus group.

What is the study about?

This study aims to explore content generation using semi-solid shape-changing displays and surfaces. Each participant has been asked to design and make their own semi-solid surface that will be used for representing data and information that is specific to them and their work. The focus group provides an opportunity to showcase the final device built and will help us understand the advantages and drawbacks of using our method of representing information compared to more traditional approaches used.

Why have I been invited?

You have been approached because we are interested in understanding how people from different professional backgrounds can use this form of shape-changing displays to represent data and information specific to their work domains. We would like to know your opinion on this new form of information visualisation and how it can be useful for you.

I would be very grateful if you would agree to take part in this focus group.

What will I be asked to do if I take part?

This focus group will involve an informal presentation of the shape-changing display developed by the main participant and a short feedback session where you, as a member of the focus group, will give your opinion on this new form of information visualisation. This will allow us to evaluate the effectiveness and engagement of the shape-changing prototype developed. The researcher will provide consent forms for all group members, to ensure their involvement in the study is ethically covered.

We will conduct a brief semi-structured discussion to ensure the all focus group member's thoughts and opinions are comprehensively recorded via audio and video.

Do I have to take part?

No. It is completely up to you to decide whether or not you take part. Your participation is voluntary and you are free to withdraw at any time, without giving any reason.

Will my data be identifiable?

After the case study, only myself, the researcher conducting this study and my supervisor (Dr. Jason Alexander) will have access to the data you shared with me. I will keep all personal information about you (e.g. your name and other information that can identify you) confidential, I will not share it with others. I will anonymise any audio recordings and hard copies of any data. This means that I will remove any personal information.



Aluna Everitt

How will my data be stored?

Your data will be stored in encrypted files (that is no-one other than me, the researcher will be able to access them) and on password protected computers.

I will store hard copies of any data securely in locked cabinets in my office.

I will keep data that can identify you separately from non-personal information (e.g. your views on a specific topic).

In accordance with University guidelines, I will keep the data securely for a minimum of ten years.

How will we use the information you have shared with us and what will happen to the results of the research study?

I will use the data you have shared with only in the following ways:

- I will use it for academic purposes only. This will include, my PhD thesis and other publications, for example journal articles. I may also present the results of my study at academic conferences.
- When writing up the findings from this study, I would like to reproduce some of the views and ideas you shared with me. When doing so, I will only use anonymised quotes (e.g. from our interview with you), so that although I will use your exact words, you cannot be identified in our publications.
- If anything you tell me in the interview (or other data collection method) suggests that you or somebody else might be at risk of harm, I will be obliged to share this information with my supervisor and/or colleagues. If possible I will inform you of this breach of confidentiality.

Who has reviewed the project?

This study has been reviewed and approved by Dr. Jason Alexander (my supervisor) and the Faculty of Science and Technology's Research Ethics Committee.

What if I have a question or concern?

If you have any queries or if you are unhappy with anything that happens concerning your participation in the study, please contact myself, Aluna Everitt (a.everitt@lancaster.ac.uk) or my supervisor, Dr. Jason Alexander (j.alexander@lancaster.ac.uk).

If you have any concerns or complaints that you wish to discuss with a person who is not directly involved in the research, you can also contact:

- Professor Jon Whittle - head of the School of Computing and Communications
j.n.whittle@lancaster.ac.uk

Thank you for considering your participation in this project.

CONSENT FORM – MAIN PARTICIPANTS



Project Title: Exploring Content Generation for Semi-Solid Shape-Changing Surfaces.

Name of Researchers: Aluna Everitt, Supervised by - Dr. Jason Alexander

Email: a.everitt@lancaster.ac.uk – j.alexander@lancaster.ac.uk

Please tick each box

1. I confirm that I have read and understand the information sheet for the above study. I have had the opportunity to consider the information, ask questions and have had these answered satisfactorily

2. I understand that my participation is voluntary and that I am free to withdraw at any time, without giving any reason. If I withdraw within 6 weeks of commencement of the study my data will be removed. If I am involved in focus groups and then withdraw my data will remain part of the study.

3. If I am participating in the focus group I understand that any information disclosed within the focus group remains confidential to the group, and I will not discuss the focus group with or in front of anyone who was not involved unless I have the relevant person's express permission.

4. I understand that any information given by me may be used in future reports, academic articles, publications or presentations by the researcher/s, but my personal information will not be included and I will not be identifiable.

5. I understand that my name/my organisation's name will not appear in any reports, articles or presentation without my consent.

6. I understand that any interviews or focus groups will be audio-recorded and transcribed and that data will be protected on encrypted devices and kept secure.

7. I understand that data will be kept according to University guidelines for a minimum of 10 years after the end of the study.

8. I agree to take part in the above study.

 Name of Participant Date Signature

I confirm that the participant was given an opportunity to ask questions about the study, and all the questions asked by the participant have been answered correctly and to the best of my ability. I confirm that the individual has not been coerced into giving consent, and the consent has been given freely and voluntarily.

Signature of Researcher /person taking the consent _____ Date _____ Day/month/year

One copy of this form will be given to the participant and the original kept in the files of the researcher at Lancaster University

CONSENT FORM – FOCUS GROUP



Project Title: Exploring Content Generation for Semi-Solid Shape-Changing Surfaces.

Name of Researchers: Aluna Everitt, Supervised by - Dr. Jason Alexander

Email: a.everitt@lancaster.ac.uk – j.alexander@lancaster.ac.uk

Please tick each box

1. I confirm that I have read and understand the information sheet for the above study. I have had the opportunity to consider the information, ask questions and have had these answered satisfactorily
2. I understand that my participation is voluntary and that I am free to withdraw at any time, without giving any reason. If I withdraw within 6 weeks of commencement of the study my data will be removed. If I am involved in focus groups and then withdraw my data will remain part of the study.
3. If I am participating in the focus group I understand that any information disclosed within the focus group remains confidential to the group, and I will not discuss the focus group with or in front of anyone who was not involved unless I have the relevant person's express permission.
4. I understand that any information given by me may be used in future reports, academic articles, publications or presentations by the researcher/s, but my personal information will not be included and I will not be identifiable.
5. I understand that my name/my organisation's name will not appear in any reports, articles or presentation without my consent.
6. I understand that any interviews or focus groups will be audio-recorded and transcribed and that data will be protected on encrypted devices and kept secure.
7. I understand that data will be kept according to University guidelines for a minimum of 10 years after the end of the study.
8. I agree to take part in the above study.

Name of Participant Date Signature

I confirm that the participant was given an opportunity to ask questions about the study, and all the questions asked by the participant have been answered correctly and to the best of my ability. I confirm that the individual has not been coerced into giving consent, and the consent has been given freely and voluntarily.

Signature of Researcher /person taking the consent _____ Date _____ Day/month/year

One copy of this form will be given to the participant and the original kept in the files of the researcher at Lancaster University

Case Study - Questionnaire

Demographic Questionnaire

* Required

Participant Number *

Your answer

Age *

- 18 - 24
- 25 - 34
- 35 - 44
- 45+
- Prefer not to say

I have good understanding of technical skills *

Technical skills are the knowledge and abilities needed to accomplish mathematical, engineering, scientific or computer-related duties, as well as other specific tasks.

	1	2	3	4	5	
Strongly disagree	<input type="radio"/>	<input type="radio"/>	<input type="radio"/>	<input type="radio"/>	<input type="radio"/>	Strongly agree

Gender *

- Female
- Male
- Other

Case Study - Questionnaire

* Required

Occupational Background

Basic information about your current work background.

Current Occupation *

Your answer

How do you usually represent information and data for your work? *

(E.g. bar charts, spreadsheets, databases, graphs, info graphics, virtual 3D models etc.)

Your answer

The data I use at work is complex for others to understand *

E.g. - non unskilled users will not be able to understand it without a comprehensive explanation.

	1	2	3	4	5	
Strongly Disagree	<input type="radio"/>	<input type="radio"/>	<input type="radio"/>	<input type="radio"/>	<input type="radio"/>	Strongly Agree

If possible, what improvements would you make to your current method for representing information? *

(E.g. make the data input process easier/faster, use visual features etc.)

Your answer

Who normally uses the output representation? *

(E.g. work colleagues, clients, researchers, students)

Your answer

Case Study - Questionnaire

* Required

Describe Your Desired Shape-Changing Display

List a set of requirements your shape-changing display must meet in order to successfully function.

What task should it achieve? *

Your answer

List a set of requirements it must achieve in order to successfully fulfill your task: *

Your answer

What do you expect the advantages of using this system to be?

Your answer

What do you expect the disadvantages of using this system to be?

Your answer

Where would you use this system? *

Your answer

BACK

SUBMIT

Workshop (Chapter 6)



Carleton
UNIVERSITY

Canada's Capital University

**REQUEST FOR CHANGES TO A CLEARED RESEARCH PROTOCOL
INVOLVING HUMAN PARTICIPANTS**

Please direct all questions regarding the completion of this form to an Ethics Coordinator in the Carleton University Office of Research Ethics at: ethics@carleton.ca

1 ADMINISTRATIVE CHANGES

1.1 Do you propose changing the title of the project? Yes No;

1.1.1 If Yes: Please provide the new title and copies of all documentation (Letter of Information, Consent Form, etc.) with the revised title.

Original title	
New title	

1.2 Has your research supervisor changed? Yes No N/A

Original supervisor	
New supervisor	

1.3 Have new team members been added or removed from the project? Yes No;

1.3.1 If Yes: Please provide the name, department and contact information of the new researchers and *submit copies of all documentation with the revised information.*

NAME	EMPLOYEE/STUDENT ID NUMBER	DEPARTMENT	CARLETON EMAIL
Aluna Everitt	101133697	School of Information Technology	AlunaEveritt@cunet.carleton.ca

1.4 Provide the name of person(s) that are being removed.

Last Modified: June 8, 2018

1



Canada's Capital University

REQUEST FOR CHANGES TO A CLEARED RESEARCH PROTOCOL
INVOLVING HUMAN PARTICIPANTS

2 METHODOLOGY

2.1 Are you proposing changes to the methodology or project design? Yes No;

2.1.1 If Yes: Please provide details of the changes

We highlight that our proposed workshop methodology is an addition to the current protocol (we still intend to use the original and therapists protocols). The original methodology has 3 parts: sensor fabrication, controller fabrication, presentation. With our new proposed population, general users of wearable devices (e.g. fitness tracking bracelets), we have redesigned the workshop to consist of 4 phases that focus on group discussions.

Phase 1 – Demo phase (30mins):

Showcase current prototype and its interactive opportunities as a wearable (hand held mechanism).

Phase 2 – Discussion (30mins):

In depth discuss current wearables used by participants – current functional requirements, expectations, possible improvements to existing technology.

Phase 3 – Design Session (1 Hour):

Participants will be asked to design and sketch 3 wearable devices based on the 3D printed we demo and showcase.

Phase 4 – Presentation (40mins):

Participants will present their designs to the group and discuss their rationale and outcomes.

Total time of workshop is 3 hours, including a 20 minutes break for participants. We aim to recruit the maximum of 15 participants for this single workshop.

We will not be asking participants to build any prototypes but rather sketch and discuss their ideas as a group. The basis of this change is to leverage user experience knowledge and opinion of general users to expand our understanding to support the design space for general wearables based on real-world user perspectives.

Because there is no educational benefit to this population for participating (they will not learn to fabricate sensors) we will compensate them with food and beverages during the session.

* Detailed table attached in appendix for methodology.



Canada's Capital University

**REQUEST FOR CHANGES TO A CLEARED RESEARCH PROTOCOL
INVOLVING HUMAN PARTICIPANTS**

3 RESEARCH PARTICIPANTS

3.1 Do you propose changing the participant group selected for the project? Yes No;

3.1.1 If Yes: Please describe the participants and any inclusion criteria (e.g. indicate details such as age group, gender, language, race, ethnicity, and medical conditions. If applicable, describe any exclusion criteria. Please also describe any control groups employed in the study. Provide a justification for the changes and copies of all revised documents.

For this study we would like to new population, the general public. Specifically, we will recruit adult participants representative of the general population, who have at least some experience using a wearable device - such as a fitness tracker bracelet, or smart watch etc. Beyond having some experience with a wearable device, there are not specific inclusion criteria. Because we do not include sensor fabrication or video games for this population, it is not a requirement that they have related skills (as will the previous population).

4 RECRUITMENT

4.1 Do you propose changing the means of participant recruitment for the project? Yes No;

4.1.1 If Yes: Please provide details of the changes and copies of all revised documents.

We do not intend to change the recruitment methods but we have updated the recruitment material for this population.

* Those materials are attached.

5 RESEARCH INSTRUMENT

5.1 Do you propose changes to questionnaire, survey, interview questions/themes or other research instrument? Yes No;

5.1.1 If Yes: Please provide details of the changes and revised copies of all documents.

6 PROJECT RECRUITMENT AND CONSENT DOCUMENTS

6.1 Do you propose changing the project documents for recruitment? Yes No;

6.1.1 If Yes: Please provide details of the changes and copies of all revised documents.
Attached is a new recruitment letter, specific to the new population

6.2 Do you propose changing the project documents for consent? Yes No;

6.2.1 If Yes: Please provide details of the changes and copies of all revised documents.
Attached is a new consent document, specific to the new population.



Canada's Capital University

**REQUEST FOR CHANGES TO A CLEARED RESEARCH PROTOCOL
INVOLVING HUMAN PARTICIPANTS**

7 EXTERNAL REB

7.1 Are you proposing changes because of an external REB review? Yes No;

7.1.1 If Yes: Please provide a copy of the correspondence from the external REB, details of the changes and copies of all revised documents.

8 OTHER CHANGES

8.1 Please include details of other changes to your project not covered in this form.

Appendix – Methodology Details

	Phase 1 – Demo phase (30mins)	Phase 2 – Discussion (30mins)	Phase 3 – Design Session (1 Hour)	Phase 4 – Presentation (40mins)
Detail	<ul style="list-style-type: none"> Showcase current prototype and its interactive opportunities as a wearable (hand held mechanism) <ol style="list-style-type: none"> Showcase interaction techniques possible (device input) Visualisation techniques and opportunities (mainly LEDs – device output) Where in the body we can wear these devices. 	<ul style="list-style-type: none"> In depth discuss current wearables used by participants – current functional requirements, expectations, possible improvements to existing technology 	<p>Participants will be asked to design and sketch 3 wearable devices based on the 3D printed we demo and showcase.</p> <ol style="list-style-type: none"> One device with just input capabilities (e.g. just user interaction) One device with just output capabilities (e.g. just visualisations) One device with both input and output capabilities (use-case where we can use both input and output) 	<p>Presentation (5min per participant – 8 users total - 40mins total – 20min break)</p> <p>Participants will present their designs to the group and discuss their rational and outcomes.</p> <p>* Designs are specifically based on the fabrication approach presented at the start of the workshop.</p>
What we want to achieve	<ul style="list-style-type: none"> Present people (users) with new forms of wearable devices – with novel interactive input and visualisation opportunities 	<ul style="list-style-type: none"> Uncover user’s current expectations for wearables – based on their previous experiences with such devices. Uncover general trends for functional user requirements that go beyond current literature (e.g. where on the body people are okay to wear devices) 	<ul style="list-style-type: none"> Explore/uncover new applications and use cases for wearables based on user’s ideas and designs – using specifically our fabrication approach. 	<ul style="list-style-type: none"> Evaluate and discuss ideas presented by participants as a group Encourage group members to provide constructive feedback for each idea presented

Appendix : Recruitment Material

Poster

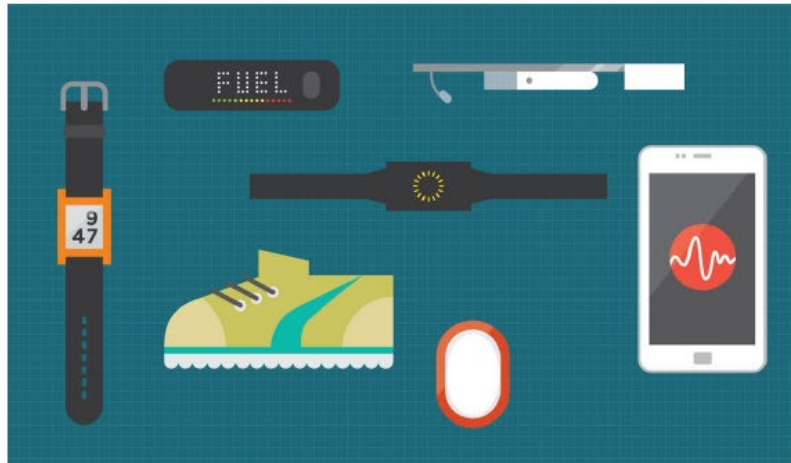

Design Your Own Wearable Tech

Join us for a workshop on:
designing wearable devices of the future.

We will demo new 3D printing technologies to create the next generation of wearable devices

- ✓ You must be over 18 years old
- ✓ Have experience using a wearable device (fitness tracker bracelet, smart watch etc.)



Location: Carleton University (Room TBC)

- Aluna Everitt
AlunaEveritt@cunet.carleton.ca
Wearable Tech
- Aluna Everitt
AlunaEveritt@cunet.carleton.ca
Wearable Tech
- Aluna Everitt
AlunaEveritt@cunet.carleton.ca
Wearable Tech
- Aluna Everitt
AlunaEveritt@cunet.carleton.ca
Wearable Tech
- Aluna Everitt
AlunaEveritt@cunet.carleton.ca
Wearable Tech
- Aluna Everitt
AlunaEveritt@cunet.carleton.ca
Wearable Tech
- Aluna Everitt
AlunaEveritt@cunet.carleton.ca
Wearable Tech
- Aluna Everitt
AlunaEveritt@cunet.carleton.ca
Wearable Tech
- Aluna Everitt
AlunaEveritt@cunet.carleton.ca
Wearable Tech
- Aluna Everitt
AlunaEveritt@cunet.carleton.ca
Wearable Tech



Permission to take part in a research study

Title: DEFORMABLE CONTROLLERS: Fabrication and Design to Promote Novel Hand Gestural Interaction Mechanisms

CUREB-B Clearance # 108433

Date of ethics clearance: February 26, 2018

Ethics Clearance for the Collection of Data Expires: February 28, 2019

What we are studying

During the workshop, you will participate in group-based discussions, focusing specifically on designing new forms of wearable devices. We seek your consent to gather information during the workshop to inform future deformables research. We are interested in: Exploring design ideas for new applications and use cases for deformable wearables. The session is 4 hours long, including a 20 minute break for refreshments (provided). There is no monetary compensation provided for participation.

The researchers for this study are Aluna Everitt and Alex Eady in the School of Information Technology at Carleton University, supervised by Dr. Audrey Girouard, with volunteer facilitators.

We will record

Images and observational notes of the creative process.
Comments made by participants about their design ideas and user experience.

We will not record

Your face, name, or other identifying material.
We will crop or blur images to remove faces in publications. Please be aware that there is still an inherent risk that you may be identifiable in such imagery.

To participate you must be at least 18 years old, able to provide informed consent, and have at least some experience using a wearable device - such as a fitness tracker bracelet, or smart watch etc.

Withdrawing from the study

You have the right to end your participation at any time during the session for any reason, simply inform a facilitator. The information generated during the workshop is collaborative and research notes do not include your name or other identifying information. If you choose to withdraw, we are unable to erase your contributions, but those contributions cannot be used to identify you.

Data protection and use

Research data will be password protected. Hard copies will be kept in a locked cabinet at Carleton University. Research data will be accessible to the researchers and the research supervisor. Once the project is completed, research data will be kept to inform future research. Images and video stills may be used in promotions and publications.

If you would like a copy of the finished research project, you are invited to contact the researcher to request an electronic copy which will be provided to you.

Ethics

The ethics protocol for this project was reviewed and cleared by the Carleton University Research Ethics Board (CUREB-B Clearance # 108433). If you have any ethical concerns with the study, please contact Dr. Andy Adler, Chair, Carleton University Research Ethics Board-B (by phone at (+1) 613-520-2600 ext. 4085 or via email at ethics@carleton.ca).

Researchers contact information

Alex Eady
Information Technology
Carleton University
Alex.Eady@carleton.ca

Aluna Everitt
Information Technology
Carleton University
Aluna.Everitt@carleton.ca

Supervisor contact information

Dr. Audrey Girouard
Information Technology
Carleton University
Audrey.Girouard@carleton.ca

Your Consent

Do you agree to participate in the study: ___Yes ___No

Signature of participant

Date

Signature of researcher

Date