



The Remote Access to Laboratories: a Fully Open Integrated System

R. Sanchez-Herrera*, A. Mejías**, M.A. Márquez***, J.M. Andújar****

*Huelva University, Huelva 21819 Spain (e-mail: reyes.sanchez@die.uhu.es).

** Huelva University, Huelva 21819 Spain (e-mail: mjas@uhu.es).

*** Huelva University, Huelva 21819 Spain (e-mail: marcoa@jesppg.net).

**** Huelva University, Huelva 21819 Spain (e-mail: andujar@uhu.es).

Abstract: An existing lab experience can be made remotely accessible in a relatively easy way. The problem is with the design of a tool which allows any kind of experience to be made remotely accessible. The complexity of this tool is out of discussion. Several universities have been working on it for years. In fact, the Huelva University presented the work “A Complete Solution for Developing Remote Labs” in the 10th IFAC Symposium on Advances in Control Education (2013). Such complete solution was the result of those universities working together. Since then, the joint-work has continued and improvements have also been achieved. Hereafter, a fully open integrated system is presented whose scope is greater than that of 2013. It offers a way to easily implement cloud services for managing the configuration and access to all type of sensors, actuators and controllers (the devices base of the any remote lab). The access proposed is secure, controlled, organized and collaborative.

© 2019, IFAC (International Federation of Automatic Control) Hosting by Elsevier Ltd. All rights reserved.

Keywords: Remote access, instrumentation, remote sensor, remote pilot plant.

1. INTRODUCTION

Among others, in areas such as automation, robotic or electronics, different approaches for remote laboratories (RL) are emerging, which allows access to different kinds of didactic or professional materials. For example, in (Indrusiak et al., 2007) the reader can get a general overview of RL for digital systems design. Andújar et al. (2011) presents an example of this kind of lab, which allows programming and interacting with a Field Programmable Gate Array (FPGA) development board. (Al-Hadithi, B.M. et al., 2016; Chacon et al., 2017; Ruano Ruano, I. et al., 2016) show RL devoted to automatic control. In addition, in the last work a comparative of the most outstanding RL of this kind is included. An example of RL applied to engineering measurement can be seen in (Restivo et al., 2009). (Nayak, S. et al., 2014) and (Mejías Borrero and Andújar Márquez, 2012) present different RL devoted to teaching robotics.

In (Rojko et al., 2010) a power engineering and motion control RL is presented, which offers 18 complete online courses with remote experiments and their corresponding documentation. Within the electrical engineering, there are some other remote platforms, (Callaghan et al., 2013; Cardoso et al., 2015).

With respect to photovoltaic systems, there are multiple studies into the use of remote transmission systems to monitor them such as (Chao and Chen, 2017) and (Koklu and Kilinç, 2016), among others. Within the educational field, the virtual lab possibilities have been explored (Cotfas et al., 2013), and RL, (Blanchard et al., 2014; Freeman et al., 2012; Schauer et al., 2012).

However, in all those RL cited above and many other approaches found in the Literature, the designed solutions to develop RL can be considered specific. Each of them solves, in its own way, the different aspects involved in RL development.

In this paper, a fully open integrated system is proposed, which offers a way to easily implement cloud services for managing the configuration and access to all type of sensors, actuators and controllers (the devices base of the any remote lab). The access proposed is secure, controlled, organized and collaborative.

The main improvements of the present work with respect to the previous version of 2013 are the next:

- The procedure proposed in 2013 was based on Java and the new one on software supported by the new generation of browsers.
- The new procedure can join a set of RL connected to different LANs.
- With the new procedure, the RL is accessible as a cloud service.

2. DESCRIPTION OF THE SYSTEM

Several issues must be clarified before exhibiting the fully integrated tool.

- First, the meaning of “open”. To be open, the system must be able to support devices from different manufacturers whose software does not have to be

compatible, connected to different local area networks (LAN) through the internet.

- Second, the scope of the system. The experimental plant which is to be made remotely accessible must be controllable from a computer. This characteristic is referred as convergent from now on; and, so, the experimental plant becomes a convergent experimental plant (CEP). In addition, the application designed for the user to control his/her experience (user interface, UI) depends on the user's experience. Thus, both the CEP and UI have to be out of the fully open integrated system (FOIS) proposed to implement the RL.

Therefore, according to Fig. 1, the FOIS must include the following (into the blue box):

- An associated PC (personal computer) (2 in Fig. 1), or simply a single-board computer (SBC).
- A camera (3) that is directly connected to the University LAN by means of an ethernet switch (4) or the PC.
- A communication system (5). The corresponding to the FOIS is a specific software designed to automatically generate the necessary communication channels (tunnel) to facilitate transparent access to the CEP via the internet. This communications system, denominated SARLAB (an acronym corresponding to its Spanish name, *Sistema de Acceso Remoto a LABORatorios*, or remote laboratory access system in English), has been designed and developed by the authors of this paper.
- A learning management system (LMS), where the access to the CEP is integrated to optimally solve the academic issues. For example, and of particular importance in the case of RL, the LMS includes a reservation system (developed by the UNED, Spanish acronym for *Universidad Nacional de Educación a Distancia*) that allows for orderly user access 24 hours a day, 7 days a week. Moreover, the proposed solution also facilitates concurrent access.

From the LMS, the user access to the UI (7) (out of the FOIS scope), which runs in the user's computer. It provides the user with all necessary commands and records to monitor and control the CEP as well as the required safety controls. Thus, the UI includes the following elements:

- Live video stream from the camera located at the CEP.
- Augmented reality features, (Andujar et al., 2011), synchronized with the live video stream to enhance the UI.
- Monitorisation and control of the CEP actuators/sensors.
- Required safety features for ensuring correct operation of the CEP.

Although the CEP and the UI are out of the FOIS scope, the authors of this paper also propose a general method to make convergent an experimental plant and other general methods to develop the UI, which could be considered as part of the FOIS.

Regarding the CEP, the FOIS develops a general conditioning/signal processing/communication architecture that can also be considered part of the FOIS. In fact, in order to make convergent an experimental plant, the first step is considering it as a black box with the required number of inputs/outputs. Outputs are sent from the sensors and inputs are received by the actuators. All signals (analogue or digital) must be normalised to standard formats: 0/5 V, 0/3.3 V, PWM and so on (signal conditioning stage). The hardware/software solutions to implement the signal conditioning stage and the A/D and D/A conversion stage may be different in each case, but the purpose of these stages remains the same. Once the experimental plant is completely monitored, the rest of the process does not absolutely depend on its nature. It may be chemical, mechanic, electric or whatever the nature. Thus, the data processing/computing stage is carried out by an associated PC or SBC which connects the experimental plant to the LAN through the network interface.

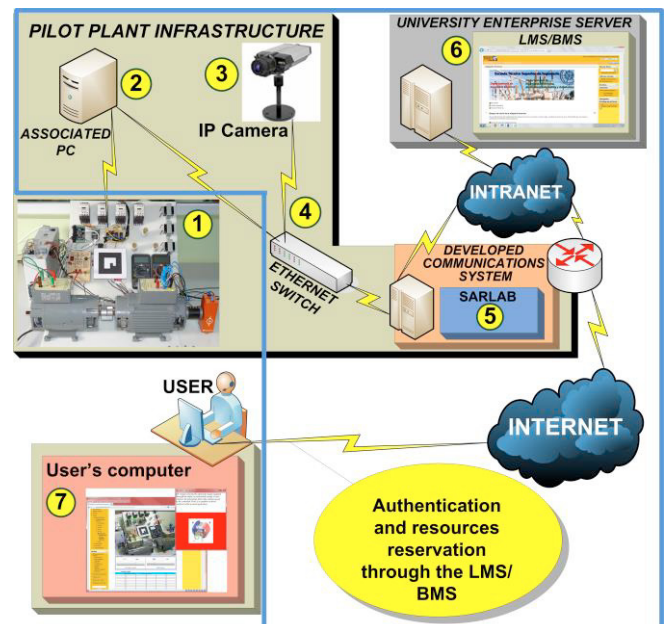

Fig. 1. General scheme of FOIS.

Regarding the UI, a free authoring tool written in Java (although compatible with the constraints of the new generation of browsers) can be created using EJS (easy Java simulations), ("EJS," n.d.), which facilitates interactive simulations, and overcomes the limitations of the proprietary software used by applications such as Matlab or LabView. EJS has been created by the Murcia University. UNED and Huelva University have also worked with EJS to include the tools necessary to develop the UI and to make convergent the experimental plants.

The core of FOIS is the communication system whose characteristics are the basis of the FOIS openness. In fact, SARLAB allows the following goals to be met:

- Internet access to devices connected to different LANs.
- Access control by means of different user profiles, including concurrent access.
- Unification of the access control to devices with different access protocols.
- Access to several commercial devices with proprietary software as well as to devices whose access procedure is implemented in open platforms with low cost software.
- Abstraction of the complexity inherent in communication programming for the RL designer and user.
- Overcoming of limitations associated with the new generation of browsers, whereby their capacity for interaction with the physical system on which they run can be restricted or even eliminated.

Three of the RL functioning in the Huelva University and made remotely accessible using FOIS are presented in the following three sections of this paper. The first is denominated electric machines RL (EMRL). The second is the photovoltaic RL (PRL). The third is the automatization RL (ARL). Although these plants are relatively simple to the potential solution, their particular characteristics allow different technical details regarding implementation to be illustrated. Indeed, our intention is to show the potential for FOIS, rather than the complexity of the plants themselves. In fact, the solution permits the inclusion of as many sensors and actuators as necessary, regardless of the complexity of the plant, as well as providing the procedure and tools for the plant's remote management.

3. THE ELECTRIC MACHINES REMOTE LAB

In this RL, the associated PC is directly connected to the CEP. An axis camera has been used directly connected to the ethernet switch. SARLAB resolves the communication problems. The UI has been embedded in the LMS and runs on the user's computer during access. Access to the UI is available 24/7 via the browser using the corresponding user profile all year around.

The CEP core is an electric machine bench, involving a synchronous generator driven by a DC (Direct Current) machine. The nominal values of the generator are 360 W, 380/220 V AC (alternating current), 1500 rpm with a power factor of 0.72. The DC machine nominal values are 440 W, 220 V DC and 1500 rpm. Both electric machines are coupled to an analogue tachometer, which sends the rotational speed signal to an I/O (input/output) board, ("PhidgetInterfaceKit 8/8/8 Mini-Format - 1010_0 at Phidgets," n.d.), with analogue inputs and digital outputs. This I/O board is directly

connected to an USB port in the associated PC. Its functions are as follows:

- Rotation speed measurement.
- Field current measurement from the current source.
- Switching the current source on/off.
- Turning the RPP supply on/off according to the orders received from the PC through a set of optocoupled relays.
- Configuring the connections suitable for each test of the synchronous generator (vacuum or short circuit tests, among others) through several contactors.

Fig. 2 shows the developed UI with the tools presented in this work. The central part of the display shows the video stream enriched with augmented reality (AR) objects in the form of interactive tabs providing useful explanatory information about the nature and function of the plant. The pop-up displayed when the user selects the DC machine tab is shown at the top right of Fig. 2 while at the bottom right, a graph illustrates the evolution of the actuators' signals.

To appreciate the AR effect, the CEP in the lab is shown in Fig. 3.

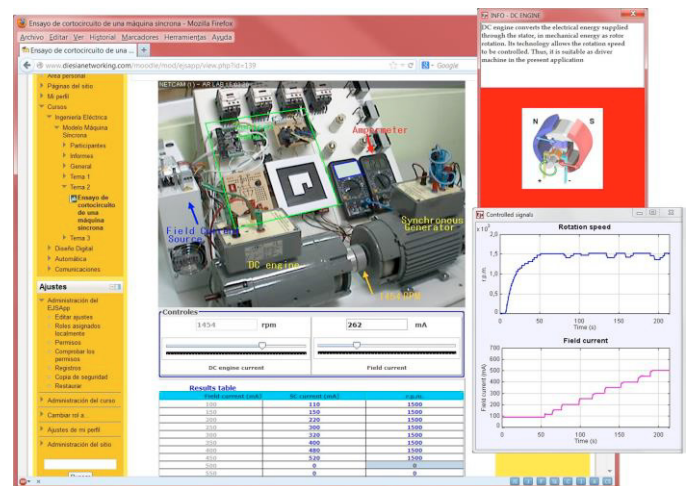

Fig. 2. UI of the EMRL.

In addition, in order to enhance the user's interaction with the UI, the video stream is reinforced with an audio stream; since the variations in rotational speed have a direct effect on the sound produced by the electric machines. Hence, the availability of audio boosts the feeling of being engaged with physical elements, although remotely.

Finally, in the case of this RL, the UI incorporates the required safety measures that are of particular relevance.

The constitution of this EMRL is the basis for designing the lab class to be carried throughout a given topic. The possible lab classes are related to the modelling of the asynchronous machine to the reproduction of its functioning within different conditions and, finally, to its control (Jesús Fraile Mora, 2015).

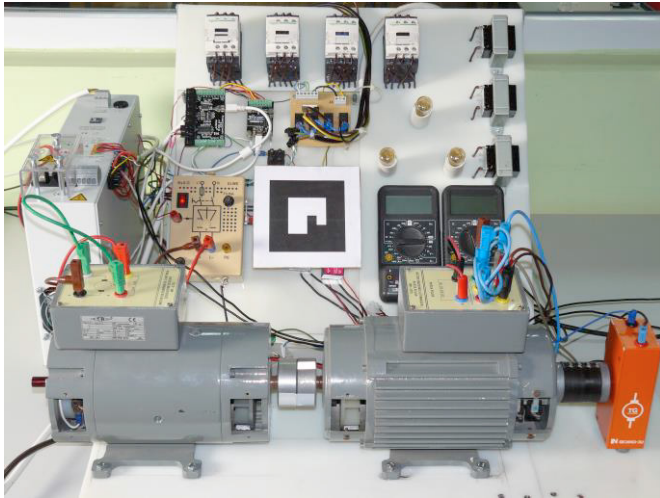

Fig. 3. The experimental plant of the EMRL.

4. THE PHOTOVOLTAIC REMOTE LAB

In this section, a remote experimental system is presented constituted by two photovoltaic modules connected to a variable load and lighted by a variable focus. It allows the students to characteristically obtain different curves and being able to compare them; for example, curves with several irradiances and curves corresponding to one and/or two modules connected in different ways (serial and parallel). In the classroom, students manually switched on/off several luminaries to simulate the variation of the solar irradiance, as well as change the position of a variable resistor (as load) to set the different work points of the photovoltaic panels. In addition, the panels connection was also manually configured.

All these manual activities required the lab class to include the same number of automatic systems to be managed/handled remotely.

In the case of the PRL, the need for energy has been optimized by means of a Raspberry Pi board (a SBC which functions as an associated PC). This switches the system on when a user requires it and switches off when the user finishes the work. In this same way as using open access devices, the I/O boards are Arduino, (“Arduino - Home,” n.d.). They are used to control the light power (variable irradiance on the panels) and the variable load as well as to measure monitored parameters.

The light power that replaces the sun light must be controlled by the corresponding circuit connected to an Arduino board. In addition, the variable load must be controlled. It has also been made by another circuit connected to another Arduino board. There is still another circuit to change connections (series or parallel) of the photovoltaic panels.

Furthermore, the experiment must be accessible from the internet. Thus, the setup modification of working points must be accessible from a TCP/IP network. To unify the method of accessing all these devices through the net involves the standard Modbus serial communications protocol. Modbus allows for sending and receiving data between all the

involved devices with reliability and efficiency. In order to achieve it, different devices in the lab are monitored by an EJS element with Modbus master architecture, (Mejías et al., 2017). In the same way, a Modbus slave must be included in all the Arduino boards.

The UI of the PRL is composed of two parts, as illustrated in Fig. 4. The video image shown at the top displays two photovoltaic panels lit by a variable light source whose irradiance change can be distinguished by the naked-eye by means of the photographic image. In order to enrich the UI, making it more intuitive and user-friendly, the load, I/V meters and panel connection shown in the image are not the real ones, but have instead been developed through AR to provide the following advantages: firstly, AR connections that are more user-friendly; secondly, from the user’s perspective, the appearance (resistance) of the physical load in the PRL operation remains unchanged, and, as such, the values can vary (V1 to V8); voltmeter and ammeter measurements have also been included as AR elements in the UI (0.65 V and 46.08 mA respectively).

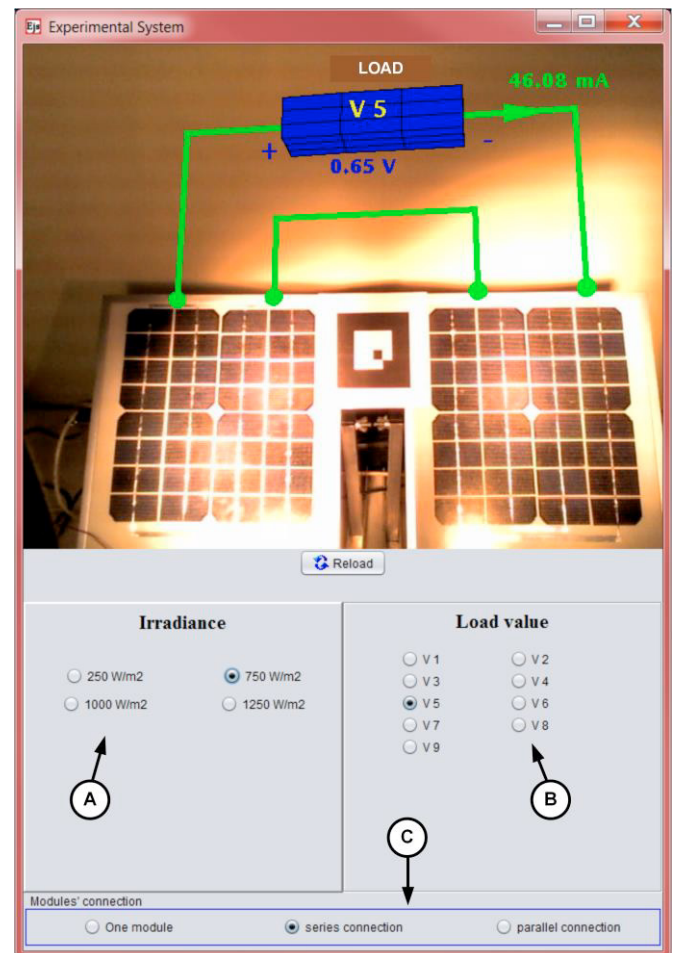

Fig. 4. UI of the PRL.

The second part of the UI, illustrated at the bottom of Fig. 4, contains the control parameters that the user has to manage: the irradiance received by the panel (depending on the lighting power of the scenario, the focus power can be modified continuously, although only four typical values can

be selected in the UI (A); the load value (B); and the panels' connections (individual, two in series or in parallel) (C).

5. THE REMOTE LAB AUTOMATIZATION

In this section, a RL is presented that is composed of an industrial automation plant, which student can control remotely and test the control programme implemented, also remotely, into the corresponding PLC (programmable logic controller). The interface, designed in EJS framework, has been "augmented" by 3D virtual objects that interact with the real ones. The software used to programme the industrial PLC is that proposed by the manufacture. The use of this kind of software into the navigator framework is one of the SARLAB's indisputable advantages/strength.

Fig. 5 shows the UI, "augmented" by 3D virtual objects that interact with the real ones. This figure may be compared with Fig. 6, which shows the original video stream received from the camera located in the University lab classroom.

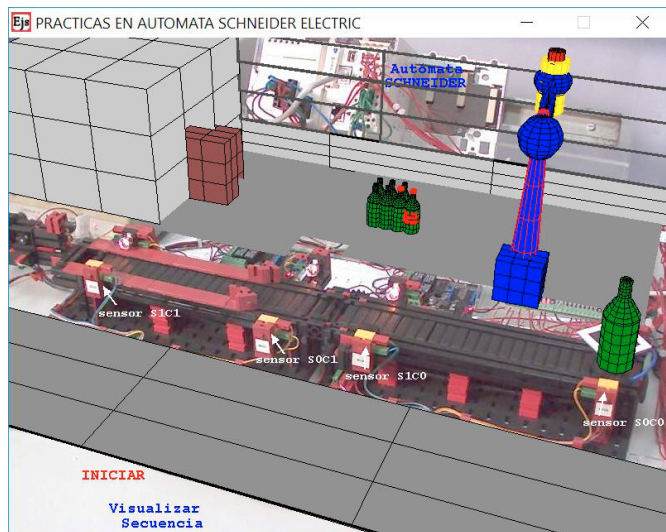

Fig. 5. The UI of the ARL.

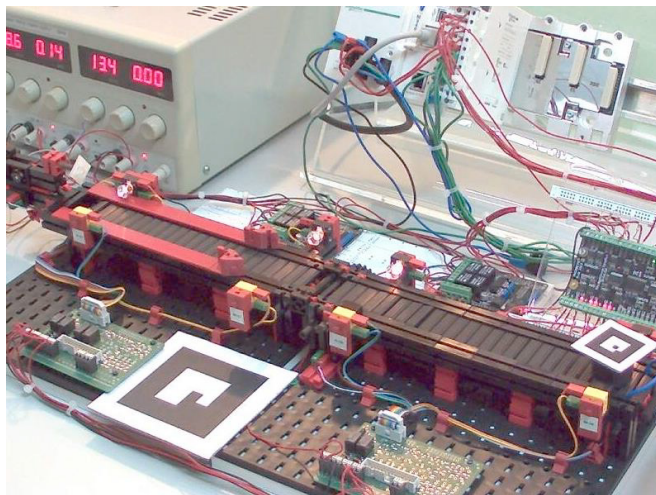

Fig. 6. The ARL experimental plant.

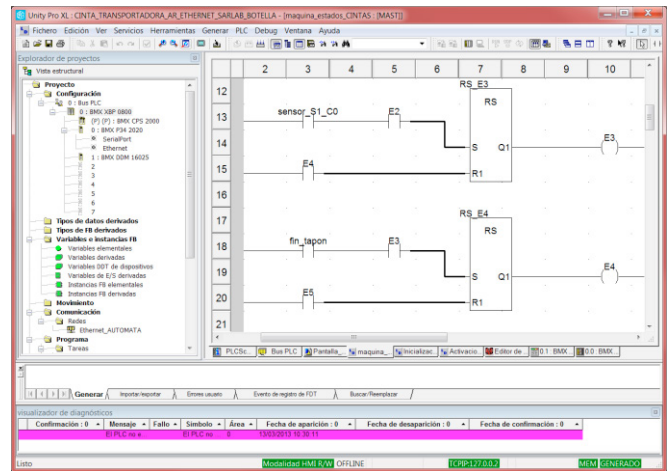

Fig. 7. Design tool (Unity Pro XL) used by the student to programme the PLC.

In Fig. 6, the ARToolkit markers used to properly superimpose the 3D virtual elements can be seen. Through its computer interface, the student can remotely operate the PLC, so that he/she can observe the evolution of the real plant according to the schedule that he/she has sent to the PLC.

The AR system transforms the conveyor belt in an automated industrial plant that must place a plug and a label into the bottle which is moved by the belt. In this case, real and virtual elements interact with each other sharing the same three-dimensional space. The PLC programming is performed remotely using the design tool (Fig. 7) provided by the PLC manufacturer. The PLC used is a Modicon M340 from Schneider ElectricTM, Schneider Electric (2013). This software uses SARLAB to remotely access the PLC.

5. CONCLUSIONS

This paper presents a fully open integrated system to make experimental plants accessible through the internet. The experimental plant can be configured with elements from different manufacturers, despite incompatibility. Thus, the system is appropriated for any kind of experimental plants and adaptable to different technologies.

Evidence of the effective potential of the proposed system is the number of projects successfully utilising the technology; three of which are outlined in this paper. These three examples have been selected for they demonstrate the adaptability of the system and allow including different technical details such as innovative problem solving techniques. The first RL example relates to the operation of electric machines; the second deals with the management of photovoltaic panels; and the last reproduces an automated industrial plant.

The proposed fully open integrated system facilitates the remote management of the labs via an internet browser, through a friendly UI, 24 hours a day, 7 days a week, using the corresponding user profile. Furthermore, it even switches the power supply on when the RL is in use and shuts it off otherwise.

REFERENCES

- Al-Hadithi, B.M., Cena, C.E.G., León, R.C., Loor, C.L., 2016. Development of an Artificial Intelligent Lighting System for Protected Crops. *Rev Iberoam Automática E Informática Ind RIAI* 13, 421–429.
- Andujar, J.M., Mejias, A., Marquez, M.A., 2011. Augmented Reality for the Improvement of Remote Laboratories: An Augmented Remote Laboratory. *IEEE Trans. Educ.* 54, 492–500. <https://doi.org/10.1109/TE.2010.2085047>
- Arduino - Home [WWW Document], n.d. URL <https://www.arduino.cc/> (accessed 2.4.19).
- Blanchard, R., Williams, S., Bliss, M., Clowes, M., Mohammed, A., Pancholi, R., 2014. Educating the world: A remote experiment in photovoltaics, in: 2014 1st International Conference on Non Conventional Energy (ICONCE 2014). Presented at the 2014 1st International Conference on Non Conventional Energy (ICONCE), IEEE, Kalyani, India, pp. 28–32. <https://doi.org/10.1109/ICONCE.2014.6808676>
- Callaghan, M.J., McCusker, K., Losada, J.L., Harkin, J., Wilson, S., 2013. Using Game-Based Learning in Virtual Worlds to Teach Electronic and Electrical Engineering. *IEEE Trans. Ind. Inform.* 9, 575–584. <https://doi.org/10.1109/TII.2012.2221133>
- Cardoso, A., Sousa, V., Leitão, J., Graveto, V., Gil, P., 2015. Demonstration of identification and control of nonlinear systems using a remote lab, in: 2015 3rd Experiment International Conference (Exp.at'15). Presented at the 2015 3rd Experiment International Conference (exp.at'15), pp. 97–98. <https://doi.org/10.1109/EXPAT.2015.7463224>
- Chacon, J., Saenz, J., Torre, L.D. la, Diaz, J.M., Esquembre, F., 2017. Design of a Low-Cost Air Levitation System for Teaching Control Engineering. *Sensors* 17, 2321. <https://doi.org/10.3390/s17102321>
- Chao, K.-H., Chen, C.-T., 2017. A remote supervision fault diagnosis meter for photovoltaic power generation systems. *Measurement* 104, 93–104. <https://doi.org/10.1016/j.measurement.2017.03.017>
- Cotfas, D.T., Cotfas, P.A., Ursutiu, D., Samoila, C., 2013. RElab - virtual laboratory of the renewable energy, in: 2013 10th International Conference on Remote Engineering and Virtual Instrumentation (REV). Presented at the 2013 10th International Conference on Remote Engineering and Virtual Instrumentation (REV), pp. 1–5. <https://doi.org/10.1109/REV.2013.6502901>
- EJS [WWW Document], n.d. URL <http://fem.um.es/Ejs/> (accessed 5.7.19).
- Freeman, J., Nagarajan, A., Parangan, M., Kumar, D., Diwakar, S., Achuthan, K., 2012. Remote triggered photovoltaic solar cell lab: Effective implementation strategies for Virtual Labs, in: 2012 IEEE International Conference on Technology Enhanced Education (ICTEE). Presented at the 2012 IEEE International Conference on Technology Enhanced Education (ICTEE), pp. 1–7. <https://doi.org/10.1109/ICTEE.2012.6208653>
- Indrusiak, L.S., Glesner, M., Reis, R., 2007. On the Evolution of Remote Laboratories for Prototyping Digital Electronic Systems. *IEEE Trans. Ind. Electron.* 54, 3069–3077. <https://doi.org/10.1109/TIE.2007.907010>
- Jesús Fraile Mora, 2015. MAQUINAS ELECTRICAS. GRUPO EDITORIAL GARCETA, España.
- Koklu, T., Kilinç, S., 2016. Remote monitoring of photovoltaic systems using embedded system clusters. 2016 24th Signal Process. Commun. Appl. Conf. SIU 1133–1136. <https://doi.org/10.1109/SIU.2016.7495944>
- Mejías, A., Herrera, R.S., Márquez, M.A., Calderón, A.J., González, I., Andújar, J.M., 2017. Easy Handling of Sensors and Actuators over TCP/IP Networks by Open Source Hardware/Software. *Sensors* 17, 94. <https://doi.org/10.3390/s17010094>
- Mejías Borrero, A., Andújar Márquez, J.M., 2012. A Pilot Study of the Effectiveness of Augmented Reality to Enhance the Use of Remote Labs in Electrical Engineering Education. *J. Sci. Educ. Technol.* 21, 540–557. <https://doi.org/10.1007/s10956-011-9345-9>
- Nayak, S., Vakrani, P., Purohit, A., Prasanna, N.S., 2014. Remote Triggered Lab for Robotics: Architecture, Design and Implementation Challenges. Presented at the IEEE Sixth International Conference on Technology for Education, pp. 214–217.
- PhidgetInterfaceKit 8/8/8 Mini-Format - 1010_0 at Phidgets [WWW Document], n.d. URL <https://www.phidgets.com/?tier=3&catid=2&pcid=1&prodid=3> (accessed 2.5.19).
- Restivo, M.T., Mendes, J., Lopes, A.M., Silva, C.M., Chouzal, F., 2009. A Remote Laboratory in Engineering Measurement. *IEEE Trans. Ind. Electron.* 56, 4836–4843. <https://doi.org/10.1109/TIE.2008.2011479>
- Rojko, A., Hercog, D., Jezernik, K., 2010. Power Engineering and Motion Control Web Laboratory: Design, Implementation, and Evaluation of Mechatronics Course. *IEEE Trans. Ind. Electron.* 57, 3343–3354. <https://doi.org/10.1109/TIE.2009.2031189>
- Ruano Ruano, I., Gámez García, J., Gómez Ortega, J., 2016. PID Control SCORM Web Laboratory with advanced Integration. *Rev Iberoam Automática E Informática Ind RIAI* 13, 472–483.
- Schauer, F., Ožvoldová, M., Čerňanský, P., Gerhátová, Ž., Tkáč, L., Kostelníková, M., 2012. Material science Internet Remote Experiments: Solid state photovoltaic inorganic and organic/inorganic nanoheterostructural cell characterization in teaching, in: 2012 15th International Conference on Interactive Collaborative Learning (ICL). Presented at the 2012 15th International Conference on Interactive Collaborative Learning (ICL), pp. 1–4. <https://doi.org/10.1109/ICL.2012.6402116>