

SIMPLE APPROACH FOR INDUCTION MOTOR CONTROL USING RECONFIGURABLE HARDWARE

Maria IMECS*, Ioan I. INCZE*, Csaba SZABÓ*, József VÁSÁRHELYI**

**Technical University of Cluj-Napoca
P.O. 1, Box 99, RO-3400, Cluj-Napoca, Romania
imecs@edr.utcluj.ro*

***Department of Automation University of Miskolc
H-3515 Miskolc Egyetemváros, Hungary
vajo@mazsola.iit.uni-miskolc.hu*

Abstract: The paper deals with rotor-field-oriented vector control structures for the induction motor drives fed by the so-called tandem frequency converter. It is composed of two different types of DC-link converters connected in parallel arrangement. The larger-power one has current-source character and is operating synchronized in time and in amplitude with the stator currents. The other one has voltage-source character and it is the actuator of the motor control system. The drive is able to run also with partial-failed tandem converter, if the control strategy corresponds to the actual operating mode. A reconfigurable hardware implemented in configurable logic cells ensures the changing of the vector-control structure. The proposed control schemes were tested by simulation based on Matlab-Simulink model.

Keywords: Frequency converter, Induction motor, Field-orientation principle, Vector control, Reconfigurable logic, Simulation, Variable speed drives.

1. INTRODUCTION

The dynamic behaviour of the AC drives is substantially improved by vector-control system based on the field-orientation principle. The structure of the control is also considerable determined by the type of the Static Frequency Converter (SFC) or/and the pulse-modulation procedure used for supplying the vector-controlled machine, especially it is depending on the current- or voltage-source character of the converter (Kelemen and Imecs, 1991).

The “*tandem*” configuration was proposed as a new solution of the SFC for medium- and high-power AC drives. It is a hybrid SFC, which combines the advantages of two component DC-link converters, which are of different type and different power range, and they are working in parallel arrangement (Trzynadlowski, *et al.*, 2001).

The control of the tandem-converter-fed induction motor may be achieved using conventional vector-control structures (Imecs, *et al.*, 2002). If one of the component SFCs fails, in order to continue the drive its mission, (with modified performances) the structure of the motor control system should be changed depending on the actual working component SFC. This change may be accomplished by a reconfigurable logic structures based on Field-Programmable Gate Arrays (FPGA) or Configurable System on Chip (CSoC).

2. ANALYSIS OF TANDEM-CONVERTER-FED VECTOR CONTROL SCHEME

The larger SFC of the tandem converter (see Fig.1) contains a conventional Current-Source Inverter (CSI) operating with 120° current waveforms controlled by

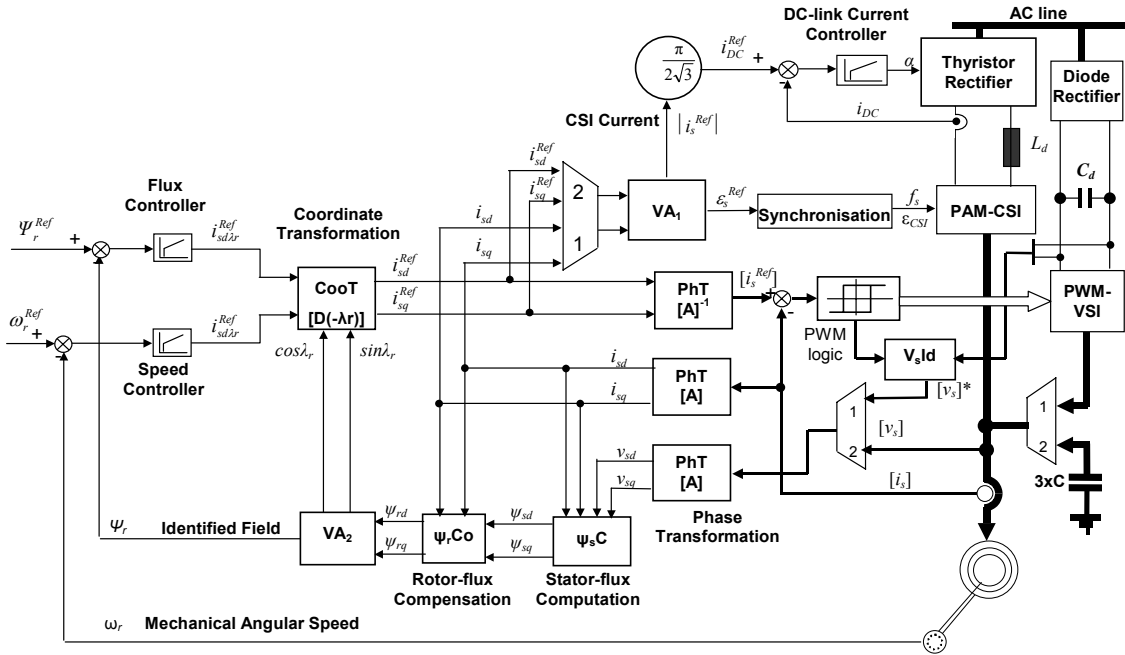

Fig. 1. Reconfigurable vector control structure with two configuration states.

Pulse-Amplitude Modulation (PAM) and it converts the most part of the motor feeding energy. The smaller component SFC involves a well-known Voltage-Source Inverter (VSI) controlled by Pulse-Width Modulation (PWM) and it supplies the power required to improve the quality of the motor currents in order to compensate them in sine-wave shape (Trzynadlowski, *et al.*, 1998). Consequently, the current in each stator phase will be given by the sum of the currents belonging to the two parallel working inverters:

$$(1) \quad i_s = i_{CSI} + i_{VSI}.$$

In this way it is no more necessary to apply PWM procedure to control the whole energy, because a large value of it is transferred through the PAM-CSI, operating with reduced number of commutations. In tandem-operation mode the CSI needs a rigorous synchronization with respect to the motor currents. The synchronization in time assures the appropriate switching moments ε_{CSI} (and inherently the switching frequency f_s). The synchronization in amplitude ensures the equality between the fundamental component of the injected current and the stator-phase-current of the motor. Vector analyser VA_1 delivers the reference quantities required for synchronization, i.e. the angle and the amplitude of stator currents. A thyristor rectifier supplies the DC-link, which realises the PAM of the CSI currents by means of a PI controller.

Due to the voltage-source character of the tandem converter, the motor absorbs freely its stator currents.

Consequently, the VSI will be the actuator ensuring the vector control of the induction motor drive. It is possible to apply the common PWM procedures (voltage- or current controlled ones) characteristic to the VSIs. (Imecs, *et al.*, 2001a).

Applying to the VSI current-controlled-PWM, in manner of the "bang-bang" converter, the tandem-converter-fed motor will be controlled in fact in current. Constant switching frequency is obtained using synchronized on-off switching controllers (Imecs, 1998). The above-mentioned procedures are appropriate for field-orientation-based tandem-fed drives (Imecs, *et al.*, 2002).

In Fig. 1 the induction motor operates supplied from the both converters in tandem mode (corresponding to position 1 of the multiplexers). Supposing a fail of the VSI the control structure has to be adapted to the new working condition, i.e. running supplied only by the CSI (position 2 of the multiplexers). That is realized by hardware reconfiguration of the structure. In both operating modes rotor-field orientation was used due to its simplicity. In the tandem-fed mode, the VSI operates with current feedback loops. Because of the difficulties encountered by direct measurement of the modulated-voltage waves, the stator voltage is identified in block V_sId using the measured DC-link voltage and the state of inverter switches according to the PWM logic and taking into account the voltage losses on semiconductor devices, too. Based on the stator-voltage and current components transformed in d-q reference frame, the block Ψ_sC integrates the natural stator-voltage equations yielding at its outputs

the stator-flux d-q components. In order to obtain the orientation flux, the block Ψ_r Co compensates the stator flux, according to following equations (Kelemen and Imecs, 1991):

$$(2) \quad \begin{aligned} \psi_{rd} &= (1 + \sigma_r) \psi_{sd} - [(1 + \sigma_r)L_{\sigma s} + L_{\sigma r}] i_{sd} \\ \psi_{rq} &= (1 + \sigma_r) \psi_{sq} - [(1 + \sigma_r)L_{\sigma s} + L_{\sigma r}] i_{sq} \end{aligned}$$

The vector-analyser VA_2 computes the amplitude and the angular position of the orientation field. The reference values of the stator-current space-phasor components are obtained from the flux- and speed-control loops. After the coordinate transformation they will be transformed in the three-phase references of the hysteresis deadband current-controllers (Imecs 1998 and Sütő 2001).

In CSI-fed mode the VSI will be replaced by three filtering capacitors to avoid the current spikes in the motor. In this case the stator-voltages are directly measurable. The identification of the orientation field is made similarly as in tandem-fed mode. For the generation of the current reference signals there are used the same flux- and speed-controllers, but with modified parameters. It is evident; the switching from operation in the tandem mode to CSI mode doesn't need complicated changing in the control structure.

3. RECONFIGURABLE CONTROL

The dynamic reconfiguration of a control system for AC drives means, the change of the computing platform structure (hardware) by a real-time application (software). In this concept, each configuration is considered as a state of a logic state machine. When a reconfiguration condition occurs, the system will start the reconfiguration process in which it will switch the actual configuration layer to the next one (Sanders, 1998; Imecs, *et al.*, 2000a).

The reconfigurable state machine for the vector control structure previously presented (see Fig. 2) is working in **State 1** as a *tandem converter-fed drive*. For the case of the logic state machine in **State 2**, only the CSI is working. Its currents are synchronized with respect to the control variables of the stator-current vector. The transition from **State 1** to **State 2** is made if the VSI is failed and the control structure needs to be reconfigured in order to be able to control the AC drive with the Current-Source Inverter (Imecs, 2000a; Vásárhelyi, *et al.*, 2000). **State 3** could be another configuration of the vector control system if the CSI failed and only the VSI is able to feed the motor. It is suitable only at reduced load conditions. The CSI has to be blocked, and the same structure may control the VSI fed-drive as in tandem-fed mode.

Analysing the two control systems, some modularity can be observed and a module library was created for fast implementation of motor control applications in

reconfigurable hardware structures. The modularity presents importance if the implementation target is based on reconfigurable hardware, such as FPGAs or

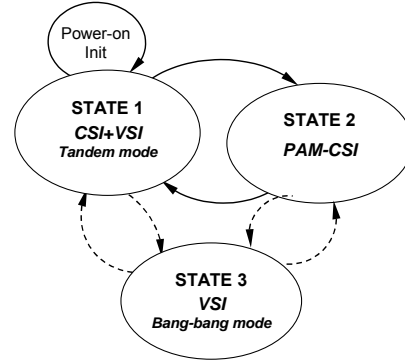

Fig. 2. State machine with three states for the tandem drive.

CsoC (Vásárhelyi, *et al.*, 2000).

Implementation on CSoC presents the advantage of an on chip RISC processor (in case of Triscend's system it is an ARM7) core, but the resources of the Configurable System Logic are somehow limited for hardware implementation as a whole control structure (Imecs, *et al.*, 2001c). An implementation in FPGA overcomes this drawback (Imecs, *et al.*, 2001b).

One of the most common and often-used modules is the Vector Analyser (VA). It is for the computing the module and angle position of a space-phasor. Its equations are given in general form, as follows:

$$(3) \quad g = \sqrt{g_d^2 + g_q^2}; \quad \sin \lambda = \frac{g_q}{g}; \quad \cos \lambda = \frac{g_d}{g}.$$

Other two modules also commonly used in vector-control structures are the direct and reverse Coordinate-Transformation ones $CoT[D(\pm\lambda)]$, which are described by the following general equations:

$$(4) \quad \begin{aligned} g_{sd\lambda} &= g_{sd} \cos \lambda \pm g_{sq} \sin \lambda; \\ g_{sq\lambda} &= g_{sq} \cos \lambda \mp g_{sd} \sin \lambda. \end{aligned}$$

One should mention also the other usual modules, like the direct and reverse Phase-Transformation ones $PhT[A]$ and $PhT[A]^{-1}$, respectively - for currents and voltages. For all the above-mentioned modules, when reconfiguration occurs, there is no need for variable transfer because these modules make all computation operations using only the actual sampled values (Imecs, *et al.*, 2001c).

The elements of the library are the most common modules of a vector control system and each of them presents a standalone unit in the library. There is the possibility to use them in other vector control systems, too (Vásárhelyi, *et al.*, 2002a).

The use of the module library increases the

computation speed, too. This results from the parallel algorithm computation of both components (d-q) and the parallel computation of each module. This would be a significant advantage compared to the DSP sequential implementations.

4. SIMULATION RESULTS

MATLAB-Simulink simulation was performed for the presented vector-control-system structures. The rated data of the motor are: 5.5 kW, 720 rpm, 50 Hz, 220/380 V^{rms}, 24.3/14 A^{rms}, cos φ = 0.735. There are simulated the behaviour of the system for the following operation modes: the starting (at negative speed reference) with speed-dependent load torque, first in tandem-fed mode and after 1.3 sec a speed reversal was performed, then at 1.9 sec it was followed by the reconfiguration of the vector-control structure corresponding to the CSI-fed mode. In Fig. 3-9 and Fig. 11-15 are presented the simulation results during the whole above described period. Fig. 10 and 16 show details of the tandem and condenser currents.

The behaviour of the tandem-fed motor system is comparable to the traditionally vector-controlled drives supplied by VSI with voltage- or current-controlled PWM procedures (Imecs, *et al.*, 2002). The reconfiguration process introduces perturbations, especially due to the deformed stator currents.

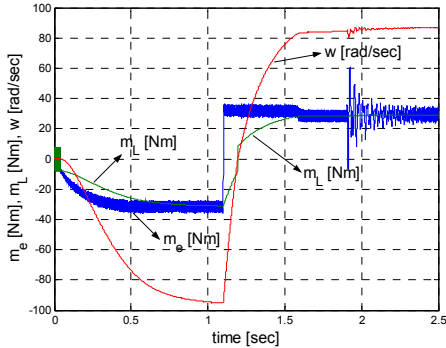

Fig. 3. Rotor electrical-angular speed ω , electromagnetic- m_e and load-torque m_L versus time.

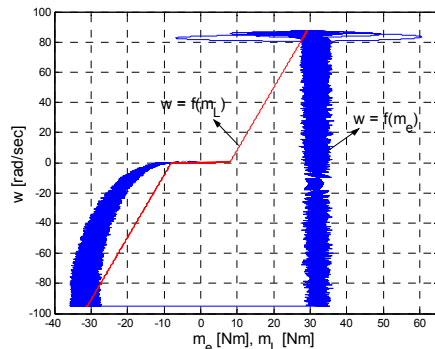

Fig. 4. Motor and load mechanical characteristics during starting, speed reversing and reconfiguration.

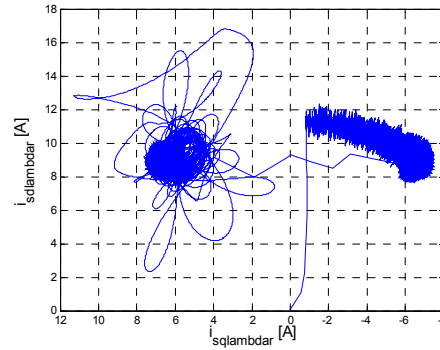

Fig. 5. Stator-current space-phaser diagram in the rotor-field-oriented reference frame.

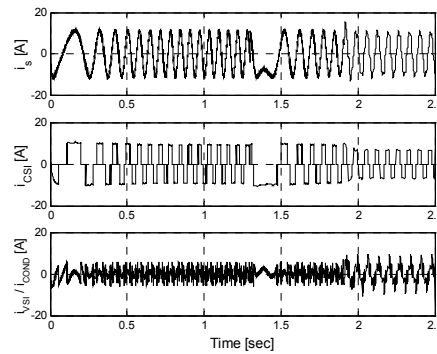

Fig. 6. Current waveforms in a motor phase and at the output of the CSI and VSI/condensers.

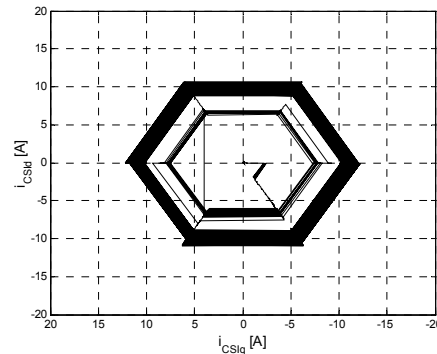

Fig. 7. CSI-current space-phaser diagram in the stator-fixed reference frame.

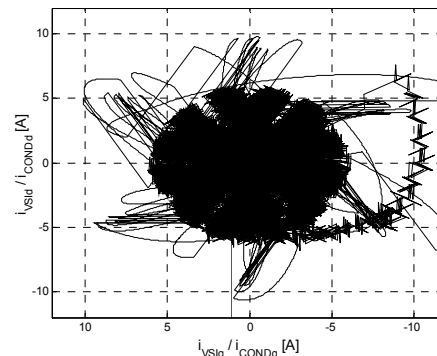

Fig. 8. VSI/condenser-current space-phaser diagram in the stator-fixed reference frame.

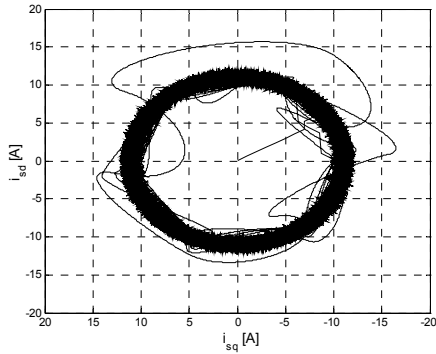

Fig. 9. Stator-current space-phasor diagram in the stator-fixed reference frame.

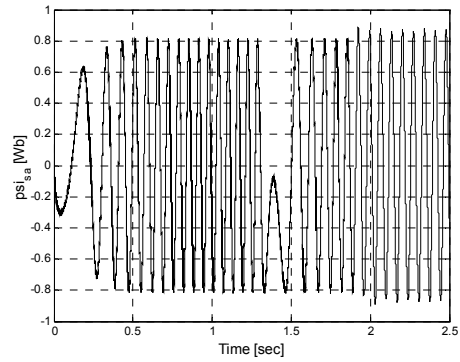

Fig. 13. Stator-flux d component versus time.

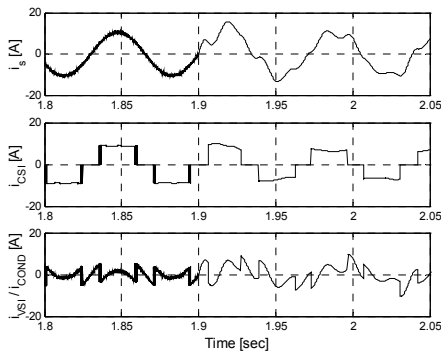

Fig. 10. Motor-, CSI- and VSI/condenser currents before and after the reconfiguration process.

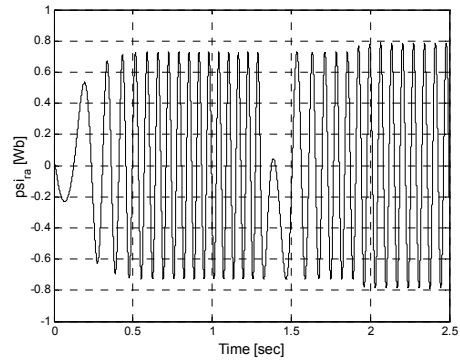

Fig. 14. Rotor-flux d component versus time.

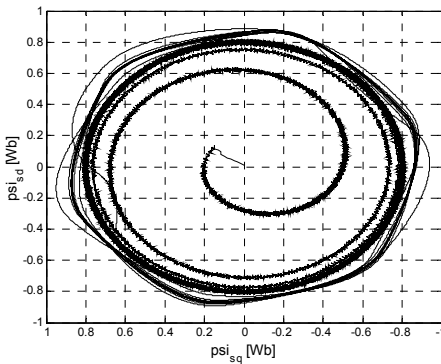

Fig. 11. Stator-flux space-phasor diagram in the stator-fixed reference frame.

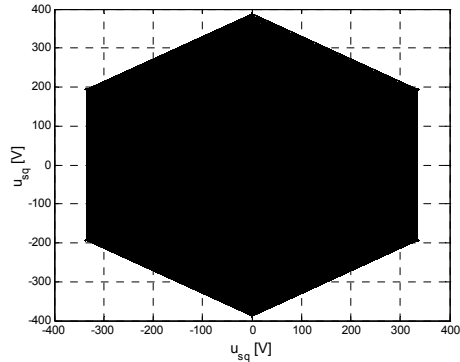

Fig. 15. Stator-voltage space-phasor diagram in the stator-fixed reference frame.

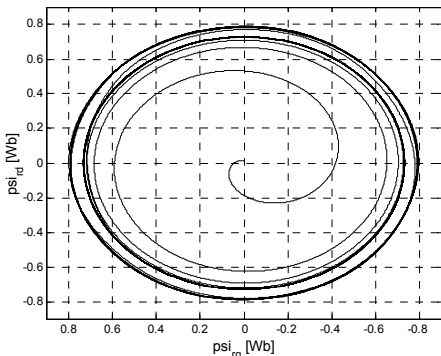

Fig. 12. Rotor-flux space-phasor diagram in the stator-fixed reference frame.

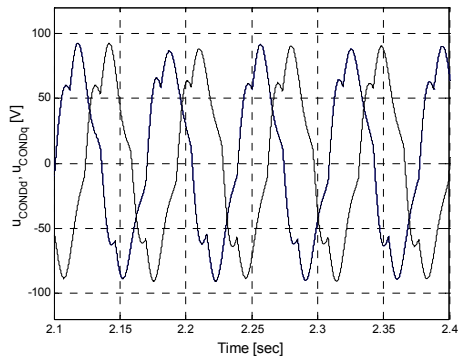

Fig. 16. Condenser-voltage d-q components time diagram after reconfiguration.

5. CONCLUSIONS

The voltage-source character of the tandem converter permits the all vector-control methods usually applied for the VSI-fed drives irrespective of the PWM procedure, voltage- or current-controlled ones. In comparison to other vector-control structures applied before for the tandem-fed induction motor, the rotor-flux orientation here excels in its simplicity and easy implementation due to the current-source character of the SFC in both operating modes from Fig. 1 (Imecs *et al.*, 2002). There are remarkable the following features:

- the only needed computing blocks are the stator-flux computation and rotor flux compensation ones;
- there is no need for cross-effect computing block;
- repeated use of some conventional blocks like the vector analyser and phase-transformation one;
- reduced number of controllers.

The reconfigurable structure - implemented on FPGA or CSoC - allows the adapting of the control system to the actually operating situations. The created module library serves the rapid development of the model-based vector-control systems for AC drives. The module parameters are freely modifiable on demand. It allows the simulation of the reconfiguration process and its effects on the behaviour of the AC drive.

6. ACKNOWLEDGMENT

A research project in the subject of the "tandem inverter" was realized at the Institute of Energy Technology, Aalborg University, Denmark. Special thanks to Prof. A. Trzynadlowski from Nevada University, Reno, USA for the collaboration in this theme, to Prof. F. Blaabjerg from the Aalborg University and to the Danfoss Drive A/S, Denmark for their generous support.

The authors are grateful to Triscend Inc. and Xilinx Inc. for donations, which made possible the research on some aspects of reconfigurable vector control framework.

7. REFERENCES

- Imecs, Maria (1998). Synthesis About Pulse Modulation Methods in Electrical Drives – Part 1 and 2. In: *Proceedings of the 9-th National Conference on Electrical Drives, CNAE '98*, pp. 19-33. Craiova, Romania.
- Imecs, Maria, A. M. Trzynadlowski, I. I. Incze, Cs. Szabó (2002). Vector Control Structures of the Tandem Converter Fed Induction Motor. In: *Proceedings of the 8th International Conference on Optimization of Electrical and Electronic Equipments, OPTIM 2002*, CD-ROM and volume II, pp. 475-48. Braşov, Romania.
- Imecs, Maria, I. I. Incze, Cs. Szabó (2001a). Control Strategies of Induction Motor Fed by a Tandem DC-Link Frequency Converter. In: *Proceedings of the 9th European Conference on Power Electronics and Applications, EPE 2001*, CD-ROM and volume pp. L1b-7. Graz, Austria.
- Imecs, Mária, J. Vásárhelyi, J. J. Incze, Cs. Szabó (2001b). Tandem Converter Fed Induction Motor Drive Controlled with Re-Configurable Vector Control System. In: *Proceedings of International PCIM 2001 Conference*, CD-ROM and volume: *Intelligent Motion*, pp 341-346. Nürnberg, Germany.
- Imecs, Mária, J. Vásárhelyi, J. J. Incze, Cs. Szabó (2001c). Vector Control of Tandem Converter Fed Induction Motor Drive Using Configurable Hardware. In: *Proceedings of International Conference on Intelligent Engineering Systems, INES 2001*, pp 489-494. Helsinki, Finland.
- Imecs, Mária, P. Bikfalvi, S. Nedeveschi, J. Vásárhelyi (2000a). Implementation of a Configurable Controller for an AC Drive Control - a Case Study. In: *Proceedings of IEEE Symposium on FPGAs for Custom Computing Machines, FCCM 2000*, pp. 323-324. Napa, CA, USA.
- Kelemen, Á. and Mária Imecs (1991). *Vector Control of AC Drives*, Electrical Engineering Library, of MEE, Editor TU of Budapest, ISBN 963-593-140-9. OMIKK Publisher, Budapest, Hungary.
- Sanders, A. (1998). The Design and Implementation of Context Switching FPGA, In: *Proceedings of IEEE Symposium on FPGAs for Custom Computing Machines, FCCM 1998*, pp. 78-85. Los Alamitos, CA, USA.
- Sütő, Z. and I. Nagy (2001). Nonlinear Dynamics in Two and in Four Energy Storage Hysteresis Controlled Converter Systems, In: *Proceedings of Conference on Electrical Drives and Power Electronics, EDPE 2001*, pp. 108-113, The High Tatras, Slovakia.
- Trzynadlowski, A. M., F. Blaabjerg, J. K. Pedersen, Niculina Patriciu (1998). The Tandem Inverter: Combining the Advantages of Voltage-Source and Current-Source Inverters. In: *Proceedings of Applied Power Electronics Conference, APEC'98*, pp.315-32. Anaheim, CA, USA.
- Trzynadlowski, A. M., Niculina Patriciu, F. Blaabjerg, J. K. Pedersen (2001). A Hybrid, Current-Source/Voltage-Source Power Inverter Circuit. In: *IEEE Transactions on Power Electronics*, 2001 Vol.16, No. 6, pp. 866-871.
- Vásárhelyi, J., Mária Imecs, J. J. Incze, Cs. Szabó, (2002a). Module Library for Rapid Prototyping and Hardware Implementation of Vector Control Systems. In: *Proceedings of International Conference on Intelligent Engineering Systems, INES 2002*. pp. 447-452. Opatija, Croatia.