

Aleksander KOWAL*, **Krzysztof FILIPOWICZ**

Silesian University of Technology, Faculty of Mining and Geology, Institute of Mining Mechanisation
Akademicka str. 2, Gliwice 44-100, Poland

**Corresponding author.* E-mail: aleksander.kowal@polsl.pl

INVESTIGATIVE STANDS TO MARKING OF CHARACTERIZATIONS OF THE METAL- SUSCEPTIBLE CLUTCH

Summary. On the job one introduced the description of investigative stands and the methodics of marking of static characterizations, quasi--dynamic and dynamic. One introduced the course of the torque at the start of the metal-clutch about the large torsional susceptibility and the reaction of the clutch on the extortion with the impulse-turning moment.

STANOWISKO LABORATORYJNE DO WYZNACZANIA CHARAKTERYSTYK METALOWEGO SPRZĘGŁA PODATNEGO SKRĘTNIE

Streszczenie. Artykuł przedstawia opis stanowiska laboratoryjnego i metalowego do wyznaczenia charakterystyk statycznych, quasi-dynamicznych i dynamicznych. Charakterystyki te przedstawiają zachowanie się to sprzęgła w określonych warunkach pracy w układzie napędowym.

1. INTRODUCTION

The load of drives of mining-machines, determines the usage in systems of driving clutches about the large torsional susceptibility, resistant on the influence of definite loads. With suitable construction we can prove the metal- susceptible clutch torsionally [2, 3, 4].

The susceptible clutch is characterized with both definite resilient features as damping which has a basic influence on the work of the driving system across the change of the course and the stabilization of torsional twitches and the torque [1, 5, 8].

With the use of susceptible clutches about inadequate characterizations, one can bring to the state of the incorrect work of the all driving system. In that case, a necessity becomes the qualification of static characterizations, quasi--dynamic and dynamic susceptible clutches. Necessary is also the qualification of the course changed by the clutch of the course of the torque, working on the metal-susceptible clutch torsionally, as the reaction of the system on the extortion in the moment of the start and at given impulse-load. Such acquaintance will assure the correct work of the drive of the working machine.

The constructional analysis of susceptible clutches which possesses the composite construction and contains couplers susceptible about with difficulty definable physicals guilds makes the motion that a most suitable and profitable manner of the delimitation of characterizations of susceptible clutches, is the removal of experimental research on suitable investigative stands. Accordingly one worked out research project for a new metal- susceptible clutch torsionally whose aim is the delimitation of exchanged earlier characterizations.

Research was passed on the clutch with a set of disk springs, consisting of of 14 packs with 4 springs in each pack. One applied springs with measurements of 40 x 20,4 x 2 mm (DIN 2093). The set was so well-chosen, that at the established maximum moment turning, carrying out $M_{max} = 100$ Nm, springs work below the margin of the work, ie. 75 % diffractions of maximum.

2. STAND TO THE RESEARCH OF MECHANICAL CLUTCHES

In the Institute of Mining Mechanization, Faculty of Mining and Geology at the Silesian University of Technology one built the investigative stand intended to the investigation of mechanical clutches (fig. 1). This Stand is the leadership in the following research:

- marking of the characterization of the static clutch,
- marking of the course changed by the clutch of the torque, working on the metal- susceptible clutch torsionally, as the reaction of the system on the extortion with the starting motor, ie. the work of the clutch during the start of the driving system,
- marking of the course changed by the clutch of the torque as the reaction of the system on the extortion in the form of given impulse-load , ie. the work of the clutch at the impulse-load of the driving system.

The electric motor (1) supplied across the inverter determining the converter of the frequency which lets on the regulation of the rotational speed from 0 to 1700 min^{-1} , is joint mechanically with torque meter (5), to serve in the measurement of the torque $M_{obr} = M_{stat}$. The value of measured torque is registered by means of the computer measuring apparatus (7) of the type SCXI of the firm National Instruments. To the exit-shaft of torque meter directly joint is one of the elements of the investigated metal- susceptible clutch (2), being its housing. The second element of the clutch the determining shaft exit-, in-line is to the disc hydraulic brake (3) with the control system (4). The disk with the angular scale (6) serves in the lecture of the angle of the relative turn of elements of the clutch at marking of the static characterization of clutches.

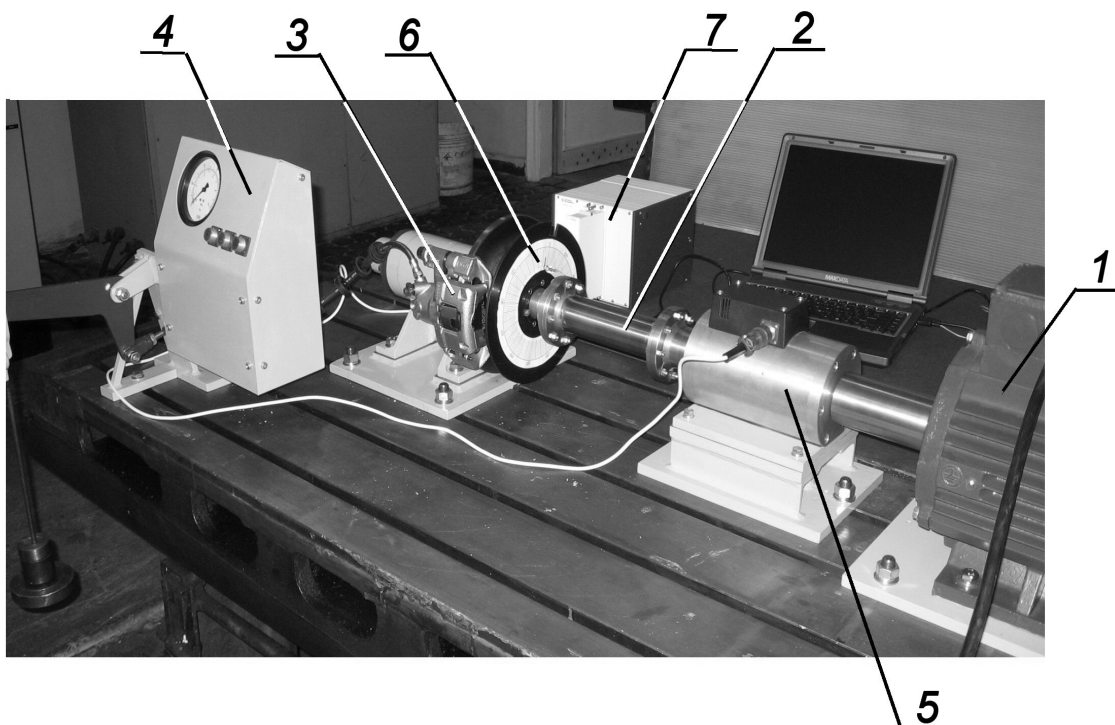

Fig. 1. The test stand for investigation of mechanical clutches
Rys.1. Stanowisko laboratoryjne z zamontowanym sprzęgiem

3. THE INVESTIGATIVE STAND TO MARKING OF CHARACTERIZATIONS QUASI-DYNAMIC AND DYNAMIC OF THE CLUTCHES

Marking of dynamic characterizations of the clutch one passed on modernized investigative stand in the Department of Logistics and Mechanical Handling, Faculty of Transport in Katowice (fig. 2) [6, 7].

On this stand one explored which lets on the delimitation:

- characterizations quasi-dynamic of the metal- susceptible clutch torsionally ,
- characterizations dynamic of the clutch.

This stand makes it possible also on research and the measurement of other sizes characterizing of the clutch. It permits on:

- the infliction impromptu continuous, the constant of the component of the torque,
- generating during the variable component of the torque ,
- the measurement of the resultant torque,
- the measurement of the relative steering angle between elements of the clutch.

Elements of principle stand investigation, shown in fig. 2, are: the inductive motor M1 (1), the inductive motor M2 (2), torque meter (3), the measuring-system of the relative steering angle of elements of the clutch (5). The investigated clutch (4) together with torque meter (3) is situated between motors (1) and (2). Both controlled motors are across inverter and the microprocessor driver.

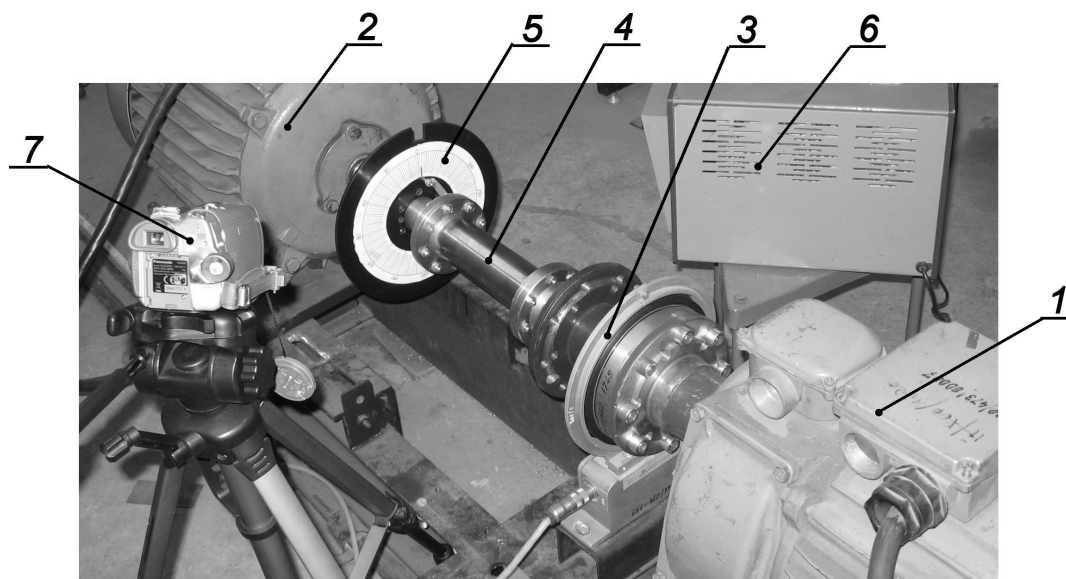

Fig. 2. The test stand view for quasi-dynamic and dynamic characteristic determination of clutches
Rys.2. Widok stanowiska laboratoryjnego podczas badań charakterystyk quasi-dynamicznych i dynamicznych

Mechanism of action of the investigative stand consists of the load variation of mechanical between two co-operative motors M1 and M2. The load is called out by the change of the rotational speed motor M2 as a result of the change of its frequency feeding with relation to the rotational speed motor M1. Therefore it makes possible this impromptu controlled generating of the moment turning. Motor M1 is connected direct to system feeding 380 V, 50 Hz and rotates with the constant of the speed rotatory (eg. $n_{obr} = 1470 \text{ min}^{-1}$). Motor M2 is supplied through the mediation of inverter. Across the change of the frequency of the power supply of the motor follows the change of its characterization which causes the change of the rotational speed. The change of the rotational speed of the motor M2 with relation to the motor M1 lets on producing of the variable or stable moment turning

which comes into being as a result of the shift of the point of the work on the mechanical characterization of the motor M1 with relation to the point of the work of the motor M2.

The moment turning M_{qdyn} is measured on the torque meter T10F. In system feeding one used the converter of the frequency of the type SIMOWERT 6SE2122-2AA01.

The control system was inserted into the microprocessor driver of the type DLM-080. This driver makes possible the measurement and the projection of the value of the moment turning and to give in definite temporary cycles of stable as and the variable load of the susceptible clutch. The level of the moment turning the clutch, which permits the program of the driver carries out from -30 Nm to 130 Nm with the period of changes of the moment within the range from 0,1 s to 25,5 s.

For the measurement of the angle of the mutual twist of elements of the clutch, one used disk with the scale angular, fastened to one element of the clutch in relation to which moves the advice secured to the second element of the clutch. The lecture of the gyral arrangement of the disk - the advice one made at the use the stroboscopic lamp (6), which makes possible the apparent stop of the picture and the immediate lecture of the angle. The accuracy of reading carried out $\pm 1^\circ$. For the purpose of the enlargement of the correctness of the lecture and the elimination of possible errors, one made the registration the cycle the measuring-angle with a digital camera (7).

4. METHODICSES OF MARKING OF CHARACTERIZATIONS OF THE METAL - SUSCEPTIBLE CLUTCH TORSIONALLY

4.1. The methodics of marking of the static characterization

In the chance of marking of the static characterization, on the investigative stand introduced in fig. 1, to the shaft of the exit-clutch one attached the rotatory disk with the angular scale $0^\circ \div 360^\circ$ (6). To the lecture of the angle of the relative turn of elements $\varphi = \varphi_{stat}$ one used secured to the casing of the clutch of the advice. After installing of the clutch on the investigative stand, one stopped the hydraulic brake which makes that one blocked the possibility of one turn of elements of the susceptible clutch. Across the inverter the electric motor starts and gradually is enlarging the torque M_{stat} . The gradation of this moment M_{stat} one fixed with the step 10 Nm to the maximum value $M_{max} = 100$ Nm. For every value of the moment one made the lecture of the angle the relative turn elements the clutch φ_{stat} on the scale of the angular disk by means of advices. The exactitude of made lecture carried out $\pm 1^\circ$. Lectures of the dependence of the torque M_{stat} from the angle of the relative turn φ_{stat} was made both at burdening, and in easing the clutch. An aim at such an accepted procedure was the qualification of the hysteresis loop, representing the course of the suppression of the mechanical energy in the arrangement [1, 5].

The example of the static characterization of the investigated metal-susceptible clutch introduces the drawing 3. In figure 3 one marked areas of sizes characterizing the course of the suppression of the mechanical energy, ie.: A_r – the work of the suppression during one duty cycle and the A_s – the work of the elastic strain on one duty cycle.

The static characterization of the susceptible clutch is a dependence of the torque M_{obr} , turning the clutch for the definite turning angle φ of the boundary strip an element active and passive of the clutch.

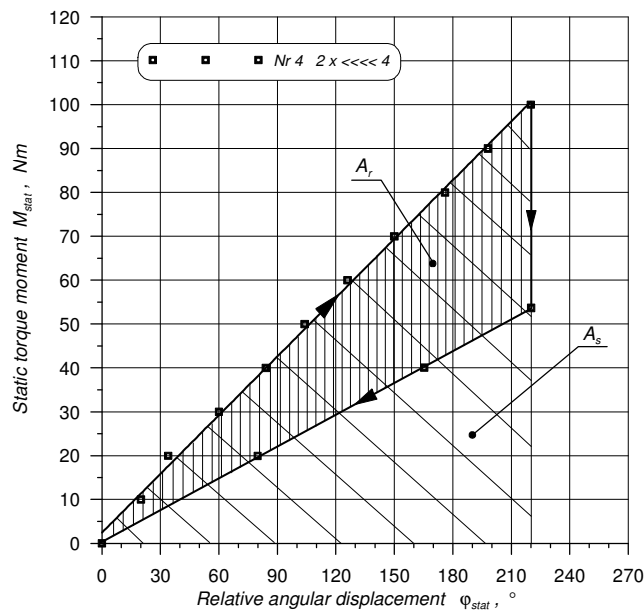

Fig. 3. The illustration of static characteristic of torsionally flexible metal clutch
Rys. 3. Charakterystyka statyczna metalowego sprzęgła podanego skrętnie

4.2. The methodics of marking of the quasi-dynamic characterization

After the start of the investigative stand introduced in fig. 2, motors together with the clutch rotate constantly with the rotational speed $n_{obr} = 1470 \text{ min}^{-1}$. During the work of the stand the torque is change M_{qdyn} , incriminating drive unit with the clutch with the step 10 Nm, until the maximum value $M_{max} = 100 \text{ Nm}$. Simultaneously is read the angle of the relative turn of elements of the clutch φ_{qdyn} .

The characterization quasi-dynamic where the example introduces the drawing 4, expresses the dependence between the torque M_{qdyn} incriminating the clutch, and with the angle of the mutual turn of elements of the clutch φ_{qdyn} , the assumption that following growing values of the torque are given comparatively slowly at the simultaneous lecture answering to them values of the angle φ_{qdyn} , during the rotation of the all driving system together with the clutch.

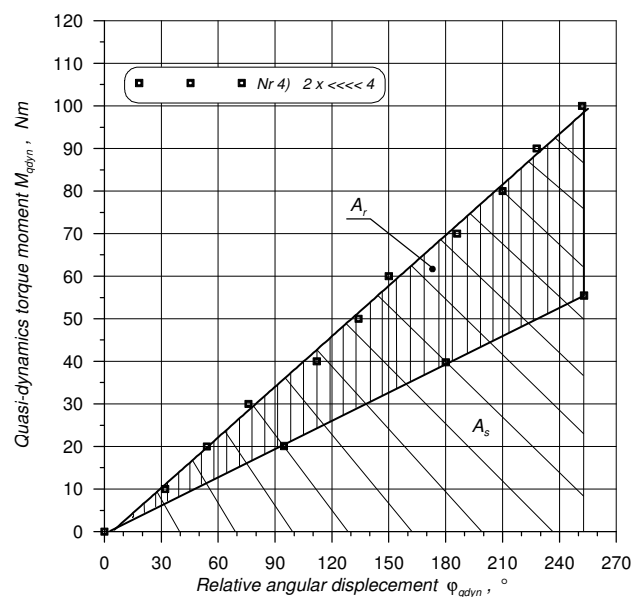

Fig. 4. The illustration of quasi-dynamic characteristic of torsionally flexible metal clutch
Rys.4. Charakterystyka quasi-dynamiczna metalowego sprzęgła podanego skrętnie

4.3. The methodics of marking of dynamic characterization

Marking of dynamic characterizations of the clutch one led on the investigative stand from the drawing 2. Started motors together with the clutch rotating constantly with the rotational speed $n_{obr} = 1470 \text{ min}^{-1}$. During the work stand the torque M_{dyn} , incriminating drive unit together with the clutch, is changed periodically what 5 s from the value $M_{dynmin} = 0 \text{ Nm}$ to the temporary maximum value of the moment M_{dynmax} . The temporary value of the maximum moment is changed with the step 10 Nm, to the value 100 Nm. The course of these changes illustrates the drawing 5.

The rule of the lecture changing in cycles the torque and the lecture and the registration of answering to the relative turn of elements of the clutch φ_{qdyn} , follows so as at marking of the characterization quasi-dynamic.

The example obtained on the basis research, the dynamic characterization of the metal-susceptible clutch, introduces the drawing 6.

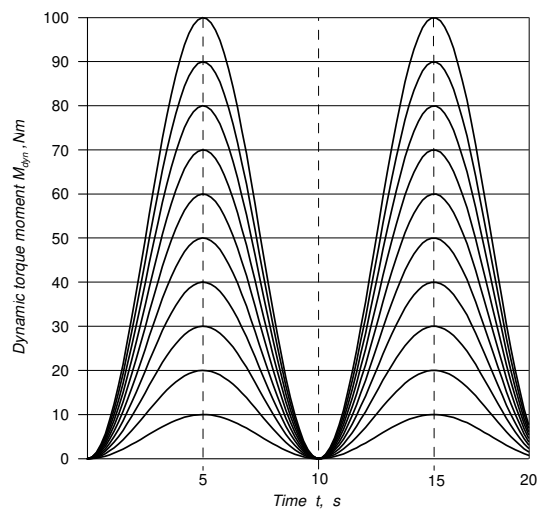

Fig. 5. The course of the changes of the rotatory moment M_{dyn} , burdening the driving system with the clutch
Rys. 5. Przebieg zmiany momentu dynamicznego M_{dyn} generowanego przez stanowisko laboratoryjne na badanym sprzęgle

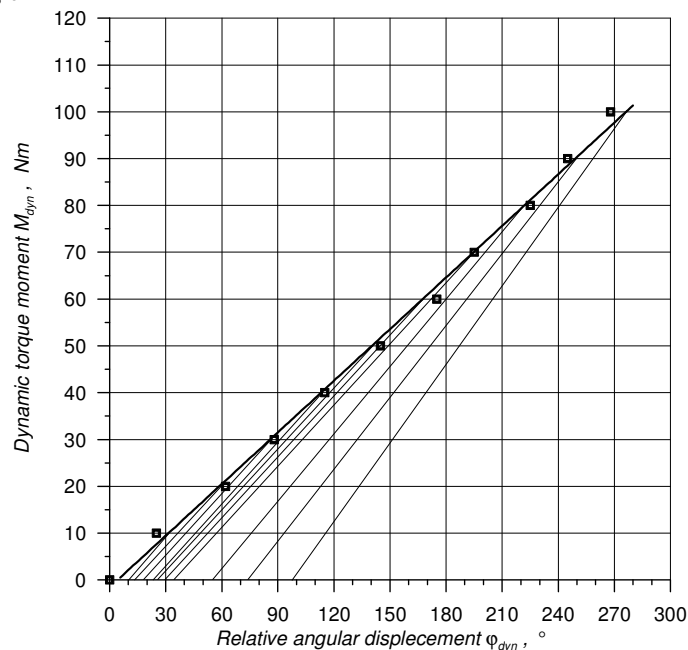

Fig. 6. The illustration of dynamic characteristic of torsionally flexible metal clutch
Rys. 6. Charakterystyka dynamiczna metalowego sprzęgła podanego skrętnie

4.4. The work of the clutch during the start of the driving system

Research of the metal-susceptible clutch torsionally, targeting delimitation of the course of changes of the torque incriminating the clutch, as the reaction of the arrangement on the resulting extortion during the start of the electric motor, propellant the investigative stand which was introduced in figure 1.

During the start of the driving system exists the surplus of the torque incriminating the clutch which is called an inertia of driven elements. In the driving system of the investigative stand, these are elements of the disc brake and its clutch.

In progress of the given cycle of research, the starting of electric motor followed by immediate connecting of the full tension feeding on his windings. This causes the dynamic start of all driving system. Additionally, during the start the laden clutch is a working torque M_h , produced by the brake of the investigative stand. The all course start is measured in real-time by means of torque meter and registered by the measuring-apparatus. Registered course of changes of the torque makes possible the removal of its analysis which takes into account the influence of the susceptible clutch on the start of the driving system.

The example of the registered course of changes of the torque, transferred by the arrangement with the metal-susceptible clutch at the start with the stable moment of the applying of the brake M_h , introduces drawing 7.

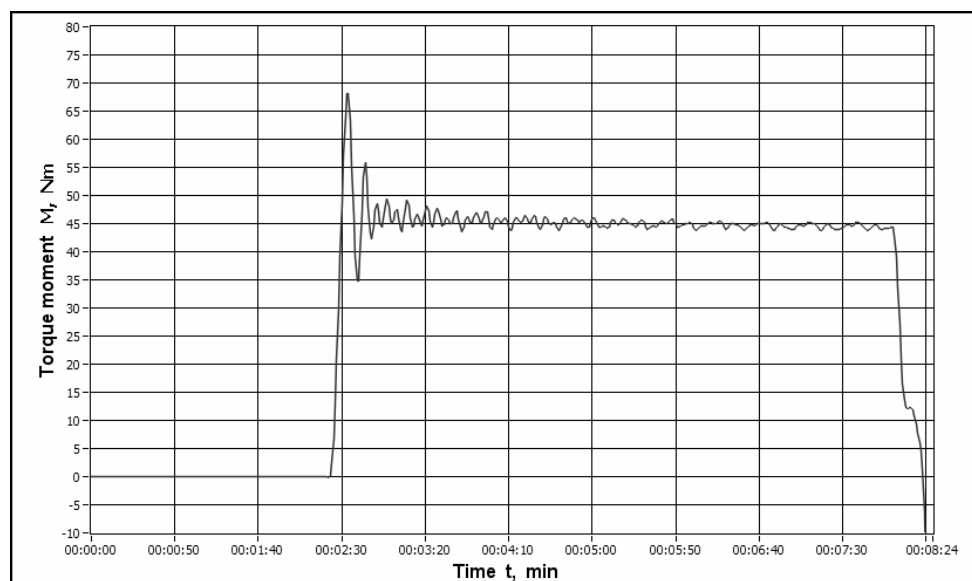

Fig. 7. The course of the changes of the rotatory moment, transferred by the system with the flexible clutch during starting

Rys. 7. Przebieg zmiany momentu rozruchowego na stanowisku laboratoryjnym z badanym sprzęgłem

4.5. The work of the clutch at the impulse-load of the driving system

The methodics of research of the clutch in this instance consisted in the actuation of the drive of the investigative stand with the settled torque of the brake to M_h and the bringing of the driving system to the achievement of the settled rotational speed. Then the arrangement is burdened an additional impulse-torque M_{imp} . In such chance by the susceptible clutch on the measuring-element, on which torque meter, transfers the moment about diminished value of the amplitude. The course of changes of the softened torque has a character of damped vibration.

Both the incriminating torque of the brake M_h how and the additional impulse-moment M_{imp} are generated by the hydraulic arrangement of the disc brake. The course and the value of the impulse-moment are appointive indirectly across the tonometry the medium in the hydraulic arrangement

which is proportional to produced torque. Courses of the softened torque and the pressure the medium are registered real-time and surrendered to the analysis.

The example of the registered course of changes of the torque, as the reaction on the additional impulse-torque and answering them courses of changes of pressure in the hydraulic arrangement of the brake, introduces the drawing 8.

a)

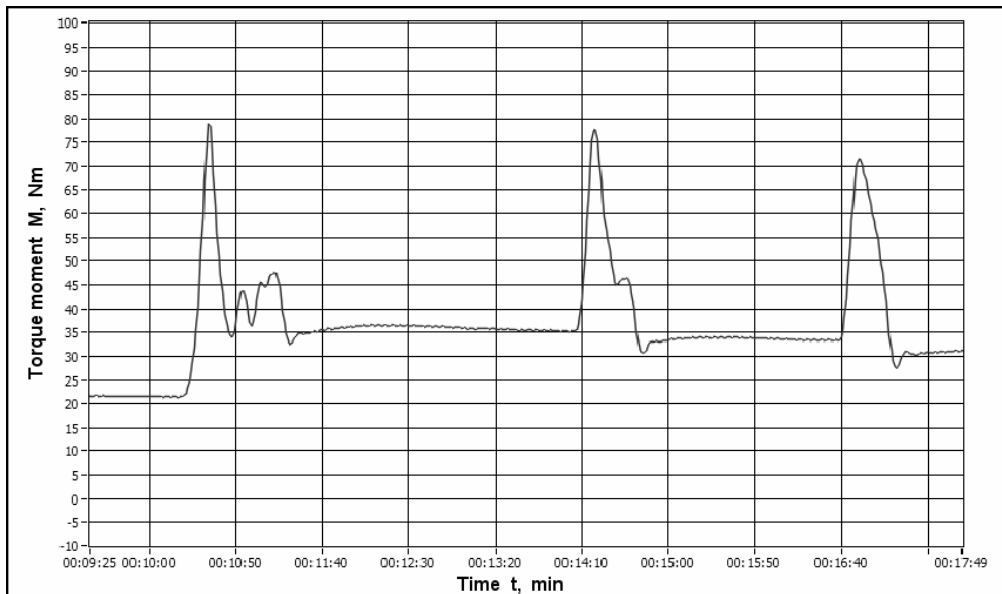

b)

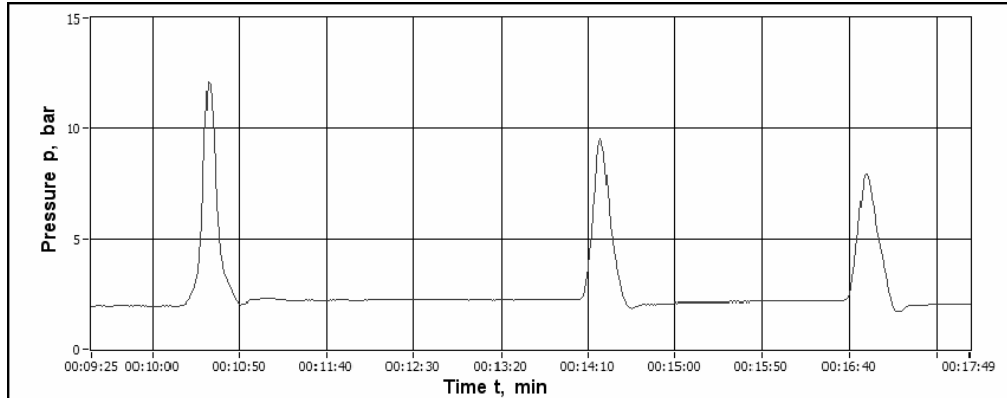

Fig. 8. The work of the clutch during the impulse load of rotatory moment, were: a) the course of the changes of the rotatory moment, b) the course of the changes of the pressure of medium in the hydraulic system of the brake

Rys. 8. Praca sprzęgła pod obciążeniem w podczas impulsu momentu dynamicznego, a) przebieg zmiany momentu, b) przebieg ciśnienia w układzie hamulcowym stanowiska laboratoryjnego

5. CONCLUSIONS

Explored on two differing manner of burdening investigative stands, the embracing delimitation of characterizations of the metal- susceptible clutch torsionally, let on the hanging indent of following conclusions:

- designed and modernized and performed investigative stands, and also the accepted methodics of research of characterizations of the clutch, let on simple and correct their marking with the properly large exactitude and the repeatability of obtained results of measurement,

- both investigative stands are universal on which one can lead other research,
- on these stands can be explored different clutches basing on different investigative methodics,
- obtained in progress of research static characterizations, quasi-dynamic and dynamic let on marking of the value of coefficients of the torsional stiffness k and the suppression ψ of the clutch,
- accepted methodics of research targeting the estimation of the work of the investigated clutch at the start how and during the extortion with the impulse-moment, result from practical standard-methods of research of susceptible clutches.

Literature

1. Dietrich M. (red.), Markusik S.: *Podstawy konstrukcji maszyn*. Tom III, wyd. 3. WNT, Warszawa 1999.
2. Kowal A.: *Sprzęgło mechaniczne*. Patent RP: PL 190945 B1 i PL-191092 B1 z lutego 2006.
3. Kowal A.: *Konstrukcja metalowego sprzęgła podatnego skrętnie*. Biblioteka TEMAG. Trwałość Elementów i Węzłów Konstrukcyjnych Maszyn Górniczych, Gliwice-Ustroń, 2005, s.107-116.
4. Kowal A., Filipowicz K.: *Metalowe sprzęgła podatne skrętnie*. Górnictwo i Geologia. T.1, Z.2, Wydawnictwo Politechniki Śląskiej, Gliwice 2006.
5. Markusik S.: *Sprzęgła mechaniczne*. WNT, Warszawa 1979.
6. Opasiak T.: *Metody wyznaczania charakterystyk statycznych i dynamicznych sprzęgieł podatnych*. Maszyny Dźwigowo-Transportowe. Nr 2/2000, s.5-15.
7. Opasiak T.: *Badania charakterystyk statycznych i dynamicznych sprzęgieł nierozłącznych podatnych oponowych*. Praca doktorska, Katowice, 2004.
8. Osiński Z.: *Sprzęgła i hamulce*. PWN, Warszawa 1985.

Received 10.10.2007; accepted in revised form 13.12.2007