



Al-Khwarizmi Engineering Journal, Vol. 4, No. 3, PP 18- 33 (2008)

Al-Khwarizmi
Engineering
Journal

New Adaptive Data Transmission Scheme Over HF Radio

Khalifa Abboud Salim*, Abdul-Karim A.R. Kadhim**
and Adil H. Ahmad***

**Departement of Information and Communication/ Al-Khwarizmi College of Engineering/University of Baghdad*

** *Departement of Information/ Collage of Engineering/ Al-Nahrain University*

****Department of Electrical and Electronic Engineering/ University of Technology*

(Received 6 March 2008; accepted 2 September 2008)

Abstract

Acceptable Bit Error rate can be maintained by adapting some of the design parameters such as modulation, symbol rate, constellation size, and transmit power according to the channel state.

An estimate of HF propagation effects can be used to design an adaptive data transmission system over HF link. The proposed system combines the well known Automatic Link Establishment (ALE) together with variable rate transmission system. The standard ALE is modified to suite the required goal of selecting the best carrier frequency (channel) for a given transmission. This is based on measuring SINAD (Signal plus Noise plus Distortion to Noise plus Distortion), RSL (Received Signal Level), multipath phase distortion and BER (Bit Error Rate) for each channel in the frequency list. Channel condition evaluation is done by two arrangements. In the first an FFT analysis is used where a pilot signal is transmitted over the channel, while the data itself is used in the second arrangement. Passive channel assessment is used to avoid bad channels hence limiting the frequency pool size to be used in the point to point communication and the time required for scanning and linking. An exchange of channel information between the transmitting and receiving stations is considered to select the modulation scheme for transmission. Mainly MPSK and MFSK are considered with different levels giving different data rate according to the channel condition. The results of the computer simulation have shown that when transmitting at a fixed channel symbol rate of 1200 symbol/sec, the information rate ranges from 2400 bps using 4FSK up to 3600 bps using 8PSK for SNR ranges from 11dB up to 26dB.

Keywords: ALE, Adaptive modulation.

Introduction

Propagation effects in HF sky-wave channels impose many restrictions on this communication media. These restrictions can be grouped into the effects of background noise, interference, and multipath propagation.

HF band has been of great interest for beyond line of sight long distance military communications. HF radio is the central element particularly for countries which can't count on reliable access to satellite links in wartime. In addition to its price advantage and freedom from third party it's inherent resilience to counter measure, and independence from foreign ownership and controlled communications assets which make it attractive for Command, Control,

Computer and Communication, interchange (C⁴I) system military users.

Unfortunately HF communication is complicated by severe interference from other users of the HF band, impulsive atmospheric noise, limited bandwidth, multipath propagation, which yields frequency selective fading. The increase in the use of the Internet Protocol (IP) networks in the military applications [1] has led to the necessity of integration of various transmission media (HF, VHF, UHF, microwave, fiber optic) into one heterogeneous network. Integration of HF link as part of any network represent a bottleneck to the whole network. To insure reliable and efficient communication over such networks a major part of research activities has been directed toward achieving reliable high

data rate communication in the presence of severe interference and time varying channel reception which is commonly used at HF installations, hence improves the reliability of HF channel [2]. The basis of diversity reception is to take advantage of signals that are not correlated, and combines these signals from separate receivers. There are several forms of diversity reception, all of which require additional equipments. Besides to diversity reception, spread spectrum, power control and adaptive modulation are also used.

The approach being undertaken in this work is to optimize the performance of HF radio communication over time varying channels, examine the quality and propagation characteristics of a radio channel, and measure the relevant HF channel parameters. Acceptable BER can be maintained by adapting some of the design parameters such as modulation, symbol rate, constellation size besides to the automatic selection of the best frequency from a set of pre-assigned channels to the time varying channel environment [3]. Besides to channel state such as fading, noise and interference power characteristics, throughput of any wireless communication channel is affected by different communication parameters such as symbol rate, transmit power and coding rate. Adaptive modulation has been proposed as an efficient technique for improving the spectral efficiency over fading channels. Adaptive modulation has been extensively studied in [3, 4]. With adaptive modulation optimum symbol rate at a given bit error rate BER is achieved where a high spectral efficiency is maintained.

In this work an estimate of the channel state is done at the receiver side and the channel information are fed back through an error free feedback channel. The channel state is used to determine the best carrier frequency from a frequency pool and the appropriate constellation size. Therefore an optimal two step adaptive HF system is considered. The channel state is obtained through a pilot single tone unmodulated carrier transmitted through the channel, at the receiver side SINAD plus multipath phase

conditions. Various techniques are used to combat HF channel impairments such as diversity distortion and RSL which reflects channel quality are measured and fed back to the transmitter. The SNR threshold is used for both ALE and choosing appropriate modulation and hence constellation size according to threshold bit error rate (BER_{th}), which is previously evaluated based on the simulation results.

The modulation type and hence constellation size are restricted to MFSK and MPSK, for the reason of constant amplitude signaling, while MQAM is avoided because it uses different amplitude levels which will be affected by fading phenomenon of the channel.

II- System Model

A communication link which consists of a transmitter, a receiver, HF channel and feedback channel as shown in Fig.(1) was considered. For each transmission the carrier frequency and the modulation scheme are selected based on the estimated SNR, because the spectral efficiency is adjusted to achieve optimum performance for a specified threshold BER. The receiver is assumed to detect all the erroneous bits.

The HF channel can be seen as consisting of two components. Firstly a filter $H(f,t)$ which varies over both frequency and time representing the changing conditions caused by multipath propagation and different kinds of ionospheric phenomena, secondly the noise $n(t)$ and the interference $I(t)$ from other HF users .

The feedback channel is used to convey the Link Quality Analysis LQA information, in order to use these data for the configuration of the transmitter station. Since there is no need to use high data rate in the feedback channel then the channel can be well protected using error correcting coding and maximum transmit power. LQA is used to provide the transmitter with the necessary information about the measured SNR, RSL and multipath phase distortion.

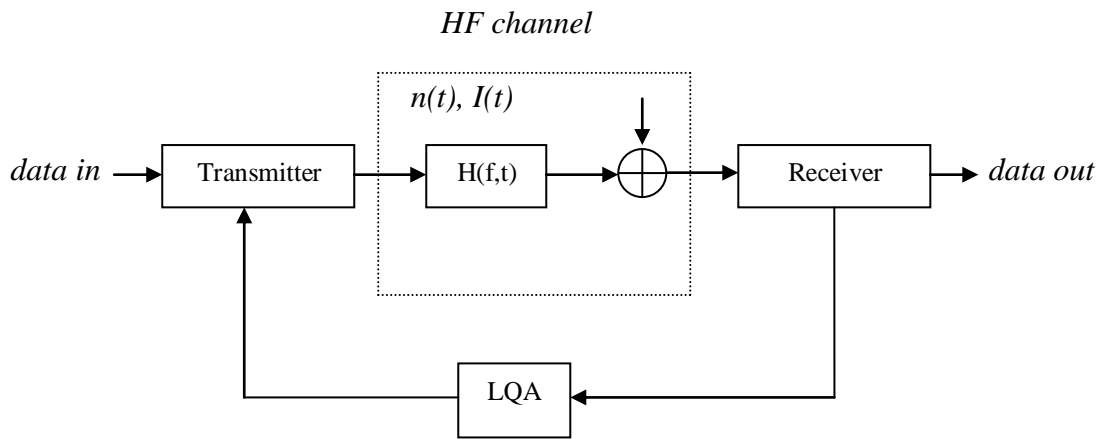

Fig. 1. Block Diagram of HF Radio Link.

1-The Communication Channel

In this investigation the widely used and well known ITU-R approved Watterson Gaussian scatter model known as Watterson model is used in the simulation of the HF channel [5,6]. This model considered stationary for small bandwidth up to 3kHz and short time less than 10 minutes. Three standard simulation channels termed good, moderate, and poor presented in table (1) are used. The HF channel was modeled as a tapped delay line with one tap for each propagation path

as shown in Fig.(2). The delayed input signal at various stages of the delay line is multiplied by the random process $g_i(t)$ and hence modulated in both amplitude and phase.

Table 1
CCIR Test Channel Parameters.

Condition	Good	Moderate	Poor
Delay Spread (ms)	0.5	1	2
Frequency Spread	0.1	0.5	1

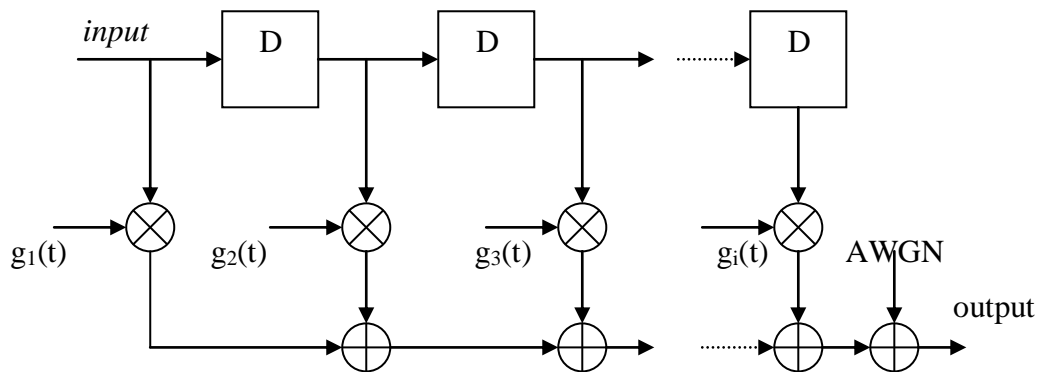

Fig. 2. Watterson HF Channel Model.

2- Adaptive Modulation

A basic relation in wireless digital communication is that a certain transmission bit rate can be achieved at a certain bit error probability for a specified SNR. For non adaptive digital communication system, the modulation type and error correcting codes are chosen such that acceptable bit error rate is achieved. When the coding fails to compensate for occurred errors the link layer will ensure that the data is correctly

received by requesting a retransmission of the erroneous databy means of Automatic Repeat Request ARQ.

As the SNR varies a more stable performance can be accomplished using adaptive modulation in such a way, the transmitter and receiver are adapted to the changing channel quality by aiming at the target bit error rate. However the BER at the receiver would be a good metric to decide switching between different modulations but reliable BER estimation is difficult over short

periods, thus channel SNR was used for switching between different modulation types. The channel SNR is defined for each modulation type such that it guaranties a BER below a certain threshold BER_{th} .

Adaptive modulation is proposed as an effective measure to maximize the spectral efficiency of the time variant wireless channel [7]. Choice of modulation type and setting of modulation switching level are the most important factors that affect the performance of adaptive modulation system. Setting of modulation switching levels is done using the target BER (BER_{th}) criterion. The symbol error rate SER and hence BER for different modulation types are as follows [8].

$$p_{s,MPSK}(\gamma) = 2Q\sqrt{2\gamma}\sin\left(\frac{\pi}{M}\right) \quad \dots (1)$$

where $Q(x)$ is the Q-function and $\gamma = E_s/N_o$
The equivalent BER for QPSK is:

$$p_{b,QPSK}(\gamma) = Q(\sqrt{\gamma}) \quad \dots(2)$$

The SER for coherent MFSK is given by:

$$p_s \leq (M - 1)Q\{\sqrt{\gamma}\} \quad \dots(3)$$

the Probability Density Function PDF of the fluctuations in instantaneous received power x , in a Rayleigh channel are given by

$$F(x, X) = \frac{2\sqrt{x}}{X} e^{-x/X} \quad \dots(4)$$

Where X is the average signal power. For any modulation scheme if $P_G(SNR)$ is the Gaussian BER performance then the upper bound for the BER performance in a Rayleigh channel is [7]:

$$p_r(\gamma) = \int_0^\infty P_G(\gamma) \cdot F(x, X) dx \quad \dots(5)$$

therefore the upper bound BER performance of an adaptive modulated signal may be computed from:

$$p_a(\gamma) = \frac{1}{T} \left\{ 2 \int_{l_1}^{l_2} p_{QPSK}(\gamma) \cdot F(x, X) dx + 3 \int_{l_2}^{l_3} p_{BPSK}(\gamma) \cdot F(x, X) dx \right. \quad \dots(6)$$

where l_1, \dots, l_4 are the SNR switching thresholds. The throughput of the adaptive modulation system can be expressed as:

$$T = 2p_{r,QPSK}(\gamma) + 3p_{r,BPSK}(\gamma) \quad \dots(7)$$

3- Automatic Link Establishment (ALE)

ALE was developed to automatically select a frequency for automatic linking in point to point or network based communication. Clearly the availability of different modems with a robust waveforms has an impact on frequency selection and link establishment process. However HF

communications are subject to disturbances and irregularities in the ionosphere, fairly high rate communications may be supported at some times. All the prediction programs give the long term median values of maximum usable frequency (MUF) and lowest usable frequency (LUF). The final selection of the appropriate frequency is upon the operator taking into account the availability of clear or interference free channel. The selection of the best frequency is done by using long term prediction. The use of RTCE techniques at the receiving station can provide a measure of channel conditions to be used for ALE functions [10]. In addition to the channel state information from propagation prediction and channel sounding, ALE is used to maintain linking with remote station.

III- HF System Adaptation Algorithm

The proposed HF adaptation process is attempted at startup of the system in two steps:

Step 1: At startup of the communication, both the transmitter and the receiver generate a LQA table through the sounding process. ALE performs linking process by choosing the best channel for communication based on the LQA data of the rank ordered channels. The selected communication frequency is chosen to be very close to the linking frequency in order to have the same propagation conditions.

Step 2: The second phase is the rate adaptation process, which is performed during the communication process. Initial handy rate with certain modulation technique is chosen depending on the SNR of the selected channel. During the communication process the system attempts to test the BER for higher possible bit rate. If the receiver acknowledges the reception of the test data with acceptable BER (chosen to be $\leq 10^{-3}$), the transmitter changes its rate to the new higher rate. Fig.(3) gives the adaptation algorithm of a point to point communication system.

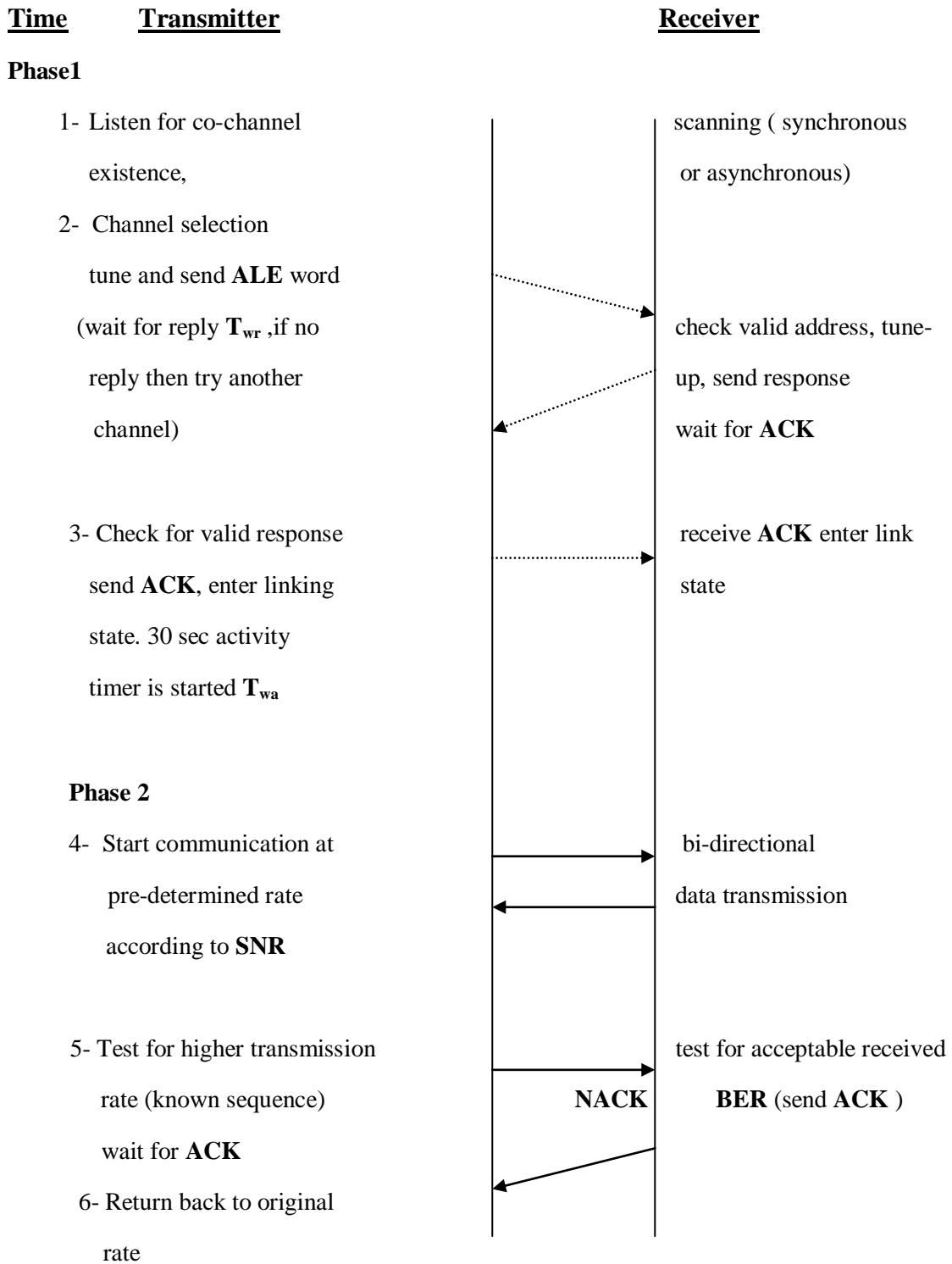

Fig. 3. Adaptation Algorithm for Point to Point.

IV- Adaptive HF System Simulation

Matching the data rate to the channel condition can be achieved in two steps, first step is selecting the best channel frequency to carry traffic data through ALE, and choose the best modulation which provides highest possible bit-rate with acceptable BER.

1- ALE Simulation

ALE initiates calls on pre-assigned rank ordered channels, depending on the LQA memory data. The LQA information exchanged between all the stations is used to optimize the choice of channels. The sequence of channels to be used in linking is derived from the information content of LQA parameters. The best channel score is tried first. The feedback channel is assumed to be error free with high transmit power and robust error correcting code to insure the correct reception of the acknowledged data.

Three types of information [10], Bit Error Rate, Signal plus Noise plus Distortion to Noise plus Distortion SINAD, measure of Multi-path MP (optional), are required to assess specific channel order. LQA data are used to score the channels and to support selection of the best channel for linking and communication.

a- BER Measurement

For each channel to be tested for BER, a stream of binary data is transmitted over the channel. The Bit Error Rate is calculated at the receiver as follows.

$$BER = \frac{\text{number of erroneous bits}}{\text{number of transmitted bits}} \quad \dots(8)$$

b- SINAD Measurement

Under the assumption that the noise is a stationary or a slowly varying process, and that the noise spectrum does not change significantly in between the update period of LQA, the effect of additive noise on the magnitude spectrum of a signal is to increase the mean and the variance of

the spectrum. The noisy signal model in the time domain is given by

$$y[m] = x[m] + n[m] \quad \dots(9)$$

where $x[m]$, $n[m]$ and $y[m]$ are the signal, the additive noise and the noisy signal respectively, and m is the discrete time index. The frequency domain of the noisy signal model of eq. (9) is:

$$Y(f) = X(f) + N(f) \quad \dots(10)$$

where $Y(f)$, $X(f)$ and $N(f)$ are the Fourier transform of the noisy signal $y[m]$, the original signal $x[m]$ and the noise $n[m]$ respectively, and f is the frequency variable. The noisy signal at the receiver front end is buffered and divided into segments of N samples length. Each segment is transformed via Fast Fourier Transform FFT to N spectral samples. The time averaged power spectrum of the noisy signal is obtained from the whole period

$$|Y(f)|^2 = \frac{1}{M} \sum_{i=0}^{M-1} |Y_i(f)|^2 \quad \dots(11)$$

where $|Y_i(f)|$ is the spectrum of the i^{th} noisy signal frame, and it is assumed that there are M frames in the allocated period.

$$|Y(f)|^2 = |X(f)|^2 + |N(f)|^2 \quad \dots(12)$$

In this work the channel is tested for SINAD, using a generic frequency domain FFT. A single tone is transmitted, The received signal is analyzed to determine the SINAD. Obviously the reference pilot tone is known to the receiver then the subtraction of the power content of the pilot tone from the total averaged received power yields the noise plus distortion power added over the channel. Then the received SINAD can be expressed as follows:

$$SINAD = \frac{|Y(f)|^2}{|Y(f)|^2 - |X(f)|^2} \quad \dots(13)$$

The averaging of the above measured parameters is taken over 5 seconds. This time is arbitrary chosen to be long enough to accommodate slow and fast variations of the channel environment and allows accurate signal strength and phase measurements. Fig.(4) shows a 500 Hz single tone passed through a 3-skywave HF channel with SNR of 10 dB.

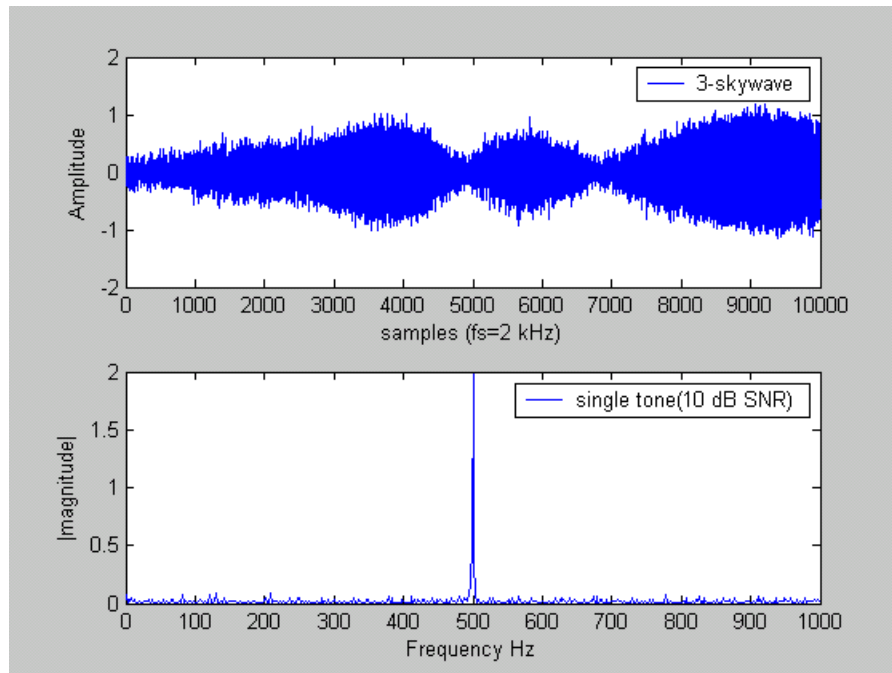

Fig. 4. Single Tone Through HF Channel.

c- Received Signal Level and Multipath Distortion

Besides to SINAD measurement, RSL, and multi-path phase distortion can be measured using N point FFT. Then the RSL of the k^{th} bin signal is measured and averaged over the whole period:

$$RSL = |Y(K)| = \frac{1}{M} \sum_{i=0}^{M-1} |Y_i(K)| \quad \dots(14)$$

In the same manner phase distortion can be computed from the FFT, by subtracting the phase of the reference pilot tone from the phase of the analyzed received signal.

$$\theta(\omega_k) = \frac{1}{M} \sum_{i=0}^{M-1} \arg [Y_i(K)] - \arg [X(K)] \quad \dots(15)$$

where $Y(K)$ and $X(K)$ represent the k^{th} amplitude component of the received and transmitted signal respectively.

2- Modulator Performance Test

The performance of different types of modulation techniques was determined by calculating Bit Error Rate for different channel parameters and signal to noise ratio. The performance test have been carried out using different modulation techniques BPSK, QPSK, 8PSK, FSK, 4FSK, 8FSK (the effect of carrier synchronization on the overall performance was not considered and the system is considered synchronized). Figs.(5) and (6) represent the

theoretical performance of the different modulation techniques over AWGN channel. Figs.(7-14) represent the BER performance of the same modulation types over different channel conditions. It is clearly shown that MFSK modulation scheme achieves the same Bit Error Rate at low signal to noise ratio when compared with MPSK. So with power limited systems MFSK is preferable while at bandwidth limited systems MPSK is preferable. MPSK modulation is bandwidth efficient scheme so as M increases in value the bandwidth efficiency also increases at the expense of increased E_b/N_o .

The proposed system uses MFSK at low E_b/N_o unless the required bandwidth exceeds the limited 3 kHz bandwidth while at higher E_b/N_o the bandwidth efficient MPSK will be employed.

3- Rate Adaptation Scheme

The second phase of adaptivity is to choose the highest transmission rate with appropriate modulation technique which gives BER performance of less than 10^{-3} at the specified SNR. After linking takes place the transmitter establishes communication with the distant station using handy initial transmission rate. This rate is a predetermined rate chosen based upon the SNR from the LQA table. During the linking process the basic ALE word is used to estimate the present

BER. To test the validity of the channel, a stream of known data is transmitted along the link with a rate higher than the initial selected data rate. If the receiver acknowledges the reception of the data with acceptable BER, then the transmitter attempts transmission at higher rate and so on according to the adaptation algorithm. If negative acknowledgment is received, then the transmitter returns to the initial data rate.

When transmission is carried out at fixed channel symbol rate of 1200 symbol/sec the required bandwidth and signal to noise ratio for both MPSK and MFSK modulation signals simulated over good channel to obtain $BER=10^{-3}$ are shown in Tables 2 & 3.

However the HF channel is bandwidth limited to less than 3 kHz in military applications, then it is clear that at low SNR, power efficient modulation techniques (MFSK) must be employed. While at high SNR the bandwidth efficient modulation techniques (MPSK) will be employed.

A signal to noise ratio threshold is chosen such that a best utilization of bandwidth with minimum signal to noise ratio is achieved. Table 4 shows the signal to noise ratio boundaries for best utilization of bandwidth with minimum signal to noise ratio. The data rate throughput evaluated over the specified threshold is plotted in Fig. (15).

Table 2
Bandwidth and Power Efficiency of MPSK for $BER=10^{-3}$

M	m	R_s symbols/sec	R_b bps	Minimum Bandwidth (Hz)	η_B bit/s/Hz	E_b/N_0 (dB) for $BER=10^{-3}$		
						Good	Moderate	Poor
2	1	1200	1200	2400	0.5	13	13.75	15
4	2	1200	2400	2400	1	13	14.1	15
8	3	1200	3600	2400	1.5	26	35.8	45
16	4	1200	4800	2400	2	Not simulated		

Table 3
Bandwidth and Power Efficiency of MFSK for $BER=10^{-3}$

M	m	R_s symbols/sec	R_b bps	Minimum Bandwidth (Hz)	η_B bit/s/Hz	E_b/N_0 (dB) for $BER=10^{-3}$		
						Good	Moderate	Poor
2	1	1200	1200	1200	1	14	15	18.2
4	2	1200	2400	2400	1	11	11.8	12.5
8	3	1200	3600	4800	.75	Requires high BW		
16	4	1200	4800	9600	0.5	Not simulated		

Table 4
Modulation Type Selection for $BER=10^{-3}$

E_b/N_0 (dB)	Modulation Type	Bandwidth efficiency	R_b (bps)
$11 \leq E_b/N_0 < 13$	4FSK	1	2400
$13 \leq E_b/N_0 < 26$	QPSK	1	2400
$26 \leq E_b/N_0$	8PSK	1.5	3600

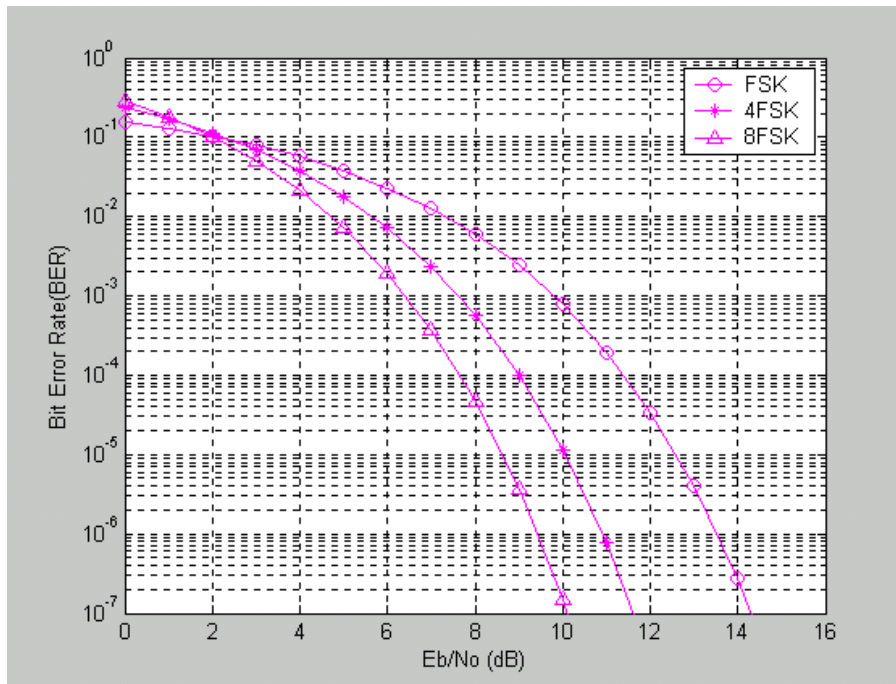

Fig. 5. MFSK Theoretical Performance.

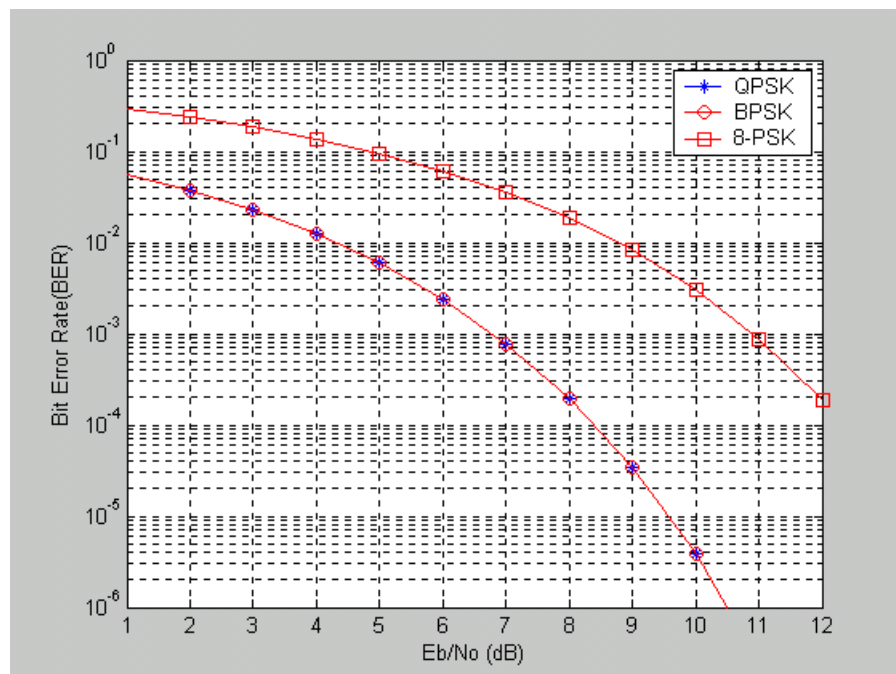

Fig. 6. MPSK Theoretical Performance.

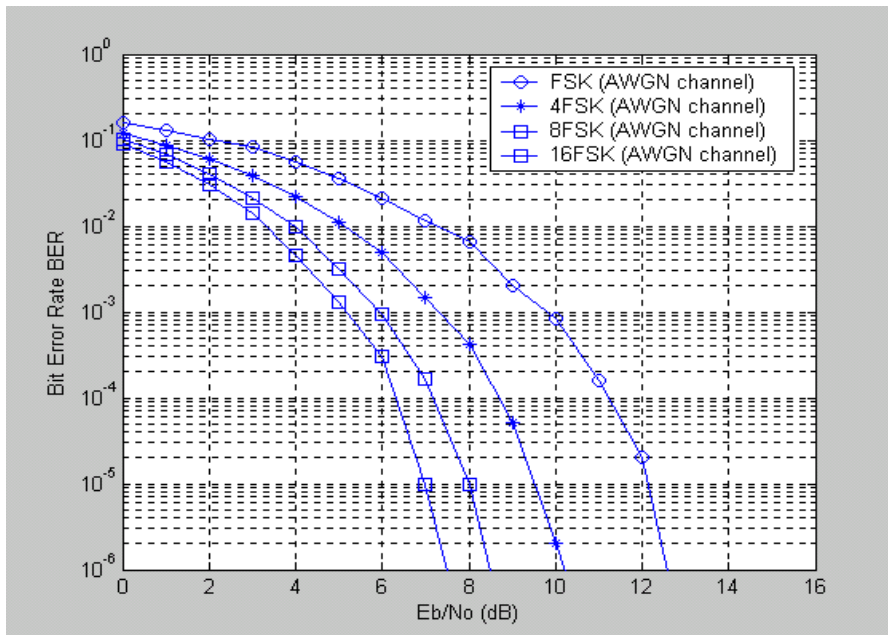

Fig. 7. MFSK Performance Over AWGN Channel (Simulated).

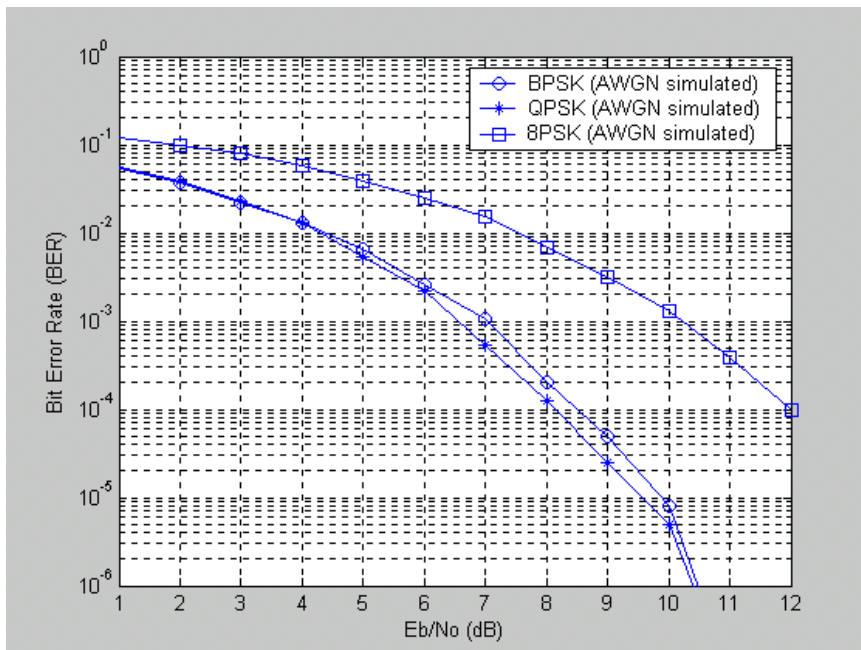

Fig. 8. MPSK Performance Over AWGN Channel (Simulated).

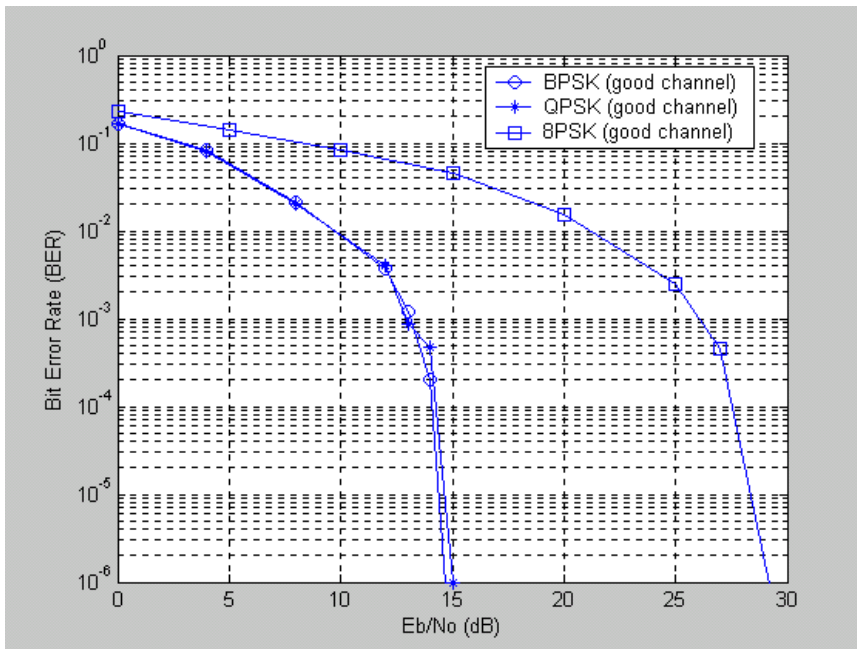

Fig. 9. MPSK Performance Over Good Channel.

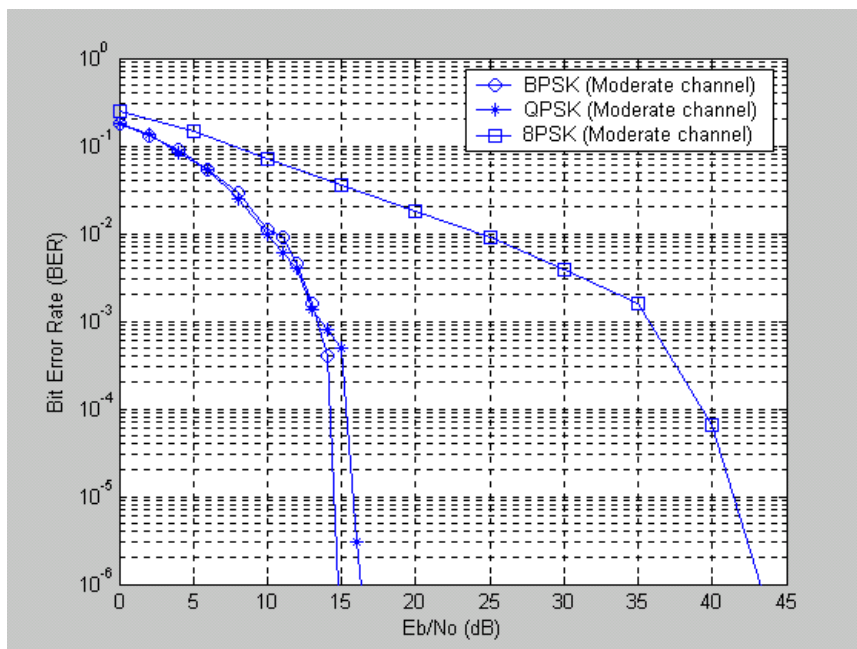

Fig. 10. MPSK Performance Over Moderate Channel.

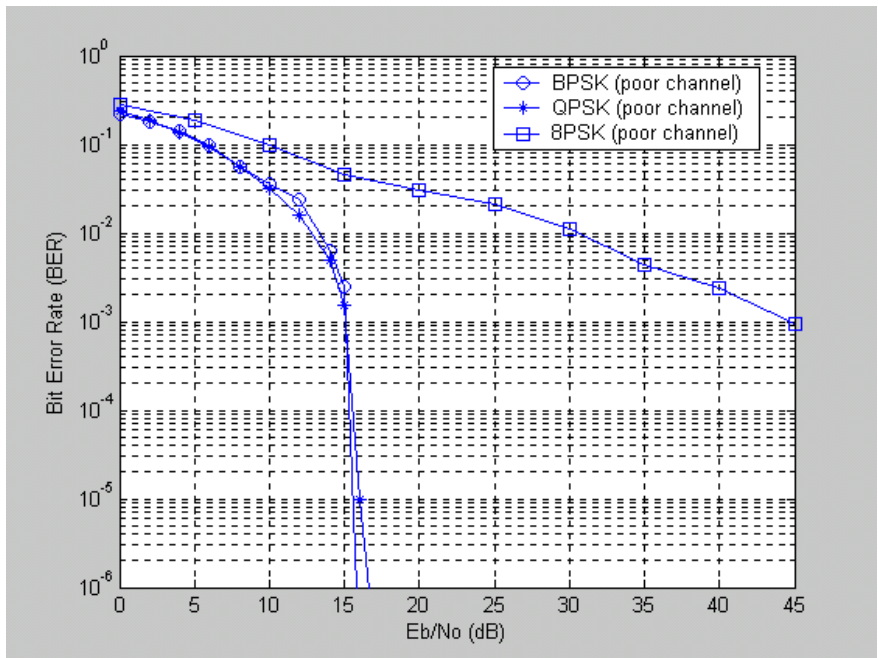

Fig. 11. MPSK Performance Over Poor Channel.

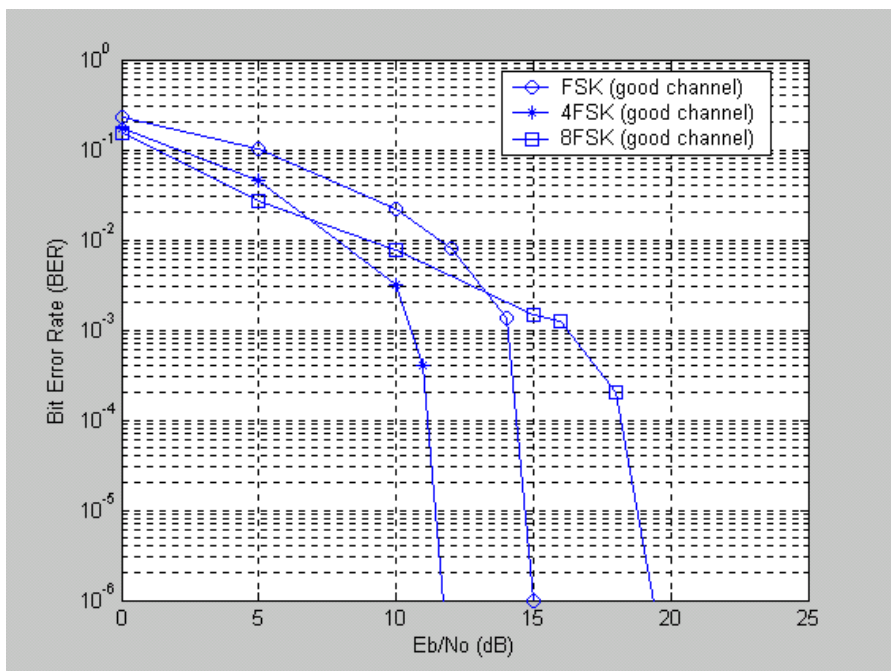

Fig. 12. MFSK Performance Over Good Channel.

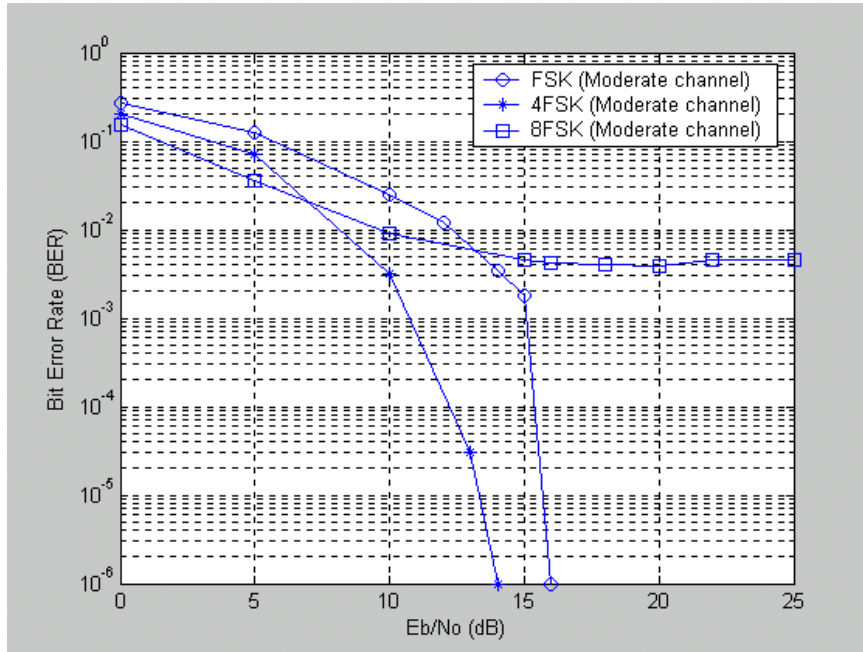

Fig. 13. MFSK Performance Over Moderate Channel.

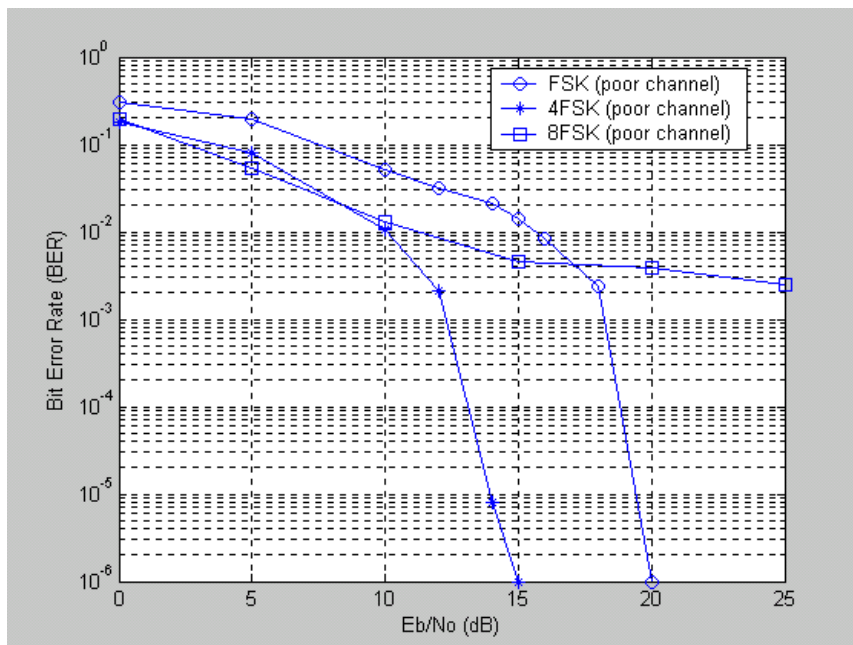

Fig. 14. MFSK Performance over Poor Channel.

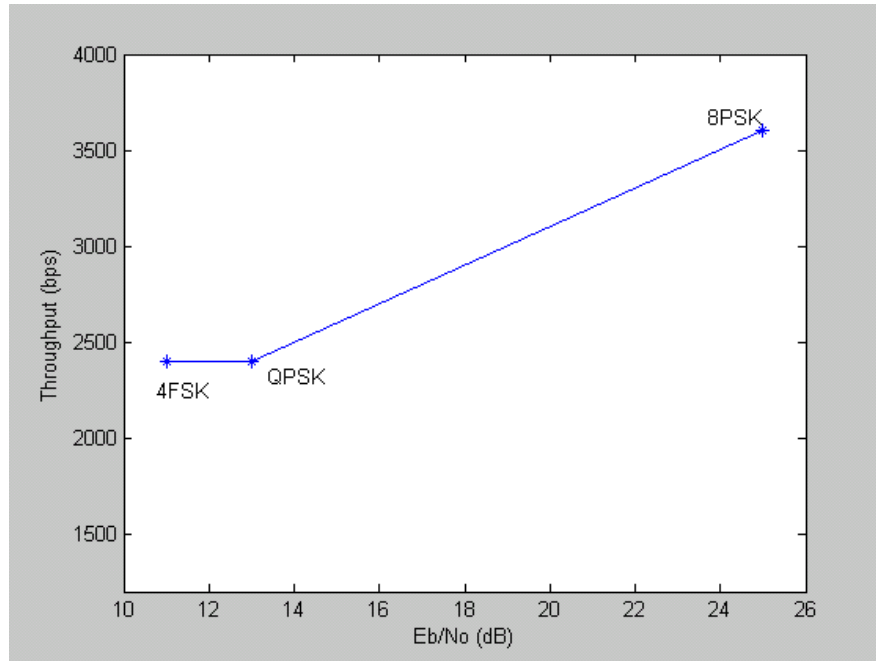

Fig. 15. HF Channel Performance.

V- Conclusions

Combination of a modified ALE with a proposed adaptive rate algorithm in which an initial data rate is selected based on the LQA data. This means that sounding channel to be used for both ALE and rate selection. The basic ALE word is used to estimate the present BER which is then used later to control the transmission rate.

The proposed system reduces the time period required to update the LQA data as compared to original time required for the standard LQA. This is because sounding individual channels is carried at predetermined intervals and updated for the selected channel at each transmission using the majority vote criterion.

The use of pilot tone to determine the received SINAD, RSL, and phase distortion is introduced using FFT measurement. This method is simple to implement and true real time operation is obtained with existing digital signal processing chips such as TMS320C5x.

References

- [1] D. J. Brown, S. E. Trinder and A.F. Gillespie "An analysis of HF for IP sub-network" 8th International Conference on HF Radio Systems and Techniques, July 2000, UK.
- [2] R.L. Freeman "Radio System Design for Telecommunications" John Wiley & sons Inc. 2nd Edition 1997, USA.
- [3] K. A. Salim "Adaptive HF System for High Speed Data Transmission" Ph.D thesis, Al-Rasheed College of Engineering and Science, University of Technology Iraq, 2005.
- [4] A.Goldsmith and S.Chua "Variable rate variable power MQAM for fading channels" IEEE Transactions on communications, Oct. 1997.
- [5] M. Rostami, J. Angeja, J. Tavares and A. Navarro "HF channel modeling for real time packet transmission" IEEE MILCOM 03 conference proceeding, 2003.
- [6] F. McVerry "High Speed Data Transmission Over HF Radio Links" Ph.D Thesis, Loughborough University of Technology, 1984, UK.
- [7] J. M. Torrance and L. Hanzo, "Upper bound performance of adaptive modulation in a slow Rayleigh fading channel", *IEEE Electronics letters*, Volume 32, April 1996.

- [8] S.Haykin "Communication Systems", John Wiley & Sons Inc. 3th edition 1994, USA.
- [9] M. D. Street and M. Darnell "Results of new Automatic Link Establishment and Maintenance Techniques for HF Radio Systems", IEEE MILCOM97 proceeding Vol.2 p1067-1071.
- [10] MIL-STD-188-141B Department of Defense Standard "Interoperability and Performance Standards for Medium and High Frequency Radio Systems", Department of Defense, March 1999, USA.

طريقة جديدة للاتصالات المتكيفة على قناة عالية التردد

خليفة عبود سالم* عبد الكريم عبد الرحمن كاظم** عادل حميد أحمد***

* قسم هندسة المعلومات والاتصالات/ كلية هندسة الخوارزمي/ جامعة بغداد

** قسم هندسة المعلومات/ كلية الهندسة/ جامعة النهرين

*** قسم هندسة الكهرباء والالكترونيك/ الجامعة التكنولوجية

الخلاصة

ان التأثيرات الكبيرة والمتغيرة مع الزمن على انتشار الموجات اللاسلكية ضمن قناة الترددات العالية HF يضع قيودا عديدة على استخدام مثل هذا الوسط لأغراض الاتصالات.

يهدف البحث الى تطوير منظومة مقترحة للاتصالات المتكيفة عبر قناة الترددات العالية. ان المنظومة المقترحة في هذا البحث تجمع بين تقنيتين هما، تحقيق الأتصال الطوعي والذي يعنى بأختيار التردد المناسب من بين مجموعة من الترددات المخصصة مسبقا للاتصال، مع تقنية اختيار سرعة ارسال البيانات المتكيفة. ان اختيار أي من الترددات المخصصة يتم من خلال تقييم كل قناة (تردد) على حده وبالتالي اختبار مدى صلاحيتها وملاءمتها لتأمين الأتصال.

ان اختبار كل قناة يتم من خلال توليد نغمة في جهة الأرسال، وقياس شدة الأشارة المستلمة ومستوى الأشارة الى الضوضاء بالإضافة الى التشويه الحاصل في الطور، حيث يتم تحليل الأشارة المستلمة بأستخدام FFT كما يتم حساب معدل الخطأ BER من خلال إرسال رسالة معلومة ومقارنتها في جهة الأستلام. ان المعلومات الناتجة من تحليل الأشارات المستلمة يتم اعادتها عكسيا الى المرسل وبالتالي استخدامها في اختيار نظام التحميل المناسب.

تم اجراء فحص محاكات بالحاسوب لتحليل وأختبار أداء هذه المنظومة، حيث تم تمثيل القناة عالية التردد بأستخدام نموذج Watterson وأستخدام نوعين من التضمين متعدد المستويات MPSK, MFSK. لقد أظهرت نتائج الأختبارات بأنه عند تثبيت سرعة ارسال البيانات الخارجة على سرعة 1200 رمز/ثانية فأن استخدام 4FSK عندما تكون مستوى الأشارة الى الضوضاء قليلة يعطي سرعة ارسال بيانات بمقدار 2400 بت/ثانية. عند ارتفاع مستوى الأشارة الى الضوضاء يتم الانتقال الى QPSK, 8PSK للحصول على سرعة إرسال بيانات 2400 و3600 على التوالي.