

Determination of ammonia concentrations in air from livestock housing systems

Reference method using gas washing as applied by Wageningen Livestock Research

J. Mosquera, J.P.M, Ploegaert, G.C.C. Kupers

Report 1187



WAGENINGEN
UNIVERSITY & RESEARCH

Determination of ammonia concentrations in air from livestock housing systems

Reference method using gas washing as applied by Wageningen Livestock Research

J. Mosquera, J.P.M, Ploegaert, G.C.C. Kupers

Wageningen Livestock Research
Wageningen, September 2019

Report 1187

Mosquera, J., J.P.M. Ploegaert, G. Kupers, 2019. *Determination of ammonia concentrations in air from livestock housing systems; Reference method using gas washing as applied by Wageningen Livestock Research*. Wageningen Livestock Research, Report 1187.

Samenvatting

In dit document wordt een beschrijving van de nat-chemisch methode uitgewerkt, zoals toegepast bij Wageningen Livestock Research. Deze meetmethode wordt vaak gebruikt als de referentiemethode voor ammoniakconcentratie metingen bij emissie metingen uit verschillende landbouwbronnen (huisvesting, mestopslag, mesttoediening). Het doel van dit document is om de prestatiekenmerken van deze methode te bepalen, en de procedure voor de implementatie van deze methode voor ammoniakconcentratie metingen bij huisvestingsystemen in de praktijk uit te werken.

Summary

This document is elaborated to give a description of the gas washing method as applied by Wageningen Livestock Research (WLR gas washing method). This measurement method is commonly used as the reference method for ammonia concentration measurements for the determination of ammonia emissions from agricultural activities (livestock housing, manure storage, field application of manure). The objective of this document is to specify the performance characteristics of the method, and the procedure for preparation and deployment of this method in practice to measure ammonia concentrations from livestock housing systems.

This report can be downloaded for free at <https://doi.org/10.18174/500006> or at www.wur.nl/livestock-research (under Wageningen Livestock Research publications).

© 2019 Wageningen Livestock Research

P.O. Box 338, 6700 AH Wageningen, The Netherlands, T +31 (0)317 48 39 53,
E info.livestockresearch@wur.nl, www.wur.nl/livestock-research. Wageningen Livestock Research is part of Wageningen University & Research.

All rights reserved. No part of this publication may be reproduced and/or made public, whether by print, photocopy, microfilm or any other means, without the prior permission of the publisher or author.

Wageningen Livestock Research is NEN-EN-ISO 9001:2015 certified.

All our research commissions are in line with the Terms and Conditions of the Animal Sciences Group. These are filed with the District Court of Zwolle.

Wageningen Livestock Research Report 1187

Table of contents

	Summary	5
1	Introduction and scope	7
2	Normative references	8
3	Terms and definitions	9
4	Description of the method	10
	4.1 Introduction	10
	4.2 Measurement principle	10
	4.3 Sampling procedure (field application)	11
	4.4 Calculation procedure	12
5	Performance characteristics	13
	5.1 Spectrophotometric detection of ammonium content.	13
	5.2 Breakthrough	14
	5.3 Verification of trueness of measurements: calibration of the WLR gas washing method	15
	5.4 Repeatability of concentration measurements (concentration differences between duplicates)	19
	5.5 Repeatability of measured flow rate (flow rate differences between replicates)	22
	5.6 Uncertainty analysis	24
6	Conclusions	26
7	Bibliography	27
	Annex 1: Calibration certificate of gas flow meters	28
	Annex 2: Certificates of calibration standards (gas cylinders)	33
	Annex 3: Calibration certificates of gas divider type Signal 821	43
	Annex 4: Calibration certificate of Mass flow controllers (Bronkhorst)	47

Summary

This document is elaborated to give a description of the gas washing method as applied by Wageningen Livestock Research (WLR gas washing method) to measure ammonia (NH₃) concentrations in the air entering and leaving livestock housing systems. Gas washing is commonly used as the reference method for ammonia concentration measurements for the determination of ammonia emissions from agricultural activities (livestock housing, manure storage, field application of manure). The objective of this document is to specify the performance characteristics of the WLR gas washing method, and the procedure for preparation and deployment of this method in practice.

The WLR gas washing method is based on the normative reference NEN2826, with a number of modifications:

1. NEN2826 prescribes using 4 flasks, 3 of them being filled with an absorption medium (acidic solution), and the fourth one (empty) as protection for the pump. The WLR gas washing method uses 3 flasks, 2 of them filled with an absorption medium. Section 5.2 shows that the effect of reducing the number of filled flasks from three to two is low (0.1% or 0.02 ppm at a concentration level of 20 ppm). Use of three filled flasks is, therefore, not necessary. Use of at least 2 filled flasks is recommended, to check for breakthrough or saturation during measurements.
2. NEN2826 prescribes using sulfuric acid as absorption medium. The idea behind the gas washing method is to use a strong acid to capture the NH₃ in the sampled air flowing through the absorption medium. The WLR gas washing method uses nitric acid instead. NEN2826 does not provide information about the reason behind their selection for sulfuric acid, or validation data to show that other (strong) acids (such as nitric acid) may not be used. WLR validated the method using nitric acid, by calibrating the modified gas washing method against a primary standard (certified calibration gas). Section 5.3 shows no significant differences between the WLR gas washing method and the primary standard. This confirms that using nitric acid instead of sulfuric acid does not result in less accurate NH₃ concentration measurements.
3. NEN2826 prescribes performing either isokinetic measurements, or applying a flow of at least 3 l/min. No information is provided about why lower flows may not be applied. In principle, the idea is to have enough flow through the absorption medium, allowing the NH₃ in the sampled air to be captured by the absorption medium, in order to have a high removal efficiency and minimize breakthrough to the following flasks. Section 5.2 shows that the breakthrough effect is negligible, and section 5.3 shows that using the WLR gas washing method (with a flow of 1 l/min), does not result in less accurate NH₃ concentration measurements.
4. NEN2826 prescribes that the flasks should be cooled down (during measurements) to a temperature below 20 °C. No information is provided to justify this selection. In the WLR gas washing method flasks are not cooled down. Since all absorption flasks are weighed before and after the measurements, there is no reason to believe that the effect of evaporation is not taken into account already by following this procedure.
5. NEN2826 prescribes using a gas flow meter to measure continuously (during the whole measurement period) the flow through the flasks. The gas flow meter is allowed to have a maximum deviation of 5%. In the WLR gas washing method flows are measured at the beginning and at the end of the (24-hours) measurement period. Section 5.5 shows small differences between these two flow values (less than 2% and lower than the requirements of NEN2826). This demonstrates that measuring the flow continuously is not necessary, and that accurate measurements of the flow at the beginning and at the end of the measurement period are sufficient.

According to NEN2826, the repeatability of NH₃ concentration measurements using the gas washing method is about 18%, independent of the concentration level. Section 5.4 shows that the WLR gas washing method has a repeatability of less than 5%. The combined (expanded) uncertainty of the WLR gas washing method is 10%, substantially lower than the 32% described in NEN2826. We can

therefore conclude that the WLR gas washing method provides results equivalent with NEN2826, and is suitable to be used as an alternative for the method described in NEN2826.

1 Introduction and scope

Agriculture is the most important source of ammonia emissions in the Netherlands. Ammonia can be emitted at all stages of the manure management chain (grazing of animals on pasture, livestock housing, manures storage, manure treatment, manure application into the field). Emission from livestock housing systems is the main contributor to ammonia emissions from agriculture, followed by application of manure to land. Cattle produce the greatest amount of emissions in the livestock sector, followed by pigs and poultry.

Since the 1990s, a number of measures have been introduced in the Netherlands to reduce ammonia emissions from agricultural sources. Determination of the ammonia reduction potential of these measures relies, among others, on accurate measurements of the ammonia concentration. The gas washing method is commonly used as the reference method for ammonia concentration measurements for the determination of ammonia emissions from agricultural activities (livestock housing, manure storage, field application of manure).

This document is elaborated to give a description of the gas washing method as applied by Wageningen Livestock Research (WLR; modified version of the gas washing method described in NEN2826), to determine its performance characteristics, and to test the suitability of the WLR gas washing method as an alternative for the method described in NEN2826. Section 2 gives an overview of the normative references used in this document. The most important terms and definitions are presented in section 3. Section 4 gives a short description of the WLR gas washing method and summarizes the most important differences of this method compared to NEN2826. In section 5, the performance characteristics of the WLR gas washing method are discussed. Finally, section 6 summarizes the main conclusions of the results presented in this document.

2 Normative references

This document incorporates information from other normative references, including:

NEN 2826:1999	Air quality – Stationary source emissions – Sampling and determination of gaseous ammonia content (in Dutch)
CEN/TS 14793:2017	Stationary source emission – Intralaboratory validation procedure for an alternative method compared to a reference method
NEN EN ISO 20988:2007	Air quality - Guidelines for estimating measurement uncertainty
NEN ISO 21748:2017	Guidance for the use of repeatability, reproducibility and trueness estimates in measurement uncertainty estimation
NEN-EN 12341:1998	Air quality – Determination of the PM 10 fraction of suspended particulate matter – Reference method and field test procedure to demonstrate reference equivalence of measurement methods (in Dutch)
NEN 6472:1983	Water - Photometric determination of ammonium content (in Dutch)
ISO 5725-1:1994	Accuracy (trueness and precision) of measurement methods and results – Part 1: General principles and definitions.

3 Terms and definitions

Absorption: process whereby one substance is physically taken into and included within another substance.

Absorption flask: bottle filled with an absorption medium, in which air (with the gas compound) is forced to pass through a narrow opening and impact into a flat surface placed inside the absorption medium (gas bubbling through the absorption medium). Also referred to as impinger.

Absorption medium: material used to absorb a particular component.

Accuracy (ISO 5725-1:1994): closeness of agreement of a measurement compared to the true value. Combination of trueness (systematic errors) and repeatability (random errors).

Air sample: volume of air taken from the main air flow and directed to the measurement equipment to be analysed.

Breakthrough: discharge of a particular component caused by overloading of the absorption medium.

Calibration: procedure performed to determine the systematic difference of a value measured by a measurement method, and the true value provided by a reference method. Calibrations in the laboratory are usually performed by using standard calibration gases.

Capturing efficiency: the capacity of an absorption medium to capture a specific component.

Detection limit: lowest value of the air quality characteristic which, with 95% probability, can be distinguished from a zero sample.

Flow rate: the rate at which a volume of air passes through a particular system.

Limit of detection: smallest (ammonia) concentration which can be detected, but not quantified, by using the selected measurement method.

Measurement: any physical dimension that is described by units.

Normal volume: gas volume at normal conditions (temperature: 293.15 K; pressure: 1013.25 hPa).

Precision: see repeatability.

Random errors: unpredictable errors which average to zero.

Repeatability (ISO 5725-1:1994): the closeness of agreement between independent test results by measuring the ammonia concentration in duplicate (simultaneous measurements) with the same measurement method. Usually expressed in terms of standard deviation of test results. Repeatability depends only on random errors and has no relation with the true concentration value (see trueness).

Systematic errors: predictable errors leading to a constant or proportional deviation of the measurement result compared to the true value.

Trueness (ISO 5725-1:1994): closeness of agreement between the mean value obtained from a large series of test results and an accepted reference value. Usually expressed in terms of bias or systematic deviation (error).

4 Description of the method

4.1 Introduction

Gas washing is commonly used as the reference method for ammonia concentration measurements for the determination of ammonia emissions from agricultural activities (livestock housing, manure storage, field application of manure). This method is described in NEN2826. Wageningen Livestock Research (WLR) uses a modified version of the gas washing method (WLR gas washing method). In particular, the following modifications are applied:

1. NEN2826 prescribes using 4 flasks, 3 of them being filled with an absorption medium (acidic solution), and the fourth one (empty) as protection for the pump. The WLR gas washing method uses 3 flasks, 2 of them filled with an absorption medium.
2. NEN2826 prescribes using sulfuric acid as absorption medium. The WLR gas washing method uses nitric acid instead.
3. NEN2826 prescribes performing either isokinetic measurements, or applying a flow of at least 3 l/min. The WLR gas washing method applies a flow of 1 l/min.
4. NEN2826 prescribes that the flasks should be cooled down (during measurements) to a temperature below 20 °C. In the WLR gas washing method flasks are not cooled down.
5. NEN2826 prescribes using a gas flow meter to measure continuously (during the whole measurement period) the flow through the flasks. In the WLR gas washing method flows are measured at the beginning and at the end of the (24-hours) measurement period.

The following sections give a description of the (modified) gas washing method, and the sampling and calculation procedure needed to determine NH₃ concentrations in the sampled air.

4.2 Measurement principle

Gas washing is an active measurement method for point sampling, and gives a time averaged concentration over the whole measurement period. This method relies on the absorption of ammonia in an acidic solution. In this method, an air sample is taken and transported from the measurement point into the absorption flasks by using a pump and sampling lines. The volume of air passing through the absorption medium shall be accurately measured, by controlling the flow using critical orifices or mass flow controllers, and measuring the flow using flow meters during the measurements. In contrast to what in NEN2826 is prescribed (continuous flow measurements), in the WLR gas washing method the flow rate is measured before and after the measurements using a DryCal® Defender 510 flowmeter (see figure 4.1). This instrument measures volumetric gas flow with an accuracy of ±1% of reading. This is lower than the 5% accuracy prescribed by NEN2826 for flow measurements. The flow rate is measured at the start and at the end of the measurements, to provide a better indication of the average flow during the measurement period. Section 5.5 gives an indication of the repeatability of flow rate measurements when using the WLR gas washing method.

The set of absorption flasks shall be placed in series and consists of at least three flasks (see figure 4.1 and section 5). This is a modification of the method described in NEN2826, where four flasks are prescribed (section 5.2 shows that the effect of reducing the number of filled flasks from three to two). In the WLR gas washing method, the first two flasks (three flask by NEN2826) are filled with an absorption medium (100 ml 0,05 M nitric acid; NEN2826 prescribes using sulfuric acid; see section 5.3 for calibration results of the WLR gas washing method against the primary standard (certified calibration gas)) for collecting the ammonia (in the form of ammonium), the last one to protect the pump, collecting any present liquids in the air before reaching the pump. No or negligible

breakthrough of ammonia is essential for the correctness of the measurements. This can be checked by using two absorption flasks (filled with absorption medium) in series. In principle, the first flask should be able to absorb all the ammonia sampled in the air. The second flask is used as a control, to check if this really occurs. If the control flask is also loaded with ammonia, meaning that not all the ammonia is absorbed in the first flask, using only one flask would lead to an underestimation of the ammonia load in the air sample. NEN2826 prescribes a maximum breakthrough of 5%. The absorption medium is analysed in the laboratory by using spectrophotometry according to NEN 6472. Ammonium reacts with dichloroisocyanurate and salicylate at a pH of 12.6 in the presence of a catalyst, pentacyanonitroferrate (III), resulting in a blue coloured solution. The extinction of the solution at 655nm is a measure of the ammonium content in the solution.



Figure 4.1 Set-up WLR gas washing method. Left: absorption flasks (measurements in duplicate; per train (in series) two absorption flasks filled with absorption medium and one empty absorption flask for protection of the pump). Middle: Dry gas flow meter (DryCal® Defender 510-m, Bios Int. Corp, USA). Right: pump (Thomas Industries Inc., model 617CD32, Wabasha, Minnesota ,VS), sampling lines (Teflon or polyethylene), and critical orifices (borosilicate glass (diameter: 8 mm; length: 80 mm), housed in a stainless steel container for protection; flow: ~1000 ml/min).

4.3 Sampling procedure (field application)

For the application of the WLR gas washing method in practice, the following steps must be followed:

- Prepare the set of absorption flasks (in duplicate, to get an accurate estimation of the concentration level; see figure 4.1). The flasks (per replicate) are connected in series: a small sampling tube (Teflon or polyethylene) is used to connect the outlet of one flask to the inlet of the next one in the series. In addition, an extra absorption flask, filled with absorption medium but closed (without being in contact with polluted air), must be used as a measure for a clean (blank, solution without ammonium) absorption medium (zero value). The concentration in the absorption flasks should be corrected for this blank value (see section 4.4).
- The sampling line (Teflon or polyethylene) from the measurement point is connected to the inlet of the first absorption flask. Heating and isolation of the sampling tubes is required when condensation problems in the sampling tubing may occur (large temperature differences along the sampling line).
- The outlet of the empty absorption flask (last in the series) is connected with the pump (Thomas Industries Inc., model 617CD32, Wabasha, Minnesota ,VS). In front of the pump, a critical orifice (borosilicate glass (diameter: 8 mm; length: 80 mm), housed in a stainless steel container for protection) is placed to provide a flow rate of approximately 1 l/min. NEN2826 prescribes performing either isokinetic measurements, or applying a flow of at least 3 l/min (see section 5.3 for calibration results of the WLR gas washing method (flow of 1l/min) against the primary standard (certified calibration gas)).
- Start the measurements by switching on the pump, and write down the date and time at which the measurements have been started.
- Measure the flow rate through the absorption flasks at the start of the measurements by using a calibrated flow meter (e.g. DryCal® Defender 510-m, Bios Int. Corp, USA; see Annex 1 for the calibration certificate of this gas flow meter). This is done by disconnecting the sampling line from the inlet of the first absorption flask, and connecting the flow meter with a Teflon or polyethylene

tube to the inlet of the first absorption flask. Measure at least 5 times and write down the average flow.

- At the end of the measurement period, before switching off the pump, measure the flow following the same procedure as at the start of the measurements.
- Stop the measurements by switching off the pump. Write down the date and time at which the measurements have been stopped.
- Remove the connection of the sampling lines from the inlet of the first absorption flasks, and flush the (internal) glass tube of the absorption flasks with demi-water.
- The absorption flasks are transported to the laboratory for analysis. NEN2826 prescribes that the flasks should be cooled down (during measurements) to a temperature below 20 °C. No information is provided to justify this selection. Since all absorption flasks are weighed before and after the measurements, there is no reason to believe that the effect of evaporation is not taken into account already by following this procedure.

4.4 Calculation procedure

Provided the acid in the absorption flasks is in excess, this technique provides quantitative results of ammonia concentration levels. First of all, the ammonium-N (NH₄-N) content in the absorption medium is calculated according to:

$$m(\text{NH}_4 - \text{N}) = \frac{(m_1 - m_0) \times (c_1 - c_0)}{1000 \times d_w}$$

Where:

$m(\text{NH}_4\text{-N})$	= ammonium-N (NH ₄ -N) content in the absorption medium, in mg.
m_1	= mass of the absorption flask after sampling, in g.
m_0	= mass of the absorption flask before sampling (empty bottle), in g.
c_1	= concentration of NH ₄ -N in the absorption medium of the sample, in mg/l.
c_0	= concentration of NH ₄ -N in the absorption medium of the blank, in mg/l.
d_w	= density of water, in kg/l (1 kg/l)

The time-averaged ammonia concentration in the sampled air can then be calculated by using the following equation:

$$C_{\text{NH}_3} = \frac{m(\text{NH}_4\text{-N})}{1000 \times F_g \times t} \times \frac{17}{14}$$

C_{NH_3}	= ammonia concentration in the air sample, in g m ⁻³
$m(\text{NH}_4\text{-N})$	= ammonium-N (NH ₄ -N) content (sum of all used flasks), in mg.
t	= sampling time [h]
F_g	= gas flow rate [m ³ h ⁻¹]
17	= molar mass of NH ₃ , in g/mol
14	= molar mass of N, in g/mol

To compare different measurements, the results can be recalculated to standard temperature (20 °C) and atmospheric pressure (101.3 kPa).

5 Performance characteristics

5.1 Spectrophotometric detection of ammonium content.

To determine the detection limit of the WLR gas washing method using spectrophotometric detection of ammonium content, a number of clean absorption flasks (flasks filled with absorption medium, without being in contact with polluted air) was sent at different times to the laboratory for analysis. Figure 5.1 shows that the ammonium concentration in these clean absorption flasks was low but not negligible. The detection limit of the method (laboratory analysis), according to these measurements, and calculated as four times the standard deviation of the values measured by clean absorption flasks, was 0.09 mg NH₄-N/l (n= 26; average: 0.09 mg NH₄-N/l; median: 0.08 mg NH₄-N/l; standard deviation: 0.02 mg NH₄-N/l). In every absorption flask, 100 ml of absorption medium is added. For an average flow through the absorption flask of 1000 ml/min, and an average measurement period of 24 hours, this would result in a detection limit of 0.008 mg NH₃/m³ (0.011 ppm NH₃ for standard conditions (temperature: 20 °C; pressure: 101.3 kPa)) per absorption flask.

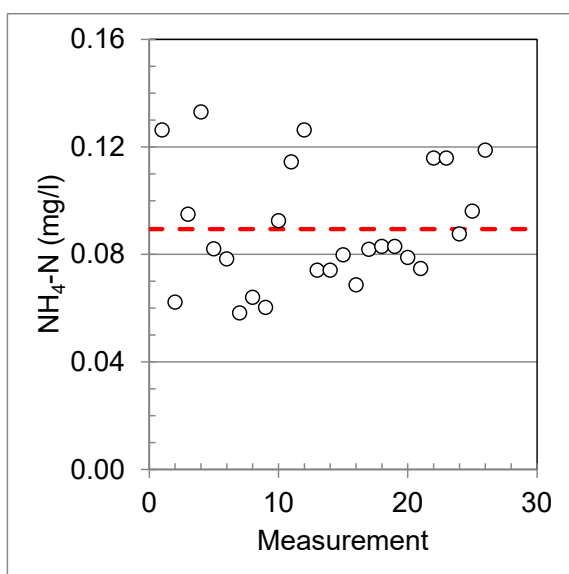

Figure 5.1 Determination of the detection limit of the WLR gas washing method by laboratory analysis using spectrophotometric detection of ammonium content. The red (dashed) line gives the average value of all measurements.

The determination of the ammonium content in an acidic solution for all samples used in this study was performed following the procedure described in NEN 6472. To test the repeatability of the system to measure a particular concentration in the laboratory, six samples were analysed at four different days separated more than one month in time. The results of this analysis are presented in Table 5.1, and show that the variation coefficient between days for all different samples was always smaller than 2%, with an average of 0.8%.

Table 5.1 Repeatability of the laboratory analysis to determine sample concentrations.

Sample number	Day 0	Day 28	Day 33	Day 36	Average	Standard deviation	Coefficient of variation (%)
14/0557-17	4.27	4.29	4.27	4.27	4.28	0.01	0.2
14/0557-19	4.06	4.06	4.07	4.08	4.07	0.01	0.2
14/0587-1	5.77	5.95	5.93	5.94	5.90	0.09	1.5
14/0587-3	5.97	6.14	6.11	6.14	6.09	0.08	1.3
14/0588-6	7.09	6.98	7.09	---	7.05	0.06	0.9
14/0588-8	6.18	6.21	6.16	---	6.18	0.03	0.4

5.2 Breakthrough

According to the normative reference NEN 2826, a set of four absorption flasks in series (three filled with absorption medium, and one empty for protection of the pump) must be used. The breakthrough between absorption flasks must be lower than 5% to be considered acceptable. In order to test whether it is necessary to include three absorption flasks filled with absorption medium, a number of measurements were performed on commercial farms (see table 5.2 for an overview of the measurement locations) by using four absorption flasks in series as specified by NEN 2826. Then, ammonia concentrations were determined by using the ammonium concentration measured by all three filled absorption flasks, only the first two absorption flasks, or only the first one. Figure 5.2 shows the effect of decreasing the number of filled flasks from three (as stated in NEN 2826) to two or even only one flask. The effect is quite small (0.1%, or 0.02 ppm for a concentration value of 20 ppm), meaning that the method functions properly with almost no breakthrough to the second and third flask. Use of three filled absorption flasks is not necessary. However, use of at least two flasks is highly recommended, to check for breakthrough or saturation of the first flask during the measurements.

Table 5.2 Overview of measurements for testing the number of absorption flasks needed.

Commercial farm	Animal category	Measurement point	Number of measurements
1	Dairy cattle	Inside the barn	28
		Outside the barn	28
2	Fattening pigs	Before scrubber	14
		After scrubber	14
3	Meat calves	Before scrubber	12
		After scrubber	11

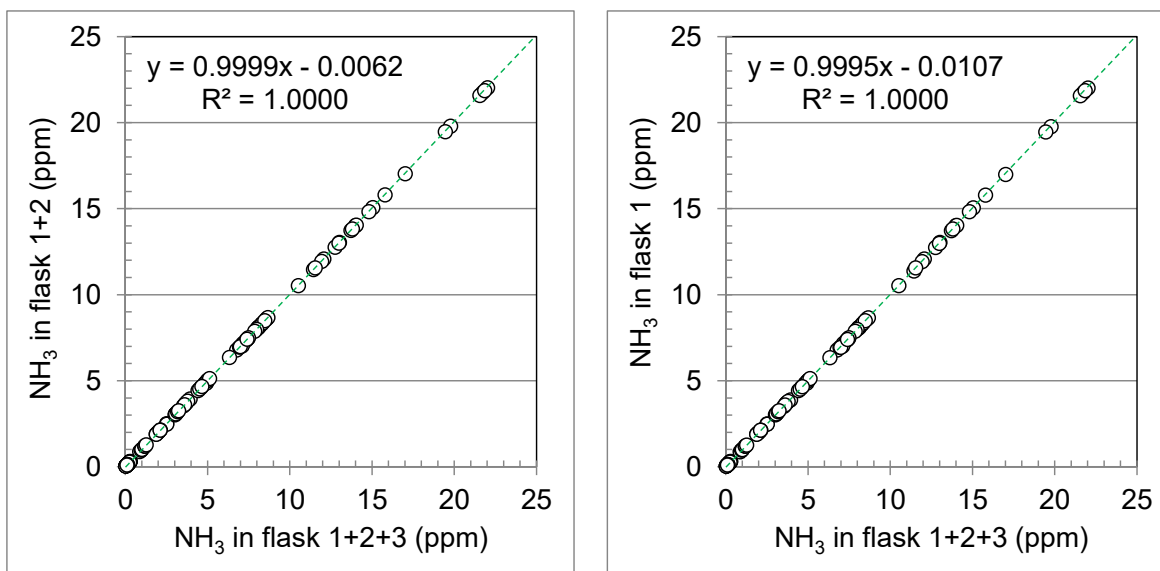

Figure 5.2 Effect of decreasing the number of flasks to one (left figure) and two (right figure) on the measured NH_3 concentration compared to the three flasks prescribed in NEN 2826.

5.3 Verification of trueness of measurements: calibration of the WLR gas washing method

The WLR gas washing method was calibrated in the laboratory against standard calibration gases (reference method) by following this procedure:

- First, a set of absorption flasks was prepared as described in section 4.
- Then, air from a calibration NH_3 gas cylinder (see Annex 2 for certificates of the standard gases used for the calibration) was diluted (as shown in Figure 5.3) with compressed air using different dilution steps and drawn through the absorption flasks at a constant air flow rate of ~ 1000 ml/min. The flow from the NH_3 gas cylinder and compressed air was regulated either with a dilution system (gas divider type Signal 821, Figure 5.4; see Annex 3 for the calibration certificates of this instrument) or with mass flow controllers (Bronkhorst; see Annex 4 for the calibration certificate of these mass flow controllers), and measured using a gas flow meter (Gilian Gilibrator, Sensidyne, Inc.; see Annex 1 for the calibration certificate of this instrument).
- For every dilution step (see table 5.4) it was calculated how much time it was needed to absorb enough NH_3 in the absorption flasks to be easy detectable by spectrophotometry, and a set of absorption flasks exposed to the diluted gas during this measurement time.
- At the end of the measurement period, the absorption flasks were transported to the lab and analysed by spectrophotometry.

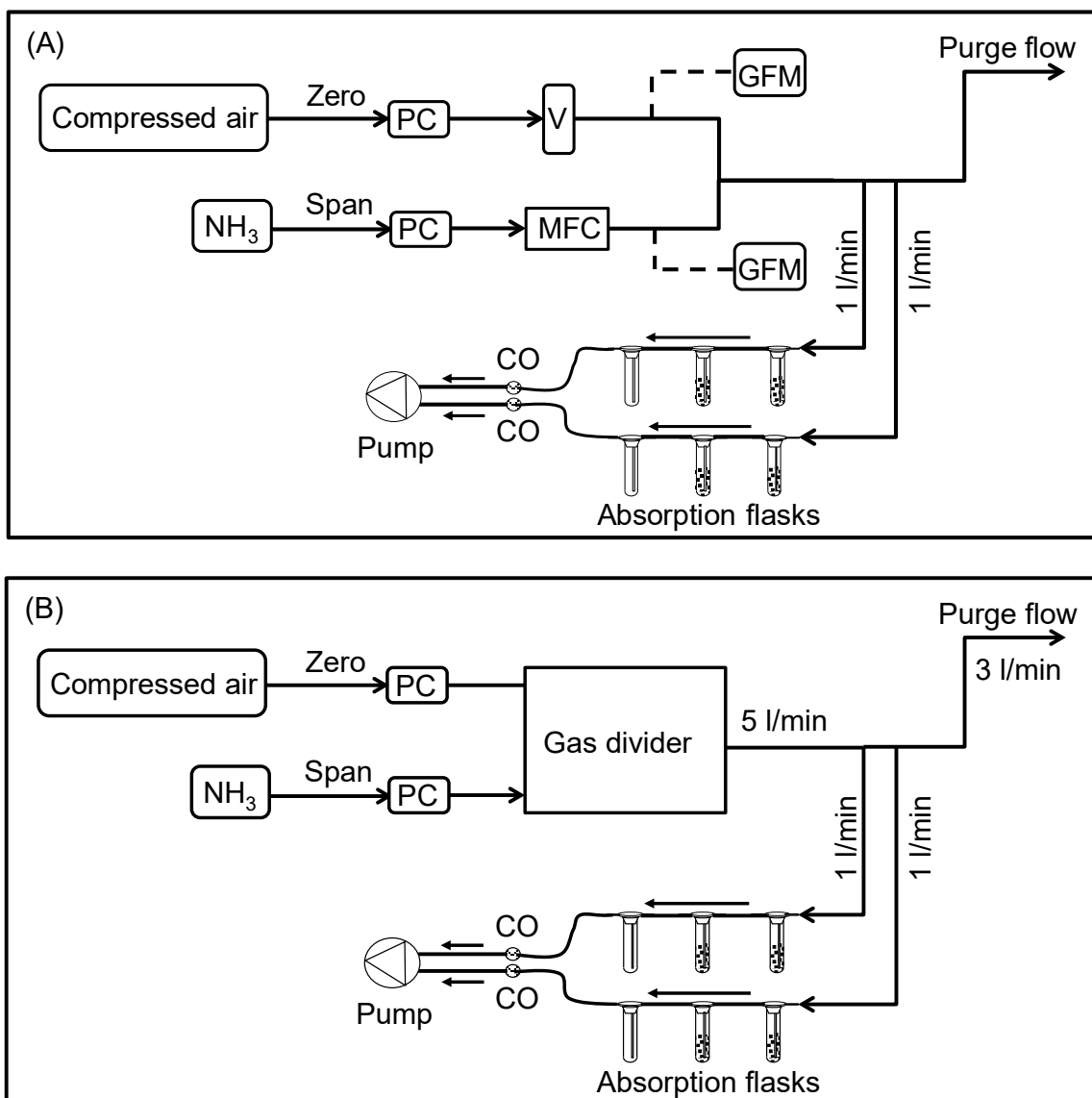

Figure 5.3 Schema of the measurement set-up used for the calibration of absorption flasks. A) Set-up for concentrations below 10 ppm. B) Set-up for concentrations above 10 ppm. PC: Pressure controller; V: Valve; MFC: Mass flow controller; GFM: Gas flow meter; CO: critical orifice (flow restrictor).



Figure 5.4 Dilution system (Signal 821) used in this study.

Table 5.3 Dilution factors for different dilution steps for the Signal 821.

Settings	Dilution factor (2015)	Dilution factor (2005)	Dilution factor (1996)
10%	0.1012	0.1007	0.1005
20%	0.2008	0.2000	0.1991
30%	0.3002	0.3001	0.2986
40%	0.3990	0.3985	0.3973
50%	0.5006	0.5003	0.4993
60%	0.6004	0.5985	0.6004
70%	0.6993	0.6981	0.6988
80%	0.7992	0.7982	0.7995
90%	0.9000	0.8994	0.8999

Table 5.4 Dilution steps for the calibration of the WLR gas washing method. Results by applied NH₃ with the same number were combined.

NH ₃ cylinder (ppm)	Setting (%) dilution system	Flow NH ₃ cylinder (l/min)	Flow compressed air (l/min)	Applied NH ₃ (ppm)	Number of measurements
Compressed air	---	---	1	<0.01 ^(*)	1
101	---	0.011	10.5	0.11	2
101	---	0.020	20.0	0.20	2
101	---	0.020	20.0	0.52	2
101	---	0.031	30.5	0.76	2
101	---	0.030	30.5	0.98	2
101	---	0.105	104.7	3.3	2
101	---	0.148	147.8	4.6	2
101	---	0.202	202.1	7.6	2
102	10	---	---	10.3	2
101	10	---	---	10.2	2
101	---	0.252	251.9	10.3	2
11	100	---	---	11.0	9
101	20	---	---	20.2	2
102	30	---	---	30.5	2
101	30	---	---	30.3	2
102	50	---	---	50.8	2
101	50	---	---	50.5	2
100	100	---	---	100	2
101	100	---	---	101	8
102	100	---	---	102	4

(*) The NH₃ concentration in the compressed air was measured during a period of 2 weeks. The average concentration was below the detection limit of 0.011 ppm.

The null hypothesis to test the trueness of measurements when using the WLR gas washing method is that the measured ammonia concentrations with the WLR gas washing method and the standard calibration gases are similar. If the null hypothesis is fulfilled, a linear regression analysis ($y=a*x+b$) of the WLR gas washing method (y) against the standard calibration gases (x) results in a slope $a=1$ and an intercept $b=0$. To test if this hypothesis was fulfilled, the following procedure was applied:

1. A linear regression analysis ($y=a*x+b$) was performed based on the calibration data (ammonia concentrations measured with the WLR gas washing method against standard calibration gases). From this regression analysis, the following parameters were determined (Table 5.5):
 - a. Slope (a)
 - b. Intercept (b)
 - c. Coefficient of determination (R^2)

2. The two-sided acceptance intervals (10% for concentrations > 1 ppm, 0.1 ppm for concentrations below 1 ppm, based on the expanded uncertainty of the modified WLR gas washing method as described in section 5.6) were determined according to:

$$\begin{aligned} \text{For concentrations } < 1\text{ ppm} \quad & y = x - 0.1 \text{ ppm} \\ & y = x + 0.1 \text{ ppm} \\ \\ \text{For concentrations } > 1\text{ ppm} \quad & y = 0.9 * x \text{ ppm} \\ & y = 1.1 * x \text{ ppm} \end{aligned}$$

3. A graph was plotted showing the following information:
- For all calibration steps ($i=1\dots n$) applied in the calibration procedure, the value of the concentration measured with the WLR gas washing method (y_i) and the applied ammonia concentration according to the standard calibration gas (x_i).
 - The line showing the null hypothesis ($y = x$).
 - The regression line determined by the regression analysis (Table 5.5).
 - The two-sided acceptance intervals.
4. For acceptance, the following criteria shall be fulfilled:
- $R^2 \geq 0.95$
 - De regression line is bounded within the limits of the acceptance intervals.

The criteria for acceptance is fulfilled for the whole concentration range (Figure 5.5 and Table 5.5). The NH_3 concentration measured in the laboratory using the WLR gas washing method was in general slightly lower or similar to the concentration supplied (by dilution) from the gas standards (gas cylinders) over the whole concentration range. These results show that it is not necessary to apply a flow rate of at least 3 l/min, as prescribed in NEN 2826, and that the applied flow rate (~1 l/min) also gives satisfactory results.

Table 5.5 Linear regression (calibration) for the WLR gas washing method. $\text{NH}_{3\text{applied}} = a * \text{NH}_{3\text{gas washing}} + b$.

Range	a	b	R ²
< 1 ppm	1.00	0.03	1.00
1-10 ppm	0.97	0.18	0.99
> 10 ppm	0.96	0.22	1.00

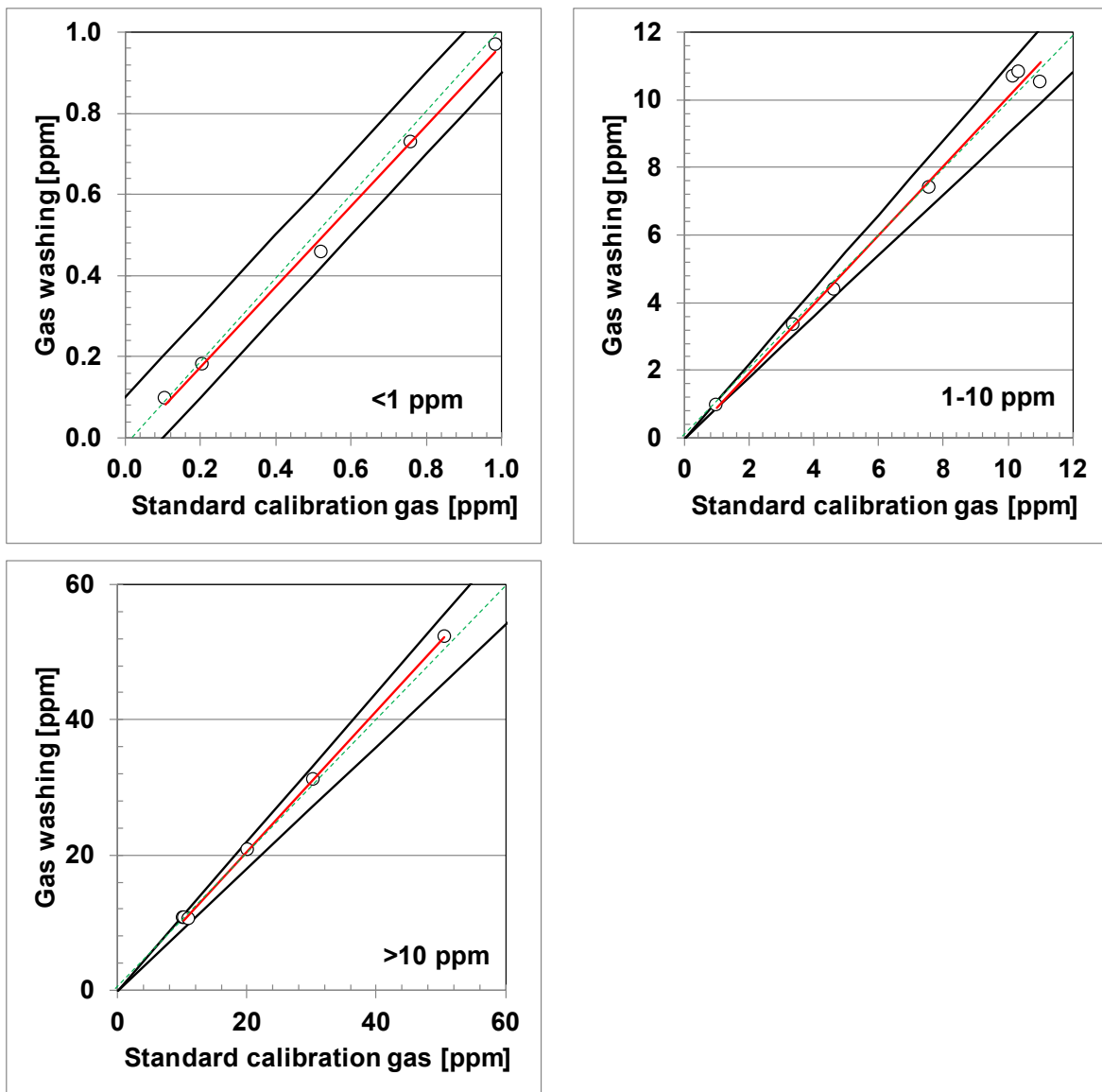

Figure 5.5 Trueness of measurements (laboratory calibration) for the WLR gas washing method. The red line represents the regression line of the measurements, the green lines represent $y=x$. The black lines represent the two-sided acceptance envelopes (0.10 ppm for concentrations < 1 ppm; 10% for concentrations > 1 ppm).

The gas washing method cannot discriminate between ammonia, ammonium, and any other N-containing volatile organic compounds. However, the concentration of these compounds in animal facilities is expected to be negligible in comparison with ammonia (Hutchinson *et al.*, 1982; Schade and Crutzen, 1995). Therefore, calibration of the method in the field (on practical farms) is not necessary.

5.4 Repeatability of concentration measurements (concentration differences between duplicates)

To test the precision (repeatability) of the concentration measurements (comparability of results between replicates), two sets of absorption flasks were prepared and exposed simultaneously to the same polluted air during measurements at different commercial farms. The dataset with the paired results was first analysed for outliers by using the box plot method with three times the interquartile range (IQR) as measure for extreme outliers:

IQR = Q3-Q1

Q1: lower (first) quartile (25%)

Q2: median (second quartile)

Q3: upper (third) quartile (75%)

Outlier if: value > Q3+3*IQR OR value < Q1-3*IQR

Then, the selected dataset of parallel measurements (without outliers) was used to validate the repeatability of concentration measurements according to the following procedure:

1. Determine for all measurement periods (i=1...n) the average concentration (Y_i) of the two replicates (Y_{i1}, Y_{i2}):

$$Y_i = \frac{(Y_{i1} + Y_{i2})}{2}$$

2. Determine the concentration difference (D_i) between replicates 1 en 2:

$$D_i = (Y_{i1} - Y_{i2})$$

3. Determine the standard deviation of the measurements according to:
 - a. From the complete dataset, select those measurements (n_{low}) with concentration values below 1 ppm and calculate the absolute standard deviation (S_a) of the measurements:

$$S_a = \sqrt{\frac{\sum_{i=1}^{n_{low}} D_i^2}{2 * n_{low}}}$$

- b. Select the measurements (n_{high}) with concentration values above 1 ppm and calculate the relative standard deviation (S_r) of the measurements:

$$S_r = \sqrt{\frac{\sum_{i=1}^{n_{high}} (D_i/Y_i)^2}{2 * n_{high}}}$$

4. Determine the critical t-value ($t_{f;95\%}$) for a two-tailed t-test with
 - a. $f=n_{low}-2$ degrees of freedom and a 95% confidence level, for concentrations below 1 ppm.
 - b. $f=n_{high}-2$ degrees of freedom and a 95% confidence level, for concentrations above 1 ppm.

5. Determine the two-tailed 95% confidence interval of the measurements according to:
 - a. For concentrations below 1 ppm, the absolute confidence interval ($CL_{95\%}^a$):

$$CL_{95\%}^a = S_a * t_{f;95\%}$$

- b. For concentrations above 1 ppm, the relative confidence interval ($CL_{95\%}^r$):

$$CL_{95\%}^r = S_r * t_{f;95\%}$$

6. For acceptance, the following criteria shall be fulfilled:

- a. For concentrations below 1 ppm:

$$CL_{95\%}^a \leq 0.1 \text{ ppm}$$

- b. For concentrations above 1 ppm: 95% confidence interval shall be lower than 0.2 ppm (absolute values) for concentrations below 1 ppm, and lower than 10% (relative values) for concentrations above 1 ppm (10% is the expanded uncertainty of the modified WLR gas washing method, see section 5.6).

$$CL_{95\%}^r \leq 0.1 (10\%)$$

Table 5.6 gives an overview of the measurement locations and number of measurements used in the analysis (outliers already excluded from this overview).

Table 5.6 Overview of measurements in duplicate using the WLR gas washing method.

Concentration range	Animal category	Measurement locations	Number of measurements
<1 ppm	Cattle	1	12
	Pigs	22	107
	Poultry	36	179
1-10 ppm	Cattle	1	14
	Pigs	17	48
	Poultry	37	169
> 10 ppm	Cattle	---	---
	Pigs	24	136
	Poultry	30	95
TOTAL		181	760

Concentration differences between replicates are low, as shown in Figure 5.6. The criteria for acceptance of the method for repeatability of measurements is fulfilled for both concentrations below 1 ppm (n= 298; absolute average difference: 0.01 ppm; median: 0.00 ppm; standard deviation: 0.02 ppm; 95%-confidence interval: 5%), for concentrations between 1-10 ppm (n= 231; relative average difference: 3%; median: 2%; standard deviation: 3%; 95%-confidence interval: 6%), and for concentrations above 10 ppm (n= 231; relative average difference: 1%; median: 1%; standard deviation: 1%; 95%-confidence interval: 2%).

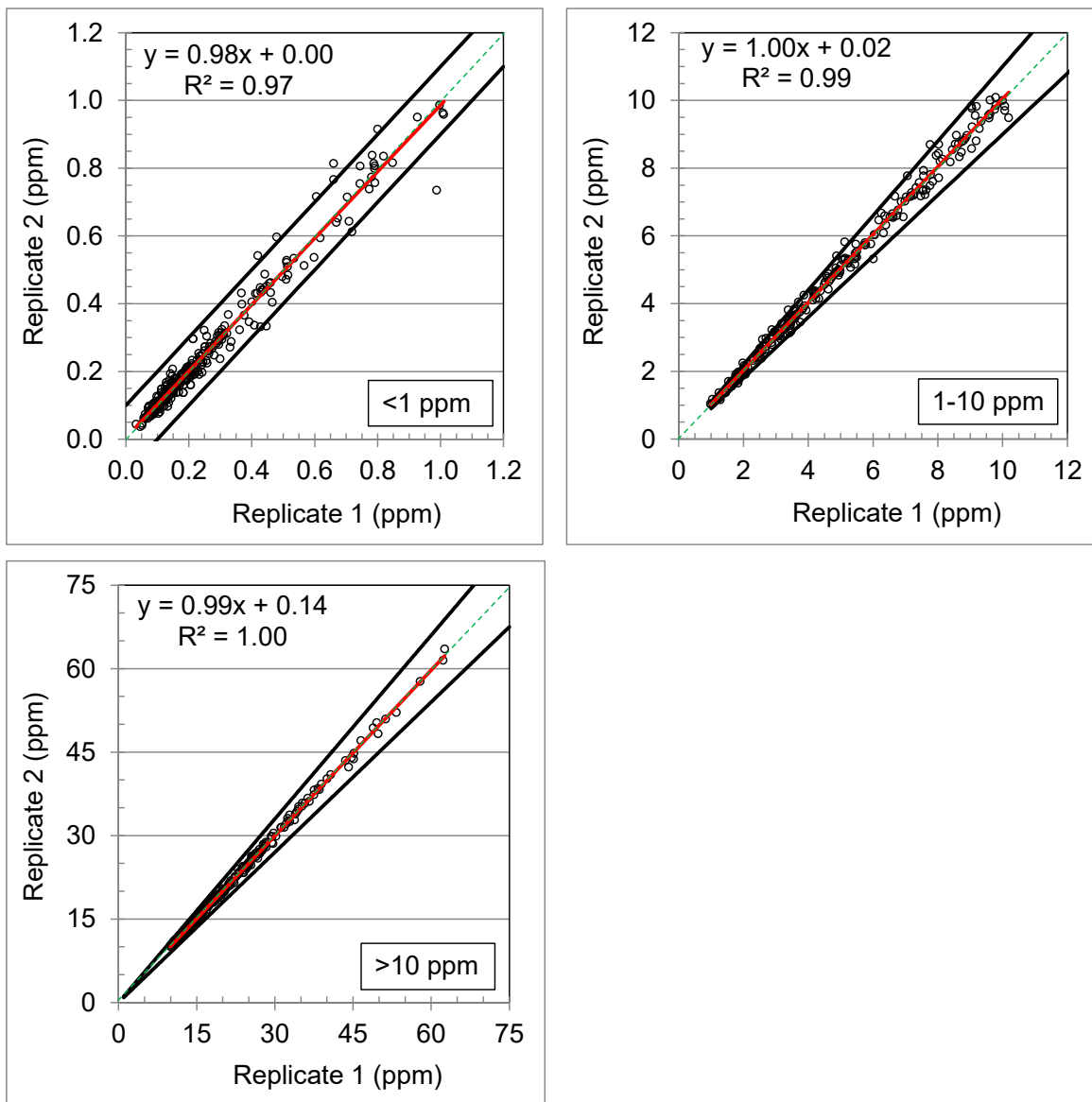

Figure 5.6 Concentration differences in samples taken in duplicate using the WLR gas washing method. The red line represents the regression line of the measurements. The black lines represent the two-sided acceptance envelopes (0.10 ppm for concentrations < 1 ppm; 10% for concentrations > 1 ppm).

5.5 Repeatability of measured flow rate (flow rate differences between replicates)

The data in section 5.4 was also used to test the precision (repeatability) of flow rate measurements (comparability of results between replicates). The procedure was similar to the one used for testing the repeatability of concentration measurements. The dataset with the paired results was first analysed for outliers by using the box plot method with three times the interquartile range (IQR) as measure for extreme outliers:

$$\text{IQR} = \text{Q3} - \text{Q1}$$

Q1: lower (first) quartile (25%)

Q2: median (second quartile)

Q3: upper (third) quartile (75%)

Outlier if: value > Q3+3*IQR OR value < Q1-3*IQR

Then, the selected dataset of parallel measurements (without outliers) was used to validate the repeatability of flow measurements according to the following procedure:

1. Determine for all measurement periods ($i=1\dots n$) the average flow (Y_i) of the two replicates (Y_{i1} , Y_{i2}):

$$Y_i = \frac{(Y_{i1} + Y_{i2})}{2}$$

2. Determine the difference in flow (D_i) between replicates 1 en 2:

$$D_i = (Y_{i1} - Y_{i2})$$

3. Determine the relative standard deviation (S_r) of the measurements ($i=1\dots n$) according to:

$$S_r = \sqrt{\frac{\sum_{i=1}^n \left(\frac{D_i}{Y_i}\right)^2}{2 * n}}$$

4. Determine the critical t-value ($t_{f,95\%}$) for a two-tailed t-test with $f=n-2$ degrees of freedom and a 95% confidence level.
5. Determine the two-tailed 95% confidence interval ($CL_{95\%}^r$) of the measurements according to:

$$CL_{95\%}^r = S_r * t_{f,95\%}$$

6. For acceptance, the following criteria shall be fulfilled:

$$CL_{95\%}^r \leq 0.1 \text{ (10\%)}$$

Differences between flow replicates (before and after the measurements) are low, as shown in Figure 5.7. The criteria for acceptance of the method for repeatability of measurements is fulfilled ($n= 1874$; relative average difference: 1.6%; median: 1.2%; standard deviation: 1.5%; 95%-confidence interval: 3%).

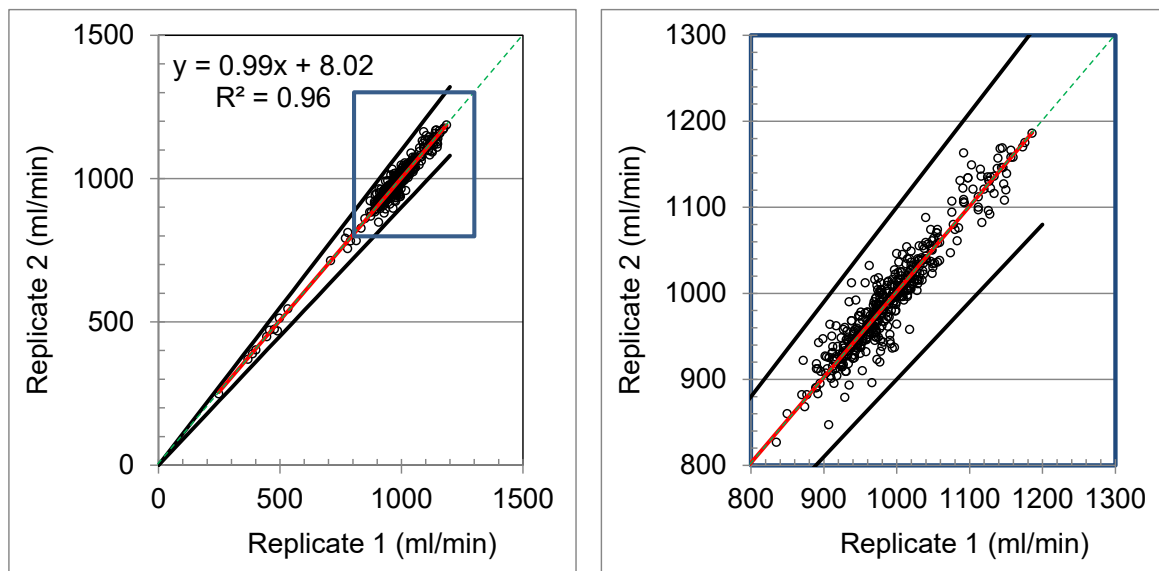

Figure 5.7 Differences in flow rates between replicates. Left: whole range. Right: close look of the commonly used flow rate (~ 1000 ml/min).

5.6 Uncertainty analysis

The procedure used to evaluate the uncertainty associated with NH₃ concentration measurements using the modified gas washing method follows the manual for the expression of uncertainty in measurement (ERASER; JCGM, 2008). The uncertainty of the NH₃ concentration measurement using this method is evaluated with the help of the law of propagation of uncertainty. This requires the identification and quantification of all sources of uncertainty related to NH₃ concentration measurements carried out with the modified WLR gas washing method. These sources of uncertainty can be classified in the following categories:

- a. Gas flow rate through the flasks (U_{gs})
- b. Repeatability of NH₃ concentration measurements (U_{dc})
- c. Sampling time (U_t)
- d. Chemical analyses in the lab (reproducibility lab analyses; U_{lab})
- e. Calibration (U_{cal}).
- f. Interferences (U_{interf}).
- g. Adsorption and desorption in piping and sampling system (U_{ads}).
- h. Flow meter (U_{flow}).

Addendum a). The gas flow rate through the bottles (F_g) is calculated as the average of the flow rate measured at the beginning of the (F_g^b) and at the end (F_g^e) of the measurement period:

$$F_g = \frac{F_g^b + F_g^e}{2}$$

According to section 5.5, a standard uncertainty of $U_{gs} = 2\%$ (normal distribution; $k = 1$) can be assigned for the gas flow rate through the flasks.

Addendum b). The repeatability of the measurements is defined as the absolute difference between the results of a duplicate measurement under similar conditions. At each measurement point, the measurements are performed in duplicate ($i = 1, 2$) and the concentration at each measurement point is calculated as the average of the duplicate measurements:

$$C_{NH_3} = \frac{C_{NH_3}^1 + C_{NH_3}^2}{2}$$

According to section 5.4, a standard uncertainty of $U_{dc} = 3\%$ (normal distribution; $k=1$) can be assigned for the repeatability of NH₃ concentration measurements.

Addendum c). The time is noted both at the beginning and at the end of the measurements. The expected uncertainty in these measurements is $U_t < 0.5\%$ (rectangular distribution; a 5-minute difference over a 24-hour period results in an uncertainty of 0.35%).

Addendum d). The determination of the ammonium content in the absorption medium is determined in the laboratory of Wageningen Livestock Research according to the procedure described in NEN 6472. To determine the reproducibility of lab analyses, six samples were analysed on four different days with a total of more than one month difference (see section 5.1). According to these results, a standard uncertainty $U_{lab} = 2\%$ (normal distribution; $k = 1$) can be assigned for the reproducibility of lab analyses.

Addendum e). The modified WLR gas washing method was calibrated in the laboratory against a primary standard (certified calibration gases, reference method). The procedure and the results are reported in section 5.3 and summarized in the table below.

Table 5.7 Linear regression (calibration) of the modified WLR gas washing method. $NH_{3\text{applied}} = a * NH_{3\text{gas washing}} + b$.

Range	a	b	R ²
< 1 ppm	1.00	0.03	1.00
1-10 ppm	0.97	0.18	0.99
> 10 ppm	0.96	0.22	1.00

When the NH₃ concentration measurements are corrected by the results of the calibration procedure, the uncertainty in the calibration is equal to the uncertainty of the standard calibration gases used for the calibration. This source (calibration WLR gas washing method) is assigned a standard uncertainty **U_{cal}=3%** (normal distribution; k = 2).

Addendum f). The WLR gas washing method cannot distinguish between ammonia, ammonium and other N-containing volatile organic compounds. The concentration of these compounds is expected to be negligible compared to ammonia (Hutchinson et al, 1982; Damage and Crutzen, 1995). This source of uncertainty is assigned a default uncertainty **U_{interf}=0%**.

Addendum g). Adsorption and desorption of ammonia in the sampling lines can be prevented in pig and poultry stalls by isolating and heating the pipes. In dairy farms this is not expected to occur (small temperature variations). Using an average concentration over the entire 24-hour measurement period will further reduce this effect. This source of uncertainty is assigned a standard uncertainty **U_{ads}=2%** (rectangular distribution).

Addendum h). The flow meter used in the modified WLR gas washing method (DryCal® Defender 510) measures the gas flow rate with an accuracy of ± 1% of the reading. This source is assigned a standard uncertainty **U_{flow}=1%** (normal distribution; k = 1).

The combined measurement Uncertainty (U_{comb}) is determined according to:

$$U_{comb} = \sqrt{(U_{gs}^2 + U_{dc}^2 + U_t^2 + U_{lab}^2 + U_{cal}^2 + U_{interf}^2 + U_{ads}^2 + U_{flow}^2)} = \sqrt{(2^2 + 3^2 + 0,5^2 + 2^2 + 3^2 + 0^2 + 2^2 + 1^2)}$$

The expanded measurement uncertainty (U_{exp}) is then determined according to:

$$U_{exp} = k * U_{comb}$$

For a 95% confidence interval, the cover factor (k) is assigned a value of k = 2. The expanded measurement uncertainty with a 95% confidence interval is then **U_{exp}=10%**.

6 Conclusions

In this document a description of the gas washing method as applied by Wageningen Livestock Research (WLR gas washing method) to measure ammonia (NH₃) concentrations in the air entering and leaving livestock housing systems has been presented. The WLR gas washing method is based on the normative reference NEN2826, with a number of modifications:

1. NEN2826 prescribes using 4 flasks, 3 of them being filled with an absorption medium (acidic solution), and the fourth one (empty) as protection for the pump. The WLR gas washing method uses 3 flasks, 2 of them filled with an absorption medium. Section 5.2 shows that the effect of reducing the number of filled flasks from three to two is low (0.1% or 0.02 ppm at a concentration level of 20 ppm). Use of three filled flasks is, therefore, not necessary. Use of at least 2 filled flasks is recommended, to check for breakthrough or saturation during measurements.
2. NEN2826 prescribes using sulfuric acid as absorption medium. The idea behind the gas washing method is to use a strong acid to capture the NH₃ in the sampled air flowing through the absorption medium. The WLR gas washing method uses nitric acid instead. NEN2826 does not provide information about the reason behind their selection for sulfuric acid, or validation data to show that other (strong) acids (such as nitric acid) may not be used. WLR validated the method using nitric acid, by calibrating the WLR gas washing method against a primary standard (certified calibration gas). Section 5.3 shows no significant differences between the WLR gas washing method and the primary standard. This confirms that using nitric acid instead of sulfuric acid does not result in less accurate NH₃ concentration measurements.
3. NEN2826 prescribes performing either isokinetic measurements, or applying a flow of at least 3 l/min. No information is provided about why lower flows may not be applied. In principle, the idea is to have enough flow through the absorption medium, allowing the NH₃ in the sampled air to be captured by the absorption medium, in order to have a high removal efficiency and minimize breakthrough to the following flasks. Section 5.2 shows that the breakthrough effect is negligible, and section 5.3 shows that using the WLR gas washing method (with a flow of 1 l/min), does not result in less accurate NH₃ concentration measurements.
4. NEN2826 prescribes that the flasks should be cooled down (during measurements) to a temperature below 20 °C. No information is provided to justify this selection. In the WLR gas washing method, flasks are not cooled down. Since all absorption flasks are weighed before and after the measurements, there is no reason to believe that the effect of evaporation is not taken into account already by following this procedure.
5. NEN2826 prescribes using a gas flow meter to measure continuously (during the whole measurement period) the flow through the flasks. The gas flow meter is allowed to have a maximum deviation of 5%. In the WLR gas washing method flows are measured at the beginning and at the end of the (24-hours) measurement period. Section 5.5 shows small differences between these two flow values (less than 2% and lower than the requirements of NEN2826). This demonstrates that measuring the flow continuously is not necessary, and that accurate measurements of the flow at the beginning and at the end of the measurement period are sufficient.

According to NEN2826, the repeatability of NH₃ concentration measurements using the gas washing method is about 18%, independent of the concentration level. Section 5.4 shows that the WLR gas washing method has a repeatability of less than 5%. The combined (expanded) uncertainty of the WLR gas washing method is 10%, substantially lower than the 32% described in NEN2826. We can therefore conclude that the WLR gas washing method provides results equivalent with NEN2826, and is suitable to be used as an alternative for the method described in NEN2826.

7 Bibliography

- Hutchinson, G.L., A.R. Mosier, and C.E. Andre. 1982. Ammonia and amine emissions from a large cattle feedlot. *J. Environ. Qual.* 11, 288-293.
- Schade, G.W., and P.J. Crutzen. 1995. Emission of aliphatic amines from animal husbandry and their reactions: potential source of N₂O and HCN. *Journal of Atmospheric Chemistry* 22, 319-346.

Annex 1: Calibration certificate of gas flow meters

DryCal® Defender-510m

			
		CALIBRATION CERTIFICATE	
		28492	
Applicant			
Customer name	Wageningen UR, PSG		
Contact	Johan Ploegaert		
Address	De Elst 1 6708 WD Wageningen The Netherlands		
Order reference applicant	-		
Order reference TPF Control	28475		
Instrument Information [DUT]			
Instrument type	Flow Calibrator		
Manufacturer	Mesa Laboratories		
Serial no.	115543		
Model	Defender 510-M		
Tag no.	-		
Calibration method	The device under test is connected in a parallel setup to the mentioned flow calibrator to compare flow readings. An appropriate warm up time is incorporated. A flow source is connected to the inlet of the instrument to generate a flow.		
Period of calibration	02 December 2014		
Calibration result	The results of the calibration are presented on the following page(s). The reported uncertainty of measurement is based on the standard uncertainty multiplied by a coverage factor $k=2$ which provides a confidence level of approximately 95%. The standard uncertainty of measurement has been determined in accordance with EA-4/02.		
Calibration traceability	The measurements have been executed using standards for which the traceability to (inter)national standards has been demonstrated towards the RvA and apply to ISO 17025.		
Remarks			
Certificate issue date	Boven Leeuwen, 02 December 2014		
Calibration technician		Technical Manager	
Bart Vissers			
		Rik van de Bovenkamp	
TPF Control b.v. Van Heemstraweg 19 6657KD BOVEN LEEUWEN (NL) Tel. +31 85 7500 110 Fax. +31 85 7500 111 Web: www.tpf-control.nl	RvA is member of the European Co-operation for Accreditation (EA) and is one of the signatories to the EA Multilateral Agreement and to the ILAC Mutual Recognition Arrangements (MRA) for the mutual recognition of calibration certificates.	Reproduction of the complete certificate is allowed. Parts of the certificate may only be reproduced after written approval of the calibration laboratory. This certificate is issued under the provision that the Raad voor Accreditatie does not assume any liability.	
Form BMS 03.41.01 - Rev F dated 15-11-13			Page 1 of 2

CALIBRATION CERTIFICATE

28492

Calibration conditions

Calibration gas : Nitrogen (grade 5.0)

Note:

1. Temperature and Pressure calibration are non accredited calibrations.

Calibration results after adjustment

Lab temperature: 21.3 °C

Atmospheric pressure: 1013.2 mBar

INSTRUMENT [ml/min]	LAB STANDARD		DEVIATION (ERROR)			UNCERTAINTY	
	[ml/min]	Tool no.	[%] O.R.	[ml/min]	Limit [%]	CMC [%]	Flow [%]
103.01	103.07	B00801	-0.06	-0.06	1.00	0.18	0.21
1004.5	1004.8	B00802	-0.03	-0.30	1.00	0.18	0.21
4993.9	4995.8	B00802	-0.04	-1.90	1.00	0.18	0.21

The deviation is determined by:
$$\text{Deviation} = \frac{\text{Instrument reading} - \text{Lab standard reading}}{\text{Lab standard reading}} \times 100 \%$$

Gilibrator (Sensidyne, Inc.)

SENSIDYNE, INC.

CALIBRATION CERTIFICATE

CELL S/N: 0812002-L DATE: 12 - 03 - 2008

This is to certify that the above referenced Gilibrator Flow Cell was calibrated using film flowmeter MCL-103, which has been calibrated by instruments directly traceable to the National Institute of Standards and Technology. NIST Report 8361604.

Results:

REFERENCE	S/N	RELATIVE	PERCENT
MCL-103	0812002-L	DIFF.	DIFF.
cc/min	cc/min	cc/min	
105.1	104.3	-.8	-0.76
105.6	106.1	.5	0.47
105.7	106.6	.9	0.85
105.3	106.1	.8	0.76
105.3	105.8	.5	0.47
105.9	106.2	.3	0.28
106.6	105.8	-.8	-0.75
106.1	106	-.1	-0.09
106.5	106.1	-.4	-0.38
105.2	106.1	.9	0.86

MAX		.9	0.86
MEAN	105.73	105.91	

CALIBRATED BY *Jon Jensen* DATE: 12 - 03 - 2008

CODE 300

LITHO. IN U.S.A.

© 2004 GOES 441CN

SENSIDYNE, INC.

CALIBRATION CERTIFICATE

CELL S/N: 0805025-S

DATE: 05 - 08 - 2008

This is to certify that the above referenced Gilibrator Flow Cell was calibrated using film flowmeter MCS-102, which has been calibrated by instruments directly traceable to the National Institute of Standards and Technology. NIST Report 8361604.

Results:

REFERENCE	S/N	RELATIVE	PERCENT
MCS-102	0805025-S	DIFF.	DIFF.
cc/min	cc/min	cc/min	
2021	2031	10	0.49
2021	2027	6	0.3
2021	2025	4	0.2
2020	2028	8	0.4
2021	2029	8	0.4
2020	2027	7	0.35
2025	2029	4	0.2
2025	2027	2	0.1
2018	2027	9	0.45
2022	2029	7	0.35

MAX 10 0.49

MEAN 2021.4 2027.9

CALIBRATED BY *[Signature]*

DATE: 05 - 08 - 2008

CODE 100

LITHO. IN U.S.A.

© 2004 GOBS 441CN

SENSIDYNE, INC.

CALIBRATION CERTIFICATE

CELL S/N: 0812004-H

DATE: 12 - 02 - 2008

This is to certify that the above referenced Gilibrator Flow Cell was calibrated using film flowmeter MCH-101, which has been calibrated by instruments directly traceable to the National Institute of Standards and Technology. NIST Report 8361604.

Results:

REFERENCE	S/N	RELATIVE	PERCENT
MCH-101	0812004-H	DIFF.	DIFF.
LPM	LPM	LPM	
4.995	5.001	.006	0.12
5.033	5.033	0	0.0
4.991	4.996	.005	0.1
4.991	4.996	.005	0.1
4.981	4.994	.013	0.26
4.989	5.009	.02	0.4
4.98	4.991	.011	0.22
4.986	4.989	.003	0.06
4.967	4.974	.007	0.14
4.982	4.979	-.003	-0.06

MAX .02 0.4

MEAN 4.99 4.996

CALIBRATED BY



DATE: 12 - 02 - 2008

CODE 300

LITHO. IN U.S.A.

© 2004 GOBS 441CN

Annex 2: Certificates of calibration standards (gas cylinders)

The calibration procedure required the use of a number of calibration standards (gas cylinders) providing different concentration levels. The following gas cylinders were used:

Gas	Concentration (ppm) according to certificate	Provider
NH ₃	11	Scott specialty gases
NH ₃	100	Scott specialty gases
NH ₃	101	Scott specialty gases
NH ₃	102	Scott specialty gases

Certificate of 11 ppm gas cylinder



CUSTOM CLASS

Takkebijsters 48 4817 BL, Breda, The Netherlands Phone: +31(0)76-5711 828 Fax: +31(0)76-5713 267

CERTIFICATE OF ACCURACY: Custom Class Calibration Standard

Product Information

Project No.: 20-97567-002
Item No.: 20020000150Z50L
P.O. No.: WUR728325

Cylinder Number: 5902857
Cylinder Size: 50L
Certification Date: 05May2014
Expiration Date: 04May2015

Customer

WAGENINGEN UR, ANIMAL SCIENCES GROUP
T.A.V. JOHAN PLOEGAERT
VEEHOUDERIJ BV
VIJFDE POLDER 1
6708 WC WAGENINGEN
NEDERLAND

CERTIFIED CONCENTRATION

Component Name

AMMONIA
NITROGEN

Concentration (Moles)

11,0 PPM
BALANCE

Accuracy (+/-%)

3

TRACEABILITY

Description

ANALYTICAL TRACEABILITY

Traceability Type

GAS STANDARDS

Traceable To

APPROVED BY:

R.J. HOFMEESTER

DATE: 14-05-2014

SUPERVISOR:

C. DÖMEN

Page 1 of 2

An Air Liquide Group Company

SPECIFICATIONS

<u>Component Name</u>	<u>Requested Concentration (Moles)</u>	<u>Gravimetric Concentration (Moles)</u>	<u>Analyzed Concentration (Moles)</u>	<u>Blend Tolerance Result (+/- %)</u>	<u>Blend Process Accuracy Result (+/- %)</u>	<u>Analytical Accuracy Result (+/- %)</u>	<u>Interlocking Result (+/- %)</u>
AMMONIA NITROGEN	10, PPM	N/A	11,0 PPM	10,0	N/A	3,00	N/A

TRACEABILITY

Analytical Traceability

<u>Type/SRM No.</u>	<u>Expiration Date</u>	<u>Cylinder Number</u>	<u>Concentration</u>	<u>Component</u>
SRS TSTD	05May2014		0,000	AMMONIA

PHYSICAL PROPERTIES

Cylinder Size: 50L Pressure: 150 BAR Valve Connection: DIN-5
Expiration Date: 04May2015
Min. Cyl. Pressure: 5 BAR Min. Temperature: -10 °C

SPECIAL HANDLING INSTRUCTIONS

Do not use or store cylinder at or below the stated dew point temperature. Possible condensation of heavier components could result. In the event the cylinder has been exposed to temperatures at or below the dew point, place cylinder in heated area for 24 hours and then roll cylinder for 15 minutes to re-mix.

Use of calibration standards at or below dew point temperature may result in calibration error.

Certificate of 100 ppm gas cylinder



CUSTOM CLASS

Takkebijsters 48 4817 BL, Breda, The Netherlands Phone: +31(0)76-5711 828 Fax: +31(0)76-5713 267

CERTIFICATE OF ACCURACY: Custom Class Calibration Standard

Product Information

Project No.: 20-06846-001
Item No.: 20020000150Z20L
P.O. No.: WUR951601

Cylinder Number: 5801924
Cylinder Size: 20L
Certification Date: 26Apr2016
Expiration Date: 25Apr2019

Customer

WAGENINGEN UR, ANIMAL SCIENCES GROUP
JOHAN PLOEGAERT
VEEHOUDERIJ BV, ZODIAC
GEBOUW 122, DE ELST 1
6708 WD WAGENINGEN
NEDERLAND

CERTIFIED CONCENTRATION

Component Name

AMMONIA
NITROGEN

Concentration (Moles)

100, PPM
BALANCE

Accuracy (+/-%)

1

TRACEABILITY

Description

ANALYTICAL TRACEABILITY

Traceability Type

GAS STANDARDS

Traceable To

APPROVED BY:

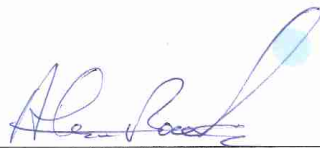
A.C. VAN POORTEN

DATE:

26-04-16

SUPERVISOR:

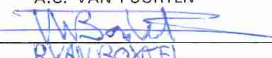
R. VAN ROOIJ

SPECIFICATIONS

<u>Component Name</u>	<u>Requested Concentration (Moles)</u>	<u>Gravimetric Concentration (Moles)</u>	<u>Analyzed Concentration (Moles)</u>	<u>Blend Tolerance Result (+/- %)</u>	<u>Blend Process Accuracy Result (+/- %)</u>	<u>Analytical Accuracy Result (+/- %)</u>	<u>Interlocking Result (+/- %)</u>
AMMONIA NITROGEN	100, PPM	N/A	100, PPM	N/A	N/A	1,00	N/A

TRACEABILITY

Analytical Traceability

<u>Type/SRM No.</u>	<u>Expiration Date</u>	<u>Cylinder Number</u>	<u>Concentration</u>	<u>Component</u>
SRS TSTD	26Apr2016		0,000	

PHYSICAL PROPERTIES

Cylinder Size: 20L Pressure: 150 BAR Valve Connection: DIN 5
Expiration Date: 25Apr2019
Min. Cyl. Pressure: 5 BAR

SPECIAL HANDLING INSTRUCTIONS

If a dew point is listed, do not use or store cylinder at or below the stated dew point temperature. Possible condensation of heavier components could result. In the event the cylinder has been exposed to temperatures at or below the dew point, place the cylinder in heated area for 24 hours and then roll cylinder for 15 minutes to remix.

Use of calibration standards at or below the stated dew point temperature may result in calibration error.

C E R T I F I C A T E

Number 3223086
Page 1 of 1

Description	Calibrated gas mixture (CGM) consisting of ammonia in nitrogen. Cylinder number 5801924.	
Method of calibration	Composition determined in accordance with ISO 6143:2001 (<i>Gas analysis - Comparison methods for determining and checking the composition of calibration gas mixtures</i>) using Photoacoustic Wave-InfraRed.	
Date of calibration	16 June 2016	
Result	Amount fraction ammonia	: $(100.5 \pm 2.0) \times 10^{-6}$ mol/mol.

The reported uncertainty of measurement is based on the standard uncertainty multiplied by a coverage factor $k = 2$, which for a normal distribution corresponds to a coverage probability of approximately 95%. The standard uncertainty has been determined in accordance with the GUM 'Evaluation of measurement data - Guide to the Expression of Uncertainty in Measurement'.

Traceability	The result of the calibration is traceable to primary and/or (inter)nationally accepted measurement standards.	
Cylinder	The cylinder pressure is 14.5 MPa. Cylinder outlet confirms to DIN 5 specifications.	

Delft, 16 June 2016
VSL B.V.

J.I.T. van Wijk
Senior Metrologist

This certificate is consistent with Calibration and Measurement Capabilities (CMCs) that are included in Appendix C of the Mutual Recognition Arrangement (MRA) drawn up by the International Committee for Weights and Measures (CIPM). Under the MRA, all participating institutes recognize the validity of each other's calibration and measurement certificates for the quantities, ranges and measurement uncertainties specified in Appendix C (for details see <http://kcdb.bipm.fr>).

VSL B.V.
Thijsseweg 11, 2629 JA Delft (NL)
P.O. Box 654, 2600 AR Delft (NL)
T +31 15 269 15 00
F +31 15 261 29 71
I www.vsl.nl



This certificate is issued under the provision that no liability is accepted and that the applicant gives warranty for each responsibility against third parties.

Reproduction of the complete certificate is permitted. Parts of this certificate may only be reproduced after written permission.

Certificate of 101 ppm gas cylinder



Scott
specialty gases

CUSTOM CLASS

Takkebijsters 48 4817 BL, Breda, The Netherlands Phone: +31(0)76-5711 828 Fax: +31(0)76-5713 267

CERTIFICATE OF ACCURACY: Custom Class Calibration Standard

Product Information

Project No.: 20-01957-002
Item No.: 20020000150Z50L
P.O. No.: WUR837436

Cylinder Number: 5902919
Cylinder Size: 50L
Certification Date: 30Apr2015
Expiration Date: 29Apr2018

Customer

WAGENINGEN UR, ANIMAL SCIENCES GROUP
ATTN: JOHAN PLOEGAERT
VEEHOUDERIJ BV, ZODIAC
GEBOUW 122, DE ELST 1
6708 WD WAGENINGEN
NEDERLAND

CERTIFIED CONCENTRATION

Component Name

AMMONIA
NITROGEN

Concentration (Moles)

101, PPM
BALANCE

Accuracy (+/-%)

1

TRACEABILITY

Description

ANALYTICAL TRACEABILITY

Traceability Type

GAS STANDARDS

Traceable To

APPROVED BY:

H.F.W. AKKERMANS

DATE: 01-05-2015

SUPERVISOR:

R.J. Hofmeester

Page 1 of 2

SPECIFICATIONS

<u>Component Name</u>	<u>Requested Concentration (Moles)</u>	<u>Gravimetric Concentration (Moles)</u>	<u>Analyzed Concentration (Moles)</u>	<u>Blend Tolerance Result (+/- %)</u>	<u>Blend Process Accuracy Result (+/- %)</u>	<u>Analytical Accuracy Result (+/- %)</u>	<u>Interlocking Result (+/- %)</u>
AMMONIA NITROGEN	100, PPM	N/A	101, PPM	1,0	N/A	1,00	N/A

TRACEABILITY

Analytical Traceability

<u>Type/SRM No.</u>	<u>Expiration Date</u>	<u>Cylinder Number</u>	<u>Concentration</u>	<u>Component</u>
SRS TSTD	30Apr2015		0,000	

PHYSICAL PROPERTIES

Cylinder Size: 50L Pressure: 150 BAR Valve Connection: DIN 5
Expiration Date: 29Apr2018
Min. Cyl. Pressure: 5 BAR

SPECIAL HANDLING INSTRUCTIONS

If a dew point is listed, do not use or store cylinder at or below the stated dew point temperature. Possible condensation of heavier components could result. In the event the cylinder has been exposed to temperatures at or below the dew point, place the cylinder in heated area for 24 hours and then roll cylinder for 15 minutes to remix.

Use of calibration standards at or below the stated dew point temperature may result in calibration error.

Certificate of 102 ppm gas cylinder



CUSTOM CLASS

Takkebijsters 48 4817 BL, Breda, The Netherlands Phone: +31(0)76-5711 828 Fax: +31(0)76-5713 267

CERTIFICATE OF ACCURACY: Custom Class Calibration Standard

Product Information

Project No.: 20-87639-003
Item No.: 20020000150Z20L
P.O. No.: WUR477691

Cylinder Number: 438372
Cylinder Size: 20L
Certification Date: 04Feb2012
Expiration Date: 03Feb2015

Customer

WAGENINGEN UR, ANIMAL SCIENCES GROUP
T.A.V. JOHAN PLOEGAERT
VEEHOUDERIJ BV
VIJFDE POLDER 1
6708 WC WAGENINGEN
NEDERLAND

CERTIFIED CONCENTRATION

Component Name

AMMONIA
NITROGEN

Concentration (Moles)

102, PPM
BALANCE

Accuracy (+/-%)

1

TRACEABILITY

Description

ANALYTICAL TRACEABILITY

Traceability Type

GAS STANDARDS

Traceable To

APPROVED BY:

ING PAC WILBORTS

SUPERVISOR:

ING D. SNIJDERS

DATE:

4-2-2012

SPECIFICATIONS

<u>Component Name</u>	<u>Requested Concentration (Moles)</u>	<u>Gravimetric Concentration (Moles)</u>	<u>Analyzed Concentration (Moles)</u>	<u>Blend Tolerance Result (+/- %)</u>	<u>Blend Process Accuracy Result (+/- %)</u>	<u>Analytical Accuracy Result (+/- %)</u>	<u>Interlocking Result (+/- %)</u>
AMMONIA NITROGEN	100, PPM	N/A	102, PPM	2,0	N/A	1,00	N/A

TRACEABILITY

Analytical Traceability

<u>Type/SRM No.</u>	<u>Expiration Date</u>	<u>Cylinder Number</u>	<u>Concentration</u>	<u>Component</u>
SRS TSTD	04Feb2012		0,000	AMMONIA

PHYSICAL PROPERTIES

Cylinder Size: 20L Pressure: 150 BAR Valve Connection: DIN-8
Expiration Date: 03Feb2015

Min. Cyl. Pressure: 5 BAR

SPECIAL HANDLING INSTRUCTIONS

Do not use or store cylinder at or below the stated dew point temperature. Possible condensation of heavier components could result. In the event the cylinder has been exposed to temperatures at or below the dew point, place cylinder in heated area for 24 hours and then roll cylinder for 15 minutes to re-mix.

Use of calibration standards at or below dew point temperature may result in calibration error.

Annex 3: Calibration certificates of gas divider type Signal 821

Calibration (2015)



SIGNAL GROUP LIMITED
 12 DOMAN ROAD, CAMBERLEY
 SURREY, ENGLAND GU15 3DF
 TELEPHONE: +44 (0)1276 682841 / 4 (4 LINES)
 FAX: +44 (0)1276 691302
 E-MAIL: INSTRUMENTS@SIGNAL-GROUP.COM
 SITE: WWW.SIGNAL-GROUP.COM

CERTIFICATE OF CALIBRATION

CONSIGNEE Wageningen

ORDER NUMBER _____

W/O NUMBER _____

DATE OF CALIBRATION 01/12/2015

DESCRIPTION OF GOODS	SERIAL NO.	REMARKS
821S gas divider	4789	

CALIBRATION RESULTS

DIVIDER SETTING	ACTUAL RESULT
100.00%	100.00
90.00%	90.00
80.00%	79.92
70.00%	69.93
60.00%	60.04
50.00%	50.06
40.00%	39.90
30.00%	30.02
20.00%	20.08
10.00%	10.12
0.00%	0.00

CALIBRATION GAS DETAILS

CALIBRATION GAS TYPE	SUPPLIER	CERTIFICATE No.	TRACEABILITY
1000ppm C3H8/air	BOC	1433495	NPL

SIGNAL AUDIT PROCEDURE NUMBER TPB00101

UNCERTAINTY OF MEASUREMENT +/- 0.2% F.S.D.

Signal Group certifies that the materials and processes used in the calibration of the unit detailed above hereon unless otherwise stated conform in all respects to Signal Group Ltd procedures and specifications

SIGNED Roy Kinslow

Calibration (2005)

CERTIFICATE OF CALIBRATION



STANDARDS HOUSE,
12 DOMAN ROAD, CAMBERLEY
SURREY, GU15 3DF, ENGLAND.
TELEPHONE: +44(0)1276 682841/6
FACSIMILE: +44(0)1276 691302
E-MAIL: instruments@signal-group.com
Web: www.signal-group.com

Everything for the Emissions Engineer

CONSIGNEE Agrotechnology & Food Innovations

ORDER NUMBER _____

W/O NUMBER _____

DATE OF CALIBRATION 14/10/05

DESCRIPTION OF GOODS	SERIAL No	REMARKS
8215 CAS Divider	4789	

CALIBRATION RESULTS

DIVIDER SETTING	EXPECTED RESULT	ACTUAL RESULT
100.00%		100.00
90.00%		89.92
80.00%		79.82
70.00%		69.81
60.00%		59.85
50.00%		50.03
40.00%		39.85
30.00%		30.01
20.00%		20.00
10.00%		10.07
0.00%		0.0

CALIBRATION GAS DETAILS

CALIBRATION GAS TYPE	SUPPLIER	CERTIFICATE No.	TRACEABILITY
1000ppm C ₂ H ₄ in air	Messer	H114023	NPL

SIGNAL AUDIT PROCEDURE NUMBER TPB00101

UNCERTAINTY OF MEASUREMENT +1-0.2% f.s.d.

Signal Group certifies that the materials and processes used in the calibration of the unit detailed above hereon unless otherwise stated conform in all respects to Signal Group Ltd procedures and specifications.

SIGNED _____



A DIVISION OF SIGNAL GROUP LTD. REGISTERED IN ENGLAND NO. 1369865

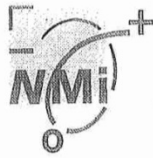

Nederlands Meetinstituut

040

Certificaat

Nummer 316430-01
blad 1 van 2

Aanvrager: IMAG - DLO
Mansholtlaan 10 - 12
Wageningen

Aangeboden: Een gas divider
fabrikaat : Signal
type : 821
serie nummer : 4789
bereik : 0 - 100%, in stappen van 10%

Wijze van onderzoek: De door de gas divider gemaakte verdunningen zijn onderzocht met een referentiemonitor welke gekalibreerd is met primaire standaard gasmengsels. Als nulgas is hoogzuivere stikstof aangeboden aan de gas divider. Als spangas is een mengsel gebruikt van $(1001 \pm 10) \cdot 10^{-6}$ mol/mol stikstofmonoxide in stikstof. Bepaald is het werkelijke verdunningspercentage. De metingen werden uitgevoerd bij een omgevingstemperatuur van $21 \pm 0,5$ °C.

Datum van onderzoek: 6 tot en met 20 september 1996

Resultaat: De resultaten staan vermeld op blad 2 van 2.
De totale meetonzekerheid is gebaseerd op twee maal de standaardafwijking (2s).

Herleidbaarheid: De bij de kalibratie gebruikte gasmengsels zijn herleidbaar naar de primaire standaard gasmengsels stikstofmonoxide in stikstof.

Datum en ondertekening: 24 september 1996
NMI Van Swinden Laboratorium B.V.

R. N. Wessel
Afdeling Chemie

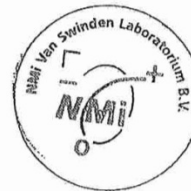

N₂ & 1000 ppm NO in N₂

Nederlands Meetinstituut
Postbus 654
2600 AR Delft (NL)
Schoemakerstraat 97
2628 VK Delft
Telefoon (015) 269 15 00
Telefax (015) 261 29 71

Nederlands Meetinstituut N.V. (ingeschreven bij de
Kamer van Koophandel Delft onder nummer 28701)

Werkmaatschappijen:
NMI Certin B.V. (KvK nr. 33418)
NMI Van Swinden Laboratorium B.V. (KvK nr. 28703)
NMI IJkwezen B.V. (KvK nr. 28700)
NMI International B.V. (KvK nr. 39176)

Dit certificaat wordt verstrekt onder het voorbehoud dat
generel aansprakelijkheid wordt aanvaard en dat
aanvrager vrijwaring geeft voor elke aansprakelijkheid
jegens derden.

Reproductie van het volledige certificaat is toegestaan.
Gedeelten van dit certificaat mogen slechts worden
gereproduceerd na verkregen schriftelijke toestemming.

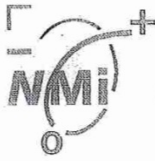

Resultaat: Hieronder wordt het resultaat van de kalibratie weergegeven.

Meetbereik 0-100% in stappen van 10%.

Werkelijk verdunningspercentage (%)	ingesteld verdunningspercentage (%)
10,05 ± 0,10	10
19,91 ± 0,12	20
29,86 ± 0,12	30
39,73 ± 0,18	40
49,93 ± 0,20	50
60,04 ± 0,25	60
69,88 ± 0,25	70
79,95 ± 0,25	80
89,99 ± 0,25	90

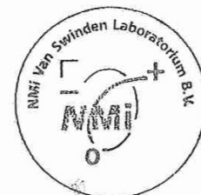

Annex 4: Calibration certificate of Mass flow controllers (Bronkhorst)



CALIBRATION CERTIFICATE

We herewith certify that the instrument mentioned below has been calibrated in accordance with the stated values and conditions. The calibration standards used are traceable to national standards of the Dutch Metrology Institute VSL.

Identifications

	Calibrated Instrument	Calibration Standard
Type	Electronic device	Flow controller (D)
Serial number	0805025-S	M13203805A
Model number	BUBBLE GEN STANDAI	F-201CV-5K0-RAD-22-V
Certificate no.	BCC002/CHK/1555402	BHT179/1434274

Conditions

Customer		Calibration	
Fluid	CH4	Fluid	CH4
Pressure	1 bar (a)	Pressure	0.0 bar (g)
Temperature	20 °C	Temperature	22.6 °C
Flow (*)	6 l/min	Room temperature	22.6 °C
Output range	0 - 6000 ml/min	Atm. pressure	1032 hPa

Results

Nominal Flow Setting	Calibrated Output Signal	Customer Flow (*)	Deviation
0.0 %	0.0000 ml/min	0.0000 l/min	0.0 %FS
12.5 %	773.6 ml/min	0.7599 l/min	0.2 %FS

Notes

Reference conditions of flow units: 20.00 °C, 1.00 bar (a).

Calibrator : H.Th.W

Date : 26 Nov 2013

Signed : 
Bronkhorst Calibration Centre

QC : 
Bronkhorst Calibration Centre

To explore
the potential
of nature to
improve the
quality of life



Wageningen Livestock Research
P.O. Box 338
6700 AH Wageningen
The Netherlands
T +31 (0)317 48 39 53
E info.livestockresearch@wur.nl
www.wur.nl/livestock-research

Wageningen Livestock Research creates science based solutions for a sustainable and profitable livestock sector. Together with our clients, we integrate scientific knowledge and practical experience to develop livestock concepts for future generations.

Wageningen Livestock Research is part of Wageningen University & Research. Together we work on the mission: 'To explore the potential of nature to improve the quality of life'. A staff of 6,500 and 10,000 students from over 100 countries are working worldwide in the domain of healthy food and living environment for governments and the business community-at-large. The strength of Wageningen University & Research lies in its ability to join the forces of specialised research institutes and the university. It also lies in the combined efforts of the various fields of natural and social sciences. This union of expertise leads to scientific breakthroughs that can quickly be put into practice and be incorporated into education. This is the Wageningen Approach.

