

STUDY OF CORROSION OF ALUMINUM ALLOYS OF NUCLEAR PURITY IN ORDINARY WATER – PART ONE

by

**Milan PEŠIĆ, Tatjana MAKSIN, Gabrijela JORDANOV,
Rajko DOBRIJEVIĆ, and Zoja IDJAKOVIĆ**

Received on May 20, 2004; accepted in revised form on October 29, 2004

Effects of corrosion of aluminum alloys of nuclear purity in ordinary water of the spent fuel storage pool of the RA research reactor at VINČA Institute of Nuclear Sciences has been examined in the framework of the International Atomic Energy Agency Coordinated Research Project “Corrosion of Research Reactor Aluminum-Clad Spent Fuel in Water” since 2002. The study presented in this paper comprises activities on determination and monitoring of chemical parameters and radioactivity of water and sludge in the RA spent fuel storage pool and results of the initial study of corrosion effects obtained by visual examinations of surfaces of various coupons made of aluminum alloys of nuclear purity of the test racks exposed to the pool water for a period from six months to six years.

Key words: corrosion, aluminum alloy, SAV-1 alloy, fuel cladding, RA research reactor, ordinary water

INTRODUCTION

The International Atomic Energy Agency (IAEA) Coordinated Research Project (CRP) “Corrosion of Research Reactor Aluminum-Clad Spent Fuel in Water” was initiated in 1996 [1]. The first phase of the project (CRP-I) was completed in 2001, while the second phase (CRP-II) has begun in 2002 with the estimated finishing date in mid-2006. The study carried out at both project phases comprises activities on examination of the corrosion effects at various aluminum alloy coupons after their exposition to water of spent fuel storage pools in different member states of the IAEA: Argentina, Brazil, China, Czech Republic, Hungary, India, Kazakhstan, Pakistan, Poland, Romania, Russian Federation, Thailand, and Serbia and Montenegro. Due to the actual political situation in the late nineties of the last century, Federal Republic of Yugoslavia was not allowed to participate

at the first phase of the CRP, but a test rack with the aluminum coupons was delivered to the VINČA Institute of Nuclear Sciences and immersed into the water of the spent fuel storage pool of the RA research reactor in June 1996. Serbia and Montenegro was accepted as the regular participant of the second phase of the CRP in 2002. Two additional test racks received during the CRP-I were immersed into the pool in February 2002 and two new test racks from the CRP-II were immersed into the pool water in June 2002. Since the water of the RA research reactor spent fuel storage pool has unique chemical and radiological parameters, a study of effects of corrosion of aluminum alloys of nuclear purity, used for fuel elements cladding, has great interest to research reactors' spent nuclear fuel community.

RA REACTOR AND TVR-S FUEL ELEMENT

The RA (fig. 1) is a 6.5 MW heavy water research reactor [2], designed to operate with low-enriched uranium (LEU) metal fuel elements. Initial enrichment of uranium was 2% in ^{235}U nuclide. Such type of research reactor was designed initially in the Institute of Theoretical and Experimental Physics, Moscow, Russian Federation, in 1948. The RA reactor was commissioned in the “Boris Kidrič”

Technical paper

UDC: 621.039.584:669.7.018

BIBLID: 1451-3994, 19 (2004), 2, pp. 77-93

Authors' address:

VINČA Institute of Nuclear Sciences

P. O. Box 522, 11001 Belgrade, Serbia and Montenegro

E-mail address of corresponding author:

mpešic@vin.bg.ac.yu (M. Pešić)



Figure 1. RA research reactor

(now known as VINČA) Institute of Nuclear Sciences, Yugoslavia, in 1959. In the period from 1976 to 1978, the reactor changed operation from LEU fuel elements to high-enriched uranium (HEU) in form of uranium dioxide dispersed in aluminum matrix. The initial enrichment of uranium was 80% in ^{235}U nuclide.

The LEU and HEU fuel elements have the same slug geometry, known as the Russian TVR-S fuel element (fig. 2). The fuel element is 11.30 cm long cylinder with 3.72 cm outer diameter. The fuel layer has length of 10.0 cm and inner/outer diameter (ID/OD) of 3.1/3.5 cm. Mass of ^{235}U nuclide in both of the TVR-S fuel elements is almost the same: 7.25 g in case of LEU fuel and 7.7 g in case of HEU fuel. Fuel layer is covered on the inner and outer side



Figure 2. TVR-S fuel element

with 1 mm thick aluminum clad. Inner tube, made of aluminum (known as the “expeller” or “ejector”) within the TVR-S fuel element, serves to adjust coolant flow rate. The top and bottom of the fuel slug are covered by the 3 mm thick “stars” with sprockets. Aluminum used in construction of the TVR-S fuel elements is known as the Russian SAV-1 alloy (0.957-0.985 weight fraction of aluminum with very low contents of neutron high-absorbing impurities, boron or cadmium). Detailed material composition of TVR-S fuel elements is given elsewhere, *e. g.*, in [3-4]. Average volume of one TVR-S fuel slug was measured as $60 \pm 5 \text{ cm}^3$, while the total area of SAV-1 alloy in contact with water was estimated at $420 \pm 40 \text{ cm}^2$. Average mass of the LEU slug is about 460 g, while average mass of the HEU slug is about 160 g.

Fuel elements of the RA reactor are known as the technological (“fuel”) channels. They are formed using 10 or 11 TVR-S fuel elements placed one above another in an aluminum tube that has ID/OD 4.1/4.3 cm and the total length about 5.5 m. From 40 to 82 fuel channels could be used in the RA reactor core moderated by heavy water. The TVR-S fuel elements in the core are cooled by forced flow of heavy water with approximate velocity of 2 m/s within fuel channel. The core has regular square lattice of fuel channels with pitch of 13 cm. The RA reactor was operated until 1984, when it was shut down for modernization of the equipment. Due to various technical and political reasons, that refurbishment has never been completed [5].

RA REACTOR SPENT FUEL STORAGE POOL

Almost all spent fuel elements, produced during operation of the RA reactor from 1959 to 1984, are stored in the temporary spent fuel storage pool within the RA reactor building. The pool, 6.5 m deep, consists of four inter-connected basins and an annex to the fourth basin. Each basin has rectangular cross-section with approximate dimension: width 1.60 m (except basin no. 1 that has 1.25 m width) and length 3.80 m. The annex is 1.60 m wide and 1.70 m long. Each basin can be separated, *i. e.*, closed (but not hermetically) by a door manufactured of carbon steel material. Concrete walls of various thickness (0.6-1.3 m) and concrete bottom of the pool are lined by 1 cm thick stainless steel plate. The pool, filled with about 200 m^3 of stagnant, tap, and water is connected by special underground water (“transport”) channel to the reactor block that allows transfer of spent fuel elements to the storage area. Due to water vaporization, tap water is added to the pool once per year.

Up to 1984, about 1500 LEU spent fuel elements and about 900 HEU spent fuel elements were stored in 245 stainless steel channel-holders (SSCH). From 1962-1982, about 5000 LEU spent fuel elements were repacked from SSCHs to 30 aluminum casks (ALB) and stored at the bottom of the pool. About 500 HEU spent fuel elements have been left in the RA reactor core.

Design of the TVR-S fuel elements proved to be very reliable. According to the reactor operation logbooks, only one LEU fuel element had lost leak-tightness in the core during 25 years of the RA operation. The fuel channel containing damaged fuel element was quickly identified, replaced in the core by a new one, and stored in a specially marked SSCH in the spent fuel storage pool.

Chemical and radiological parameters of the storage pool water

The first report about water bad quality in the basins, based on visual inspection, was given in the Annual Report of RA Operation in 1962 [6]. Water purification was proposed, but no actions were taken. In 1984, a low specific (volume) activity of ^{137}Cs in water of the storage pool was discovered for the first time and attributed to the leaking of one LEU spent TVR-S fuel element, sitting at the bottom of the pool since 1976. Periodic monitoring of chemical and radiation parameters of the pool water, water purification system and appropriate regulation rules were proposed. However, no actions were taken from beginning of the RA reactor operation in 1959 until 1994. In 1994, visual inspection of the storage pool has discovered thick deposits of sludge at the walls and bottom of the pool, indicating that detail inspection should be made. Experts from the IAEA, USA, and Russian Federation were asked for help.

Analyses of water and sludge samples taken from the basins and transport channel were made for the first time in 1995. Inadequate water chemical parameters and gamma-ray specific volume activity originated from ^{137}Cs and ^{60}Co nuclides were found in the water samples. Analyses showed that the pool water was high corrosive to aluminum alloys due to high electrical conductivity. Specific (volume) activity in the range of 100-130 Bq/mL attributed to ^{137}Cs nuclide was measured in the water samples and about ten times more in the sludge samples [7]. Chemical composition of the few sludge samples was determined in radiochemical laboratories of the IAEA. It was shown that the main component of the sludge was iron oxide – Fe_2O_3 (about 83% by weight, in average) that gave the dark red-brown color to the sludge due to iron corrosion products. Impurities of lead, chromium,

manganese, calcium, and zinc were confirmed within few percents, while traces of copper and nickel were found too.

Examinations of water samples taken from SSCHs and ALBs in the period from 1997 to 2001 were carried out. These studies have shown that not only the first fission products barrier (fuel element cladding) but also the second one (ALBs walls) were penetrated due to corrosion process. It is also believed that cadmium strips, placed initially in the ALBs with the aim to assure sub-criticality, created electro-potential couple with aluminum (of the barrels and SAV-1 cladding of fuel elements) and contributed to increasing corrosion processes inside ALBs. As a result, a slow leakage of fission products (mainly ^{137}Cs nuclide) from failed-by-corrosion fuel elements to the water in the spent fuel storage pool is occurring.

Serious actions to improve conditions and remedy water in the pool have been under way since 1997. Debris and most of the sludge (about 3 m^3) were removed from the basins of the pool using a special pump. Sludge immobilization was done by using technique and equipment developed in the VINČA Institute for sedimentation and cementing of the sludge-water mixture in concrete shielded barrels. About 40 such barrels are stored as low-level waste at the intermediate waste storage at the VINČA Institute [8].

Chemical parameters of the water samples taken from the basins of the storage pool have been measured few times per year since 1997, and once per month, since 2002. The samples are analyzed for the most of the main chemical parameters related to corrosion process [1]. Range (minimum to maximum) and average values of measured chemical parameters in the water samples of the RA spent fuel storage pool in period from 2002 to 2003 are shown in tab. 1.

Table 1. Chemical parameters of RA spent fuel storage pool water

Water parameter	Range in 2002-2003	Average value	1
pH factor	7.31-8.39	7.53	0.12
Electric conductivity [S/cm]	360-570	451.3	27.6
Fe ions [mg/L]	0.07-0.21	0.13	0.01
Cu ions [mg/L]	0.01	<0.01	
Al ions [mg/L]	0.01	<0.01	
Chlorides, Cl [mg/L]	65-85	73.0	
Sulphate ions, SO_4 [mg/L]	31-70	48.6	1.5
Nitrate ions, NO_3 [mg/L]	0.05	0.05	
Hardness, dH	6.5-7.5	6.9	0.1
Temperature [C]	14-21		

All chemical parameters are determined by classical analytical volumetric methods using volumetric titration, except that Al ions are determined by the spot test.

- Cl⁻ ions are determined by argent-metric method, providing the limit of identification (minimum detectable concentration) of 5 mg/L,
- SO₄⁻ ions are determined by iodine-metric (Ohelu) method, providing the limit of identification (minimum detectable concentration) of 2 mg/L,
- Fe ions are determined by spectrophotometer method with 1,10-fenantroline, providing the limit of identification (minimum detectable concentration) of 0.1 mg/L, and
- Al³⁺ ions are determined by spot-test reaction with alizarin sulfonic acid, providing the limit of identification (minimum detectable concentration) of 2 mg/L.

General estimation is that the total uncertainties of the measuring quantities are less or equal to 5% for probability of 67% ($p = 0.67$) and the coverage factor equal to 1 ($k=1$).

Water purification system of the RA spent fuel storage pool includes a pump with mechanical filter (25 m) only. The circulation rate of the water is about 60 L per minute in the basin no. 4. After sludge removal in 1996 and day-per-day operation of the purification system, clearness and visibility of the pool water were improved (fig. 3) in spite of further accumulation of dust at the water surface.



Figure 3. Water sample of RA reactor spent fuel storage pool

Since 1995, specific volume activity in the pool water has been measured few times per year. Since 2002, the activity in the water has been measured once per week. Average values of water specific volume activity in 2002-2003 are: (90 ± 9) Bq/mL from ¹³⁷Cs nuclide. Measured value of water specific volume activity from ⁶⁰Co nuclide was always less than 1 mBq/mL, that is a minimum detectable activity (MDA) for that nuclide at this Ge detector. Specific volume activity of ¹³⁷Cs nuclide in the pool water is contributed to the cladding failure of fuel elements due to corrosion process in the ALBs stored in the pool. Measured ¹³⁷Cs nuclide specific volume activity in RA spent fuel storage pool is shown graphically in fig. 4. Relative uncertainty of specific (volume or mass) activity measuring of ¹³⁷Cs and ⁶⁰Co in the water and sludge samples is in the range of 5-10% ($p = 0.67$) and the coverage factor equal to 1 ($k = 1$).

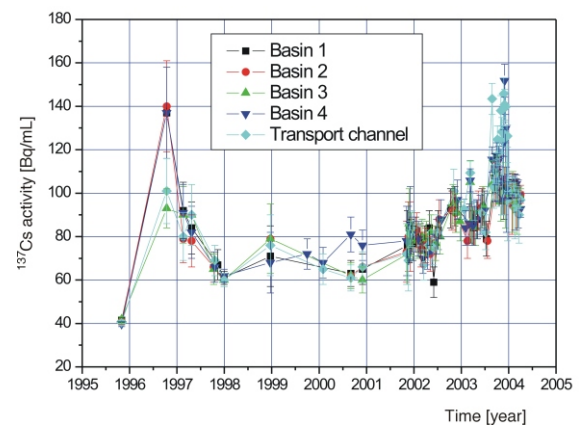

Figure 4. Specific volume activity of ¹³⁷Cs nuclide measured in water samples taken from the RA spent fuel storage pool

Peaks of measured ¹³⁷Cs specific (volume) activity in the RA spent fuel storage pool, shown in fig. 4, are attributed to increased operator-related activities in the pool basins, e. g., sludge removal in 1996, drilling of ALBs in 2000 and 2001 and examination of SSCHs in 2003. These man-related activities, carried out in the basins, have contributed to rising of suspension of the sludge in the pool water. Thus consequently has led to an increased value of ¹³⁷Cs specific volume activity in water samples, since the ¹³⁷Cs nuclide is bounded mainly in sludge.

This conclusion was confirmed experimentally in December 2003 [9]. A large (13 L) water sample, taken from the basin no. 4 of the pool, with measured ¹³⁷Cs specific volume activity of

100.6 ± 4.0 Bq/mL was filtrated through a sand filter. After filtration, water sample has shown ^{137}Cs specific volume activity of 6.3 ± 0.3 Bq/mL only, while the major of ^{137}Cs specific volume activity of 77.4 ± 3.1 Bq/mL has remained bounded in the wet sand filter.

Composition, radioactivity and sedimentation rate of the sludge in the pool

Few sludge samples, taken from the pool in 1996, were shipped to the IAEA Seibersdorf Laboratory in 1997 for qualitative analysis of the sludge composition by using X-ray method [7]. Independent qualitative analysis of a sludge sample was carried out in the VINČA Institute by an X-ray sensitive Si(Li) semiconductor detector. Standard X-ray source of ^{109}Cd nuclide was used for calibration of the instrument. Iron and lead were found as the main macro components of the sludge material. Impurities of calcium, chromium, manganese, zinc, gallium, and strontium in the sludge sample were confirmed by this measurement, while traces of nickel and copper were detected, but not confirmed.

Experiences gained in the VINČA Institute during collecting a huge amount of sludge deposited for a period of about 35 years at the bottom and walls of the spent nuclear fuel storage pool in 1996 show that mass density of various sludge samples strongly depend on activities carried out in the pool, drying procedure used and water bounded in the “dry” sludge components [10].

According to the CRP-II recommendation, the sludge sedimentation rate was measured using a cylindrical aluminum pot (base inner diameter 9.0 cm, and wall height 12.0 cm) immersed in the basin no. 4 of the pool, at height of about 1 m above the basin bottom. The sediments were collected for seven months. The pot was taken out (fig. 5), part of water was decanted and the rest of the sludge-water mixture was mixed and filtered using filter paper. The filter paper was dried out, the sediments were collected and the total mass was weighted 5.038 ± 0.005 g. Sedimentation rate was determined as 11.3 ± 0.5 mg/cm² per month. The sludge was also examined at the ultra-low background shielded Ge detector spectrometer calibrated by appropriate software packages [11]. Specific mass activity was



Figure 5. Withdrawn of the pot used for sludge sedimentation from the pool

determined as 12.70 ± 0.35 kBq/g originating from ^{137}Cs nuclide, and as 960 ± 20 Bq/g originating from ^{60}Co nuclide, using sludge average density of 0.84 ± 0.05 g/cm³.

TEST RACKS

Various (test) racks with coupons of different aluminum alloys and stainless steel were prepared and distributed to participants within phase I (CRP-I: 1996 – 2001, [1]) and phase II (CRP-II, 2002–2005) of the IAEA CRP on “Corrosion of Research Reactor Aluminum-Clad Spent Fuel in Water”. As it was already mentioned, Yugoslavia was not allowed to participate in the CRP-I due to political reasons, but three racks were received and immersed in the RA reactor spent fuel storage pool. Yugoslavia (Serbia and Montenegro, since March 2003) has been a fully accepted participant in the CRP-II since 2002 and two racks were received and immersed in the pool up to March 2003.

Table 2. Chemical composition of aluminum alloys

Alloy	Al [%]	Cu [%]	Mg [%]	Mn [%]	Si [%]	Fe [%]	Ti [%]	Zn [%]	Cr [%]	Br [%]
1100	99.100	0.16	0.1	0.05	0.16	0.48	0.005	0.03	0.005	
5086	99.561	0.2	4.1	0.43	0.19	0.33	0.04	0.045	0.10	0.004
6061	973690	0.25	0.94	0.12	0.65	0.24	0.04	0.03	0.04	
6063	98.325	0.16	0.73	0.05	0.37	0.24	0.04	0.03	0.055	
SAV-1	98.570	0.01	0.53	< 0.05	0.71	0.09	0.005	0.03	0.005	

Table 3. Composition of the racks used at the VINČA site

Rack name/CRP-phase				
Rack#1/CRP-I (Batch-I)	Rack#2.1/CRP-I (Batch-II)	Rack#2.2/CRP-I (Batch-II)	Rack#1/CRP-II	Rack#2/CRP-II
Top side of the rack				
Ceramic ring SAV-1/04 SAV-1/60 Ceramic ring SS 316/02 AA 6063/68 Ceramic ring SS 316/01 AA 6063/59 Ceramic ring AA 6063/05 AA 6061/60 Ceramic ring AA 6063/04 AA 6061/56 Ceramic ring AA 6061/18 AA 1100/56 Ceramic ring AA 6061/07 AA 1100/53 Ceramic ring	Ceramic ring SS 316/133 AA 6063/145 Ceramic ring SS 316/121 AA 6061/123 Ceramic ring AA 6063/159 AA 6063/196 Ceramic ring AA 6061/217 AA 6063/227 Ceramic ring AA 1100/229 AA 1100/236 Ceramic ring	Ceramic ring SS 316/114 AA 6063/135 Ceramic ring SS 316/115 AA 6061/142 Ceramic ring AA 6063/150 AA 6063/198 Ceramic ring AA 6061/212 AA 6063/200 Ceramic ring AA 1100/240 AA 1100/214 Ceramic ring	Ceramic ring SS 304/330 AA 6061/302 Ceramic ring AA 6063/249 AA 6063/228 Ceramic ring AA 6063/204 Ceramic ring AA 6061/312 Ceramic ring SS 304/350 SAV-1/377 Ceramic ring SAV-1/358 SAV-1/346 Ceramic ring SAV-1/335 Ceramic ring SAV-1/312 Ceramic ring	Ceramic ring SS 304/332 AA 6061/305 Ceramic ring AA 6063/208 AA 6063/244 Ceramic ring AA 6063/221 Ceramic ring SS 304/360 SAV-1/366 Ceramic ring AA 6061/321 Ceramic ring SAV-1/376 SAV-1/353 Ceramic ring SAV-1/317 Ceramic ring SAV-1/329 Ceramic ring

Chemical composition of aluminum alloys used for the test coupons of the racks, produced entirely in the AEKI [12], is shown in tab. 2. Percent weight fractions are given for main impurities, while the contents of pure aluminum are calculated in such a way that the total sum of all components of the alloy is equal to 100%. Numbers equal to the given limits are used for impurities which fractions are given by limit values, *e. g.*, values given as <0.1% or >0.2% are used in the calculations as 0.1% and 0.2%, respectively.

Coupons of the racks were manufactured in the KFKI, Hungary [1, 12] in the form of disks (3 mm thick) with ID/OD = 3.0/7.0 cm and ID/OD = 3.0/10.0 cm. Positions of coupons made of aluminum alloys (AA or SAV) and stain-

less steel (SS) within the racks (from the top part, used for hanging, to the bottom) are given in tab. 3. Single aluminum coupons (AA or SAV), galvanic coupon couples (SS-AA, or SS-SAV) or aluminum coupon couples (AA-AA, or SAV-SAV) were used at the racks. Number given after a slash corresponds to the identification number of particular coupon. Some aluminum coupons were pre-oxidized, while some of them were pre-oxidized and scratched. Spacers between coupons were manufactured as ceramic rings (7 mm thick, ID/OD = 2.8/5.8 cm) made of aluminum oxide (Al₂O₃). Supporting elements of the racks assembly were made of X8CrNiTi1810 stainless steel (mainly) and of 99.9% pure aluminum (DIN 1712). Total height of each rack is about 15 cm.

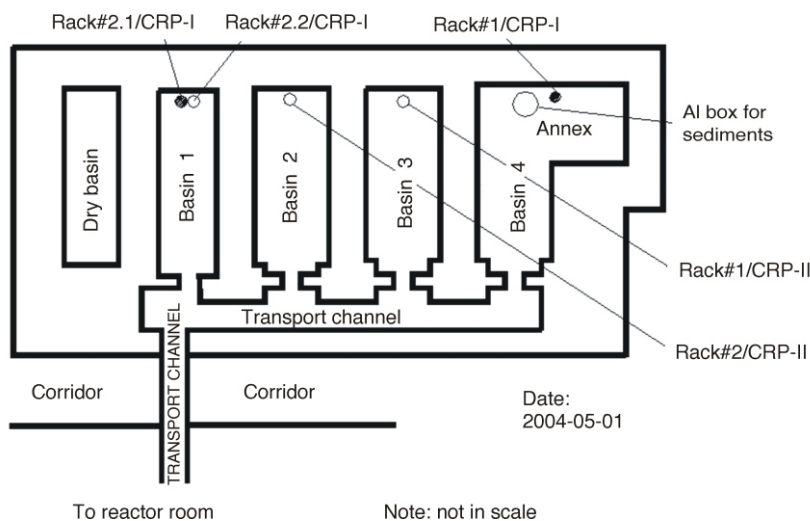

Figure 6. Sketch of positions of the racks in the RA spent fuel storage pool

Table 4. Exposition time of the racks

Rack name /CRP-phase No.	Immersion date/basin No. (B-#)	Removal date	Exposition time [month]
Rack#1 /CRP-I	1996-07-00/B-4	2002-07-30	72
Rack#2.1 /CRP-I	2002-02-26/B-1	2003-07-25	16
Rack#2.2 /CRP-I	2002-02-26/B-1	2004-03-02	24
Rack#1 /CRP-II	2003-03-26/B-3	2003-09-26	6
Rack#2 /CRP-II	2003-03-26/B-2	2004-04-06	12

Optional, site-specific, coupons were not prepared in the VINČA Institute due to the lack of appropriate aluminum material and necessary technology for coupon preparation.

All coupons of racks were carefully cleaned from grease and dust before immersion to the pool water according to the procedure given in the IAEA Test Protocol and instructions sent with the racks. Sketch of positions of all racks immersed in the water basins of the spent fuel storage pool of the RA research reactor at the VINČA Institute is shown in fig. 6.

Exposition time of the racks to the water of the basins of the RA spent fuel storage pool is given in tab. 4. All racks were immersed in the water of the pool near containers with spent fuel elements in the “vertical position”, *i. e.*, the rack axis was vertical and the coupons surfaces were horizontal.

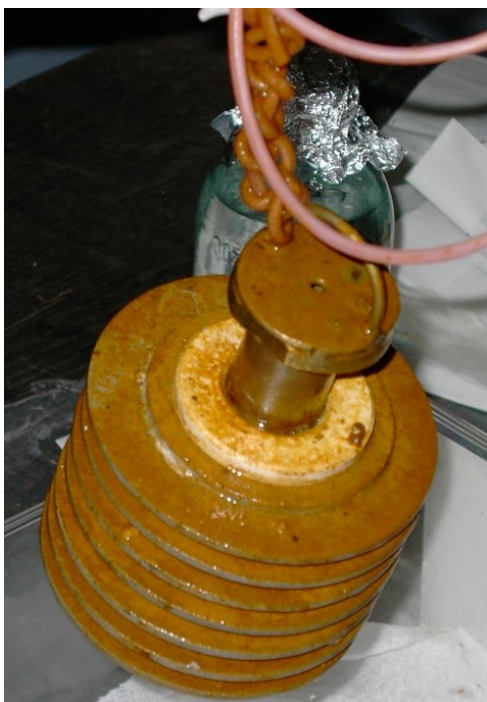

Figure 7. Rack#1/CRP-I after 72 months of exposition time

VISUAL EXAMINATION RESULTS

Rack#1/CRP-I

Rack#1 from CRP-I was received by the VINČA Institute in 1996 and assembled according to the IAEA instructions. It contains only the couples of coupons: smaller diameter aluminum alloy or stainless steel coupons at the top are coupled to aluminum alloy coupons at the bottom of the couple. The rack was exposed to the water in the basin no. 4 of the RA spent fuel storage pool for 72 months, from July 1996 to July 2002. It was taken out on July 30, 2002 (fig. 7) and temporarily placed in a glass beaker partially covered by pool water with the aim to obtain instructions for its disassembling and coupons cleaning from large quantity of sediments accumulated.

During the Rack#1/CRP-I removal, a bottle of the basin water was also collected and used to cover the Rack#1/CRP-I in the glass beaker. The pH factor, measured by pH paper at wet surfaces of the coupons, just after the Rack#1/CRP-I was withdrawn, was 7.0. Measured gamma-ray dose rate in vicinity of the Rack#1/CRP-I was about 3.5 $\mu\text{Sv/h}$. At the same time, significant beta contamination was confirmed too.

The Rack#1/CRP-I was kept in a glass beaker until January 2003, when the first examinations started. Two coupons on the top of the rack were dry, so pH factor was not measured for them. Values of pH factor on the external surface of others coupons were in the range from 5.5 to 6.5. The pH factor of water in the glass beaker was 7.5.

The initial visual examination of the Rack#1/CRP-I showed that the backside of the coupons was not covered by sediments (fig. 8) as it was the case at the front side of the coupons. The Rack#1/CRP-I was disassembled and all coupons



Figure 8. No sediments at the back side of coupons of Rack#1/CRP-I



Figure 9. Front side (A) of coupon couples of disassembled Rack#1/CRP-I

were removed from the Rack#1/CRP-I according to the IAEA Test Protocol. It was very hard to separate coupled coupons and in few cases a tool has to be applied. Photographs of the top – “the front” (fig. 9, A) and the bottom – “the back” (fig. 10, B) sides of each coupon are presented. The number beside a coupon corresponds to the type of aluminum alloy or stainless steel. The first – left number, corresponds to the upper coupon, while the second – right number, corresponds to the lower coupon of the couple. Label “SZAV”, the Hungarian spelling for SAV-1 aluminum alloy, is used at the photographs.

Since the front side of each coupon was covered by dark-red sediment (fig. 9), effects of corrosion process could not be seen without cleaning the surfaces. Small white sediments (like jelly-mushroom type sludge) at the front side of few coupons (fig. 9) were noted. Some of these sediments were collected for further analysis. The backside of the coupons was not covered by sediment (figs. 8 and 10) and effects of the corrosion process were noted. Pitting, as a main localized form of corrosion of aluminum in water, was seen at the backside of the surfaces of all coupons. Spots of different shades of gray and black color (assumed to be aluminum-oxide) were observed at coupons too.

In an on-line cooperation with an aluminum corrosion expert, Mr. Lalgudi Ramanathan, from IPEN, Brazil, an iterative cleaning of dried coupons of the Rack#1/CRP-I was performed in a step by step manner. In the first step, coupons were treated by 5% phosphoric acid solution according to the IAEA Test Protocol for 3 minutes only. Later, in further steps, the cleaning time was increased gradually (up to 10 minutes) with the aim to remove dried

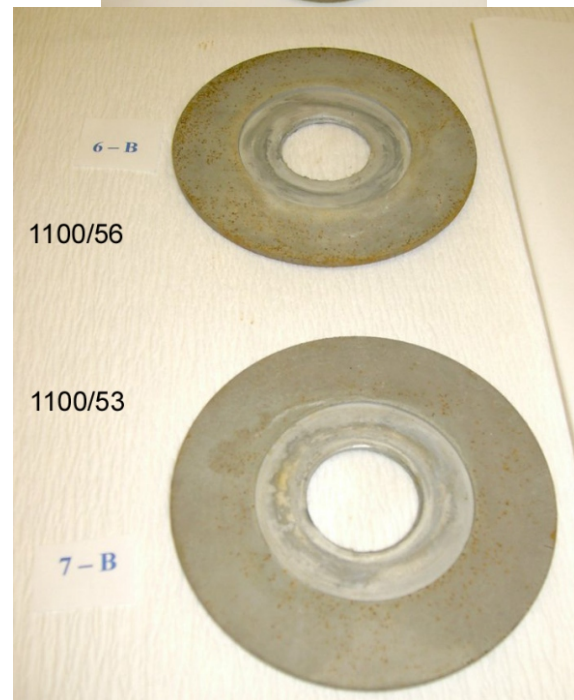

Figure 10. Backside (B) of coupons of disassembled Rack#1/CRP-I

and heavily accumulated sediments, but carefully not to remove corrosion effects. Cleaned coupons of the Rack#1/CRP-I are shown in fig. 11. After cleaning process, the coupons were examined visually carefully and damaged areas were marked for further examination under microscope. Results of visual and microscopic examination will be summarized in tables later. An example of crevice corrosion process at a couple SAV-1 to SAV-1 coupons is given in fig. 12.

Examinations of coupons under a microscope with magnification 10 and 20 are under way with the aim to study corrosion pitting in more details.

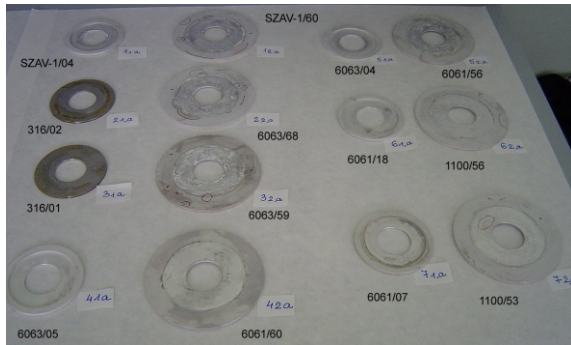

Figure 11. Front side (A) of coupons of disassembled Rack#1/CRP-I after cleaning

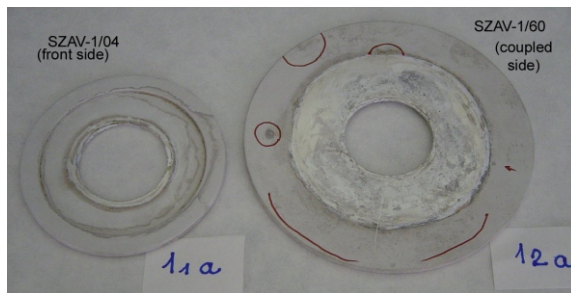

Figure 12. Front side (A) of crevice couple SAV-1 to SAV-1 coupon of RAC#1/CRP-I

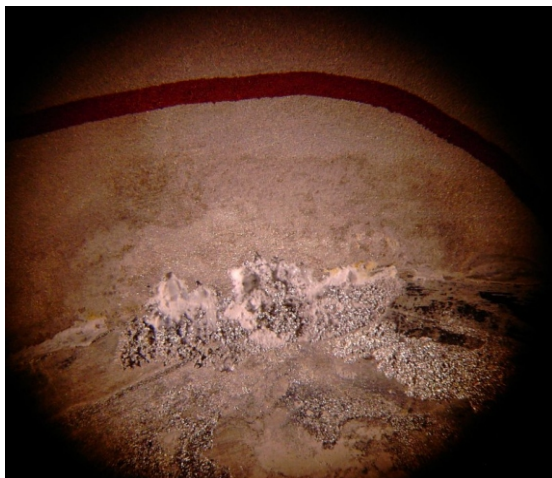

Figure 13. Galvanic corrosion with white deposit (aluminum-oxide) at coupon 6063/68

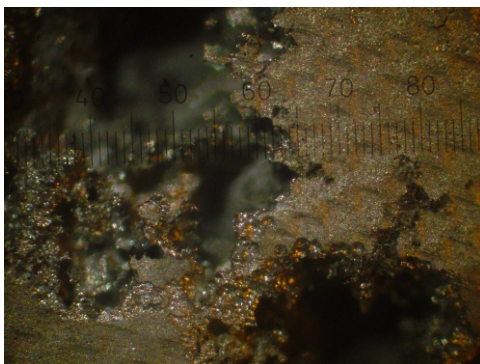

Figure 14. Deep pit of irregular shape at the front side of coupon 6061/18



Figure 15. A pit covered with white blister at coupon SAV-1/60

Only few photographs of various effects of corrosion process are shown in figs. 13-15.

Rack#2.1/CRP-I

Rack#2.1 from CRP-I was received by the VINČA Institute in 1998 and assembled in 2002 according to the IAEA instructions. It was exposed to water in the basin No. 1 of the RA spent fuel storage pool for 16 months from February 26, 2002. It was taken out on July 25, 2003 (fig. 16).

The pH factor, measured at the wet surface of the coupons, immediately after the Rack#2.1/CRP-I was with drawn, was 7.0. Gamma-ray dose rate in the vicinity of the Rack#2.1/CRP-I was about $4 \mu\text{Sv/h}$. Values of pH factor on the external surface of others coupons, determined by using pH paper, were in the range from 5.5 to 6.0. The pH factor of the water in basin No. 1 was 7.5. Initial visual examination of the



Figure 16. Rack#2.1/CRP-I after 16 months of exposition time



Figure 17. Front side (A) and backside (B) of coupons of disassembled Rack#2.1/CRP-I

Rack#2.1/CRP-I showed that the backside of the coupons was not covered with sediment, as it was the case at the front side of coupons.

The Rack#2.1/CRP-I was disassembled and all coupons were removed according to the IAEA Test

Protocol. It was very hard to separate coupled coupons and a tool was used in few cases. Photographs of the front (A) and the back (B) side of each coupon are presented (fig. 17) with numbers corresponding to the type of aluminum alloy or stainless steel.

Dark-red sediments covered the front side of coupons and effects of corrosion process could not be seen without cleaning surfaces. White sediments (like jelly-mushroom type sludge) at the front side of few coupons (fig. 18) and the supporter of the Rack#2.1/CRP-I were noted and collected for further analysis. Sediments did not cover the backside of the coupons and effects of corrosion process were noted. Pitting, as a main localized form of corrosion of aluminum in water, was seen at surfaces of all coupons, except one that was pre-oxidized during manufacturing process. Spots of different shades of gray and black color (assumed to be aluminum-oxide) were observed at coupons, too.

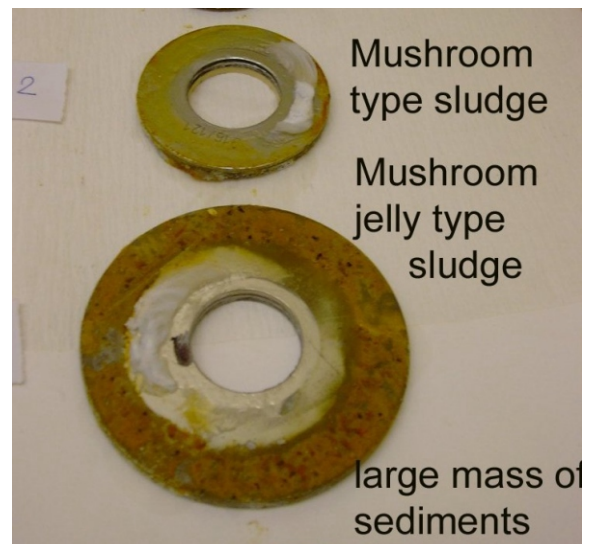

Figure 18. Mushroom-jelly type of sludge and red-brown deposits at the front side (A) of 6063/159 (lower one) and 316/121 coupon

The coupons were treated by 5% phosphoric acid solution according to the IAEA Test Protocol for about 1-2 minutes to remove sediments and clean the surfaces. After that process, the coupons were examined visually with the aim to study corrosion effects and the results will be given in a table later.

Examinations of coupons under a microscope with magnification 10 and 20 are under way with the aim to study corrosion effects in more details. Some examples of these examinations are shown in figs. 19-21.

Rack#1/CRP-II

Rack#1 from CRP-II was received, completely pre-assembled, by the VINČA Institute in

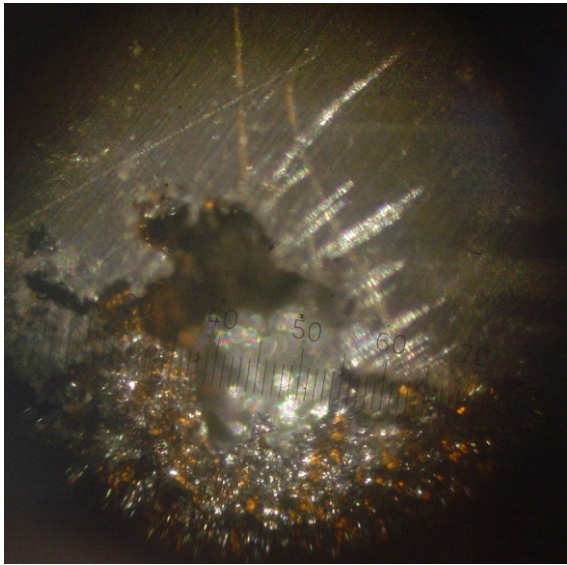

Figure 19. Galvanic corrosion and a deep pit at the front side of 6063/145 coupon

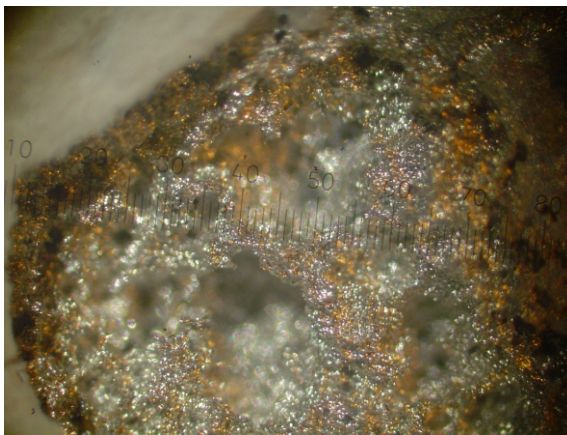

Figure 20. Very deep pits from galvanic corrosion at the backside of 6063.145 coupon

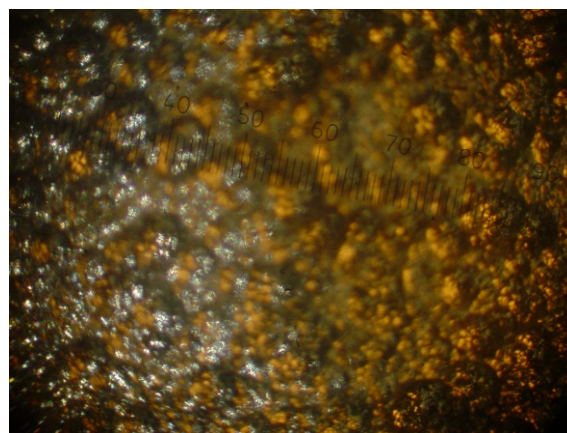

Figure 21. General corrosion under ceramic ring: spherical shaped pits at the front side of 6063.159 coupon

February 2003. It was exposed to water in the basin No. 3 of the RA spent fuel storage pool for only 6 months, from March 26, 2003. It was taken out on September 26, 2003 (fig. 22).



Figure 22. Rack#1/CRP-II before immersion and after 6 months of exposition time

The pH factor, measured by using pH paper just after the Rack#1/CRP-II was withdrawn at wet surfaces of the coupons, was 6.5 at the top and middle coupons and 7 at the bottom coupon. Gamma-ray dose rate measured in the vicinity of the Rack#1/CRP-II was about $3 \mu\text{Sv/h}$. The pH factor of the water in basin No. 3 was 7.5.

The first visual examination of the Rack#1/CRP-II showed that the front side of the coupons (fig. 23) was covered by sediments despite relatively short exposition time. There were no sediments at the backside of the coupons (fig. 24). The Rack#1/CRP-II was disassembled and all coupons were removed according to the IAEA Test Protocol. It was difficult to separate some coupled coupons, in spite of a short immersion period, and a tool had to be used. Photographs of the front (fig. 23, A) and the back (fig. 24, B) side of each coupon are presented. The number beside a coupon corresponds to the type and number of aluminum alloy or stainless steel.

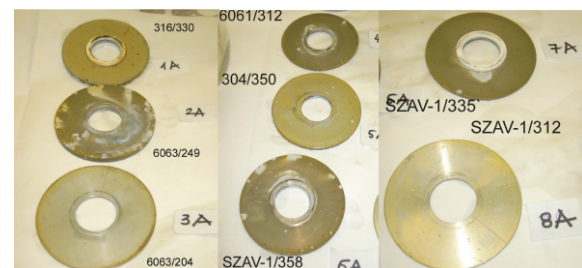

Figure 23. Front side (A) of coupons of disassembled Rack#1/CRP-II



Figure 24. Back side (B) of coupons of disassembled Rack#1/CRP-II

Dark-red sediments covered the front side of the coupons and effects of corrosion process could not be seen without cleaning surfaces. White sediments, like jelly-mushroom type sludge, at the front side of few coupons (fig. 25) and the supporter of the Rack#1/CRP-II were noted and collected for further analysis. Sediments did not cover the back-side of the coupons and effects of corrosion process were noted. Spots of different shades of gray and black color (assumed to be aluminum-oxide) were observed at coupons, too. Pitting, as the main localized form of corrosion of aluminum in water, was seen at the surface of all coupons, except one that was pre-oxidized during manufacturing process.

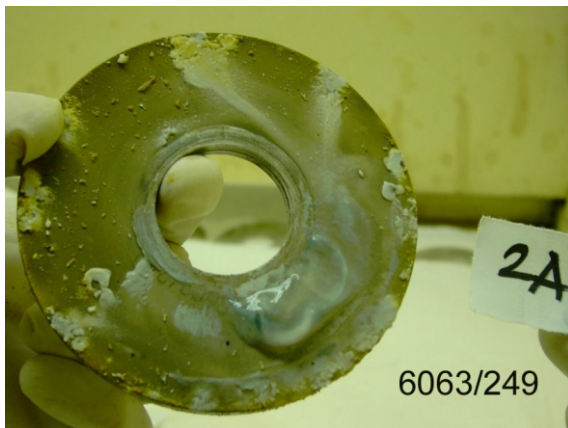

Figure 25. White, jelly-mushroom type sludge at the front side of coupon 6063/249

All coupons were treated by 5% phosphoric acid solution immediately after the transfer to the working place ("glove-box" facility) according to the IAEA Test Protocol for few minutes with the aim to remove sediments and clean the surfaces. After that process, the coupons were examined visually. Further examination of coupons was continued under a microscope with magnification 10 and 20, with the aim to study corrosion effects in details. Examples of the visual examination are given

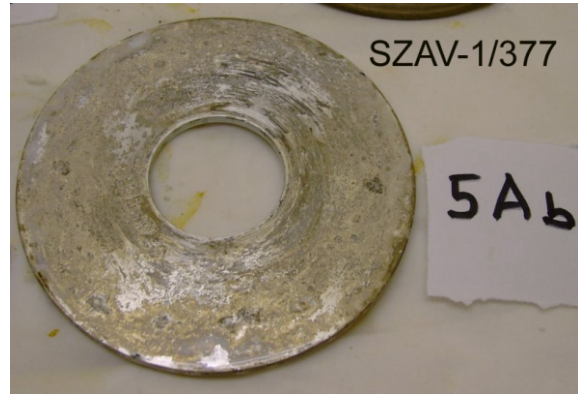

Figure 26. Galvanic corrosion at the coupled side of coupon SAV-1/377



Figure 27. Crevice corrosion at the coupled side of coupon SAV-1/358

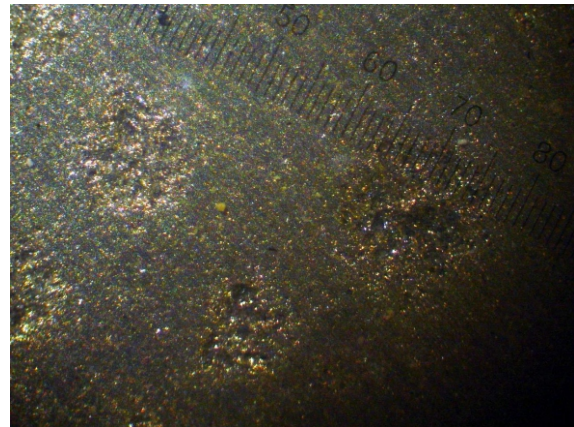

Figure 28. Deep pits at the top surface of coupon SAV-1/335 (magnification 10)



Figure 29. Circular pits at the top surface of coupon 6061/302 (magnification 10)

in figs. 26 and 27, while examples of the microscopic examinations are shown in figs. 28 and 29.

Rack#2.2/CRP-I

Rack#2.2 from CRP-I was received by the VINČA Institute in 1998 and assembled in 2002 according to the IAEA instructions. It was exposed to water in the basin No. 1 of the RA spent fuel storage pool for 24 months from February 26, 2002. It was taken out on March 2, 2004 (fig. 30).



Figure 30. Rack#2.2/CRP-I after 24 months of exposition time

The pH factor, measured just after the Rack#2.2/CRP-I was withdrawn at the wet surfaces of the coupons, was from 5.6 to 5.9. Gamma-ray dose rate in the vicinity of the Rack#2.2/CRP-I was about $3.5 \mu\text{Sv/h}$. Value of pH (obtained by using pH paper) on the external front or back surfaces of the middle coupons was 6.5, while pH factor measured deep inside the rack, between coupons, was 5.3. The pH factor of water in basin No. 1 was 7.0.

Initial visual examination of the Rack#2.2/CRP-I showed the same effects noted at all racks. The backside of the coupons was not covered by sediment, as it was the case at the front sides. The Rack#2.2/CRP-I was disassembled and all coupons were removed according to the IAEA Test Protocol. It was difficult to separate coupled coupons and a tool was used. Photographs of the front (fig. 31, A) side of each top coupon (including coupons in couples) are presented. In the case of couples, the surface of the coupled side of the bottom coupon is shown. The number beside a coupon corresponds to the type of aluminum alloy or stainless steel.

Dark-red sediments covered the front side of the coupons (fig. 32) that was exposed to water and ef-



Figure 31. Front side (A) of coupons of disassembled Rack#2.2/CRP-I

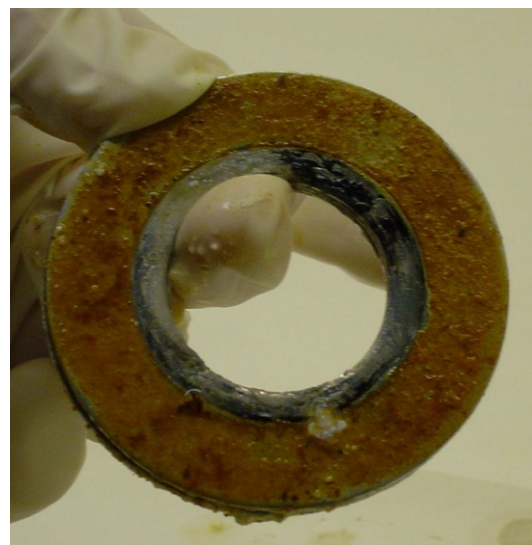

Figure 32. Dark-red sediments at the front side of coupon 316/114

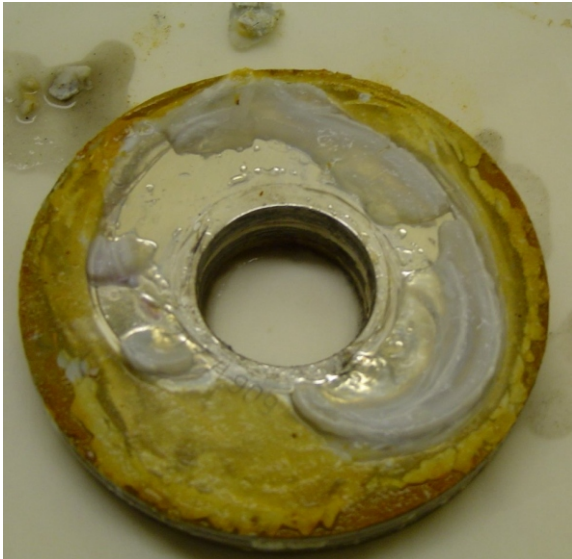

Figure 33. White jelly-mushroom type sludge at the front side of coupon 6061/212

fects of corrosion process could not be seen without cleaning surfaces. White sediments (like jelly-mushroom type sludge) at the front side of few coupons (fig. 33) and the supporter (fig. 30) of the Rack#2.2/CRP-I were noted and collected for further analysis. Effects of corrosion process were clearly noted at the backside of the coupons. The main localized form of corrosion of aluminum in water – pitting was seen at the surface of all coupons. Spots of different shades of gray and black color (assumed to be aluminum-oxide) were observed at coupons, too.

The coupons were treated by 5% phosphoric acid solution, immediately after rack transfer to examining facility, according to the IAEA Test Protocol for about 3 minutes with the aim to remove sediments and clean the surfaces. After that process, the coupons were examined visually. Then, study of corrosion effects in details was initiated using a microscope with magnification 10 and 20. Examples of visual examination are given in figs. 34 and 35.



Figure 34. Crevice corrosion at the coupled side of coupon 6061/212



Figure 35. Uniformly dull surface of the front side of coupon 1100/244

Some initial examples of general and galvanic corrosion effects at aluminum coupons studied under a microscope are given in figs. 36 and 37.



Figure 36. Corrosion at the outer edge of coupon 6063/135 (magnification 10)

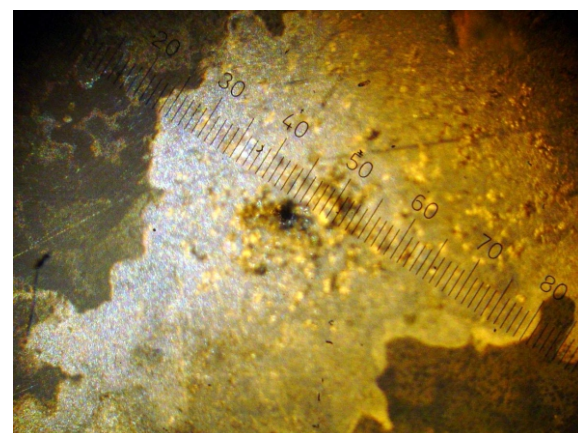

Figure 37. Galvanic corrosion at the front surface of coupon 6063.135 (magnification 10)

Rack#2/CRP-II

Rack#2 from CRP-II was received by the VINČA Institute, completely pre-assembled, in February 2003. It was exposed to water in the basin No. 2 of the RA spent fuel storage pool for 12 months from March 26, 2003. It was taken out on April 8, 2004 (fig. 38).

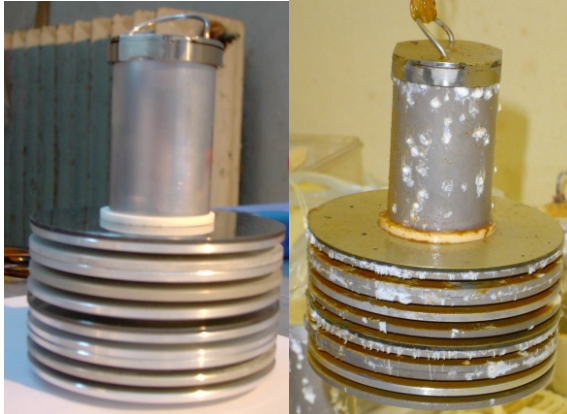

Figure 38. Rack#2/CRP-II before immersion and after 12 months of exposition time

Value of the pH factor, measured by using pH paper, immediately after the Rack#2/CRP-II was withdrawn, at wet surfaces of the coupons, was 6.5 at the top and middle coupons and 6.0 at the bottom coupon. Gamma-ray dose rate measured in the vicinity of the Rack#2/CRP-II was about $4 \mu\text{Sv/h}$. The pH factor of water in basin No. 2 was about 7.5. The first visual examination of the Rack#2/CRP-II showed that backside of the coupons were not covered by sludge deposits. Sediments covered only the front side of the coupons.

The Rack#2/CRP-II was disassembled and all coupons were removed according to the IAEA Test Protocol. Coupled coupons were difficult to separate and a tool was used in few cases. Photographs of the front (fig. 39, A) side of each coupon (including coupons in couples) are presented. In the case of couples, the surface of the coupled side of the bottom coupon is shown. The number beside a coupon corresponds to the type of aluminum alloy or stainless steel.

The coupons were treated by 5% phosphoric acid solution immediately according to the IAEA Test Protocol for about 3 minutes with the aim to remove sediments and clean the surfaces. After that process, the coupons were examined visually with the aim to study corrosion effects. Pitting, as the main localized form of corrosion of aluminum in water, was seen at the surface of almost all coupons. Spots of different shades of gray and black color (assumed to be aluminum-oxide) were observed at



Figure 39. Front side (A) of coupons of disassembled Rack#2/CRP-II

coupons, too. Some of results of the study are shown in figs. 40 and 41.

Corrosion effects were not discovered at coupon SAV-1/317 since it was pre-oxidized during manufacturing. It was scratched intentionally at the front side (shown at the left side of the fig. 41) during manufacturing process with the aim to study influence of mechanical damage to corrosion process. Visual

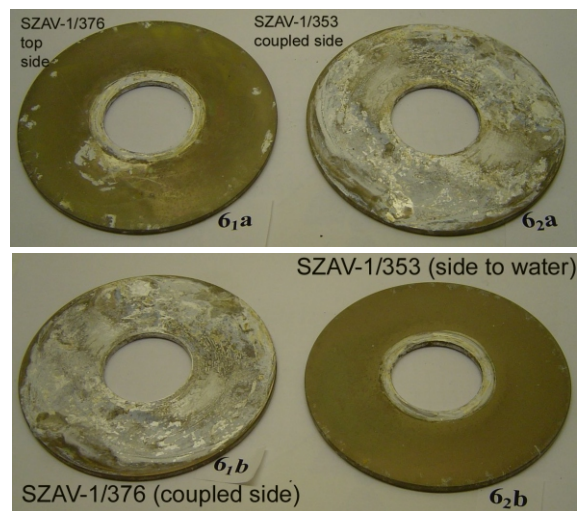

Figure 40. Crevice couples SAV-1/376 + SAV-1/353



Figure 41. No corrosion observed at the single coupon SAV-1/317

and later microscopic examination showed that corrosion effects were not found at both surfaces or under the scratched line of the coupon SAV-1/317 or other aluminum alloy coupons that were intentionally pre-oxidized and scratched during manufacturing process.

CONCLUSION

VINČA Institute of Nuclear Sciences participates in the IAEA CRP on “Corrosion of Research Reactor Aluminum-Clad Spent Fuel in Water – Phase II”. Information related to the study of water and sludge chemical and radioactivity characteristic in the RA reactor spent nuclear fuel storage pool and influence of corrosion process at test racks with coupons made of various alloys from aluminum of nuclear purity are given in this overview. The ordinary water in the storage pool has very high electrical conductivity, inappropriate pH factor, large contents of chloride and iron ions, high sedimentation rate of sludge, and moderate specific volume activity of ^{137}Cs nuclide (100 Bq/mL).

The racks with coupons, delivered by the IAEA to the VINČA site, were exposed to the water influence in the storage pool for the period of 6 months to 6 years. Effects of corrosion process has been noted at all coupons and initially studied visually only up to now. Further studies of the corrosion effects at coupons will be continued using a microscope and appropriate metallographic methods with the aim to find a correlation of corrosion effects to exposition time and water chemical parameters during further research.

It is believed that the final results of the VINČA Institute of Nuclear Sciences studies on this topic will improve the management and storage practices and procedures at research reactor interim spent fuel wet storage facilities through better understanding of the localized corrosion of aluminum cladding and the ranges of water chemistry parameters and radioactivity levels that provide resistance to corrosion.

ACKNOWLEDGEMENT

This study has been carried out for the IAEA CRP “Corrosion of Research Reactor Aluminum-Clad Spent Fuel in Water – Phase II” under Project no. 11968/RBE Part of the work is funded by the Ministry of Science and Environmental Protection of the Republic Serbia under project No. 1958 “Transport processes of particles in fission and fusion systems”. Authors are especially grateful to Mr. Lalgudi Ramanathan – “Ravi”, from the “IPEN”, Brazil, for his instructions and help offered to apply

appropriately the IAEA Test Protocol procedures during treatment and examinations of the coupons.

REFERENCES

- [1] ***, International Atomic Energy Agency, Corrosion of Research Reactor Aluminum-Clad Spent Fuel in Water, Technical Report Series (TRS) No. 418, IAEA, Vienna, Austria, 2003
- [2] Milošević, M., Martinc, R., Research Reactor RA – Technical Characteristics and Exploitation Possibilities (in Serbian), *Proceedings*, Conference on Utilization of Nuclear Reactors in Yugoslavia, Belgrade, Yugoslavia, May 17-20, 1978, pp. 81-97
- [3] Pešić, M. P., RB Reactor: Lattices of 2%-Enriched Uranium Elements in Heavy Water, International Handbook of Evaluated Criticality Safety Benchmark Experiments, NEA/NSC/DOC(95)03/IV, Vol. IV, contribution LEU-MET/THERM-002, 1999 edition, OECD/NEA, Nuclear Science Committee, Paris, France, 1999, pp. 2-146
- [4] Pešić, M. P., Reactor: Lattices of 80%-Enriched Uranium Elements in Heavy Water, International Handbook of Evaluated Criticality Safety Benchmark Experiments, NEA/NSC/DOC(95)03/II, Vol. II, contribution HEU-COMP/THERM-017, 2000 edition, OECD/NEA, Nuclear Science Committee, Paris, France, 2000, pp. 2-189
- [5] Pešić, M., Cupać, S., Vukadin, Z., Management of Ageing Research Reactors in the VINČA Institute, IAEA International Symposium on Research Reactor Utilisation, Safety and Management, Lisbon, Portugal, September 6-10, 1999, paper IAEA-SM-360/042P, CD ROM CSP-4/C, Vienna, Austria, 2000, pp. 042P1-042P9
- [6] ***, The Boris Kidrič Institute of Nuclear Sciences, Annual Reports of the RA Reactor Operation (in Serbian), The VINČA Institute of Nuclear Sciences, Belgrade, 1960-1984
- [7] ***, International Atomic Energy Agency, Appendix II to IAEA Mission Report to VINČA Institute in February 1997, IAEA, Vienna, 1997
- [8] Idjaković, Z., Milonjić, S., Čupić, S., Quality of Water from the Pool, Original Containers and Aluminum Drums used for Storage of Spent Nuclear Fuel, *Nuklearna tehnologija*, 16 (2001), 2, pp. 46-49
- [9] Karlin, Y., Evaluate the Possibility to Use Aqua Express Facility for Spent Fuel Pool Water Cleaning, End-of-Mission Report, SCG/4/003 01 01, IAEA, Vienna, 2003, pp. 1-39
- [10] Pešić, M., Plećaš, I., Pavlović, R., Pavlović, S., Calculation of Gamma-Ray Dose Rate from Storage Cask with Radioactive Sludge, *Proceedings*, 4th Yugoslav Nuclear Society International Conference – YUNSC 2002, Belgrade, September 30 – October 4, 2002, CD ROM, 2003, pp. 277-284
- [11] ***, Canberra Industries Inc., GENIE 2000 Spectroscopy System, ver. 2.1 and LabSOCS Calibration Software, ver. 4.1, Meriden, CT, USA, 2002
- [12] ***, KFKI-AEKI, Specimen Set for IAEA CRP on Corrosion of Research Reactor Aluminum-Clad Spent Fuel in Water, AEKI FRL Report, Budapest, Hungary, 1996

**Милан ПЕШИЋ, Татјана МАКСИН, Габријела ЈОРДАНОВ,
Рајко ДОБРИЈЕВИЋ, Зоја ИБАКОВИЋ**

**СТУДИЈА КОРОЗИЈЕ НУКЛЕАРНО ЧИСТИХ АЛУМИНИЈУМСКИХ
ЛЕГУРА У ОБИЧНОЈ ВОДИ – ДЕО ПРВИ**

У оквиру координираног истраживачког пројекта Међународне агенције за атомску енергију „Корозија алуминијумске кошуљице озраченог нуклеарног горива истраживачких реактора у води”, отпочела су, почевши од 2002. године, испитивања корозије легура нуклеарно чистог алуминијума у води базена за одлагање горивних елемената реактора РА. Студија приказана у овом раду обухвата извршене активности на испитивању и регуларној контроли хемијских параметара и радиоактивности воде и талога у базену са озраченим нуклеарним горивом реактора РА и почетне резултате добијене визуелним испитивањима површина узорака израђених од различитих легура нуклеарно чистог алуминијума који су били изложени утицају воде у базену у периоду од шест месеци до шест година.
