

Technical University of Denmark



DeepWind - from Idea to 5 MW Concept

Schmidt Paulsen, Uwe; Aagaard Madsen , Helge; Kragh, Knud Abildgaard; Nielsen, Per Hørlyk; Baran, Ismet; Hattel, Jesper Henri; Ritchie, Ewen; Leban, Krisztina; Svendsen, Harald; Berthelsen, Petter A.

Published in:
Energy Procedia

Link to article, DOI:
[10.1016/j.egypro.2014.07.212](https://doi.org/10.1016/j.egypro.2014.07.212)

Publication date:
2014

Document Version
Publisher's PDF, also known as Version of record

[Link back to DTU Orbit](#)

Citation (APA):
Schmidt Paulsen, U., Aagaard Madsen , H., Kragh, K. A., Nielsen, P. H., Baran, I., Hattel, J. H., ... Berthelsen, P. A. (2014). DeepWind - from Idea to 5 MW Concept. Energy Procedia, 53, 23-33. DOI: 10.1016/j.egypro.2014.07.212

DTU Library

Technical Information Center of Denmark

General rights

Copyright and moral rights for the publications made accessible in the public portal are retained by the authors and/or other copyright owners and it is a condition of accessing publications that users recognise and abide by the legal requirements associated with these rights.

- Users may download and print one copy of any publication from the public portal for the purpose of private study or research.
- You may not further distribute the material or use it for any profit-making activity or commercial gain
- You may freely distribute the URL identifying the publication in the public portal

If you believe that this document breaches copyright please contact us providing details, and we will remove access to the work immediately and investigate your claim.



EERA DeepWind'2014, 11th Deep Sea Offshore Wind R&D Conference

DeepWind-from idea to 5 MW concept

Uwe S. Paulsen^{*}, Helge A. Madsen, Knud A. Kragh, Per H. Nielsen^a
Ismet Baran, Jesper Hattel^b, Ewen Ritchie, Krisztina Leban^c
Harald Svendsen^d, Petter A. Berthelsen^e

^aDanish Technical University DTU Department of Wind Energy, Frederiksborgvej 399, Dk-4000 Roskilde, Denmark

^bDanish Technical University DTU Department of Mechanical Engineering, Produktionstorvet Building 425, DK-2800 Lyngby, Denmark

^cÅlborg University Department of Energy Technology, Pontoppidanstræde 101, 67, Dk-9220 Ålborg, Denmark

^dSintef Energy Research Box 4761 Sluppen, NO-7465 Trondheim, Norway

^eMARINTEK, Otto Nielsens veg 10, NO-7052 Trondheim, Norway

Abstract

The DeepWind concept has been described previously on challenges and potentials, this new offshore floating technology can offer to the wind industry [1]. The paper describes state of the art design improvements, new simulation results of the DeepWind floating vertical axis wind turbine concept, which implies a high potential for cost saving. The most critical aspects of the concept are addressed in proving feasibility, and if it can be scaled up to 20 MW. Applying structural mechanics, generator, floater & mooring system, control system design, and rotor design using detailed integrated models, results have evolved to a 5 MW baseline design. This important outcome will be used as a reference for further improvements. Emphasis in this paper is made on the interplay between different components and some trade-offs. One such example is the rotational speed which largely influences the design of both the generator and the aerodynamic rotor. Another example is aerofoil design affecting energy capture, stall behaviour, structural dynamics and control design. Finally, the potential for up-scaling to 20 MW is discussed.

© 2014 Elsevier Ltd. This is an open access article under the CC BY-NC-ND license (<http://creativecommons.org/licenses/by-nc-nd/3.0/>).

Selection and peer-review under responsibility of SINTEF Energi AS

Keywords: VAWT; offshore wind turbine; structural design; pultrusion; submerged generator; optimization

^{*} Corresponding author. Tel.: +45 46775044; fax: +4546775083.
E-mail address: uwpa@dtu.dk

1. Introduction

The Deepwind concept is a vertical axis wind turbine (VAWT) with a two-bladed Darrieus rotor, with a modified Troposkien shape to account for the large blade weight and a rotating spar platform. An illustration of the turbine is shown in Figure 1(left). The performance and structural dynamics of the concept has been investigated using the Hywind site as a reference, located off the Norwegian coast as indicated in Figure 1(right).

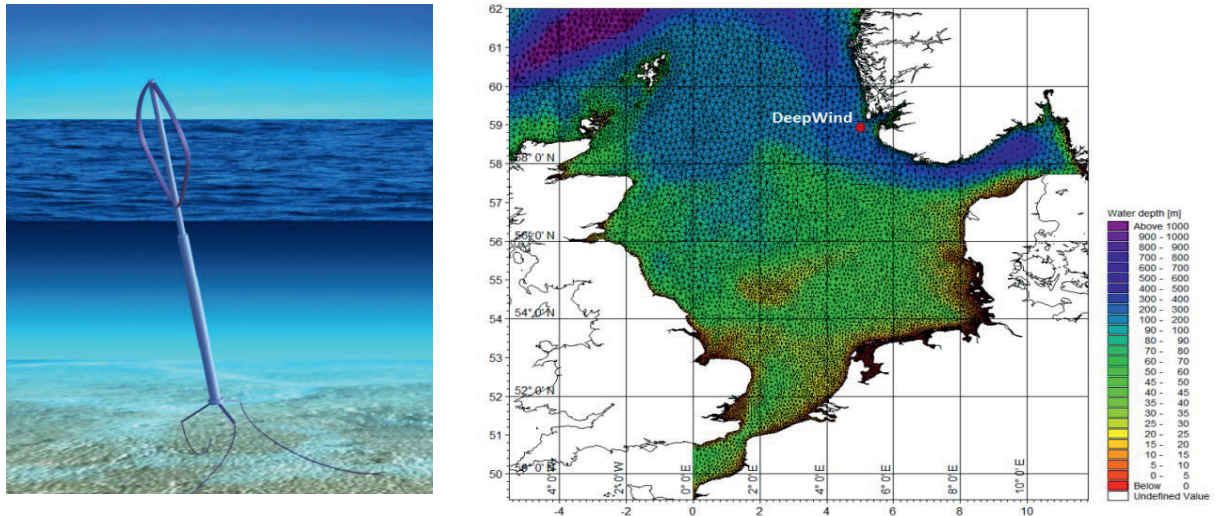

Figure 1 Left: DeepWind, the Vertical-Axis Darrieus concept for deep sea concept. Right: Approximate position of the DeepWind turbine evaluation site[1], Latitude: $59^{\circ} 8'44.88''\text{N}$, Longitude: $5^{\circ} 1'25.66''\text{E}$ (from DHI's Hindcast model)

The simulation code (HAWC2 ver 11.6) has been developed to handle VAWT aero-elasticity, hydrodynamics generator controls and using the met-ocean data at the test site. In the design process this code has also been used to evaluate loads and constraints input to specific component design tools: a generator and bearing design tool, and a control & floater optimization tool. For the blades a pulltrusion process specific tool has been developed. This paper describes some results from the 5 MW baseline design iteration process in deriving such a reference for the rotor and blades, the floating platform and the generator.

The above global model approach satisfies partly the applied approach in current certification, by taking into account all main components of the structure, namely 1) global structural behavior of both the above – and below sea water level structure and substructures, 2) all coupling effects caused by simultaneously applied loads (aero-dynamical, hydro-dynamical, Magnus forces, structural, electrical) and that the methodology is transparent with the IEC norms 61400- 1 and -3 series. At this stage particular load cases from slamming, ice and snow have not been considered and particular load cases arising from transportation or erection have not yet been considered. However, gravity loads analysis during rotation has led to a rotor blade shape different from the Troposkien shape in order to reduce the mean bending moments along the blade. An overview of applied load cases (sea states) can be found in [1,2]. Analysis of extreme operating gust was provided by extending the usual IEC 61400-1 gust formulation in space, with an additional time varying term using Taylor's hypothesis[†].

An important requirement is that that the turbine satisfies grid code requirements and is able to withstand

[†] Larsen TJ, Madsen HA. On The Way To Reliable Aero-elastic Load Simulation On Vawt's. Proceedings of EWEA 2013 Wind Energy conference Vienna;2013

disturbances propagated through the electricity grids such as a sudden loss of grid voltage. The couplings between the electrical grid and the turbine rotor have been analyzed and control concepts for grid code compliance have been developed. A new set of paradigms for underwater generator design have been developed in the project. DeepWind is special in that the stator has a rotational elastic degree of freedom during the coupling to the mooring system, therefore a rapid change in generator torque may give severe stresses on the mooring system. Simulations results are presented to illustrate potential problems and solutions.

2. Aspects of the proposed solutions

2.1. Wind Turbine Characteristics

The rotor design in the first design iteration was matched to the rated power of the 5 MW NREL HAWT; this criterion has been changed into that annual energy production (AEP) matches. Values for solidity σ and aspect ratio $H/2R$ have been selected as a compromise of maximum rotor efficiency, cost reduction and considerations on the design of the floater platform. The selected values are: $\sigma=0.165$ and $H/(2R)=1.18$. Table 1 provides an overview of the rotor characteristics in terms of geometry and performance, and Figure 2, left shows the power curve and Figure 2, right the shaft speed calculated at the site specific met-ocean conditions, including turbulence at the site and with an optimized rotor shape as shown in Figure 3(middle). The blade is sectionized about 10 m from top and from rotor bottom with a NACA0025 profile, and in between a NACA0018 section. The power curve shown has to be adjusted marginally in order to produce the necessary AEP. This could be a combination of using stall strips on the blades to provide a more distinct stall and then adjust by the maximum rotational speed setting.

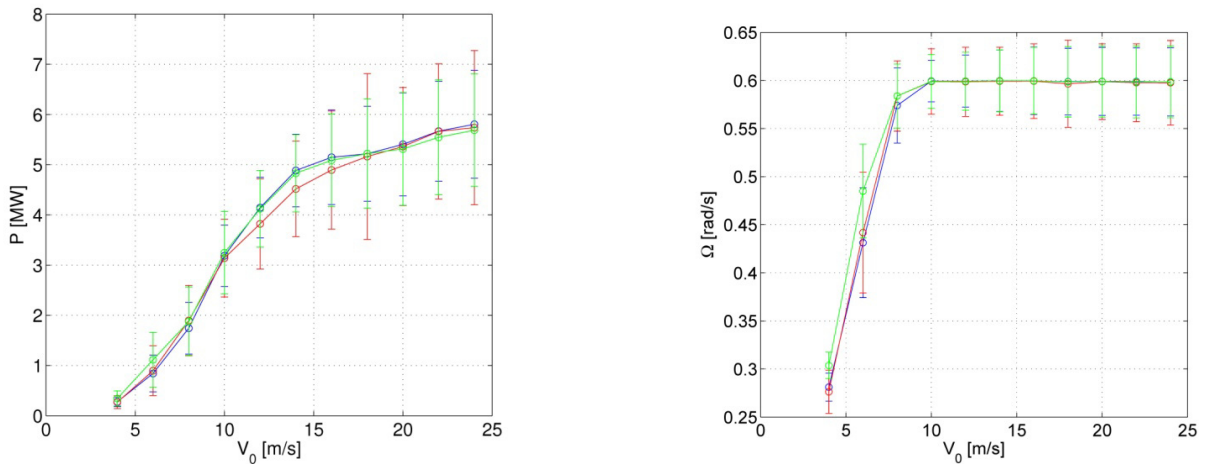

Figure 2 Left: Power curve and Right: Rotational speed at 4 different sea states. Circles: mean values. Whiskers: ± 1 standard deviation
Blue: Sea state 0, red: Sea state 1, green: Sea state 2, black: Sea state 3 [1, 2].

Table 1 Baseline 5 MW rotor design [2].

Geometry		Performance		
Rotor radius (R)	[m]	60.48	Rated power	[kW] 5000
Rotor height (H)	[m]	143	Rated rotational speed	[rad] 0.6
Chord (c)	[m]	5	Rated wind speed	[m/s] 15
Solidity ($\sigma = Nc/R$)	[-]	0.165	Cut in wind speed	[m/s] 4
Swept Area	[m ²]	11996	Cut out wind speed	[m/s] 25

2.2. Rotor blades

The Optimized blade profile having a low weight and high stiffness is obtained according to the design evaluations based on the standstill calculations in ANSYS software [1]. According to the design evaluations performed in [1], an optimized blade having low weight and high stiffness is obtained leading to the maximum linear elastic strain being less than $5000 \mu\text{m}/\text{m}$. The design loads of the DeepWind 5 MW turbine are calculated using HAWC2 (ver 11.4) and reported in [2] for the 2nd iteration of the DeepWind 5 MW design.

A static analysis of the rotor subjected to the calculated design loads in [2] is carried out using a general purpose finite element (FE) software ANSYS [3]. The schematic of the structural simulation is shown in Figure 3(left). The design loads are applied at 7 specified locations of the rotor blade as shown. These loads consist of forces (F_x , F_y , F_z) and moments (M_x , M_y , M_z) calculated for the deterministic flow and a wind speed of 24 m/s at sea state 3. The coordinate system is taken as the same with the one in [2]. The tips of the rotor are assumed to be fixed to the shaft. The rotor is modelled using quadratic 3D BEAM189 elements which have 3 nodes and include also the shear deformation effects. The BEAM189 element is well suited for large rotation and/or large strain nonlinear applications [3].

The deformation of the rotor under applied design loads is depicted in Figure 3(left) and compared to the one obtained under standstill calculation. It is seen that, under the design loads, the rotor is lifted up as compared with the undeformed and self-weight conditions (see Figure 3(left)). The strain distribution along the blade height is shown in Figure 3(right). It is seen that the strain level under the design loads are in the limit of maximum elastic strain level, i.e. $5000 \mu\text{m}/\text{m}$, as obtained also for the standstill calculations. However, the strain distributions are relatively more complex due to the non-uniform distribution of the applied design loads, i.e. discrete loads.

According to the static analysis performed in ANSYS software, it is found that the sectionized blade developed in the DeepWind 2nd iteration for 5 MW design can carry the design loads calculated by HAWC2 for the deterministic flow and a wind speed of 24 m/s at sea state 3, i.e. the strain level is predicted as less than the maximum limit $5000 \mu\text{m}/\text{m}$.

With this methodology the combined effects of blade gravity at standstill and met-ocean loads during operation is demonstrated and that iterated rotor design have propagated into a rotor shape, almost tolerant to turbulent aerodynamics.

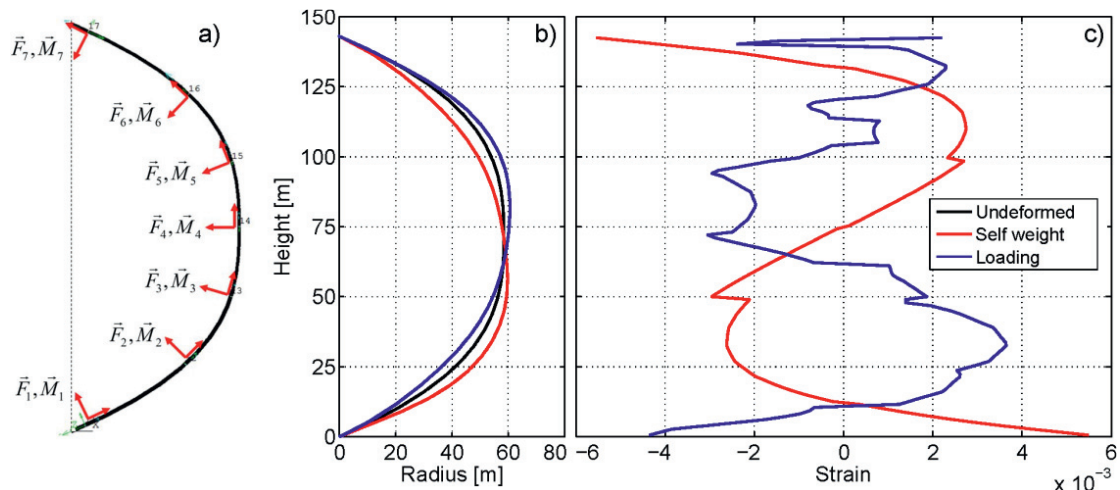

Figure 3 Left: Schematic view of the locations for the discrete applied loads Middle: Deformation of the rotor under its standstill and applied design loads Right: Strain distribution through the rotor height under its self-weight (standstill) and under the applied design loads

Pulltrusion process is considered to manufacture the blades within the DeepWind concept. Pulltrusion is one of the most cost-efficient composite manufacturing methods to produce constant cross sectional profiles at any length. Pulltrusion has already been utilized to manufacture blades for a Darrieus wind turbine blade in 1995 [4]. The

consequences of using pulltrusion have been reported in detail in [1]. Numerical modeling studies of the pulltrusion process have been carried out in connection with the DeepWind [5-12].

2.3. Generator

A direct drive, permanent magnet, three phase, radial flux generator was chosen [13], for the DeepWind generator after reviewing the relationship between size of the active materials and the required torque. Driven by the four quadrant converter this is able to act as starter motor and brake in addition to normal duty as a generator. The 6 MW shaft input at 0.6 radians per second requires a nominal full load torque of 10 MNm, which demands a very large generator. In order to conveniently design this generator and other similar ones, the team has developed a design tool [14], enabling rapid evaluation of ideas and changes of specification requirements.

It is important to analyze the generator design thoroughly from several points of view like finite element and dynamic simulations. Analytical design using MATLAB gives a data set that is transported to the finite element and computer assisted design programs as well as the dynamic simulation model using data subsets. With the design tool this process is fast and straightforward. The design tool was verified using a small scale prototype in a purpose built laboratory test rig. To obtain the full load rated output voltage of 13.5 kV, a concentrated fractional slot pitch winding was selected. A sample sketch of a segment of the generator is shown in Figure 4(left). An idea of the proportions is given in Figure 4(right).

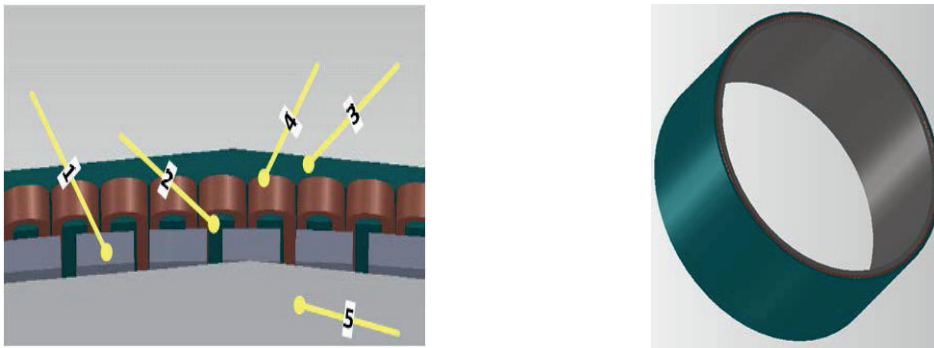

Figure 4 Left: Sample segment of the generator produced by the Design Tool. Legend: 1)Permanent magnet, 2)Stator tooth, 3)Stator back iron, 4)Winding coil, 5)Rotor back iron. Right: 3D sketch of the active parts of the 6 MW DeepWind Generator. Outside Diameter:5811mm, Length O/A:2648mm

The supporting structure of the generator has to be large and stiff as it needs to transmit all the forces and torques to the structure of the DeepWind floater and to the anchoring system, but is not shown here.

2.4. Bearings

The DeepWind operating conditions are characterized by the bearing loads, the shaft torque and speed, the ambient conditions and the dynamic loading. The bearings will be required to carry loads while the shaft is stationary, during acceleration and under all operating conditions. The ambient conditions include the water pressure and temperature, the chemical composition of the water and the presence of life in the water. The load bearing capacity of a bearing is a function of the operating speed, the torque and the forces applied to the shaft. Forces applied to the bearing must be resolved into components along the tube axis and components normal to the tube axis. Components along the axis are known as thrust components and components normal to the axis are known as radial components. In addition to the magnitude of the loads, it is interesting to know the eigenvalues of the tube and the

turbine, the expected forcing frequencies arising from the interaction of the wind and the waves, forces arising from the action of the generator, and the response of the bearing to these.

A controlled magnetic bearing was chosen for study[15]. In order to design a magnetic bearing that supports the shaft reliably in the housing, it will be necessary to control the forces generated by the bearing somehow. This is because the relationship between the magnetic force and the distance is in unstable equilibrium. The controlled or active magnetic bearing was chosen for study because it can be controlled to respond well to the changing loading conditions expected in the DeepWind application. Disadvantages are that it will require a control system and power supply, and the windings will need to be insulated and may require maintenance. As the bearing loads may vary considerably with floater design and generator design, a Design Tool was developed by the team to enable rapid evaluation of the journal and thrust bearings as required. This tool was validated on a purpose built laboratory test rig. The design tool was programmed on the MATLAB platform, and linked to a dynamic model in SIMULINK. The magnetic circuit of a simple controlled magnetic journal bearing is illustrated in Figure 5. For each vectorial direction requiring force control, a control system is required. In this case, a dedicated control system is proposed, using appropriate sensors and a controlled power supply for each direction.

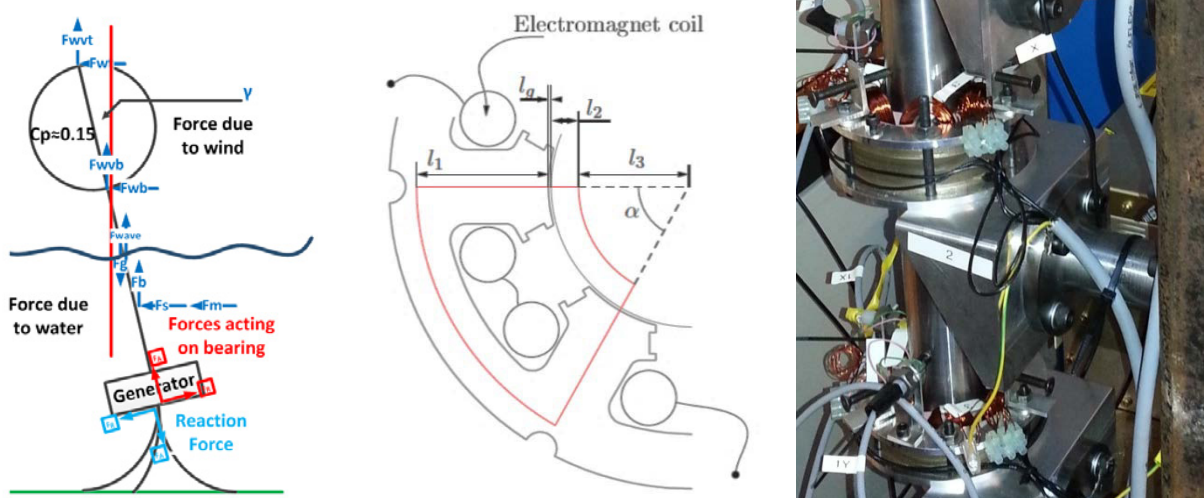

Figure 5 Left: Diagram illustrating the forces acting on the bearing of the DeepWind Generator. Middle: Mean flux path of one electromagnet of the laboratory model controlled magnetic bearing. Right: Laboratory model [15]

2.5. Grid connection and control

As the Darrieus wind turbine is not self-starting, it is necessary to connect the generator to the grid using a four quadrant inverter. This also conveniently allows independent control of the active power and the reactive power. The output of the grid-side converter is connected directly to the three phase 50 Hz mains via a filter, without the use of a transformer. In this way the power flow and shaft speed may be controlled by a single speed reference supplied to the converter controller. An outline of the grid integration concept is shown in Figure 6.

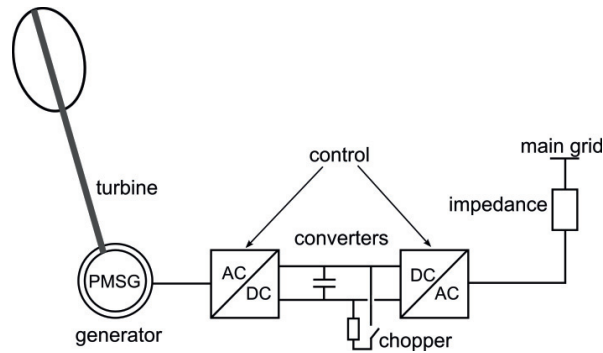

Figure 6 Grid integration via four quadrant converter[16]

The variable speed permanent magnet generator will generate voltage and frequency, both directly proportional to the shaft speed. The frequency is compensated by the generator side inverter, as the generator output is converted to DC. The fixed voltage required by the grid under normal operation is provided by the grid side inverter. Additional functions of the converter are to start the rotation of the floater, and to keep it rotating at low wind speeds, by reversing the power flow. The converter may also be used for braking the floater as required, by increasing the generating torque beyond that produced by the turbine rotor. In an emergency, if the grid connection is lost for any reason, braking may be provided by connecting a suitable resistor across the DC bus.

A baseline controller has been developed and verified in different operating conditions [17, 18]. The basic structure is that of a proportional–integral (PI) feedback controller which compares measured generator speed with a reference value obtained from measured torque via a variable speed look-up table. Controller gains have been tuned to minimise generator torque variations and over-speed. A characteristic of 2-bladed vertical axis wind turbines is the large twice-per-revolution (2p) variations in aerodynamic torque. These need to be isolated from the generator so as to avoid similar pulsations in the mooring line tension, and to enable smoother electric power output. In the baseline controller, this has been achieved by means of a notch filter that eliminates 2p variations in the measured generator speed. In other words, the controller trades large 2p torque variations with small 2p speed variations. The aerodynamic power variations are absorbed by the kinetic energy of the rotor. This works well unless the stator/mooring system has a resonance frequency that coincides with the 2p frequency, in which case the stator will tend to oscillate such as to render the notch filter ineffective. Such stator system oscillations are believed to be undesirable due to the impact on the mooring system.

2.6. Grid code compliance – response to a fault in the electrical grid

An important requirement is that that the turbine satisfies grid code requirements and is able to remain grid connected and withstand disturbances propagated through the electricity grids such as those due to a sudden loss of grid voltage. The use of a full converter interface between the permanent magnet synchronous generator and the main electricity grid enables a high degree of controllability that makes this possible. However, this controllability in itself is not sufficient: It is also necessary to have some means of storing or dissipating excess power production during grid faults to avoid over-rated converter currents and over-rated voltages in the DC link. Two different approaches have been implemented and tested in numerical simulations with a grid voltage loss event [19]. The first is a DC chopper system which includes a switched resistor in the DC link that absorbs power when the DC voltage rises above a given threshold value. The second is based on de-loading of the generator, effectively reducing the generator torque and allowing the turbine to speed up during the fault.

Analyses of grid disturbances such voltage faults are important to demonstrate that the turbine is compliant with strict modern grid codes. A critical requirement for wind turbines has been the ride-through capability during low voltage events. But it is also important to investigate whether grid disturbances affect other parts of the turbine. The coupling between the electrical system and the mechanical system is via the generator torque and speed. And

DeepWind is special in that the stator is not actually fixed, but has a rotational degree of freedom around the rotor axis due to the elasticity in the mooring system. The generator speed is therefore not identical to the rotor speed, but equals the difference between rotor and stator rotational speed. Because the rotational inertia of the stator part of the turbine (generator and mooring system) is much less than the inertial of the rotor part (shaft and blades), a rapid change in generator torque will give rise to a rapid change in the mooring line tension, and only a small effect on the turbine rotation. This has an undesirable effect on mooring system design.

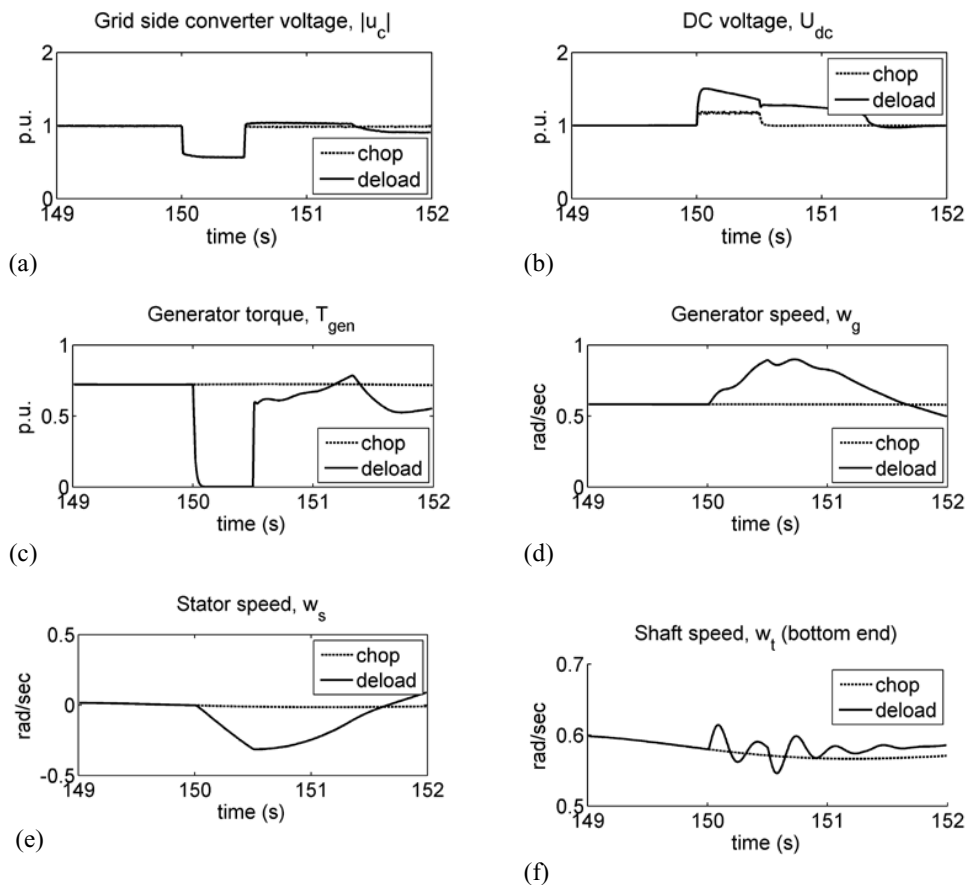

Figure 7: Simulation results for a 500 ms grid fault occurring at time 150 s for DC chopper and de-loading control strategies.

Simulation have been performed with a simplified model of the turbine and the electrical connection scheme outlined in Figure 7 for a main grid voltage dip of 500 ms. The results are shown in Figure 7 for the two control strategies. The voltage dip propagates to the grid-side converter terminal (a), with a resulting rise in the DC voltage (b). The chopper system is able to limit the DC voltage at the specified maximum value and immediately return to the nominal value after fault clearance. In this case the chopper absorbs all the effects of the grid fault and the turbine continues undisturbed operation. The de-loading system is not able to limit the DC voltage, despite a complete reduction in generator torque (c). The drop in generator torque does not lead to mild acceleration of the turbine, but instead to a rapid acceleration of the stator (e), driven by the suddenly unbalanced tension in the mooring lines. This is reflected in the generator speed. The rotor also experiences a sudden loss of torque at the bottom end that gives rise to torsional vibration (f). Clearly, the pure de-loading strategy as presented here is not satisfactory. However, it may be that a combined chopper/de-loading system is beneficial since the de-loading may reduce the size of the required chopper resistor, if not eliminate it completely. Whether this is the case has not yet been assessed.

2.7. Floating Platform

There are several constraints in designing a floating VAWT with a rotating spar platform:

- Structural constraints, limiting the loads on the structure.
- Stability constraints, linked to variables which provide acceptable stiffness in pitch and roll while keeping natural periods above dominant wave periods.
- Cost constraints, addressing a general reduction in the mass of the structure.

Main design drivers influencing a technical optimal solution in design space are geometry, materials and constraints linked to operation of the wind turbine [20]. Several design parameters have a multiple dependency from different requirements, showing the necessity of an iterative and integrated design process. The conflicting requirements reduce significantly the concept design space, as shown in Figure 8 where the simplified case of the design of a spar buoy support structure with a constant diameter section is illustrated [21]. The current floater design has not changed significantly in comparison with the first iteration baseline design [20]. A global optimization requires numerous iterations which in this phase cannot be fulfilled; choices have to be made in keeping design iterations at sub-components level affordable. The current design is in the final stage of this process, and further component changes will rely on a sensitivity analysis performed on main parameters changing cost.

The present concept evaluation with the global model of the site condition effects for platform stability has resulted in Figure 9. A clear impact of Roll sensitivity change of from about 4 to about 8 Deg from the Magnus forces is seen above and below 13 m/s.

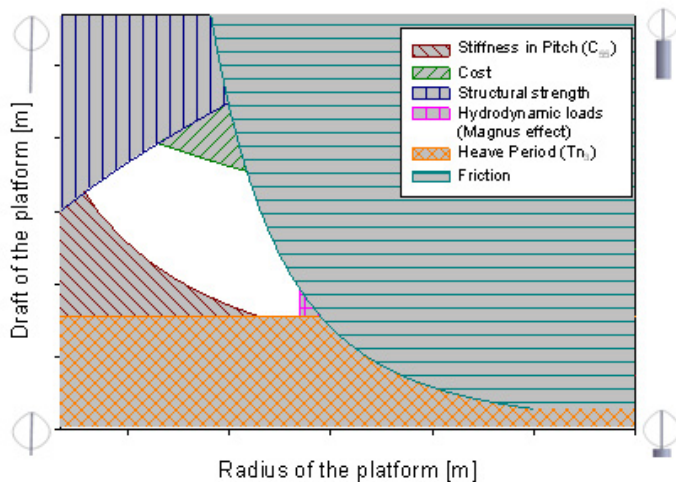

Figure 8 Design space for the rotating supporting structure of a floating VAWT [21].

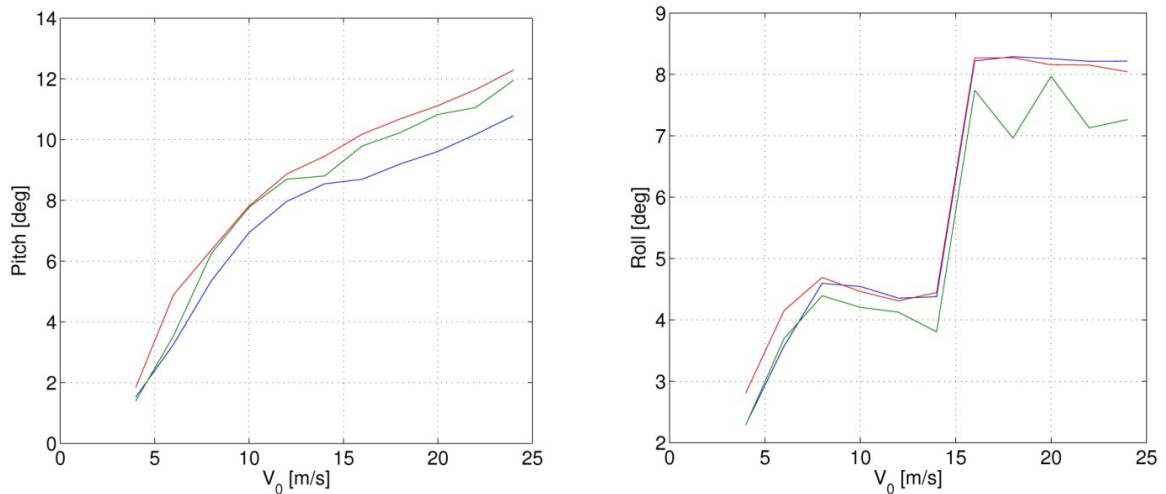

Figure 9 Platform stability at different sea states. Left : Pitch. Right: Roll [2] The turbine inflow is in the direction of the Roll -axis.

3. Conclusions

The DeepWind rotor, floater, generator, controller and bearings were presented briefly. Regarding the structural performance of the rotor, the predicted strain level was found to be less than the maximum strain limit under design loads obtained by HAWC2 for the deterministic flow and a wind speed of 24 m/s at sea state 3. The DeepWind application poses significant engineering challenges to the electrical system, because of the undersea environment and the very slow rotational speeds of the Darrieus wind turbine.

The current results are promising for further initiatives within this technology. A major result is that the full aero-elastic/hydro modelling has showed that the present baseline concept without any horizontal struts applied in the rotor/blade design performs with expected performance and can operate during the whole wind speed range without stability problems. Another result that the influence from the Magnus forces on the rotating floater can be controlled. At the start of the project this was considered as a potential show stopper.

The response to a fault in the electrical grid shows that we need to avoid rapid variations in the generator torque. However details needs still to be examined in order to justify overall integration of sub-components, optimized technically in subsequent levels accounting for loads, and in a demonstration of the concept under real conditions and particular load situations.

Acknowledgements

The present work is a result of the contributions within the DeepWind project, supported by the European Commission, Grant 256769 FP7 Energy 2010- Future emerging technologies, and by the DeepWind beneficiaries: DTU(DK), AAU(DK), TUDELFT(NL), TUTRENTO(I), DHI(DK), SINTEF(N), MARINTEK(N), MARIN(NL), NREL(USA), STATOIL(N), VESTAS(DK) and NENUPHAR(F).

References

- [1] Paulsen US, Madsen HA, Hattel JH, Baran I, Nielsen PH. Design optimization of a 5 MW floating offshore vertical-axis wind turbine. Energy Procedia 2013. 35; 22-32.
- [2] Kragh KA, Madsen HA. 2nd iteration design loads for the DeepWind 5 MW Turbine. DTU Wind Energy Report 2013.
- [3] Users manual of ANSYS 13.0, ANSYS Inc., 2010.
- [4] H.J. Sutherland, D.E. Berg, T.D. Ashwill, *A retrospective of VAWT technology*. Sandia Report, SAND2012-0304, January 2012.

- [5] Carlone P, Baran I, Hattel JH, Palazzo GS. Computational Approaches for Modeling the Multiphysics in Pultrusion Process. *Advances in Mechanical Engineering*, vol. 2013, Article ID 301875, 14 pages, 2013. doi:10.1155/2013/301875.
- [6] Baran I, Tutum CC, Hattel JH. The effect of thermal contact resistance on the thermo-setting pultrusion process. *Compos. Part B: Eng.* 2013; 45, 995-1000.
- [7] Baran I, Tutum CC, Hattel JH. Thermo-chemical modelling strategies for the pultrusion process. *App. Compos. Mat.* 2013; 20(6): 1247-1263.
- [8] Baran I, Tutum CC, Hattel JH. Reliability estimation of the pultrusion process using the first-order reliability method (FORM). *App. Compos. Mat.* 2013; 20: 639-653.
- [9] Baran I, Tutum CC, Hattel JH. Optimization of the thermo-setting pultrusion process by using hybrid and mixed integer genetic algorithms. *App. Compos. Mat.* 2013; 20: 449-463.
- [10] Tutum CC, Baran I, Hattel JH. Utilizing multiple objectives for the optimization of the pultrusion process. *Key Eng. Mat.* 2013; 554-557: 2165-2174.
- [11] Baran I, Tutum CC, Nielsen MW, Hattel JH. Process induced residual stresses and distortions in pultrusion. *Compos. Part B: Eng.* 2013; 51: 148-161.
- [12] Baran I, Tutum CC, Hattel JH. The internal stress evaluation of the pultruded blades for a Darrieus wind turbine. *Key Eng. Mat.* 2013; 554-557: 2127-2137.
- [13] Leban K, Ritchie E, Argeseanu A. Design Preliminaries for Direct Drive under Water Wind Turbine Generator; Proceedings of 20th International Conference on Electrical Machines, ICEM 2012, September 2012, Marseilles, France; IEEE Catalog Number: CFP1290B-USB; ISBN: 978-1-4673-0141-1
- [14] Leban K, Ritchie E, Argeseanu A. Design Tool for Large Direct Drive Generators 14th International Conference on "Optimization of Electrical and Electronic Equipment - OPTIM 2014" -SUBMITTED
- [15] Bjerregaard H, Sloth K, Thygesen RR Design of Active Electromagnetic Bearing for Darrieus Type Wind Turbines, MSc thesis, Aalborg University, June 2013
- [16] Nica FVT, Burlacu PD, Shivachev SI Control of 5MW multilevel converter for direct drive wind turbine application;; AAU, Energiteknik Kandidat, (Kandidatuddannelse) 2. semester, 2013, Semesterprojekt.
- [17] K. O. Merz, H. G. Svendsen, A control algorithm for the deepwind floating vertical-axis wind turbine, *J. Renewable Sustainable Energy* 5 (2013) 063136, doi:10.1063/1.4854675.
- [18] H. G. Svendsen, K. O. Merz, Control system for start-up and shut-down of a floating vertical axis wind turbine, *Energy Procedia* 35 (2013) 33–42, doi:10.1016/j.egypro.2013.07.156.
- [19] G. Endegnanew, H. G. Svendsen, Grid code compliance of the Deepwind floating vertical axis wind turbine, *EWEA Offshore* 2013, Frankfurt, November, 2013.
- [20] Paulsen US, Vita L, Madsen HA, Hattel J, Ritchie E, Leban KM, Berthelsen PA, Carstensen S *1st DeepWind 5 MW baseline design* *Energy Procedia* 2012, 24: 27-35
- [21] Vita L Offshore Floating Vertical Axis Wind Turbines with Rotating Platform Risø-PhD-80(EN) 2011, 164 pp.