

## Chapter 1. Preface

In 1963, John Milnor put forward a list of problems in geometric topology.

1. Let  $M^3$  be a homology 3-sphere with  $\pi_1 \neq 0$ . Is the double suspension of  $M^3$  homeomorphic to  $S^5$ ?
2. Is simple homotopy type a topological invariant?
3. Can rational Pontrjagin classes be defined as topological invariants?
4. (HAUPTVERMUTUNG) If two PL manifolds are homeomorphic, does it follow that they are PL homeomorphic?
5. Can topological manifolds be triangulated?
6. The Poincaré hypothesis in dimensions 3, 4.
7. (THE ANNULUS CONJECTURE) Is the region bounded by two locally flat  $n$ -spheres in  $(n + 1)$ -space necessarily homeomorphic to  $S^n \times [0, 1]$ ?

These were presented at the 1963 conference on differential and algebraic topology in Seattle, Washington. A much larger problem set from the conference is published in *Ann. Math.*81 (1965) pp. 565–591.

In the last 30 years, much progress has been made on these problems. Problems 1, 2, 3, and 7 were solved affirmatively by Edwards-Cannon, Chapman, Novikov, and Kirby in the late 1960's and early 1970's, while problems 4 and 5 were solved negatively by Kirby-Siebenmann in 1967. Freedman solved the 4-dimensional (TOP) Poincaré Conjecture in 1980. The 3-dimensional Poincaré Conjecture and the 4-dimensional PL/DIFF Poincaré Conjecture remain open as of this writing. This book introduces high-dimensional PL and TOP topology by providing solutions – or at least useful information pointing towards solutions – of problems 1, 2, 3, 4, 5, and 7.

This sort of geometric topology has recently been applied to Gromov-style differential geometry, index theory, and algebraic geometry. One of the author's goals in writing this book is to help workers in other areas to understand what the machinery of geometric topology can do. In a sense, this is intended as a book for people who haven't decided, yet, whether they want to make the (substantial) investment of learning geometric topology! Accordingly, the focus here is on examples and techniques of proof, rather than on developing any one theory or technique to its logical limits.

## Chapter 2. Some TOP topology

We begin with a study of embeddings of  $S^{n-1}$  into  $S^n$ . We know from algebraic topology that if  $i : S^{n-1} \rightarrow S^n$  is an embedding, then  $i(S^{n-1})$  separates  $S^n$  into two parts. We remind the student of the statement of Alexander Duality:

*If  $K$  is a polyhedron and  $i : K \rightarrow S^n$  is an embedding, then  $\bar{H}_\ell(S^n - K) \cong H^{n-\ell-1}(K)$ .*

If  $K = S^{n-1}$  and  $\ell = 0$ , this says that  $\bar{H}_0(S^n - S^{n-1}) \cong H^{n-1}(S^{n-1}) = \mathbb{Z}$ . Thus,  $S^n - S^{n-1}$  has two path components. Further applications of Alexander duality show that each of these complementary domains has the homology of a point.

The naive conjecture is that each complementary domain is homeomorphic to  $D^n$  and that all embeddings  $S^{n-1} \rightarrow S^n$  which preserve orientation should be topologically equivalent – that if  $i : S^{n-1} \rightarrow S^n$  is an orientation-preserving embedding, then there should be a homeomorphism  $h : S^n \rightarrow S^n$  so that  $h \circ i$  is the standard embedding of  $S^{n-1}$  onto the equator of  $S^n$ . A classical example, the Alexander Horned sphere, shows that this conjecture is false for  $n = 3$ . In Example 2.22, we provide a slightly different example of an embedded  $S^2$  in  $S^3$  which fails to bound a disk in  $S^3$ .

To achieve positive results in the face of such counterexamples, we must impose hypotheses on the embedding  $i$ . The classical condition is that  $i$  should be either locally or globally collared in  $S^n$ . Accordingly, we begin the section with a proof of Morton Brown's collaring theorem. In the case of  $S^{n-1} \subset S^n$ , Brown's theorem says that if either complementary domain of  $S^{n-1}$  in  $S^n$  is a manifold, then boundary of this complementary domain has a neighborhood (in the complementary domain) homeomorphic to  $S^{n-1} \times [0, 1)$ . Here is the general definition of a local collaring:

**DEFINITION 2.1.** Let  $X$  be a topological space and let  $B$  be a subset of  $X$ . Then  $B$  is *collared* in  $X$  if there is an open embedding  $h : B \times [0, 1) \rightarrow X$  with  $h|_{B \times \{0\}} = id$ . If  $B$  can be covered by a collection of open subsets, each of which is collared in  $X$ , then  $B$  is said to be *locally collared* in  $X$ .

**THEOREM 2.2 (M. BROWN [B3], [CON]).** *If  $X$  and  $B$  are compact metric and  $B$  is locally collared in  $X$ , then  $B$  is collared in  $X$ .*

**PROOF:** The proof is by induction on the number of elements in the cover of  $B$ . This reduces immediately to the case in which  $B = U \cup V$  with both  $U$  and  $V$  collared in  $X$ .

Form a space  $X^+ = X \cup B \times [0, \infty)$ . Using the collars on  $U$  and  $V$ , we can find open subsets  $U^+$  and  $V^+$  of  $X^+$  homeomorphic to  $U \times [-\infty, \infty]$  and  $V \times [-\infty, \infty]$  so that  $U^+ \cup V^+$  is a neighborhood of  $B$ . Choose functions  $\sigma, \tau : B \rightarrow [0, 1]$  so that  $\sigma + \tau = 1$ , and so that  $\sigma$  and  $\tau$  are supported on closed subsets (in  $B$ ) of  $U$  and  $V$ , respectively. Define homeomorphisms  $h_\sigma : U^+ \rightarrow U^+$  and  $h_\tau : V^+ \rightarrow V^+$  so that  $h_\sigma(u, t) = (u, t + \sigma(u))$  and  $h_\tau(v, t) = (v, t + \tau(v))$ . If we choose the inner collars on  $U$  and  $V$  carefully, perhaps by reparameterizing  $U \times [-1, 0]$  and  $V \times [-1, 0]$  to be the new  $U \times [-\infty, 0]$  and  $V \times [-\infty, 0]$ , we can assume that  $h_\sigma$  and  $h_\tau$  extend continuously to  $X^+$  using the identity outside of  $U^+$  and  $V^+$ . The composition  $h_\sigma \circ h_\tau$  throws  $X$  onto  $X \cup B \times [0, 1]$ , exhibiting a collar on  $B$ . ■

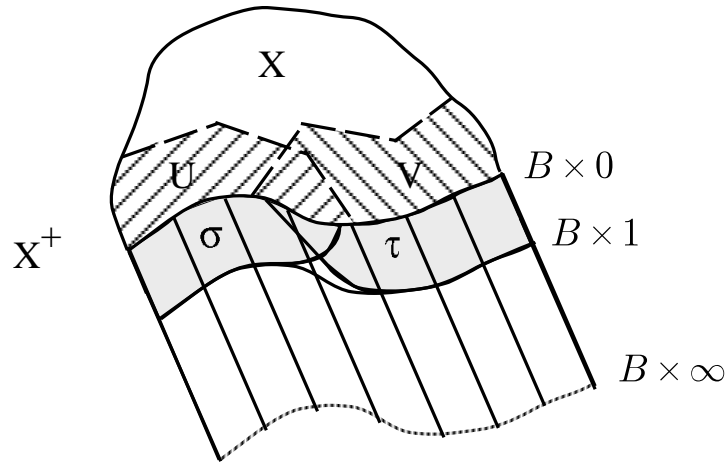

COROLLARY 2.3. *The boundary of a topological manifold is collared.* ■

It is amazing that this was a new result as late as 1962. Our main goal for this section is to prove the Generalized Schoenflies Theorem, which says that if both complementary domains of  $S^{n-1}$  in  $S^n$  are topological manifolds, then they are homeomorphic to balls.

DEFINITION 2.4. By an  $n$ -ball  $B$  in a manifold  $M^n$ , we mean the homeomorphic image of a standard  $n$ -ball in  $\mathbb{R}^n$ . An  $n$ -ball is collared if  $\partial B$  is collared in  $M^n - \overset{\circ}{B}$ . The homeomorphic image of a  $k$ -ball is also referred to as a  $k$ -cell.

Many useful homeomorphisms in the topological category are constructed as compositions of pushes. The next lemma constructs one such push.

LEMMA 2.5. *Let  $B$  be a collared  $n$ -ball in  $\mathbb{R}^n$  with collar  $C$  and let  $D$  be a compact subset of  $\mathbb{R}^n$ . Then there is a homeomorphism  $h : \mathbb{R}^n \rightarrow \mathbb{R}^n$  with compact support such*

that  $h|_B = id$  and  $h(B \cup C) \supset B \cup D$ .

PROOF: Choose a point  $b \in \overset{\circ}{B}$  and a standard ball  $B_1 \subset \overset{\circ}{B}$  centered at  $b$ . Let  $\rho : \mathbb{R}^n \rightarrow \mathbb{R}^n$  be a homeomorphism with compact support in  $B \cup C$  shrinking  $B$  into  $B_1$ . This homeomorphism is easy to construct after parametrizing  $B \cup C$  as the cone from  $b$  on  $\partial(B \cup C)$ .

Let  $\sigma : \mathbb{R}^n \rightarrow \mathbb{R}^n$  be a homeomorphism with compact support so that  $\sigma|_{B_1} = id$  and  $\sigma(B \cup C) \supset B \cup C \cup \rho(D)$ . Such a homeomorphism is obtained by radially stretching a small collar on  $B_1$ . Setting  $h = \rho^{-1} \circ \sigma \circ \rho$  completes the proof, since we have  $h|_B = id$  and  $h(B \cup C) = \rho^{-1} \circ \sigma \circ \rho(B \cup C) = \rho^{-1} \circ \sigma(B \cup C) \supset \rho^{-1}(\rho(D)) = D$ . ■

We obtain a striking characterization of euclidean  $n$ -space which is valid for any  $n$ .

**THEOREM 2.6** (M. BROWN [B2]). *Let  $M^n$  be a TOP  $n$ -manifold such that every compact subset  $D$  of  $M$  is contained in some open subset  $P$  of  $M^n$  with  $P \cong \mathbb{R}^n$ . Then  $M^n \cong \mathbb{R}^n$ .*

PROOF: Write  $M = \bigcup_{i=1}^{\infty} D_i$  with  $D_1 \subset D_2 \subset \dots$  and  $D_i$  compact for all  $i$ . Choose a small standard ball  $B \subset M$  with collar  $C$ . Write  $B \cup C = \bigcup B_i$  with  $B_i$  a ball,  $\overset{\circ}{B}_{i+1} = B_i \cup C_i, C_i$  a collar on  $B_i, B_1 \subset \overset{\circ}{B}_2 \subset \dots$ . We define a sequence of homeomorphisms  $h_i : M^n \rightarrow M^n$  so that  $h_i|_{B_i} = h_{i+1}|_{B_i}$  and  $h_i(B_i) \supset D_i$ . This will suffice to prove the Theorem, since  $\lim_{i \rightarrow \infty} h_i|_{B \cup C}$  is a homeomorphism from  $B \cup C$  onto  $M$ .

Such a sequence of homeomorphisms is easily obtained by repeated application of Lemma 2.5. Given  $h_i$ , choose  $P \cong \mathbb{R}^n$  so that  $P \supset h_i(B \cup C) \cup D_{i+1}$ . Applying Lemma 2.5, we obtain a homeomorphism  $h' : P \rightarrow P$  with compact support so that  $h'|_{h_i(B_i)} = id$  and  $h'(h_i(\overset{\circ}{B}_{i+1})) \supset D_{i+1}$ . Setting  $h_{i+1} = h' \circ h_i$  and extending to  $M^n$  by the identity completes the construction of  $h_{i+1}$ . ■

**THEOREM 2.7.** *Let  $M^n$  be a compact TOP  $n$ -manifold which is the union of two open sets  $U$  and  $V$  which are homeomorphic to  $\mathbb{R}^n$ . Then  $M^n$  is homeomorphic to  $S^n$ .*

PROOF: Replace  $V$  by a smaller copy of  $\mathbb{R}^n$  and choose a point  $p \in U - \bar{V}$ . We will show that  $M - \{p\}$  is homeomorphic to  $\mathbb{R}^n$ , which will complete the proof, since the one-point compactification of  $\mathbb{R}^n$  is  $S^n$ .

Let  $D$  be a compact subset of  $M - \{p\}$  and let  $B_1$  be a standard ball in  $U - D$  centered at  $p$ . Now,  $U - V$  is a compact subset of  $U$ , so there is a homeomorphism  $\sigma : U \rightarrow U$  with compact support so that  $\sigma(B_1) \supset U - V$ . Extend  $\sigma$  by the identity to all of  $M$ . We

have  $\sigma(B_1) \cup V = M$ , so  $B_1 \cup \sigma^{-1}(V) = M$  and  $\sigma^{-1}(V) \supset D$ , so Theorem 2.6 applies to show that  $M - \{p\} \cong \mathbb{R}^n$ . ■

COROLLARY 2.8. *If a closed topological manifold  $M^n$  is a suspension, then  $M^n \cong S^n$ .*

PROOF: If  $\Sigma X \cong M$ , let  $U'$  and  $V'$  be euclidean neighborhoods of the suspension points. Radial expansion gives open sets  $U$  and  $V$  homeomorphic to  $U'$  and  $V'$  covering  $M$ . ■

Our proof of the Generalized Schoenflies Theorem will depend on a technique called “Bing Shrinking.” Strictly speaking, the introduction of Bing Shrinking at this stage is unnecessary, but the proof is not hard and shrinking is a basic technique in the topological category, so we introduce it as quickly as possible. For an argument which does not explicitly use Bing’s results, see [B1].

### BING SHRINKING

DEFINITION 2.9.

- (i) A map  $p : X \rightarrow Y$  between compact metric spaces is called a *near-homeomorphism* if  $p$  is a uniform limit of homeomorphisms.
- (ii) A surjective map  $p : X \rightarrow Y$  between compact metric spaces is said to be *shrinkable* if for each  $\varepsilon > 0$  there is a homeomorphism  $h : X \rightarrow X$  such that
  - (1)  $\text{diam}(h(p^{-1}(y))) < \varepsilon$  and
  - (2)  $d(p, p \circ h) < \varepsilon$ .

$h$  is called a *shrinking homeomorphism* for  $p$ .

The first condition in part (ii) says that there is a self-homeomorphism  $h$  of  $X$  making the point-inverses  $p^{-1}(y)$  arbitrarily small. The second condition says that this homeomorphism may be chosen to keep every point-inverse in a small neighborhood of itself. To an observer standing in the range space  $Y$ , and looking up at the graph of  $p$  in  $X \times Y$ , the motion  $h$  appears to be very small. The exercise below puts this into symbols.

EXERCISE 2.10. Prove that if  $X$  and  $Y$  are compact metric and  $f : X \rightarrow Y$  is continuous with  $\text{diam}(f^{-1}(y)) < \epsilon$  for all  $y \in Y$ , then there is a  $\delta > 0$  so that if  $g : X \rightarrow X$  is continuous with  $d(f \circ g, f) < \delta$ , then  $d(g, id) < \epsilon$ . (Hint: Show that there is a  $\delta > 0$  so that if  $d(f(x), f(x')) < \delta$ , then  $d(x, x') < \epsilon$ .)

THEOREM 2.11 (BING SHRINKING THEOREM [Bi]). *A surjective map  $p : X \rightarrow Y$  between compact metric spaces is a near-homeomorphism if and only if it is shrinkable. In particular, if  $p$  is shrinkable, then  $X$  and  $Y$  are homeomorphic.*

PROOF: ( $\Leftarrow$ ) Suppose that  $p$  is shrinkable. The plan is to construct a sequence of homeomorphisms  $h_i : X \rightarrow X$  converging to a map  $q : X \rightarrow X$  which has the same collection of point-inverses as  $p$ . Then  $p \circ q^{-1}$  is well-defined map  $X$  to  $Y$  with  $q \circ p^{-1} : Y \rightarrow X$  as its inverse.

We will choose the homeomorphisms  $h_i$  so that

- (h1)  $d(h_i, h_{i+1}) < 1/2^i$ ,  $i \geq 1$ .
- (h2)  $\text{diam}(h_i(p^{-1}(y))) < 1/2^i$  for all  $y \in Y$  and  $i \geq 1$ .
- (h3)  $d(p \circ h_{i-1}^{-1}, p \circ h_i^{-1}) < 1/2^{i-1}$  for all  $i$ .

We will construct  $h_i$  as  $k_i \circ k_{i-1} \circ \cdots \circ k_1$ .

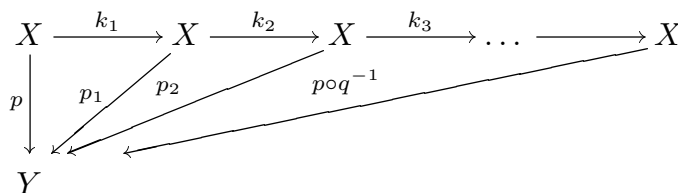

In terms of  $k_i$ 's, the condition (h1) simply says that:

- (k1)  $d(k_{i+1}, id) < 1/2^i$ ,  $i \geq 1$ .

Conditions (h2) and (h3) reduce to:

- (k2)  $k_i$  is a shrinking homeomorphism for  $p_{i-1} = p \circ h_{i-1}^{-1}$ .

Of course  $p_i$  is shrinkable when  $p$  is, so we need to find shrinking homeomorphisms  $k_i$  for which condition (k1) holds. We start by choosing  $k_1$  to shrink all point-inverses of  $p$  to diameters of less than  $\frac{1}{4}$ . At each further stage, we choose  $k_{i+1}$  to shrink all point-inverses of  $p_i$  to diameter less than  $1/2^{i+1}$ . This  $k_{i+1}$  can be chosen with  $d(k_{i+1}, id) < 1/2^i$ , since the point-inverses of  $p_i$  have diameter  $< 1/2^i$ . In fact, choosing  $\varepsilon$  sufficiently small for the shrinking homeomorphism  $k_{i+1}$  forces this last condition, since the motion of  $k_{i+1}$  is constrained to lie near the point-inverses of  $p_i$ . Having chosen  $h_i$ 's satisfying (h1)-(h3), we have  $q = \lim h_i : X \rightarrow X$ . Condition (h2) implies that  $q \circ p^{-1}(y)$  is a single point for all  $y \in Y$ , so  $q \circ p^{-1} : Y \rightarrow X$  is well-defined. Condition (h3) implies that  $q' = \lim p \circ h_i^{-1} : X \rightarrow Y$  exists. The maps  $q \circ p^{-1}$  and  $q'$  are inverses, showing that  $X$  and  $Y$  are homeomorphic.

( $\Rightarrow$ ) Let  $\varepsilon > 0$  be given and suppose that  $p$  is a uniform limit of homeomorphisms. Let  $\{h_i\}$  be a sequence of homeomorphisms converging uniformly to  $p$ . Choose  $i$  so that

$d(h_j, p) < \varepsilon/2$  for  $j \geq i$ . By continuity, there is a  $\delta > 0$  such that if  $d(y, y') < \delta$ , then  $d(h_i^{-1}(y), h_i^{-1}(y')) < \varepsilon/2$ . If  $j$  is large,  $\text{diam}(h_j(p^{-1}(y))) < \delta$  for each  $y \in Y$ , so  $\text{diam}(h_i^{-1} \circ h_j(p^{-1}(y))) < \varepsilon$ .  $d(p \circ h_i^{-1} \circ h_j, p) = d(p \circ h_j^{-1}, p \circ h_i^{-1}) < d(p \circ h_j^{-1}, id) + d(id, p \circ h_i^{-1}) = d(p, h_i) + d(p, h_j) < \varepsilon/2 + \varepsilon/2 = \varepsilon$ . Thus,  $h = h_i^{-1} \circ h_j$  is a shrinking homeomorphism for  $p$ . ■

REMARK 2.12. We can extend this theorem to the locally compact metric case using one-point compactifications. In particular, a proper map between locally compact metric spaces which satisfies the shrinking condition as stated is a limit of homeomorphisms. The Bing Shrinking Theorem is true in extreme generality. See [D] for much more general results.

#### THE PROOF OF THE GENERALIZED SCHOENFLIESS THEOREM

DEFINITION 2.13. A compact subset  $X$  of a manifold  $M^n$  is said to be *cellular* if for each neighborhood  $U$  of  $X$  there is a topological  $n$ -ball ( $\equiv n$ -cell)  $Q$  with  $X \subset \overset{\circ}{Q} \subset U$ .

PROPOSITION 2.14. *If  $X \subset M^n$  is cellular, then  $p : M \rightarrow M/X$  is a near-homeomorphism.*

PROOF: This is an easy application of the Bing Shrinking Theorem. If  $U$  is a small open neighborhood of  $X$  and  $Q$  is an  $n$ -cell in  $U$  containing  $X$ , a shrinking homeomorphism is obtained by radially contracting  $Q$  in itself to make  $X$  small. ■

EXERCISE 2.15. The serious student is urged to prove the preceding proposition by hand without appealing to Bing Shrinking.

PROPOSITION 2.16. *If  $X \subset \mathbb{R}^n$  is compact and there is a map  $\phi : \mathbb{R}^n \rightarrow \mathbb{R}^n$  so that  $\phi(X) = pt$  and  $\phi^{-1}(\phi(y)) = y$  for  $y \notin X$ , then  $X$  is cellular.*

PROOF: Let  $Q' \subset \mathbb{R}^n$  be a topological  $n$ -cell containing  $X$  and let  $V$  be an open neighborhood of  $X$ . Let  $\sigma : \mathbb{R}^n \rightarrow \mathbb{R}^n$  be a homeomorphism which squeezes  $\phi(Q')$  into  $\phi(V)$  while fixing a (very small) neighborhood of  $\phi(X)$ . Then  $Q = \phi^{-1} \circ \sigma \circ \phi(Q')$  is a cell in  $V$  containing  $X$ . ■

REMARK 2.17. It is important to notice that the argument above does not require  $\phi$  to be onto.

PROPOSITION 2.18. *If  $X, Y \subset \mathbb{R}^n$  are compact and there is a map  $\phi : \mathbb{R}^n \rightarrow \mathbb{R}^n$  so that*

- (i)  $\phi(X) = pt$ .
- (ii)  $\phi(Y) = pt$ .

(iii)  $\phi^{-1}(\phi(z)) = z$  for  $z \notin X, Y$ .

Then  $X$  and  $Y$  are cellular.

PROOF: Let  $\sigma : \mathbb{R}^n \rightarrow \mathbb{R}^n$  be a radial contraction from the point  $\phi(X)$  so that  $\sigma(\mathbb{R}^n) \subset \mathbb{R}^n - \phi(Y)$  and so that  $\sigma = id$  on a neighborhood of  $\phi(X)$ . Then  $\psi = \phi^{-1} \circ \sigma \circ \phi : \mathbb{R}^n \rightarrow \mathbb{R}^n$  has  $Y$  as its only nondegenerate point-inverse. By the previous proposition,  $Y$  is cellular. Note that since  $\sigma = id$  on a neighborhood of  $\phi(X)$ ,  $\psi = id$  on a neighborhood of  $X$ . ■

DEFINITION 2.19.  $S^{n-1} \subset S^n$  is said to be *bicollared* if it is collared in each of its complementary domains. In view of Theorem 2.2,  $S^{n-1}$  is bicollared if and only if it is locally collared in each of its complementary domains.

THEOREM 2.20 (GENERALIZED SCHOENFLIESS THEOREM [B1], [M]). *If  $S^{n-1} \subset S^n$  is bicollared, then the closed complementary domains of  $S^{n-1}$  in  $S^n$  are topological  $n$ -cells.*

PROOF: Let  $C$  be a bicollar on  $S^{n-1}$  and let  $D_1$  and  $D_2$  be the complementary domains of  $C$ . Consider the map  $\phi : S^n \rightarrow \Sigma(S^{n-1}) = S^n$  which crushes  $D_1$  and  $D_2$  to the north and south poles. By the previous proposition,  $D_1$  and  $D_2$  are cellular. Let  $D$  be the closed complementary domain of  $S^{n-1}$  containing  $D_1$ . Since  $D_1$  is cellular,  $D \rightarrow D/D_1$  is a near-homeomorphism. Since  $D/D_1$  is a cell,  $D$  must also be a cell, proving the theorem. ■

EXERCISE 2.21. Show that if  $S^{n-1} \rightarrow S^n$  is an embedding with a single complementary domain which is a topological manifold, then that complementary domain is a topological ball.

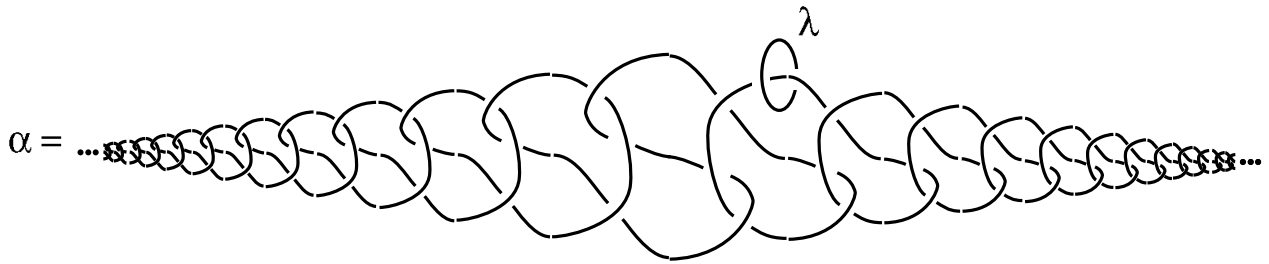

EXAMPLE 2.22 (FOX-ARTIN ARC).

- (i) *The picture above is a “wild arc”  $\alpha \subset \mathbb{R}^3$ . Technically, we have a 1-1 map  $[0, 1] \rightarrow \mathbb{R}^3$  with image  $\alpha$  such that  $\mathbb{R}^3 - \alpha$  is not simply connected. If the loop  $\lambda$  could be contracted to a point in the complement of  $\alpha$ , then it could be contracted*



to a point missing an  $\epsilon$ -neighborhood of the endpoints. Inspection (or, better,  $\pi_1$  calculations) shows that this is impossible. See [AF] for details.

- (ii) Thickening the arc slightly, tapering towards the ends, gives an embedding of  $D^3$  into  $S^3$  whose complement is not simply connected. This shows that some local condition on the embedding is needed to ensure that the complementary domains of an embedded  $S^{n-1}$  in  $S^n$  are balls.

A similar looking, but (apparently) much harder result is the Annulus Theorem. This was a famous open problem for a long time, so it is still often referred to as the Annulus Conjecture.

**THEOREM 2.23** (ANNULUS THEOREM KIRBY [K], QUINN [Q]). *If  $f : B^n \rightarrow \mathring{C}^n$ ,  $n \geq 4$ , is a locally collared embedding of a ball into the interior of a ball, then  $C^n - f(\mathring{B}^n)$  is homeomorphic to  $S^{n-1} \times [0, 1]$ .*

The proof referred to relies on deep results of Hsiang, Shaneson, and Wall classifying PL manifolds homotopy equivalent to tori. There is another proof in the spirit of Quinn's 4-dimensional proof which relies on Quinn's end theorem and Edwards' Disjoint Disk Theorem and there is another high-dimensional proof relying on bounded surgery theory [FP]. We will spend quite a bit of time in these notes discussing the annulus conjecture. The theorem in dimensions  $\leq 3$  follows quickly from the unique triangulability of 3-manifolds. Here is a weaker theorem which follows immediately from the methods used in proving the Schoenflies Theorem.

**THEOREM 2.24.** *If  $f : B^n \rightarrow \mathring{C}^n$ ,  $n \geq 4$ , is a locally collared embedding of a ball into the interior of a ball, then  $C^n - f(B^n)$  is homeomorphic to  $S^{n-1} \times (0, 1]$ .*

**PROOF:** Since  $f(B)$  is cellular in  $\mathring{C}$ ,  $C/f(B) \cong C$ , so

$$C - f(B) \cong C - pt \cong S^{n-1} \times (0, 1]. \blacksquare$$

**REMARK 2.25.**

- (i) The Schoenflies Theorem for  $S^1 \subset S^2$  is a consequence of the Riemann Mapping Theorem and is true without the collaring hypothesis. Of course, purely topological proofs are also known.

- (ii) The hypotheses on the Schoenflies Theorem can be weakened. If  $S^{n-1} \subset S^n$  is an embedded sphere and  $D$  is one of its open complementary domains, then  $\bar{D}$  is a ball if and only if for each  $\epsilon > 0$  there is a  $\delta > 0$  so that if  $\alpha : S^1 \rightarrow D$  is a map with  $\text{diam}(\alpha(S^1)) < \delta$ , then there is a map  $\bar{\alpha} : D^2 \rightarrow D$  extending  $\alpha$  with  $\text{diam}(\bar{\alpha}(D^2)) < \epsilon$ . The list of contributors to this result includes Bing, Cannon, Černavskii, Daverman, Ferry, Price, and Seebeck. For  $n \geq 5$ , the theorem stated appears as Theorem 5 of [F]. See [FQ] and [C] for the 4- and 3-dimensional versions.
- (iii) A related problem is the PL Schoenflies Conjecture. If  $S^{n-1} \subset S^n$  is a bicollared embedding, then the complementary domains are known to be disks for  $n \neq 4$ . If the embedding is not known to be bicollared, the problem is open in dimensions  $n \geq 4$ . An easy induction on links shows that an affirmative answer to the 4-dimensional problem implies the collaring hypothesis and therefore an affirmative answer to the high-dimensional problem.

## REFERENCES

- [AF] Artin, E. and Fox, R. H., *Some wild cells and spheres in three-dimensional space*, Ann. Math. **49** (1948), 979–990.
- [Bi] R. H. Bing, *A homeomorphism between the 3-sphere and the sum of two solid horned spheres*, Ann. of Math. **56** (1952), 554–562.
- [B1] M. Brown, *A proof of the generalized Schoenflies theorem*, Bul. Amer. Math. Soc. **66** (1960), 74 – 76.
- [B2] \_\_\_\_\_, *The monotone union of open  $n$ -cells is an open  $n$ -cell*, Proc. Amer. Math. Soc. (1961).
- [B3] \_\_\_\_\_, *Locally flat embeddings of topological manifolds*, Ann. Math. (1962).
- [Con] R. Connelly, *A new proof of Brown’s collaring theorem*, Proc. Amer. Math. Soc. **27** (1971), 180–182.
- [D] R.J. Daverman, *Decompositions of manifolds*, Academic Press, New York, 1986.
- [F] S. Ferry, *Homotoping  $\epsilon$ -maps to homeomorphisms*, Amer. J. Math. **101** (1979), 567–582.
- [FP] S. Ferry and E. Pedersen, *Epsilon surgery theory*, preprint.
- [FQ] M. H. Freedman and F. S. Quinn, *Topology of 4-manifolds*, Princeton University Press, Princeton, NJ, 1989.

- [K] R. Kirby, *Stable homeomorphisms and the annulus conjecture*, Ann. Math **89** (1969), 575–582.
- [M] B. Mazur, *On embeddings of spheres*, Bul. Amer. Math. Soc. **65** (1959), 59–65.
- [Q] F. Quinn, *Ends of maps IV*, Amer. J. of Math. **108** (1986), 1139–1162.

### Chapter 3. Klee's Trick

In the last section, we saw that there are many different embeddings of  $[0, 1]$  into  $\mathbb{R}^3$ . The purpose of this section is to show that this situation becomes more pleasant if we allow ourselves to stabilize by including  $\mathbb{R}^3$  into  $\mathbb{R}^4$ .

DEFINITION 3.1. We will say that embeddings  $i : A \rightarrow X$  and  $j : A \rightarrow X$  are *equivalent* if there is a homeomorphism  $h : X \rightarrow X$  with  $h \circ i = j$ .

In this section, we will show that topological embeddings become equivalent after stabilization. For example, any embedding  $\alpha : [0, 1] \rightarrow \mathbb{R}^3$  becomes equivalent to the standard embedding after composition with the inclusion  $\mathbb{R}^3 \times \{0\} \rightarrow \mathbb{R}^4$ .

THEOREM 3.2 (KLEE [K]). *If  $A$  is compact and  $i : A \rightarrow \mathbb{R}^m$  and  $j : A \rightarrow \mathbb{R}^n$  are embeddings, then there is a homeomorphism  $h : \mathbb{R}^{m+n} \rightarrow \mathbb{R}^{m+n}$  with  $h \circ (i \times \{0\}) = \{0\} \times j$ .*

PROOF: Consider the function  $j \circ i^{-1} : i(A) \rightarrow j(A)$ . By the Tietze extension theorem, this extends to a function  $\Phi : \mathbb{R}^m \rightarrow \mathbb{R}^n$ . Define a homeomorphism<sup>1</sup>  $v : \mathbb{R}^m \times \mathbb{R}^n \rightarrow \mathbb{R}^m \times \mathbb{R}^n$  by

$$v(x, y) = (x, y + \Phi(x)).$$

Similarly, let  $\Psi$  be an extension of  $i \circ j^{-1}$  and let

$$u(x, y) = (x - \Psi(y), y).$$

Then  $h = u \circ v$  is the desired homeomorphism, since

$$\begin{aligned} u \circ v(i(a), 0) &= u(i(a), \Phi(i(a))) \\ &= u(i(a), j(a)) \\ &= (i(a) - \Psi \circ j(a), j(a)) \\ &= (i(a) - i(a), j(a)) \\ &= (0, j(a)). \end{aligned}$$

In words,  $u$  pushes  $i(A)$  up to the graph of  $j^{-1} \circ i$  and  $v$  pushes the graph of  $i^{-1} \circ j$  over to  $j(A)$ . Since the graphs of  $j^{-1} \circ i$  and  $i^{-1} \circ j$  are the same as subsets of  $\mathbb{R}^m \times \mathbb{R}^m$ , the composition throws one copy of  $A$  onto the other. ■

---

<sup>1</sup> Check that  $v'(x, y) = (x, y - \Phi(x))$  is an inverse.

COROLLARY 3.3. *If  $i_1, i_2 : [0, 1] \rightarrow \mathbb{R}^3$  are embeddings, then there is a homeomorphism  $h : \mathbb{R}^4 \rightarrow \mathbb{R}^4$  with  $h \circ i_1 = i_2$ .*

PROOF: Both embeddings are equivalent to the standard embedding  $[0, 1] \rightarrow \mathbb{R}^1 \subset \mathbb{R}^3 \times \mathbb{R}^1$ . ■

EXERCISE 3.4. Examine the compactness hypothesis in Klee's trick. Prove that embeddings of  $S^1$  into  $\mathbb{R}^3$  become equivalent upon inclusion into  $S^4$ . (Hint: Remove a point from  $S^1$ , apply the noncompact theorem, and 1-point compactify.)

#### REFERENCES

- [K] V. L. Klee, *Some topological properties of convex sets*, Trans. Amer. Math. Soc. **78** (1955), 30–45.

## Chapter 4. Manifold factors

DEFINITION 4.1. A space  $X$  is called a *manifold factor* if there is a space  $Y$  so that  $X \times Y$  is a topological manifold.

THEOREM 4.2. *In the PL category, manifold factors are manifolds.*

We begin the proof by recalling a link formula:

PROPOSITION 4.3. *If  $K$  and  $L$  are polyhedra with  $k \in K$  and  $\ell \in L$ , then*

$$Lk((k, \ell), K \times L) = Lk(k, K) * Lk(\ell, L).$$

Here,  $*$  denotes the polyhedral join operation.

If  $K \times L$  is a manifold, then  $Lk(k, K) * Lk(\ell, L)$  is a sphere for each  $k \in K$  and  $\ell \in L$ , so the result follows from:

LEMMA 4.4. *If  $K * L$  is PL homeomorphic to  $S^n$ , then both  $K$  and  $L$  are PL spheres.*

PROOF: The proof is by induction on  $n$ . If  $n = 1$ , the result is true by inspection. If  $k \in K$ , then  $Lk(k, K * L) = Lk(k, K) * L$ , so if  $K * L$  is an  $n$ -sphere, then  $Lk(k, K) * L$  is an  $n - 1$ -sphere and  $L$  is a PL sphere by induction. By symmetry,  $K$  is a PL sphere, as well. ■

The analogous theorem is false in the topological category. In particular, there exist nonmanifolds  $X$  so that  $X \times \mathbb{R}^1$  is homeomorphic to  $S^3 \times \mathbb{R}^1$ . Here is an example.

DEFINITION 4.5. A *Whitehead continuum*  $W$  is the intersection of solid tori  $T_i$ ,  $i = 0, 1, \dots$  which are geometrically linked but homotopically unlinked as in the picture below.

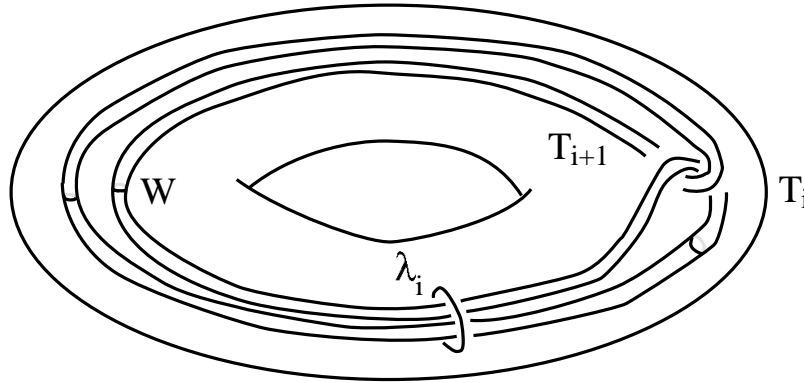

There are choices involved in this construction, but the specific choices will not affect the argument of this section.

The space  $T_0 - W$  is not simply connected, since the curve  $\lambda$  pictured does not bound in  $T_0 - W$ .<sup>2</sup> It follows that the point  $[W] \in S^3/W$  has no neighborhood  $U$  so that  $U - [W]$  is simply connected. We see from this that  $S^3/W$  is not a manifold.

**THEOREM 4.6.**  $S^3/W \times \mathbb{R}^1$  is homeomorphic to  $S^3 \times \mathbb{R}^1$ .

**PROOF:** We give an argument due to Andrews-Rubin [AR]. We wish to apply Bing Shrinking to the map  $p : S^3 \times \mathbb{R}^1 \rightarrow S^3/W \times \mathbb{R}^1$ . The goal, given  $\epsilon > 0$ , is to find a homeomorphism  $h : S^3 \times \mathbb{R}^1 \rightarrow S^3 \times \mathbb{R}^1$  so that  $h(W \times \{t\}) < \epsilon$  for each  $t$  and so that  $d(p \circ h, p) < \epsilon$ . For this, it suffices to find a homeomorphism  $h : S^3 \times \mathbb{R}^1 \rightarrow S^3 \times \mathbb{R}^1$  which shrinks  $T_{i+1} \times \{t\}$  to epsilon size inside of  $T_i \times [t - \epsilon, t + \epsilon]$  for some  $i$  and which does not move points outside of  $T_i \times \mathbb{R}^1$ . If we are successful in finding such homeomorphisms, the Bing Shrinking Theorem shows that  $p$  is a uniform limit of homeomorphisms, so in particular,  $S^3/W \times \mathbb{R}^1 \cong S^3 \times \mathbb{R}^1$ .

We write each  $T_i$  as  $D_i \times S^1$  in such a way that each  $D_i \times \theta$  has diameter  $\epsilon_i$  with  $\epsilon_i \rightarrow 0$ . We will control the sizes of the  $h(T_{i+1} \times t)$ 's by making sure that  $h(T_{i+1} \times t) \subset D_i \times \theta_t \times [t - \epsilon_i, t + \epsilon_i]$ .

Since the composition  $T_{i+1} \rightarrow T_i \rightarrow S^1$  is nullhomotopic, there is a lift to  $\mathbb{R}^1$ . That is, there is a map  $\phi : T_{i+1} \rightarrow \mathbb{R}^1$  such that  $\phi(x)$  is equivalent mod  $(2\pi)$  to the  $S^1$ -coordinate of  $x$  in  $T_i$ . Extend  $\phi$  to a map  $T_i \rightarrow \mathbb{R}^1$  which is zero on  $\partial T_i$ .

Our homeomorphism  $h$  is the composition of two homeomorphisms  $v$  and  $r$ . The homeomorphism  $v$  pushes by an amount  $\phi$  in the  $\mathbb{R}^1$ -direction. Thus,

$$v(x, \theta, t) = (x, \theta, t + \phi(x, \theta)), \quad (x, \theta, t) \in D_i \times S^1 \times \mathbb{R}^1.$$

To see that  $v$  is a homeomorphism, we need only check that  $v'(x, \theta, t) = (x, \theta, t - \phi(x, \theta))$  is its inverse. To define  $r$ , we first choose a function  $\rho : T_i \rightarrow [0, 1]$  with  $\rho(T_{i+1}) = 1$  and  $\rho(\partial T_i) = 0$ . Now define

$$r(x, \theta, t) = (x, \theta - t\rho(x), t) \quad (x, \theta, t) \in D_i \times S^1 \times \mathbb{R}^1.$$

In words, this homeomorphism twists points of  $T_{i+1} \times \mathbb{R}^1$  according to their heights and phases out the twists as we move out to the boundary of  $T_i$ . The inverse of  $r$  is  $r'(x, \theta, t) = (x, \theta + t\rho(x), t)$ .

<sup>2</sup> A diligent student could compute the fundamental group and show that  $\lambda_i$  is nontrivial. See [W] for details.

The composition  $h = r \circ v$  is

$$r \circ v(x, \theta, t) = (x, \theta - (t + \phi(x, \theta))\rho(x), t + \phi(x, \theta)) \quad (x, \theta, t) \in D_i \times S^1 \times \mathbb{R}^1.$$

For  $x \in T_{i+1}$ ,  $\rho(x) = 1$ . Since  $\theta$  is congruent to  $\phi(x, \theta) \pmod{2\pi}$ ,

$$r \circ v(T_{i+1} \times \{t\}) \subset D_i \times \{-t\} \times \mathbb{R}^1 \subset T_i \times \mathbb{R}^1.$$

After rescaling the  $\mathbb{R}^1$ -direction to make the vertical move  $\epsilon_i$ -sized, the desired shrinking has been accomplished. ■

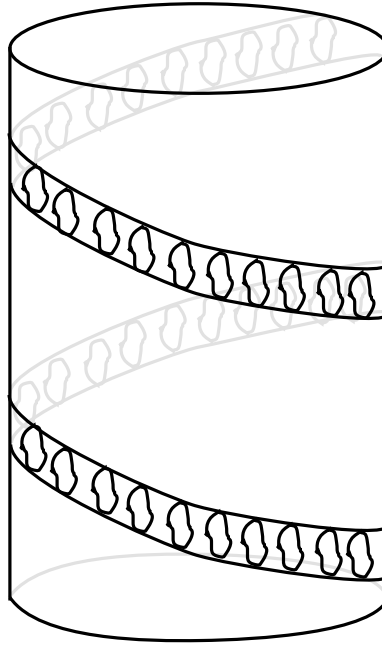

REMARK 4.7. The original example of this sort was Bing's "dogbone space." See [B1]. The observation that  $S^3/W \times \mathbb{R}^1 \cong S^3 \times \mathbb{R}^1$  was made by Arnold Shapiro.

DEFINITION 4.8. A (topological) group  $G$  acts on a space  $X$  if there is a (continuous) map  $\cdot : G \times X \rightarrow X$  so that for all  $x \in X$  and  $g \in G$ :

- (i)  $g_1 \cdot (g_2 \cdot x) = (g_1 g_2) \cdot x$ .
- (ii)  $e \cdot x = x$ .

The action is *free* if  $g \cdot x \neq x$  for all  $x \in X$  and  $g \in G$ ,  $g \neq e$ .



COROLLARY 4.9. *There is a free circle action on  $S^3 \times S^1$  so that one of the orbits is wild. In particular,  $S^3 \times S^1$  contains a circle  $S^1$  which is wild but homogeneous in the sense that given  $x, y \in S^1$ , there is a homeomorphism  $h : (S^3 \times S^1, S^1) \rightarrow (S^3 \times S^1, S^1)$  with  $h(x) = y$ .*

PROOF:  $S^1$  acts on  $S^3/W \times S^1 \cong S^3 \times S^1$  by  $\alpha \cdot (x, \beta) = (x, \alpha + \beta)$ . ■

COROLLARY 4.10. *There is a  $\mathbb{Z}/2\mathbb{Z}$ -action on  $S^4$  with fixed point set a nonmanifold.*

PROOF: There is an involution on  $S^3/W \times \mathbb{R}^1$  which is obtained by flipping the  $\mathbb{R}^1$ -coordinate. Since  $S^3/W \times \mathbb{R}^1 \cong S^3 \times \mathbb{R}^1$ , the two-point compactification of this involution is an involution on  $S^4$ . ■

REMARK 4.11. The first example of this sort is due to Bing, [B2]. The question of which spaces are manifold factors has been studied extensively. A great deal of information concerning this problem can be found in [D]. It is known, for instance, that if  $\beta \subset \mathbb{R}^n$  is a (possibly wild)  $k$ -cell, then  $\mathbb{R}^n/\beta \times \mathbb{R}^1$  is homeomorphic to  $\mathbb{R}^{n+1}$ . See [AnC] for  $k = 1$  and [B] for  $k > 1$ . This construction will be used in constructing noncombinatorial triangulations of  $S^5$ .

#### REFERENCES

- [AnC] J.J. Andrews and M. L. Curtis, *n-space modulo an arc*, Ann. of Math. **75** (1962), 1–7.
- [AR] J. J. Andrews and L. Rubin, *Some spaces whose product with  $E^1$  is  $E^4$* , Bul. Amer. Math. Soc. **71** (1965), 675–677.
- [B1] R. H. Bing, *The cartesian product of a certain nonmanifold and a line is  $E^4$* , Ann. of Math. **70** (1959), 399–412.
- [B2] \_\_\_\_\_, *A homeomorphism between the 3-sphere and the sum of two solid horned spheres*, Ann. of Math. **56** (1952), 354–362.
- [B] J. Bryant, *Euclidean space modulo a cell*, Fund. Math. **63** (1968), 43 – 51.
- [D] R.J Daverman, *Decompositions of manifolds*, Academic Press, New York, 1986.
- [W] J. H. C. Whitehead, *A certain open manifold whose group is unity*, Quart. J. Math. Oxford **6** (1935), 268–279.

## Chapter 5. Stable homeomorphisms and the annulus conjecture

In this section, we will define “stable homeomorphisms” and discuss their relation to the annulus conjecture. We will continue our discussion of the annulus conjecture in section 14. For the most part, the treatment follows [BG] and [K]. This will also be our introduction to bounded topology.

ANNULUS CONJECTURE. *If  $h : B^n \rightarrow \overset{\circ}{C}^n$ ,  $n \geq 4$ , is a locally collared embedding of a ball into the interior of a ball, then  $C^n - h(\overset{\circ}{B}^n)$  is homeomorphic to  $S^{n-1} \times [0, 1]$ .*

Of course, we can assume that  $C^n$  is a standard ball in  $\mathbb{R}^n$  and the Schoenflies Theorem lets us extend  $h$  to all of  $\mathbb{R}^n$  by coning from a point at infinity in  $S^n$ , so we can just as well ask if  $B^n - h(\overset{\circ}{B}^n)$  is an annulus whenever  $h : \mathbb{R}^n \rightarrow \mathbb{R}^n$  is a homeomorphism with  $h(B^n) \subset \overset{\circ}{B}^n$ . Note that it would be equivalent to ask whether  $KB^n - h(\overset{\circ}{B}^n)$  is an annulus for any large  $K$ , since the  $KB^n - \overset{\circ}{B}^n$  is an annulus and adding or subtracting a boundary collar does not change the homeomorphism type of a manifold. If  $KB^n - h(\overset{\circ}{B}^n)$  is an annulus for some (and therefore all) large  $K$ , we will say that the annulus conjecture is *true for  $h$* .

DEFINITION 5.1. A homeomorphism  $h : \mathbb{R}^n \rightarrow \mathbb{R}^n$  is *stable* if it can be written as a composition  $h_k \circ h_{k-1} \circ \cdots \circ h_1$  of homeomorphisms  $h_i : \mathbb{R}^n \rightarrow \mathbb{R}^n$  such that for each  $h_i$  there is a nonempty open subset  $U_i$  such that  $h_i|_{U_i} = id$ .

STABLE HOMEOMORPHISM CONJECTURE (NOW THEOREM). *Every orientation-preserving homeomorphism  $h : \mathbb{R}^n \rightarrow \mathbb{R}^n$  is stable.*

PROPOSITION 5.2. *The stable homeomorphism conjecture implies the annulus conjecture.*

PROOF: We begin with a claim.

CLAIM. If the annulus conjecture is true for  $h$  and  $k$ , then the annulus conjecture is true for  $k \circ h$ .

PROOF OF CLAIM: Choose  $K$  large enough that  $KB^n - k(\overset{\circ}{B}^n)$  is an annulus. Then  $h(KB^n) - h \circ k(\overset{\circ}{B}^n)$  is also an annulus. Choose  $L$  large enough that  $LB^n - h(\overset{\circ}{B}^n)$  is an annulus and so that  $h(KB^n) \subset LB^n$ . Then  $Z = (LB^n - h(K\overset{\circ}{B}^n))$  is an annulus, since  $Z$

is a manifold with boundary and adding the boundary collar  $h(KB^n) - h(\overset{\circ}{B}^n)$  to  $Z$  yields the annulus  $LB^n - h(\overset{\circ}{B}^n)$ . Since  $h(KB^n) - h \circ k(\overset{\circ}{B}^n)$  is an annulus,  $LB^n - h \circ k(\overset{\circ}{B}^n)$  is an annulus, proving the claim.

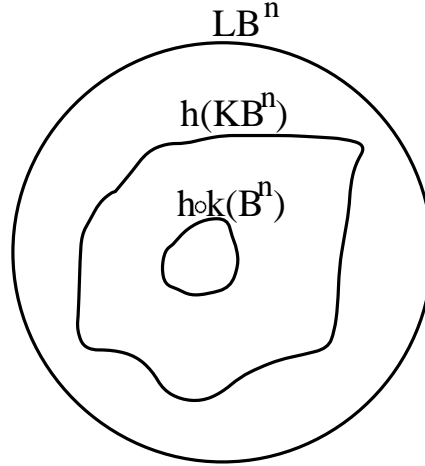

Returning to the proof of the proposition, we need to show that the annulus conjecture is true for  $h$  if there is an open set  $U$  such that  $h|U = id$ . Choose  $L$  large enough that  $LB^n \supset h(B^n)$  and  $LB^n \cap U \neq \emptyset$ . Let  $B'$  be a standard ball in  $LB^n \cap U$ .

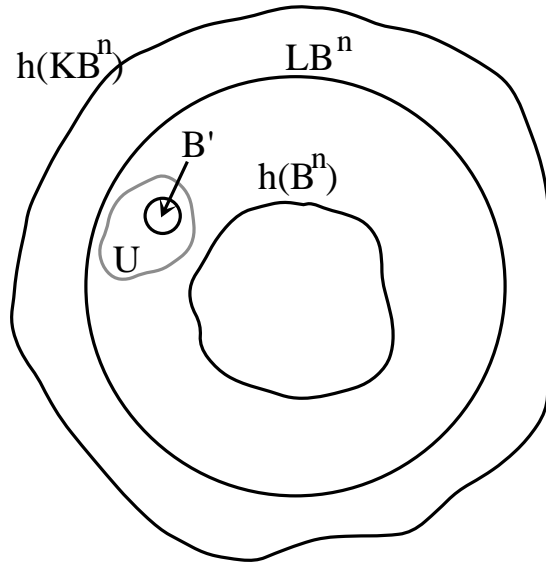

Choose  $K$  large enough that  $h(KB^n) \supset LB^n$ . Then  $h(KB^n - \overset{\circ}{B}') = h(KB^n) - \overset{\circ}{B}'$  is an annulus, so  $h(KB^n) - LB^n$  is an annulus, so  $LB^n - h(\overset{\circ}{B}^n)$  is  $h(KB^n) - h(\overset{\circ}{B}^n)$  minus

a boundary collar and is therefore an annulus. ■

It follows immediately from the definition of stability that if  $h, k : \mathbb{R}^n \rightarrow \mathbb{R}^n$  are homeomorphisms agreeing on some nonempty open set, then  $h$  and  $k$  are either both stable or both unstable. Hint:  $k = h \circ (h^{-1} \circ k)$ .

Using the Schoenflies theorem, if  $U \subset \mathbb{R}^n$  is open,  $x \in U$ , and  $h : U \rightarrow \mathbb{R}^n$  is an embedding, then there is a homeomorphism  $\bar{h} : \mathbb{R}^n \rightarrow \mathbb{R}^n$  with  $\bar{h} = h$  on a neighborhood of  $x$ . Since any two such homeomorphisms agree on a neighborhood of  $x$ , the definition of stability can be extended to germs of embeddings  $h : U \rightarrow \mathbb{R}^n$ . If  $U$  is connected, these definitions agree at all points  $x \in U$ .

DEFINITION 5.3. A homeomorphism  $h : \mathbb{R}^n \rightarrow \mathbb{R}^n$  is *bounded* if there is a  $k$  such that  $|h(x) - x| < k$  for all  $x \in \mathbb{R}^n$ .

THEOREM 5.4 (CONNELL [C]). *Bounded homeomorphisms are stable.*

PROOF: Let  $h : \mathbb{R}^n \rightarrow \mathbb{R}^n$  be a bounded homeomorphism. Since translations  $\vec{x} \rightarrow \vec{x} + \vec{a}$  are clearly stable, we can assume that  $h(\vec{0}) = \vec{0}$  and let  $\rho : [0, \infty) \rightarrow [0, 2)$  be a homeomorphism which is the identity on  $[0, 1]$ . Then

$$\vec{x} \xrightarrow{\gamma} \rho(|\vec{x}|) \frac{\vec{x}}{|\vec{x}|}$$

defines a homeomorphism  $\gamma : \mathbb{R}^n \rightarrow \mathring{2}B^n$  which is the identity on  $B^n$ . The homeomorphism  $\gamma \circ h \circ \gamma^{-1} : \mathring{2}B^n \rightarrow \mathring{2}B^n$  extends continuously by the identity to  $\mathbb{R}^n$ . This shows that  $h$  agrees on a neighborhood of  $\vec{0}$  with a homeomorphism which is the identity on a nonempty open set, so  $h$  is stable. ■

We digress for a moment to state and prove a smooth isotopy extension theorem.

THEOREM 5.5. *Let  $h : U \times [0, 1] \rightarrow \mathbb{R}^n \times [0, 1]$  be a smooth isotopy through open embeddings and let  $x \in U$ . Then there is a smooth isotopy  $H : \mathbb{R}^n \times [0, 1] \rightarrow \mathbb{R}^n \times [0, 1]$  with  $H_0 = id$  such that  $H_t \circ h_0 = h_t$  in a neighborhood of  $\{x\} \times [0, 1]$  and such that  $H$  has compact support.*



PROOF: Let  $\rho : \mathbb{R}^n \times [0, 1] \rightarrow [0, 1]$  be a smooth function which is 1 on a neighborhood of  $h(\{x\} \times [0, 1])$  and 0 outside of a compact subset of  $h(U \times [0, 1])$ . Then

$$\rho h_* \frac{\partial}{\partial t} + (1 - \rho) \frac{\partial}{\partial t}$$

is a vector field on  $\mathbb{R}^n \times [0, 1]$  which can be integrated to give the required  $H$ . ■

COROLLARY 5.6. *Every orientation preserving diffeomorphism of  $\mathbb{R}^n$  is stable. The same is true for PL homeomorphisms.*

PROOF: If  $h : \mathbb{R}^n \rightarrow \mathbb{R}^n$  is a diffeomorphism, composing with a translation gives  $h(0) = 0$ . Setting

$$H_t(x) = \begin{cases} \frac{1}{t}h(tx) & 0 < t \leq 1 \\ dh|_{x=0} & t = 0 \end{cases}$$

gives an isotopy from  $h$  to a linear map. The general linear group has two path components which are detected by the sign of the determinant, so choosing a smooth path from  $dh|_{x=0}$  to  $I$  in  $Gl_n(\mathbb{R})$  ( $Gl_n(\mathbb{R})$  is an open subset of  $\mathbb{R}^{n^2}$ ) gives an isotopy from  $h$  to  $id$ . The isotopy extension theorem then gives us a homeomorphism agreeing with  $h$  near 0 which is the identity outside of a compact set, so the result follows.

In the PL case, we know that every orientation-preserving PL embedding of  $B^n$  in  $\mathbb{R}^n$  is isotopic to the identity. The PL isotopy extension theorem then shows that a germ near 0 can be extended to a homeomorphism which is the identity outside of a compact set. ■

REMARK 5.7. To see that  $Gl_n(\mathbb{R})$  has two path components, note that if  $E$  is an elementary matrix, then  $t \rightarrow t(E - I) + I$  gives a path through elementary matrices from  $E$  to  $I$ . Multiplying such paths gives a path from  $I$  to any product of elementary matrices, so the result follows from the fact that any invertible matrix with positive determinant is a product of elementary matrices.

DEFINITION 5.8. A *coordinate chart* on a manifold  $M^n$  is a pair  $(U, \phi)$  where  $U \subset M$  is open and  $\phi : U \rightarrow \mathbb{R}^n$  is an open embedding. The manifold  $M$  is said to be *smooth* (or *PL*) if there is a covering  $\{U_\alpha\}_{\alpha \in \mathcal{A}}$  of  $M$  by coordinate charts  $\phi_\alpha : U_\alpha \rightarrow \mathbb{R}^n$  so that  $\phi_\beta \circ (\phi_\alpha)^{-1}$  is smooth (or PL) on  $\phi_\alpha(U_\alpha \cap U_\beta)$  for all  $\alpha, \beta \in \mathcal{A}$ .

DEFINITION 5.9. We will say that a homeomorphism  $h : M \rightarrow N$  between connected oriented smooth (or PL) manifolds is *stable* if for smooth coordinate charts  $\phi : U \rightarrow \mathbb{R}^n$ ,  $\psi : V \rightarrow \mathbb{R}^n$ , with  $U \subset M$ ,  $V \subset N$ ,  $h(U) \cap V \neq \emptyset$ , the germ  $\psi \circ h \circ \phi^{-1} : \phi(h^{-1}(V) \cap U) \rightarrow \mathbb{R}^n$  is stable.

That this notion is well-defined follows from the fact that orientation-preserving diffeomorphisms and PL homeomorphisms are stable, together with the following exercise:

EXERCISE 5.10. If  $M$  is a connected (DIFF or PL) topological manifold, and  $x, y \in M$ , then there is a (DIFF or PL) ball in  $M$  containing  $x$  and  $y$ .

The arguments above show that the notion of stability is also well-defined for germs of open embeddings of subsets of  $M$  into  $N$ . It follows immediately that orientation-preserving PL homeomorphisms and diffeomorphisms of PL and smooth manifolds are stable.

PROPOSITION 5.11. *Every orientation-preserving homeomorphism  $h : T^n \rightarrow T^n$  is stable.*<sup>3</sup>

PROOF: We can assume that  $h$  preserves a basepoint, so lifting to the universal cover gives a homeomorphism  $\tilde{h} : \mathbb{R}^n \rightarrow \mathbb{R}^n$  which sends the integral lattice onto itself. This gives an element of  $A \in Gl_n(\mathbb{Z})$ , which induces a diffeomorphism  $h_A : T^n \rightarrow T^n$  by passing to the quotient space. It suffices to show that  $(h_A)^{-1} \circ h$  is stable, so we can assume that  $\tilde{h}$  restricts to the identity on the integral lattice. In that case, one easily checks that  $\tilde{h}$  is bounded, the maximum distortion being achieved somewhere in the unit cube, so  $\tilde{h}$  is stable. Using the restriction of the cover to  $\frac{1}{2}B^n$  as a coordinate chart shows that  $h$  is stable. ■

We've shown that in order to show that  $h$  is stable, it suffices to restrict to a germ and extend to a homeomorphism of  $T^n$  or to a bounded homeomorphism of  $\mathbb{R}^n$ . On the other hand, a little thought shows that extending a germ to a homeomorphism which is the identity outside of a ball requires something very much like the annulus conjecture, (actually, the annulus conjecture in all lower dimensions), so it is not clear that we are making progress.

#### REFERENCES

- [BG] M. Brown and H. Gluck, *Stable structures on manifolds:I-III, Homeomorphisms of  $S^n$* , Ann. of Math. **79** (1964), 1–58.  
 [C] E.H. Connell, *Approximating stable homeomorphisms by piecewise linear ones*, Ann. of Math. **78** (1963), 326–338.

<sup>3</sup>By  $T^n$ , we mean the  $n$ -fold product  $S^1 \times S^1 \times \dots \times S^1$ .

- [K] R. Kirby, *Stable homeomorphisms and the annulus conjecture*, Ann. of Math. **89** (1969), 575–582.

## Chapter 6. Cellular homology

Most geometric topologists think of homology as *cellular homology* or *CW homology* because it is rather concrete and makes certain questions a lot easier.

If  $X$  is a CW complex, then  $X^k/X^{k-1}$  is a bouquet of  $k$ -spheres with one sphere for each  $k$ -cell of  $X$ . Thus,  $H_k(X^k/X^{k-1}) \cong H_k(X^k, X^{k-1})$  for  $k > 0$  can fairly be thought of as a free abelian group generated by the  $k$ -cells of  $X$ . We write

$$C_k(X) \equiv H_k(X^k, X^{k-1}).$$

We define  $\partial : C_k(X) \rightarrow C_{k-1}(X)$  by taking the composition:

$$H_k(X^k, X^{k-1}) \xrightarrow{\partial'} H_{k-1}(X^{k-1}) \xrightarrow{i} H_{k-1}(X^{k-1}, X^{k-2})$$

where  $\partial'$  is the boundary map in the long exact sequence of the pair  $(X^k, X^{k-1})$ .

This boundary map isn't terribly hard to understand. If we write  $X^k = X^{k-1} \cup_\phi (\cup D^k)$ , where  $\phi : (\coprod D^k, \coprod S^{k-1}) \rightarrow (X^k, X^{k-1})$ , then we have a diagram:

$$\begin{array}{ccccc} H_k(X^k, X^{k-1}) & \xrightarrow{\partial'} & H_{k-1}(X^{k-1}) & \xrightarrow{i} & H_{k-1}(X^{k-1}, X^{k-2}) \\ \cong \uparrow \phi_* & & \uparrow \phi|_* & & \\ H_k(\coprod D^k, \coprod S^{k-1}) & \xrightarrow{\cong \partial} & H_{k-1}(\coprod S^{k-1}) & & \end{array}$$

Since  $\phi$  is a relative homeomorphism, the first vertical map is an isomorphism. We know what the boundary map looks like for  $(D^k, S^{k-1})$ . It takes the (relative) top class of  $(D^k, S^{k-1})$  to its boundary, which is the top class of  $S^{k-1}$ . It really is just a *boundary* map. If  $X$  has  $r$   $k$ -cells and  $s$   $(k-1)$ -cells,  $H_k(X^k, X^{k-1})$  is free abelian of rank  $r$  and  $H_{k-1}(X^{k-1}, X^{k-2})$  is free abelian of rank  $s$ , so the boundary map has a matrix with respect to these bases.

By the diagram above, the  $ij^{th}$  entry in the matrix is the degree of the map gotten by mapping the  $i^{th}$   $k$ -cell into  $X^{k-1}$  using  $\phi|$  and composing with the maps  $X^{k-1} \rightarrow X^{k-1}/X^{k-2} \rightarrow D_j^{k-1}/\partial$ . In other words (for decent  $\phi$ ), if you pick a random point in the middle of the  $j^{th}$   $(k-1)$ -cell and count preimages under  $\phi|D_i^k$ , then that number goes in the  $ij^{th}$  slot in the matrix of the boundary operator.

**EXAMPLE 6.1.** Let  $X = \langle a, b, c \rangle$  be a triangle with the CW structure having 0-cells  $\langle a \rangle$ ,  $\langle b \rangle$ , and  $\langle c \rangle$  and 1-cells  $\langle a, b \rangle$ ,  $\langle a, c \rangle$ , and  $\langle b, c \rangle$ . Consider  $\partial : C_1(X) \rightarrow C_0(X)$ .



$H_1(X^1, X^0)$  is free abelian generated by classes corresponding to  $\langle a, b \rangle$ ,  $\langle a, c \rangle$ , and  $\langle b, c \rangle$ , while  $H_0(X^0)$  is free abelian generated by classes corresponding to  $\langle a \rangle$ ,  $\langle b \rangle$ , and  $\langle c \rangle$ . The boundary map is:

$$\begin{aligned}\partial\langle a, b \rangle &= \langle b \rangle - \langle a \rangle \\ \partial\langle a, c \rangle &= \langle c \rangle - \langle a \rangle \\ \partial\langle b, c \rangle &= \langle c \rangle - \langle b \rangle\end{aligned}$$

In other words, we have recovered the simplicial chain complex of  $X$ . This is true in general. If  $X$  is a simplicial complex and we give  $X$  the CW structure given by the simplices, then  $C_*(X)$  is the simplicial chain complex of  $X$ . ■

On the other hand, we could give  $X$  a different CW structure, say one with one 0-cell and one 1-cell. In that case, the cellular chain complex has one generator in each dimension and the boundary map is 0. Note that in both cases the homology of  $C_*(X)$  is the homology of  $S^1$ .

This is generally true. The complex  $C_*(X)$  is a chain complex (i.e.,  $\partial\partial = 0$ ) and the homology of this chain complex is isomorphic to the homology of  $X$ .

PROPOSITION 6.2.  $\partial\partial = 0$ .

PROOF: The composition  $\partial\partial : C_k(X) \rightarrow C_{k-2}(X)$  is given by:

$$H_k(X^k, X^{k-1}) \xrightarrow{\partial'} H_{k-1}(X^{k-1}) \xrightarrow{i} H_{k-1}(X^{k-1}, X^{k-2}) \xrightarrow{\partial'} H_{k-2}(X^{k-2}) \xrightarrow{i} H_{k-2}(X^{k-2}, X^{k-3}).$$

The composition of the middle two maps is zero because they are two consecutive terms in the long exact homology sequence of  $(X^{k-1}, X^{k-2})$ . ■

The proof that the homology of the cellular chain complex is the homology of  $X$  is a little bit harder. We start the proof with an algebraic lemma.

LEMMA 6.3. Suppose we are given a diagram

$$\begin{array}{ccccccc} & & & & E & & \\ & & & & \uparrow & & \\ & & & & \gamma & & \\ & & & & | & & \\ A & \xrightarrow{\alpha} & B & \xrightarrow{\beta} & C & \longrightarrow & 0 \\ & & & & \uparrow & & \\ & & & & D & & \\ & & & & \uparrow & & \\ & & & & 0 & & \end{array}$$

with exact row and column. Then  $D \cong \ker(\gamma) \cong \frac{\ker(\gamma \circ \beta)}{\text{im}(\alpha)}$ .

PROOF: This is a diagram chase. ■

The proof that the homology of the cellular chain complex is isomorphic to the usual homology now follows from the lemma and the diagram below. The row is the long exact sequence of  $(X^{k+1}, X^k, X^{k-1})$  and the column is the long exact sequence of  $(X^{k+1}, X^{k-1}, X^{k-2})$ .

$$\begin{array}{ccccccc}
 & & & & H_{k-1}(X^{k-1}, X^{k-2}) & & \\
 & & & \nearrow \partial & \uparrow & & \\
 H_{k+1}(X^{k+1}, X^k) & \xrightarrow{\partial} & H_k(X^k, X^{k-1}) & \longrightarrow & H_k(X^{k+1}, X^{k-1}) & \longrightarrow & H_k(X^{k+1}, X^k) = 0 \\
 & & & & \uparrow & & \\
 & & & & H_k(X^{k+1}, X^{k-2}) & & \\
 & & & & \uparrow & & \\
 & & & & H_k(X^{k-1}, X^{k-2}) = 0 & & 
 \end{array}$$

and the fact that  $H_k(X^{k+1}, X^{k-2}) \cong H_k(X)$ . This last is true because

- (i)  $H_k(X) \cong H_k(X^{k+1})$  and
- (ii)  $H_k(X^{k+1}) \cong H_k(X^{k+1}, X^{k-2})$ .

For finite CW complexes, (i) and (ii) follow immediately by Mayer-Vietoris and induction on cells. The case of infinite CW complexes follows from the finite case by taking direct limits. ■

The singular complex is a huge object which is great for proving theorems. The cellular complex has the advantage that you can write down matrices and really get your hands on things. To help the beginning student to get his/her feet on the ground, we reprove a few standard theorems from algebraic topology. We should emphasize that the standard proofs of these facts are more functorial and have wider applicability. Nevertheless, we feel that there is some virtue in seeing special cases of the general results done in an extremely concrete fashion.

PROPOSITION 6.4. *If  $X$  and  $Y$  are finite CW complexes, then  $C_*(X \times Y) \cong C_*(X) \otimes C_*(Y)$ .*

PROOF: The cells in the product complex are the products of the cells of the original complexes. Sending the product of cells  $x$  and  $y$  to  $x \otimes y$  is clear enough, so the only thing to check is that the signs are right. The differential in  $C_*(X) \otimes C_*(Y)$  is

$$\partial(x \otimes y) = \partial x \otimes y + (-1)^{\deg x} x \otimes \partial y.$$

The problem reduces to checking the signs for the case of  $I^m \times I^n$  and the reader is left to come to terms with that by him/herself. We could have written  $\dim x$  instead of  $\deg x$  in the display above, but  $\deg$  somehow looks better in the company of tensor products. ■

EXAMPLE 6.5. Give  $S^1$  the CW structure with one 0-cell and one 1-cell. The cellular chain complex is

$$0 \rightarrow Z \xrightarrow{0} Z \rightarrow 0$$

with one generator  $x$  in dimension 1.  $T^2$  then has a CW structure with one 2-cell, two 1-cells, and one 0-cell. The chain complex is:

$$0 \rightarrow Z \rightarrow Z \oplus Z \rightarrow Z \rightarrow 0$$

The generator in dimension 2 is  $x \otimes y$  and  $\partial(x \otimes y) = 0$ . The generators in dimension 1 are  $x \otimes 1$  and  $1 \otimes y$  and their boundaries are also 0, so the homology is easy to calculate. ■

We can calculate the cohomology of a CW complex  $X$  by taking the dual of  $C_*(X)$ , i.e., by taking the transposes of the  $\partial$ 's. This leads to a rather direct understanding of universal coefficient theorem.

PROPOSITION 6.6. *If  $C_*$  is a chain complex of finitely generated abelian groups, then  $C_*$  can be written as the direct sum of a finite number of chain complexes  $K_*^i$  where  $K_*^i$  has the form*

$$0 \rightarrow K_{i+1}^i \rightarrow K_i^i \rightarrow 0.$$

PROOF: Let  $C_*$  be given by:

$$0 \rightarrow C_k \xrightarrow{\partial} C_{k-1} \xrightarrow{\partial} \dots \xrightarrow{\partial} C_1 \xrightarrow{\partial} C_0 \rightarrow 0$$

By standard matrix theory, there are bases for  $C_1$  and  $C_0$  so that  $\partial : C_1 \rightarrow C_0$  has the form:

$$\begin{pmatrix} d_1 & 0 & 0 & \dots & 0 \\ 0 & d_2 & 0 & \dots & 0 \\ \vdots & \vdots & \vdots & \ddots & \vdots \\ 0 & 0 & 0 & \dots & 0 \\ 0 & 0 & 0 & \dots & 0 \end{pmatrix}$$

where the integers  $d_1$  are nonzero. We can therefore decompose  $C_1$  into  $K_1^0 \oplus K_1^1$  so that  $\partial|K_1^0$  is a monomorphism and  $\partial|K_1^1$  is 0. The chain complex  $C_*$  now looks like:

$$\begin{array}{ccccccc} \dots & \rightarrow & C_2 & \xrightarrow{\partial} & K_1^1 & \xrightarrow{0} & 0 \\ & & & & \oplus & & \oplus \\ & & & & K_1^1 & \xrightarrow{\partial} & C_0 = K_0^0 \rightarrow 0. \end{array}$$

An easy induction completes the proof. Note that the boundary map coming from  $C_2$  cannot hit the  $K_0^1$  summand because  $\partial|K_0^1$  is a monomorphism. ■

The argument shows a little more than we said above – it shows that  $C_*$  decomposes as a finite direct sum of complexes of the form  $0 \rightarrow \mathbb{Z} \xrightarrow{d} \mathbb{Z} \rightarrow 0$  and  $0 \rightarrow \mathbb{Z} \rightarrow 0$ . The dual complex  $C^*$  therefore decomposes into corresponding complexes of the form  $0 \leftarrow \mathbb{Z} \xleftarrow{d} \mathbb{Z} \leftarrow 0$  and  $0 \leftarrow \mathbb{Z} \leftarrow 0$ . Computing the homology and cohomology shows that the free parts of the homology and cohomology are isomorphic, while the torsion parts shift by one dimension.

EXAMPLE 6.7. Consider  $RP^3$  with one cell in each dimension 0 – 3. The chain complex is:

$$0 \rightarrow Z \xrightarrow{0} Z \xrightarrow{2} Z \xrightarrow{0} Z \rightarrow 0$$

To check the boundary map from the 3-cell to the 2-cell, for instance, think of  $RP^3$  as being  $S^3$  with antipodal points identified. This identifies the northern hemisphere of  $S^3$  with the 3-cell in the CW decomposition. The boundary of the 3-cell maps to the lower skeleton by mapping to  $S^2$  by the identity and composing with the quotient map to  $RP^2$ . The inverse image of a point in the 2-cell under this attaching map therefore consists of 2 antipodal points on  $S^2$ . Since the antipodal map in dimension 2 is orientation reversing, the signs cancel and the boundary map is trivial.

The dual complex is:

$$0 \leftarrow Z \xleftarrow{0} Z \xleftarrow{2} Z \xleftarrow{0} Z \leftarrow 0$$

from which the cohomology is easily computed. ■

PROPOSITION 6.8. *If  $M$  is a closed PL manifold, then  $H_*(M; \mathbb{Z}_2) \cong H^{n-*}(M; \mathbb{Z}_2)$ .*

PROOF: If  $A$  is a  $k$ -simplex of  $M^n$ , then the dual cell  $A^*$  (see Rourke and Sanderson, p. 27) is an  $(n - k)$ -ball. Moreover,  $A < B$  if and only if  $B^* < A^*$ . This means that the chain complex  $C^*(M; \mathbb{Z}_2)$  is isomorphic to  $C_*(M^*; \mathbb{Z}_2)$  under the isomorphism sending  $A$  to  $A^*$ . ■

REMARK 6.9. The same argument works with  $\mathbb{Z}$ -coefficients modulo signs. When  $M$  is orientable, sending  $A$  to  $A^*$  induces maps  $C^k(M) \rightarrow C_{n-k}(M^*)$  so that the resulting diagram:

$$\begin{array}{ccccccccccc}
 0 & \longrightarrow & C_n(M^*) & \xrightarrow{\partial} & C_{n-1}(M^*) & \xrightarrow{\partial} & \dots & \xrightarrow{\partial} & C_1(M^*) & \xrightarrow{\partial} & C_0(M^*) & \longrightarrow & 0 \\
 & & \cong \uparrow & & \cong \uparrow & & & & \cong \uparrow & & \cong \uparrow & & \\
 0 & \longrightarrow & C^0(M) & \xrightarrow{\delta} & C^1(M) & \xrightarrow{\delta} & \dots & \xrightarrow{\delta} & C^{n-1}(M) & \xrightarrow{\delta} & C^n(M) & \longrightarrow & 0
 \end{array}$$

commutes up to sign. This is enough to show that  $H^*(M) \cong H_{n-*}(M)$ . ■

## Chapter 7. Some elementary homotopy theory

This section contains a short review of some elementary homotopy theory related to the Hurewicz and Whitehead theorems. These theorems give algebraic criteria determining when a map  $f : X \rightarrow Y$  is a homotopy equivalence. The theorems below are all stated for CW complexes, but the results are clearly true for spaces homotopy equivalent to CW complexes. We shall see that locally compact metric ANR's, including topological manifolds, satisfy this last condition.

**THEOREM 7.1.** *If  $X$  and  $Y$  are connected CW complexes and  $f : X \rightarrow Y$  is a map such that  $f_* : \pi_k(X) \rightarrow \pi_k(Y)$  is an isomorphism for all  $k \geq 1$ , then  $f$  is a homotopy equivalence.*

**SKETCH OF PROOF:** Replacing  $Y$  by the mapping cylinder of  $f$ , we can assume that  $f$  is an inclusion. The long exact homotopy sequence of the pair  $(Y, X)$  shows that  $\pi_k(Y, X) = 0$  for all  $k \geq 1$ . An easy induction on skeleta gives a strong deformation retraction from  $Y$  to  $X$ , so  $f$  is a homotopy equivalence. ■

**COROLLARY 7.2.** *If  $X$  is a connected CW complex and  $\pi_k(X) = 0$  for  $k \geq 1$ , then  $X$  is contractible. ■*

The difficulty in applying Theorem 7.1 is that homotopy groups are difficult to compute. A measure of the difficulty is that there is no finite simply connected CW complex for which all of the homotopy groups are known. Homology is far easier to compute, so the following is a more useful theorem for  $X$  and  $Y$  simply connected.

**THEOREM 7.3.** *If  $X$  and  $Y$  are simply connected CW complexes and  $f : X \rightarrow Y$  is a map such that  $f_* : H_k(X) \rightarrow H_k(Y)$  is an isomorphism for all  $k \geq 2$ , then  $f$  is a homotopy equivalence.*

**PROOF:** This one is harder. The idea is to replace  $f$  by an inclusion and note that  $H_*(Y, X) = 0 \Rightarrow \pi_*(Y, X) = 0$  by the relative Hurewicz Theorem. This, in turn, implies that  $f_* : \pi_k(X) \rightarrow \pi_k(Y)$  is an isomorphism for all  $k$ . ■

Of course, we want to be able to deal with all complexes, not just simply connected ones. The solution is to pass to the universal covers.

**THEOREM 7.4.** *If  $X$  and  $Y$  are connected CW complexes and  $f : X \rightarrow Y$  is a map such that  $f_* : \pi_1(X) \rightarrow \pi_1(Y)$  is an isomorphism and such that  $\tilde{f}_* : H_k(\tilde{X}) \rightarrow H_k(\tilde{Y})$  is an*

isomorphism for all  $k \geq 2$ , then  $f$  is a homotopy equivalence. Here,  $\tilde{f} : \tilde{X} \rightarrow \tilde{Y}$  is a lift of  $f$  to the universal covers.

PROOF: This theorem follows from the previous two theorems and the fact that the covering projection  $p : \tilde{X} \rightarrow X$  induces isomorphisms on  $\pi_k$  for  $k \geq 2$ . If  $\tilde{f} : \tilde{X} \rightarrow \tilde{Y}$  induces isomorphisms on homology, then  $\tilde{f}$  is a homotopy equivalence and induces isomorphisms on homotopy. The diagram:

$$\begin{array}{ccc} \tilde{X} & \xrightarrow{\tilde{f}} & \tilde{Y} \\ p_X \downarrow & & \downarrow p_Y \\ X & \xrightarrow{f} & Y \end{array}$$

shows that  $f : X \rightarrow Y$  induces isomorphisms on  $\pi_k$  for all  $k \geq 1$  and Theorem 7.1 shows that  $f$  is a homotopy equivalence. ■

DEFINITION 7.5. There is a homomorphism  $\rho : \pi_k(X) \rightarrow H_k(X)$  called the *Hurewicz homomorphism* defined as follows: If  $\alpha : S^k \rightarrow X$  represents an element of  $\pi_k(X)$ ,  $\alpha_* : H_k(S^k) \rightarrow H_k(X)$ , so we define  $\rho([\alpha])$  to be  $\alpha_*([1])$ , where  $[1] \in H_k(S^k) \cong \mathbb{Z}$  is the generator. The relative Hurewicz homomorphism is defined similarly, starting with  $\alpha : (D^k, S^{k-1}) \rightarrow (Y, X)$ .

THEOREM 7.6 (HUREWICZ THEOREM).

- (i) If  $X$  is a connected CW complex and  $\pi_\ell(X) = H_\ell(X) = 0$  for  $1 \leq \ell \leq k$ , then  $\rho : \pi_{k+1}(X) \xrightarrow{\cong} H_{k+1}(X)$ .
- (ii) If  $(Y, X)$  is a simply connected CW pair and  $\pi_\ell(Y, X) = H_\ell(Y, X) = 0$  for  $1 \leq \ell \leq k$ , then  $\rho : \pi_{k+1}(Y, X) \xrightarrow{\cong} H_{k+1}(Y, X)$ .

REMARK 7.7. We used mapping cylinder constructions several times in the above to turn arbitrary maps into inclusions. The point is that if  $f : X \rightarrow Y$  is a map and  $M(f)$  is the mapping cylinder of  $f$  with  $i : X \rightarrow M(f)$  the inclusion of  $X$  into the top of the cylinder and  $c : M(f) \rightarrow Y$  the mapping cylinder retraction, then the diagram

$$\begin{array}{ccc} X & \xrightarrow{i} & M(f) \\ \downarrow & & \downarrow c \simeq \\ X & \xrightarrow{f} & Y \end{array}$$

commutes and we can substitute into the long exact homology and homotopy sequences of  $(M(f), X)$  to get a commuting diagram

$$\begin{array}{ccccccc} \dots & \longrightarrow & \pi_k(X) & \xrightarrow{f_*} & \pi_k(Y) & \longrightarrow & \pi_k(f) \longrightarrow \dots \\ & & \downarrow \rho & & \downarrow \rho & & \downarrow \rho \\ \dots & \longrightarrow & H_k(X) & \longrightarrow & H_k(Y) & \longrightarrow & H_k(f) \longrightarrow \dots \end{array}$$

where  $H_k(f) \equiv H_k(M(f), X)$ ,  $\pi_k(f) \equiv \pi_k(M(f), X)$ , and the vertical maps are Hurewicz homomorphisms.

The hypotheses in these theorems are all necessary. Here is a key example of a CW pair  $(Y, X)$  with  $\pi_1(X) \xrightarrow{\cong} \pi_1(Y)$  and  $H_k(X) \xrightarrow{\cong} H_k(Y)$  for all  $k$ , where  $X \rightarrow Y$  is *not* a homotopy equivalence.

EXAMPLE 7.8. Let  $X = S^1$ . Let  $Y$  be obtained from  $X \vee S^2$  by attaching a 3-cell using a map  $S^2 \rightarrow X \vee S^2$  which pinches  $S^2$  to a dumbbell and maps the top half to  $S^2$  by a degree +2 map, the middle around the  $S^1$  once in the positive direction, and the bottom to  $S^2$  by a degree -1 map.

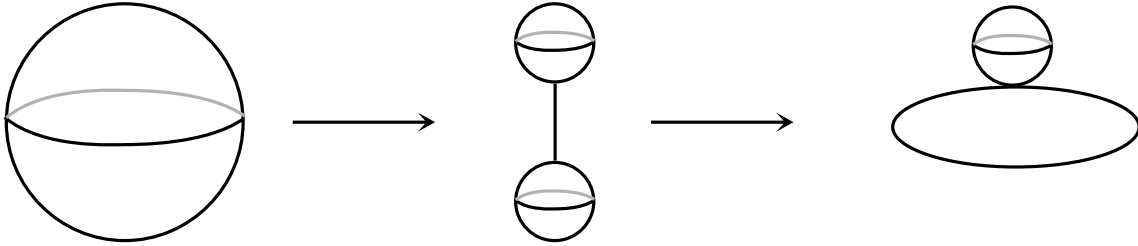

The cellular chain complex of  $Y$  is

$$0 \rightarrow \mathbb{Z} \xrightarrow{\times 1} \mathbb{Z} \xrightarrow{0} \mathbb{Z} \xrightarrow{0} \mathbb{Z} \rightarrow 0$$

so  $S^1 \rightarrow Y$  induces isomorphisms on homology in all dimensions.

The universal cover of  $S^1 \vee S^2$  is a line with an infinite string of  $S^2$ 's. Since there is an action of  $\mathbb{Z}$  by the covering translation, it is usual to think of the universal cover as a complex of free  $\mathbb{Z}\mathbb{Z} = \mathbb{Z}[t, t^{-1}]$ -modules.

$$0 \rightarrow \mathbb{Z}[t, t^{-1}] \xrightarrow{0} \mathbb{Z}[t, t^{-1}] \xrightarrow{t^{-1}} \mathbb{Z}[t, t^{-1}] \rightarrow 0$$



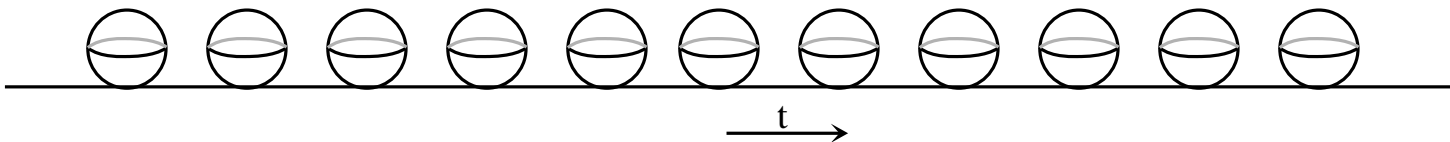

$\tilde{Y}$  is the same with an infinite number of  $D^3$ 's attached. Each  $D^3$  is attached by squeezing to a dumbbell and using a degree 2 map on one sphere and a degree -1 map on the next one to the right. The chain complex of  $\tilde{Y}$  as a complex of free  $\mathbb{Z}[t, t^{-1}]$ -modules is

$$0 \rightarrow \mathbb{Z}[t, t^{-1}] \xrightarrow{2-t} \mathbb{Z}[t, t^{-1}] \xrightarrow{0} \mathbb{Z}[t, t^{-1}] \xrightarrow{t-1} \mathbb{Z}[t, t^{-1}] \rightarrow 0.$$

The second homology of this chain complex is not 0, since any element of the form  $(2-t)a$ ,  $a \in \mathbb{Z}[t, t^{-1}]$ , has its coefficient of lowest degree divisible by 2, so the boundary map  $\mathbb{Z}[t, t^{-1}] \xrightarrow{2-t} \mathbb{Z}[t, t^{-1}]$  is not onto. This means that the inclusion  $X = S^1 \rightarrow Y$  does not induce a homotopy equivalence on universal covers and is therefore not a homotopy equivalence.

We should say a few more words about the  $\mathbb{Z}\mathbb{Z}$ -module structure used in the last example.

DEFINITION 7.9. If  $G$  is a group,  $\mathbb{Z}G$  is the *integral group ring* whose elements are formal sums  $\sum_{g \in G} n_g g$  such that  $n_g = 0$  for all but finitely many  $g$ .  $\mathbb{Z}G$  is a ring with addition given by

$$\sum_{g \in G} n_g g + \sum_{g \in G} m_g g = \sum_{g \in G} (m_g + n_g) g$$

and multiplication given by

$$\left( \sum_{g \in G} n_g g \right) \left( \sum_{g' \in G} m'_g g' \right) = \sum_{g \in G} \sum_{g' \in G} (n_g m'_g) g g'.$$

Let  $A$  be an abelian group and let  $G$  be a group. An *action* of  $G$  on  $A$  is a homomorphism  $\rho : G \rightarrow \text{Aut}(A)$ . An action of  $G$  on  $A$  makes  $A$  into a  $\mathbb{Z}G$ -module by

$$\left( \sum_{g \in G} n_g g \right) a = \left( \sum_{g \in G} n_g \rho(g)(a) \right).$$

Conversely, if  $A$  is a  $\mathbb{Z}G$ -module, then  $a \rightarrow (1g)a$  is an automorphism of  $A$  with inverse  $a \rightarrow (1g^{-1})a$  and we have a homomorphism  $G \rightarrow \text{Aut}(A)$ . Thus, actions of  $G$  on  $A$  are in 1-1 correspondence with  $\mathbb{Z}G$ -module structures on  $A$ .

If  $X$  is a connected CW complex, then  $\pi_1(X)$  acts freely and cellularly on  $\tilde{X}$  by covering transformations, so the cellular chain complex of  $\tilde{X}$  becomes a complex of free  $\mathbb{Z}\pi_1(X)$ -modules with generators obtained by choosing a single lift for each cell of  $X$ . Of course, this also makes  $H_k(\tilde{X})$  into a  $\mathbb{Z}\pi_1(X)$ -module for each  $k$ . The groups  $\pi_k(\tilde{X})$  are also  $\mathbb{Z}\pi_1(X)$ -modules with action given by the covering translations, since the higher homotopy groups of a simply connected space can be defined without reference to a basepoint. Given an arbitrary  $\alpha : S^k \rightarrow \tilde{X}$ , there is a unique way (up to basepoint-preserving homotopy) of homotoping  $\alpha$  to a basepoint-preserving map. The isomorphism  $\pi_k(\tilde{X}) \xrightarrow{p_*} \pi_k(X)$ ,  $k \geq 2$  takes this action to the usual action of  $\pi_1(X)$  on  $\pi_k(X)$ ,  $k \geq 2$ .

EXAMPLE 7.10. It is also important that the isomorphism of homotopy groups in Theorem 7.1 be induced by a map between spaces. The spaces  $\mathbb{R}P^2 \times S^3$  and  $\mathbb{R}P^3 \times S^2$  both have fundamental group  $\mathbb{Z}/2$ . Their universal covers are  $S^2 \times S^3$ , so their higher homotopy groups are also isomorphic, but calculating the homology shows that the spaces are not homotopy equivalent.

REMARK 7.11. A somewhat more detailed treatment of CW complexes, covering spaces, etc, may be found in pp. 4-15 of [Co]. The Hurewicz theorems appear on p. 349 of [HW].

#### REFERENCES

- [Co] M. M. Cohen, *A course in simple-homotopy theory*, Springer-Verlag, Berlin-New York, 1973.
- [HW] P. J. Hilton and S. Wylie, *Homology Theory*, Cambridge University Press, London, 1960.

## Chapter 8. Wall's finiteness obstruction

In this section, we develop Wall's finiteness obstruction [W1], [W2]. An immediate corollary is that every compact simply connected topological manifold has the homotopy type of a finite polyhedron. The finiteness obstruction will play an important role later on in Siebenmann's thesis and in proving various "splitting theorems." The finiteness obstruction also provides our first example where analysis of a geometric problem leads to an algebraic  $K$ -theoretic obstruction involving the group ring of the fundamental group. Our approach is to do a rather geometric development of the basic theory and then use more algebraic techniques to prove extensions and improvements.

**DEFINITION 8.1.** A space  $X$  is said to be *homotopy dominated* by a space  $Y$  if there are maps  $d : Y \rightarrow X$  and  $u : X \rightarrow Y$  such that the composition  $d \circ u$  is homotopic to  $id_X$ . In this case, the map  $d$  is called a *domination*. A domination is *pointed* if  $d, u$ , and the homotopy  $d \circ u \sim id$  preserve basepoints. The space  $X$  is said to be *finitely dominated* if there is a finite CW complex  $K$  which dominates  $X$ .

**REMARK 8.2.**

- (i) If  $X$  is dominated by an  $n$ -dimensional CW complex  $K$ , it follows immediately from the definition that  $H_*(X) = 0$  for  $* > n$ . In fact, the diagram  $H_*(K) \begin{smallmatrix} \xrightarrow{d_*} \\ \xleftarrow{u_*} \end{smallmatrix} H_*(X)$  splits  $H_*(K)$  as  $H_*(X) \oplus H_{*+1}(d)$ .
- (ii) A CW complex  $X$  is homotopy dominated by a finite  $n$ -dimensional CW complex if and only if there is a homotopy  $h_t : X \rightarrow X$  with  $h_0 = id$  and  $h_1(X)$  contained in a compact subset of  $X^{(n)}$  for some  $n$ . If  $d : K^n \rightarrow X$  is a domination with right inverse  $u$ , then cellular approximation lets us assume that  $d(K)$  is a compact subset of  $X^{(n)}$ . The homotopy  $h : d \circ u \sim id$  drags  $X$  into the image of  $K$ , proving one direction. Conversely, if such a homotopy exists, let  $K$  be a compact subset of  $X^{(n)}$  containing  $h_1(X)$ . Then  $i : K \rightarrow X$  is a domination with right inverse  $h_1 : X \rightarrow K$ .

**PROPOSITION 8.3.** *Every compact topological manifold is finitely dominated.*

**PROOF:** Every compact topological manifold  $M^n$  embeds in  $\mathbb{R}^k$  for some  $k$ : Choose a cover by open balls  $B_i$ ,  $i = 1, \dots, s$  and choose maps  $\phi_i : M^n \rightarrow S^n$  which send  $B_i$  homeomorphically to the complement of the north pole and send  $M - B_i$  to the north

pole. The product of these maps embeds  $M$  into  $\prod_{i=1}^s S^n$ , and therefore into  $\mathbb{R}^{(n+1)s}$ . A more careful argument shows that  $M^n$  embeds in  $\mathbb{R}^{2n+1}$ .

If  $M^n \subset \mathbb{R}^k$ , we construct a retraction from a neighborhood  $U$  of  $M$  to  $M$ . Assume inductively that we have constructed a neighborhood  $U_\ell$  of  $M$  and a retraction  $r_\ell : (U_\ell - M)^{(\ell)} \cup M \rightarrow M$ . Here,  $(U_\ell - M)^{(\ell)}$  is an  $\ell$ -skeleton of  $(U_\ell - M)$  which gets finer and finer near  $M$ .

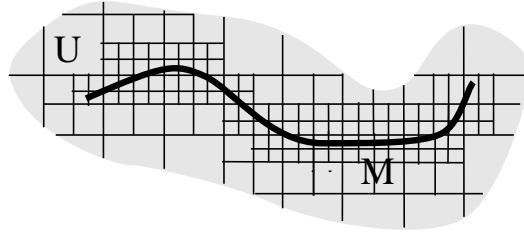

If  $\{\Delta_i\}$  is the collection of  $(\ell + 1)$ -simplexes of  $U_\ell - M$ , the diameters of the  $r_\ell(\partial\Delta_i)$  get smaller and smaller as  $i \rightarrow \infty$ . Since  $M$  is locally euclidean,  $r_\ell|_{\partial\Delta_i}$  extends to a map  $r_{\ell+1} : \Delta_i \rightarrow M$  for  $i$  large with  $\lim_{i \rightarrow \infty} \text{diam}(r_{\ell+1}(\Delta_i)) \rightarrow 0$ . Choosing  $U_{\ell+1}$  small enough that  $r_{\ell+1}$  is defined on  $U_{\ell+1}^{(\ell+1)}$  completes the inductive step.

If  $r : U \rightarrow M$  is a retraction, then choosing a finite polyhedron  $K \subset U$  with  $X \subset K$  gives a domination  $d = r|_K$  with right inverse  $u = i : X \rightarrow K$ . ■

DEFINITION 8.4. A locally compact metric space  $X$  is an ANR if whenever  $A$  is a closed subset of normal space  $Y$ , then any continuous function  $f : A \rightarrow X$  extends to a continuous  $\bar{f} : U \rightarrow X$ , where  $U$  is a neighborhood of  $A$  in  $Y$ . In particular, if  $X$  is a closed subset of  $\mathbb{R}^n$  for some  $n$ , then the identity map  $id : X \rightarrow X$  extends to  $r : U \rightarrow X$ , where  $U$  is a neighborhood of  $X$  in  $\mathbb{R}^n$ , giving a retraction from  $U$  to  $X$ .

REMARK 8.5. Every compact ANR is finitely dominated. This is easily seen in the finite-dimensional case, since we can embed the ANR in  $\mathbb{R}^n$  for some large  $n$  and retract a polyhedral neighborhood to  $X$ . Again, the retraction becomes the  $d$  and the inclusion becomes the  $u$ .

DEFINITION 8.6. We will say that a space  $X$  is *locally contractible* if for each  $x \in X$  and neighborhood  $U$  of  $x$  there is a neighborhood  $V$  of  $x$  contained in  $U$  so that  $V \rightarrow U$  is nullhomotopic. We will say that a space has dimension  $\leq n$  if every open cover  $\mathcal{U}$  has a refinement  $\mathcal{V}$  so that  $V_0 \cap \cdots \cap V_{n+1} = \emptyset$  for all distinct  $V_i$  in  $\mathcal{V}$ .

**THEOREM 8.7.** *Every locally compact finite-dimensional locally contractible space is an ANR.*

**PROOF:** A standard Baire category argument [Mu] shows that  $X$  embeds in  $\mathbb{R}^n$  for some  $n$ . Replacing  $X$  by the graph of a proper function  $X \rightarrow \mathbb{R}$  embeds  $X$  as a closed subset of  $\mathbb{R}^{n+1}$ . An induction on skeleta as above then produces a neighborhood  $U$  of  $X$  in  $\mathbb{R}^{n+1}$  which retracts to  $X$ . ■

A basic question in geometric topology is whether every compact topological manifold is homeomorphic to a finite polyhedron<sup>4</sup>. As a step toward answering this question, it is natural to ask whether every compact topological manifold has the homotopy type of some finite polyhedron.<sup>5</sup> If it could be shown that every finitely dominated CW complex is homotopy equivalent to a finite complex, the finiteness of homotopy types<sup>6</sup> for compact topological manifolds would follow. The next theorem shows that finitely dominated spaces are homotopy equivalent to *finite-dimensional* CW complexes.

**THEOREM 8.8 (MATHER [MA]).** *If  $X$  is homotopy dominated by an  $n$ -dimensional CW complex, then  $X$  is homotopy equivalent to an  $(n + 1)$ -dimensional CW complex.<sup>7</sup>*

**PROOF:** This is easily proven using the following:

**DEFINITION 8.9.** If  $X$  and  $Y$  are CW complexes, we say that  $X \xrightarrow{e} Y$  if  $X = Y \cup_f B^n$ , where  $f : F \rightarrow Y$  is a map and  $F \subset \partial B^n$  is a standard face. We write  $X \searrow Y$  if  $X = X_0 \xrightarrow{e} X_1 \xrightarrow{e} \dots \xrightarrow{e} X_k = Y$ .

**PROPOSITION 8.10 (MAPPING CYLINDER CALCULUS).**

- (i) *If  $f_1 : X \rightarrow Y$  and  $f_2 : X \rightarrow Y$  are homotopic maps, then the mapping cylinder of  $f_1$  is a homotopy equivalent to the mapping cylinder of  $f_2$  rel  $X \cup Y$ .*
- (ii) *If  $f : X \rightarrow Y$  and  $g : Y \rightarrow Z$  are maps, then the mapping cylinder of  $g \circ f$  is homotopy equivalent to  $M(f) \cup_Y M(g)$ .*

<sup>4</sup> Casson has shown this to be false in dimension 4, but the problem is still open in higher dimensions.

<sup>5</sup> By Kirby-Siebenmann, the answer to this question is “yes.” Theorem 18.4 of these notes proves a strong generalization of this.

<sup>6</sup> We say that a CW complex  $X$  has *finite homotopy type* if  $X$  is homotopy equivalent to a finite CW complex. More algebraic topologists use the same term for a CW complex which is homotopy equivalent to one with finitely many cells in each dimension.

<sup>7</sup> This can be improved to dimension  $n$  when  $n \geq 3$ . See Exercise 8.30.

PROOF OF PROPOSITION: For  $X$  and  $Y$  CW complexes, these both follow from the next lemma.

LEMMA 8.11. *If  $f : X \rightarrow Z$  and  $X \searrow Y$ , then  $M(f) \searrow M(f|Y) \cup X$ .*

PROOF: We may as well assume that  $X \xrightarrow{e} Y$ . Then  $B^n \times I$  is a cell in the mapping cylinder and  $(\partial B^n - \overset{\circ}{F}) \times I$  is a free face. Collapsing this cell from this face completes the argument. ■

Let  $F$  be a homotopy from  $f_1$  to  $f_2$ . Then  $M(F) \searrow M(f_1) \cup (X \times I)$  and  $M(F) \searrow M(f_2) \cup (X \times I)$ . Collapsing  $X \times I$  to  $X$  in  $M(F)$  gives a CW complex which collapses to both  $M(f_1)$  and  $M(f_2)$ , proving (i).

If  $f : X \rightarrow Y$  and  $g : Y \rightarrow Z$ , let  $c : M(f) \rightarrow Y$  be the mapping cylinder collapse and consider  $M(g \circ c)$ . Since  $M(f) \searrow Y$ , we have

$$M(g \circ c) \searrow M(g \circ c|Y) \cup M(f) = M(f) \cup_Y M(g)$$

On the other hand, since a mapping cylinder collapses to a subcylinder,

$$M(g \circ c) \searrow M(g \circ c|X) = M(g \circ f).$$

This proves (ii). ■

REMARK 8.12. The result is true for arbitrary compact spaces and the result is more-or-less the same. To show that  $M(g \circ f) \simeq M(f) \cup_Y M(g)$ , for instance, form  $M(g \circ c)$  as above and note that each point  $x \in X$  generates a triangle in  $M(g \circ c)$  with vertices  $x$ ,  $f(x)$ , and  $g \circ f(x)$ . Collapsing these triangles to  $\overline{x \ f(x) \cup f(x) \ g \circ f(x)}$  and to  $\overline{x \ g \circ f(x)}$  gives a homotopy equivalence as above. The other case is similar. See [F] for details.

PROOF OF MATHER'S THEOREM: Let  $d : K \rightarrow X$  be a domination with right inverse  $u$ . Since  $d \circ u \sim id_X$ , we have:

$$X \times \mathbb{R}^1 = \bigcup_{i=-\infty}^{\infty} M(id_X) \simeq \bigcup_{i=-\infty}^{\infty} M(u) \cup_K M(d) = \bigcup_{i=-\infty}^{\infty} M(d) \cup_X M(u) \simeq \bigcup_{i=-\infty}^{\infty} M(u \circ d).$$

In pictures:

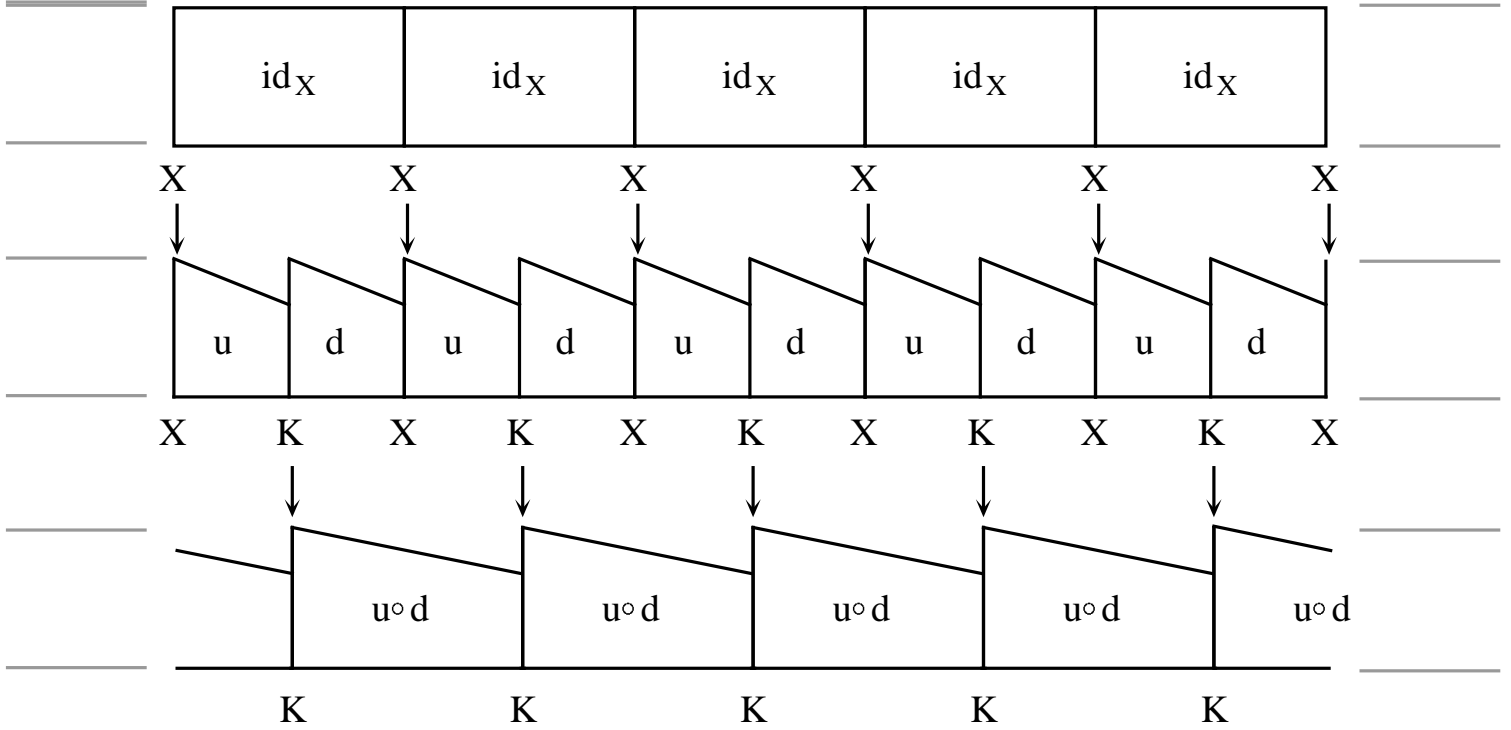

This last space is homotopy equivalent to the CW complex obtained by concatenating mapping cylinders of a CW approximation to  $u \circ d$ . ■

PROPOSITION 8.13. *If  $K$  and  $X$  are connected CW complexes and  $d : K \rightarrow X$  is a domination, then  $d$  is a pointed domination.*

PROOF: Choose basepoints  $k_0 \in K$  and  $x_0 \in X$ , so that  $d(k_0) = x_0$ . Using the homotopy extension theorem, it is easy to find a homotopy from  $u$  to  $u'$  with  $u'(x_0) = k_0$ .

We will be done if we can show that  $d \circ u'$  is a pointed homotopy equivalence, since if  $\phi : X \rightarrow X$  is a pointed homotopy inverse for  $d \circ u'$ ,  $u' \circ \phi$  is a pointed right inverse for  $d$ . Thus, the result follows from applying the next proposition to  $d \circ u' : (X, x_0) \rightarrow (X, x_0)$ .

PROPOSITION 8.14. *If  $f : (A, B) \rightarrow (C, D)$  is a map of CW pairs such that  $f$  and  $f|B : B \rightarrow D$  are homotopy equivalences, then  $f$  is a homotopy equivalence of pairs.*

PROOF: Since the maps are homotopy equivalences, the mapping cylinders  $M(f)$  and  $M(f|B)$  strong deformation retract to their tops. Retracting  $M(f|B)$  to its top, extending by the homotopy extension theorem, and then retracting the mapping cylinder  $M(f)$  to its top gives a strong deformation retraction of pairs from  $(M(f), M(f|B))$  to  $(A, B)$ , showing that  $f$  is a homotopy equivalence of pairs. ■

REMARK 8.15. This simple argument is extremely useful and is a basic geometric construction which the student would do well to learn. We will often use it without explicit mention in what follows.

PROPOSITION 8.16. *If  $d : K \rightarrow X$  is a pointed finite domination, then the kernel of  $d_* : \pi_1(K) \rightarrow \pi_1(X)$  is normally generated by finitely many elements.*

PROOF: We prove that if  $G$  is a finitely generated group and  $s : G \rightarrow H$  and  $t : H \rightarrow G$  are group homomorphisms with  $s \circ t = id$ , then  $ker(s)$  is normally generated by a finite number of elements.

Let  $\{g_i\}$  be a generating set for  $G$ . Let  $t \circ s = \alpha$ . We show that  $P = \{g_i \alpha(g_i^{-1})\}$  normally generates  $ker(s)$ . The normal closure of  $P$  is contained in the kernel of  $s$ , since  $s(g \alpha(g^{-1})) = s(g) s \circ t \circ s(g^{-1}) = s(g) s(g^{-1}) = 1$ . Note that the normal closure of  $P$  contains all elements of  $G$  of the form  $g \alpha(g^{-1})$ ,  $g \in G$ , by the identity

$$uv \alpha((uv)^{-1}) = uv \alpha(v^{-1}) \alpha(u^{-1}) = u[v \alpha(v^{-1})] u^{-1} [u \alpha(u^{-1})]$$

and induction on word length. Since  $u \in ker(s)$  implies  $u = u \alpha(u^{-1})$ , we see that the normal closure of  $P$  contains the kernel of  $s$ . ■

PROPOSITION 8.17. *If  $d : K \rightarrow X$  is a finite domination of CW complexes, we can attach 2-cells to  $K$  to form a complex  $\bar{K}$  and extend  $d$  to a map  $\bar{d} : \bar{K} \rightarrow X$  so that  $\bar{d}$  induces an isomorphism  $\pi_1 \bar{K} \cong \pi_1 X$ .*

PROOF: Choose a finite number of maps  $\alpha_i : S^1 \rightarrow K$  so that the classes  $[\alpha_i]$  normally generate  $ker(d_*)$ . Attach finitely many 2-cells using the maps  $\alpha_i$ . This kills the kernel of  $d_*$ . The map  $d$  extends over the new cells because the boundaries of the cells lie in the kernel of  $d_*$ , providing the nullhomotopy needed for the extension. ■

Since  $\bar{d} \circ u = d \circ u$ ,  $\bar{d}$  is a domination with right inverse  $u$ . We replace  $\bar{K}$  by  $K$  and  $\bar{d}$  by  $d$  to conserve notation. We want to continue attaching higher dimensional cells to make  $d : K \rightarrow X$  more and more highly connected. For this, we need to prove finite generation of higher relative homotopy groups.

Let  $\tilde{K}$  and  $\tilde{X}$  be the universal covers of  $K$  and  $X$  and let  $\tilde{d}$  be a lift of  $d$ . We have an exact sequence in homology:

$$\cdots \longrightarrow H_2(\tilde{K}) \xrightleftharpoons[\tilde{u}_*]{\tilde{d}_*} H_2(\tilde{X}) \longrightarrow H_2(\tilde{X}, \tilde{K}) \longrightarrow 0.$$



Choosing a lift  $\tilde{u}$  of  $u$  so that  $\tilde{d} \circ \tilde{u} \sim id$ , we see that  $\tilde{u}_*$  splits the sequence, so we have  $H_2(\tilde{X}, \tilde{K}) = 0$  and we have split short exact sequences:

$$0 \longrightarrow H_{k+1}(\tilde{X}, \tilde{K}) \longrightarrow H_k(\tilde{K}) \xrightarrow{\tilde{d}_*} H_k(\tilde{X}) \longrightarrow 0$$

for  $k \geq 2$ .

If  $H_k(\tilde{X}, \tilde{K}) = 0$  for  $1 < k \leq n$ , then by the relative Hurewicz Theorem,  $\pi_k(\tilde{X}, \tilde{K}) = \pi_k(X, K) = 0$  in the same range.

DEFINITION 8.18. If  $f : X \rightarrow Y$  is a map, we write  $M(f)$  for the mapping cylinder of  $f$  and  $\pi_n(f)$  for  $\pi_n(M(f), X)$ . This gives a long exact sequence

$$\cdots \rightarrow \pi_k(X) \xrightarrow{f_*} \pi_k(Y) \rightarrow \pi_k(f) \rightarrow \cdots$$

Next, we wish to prove the following proposition:

PROPOSITION 8.19. *If  $d : K \rightarrow X$  is a pointed finite domination between CW complexes and  $\pi_k(d) = 0$  for  $0 \leq k \leq n-1$ ,  $n \geq 2$ , then we can attach finitely many  $n$ -cells to  $K$  to form  $\tilde{K}$  and extend  $d$  to  $\tilde{d}$  so that  $\pi_k(d) = 0$  for  $0 \leq k \leq n$ .*

PROOF: The exact sequence of the pair  $(M(d), K)$  gives us:

$$0 \rightarrow \pi_n(d) \rightarrow \pi_{n-1}(K) \xrightarrow{d_*} \pi_{n-1}(X) \rightarrow 0,$$

which is split by  $u_*$ . We need to show that  $\pi_n(d) = \ker(d_*)$  is finitely generated as a  $\mathbb{Z}\pi_1(K)$ -module so that we can kill it as before by adding finitely many  $n$ -cells to  $K$ . We have  $\pi_n(d) \cong \pi_n(\tilde{d}) \cong H_n(\tilde{X}, \tilde{K})$  by covering space theory and the Hurewicz Theorem. Moreover, these are isomorphisms of  $\mathbb{Z}\pi_1(K)$ -modules, where the action on  $\pi_n(d)$  is the usual action of  $\pi_n(K)$  on the homotopy groups of a pair and the action on  $\pi_n(\tilde{d})$  and  $H_n(\tilde{X}, \tilde{K})$  comes from the action of  $\pi_1(X) \cong \pi_1(K)$  on  $\tilde{X}$  by covering translations. Thus, we need to show that  $H_n(\tilde{X}, \tilde{K})$  is finitely generated as a  $\mathbb{Z}\pi_1(K)$ -module.

There is an obvious problem at this point.  $C_*(\tilde{X})$  is not finitely generated, so it appears that  $H_n(\tilde{X}, \tilde{K})$  might not be finitely generated, either. To get back to finite complexes, consider  $\alpha = u \circ d : K \rightarrow K$ . Since  $d \circ u \sim id$ ,  $\tilde{u}$  induces monomorphisms on homology and  $\ker(\tilde{d}_*) = \ker(\tilde{\alpha}_*)$ . Since  $\tilde{\alpha} \circ \tilde{\alpha} \simeq \tilde{\alpha}$ , the exact sequence

$$0 \rightarrow \ker(\tilde{\alpha}_*) \rightarrow H_*(\tilde{K}) \rightarrow im(\tilde{\alpha}_*) \rightarrow 0$$

is split, so  $H_*(\tilde{K}) \cong \ker(\tilde{d}_*) \oplus \text{im}(\tilde{\alpha}_*)$  and  $\ker(\tilde{\alpha}_*) \cong \text{coker}(\tilde{\alpha}_*)$ .<sup>8</sup> The exact sequence of the pair  $(M(\tilde{\alpha}), \tilde{K})$  yields

$$\cdots \rightarrow H_{n-1}(\tilde{K}) \xrightarrow{\alpha_*} H_{n-1}(\tilde{K}) \rightarrow H_{n-1}(\tilde{\alpha}) \rightarrow 0$$

which shows that  $\text{coker}(\tilde{\alpha}_*) \cong H_{n-1}(\tilde{\alpha})$ . The same sequences in lower degrees show that this is the first nonvanishing homology group of  $C_*(\tilde{\alpha})$ . The finite generation of  $\ker(\tilde{d}_*) \simeq H_{n-1}(\tilde{\alpha})$  now follows from the lemma below.

LEMMA 8.20. *If  $C_*$  is a chain complex of free, finitely generated  $\Lambda$  modules with  $H_k(C_*) = 0$  for  $k < n$ , then  $H_n(C_*)$  is finitely generated.*

PROOF: Let  $\partial_k : C_k \rightarrow C_{k-1}$  be the  $k^{\text{th}}$  boundary map. We will show that  $\ker(\partial_k)$  is a finitely generated projective module for  $0 \leq k \leq n$ . This will prove the lemma, since  $H_n(C_*)$  is a quotient of  $\ker(\partial_n)$ .

The proof is by induction of  $k$ .  $\text{Ker}(\partial_0) = C_0$  is finitely generated and free by hypothesis. Assuming the result for  $k-1, k \leq n$ , the exact sequence

$$0 \rightarrow \ker(\partial_k) \rightarrow C_k \rightarrow \ker(\partial_{k-1}) \rightarrow H_{k-1}(C_*) = 0$$

implies that  $\ker(\partial_k)$  is a direct summand of the finitely generated free module  $C_k$ , proving the lemma. ■

REMARK 8.21.

- (i) The same argument shows that the  $\ker(\partial_k)$ 's are, in fact, stably free for  $k < n$ .
- (ii) (For the student.) To see what all the fuss about finite generation over  $\mathbb{Z}\pi_1(K)$  is about, consider the kernel on  $\pi_2$  of  $d : S^1 \vee S^2 \rightarrow S^1$ .

DEFINITION 8.22. If  $\Lambda$  is a ring, we will say that two finitely generated projective modules  $P$  and  $Q$  over  $\Lambda$  are *stably equivalent* if there are finitely generated free modules  $F_1$  and  $F_2$  over  $\Lambda$  such that  $P \oplus F_1 \cong Q \oplus F_2$ . We will denote the stable equivalence classes of finitely generated projective  $\Lambda$ -modules by  $\tilde{K}_0\Lambda$ .  $\tilde{K}_0\Lambda$  is a group under direct sum.

The propositions established so far enable us to improve a given pointed domination  $d : K \rightarrow X$ ,  $K$   $n$ -dimensional, to get  $\bar{d} : K \rightarrow X$  with  $\pi_k(\bar{d}) = 0$ ,  $0 \leq k \leq n$  and  $\dim(\bar{K}) = n$ . To make  $\bar{d}$  a homotopy equivalence requires that we be able to add

<sup>8</sup> This is standard behavior for projections.

$(n + 1)$ -cells to  $\bar{K}$  to kill  $\ker(\tilde{d}_*) : \pi_n(\bar{K}) \rightarrow \pi_n(X)$ . This is easily accomplished if the kernel is free over  $\mathbb{Z}\pi_1(\bar{K})$ . If the kernel is even stably free, we can finish by adding trivially attached  $n$ -cells to  $K$  to make the kernel free and then adding  $(n + 1)$ -cells as before. In the next proposition, we will show that the kernel is always projective. As before, we note that the kernel we wish to compute is isomorphic as a  $\mathbb{Z}\pi_1(K)$ -module to  $H_{n+1}(M(\tilde{d}), \tilde{K})$ . By Theorem 8.8,  $X$  can be taken to be an  $(n + 1)$ -dimensional complex, so the kernel is the  $(n + 1)^{st}$  homology of an  $(n + 1)$ -dimensional complex which is acyclic in dimensions  $< n + 1$ .

**PROPOSITION 8.23.** *If  $C_*$  is an  $(n + 1)$ -dimensional complex of free  $\Lambda$  modules and  $H_k(C_*) = 0$  for  $0 \leq k < n + 1$ , then  $H_{n+1}(C_*)$  is projective.*

**PROOF:** The proof proceeds as in the proof of Lemma 8.20. The only difference is that the  $C_i$ 's are not finitely generated, so we cannot conclude that the kernel of the boundary map  $\partial_{n+1} : C_{n+1} \rightarrow C_n$  is stably free. Since  $C_{n+2} = 0$ , this kernel is the  $(n + 1)^{st}$  homology group. ■

Thus,  $H_{n+1}(\tilde{d}) \cong \pi_{n+1}(d)$  is a projective  $\mathbb{Z}\pi_1(X)$ -module. Of course, Lemma 8.20 shows that this projective module is finitely generated over  $\mathbb{Z}\pi_1(X)$ . This leads to the following definition:

**DEFINITION 8.24.** If  $K$  is an  $n$ -dimensional finite complex,  $n \geq 2$ , and  $d : K \rightarrow X$  is a domination with  $\pi_k(d) = 0$ ,  $0 \leq k \leq n$ , we define  $\sigma(X)$  to be the element  $(-1)^{n+1}[H_{n+1}(\tilde{d})] \in \tilde{K}_0(\mathbb{Z}\pi_1(X))$ .

**THEOREM 8.25.** *If  $X$  is a finitely dominated space the element  $\sigma(X) \in \tilde{K}_0(\mathbb{Z}\pi_1(X))$  vanishes if and only if  $X$  has the homotopy type of some finite complex.*

**PROOF:** The theorem will follow immediately upon showing that the obstruction is well-defined. For  $i = 1, 2$ , let  $d_i : K_i \rightarrow X$  be finite dominations with right inverses  $u_i$ . We may assume that  $\dim(K_1) = \dim(K_2) = n$  and that  $\pi_k(d_i) = 0$  for  $0 \leq k \leq n$ . Consider the map  $\beta = u_2 \circ d_1 : K_1 \rightarrow K_2$ . Clearly,  $\pi_k(\beta) = 0$  for  $0 \leq k \leq n - 1$  and we have  $\pi_{n+1}(\tilde{d}_2) \cong H_n(\tilde{u}_2) \cong H_n(\tilde{\beta})$  as in the proof of Proposition 8.19.<sup>9</sup> Since  $H_{n+1}(\tilde{\beta}) \cong \ker(\tilde{\beta}_*) \cong H_{n+1}(\tilde{d}_1) \cong \pi_{n+1}(\tilde{d}_1)$ , applying the following lemma to  $C_*(\tilde{\beta})$  completes the proof that  $\sigma(X)$  is well-defined. ■

<sup>9</sup> The point is that  $H_n(\tilde{K}_i) \cong H_n(\tilde{X}) \oplus H_{n+1}(\tilde{d}_i)$ .

LEMMA 8.26. *If  $C_*$  is an  $(n+1)$ -dimensional chain complex of free finitely generated  $\Lambda$ -modules with  $H_k(C_*) = 0$ ,  $0 \leq k \leq n-1$ , and  $H_n(C_*)$  projective over  $\Lambda$ , then  $H_{n+1}(C_*)$  is stably equivalent to  $H_n(C_*)$ .*

PROOF: We have an exact sequence:

$$0 \rightarrow H_{n+1}(C_*) \rightarrow C_{n+1} \xrightarrow{\partial_{n+1}} C_n \rightarrow H_n(C_*) \rightarrow 0.$$

This yields two short exact sequences:

$$0 \rightarrow \text{im}(\partial_{n+1}) \rightarrow C_n \rightarrow H_n(C_*) \rightarrow 0$$

and

$$0 \rightarrow H_{n+1}(C_*) \rightarrow C_{n+1} \rightarrow \text{im}(\partial_{n+1}) \rightarrow 0$$

Since  $H_n(C_*)$  is projective, the top sequence splits,  $\text{im}(\partial_{n+1})$  is projective, and  $H_n(C_*)$  and  $H_{n+1}(C_*)$  are stably equivalent, since each is a stable inverse for  $\text{im}(\partial_{n+1})$ . ■

Let  $X$  be a CW complex which is dominated by a finite  $n$ -dimensional CW complex. If  $\sigma(X) = 0$ , the development above shows that  $X$  has the homotopy type of a finite  $(n+1)$ -dimensional complex. We show that in this case for  $n \geq 3$ ,  $X$  is homotopy equivalent to an  $n$ -dimensional complex.

THEOREM 8.27. *Let  $X$  be homotopy dominated by a finite  $n$ -complex,  $n \geq 3$ , with  $\sigma(X) = 0$ . Then  $X$  is homotopy equivalent to an  $n$ -dimensional complex.*

PROOF: Let  $d : K^n \rightarrow X$  be a finite domination with right inverse  $u : X \rightarrow K$ , and  $h_t : X \rightarrow X$  with  $h_0 = id$ ,  $h_1 = d \circ u$ . By cellular approximation, we may assume that  $d(K) \subset X^{(n)}$ , so taking  $d' : X^{(n)} \rightarrow X$  to be the inclusion and  $u' : X \rightarrow X^{(n)}$  to be  $h_1$  shows that  $X$  is dominated by its  $n$ -skeleton. By cellular approximation and the homotopy extension theorem, we can assume that  $h_1 = id$  on the  $(n-1)$ -skeleton.

We want to show that we can attach finitely many  $n$ -cells to  $X^{(n-1)}$  to get a finite CW complex  $\tilde{X}$  homotopy equivalent to  $X$ . Since  $X$  is dominated by an  $n$ -dimensional complex,

$$H_{n+1}(\tilde{X}, \tilde{X}^{(n-1)}) = H_{n+1}(\tilde{X}) = 0$$

and the exact sequence of the triple  $(\tilde{X}, \tilde{X}^{(n)}, \tilde{X}^{(n-1)})$  gives us:

$$0 \longrightarrow H_{n+1}(\tilde{X}, \tilde{X}^{(n)}) \longrightarrow H_n(\tilde{X}^{(n)}, \tilde{X}^{(n-1)}) \xrightarrow{\tilde{h}_{1*}} H_n(\tilde{X}, \tilde{X}^{(n-1)}) \longrightarrow 0.$$

This shows that  $H_n(\tilde{X}, \tilde{X}^{(n-1)})$  is finitely generated and projective.<sup>10</sup> It follows that

$$(*) \quad [H_n(\tilde{X}, \tilde{X}^{(n-1)})] = -[H_{n+1}(\tilde{X}, \tilde{X}^{(n)})] = (-1)^n \sigma(X)$$

in  $\tilde{K}_0(\mathbb{Z}\pi_1(X))$ . Since  $\sigma(X) = 0$ ,  $H_n(\tilde{X}, \tilde{X}^{(n-1)})$  is stably free. Subdividing  $X$  stabilizes  $H_n(\tilde{X}, \tilde{X}^{(n-1)})$ , so we can assume that  $H_n(\tilde{X}, \tilde{X}^{(n-1)})$  is free.

Since  $H_\ell(\tilde{X}, \tilde{X}^{(n-1)}) = 0$  for  $\ell < n$ , the relative Hurewicz Theorem shows that every element of  $H_n(\tilde{X}, \tilde{X}^{(n-1)})$  is the image in homology of a map  $(D^n, \partial D^n) \rightarrow (\tilde{X}, \tilde{X}^{(n-1)})$ . Projecting back to  $X$  and forming  $\tilde{X}$  by attaching cells to  $X^{(n-1)}$  to kill a basis for  $\pi_n(X, X^{(n-1)}) = H_n(\tilde{X}, \tilde{X}^{(n-1)})$  produces the desired finite  $n$ -dimensional complex homotopy equivalent to  $X$ . ■

REMARK 8.28. At the time of this writing the question of whether this theorem is true for  $n = 2$  is open and interesting.

THEOREM 8.29. *If  $X$  is homotopy dominated by a finite  $n$ -dimensional complex  $L$ ,  $n \geq 3$ , and  $\phi : K^{n-1} \rightarrow X$  is  $(n-1)$ -connected,  $K = K^{n-1}$  a finite complex, then  $\pi_n(\phi)$  is projective and  $\sigma(X) = (-1)^n [\pi_n(\phi)]$ .*

PROOF: Form the mapping cylinder  $M(\phi)$  of  $K^{n-1} \rightarrow X$ . By Whitehead's cell-trading lemma, Proposition 11.9,<sup>11</sup> we can trade cells in  $M(\phi), K$  to obtain a CW complex  $X'$  homotopy equivalent to  $X$  with  $K = X'^{(n-1)}$ . The theorem now follows from equation (\*) above. ■

EXERCISE 8.30. Show that if  $X$  is homotopy dominated by a finite  $n$ -dimensional complex,  $n \geq 3$ , then  $X$  is homotopy equivalent to an  $n$ -dimensional CW complex.

EXERCISE 8.31. Prove the following theorem of J.H.C. Whitehead: If  $X, Y$  are finite  $n$ -dimensional CW complexes and  $f : X \rightarrow Y$  is a map such that  $f_* : \pi_k(X) \rightarrow \pi_k(Y)$  is an isomorphism for  $k \leq n-1$ , then there exist  $r, s$  so that

$$X \vee \bigvee_{i=1}^r S^n \simeq Y \vee \bigvee_{i=1}^s S^n.$$

<sup>10</sup> We've cheated a tiny bit here. We really only know that  $\tilde{h}_{1*} : H_*(\tilde{X}, \tilde{X}^{(n-1)}) \rightarrow H_*(\tilde{X}^{(n)}, \tilde{X}^{(n-1)})$  is an isomorphism, rather than the identity, but composing with an inverse splits the sequence. The maps  $h_{1\downarrow}$  and  $h_{1\uparrow}|X^{(n-1)}$  are homotopic to the identity separately, but possibly not as pairs.

<sup>11</sup> The author apologizes for the forward reference, but it seems the least of several evils.

(Hint: Show that we can assume that  $X^{(n-1)} = Y^{(n-1)}$  and  $f|X^{(n-1)} = id$ . Then consider the space  $X \cup_{X^{(n-1)}} Y$ .) It follows that we can make choices so that  $X \vee \bigvee_{i=1}^r S^n$  and  $Y \vee \bigvee_{i=1}^s S^n$  are simple homotopy equivalent, since the negative of the torsion of an equivalence  $X \vee \bigvee_{i=1}^r S^n \xrightarrow{\simeq} Y \vee \bigvee_{i=1}^s S^n$  can be realized by a self equivalence of  $Y \vee \bigvee_{i=1}^s S^n$  for  $s$  large.

Here is a more algebraic and/or global view of the finiteness obstruction. This is inspired by the algebraic treatment in [W2].

DEFINITION 8.32.

- (i) If  $\Lambda$  is a ring, the (unreduced) projective class group  $K_0(\Lambda)$  of  $\Lambda$  consists of equivalence classes of pairs  $(P, Q)$  where  $P$  and  $Q$  are finitely generated projective left  $\Lambda$ -modules and  $(P, Q) \sim (P', Q')$  if  $P \oplus Q' \cong P' \oplus Q$ . We write  $[P]$  for  $[(P, 0)]$  and  $-[P]$  for  $[(0, P)]$ . There is a short exact sequence  $0 \rightarrow \mathbb{Z} \rightarrow K_0(\mathbb{Z}\pi) \rightarrow \tilde{K}_0(\mathbb{Z}\pi) \rightarrow 0$  where the kernel is generated by the free module on one generator.
- (ii) If  $s : \Lambda \rightarrow \Lambda'$  is a homomorphism, we define  $s_* : K_0(\Lambda) \rightarrow K_0(\Lambda')$  by  $s_*(P) = \Lambda' \otimes_{\Lambda} P$ . This means that  $\lambda' \otimes \lambda p \sim \lambda' s(\lambda) \otimes p$ . The homomorphism  $s_*$  preserves direct sums and  $s_*(\Lambda) = \Lambda'$ , so  $s_*$  takes finitely generated projectives to finitely generated projectives.
- (iii) Let

$$0 \rightarrow P_n \rightarrow \cdots \rightarrow P_1 \rightarrow P_0 \rightarrow 0$$

be a chain complex of finitely generated projective  $\mathbb{Z}\pi$ -modules. Then

$$\bar{\sigma}(P_*) = \sum_{i=0}^n (-1)^i [P_i] \in K_0(\mathbb{Z}\pi).$$

LEMMA 8.33. *If  $P_*$  is a finite chain complex of free finitely generated  $\mathbb{Z}\pi$ -modules and  $H_*(P_*) = 0$ , then  $\bar{\sigma}(P_*) = 0$ .*

PROOF: The result follows immediately upon showing that there is an isomorphism

$$\sum_{\text{even}} P_i \cong \sum_{\text{odd}} P_i.$$

To see this, use the surjectivity of  $P_1 \rightarrow P_0$  to write  $P_1 = P_0 \oplus P'_1$ . We can write  $P_*$  in the form:

$$\begin{array}{ccccccc} \cdots & \rightarrow & P_2 & \xrightarrow{\partial} & P'_1 & \xrightarrow{0} & 0 \\ & & & & \oplus & & \oplus \\ & & & & P_0 & \xrightarrow{id} & P_0 \rightarrow 0. \end{array}$$

The lemma now follows by induction, since

$$0 \rightarrow P_n \rightarrow \cdots \rightarrow P_2 \rightarrow P_1' \rightarrow 0$$

has no homology.■

**THEOREM 8.34.** *If  $P_*$ ,  $Q_*$  are finite chain complexes of free finitely generated  $\mathbb{Z}\pi$ -modules and  $f : P_* \rightarrow Q_*$  induces isomorphisms on homology, then  $\bar{\sigma}(P_*) = \bar{\sigma}(Q_*)$ .*

**PROOF:** The algebraic mapping cone  $C(f)_*$ <sup>12</sup> has no homology. But  $C(f)_k = P_{k-1} \oplus Q_k$ , so  $\bar{\sigma}(C(f)_*) = 0$  implies that  $\bar{\sigma}(P_*) = \bar{\sigma}(Q_*)$ .■

**PROPOSITION 8.35.** *If  $X$  is a finitely dominated CW complex, then  $C_*(\tilde{X})$  is chain homotopy equivalent to a finite chain complex of finitely generated projective  $\mathbb{Z}\pi$ -modules.*

**PROOF:** The argument above produced a finite complex  $K^n$  and a homotopy domination  $d : K \rightarrow X$  such that  $\tilde{d} : \tilde{K} \rightarrow \tilde{X}$  induced isomorphisms on homology through dimension  $n$  and such that  $H_{n+1}(\tilde{d})$  was projective.

Since  $H_\ell(\tilde{X}) = 0$  for  $\ell \geq n+1$ ,  $H_{n+1}(\tilde{d})$  is the kernel of  $H_n(\tilde{K}) \rightarrow H_n(\tilde{X})$ . Consider the diagram:

$$\begin{array}{ccccccccccc} \dots & \rightarrow & 0 & \rightarrow & H_{n+1}(\tilde{d}) & \rightarrow & C_n(\tilde{K}) & \rightarrow & C_{n-1}(\tilde{K}) & \xrightarrow{\partial} & \dots \\ & & \downarrow & & \downarrow & & \downarrow & & \downarrow & & \\ \dots & \rightarrow & C_{n+2}(\tilde{X}) & \rightarrow & C_{n+1}(\tilde{X}) & \rightarrow & C_n(\tilde{X}) & \rightarrow & C_{n-1}(\tilde{X}) & \xrightarrow{\partial} & \dots \end{array}$$

The vertical maps induce isomorphisms on homology, so by the proposition below, we are done.■

**PROPOSITION 8.36.** *If  $A_*$  and  $B_*$  are free chain complexes over  $\Lambda$ , and  $f : A_* \rightarrow B_*$  is a chain homomorphism inducing an isomorphism on homology, then  $f$  is a chain homotopy equivalence.*

**PROOF:** Replacing  $B_*$  by the algebraic mapping cylinder of  $f$ , we can assume that we have a short exact sequence of free chain complexes  $0 \rightarrow A_* \xrightarrow{i} B_* \xrightarrow{j} C_* \rightarrow 0$  with

<sup>12</sup> The algebraic, mapping cone  $C(f)_*$  of  $f : A_* \rightarrow B_*$  is the chain complex with  $C(f)_k = A_{k-1} \oplus B_k$  and  $\partial(a, b) = (-\partial a, \partial b + f(a))$ . The algebraic, mapping cylinder is  $M(f)_k = A_k \oplus A_{k-1} \oplus B_k$  with boundary map  $\partial(a, a', b) = (\partial a - a', -\partial a', \partial b + f(a'))$ . The retraction  $c : M(f)_* \rightarrow B_*$  is given by  $c(a, a', b) = (0, 0, f(a) + b)$  and the chain homotopy  $s(a, a', b) = (0, a, 0)$  gives a chain homotopy from  $c$  to  $id$ . The sequence  $0 \rightarrow A_* \rightarrow M(f)_* \rightarrow C(f)_* \rightarrow 0$  is exact.

$H_*(C_*) = 0$ . Since  $H_*(C_*) = 0$ , there is a chain contraction  $s : C_* \rightarrow C_{*+1}$  with  $\partial s + s\partial = 1$ . Choose  $r : C_* \rightarrow B_{*+1}$  so that  $j \circ r = s$  and consider

$$q = \partial \circ r \circ j + r \circ \partial \circ j - id : B_* \rightarrow B_*.$$

We have

$$\partial \circ q = q \circ \partial = \partial \circ r \circ \partial \circ j - \partial,$$

so  $q$  is a chain map.

$$\begin{aligned} j \circ q &= j \circ \partial \circ r \circ j + j \circ r \circ \partial \circ j - j \\ &= \partial \circ s \circ j + s \circ \partial \circ j - j \\ &= (\partial \circ s + s \circ \partial - id) \circ j \\ &= 0 \end{aligned}$$

This means that  $q : B_* \rightarrow A_*$ . If  $a \in A$ ,  $q(a) = -a$ , so  $-q$  is a retraction from  $B_*$  to  $A_*$ . Since

$$\begin{aligned} q + id &= \partial \circ r \circ j + r \circ \partial \circ j \\ &= \partial \circ r \circ j + r \circ j \circ \partial, \end{aligned}$$

$r \circ j$  is a chain homotopy from  $-q$  to  $id$ . This shows that  $-q$  is a chain-homotopy inverse for  $i : A_* \rightarrow B_*$ . ■

**COROLLARY 8.37.** *If  $C_*(\tilde{X})$  is chain homotopy equivalent to a finite length chain complex of finitely generated projective  $\mathbb{Z}\pi_1(X)$ -modules,  $P_*$ , then  $\bar{\sigma}(P_*)$  is a well-defined invariant of  $X$ .*

**REMARK 8.38.**

- (i) This means that  $\bar{\sigma}(X)$  is a well-defined invariant of  $X$ . This invariant combines the finiteness obstruction of  $X$  with the Euler characteristic, since the isomorphism

$$K_0(\mathbb{Z}\pi_1(X)) \cong \mathbb{Z} \oplus \tilde{K}_0(\mathbb{Z}\pi_1(X))$$

takes  $\bar{\sigma}(X)$  to  $(\chi(X), \sigma(X))$ . The splitting is given by  $[P] \rightarrow (rank(P), [P] - [\mathbb{Z}\pi_1(X)]^{rank(P)})$ .

- (ii) Instead of referring back to the geometry at the beginning of the section, we could have mimicked all of the constructions algebraically. This would have the virtue of developing the finiteness obstruction for chain complexes over rings other than group rings.



## COMPUTATIONS

$\tilde{K}_0(\mathbb{Z}\Pi)$  is trivial for  $\Pi$  free or free abelian, [BHS]. For  $\Pi$  finite,  $\tilde{K}_0(\mathbb{Z}\Pi)$  is finite.  $\tilde{K}_0(\mathbb{Z}\mathbb{Z}_{23})$  has a  $\mathbb{Z}_3$ -summand. In his Whitehead torsion article [Mi], Milnor opines that  $\tilde{K}_0(\mathbb{Z}\mathbb{Z}_p)$  is *surely* nontrivial for all primes  $p \geq 23$ . Information about these groups can be found in [U] and [O].

## REALIZATION

Realization of finiteness obstructions is easy. Let  $K$  be a finite complex and let  $[P] \in \tilde{K}_0(\mathbb{Z}\pi_1(K))$ . Choose  $Q$  so that  $P \oplus Q = \mathbb{Z}\pi_1(K)^\ell$ . Wedge a bouquet of  $\ell$  2-spheres onto  $K$  and attach  $\ell$  3-cells to kill off the  $Q$ -summand. This creates a copy of  $P$  in the 3-dimensional homology of the universal cover. Attach 4-cells to kill this off and continue. The result is an infinite dimensional CW complex with finite skeleta in each dimension realizing the finiteness obstruction  $[P]$ . Alternatively, we could attach infinitely many wedges of  $S^2$ 's and kill off all but a copy of  $[P]$  by attaching infinitely many 3-cells.

REMARK 8.39. This realization is a geometric version of the ‘‘Eilenberg swindle,’’ which shows that for any finitely generated projective  $P$  over a ring  $\Lambda$ ,  $P \oplus \Lambda^\infty$  is free. The point is that if  $Q$  is a stable inverse for  $P$ , we have:

$$\begin{aligned} P \oplus \Lambda^\infty &\cong P \oplus (Q \oplus P \oplus Q \oplus P \oplus Q \oplus \dots) \\ &\cong P \oplus Q \oplus P \oplus Q \oplus P \oplus Q \oplus \dots \\ &\cong \Lambda^\infty. \end{aligned}$$

REMARK 8.40. A little work shows that every finitely dominated complex comes about via a construction similar to the above. If  $X$  is finitely dominated with finiteness obstruction  $\sigma(X)$ , attach  $S^2$ 's and  $D^3$ 's to add a stable inverse to the finiteness obstruction, making the obstruction 0. Adding  $S^2$ 's and  $D^3$ 's to the resulting finite complex  $K$  to kill off the stable inverse shows that every finitely dominated complex is obtained by wedging infinitely many finite bouquets of  $S^2$ 's onto a finite complex  $K$  and then attaching  $D^3$ 's to the result. The first set of  $D^3$ 's kills off a projective in the first wedge of  $S^2$ 's together with a stable complement in  $K$  and the other  $D^3$ 's complete the Eilenberg swindle. Proving that manifolds (and compact ANR's!) have the homotopy types of finite complexes has inspired the development of more refined methods.

With regard to the original finiteness question about homotopy types of closed TOP manifolds, this argument proves that closed TOP manifolds with trivial, free, and free abelian fundamental groups have the homotopy types of finite complexes.

## REFERENCES

- [BHS] H. Bass, A. Heller, and R. Swan, *The Whitehead group of a polynomial extension*, Publ. Inst. Etudes Sci. **22** (1964).
- [F] S.C. Ferry, *Homotopy, simple homotopy, and compacta*, Topology **19** (1980), 101–110.
- [Ma] M. Mather, *Counting homotopy types of topological manifolds*, Topology **4** (1965), 93–94.
- [Mi] J. Milnor, *Whitehead torsion*, Bul. Amer. Math. Soc. **72** (1966), 358–426.
- [O] R. Oliver, *Projective class groups of integral group rings: a survey*, Orders and their applications, SLN 1142, pp. 211–232.
- [U] S. Ullom, *A survey of class groups of integral group rings*, Algebraic number fields, Academic Press, 1977, pp. 497–524.
- [W1] C.T.C. Wall, *Finiteness conditions for CW complexes*, Ann. Math. **8** (1965), 55–69.
- [W2] \_\_\_\_\_, *Finiteness conditions for CW complexes II*, Proc. Royal Soc A **295** (1966), 129–139.

## Chapter 9. A weak Poincaré Conjecture in high dimensions

In this section, we will prove a form of the Poincaré Conjecture in dimensions  $\geq 7$ . The plan of the proof is to show that if  $\Sigma^n$  is a PL manifold homotopy equivalent to  $S^n$ , then  $\Sigma^n$  can be covered by two coordinate charts. That  $\Sigma^n$  is (topologically) homeomorphic to  $S^n$  then follows from Theorem 2.7.

Here is the idea of the proof in the 7-dimensional case. To show that  $\Sigma^7$  is the union of two coordinate patches, we will use Stallings' engulfing technique to prove that every 3-dimensional subcomplex of  $\Sigma^7$  is contained in an open PL ball. We will also exhibit a decomposition  $\Sigma^7 = N(K_1) \cup N(K_2)$ , where  $N(K_1)$  and  $N(K_2)$  are regular neighborhoods of 3-complexes  $K_1$  and  $K_2$ . If  $U$  and  $V$  are open PL balls containing  $K_1$  and  $K_2$ , then  $U$  and  $V$  contain small regular neighborhoods  $N'(K_1)$  and  $N'(K_2)$  of  $K_1$  and  $K_2$ . Uniqueness of regular neighborhoods then provides homeomorphisms  $h, k : \Sigma^7 \rightarrow \Sigma^7$  with  $h(N'(K_1)) = N(K_1)$  and  $k(N'(K_2)) = N(K_2)$ . It follows that  $h(U)$  and  $k(V)$  are open subsets of  $\Sigma^7$  homeomorphic to  $\mathbb{R}^7$  whose union is  $\Sigma^7$ .

We begin the proof that  $\Sigma^7$  has the required decomposition with a quick review of regular neighborhood theory. Detailed proofs may be found in pp 31-43 of [RS].

### A REVIEW OF REGULAR NEIGHBORHOOD THEORY

**DEFINITION 9.1.** Let  $P$  be a triangulated polyhedron and let  $K$  be a subcomplex of  $P$ . The *characteristic function* of  $K$  is the simplicial map  $\lambda_K : P \rightarrow [0, 1]$  which is defined by sending vertices of  $K$  to 0, vertices of  $P - K$  to 1, and extending linearly.  $K$  is said to be *full* in  $P$  if  $\lambda_K^{-1}(0) = K$ . This is equivalent to saying that  $K$  is full in  $P$  if every simplex in  $P$  which has its vertices in  $K$  lies in  $K$ . If  $K$  is full in  $P$ , we write  $C(K) = \lambda_K^{-1}(1)$ . This is the *simplicial complement* of  $K$  in  $P$ . If  $K$  is full in  $P$ , a *regular neighborhood* of  $K$  in  $P$  is a neighborhood  $\lambda_K^{-1}[0, \epsilon]$  for any  $\epsilon \in (0, 1)$ .

Given  $\epsilon_1, \epsilon_2 \in (0, 1)$ , one can construct a PL homeomorphism  $h : P \rightarrow P$  which is fixed on  $K \cup C(K)$  such that  $h(\lambda_K^{-1}[0, \epsilon_1]) = h(\lambda_K^{-1}[0, \epsilon_2])$ . This is a consequence of Theorem 3.8 on p. 33 of [RS]. It is not difficult to show that  $\lambda_K^{-1}(0, 1)$  is PL homeomorphic to the product  $\lambda_K^{-1}(\frac{1}{2}) \times (0, 1)$  by a PL homeomorphism preserving projection onto  $(0, 1)$ . We sketch an argument below in a series of exercises.

EXERCISE 9.2. If  $X$  and  $Y$  are compact metric spaces, the *join* of  $X$  and  $Y$  is the space

$$X * Y = \frac{X \times Y \times [0, 1]}{\sim}$$

where  $(x, y, 0) \sim (x, y', 0)$  and  $(x, y, 1) \sim (x', y, 1)$  for all  $x, y$ . Show that  $S^m * S^n$  is homeomorphic to  $S^{m+n+1}$ ,  $D^m * D^n$  is homeomorphic to  $D^{m+n+1}$ , and  $S^m * D^n$  is homeomorphic to  $D^{m+n+1}$  for all  $m, n$ .

Note that the join contains copies of  $X \times Y \times \{t\}$  for all  $0 < t < 1$ , so the join can be thought of as starting with a copy of  $X \times Y \times \{\frac{1}{2}\}$  and building successive copies of  $X \times Y \times \{t\}$  where  $Y$  shrinks to a point as  $t \rightarrow 0$  and  $X$  shrinks to a point as  $t \rightarrow 1$ .

EXERCISE 9.3. Show that if  $P$  is a triangulated polyhedron and  $K$  is full in  $P$ , then every simplex  $\Delta$  in  $P$  decomposes as  $\Delta_1 * \Delta_2$  where  $\Delta_1$  is a simplex in  $K$  and  $\Delta_2$  is a simplex in  $C(K)$ . Show that  $\lambda_K^{-1}(t)$ ,  $0 < t < 1$ , is a cell complex consisting of cells  $\Delta_1 \times \Delta_2$  such that  $\Delta_1$  is a simplex in  $K$ ,  $\Delta_2$  is a simplex in  $C(K)$ , and  $\Delta_1 * \Delta_2$  is a simplex of  $P$ . Use this to prove that  $\lambda_K^{-1}(0, 1)$  is homeomorphic to the product  $\lambda_K^{-1}(\frac{1}{2}) \times (0, 1)$ .

EXERCISE 9.4. If  $P$  is a triangulated polyhedron and  $x \in P$ ,  $x$  can be represented uniquely as  $x = \sum \lambda_i v_i$  where  $0 < \lambda_i < 1$ , each  $v_i$  is a vertex of  $P$ , and  $\sum \lambda_i = 1$ . The  $\lambda_i$ 's are called *barycentric coordinates* for  $x$ . Write down a formula for a (topological) homeomorphism  $\lambda_K^{-1}(0, 1) \cong \lambda_K^{-1}(\frac{1}{2}) \times (0, 1)$  using barycentric coordinates.

DEFINITION 9.5. If  $K$  is an abstract simplicial complex with simplices  $\{\tau\}$ ,  $K'$  is the abstract simplicial complex whose vertex set is  $\{\hat{\tau} \mid \tau \in K\}$  and whose simplices are  $\{\langle \hat{\tau}_0, \dots, \hat{\tau}_n \rangle \mid \tau_0 < \dots < \tau_n\}$ .  $K'$  is called the *first derived* subdivision of  $K$ . Geometrically, we can think of  $K'$  as being obtained from  $K$  by inserting a new vertex  $\hat{\tau}$  into the interior of each simplex  $\tau$  and then retriangulating by starrng from these new vertices in order of increasing dimension.

DEFINITION 9.6. If  $P$  is a triangulated polyhedron and  $K$  is a full subcomplex, we define  $K^* \subset P'$  to be

$$\{\langle \hat{A}_0 \dots \hat{A}_\ell \rangle \mid A_i \text{ is not a simplex of } K\}.$$

$K^*$  is a full subcomplex of  $P' = \{\langle \hat{A}_0 \dots \hat{A}_\ell \rangle \mid A_0 < A_1 < \dots < A_\ell\}$ .  $P$  is the union of regular neighborhoods  $\lambda_K^{-1}([0, \frac{1}{2}))$  and  $\lambda_K^{-1}([\frac{1}{2}, 1])$  of  $K$  and  $K^*$ .

Of course,  $K^*$  is just an explicit triangulation of the simplicial complement,  $C(K)$ , but we will need the notation later on.

We will also need the following:

DEFINITION 9.7.

- (i) If  $B^n$  is a PL ball, then  $F \subset \partial B$  is a *face* of  $B$  if there is a PL homeomorphism  $(B, F) \cong (I^n, I^{n-1} \times 0)$ .
- (ii) Suppose  $X \supset Y$  are polyhedra and that  $X = Y \cup B^n$  and  $Y \cap B^n$  is a face of  $B^n$ . Then we write  $X \searrow Y$ . If we have a chain  $X = X_0 \searrow X_1 \searrow \cdots \searrow X_k = Y$ , then we write  $X \searrow Y$ .

THEOREM 9.8 ([RS p. 41, THM. 3.26]). *If  $M$  is a closed PL manifold and  $X \subset M$  is a polyhedron. Suppose further that  $X \searrow Y$ . Then there is a PL homeomorphism throwing (any) regular neighborhood of  $X$  onto (any) regular neighborhood of  $Y$ .*

This completes our review of regular neighborhood theory.

We continue with the proof of the Poincaré Conjecture. For definiteness, we stick with the 7-dimensional case.

THEOREM 9.9 (STALLINGS [ST]). *Let  $\Sigma^7$  be a PL manifold homotopy equivalent to  $S^7$ . Then  $\Sigma^7$  is (topologically) homeomorphic to  $S^7$ .*

PROOF OF THEOREM: STEP I. We first show that  $\Sigma - pt$  is contractible for each  $pt \in \Sigma$ . To see that  $H_*(\Sigma - pt) \cong H_*(x)$  for any  $x \in \Sigma^7 - pt$ , note that  $\Sigma - pt \simeq \Sigma - \overset{\circ}{B}$  for  $B$  a PL ball containing  $pt$ , and

$$H_*(\Sigma - \overset{\circ}{B}) \cong H^{7-*}(\Sigma - \overset{\circ}{B}, \partial B) \cong H^{7-*}(\Sigma, B) \cong \begin{cases} \mathbb{Z} & * = 0 \\ 0 & * \neq 0. \end{cases}$$

The fact that  $\pi_1(\Sigma^7 - pt) \cong \pi_1(\Sigma^7) \cong \{e\}$  is an easy argument using either cellular approximation or the Van Kampen theorem – the fundamental group of a CW complex is always isomorphic to the fundamental group of its 2-skeleton. That  $x \rightarrow (\Sigma^7 - pt)$  is a homotopy equivalence for any  $x \in \Sigma^7 - pt$  now follows from the Whitehead theorem, so  $\Sigma^7 - pt$  is contractible.

STEP II. We prove that it suffices to show that every 3-dimensional subpolyhedron of  $\Sigma^7$  is contained in an open subset  $U$  of  $\Sigma^7$  which is homeomorphic to  $\mathbb{R}^7$ .

Given that every 3-dimensional subpolyhedron of  $\Sigma^7$  is contained in such a  $U$ , choose a triangulation of  $\Sigma$  and denote its 3-skeleton by  $\Sigma^{(3)}$ . Let  $\Sigma^{(3)*}$  be defined as in Definition 9.6. Since  $\Sigma^{(3)*}$  consists of simplices  $\langle \hat{\tau}_0, \dots, \hat{\tau}_n \rangle$  where  $\tau_0$  is at least 4-dimensional and  $\tau_0 < \dots < \tau_n$ ,  $\Sigma^{(3)*}$  has dimension 3. Find open sets  $U_1 \supset \Sigma^{(3)}$  and  $U_2 \supset \Sigma^{(3)*}$  with  $U_i \cong \mathbb{R}^7$ .  $U_1$  and  $U_2$  contain small regular neighborhoods of  $\Sigma^{(3)}$  and  $\Sigma^{(3)*}$ , respectively. Choosing homeomorphisms  $h_1, h_2 : \Sigma \rightarrow \Sigma$  throwing these regular neighborhoods onto regular neighborhoods  $\lambda_{\Sigma^{(3)}}^{-1}([0, \frac{1}{2}])$  and  $\lambda_{\Sigma^{(3)*}}^{-1}([\frac{1}{2}, 1])$  as above, we see that  $\Sigma = h_1(U_1) \cup h_2(U_2)$ , whence  $\Sigma$  is a topological sphere by Theorem 2.7.

STEP III. Every 3-dimensional subpolyhedron of  $\Sigma^7$  is contained in an open subset  $U$  of  $\Sigma^7$  which is homeomorphic to  $\mathbb{R}^7$ .

This is the “engulfing” step. We will need to use the following general position theorem.

THEOREM 9.10 (GENERAL POSITION FOR MAPS, [RS, p.61]). *Let  $\epsilon > 0$  be given. If  $P$  is a finite polyhedron and  $f : P \rightarrow M$  is a map from  $P$  to a closed PL manifold  $M^m$ , then  $f$  is  $\epsilon$ -close to a map  $\bar{f} : P \rightarrow M$  such that the singular set  $S(\bar{f})$  of  $\bar{f}$  has dimension  $\leq m - 2p$ . The singular set of  $\bar{f}$  is the closure of the set of points for which  $\bar{f}$  is not one-to-one. In symbols,*

$$S(\bar{f}) = cl\{x \in P \mid \bar{f}^{-1}\bar{f}(x) \neq x\}.$$

We begin with the case of a 2-dimensional polyhedron  $K = K^2$ . Since  $\Sigma - pt$  is contractible, we can remove any point  $*$  of  $\Sigma - K$  and find a homotopy  $H : K \times I \rightarrow \Sigma - * \subset \Sigma$  with  $H(K \times 1) = K$  and  $H(K \times 0) \subset U$  where  $U$  is a coordinate patch PL homeomorphic to  $\mathbb{R}^7$ . By general position, we may assume that the homotopy  $H$  is a PL embedding. Since  $K \times I \searrow K \times 0$  and  $H$  is a PL embedding,  $H(K \times I) \searrow H(K \times 0)$ , so by Theorem 9.8 there is a PL homeomorphism  $h : \Sigma \rightarrow \Sigma$  throwing a small regular neighborhood of  $H(K \times 0)$  onto a regular neighborhood of  $H(K \times I)$ . This homeomorphism consequently throws  $U$  onto an open set  $h(U)$  containing  $H(K \times I)$ . In particular,  $h(U) \supset K$ .  $K$  has been engulfed. Note that if  $P \subset U$  is a 3-dimensional polyhedron, we can choose  $h|P = id$ , since by general position  $H(K \times I)$  need not intersect  $P$ . That is to say, in engulfing a 2-complex into  $U$ , we need not uncover a specified 3-complex which already lies in  $U$ .

To see that 3-dimensional polyhedra can be engulfed by copies of  $\mathbb{R}^7$ , let  $K = K^3$  and let  $H : K \times I \rightarrow \Sigma$  be a homotopy with  $H(K \times 1) = id$  and  $H(K \times 0) \subset U \cong \mathbb{R}^7$ . By

general position, we may assume that the singular set

$$S(H) = cl\{(x, t) \in K \times I \mid H^{-1}H(x, t) \neq (x, t)\}$$

has dimension 1. This means that the set

$$Z = \{(x, t) \mid (x, t') \in S(H) \text{ for some } t' \text{ and } t \in I\} \subset K \times I$$

is 2-dimensional.  $Z$  is called the *shadow* of  $S(H)$ . By engulfing for 2-dimensional polyhedra, we can assume that  $H(Z \cup K \times 0)$  is already contained in  $U$ . Let  $N$  be a regular neighborhood of  $Z \cup K \times 0$  in  $K \times I$  such that  $H(N) \subset U$ . Since  $K \times I \searrow K \times 0 \cup N$  and  $H$  is a PL embedding outside of  $N$ , we have  $H(K \times I) \searrow H(K \times 0 \cup N)$  by the same collapses. Thus, a small regular neighborhood of  $H(K \times 0 \cup N)$  can be thrown onto a regular neighborhood of  $H(K \times I)$  by a PL homeomorphism  $h : \Sigma \rightarrow \Sigma$ . As before, this guarantees that  $h(U) \supset H(K \times I)$  and that, in particular,  $h(U) \supset H(K \times 1) = K$ . ■

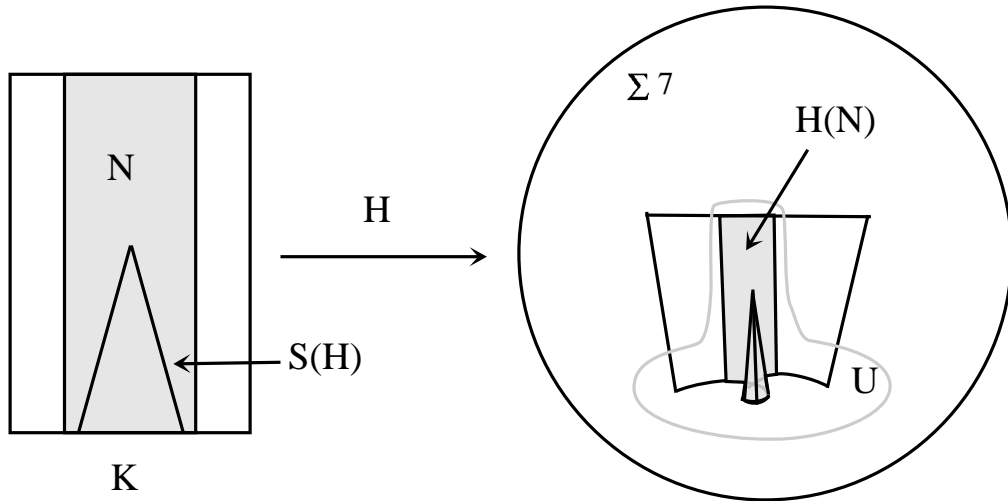

REMARK 9.11. With minor modifications, this argument works in all dimensions  $\geq 7$ . With a little more work, it can be pushed down into dimensions 5 and 6.

REFERENCES

[RS] C. Rourke and B. Sanderson, *Introduction to Piecewise-Linear Topology*, Springer Verlag, New York, Berlin, 1982.  
 [St] J. Stallings, *Polyhedral homotopy spheres*, Bul. Amer. Math. Soc. **66** (1960), 485–488.

## Chapter 10. Stallings' characterization of euclidean space

Except for the important Lemma 10.10 the material in this section is taken from [St], which is beautifully written. The reader is urged to consult the original in addition to our version.

**DEFINITION 10.1.** A space  $X$  is said to be *k-connected at infinity* if for every compact  $C \subset X$  there is a compact  $D \subset X$  with  $C \subset D$  so that  $\pi_\ell(X - D) \xrightarrow{0} \pi_\ell(X - C)$  for all  $\ell \leq k$ . If a manifold or polyhedron  $X$  is 0-connected at infinity, then  $X$  is said to be *1-ended*. A manifold or polyhedron which is 1-connected at infinity is called *simply connected at infinity*. The analogous condition on homology will be called *homologically k-connected at infinity*.

**THEOREM 10.2 (STALLINGS).** *If  $V^n$ ,  $n \geq 5$ , is a contractible PL  $n$ -manifold without boundary, then  $V$  is PL homeomorphic to  $\mathbb{R}^n$  if and only if  $V$  is simply connected at infinity.*

**COROLLARY 10.3.** *If  $V^n$  is a contractible PL manifold without boundary,  $n \geq 4$ , then  $V \times \mathbb{R}$  is PL homeomorphic to  $\mathbb{R}^{n+1}$ .*

**PROOF OF COROLLARY:** We begin by showing that every contractible PL manifold without boundary “has the homology of a sphere at infinity.”

**LEMMA 10.4.** *If  $V^n$  is a contractible PL manifold, then for every compact  $C \subset V$  there is a compact  $D \subset V$  so that  $C \subset D$  and*

$$(*) \quad \text{im}(H_k(V - D) \rightarrow H_k(V - C)) \cong \begin{cases} \mathbb{Z} & k = 0, n - 1 \\ 0 & \text{otherwise.} \end{cases}$$

**PROOF OF LEMMA:** Given  $C$ , choose  $D$  so that  $C$  contracts to a point in  $D$ . By taking regular neighborhoods of polyhedral neighborhoods, we can assume that  $C$  and  $D$  are codimension 0 PL submanifolds. For  $1 < k < n$ , Poincaré duality gives us a sign-



commutative diagram

$$\begin{array}{ccc}
H_{k-1}(V - \overset{\circ}{D}) & \longrightarrow & H_{k-1}(V - \overset{\circ}{C}) \\
\cong \uparrow & & \cong \uparrow \\
H_k(V, V - \overset{\circ}{D}) & \longrightarrow & H_k(V, V - \overset{\circ}{C}) \\
\cong \downarrow & & \cong \downarrow \\
H_k(D, \partial D) & & H_k(C, \partial C) \\
\cong \downarrow & & \cong \downarrow \\
H^{n-k}(D) & \xrightarrow{0} & H^{n-k}(C)
\end{array}$$

which shows that  $H_{k-1}(V - \overset{\circ}{D}) \xrightarrow{0} H_{k-1}(V - \overset{\circ}{C})$ .

We also have diagrams

$$\begin{array}{ccc}
H_1(V, V - \overset{\circ}{D}) & \longrightarrow & H_1(V, V - \overset{\circ}{C}) \\
\cong \downarrow & & \cong \downarrow \\
H_1(D, \partial D) & & H_1(C, \partial C) \\
\cong \downarrow & & \cong \downarrow \\
H^{n-1}(D) & \xrightarrow{0} & H^{n-1}(C)
\end{array}$$

and

$$\begin{array}{ccc}
H_0(V) & \longrightarrow & H_0(V) \\
\uparrow & & \uparrow \\
H_0(V - \overset{\circ}{D}) & \longrightarrow & H_0(V - \overset{\circ}{C}) \\
\uparrow & & \uparrow \\
H_1(V, V - \overset{\circ}{D}) & \longrightarrow & H_1(V, V - \overset{\circ}{C})
\end{array}$$

in which an easy diagram chase shows that if  $\alpha, \alpha'$  are generators of  $H_0(V - \overset{\circ}{D})$  which map to the same generator of  $H_0(V)$ , then the image of  $\alpha - \alpha'$  in  $H_0(V - \overset{\circ}{C})$  is 0. It also follows from the bottom diagram that  $H_0(V - \overset{\circ}{D})$  is finitely generated.

Finally, we have

$$\begin{array}{ccc}
H_{n-1}(V - \overset{\circ}{D}) & \longrightarrow & H_{n-1}(V - \overset{\circ}{C}) \\
\cong \uparrow & & \cong \uparrow \\
H_n(V, V - \overset{\circ}{D}) & \longrightarrow & H_n(V, V - \overset{\circ}{C}) \\
\cong \downarrow & & \cong \downarrow \\
H_n(D, \partial D) & & H_n(C, \partial C) \\
\cong \downarrow & & \cong \downarrow \\
H^0(D) & \longrightarrow & H^0(C).
\end{array}$$

The image of the map at the bottom is clearly  $\mathbb{Z}$ , since it is  $\text{Hom}$  of  $H_0(C) \rightarrow H_0(D)$ . This completes the proof of (\*). ■

Continuing with the proof of the corollary, since  $H_0(V - \overset{\circ}{D})$  is finitely generated and  $H_0(V - \overset{\circ}{D}) \rightarrow H_0(V - \overset{\circ}{C})$  has image  $\mathbb{Z}$ , we can use regular neighborhoods of finitely many arcs to connect up the components of  $V - \overset{\circ}{D}$  in the complement of  $C$ . This shows that for every compact  $C \subset V$  there is a compact codimension 0 submanifold  $D'$  of  $V$  so that  $D' \supset C$  and  $V - \overset{\circ}{D}'$  is connected.

It follows that  $V \times \mathbb{R}$  is simply connected at infinity. If  $C \subset V \times \mathbb{R}$  is compact, we can assume that  $C$  has the form  $C' \times I$  where  $I \subset \mathbb{R}$  is an interval. Choose  $D \supset C'$  so that  $V - \overset{\circ}{D}$  is connected and choose  $J$  to be an interval containing  $I$ . Then the Van Kampen Theorem shows that  $V \times \mathbb{R} - D \times J$  is simply connected. If  $x \in J$ , then  $V_1 = (V \times \mathbb{R} - D \times J) \cap [x, \infty)$  and  $V_2 = (V \times \mathbb{R} - D \times J) \cap (-\infty, x]$  are contractible sets meeting in a connected set  $(V - \overset{\circ}{D}) \times \{x\}$  with  $V \times \mathbb{R} - D \times J = V_1 \cup V_2$ . ■

Before proving Stallings' theorem, we digress to give some examples of contractible open manifolds which are not homeomorphic to euclidean space. The construction begins with an algebraic lemma.

**PROPOSITION 10.5.** *Let  $P \neq 1$  be a finitely generated perfect group. Then there is a two-dimensional complex  $K$  with  $H_*(K) \cong H_*(pt)$  and  $\pi_1(K) \xrightarrow{\text{onto}} P$ .*

**PROOF:** Let  $x_1, \dots, x_n$  be generators of  $P$ . For each  $i$ , let  $x_i = r_i$  be a relation which writes  $x_i$  as a product of conjugates of commutators, written as words in the  $x_i$ . Let  $Q$  be the group

$$Q = \{x_1, \dots, x_n \mid x_1 = r_1, \dots, x_n = r_n\}.$$

The group  $Q$  is perfect and there is a homomorphism  $Q \xrightarrow{\text{onto}} P$ .

Let  $K$  be a complex with a single 0-cell,  $n$  1-cells corresponding to the  $x_i$ , and  $n$  2-cells attached according to the words  $x_i(r_i)^{-1}$ . The cellular chain complex of  $K$  is:

$$0 \rightarrow \mathbb{Z}^n \xrightarrow{id} \mathbb{Z}^n \xrightarrow{0} \mathbb{Z} \rightarrow 0$$

so  $H_*(K) \cong H_*(pt)$ . ■

EXERCISE 10.6. Show that the  $K$  produced in Proposition 10.5 has the homotopy type of a 2-dimensional polyhedron.

EXAMPLE 10.7. Embed  $K^2$  in  $S^5$ , where  $K$  is a 2-dimensional polyhedron with  $\pi_1(K) = Q \neq 1$  and  $H_*(K) = H_*(pt)$ . Then  $S^5 - K$  is an open contractible manifold which is not simply connected at infinity.

PROOF: Let  $N$  be a regular neighborhood of  $K$  in  $S^5$ . Then

$$H_\ell(S^5 - K) \cong H_\ell(S^5 - \overset{\circ}{N}) \cong H^{5-\ell}(S^5 - \overset{\circ}{N}, \partial N) \cong H^{5-\ell}(S^5, N) \cong H^{5-\ell}(S^5, K) = \begin{cases} \mathbb{Z} & \ell = 0 \\ 0 & \text{otherwise.} \end{cases}$$

$\pi_1(S^5 - K) = 1$  because each loop in  $S^5 - K$  bounds a disk in  $S^5$  which can be pushed off of  $K$  by general position.

The Whitehead Theorem shows that,  $x \rightarrow S^5 - K$  is a homotopy equivalence for any  $x \in S^5 - K$  and that  $S^5 - K$  is contractible. ■

EXERCISE 10.8. In Example 10.7 show that  $H_*(\partial N) \cong H_*(S^4)$  but  $\pi_1(\partial N) \cong Q$ .

EXERCISE 10.9 (THE WHITEHEAD CONTINUUM). Let  $X$  be an infinite intersection of solid tori in  $S^3$  as pictured below.

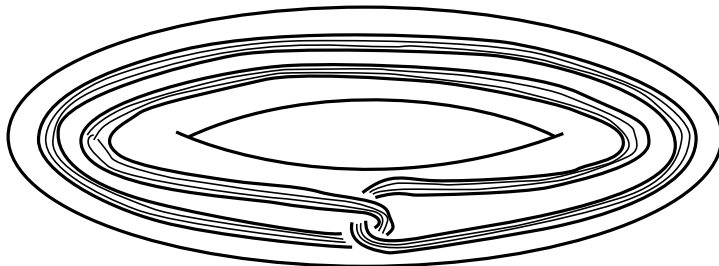

Note that each solid torus is nullhomotopic in the preceding one. Show that  $S^3 - X$  is a contractible open subset of  $S^3$  which is not simply connected at infinity. (Hint: All of the solid tori are unknotted in  $S^3$ .)

We will now get on with the proof of Stallings' characterization. The theorem is another application of Stallings' engulfing. We begin by noting that our definition of "simply connected at infinity" implies that there are arbitrarily small simply connected manifold neighborhoods of infinity. This is given as the definition of "simply connected at infinity," in [St], but has the disadvantage of not being a proper homotopy invariant.

**PROPOSITION 10.10.** *Let  $V^n$  be a noncompact connected PL manifold without boundary,  $n \geq 5$ . If  $V$  is simply connected at infinity, then for each compact  $C \subset V$  there is a compact codimension-0 PL submanifold  $D \subset V$  so that  $D \supset C$  and  $V - \overset{\circ}{D}$  is simply connected with simply connected boundary  $\partial D$ .*

We defer the proof until the end of the section and proceed with the proof of Stallings' theorem. Here is the statement of engulfing we will use.

**THEOREM 10.11 (STALLINGS' ENGULFING LEMMA).** *Let  $M^n$  be a PL  $n$ -manifold without boundary,  $U$  an open set in  $M^n$ ,  $K$  a (possibly infinite) complex in  $M^n$  of dimension at most  $n - 3$  such that  $|K|$  is closed in  $M^n$ , and  $L$  a (possibly infinite) subcomplex of  $K$  in  $U$  such that  $Cl(|K| - |L|)$  is the polyhedron of a finite  $r$ -subcomplex  $R$  of  $K$ . Suppose that  $(M^n, U)$  is  $r$ -connected. Then there is a compact set  $E \subset M^n$  and an ambient isotopy  $e_t$  of  $M^n$  such that  $|K| \subset e_1(U)$  and  $e_t|(M^n - E) \cup |L| = id$ .*

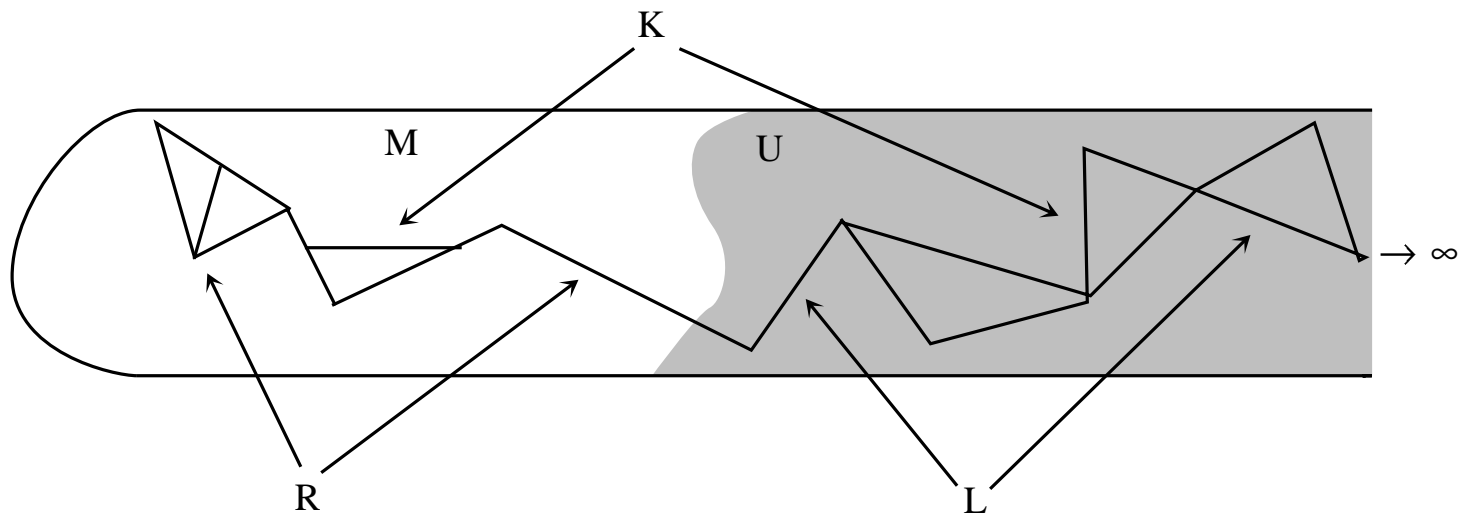

PROOF: The proof is essentially the same as the proof of Theorem 9.9. The reader wishing more details should consult [St]. ■

PROOF OF STALLINGS' CHARACTERIZATION:

STEP I. Since  $V$  is contractible and  $V - \overset{\circ}{D}$  is simply connected, it follows from the homotopy sequence of  $(V, V - \overset{\circ}{D})$  that the pair  $(V, V - \overset{\circ}{D})$  is 2-connected. Thus, there is a homeomorphism  $h : V \rightarrow V$  with compact support so that  $h(V - \overset{\circ}{D})$  contains the 2-skeleton of  $V$ . Let  $E$  be a compact codimension-0 PL submanifold of  $V$  so that  $h$  is supported in  $E$ .

STEP II. Let  $W$  be a coordinate chart in  $V$ . The pair  $(V, W)$  is  $n$ -connected and  $(E \cup V^{(2)})^*$  a finite complex with codimension 3, so there is a homeomorphism  $k' : V \rightarrow V$  with  $k'(W) \supset (E \cup V^{(2)})^*$ . The open set  $k'(W)$  therefore contains a small regular neighborhood  $N$  of  $(E \cup V^{(2)})^*$ . The region between a small regular neighborhood of  $(E \cup V^{(2)})$  and a small regular neighborhood of  $(E \cup V^{(2)})^*$  is a product  $\partial N \times [0, 1]$ , so there is a homeomorphism  $k : V \rightarrow V$  with  $k(W) \cup h(V - \overset{\circ}{D}) = V$ . But then we have  $h^{-1} \circ k(W) \cup (V - \overset{\circ}{D}) = V$ , so  $h^{-1} \circ k(W) \supset D$ .

This shows that every compact subset of  $V$  is contained in a PL ball. It follows that  $V = \bigcup_{i=1}^{\infty} B_i$  where each  $B_i$  is a PL ball and  $B_i \subset \overset{\circ}{B}_{i+1}$  for all  $i$ . Since the space between PL balls is a PL annulus, it follows easily that  $V$  is PL homeomorphic to  $R^n$ . ■

LEMMA 10.12. *If  $K^k \subset M^n$  is a polyhedron in a PL manifold and  $N$  is a regular neighborhood of  $K$  in  $M$  (by this we mean a stellar neighborhood in a second derived) then*

$$\pi_{\ell}(M - \overset{\circ}{N}) \rightarrow \pi_{\ell}(M)$$

is iso for  $\ell \leq n - k - 2$  and epi for  $\ell = n - k - 1$ .

PROOF: If  $\alpha : S^{\ell} \rightarrow M$  is a map, general position allows us to move  $\alpha(S^{\ell})$  off of  $K$  and out of  $N$  for  $\ell \leq n - k - 1$ . This shows that  $\pi_{\ell}(M - \overset{\circ}{N}) \rightarrow \pi_{\ell}(M)$  is epi. If  $\alpha : S^{\ell} \rightarrow M - \overset{\circ}{N}$  extends to  $\bar{\alpha} : D^{\ell+1} \rightarrow M$  and  $\ell + 1 \leq n - k - 1$ , then  $\bar{\alpha}(S^{\ell})$  can be pushed out of  $N$  rel boundary. This shows that  $\pi_{\ell}(M - \overset{\circ}{N}) \rightarrow \pi_{\ell}(M)$  is mono. ■

LEMMA 10.13. *If  $V^n$ ,  $n \geq 5$ , is a PL manifold,  $U \subset V$  is a codimension-0 PL submanifold,  $D$  is a 2-dimensional disk in  $V - \overset{\circ}{U}$  with  $D \cap U = \partial D$ , and  $N$  is a regular neighborhood of  $D$  in  $V - \overset{\circ}{U}$ , then  $\pi_1(\partial(U \cup N)) \cong \pi_1(\partial U \cup D)$ .*

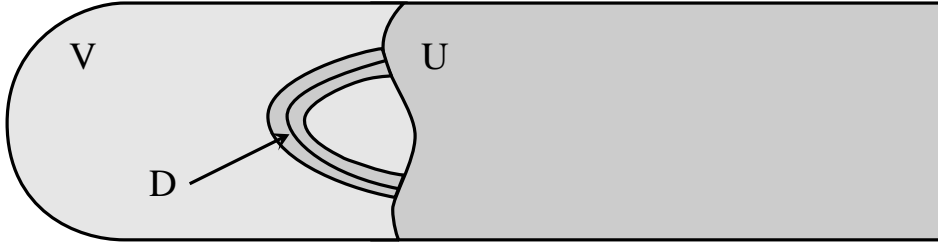

PROOF: The argument is much like the one above. We have  $\pi_1(\partial U \cup D) \cong \pi_1(\partial U \cup N)$  and general position arguments show that  $\pi_1(\partial U \cup N) \cong \pi_1(\partial(U \cup N))$ . ■

LEMMA 10.14. *If  $V^n$ ,  $n \geq 5$ , is a PL manifold,  $U \subset V$  is a codimension-0 PL submanifold,  $D$  is a 2-dimensional disk in  $U$  with  $D \cap \partial U = \partial D$ , and  $N$  is a regular neighborhood of  $D$  in  $U$ , then  $\pi_1(\partial(U - N)) \cong \pi_1(\partial U \cup D)$ .*

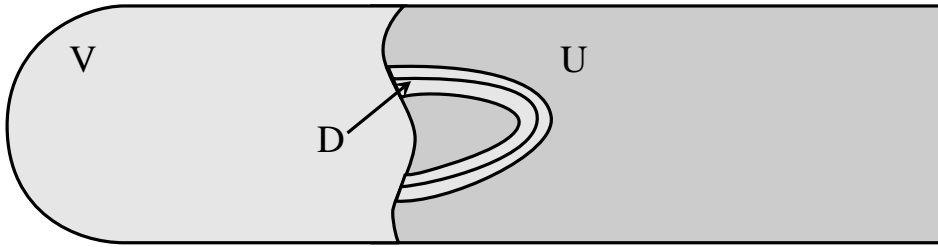

PROOF: The proof is the same as above. ■

It remains to prove Proposition 10.10. We begin with a lemma.

LEMMA 10.15. *Let  $V^n$  be a noncompact PL manifold without boundary,  $n \geq 3$ . If  $V$  is 1-ended, then for each compact  $C \subset V$  there is a compact  $D \subset V$  so that  $D \supset C$  and  $V - \overset{\circ}{D}$  is connected with connected boundary  $\partial D$ .*

PROOF OF LEMMA: Given  $C$ , choose  $D_1$  so that any two points in  $V - \overset{\circ}{D}_1$  can be connected by an arc in  $V - \overset{\circ}{C}$ . Choose a finite number of disjoint arcs in  $V - \overset{\circ}{C}$  connecting the boundary components of  $D_1$ . We can assume that the interior of each arc lies entirely in  $D_1$  or in  $V - \overset{\circ}{D}_1$ . For each arc in  $D_1$ , excise a regular neighborhood of the arc from  $D_1$ . For each arc in  $V - \overset{\circ}{D}_1$ , adjoin a regular neighborhood of the arc to  $D_1$ . This gives  $D \supset C$  with  $\partial D$  connected. This implies that  $V - \overset{\circ}{D}$  is connected. Any two points in  $V - \overset{\circ}{D}$  can be connected by an arc in  $V$ . If the arc misses  $\partial D$ , we are done. If not, choose the first and last points where the arc meets  $\partial D$  and connect them by an arc in  $\partial D$ . ■

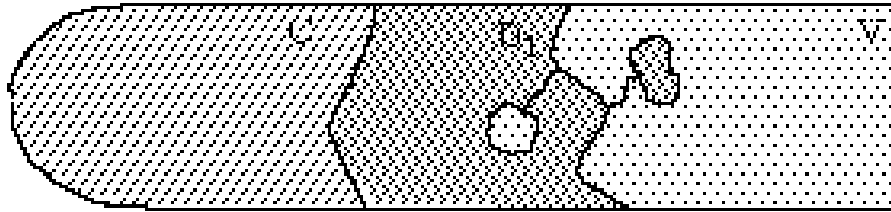

Next, we prove that embedded  $D^2$ 's can be made transverse to bicollared codimension 1 submanifolds.

LEMMA 10.16. *If  $V$  is a PL manifold,  $F$  is a bicollared codimension-1 submanifold of  $V$ , and  $\ell$  is a loop in  $F$  which is nullhomotopic in  $V$ , then  $\ell$  bounds a disk in  $V$  which meets  $F$  transversally<sup>13</sup> in a finite number of interior circles.*

PROOF: Since  $F$  is bicollared, we can choose a triangulation of the bicollar so that there are no vertices in the interior.

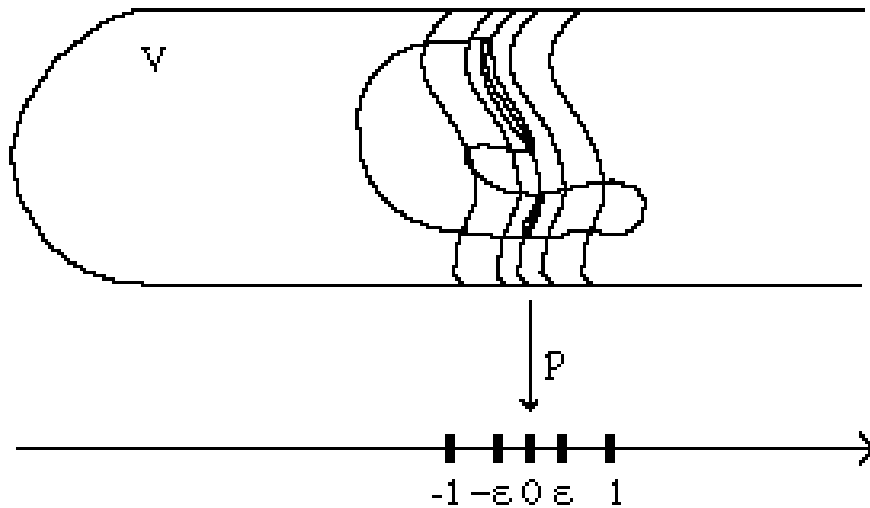

Think of the collar as being parameterized by a PL map to  $[-1,1]$  and extend to a proper PL map  $p : V \rightarrow (-\infty, \infty)$ . Displace  $\ell$  into the  $-\epsilon$ -level along the collar lines and extend to a PL embedding  $f : D^2 \rightarrow V$ . By displacing  $F \times 0$  slightly towards  $\epsilon$ , if necessary, we

<sup>13</sup> For now, we'll just say that this means that near  $F$  the embedding of  $D^2$  is a product along the collar lines.

can assume that  $f$  is simplicial with respect to a triangulation with no vertices on  $F \times 0$ . This guarantees that  $(p \circ f)^{-1}(0)$  is a submanifold of  $D^2$  consisting of a finite union of collared circles such that  $p \circ f$  maps the collar coordinates map homeomorphically onto a small interval around 0. This might be more circles than  $f^{-1}(F)$ , but that doesn't matter. The map  $f$  is homotopic to a map  $\bar{f}: D^2 \rightarrow V$  which has the same intersection with  $F \times 0$  but which goes straight across the collar. General position outside of the collar lets us assume that  $\bar{f}$  is an embedding, completing the proof. ■

PROOF OF PROPOSITION 10.10: The proof of the proposition is similar to the proof of Lemma 10.15. Given  $C$ , choose  $D_1$  so that  $V - \overset{\circ}{D}_1$  and  $\partial D_1$  are connected and so that loops in the complement of  $D_1$  contract in the complement of  $C$ . Choose a finite set  $\{\gamma_i\}$  of generators for  $\pi_1(\partial D_1)$ . By general position, these generators bound disks in  $V - \overset{\circ}{C}$ .

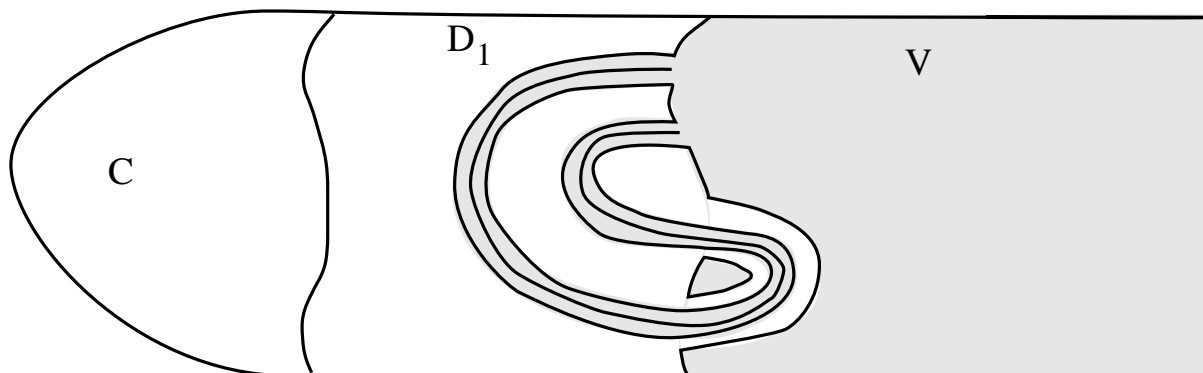

We arrange for the disks to meet  $\partial D_1$  transversally in a finite number of circles. Consider the innermost circles. Add regular neighborhoods of the disks bounded by these circles to  $D_1$  if the disks lie in  $V - \overset{\circ}{D}_1$  and excise them from  $D_1$  if the disks lie in  $D_1$ . Note that neither operation increases  $\pi_1$  of the boundary. Call the resulting region  $D'$ . In either case, the disks meet  $\partial D'_1$  in fewer circles, so we continue until all of the disks lie in  $D_1$  or  $V - \overset{\circ}{D}_1$ . At this last stage, adding or subtracting a regular neighborhood of the disk kills the generator of  $\pi_1(\partial D)$  represented by the boundary. Doing this for all of the generators makes the boundary simply connected. It follows immediately from Van Kampen's Theorem that we have constructed the desired simply connected neighborhood of infinity. ■

#### REFERENCES



- [St] J. Stallings, *On the piecewise-linear structure of Euclidean space*, Proc. Cambridge Philos. Soc. **58** (1962), 481–488.

## Chapter 11. Whitehead torsion

This section contains a quick sketch of simple homotopy theory. The classical references on the subject are [Co] and [Mi]. The reader who wants more details should consult those references.

### ALGEBRA

If  $\Lambda$  is a ring with identity, we define  $Gl_n(\Lambda)$  to be the group of invertible  $n \times n$  matrices over  $\Lambda$  and let

$$Gl(\Lambda) = \lim_{n \rightarrow \infty} Gl_n(\Lambda).$$

Here the inclusion  $Gl_n(\Lambda) \subset Gl_{n+1}(\Lambda)$  is given by

$$A \rightarrow \begin{pmatrix} A & 0 \\ 0 & 1 \end{pmatrix}.$$

We define  $E(\Lambda)$  to be the subgroup of  $Gl(\Lambda)$  generated by elementary matrices.

LEMMA 11.1 (WHITEHEAD LEMMA).  $E(\Lambda)$  is the commutator subgroup of  $Gl(\Lambda)$ .

PROOF: It is easy to show that  $E(\Lambda) \subset [Gl(\Lambda), Gl(\Lambda)]$  – if  $E_{j,k}$  is a matrix with a 1 in the  $j, k^{th}$  slot and 0's elsewhere, we have:

$$(I + aE_{i,k}) = (I + aE_{i,j})(I + E_{j,k})(I - aE_{i,j})(I - E_{j,k})$$

for  $i, j, k$  distinct.

Conversely, we show that  $Gl(\Lambda)/\langle E(\Lambda) \rangle$  is abelian, which implies that  $E(\Lambda) \supset [Gl(\Lambda), Gl(\Lambda)]$ . During this argument, if  $A$  and  $B$  are matrices, we write  $A \Leftrightarrow B$  if  $B$  can be obtained from  $A$  by row and column operations.

$$\begin{aligned} AB &\Leftrightarrow \begin{pmatrix} AB & 0 \\ 0 & I \end{pmatrix} \Leftrightarrow \begin{pmatrix} AB & B \\ 0 & I \end{pmatrix} \Leftrightarrow \begin{pmatrix} 0 & B \\ -A & I \end{pmatrix} \Leftrightarrow \begin{pmatrix} 0 & B \\ -A & 0 \end{pmatrix} \\ &\Leftrightarrow \begin{pmatrix} 0 & B \\ -A & 0 \end{pmatrix} \Leftrightarrow \begin{pmatrix} A & B \\ -A & 0 \end{pmatrix} \Leftrightarrow \begin{pmatrix} A & 0 \\ 0 & B \end{pmatrix} \\ &\Leftrightarrow \begin{pmatrix} 0 & B \\ -A & 0 \end{pmatrix} \Leftrightarrow \begin{pmatrix} B & B \\ -A & 0 \end{pmatrix} \Leftrightarrow \begin{pmatrix} B & 0 \\ 0 & A \end{pmatrix} \Leftrightarrow BA. \blacksquare \end{aligned}$$

DEFINITION 11.2. A chain contraction  $s : C_* \rightarrow C_{*+1}$  is a map such that  $\partial s + s\partial = id$ .

LEMMA 11.3. If  $C_*$  is a chain complex of finitely generated projective  $\Lambda$ -modules with  $H_*(C) = H_*(pt)$ , then  $C_*$  has a chain contraction.

PROOF: This is an easy induction. See [Co, p. 47] or the proof of Lemma 11.5 for details. ■

DEFINITION 11.4. We write  $K_1(\Lambda) = Gl(\Lambda)/E(\Lambda)$ . If  $\Lambda = \mathbb{Z}G$  for some  $G$ , we write

$$Wh(\mathbb{Z}G) = K_1(\mathbb{Z}G)/D$$

where  $D$  is the subgroup generated by  $1 \times 1$  matrices  $(\pm g)$  with entries from  $G$ . If  $A \in Gl_n(\mathbb{Z}G)$ , we will write  $\tau(A)$  for its image in  $Wh(\mathbb{Z}G)$ . We think of  $\tau(A)$  as a generalized determinant of  $A$ .

Next, suppose that  $C_*$  is a finite chain complex of free finitely generated  $\mathbb{Z}G$ -modules with preferred bases for each of the  $C_i$ 's. If  $H_*(C_*) = 0$ , we show how to associate an element  $\tau(C_*) \in Wh(\mathbb{Z}G)$  to  $C_*$ .

Since  $H_*(C_*) = 0$ ,  $C_*$  has a chain contraction. Consider

$$(\partial + s) : \begin{matrix} \oplus C_i \\ \text{even} \end{matrix} \rightarrow \begin{matrix} \oplus C_i \\ \text{odd} \end{matrix}.$$

We have  $(\partial + s)(\partial + s) = 1 + s^2$ , which is invertible because it has the form

$$\begin{matrix} & C_0 & C_2 & C_4 & \dots \\ C_0 & \left( \begin{matrix} I & 0 & 0 & \dots \\ s^2 & I & 0 & \dots \\ 0 & s^2 & I & \dots \\ \vdots & \vdots & \vdots & \end{matrix} \right) \\ C_2 & & & & \\ C_4 & & & & \\ \vdots & & & & \end{matrix}.$$

Choose an isomorphism  $i : \oplus_{\text{odd}} C_i \rightarrow \oplus_{\text{even}} C_i$  which sends bases to bases and define  $\tau(C_*) = \tau(i \circ (\partial + s))$ . If  $i'$  is another such isomorphism, then  $i \circ (i')^{-1}$  is a permutation matrix and  $\tau(i \circ (i')^{-1}) = 0$ , since a permutation matrix can be reduced to a matrix with  $\pm 1$ 's on the diagonal by row and column operations. This means that

$$\tau(i' \circ (\partial + s)) = \tau(i \circ (i')^{-1}) + \tau(i' \circ (\partial + s)) = \tau(i \circ (\partial + s))$$

so our definition is independent of the choice of  $i$ . Notice that since  $1 + s^2$  has the form above, it is a product of elementary matrices and  $\tau(1 + s^2) = 0$ , so  $\tau((\partial + s) \circ i^{-1}) = -\tau(i \circ (\partial + s))$  in the Whitehead group.

It remains to show that the definition is independent of the choice of  $s$ . We need to show that

$$-\tau(i \circ (\partial + s)) + \tau(i \circ (\partial + \bar{s})) = \tau((\partial + s) \circ i^{-1} \circ i \circ (\partial + \bar{s})) = \tau((\partial + s)(\partial + \bar{s})) = 0.$$

We first note that if  $\bar{s}$  is another chain contraction, then  $s$  and  $\bar{s}$  are chain homotopic.

LEMMA 11.5. *There is a collection of homomorphisms  $\{F_k : C_k \rightarrow C_{k+2}\}$  such that  $\partial F - F\partial = s - \bar{s}$ .*

PROOF:  $\{F_k\}$  can be defined inductively, starting with  $F_{-1} = 0$ . We have:

$$\begin{aligned} \partial(F_{k-1}\partial + s - \bar{s}) &= \partial F_{k-1}\partial + \partial s - \partial \bar{s} \\ &= (F_{k-2}\partial + s - \bar{s})\partial + \partial s - \partial \bar{s} \\ &= 0. \end{aligned}$$

Thus letting  $F_k = s(F_{k-1}\partial + s - \bar{s})$ , we have

$$\begin{aligned} \partial F_k - F_{k-1}\partial &= \partial s(F_{k-1}\partial + s - \bar{s}) - F_{k-1}\partial \\ &= (1 - s\partial)(F_{k-1}\partial + s - \bar{s}) - F_{k-1}\partial \\ &= s - \bar{s}. \blacksquare \end{aligned}$$

We then have

$$\begin{aligned} (\partial + s)(\partial + \bar{s}) &= (\partial + \partial F - F\partial + \bar{s})(\partial + \bar{s}) \\ &= \partial F\partial + \bar{s}\partial + \partial \bar{s} + \partial F\bar{s} - F\partial \bar{s} + \bar{s}\bar{s} \\ &= 1 + \partial F\partial + (\partial F\bar{s} - F\partial \bar{s} + \bar{s}\bar{s}). \end{aligned}$$

Note that  $1 + \partial F\partial$  is invertible with inverse  $1 - \partial F\partial$ . The terms in parentheses have degree +2, so  $(\partial + s)(\partial + \bar{s})(1 - \partial F\partial)$  is blocked in the same way as  $(1 + s^2)$  and has torsion equal to 0. It therefore suffices to show that  $\tau(1 + \partial F\partial) = 0$ .

LEMMA 11.6.  *$\partial s$  and  $s\partial$  are complementary projections. That is:*

- (i)  $\partial s\partial = \partial$ .
- (ii)  $s\partial s\partial = s\partial$ .
- (iii)  $\partial s\partial s = \partial s$ .
- (iv)  $(\partial s)(s\partial) = (s\partial)(\partial s) = 0$ .

PROOF:  $\partial s \partial = (1 - s \partial) \partial = \partial$ . The rest follows from this and the observation that  $\partial s s \partial = (1 - s \partial) s \partial = 0$ . ■

It follows immediately that the matrix

$$A = \begin{pmatrix} s\partial & \partial s \\ \partial s & s\partial \end{pmatrix}$$

has  $A = A^{-1}$ . Thus

$$\begin{aligned} \tau(1 + \partial F \partial) &= \tau \left( \begin{pmatrix} s\partial & \partial s \\ \partial s & s\partial \end{pmatrix} \begin{pmatrix} 1 + \partial F \partial & 0 \\ 0 & 1 \end{pmatrix} \begin{pmatrix} s\partial & \partial s \\ \partial s & s\partial \end{pmatrix} \right) \\ &= \tau \begin{pmatrix} 1 & 0 \\ \partial F \partial & 1 \end{pmatrix} = 0. \end{aligned}$$

This completes the proof that  $\tau(C_*)$  is well-defined. ■

### Geometry

DEFINITION 11.7. A finite CW complex  $\bar{X}$  is an *elementary expansion* of a CW complex  $X$  if  $\bar{X} = X \cup_f B^n$  where  $F$  is a PL  $(n - 1)$ -ball in  $\partial B^n$  and  $f : F \rightarrow X^{(n-1)}$  is a map with  $f(\partial F) \subset X^{(n-2)}$ . We write  $X \xrightarrow{e} \bar{X}$  or  $\bar{X} \xleftarrow{e} X$ . If  $X = X_0 \xrightarrow{e} X_1 \xrightarrow{e} \dots \xrightarrow{e} X_n = Y$ , we write  $X \nearrow Y$ . Similarly, if  $X = X_0 \xleftarrow{e} X_1 \xleftarrow{e} \dots \xleftarrow{e} X_n = Y$ , we write  $X \searrow Y$ . If  $X = X_0 \nearrow X_1 \searrow \dots \nearrow X_n = Y$ , we say that  $X$  and  $Y$  are *simple homotopy equivalent*. We say that the sequence  $\{X_i\}$  is a *formal deformation* from  $X$  to  $Y$  and write  $X \nearrow \searrow Y$ . If  $X \nearrow \searrow Y$ , we can always do all of the expansions first, so there is a formal deformation from  $X$  to  $Y$  which has the form  $X \nearrow Z \searrow Y$ .

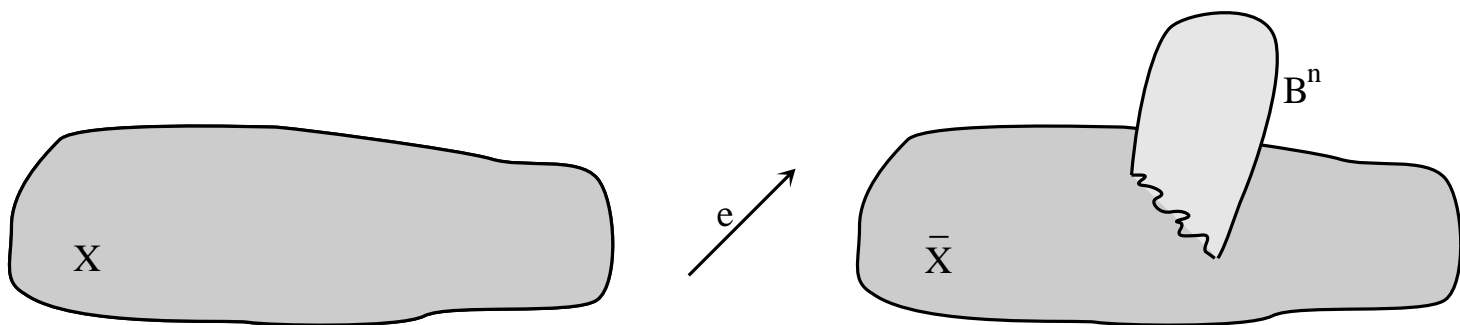

DEFINITION 11.8. If  $(X, Y)$  is a finite CW pair such that  $Y \rightarrow X$  is a homotopy equivalence, we write  $\tau(X, Y) = \tau(C_*(\tilde{X}, \tilde{Y})) \in Wh(\mathbb{Z}\pi_1(Y))$ .

If  $(X, Y)$  is a finite CW pair such that  $Y \rightarrow X$  is a homotopy equivalence and  $X \not\approx X'$ , then  $X' = X \cup e^{n-1} \cup e^n$ , where  $e^{n-1} = \partial B^n - \overset{\circ}{F}$ . We choose orientations so that  $\partial[e^n] = [e^{n-1}] + c$ , where  $c \in C_{n-1}(\tilde{X}, \tilde{Y})$ . We extend  $s$  to  $C_*(\tilde{X}', \tilde{Y})$  by setting  $s([e^n]) = 0$  and  $s([e^{n-1}]) = [e^n] - sc$ . For  $n$  even, the matrix of the new  $(\partial + s)$  is

$$\begin{array}{c} \oplus C_i \\ \text{even} \end{array} [e^n] \\ \oplus C_i \\ \text{odd} \\ [e^{n-1}] \begin{pmatrix} 1 & * \\ 0 & 1 \end{pmatrix} .$$

and  $\tau(X', Y) = \tau(X, Y)$ . Similar considerations apply for  $n$  odd, so  $\tau(X, Y) = \tau(X', Y)$  whenever  $X \frown X' \text{ rel } Y$ .

We claim that the converse of this last is true, as well. The proof will make use of the following cell-trading lemma.

**PROPOSITION 11.9 (WHITEHEAD'S CELL-TRADING LEMMA).** *Let  $(X, Y)$  be a finite CW pair with  $\pi_k(X, Y) = 0$ ,  $0 \leq k \leq n$ . Then  $X \frown \bar{X} \text{ rel } Y$  so that  $\dim(\bar{X} - Y) \geq n + 1$ .*

**PROOF:** We can assume by induction that  $X = Y \cup \{e_i^n\} \cup \dots$ . Let  $\phi : (B^n, S^{n-1}) \rightarrow (X, Y)$  map  $\overset{\circ}{B}^n$  homeomorphically onto the interior of an  $n$ -cell  $e^n$  of  $(X - Y)$ . Since  $\pi_n(X, Y) = 0$ , there is a homotopy  $\Phi : (B^n, S^{n-1}) \times I \rightarrow (X, Y)$  with  $\Phi(B^n \times 1) \subset X$ .

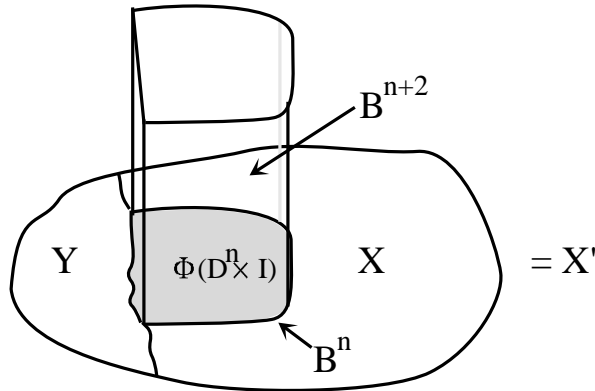

Think of  $\Phi$  as a map from  $B^{n+1} \subset \partial B^{n+2}$  to  $X$  and form  $X' = X \cup_{\Phi} B^{n+2}$ . Let  $C = \partial B^{n+2} - \text{int } B^{n+1}$  be the complementary face to  $B^{n+1}$  in  $\partial B^{n+2}$ . In the picture,  $C$  consists of everything except the part of  $B^{n+2}$  which meets  $X$ .

Let  $F : C \cup Y \rightarrow Y$  be the elementary collapse from  $B^n$ . Let  $\bar{X} = X' \cup_F Y$ . We claim

that the space  $\bar{X}$  is simple homotopy equivalent to  $X \text{ rel } Y$  with one more  $(n + 2)$ -cell and one less  $n$ -cell. This follows from the next lemma.

LEMMA 11.10. *If  $X \searrow_{\mathcal{E}} X_0$  and  $r : X \rightarrow X_0$  is a retraction realizing the collapse, then  $M(r) \searrow X \cup X_0 \times I$ .*

PROOF: If  $X = X_0 \cup e^n \cup e^{n+1}$ , then  $M(r) = X \cup X_0 \times I \cup e^n \times I \cup e^{n+1} \times I$ . Collapsing across  $e^{n+1} \times I$  from  $e^n \times I$  proves the lemma. ■

ADDENDUM 11.11. *If  $X \searrow_{\mathcal{E}} X_0$  and  $r : X \rightarrow X_0$  is a retraction realizing the collapse, then  $M_{X_0}(r) \searrow_{\mathcal{E}} X$ , where  $M_{X_0}(r)$  is the mapping cylinder of  $r$  reduced over  $Y$ . ■*

To complete the proof of Proposition 11.9, consider the reduced mapping cylinder  $M_Y(q)$  of  $q : X' \rightarrow \bar{X}$ .  $M(q) \searrow \bar{X}$  by the mapping cylinder collapse. Since  $q$  is a homeomorphism off of  $C$ ,  $M(q)$  collapses from the bottom to  $X' \cup M_Y(F)$ , which collapses to  $X'$ . Since  $X' \searrow_{\mathcal{E}} X$ , we have  $X \searrow \bar{X}$ . Iterating this procedure (or, better, doing all of the  $n$ -cells at once) trades away all of the  $n$ -cells of  $X - Y$ . ■

THEOREM 11.12. *If  $(X, Y)$  is a finite CW pair such that  $Y \rightarrow X$  is a homotopy equivalence, then  $\tau(X, Y) = 0$  if and only if  $X \searrow Y \text{ rel } Y$ .*

PROOF: We have already seen that  $\tau(X, Y) = 0$  if  $X \searrow Y \text{ rel } Y$ , so we need only prove the converse. If  $(X, Y)$  is a CW pair with  $Y \rightarrow X$  a homotopy equivalence, repeated application of Whitehead's cell-trading lemma gives  $X \searrow X' \text{ rel } Y$  where  $X' = Y \cup \{e_i^n\} \cup \{e_j^{n+1}\}$  for some  $n$ . The chain complex  $C_*(\tilde{X}', \tilde{Y})$  then looks like

$$0 \rightarrow C_{n+1}(\tilde{X}', \tilde{Y}) \xrightarrow{\cong} C_n(\tilde{X}', \tilde{Y}) \rightarrow 0.$$

CASE I. Suppose that  $\partial = id$  with respect to the preferred bases given by  $\{e_i^n\}$  and  $\{e_j^{n+1}\}$ . Since  $C_n(\tilde{X}', \tilde{Y}) = H_n(\tilde{X}', \tilde{Y}) \cong \pi_n(\tilde{X}', \tilde{Y})$ , this means that the composition

$$(D^n, S^{n-1}, *) \rightarrow (D^n/S^{n-1}, *, *) \cong (S^n, *, *) \xrightarrow{\phi_i} (Y \cup \{e_i^n\}, Y, *)$$

where  $\phi_i : S^n \rightarrow Y \cup \{e_i^n\}$  is the attaching map for  $e_i^{n+1}$  is homotopic to a map  $\bar{\phi}_i$  which sends  $\mathring{D}^n$  homeomorphically onto the interior of  $e_i^n$ . If  $\Phi'_i$  is such a homotopy,  $\Phi'_i$  induces a map  $\Phi_i : ((D^n \times I)/(S^{n-1} \times 0), S^{n-1} \times I, * \times I) \rightarrow (Y \cup \{e_i^n\}, Y, *)$ . This gives a homotopy from  $\phi_i = \Phi|S_1^n$  to a map  $\phi'_i = \Phi|S_2^n$  which sends the upper hemisphere of  $S^n$  homeomorphically onto  $e_i^n$  and the lower hemisphere into  $Y$ .

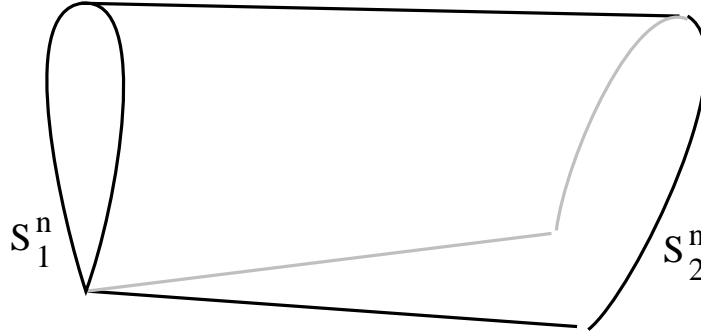

LEMMA 11.13. If  $X$  is a finite CW complex and  $X_i = X \cup_{\phi_i} D^n$  where  $\phi_i : S^{n-1} \rightarrow X$ ,  $i = 1, 2$ , then  $\phi_1 \simeq \phi_2 \Rightarrow X_1 \wedge X_2$ .

PROOF: Let  $\Phi : S^{n-1} \times I \rightarrow X$  be a homotopy from  $\phi_1$  to  $\phi_2$  and form  $Z = X \cup_{\Phi} D^n \times I$ . Then  $Z \searrow_{\simeq} X_1$  and  $Z \searrow_{\simeq} X_2$  by collapses across  $D^n \times I$  from  $\Phi(D^n \times 1)$  and  $\Phi(D^n \times 0)$ , respectively. ■

By this Lemma,  $X' \wedge X''$ , where the  $n+1$ -cells of  $X''$  are attached using the maps  $\phi'_i$ . But  $e_i^n \cup e_i^{n+1}$  is an  $n+1$ -cell attached to  $Y$  along a face, so  $X'' \searrow Y$ . This completes Case I.

CASE II. In general, since  $\tau(X', Y) = 0$ , we know that after stabilization by the identity, the matrix of  $\partial$  is a product of elementary matrices and diagonal matrices with  $\pm$ group elements on the diagonal. Doing a few more elementary expansions stabilizes the matrix by the identity, while passing one  $n+1$ -cell over another changes  $\partial$  by an elementary row operation. Choosing new lifts for the cells  $e_{i+1}^n$  changes the matrix by multiplication by a diagonal matrix with  $\pm$ group elements on the diagonal, so a sequence of such operations tells us how to deform  $X'$  to  $X''$  such that the boundary map is the identity. This is covered in considerably greater detail on pp. 30-32 of [Co]. ■

#### REFERENCES

- [Co] M. M. Cohen, *A course in simple-homotopy theory*, Springer-Verlag, Berlin-New York, 1973.  
 [Mi] J. Milnor, *Whitehead torsion*, Bul. Amer. Math. Soc. **72** (1966), 358–426.



## Chapter 12. Siebenmann's Thesis

Siebenmann's 1965 Princeton thesis deals with the problem of when a noncompact manifold without boundary is the interior of a manifold with boundary. In order to state the theorem, we will introduce some language for discussing systems of groups and homomorphisms.

### SOME PRO-LANGUAGE

We begin by talking a little bit about the pro-category, which is the setting in which we will discuss the fundamental group system at infinity.

DEFINITION 12.1. Let

$$G_1 \xleftarrow{h_2} G_2 \xleftarrow{h_3} G_3 \xleftarrow{h_4} \dots$$

be a sequence of groups and homomorphisms. By a *subsequence* of  $\{G_i, h_i\}$ , we shall mean a sequence

$$G_{i_1} \xleftarrow{h_{i_1+1} \circ \dots \circ h_{i_2}} G_{i_2} \xleftarrow{h_{i_2+1} \circ \dots \circ h_{i_3}} G_{i_3} \xleftarrow{h_{i_3+1} \circ \dots \circ h_{i_4}} \dots$$

We will say that two such sequences are *pro-equivalent* if they are equivalent under the relation generated by passing to subsequences.

EXERCISE 12.2. Show that  $\{G_i, h_i\}$  and  $\{G'_i, h'_i\}$  are pro-equivalent if and only if after passing to subsequences, there is a commuting diagram:

$$\begin{array}{ccccccc} G_{i_1} & \longleftarrow & G_{i_2} & \longleftarrow & G_{i_3} & \longleftarrow & G_{i_4} & \longleftarrow & \dots \\ & \swarrow & & \swarrow & & \swarrow & & \swarrow & \\ & G'_{j_1} & \longleftarrow & G'_{j_2} & \longleftarrow & G'_{j_3} & \longleftarrow & G'_{j_4} & \longleftarrow & \dots \end{array}$$

DEFINITION 12.3. A system  $\{G_i, h_i\}$  is said to be *stable* if and only if it is pro-equivalent to a constant system  $\{G, id\}$ .

DEFINITION 12.4. The *inverse limit*,  $\varprojlim \{G_i, h_i\}$  is the subgroup of  $\prod G_i$  consisting of elements  $(g_1, g_2, \dots)$  such that  $h_i(g_i) = g_{i-1}$ .

EXERCISE 12.5. If  $\{G_i, h_i\}$  and  $\{G'_i, h'_i\}$  are pro-equivalent, then their inverse limits are isomorphic.

DEFINITION 12.6. The system  $\{G_i, h_i\}$  is said to be *Mittag-Leffler* if it is pro-equivalent to a system  $\{G'_i, h'_i\}$  where all of the maps  $h'_i$  are epimorphisms.

#### THE FUNDAMENTAL GROUP AT INFINITY

We now have the appropriate language for talking about fundamental group systems at infinity.

DEFINITION 12.7. If  $M^n$  is a PL manifold, a *clean neighborhood of infinity* in  $M$  is a PL submanifold  $V$  with bicollared boundary such that  $M - \overset{\circ}{V}$  is compact.

DEFINITION 12.8. If  $M^n$  is a noncompact PL manifold which is connected at infinity, then a *proper ray*  $R$  in  $M$  is a proper map  $p : [0, \infty) \rightarrow M$ .

DEFINITION 12.9. If  $M^n$  is a noncompact PL manifold which is connected at infinity,  $\{V_i\}$  is a nested collection of connected clean neighborhoods at infinity such that  $\bigcap V_i = \emptyset$ , and  $R$  is a proper ray in  $M$ , then the  $\pi_1$ -*system of  $M$  at infinity with respect to  $R$*  is the pro-equivalence class of the system of groups and homomorphisms given by

$$\pi_1(V_1) \leftarrow \pi_1(V_2) \leftarrow \pi_1(V_3) \leftarrow \pi_1(V_4) \leftarrow \dots$$

where the basepoint  $b_i \in V_i$  is taken in the noncompact component of  $R \cap V_i$  and the map  $\pi_1(V_i) \rightarrow \pi_1(V_{i-1})$  is induced by changing basepoints using the arc from  $b_i$  to  $b_{i-1}$  in  $R$ .

EXERCISE 12.10. Show that the  $\pi_1$ -system of  $M$  at infinity is well-defined (up to pro-equivalence) and that if  $R$  and  $R'$  are proper homotopic rays, then the fundamental group systems with respect to  $R$  and  $R'$  are isomorphic.

Unfortunately, it is possible for a manifold to be connected at infinity and yet have many different proper homotopy classes of proper rays. Here is a simple example:

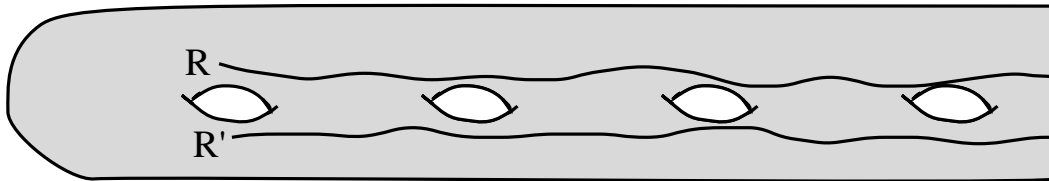

PROPOSITION 12.11. *If the fundamental group system of  $M$  is stable at infinity with respect to the proper ray  $R$ , then any other proper ray  $R'$  is proper homotopic to  $R$ .*

PROOF: Choose clean connected neighborhoods  $V_1 \supset V_2 \supset \dots$  of infinity with  $\cap V_i = \emptyset$ . After passing to a subsequence, if necessary, we may assume that there is a commuting diagram:

$$\begin{array}{ccccccc}
 \pi_1(V_1) & \longleftarrow & \pi_1(V_2) & \longleftarrow & \pi_1(V_3) & \longleftarrow & \pi_1(V_4) & \longleftarrow & \dots \\
 & \swarrow & \swarrow & \swarrow & \swarrow & \swarrow & \swarrow & \swarrow & \\
 & G & \xleftarrow{id} & G & \xleftarrow{id} & G & \xleftarrow{id} & G & \xleftarrow{\quad} \dots
 \end{array}$$

Let  $b_i$  and  $b'_i$  be the basepoints in  $V_i$  along the rays  $R$  and  $R'$ , respectively. Choose paths in  $V_i$  connecting  $b_i$  to  $b'_i$ . Consider the loop  $\omega$  formed by following the path from  $b_2$  to  $b'_2$ , the segment of  $R'$  from  $b'_2$  to  $b'_3$ , the path from  $b'_3$  to  $b_3$ , and the segment of  $R$  back to  $b_2$ . This gives an element of  $\pi_1(V_2, b_2)$ . According to the diagram, there is an element  $\nu$  of  $\pi_1(V_3, b_3)$  whose image is the same as the image of  $\omega$  in  $\pi_1(V_1, b_1)$ . Changing the path from  $b'_3$  to  $b_3$  by  $\nu^{-1}$  gives a loop  $\omega'$  which is nullhomotopic in  $V_1$ . Going “up the ladder” iterating this procedure fills in a proper homotopy from  $R$  to  $R'$  (by retracting  $R$  and  $R'$  to the portions beyond  $b_2$  and  $b'_2$  and then using the homotopy we’ve just constructed.) ■

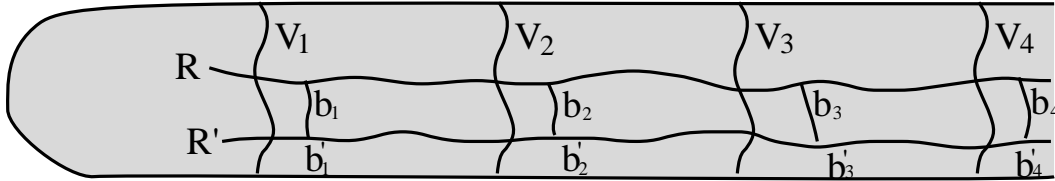

REMARK 12.12. Note that we did not use the full strength of stability. It would have sufficed to have known that the  $\pi_1$  system was Mittag-Leffler.

EXERCISE 12.13. The *dyadic solenoid* is the inverse limit  $D = \varprojlim \{S^1, 2\}$  where “2” is the degree two map  $z \rightarrow z^2$ . Show that the dyadic solenoid is homeomorphic to the subset of  $S^3$  obtained by intersecting a sequence of suitably chosen solid tori. Show that there are uncountably many proper homotopy classes of proper rays in  $M = S^3 - D$ .

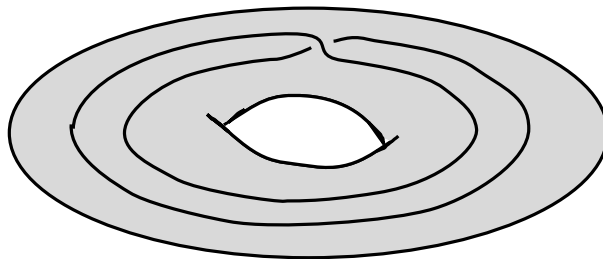

## THE STATEMENT OF SIEBENMANN'S THEOREM

DEFINITION 12.14. A manifold is said to be *tame at infinity* if each clean neighborhood of infinity is finitely dominated.<sup>14</sup>

THEOREM 12.15 (SIEBENMANN, 1965). *Let  $M^n$ ,  $n \geq 6$  be a 1-ended PL manifold without boundary. Then  $M$  has a compactification to a PL manifold with boundary  $W$  if and only if*

- (i) *The  $\pi_1$ -system of  $M$  is stable at infinity.*
- (ii)  *$M$  is tame at infinity.*
- (iii) *An invariant  $\sigma(\epsilon) \in \tilde{K}_0(\pi_1\epsilon)$  vanishes.*

Here,  $\epsilon$  denotes the end of  $M$  and  $\pi_1\epsilon = \varprojlim\{\pi_1V_i\}$  where  $\{V_i\}$  is a sequence of clean connected neighborhoods of infinity with  $V_1 \supset V_2 \supset \dots$  and  $\cap V_i = \emptyset$ .

REMARK 12.16. If  $V$  is chosen to be a small enough neighborhood of infinity that projection from the inverse limit gives homomorphisms  $\pi_1\epsilon \xrightarrow{t} \pi_1V \xrightarrow{r} \pi_1\epsilon$  with  $r \circ t = id$ , then  $r_*\sigma(\epsilon) = \sigma(V)$ , where this last is Wall's finiteness obstruction. In particular, since  $r_* \circ t_* = id$ ,  $\sigma(\epsilon) = 0$  if and only if  $V$  has the homotopy type of a finite complex.

COROLLARY 12.17 (BROWDER-LEVINE-LIVESAY). *If  $M^n$  is a noncompact PL manifold without boundary,  $n \geq 6$ ,  $H_*(M)$  is finitely generated, and  $M$  is connected and simply connected at infinity, then  $M$  is the interior of a compact manifold with boundary.*

PROOF: By a Mayer-Vietoris argument,  $H_*(V)$  is finitely generated for every clean neighborhood  $V$  of infinity. We need only show that if  $V$  is simply connected and  $H_*(V)$  is finitely generated, then  $V$  has the homotopy type of a finite polyhedron.

The argument follows the proof of Wall's finiteness obstruction:  $H_2(V) \cong \pi_2(V)$  is finitely generated, so there is a finite wedge  $K_2$  of  $S^2$ 's and a map  $\phi_2 : K_2 \rightarrow V$  which is onto on  $\pi_2$ . We have  $\pi_3(\phi_2) \cong H_3(\phi_2)$  and this last group is finitely generated, so we can construct a 3-dimensional complex  $K_3$  and a map  $\phi_3 : K_3 \rightarrow V$  so that  $\pi_i(\phi_3) = 0$  for  $i \leq 3$ . Proceeding, we obtain  $\phi_n : K_n \rightarrow V$  with  $\pi_i(\phi_n) = 0$  for  $i \leq n$ . Since  $V$  is noncompact,  $H_n(V) = 0$  and  $H_{n+1}(\phi_n) \cong H_n(K_n)$ . But this group is free and finitely generated, since it is a subgroup of a finitely generated abelian group, so we can attach  $(n+1)$ -cells to obtain a finite  $(n+1)$ -dimensional complex homotopy equivalent to  $V$ . ■

## THE STRATEGY

<sup>14</sup> This is different from Siebenmann's definition, which includes  $\pi_1$ -stability. The definition given here is more consistent with later developments by Chapman-Siebenmann and Quinn.

The idea of the proof is to find a sequence  $V_1 \supset V_2 \supset \dots$  of clean neighborhoods of infinity such that  $\cap V_i = \emptyset$ ,  $\pi_1(V_i) \rightarrow \pi_1(V_{i-1})$  is an isomorphism for all  $i$ , and so that  $\partial V_i \rightarrow V_i$  is a homotopy equivalence for all  $i$ . Let  $C_i = V_i - \overset{\circ}{V}_{i+1}$ . The homology exact sequence of the triple  $(\tilde{V}_i, \tilde{C}_i, \partial\tilde{V}_i)$  is

$$\dots \rightarrow H_k(\tilde{C}_i, \partial\tilde{V}_i) \rightarrow H_k(\tilde{V}_i, \partial\tilde{V}_i) \rightarrow H_k(\tilde{V}_i, \tilde{C}_i) \cong H_k(\tilde{V}_{i+1}, \partial\tilde{V}_{i+1}) \rightarrow \dots$$

The last two terms are zero for all  $k$ , so we have  $H_k(\tilde{C}_i, \partial\tilde{V}_i) = 0$  for all  $k$ . This, together with the  $\pi_1$  isomorphisms, shows that each  $C_i$  is an  $h$ -cobordism<sup>15</sup>.

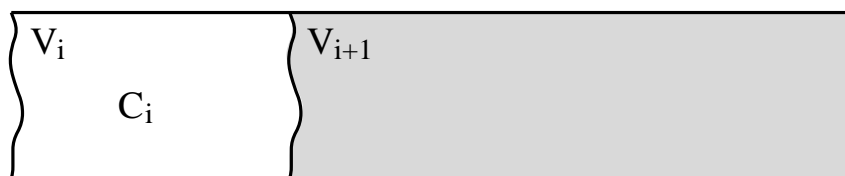

It follows that  $V_1 \cong \partial V_1 \times [0, \infty)$ . The point is that every  $h$ -cobordism  $(W, M_0, M_1)$  is invertible in the sense that there is a cobordism  $(W', M_1, M_0)$  so that  $W \cup_{N_1} W' \cong M_0 \times [0, 1]$ . If  $\tau$  is the torsion of  $W$ ,  $W'$  is just the  $h$ -cobordism with torsion  $-\tau$  constructed by starting with  $M_1$ . This means that if  $V$  is a concatenation of  $h$ -cobordisms  $(C_i, \partial V_i, \partial V_{i+1})$ , then by adding on  $h$ -cobordisms with appropriately chosen torsions  $\tau_i$  inside a collar neighborhood of each  $\partial V_{i+1}$  we can guarantee that all of the cobordisms  $C'_i$  in the picture are product cobordisms. This shows that that  $V \cong \partial V \times [0, \infty)$ . ■

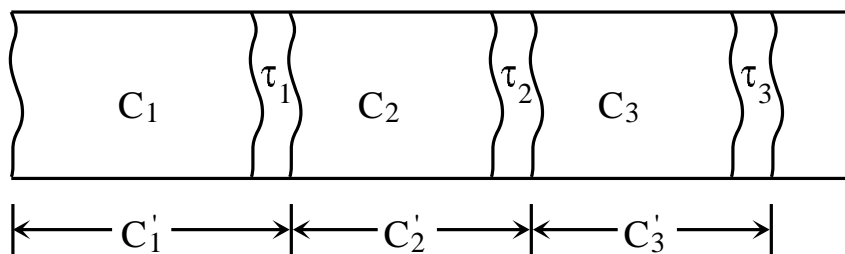

POINCARÉ DUALITY OVER  $\mathbb{Z}\pi$

Suppose that we have a compact  $n$ -dimensional cobordism  $(V, M_0, M_1)$  and consider the universal cover  $(\tilde{V}, \hat{M}_0, \hat{M}_1)$ .<sup>16</sup> We have a chain complex of finitely generated  $\mathbb{Z}\pi$ -

<sup>15</sup> See the section on Poincaré duality over  $\mathbb{Z}\pi$  below.

<sup>16</sup> We are not assuming that the homomorphisms  $\pi_1 M_i \rightarrow \pi_1 V$  are isomorphisms. In fact, the case  $M_i = \emptyset$  is an interesting special case. This is why we use  $\hat{M}_i$  instead of  $\tilde{M}_i$ .

modules, where  $\pi = \pi_1(V)$ .

$$\dots \xrightarrow{\partial} C_{k+1}(\tilde{V}, \hat{M}_0) \xrightarrow{\partial} C_k(\tilde{V}, \hat{M}_0) \xrightarrow{\partial} C_{k-1}(\tilde{V}, \hat{M}_0) \xrightarrow{\partial} \dots$$

We wish to compare this with  $C^*(\tilde{V}, \hat{M}_1)$ , but first a few definitions are in order.

DEFINITION 12.18.

- (i) An (anti)involution on a ring  $\Lambda$  is a map  $\star : \Lambda \rightarrow \Lambda$  such that  $\star(a + b) = \star a + \star b$  and  $\star(ab) = (\star b)(\star a)$ .
- (ii) If  $\Lambda$  is a ring with involution  $\star$  and  $A$  is a left  $\Lambda$ -module, we define the dual module  $A^*$  to be  $\text{Hom}_\Lambda(A, \Lambda)$  with the left  $\Lambda$ -module structure  $\lambda h(a) = h(a)(\star(\lambda))$ .
- (iii) If  $f \in \text{Hom}_\Lambda(A, B)$ , then  $f^* : B^* \rightarrow A^*$  is defined by  $f^*(g) = g \circ f$ .

EXAMPLE 12.19. The example we have in mind is the group ring  $\mathbb{Z}G$  with  $\star(\sum n_i g_i) = \sum n_i g_i^{-1}$ .

Choosing a handle decomposition for  $V$  on  $M_0$ ,  $C^*(\tilde{V}, \hat{M}_0)$  is the chain complex

$$\dots \xrightarrow{\partial^*} C^{k-1}(\tilde{V}, \hat{M}_0) \xrightarrow{\partial^*} C^k(\tilde{V}, \hat{M}_0) \xrightarrow{\partial^*} C^{k+1}(\tilde{V}, \hat{M}_0) \xrightarrow{\partial^*} \dots$$

For  $V$  orientable, this isomorphic up to sign to the chain complex

$$\dots \xrightarrow{\partial'} C_{n-k+1}(\tilde{V}, \hat{M}_1) \xrightarrow{\partial'} C_{n-k}(\tilde{V}, \hat{M}_1) \xrightarrow{\partial'} C_{n-k-1}(\tilde{V}, \hat{M}_1) \xrightarrow{\partial'} \dots$$

which is the chain complex  $C_*(\tilde{V}, \hat{M}_1)$  with respect to the dual handle decomposition of  $V$  on  $M_1$ . The anti-involution comes in at this point, since if the core of the handle  $e^k$  meets the cocore of the handle  $ge^{k-1}$ , then the core of the dual handle  $g^{-1}e^{n-k+1}$  meets the cocore of the dual handle  $e^{n-k}$ . We have:

THEOREM 12.20 ( $\mathbb{Z}\pi$  POINCARÉ-LEFSCHETZ DUALITY). *If  $(V^n, M_0, M_1)$  is oriented, then*

$$H_k(\tilde{V}, \hat{M}_0) \cong H^{n-k}(\tilde{V}, \hat{M}_1). \blacksquare$$

In particular, if  $H_*(\tilde{V}, \hat{M}_0) = 0$ , then there is a chain contraction  $s$  for the chain complex  $C^*(\tilde{V}, \hat{M}_1)$ , so dualizing gives a chain contraction  $s^*$  for the chain complex  $C_*(\tilde{V}, \hat{M}_1)$ . It follows that if the inclusions  $M_i \rightarrow V$  induce  $\pi_1$ -isomorphisms and  $H_*(\tilde{V}, \hat{M}_0) = 0$ , then  $H_*(\tilde{V}, \hat{M}_1) = 0$ , so we have:

PROPOSITION 12.21. *If  $M_i \rightarrow V$  induce isomorphisms on  $\pi_1$ ,  $i = 0, 1$ , and  $H_*(\tilde{V}, \tilde{M}_0) = 0$ , then  $V$  is an  $h$ -cobordism. ■*

FIXING UP  $\pi_1$

PROPOSITION 12.22. *Let  $M^n$ ,  $n \geq 5$  be a 1-ended manifold with compact boundary which is tame at infinity with  $\pi_1$  stable at infinity. Then there exist arbitrarily small clean neighborhoods  $V$  of infinity with  $V$  and  $\partial V$  connected and  $\pi_1 \partial V \xrightarrow{\cong} \pi_1 V \cong G$ , where  $G$  is the fundamental group at infinity.*

PROOF: Let  $\{U_i\}$  be a sequence of decreasing clean, connected neighborhoods of infinity with connected boundaries.

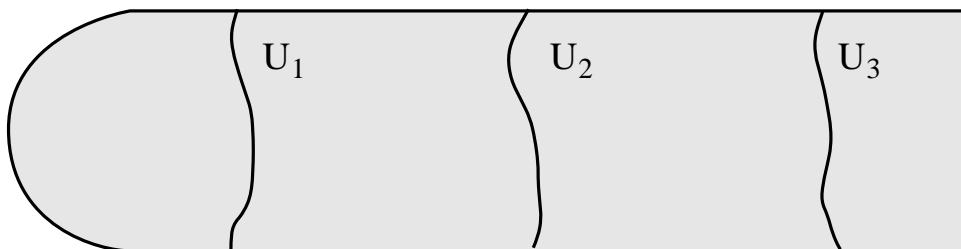

We may assume that there is a diagram:

$$\begin{array}{ccccccc}
 \pi_1(U_1) & \longleftarrow & \pi_1(U_2) & \longleftarrow & \pi_1(U_3) & \longleftarrow & \pi_1(U_4) & \longleftarrow & \dots \\
 & \swarrow & \searrow & \swarrow & \searrow & \swarrow & \searrow & \swarrow & \\
 & G & \xleftarrow{id} & G & \xleftarrow{id} & G & \xleftarrow{id} & G & \dots
 \end{array}$$

Since  $U_i$  is finitely dominated,  $\pi_1 U_i$  is finitely presented (see Proposition 8.16). The diagram shows that we have  $G \xrightarrow{t} \pi_1 U_i \xrightarrow{s} G$  with  $s \circ t = id$ , so Proposition 8.16 shows that  $\pi_1 U_i \xrightarrow{s} G$  has kernel normally generated by finitely many elements. Of course, an element of  $ker(\pi_1 U_i \rightarrow G)$  is an element of  $ker(\pi_1 U_i \rightarrow \pi_1 U_{i-1})$ , so we can find finitely many loops in  $U_i$  bounding disks in  $U_{i-1}$  so that these loops normally generate  $ker(\pi_1 U_i \rightarrow G)$ . Trading disks along the boundary as in the proof of Proposition 10.10 gives us a sequence of  $U'_i$ 's so that  $\pi_1 U'_i \cong G$  for each  $i$ . Choose a set of generators for  $\pi_1 U'_i$  based at a point on  $\partial U'_i$ . Removing tubular neighborhoods of these arcs from  $U'_i$  gives  $U''_i$  with  $\pi_1(\partial U''_i) \xrightarrow{onto} \pi_1(U''_i)$ . By general position, the fundamental group of  $U'_i$  is not changed by this. The following algebraic lemma allows us to excise regular neighborhoods of finitely many  $D^2$ 's from  $U''_i$  to obtain  $V_i$ .

LEMMA 12.23 (SIEBENMANN). *Suppose that  $\theta : G \rightarrow H$  is a homomorphism of a group  $G$  onto a group  $H$ . Let  $\{x; r\}$  and  $\{y; s\}$  be presentations for  $G$  and  $H$  with  $|x|$  generators for  $G$  and  $|s|$  relators for  $H$ . Then  $\ker(\theta)$  can be expressed as the least normal subgroup containing a set of  $|x| + |s|$  elements.*

PROOF: Let  $\xi$  be a set of words so that  $\theta(x) = \xi(y)$  in  $H$ . Since  $\theta$  is onto, there exists a set of words  $\eta$  so that  $y = \eta(\theta(x))$  in  $H$ . Then Tietze transformations give the following isomorphisms:

$$\begin{aligned} \{y; s\} &\cong \{x, y; x = \xi(y), s(y)\} \\ &\cong \{x, y; x = \xi(y), s(y), r(x), y = \eta(x)\} \\ &\cong \{x, y; x = \xi(\eta(x)), s(\eta(x)), r(x), y = \eta(x)\} \\ &\cong \{x; x = \xi(\eta(x)), s(\eta(x)), r(x)\}. \end{aligned}$$

Since  $\theta$  is specified in terms of the last presentation by the correspondence  $x \rightarrow x$ , it is clear that  $\ker(\theta)$  is the normal closure of the  $|x| + |s|$  elements  $\xi(\eta(x))$  and  $s(\eta(x))$ . ■

Using this lemma, we can find a finite collection of disjoint loops in  $\partial U_i''$  generating the kernel of  $\pi_1 \partial U_i'' \rightarrow \pi_1 U_i''$ . Since we are in dimension  $\geq 5$ , these loops bound disjoint embedded disks in  $U_i''$ . Excising regular neighborhoods of these disks from  $U_i''$  gives us manifolds  $V_i \subset U_i''$  so that the maps  $\pi_1 \partial V_i \rightarrow \pi_1 V_i$  are isomorphisms.

LEMMA 12.24. *If  $V$  is a finitely dominated clean neighborhood of infinity with  $\pi_1 \partial V \cong \pi_1 V \cong \pi_1 \epsilon$ , we can find a finite collection of embeddings  $\{(D_i^2, \partial D_i^2) \rightarrow (V, \partial V)\}$  so that excising regular neighborhoods of the  $D_i$ 's gives  $V' \subset V$  with  $H_2(\tilde{V}', \partial \tilde{V}') = 0$ .*

PROOF: We need to examine the effect of excising a regular neighborhood of a single  $D^2$  from  $(V, \partial V)$ .

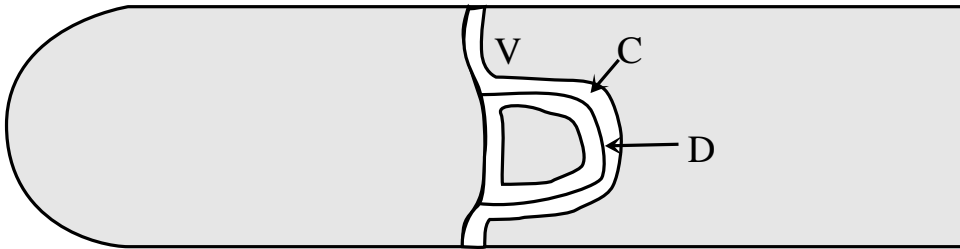

Let  $C$  be a regular neighborhood of  $\partial V \cup D$  and consider the homology sequence of  $(\tilde{V}, \tilde{C}, \partial \tilde{V})$ .

$$0 \rightarrow H_3(\tilde{V}, \partial \tilde{V}) \rightarrow H_3(\tilde{V}, \tilde{C}) \rightarrow H_2(\tilde{C}, \partial \tilde{V}) \rightarrow H_2(\tilde{V}, \partial \tilde{V}) \rightarrow H_2(\tilde{V}, \tilde{C}) \rightarrow 0$$



Since  $H_k(\tilde{V}, \tilde{C}) \cong H_k(\tilde{V}', \partial\tilde{V}')$ , where  $V' = V - \overset{\circ}{C}$  and  $H_2(\tilde{C}, \partial\tilde{V}) \cong \mathbb{Z}\pi$ , this becomes

$$0 \rightarrow H_3(\tilde{V}, \partial\tilde{V}) \rightarrow H_3(\tilde{V}', \partial\tilde{V}') \rightarrow \mathbb{Z}\pi \rightarrow H_2(\tilde{V}, \partial\tilde{V}) \rightarrow H_2(\tilde{V}', \partial\tilde{V}') \rightarrow 0.$$

Thus, the effect is to kill the image of  $(D, \partial D)$  in the homology of the universal cover while creating homology in the next dimension corresponding to the kernel of  $(D, \partial D) \rightarrow (V, \partial V)$ . To achieve our goal, we need only show that  $H_2(\tilde{V}, \partial\tilde{V})$  is finitely generated over  $\mathbb{Z}\pi$  and that a generating set is represented by maps  $(D^2, \partial D^2) \rightarrow (V, \partial V)$ .

The last part is easy, since by the Hurewicz Theorem and covering space theory,  $H_2(\tilde{V}, \partial\tilde{V}) \cong \pi_2(\tilde{V}, \partial\tilde{V}) \cong \pi_2(V, \partial V)$ . Given our work on Wall's finiteness obstruction, the first part is equally easy. Since  $V$  is finitely dominated, it has the homotopy type of a space  $X$  which has only finitely many cells in each dimension. Taking a mapping cylinder, we can assume that  $\partial V \subset X$ . The chain complex  $C_*(\tilde{X}, \partial\tilde{V})$  is a chain complex of finitely generated free  $\mathbb{Z}\pi$ -modules which has its first nonvanishing homology in dimension 2. By Lemma 8.20,  $H_2(\tilde{X}, \partial\tilde{V}) \cong H_2(\tilde{V}, \partial\tilde{V})$  is finitely generated. ■

REMARK 12.25. In general, if we excise a regular neighborhood of a  $k$ -cell  $(D^k, \partial D^k) \subset (V, \partial V)$ , we get an exact sequence

$$0 \rightarrow H_{k+1}(\tilde{V}, \partial\tilde{V}) \rightarrow H_{k+1}(\tilde{V}', \partial\tilde{V}') \rightarrow \mathbb{Z}\pi \rightarrow H_k(\tilde{V}, \partial\tilde{V}) \rightarrow H_k(\tilde{V}', \partial\tilde{V}') \rightarrow 0.$$

We can repeat the process of Lemma 12.24 without change until we reach the middle dimension. At that point, we begin to have trouble embedding the disks. That we can overcome this problem is the main point of the following.

PROPOSITION 12.26. *If  $M$  is as above, we can find arbitrarily small clean neighborhoods  $V$  of infinity with  $\pi_1\partial V \cong \pi_1V \cong \pi_1\epsilon$  and  $H_\ell(\tilde{V}, \partial\tilde{V}) = 0$  for  $\ell \leq n - 3$ .*

PROOF: We proceed by induction, our hypothesis being that there are arbitrarily small neighborhoods  $V$  of infinity with  $H_\ell(\tilde{V}, \partial\tilde{V}) = 0$ ,  $\ell \leq k$ . As before,  $H_{k+1}(\tilde{V}, \partial\tilde{V})$  is finitely generated. We need to show that the generators are represented by finitely many disjoint embeddings  $(D^{k+1}, \partial D^{k+1}) \rightarrow (\tilde{V}, \partial\tilde{V})$ .

Choose a neighborhood  $V'$  of infinity so that  $H_\ell(\tilde{V}', \partial\tilde{V}') = 0$ ,  $\ell \leq k$  and so that  $H_{k+1}(\tilde{C}, \partial\tilde{V}) \rightarrow H_{k+1}(\tilde{V}, \partial\tilde{V})$  is onto, where  $C = V - \overset{\circ}{V}'$ . This last is possible because chains are compact. The homology sequence of  $(\tilde{V}, \tilde{C}, \partial\tilde{V})$  shows that  $H_\ell(\tilde{C}, \partial\tilde{V}) = 0$  for  $\ell \leq k - 1$ . Consider a handle decomposition of  $(C, \partial V)$  as in the schematic picture below.

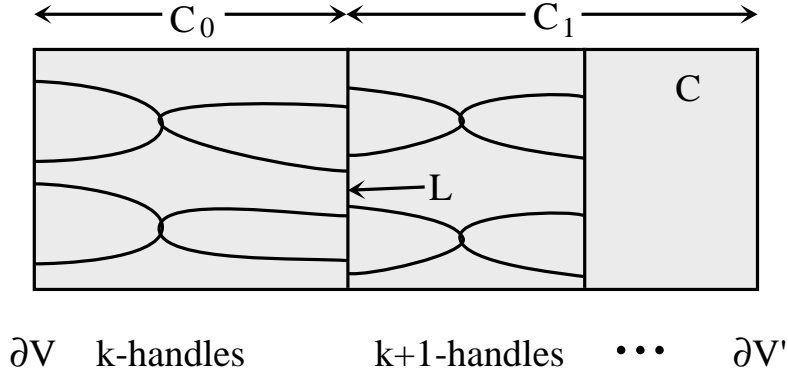

By the Reordering Lemma [RS, p. 76], we can assume that the handles are attached in order of increasing index. Let  $L$  be the new boundary after all of the  $K$ -handles have been attached and before any of the  $(k+1)$ -handles have been attached.  $L$  divides  $C$  into regions  $C_0$  and  $C_1$ .

Introduce a cancelling  $(k+1)$ - $(k+2)$  pair in  $(C_1, L)$ . If  $[c] \in H_{k+1}(\tilde{C}, \partial\tilde{V})$ , write  $c = \sum n_i g_i e_i$ , where the  $e_i$ 's are preferred lifts of  $(k+1)$ -handles of  $V$ . By adding our newborn trivial handle to the handles  $g_i e_i$  with appropriate multiplicities, we can find a single handle  $e^{k+1}$  representing  $c$ . Since  $\partial c = 0$ , we can use the Whitney trick to move the attaching sphere of  $e^{k+1}$  off of the cocores of the  $k$ -handles. This means that there is a handle  $e^{k+1}$  attached to  $\partial V$  which represents  $c$  in  $H_{k+1}(\tilde{V}, \partial\tilde{V})$ . As before, excising such handles corresponding to a set of generators for  $H_{k+1}(\tilde{V}, \partial\tilde{V})$  gives us a new manifold  $V'$  with  $H_{k+1}(\tilde{V}', \partial\tilde{V}') = 0$ . ■

LEMMA 12.27. *If  $V_1 \supset V_2$  are clean neighborhoods of infinity with  $\pi_1 \partial V_i \cong \pi_1 V_i \cong \pi_1 \epsilon$ , then  $(C, \partial V_1)$  has the homotopy type of a CW pair  $(K^{n-2}, \partial V_1)$ , where  $C = V_1 - \overset{\circ}{V}_2$ .*

PROOF: By Van Kampen's theorem,  $\pi_1 \partial V_2 \rightarrow \pi_1 C$  is an isomorphism. Starting with a handle decomposition of  $(C, \partial V_2)$ , we may therefore trade away all of the 0- and 1-handles as in the proof of the  $s$ -cobordism theorem. The dual handle decomposition of  $(C, \partial V_1)$  has handles of index  $0 \dots n-2$ . Collapsing to the underlying  $(n-2)$ -dimensional CW complex completes the proof. ■

PROPOSITION 12.28. *Let  $M^n$ ,  $n \geq 5$  be a 1-ended manifold with compact boundary which is tame at infinity with  $\pi_1$  stable at infinity. If  $V$  is a clean neighborhood of infinity with  $V$  and  $\partial V$  connected and  $\pi_1 \partial V \cong \pi_1 V \cong \pi_1 \epsilon$ , then  $(V, \partial V)$  is homotopy dominated rel  $\partial V$  to a finite CW pair  $(K^{n-2}, \partial V)$ .*

PROOF: This follows immediately from the lemma above by a direct limit argument. ■

PROPOSITION 12.29. *Let  $M^n$ ,  $n \geq 5$  be a 1-ended manifold with compact boundary which is tame at infinity with  $\pi_1$  stable at infinity. If  $V$  is a clean neighborhood of infinity with  $V$  and  $\partial V$  connected and  $\pi_1 \partial V \cong \pi_1 V \cong \pi_1 \epsilon$ , and  $H_k(\tilde{V}, \partial \tilde{V}) = 0$ ,  $k \neq n - 2$ , then  $H_{n-2}(\tilde{V}, \partial \tilde{V})$  is a finitely generated projective module over  $\mathbb{Z}\pi$ .*

PROOF: By the above,  $(\tilde{V}, \partial \tilde{V})$  is homotopy equivalent to a CW pair  $(\tilde{K}^{n-2}, \partial \tilde{V})$ . By cell-trading, we may assume that  $K^{n-2} = \partial V \cup \{e_i^{n-3}\} \cup \{e_j^{n-2}\}$ . The chain complex  $C_*(\tilde{K}, \partial \tilde{V})$  is then

$$0 \rightarrow C_{n-2}(\tilde{K}, \partial \tilde{V}) \rightarrow C_{n-3}(\tilde{K}, \partial \tilde{V}) \rightarrow 0$$

Since  $H_{n-3}(\tilde{K}, \partial \tilde{V}) = 0$ , the boundary map splits and it follows immediately that  $H_{n-2}(\tilde{K}, \partial \tilde{V})$  is projective. That  $H_{n-2}(\tilde{K}, \partial \tilde{V})$  is finitely generated follows as in Lemma 12.24. ■

REMARK 12.30. Since the chain complexes for  $(V, \partial V)$  and  $V$  differ by the chain complex of the finite complex  $\partial V$ , it follows immediately from the Euler characteristic definition of the finiteness obstruction that  $[H_{n-2}(\tilde{K}, \partial \tilde{V})] = (-1)^n \sigma(V)$ . It follows from the sum theorem for the finiteness obstruction, which we will discuss in due course, that  $[H_{n-2}(\tilde{V}, \partial \tilde{V})] \in \tilde{K}_0(\mathbb{Z}\pi)$  is independent of the choice of  $V$ .

DEFINITION 12.31. Let  $M^n$ ,  $n \geq 6$  be a 1-ended manifold with compact boundary which is tame at infinity with  $\pi_1$  stable at infinity. If  $V$  is a clean neighborhood of infinity with  $V$  and  $\partial V$  connected and  $\pi_1 \partial V \xrightarrow{\cong} \pi_1 V$ , and  $H_k(\tilde{V}, \partial \tilde{V}) = 0$ ,  $k \neq n - 2$ , we define  $\sigma(\epsilon)$  to be the class of  $H_{n-2}(\tilde{V}, \partial \tilde{V}) \in \tilde{K}_0(\mathbb{Z}\pi)$ .

It remains to show that  $M$  admits a boundary if the obstruction  $\sigma(\epsilon)$  vanishes. The basic idea is the same as before. We stabilize by excising trivial  $(n - 3)$ -handles from  $V$ . This allows us to assume that  $H_{n-2}(\tilde{V}, \partial \tilde{V})$  is free. Next, we introduce trivial handles and use handle additions and the Whitney trick to create a collection of new handles representing a basis for  $H_{n-2}(\tilde{V}, \partial \tilde{V})$ . This all follows the corresponding steps in the proof of the  $s$ -cobordism theorem. After excising these handles to form a new manifold  $V'$ , we will be done once we show that  $\partial V' \rightarrow V'$  induces an isomorphism on  $\pi_1$ . Notice that this is no longer an automatic consequence of general position, since we are excising handles whose cores are  $(n - 2)$ -dimensional.

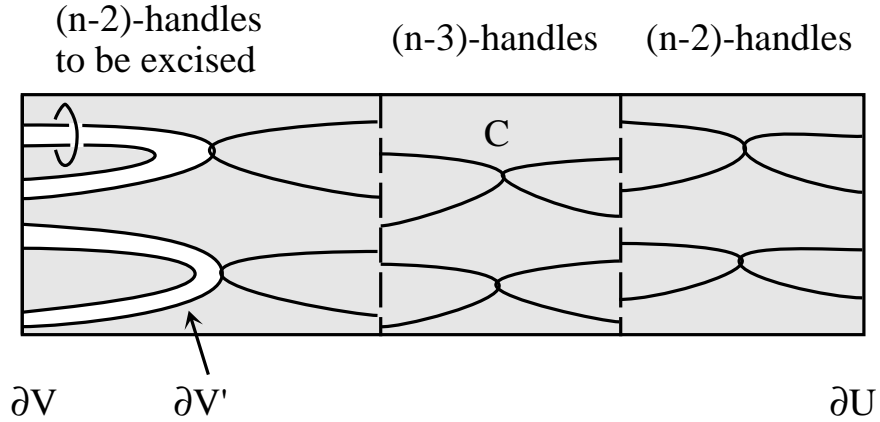

As before, choose a clean neighborhood  $U$  of infinity with  $\pi_1 \partial U \rightarrow \pi_1 U \rightarrow \pi_1(\epsilon)$  isomorphisms and let  $C = V - \overset{\circ}{U}$ . First, we note that  $\pi_1 \partial V' \cong \pi_1 C \cap V'$ , since  $C \cap V'$  is obtained from  $\partial V'$  by attaching  $(n-2)$ - and  $(n-3)$ -handles. On the other hand,  $C \cap V'$  is obtained from  $\partial U$  by attaching 2- and 3-handles. Moreover,  $C$  is obtained by attaching even more 2-handles to  $C \cap V'$ . Since  $\pi_1 \partial U \xrightarrow{\cong} \pi_1 C$ , all of these 2-handles are trivially attached and  $\pi_1 \partial U \xrightarrow{\cong} \pi_1 C \cap V'$ . Thus,  $\partial V' \rightarrow V'$  induces a  $\pi_1$ -isomorphism and we have produced arbitrarily small neighborhoods  $V'$  of  $\infty$  with  $\partial V' \rightarrow V'$  a homotopy equivalence. ■

#### THE SUM THEOREM FOR THE FINITENESS OBSTRUCTION

**THEOREM 12.32 (SIEBENMANN).** *If  $X$  is a CW complex with subcomplexes  $X_1, X_2$ , and  $X_0 = X_1 \cap X_2$  such that each  $X_i$  is finitely dominated, then  $\bar{\sigma}(X) = i_{1*} \bar{\sigma}(X_1) + i_{2*} \bar{\sigma}(X_2) - i_{0*} \bar{\sigma}(X_0)$ , where  $i_{j*} : K_0(\mathbb{Z}\pi_1 X_j) \rightarrow K_0(\mathbb{Z}\pi_1 X)$  is the inclusion induced map.*

**PROOF:** By Remark 8.40, each of the  $X_i$ 's may be thought of as the union of a finite complex  $K_i$  together with infinitely many bouquets of  $S^2$ 's and infinitely many  $D^3$ 's.  $X$  is then homotopy equivalent to the double mapping cylinder of  $X_0 \rightarrow X_1$  and  $X_0 \rightarrow X_2$ . The theorem is then self-evident, since the cells representing the projective on  $X_0$  appear only once in the double mapping cylinder. ■

**REMARK 12.33.** Another way to see this is to note that if  $d_i : K_i \rightarrow X_i$  is a domination with right inverse  $u_i$  and  $j_i : X_0 \rightarrow X_i$  is the inclusion, then we have a homotopy

commuting diagram

$$\begin{array}{ccccc}
 K_1 & \xleftarrow{u_1 \circ j_1 \circ d_0} & K_0 & \xrightarrow{u_2 \circ j_2 \circ d_0} & K_2 \\
 d_1 \updownarrow u_1 & & d_0 \updownarrow u_0 & & d_2 \updownarrow u_2 \\
 X_1 & \xleftarrow{j_1} & X_0 & \xrightarrow{j_2} & X_2.
 \end{array}$$

This leads to maps between the double mapping cylinders as pictured below. We see that the double mapping cylinder composed of  $K_i$ 's dominates the one composed of  $X_i$ 's, since the compositions up and down on each of the  $X_i$ 's is homotopic to the identity, the composition on the entire double mapping cylinder is a homotopy equivalence and that the map down is a domination.

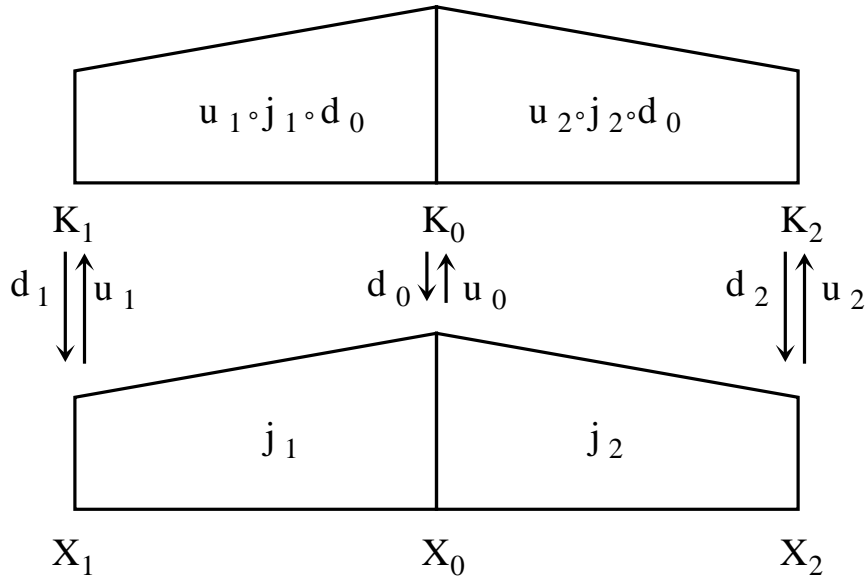

It is now easy to compute the kernel of this domination in terms of the kernels of the original  $d_i$ 's, proving the sum theorem.

REMARK 12.34. The sum theorem shows that the obstruction to adding a boundary can be measured in any  $V_i$  for which  $\pi_1 \partial V_i \cong \pi_1 V_i \cong \pi_1 \epsilon$ , since if  $V_2 \subset V_1$  is another such neighborhood, then  $\sigma(V_1) = \sigma(V_2) + \sigma(V_1 - \overset{\circ}{V}_2) - \sigma(\partial V_2) = \sigma(V_2)$ , since the other two complexes are finite.

REFERENCES

- [BLL] W. Browder, J. Levine and R. Livesay, *Finding a boundary for an open manifold*, American J of Math **87** (1965), 1017–1028.
- [Si] L.C. Siebenmann, *The obstruction to finding a boundary for an open manifold of dimension greater than 5*, Ph. D. thesis, Princeton University, 1965.
- [RS] C. Rourke and B. Sanderson, *Introduction to Piecewise-Linear Topology*, Springer Verlag, New York, Berlin, 1982.

### Chapter 13. Torus trickery 101 - local contractibility

**THEOREM 13.1** (ČERNAVSKII, KIRBY). *Given  $n$ , there is an  $\epsilon_n > 0$  so that if  $\alpha : \mathbb{R}^n \rightarrow \mathbb{R}^n$  is a homeomorphism such that  $\|\alpha(x) - x\| < \epsilon_n$  for  $x \in B^n$ , then  $\alpha$  is stable. In particular,  $\alpha$  is isotopic to the identity.*

We begin with a statement of the Generalized Schoenflies Theorem for the torus.

**PROPOSITION 13.2.** *Let  $S^{n-1} \subset T^n$  be a bicollared sphere,  $n \geq 2$ . Then  $S^{n-1}$  bounds a disk in  $T^n$ .*

**PROOF:** Pass to the universal cover. By the Generalized Schoenflies Theorem, each lift of  $S^{n-1}$  bounds a disk which projects to a disk in  $T^n$  bounded by the original  $S^{n-1}$ . ■

**DEFINITION 13.3.** A map  $\beta : M^n \rightarrow N^n$  is an *immersion* if for each  $x \in M$  there is a neighborhood  $U$  of  $x$  so that  $\beta|U$  is a homeomorphism.

**PROPOSITION 13.4** (SMALE). *If  $M$  is a smooth  $n$ -manifold with no closed components, then  $M$  immerses in  $\mathbb{R}^n$  if and only if the tangent bundle of  $M$  is trivial. In particular, there is an immersion  $\beta : T^n - \{pt\} \rightarrow \mathbb{R}^n$ .*

This is a special case of Smale's general immersion theory, which shows that for  $M$  a smooth  $n$ -manifold with no closed components, regular homotopy classes of immersions  $i : M^n \rightarrow N^n$  are in one-to-one correspondence with homotopy classes of bundle maps

$$\begin{array}{ccc} TM & \xrightarrow{\hat{f}} & TN \\ \downarrow & & \downarrow \\ M & \xrightarrow{f} & N \end{array}$$

such that the restriction of  $\hat{f}$  to each fiber  $TM_m$  is nonsingular. At the end of this section, we will give an explicit construction of a smooth immersion  $\beta : T^n - \{pt\} \rightarrow \mathbb{R}^n$ . A PL immersion may be found on pp. 290-292 of [Rus]. Here is a picture of an immersed  $T^2 - \{pt\} \subset \mathbb{R}^2$ .

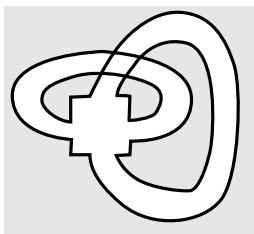

PROOF OF THEOREM: We will think of  $S^1$  as being  $[0, 2]/\{0 \sim 2\}$ , so  $[0, 1] \subset S^1$ . Then  $[0, 1]^n \subset T^n - \{pt\}$ . Choose a small ball  $B' \subset T^n$  so that  $\beta|_{B'}$  is a homeomorphism and let  $B'' = \beta(B')$ . Choosing homeomorphisms  $h : T^n - \{pt\} \rightarrow T^n - \{pt\}$  and  $k : \mathbb{R}^n \rightarrow \mathbb{R}^n$  so that  $h(B') = [0, 1]^n$  and  $k(B'') = B$ , the unit cube,  $k \circ \beta \circ h^{-1}$  is an immersion  $T^n - \{pt\} \rightarrow \mathbb{R}^n$  which is the “identity” on  $[0, 1]^n = B$ . After a radial squeeze, we can assume that  $\beta(T^n - \{pt\}) \subset 2B^n$ .

Choose balls  $D^n \subset 2D^n$  centered at  $\{pt\}$  and disjoint from  $B$  in  $T^n$ .

- (i) Choose  $\epsilon_1 > 0$  so that  $\beta|_{B(\epsilon_1, x)}$  is a homeomorphism for each  $x \in T^n - \overset{\circ}{D}^n$ .
- (ii) Choose  $\epsilon_2 > 0$  so that  $\beta(B(\epsilon_1, x)) \supset B(\epsilon_2, \beta(x))$  for each  $x \in T^n - \overset{\circ}{D}^n$ .
- (iii) Choose  $\epsilon_3 > 0$  so that  $\epsilon_3 < \epsilon_2$  and so that if  $\|y - \beta(x)\| < \epsilon_3$ ,  $x \in T^n - 2\overset{\circ}{D}^n$ , then  $y \in \beta(T^n - \overset{\circ}{D}^n)$ .

If  $\|\alpha(x) - x\| < \epsilon_3/2$  on  $2B^n$ , then the formula

$$\bar{\alpha}(x) = (\beta|_{B(\epsilon_1, x)})^{-1} \circ \alpha \circ (\beta|_{B(\epsilon_1, x)})(x)$$

defines a “lift”  $\bar{\alpha}$  of  $\alpha$  making the diagram below commute.

$$\begin{array}{ccc} T^n - \overset{\circ}{D}^n & \xleftarrow{\bar{\alpha}} & T^n - 2\overset{\circ}{D}^n \\ \downarrow \beta & & \downarrow \beta \\ \mathbb{R}^n & \xrightarrow{\alpha} & \mathbb{R}^n \end{array}$$

Our convention that  $\beta$  identifies  $B \subset T^n$  with  $B \subset \mathbb{R}^n$  allows us to say that  $\bar{\alpha} = \alpha$  on  $(1 - \epsilon_3)B$ . By Proposition 13.2,  $\bar{\alpha}(\partial D^n)$  bounds a disk in  $T^n$ . We can therefore extend  $\bar{\alpha}$  to a homeomorphism  $\hat{\alpha} : T^n \rightarrow T^n$  with  $\hat{\alpha} = \alpha$  on  $(1 - \epsilon_3)B$ . The result is a diagram:

$$\begin{array}{ccc} T^n & \xleftarrow{\hat{\alpha}} & T^n \\ \uparrow & & \uparrow \\ T^n - \overset{\circ}{D}^n & \xleftarrow{\bar{\alpha}} & T^n - 2\overset{\circ}{D}^n \\ \downarrow \beta & & \downarrow \beta \\ \mathbb{R}^n & \xrightarrow{\alpha} & \mathbb{R}^n. \end{array}$$

We now pass to the universal cover, choosing  $e : \mathbb{R}^n \rightarrow T^n$  so that  $B = [0, 1]^n \subset \mathbb{R}^n$  is



mapped onto  $B \subset T^n$  by the “identity.” The result is a diagram

$$\begin{array}{ccc}
 \mathbb{R}^n & \xrightarrow{\tilde{\alpha}} & \mathbb{R}^n \\
 \downarrow e & & \downarrow e \\
 T^n & \xrightarrow{\hat{\alpha}} & T^n \\
 \uparrow & & \uparrow \\
 T^n - \overset{\circ}{D}^n & \xleftarrow{\bar{\alpha}} & T^n - 2\overset{\circ}{D}^n \\
 \downarrow \beta & & \downarrow \beta \\
 \mathbb{R}^n & \xrightarrow{\alpha} & \mathbb{R}^n
 \end{array}$$

with  $\tilde{\alpha} = \alpha$  on  $(1 - \epsilon_3)B$ .

The homeomorphism  $\tilde{\alpha}$  is bounded, and therefore stable, so the original homeomorphism  $\alpha$ , which agrees with  $\tilde{\alpha}$  on an open set, is also stable. ■

REMARK 13.5. Stable homeomorphisms of  $\mathbb{R}^n$  are isotopic to the identity. If  $h : \mathbb{R}^n \rightarrow \mathbb{R}^n$  is fixed on a ball  $B$ , we can extend to  $S^n$  by one-point compactifying and then use an Alexander isotopy on  $h|S^n - \overset{\circ}{B}^n$  coning from infinity to isotop  $h$  to the identity. The entire Theorem 13.1 can be done canonically in such a way that it continuously deforms homeomorphisms of  $\mathbb{R}^n$  which are sufficiently close to the identity back to the identity. This leads to a proof that the homeomorphism group of  $\mathbb{R}^n$  is locally contractible. See [Rus] for details.

Several stronger theorems are known. Reference [EK] contains elegant proofs of the following:

THEOREM 13.6 ([CER]). *The homeomorphism group  $\mathcal{H}(M)$  of a compact manifold is locally contractible.*

THEOREM 13.7. *Let  $h_t : C \rightarrow M, t \in I$  be a proper isotopy of a compact subset  $C$  of a manifold  $M$  such that  $h_t$  has a proper extension to a neighborhood  $U$  of  $C$ . Then  $h_t$  can be covered by an ambient isotopy of  $M$ , that is, there is an isotopy  $H_t : M \rightarrow M$  such that  $H_0 = 1_M$  and  $h_t = H_t \circ h_0$  for all  $t$ .*

DEFINITION 13.8. If  $h_t : M \rightarrow M, t \in I$  is an isotopy of  $M$  and  $B$  is a subset of  $M$ , then  $h_t$  is supported by  $B$  if  $h_t|_{M - B} = 1$  for all  $t$ .

THEOREM 13.9. *Let  $h_t : M \rightarrow M, t \in I$  be an isotopy of a compact manifold  $M$  and let  $\{B_i | 1 \leq i \leq p\}$  be an open cover of  $M$ . Then  $h_t$  can be written as a composition of*

isotopies  $h_t = h_{k,t} \circ \dots \circ h_{1,t} \circ h_0$  where each isotopy  $h_{j,t} : M \rightarrow M$  is an ambient isotopy which is supported by some member of  $\{B_i\}$ .

Theorem 13.6 suggests the following well-known open question:

QUESTION 13.10 (THE HOMEOMORPHISM GROUP PROBLEM). *Is the homeomorphism group of a compact topological  $n$ -manifold an ANR?*

The answer is known to be “yes” for  $n = 2$  and for Hilbert cube manifolds. In general, the results of Edwards-Kirby referred to above can be used to reduce the question to whether  $\mathcal{H}(D^n, \partial D^n) = \{h : D^n \rightarrow D^n \mid h|_{\partial} = id\}$  is an ANR. An affirmative answer to the question implies that  $\mathcal{H}(M)$  is a manifold modeled on separable Hilbert space.

#### AN EXPLICIT IMMERSION

Elements of  $T^n$  will be written as  $\theta = (\theta_1, \dots, \theta_n)$  with  $\theta_i \in S^1$ .

LEMMA 13.11. *Let  $(\theta, t) \rightarrow (f_1(\theta, t), \dots, f_{n+1}(\theta, t))$  be an embedding of  $T^n \times (-1, 1)$  into  $\mathbb{R}^{n+1}$  with  $f_{n+1}(\theta, t) > 0$ . The map of  $T^{n+1} \times (-1, 1)$  into  $\mathbb{R}^{n+2}$  defined by*

$$(\theta, t) \rightarrow (f_1(\theta, t), \dots, f_n(\theta, t), f_{n+1}(\theta, t)\cos \theta_{n+1}, f_{n+1}(\theta, t)\sin \theta_{n+1})$$

*is an embedding. ■*

DEFINITION 13.12. The *standard embedding* of  $T^n \times (-1, 1) \rightarrow \mathbb{R}^{n+1}$  is the embedding obtained by starting with  $(\theta_1, t) \rightarrow ((1+t)\cos \theta_1, (1+t)\sin \theta_1 + 2)$  and iterating the process described in the lemma above. At each stage we must add 2 to the last term so that the condition  $f_{n+1}(\theta, t) > 0$  will be satisfied.

As an example, for the standard embedding of  $T^3 \times (-1, 1) \rightarrow \mathbb{R}^4$ , we have

$$f_3(\theta, t) = (((1+t)\sin \theta_1 + 2)\sin \theta_2 + 4)\cos \theta_3$$

and

$$f_3(\theta, t) = (((1+t)\sin \theta_1 + 2)\sin \theta_2 + 4)\sin \theta_3 + 8$$

Let  $S \subset T^n$  be the set of  $\theta$  such that  $\theta_i = 0$  for some  $i$  and let

$$\phi(\theta) = \frac{\sin \theta_1 \dots \sin \theta_n}{2^n} + \frac{\sin \theta_2 \dots \sin \theta_n}{2^{n-1}} + \dots + \frac{\sin \theta_n}{2}$$

THEOREM 13.13. *Let  $(\theta, t) \rightarrow (f_1(\theta, t), \dots, f_{n+1}(\theta, t))$  be the standard embedding of  $T^n \times (-1, 1)$  into  $\mathbb{R}^{n+1}$ . For some  $\epsilon > 0$  the map  $\theta \rightarrow (f_1(\theta, \epsilon\phi(\theta)), \dots, f_{n+1}(\theta, \epsilon\phi(\theta)))$  has nonsingular Jacobian on  $S$ . It therefore immerses a regular neighborhood of  $S$ , and therefore of  $T^n - D^n$  into  $\mathbb{R}^n$ .*

PROOF: We compute:

$$\begin{aligned}
\det \left( \frac{\partial f_i}{\partial \theta_j} + \epsilon \frac{\partial f_i}{\partial t} \frac{\partial \phi}{\partial \theta_j} \right) \Big|_{\substack{\theta \in S \\ t = \epsilon \phi}} &= \det \begin{pmatrix} \frac{\partial f_i}{\partial \theta_j} + \epsilon \frac{\partial f_i}{\partial t} \frac{\partial \phi}{\partial \theta_j} & 0 \\ \frac{\partial \phi}{\partial \theta_j} & 1 \end{pmatrix} \Big|_{\substack{\theta \in S \\ t = \epsilon \phi}} \\
&= \det \begin{pmatrix} \frac{\partial f_i}{\partial \theta_j} & -\epsilon \frac{\partial f_i}{\partial \theta_j} \\ \frac{\partial \phi}{\partial \theta_j} & 1 \end{pmatrix} \Big|_{\substack{\theta \in S \\ t = \epsilon \phi}} \\
&= \det \begin{pmatrix} \frac{\partial f_i}{\partial \theta_j} & -\epsilon \frac{\partial f_i}{\partial \theta_j} \\ \frac{\partial \phi}{\partial \theta_j} & 0 \end{pmatrix} \Big|_{\substack{\theta \in S \\ t = \epsilon \phi}} + \det \begin{pmatrix} \frac{\partial f_i}{\partial \theta_j} & -\epsilon \frac{\partial f_i}{\partial \theta_j} \\ 0 & 1 \end{pmatrix} \Big|_{\substack{\theta \in S \\ t = \epsilon \phi}}
\end{aligned}$$

By construction,  $f_i$  involves only  $\theta_1, \dots, \theta_i$  and  $\frac{\partial f_i}{\partial \theta_i}$  has a factor of  $\sin \theta_i$ . Thus, on  $S$ , the upper left hand corner of the second matrix is triangular with at least one 0 on the diagonal. We have

$$\det \left( \frac{\partial f_i}{\partial \theta_j} + \epsilon \frac{\partial f_i}{\partial t} \frac{\partial \phi}{\partial \theta_j} \right) \Big|_{\substack{\theta \in S \\ t = \epsilon \phi}} = -\epsilon \det \begin{pmatrix} \frac{\partial f_i}{\partial \theta_j} & \frac{\partial f_i}{\partial \theta_j} \\ \frac{\partial \phi}{\partial \theta_j} & 0 \end{pmatrix} \Big|_{\substack{\theta \in S \\ t = \epsilon \phi}}$$

Notice that  $f_{n+1}(\theta, 0) = 2^n \phi(\theta)$  and that  $\frac{\partial f_{n+1}}{\partial t}$  is identically zero on  $S$ . Thus, if the above determinant is evaluated at  $\theta \in S$ ,  $t = 0$ , it is  $\left(\frac{-\epsilon}{2^n}\right)$  times the determinant of the standard embedding. It is therefore nonsingular when evaluated at  $\theta \in S$ ,  $t = \epsilon \phi$  for sufficiently small  $\epsilon$ . This completes the proof. ■

REMARK 13.14. This immersion is taken from [F].

#### REFERENCES

- [Č] A. V. Černavskii, *Local contractibility of the group of homeomorphisms of a manifold*, math. Sb. **8** (1969), 287–333.
- [EK] R. D. Edwards and R. C. Kirby, *Deformations of spaces of imbeddings*, Ann. Math. **93** (1971), 63–88.
- [F] S. C. Ferry, *An immersion of  $T^n - D^n$  into  $R^n$* , L'Enseignement Mathematique **29** (1974), 12–13.
- [Rus] T.B. Rushing, *Topological Embeddings*, Academic Press, New York, 1970.

## Chapter 14. Torus trickery 102 – the Annulus Conjecture

In this section, we outline Kirby’s proof of the annulus conjecture. We say “outline” because the proof relies heavily on the following result, which we will not prove.

**THEOREM 14.1** (HSIANG-SHANESON [HS], WALL [WA, P. §15A]). *If  $W^n$ ,  $n \geq 5$  is a PL manifold and  $f : W \rightarrow T^n$  is a homotopy equivalence, then there is a commuting diagram of  $2^n$ -fold covering spaces*

$$\begin{array}{ccc} \widehat{W} & \xrightarrow{\hat{f}} & T^n \\ \downarrow 2^n & & \downarrow 2^n \\ W & \xrightarrow{f} & T^n \end{array}$$

so that  $\hat{f}$  is homotopic to a PL homeomorphism.

Before proceeding with Kirby’s proof, the reader unfamiliar with the pullback construction is urged to work the following exercise.

**DEFINITION 14.2.** If  $f : A \rightarrow C$  and  $g : B \rightarrow C$  are maps, the *pullback* of  $f$  and  $g$  is the subset  $P = \{(a, b) \in A \times B \mid f(a) = g(b)\}$ . We have a commuting diagram

$$\begin{array}{ccc} P & \xrightarrow{f^*} & B \\ \downarrow g^* & & \downarrow g \\ A & \xrightarrow{f} & C \end{array}$$

where the maps  $f^*$  and  $g^*$  are induced by projection.

**EXERCISE 14.3.**

- (i) Show that if  $P'$  is a space with maps  $f' : P' \rightarrow B$ ,  $g' : P' \rightarrow A$  so that  $g \circ f' = f' \circ g^*$ , then there is a unique map  $P' \rightarrow P$  making the diagram below commute.

$$\begin{array}{ccccc} & & & & \\ & & & & \\ & & & & \\ & & & & \\ P' & \xrightarrow{f'} & & & \\ & \searrow & & & \\ & & P & \xrightarrow{f^*} & B \\ & \searrow g' & \downarrow g^* & & \downarrow g \\ & & A & \xrightarrow{f} & C \end{array}$$

- (ii) Each point-inverse of  $f^*$  is homeomorphic to some point-inverse of  $f$  and each point-inverse of  $g^*$  is homeomorphic to some point-inverse of  $g$ .
- (iii) If  $f$  is proper, i.e., if the inverse image under  $f$  of a compact set is compact, then  $f^*$  is also proper.
- (iv) If  $A$  and  $B$  are polyhedra and  $f$  and  $g$  are PL, then  $P$  is a polyhedron and  $f^*$  and  $g^*$  are PL.
- (v) If  $g$  is a covering projection, then  $g^*$  is also a covering projection.

THEOREM 14.4 (KIRBY [K]). *Every orientation-preserving homeomorphism of  $\mathbb{R}^n$  is stable for  $n \geq 5$ .*

PROOF: The proof follows easily from the diagram below, which we now explain.

$$\begin{array}{ccccc}
 \mathbb{R}^n & \xrightarrow[\text{PL}]{\tilde{g}^{-1}} & \widetilde{W}^{PL} & \xrightarrow{\tilde{h}_1} & \mathbb{R}^n \\
 \downarrow & & \downarrow & & \downarrow \\
 T^n & \xrightarrow[\text{PL}]{g^{-1}} & \widehat{W}_1^{PL} & \xrightarrow{\hat{h}_1} & T^n \\
 & & \downarrow 2^n & & \downarrow 2^n \\
 & & W_1^{PL} & \xrightarrow{h_1} & T^n \\
 & & \uparrow & & \uparrow \\
 & & W_0^{PL} & \xrightarrow{h_0} & T^n - \{pt\} \\
 & & \downarrow \beta'^{PL} & & \downarrow \beta^{PL} \\
 \mathbb{R}^n & \xrightarrow{h} & \mathbb{R}^n & & \mathbb{R}^n
 \end{array}$$

Let  $h : \mathbb{R}^n \rightarrow \mathbb{R}^n$  be a homeomorphism and let  $\beta : T^n - \{pt\} \rightarrow \mathbb{R}^n$  be a PL immersion which, as before, is the identity on  $B^n$ . Let  $W_0$  be the pullback of  $\beta$  over  $h$  with  $\beta' : W \rightarrow \mathbb{R}^n$  and  $h_0 : W_0 \rightarrow T^n - \{pt\}$  the natural maps. The map  $\beta'$  is an immersion (see Lemma 14.5 below) so  $W_0$  is a PL manifold with PL coordinate patches obtained by restricting  $\beta'$ . Since  $\beta|_B = id$ ,  $\beta'|_{h^{-1}(B)}$  can be thought of as the identity. With this convention,  $h_0$  is a topological homeomorphism which is equal to  $h$  on  $h^{-1}(B)$ .

The end of  $W_0$  is homeomorphic to  $S^{n-1} \times [0, \infty)$ , so it is tame. If  $n \geq 6$ , by Browder-Livesay-Levine,  $W_0$  admits a PL boundary which, by the Generalized Poincaré Conjecture, must be a PL sphere. For  $n = 5$ , we use a theorem of Wall [Wa], which says that a PL manifold which is homeomorphic to  $S^4 \times \mathbb{R}$  is PL homeomorphic to  $S^4 \times \mathbb{R}$ .

Cutting back a little bit and coning now allows us to extend  $h_0$  to a homeomorphism  $h_1 : W_1 \rightarrow T^n$ . We now apply Hsiang-Shaneson-Wall to conclude that after passage to a finite cover, there is a PL homeomorphism  $g : \widehat{W}_1 \rightarrow T^n$  which is homotopic to  $\hat{h}_1^{-1}$ . Lifting to the universal covers gives us the top row of the diagram.

The homeomorphism  $\tilde{g}^{-1}$  is PL, and therefore stable. The homeomorphism  $\tilde{h}_1 \circ \tilde{g}^{-1}$  is bounded because it covers a homeomorphism of  $T^n$  which is homotopic to the identity. Therefore, the homeomorphism  $\tilde{h}_1$  is stable. But  $\tilde{h}_1$  agrees with  $h$  on  $h^{-1}(B)$ , so  $h$  is stable. ■

LEMMA 14.5. *The pullback of an open immersion is an immersion.*

PROOF: Consider a pullback diagram

$$\begin{array}{ccc} P & \longrightarrow & Q \\ \downarrow \beta' & & \downarrow \beta \\ R & \xrightarrow{f} & S \end{array}$$

with  $\beta$  an immersion. Given  $q \in Q$ , choose a neighborhood  $U$  of  $q$  in  $Q$  such that  $\beta|_U$  is a homeomorphism. If  $r \in R$  with  $f(r) = \beta(q)$ , choose a neighborhood  $V$  of  $r$  with  $f(V) \subset \beta(U)$ . Then  $(V \times U) \cap P = \{(v, (\beta|_U)^{-1}(f(r)))\}$  is an open neighborhood of  $(r, q) \in P$  such that  $\beta'|_{(V \times U)}$  is an immersion. ■

#### REFERENCES

- [BLL] W. Browder, J. Levine and R. Livesay, *Finding a boundary for an open manifold*, American J of Math **87** (1965), 1017–1028.
- [HS] W.-C. Hsiang and J. Shaneson, *Fake tori, the annulus conjecture and the conjectures of Kirby*, Proc. Nat. Acad. Sci. U.S.A. **62** (1969), 687–691.
- [Sha] J. Shaneson, *Wall's surgery obstruction groups for  $\mathbb{Z} \times G$* , Ann. Math. **90** (1969), 296–334.
- [K] R. C. Kirby, *Stable homeomorphisms and the annulus conjecture*, Ann. Math. **89** (1969), 575–582.
- [Wa] C.T.C. Wall, *On bundles over a sphere with a fiber euclidean space*, Fund. Math. **61** (1967), 57-72.

## Chapter 15. Homotopy structures on manifolds

In this section and the next, we will say a few words about *surgery theory*, which is the machinery used in proving the theorem of Hsiang and Shaneson used in the last section. A basic object of study in surgery theory is the set of homotopy structures on a manifold  $M$ . Here is the definition.

DEFINITION 15.1. If  $M$  is a PL manifold, a *homotopy PL structure on  $M$*  is a PL manifold  $N$  together with a homotopy equivalence  $f : N \rightarrow M$ . Structures  $(N, f)$  and  $(N', f')$  are *equivalent* if there is a PL homeomorphism  $\phi : N \rightarrow N'$  so that  $f' \circ \phi$  is homotopic to  $f$ .

$$\begin{array}{ccc}
 N & \xrightarrow{f} & M \\
 \phi \cong \downarrow & & \nearrow f' \\
 N' & & 
 \end{array}$$

We denote the set of equivalence classes of PL structures on  $M$  by  $\mathcal{S}^{PL}(M)$ . In words, a homotopy structure on  $M$  is a homotopy equivalence from a manifold  $N$  to  $M$ . Two of these are equivalent if there is a homeomorphism from one to the other making the diagram homotopy commute.

For  $n \geq 5$ ,  $\mathcal{S}^{PL}(M)$  can often be calculated using the *Sullivan-Wall surgery exact sequence* [Br, p. 49], [W, pp. 107-108], [Su]:

$$\dots \longrightarrow [M \times I, M \times \partial I; G/PL] \longrightarrow L_{n+1}(\mathbb{Z}\pi_1(M)) \xrightarrow{\text{act}\xi} \mathcal{S}^{PL}(M) \longrightarrow [M; G/PL] \longrightarrow L_n(\mathbb{Z}\pi_1(M)).$$

In case  $M$  is simply connected, the Wall groups  $L_n(\mathbb{Z}\pi_1(M))$  are:

$$L_n(e) = \begin{cases} 0 & n \text{ odd} \\ \mathbb{Z} & n = 4k \\ \mathbb{Z}_2 & n = 4k + 2. \end{cases}$$

The computation of these groups follows from Kervaire-Milnor [KM].

The reader should be warned that since  $\mathcal{S}^{PL}(M)$  has no obvious group structure, this is an exact sequence of *sets* at the term  $\mathcal{S}^{PL}(M)$ <sup>17</sup> in the sense that there is an action

---

<sup>17</sup> Actually, this is a sequence of groups and homomorphisms. See 25.7. The corresponding sequence in DIFF is not known to be a sequence of groups and homomorphisms.

of  $L_{n+1}(\mathbb{Z}\pi_1(M))$  on  $\mathcal{S}^{PL}(M)$  and two elements of  $\mathcal{S}^{PL}(M)$  go to the same element of  $[M; G/PL]$  if and only if they are in the same orbit of the action of  $L_{n+1}(\mathbb{Z}\pi_1(M))$ . This still provides quite a bit of information. Letting  $M = S^n$  and using the fact that the Generalized Poincaré Conjecture gives  $\mathcal{S}^{PL}(S^n) = 1$  for  $n \geq 5$ , we see that  $\pi_n(G/PL)$  injects into  $L_n(e)$  and that  $\pi_{n+1}(G/PL)$  surjects onto  $L_{n+1}(e)$ . Thus, the homotopy groups of  $G/PL$  are isomorphic to the surgery groups  $L_n(e)$  in high dimensions. A more careful argument [MM, p. 43] shows that the map  $[S^n; G/PL] \rightarrow L_n(e)$  is an isomorphism for  $n \geq 5$ .

The surgery exact sequence for  $T^n$  is

$$[T^n \times I, \partial; G/PL] \rightarrow L_{n+1}(\mathbb{Z}\mathbb{Z}^n) \rightarrow \mathcal{S}^{PL}(T^n) \rightarrow [T^n, G/PL] \rightarrow L_n(\mathbb{Z}\mathbb{Z}^n).$$

One can show that there is a space  $B(G/PL)$  so that  $G/PL$  is homotopy equivalent to  $\Omega B(G/PL)$ , so ignoring low-dimensional problems, we have

$$[T^n, G/PL] = [T^n, \Omega B(G/PL)] = [\Sigma T^n, B(G/PL)] = [\bigvee_{i=1}^n \binom{n}{i} S^i, G/PL] = \bigoplus_{i=1}^n \binom{n}{i} \pi_i(G/PL).$$

The group  $L_n(\mathbb{Z}\mathbb{Z}^n)$  was computed in Shaneson's thesis [Sha] and turns out to be the same. This is a clever splitting argument. The remaining problem in proving the theorem of Hsiang-Shaneson and Wall is to understand the maps  $[T^n, G/PL] \rightarrow L_n(\mathbb{Z}\mathbb{Z}^n)$  and  $[T^n \times I, \partial; G/PL] \rightarrow L_{n+1}(\mathbb{Z}\mathbb{Z}^n)$  in the surgery exact sequence. The map turns out to be multiplication by 2 on  $\pi_4$ , so there is potentially a nonzero obstruction. That obstruction is eliminated by passing to a suitable finite cover. We will not go into that part of the argument here.

Next, we try to give a quick idea of how the Sullivan-Wall sequence is derived. The basic tool is surgery theory. A very nice survey of surgery theory is contained in the first three chapters of Shmuel Weinberger's upcoming book *The topological classification of stratified spaces*.

A *surgery problem* is a degree one map  $f : N \rightarrow M$ ,<sup>18</sup>  $N, M$  closed manifolds, which is covered by a map of normal bundles in  $\mathbb{R}^k$ ,  $k$  large. The bundle map is part of the data. A *solution* to a surgery problem is

---

<sup>18</sup>I lied here. In general, the target space is a Poincaré Duality space rather than a manifold. The reason I lied is that the bundle theory is more difficult to describe in the Poincaré case, so this seems an inappropriate level of generality for a quick sketch. The theory with a Poincaré duality space in place of a manifold is more satisfying in that the output of a solved surgery problem is a homotopy equivalence from a manifold to the Poincaré Duality space.



- (i) A manifold with boundary  $(W, N, N')$ , called a cobordism.
- (ii) A map

$$F : (W, N, N') \rightarrow (M \times [0, 1]; M \times \{0\}, M \times \{1\})$$

such that

- (a)  $F|N = f$
- (b)  $F$  is covered by a map of normal bundles in  $\mathbb{R}^k \times [0, 1]$
- (c)  $F|N'$  is a homotopy equivalence.

A surgery problem  $f$  gives rise to a surgery obstruction  $\sigma(f)$  in the Wall group  $L_n(\mathbb{Z}\pi_1(M))$ . Of course,  $\sigma(f) = 0$  if and only if the surgery problem has a solution.

Here is how surgery is used to classify homotopy PL structures: If  $f : N \rightarrow M$  is a homotopy equivalence of PL manifolds, we first ask if there is a *normal cobordism* from  $N$  to  $M$ . This is a manifold with boundary  $(W, N, M)$  together with a map

$$F : (W, N, M) \rightarrow (M \times [0, 1]; M \times \{0\}, M \times \{1\})$$

such that  $F|N = f$ ,  $F|M = id$ , and such that  $F$  is covered by a map of normal bundles. Given a homotopy equivalence  $f : N \rightarrow M$ , a transversality construction shows that the desired normal cobordism exists if and only if a certain map  $M \rightarrow G/PL$  is nullhomotopic. This gives rise to the map

$$\mathcal{S}^{PL}(M) \rightarrow [M, G/PL]$$

in the surgery exact sequence.

If the normal cobordism exists,

$$F : (W, N, M) \rightarrow (M \times [0, 1]; M \times \{0\}, M \times \{1\})$$

can be considered to be a relative surgery problem, the problem being to find a cobordism rel boundary to a homotopy equivalence. This leads to an obstruction in  $L_{n+1}(\mathbb{Z}\pi_1(M))$ . If this obstruction dies, then there is an  $h$ -cobordism  $(W', N, M)$  together with a homotopy equivalence

$$F' : (W', N, M) \rightarrow (M \times [0, 1]; M \times \{0\}, M \times \{1\})$$

extending  $f$  and the identity. In the simply connected case, at least, the  $h$ -cobordism theorem then shows that the original structure was trivial. In general, one either cobords to simple homotopy equivalences or relaxes the definition of equivalence of structures.

In analyzing a surgery problem, one constructs the cobordism  $W$  starting with  $M \times [0, 1]$ , attaching one handle at a time to in an effort to make  $f$  more and more highly connected.

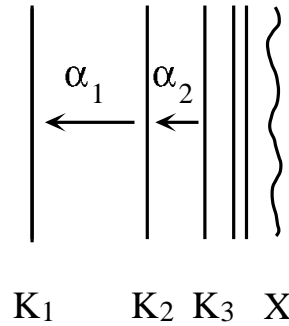

The problem is quite analogous to the problem of attaching cells to a domination to obtain a homotopy equivalence which was discussed in §8.

#### REFERENCES

- [Br] W. Browder, *Surgery on simply connected manifolds*, Springer-Verlag, Berlin-New York, 1970.
- [KM] M. Kervaire and J. Milnor, *Groups of homotopy spheres*, Ann. Math. **77** (1963), 504–537.
- [MM] I. Madsen and R. J. Milgram, *The Classifying Spaces for Surgery and Cobordism of Manifolds*, Annals of Math. Studies #92, Princeton U. Press, Princeton, NJ, 1979.
- [Su] D. Sullivan, *Triangulating homotopy equivalences*, Ph. D. thesis, Princeton University, 1965.
- [Wa] C.T.C. Wall, *Surgery on Compact Manifolds*, Academic Press, New York, 1971.

## Chapter 16. Bounded structures and the annulus conjecture

The purpose of this section is to mention a new variant of surgery theory which can also be used to prove the Annulus Conjecture. This is *bounded surgery theory* [FP].

DEFINITION 16.1.

- (i) A *bounded  $n$ -manifold* over  $X$  is an  $n$ -manifold  $M$  together with a not necessarily continuous map  $p : M \rightarrow X$  so that the inverse image of every bounded subset of  $X$  has compact closure in  $M$ . A homotopy  $h_t : M \rightarrow M$  is bounded if there is a  $d$  so that  $\text{diam}(p \circ h_t(m)) \leq d$  for all  $m \in M$ .
- (ii) If  $p : M^n \rightarrow X$  is a bounded object over  $X$ , a *bounded structure on  $M$*  is a bounded homotopy equivalence  $f : (N, q) \rightarrow (M, p)$ . Two bounded structures  $f : (N, q) \rightarrow (M, p)$  and  $f' : (N', q') \rightarrow (M, p)$  are *equivalent* if there is a PL homeomorphism  $\phi : N \rightarrow N'$  so that the diagram

$$\begin{array}{ccc}
 N & \xrightarrow{f} & M \\
 \phi \Big| \cong & & \\
 N' & \xrightarrow{f'} & M
 \end{array}$$

bounded homotopy commutes over  $X$ .

In particular, we can consider  $\mathcal{S}^{PL} \left( \begin{array}{c} \mathbb{R}^n \\ \downarrow id \\ \mathbb{R}^n \end{array} \right)$ , the bounded PL structures on  $\mathbb{R}^n$  parameterized over itself. A bounded homotopy equivalence  $f : M \rightarrow \mathbb{R}^n$  is equivalent to the trivial structure if and only if  $f$  is bounded homotopic to a *PL* homeomorphism  $\bar{f} : M \rightarrow \mathbb{R}^n$ .

There is a bounded surgery theory analogous to the compact theory and the bounded surgery exact sequence in this case is

$$\dots \longrightarrow L_{\mathbb{R}^n, n+1}(e) \xrightarrow{act_s} \mathcal{S}^{PL} \left( \begin{array}{c} \mathbb{R}^n \\ \downarrow id \\ \mathbb{R}^n \end{array} \right) \longrightarrow [\mathbb{R}^n; G/PL] \longrightarrow L_{\mathbb{R}^n, n}(e).$$

A splitting argument shows that

$$L_{\mathbb{R}^n, k}(e) = \begin{cases} 0 & k - n \text{ odd} \\ \mathbb{Z} & k - n \equiv 0 \pmod{4} \\ \mathbb{Z}_2 & k - n \equiv 2 \pmod{4}, \end{cases}$$

so both  $L_{\mathbb{R}^n, n+1}(e)$  and  $[\mathbb{R}^n; G/PL]$  are trivial, implying the triviality of  $\mathcal{S}^{PL} \begin{pmatrix} \mathbb{R}^n \\ \downarrow id \\ \mathbb{R}^n \end{pmatrix}$ .

A topological homeomorphism  $h : \mathbb{R}^n \rightarrow \mathbb{R}^n$  gives a bounded homotopy equivalence  $(\mathbb{R}^n, h) \rightarrow (\mathbb{R}^n, id)$ . Since the structure  $(\mathbb{R}^n, h)$  is equivalent to the trivial structure, there is a PL homeomorphism  $\bar{h} : \mathbb{R}^n \rightarrow \mathbb{R}^n$  which is boundedly close to  $h$ . But  $\bar{h}$  is stable, since it is PL and  $h \circ \bar{h}^{-1}$  is bounded (and therefore stable), so  $h = (h \circ \bar{h}^{-1}) \circ \bar{h}$  is stable. This proves that (simply connected) bounded surgery theory implies the Annulus Conjecture in dimensions  $n \geq 5$ .

#### ADDENDUM

Actually, if we're going to use  $\mathcal{S}^{PL} \begin{pmatrix} \mathbb{R}^n \\ \downarrow id \\ \mathbb{R}^n \end{pmatrix} = *$  to prove the annulus conjecture, we can dispense with most of the stable homeomorphism stuff. Let  $\mathbb{R}^n$  be compactified by  $D^n$ .

LEMMA 16.2. *If  $h : \mathbb{R}^n \rightarrow \mathbb{R}^n$  is a homeomorphism which extends to a homeomorphism  $\bar{h} : D^n \rightarrow D^n$ , then the annulus conjecture is true for  $h$ .*

PROOF:  $D^n - L\overset{\circ}{B}^n$  is an annulus, so  $\bar{h}(D^n - L\overset{\circ}{B}^n) = D^n - h(L\overset{\circ}{B}^n)$  is an annulus for all  $L$ . This implies that  $h(LB^n) - \overset{\circ}{B}^n$  is an annulus for large  $L$ , since the annulus  $D^n - \overset{\circ}{B}^n$  is  $h(LB^n) - \overset{\circ}{B}^n$  plus a collar. ■

If  $h : \mathbb{R}^n \rightarrow \mathbb{R}^n$  and  $k : \mathbb{R}^n \rightarrow \mathbb{R}^n$  is a PL homeomorphism boundedly close to  $h$ , then  $k^{-1} \circ h$  is bounded. Bounded homeomorphisms extend to  $D^n$ , so  $k^{-1} \circ h(LB^n) - K\overset{\circ}{B}^n$  is an annulus for  $L \gg K$ . This means that  $h(LB^n) - k(K\overset{\circ}{B}^n)$  is an annulus for the same values of  $K$  and  $L$ . Since  $k$  is PL, regular neighborhood theory shows that the annulus conjecture is true for  $k$ , so for  $K \gg L$ ,  $L$  large,  $h(KB^n) - \overset{\circ}{B}^n$  is the union of annuli  $h(KB^n) - k(L\overset{\circ}{B}^n)$  and  $k(LB^n) - \overset{\circ}{B}^n$ .

The stable homeomorphism apparatus is worth retaining, however, since it is the basic ingredient required for the proof of the following Product Structure Theorem.

THEOREM 16.3 (PRODUCT STRUCTURE THEOREM). *Let  $M$  be a TOP manifold without boundary. If  $n \geq 5$  and  $s \geq 1$ , then  $M$  has a PL structure if and only if  $M \times \mathbb{R}^s$  has a PL structure.*

The proof of this fundamental result is contained in pages 31–37 of [KS]. We have stated only a very weak version of the theorem. The commercial-grade version in [KS]

gives a relative version and shows that concordance classes of structures on  $M$  and  $M \times \mathbb{R}^s$  are in 1-1 correspondence.

The Product Structure Theorem reduces questions about the triangulability of topological manifolds to bundle theory. Here is an outline of the argument. We will say more about this later on.

First, one develops an appropriate topological bundle theory. The main results say:

- (i) Topological  $n$ -manifolds have tangent  $\mathbb{R}^n$  bundles  $\tau_M$  with structure group the self-homeomorphisms of  $\mathbb{R}^n$ .
- (ii) If  $i : M \rightarrow \mathbb{R}^m$  is a topological embedding, then  $i \times 0 : M \rightarrow \mathbb{R}^m \times \mathbb{R}^k$  has a normal bundle  $\nu_M$  for sufficiently large  $k$ .
- (iii) The total space of  $\nu_M$  is an open regular neighborhood of  $M$  in  $\mathbb{R}^{m+k}$  and  $\tau_M \oplus \nu_M$  is trivial.

If the structure group of  $\tau_M$  reduces to PL, then the total space of the pullback of  $\tau_M$  over  $proj : E(\nu_M) \rightarrow M$  is a PL bundle over a PL manifold, so it is a PL manifold. (Since  $E(\nu_M)$  is an open subset of euclidean space, it is a PL manifold.) The pullback of  $\tau_M$  over  $proj : E(\nu_M) \rightarrow M$  is the total space of the Whitney sum  $\tau_M \oplus \nu_M$ , which is trivial, so  $M \times \mathbb{R}^{m+k}$  has a PL structure for some  $m$  and  $k$ , so by the Product Structure Theorem,  $M$  has the structure of a PL manifold.

**COROLLARY 16.4.** *If  $M^n$  is a contractible topological manifold without boundary,  $n \geq 5$  or with boundary,  $n \geq 6$ , then  $M$  has a PL structure.*

A tantalizing aspect of the stable homeomorphism approach to the annulus conjecture is that it shows that if we could find some way to extend the tiniest germ of a homeomorphism so that it had reasonable behavior at infinity, then we would have a direct proof of the annulus conjecture. The reader should be warned that the 3-parameter annulus conjecture is false – if  $f : B^n \times S^3 \rightarrow B^n \times S^3$  is a 3-parameter family of embeddings,  $B^n \times S^3 - f(\overset{\circ}{B}^n \times S^3)$  need not be fiber-preserving homeomorphic to  $S^{n-1} \times [0, 1] \times S^3$ . This means that an elementary proof of the annulus theorem must contain steps which don't generalize to the 3-parameter case.

#### REFERENCES

- [FP] S. C. Ferry and E. K. Pedersen, *Epsilon Surgery Theory*, (preprint) SUNY Binghamton.

- [KS] R. Kirby and L. C. Siebenmann, *Foundational essays on topological manifolds, smoothings, and triangulations*, Princeton University Press, Princeton, New Jersey, 1977.

## Chapter 17. The topological invariance of Whitehead torsion

DEFINITION 17.1. If  $(L, K)$  is a polyhedral pair, and  $r : L \rightarrow K$  is a retraction, we say that  $r$  is an  $\epsilon$  *strong deformation retraction* or  $\epsilon$ -SDR if there is a homotopy  $r_t : L \rightarrow L$  with  $r_0 = id$ ,  $r_1 = r$ ,  $r_t|_K = id$ , and such that for all  $x$ ,  $\sup_t(\{d(r(x), r \circ r_t(x)) \mid 0 \leq t \leq 1\}) < \epsilon$ . In words, this says that the images under  $r$  of the tracks of the homotopy  $r_t$  are small. In general, we will define the *radius* of a homotopy  $h_t$  to be  $\sup\{d(p \circ h_0(x), p \circ h_t(x))\}$ , where  $p$  is the control map. The advantage of this over the more obvious notion of diameter is that if  $r : L \rightarrow K$  and  $r' : L' \rightarrow K$  are  $\epsilon$ -SDR's, then  $L \cup_K L' \rightarrow K$  is also an  $\epsilon$ -SDR.

Our next goal is to give a proof of the following, which generalizes Chapman's topological invariance of Whitehead torsion. The original argument used the theory of Hilbert cube manifolds [Fe]. The argument given here is modeled on an argument of Chapman [Ch2] which is modeled on an argument of Siebenmann [Si]. An argument similar to Chapman's appears in [L].

THEOREM 17.2 (FERRY [Fe]). *If  $K$  is a finite polyhedron, then there is an  $\epsilon > 0$  so that if  $(L, K)$  is a polyhedral pair and  $r : L \rightarrow K$  is an  $\epsilon$ -SDR, then  $\tau(L, K) = 0$ .*

COROLLARY 17.3 (TOPOLOGICAL INVARIANCE OF TORSION, CHAPMAN [Ch]). *If  $K$  and  $L$  are finite polyhedra and  $h : K \rightarrow L$  is a homeomorphism, then  $\tau(h) = 0$ .*

Before proving the corollary, we should say a few more words about Whitehead torsion. If  $f : K \rightarrow L$  is a homotopy equivalence, we will say that  $f$  is *simple* if  $\tau(M(f'), K) = 0$ , where  $f'$  is a cellular approximation to  $f$ . If  $f''$  is another cellular approximation to  $f$ , then by the mapping cylinder calculus we have  $M(f') \wedge_{\simeq} M(f'') \text{ rel } K \cup L$ . Since the torsion of a homotopy equivalence belongs in the range for formal reasons, if  $f : K \rightarrow L$  is a cellular homotopy equivalence, we define  $\tau(f) = f_{\#}\tau(M(f), K)$ . Geometrically, this is the same as defining  $\tau(f)$  to be the torsion of the pair  $(M(f) \cup_K M(f), L)$ . It follows easily from the mapping cylinder calculus that  $\tau(g \circ f) = f_{\#}\tau(g) + \tau(f)$ . The interested reader should see the first 30 pages of [Co] for details.

PROOF OF COROLLARY: The mapping cylinder of  $h$  retracts to  $K$  by an  $\epsilon$ -SDR for each  $\epsilon > 0$ . Unfortunately, the space  $M(h)$  is not a polyhedron. Taking fine subdivisions of  $K$  and  $L$  and a cellular approximation  $h'$  to  $h$ , there is an  $\epsilon$ -SDR from  $M(h')$  to  $K$ ,<sup>19</sup>

---

<sup>19</sup> This follows from a controlled version of the mapping cylinder calculus. See Proposition 19.5.

showing that  $h'$ , and therefore  $h$ , is simple.

#### THE SUM THEOREM FOR WHITEHEAD TORSION

**THEOREM 17.4** ([CO], p. 76). *Suppose that  $K = K_1 \cup K_2$ ,  $K_0 = K_1 \cap K_2$ ,  $L = L_1 \cup L_2$ ,  $L_0 = L_1 \cap L_2$  and that  $f : K \rightarrow L$  is a map which restricts to homotopy equivalences  $f_\alpha : K_\alpha \rightarrow L_\alpha$  ( $\alpha = 0, 1, 2$ ). Then  $f$  is a homotopy equivalence and*

$$\tau(f) = j_{1\#}\tau(f_1) + j_{2\#}\tau(f_2) - j_{0\#}\tau(f_0).$$

where  $j_\alpha : L_\alpha \rightarrow L$  is the inclusion.

**REMARK 17.5.** As in the proof of the sum theorem for the finiteness obstruction, the proof is basically an Euler characteristic argument. The chain complex for  $C_*(\tilde{M}(f), \tilde{K})$  contains the complexes for  $C_*(\tilde{M}(f_1), \tilde{K}_1)$  and  $C_*(\tilde{M}(f_2), \tilde{K})$  but this union counts  $C_*(\tilde{M}(f_0), \tilde{K}_0)$  twice.

We start the proof of topological invariance with a useful theorem.

**THEOREM 17.6.** *If  $X$  is a compact ENR, then for every  $\epsilon > 0$  there is a  $\delta > 0$  so that if  $f, g : Z \rightarrow X$  are maps with  $d(f, g) < \delta$ , then there is a homotopy  $h_t : Z \rightarrow X$  with  $h_0 = f$ ,  $h_1 = g$ , and  $\text{diam}(h_t(z)) < \epsilon$  for each  $z \in Z$ . Moreover, if  $Z_0 \subset Z$  is a set with  $f|_{Z_0} = g|_{Z_0}$ , then  $h_t|_{Z_0} = f|_{Z_0} = g|_{Z_0}$ .*

**PROOF:** Embed  $X$  in  $\mathbb{R}^n$  for some  $n$  and let  $U$  be a neighborhood of  $X$  with retraction  $r : U \rightarrow X$ . Choose  $\epsilon_0 > 0$  so that  $B(\epsilon_0, x) \subset U$  for each  $x \in X$ . If  $d(f, g) < \epsilon_0$ , then  $h'_t(z) = tf(z) + (1-t)g(z)$  is a homotopy from  $f$  to  $g$  in  $U$ . Letting  $h_t = r \circ h'_t$  gives a homotopy from  $f$  to  $g$  in  $X$ . Continuity of  $r$  gives the estimate. ■

**REMARK 17.7.** A slight generalization of this argument also works for compact metric ANR's, since they are neighborhood retracts in separable Hilbert space. This local homotopy property is the basic property which distinguishes ANR's from other spaces. We can think of ANR's as having "local homotopy geodesics."

**DEFINITION 17.8.** A PL map  $f : K \rightarrow L$  will be called *CE-PL* if  $f^{-1}(\ell)$  is contractible for each  $\ell \in L$ .

As an application of the Sum Theorem and as a warm-up for the proof of Theorem 17.2, we will prove the following

**THEOREM 17.9.** *If  $f : K \rightarrow L$  is CE-PL, then  $\tau(f) = 0$ .*



LEMMA 17.10. *If  $f : K \rightarrow L$  is CE-PL, then  $f$  is a homotopy equivalence.*

PROOF THAT LEMMA  $\Rightarrow$  THEOREM: The proof is by induction on the number of cells in  $L$ . We write  $L = L_1 \cup \Delta^n$ , where  $\Delta^n$  is a top-dimensional cell of  $L$ . Then  $K = f^{-1}(L_1) \cup f^{-1}(\Delta^n)$  and the sum theorem applies to show that

$$\tau(f) = j_{1\#}\tau(f|f^{-1}(L_1)) + j_{2\#}\tau(f|f^{-1}(\Delta^n)) - j_{0\#}\tau(f|f^{-1}(\partial\Delta^n)).$$

The first and last terms are zero by induction, while the second is zero because  $\Delta^n$  is contractible.

CLAIM A. *If  $f : K \rightarrow L$  is CE-PL and  $\alpha : P \rightarrow L$  is continuous with  $(P, P_0)$  a polyhedral pair, then for every  $\epsilon > 0$  there is a  $\delta > 0$  depending only on  $\dim(P - P_0)$  so that if  $\alpha_0 : P_0 \rightarrow K$  is a map with  $d(f \circ \alpha_0, \alpha|P_0) < \delta$ , then there is a map  $\bar{\alpha} : P \rightarrow K$  extending  $\alpha_0$  so that  $d(f \circ \bar{\alpha}, \alpha) < \epsilon$ .*

$$\begin{array}{ccc} P_0 & \xrightarrow{\alpha_0} & K \\ \downarrow & \nearrow \hat{\alpha} & \downarrow f \\ P & \xrightarrow{\alpha} & L \end{array}$$

CLAIM  $\Rightarrow$  LEMMA: Choose basepoints for  $K$  and  $L$  so that  $f : (K, *) \rightarrow (L, *)$  is a pointed map. We show that  $f$  induces an isomorphism on homotopy groups. If  $\alpha : (S^k, *) \rightarrow (L, *)$  is a map then for any  $\epsilon > 0$ , applying the Claim with  $P_0 = *$  gives a map  $\hat{\alpha} : (S^k, *) \rightarrow (K, *)$  with  $d(f \circ \hat{\alpha}, \alpha) < \epsilon$ . Applying Proposition 17.6, we see that for  $\epsilon$  sufficiently small,  $\alpha$  is homotopic to  $f \circ \hat{\alpha}$  rel  $*$ . This shows that  $f_* : \pi_k(K, *) \rightarrow \pi_k(L, *)$  is onto. To see that  $f_*$  is 1-1, we consider  $\alpha_0 : (S^k, *) \rightarrow (K, *)$  with an extension  $\alpha : D^{k+1} \rightarrow L$  of  $f \circ \alpha_0$ . Applying the Claim gives  $\hat{\alpha} : D^{k+1} \rightarrow K$  extending  $\alpha_0$ , as desired. ■

PROOF OF CLAIM: We prove the theorem by induction on  $n = \dim(P - P_0)$ . The case  $n = 0$  is trivial, so we assume the result for  $n < k$  and try to prove it for  $n = k$ . Triangulate  $K$  and  $L$  so that  $f$  is simplicial. If  $x \in L$ , choose a derived subdivision of  $L$  so that  $x$  is a vertex. If  $N_x$  is a simplicial neighborhood of  $x$  in the second derived, then  $f^{-1}(N_x)$  is a regular neighborhood of  $f^{-1}(x)$  and is therefore contractible.  $L$  is covered by such  $N_x$ 's and we may assume that the triangulations have been chosen to be so fine that each  $N_x$  has diameter  $< \epsilon/3$ . Let  $\epsilon_1 > 0$  be a Lebesgue number for the cover of  $L$  by  $N_x$ 's and let  $\delta_1 > 0$  be so small that the Claim is true for  $\dim(P - P_0) \leq k - 1$  with  $\epsilon_1/3$  and  $\delta_1$  in place of  $\epsilon$  and  $\delta$ . Triangulate  $P$  so that the image of each simplex of  $P$  under  $\alpha$  has diameter  $< \epsilon_1/3$ .

By induction, we can find  $\hat{\alpha}' : P^{(k-1)} \cup P_0 \rightarrow K$  so that  $d(f \circ \hat{\alpha}', \alpha) < \epsilon_1/3$ . It follows that for each  $\Delta^k$  in  $P - P_0$ ,  $\text{diam}(f \circ \hat{\alpha}'(\partial\Delta^k)) < \epsilon_1$ . There is therefore an  $x \in L$  so that  $f \circ \hat{\alpha}'(\partial\Delta^k) \subset N_x$ , so  $\hat{\alpha}'(\partial\Delta^k) \subset f^{-1}(N_x)$ . Since  $f^{-1}(N_x)$  is contractible,  $\hat{\alpha}'|_{\partial\Delta^k}$  extends to  $\hat{\alpha} : \Delta^k \rightarrow f^{-1}(N_x)$ . Since  $f \circ \hat{\alpha}(\Delta^k) \subset N_x$ ,  $\text{diam}(f \circ \hat{\alpha}(\Delta^k)) < \epsilon/3$ . We also have  $\text{diam}(\alpha(\Delta)) < \epsilon_1/3$  and  $d(\alpha|_{\partial\Delta}, f \circ \hat{\alpha}|_{\partial}) < \delta_1$ , so  $d(f \circ \hat{\alpha}, \alpha) < \epsilon$ . ■

We can use the Sum Theorem for Whitehead torsion and Theorem 17.9 to show that polyhedra  $K$  and  $L$  are simple homotopy equivalent if and only if they are stably PL homeomorphic.

**THEOREM 17.11.** *Let  $K$  and  $L$  be polyhedra and let*

$$n \geq \max(2 \max(\dim(K), \dim(L)) + 1, 5).$$

*Then  $f : K \rightarrow L$  is a simple homotopy equivalence if and only if there is a homotopy commutative diagram*

$$\begin{array}{ccc} N(K) & \xrightarrow{\hat{f}} & N(L) \\ p_K \downarrow & & p_L \downarrow \\ K & \xrightarrow{f} & L \end{array}$$

*where  $N(K)$  and  $N(L)$  are regular neighborhoods of  $K, L$  in  $\mathbb{R}^n$  and  $p_K$  and  $p_L$  are CE-PL regular neighborhood collapses, and  $\hat{f}$  is a PL homeomorphism.*

**PROOF:** Since CE – PL maps are simple,  $\hat{f}$  is simple if and only if  $f$  is. In particular, if  $\hat{f}$  is a PL homeomorphism, then  $f$  is simple.

If  $f : K \rightarrow L$  is simple, let  $i : L \rightarrow N(L)$  be the inclusion and approximate  $i \circ f : K \rightarrow N(L)$  by an embedding,  $f'$ . Let  $N(K)$  be a regular neighborhood of  $f'(K)$  in  $N(L)$  and let  $\bar{i} : N(K) \rightarrow N(L)$  be the inclusion. Passing to the universal cover and applying excision and Poincaré duality, we discover that

$$(N(K), \partial N(K), \partial N(K)) \rightarrow (N(L), N(L) - \overset{\circ}{N}(K), \partial N(K))$$

is a homotopy equivalence of triples. The sum theorem then tells us that  $\partial N(K) \rightarrow N(L) - \overset{\circ}{N}(K)$  is a simple homotopy equivalence, so the space between  $\partial N(K)$  and  $\partial N(L)$  is a collar and the existence of the PL homeomorphism  $\hat{f}$  follows. ■

DEFINITION 17.12. We will use the word *over* to mean “when restricted to the inverse image of.” Thus, the phrase “ $f : \rightarrow Y$  is CE-PL over  $A$ ” will mean that  $f|_{f^{-1}(A)} : f^{-1}(A) \rightarrow A$  is a CE-PL map. The hypothesis “if  $r : V \rightarrow \mathbb{R}^n$  is a  $\delta$ -SDR over  $3B^n$ ” below is slightly more complicated. It means that there is a homotopy  $r_t : r^{-1}(3B^n) \rightarrow V$  with  $r_0 = id$ ,  $r_1 = r$ ,  $r_t|_{3B^n} = id$  such that the images of the tracks  $\{r(r_t(x)) | t \in I\}$  have diameter  $< \delta$ .

MAIN TECHNICAL THEOREM. *If  $V$  is a polyhedron and  $n$  is given, then for every  $\epsilon > 0$  there is a  $\delta > 0$  so that if  $r : V \rightarrow \mathbb{R}^n$  is a  $\delta$ -SDR over  $3B^n$ , then there exist a polyhedron  $\bar{V}$  and a map  $\bar{r} : \bar{V} \rightarrow \mathbb{R}^n$  so that*

- (i)  $\bar{r}$  is an  $\epsilon$ -SDR over  $3B^n$ .
- (ii)  $\bar{r} = r$  over  $\mathbb{R}^n - 2\overset{\circ}{B}^n$  and  $\bar{r}$  is a PL homeomorphism over  $B^n$ .

REMARK 17.13. Condition (ii) implies, in particular, that  $V$  and  $\bar{V}$  are the same space over  $\mathbb{R}^n - 2\overset{\circ}{B}^n$ .

MAIN TECHNICAL THEOREM  $\Rightarrow$  THEOREM 17.2: Let  $r : L \rightarrow K$  be a  $\delta$ -SDR and let  $D^n = \Delta^n$  be a top-dimensional simplex of  $K$ . We identify  $\overset{\circ}{D}^n$  with  $\mathbb{R}^n$  in such a way that  $\frac{1}{2}D^n$  is identified with  $B^n$ . For  $\delta$  small, the Main Technical Theorem applies over  $\mathbb{R}^n$  to give us  $\bar{r} : \bar{V} \rightarrow \mathbb{R}^n$  as above. Form a complex  $\bar{L}$  by ripping out  $r^{-1}(3B^n)$  and pasting in  $\bar{r}^{-1}(3B^n)$  in its place. The result is an  $\epsilon$ -SDR  $s : \bar{L} \rightarrow K$ , where we can make  $\epsilon$  as small as we like by choosing  $\delta$  sufficiently small.

Define a map  $g : L \rightarrow \bar{L}$  as follows: Let  $g = id$  over  $K - 3B^n$  and let  $g = r_{\rho(r(x))}(x)$  for  $x$  over  $3B^n$ , where  $\rho : 3B^n \rightarrow [0, 1]$  is a function which is 0 on  $\partial(3B^n)$  and 1 on  $2B^n$ . In other words,  $g$  is constructed by doing more and more of the retraction  $r_t$  as we get in towards  $B^n$  and including into  $\bar{L}$  by the identity.

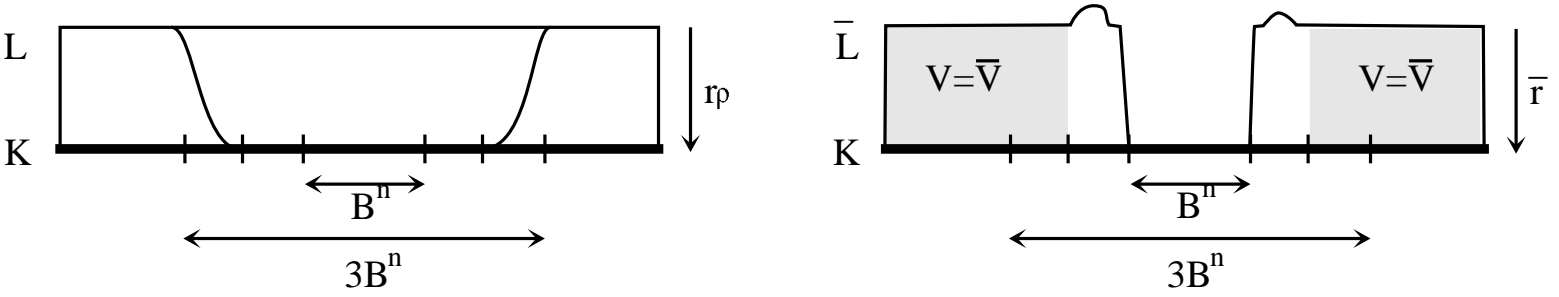

The map  $g$  is a homotopy equivalence, since it is homotopic to the composition of the retraction  $r$  with the inclusion. The torsion of  $g$  is trivial by the sum theorem: If  $P$  is a regular neighborhood of a polyhedron in  $r^{-1}(4B^n)$  containing  $r^{-1}(3B^n)$ ,  $\tau(g) = 0$ , since  $g = id$  outside of  $P$  and on the boundary. But  $i$  is nullhomotopic for  $\epsilon$  sufficiently small, so  $i_*\tau(g|P) = 0$ . Since  $\bar{r} \circ g$  is homotopic to  $r$ , we have  $\tau(r) = r_*\tau(g) + \tau(\bar{r}) = \tau(\bar{r})$ , so it suffices to show that  $\tau(\bar{r}) = 0$ .

This is like the earlier proof for CE-PL maps. Let  $K = K_1 \cup_{\partial D^n} D^n$  and excise  $\bar{r}^{-1}(B^n)$ ,  $B^n \subset D^n$ . By the sum theorem,  $\tau(\bar{r}) = i_*\tau(\bar{r}')$ , where  $\bar{r}'$  is the restriction of  $\bar{r}$  over  $K - \overset{\circ}{B}^n$ . Let  $s : (K - \overset{\circ}{B}^n) \rightarrow K_1$  be a CE-PL retraction and let  $\bar{r}_1 = s \circ \bar{r}'$ . The torsion of  $\bar{r}_1$  is the torsion of  $\bar{r}'$ , as above. Since  $\bar{r}_1$  is a controlled SDR over  $K_1$ , the induction hypothesis shows that  $\tau(\bar{r}_1) = 0$ , completing the proof. ■

The MTT is a consequence of the following Main Technical Lemma. The lemma has the same hypotheses as the theorem. It differs in that it shows how to leave things alone near the origin while fixing them up near infinity.

MAIN TECHNICAL LEMMA. *If  $n$  is given, then for every  $\epsilon > 0$  there is a  $\delta > 0$  so that if  $r : V \rightarrow \mathbb{R}^n$  is a  $\delta$ -SDR over  $3B^n$ , then there exist  $\bar{V}$  and an  $\epsilon$ -SDR  $\bar{r} : \bar{V} \rightarrow \mathbb{R}^n$  so that  $\bar{r} = r$  over  $B^n$  and  $\bar{r}$  is the identity over  $\mathbb{R}^n - 2\overset{\circ}{B}^n$ .*

PROOF THAT MTL  $\Rightarrow$  MTT: This is ‘‘Siebenmann’s inversion trick.’’

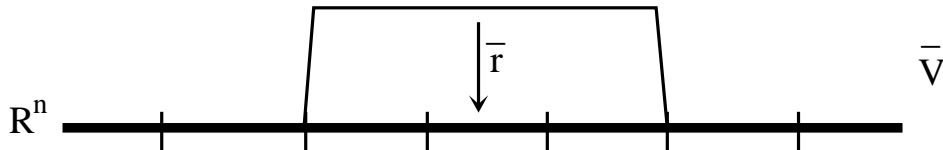

The data for the MTT is the same as for the MTL, so we apply the MTL to get  $\bar{r}$  and  $\bar{V}$  as in the schematic picture above. Add a point  $N$  at infinity and extend  $\bar{r}$  to a retraction  $\bar{r}' : \bar{V}' \rightarrow S^n$ .

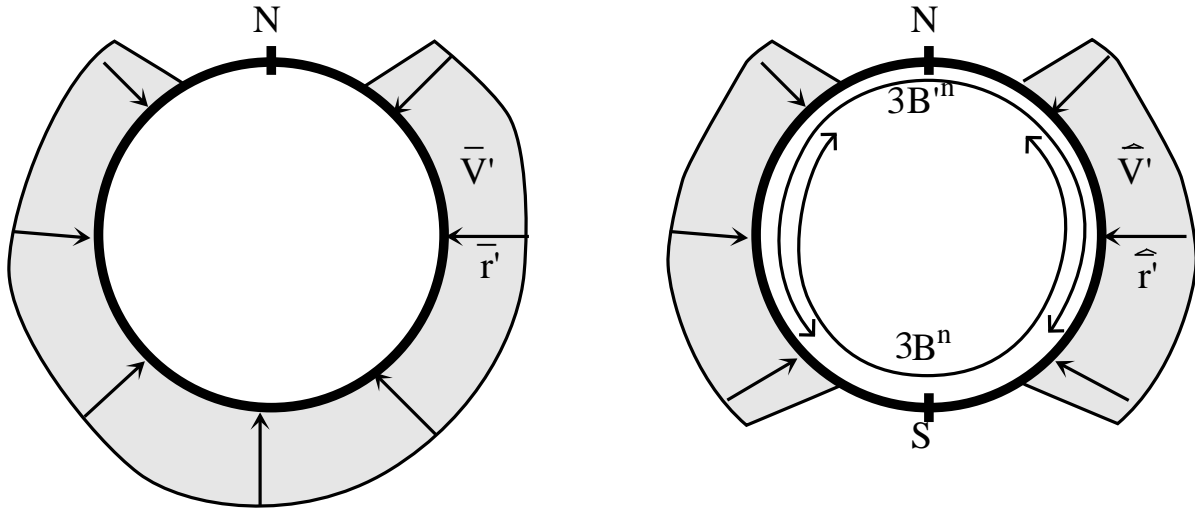

Let  $S$  be the south pole. Removing  $S$  and  $\bar{r}'^{-1}(S)$  and identifying  $S^n - S$  with  $\mathbb{R}^n$ , we again have an SDR satisfying the hypotheses of the MTL except, of course, that the control has become a bit weaker.

Apply the MTL again and plug  $S$  back in. The result is an SDR  $\hat{r}' : \hat{V}' \rightarrow S^n$  such that  $\hat{r}'$  agrees with  $\bar{r}'$  over  $B^n$  and is CE-PL over a neighborhood of infinity. Remove the inverse image of 0, which is the original  $\infty$ . The result of all of this is  $\hat{r}' : \hat{V}' \rightarrow \mathbb{R}^n$  which is a PL homeomorphism over  $B^n$  and which is equal to  $\bar{r}'$  over  $\mathbb{R}^n - 2B^n$ .

If the various reparameterizations were chosen to overlap correctly, this means that  $\hat{r}'$  is equal to the original  $r$  over a band, say  $3B^n - 2\overset{\circ}{B}^n$  in the original coordinate system, so we can paste it back together with the original  $r$ , proving the MTT. ■

The next step in the proof of Theorem 17.2 is the proof of the MTL. This is a torus argument and involves the construction of the diagram below:

$$\begin{array}{ccc}
2B^n \times D^k \cup \mathbb{R}^n & \xrightarrow{r_5} & \mathbb{R}^n \\
\uparrow i & & \uparrow i \\
2\overset{\circ}{B}^n \times D^k & \xrightarrow{r_4} & 2\overset{\circ}{B}^n \\
\uparrow \gamma \times id & & \uparrow \gamma \\
\mathbb{R}^n \times D^k & \xrightarrow{r_3} & \mathbb{R}^n \\
\downarrow e & & \downarrow e \\
T^n \times D^k & \xrightarrow{CE-PL} W_2^{PL} \xrightarrow{r_2} & T^n \\
& \uparrow i & \uparrow i \\
& W_1^{PL} \xrightarrow{r_1} & T^n - 2\overset{\circ}{D}^n \\
& \downarrow i & \downarrow i \\
& W_0^{PL} \xrightarrow{r_0} & T^n - \{*\} \\
& \downarrow \beta'^{PL} & \downarrow \beta^{PL} \\
& V \xrightarrow{r} & \mathbb{R}^n
\end{array}$$

- (i) The map  $r$  is a  $\delta$ -SDR as in the statement of the MTL. The map  $\beta : T^n - * \rightarrow 2B^n \subset \mathbb{R}^n$  is a PL immersion. As usual, we take  $\beta$  to be the “identity” sending our favorite ball in  $T^n$  to the unit ball in  $\mathbb{R}^n$ .
- (ii) Next, we form the pullback,  $W_0$ . Since  $\beta$  is an immersion,  $\beta'$  is an immersion, as well. We use the coordinate charts from  $\beta'$  to make  $W_0$  into a polyhedron. The map  $r_0$  is an  $\epsilon_0$ -SDR (see Lemma 17.14 below) over  $T^n - \overset{\circ}{D}^n$ , where  $D^n$  is a small disk centered at  $*$ . In addition,  $r_0 = r$  over  $B^n$ .
- (iii) After stabilizing  $W_0$  by multiplying by  $D^\ell$  for some  $\ell$ , we can use the Splitting Lemma below to find a compact subpolyhedron  $W_1 \subset W_0$  and an  $\epsilon_1$ -SDR,  $r_1 : (W_1, \partial W_1) \rightarrow (T^n - 2\overset{\circ}{D}^n, \partial(2D^n))$ . The map  $r_1$  agrees with  $r_0$  over the complement of a small neighborhood of  $\partial(2D^n)$ .
- (iv) Plug the hole in the torus, obtaining  $W_2$ . Since  $r_1$  is a retraction, this also plugs the hole in  $W_1$ . The retraction  $r_2 : W_2 \rightarrow T^n$  extends  $r_1$  by the identity over the plug. The map  $r_2$  is  $r \circ proj$  over  $B^n \subset T^n$ .
- (v) Take a regular neighborhood of  $W_2$  in euclidean space. By Bass-Heller-Swan [BHS],  $Wh(\mathbb{Z}\mathbb{Z}^n) = 0$ , so a regular neighborhood of  $W_2$  is PL homeomorphic to

$T^n \times D^k$  in such a way that the composition

$$T^n \times D^k \xrightarrow{CE-PL} W_2 \xrightarrow{r_2} T^n$$

is homotopic to the identity.

- (vi) Lift to the universal covers. Choose a radial homeomorphism  $\gamma : \mathbb{R}^n \rightarrow \mathring{2B}^n$ , which is the identity over  $B^n$  and use it to squeeze  $r_3$  to an SDR  $r_4$  which extends by projection to  $2B^n \times D^k \rightarrow 2B^n$ . We take  $\gamma = id$  on  $B^n$ .
- (vii) Include  $r_4$  into  $2B^n \times D^k \cup \mathbb{R}^n$ , where the union is along the copy of  $2B^n$  in the image of the retraction. Extend the retraction by the identity. The result is an  $\epsilon$ -SDR which is  $r \circ proj$  over  $B$  and which is  $id$  outside of  $\mathring{2B}^n$ .

We have obtained a polyhedron  $V' = 2B^n \times D^k \cup \mathbb{R}^n$  with an  $\epsilon$ -SDR to  $\mathbb{R}^n$  and a subset  $V'_0$  with a CE-PL map  $c : V'_0 \cup \mathbb{R}^n \rightarrow r^{-1}(B^n) \cup \mathbb{R}^n$  so that the diagram below commutes.

$$\begin{array}{ccc} V'_0 \cup \mathbb{R}^n & \xrightarrow[c]{CE-PL} & r^{-1}(B^n) \cup \mathbb{R}^n \\ & \searrow r_5| & \swarrow r \\ & \mathbb{R}^n & \end{array}$$

We form the polyhedron  $\bar{V} = (V' \cup \mathbb{R}^n) \cup_c (r^{-1}(B^n) \cup \mathbb{R}^n)$ .

DIGRESSION ON SIMPLICIAL ADJUNCTION SPACES

If  $(K, K_0)$  is a triangulated polyhedral pair with  $K_0$  full in  $K$  and  $f : K_0 \rightarrow L$  is a simplicial map, here is how we form  $K \cup_f L$ : First, we pass to derived complexes  $K', L'$  and  $f' : K' \rightarrow L'$ . Let  $N$  be a simplicial neighborhood of  $K_0$  in  $K$ .  $N$  consists of simplices of the form  $\tau * \sigma$  with  $\tau \in \partial N$  and  $\sigma \in K_0$ . The polyhedron  $K \cup_f L$  consists of simplices of  $K' - int(N)$ , simplices of  $L'$ , and simplices of the form  $\tau * f(\sigma)$  with  $\tau \in \partial N$  and  $\sigma \in K_0$ . A simplicial map  $K' \rightarrow K \cup_f L$  is given by mapping simplices of  $K' - int(N)$  by the identity, simplices of  $K_0$  by  $f$ , and simplices  $\tau * \sigma$  by  $id * f$ . The preimages of points under this map are the original preimages together with convex cells arising from maps of the form  $\tau * \sigma \rightarrow \tau * f(\sigma)$  where  $\sigma \rightarrow f(\sigma)$  is not 1-1. A more efficient triangulation can be obtained by deriving  $K$  near  $K_0$ , that is, by starring at points in simplices which meet, but are not contained in, simplices of  $K_0$ . In the construction of the simplicial mapping cylinder of  $f : K \rightarrow L$ , for instance, this yields a polyhedron containing  $K$  and  $L$ , rather than subdivisions.

Returning to the proof of MTL, the induced map  $j : V' \rightarrow \bar{V}$  is a CE-PL map which is the identity on  $\mathbb{R}^n$ . The basic lifting property of CE-PL maps proven in Claim A at the beginning of this section shows that for any  $\mu > 0$  we can find a map  $s : \bar{V} \rightarrow V'$  so that  $s|_{\mathbb{R}^n} = id$  and  $d(j \circ s, id) < \mu$ . Define  $\bar{r}' : \bar{V} \rightarrow \mathbb{R}^n$  to be  $r_5 \circ s$ . This is a retraction from  $\bar{V} \rightarrow \mathbb{R}^n$  and for points  $x$  in  $r^{-1}(B^n)$ , we have

$$d(r(x), \bar{r}'(x)) = d(r(x), r_5 \circ s(x)) \leq d(r(x), r(j(s(x)))) + d(r(j(s(x))), r_5(s(x))).$$

For  $x \in (1 - \mu)B^n$ ,  $s(x) \in r^{-1}(B^n)$ , so  $d(r(x), \bar{r}'(x)) = d(r(x), r(j(s(x))))$ . By continuity, this is small for small  $\mu$ . We now construct  $\bar{r}$  by first doing the SDR  $r$  on  $(1 - 2\mu)B^n$ , phasing it out to be the identity outside of  $(1 - \mu)B^n$ . In symbols, we deform by a map  $x \rightarrow r_{t\rho(x)}(x)$ , where  $\rho$  is 0 outside of  $(1 - \mu)B^n$  and 1 inside of  $(1 - 2\mu)B^n$ . We follow this with  $\bar{r}'$ . By choosing  $\mu > 0$  to be sufficiently small, we can guarantee that this composition will be an  $\epsilon$ -SDR. This completes the proof of the MTL modulo the Splitting Lemma. ■

Here are the statement and proof of the immersion lemma which was promised in Step (ii) of the construction of the main diagram.

LEMMA 17.14. *Let  $\beta : Y \rightarrow X$  be an open immersion and let  $C$  be a compact subset of  $Y$ . Let  $V^*$  be the pullback. Then for every  $\epsilon > 0$  there is a  $\delta > 0$  so that if  $r : V \rightarrow X$  is a  $\delta$ -SDR over  $\beta(C)$ , then  $r^*$  is an  $\epsilon$ -SDR over  $C$ .*

$$\begin{array}{ccc} V^* & \xrightarrow{r^*} & Y \\ \downarrow \beta^* & & \downarrow \beta \\ V & \xrightarrow{r} & X \end{array}$$

PROOF: If  $c \in C$ , choose  $U_c \subset Y$  containing  $c$  so that  $\beta|_{U_c}$  is a homeomorphism. Let  $\delta'$  be a Lebesgue number for the cover of  $C$  by such  $U$ 's and let  $\delta''$  be chosen<sup>20</sup> so that  $\beta(B(\delta', c))$  contains the ball of radius  $\delta''$  around  $\beta(c)$  for every  $c \in C$ . If  $\delta = \delta''/3$ , then  $r^*$  is an SDR over  $C$ , since  $r_t^*(v, c) = (r_t(v), \beta^{-1}(r \circ r_t(v)))$  is well-defined in a neighborhood of  $(v, c)$  for  $0 \leq t \leq 1$ . It is clear that making  $\delta$  sufficiently small forces  $r^*$  to be an  $\epsilon$ -SDR over  $C$ . ■

---

<sup>20</sup> Exercise!



LEMMA 17.15 (SPLITTING LEMMA). *Given disks  $D^n \subset 2D^n \subset 3D^n \subset T^n$  centered at  $*$ , there is a  $\delta > 0$  so that if  $r : W \rightarrow T^n - *$  is a  $\delta$ -SDR over  $T^n - \overset{\circ}{D}^n$ , then there exist a compact subpolyhedron  $W' \subset W \times D^k$  for some  $k$  and an SDR,  $r' : (W', \partial W') \rightarrow (T^n - \overset{\circ}{2D}^n, \partial(2D^n))$ . The map  $r'$  agrees with  $r$  over the complement of a  $6\delta$ -neighborhood of  $2D^n$ .*

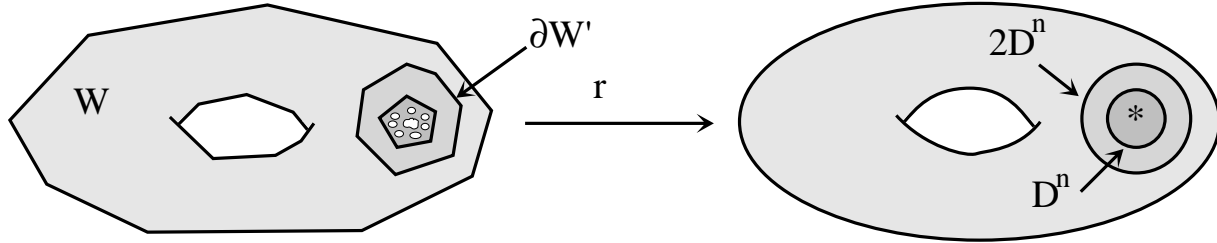

PROOF: Here is a blown-up picture of the end of  $W$ . We parameterize the end of  $T^n - *$  as  $S^{n-1} \times (0, 3]$ . The polyhedron  $r^{-1}(S^{n-1} \times \{2\})$  splits the end into components. We call the component containing  $S^{n-1} \times \{1\}$  “LHS” and the component containing  $S^{n-1} \times \{3\}$  “RHS”.

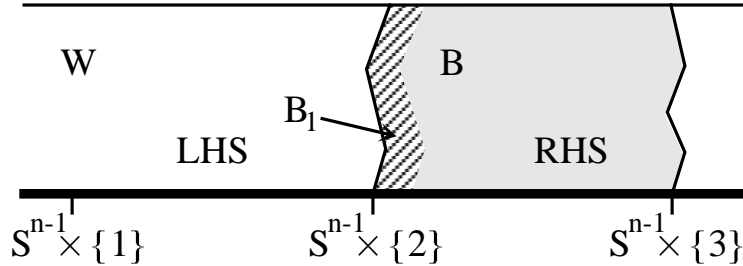

By simplicial approximation, we can assume that  $r$  is a PL  $\delta$ -SDR. Choose a function  $\rho : W \rightarrow [0, 1]$  so that  $\rho$  is 0 on  $LHS \cup r^{-1}(S^{n-1} \times \{2\})$  and so that  $\rho = 1$  outside of a  $5\delta$ -neighborhood of  $r^{-1}(S^{n-1} \times \{2\}) \cap RHS$ . Let  $B = r^{-1}[2, 3]$ . We construct a deformation of  $B$  into  $B_1 = r^{-1}([2, 2 + 6\delta])$  inside of  $r^{-1}([2, 3 + \delta])$  as follows: First use  $x \rightarrow r_{t\rho(x)}(x)$  to deform  $B$  into  $r^{-1}([2, 2 + 6\delta]) \cup S^{n-1} \times [0, 3 + \delta]$ . Then use the product structure on  $S^{n-1} \times [0, 3 + \delta]$  to deform into  $B_1$ , rel  $S^{n-1} \times [0, 3\delta]$ .

Call this deformation  $e_t$  and note that  $e_t(B_1) \subset B$  for all  $t$  and that  $e_t = id$  on a neighborhood of  $r^{-1}([2, 2 + 3\delta])$  for all  $t$ . We write  $e : B \rightarrow B_1$  for  $e_1$ .

CLAIM B. *There is a finite polyhedron  $\bar{B}$  and a map  $\bar{e} : \bar{B} \rightarrow B_1$  extending  $e$  so that*

the composition

$$(*) \quad \bar{B} \xrightarrow{\bar{e}} B_1 \xrightarrow{i} \bar{B}$$

is homotopic to the identity.

Given this claim, we can cross  $W$  with  $D^k$  for some  $k$  and approximate  $\bar{e}^2$  by an embedding. Crossing with another copy of  $[0, 1]$ , we can embed  $\bar{B}$  into  $W \times D^k \times \{1\}$ . Call the result  $\bar{B}_1 = \bar{e}^2(\bar{B})$ . We simplify the notation by suppressing the  $D^k$  factors in what follows.

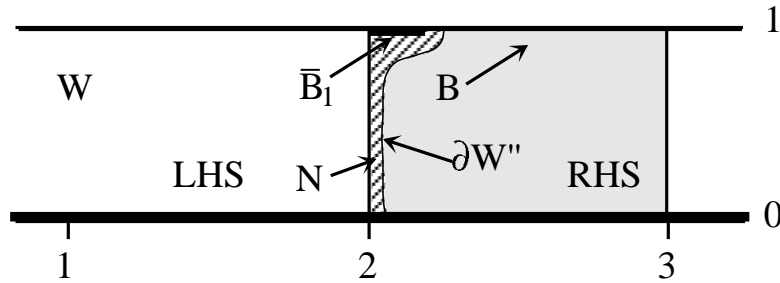

We claim that there is a deformation of  $B \times I$  into  $(r^{-1}\{2\} \cup \bar{B}_1) \text{ rel } r^{-1}\{2\} \cup \bar{B}_1$ . Crossing with some  $D^k$ 's and approximating by embeddings, we have

$$\bar{B}_1 \subset e(B) \subset \bar{e}(\bar{B}) = \bar{B}_2.$$

The inclusion  $\bar{B}_1 \rightarrow \bar{B}_2$  is a homotopy equivalence, so restriction gives a deformation from  $e(B)$  into  $\bar{B}_1 \text{ rel } \bar{B}_1$ . A deformation of  $B$  is then obtained by deforming  $B$  to  $e(B)$  and following that by the previous deformation. Since  $\bar{B}_1 \rightarrow \bar{B}_1 \cup r^{-1}(2)$  is a homotopy equivalence, an application of the homotopy extension theorem gives a deformation from  $B$  to  $\bar{B}_1 \cup r^{-1}(2) \text{ rel } \bar{B}_1 \cup r^{-1}(2)$ .

Let  $N$  be a regular neighborhood of  $\bar{B}_1 \cup r^{-1}(2)$  in  $RHS$ . Since  $\bar{B}_1 \cup r^{-1}(2)$  lies in the boundary,  $N$  is  $N_0 \times I$ , where  $N_0$  is a regular neighborhood of  $\bar{B}_1 \cup r^{-1}(2)$  in the boundary. By homotopy extension, there is a deformation from  $B$  to  $N \text{ rel } N$ . Composing with a retraction  $N \rightarrow \partial N$  gives a deformation from  $W'' = (B - \overset{\circ}{N})$  to  $\partial N$ .

We now play the same game on the left side, starting with  $\partial W''$  in place of  $r^{-1}\{2\}$ . This involves proving a similar claim.

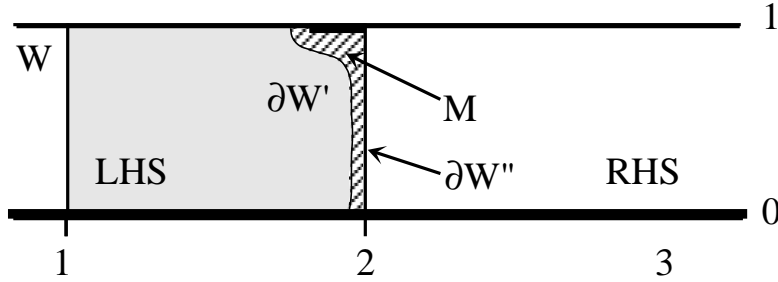

The result is a bicollared subset  $\partial W'$  so that there is a deformation  $e^*$  of  $r^{-1}([1, 2])$  into  $r^{-1}\{2\}$  rel  $r^{-1}\{2\}$ . Note that  $\partial W'$  is a strong deformation retract of  $RHS \cup M$ , since the retraction to  $\partial W''$  can be followed by a retraction from  $M$  to  $\partial W''$ .

One checks easily that this guarantees that the map  $proj \circ r : \partial W' \rightarrow S^{n-1}$  is a homotopy equivalence and that the retraction  $\bar{r} = r \circ e^*|_{RHS}$  has the desired properties. ■

PROOF OF CLAIM B: The map  $e : B \rightarrow B$  has the property that  $e \circ e$  is homotopic to  $e$  rel  $r^{-1}(S^{n-1} \times \{2\})$ , since a homotopy is given by  $e_t \circ e$ . Form the infinite mapping cylinder  $T(e)$  of  $e : B \rightarrow B$  and let  $d : B \rightarrow T(e)$  be inclusion into the top level.

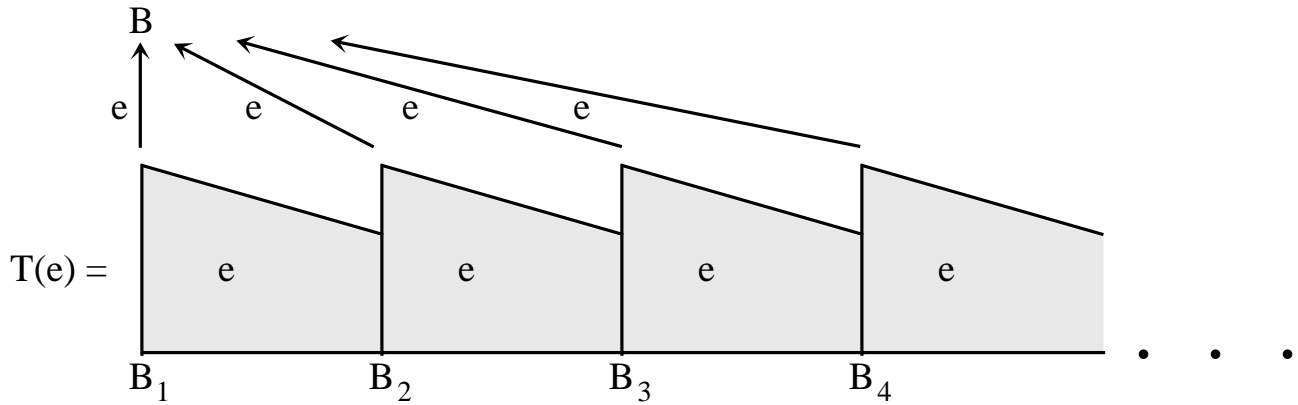

There is a map  $u' : T(e) \rightarrow B$  defined by setting  $u = e$  on each of the levels  $B_i$  and extending using the homotopy  $e \circ e \sim e$ .

Next, we show that  $d$  is a domination. Choose  $*$   $\in B$  with  $e_t(*) = *$  for all  $t$ . This gives us a base ray  $R$  in  $T(e)$ . If  $\alpha : (S^k, *) \rightarrow (T(e), R)$  is a map, sliding down the rays of the mapping cylinder, we can assume that  $\alpha$  maps into one of the  $B_i$  levels. But then we may as well assume that  $\alpha$  maps into  $B_0$ , since sliding down to  $B_{i+1}$  gives a homotopy between  $\alpha$  and the “same” map into the top level. The same argument shows that  $d \circ u' \circ \alpha$  is homotopic to  $\alpha$  keeping  $*$  in  $R$ . It follows that  $d \circ u'$  is a homotopy

equivalence and that  $d$  is a domination with right inverse  $u = u' \circ \phi$ , where  $\phi$  is a right homotopy inverse for  $d \circ u'$ .

Let  $B' = r^{-1}([2 + 3\delta, 3])$ . The construction of the homotopy idempotent  $e : B \rightarrow B$  was done in such a way that  $e|_{B'} : B' \rightarrow B'$  is also a homotopy idempotent. We write  $e' = e|_{B'}$ .  $T(e)$  is homotopy equivalent to  $T(e') \cup B$ , where  $T(e')$  is finitely dominated and the union is along the first copy of  $B'$ . Since  $B - B'$  is finite, the finiteness obstruction of  $T(e)$  is the image of the finiteness obstruction of  $T(e')$  in  $\tilde{K}_0(\mathbb{Z}\pi_1(T(e)))$ . The fundamental groups of  $T(e)$  and  $T(e')$  are retracts of the fundamental groups of  $B$  and  $B'$ . Since the inclusion  $B' \subset B$  factors through  $S^{n-1}$  up to homotopy, the image of the finiteness obstruction of  $T(e')$  in  $\tilde{K}_0(\mathbb{Z}\pi_1(T(e)))$  lies in the image of  $\tilde{K}_0(\mathbb{Z}\pi_1(S^{n-1})) = 0$  and we find  $\bar{B} \subset B$  and  $\bar{d} : \bar{B} \rightarrow T(e)$  so that  $\bar{d}$  is a homotopy equivalence. ■

This completes the proof of Theorem 17.2.

#### REFERENCES

- [BHS] H. Bass, A. Heller, and R. Swan, *The Whitehead group of a polynomial extension*, Publ. Inst. Etudes Sci. **22** (1964).
- [Ch1] T. A. Chapman, *Topological invariance of Whitehead torsion*, Amer. J. Math. **96** (1974), 488–497.
- [Ch2] \_\_\_\_\_, *Cell-like mappings*, Lecture Notes in Math. **482** (1973), 230–240.
- [Co] M. M. Cohen, *A course in simple-homotopy theory*, Springer-Verlag, Berlin-New York, 1973.
- [Fe] S. C. Ferry, *The homeomorphism group of a compact  $Q$ -manifold is an ANR*, Ann. of Math. **106** (1977), 101–120.
- [L] R. C. Lacher, *Cell-like mappings and their generalizations*, Bul. Amer. Math. Soc. **83** (1977), 495–552.
- [Si] L. C. Siebenmann, *Approximating cellular maps by homeomorphisms*, Topology **11** (1972), 271–294.

## Chapter 18. Compact ENR's have finite types

Our next goal is to show that every compact ENR has the homotopy type of a finite polyhedron. This theorem is originally due to J. West [We]. His proof used Hilbert cube manifold theory. The proof we give here is a modification of a proof due to Chapman, [Ch2]. We begin with a definition and a useful extension of Theorem 17.2.

DEFINITION 18.1. Let  $X$ ,  $Y$ , and  $Z$  be spaces,  $Z$  metric, and let  $p : Y \rightarrow Z$  be a map. A map  $f : X \rightarrow Y$  is an  $\epsilon$ -equivalence over  $Z$  if there exist a map  $g : Y \rightarrow X$  and homotopies  $h_t : id_X \simeq g \circ f$ ,  $k_t : id_Y \simeq f \circ g$  so that the tracks  $p \circ f \circ h_t(x)$  and  $p \circ k_t(x)$ ,  $0 \leq t \leq 1$ , have radius  $< \epsilon$ .

$$\begin{array}{ccc} X & \begin{array}{c} \xrightarrow{f} \\ \xleftarrow{g} \end{array} & Y \\ & & \downarrow p \\ & & Z \end{array}$$

THEOREM 18.2 (CHAPMAN). *If  $K$  is a finite polyhedron, then there is an  $\epsilon > 0$  so that if  $M$  and  $N$  are finite polyhedra  $p : N \rightarrow K$  is a map, and  $f : M \rightarrow N$  is an  $\epsilon$ -equivalence over  $K$ , then  $p_{\#}(\tau(f)) = 0$ .*

PROOF: Geometrically,  $p_{\#}(\tau(f))$  is represented by the torsion of the pair  $(M(g) \cup_N M(p), K)$ , where  $g$  is a controlled right inverse for  $f$  as in the definition.

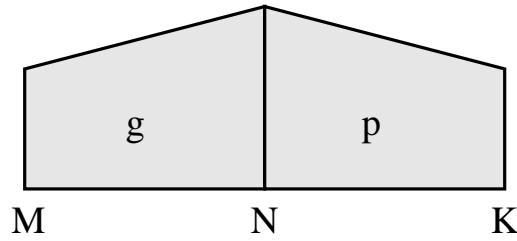

The controlled mapping cylinder calculus shows that there is a  $5\epsilon$ -SDR from  $(M(g) \cup_N M(p))$  to  $K$ , so  $p_{\#}(\tau(f)) = 0$ . ■

LEMMA 18.3 (M. MATHER). *If  $X$  is a compact ENR, then  $X \times S^1$  has the homotopy type of a finite complex.*

PROOF: Let  $r : U \rightarrow X$  be a retraction from a neighborhood of  $U$  in  $\mathbb{R}^n$  to  $X$  and let  $K \subset U$  be a polyhedron containing  $X$ . Now consider the mapping torus of  $r|_K$ , which we rename  $r$ .

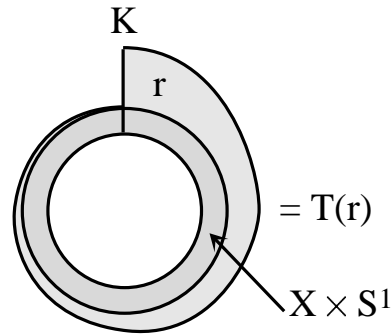

By simplicial approximation and the mapping cylinder calculus,  $T(r)$  is homotopy equivalent to a finite polyhedron. Rotating  $T(r)$  gives a deformation from  $T(r)$  into  $X \times S^1$  which keeps  $X \times S^1$  inside of itself. By homotopy extension, this gives a strong deformation retraction from  $T(r)$  to  $X \times S^1$ , so  $X \times S^1$  also has the homotopy type of a finite polyhedron. ■

**THEOREM 18.4 (BORSUK CONJECTURE).** *Every compact ANR is homotopy equivalent to some finite complex.*

**PROOF:** We can make the strong deformation retraction from  $T(r)$  to  $X \times S^1$  into a controlled strong deformation retraction over  $X \times S^1$  by passing to a smaller polyhedron  $K_1$  containing  $X$  and adding on more fins or, equivalently, passing to a large finite cover. Retracting into  $X \times S^1$  and including into a reversed copy of this (multi)-mapping torus gives us a controlled homotopy

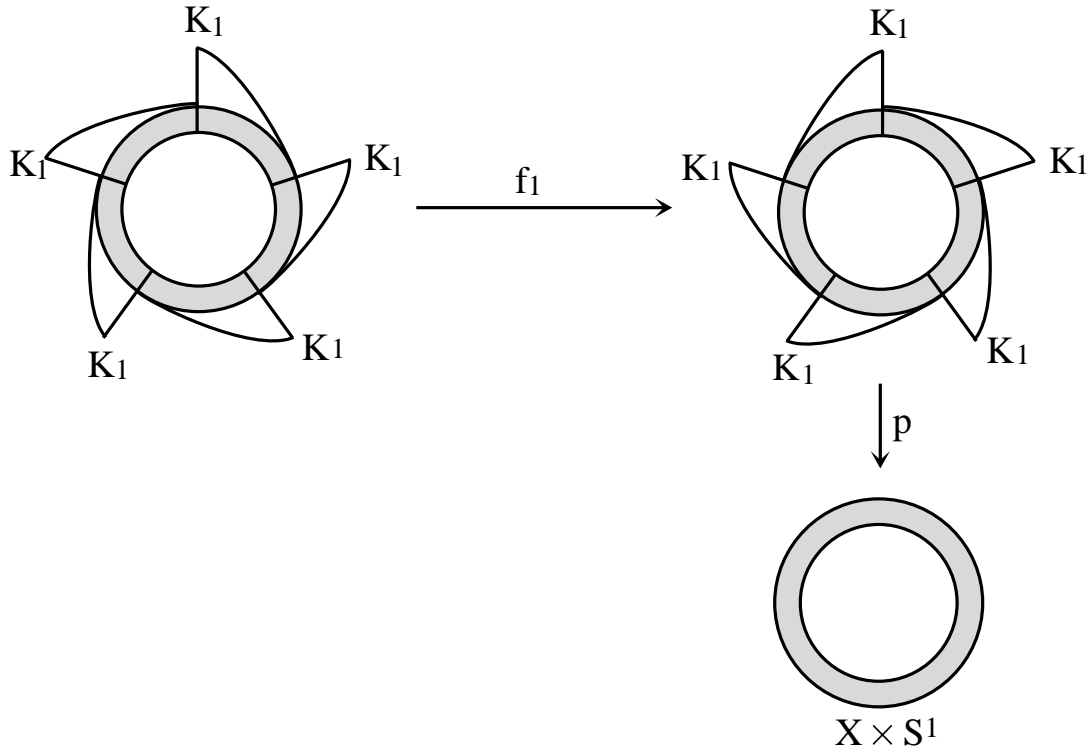

equivalence over  $X \times S^1$  which reverses the orientations of the mapping tori. Choose a homotopy equivalence  $\phi : T(r) \rightarrow P$ , where  $P$  is a finite polyhedron and choose  $\epsilon > 0$  so that Theorem 18.2 holds for  $P$ . If we choose  $K_1$  close enough to  $X$  and use enough fins, we can insure that  $f_1$  is an  $\epsilon$ -equivalence over  $P$  via the control map  $\phi \circ p$ . If our mapping tori were finite polyhedra, we could deduce that  $\tau(f_1) = 0$ , since  $(\phi \circ p)_\#(\tau(f_1)) = 0$  and  $(\phi \circ p)_\#$  is an isomorphism. To get around this problem, we replace our mapping tori by tori constructed using simplicial mapping cylinders of a close simplicial approximation  $r_1$  to  $r$ . The result is a simple homotopy equivalence  $f_2 : T_1 \rightarrow T_2$  of simplicial mapping tori homotopy equivalent to  $X \times S^1$ .

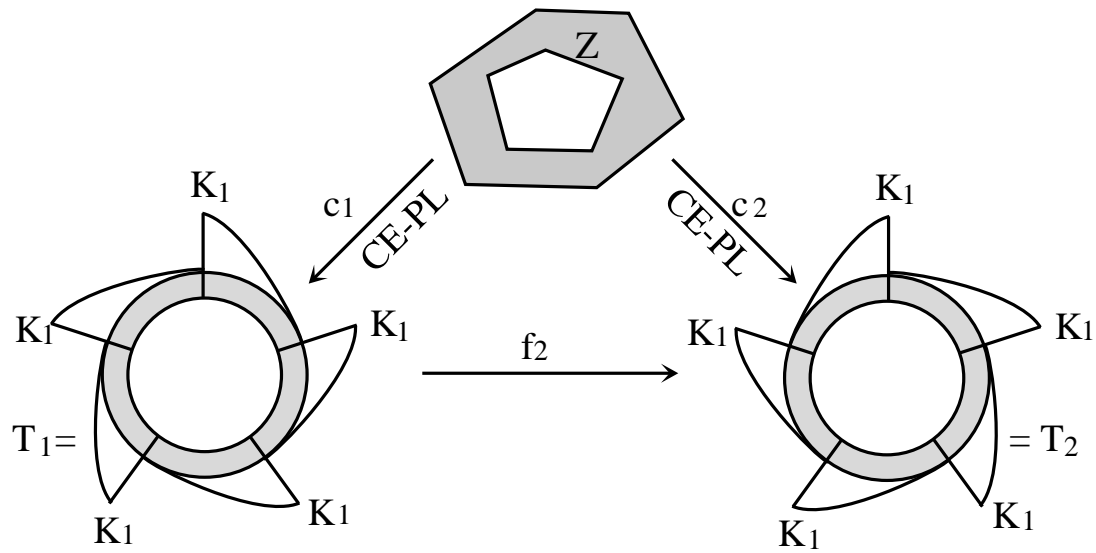

This means that we have a finite polyhedron  $Z$  and CE-PL maps  $Z \rightarrow T_1$  and  $Z \rightarrow T_2$ .  
 Passing to cyclic covers by pulling back  $\mathbb{R}^1 \rightarrow S^1$ , we have:

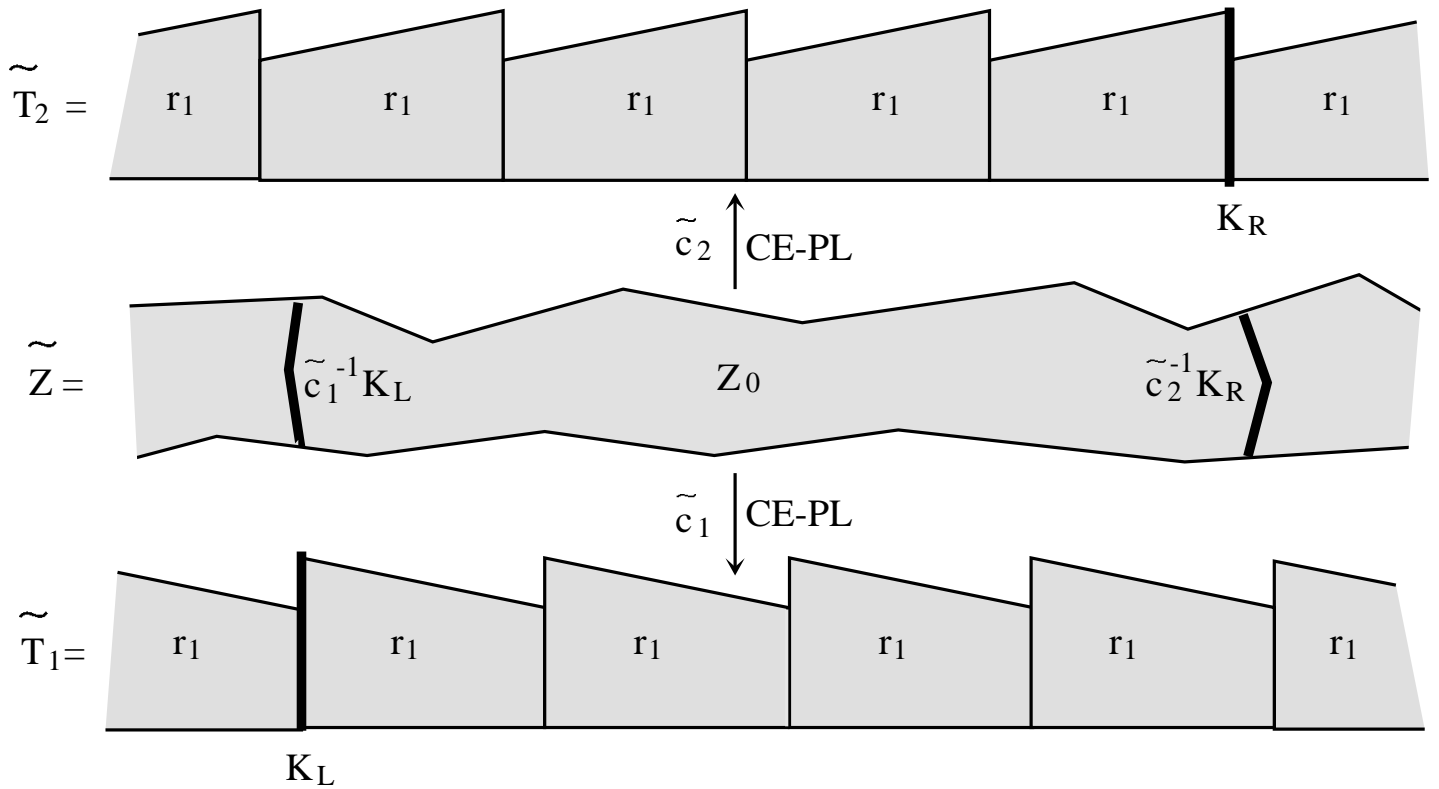



Choose  $K_R$  to be one of the copies of  $K_1$  in  $\tilde{T}_2$ . Since  $\tilde{c}_2$  is CE-PL,  $\tilde{c}_2^{-1}(K_R)$  divides  $\tilde{Z}$  into two pieces homotopy equivalent to the corresponding pieces of  $\tilde{T}_2$ . In particular, there is a strong deformation retraction from the right-hand component of  $\tilde{Z} - \tilde{c}_2^{-1}(K_R)$  to  $K_R$ , where “right” and “left” are measured in  $\mathbb{R}^1$ . Now choose  $K_L$  so that  $c_1^{-1}(K_L)$  is to the left of  $c_2^{-1}(K_R)$ . Then there is a strong deformation retraction from the part of  $\tilde{Z}$  to the left of  $c_1^{-1}(K_L)$  to  $K_L$ . This means that the compact polyhedron  $Z_0$  trapped between  $c_1^{-1}(K_L)$  and  $c_2^{-1}(K_R)$  is a strong deformation retract of  $\tilde{Z}$ . Since  $\tilde{Z}$  has the homotopy type of  $X$ ,  $X$  has the homotopy type of a finite polyhedron. ■

REMARK 18.5. In [Mi], Milnor asked whether the finiteness obstruction of a finitely dominated compact space is always zero. In [Fe], the author proved that every finitely dominated space has the homotopy type of a compact metric space.

#### REFERENCES

- [Ch1] T.A. Chapman, *Homotopy conditions which detect simple homotopy equivalence*, Pac. J. Math. **80** (1979), 13–46.
- [Ch2] \_\_\_\_\_, *Invariance of Torsion and the Wall Finiteness Obstruction*, Canad. J. Math. **326** (1980), 583–607.
- [Fe] \_\_\_\_\_, *Homotopy, simple homotopy, and compacta*, Topology **19** (1980), 101–110.
- [Mi] J. Milnor, *Uses of the fundamental group, ??? ??? (???)*, 1–18.
- [We] J. West, *Mapping Hilbert cube manifolds to ANR's: A solution to a conjecture of Borsuk*, Ann. of Math. **106** (1977), 1–18.

## Chapter 19. CE maps and controlled homotopy lemmas

The material on cell-like maps is from [La1] and [La2].

DEFINITION 19.1.

- (i) A compact metric space  $X$  is *cell-like* if it can be embedded in an ANR  $Z$  so that for each neighborhood  $U$  of  $X$  there is a neighborhood  $V$  of  $X$  contained in  $U$  so that  $V$  contracts to a point in  $U$ . This is often called *property  $UV^\infty$* .
- (ii) A map  $f : X \rightarrow Y$  is said to be *proper* if  $f^{-1}(K)$  is compact for each compact  $K \subset Y$ .
- (iii) A proper map  $f : X \rightarrow Y$  is *cell-like* or *CE* if  $f^{-1}(y)$  is cell-like for each  $y \in Y$ .

PROPOSITION 19.2. *If  $X$  is cell-like and  $X$  is embedded in an ANR  $Y$ , then  $X$  has property  $UV^\infty$  in  $Y$ .*

PROOF: We have  $X \subset Z$  and  $X \subset Y$  and we know that  $X$  has property  $UV^\infty$  in  $Z$ . Let  $U$  be a neighborhood of  $X$  in  $Y$  as in the definition. Since  $Y$  and  $Z$  are ANR's, the identity map extends to  $i_{ZY} : U_Z \rightarrow U \subset Y$ . Choose a neighborhood  $V_Z$  of  $X$  so that  $V_Z$  contracts to a point in  $U_Z$ . Now choose a neighborhood  $V_Y \supset X$  in  $Y$  so that the identity map extends to  $i_{YZ} : V_Y \rightarrow V_Z$  and so that the composition  $i_{ZY} \circ i_{YZ} : V_Y \rightarrow U$  is homotopic to the identity in  $U$ . This last uses the remark following Proposition 17.6.

We now see that the inclusion  $V_Y \rightarrow U$  is homotopic to  $i_{ZY} \circ i_{YZ}$ , which is nullhomotopic, since  $i_{YZ}|_{V_Y}$  is nullhomotopic. ■

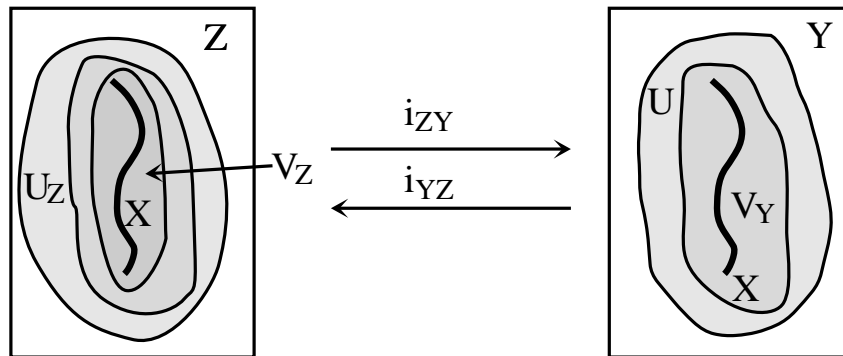

THEOREM 19.3 (LACHER). *If  $X$  and  $Y$  are compact ENR's and  $f : X \rightarrow Y$  is a cell-like map, then  $f$  is an  $\epsilon$ -homotopy equivalence over  $Y$  for all  $\epsilon > 0$ .*

PROOF: We will first prove the following claim:

CLAIM A (POLYHEDRAL LIFTING PROPERTY). *If  $f : X \rightarrow Y$  is CE,  $X$  a compact ENR, and  $\alpha : P \rightarrow Y$  is continuous with  $(P, P_0)$  a polyhedral pair then for every  $\epsilon > 0$  there is  $\delta > 0$  depending only on  $\dim(P - P_0)$  so that if  $\alpha_0 : P_0 \rightarrow X$  is a map with  $d(f \circ \alpha_0, \alpha|_{P_0}) < \delta$ , then there is a map  $\bar{\alpha} : P \rightarrow X$  extending  $\alpha_0$  so that  $d(f \circ \bar{\alpha}, \alpha) < \epsilon$ .*

$$\begin{array}{ccc} P_0 & \xrightarrow{\alpha_0} & X \\ \downarrow & \nearrow \hat{\alpha} & \downarrow f \\ P & \xrightarrow{\alpha} & Y \end{array}$$

PROOF OF CLAIM: Since each point-inverse of  $f$  is cell-like, and therefore has property  $UV^\infty$  in  $X$ , given  $\epsilon > 0$ , there is a  $\delta > 0$  so that  $f^{-1}B(\delta, y)$  contracts to a point in  $f^{-1}B(\epsilon, y)$  for each  $y \in Y$ . The proof of the claim is then essentially the same as the proof of Lemma 17.10.

CLAIM B (LIFTING PROPERTY FOR ENR'S). *If  $f : X \rightarrow Y$  is CE,  $X$  a compact ENR, and  $\alpha : Z \rightarrow Y$  is continuous with  $(Z, Z_0)$  an ENR pair, then for every  $\epsilon > 0$  there is  $\delta > 0$  depending only on  $\dim(Z)$  so that if  $\alpha_0 : Z_0 \rightarrow X$  is a map with  $d(f \circ \alpha_0, \alpha|_{Z_0}) < \delta$ , then there is a map  $\bar{\alpha} : Z \rightarrow X$  extending  $\alpha_0$  so that  $d(f \circ \bar{\alpha}, \alpha) < \epsilon$ .*

$$\begin{array}{ccc} Z_0 & \xrightarrow{\alpha_0} & X \\ \downarrow & \nearrow \hat{\alpha} & \downarrow f \\ Z & \xrightarrow{\alpha} & Y \end{array}$$

PROOF OF CLAIM B: Embed  $(Z, Z_0)$  in  $(D^\ell, \partial D^\ell)$  and choose a polyhedral neighborhood  $(P, P_0)$  with a retraction  $r : (P, P_0) \rightarrow (Z, Z_0)$ . Extend  $\alpha$  and  $\alpha_0$  to  $P$  and  $P_0$  by composing with  $r$ . Cutting  $(P, P_0)$  down to a smaller neighborhood of  $(Z, Z_0)$ , if necessary, the conditions of Claim A are satisfied, giving  $\hat{\alpha} : P \rightarrow X$ . Restricting  $\hat{\alpha}$  to  $Z$  completes the proof of Claim B.

PROOF OF THEOREM: Applying Claim B to the diagram

$$\begin{array}{ccc} & & X \\ & \nearrow g & \downarrow f \\ Y & \xrightarrow{id} & Y \end{array}$$

for  $\delta_1 > 0$  small produces  $g : Y \rightarrow X$  so that  $f \circ g$  is  $\epsilon_1$ -homotopic to  $id$ . Applying Claim B again to the diagram for  $\epsilon_1 = \delta$  sufficiently small

$$\begin{array}{ccc}
 X \times \{0\} \amalg X \times \{1\} & \xrightarrow{id \amalg g \circ f} & X \\
 \downarrow & \nearrow H & \downarrow f \\
 X \times [0, 1] & \xrightarrow{f \circ proj} & Y
 \end{array}$$

for  $\epsilon_1 = \delta$  sufficiently small gives an  $\epsilon$ -homotopy  $H$  from  $id$  to  $g \circ f$  where  $\epsilon$  is measured over  $Y$ .

REMARK 19.4. The proof above actually shows that  $Y$  is locally  $k$ -contractible for all  $k$  in the sense that for every  $\epsilon > 0$  there is a  $\delta > 0$  such that a map  $\alpha : S^k \rightarrow Y$  with diameter  $< \delta$  extends to a map  $\bar{\alpha} : D^{k+1} \rightarrow Y$  with diameter  $< \epsilon$ . Just lift to  $X$ , use one of the contractions in  $X$ , and project back. The proof of Claim B then works for finite-dimensional compact pairs,  $(Z, Z_0)$  by using the ANR property of  $X$  and the local contractibility of  $Y$  to extend  $(\alpha, \alpha_0)$  to a neighborhood of  $(Z, Z_0)$  in  $(D^\ell, \partial D^\ell)$  and proceeding as above.

PROPOSITION 19.5 (ESTIMATED MAPPING CYLINDER CALCULUS).

- (i) If  $p : Y \rightarrow B$  is a map and  $f_1 : X \rightarrow Y$  and  $f_2 : X \rightarrow Y$  are  $\epsilon$ -homotopic maps over  $B$ , then the mapping cylinder of  $f_1$  is  $\epsilon$ -homotopy equivalent to the mapping cylinder of  $f_2$  rel  $X \cup Y$ . Where the control map  $M(f_2) \rightarrow B$  is the composition of  $p$  with the mapping cylinder projection.
- (ii) If  $f : X \rightarrow Y$  and  $g : Y \rightarrow Z$  are maps, then there is a cell-like map

$$c : M(f) \cup_Y M(g) \rightarrow M(g \circ f)$$

which is the identity on  $X \amalg Z$ . The diagram

$$\begin{array}{ccc}
 M(f) \cup_Y M(g) & \xrightarrow{c} & M(g \circ f) \\
 \searrow \text{proj}_g \circ \text{proj}_f & & \swarrow \text{proj}_{(g \circ f)} \\
 & Z &
 \end{array}$$

strictly commutes, where  $proj_k$  denotes the mapping cylinder projection of the map  $k$ . Thus, if the spaces are ANR's, the homotopy equivalence is as controlled as we like over  $Z$  or any image of  $Z$ .

PROOF:

- (i) For each point  $x \in X$ , we have a triangle bounded by segments attaching  $x$  to  $f_1(x)$  and  $f_2(x)$ , along with the path from  $f_1(x)$  to  $f_2(x)$  given by the homotopy. These triangles collapse from one free face to the union of the bottom and the other free face, giving a homotopy whose tracks are the tracks of the original homotopy.
- (ii)  $c$  is the map which collapses  $M(g)$  to  $Z$ . ■

THEOREM 19.6. *If  $f : X \rightarrow Y$  is an  $\epsilon$ -equivalence over  $B$ , then  $X$  is a  $5\epsilon$ -SDR of  $M(f)$ .*

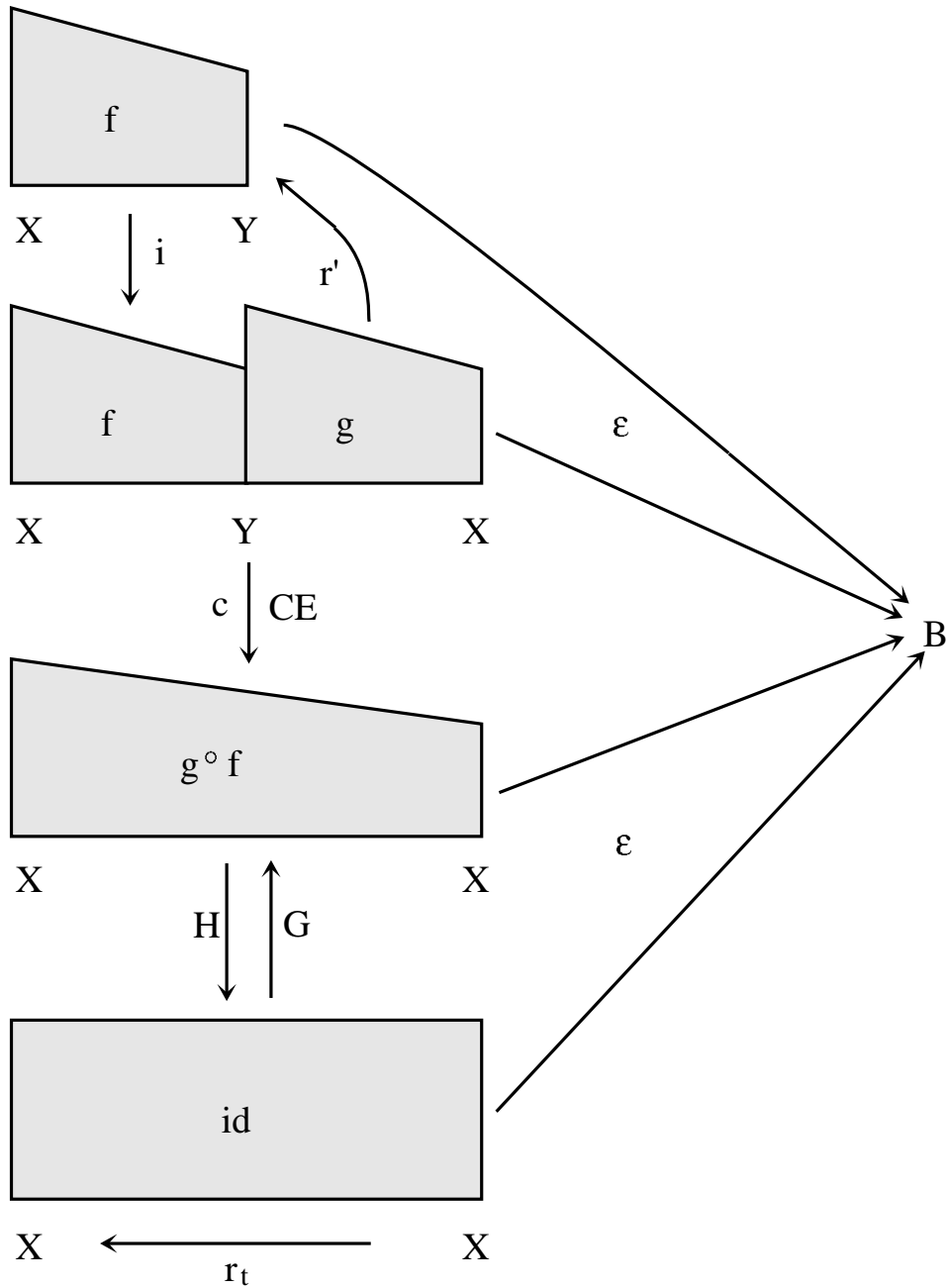

PROOF: Consider the diagram above, where  $r' : M(f) \cup_Y M(g)$  is the retraction obtained by  $id \amalg f : Y \amalg X \rightarrow Y$  using the homotopy from  $f \circ g$  to  $id$  and  $r_t$  is a deformation from  $X \times I$  to  $X$ . The retraction is given by:

$$r' \circ c^{-1} \circ G \circ r_t \circ H \circ c \circ i.$$

The last  $\epsilon$  sneaks in because the diagram only  $2\epsilon$ -commutes in the  $r'$  direction. ■

REMARK 19.7. The teacher doesn't have much faith in the 5. It seems clear that something  $< 10^6$  works, however.

REMARK 19.8. Since there is a CE map from the ordinary mapping cylinder to the simplicial mapping cylinder, using the simplicial mapping cylinder with respect to sufficiently fine subdivisions gives the same result.

#### REFERENCES

- [La1] R.C. Lacher, *Cell-like mappings, I*, Pacific J. Math. **30** (1969), 717–731.
- [La2] \_\_\_\_\_, *Cell-like maps and their generalizations*, Bul. Amer. Math. Soc. **83** (1977), 495–552.

## Chapter 20. Bounded structures and the CE Approximation Theorem

The purpose of this section is to give a proof of Siebenmann's CE Approximation Theorem using bounded topology.

**THEOREM 20.1 (CE APPROXIMATION THEOREM [Si]).** *Let  $f : M^n \rightarrow N^n$ ,  $n \geq 5$ , be a CE map between topological  $n$ -manifolds without boundary. Then  $f$  is a uniform limit of homeomorphisms.*

**PROOF:** For each  $x \in N$ , choose a disk  $D^n$  containing  $x$ . Let  $V = f^{-1}(\overset{\circ}{D})$ . Let  $\phi : \overset{\circ}{D}^n \rightarrow \mathbb{R}^n$  be a radial homeomorphism. By Corollary 16.4,  $\phi \circ f : V \rightarrow \mathbb{R}^n$  defines an element of  $S^{PL} \left( \begin{array}{c} \mathbb{R}^n \\ \downarrow id \\ \mathbb{R}^n \end{array} \right) = *$ . If  $h : V \rightarrow \mathbb{R}^n$  is a PL homeomorphism boundedly close to  $\phi \circ f$ ,  $\phi^{-1} \circ h$  is a homeomorphism from  $f^{-1}(\overset{\circ}{D}^n)$  to  $\overset{\circ}{D}^n$  which extends by  $f$  on the complement to give a CE map from  $M$  to  $N$  which is a homeomorphism over  $\overset{\circ}{D}^n$ . Applying this process inductively gives a homeomorphism from  $M$  to  $N$  which is homotopic to  $f$ .

We have to work a little harder to get the approximation. The basic idea is to do a finite induction by working on lots of disjoint balls at once. This is easy if the range manifold is PL – we just induct over a handle decomposition. In the general case, dimension theory \*\*\* ■

**THEOREM 20.2 (EDWARDS-KIRBY [EK]).** *If  $C$  is a compact subset of a TOP manifold  $M$  and  $U$  is a neighborhood of  $C$  in  $M$ , then for every  $\epsilon > 0$  there is a  $\delta > 0$  so that if  $i : U \rightarrow M$  is an embedding with  $d(i(x), x) < \delta$ , then there is a homeomorphism  $h : M \rightarrow M$  with compact support in  $U$  so that  $h(x) = i(x)$  for  $x \in C$  and so that  $d(h(x), x) < \epsilon$  for all  $x \in M$ . ■*

### REFERENCES

- [EK] R. D. Edwards and R. C. Kirby, *Deformations of spaces of imbeddings*, Ann. Math. **93** (1971), 63-88.
- [Si] L. C. Siebenmann, *Approximating cellular maps by homeomorphisms*, Topology **11** (1972), 271-294.



## Chapter 21. The $\alpha$ -approximation theorem

The goal of this section is to prove a manifold version of Theorem 17.2. The reader is advised to read the proof of that theorem first, since we will be assuming familiarity with the details of that argument. We should also mention that this section and the next on rational Pontrjagin classes are rather badly out of historical and logical order. This proof of the  $\alpha$ -approximation theorem invokes the topological classification of homotopy tori, which uses most of the machinery of Kirby-Siebenmann. In contrast, the topological invariance of Pontrjagin classes would be an immediate consequence of any useful form of topological transversality. Nevertheless, we feel that this section is useful as motivation for what follows. Since well-controlled homotopy equivalences between manifolds are close to homeomorphisms, it makes sense to look for proofs of topological invariance theorems which apply to controlled homotopy equivalences between manifolds, rather than just to homeomorphisms. We have already done this with the invariance of torsion. We will do the same with the topological invariance of rational Pontrjagin classes. We will return to this point later. The  $\alpha$ -Approximation Theorem is a “finite” form of Siebenmann’s CE approximation Theorem. Using bounded methods, we proved by the CE Approximation Theorem itself as Theorem 20.1, but the proof of our generalization will use the techniques of Siebenmann’s original proof.

**THEOREM 21.1** ( $\alpha$ -APPROXIMATION THEOREM [CHF]). *Let  $M^n$ ,  $n \geq 5$ , be a closed topological manifold with a fixed topological metric  $d$ . Then for every  $\epsilon > 0$  there is a  $\delta > 0$  so that if  $f : N \rightarrow M$  is a  $\delta$ -equivalence over  $M$ , then  $f$  is  $\epsilon$ -homotopic to a homeomorphism.*

We give the proof in dimensions  $\geq 6$ . The proof is a torus argument modeled on the proof of Siebenmann’s CE Approximation Theorem. The first step in the proof is a (rather!) technical lemma.

**COROLLARY 21.2** (CE APPROXIMATION THEOREM [SI]). *Let  $f : M^n \rightarrow N^n$ ,  $n \geq 5$ , be a CE map between topological  $n$ -manifolds without boundary. Then  $f$  is a uniform limit of homeomorphisms.*

**LEMMA 21.3** (HANDLE LEMMA). *Let  $V^n$  be a topological manifold,  $n \geq 5$ , and let  $f : V \rightarrow B^k \times \mathbb{R}^m$  be a proper map such that  $\partial V = f^{-1}(\partial B^k \times \mathbb{R}^m)$  and  $f$  is a homeomorphism over  $(B^k - \frac{1}{2}\overset{\circ}{B}^k) \times \mathbb{R}^m$ . For every  $\epsilon > 0$  there is a  $\delta > 0$  so that if  $f$  is a  $\delta$ -equivalence over  $B^k \times 3B^m$  and  $m \geq 1$ , then:*

- (i) There exists an  $\epsilon$ -equivalence  $F : B^k \times \mathbb{R}^m \rightarrow B^k \times \mathbb{R}^m$  such that  $F = id$  over  $(B^k - \frac{5}{6}\overset{\circ}{B}^k) \times \mathbb{R}^m \cup B^k \times (\mathbb{R}^m - 4\overset{\circ}{B}^m)$ , and
- (ii) There exists a homeomorphism  $\phi : f^{-1}(U) \rightarrow F^{-1}(U)$  such that  $F \circ \phi = f|_{f^{-1}(U)}$ , where  $U = (B^k - \frac{5}{6}\overset{\circ}{B}^k) \times \mathbb{R}^m \cup B^k \times 2B^m$ .

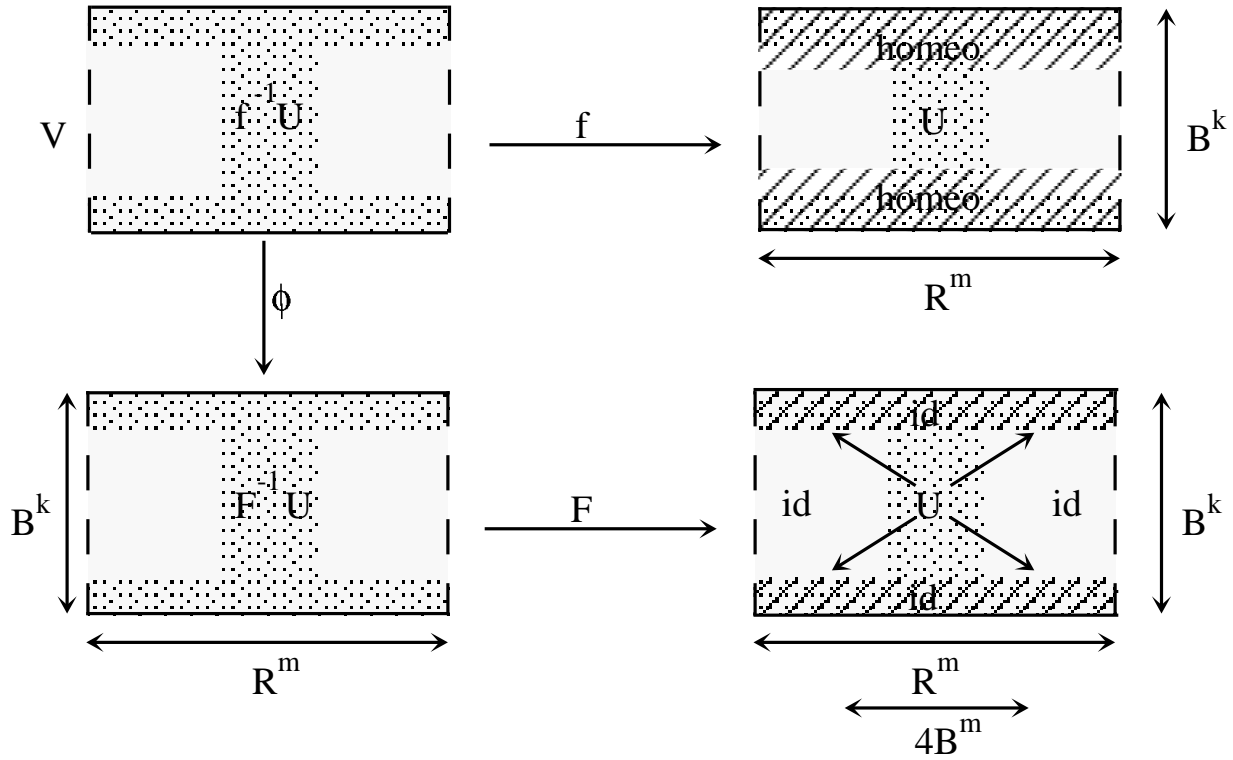

PROOF: We construct the following diagram:

$$\begin{array}{ccc}
 B^k \times \mathbb{R}^m & \xrightarrow{F} & B^k \times \mathbb{R}^m \\
 \uparrow i & & \uparrow i \\
 B^k \times \mathbb{R}^m & \xrightarrow{F'} & B^k \times \mathbb{R}^m \\
 \downarrow id \times e & & \downarrow id \times e \\
 B^k \times T^m & \xleftarrow{h} W_3 \xrightarrow{f_3} & B^k \times T^m \\
 \uparrow \downarrow & & \uparrow \downarrow \\
 W_2 & \xrightarrow{f_2} & (B^k \times T^m) - \overset{\circ}{D}^n \\
 \uparrow \downarrow & & \uparrow \downarrow \\
 W_1 & \xrightarrow{f_1} & (B^k \times T^m) - (\frac{2}{3}B^k \times \{x_0\}) \\
 \uparrow \downarrow & & \uparrow \downarrow \\
 W_0 & \xrightarrow{f_0} & B^k \times T_0^m \\
 \downarrow \beta' & & \downarrow id \times \beta \\
 V & \xrightarrow[f \text{ homeo over } \partial]{} & B^k \times \mathbb{R}^m
 \end{array}$$

- (i)  $W_0$  is constructed by taking the pullback.  $W_0$  is a manifold and  $f_0$  is an  $\delta_1$ -equivalence away from the hole in the torus. One way to see this is to pull back the mapping cylinder projection from the mapping cylinder of  $f$  to  $V$ . This is the mapping cylinder of  $f_0$  and the  $5\delta$ -SDR from  $M(f)$  to  $V$  lifts to a  $\delta_1$ -SDR from  $M(f_0)$  to  $W_0$  away from the hole.
- (ii) Since  $f$  is a homeomorphism over the boundary, we can put the plug in over  $B^k - \frac{2}{3}B^k) \times T^m$ . This gives us  $W_1$  and  $f_1$ .
- (iii) Parameterize the end of  $(B^k \times T^m) - (\frac{2}{3}B^k \times \{x_0\})$  as  $S^{n-1} \times [0, 1)$  and choose  $D^n$  to be a disk in  $B^k \times T^m$  containing  $(\frac{2}{3}B^k \times \{x_0\})$ . For  $\delta$  sufficiently small, we can use the Splitting Theorem below to find  $W_2 \subset W_1$  and a homotopy equivalence of pairs  $f_2 : (W_2, \partial W_2) \rightarrow ((B^k \times T^m) - \overset{\circ}{D}^n, \partial D^n)$ . Moreover, we can take  $f_2 = f_1$  outside of a small neighborhood of  $\partial D^n$ . Note that at this stage we have lost some control, since  $f_2$  is an uncontrolled homotopy equivalence over  $\partial D^n$  and  $D^n$  is not small.

- (iv) We cone off  $\partial W_2$  and extend to  $f'_3 : W_3 \rightarrow B^k \times T^m$ . We regain the lost control by Stretching out a collar on a disk  $2D^n \supset D^n$  and squeezing  $D^n$  to be small. The result is a  $\delta_2$ -equivalence  $f_3 : W_3 \rightarrow B^k \times T^m$ .
- (v) Choose  $h : W_3 \rightarrow B^k \times T^m$  to be a homeomorphism agreeing with  $f_3$  over  $(B^k - \frac{5}{6}\overset{\circ}{B}^k) \times T^m$  and homotopic to  $f_3$ . The existence of  $h$  is a consequence of topological surgery theory.
- (vi) Pass to the universal cover and get  $F'$ , which is bounded and equal to the identity over  $(B^k - \frac{5}{6}\overset{\circ}{B}^k) \times \mathbb{R}^m$ .
- (vii) Let  $\rho : \mathbb{R}^m \rightarrow 4\overset{\circ}{B}^m$  be a radial homeomorphism which is the identity on  $2B^m$ . Conjugating  $F'$  by  $id \times \rho$  squeezes  $F'$  to a homeomorphism  $F'' = \rho \circ F' \circ \rho^{-1} : B^k \times 4\overset{\circ}{B}^m \rightarrow B^k \times 4\overset{\circ}{B}^m$  which comes closer and closer to commuting with projection near the boundary. Squeezing in the  $B^k$ -direction – this is essentially an Alexander isotopy – gives an  $F : B^k \times 4\overset{\circ}{B}^m \rightarrow B^k \times 4\overset{\circ}{B}^m$  which extends by the identity to  $B^k \times \mathbb{R}^m$ .



- (viii) The construction of  $\phi$  proceeds as usual. We simply note that  $F$  contains a copy of  $f$  over  $B^n$  and extend near the boundary using  $f$  to identify a neighborhood of the boundary in  $V$  with a neighborhood of the boundary in the range.

This completes the proof of the Handle Lemma. ■

The next step in the proof is to use Siebenmann’s inversion trick to prove the following Handle Theorem.

**THEOREM 21.4 (HANDLE THEOREM).** *Let  $V^n$  be a topological manifold,  $n \geq 5$ , and let  $f : V \rightarrow B^k \times \mathbb{R}^m$  be a proper map such that  $\partial V = f^{-1}(\partial B^k \times \mathbb{R}^m)$  and  $f$  is a homeomorphism over  $(B^k - \frac{1}{2}\overset{\circ}{B}^k) \times \mathbb{R}^m$ . For every  $\epsilon > 0$  there is a  $\delta > 0$  so that if  $f$  is a  $\delta$ -equivalence over  $B^k \times 3B^m$ , then there exists a proper map  $\bar{f} : V \rightarrow B^k \times \mathbb{R}^m$  such that*

- (i)  $\bar{f}$  is an  $\epsilon$ -equivalence over  $B^k \times 2.5B^m$

- (ii)  $\bar{f} = f$  over  $[(B^k - \frac{2}{3}\overset{\circ}{B}^k) \times \mathbb{R}^m] \cup [B^k \times (\mathbb{R}^m - 2\overset{\circ}{B}^m)]$ ,
- (iii)  $\bar{f}$  is a homeomorphism over  $B^k \times B^m$ .

PROOF: The case  $m = 0$  follows from the generalized Poincaré Conjecture and coning, so we assume  $m \geq 1$ .

We apply the Handle Lemma to obtain  $F$  as above and compactify  $F$  by the identity to obtain a homeomorphism  $B^k \times S^m \rightarrow B^k \times S^m$ . We take out  $B^k \times$  south pole and its inverse image and apply the handle lemma again, parameterizing  $B^k \times \mathbb{R}^m$  so that there is an overlap where we still have the original  $f$ . We compactify again.

As in the proof of Theorem 17.2, the result is a new space  $\bar{V}$  with a global  $\epsilon$ -equivalence  $\bar{F} : \bar{V} \rightarrow B^k \times \mathbb{R}^m$  so that  $\bar{F}$  is a homeomorphism over  $B^k \times B^m$  and  $\bar{F} = f$  over  $B^k \times (3B^m - 2\overset{\circ}{B}^m) \cup (B^k - \frac{7}{8}\overset{\circ}{B}^k) \times 3B^m$ . Using the Splitting Theorem and the Generalized Poincaré conjecture, we can find an  $S^{n-1} \subset f^{-1}(B^k \times (3B^m - 2\overset{\circ}{B}^m) \cup (B^k - \frac{7}{8}\overset{\circ}{B}^k) \times 3B^m)$  which bounds a ball in  $V$  containing  $f^{-1}(\frac{1}{2}B^k \times B^m)$ . By coning, we can identify  $\bar{F}^{-1}(B^k \times 3B^m)$  with a subset of  $V$ , completing the proof. ■

PROOF OF  $\alpha$ -APPROXIMATION: The proof of the  $\alpha$ -approximation theorem is now an easy handle induction. We begin by taking a small handle decomposition of  $M$ . A 0-handle is a closed  $n$ -ball. Taking an open collar on the boundary, we have a  $B^0 \times \mathbb{R}^n$ . The Handle Theorem produces a new  $\delta_1$ -equivalence which is a homeomorphism over a neighborhood of the original handle. After doing this for all 0-handles, each 1-handle is a  $B^1 \times B^{n-1}$  meeting the 0-handles in  $\partial B^1 \times B^{n-1}$ . Adding a collar, we have a  $\delta_1$ -equivalence over  $B^1 \times 3B^{n-1}$  and a homeomorphism over a neighborhood of  $\partial B^1 \times \mathbb{R}^m$ . Applying the Handle Theorem gives a  $\delta_2$ -equivalence which is a homeomorphism over a neighborhood of the original 1-handle. The induction continues until the Poincaré Conjecture and the Alexander trick allow us to cone off at the last stage. The degree of approximation is governed by the sizes of the original handles. ■

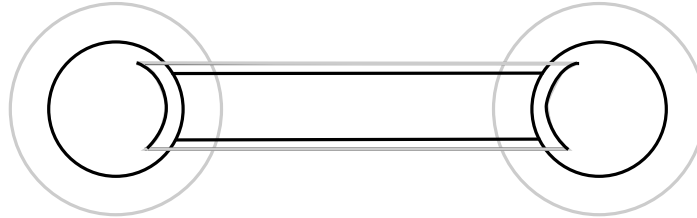

REMARK 21.5. Of course, this requires that we know that topological manifolds in dimensions  $\geq 6$  have small handle decompositions. This is one of the results of the Kirby-Siebenmann program [KS, p.104]. A way of avoiding this is to use a handle decomposition of  $\mathbb{R}^n$  to prove the result over coordinate patches and then use the following strong version of local contractibility of the homeomorphism group.

THEOREM [EK]. *Let  $M^n$  be a topological manifold. If  $C$  is a compact subset of  $M$  and  $U$  is an open neighborhood of  $C$  in  $M$ , then for every  $\epsilon > 0$  there is a  $\delta > 0$  so that if  $h : U \rightarrow M$  is an open embedding with  $d(h(x), x) < \delta$ , then there is a homeomorphism  $\bar{h} : M \rightarrow M$  so that  $\bar{h}|_C = h|_C$ ,  $\bar{h}|(M - U) = id$ , and  $d(\bar{h}(x), x) < \epsilon$ .*

Here is how the piecing together process works. Cover  $M$  by finitely many balls  $\{B_i\}_{i=0}^p$  and for each  $i$ , let  $B_{i,0} \supset \overset{\circ}{B}_{i,0} \supset B_{i,1} \cdots \supset \overset{\circ}{B}_{i,n-1} \supset B_{i,n} = B_i$  be a sequence of nested neighborhoods of  $B_i$ . We prove inductively that for every  $\epsilon > 0$  there is a  $\delta > 0$  so that every  $\delta$ -equivalence  $f : N \rightarrow M$  is  $\epsilon$ -close to an  $\epsilon$ -equivalence  $f_i$  which is a homeomorphism over  $B_{1,i} \cup \cdots \cup B_{i,i}$ .

The case  $i = 1$  is easy. We take a handle decomposition of  $\overset{\circ}{B}_{1,0}$  and use the handle induction above to get a homeomorphism over  $B_{1,1}$ .

The case  $i = 2$  is representative of the general case. We have homeomorphisms  $h$  and  $k$  over  $B_{1,1}$  and  $B_{2,1}$  which are close to our original  $f$ . We therefore have an homeomorphism  $h \circ k^{-1} : \overset{\circ}{B}_{1,1} \cap \overset{\circ}{B}_{2,1} \rightarrow M$  which is close to the identity. By the Edwards-Kirby theorem above, we can find  $\bar{h} : M \rightarrow M$  agreeing with  $h \circ k^{-1}$  on  $\overset{\circ}{B}_{1,2} \cap \overset{\circ}{B}_{2,2}$  which is close to the identity and which is equal to the identity outside of  $\overset{\circ}{B}_{1,1} \cap \overset{\circ}{B}_{2,1}$ . Defining a new homeomorphism over  $\overset{\circ}{B}_{1,2} \cup \overset{\circ}{B}_{2,2}$  to be  $h$  over  $\overset{\circ}{B}_{1,2}$  and  $\bar{h} \circ k$  over  $\overset{\circ}{B}_{2,2}$  completes the inductive step. ■

Of course, we're still left using the classification of topological homotopy tori in high dimensions, but this trick of blending homeomorphisms using local contractibility is often useful.

THEOREM 21.6 (SPLITTING THEOREM). *Let  $W^n$  be a manifold,  $n \geq 5$  and  $\partial W = \emptyset$ , and let  $f : W \rightarrow S^{n-1} \times \mathbb{R}$  be a proper map which is an  $\epsilon$ -equivalence over  $[-2, 2]$  via the projection map  $p : S^{n-1} \times \mathbb{R} \rightarrow \mathbb{R}$ . If  $\epsilon > 0$  is sufficiently small, then there is an  $(n - 1)$ -sphere  $S$  subset  $f^{-1}(S^{n-1} \times [-1, 1])$  such that  $f|_S : S \rightarrow S^{n-1} \times \mathbb{R}$  is a homotopy equivalence,  $S$  is bicollared, and  $S$  separates the component of  $W$  containing*

$f^{-1}(S^{n-1} \times [-1, 1])$  into two components, one containing  $f^{-1}(S^{n-1} \times \{-1\})$  and one containing  $f^{-1}(S^{n-1} \times \{1\})$ .

PROOF: In dimensions  $n \geq 6$ , this is similar to the proof of Siebenmann's thesis. Split by transversality over  $S^{n-1} \times \{0\}$  and do surgery to make the map

$$H_k(f^{-1}(S^{n-1} \times [0, 1 - \frac{1}{n-k+3}]), f^{-1}(0)) \rightarrow H_k(f^{-1}(S^{n-1} \times [0, 1]), f^{-1}(0))$$

the zero map.

The only novelty here is that at each stage we must extend the map so that the surgered boundary manifold is the new inverse image of zero. This is done by applying a homotopy  $h_t$  which drags the image of the handle into  $S^{n-1} \times \{0\}$  and then poking the interior of the handle across  $S^{n-1} \times \{0\}$  inside a collar neighborhood of  $S^{n-1} \times \{0\}$ . ■

REMARK 21.7. Given the basic tools of topological surgery – handle decompositions, transversality, and periodicity – the proof of the torus geometry we need isn't too hard.

It suffices for our argument to show that a homotopy  $B^k \times T^m \text{ rel } \partial$  becomes standard after passage to a finite cover. After passing to a finite cover, we can use a relative version of Siebenmann's thesis to split open over  $T^{m-1}$  and reduce to the same problem for  $B^{k+1} \times T^{m-1} \text{ rel } \partial$  and for  $B^k \times T^{m-1}$ . The first factor is no problem. We just induct on down to the case of  $B^n \text{ rel } \partial$ , which we solve by an Alexander trick. The second is more of a problem because of low-dimensional difficulties. Here is where periodicity comes into play, since  $\mathcal{S}(B^k \times T^{m-1}) \cong \mathcal{S}(B^{k+3} \times T^{m-1}, \partial)$ , which pushes up the dimension, avoiding low-dimensional difficulties. See [We] for a nice explanation.

#### REFERENCES

- [ChF] T. A. Chapman and S.C. Ferry, *Approximating homotopy equivalences by homeomorphisms*, Amer. J. Math. **101** (1979), 583–607.
- [EK] R. D. Edwards and R. C. Kirby, *Deformations of spaces of imbeddings*, Ann. Math. **93** (1971), 63–88.
- [KS] R. Kirby and L. C. Siebenmann, *Foundational essays on topological manifolds, smoothings, and triangulations*, Princeton University Press, Princeton, New Jersey, 1977.
- [Si] L. C. Siebenmann, *Approximating cellular maps by homeomorphisms*, Topology **11** (1972), 271–294.

[We] S. Weinberger, *The topological classification of stratified spaces*, U. of Chicago Press, Chicago, IL.



## Chapter 22. The topological invariance of rational Pontrjagin classes

### THE SIGNATURE OF A TOPOLOGICAL MANIFOLD

DEFINITION 22.1. We will say that a bilinear form  $\langle \cdot, \cdot \rangle$  on a finite-dimensional rational vector space  $V$  is *nonsingular* if  $\det(A) \neq 0$  where  $\langle x, y \rangle = xAy^t$ .

LEMMA 22.2. Let  $M^n$  be a closed oriented  $4k$ -manifold. Then cup product induces a nonsingular quadratic form on  $H^{2k}(M; \mathbb{Q})$ .

PROOF: We define  $\langle \alpha, \beta \rangle = \langle \alpha \cup \beta, \mu_M \rangle$ , where  $\mu_M$  is the orientation class. This is singular if and only if there is a  $\beta \in H^{2k}(M; \mathbb{Q})$  so that  $\langle \alpha \cup \beta, \mu_M \rangle = 0$  for all  $\alpha \in H^{2k}(M; \mathbb{Q})$ . But this is impossible, since  $\langle \alpha \cup \beta, \mu_M \rangle = \langle \alpha, \beta \cap \mu_M \rangle$  and we could take  $\alpha$  dual to  $\beta \cap \mu_M$ , which is nonzero by Poincaré duality, in  $H^{2k}(M; \mathbb{Q}) = \text{Hom}(H_{2k}(M; \mathbb{Q}), \mathbb{Q})$ . ■

DEFINITION 22.3. Any nonsingular rational quadratic form can be diagonalized. This is just a matter of completing the square. The *signature* of the form is the number of positive diagonal entries minus the number of negative diagonal entries. This is well-defined because the number of positive diagonal entries is the dimension of the maximal subspace on which the form is positive definite. The *signature* or *index*  $\sigma(M)$  of a  $4k$ -manifold is the signature of the quadratic form on  $2k$ -dimensional cohomology.

EXERCISE 22.4. If  $M^{4k}$  is an oriented manifold, show that the signature of  $M \times \mathbb{C}P^2$  is the same as the signature of  $M$ .

THEOREM 22.5. If  $M^{4k}$  is the boundary of an oriented  $W^{4k+1}$ , then  $\sigma(M) = 0$ .

PROOF: We have a sign-commuting diagram with  $\mathbb{Q}$  coefficients:

$$\begin{array}{ccccc} H^{2k}(W) & \xrightarrow{j^*} & H^{2k}(M) & \xrightarrow{\delta} & H^{2k+1}(W, M) \\ \downarrow \cong & & \downarrow \cong & & \downarrow \cong \\ H_{2k+1}(W, M) & \xrightarrow{\partial} & H_{2k}(M) & \xrightarrow{j_*} & H_{2k}(W) \end{array}$$

We have  $\dim(\text{im } j^*) + \dim(\ker(\delta)) = \dim H^{2k}(M)$ . But

$$\begin{aligned} \dim(\ker(\delta)) &= \dim(\ker(j_*)) = \dim(\text{im}(\partial)) \\ &= \dim(\text{im}(\delta)) = \dim(\text{im}(j_*)) = \dim(\text{im}(j^*)), \end{aligned}$$

where the last uses the fact that  $j_*$  and  $j^*$  are duals and row rank equals column rank. The upshot is that the dimension of  $\text{im}(j^*)$  is half the dimension of  $H^{2k}(M)$ .

Now we have

$$\begin{aligned} \langle j^* \alpha \cup j^* \beta, \mu_M \rangle &= \langle j^* \alpha \cup j^* \beta, \partial \mu_W \rangle = \langle j^* \alpha, j^* \beta \cap \partial \mu_W \rangle \\ &= \pm \langle j^* \alpha, \partial(\beta \cap \mu_W) \rangle = \langle \delta j^* \alpha, \beta \cap \mu_W \rangle = 0. \end{aligned}$$

Thus,  $im(j^*)$  is a self-annihilating subspace whose dimension is half the dimension of  $H^{2k}(M)$ . Since neither a maximal positive definite subspace nor a maximal negative definite subspace can intersect  $im(j^*)$ ,  $\sigma(M) = 0$ . ■

COROLLARY 22.6. *If  $M_1^{4k}$  and  $M_2^{4k}$  are oriented cobordant, then  $\sigma(M_1) = \sigma(M_2)$ .*

PROOF:  $M_1 \amalg (-M_2)$  bounds, so  $\sigma(M_1) - \sigma(M_2) = 0$ . ■

COROLLARY 22.7. *If  $f : M^n \rightarrow N^n$  is a map between smooth closed oriented manifolds and  $Q^{4k}$  is a smooth closed oriented submanifold of  $N$ , then  $sgn(\bar{f}^{-1}(Q))$  is an invariant of the homotopy class of  $f$ , where  $\bar{f}$  is homotopic to  $f$  and transverse to  $Q$ .*

### CHARACTERISTIC CLASSES

DEFINITION 22.8. The  $G_k(\mathbb{R}^n)$  is the space of  $k$ -planes in  $n$ -space. We topologize  $G_k(\mathbb{R}^n)$  by noting that  $O(n)$  acts transitively on the  $k$ -planes in  $\mathbb{R}^n$  and that the subgroup of  $O(n)$  fixing the standard  $\mathbb{R}^k$  is  $O(k) \times O(n - k)$ . The Grassman manifold is therefore  $\frac{O(n)}{O(k) \times O(n-k)}$ . There is a natural inclusion  $G_k(\mathbb{R}^n) \rightarrow G_k(\mathbb{R}^{n+1})$ . We call the limit  $G_k$ . We construct the space  $\tilde{G}(\mathbb{R}^n)$  similarly and prove that  $\tilde{G}(\mathbb{R}^n) = \frac{SO(n)}{SO(k) \times SO(n-k)}$ . The *universal bundle*  $\gamma^k$  over  $G_k$  is the bundle for which the fiber over  $x \in G_k$  is the  $k$ -dimensional vector space  $x$ . The universal bundle  $\tilde{\gamma}^k$  over  $\tilde{G}_k$  is defined similarly.

PROPOSITION 22.9 ([MS], §5). *Any vector bundle  $\xi^k$  over a paracompact base space  $B$  admits a well-defined homotopy class of classifying maps  $c_\xi : B \rightarrow G^k$  such that the pullback  $(c_\xi)^* \gamma^k = \xi$ . Similarly, an oriented vector bundle  $\xi^k$  over a paracompact base space  $B$  admits a well-defined homotopy class of classifying maps  $c_\xi : B \rightarrow \tilde{G}^k$  such that  $(c_\xi)^* \tilde{\gamma}^k = \xi$ .*

This map is particularly easy to describe for the tangent bundle of a smooth manifold: If  $M$  is a smooth  $n$ -manifold, embedding  $M$  into  $\mathbb{R}^\ell$ ,  $\ell$  large and sending each  $m \in M$  to a tangent plane at  $m$  gives a map  $c_M : M \rightarrow G_n$ . This map is well-defined up to homotopy since any two such embeddings can be extended to an embedding of  $M \times I$ . A similar construction gives a well-defined homotopy class of maps  $\tilde{c}_M : M \rightarrow \tilde{G}_n$  when  $M$  is an oriented manifold.

Whitney sum with a trivial bundle gives stabilization maps  $G_k \rightarrow G_{k+1}$  and  $\tilde{G}_k \rightarrow \tilde{G}_{k+1}$ . Calling the limits  $Gr$  and  $\tilde{G}r$ , we have:

THEOREM 22.10 ([MS], p. 179). *Let  $M$  be a smooth manifold.*

- (i) *There are classes  $w_1, \dots, w_i, \dots$  with  $w_i \in H^i(Gr; \mathbb{Z}_2)$  so that*

$$H^*(Gr; \mathbb{Z}_2) \cong \mathbb{Z}_2[w_1, w_2, \dots].$$

- (ii) *There are classes  $p_1, \dots, p_i, \dots$  with  $p_i \in H^{4i}(\tilde{G}r; \mathbb{Z})$  so that*

$$H^*(\tilde{G}r; \mathbb{Z}[\frac{1}{2}]) \cong \mathbb{Z}[\frac{1}{2}][p_1, p_2, \dots].$$

DEFINITION 22.11.

- (i) The classes  $w_i = w_i(\tau_M) = c_M^*(w_i)$  obtained by pulling back these  $w_i$ 's are called the *Stiefel-Whitney classes* of  $M$ .
- (ii) The classes  $p_i = p_i(\tau_M) = \tilde{c}_M^*(p_i)$  obtained by pulling back the  $p_i$ 's are called the *Pontrjagin classes* of  $M$ .

The Stiefel-Whitney classes are completely characterized by axioms (see [MS, p. 37]):

- (i) To each vector bundle  $\xi$  there corresponds a sequence of cohomology classes

$$w_i(\xi) \in H^i(B(\xi); \mathbb{Z}/2).$$

The class  $w_0(\xi)$  is  $1 \in H^0(B(\xi); \mathbb{Z}/2)$ .

- (ii) If  $f : B(\xi) \rightarrow B(\eta)$  is a map covered by a map of vector bundles which is a linear isomorphism on each fiber, then  $w_i(\xi) = f^*w_i(\eta)$ .
- (iii) If  $\xi$  and  $\eta$  are vector bundles over  $B$ , then  $w_k(\xi \oplus \eta) = \sum w_i(\xi) \cup w_{k-i}(\eta)$ .
- (iv) For the Möbius band  $\gamma^1$  over the circle,  $w_1(\gamma^1) \neq 0$ .

The Pontrjagin classes satisfy similar formulas, except that (iii) is only true modulo 2. Here is Hirzebruch's signature theorem, which relates the characteristic classes of  $\tau_M$  to the algebraic topology of  $M$ . This is a major result in differential and algebraic topology. It has some of the flavor of the Poincaré-Hopf and Gauss-Bonnet Theorems, in that it relates differential geometric invariants of a smooth manifold  $M$  to its underlying homotopy structure.

THEOREM 22.12 (HIRZEBRUCH'S SIGNATURE THEOREM([MS, P. 225], [H])). *There is a sequence  $\{L_k(p_1(\tau_M), \dots, p_k(\tau_M))\}$  of polynomials with rational coefficients so that*

$$\sigma(M^{4k}) = \langle L_k(p_1, \dots, p_k), [M] \rangle.$$

The first few  $L$ -polynomials are:

$$\begin{aligned} L_1 &= \frac{1}{3}p_1 \\ L_2 &= \frac{1}{45}(7p_2 - p_1^2) \\ L_3 &= \frac{1}{945}(62p_3 - 13p_2p_1 + 2p_1^3) \\ L_4 &= \frac{1}{14175}(381p_4 - 71p_3p_1 - 19p_2^2 + 22p_2p_1^2 - 3p_1^4). \blacksquare \end{aligned}$$

This shows that the signature of a smooth manifold is determined by the characteristic classes of its tangent bundle. This leads fairly directly to the following: Let  $u \in H^k(S^k, \mathbb{Z})$  and  $\mu_M \in H_n(M; \mathbb{Z})$  be the standard generators.

LEMMA 22.13 ([MS, P.232]). *For every smooth map  $f : M^n \rightarrow S^{n-4i}$  and every regular value  $y$ , the Kronecker index*

$$\langle L_i(\tau^n) \cup f^*(u), \mu_M \rangle$$

*is equal to the signature of the manifold  $M^{4i} = f^{-1}(y)$ . In the case  $4i < (n - 1)/2$ , the class  $L_i(p_1(\tau^n), \dots, p_i(\tau^n))$  is completely characterized by these identities.  $\blacksquare$*

Notice that this means that we can solve for  $p_i(\tau^n) \in H^{4i}(M; \mathbb{Q})$  for  $4i < (n - 1)/2$ . The maps  $i : M \rightarrow M \times T^\ell$  and  $proj : M \times T^\ell$  are both covered by maps of the stabilized tangent bundles, so the Pontrjagin classes of  $M$  may be identified with those of  $M \times T^\ell$ . After such stabilization, the lemma above gives an interpretation of the rational Pontrjagin classes in terms of signatures of inverse images of submanifolds with trivial normal bundles. This is the basis of Thom's definition of the rational Pontrjagin classes of a piecewise linear manifold. See [MS, p. 231].

The proof of the second part of the theorem proceeds by noting that

$$[M^n, S^k] \rightarrow [\Sigma M, \Sigma S^k] \cong [M, \Omega \Sigma S^k]$$

is an isomorphism for  $n < 2k - 1$ . This means that  $[M^n, S^k]$  is the  $k^{th}$  cohomotopy group of  $M$ . Cohomotopy is a generalized cohomology theory for which the coefficients

in dimensions other than zero are finite groups. It follows that for any finite complex  $K^n$ ,  $n < 2k - 1$ ,  $[K^n, S^k] \otimes \mathbb{Q} \cong H^k(K; \mathbb{Q})$  where the isomorphism is given by pulling back the top-dimensional cohomology class of  $S^k$ .

CUP PRODUCTS AND INTERSECTIONS

PROPOSITION 22.14. *Suppose that  $P^p$  and  $Q^q$  are closed oriented submanifolds of the closed oriented manifold  $M^n$  with  $p + q = n$ . Suppose further that  $P$  and  $Q$  meet transversally in a finite number of points and let  $[P]$  and  $[Q]$  be the orientation classes. Then*

$$\langle (i_*[P])^* \cup (j_*[Q])^*, [M] \rangle = \epsilon(P, Q)$$

where  $i$  and  $j$  are the inclusions,  $*$  denotes Poincaré duality, and  $\epsilon(P, Q)$  is the intersection number as defined in [RS].

PROOF: Let  $N$  be a regular neighborhood of  $P$  in  $M$ . We have a sign-commuting diagram

$$\begin{array}{ccccc} H_p(N) & \longrightarrow & H_p(M) & \longrightarrow & H_p(M, N) \\ \downarrow \cong & & \downarrow \cong & & \downarrow \cong \\ H^{n-p}(N, \partial) & \longrightarrow & H^{n-p}(M) & \longrightarrow & H^{n-p}(M - N) \\ \downarrow \cong & \nearrow & & \searrow & \downarrow \cong \\ H^{n-p}(M, M - P) & & & & H^{n-p}(M - P) \end{array}$$

$[P] \in H_p(N)$  is dual to  $[P]^* \in H^{n-p}(M, M - P)$  and the image of  $[P]^*$  under restriction is  $(i_*[P])^*$ . Similarly,  $(j_*[Q])^*$  is the image under restriction of a class in  $H^{n-q}(M, M - Q)$ , so the product  $(i_*[P])^* \cup (j_*[Q])^*$  is the image of  $[P]^* \cup [Q]^* \in H^n(M, M - (P \cap Q))$ . Therefore, to understand the cup product, we need only understand what happens in neighborhoods of the intersection points. But the formula works for  $S^p \cap S^q \subset S^{p+q}$ , where the local picture is the same, so the formula works in general. ■

MILNOR'S SEVEN SPHERE

We now digress to present one of the most famous examples in topology – Milnor’s example of a smooth manifold which is homeomorphic to  $S^7$  but not diffeomorphic to  $S^7$ . Take 8 copies of the tangent disk bundle to  $S^4$  and “plumb” them together according to the following diagram:



We wish to prove the following celebrated theorem of Novikov. For reasons of historical piety,<sup>21</sup> we work in the smooth category, though the PL category would work equally well. The reader who would like a quick introduction to the smooth category and the sorts of transversality arguments used here is urged to consult [M].

**THEOREM 22.16 (TOPOLOGICAL INVARIANCE OF RATIONAL PONTRJAGIN CLASSES, [N]).** *If  $M^n$  and  $N^n$  are closed smooth oriented  $n$ -manifolds, and  $h : M \rightarrow N$  is an orientation-preserving homeomorphism, then  $h^*(p_i(\tau_N)) = p_i(\tau_M)$  in  $H^*(M, \mathbb{Q})$ .*

Given this topological invariance of rational Pontrjagin classes, Milnor's construction also gives us an example of a PL manifold with no smooth structure.  $M^8$  is clearly a PL manifold, so  $\Sigma^7$  is a standard PL sphere and we can get a closed PL 8-manifold  $\hat{M}$  by coning the boundary. Since  $p_1$  is a topological invariant, we would have  $p_1 = 0$  in any smooth structure on  $\hat{M}$ , so for the reasons described above,  $\hat{M}$  could not be homeomorphic to a smooth manifold.

**PROOF OF TOPOLOGICAL INVARIANCE:** By Lemma 22.13, it will suffice to show that if  $f : N \rightarrow S^k$  is a map and  $\bar{h} : M \rightarrow N$  is a smooth approximation to  $h$ , then  $\sigma((f \circ h)^{-1}(y)) = \sigma(f^{-1}(y))$  for some regular point  $y \in S^k$  of  $f \circ h$ .

**DEFINITION 22.17.** Let  $B$  be a metric space and let  $p : X \rightarrow B$  be a function such that  $p^{-1}(C)$  has compact closure for every compact  $C \subset B$ . A map  $f : Y \rightarrow X$  is said to be a *bounded homotopy equivalence over  $B$*  if there exist a map  $g : X \rightarrow Y$  and homotopies  $k_t : g \circ f \simeq id_Y$ ,  $h_t : f \circ g \simeq id_X$  so that there is a  $d > 0$  so that the tracks  $p(h_t(x))$  and  $p(f(k_t(y)))$  all have diameter  $< d$ .

Our proof of the topological invariance of rational Pontrjagin classes makes use of the following stable bounded splitting theorem.

**THEOREM 22.18 (STABLE BOUNDED SPLITTING THEOREM).** *Let  $V^n$  be a closed orientable smooth manifold and let  $W^{n+k} \rightarrow V^n \times \mathbb{R}^k$  be a bounded homotopy equivalence over  $\mathbb{R}^k$ ,  $W$  a smooth manifold and  $n+k \geq 5$ . Then there is a bicollared smooth submanifold  $W' \subset W \times S^1$  so that  $W' \rightarrow V^n \times S^1 \times \mathbb{R}^{k-1}$  is a bounded homotopy equivalence over  $\mathbb{R}^{k-1}$ .*

This splitting theorem is called "stable" because of the extra  $S^1$  factor.

---

<sup>21</sup> ...and also to make the transversality arguments easier.

PROOF THAT STABLE BOUNDED SPLITTING IMPLIES TOPOLOGICAL INVARIANCE: Let  $W^n$  and  $M^n$  be smooth manifolds and let  $f : W \rightarrow M$  be a homeomorphism. If  $p : M \rightarrow S^k$  is a smooth map, let  $y \in S^k$  be a regular value of  $p$ . By the implicit function theorem, there is a neighborhood  $U$  of  $Y$  homeomorphic to  $\mathbb{R}^k$  and a diffeomorphism  $p^{-1}(U) \cong V \times \mathbb{R}^k$ , with  $V$  smooth and compact. We will show in due course that it suffices to consider the case in which  $V$  is simply connected. For now, we assume that  $\pi_1 V = 0$ .

Setting  $W = f^{-1} \circ p^{-1}(U)$ , we have a homeomorphism  $f| : W \rightarrow V \times \mathbb{R}^k$ . Since a homeomorphism is a bounded homotopy equivalence over any control space, we are in the situation of the Bounded Splitting Theorem, except for the dimension assumption, which can always be satisfied by crossing with  $\mathbb{C}P^{2k}$  for some  $k$ . We split and find a smooth map  $\bar{f}_1 : W \times S^1 \rightarrow V \times S^1 \times \mathbb{R}^k$  so that  $\bar{f}_1$  is transverse to  $V \times \mathbb{R}^{k-1}$  and so that the restriction of  $\bar{f}_1$  to  $\bar{f}_1^{-1}(V \times S^1 \times \mathbb{R}^{k-1} \times \{0\})$  gives a bounded homotopy equivalence to  $V \times S^1 \times \mathbb{R}^{k-1} \times \{0\}$  over  $\mathbb{R}^{k-1} \times \{0\}$ . Assuming that the dimension condition continues to hold, we proceed by induction, eventually arriving at  $\bar{f}_k : W \rightarrow V \times \mathbb{R}^k$  so that  $\bar{f}_k$  is transverse to  $V \times \{0\}$  and  $\bar{f}_k^{-1} : \bar{f}_k^{-1}(V \times T^k \times \{0\}) \rightarrow V \times T^k \times \{0\}$  is a homotopy equivalence. We have therefore reduced the question to the following:

LEMMA 22.19. *If  $f : W \rightarrow V \times T^k$  is a homotopy equivalence of closed smooth oriented manifolds,  $V$  simply connected, then  $\sigma(V) = \sigma(V')$ , where  $V' = f^{-1}(V \times \{y\})$  for  $y$  a regular value of  $proj_{T^k} \circ f$ .*

PROOF: Since crossing with  $\mathbb{C}P^2$  does not change the signature, we may assume that  $n \geq 6$ . Passing to a cyclic cover, we have  $\tilde{W} \rightarrow V \times T^{k-1} \times \mathbb{R}$ . We can split as in the proof of Theorem 21.6 to obtain a bicollared  $W' \subset W$  and a homotopy equivalence  $W' \rightarrow V \times T^{k-1}$ . This uses the vanishing of  $\tilde{K}_0(\mathbb{Z}\mathbb{Z}^k)$ .

By induction, we eventually get  $W^* \subset W$  and a homotopy equivalence  $W^* \rightarrow V$ . Since the signature is a homotopy invariant,  $\sigma(W^*) = \sigma(V)$ . But  $W^*$  is the transverse inverse image of  $V \times \{0\}$  under a map homotopic to some finite cover of the original map  $f$ , so  $\sigma(W^*) = \sigma(f^{-1}(V \times \{y\}))$  for  $y$  a regular value of  $proj_{T^k} \circ f$ , as desired. ■

In case the original manifolds  $M$  and  $N$  are simply connected, the reduction to simply connected  $V$  is not difficult. We do ambient surgery on the map  $p : N \rightarrow S^k$  to obtain a simply-connected point-inverse. This is like the first few steps in the proof of Siebenmann's thesis. We divide  $S^k$  along  $S^{k-1}$  and trade 0-, 1-, and 2-handles across the inverse image of  $S^{k-1}$  to get  $p^{-1}(S^{k-1})$  to be smoothly bicollared and simply connected.



We then split  $S^{k-1}$  along  $S^{k-2}$  and continue the process until we arrive at a regular value  $x_0 \in S^k$  whose inverse image under a map homotopic to  $p$  is simply connected. This completes the proof of the topological invariance of rational Pontrjagin classes in the simply-connected case modulo the proof of the Stable Bounded Splitting Theorem. ■

REMARK 22.20. Lemma 22.19 is a very special case of the Novikov Conjecture on higher signatures, which we now state.

NOVIKOV CONJECTURE. *If  $M$  is a closed manifold,  $g : M \rightarrow B\pi$  is a map and  $\alpha \in H^*(\pi; \mathbb{Q})$ , then the number*

$$\langle g^* \alpha \cup L_i(\tau_M), [M] \rangle$$

*is a homotopy invariant of  $M$ . That is, if  $h : M' \rightarrow M$  is an orientation-preserving homotopy equivalence, then*

$$\langle g^* \alpha \cup L_i(\tau_M), [M] \rangle = \langle (g \circ h)^* \alpha \cup L_i(\tau_{M'}), [M'] \rangle.$$

Lemma 22.19 is the case in which  $\pi = \mathbb{Z}^k$ ,  $B\pi = T^k$ ,  $g : V^{4i} \times T^k \rightarrow T^k$  is projection, and  $\alpha$  is the orientation class of  $T^k$ . Since the orientation class of  $T^k$  pulls back from the orientation class of  $S^k$ , Lemma 22.13 says that  $\langle (g \circ f)^* \alpha \cup L_i(\tau_W), [W] \rangle$  is the signature of the inverse image of a regular value in  $S^k$  under the composition

$$W \rightarrow V \times T^k \rightarrow T^k \rightarrow S^k.$$

The usual transversality argument shows that the signature of the inverse image of a regular value is a homotopy invariant of the map, so this is the same as the signature of the inverse image of a regular value of  $W \rightarrow V \times T^k \rightarrow T^k$ , which is the same as the signature of  $f^{-1}(V \times \{y\})$  for  $y$  a regular value of  $proj_{T^k} \circ f$ . On the other hand, the Lemma 22.13 also shows that  $\langle g^* \alpha \cup L_i(\tau_M), [M] \rangle = \sigma(V)$ . This shows that the Novikov Conjecture for  $\mathbb{Z}^k$  implies Lemma 22.19. Note that the Novikov Conjecture contains nothing analogous to our simple connectivity hypothesis on  $V$ , so in the presence of Stable Bounded Splitting the Novikov Conjecture for  $\mathbb{Z}^k$  implies the topological invariance of rational Pontrjagin classes. ■

We now proceed with the proof of the stable bounded splitting theorem. Thus, we have a homotopy equivalence  $W \rightarrow V \times R^k$  which is bounded over  $\mathbb{R}^k$ .

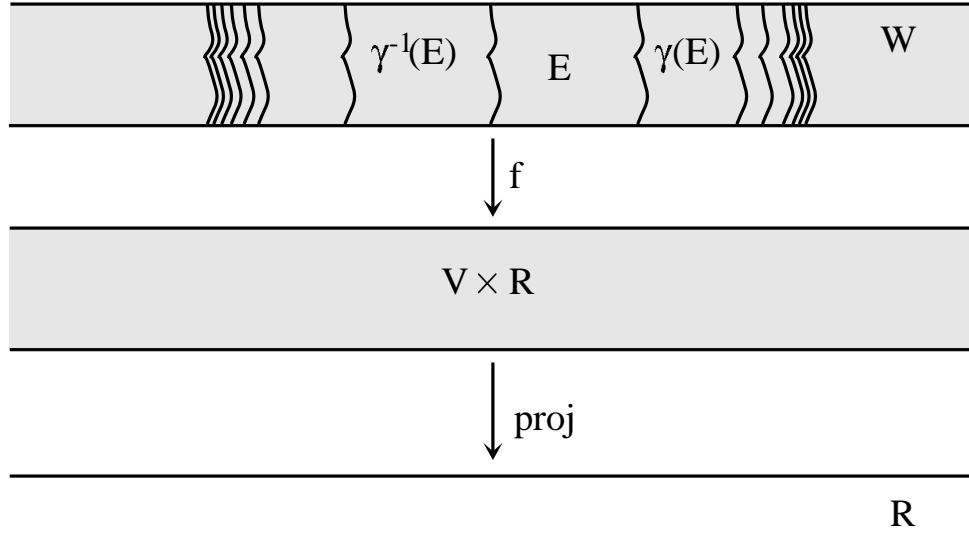

For notation, we write  $W_{[a,b]} = (proj \circ f)^{-1}[a, b]$ , where  $proj$  is projection onto the last factor. Using the bounded homotopy equivalence and the homotopy extension theorem, we can find a  $K > 0$  so that for any  $\alpha \in \mathbb{R}$  and  $N \in \mathbf{N}$ , there is a bounded homotopy  $h_t : W \rightarrow W$  over  $\mathbb{R}^{k-1}$  so that  $h_0 = id$ ,  $h_1(W) \subset W_{[\alpha-(N+1)K, \alpha+(N+1)K]}$ , and  $h_t|_{W_{[\alpha-NK, \alpha+NK]}}$  is the identity for all  $t$ . By engulfing, we will construct a bounded diffeomorphism  $\gamma : W \rightarrow W$  so that  $\gamma$  has support in  $W_{[A,B]}$  for some  $A$  and  $B$ ,  $\gamma$  is smoothly isotopic to the identity,  $\gamma(W_0) \subset W_{[K,2K]}$ , and  $\gamma^2(W_0) \subset W_{[3K,4K]}$ . Postponing the construction of  $\gamma$ , we proceed with the proof, which is a manifold version of Mather's trick.

Since  $\gamma$  is boundedly isotopic to the identity, the mapping torus,  $T(\gamma)$  is boundedly diffeomorphic to  $W \times S^1$ . After a few preliminary surgeries, we may assume that  $(proj \circ f)^{-1}\{0\}$  is a connected bicollared codimension-one submanifold separating  $W$  into two components. It then makes sense to talk about the closure of the region between  $M = (proj \circ f)^{-1}\{0\}$  and  $\gamma(M)$ . We call this region  $E$ .  $E$  is a manifold with two connected boundary components and  $U = \cup_{i=-\infty}^{\infty} \gamma^i(E)$  is an open subset of  $W$ . For any  $N$ , we can consider the region  $U_N = \cup_{i=-N}^N \gamma^i(E)$  and form a manifold  $P_N = U_N \times [0, 1] / \sim$  where  $x \times \{0\} \sim \gamma(x) \times \{1\}$  for  $x \in \cup_{i=-(N-1)}^{N-1} \gamma^i(E)$ .

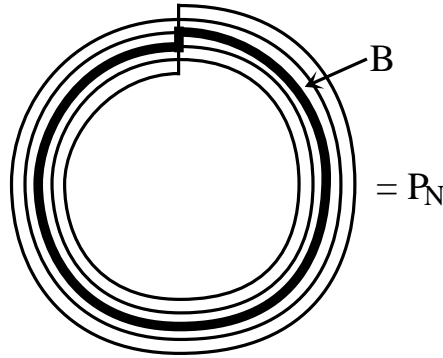

Note that there is a bounded strong deformation retraction – by collapsing from the free faces  $\gamma^{-N}(E) \times \{0\}$  and  $\gamma^N(E) \times \{1\}$  – from  $P_N$  to the codimension-one submanifold  $B = E \times \{0\} \cup M \times [0, 1] / \sim$ . This codimension-one submanifold is homeomorphic to  $E / \sim$ , where  $x \sim \gamma(x)$  for  $x \in M$ .

We wish to show that  $B$  splits  $T(\gamma) \cong W \times S^1$ , so we need to construct a bounded strong deformation retraction from  $T(\gamma)$  to  $B$ . We do this by using the homotopies  $h_t$  above to retract  $T(\gamma)$  into  $P_N$  for some  $N$  rel  $B$  and then retracting  $P_N$  into  $B$ . Here are the details:

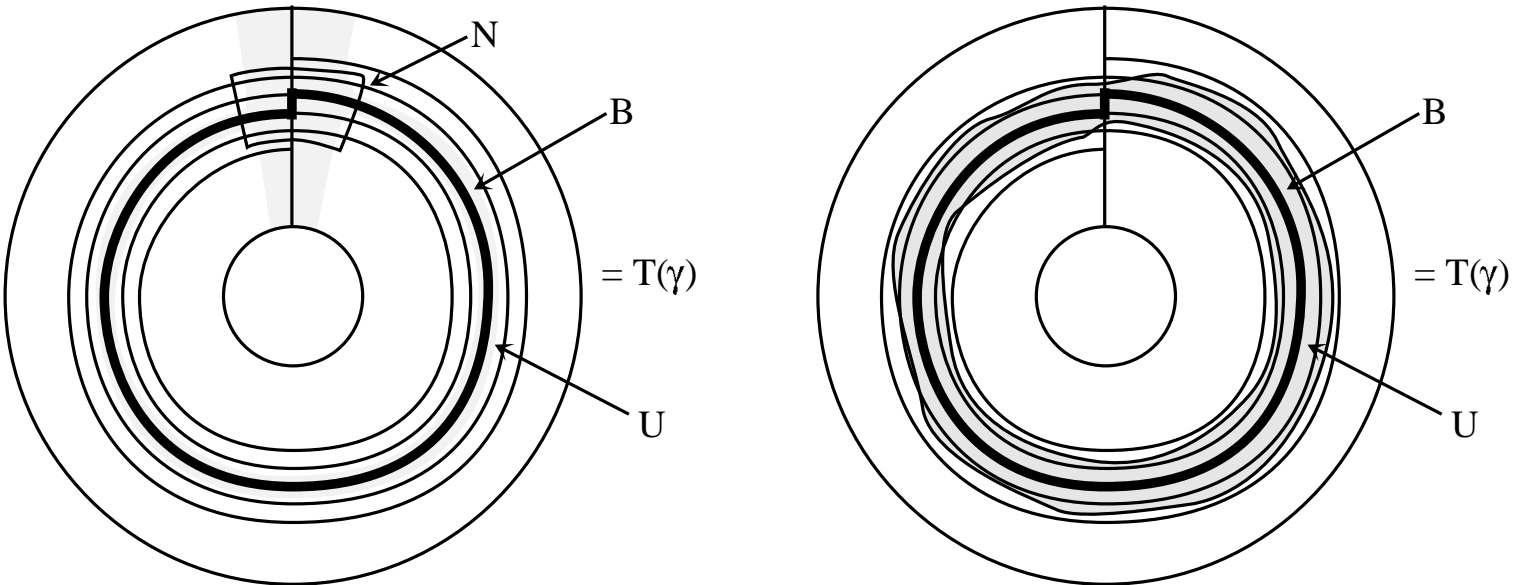

Choose a deformation  $h_t : W \rightarrow W$  so that  $h_0 = id$ ,  $h_1(W) \subset \gamma^{-1}(E) \cup E$  and so that  $h_t$  is the identity on  $M$ . Choose  $\epsilon$  with  $\frac{1}{12} > \epsilon > 0$  and apply  $h_{\rho(t)}$  to  $W \times \{t\} \subset W \times [0, 1]$ ,

where  $\rho$  is a function  $\rho : [0, 1] \rightarrow [0, 1]$  which is 1 on  $[3\epsilon, 1 - 3\epsilon]$  and 0 on  $[0, \epsilon] \cup [1 - \epsilon, 1]$ . Identifying the two ends via  $\gamma$ , we have a deformation of  $T(\gamma)$  into the shaded region in the left-hand picture above. Now choose  $k_t : W \rightarrow W$  so that  $k_1(W) \subset \gamma^{-2}(E) \cup \dots \cup \gamma^2(E)$  and  $k_t$  is fixed on  $\gamma^{-1}(E) \cup E \cup \gamma(E)$ . Applying  $k_1$  on  $W \times [0, 3\epsilon]$  and  $\gamma \circ k_1 \circ \gamma^{-1}$  on  $W \times [1 - 3\epsilon, 1]$  and phasing out as above gives a deformation  $\bar{k}_t : T(\gamma) \rightarrow T(\gamma)$ . Composing with the previous deformation, we have a deformation from  $T(\gamma)$  into  $P_2$ . Composing with the strong deformation retraction  $P_2 \rightarrow B$  completes the construction of the desired deformation retraction from  $T(\gamma)$  to  $B$ . ■

The manifold  $B$  is boundedly homotopy equivalent to  $V \times S^1 \times \mathbb{R}^{k-1}$ , since  $B$  is a bounded deformation retract of  $T(\gamma)$ , which is boundedly diffeomorphic to  $W \times S^1$ .

THE CONSTRUCTION OF  $\gamma$ : We still have to complete the engulfing argument, but this is not difficult in the present case.

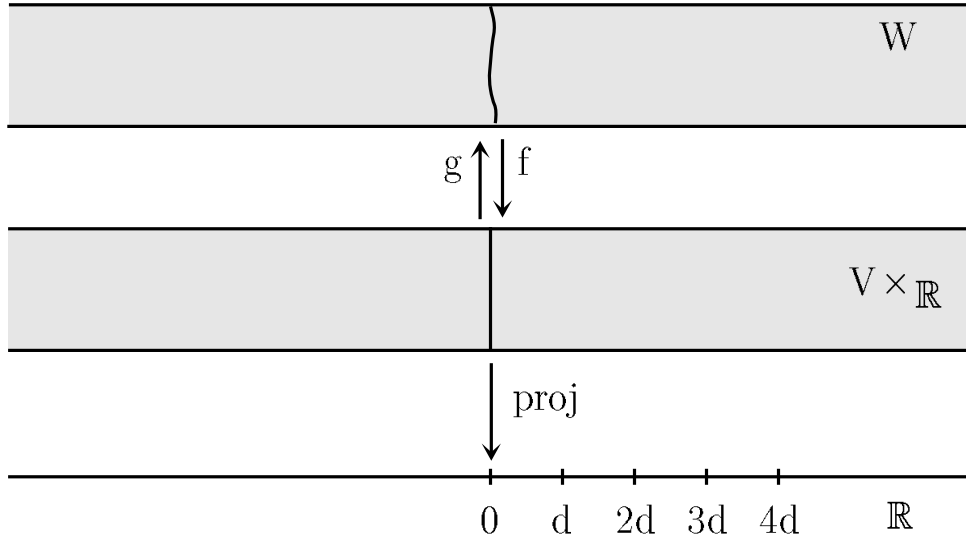

Let  $r_t : V \times \mathbb{R} \rightarrow V \times (-\infty, 3d]$  be a bounded strong deformation retraction. Then  $k_t = g \circ r_t \circ f : W \rightarrow W$  is a homotopy so that there is a  $d$ -homotopy from  $id_W$  to  $k_0$  and so that  $k_1(W) \subset W_{(-\infty, 4d]}$ . Using the homotopy extension theorem, we get a bounded homotopy  $\bar{k}_t : W \rightarrow W$  over  $\mathbb{R}^{k-1}$  so that  $\bar{k}_t = id$  on  $W_{(-\infty, d]}$  and  $k_1(W) \subset W_{(-\infty, 4d]}$ . Note that this deformation is especially nice in that  $W_{[0, \infty)}$  stays inside of itself. Of course, similar deformations exist deforming  $W_{[\beta, \infty)}$  into  $W_{[\beta, \beta+4d]}$  for all  $\beta$ .

CLAIM A. *If  $P^p \subset W_{0, \infty}$ ,  $p \leq [\frac{n}{2}]$ ,  $n$  large, is a finite polyhedron, then there is a bounded isotopy  $\ell_t$  with  $\ell_0 = id$  and  $\ell_1(P) \subset W_{[0, 8d]}$ . If  $P$  is contained in  $W_{[0, a]}$ , we can take  $\ell_t$  to be supported on  $W_{[0, a+8d]}$ .*

PROOF OF CLAIM A: A deformation as above gives a homotopy dragging  $P$  into  $W_{[0, 4d]}$ . The singular  $P_0$  set of this homotopy is at most 2-dimensional, so the shadow  $S(P_0)$  of the singular set is at most 3-dimensional. The reader is urged to reread the proof of Theorem 9.9 to align his brain cells for this engulfing argument.

For  $n \geq 9$ ,<sup>22</sup> which by the “cross with  $\mathbb{C}P^k$  trick” is no restriction, there is a nonsingular bounded homotopy dragging the singular set into  $W_{[4d, 8d]}$ , so there is a bounded isotopy  $h_t : W_{[4d, \infty)} \rightarrow W_{[4d, \infty)}$  with  $h_0 = id$  and  $h_1(W_{[4d, 8d]}) \supset S(P_0)$ . Moreover,

<sup>22</sup> The isotopy exists for  $n \geq 5$ . The extra dimensions just make the estimated engulfing easier

$h_t | W_{(-\infty, 4d]} = id$  for all  $t$ . We therefore have a nonsingular bounded homotopy of  $P$  into  $h_1(W_{[0, 8d]})$ , so regular neighborhood theory provides an isotopy  $k_t$  “inverting collapses” with  $k_0 = id$  and  $k_1(W_{[0, 8d]}) \supset P$ . Composing with  $h_t^{-1}$  gives an isotopy  $\ell_t$  dragging  $P$  into  $W_{[0, 8d]}$ , as desired. Note that the tracks of this isotopy are close to the tracks of the two homotopies used in the isotopy’s construction, so bounded homotopies yield bounded isotopies. It is clear that if  $P$  is contained in  $W_{[0, a]}$ , then we can take  $\ell_t$  to be supported on  $W_{[0, a+8d]}$ . This completes the proof of Claim A. ■

CLAIM B. *For every  $a, b \in \mathbb{R}$  there is a bounded isotopy  $q_t$  supported on  $W_{[a-16d, b+16d]}$  so that  $q_0 = id$  and  $q_1(W_{[a-16d, a]}) \supset W_{[a, b]}$ .*

PROOF OF CLAIM B: By Claim A, there exist a bounded isotopy  $h_t$  supported on  $W_{[a-8d, b+16d]}$  so that

$$h_1(W_{(-\infty, a]}) \supset W_{(-\infty, a-8d]} \cup W_{[a-8d, b+8d]}^{(k)}.$$

Similarly, there is an isotopy  $\ell_t$  supported on  $W_{[a-16d, b+8d]}$  so that

$$\ell_1(W_{[b+8d, \infty)}) \supset \left( W_{[a-8d, b+8d]}^{(k)} \right)^* \cup W_{[b+8d, \infty)} \supset h_1(W_{(-\infty, a]})^*.$$

Here  $*$  denotes the dual complex as in Definition 9.6. It follows as in the proof of Theorem 9.9 that there is a homeomorphism  $s$  isotopic to the identity so that

$$W = h_1(W_{(-\infty, a]}) \cup s \circ \ell_1(W_{[b+8d, \infty)}).$$

We then have

$$W = \ell_1^{-1} \circ s^{-1} \circ h_1(W_{(-\infty, a]}) \cup W_{[b+8d, \infty)},$$

so

$$\ell_1^{-1} \circ s^{-1} \circ h_1(W_{(-\infty, a]}) \supset W_{(-\infty, b+8d]}.$$

Setting  $q_t = \ell_t^{-1} \circ s_t^{-1} \circ h_t$  completes the proof of Claim B. ■

Clearly, the bounded isotopy  $q_t$  constructed in Claim B pushes  $W_a$  into  $W_{[b, b+16d]}$ . Let  $r_t$  be a bounded isotopy supported on  $W_{[b-16d, c+32d]}$  pushing  $W_{[b, b+16d]}$  into  $W_{[c, c+16d]}$ . If  $a < b - 16d$ , this isotopy is fixed on  $W_a$ . It follows that  $\gamma = q_1 \circ r_1$  sends  $W_a$  into  $W_{[b, b+16d]}$  and  $\gamma(W_a)$  into  $W_{[c, c+16d]}$ . Setting  $a = 0$ ,  $K = 32d$ ,  $b = 32d$ , and  $c = 96d$  yields a bounded  $\gamma$  with  $\gamma(W_0) \subset W_{[K, 2K]}$  and  $\gamma^2(W_0) \subset W_{[3K, 4K]}$ , as desired. ■

The last remaining technical point is our assumption that  $V$  is simply connected. We have already dealt with this in case the original manifolds  $M$  and  $N$  are simply connected. We will now deal with it in general.

We go back to the stage where we had a homeomorphism  $f| : W \rightarrow V \times \mathbb{R}^k$ . We choose a finite set of embedded  $S^1$ 's in  $V$  generating  $\pi_1$ . Since  $V$  is orientable, these  $S^1$ 's have trivial normal bundles and we can attach 2-handles to  $V \times [0, 1]$  to form a cobordism from  $V$  to a simply connected  $V'$ . Crossing with  $\mathbb{R}^k$  gives a cobordism from  $V \times V$  to  $V' \times \mathbb{R}^k$ .

Applying  $f^{-1}$  gives topologically embedded  $S^1 \times D^{n-1} \times \mathbb{R}^k$ 's in  $W$ . Approximating these embeddings by smooth embeddings – as usual, we can assume that  $n \gg k$  – we get a simply-connected smooth manifold  $W'$  cobordant to  $W$  which is boundedly homotopy equivalent to  $V' \times \mathbb{R}^k$ . Since cobordism does not effect signatures, we have reduced the problem to the simply-connected case.

Notice that this would have been more difficult technically if we had tried to preserve the homeomorphism, rather than just the bounded homotopy equivalence. This is one of the advantages of proving invariance theorems using controlled homotopies. We can approximate and work in the smooth or PL categories without losing our inductive hypothesis.

With a little more care, we could use the same technique to prove an  $\epsilon$ -version of the invariance of Novikov's theorem.

**THEOREM 22.21.** *If  $M$  is a smooth manifold, then there exists  $\epsilon > 0$  so that if  $f : N \rightarrow M$  is an  $\epsilon$ -equivalence, then  $f$  preserves rational Pontrjagin classes.*

The point is that we didn't require the full strength of the bounded hypothesis to construct  $\gamma$ . We only used  $d$ -control over a  $128d$  region in the direction of the last coordinate factor. On the other hand, since we know that the  $\alpha$ -approximation theorem is true, this extra generality is only apparent.<sup>23</sup>

**REMARK 22.22.** With a larger investment in developing bounded machinery, we could have proven the theorem using

**THEOREM 22.23 (BOUNDED SPLITTING THEOREM).** *Let  $V^n$  be a closed orientable simply-connected smooth manifold and let  $W^{n+k} \rightarrow V^n \times \mathbb{R}^k$  be a bounded homotopy equivalence over  $\mathbb{R}^k$ ,  $W$  a smooth manifold and  $n + k \geq 5$ . Then there is a bicollared*

---

<sup>23</sup> But on yet another hand, our proof of the  $\alpha$ -approximation theorem relies on topological surgery and is hardly self-contained. Except for Groethendieck's Theorem on  $\tilde{K}_0(\mathbb{Z}\mathbb{Z}^k)$  and the references to Milnor-Stasheff, the proof given here of the topological invariance of Pontrjagin classes is complete.

smooth submanifold  $W' \subset V^n \times \mathbb{R}^{k-1}$  so that  $W' \rightarrow V^n \times \mathbb{R}^{k-1}$  is a bounded homotopy equivalence over  $\mathbb{R}^{k-1}$ .

Since this introduces no extra  $S^1$ -factors, the last splitting argument is unnecessary. Groethendieck's theorem appears here in showing that the obstruction group for simply connected bounded splitting is zero. This is the approach taken in [FW]. The general approach taken here owes a good deal to that paper and to [We].<sup>24</sup>

## REFERENCES

- [FW] S. Ferry and S. Weinberger, *A coarse approach to the Novikov Conjecture* (to appear).
- [H] F. Hirzebruch, *Topological methods in algebraic geometry*, Springer Verlag, New York, Berlin, 1978.
- [M] J. Milnor, *Topology from the differentiable viewpoint*, University of Virginia Press, Charlottesville, VA, 1965.
- [MS] J. Milnor and J. Stasheff, *Characteristic Classes*, Princeton University Press, Princeton, NJ, 1974.
- [N] S. Novikov, *On manifolds with free abelian fundamental groups and applications (Pontrjagin classes, smoothings, high dimensional knots)*, *Izv. Akad. Nauk SSSR ser mat* **30** (1966), 208–246.
- [We] S. Weinberger, *Aspects of the Novikov conjecture*, *Contemp. Math.* (Geometric invariants of elliptic operators) **105** (1990), 281–297.

---

<sup>24</sup> – and even more to Novikov!



## Chapter 23. Homotopy equivalent manifolds which are not homeomorphic

Our next goal is to use this machinery to produce simply-connected smooth manifolds which are homotopy equivalent without being (topologically) homeomorphic. The basic idea is to take advantage of the fact that Pontrjagin classes take integral values, while higher homotopy groups of spheres are finite. This is used to construct an  $(n + 1)$ -dimensional vector bundle  $E$  over  $S^4$  so that the unit sphere bundle  $S(E)$  is homotopy equivalent to  $S^4 \times S^n$  but so that  $p_1(\tau_{S(E)}) \neq 0$ .

The first step is to show that we can build bundles over  $S^4$  with nontrivial Pontrjagin classes. We know from [MS] that  $H^*(\tilde{G}r, \mathbb{Q})$  is a polynomial algebra generated by  $p_i \in H^{4i}(\tilde{G}r, \mathbb{Q})$ . Choosing maps  $\alpha_i : \tilde{G}r \rightarrow K(\mathbb{Z}, 4i)$  representing the  $p_i$ 's (see [S, p. 428]), we see that  $\prod_i \alpha_i : \tilde{G}r \rightarrow \prod K(\mathbb{Z}, 4i)$  induces isomorphisms on rational cohomology, and therefore on rational homology. A generalized Whitehead theorem of Serre (see below) then tells us that  $\prod \alpha_i$  induces isomorphisms on rational homotopy. The homotopy of  $\prod K(\mathbb{Z}, 4i)$  has a single  $\mathbb{Z}$  in each dimension  $4i$ , so we know that the rank of the homotopy group  $\pi_k(\tilde{G}r)$  is 1 for  $k = 4i$  and 0 otherwise. More particularly, we know that if  $\beta : S^4 \rightarrow K(\mathbb{Z}, 4)$  represents the generator, then there is a map  $\beta_1 : S^4 \rightarrow \tilde{G}r$  so that  $\alpha_i \circ \beta_1 : S^4 \rightarrow K(\mathbb{Z}, 4)$  is a nonzero multiple  $k$  of  $\alpha$ . Pulling back the universal bundle  $\gamma$  over  $\beta_1$  therefore gives a vector bundle  $E$  over  $S^4$  whose first Pontrjagin class  $p_1(E)$  is  $k\iota$  where  $\iota \in H^4(S^4)$  is the generator. Vector bundles over  $S^4$  with dimension  $\geq 5$  admit nontrivial sections, and such a section allows us to split off a line bundle and exhibiting  $E$  as a sum  $E \oplus \varepsilon$ . This means that we can destabilize  $E$  without disturbing the Pontrjagin class. We choose  $E$  to be 6-dimensional, so  $S(E)$  is a 5-sphere bundle over  $S^4$ .

Next, we show that the sphere bundle corresponding to some integral multiple of  $\beta_1$  is homotopy equivalent to  $S^4 \times S^5$ . The vector bundle  $E$  is trivial over the northern and southern hemispheres of  $S^4$ . This says that there is a "clutching function"  $\gamma : S^3 \rightarrow SO(6)$  so that  $E$  is obtained by pasting  $D_-^4 \times \mathbb{R}^6$  to  $D_+^4 \times \mathbb{R}^6$  by  $(x, \mathbf{v}) \rightarrow (x, \gamma(x)\mathbf{v})$  for  $x \in S^3$ .

Of course, we can forget about the linear structure and just think of  $E(S)$  as a space obtained by pasting together two copies of  $D^4 \times S^5$  using a fiber-preserving map  $S^3 \times S^5 \rightarrow S^3 \times S^5$ . Thus, we can compose  $\gamma$  with the map  $SO(6) \rightarrow Maps(S^5, S^5)$  obtained by restriction to the unit sphere to get  $\gamma' : S^3 \rightarrow Maps(S^5, S^5)$ .

What is the third homotopy group of  $Maps(S^5, S^5)$ ? Evaluating at a point  $*$  gives a map  $Maps(S^5, S^5) \rightarrow S^5$ . By the homotopy extension theorem, this map is a fibration (exercise) and the fiber is  $Maps(S^5, *, S^5, *)$ . The homotopy sequence of the fibration shows that  $\pi_3(Maps(S^5; S^5)) \cong \pi_3(Maps(S^5, *, S^5, *))$ .

$Maps(S^5; S^5)$  has  $\mathbb{Z}$  components enumerated by degree, so we write

$$Maps(S^5; S^5) = \coprod_{d \in \mathbb{Z}} Maps_d(S^5; S^5).$$

We have a sum

$$+ : Maps(S^5; S^5) \times Maps(S^5; S^5) \rightarrow Maps(S^5; S^5)$$

where  $f + g$  is given by the composition

$$S^5 \rightarrow S^5 \vee S^5 \xrightarrow{f \vee g} S^5 \vee S^5 \xrightarrow{fold} S^5.$$

The degree of  $f + g$  is  $deg(f) + deg(g)$ , so sum with a fixed map of degree  $-d$  gives a map

$$Maps_d(S^5; S^5) \rightarrow Maps_0(S^5; S^5).$$

It is easy to check that sum with a fixed map of degree  $d$  gives a homotopy inverse, so the homotopy groups of  $Maps_d(S^5; S^5)$  are isomorphic to the homotopy groups of  $Maps_0(S^5; S^5)$ . The clutching construction above gives us a map  $S^3 \rightarrow Maps_1(S^5, S^5)$ , but we will compute  $\pi_3 Maps_0(S^5, S^5)$ .

A map  $(S^3, *) \rightarrow Maps_0(S^5, *, S^5, *)$  gives a map  $S^3 \times S^5 \rightarrow S^5$  such that  $S^3 \times * \vee * \times S^5 \rightarrow *$ . We therefore have a map  $S^3 \wedge S^5 \cong S^8 \rightarrow S^5$ . But  $\pi_8(S^5)$  is a group of order 24, so  $24\gamma'$  is nullhomotopic. Thus, if we take the bundle  $E_{24}$  pulled back by  $24\beta_1$ ,  $S(E_{24})$  is homotopy equivalent to  $S^4 \times S^5$ .<sup>25</sup>

It remains to show that  $p_1(\tau_{S(E_{24})}) \neq 0$ . This will guarantee that  $S^4 \times S^5$  and  $S(E_{24})$  are not homeomorphic.

<sup>25</sup> The student worried about showing that  $p_1(E_{24}) = 24p_1(E)$  is urged to consider the fact that the Hurewicz homomorphism is a homomorphism and then to apply the universal coefficient theorem in rational cohomology.

Let  $proj : E_{24} \rightarrow S^4$  be the projection. The tangent bundle to  $E_{24}$ , considered as a smooth manifold, is  $proj^*(E) \oplus proj^*\tau_{S^4}$ . But  $\tau_{S^4} \oplus \varepsilon$  is trivial, so the Pontrjagin classes of  $E_{24}$  as a smooth manifold pull back from the Pontrjagin classes of  $E_{24}$  considered as a vector bundle over  $S^4$ . Consider the codimension-one embedding  $i : S(E_{24}) \rightarrow E_{24}$ . We have  $i^*\tau_{E_{24}} \cong \tau_{S(E_{24})} \oplus \varepsilon$ , so  $i$  induces an isomorphism of Pontrjagin classes and  $p_1(\tau_{S(E_{24})})$  is  $24k\iota_1$ , where  $\iota_1 = proj^*\iota$ . This completes the construction of the example. Of course the same argument applies to  $S(E_{24\ell})$  for any  $\ell$ . Since any homotopy equivalence to a manifold homotopy equivalent to  $S^5 \times S^4$  sends a generator<sup>26</sup> of  $H^4(S^5 \times S^4; \mathbb{Q})$  to  $\pm$  a generator, infinitely many of these manifolds are pairwise nonhomeomorphic.

In [MS, pp. 245-248] there is a more specific construction of the above sort along with an exposition of Milnor's original construction of a smooth homotopy 7-sphere which is not diffeomorphic to  $S^7$ . One key lemma explicitly determines the multiple of the generator of  $H_*(\tilde{G}r_4; \mathbb{Z})$  which lies in the image of the Hurewicz homomorphism.

LEMMA 23.1. *Given integers  $k, \ell$  satisfying  $k \equiv 2\ell \pmod{4}$ , there exists an oriented 4-plane bundle  $\xi$  over  $S^4$  with  $p_1(\xi) = ku, e(u) = \ell u, u$  the generator of  $H^4(S^4)$ .*

The interested student is urged again to consult [MS].

Here are a few definitions and theorems supporting the homotopy theory used above. Most of this material is found in §3 – §7 of Chapter 9 of [S].

DEFINITION 23.2. A homomorphism  $h : A \rightarrow B$  between finitely generated abelian groups is called

- (i) a *rational monomorphism* if the kernel is finite.
- (ii) a *rational epimorphism* if the cokernel is finite.
- (iii) a *rational isomorphism* if both the kernel and the cokernel are finite.

THEOREM 23.3 ([S, P. 512]). *Let  $f$  be a map between simply connected spaces. For  $n \geq 1$ , the following are equivalent:*

- (i)  $f_{\#} : \pi_i(X) \rightarrow \pi_i(Y)$  is a rational isomorphism for  $i \leq n$  and a rational epimorphism for  $i = n + 1$ .
- (ii)  $f_{\#} : H_i(X) \rightarrow H_i(Y)$  is a rational isomorphism for  $i \leq n$  and a rational epimorphism for  $i = n + 1$ .

---

<sup>26</sup> By this, we mean the image of a generator of  $H^4(S^5 \times S^4; \mathbb{Z})$ .

THEOREM 23.4 ([S, P. 509]). *A simply connected space  $X$  has finitely generated homology groups in every dimension if and only if it has finitely generated homotopy groups in every dimension.*

THEOREM 23.5 ([S, P. 515, 516]). *If  $n$  is odd, then  $\pi_m(S^n)$  is finite for all  $m \neq n$ . If  $n$  is even, then  $\pi_m(S^n)$  is finite for all  $m \neq n, 2n - 1$ .*

## Chapter 24. The surgery exact sequence revisited

We have just given a direct construction showing that the structure set of  $S^4 \times S^5$  is infinite. We will now reexamine the same situation using the surgery exact sequence. By [Br, p. 49], the sequence in this case is

$$L_{10}(e) \xrightarrow{\text{acts}} \mathcal{S}^{DIFF}(S^4 \times S^5) \xrightarrow{\eta} [S^4 \times S^5; G/O] \xrightarrow{\sigma} L_9(e).$$

Here  $\mathcal{S}^{DIFF}(S^4 \times S^5)$  is a set and exactness means that two structures  $(M, f)$  and  $(M', f')$  have the same image in  $[S^4 \times S^5; G/O]$  if and only if there is a  $\tau \in L_{10}(e)$  so that  $\tau(M, f) = (M', f')$ . The action is connected sum with a homotopy sphere obtained by realizing a surgery obstruction as in our discussion of plumbing. See [Br, II.4.10]<sup>27</sup>. Since  $L_{10}(e) = \mathbb{Z}/2\mathbb{Z}$ , and  $L_9(e) = 0$ , this means that

$$|[S^4 \times S^5; G/O]| \leq |\mathcal{S}(S^4 \times S^5)| \leq 2|[S^4 \times S^5; G/O]|,$$

where  $|\cdot|$  denotes cardinality.

LEMMA 24.1. *If  $X$  and  $Y$  are pointed spaces,  $X$  compact, then  $\text{Maps}(\Sigma X, *; Y, *) \cong \text{Maps}(X, *; \Omega Y)$ .*

PROOF: Since  $X$  is pointed,  $\Sigma X$  refers to the *reduced* suspension  $(X \times I)/(X \times \partial I \cup * \times I)$ . A map  $\rho : \Sigma X \rightarrow Y$  gives us a map  $\rho' : X \rightarrow \Omega Y$  by

$$\rho'(x)(t) = \rho(x, t).$$

This formula evidently defines a homeomorphism between the mapping spaces under consideration. ■

LEMMA 24.2. *There is a space  $B(G/O)$  such that  $\Omega B(G/O)$  is homotopy equivalent to  $G/O$ .*

It follows that  $[S^4 \times S^5, G/O] = [\Sigma(S^4 \times S^5), B(G/O)]$ .

LEMMA 24.3.  $\Sigma(S^4 \times S^5) \simeq S^5 \vee S^6 \vee S^{10}$ .

---

<sup>27</sup> This means that in the PL and TOP cases, the action becomes trivial and we have  $\mathcal{S}^{CAT}(M) \cong [\overset{\circ}{M}, G/CAT]$  for CAT=TOP, PL.

PROOF: We have maps  $\gamma_1 : S^4 \times S^5 \rightarrow S^4$ ,  $\gamma_2 : S^4 \times S^5 \rightarrow S^5$ ,  $\gamma_3 : S^4 \times S^5 \rightarrow S^9$ . After suspending, we can add these maps and the resulting map

$$\Sigma\gamma_1 + \Sigma\gamma_2 + \Sigma\gamma_3 : \Sigma(S^4 \times S^5) \rightarrow \Sigma(S^4 \vee S^5 \vee S^9)$$

induces isomorphisms in homology and is therefore a homotopy equivalence. ■

Therefore,

$$\begin{aligned} [\Sigma(S^4 \times S^5), B(G/O)] &= \pi_5(B(G/O)) \oplus \pi_6(B(G/O)) \oplus \pi_{10}(B(G/O)) \\ &= \pi_4(G/O) \oplus \pi_5(G/O) \oplus \pi_9(G/O). \end{aligned}$$

The surgery exact sequence for  $S^n$  is

$$L_{n+1}(e) \xrightarrow{\text{acts}} \mathcal{S}^{DIFF}(S^n) \longrightarrow [S^n; G/O] \longrightarrow L_n(e).$$

Kervaire and Milnor showed that  $\mathcal{S}^{DIFF}(S^n)$  is finite for  $n \geq 5$ , so up to finite ambiguity,  $\pi_n(G/O) \cong L_n(e)$ . Therefore, up to finite ambiguity,  $[S^4 \times S^5; G/O] = \pi_4(G/O) \cong \mathbb{Z}$ . This shows that there are infinitely many smooth manifolds  $M$  and homotopy equivalences  $h : M \rightarrow S^4 \times S^5$ .

It is probably (past) time to say something about the space  $G/O$  and the map  $\eta : \mathcal{S}^{DIFF}(S^4 \times S^5) \rightarrow [S^4 \times S^5; G/O]$ . The space  $BO$  is the space we have been calling  $Gr$ . Homotopy classes of maps from  $X$  into  $BO$  classify vector bundles over  $X$ . The space  $BG$  is a classifying space for spherical fibrations. We have  $\Omega BO \simeq O$ , the infinitely stabilized orthogonal group, and  $\Omega BG \simeq G$ , where  $G = \varinjlim Maps\{S^n; S^n\}$ . See [Br, p. 45] for more information. The space  $G/O$  is defined to be the homotopy fiber<sup>28</sup> of a map  $O \rightarrow G$ . The map is obtained by restricting an orthogonal transformation to the unit sphere.

The homotopy groups of  $G$  are the stable homotopy groups of spheres, which are finite by Theorem 23.5, so Theorem 23.3 above says that the homology groups are also finite. This means that the map  $G/O \rightarrow BO$  is a rational equivalence, so  $H^*(G/O; \mathbb{Q})$  is a polynomial algebra generated by Pontrjagin classes. As before,  $G/O$  is rationally equivalent to a product of  $K(\mathbb{Q}, 4i)$ 's, so

$$[M, G/O] \otimes \mathbb{Q} \cong \oplus H^{4i}(M; \mathbb{Q}).$$

Rationally, the map  $\mathcal{S}(M) \rightarrow [M, G/O]$  measures the difference between the  $L$ -classes of the domain and range of a structure.

<sup>28</sup> The *homotopy fiber* is the fiber of the mapping path fibration  $P_f$ , [S, p. 99].

In the case of  $M = S^5 \times S^4$ , the surgery exact sequence produces infinitely many smooth manifolds  $N_i$  homotopy equivalent to  $M$  such that the difference between  $M$  and  $N_i$  is detected by the first Pontrjagin class.

The computation would be much the same for any simply connected manifold of dimension  $\neq 4k$ . In the  $4k$ -dimensional case, we have:

$$0 \rightarrow \mathcal{S}(M) \rightarrow [M, G/O] \rightarrow \mathbb{Z}$$

so after tensoring with  $\mathbb{Q}$  and interpreting the terms in the sequence, we see that up to finite ambiguity,  $\mathcal{S}(M)$  is in 1-1 correspondence with the kernel of a homomorphism

$$\oplus H^{4i}(M; \mathbb{Q}) \xrightarrow{\sigma} \mathbb{Q}.$$

The map  $\sigma$  is onto because Hirzebruch's signature theorem says that  $L_k$  of a  $4k$ -dimensional manifold is a homotopy invariant, which means that  $H^{4k}(M^{4k}; \mathbb{Q})$  is not in the image of the structure set.

The upshot is that subject to Hirzebruch's formula and a possible finite ambiguity, the Pontrjagin classes of manifolds homotopy equivalent to a smooth simply connected manifold  $M$  take on all possible values. For sharper integral results, see [Ka]. The space  $G/O$  and its siblings  $G/TOP$  and  $G/PL$  are much studied. See, for instance, [MM].

#### REFERENCES

- [Br] W. Browder, *Surgery on simply connected manifolds*, Springer-Verlag, Berlin-New York, 1970.
- [Ka] P. Kahn, *A note on topological Pontrjagin classes and the Hirzebruch index formula*, Illinois J. Math. **16** (1972), 243–256.
- [KM] M. Kervaire and J. Milnor, *Groups of homotopy spheres*, Ann. Math. **77** (1963), 504–537.
- [MM] I. Madsen and R. J. Milgram, *The Classifying Spaces for Surgery and Cobordism of Manifolds*, Annals of Math. Studies #92, Princeton U. Press, Princeton, NJ, 1979.
- [N] S. P. Novikov, *Homotopy equivalent smooth manifolds I*, Translations of the A.M.S. **48** (1965), 271–396.
- [S] E. Spanier, *Algebraic Topology*, McGraw Hill, Princeton, NJ, 1966.
- [MS] J. Milnor and J. Stasheff, *Characteristic Classes*, Princeton University Press, New York, 1974.

## Chapter 25. Generalized homology theories

We also need to say something about spectra and generalized homology theories. Basic references for this topic are [A1], [A2]. One reason for our interest in this topic is role played by stable cohomotopy theory in the last two sections. An understanding of stable cohomotopy was essential to the proof that rational  $L$ -classes could be understood in terms of signatures of submanifolds with trivial normal bundles.

A second reason for our interest is appearance of the term  $[M; G/TOP]$  in the surgery exact sequence. We have already seen that this is calculable rationally. For purposes of integral computation and, even more importantly, in order to improve the functoriality of the surgery exact sequence, it is good idea to replace this first by  $H^0(M; G/TOP)$  and then by the Poincaré dual expression  $H_n(M, G/TOP)$ . It is obvious that we need some definitions.

**DEFINITION 25.1.** A *spectrum* is a sequence  $E_n$  of spaces with maps  $\varepsilon_n : \Sigma E_n \rightarrow E_{n+1}$ . Of course, we are equally free to specify maps  $\varepsilon'_n : E_n \rightarrow \Omega E_{n+1}$ . If these maps  $E_n \rightarrow \Omega E_{n+1}$  are homotopy equivalences, the spectrum is called an *omega spectrum*.

It is often good to take the maps  $\varepsilon_n$  to be embeddings and the maps  $\varepsilon'_n : E_n \rightarrow \Omega E_{n+1}$  to be homeomorphisms. We ignore such points here.

**EXAMPLE 25.2.**

- (i) The *sphere spectrum* is the spectrum with  $E_n = S^n$  and maps  $\Sigma S^n \rightarrow S^{n+1}$ .
- (ii) If  $X$  is a CW complex, its *suspension spectrum*,  $\Sigma^\infty X$  is the spectrum with  $E_n = \Sigma^n X$ .
- (iii) The Eilenberg-MacLane spectrum is the spectrum

$$K(\mathbb{Z}, n) \rightarrow \Omega K(\mathbb{Z}, n + 1).$$

- (iv) If  $\mathbb{E} = \{E_n\}$  is a spectrum, then so is  $X \wedge \mathbb{E} = \{X \wedge E_n\}$  for any fixed  $X$ .

**DEFINITION 25.3** (G. W. WHITEHEAD, [W]).

- (i)  $\tilde{H}^n(X, \mathbb{E}) = \varinjlim [\Sigma^k X, E_{n+k}]$  and
- (ii)  $\tilde{H}_n(X, \mathbb{E}) = \varinjlim [S^{n+k}, E_k \wedge X]$ .



Part (i) should be familiar to most readers in case  $E_n = K(\mathbb{Z}, n)$ , since by obstruction theory,

$$[\Sigma^k X, *, K(\mathbb{Z}, n+k), *] \cong \tilde{H}^{n+k}(\Sigma^k X, *; \mathbb{Z}) = \tilde{H}^n(X; \mathbb{Z}).$$

To the geometrically oriented reader, such as the author, part (ii) may be less clear. One derives some comfort from the observation that

$$\tilde{H}_{n+1}(\Sigma X, \mathbb{E}) = \varinjlim[S^{n+k+1}, (S^1 \wedge X) \wedge E_k] = \varinjlim[S^{n+k}, \Omega\Sigma(X \wedge E_k)],$$

so if  $E_k$  is  $(k-1)$ -connected, as in the examples above, then  $X \wedge E_k$  is  $(k-1)$ -connected and  $\pi_{n+k}(X \wedge E_k) \cong \pi_{n+k}(\Omega\Sigma(X \wedge E_k))$  if  $n \leq 2k-3$ , [S, p.458]. The upshot is that  $\tilde{H}_{n+1}(\Sigma X, \mathbb{E}) = \tilde{H}_n(X, \mathbb{E})$ . We will refer to a spectrum for which  $E_k$  is  $(k-1)$ -connected as a *connective* spectrum.

We define relative groups by  $\tilde{H}_n(X, A; \mathbb{E}) = H_n(X \cup CA; \mathbb{E})$  and verify that the resulting theory satisfies the Eilenberg-Steenrod axioms.<sup>29</sup> The only axioms which are in doubt are the long exact sequence of a pair and excision. The long exact sequence of  $(X, A)$  comes about by considering the sequence:

$$A \rightarrow X \rightarrow X \cup CA \rightarrow X \cup CA \cup CX \rightarrow \dots$$

where at each stage we form the next stage by coning off the image of the previous stage. Applying  $H_n( ; \mathbb{E})$  to this sequence and identifying  $X \cup CA \cup CX$  with the homotopy equivalent space  $\Sigma A$ , we obtain

$$H_n(A; \mathbb{E}) \rightarrow H_n(X; \mathbb{E}) \rightarrow H_n(X \cup CA; \mathbb{E}) \rightarrow H_n(\Sigma A; \mathbb{E}) \cong H_{n-1}(A; \mathbb{E}) \rightarrow \dots$$

It is clear that the composition

$$\tilde{H}_n(A; \mathbb{E}) \rightarrow \tilde{H}_n(X; \mathbb{E}) \rightarrow \tilde{H}_n(X \cup CA; \mathbb{E})$$

is trivial. It is less clear that it is exact at the middle term. In fact, if we think about the possibility  $(X, A) = (M, \Sigma)$ , where  $\Sigma$  is a homology sphere and  $M$  is a contractible manifold which it bounds, then the possibility of an exact sequence of such homology groups defined as *homotopy* groups seems rather unlikely. The solution lies in the magic of stabilization:

---

<sup>29</sup> Excepting, of course, the dimension axiom, which is false for such theories.

THEOREM 25.4 ([S, P. 487]). *Let  $(X, A)$  be an  $n$ -connected relative CW complex, where  $n \geq 2$ , such that  $A$  is  $m$ -connected, where  $m \geq 1$ . Then the collapsing map  $k : (X, A) \rightarrow (X/A, *)$  induces an isomorphism*

$$k_{\#} : \pi_q(X, A) \rightarrow \pi_q(X/A)$$

for  $q \leq m + n$  and an epimorphism for  $q = m + n + 1$ .

We are interested in the exactness of the bottom row in

$$\begin{array}{ccccccc} \pi_{n+k}(E_k \wedge A) & \longrightarrow & \pi_{n+k}(E_k \wedge X) & \longrightarrow & \pi_{n+k}(E_k \wedge X, E_k \wedge A) & \longrightarrow & \\ \downarrow & & \downarrow & & \downarrow & & \\ \pi_{n+k}(E_k \wedge A) & \longrightarrow & \pi_{n+k}(E_k \wedge X) & \longrightarrow & \pi_{n+k}(E_k \wedge (X \cup CA)) & \longrightarrow & \end{array}$$

The top row is exact. Because of the suspension isomorphism, proving exactness for the pair  $(X, A)$  is the same as proving exactness for the pair  $(\Sigma^\ell X, \Sigma^\ell A)$ ,  $\ell$  large. We may therefore assume that  $X$  and  $A$  are highly connected, whence the bottom row is exact as a consequence of the Five Lemma. If  $\mathbb{E}$  is connective, the limit stabilizes and this is enough to prove exactness.

The excision axiom follows easily from suspension and the exact sequence of a pair, so we have all of the axioms of homology except the dimension axiom. What is  $H_k(pt, \mathbb{E})$ ? We write

$$H_k(pt; \mathbb{E}) = \tilde{H}_k(S^0; \mathbb{E}) = \varinjlim \pi_{n+k}(S^0 \wedge E_n) = \varinjlim \pi_{n+k}(E_n).$$

For the Eilenberg-MacLane spectrum, then, the homology of a point has a  $\mathbb{Z}$  in dimension 0 and nothing elsewhere. Thus, all of the Eilenberg-Steenrod axioms hold for “Eilenberg-MacLane homology” and for finite CW complexes, at least, Eilenberg-MacLane homology is isomorphic to ordinary homology with  $\mathbb{Z}$  coefficients. The coefficients of the homology based on the sphere spectrum is the stable homotopy groups of spheres. This homology theory is called stable homotopy theory<sup>30</sup> and the associated cohomology theory is stable cohomotopy theory.

These results also hold in the nonconnective case, but there they require a certain amount of infrastructure. The third section of [A1] – which is more-or-less independent of sections 1 and 2 – contains a pleasant exposition of the theory of spectra and generalized homology.

<sup>30</sup> Note that  $H_k(X; \mathbb{S}) = \varinjlim \pi_{n+k}(\Sigma^m X)$ .

Computing  $[X, Y]$  is much easier when we know that  $Y$  is one of the spaces in an  $\Omega$ -spectrum, since we have Mayer-Vietoris sequences, transfers, duality – all of the usual homological machinery – helping us out. There is also an Atiyah-Hirzebruch spectral sequence which starts with  $E_{p,q}^2 = H_p(X; \pi_q(\mathbb{E}))$  and converges to  $H_*(X; \mathbb{E})$ .

The slogan, as expressed in a memorable lecture by Frank Quinn, is that “homology is your friend,” the point being that one should regard oneself as being able to compute, or at least extract reasonable information from any part of a theory which is expressible as generalized homology.

REMARK 25.5. Workers in this area often prefer to talk about the *homology spectrum* of  $X$  with coefficients in  $\mathbb{E}$  as being  $\mathbb{H}(X; \mathbb{E}) = X \wedge \mathbb{E}$  and then consider the homology groups to be the homotopy groups of the homology spectrum. With this approach, the usual long exact sequences of topology become homotopy exact sequences of fibration sequences. Thus, for example, we have a fibration

$$\mathbb{H}(A) \rightarrow \mathbb{H}(X) \rightarrow \mathbb{H}(X, A)$$

whose homotopy sequence is the usual homology sequence of a pair.<sup>31</sup> The advantage of this is that spaces contain considerably more information –  $k$ -invariants, for instance – than their sequence of homology groups.

One particularly interesting spectrum, constructed by Frank Quinn in his thesis [Q], is the simply connected  $\mathbb{L}$ -theory spectrum. The space  $\mathbb{L}_i(e)$  is a (huge) simplicial complex where the 0-simplices are surgery problems  $f : (N^i, \partial N) \rightarrow (M^i, \partial M)$  with  $f|_{\partial N}$  a homotopy equivalence.

A 1-simplex connecting 0-simplices  $(N, f)$  and  $(N', f')$  is a cobordism of such objects, that is, a surgery problem  $F : (P; \partial P, N, N') \rightarrow (W; \partial W, M, M')$  so that  $F|_N = f$ ,  $F|_{N'} = f'$ ,  $\partial P = N \cup N' \cup Q$ ,  $\partial W = M \cup M' \cup R$ , and  $F : (Q, \partial N, \partial N') \rightarrow (R, \partial M, \partial M')$  is a homotopy equivalence of triples.

---

<sup>31</sup> The bemused reader will be relieved to hear that fiberings and cofiberings are the same for CW spectra [A1, p. 156].

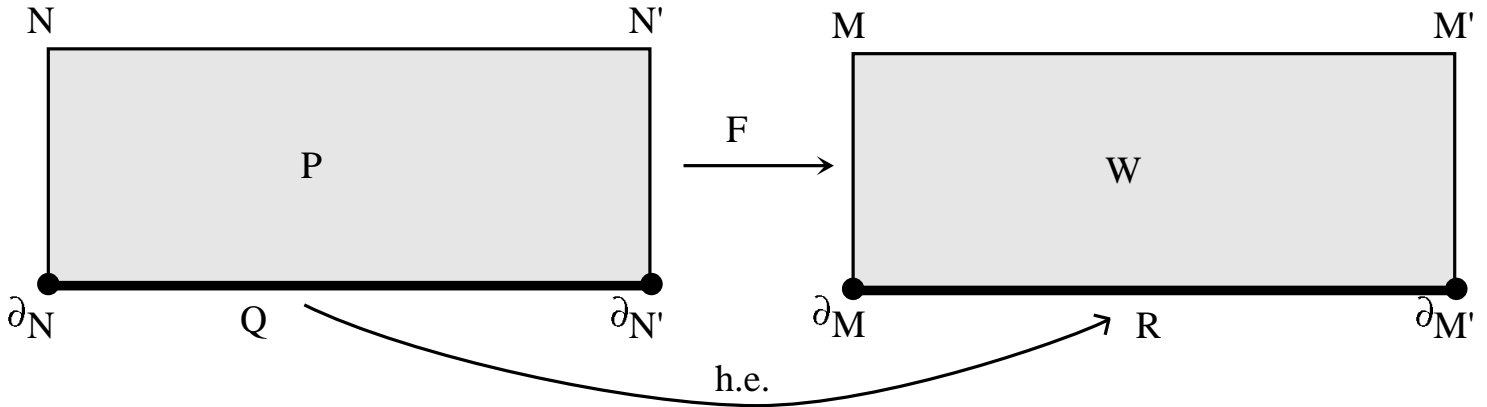

A 2-simplex is a similar gadget modeled on a 2-simplex, etc.

We call this space  $\mathbb{L}_i(e)$  because we have not controlled the fundamental group. If  $(N, \partial N) \rightarrow (M, \partial M)$  is a vertex,  $i \geq 5$ , we can do simultaneous surgery on  $S^1$ 's in  $\overset{\circ}{N}$  and  $\overset{\circ}{M}$  to make  $N$  and  $M$  simply connected and then excise neighborhoods of corresponding disks  $(D_i^2, \partial D_i^2)$  in  $(N, \partial N)$  and  $(M, \partial M)$  to make the boundaries simply connected. A similar process works for higher-dimensional simplices.

Notice that a loop in  $\mathbb{L}_i(e)$  would give us a sequence of cobordisms which could be pasted together to give a vertex in  $\mathbb{L}_{i+1}(e)$ .

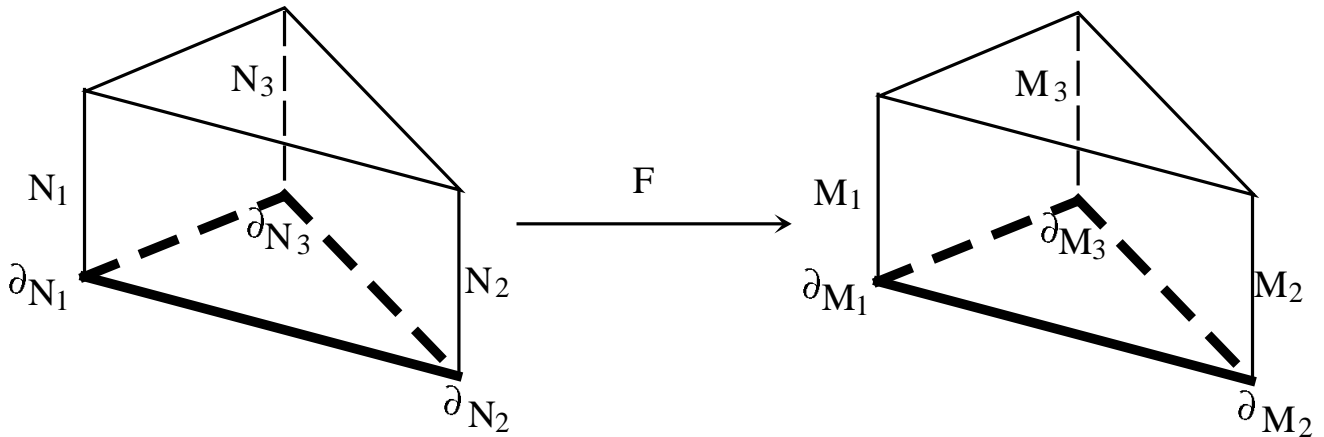

Now, a loop in  $\mathbb{L}_i(e)$  is a vertex in  $\Omega\mathbb{L}_i(e)$ , so this leads to

$$\Omega\mathbb{L}_i(e) \cong \mathbb{L}_{i+1}(e).$$

This says that the spaces  $\mathbb{L}_i(e)$  form an (upside down) spectrum. Wall's theorem that " $\times \mathbb{C}\mathbb{P}^2$ " induces an isomorphism of surgery groups generalizes to give a homotopy equivalence  $\mathbb{L}_i(e) \cong \mathbb{L}_{i+4}(e)$ ,  $i \geq 5$ , so we have a 4-periodic sequence of "surgery spaces."

Quinn goes on to perform similar "spacification" operations in the nonsimply connected case and on the other terms of the surgery exact sequence. The result is that the surgery exact sequence becomes the homotopy sequence of a fibration. See [Q], [N], [We] for more information.

REMARK 25.6. The reader will have noticed that the sketch above lacks detail. Talking about the "space of all manifolds," for instance, should and does lead to confusion. The reference [N] contains a very nice treatment of these and many other issues.

One consequence of this is:

THEOREM 25.7 [N, p. 81]. *The surgery exact sequence in the TOP and PL categories is an exact sequence of groups and homomorphisms.*

#### REFERENCES

- [A1] J. F. Adams, *Stable homotopy and generalised homology*, U. of Chicago Press, Chicago, 1974.
- [A2] \_\_\_\_\_, *Infinite Loop Spaces*, Annals of Math. Studies #90, Princeton University Press, Princeton, 1978.
- [N] A. Nicas, *Induction theorems for groups of manifold homotopy structure sets*, Memoirs AMS **267** (1982).
- [Q] F. Quinn, *A geometric formulation of surgery*, Princeton University Thesis, 1969.
- [We] S. Weinberger, *The topological classification of stratified spaces*, U. of Chicago Press, Chicago, 1993 (to appear).
- [W] G. W. Whitehead, *Generalised homology theories*, Trans. Amer. Math. Soc. **102** (1963), 227–283.

## Chapter 26. Double Suspension and the Giffen construction

In this section, we will exhibit a simplicial complex which is homeomorphic to  $S^5$  but which is not PL homogeneous. This shows that manifolds can have simplicial triangulations which are not PL triangulations. We begin with the construction of a certain homology 3-sphere and a contractible 4-manifold which it bounds.

EXAMPLE 26.1 (THE MAZUR MANIFOLD [Z]). Construct  $W^4$  by attaching a 2-handle to the link in  $S^1 \times D^2 \subset \partial(S^1 \times D^3)$  pictured below:

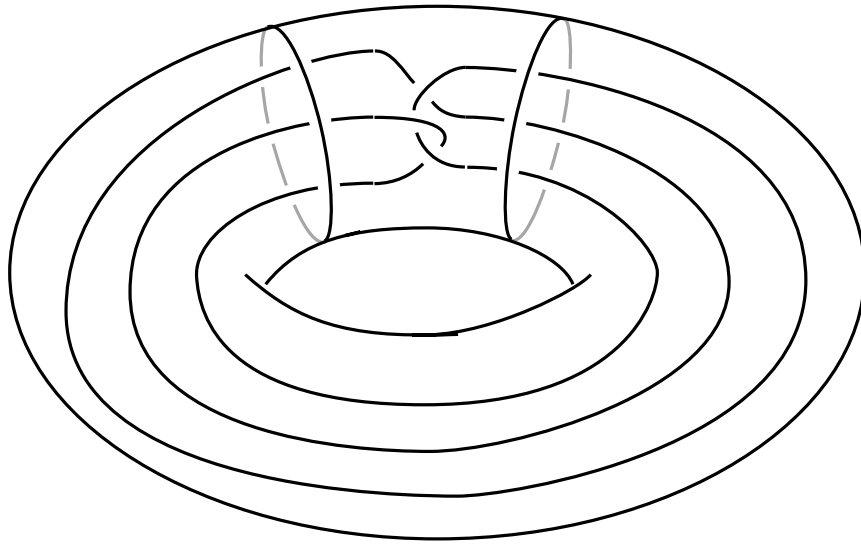

$W^4$  is contractible and its boundary is therefore a homology sphere. Computation shows that  $\pi_1(\partial W) \neq 1$ . The homology sphere  $\partial W$  is called the *Mazur homology sphere*. Consider the universal cover of  $S^1 \times D^2$  pictured below. Note that the two-point compactification of this universal cover is a  $D^3$  containing a Fox-Artin arc.<sup>32</sup>



<sup>32</sup> See example 2.22.

The shift on the universal cover induces a shift  $\sigma : D^3 \rightarrow D^3$  with two fixed points at  $\pm\infty$ . Cutting the  $D^3$  in half yields the picture below, where  $\beta$  is the part of the Fox-Artin arc over the positive real axis:

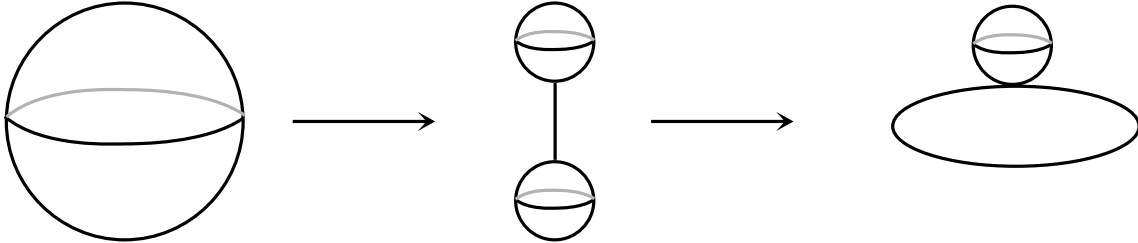

Form the mapping torus  $T(\sigma) = D^3 \times [0, 1] / \sim$ , where  $(x, 0) \sim (\sigma(x), 1)$ .  $T(\sigma)$  is homeomorphic to  $D^3 \times S^1$  and contains the mapping torus of the restriction of  $\sigma$  to the piece  $\beta$  of the Fox-Artin arc. Even though  $\beta$  has two components, the mapping torus of  $\alpha|\beta$  is homeomorphic to  $S^1 \times [0, 1]$ . We can verify this by noting that the mapping torus is a connected 2-manifold with Euler characteristic zero and boundary consisting of two  $S^1$ 's. A more direct verification is to straighten out the arc and draw the mapping torus.

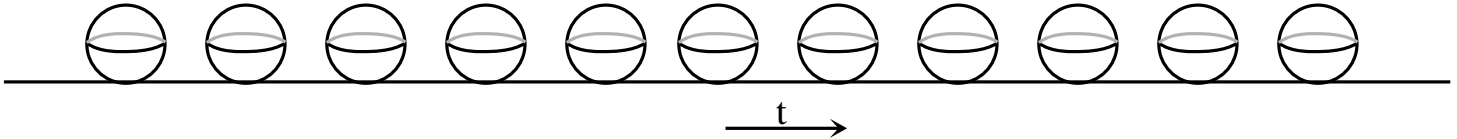

The top boundary curve of this annulus is a Mazur link in the boundary of  $S^1 \times D^3$ . This Mazur link consists of the fundamental domain of the shift, which is in the boundary of the mapping torus, together with three arcs formed by dragging the points at the top of the fundamental domain around the mapping torus. The confused reader should look back at the picture of the Mazur link. The other boundary curve is a standard circle. Adding a boundary collar to  $S^1 \times D^3$  and pushing the Mazur link out to the boundary shows that  $S^1 \times D^3$  contains a (wild) annulus such that one boundary component is a Mazur link in the boundary and the other component is  $S^1 \times \{0\}$ . This is the *Giffen construction*. Attaching the core of the 2-handle of the Mazur manifold  $W^4$  to this annulus gives a (wild)  $D^2$  in the interior of  $W^4$  whose boundary curve is the central circle in  $S^1 \times D^3$ . The disk  $D$  is called the *Giffen disk*.

**THEOREM 26.2 (DOUBLE SUSPENSION [CA]).** *The double suspension of any homology 3-sphere is homeomorphic to  $S^5$ .*

**PROOF FOR THE MAZUR HOMOLOGY SPHERE:** We will prove that the double suspension of  $\partial W^4$  is homeomorphic to  $S^5$ . By Theorem 2.7, it suffices to show that the double

suspension of  $\partial W^4$  is a manifold. The double suspension of  $\partial W^4$  is the join  $S^1 * \partial W^4$ , which is a manifold away from a singular circle. Near this singular circle,  $S^1 * \partial W^4$  is locally homeomorphic to  $\text{cone}(\partial W^4) \times \mathbb{R}$ .

CLAIM:  $W^4/D$  is homeomorphic to  $\text{cone}(\partial W^4)$ , where  $D$  is the Giffen disk.

Given this claim, the special case follows from a theorem of Bryant:

THEOREM 26.3 (J. BRYANT [B]). *If  $D \subset \overset{\circ}{M}^n$  is homeomorphic to  $D^k$ , then  $M^n/D \times \mathbb{R}^1$  is homeomorphic to  $M^n \times \mathbb{R}^1$ .*<sup>33</sup>

PROOF OF CLAIM: We will show that  $D = \bigcap_{i=1}^{\infty} K_i$ , where  $K_1 \supset K_2 \supset \dots$  and  $W$  collapses to  $K_i$  for each  $i$ . This suffices, since if  $N_i$  is a small enough regular neighborhood of  $K_i$ , we have  $\overset{\circ}{N}_i \supset N_{i+1}$  for all  $i$  and  $(N_i - \overset{\circ}{N}_{i+1}) \cong \partial N_i \times [0, 1]$  for all  $i$ , so  $W - D \cong \partial W \times [0, \infty)$ . Since  $\text{cone}(\partial W)$  and  $W/D$  are both one-point compactifications of  $\partial W \times [0, \infty)$ , they are homeomorphic.

Let  $K_1$  be the union of  $S^1 \times D^3$  with the core of the 2-handle. Since a mapping cylinder collapses to a subcylinder, the mapping torus of  $\sigma$  collapses to the mapping torus of  $\sigma|_{\alpha}$  union the mapping torus of  $\sigma|[1, \infty) \times D^2$ . The result is  $K_2$ . Here is a very schematic picture:

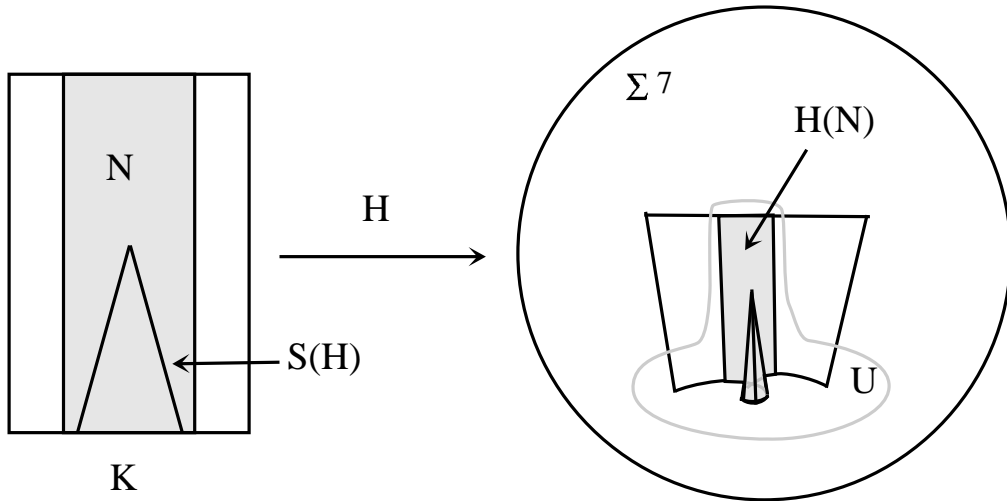

Further  $K_i$ 's are constructed by collapsing further around the torus. ■

<sup>33</sup> For  $k = 1$ , this theorem is due to Andrews-Curtis [AnC]. The proof is a Bing Shrinking argument using the “Bing staircase construction.” A different proof of Bryant’s theorem is given in [D].



REMARK 26.4. In fact, to get the  $K_i$ 's into the *interior* of  $W$ , we should probably add a boundary collar to  $W$  before starting this process. Begin by collapsing the collar and then collapsing to  $K_1$  as above.

COROLLARY 26.5 (EDWARDS). *Noncombinatorial triangulations of  $S^5$  exist.*

PROOF: The link of a 1-simplex of the singular circle is  $\partial W$ , so the double suspension triangulation of  $\partial W$  is not combinatorial. ■

REMARK 26.6. Notice that the simplices of the double suspension triangulation of  $S^5$  are wild when viewed in the ordinary triangulation. In particular, it is not always possible to move a 2-disk off a “singular” 1-simplex by general position.

Edwards proved that the double suspension of the Mazur homology 3-sphere is  $S^5$  and showed that the triple suspension of any homology sphere is a sphere. Soon after, Cannon [Ca] proved that the double suspension of an arbitrary homology 3-sphere is a sphere.

DEFINITION 26.7. A metric space  $X$  has the *disjoint disk property* if for any  $f_1, f_2 : D^2 \rightarrow X$  and  $\varepsilon > 0$ , there exist  $\bar{f}_1, \bar{f}_2 : D^2 \rightarrow X$  so that  $d(f_i, \bar{f}_i) < \varepsilon, i = 1, 2$ , and  $\bar{f}_1(D^2) \cap \bar{f}_2(D^2) = \emptyset$ .

DEFINITION 26.8. A metric space  $X$  is an *ANR homology  $n$ -manifold* if

- (i)  $X$  has finite covering dimension.
- (ii) For each  $x \in X$  and neighborhood  $U$  of  $x$  in  $X$ , there is a neighborhood  $V$  of  $x$  contained in  $U$  so that  $V \rightarrow U$  is nullhomotopic.
- (iii) For each  $x \in X$ ,  $\check{H}^k(X, X - \{x\})$  is 0 for  $k \neq n$  and  $\mathbb{Z}$  for  $k = n$ .

THEOREM 26.9 (EDWARDS' DISJOINT DISK THEOREM [D]). *If  $f : M \rightarrow X$  is a cell-like map from a closed  $n$ -manifold to an ANR homology manifold,  $n \geq 5$ , then  $X$  is a manifold if and only if  $X$  has the disjoint property.*

THEOREM 26.10 (QUINN'S RESOLUTION THEOREM [Q1], [Q2]). *If  $X$  is a connected ANR homology  $n$ -manifold,  $n \geq 4$ , then there exist an  $n$ -manifold  $M$  and a cell-like map  $f : M \rightarrow X$  if and only if a single  $\mathbb{Z}$  obstruction vanishes. This obstruction vanishes whenever  $X$  contains a manifold point. Thus, a connected ANR homology manifold with a manifold point is a manifold if and only if it has the disjoint disk property. When a resolution exists, it can be taken to be a homeomorphism over any  $n$ -manifold subset of  $X$ .*

REMARK 26.11. Ferry-Weinberger and Bryant-Mio have recently shown that this obstruction can be realized.

We illustrate the use of these theorems by proving that every embedding of  $S^{n-1}$  in  $S^n$  can be approximated by a locally flat embedding. (Corollary 3.5 shows that not all codimension one embeddings of  $S^{n-1}$  in  $S^n$  are locally flat.) This proof is due to R. Ancel [A]. We begin by stating the basic tameness condition for codimension-one embeddings of manifolds.

Here is the statement of the theorem:

THEOREM 26.12 (LOCALLY FLAT APPROXIMATION THEOREM [AC]). *Let  $M^{n-1}$  and  $N^n$  be manifolds,  $M$  closed,  $\partial N = \emptyset$ ,  $n \geq 5$ , and let  $f : M \rightarrow N$  be an embedding. Let  $\varepsilon > 0$  be given. Then there is a locally flat embedding  $\bar{f} : M \rightarrow N$  with  $d(f(x), \bar{f}(x)) < \varepsilon$  for each  $x \in M$ .*

PROOF: If  $M^{n-1} \subset N^n$  is a separating submanifold, let  $C_1$  and  $C_2$  be the two components of  $N - M$ . Form an ANR homology manifold  $X = C_1 \cup M \times [-1, 1] \cup C_2$ . There is a CE map  $p : X \rightarrow N$  obtained by collapsing  $M \times [-1, 1]$  to  $M$ . By the Resolution Theorem, there is a manifold  $P$  and a CE map  $q : P \rightarrow X$ . The map  $q$  can be taken to be the identity on a neighborhood of  $M \times 0$ . Using Siebenmann's Theorem to approximate the CE composition  $p \circ q$  by homeomorphism  $h$  gives the desired locally flat approximation to  $M$ . ■

#### REFERENCES

- [A] F. D. Ancel, *The locally flat approximation of cell-like embedding relations*, Notices of the AMS.
- [AC] F.D. Ancel and J.W. Cannon, *The locally flat approximation of cell-like embedding relations*, Ann. of Math. **109** (1979), 61–86.
- [AnC] J.J. Andrews and M. L. Curtis, *n-space modulo an arc*, Ann. of Math. **75** (1962), 1–7.
- [B] J. Bryant, *Euclidean space modulo a cell*, Fund. Math. **63** (1968), 43 – 51.
- [Ca] J. Cannon, *Shrinking cell-like decompositions of Manifolds in Codimension three*, Ann. of Math. **110** (1979), 83–112.
- [D] R.J Daverman, *Decompositions of manifolds*, Academic Press, New York, 1986.
- [L] R.C. Lacher, *Cell-like mappings and their generalizations*, Bul. Amer. Math. Soc. **83** (1977), 495–552.

- [Q1] F. Quinn, *Resolutions of homology manifolds, and the topological characterization of manifolds*, Invent. Math. **72** (1983), 267–284.
- [Q2] \_\_\_\_\_, *An Obstruction to the Resolution of Homology Manifolds*, Michigan Math. J. **301** (1987), 285–292.
- [Rus] T.B. Rushing, *Topological Embeddings*, Academic Press, New York, 1970.
- [Si] L. C. Siebenmann, *Approximating cellular maps by homeomorphisms*, Topology **11** (1972), 271–294.

## Chapter 27. Inverse limits

DEFINITION 27.1. If  $X_1 \xleftarrow{\alpha_2} X_2 \xleftarrow{\alpha_3} X_3 \xleftarrow{\alpha_4} \dots$  is an inverse sequence of spaces and maps, we define

$$\varprojlim \{X_i, \alpha_i\} = \{(x_1, x_2, x_3, \dots) \mid \alpha_i(x_i) = x_{i-1}\}.$$

We write  $\alpha_{ij}$  for the composition  $\alpha_{j+1} \circ \dots \circ \alpha_i : K_i \rightarrow K_j$ . The space  $\varprojlim \{X_i, \alpha_i\}$  is called the *inverse limit* and the maps  $\alpha_i$  are called *bonding maps*.

EXERCISE 27.2. If  $X = \varprojlim \{K_i, \alpha_i\}$  and  $Y = \varprojlim \{L_i, \beta_i\}$ , then a collection of maps  $f_i : K_i \rightarrow L_i$  with  $\beta_i \circ f_i = f_{i-1} \circ \alpha_i$  induces a map  $f : X \rightarrow Y$ . ■

Let  $X = \varprojlim \{K_i, \alpha_i\}$ , with  $\text{diam}(K_i) \leq 1$ . We metrize  $\coprod K_i$  as follows: If  $k, \ell \in K_i$ , let  $k_j = \alpha_{ij}(k)$  and let  $\ell_j = \alpha_{ij}(\ell)$ . Then

$$d(k, \ell) = \sum_{j=1}^i \frac{1}{2^j} \rho_j(k_j, \ell_j).$$

Here,  $\rho_j$  denotes the metric on  $K_j$ . If  $k \in K_i, \ell \in K_j, i > j$ ,

$$d(k, \ell) = \frac{1}{2^j} d(\alpha_{ij}(k), \ell) + \left(\frac{1}{2^j} - \frac{1}{2^i}\right).$$

LEMMA 27.3. The metric completion of  $\coprod K_i$  with this metric is  $\coprod K_i \cup X$ .

PROOF: If  $\{x_i\}$  is a Cauchy sequence with  $x_i \in K_i$ , then the sequences  $\{\alpha_{ij}(x_i)\}_{i \geq j}$  are Cauchy in  $K_j$  for each  $j$  and their limits determine an element of  $X$ . Conversely, projections of elements of  $X$  determine Cauchy sequences in  $\coprod K_i$ . ■

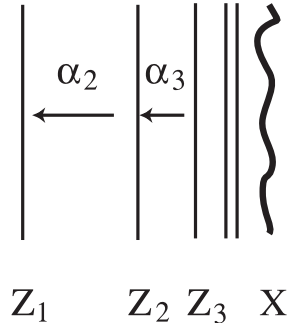

For emphasis, we state the following as a lemma.



Note that the existence of such a sequence immediately implies the theorem, since then

$$d(k, \ell) < \delta_i \Rightarrow d'(k, \ell) < \frac{\epsilon_1}{2} + \delta_i < \epsilon_i.$$

We begin with  $n = 1$ . In this case,  $d(k, \ell) = d'(k, \ell) = \frac{1}{2}\rho_1(k, \ell)$  and the result is trivial. We take  $\delta_1 = \frac{\epsilon_1}{4}$ . Of course, this only holds on  $Z_1$ , since  $d'$  is not yet defined on all of  $\coprod Z_i$ .

For the inductive step, assume that we have chosen  $\delta_i < \frac{\epsilon_i}{2}$ ,  $1 \leq i \leq n-1$ , so that if  $k, \ell \in Z_i$ ,  $i = 1, \dots, n-1$ , and  $d(k, \ell) < \delta_j$  or  $d'(k, \ell) < \delta_j$ ,  $1 \leq j \leq n-1$ , then

$$|d(k, \ell) - d'(k, \ell)| < \frac{\epsilon_j}{2}.$$

Let  $k, \ell \in Z_n$ . Then

$$|d(k, \ell) - d'(k, \ell)| = |d(k, \ell) - d'(k'_{n-1}, \ell'_{n-1})|.$$

Choosing  $\alpha'_n$  close to  $\alpha_n$ , we have

$$|d(k, \ell) - d'(k'_{n-1}, \ell'_{n-1})| \doteq |d(k, \ell) - d'(k_{n-1}, \ell_{n-1})| < \frac{\epsilon_i}{2}$$

whenever  $d(k, \ell) < \delta_i$  or  $d'(k, \ell) < \delta_i$ ,  $i = 1, \dots, n-1$ . Choosing  $d_n$  so that

$$|d(k, \ell) - d'(k, \ell)| < \frac{\epsilon_n}{2}$$

for  $d(k, \ell) < \delta_n$ ,  $k, \ell \in K_1 \coprod \dots \coprod K_n$  completes the induction and the proof. ■

**COROLLARY 27.6.** *If  $X = \varprojlim\{X_i, \alpha_i\}$  with each  $\alpha_i$  a near-homeomorphism, then  $X$  is homeomorphic to  $X_i$  for each  $i$ . ■*

**COROLLARY 27.7 (M. BROWN).** *If  $X$  and  $Y$  are spaces with maps  $f : X \rightarrow Y$  and  $g : Y \rightarrow X$  so that  $f \circ g$  and  $g \circ f$  are near-homeomorphisms, then  $X \cong Y$ .*

**PROOF:** Consider the inverse limit

$$Z = \varprojlim\{X \xleftarrow{g} Y \xleftarrow{f} X \xleftarrow{g} Y \xleftarrow{f} X \xleftarrow{g} \dots\}.$$

Associating one way, we see that  $Z$  is a limit of copies of  $X$  under bonding maps which are near-homeomorphisms. Letting the sets  $A_i$  in Theorem 27.5 be the set of homeomorphisms from  $X$  to  $X$ , this shows that  $Z$  is homeomorphic to  $X$ . Associating the other way shows that  $Z$  is homeomorphic to  $Y$ , so  $X$  is homeomorphic to  $Y$ . ■

EXAMPLE 27.8. The inverse limit of near-homeomorphisms need not be a near-homeomorphism.

PROOF: Consider the diagram below:

$$\begin{array}{ccccccc}
 [0, 1] & \xleftarrow{\alpha_2} & [0, 1] & \xleftarrow{\alpha_3} & [0, 1] & \xleftarrow{\alpha_4} & \dots X \\
 \downarrow & & \downarrow & & \downarrow & & \downarrow \\
 * & \xleftarrow{\quad} & * & \xleftarrow{\quad} & * & \xleftarrow{\quad} & \dots *
 \end{array}$$

If the result were true, we could cross the diagram with the Hilbert cube  $Q^{34}$  and show that the product of an arbitrary inverse limit of intervals times  $Q$  is homeomorphic to  $Q$ . This is false, since such an inverse limit need not be an ANR. ■

EXAMPLE 27.9. We give an example of spaces  $X$  and  $Y$  such that for each  $\epsilon > 0$  there are maps  $f_\epsilon : X \rightarrow Y$  and  $g_\epsilon : Y \rightarrow X$  so that the compositions  $f_\epsilon \circ g_\epsilon$  and  $g_\epsilon \circ f_\epsilon$  are  $\epsilon$ -close to the identity.

PROOF: Let  $\alpha \subset S^3$  be a wild arc and let  $X = S^3$ ,  $Y = S^3/\alpha$ . Given  $\epsilon > 0$ , choose a copy of  $\alpha$  in  $S^3$  which has diameter  $\ll \epsilon$  and let  $f_\epsilon$  be the map which collapses  $\alpha$  to a point. Let  $g_\epsilon$  be a  $\delta$ -inverse to  $f_\epsilon$ , where  $\delta \ll \epsilon$ . Such  $\delta$ -inverses exist by standard CE map stuff. We have  $f_\epsilon \circ g_\epsilon$   $\delta$ -close to id by construction. The composition  $g_\epsilon \circ f_\epsilon$  is  $\epsilon$ -close to the identity because the tracks of the homotopy lie in small neighborhoods of the point-inverses. Thus, the homotopy is quite small away from the arc  $\alpha$  and is  $\epsilon$ -sized near the arc. This makes it  $\epsilon$ -sized overall. ■

THEOREM 27.10 (ALEXANDROFF). *Every compact metric space is an inverse limit of finite polyhedra and PL maps.*

PROOF: Choose a countable dense subset  $\{x_i\}$  of  $X$  and let  $\phi_i(y) = \min\{d(y, x_i), 1\}$ . Then  $\phi(x) = (\phi_i(x))$  defines an embedding of  $X$  into  $Q$ . We write  $X = \cap U_i$  where  $U_i$  is a neighborhood of  $X$  in  $Q$ ,  $U_i \supset U_{i+1}$ . For each  $i$ ,  $X$  is covered by finitely many basic open sets  $U_{ij} \subset U_i$ , where  $U_{ij} = V_{ij} \times \prod_{k_{i,j}+1}^\infty [0, 1]$ . Here,  $V_{ij}$  is an open subset of  $\prod_1^{k_{ij}} [0, 1]$ . Since a finite union of such sets is a set of the same form, we can take  $U_i = V_i \times \prod_{k_i+1}^\infty [0, 1]$ . Since the projection of  $X$  onto  $\prod_{i=1}^{k_i} [0, 1]$  is a compact subset of  $V_i$ , we can choose a finite polyhedron  $K_i \subset V_i$  so that  $X \subset K_i \times \prod_{k_i+1}^\infty [0, 1]$ .

---

<sup>34</sup> The Hilbert cube is  $Q = \prod_{i=1}^\infty [0, 1]$  with the metric  $d((q_i), (q'_i)) = \sum_{i=1}^\infty \frac{|q_i - q'_i|}{2^i}$ . The projection map  $Q \times [0, 1] \rightarrow Q$  is clearly (?) a near-homeomorphism.

We have  $X = \varprojlim \{K_i \times \prod_{k_i+1}^{\infty} [0, 1], \alpha_i\}$ , where the bonding maps are inclusions. By Theorem 27.5, there is some choice of  $\{\ell_i\}$  so that  $X = \varprojlim \{K_i \times \prod_{k_i+1}^{\infty} [0, 1], p_{i-1} \circ \alpha_i\}$ , where

$$p_i : K_i \times \prod_{k_i+1}^{\infty} [0, 1] \rightarrow K_i \times \prod_{k_i+1}^{\ell_i} [0, 1].$$

But then

$$X = \varprojlim \left\{ K_1 \times \prod_{k_1+1}^{\infty} [0, 1] \xleftarrow{\times 0} K_1 \times \prod_{k_1+1}^{\ell_1} [0, 1] \xleftarrow{p_1 \circ \alpha_2} K_2 \times \prod_{k_2+1}^{\infty} [0, 1] \xleftarrow{\times 0} K_2 \times \prod_{k_2+1}^{\ell_2} [0, 1] \leftarrow \dots \right\}$$

and passing to the subsequence of even-numbered terms writes  $X$  as an inverse limit of finite polyhedra. By Theorem 27.5 and simplicial approximation, we can use PL bonding maps. Note that there do not exist triangulations of the  $K_i$ 's making  $\{K_i, \alpha_i\}$  into a sequence of polyhedra with *simplicial* bonding maps, since the inverse limit of positive-dimensional polyhedra and simplicial maps contains nontrivial simplices. ■

EXERCISE 27.11. Let  $\gamma : [0, 1] \rightarrow [0, 1]$  be the map

$$\gamma(x) = \begin{cases} 2x & 0 \leq x \leq \frac{1}{2} \\ 1 - 2x & \frac{1}{2} \leq x \leq 1. \end{cases}$$

Show that  $\varprojlim \{I, \gamma\}$  is connected but contains no nontrivial arcs.

EXERCISE 27.12. Show that the bonding maps can be taken to be surjective. (Hint: This requires some work.)

#### REFERENCES

- [B] M. Brown, *Some applications of an approximation theorem for inverse limits*, Proc. Amer. Math. Soc. **11** (1960), 478–483.



## Chapter 28. Hilbert cube manifolds

DEFINITION 28.1. A *compact Hilbert cube manifold* is a compact metric space  $X$  such that every  $x \in X$  has arbitrarily small neighborhoods homeomorphic to  $\overset{\circ}{B}^n \times Q$ , where  $\overset{\circ}{B}^n$  is an open  $n$ -ball and  $Q$  is the Hilbert cube. Of course,  $n$  varies with the size of the neighborhood.

THEOREM 28.2. *If  $c : K \rightarrow L$  is a CE-PL map between finite polyhedra, then  $K \times Q$  is homeomorphic to  $L \times Q$ .*

*We begin by stating a proposition on inverting CE maps.*

PROPOSITION 28.3. *Let  $c : K \rightarrow L$  be a CE-PL map. Then for any  $\epsilon > 0$  there is a CE-PL map  $\rho : L \times D^{2\dim K+1} \rightarrow K$  so that the composition  $c \circ \rho$  is  $\epsilon$ -close to projection.*

PROOF OF THEOREM: We have  $K \times Q = \varprojlim \{K \times I^n, proj\}$ . Repeated application of Proposition 28.3 lets us construct a sequence of CE-PL maps

$$L \leftarrow K \leftarrow L \times I^{N_1} \leftarrow K \times I^{N_2} \leftarrow L \times I^{N_3} \leftarrow K \times I^{N_4} \leftarrow \dots$$

so that the 2-fold compositions are as close as we like to projection. The inverse limit of the odd-numbered terms is therefore  $L \times Q$ , while the inverse limit of the even-numbered terms is  $K \times Q$ . ■

PROOF OF PROPOSITION: Choose a PL embedding  $i : K \rightarrow K \times \overset{\circ}{D}^N$  and consider the embedding  $c \times i : K \rightarrow L \times D^N$ . Choose triangulations so that  $c \times i$  is simplicial and choose a subdivision of the triangulation of  $L \times D^N$  so that  $proj : L \times D^N \rightarrow L$  is simplicial with respect to a fine triangulation of  $L$ . Take second deriveds so that projection is still simplicial and let  $R$  be a simplicial neighborhood of  $(c \times i)(K)$  in the second derived.

For each simplex  $\Delta \in L$ ,  $(c \times i)(K) \cap (\Delta \times D^N)$  is PL homeomorphic to the contractible polyhedron  $c^{-1}(\Delta)$ , so  $R \cap (\Delta \times D^N)$  is a PL ball. We call  $R$  a *blocked regular neighborhood* of  $(c \times i)(K)$  over  $L$ . By induction on  $\dim(L)$ , there is a block-preserving CE-PL map  $R \rightarrow (c \times i)(K)$ .

There is also a block-preserving CE-PL map from  $L \times D^N$  to  $R$ . One way to obtain this is via a sequence of CE-PL maps

$$(L^{(i)} \times D^N) \cup R \rightarrow (L^{(i-1)} \times D^N) \cup R$$

which can be constructed by applying the  $h$ -cobordism theorem for manifolds with boundary over each  $\Delta^i \in L$  to show that  $L \times \Delta^i \overset{\circ}{=} \bar{R}$ . ■

**THEOREM 28.4 (ANDERSON-WEST).** *If  $K$  is a finite polyhedron, then  $K \times Q$  is a Hilbert cube manifold.*

**PROOF:** The proof is by induction on simplices in a triangulation. Let  $K = K_1 \cup \Delta$ , where  $\Delta$  is a top-dimensional simplex. Let  $\frac{1}{2}\Delta$  be a small simplex inside of  $\Delta$ . By induction,  $K_1 \times Q$  is a Hilbert cube manifold, so by Theorem 28.2,  $K - \text{int}(\frac{1}{2}\Delta)$  is a  $Q$ -manifold. It is now easy to see that every point in  $K \times Q$  has neighborhoods of the required sort, so  $K \times Q$  is a  $Q$ -manifold. ■

**REMARK 28.5.** The argument of this section is adapted from [BC].

#### HOMOGENEITY OF THE HILBERT CUBE

Our next task is to show that  $Q$  is homogeneous, that is, we will show that if  $x, y \in Q$ , then there is a homeomorphism  $h : Q \rightarrow Q$  with  $h(x) = y$ . If  $x \in Q$  and none of the coordinates of  $x$  are either 0 or 1, then it is easy to construct a homeomorphism  $s : Q \rightarrow Q$  with  $s(x) = (\frac{1}{2}, \frac{1}{2}, \frac{1}{2}, \dots)$ . Thus, we need to show that if  $x \in Q$ , then there is a homeomorphism  $h : Q \rightarrow Q$  so that  $h(x)$  has no coordinates equal to 0 or 1. Applying the Baire category theorem to the space of homeomorphisms  $h : Q \rightarrow Q$ , we see that it suffices to prove that for each  $n \in \mathbb{Z}$  and  $\epsilon > 0$ , there is a homeomorphism  $h : Q \rightarrow Q$  with  $|h - id| < \epsilon$  so that the  $n^{\text{th}}$  coordinate of  $h(x)$  is neither 0 nor 1.

Recall that the metric on  $Q$  is  $d(\mathbf{x}, \mathbf{y}) = \sum \frac{|x_i - y_i|}{2^i}$ . Suppose that the  $n^{\text{th}}$  coordinate of  $x$  is 1. Choose  $m$  so that  $2^{-m} \ll 2^{-n}$  and let  $h$  be a small self-homeomorphism of the rectangle in the  $n - m$  plane pictured below.

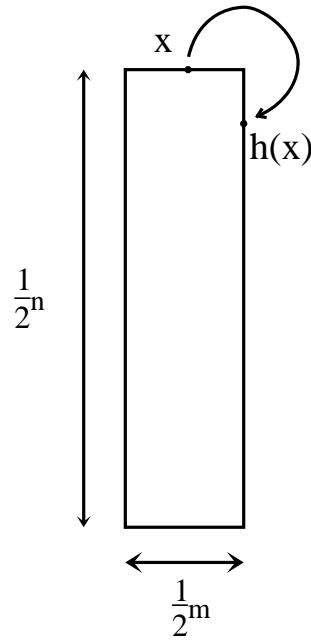

The picture has been drawn to emphasize that distances are very compressed in the  $m$ -direction for  $m$  large. Extend  $\bar{h}(x)$  to  $h : Q \rightarrow Q$  by fixing the other coordinates. The homeomorphism  $h$  clearly has the desired property, so homeomorphisms throwing  $x$  into the “interior” of  $Q$  are open and dense in the self-homeomorphisms of  $Q$ .

**THEOREM 28.6.** *If  $M$  is a connected  $Q$ -manifold, then  $M$  is homogeneous. ■*

#### REFERENCES

- [BC] M. Brown and M.M. Cohen, *A proof that simple-homotopy equivalent polyhedra are stably homeomorphic*, Mich. Math. J. **21** (1974), 181–191.

## Chapter 29. The Grove-Petersen-Wu finiteness Theorem

The next few sections will be concerned the Gromov-Hausdorff space of isometry classes of compact metric metric spaces. Here is a theorem, due to Grove-Petersen-Wu, which is a spectacular application of this very global approach to differential geometry.

**THEOREM 29.1.** *Let  $\mathcal{M}_{k,v}^{D:}(n)$  refer to the set of closed Riemannian  $n$ -manifolds with curvature bounded below by  $k$ , diameter bounded above by  $D$ , and volume bounded below by  $v$ . If  $n \neq 3$ ,  $\mathcal{M}_{k,v}^{D:}(n)$  contains only finitely many homeomorphism types of manifolds. For  $n \neq 3, 4$ , smoothing theory then implies that  $\mathcal{M}_{k,v}^{D:}(n)$  contains only finitely many diffeomorphism types of manifolds.*

### SOME PROPERTIES OF ANR'S

**DEFINITION 29.2.** A function  $f : X \rightarrow Y$  is  $(\epsilon, \delta)$ -continuous if

$$d(x, x') < \delta \Rightarrow d(f(x), f(x')) < \epsilon.$$

$f$  is  $\epsilon$ -continuous if there is a  $\delta > 0$  such that  $f$  is  $(\epsilon, \delta)$ -continuous.

**REMARK 29.3.** Perhaps this definition should be rephrased to say that  $f : X \rightarrow Y$  is **only**  $(\epsilon, \delta)$ -continuous, since  $(\epsilon, \delta)$ -continuous does *not* imply continuous.

**LEMMA 29.4.** *If  $f : X \rightarrow Y$  is uniformly continuous and  $d(f, g) < \epsilon$ , then  $g$  is  $3\epsilon$ -continuous (using the same  $\delta$  that works for  $\epsilon$  and  $f$ ).*

**PROOF:** Choose  $\delta > 0$  so that  $d(x, x') < \delta \Rightarrow d(f(x), f(x')) < \epsilon$ . Then  $g$  is  $(3\epsilon, \delta)$ -continuous. ■

**LEMMA 29.5.** *The composition  $f \circ g$  of an  $(\epsilon_1, \epsilon_2)$ -continuous function  $f$  and an  $(\epsilon_2, \epsilon_3)$ -continuous function  $g$  is  $(\epsilon_1, \epsilon_3)$ -continuous. ■*

**DEFINITION 29.6.** Let  $X$  be a compact metric space and let  $\mathcal{U}$  be a finite open cover of  $X$ . Then the *nerve* of  $\mathcal{U}$  is the abstract simplicial complex  $\mathcal{N}(\mathcal{U})$  whose simplices are  $\langle U_0, U_1, \dots, U_n \rangle$  such that  $U_i \in \mathcal{U}$  and  $\bigcap_{i=1}^n U_i \neq \emptyset$ . The geometric realization  $|\mathcal{N}(\mathcal{U})|$  of  $\mathcal{N}(\mathcal{U})$  is obtained by associating each  $\langle U_i \rangle$  to  $e_i$ , the  $i^{\text{th}}$  basis vector in the separable Hilbert space  $l_2$ , and associating to each simplex  $\langle U_0, U_1, \dots, U_n \rangle$  the convex hull of  $e_0, \dots, e_n$ . If  $\{\phi_U\}$  is a partition of unity subordinate to  $\mathcal{U}$ , then  $\phi(x) = \sum \phi_U(x) \langle U \rangle$

gives a map from  $X$  into  $|\mathcal{N}(\mathcal{U})|$ . Note that if  $z = \sum_{i=0}^n t_i \langle U_i \rangle \in |\mathcal{N}(\mathcal{U})|$ ,  $t_i \neq 0$ , then

$$\phi^{-1}(z) \subset \bigcap_{i=0}^n U_i.$$

**THEOREM 29.7.** *If  $X$  is a compact ANR, then for every  $\epsilon > 0$  there is a  $\delta > 0$  so that if  $Z$  is a metric space and  $f : Z \rightarrow X$  is  $\delta$ -continuous, then there is a continuous  $\bar{f} : Z \rightarrow X$  such that  $d(f, \bar{f}) < \epsilon$ . If  $Z_0 \subset Z$  is a closed subset such that  $f|_{Z_0}$  is continuous, then we can take  $\bar{f}|_{Z_0} = f|_{Z_0}$ .*

**PROOF:** To keep things relatively simple, we restrict ourselves to the case in which  $Z$  is compact. Suppose that  $f$  is  $(\delta, \delta')$ -continuous.

**Step I.** We show that  $Z$  can be taken to be a finite polyhedron.

**PROOF:** Choose a finite covering  $\mathcal{U}$  of  $Z$  by open sets  $U$  of diameter  $\leq \frac{\delta'}{3}$ . Let  $\phi : Z \rightarrow |\mathcal{N}(\mathcal{U})|$  the map associated to a partition of unity subordinate to  $\mathcal{U}$ , as above. Define a discontinuous map  $\rho : |\mathcal{N}(\mathcal{U})| \rightarrow X$  by setting  $\rho(\text{int } \sigma) = f(x_\sigma)$ , where  $x_\sigma$  is any element of  $U_0 \cap \cdots \cap U_n$ ,  $\sigma = \langle U_0, \dots, U_n \rangle$ . Clearly,  $\rho$  is  $\delta$ -continuous and  $d(\rho \circ \phi, f) < \delta$ , so  $f$  can be closely approximated by continuous functions if  $\rho$  can.

**Step II.** We assume that  $Z$  is a polyhedron, that  $f : Z \rightarrow X$  is  $(\delta, \delta')$ -continuous, and that  $Z_0 \neq \emptyset$ .

**PROOF:** Embed  $X$  in  $R^m$  for some  $m$  and let  $r : U \rightarrow X$  be a retraction,  $U$  an open neighborhood of  $X$ . Choose  $\delta > 0$  so that for each  $x \in X$ ,  $B_\delta(x) \subset U$  and  $r|_{B_\delta(x)}$  is  $\frac{\epsilon}{4}$ -close to the identity. We may also assume that  $\delta < \frac{\epsilon}{4}$ .

Subdivide  $Z$  so that  $\text{diam}(\sigma) < \delta'$  for each simplex  $\sigma \subset Z$ . For each vertex  $v$  of  $Z$ , let  $f'(v) = f(v)$  and define  $f' : Z \rightarrow R^m$  by extending linearly over each simplex  $\sigma$ . Note that since  $\text{diam}(\sigma) < \delta'$ ,  $f(\sigma)$  is contained in  $B_\delta(f(v))$ , where  $v$  is any vertex of  $\sigma$ . Since  $B_\delta(f(v))$  is convex,  $f'(\sigma) \subset B_\delta(f(v)) \subset U$  for each  $\sigma \subset Z$ . Finally, set  $\bar{f} = r \circ f'$ .  $\bar{f}$  is clearly continuous, and  $d(f, \bar{f}) \leq d(f, f') + d(f', \bar{f}) \leq 2\delta + d(f', r \circ f') \leq 2\delta + \frac{\epsilon}{4} < \epsilon$ .

To finish the proof of the theorem, we need to consider the case in which  $Z_0 \neq \emptyset$ . Triangulate  $Z - Z_0$  by a triangulation which gets finer and finer near  $Z_0$ . In the construction of  $f'$ , if  $v$  is a vertex of a simplex  $\sigma$  with  $\text{diam}(\sigma) \leq \frac{\delta'}{3}$  and  $d(v, Z_0) < \frac{\delta'}{3}$ , let  $f'(v) = f(z)$  for some  $z \in Z_0$  with  $d(v, z) < \frac{\delta'}{3}$  and extend linearly, as before. Let  $\bar{f}|_{Z - Z_0} = r \circ f'|_{Z - Z_0}$ . Extending over  $Z_0$  by  $f$  gives the desired function  $\bar{f}$ . ■

**DEFINITION 29.8.** If  $f_1, f_2 : Z \rightarrow X$  are maps, then  $f_1$  and  $f_2$  are  $\epsilon$ -homotopic if there is a homotopy  $h$  from  $f_1$  to  $f_2$  such that  $\text{diam}(h(\{z\} \times I)) < \epsilon$  for each  $z \in Z$ .

COROLLARY 29.9. *If  $X$  is a compact ANR, then for every  $\epsilon > 0$  there is a  $\delta > 0$  so that if  $f_1, f_2 : Z \rightarrow X$  are maps with  $d(f_1, f_2) < \delta$ , then  $f_1$  and  $f_2$  are  $\epsilon$ -homotopic.*

PROOF: Let  $h : Z \times I \rightarrow X$  be defined by  $h(x, t) = \begin{cases} f_1(x), & x \geq \frac{1}{2} \\ f_2(x), & x < \frac{1}{2}. \end{cases}$  Approximating  $h$  by a continuous map  $\text{rel } Z \times \{0, 1\}$  gives the desired homotopy. ■

COROLLARY 29.10 (EILENBERG). *If  $X$  is a compact ANR, then for each  $\epsilon > 0$ , there is a  $\delta > 0$  so that if  $f : X \rightarrow Y$  is continuous with  $\text{diam } f^{-1}(y) \leq \delta$  for each  $y \in Y$ , then there is a continuous function  $g : f(X) \rightarrow X$  such that  $g \circ f$  is  $\epsilon$ -homotopic to the identity.*

PROOF: For each point  $y \in f(Y)$ , let  $g'(y)$  be a point in  $f^{-1}(y)$ . Approximating  $g'$  by a continuous function  $g$  and applying Corollary 29.9 does the trick. ■

COROLLARY 29.11. *If  $M^n$  is a closed connected  $n$ -manifold, then there is an  $\epsilon > 0$  so that if  $N$  is a connected  $n$ -manifold and  $f : M \rightarrow N$  is a map with  $\text{diam } f^{-1}(y) \leq \epsilon$  for each  $y \in N$ , then  $f$  is onto,  $N$  is closed, and there is a map  $g : N \rightarrow M$  such that  $G \circ f \cong \text{id}$ .*

PROOF: By Corollary 29.9, we can choose  $\epsilon > 0$  small enough that there is a map  $g : f(M) \rightarrow M$  with  $g \circ f \simeq \text{id}$ . Then  $g_* \circ f_* : H_n(M) \rightarrow H_n(M)$  is the identity, which implies that  $H_n(f(M)) = Z \Rightarrow f(M) = N$ . The rest follows. □

REMARK 29.12. It follows from this that  $f$  is a homotopy equivalence. The argument is not difficult, but it takes us a bit afield, so we omit it. In fact, Berstein and Ganea have proven: “Let  $f : X \rightarrow Y$  be a continuous map of an arbitrary topological space to a manifold. If  $H^n(X; Z) \neq 0$  and if  $f$  has a left homotopy inverse, then  $f$  is a homotopy equivalence.” ■

DEFINITION 29.13. A function  $\rho : [0, R) \rightarrow [0, \infty)$  is a *contractibility function* if  $\rho$  is continuous at 0 and  $\rho(t) \geq t$  for all  $t$ . We define  $\mathcal{M}(\rho, n)$  to be the set of all compact metric spaces of dimension  $\leq n$  such that for each  $r$ , the ball  $B_r(x)$  contracts to a point in  $\text{int } B_{\rho(r)}(x)$ . Here,  $n$  can be any nonnegative integer or infinity.

THEOREM 29.14. *A compact,  $n$ -dimensional metric space  $X$  is an ANR if and only if  $X$  is in  $\mathcal{M}(\rho, n)$  for some contractibility function  $\rho$ .*

PROOF: ( $\Rightarrow$ ) We may assume that  $X \subset R^m$  for some  $m$ . If  $X$  is an ANR, let  $r : U \rightarrow X$  be a retraction from a closed neighborhood  $U$  of  $X$  to  $X$ . Let  $\epsilon > 0$  be given. WLOG, we

may assume that  $B_\epsilon(x) \subset U$  for each  $x \in X$ . Now choose  $\delta > 0$  so that  $r(B_\delta(x)) \subset B_\epsilon(x)$  for each  $x \in X$ . This is possible by uniform continuity of  $r$ . If  $c_t : B_\delta(x) \rightarrow U$  is a straight-line homotopy from the inclusion to the constant map  $x$ , then  $r \circ c_t \mid (B_\delta(x) \cap X)$  is a homotopy from the inclusion to a constant map in  $B_\epsilon(x) \cap X$ . If  $\delta_n$  is the  $\delta$  corresponding to  $\epsilon = \frac{1}{n}$ , let  $\rho(t)$  be  $\frac{1}{n}$  for all  $t$  between  $\delta_n$  and  $\delta_{n+1}$ .

( $\Leftarrow$ ) We begin by noting that:

(\*) If  $\Delta$  is a simplex, then every continuous  $f : \partial\Delta \rightarrow X$  with diameter  $< t$  extends to a map  $\bar{f} : \Delta \rightarrow X$  with diameter  $< \rho(t)$ .

It follows by induction that if  $0 < \delta_i \leq \rho(\delta_i) < \delta_{i+1} < R$  for  $i = 1, \dots, n-1$ , then any  $\delta_1$ -continuous map  $f$  from an  $n$ -dimensional polyhedron to  $X$  can be  $\rho(\delta_{n-1})$ -approximated by a continuous map  $\bar{f}$ . As in the last part of the proof of Theorem 29.7 that we can take  $\bar{f} = f$  on any closed subset  $K_0 \subset K$  where  $f$  is continuous.

Embed  $X$  in  $R^n$  for some  $n$  and choose a sequence  $\{\delta_i\}_{i=1}^{n-1}$  as above. Let  $f : R^n \rightarrow X$  be a function such that  $d(\mathbf{v}, f(\mathbf{v})) = d(\mathbf{v}, X)$  for all  $\mathbf{v} \in R^n$ . If  $K \supset X$  is a polyhedral neighborhood so small that  $d(k, X) < \delta_1$  for all  $k \in K$ , then  $f \mid K$  can be approximated by a continuous function  $\bar{f} : K \rightarrow X$  such that  $\bar{f} \mid X = f \mid X = \text{id}$ . ■

COROLLARY 29.15 (KURATOWSKI SEE THEOREM 8.7). *Compact topological manifolds and finite polyhedra are ANR's. In fact, every compact, finite-dimensional, locally contractible space is an ANR.*

REMARK 29.16. Theorems 29.7 and 29.14, are quite similar, but they differ in an important regard. In Theorem 29.7, the  $\delta$  depends on  $\epsilon$  and on  $X$ , but not on  $Z$ . In Theorem 29.14, the dimension of  $Z$  comes into play.

THE GROMOV-HAUSDORFF METRIC

DEFINITION 29.17. If  $Z$  is a compact metric space and  $X$  and  $Y$  are closed subsets of  $Z$ , then  $d_Z^H(X, Y) = \inf\{\epsilon > 0 \mid X \subset N_\epsilon(Y) \text{ and } Y \subset N_\epsilon(X)\}$ . This is the Hausdorff distance from  $X$  to  $Y$  in  $Z$ . The Gromov-Hausdorff distance from  $X$  to  $Y$  is:

$$d_G(X, Y) = \inf_Z \{d_Z^H(X, Y) \mid X \text{ and } Y \text{ are embedded isometrically in } Z\}.$$

THEOREM 29.18.  $d_G(X, Y) = 0 \Leftrightarrow X$  and  $Y$  are isometric.

PROOF: The proof is deferred.

DEFINITION 29.19. If  $X$  and  $Y$  are subsets of a metric space  $Z$ , then we will say that  $X$  and  $Y$  are *homotopy equivalent by  $\epsilon$ -moves* if there are maps  $f : X \rightarrow Y$  and  $g : Y \rightarrow X$  such that  $f$ ,  $g$ , and the homotopies all move points less than  $\epsilon$ .

THEOREM 29.20. *If  $\rho$  is a contractibility function, then for each  $\epsilon > 0$  there is a  $\delta > 0$  such that if  $X, Y \in \mathcal{M}(\rho, n)$  and  $d_G(X, Y) < \delta$ , then  $X$  and  $Y$  are homotopy equivalent by  $\epsilon$ -moves.*

PROOF: Choose a sequence  $\{\delta_i\}_{i=1}^n$  with  $0 < 4\rho(\delta_{i-1}) < \delta_i < \epsilon$  for  $i = 2, \dots, 2n$ . If  $d_G(X, Y) < \frac{\delta_1}{2}$ , then there are  $\delta_1$ -continuous functions  $f' : X \rightarrow Y$  and  $g' : Y \rightarrow X$ .  $f'$  and  $g'$  can be  $\rho(\delta_{n-1})$ -approximated by continuous functions  $f : X \rightarrow Y$  and  $g : Y \rightarrow X$ . This argument is the same as the last half of Theorem 29.14. Since  $f'$  and  $g'$  were  $\frac{\delta_1}{2}$ -close to id,  $f$  and  $g$  are  $2\rho(\delta_{n-1})$ -close to id and  $f \circ g$  and  $g \circ f$  are  $4\rho(\delta_{n-1})$ -close to id. The same inductive argument now produces  $\rho(\delta_{2n})$ -homotopies  $f \circ g \simeq \text{id}$  and  $g \circ f \simeq \text{id}$ . ■

COROLLARY 29.21 (BORSUK, PETERSEN). *Any precompact subset of  $\mathcal{M}(\rho, n)$  contains only finitely many homotopy types. (A metric space  $X$  is precompact if  $X$  has a finite cover by  $\epsilon$ -balls for each  $\epsilon > 0$ ).*

PROPOSITION 29.22. *Given compact metric spaces  $X$  and  $Y$  and  $\epsilon, \delta > 0$  there is a finite set  $f_1, \dots, f_k$  of  $(\epsilon, \delta)$ -continuous functions  $f_i : X \rightarrow Y$  such that if  $f : X \rightarrow Y$  is  $(\epsilon, \delta)$ -continuous, then  $d(f, f_i) < 4\epsilon$  for some  $i$ .*

PROOF: Choose a finite collection  $\{B_\delta(c_i)\}_{i=1}^n$  covering  $X$ . Consider the set  $Y^n$  of functions  $\{1, \dots, n\} \rightarrow Y$  and choose  $f'_1, \dots, f'_k$  so that for each function  $f : \{1, \dots, n\} \rightarrow Y$  there is an  $i$  so that  $d(f'_i(j), f(j)) < \epsilon$  for  $j = 1, \dots, n$ . If there are any  $(\epsilon, \delta)$ -continuous functions  $f : X \rightarrow Y$ , such that  $d(f'_i(j), f(c_j)) < \epsilon$  for all  $j$ , choose one and call it  $f_i$ .

We claim that for every  $(\epsilon, \delta)$ -continuous function  $f : X \rightarrow Y$ , there is an  $i$  so that  $d(f, f_i) < 4\epsilon$ . Given such an  $f$ , choose  $i$  so that  $d(f'_i(j), f(c_j)) < \epsilon$  for all  $j$ . Then  $d(f_i(c_j), f(c_j)) < 2\epsilon$  for all  $j$ . Since both  $f$  and  $f_i$  are  $(\epsilon, \delta)$ -continuous and every  $x \in X$  is within  $\delta$  of one of the  $c_j$ 's, we conclude that  $d(f_i, f) < 4\epsilon$ . ■

COROLLARY 29.23. *If  $X$  and  $Y$  are compact metric spaces,  $\{(\epsilon_i, \delta_i)\}_{i=1}^\infty$  is a sequence of pairs of positive numbers with  $\lim_{i \rightarrow \infty} \epsilon_i = \lim_{i \rightarrow \infty} \delta_i = 0$ , and  $\{f_i\}_{i=1}^\infty$  is a sequence of functions from  $X$  to  $Y$  such that  $f_k$  is  $(\epsilon_i, \delta_i)$ -continuous for  $i \leq k$ , then  $\{f_i\}$  has a subsequence which converges to a continuous function  $f : X \rightarrow Y$ .*

PROOF: By Proposition 29.22, there is a subsequence  $\{f_{i_j}\}$  of  $\{f_i\}$  so that  $d(f_{i_j}, f_{i_k}) < 8\epsilon_1$  for all  $j, k$ . Keeping  $f_{i_1}$  and taking another subsequence gets  $d(f_{i_j}, f_{i_k}) < 8 \cdot \min(\epsilon_1, \epsilon_2)$



for  $j, k \geq 1$ . Iterating this procedure yields a sequence of functions which converges to a function which is  $(\epsilon_i, \delta_i)$ -continuous for all  $i$  and which is therefore continuous. ■

REMARK 29.24. Note that  $(\epsilon, \delta)$ -continuous does not imply  $(k\epsilon, k\delta)$ -continuous for  $k > 1$ . Consider  $\{0, 1\} \subset \mathbb{R}^1$ . Any map defined on this space is  $(\frac{1}{2}, \frac{1}{2})$ -continuous, but not all maps are  $(2, 2)$ -continuous.

LEMMA 29.25. *If  $X$  and  $Y$  are compact metric and  $d_G(X, Y) < \epsilon$ , then there are maps  $f : X \rightarrow Y$  and  $g : Y \rightarrow X$  which are  $(3\gamma, \gamma)$ -continuous for every  $\gamma \geq \epsilon$ . Moreover,  $f \circ g$  and  $g \circ f$  are  $4\epsilon$ -close to  $id$ .*

PROOF: Let  $Z$  be a compact metric space containing isometric copies of  $X$  and  $Y$  such that  $d_Z(X, Y) < \epsilon$ . For each point  $x \in X$ , choose  $f(x) \in Y$  so that  $d(x, f(x)) < \epsilon$ . The inclusion  $i : X \rightarrow X$  is  $(\delta, \delta)$ -continuous for every  $\delta > 0$  and  $d(i, f) < \epsilon \leq \gamma$ , so  $f$  is  $(3\gamma, \gamma)$ -continuous for  $\gamma \geq \epsilon$  by Lemma 29.4. ■

We are now in a position to prove Theorem 29.18:

PROOF: If  $d_G(X, Y) = 0$ , we can choose sequences  $\{f_i\}$  and  $\{g_i\}$  of functions  $f_i : X \rightarrow Y$  and  $g_i : Y \rightarrow X$  for  $i = 1, \dots, \infty$ , so that  $f_i$  and  $g_i$  are  $\frac{3}{2^i}$ -continuous and  $f_i \circ g_i$  and  $g_i \circ f_i$  are  $\frac{2}{i}$ -close to  $id$ . This is Lemma 29.25 with  $\epsilon = \frac{1}{2^i}$ . By Corollary 29.23 we can find a subsequence so that  $\{f_{i_j}\}$ ,  $\{g_{i_j}\}$ ,  $\{f_{i_j} \circ g_{i_j}\}$ , and  $\{g_{i_j} \circ f_{i_j}\}$  converge to continuous functions.  $\lim_{i \rightarrow \infty} \{f_{i_j} \circ g_{i_j}\} = id_Y$ ,  $\lim_{i \rightarrow \infty} \{g_{i_j} \circ f_{i_j}\} = id_X$ , and  $f = \lim_{i \rightarrow \infty} \{f_i\}$  and  $g = \lim_{i \rightarrow \infty} \{g_i\}$  are isometries. ■

THEOREM 29.26 (GROMOV-HAUSDORFF).  *$d_G$  is a complete metric on the set of isometry classes of compact metric spaces.*

DEFINITION 29.27. The set of isometry classes of compact metric spaces with the Gromov-Hausdorff metric will be denoted by  $\mathcal{CM}$ .

PROOF: Clearly,  $d_G(X, Y) = d_G(Y, X)$  and we just proved that  $d_G(X, Y) = 0 \Leftrightarrow X$  and  $Y$  are isometric, so it remains to prove the triangle inequality.

We will show that  $d_G(X, Y) < \epsilon_1$  and  $d_G(Y, Z) < \epsilon_2$  implies that  $d_G(X, Z) < \epsilon_1 + \epsilon_2$ . Since  $d_G(X, Y) < \epsilon_1$  and  $d_G(Y, Z) < \epsilon_2$ , we can choose metrics  $d_1$  and  $d_2$  on  $X \amalg Y$  and  $Y \amalg Z$  so that  $d_1(X, Y) < \epsilon_1$  and  $d_2(Y, Z) < \epsilon_2$ . Define  $d_3$  on  $X \amalg Y \amalg Z$  by:

$$d_3(a, b) = \begin{cases} d_1(a, b) & \text{if } a, b \in X \amalg Y \\ d_2(a, b) & \text{if } a, b \in Y \amalg Z \\ \inf\{d_1(a, y) + d_2(y, b) \mid y \in Y\}, & \text{if } a \in X \text{ and } b \in Z. \end{cases}$$

It is not difficult to check that  $d_3$  is a metric and that  $d_3(X, Z) < \epsilon_1 + \epsilon_2$ .

That  $d_G$  is complete is not difficult to prove. If  $\{X_i\}$  is a Cauchy sequence of metric spaces, one can metrize  $\prod_{i=1}^{\infty} X_i$  as above and take the metric completion  $\bar{X}$  on  $X$ . One then shows that  $\bar{X}$  is compact and that  $\lim X_i = \bar{X} - X$ . ■

**THEOREM 29.28 (GROMOV? HAUSDORFF?).** *If  $X$  and  $Y$  are compact metric spaces such that every finite subset of  $X$  is isometric to a finite subset of  $Y$  and vice versa, then  $X$  and  $Y$  are isometric.*

**PROOF:** Let  $\epsilon > 0$  be given and let  $\{x_i\}_{i=1}^n$  be a maximal collection of points in  $X$  such that  $d(x_i, x_j) \geq \epsilon$  for  $i \neq j$ . This maximal number  $n$  must be less than the number of elements in any cover of  $X$  by balls of radius  $\leq \frac{\epsilon}{2}$ , since no element of such a cover can contain two of the  $x_i$ 's. Let  $\{y_i\}_{i=1}^n$  be a collection of points in  $Y$  such that  $d(y_i, y_j) = d(x_i, x_j)$  for all  $i, j$ . The hypotheses imply that  $\{y_i\}$  is also maximal. Then

$$d_G(X, Y) \leq d_G(X, \{x_i\}) + d_G(\{x_i\}, \{y_i\}) + d_G(\{y_i\}, Y) \leq 2\epsilon + 0 + 2\epsilon = 4\epsilon.$$

Since  $\epsilon$  was arbitrary, it follows that  $d_G(X, Y) = 0$  and that  $X$  and  $Y$  are isometric. ■

**DEFINITION 29.29.** If  $\rho : [0, R) \rightarrow \mathbb{R}$  is a contractibility function, we will say that a space  $X$  is in class  $\text{LGC}(\rho, n)$  (LGC stands for locally geometrically contractible) if for every  $\epsilon > 0$  and map  $\alpha : \partial\Delta^k \rightarrow X$ ,  $0 \leq k \leq n$ , with  $\text{diam}(\alpha(\partial\Delta^k)) < t < R$ , there is a map  $\bar{\alpha} : \Delta^k \rightarrow X$  with  $\text{diam}(\bar{\alpha}(\Delta^k)) < \rho(t)$ . We say that  $X \in \text{LGC}(k)$  if  $X \in \text{LGC}(\rho, k)$  for some contractibility function  $\rho$ . Note that if  $X \in \mathcal{M}(\rho, \infty)$ , then  $X \in \text{LGC}(k)$  for all  $k$ .

**PROPOSITION 29.30.** *Let  $\rho : [0, R) \rightarrow \mathbb{R}$  be a contractibility function and let  $0 < \delta_i \leq \rho(\delta_i) \leq \delta_{i+1} < R$  for  $i = 1, \dots, k-1$ . If  $X \in \text{LGC}(\rho, k-1)$ , then any  $\delta_1$ -continuous map  $f$  from a  $k$ -dimensional polyhedron to  $X$  can be  $\rho(\delta_{n-1})$ -approximated by a continuous map  $\bar{f} : K \rightarrow X$ . Moreover, we can take  $\bar{f} = f$  on any close subset of  $L$  where  $f$  is continuous.*

**PROOF:** We proceed exactly as in the proofs of Theorems 29.7 and 29.14. By induction, any  $\delta_1$ -continuous map  $f$  from an  $n$ -dimensional polyhedron to  $X$  can be  $\rho(\delta_{n-1})$ -approximated by a continuous map  $\bar{f}$ . As in the last part of the proof of Theorem 29.7, we can take  $\bar{f} = f$  on any closed subset  $K_0 \subset K$  where  $f$  is continuous. □

**PROPOSITION 29.31.** *If  $X$  is  $n$ -dimensional and  $X \in \text{LGC}(\rho, 2n+1)$ , then  $X$  is an ANR.*

PROOF: The argument above shows that  $X \in \text{LGC}(\rho^{2n+1}, 2n + 1)$ . If we embed  $X$  into  $R^{2n+1}$ , then the proposition above allows us to construct a contraction from a neighborhood  $U$  of  $X$  in  $X^{2n+1}$  to  $X$ .  $\square$

The next proposition gives a criterion for finite dimensionality.

PROPOSITION 29.32. *If  $X$  is a compact metric space such that for every  $\epsilon > 0$  there is a map  $f : X \rightarrow K$  from  $X$  to an  $n$ -dimensional polyhedron such that  $\text{diam } f^{-1}(y) < \epsilon$  for all  $y \in Y$ , then  $X$  has dimension  $\leq n$ .*

PROOF: Let  $\mathcal{U}$  be an open cover of  $X$  and let  $\epsilon$  be a Lebesgue number for  $\mathcal{U}$ . Choose  $f : X \rightarrow K$  so that  $K$  is  $n$ -dimensional and  $\text{diam } f^{-1}(y) < \epsilon$  for each  $y \in K$ . For each  $y \in K$ , choose a neighborhood  $V_y$  of  $y$  so that  $f^{-1}(V_y) \subset U$  for some  $U$ . Then  $\mathcal{V} = \{V_y \mid y \in Y\}$  is an open cover of  $K$  and has a refinement  $\mathcal{V}'$  such that no more than  $(n + 1)$  distinct elements of  $\mathcal{V}'$  can have nonempty intersection.  $f^{-1}(\mathcal{V}')$  is a refinement of  $\mathcal{U}$  having the same property, so  $X$  is  $\leq n$ -dimensional.  $\blacksquare$

DEFINITION 29.33. We say that  $X \in \text{LGC}(\rho, k)$  (LGC stands for *locally geometrically contractible*) if for each  $\ell \leq k$  and  $\alpha : S^\ell \rightarrow X$  with  $\text{diam}(\alpha(S^\ell)) < t < R$ , we have  $\bar{\alpha} : D^{\ell+1} \rightarrow X$  with  $\bar{\alpha}|_{\partial D^{\ell+1}} = \alpha$  and  $\text{diam}(\bar{\alpha}(D^{\ell+1})) < \rho(t)$ .

PROPOSITION 29.34. *If  $X_i \in \text{LGC}(\rho, k)$ ,  $i = 1, 2, \dots$ , and  $\lim_{i \rightarrow \infty} X_i = X$  in the Gromov-Hausdorff metric, then  $X \in \text{LGC}(k)$ .*

PROOF: We induct on  $k$ , so we may assume that  $X \in \text{LGC}(\rho', k - 1)$  for some  $\rho'$ . Setting  $\rho'' = \max(\rho, \rho')$  and then renaming  $\rho''$  as  $\rho$ , we may assume that  $X_i, X \in \text{LGC}(\rho, k - 1)$ .

Claim: For any map  $\alpha : \partial\Delta^k \rightarrow X$ ,  $0 \leq k \leq n$ , with  $\text{diam}(\alpha(\partial\Delta^k)) < t < R$ , and  $\epsilon > 0$ , there is a triangulation  $T$  of  $\Delta^k$  and a map  $\bar{\alpha} : |T^{k-1}| \rightarrow X$  with  $\bar{\alpha}|_{\partial\Delta^k} = \alpha$  and  $\text{diam}(\alpha(|T^{k-1}|)) < 2\rho(t)$  and  $\text{diam}(\bar{\alpha}(\partial|\sigma|)) < \epsilon$  for every  $\sigma \in T^k$ .

We defer the proof of the claim and show how the claim implies the proposition. Let  $\alpha : \partial\Delta^k \rightarrow X$  with  $\text{diam}(\alpha(\partial\Delta^k)) < t < R$ . Choose  $\{\epsilon_i\}$  so that  $2\rho(\epsilon_i) < t/2^i$  for each  $i > 0$ . By the claim, we can find a triangulation  $T_1$  of  $\Delta^k$  and a map  $\alpha_1 : |T^{k-1}| \rightarrow X$  with  $\alpha_1|_{\partial\Delta^k} = \alpha$ ,  $\text{diam}(\alpha_1(|T^{k-1}|)) < 2\rho(t)$ , and with  $\text{diam}(\alpha_1(|\sigma|)) < \epsilon_1$  for every  $\sigma \in T_1^{k-1}$ . Applying the claim again to the  $k$ -simplexes of  $T_1$ , we obtain a subdivision  $T_2$  of  $T_1$  and a map  $\alpha_2 : |T_2^{k-1}| \rightarrow X$  extending  $\alpha_1$  with  $\text{diam}(\alpha_2(|\partial\sigma|)) < 2\rho(\epsilon_1) < t/2$  for each simplex  $\sigma \in T_1^k$  and  $\text{diam}(\alpha_2(|\partial\sigma|)) < \epsilon_2$  for every  $\sigma \in T_2^k$ . Subdivisions  $T_i$  and maps  $\alpha_i : T_i \rightarrow X$  are defined similarly, with simplexes at the  $i^{\text{th}}$  level having diameter  $< t/2^i$ . In the limit, these maps define a continuous function  $\bar{\alpha} : \Delta^k \rightarrow X$ , since the

image of every point is specified to within  $t/2^{i-2}$  at the  $i^{\text{th}}$  stage of the construction. The diameter of  $\bar{\alpha}(\Delta^k)$  is less than or equal to  $2\rho(t) + t$ , so  $X \in \text{LGC}(2\rho(t) + t, k)$ . We now prove the claim

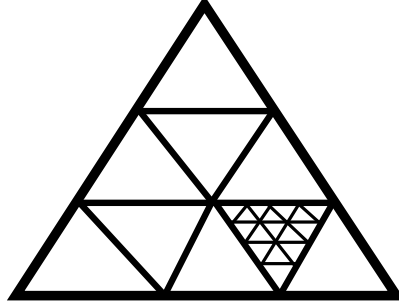

PROOF OF CLAIM: By the proof of Theorem 29.14, it suffices to show that for any  $\delta > 0$  there is a  $\delta$ -continuous map  $\bar{\alpha} : \Delta^k \rightarrow X$  such that  $\text{diam}(\bar{\alpha}(\Delta^k)) < \rho(t) + \delta$  and  $d(\alpha, \bar{\alpha} | \partial\Delta^k) < \delta$ , since we can define  $\beta : \Delta^k \rightarrow X$  to be  $\alpha$  on  $\partial\Delta$  and  $\bar{\alpha}$  elsewhere. This  $\beta$  is  $2\delta$ -continuous, so if  $\epsilon > 0$  is given and  $\delta$  is chosen sufficiently small,  $\beta | |T^k|$  can be  $\epsilon$ -approximated by a continuous function  $\bar{\alpha} : |T^k| \rightarrow X$  extending  $\alpha$ . One easily checks that for a fine enough triangulation  $T$ ,  $\bar{\alpha}$  has the desired properties.

Given  $\delta > 0$ , choose  $X_i \in \text{LGC}(\rho, k)$  with  $d_G(X_i, X) < \delta'$ . Then there are  $(3\delta', \delta')$ -continuous maps  $f : X_i \rightarrow X$  and  $g : X \rightarrow X_i$  so that  $d(f, \text{id}), d(g, \text{id}) < \delta'$ . Since  $f \circ \alpha$  is  $3\delta'$ -continuous, by Theorem 29.14, we can  $\epsilon'$ -approximate  $f \circ \alpha$  by a continuous function  $\alpha' : \partial\Delta^k \rightarrow X_i$ . Since  $\text{diam}(\alpha'(\partial\Delta^k)) < t$ , there is a continuous extension  $\bar{\alpha}'$  of  $\alpha'$  to  $\Delta^k$  with  $\text{diam}(\bar{\alpha}'(\Delta^k)) < \rho(t)$ . Now,  $\bar{\alpha} = g \circ \bar{\alpha}' : \Delta^k \rightarrow X$  is the desired approximation to  $\alpha$ . ■

A finite-dimensional compact metric space is an ANR if and only if it is locally contractible. This condition does not suffice when  $X$  is infinite-dimensional. Here is a useful criterion for an infinite-dimensional compactum to be an ANR. Since we use only the easy half of this theorem, we will prove only that half.

THEOREM 29.35 (HANNER). *A compact metric space  $X$  is an ANR if and only if it is  $\epsilon$ -dominated by finite complexes  $K$  for each  $\epsilon > 0$ .*

PROOF: ( $\Rightarrow$ ) Let  $\delta > 0$  be given. Cover  $X$  by open sets of diameter  $< \delta/3$  and let  $\mathcal{U}$  be a finite subcover of this cover. Let  $\phi : X \rightarrow \mathcal{N}(\mathcal{U})$  be the map from  $X$  to the nerve of  $\mathcal{U}$  obtained by  $\phi(x) = \sum \psi_U(x)\langle U \rangle$  where  $\psi_U$  is a partition of unity subordinate to  $\mathcal{U}$ .

The map  $\nu : \mathcal{N}(\mathcal{U}) \rightarrow X$  obtained by  $\nu(\sum t_i \langle U_i \rangle) = x$ , where  $x \in U_i$  and  $t_i \neq 0$  is  $\delta$ -continuous. For  $\delta$  small, it can therefore be  $\epsilon'$ -approximated by a continuous function.

The composition  $\nu \circ \phi$  is  $2\epsilon'$ -close to the identity, so for  $\epsilon'$  small, it is  $\epsilon$ -homotopic to the identity. Thus,  $K = \mathcal{N}(\mathcal{U})$   $\epsilon$ -dominates  $X$ . ■

PROPOSITION 29.36. *Suppose that:*

- (i)  $X = \varinjlim_{i \rightarrow \infty} \{X_i\}$  in the Gromov-Hausdorff metric.
- (ii) Each  $X_i$  is in  $\mathcal{M}(\rho, n)$ .

Then  $X$  is  $n$ -dimensional iff  $X$  is an ANR.

PROOF: If  $X$  is  $n$ -dimensional, then the fact that  $X \in \text{LGC}(\rho', 2n + 1)$  implies that  $X$  is ANR.

If  $X$  is ANR, choose a finite complex  $K$  and maps  $d : K \rightarrow X$ ,  $u : X \rightarrow K$  so that  $d \circ u$  is  $\epsilon$ -homotopic to the identity. Since the  $X_i$ 's are in  $\mathcal{M}(\rho, n)$ , the  $(\Leftarrow)$  argument in Theorem 29.14 shows that if  $X \in \mathcal{M}(\rho, n)$ , then  $X \in \text{LGC}(\rho_k, n)$  for each  $k$ , where  $\rho_k$  is a function depending only on  $\rho$ . Proposition 29.30 then shows that for large  $i$  there are maps  $d_i : K \rightarrow X_i$  so that  $\varinjlim_{i \rightarrow \infty} d_i = d$ . It follows that for sufficiently large  $i$   $d_i \circ u$  is  $\epsilon$ -close to the identity and, therefore, has small point-inverses. By Proposition 29.32, therefore,  $X$  has dimension  $\leq n$ . ■

REMARK 29.37. Note that the proof above shows that  $X$  is  $n$ -dimensional  $\Leftrightarrow X$  is finite-dimensional. We have  $X$  finite-dimensional  $\Rightarrow X$  ANR  $\Rightarrow X$   $n$ -dimensional.

PROPOSITION 29.38. *Suppose that:*

- (i)  $X = \varinjlim_{i \rightarrow \infty} \{X_i\}$  in the Gromov-Hausdorff metric.
- (ii) Each  $X_i$  is a closed manifold in  $\mathcal{M}(\rho, n)$ .
- (iii)  $X$  is finite-dimensional.

Then  $X$  is an ANR homology manifold.

PROOF:  $(X, X - pt) = \varinjlim \{(X, X - \text{int } B_{\epsilon_i}(x))\}$ , where the bonding maps are inclusions and the  $\epsilon_i$ 's converge monotonically to zero. Thus,  $H_*(X, X - pt) = \varinjlim \{H_*(X, X - \text{int } B_{\epsilon_i}(x))\}$ , where the bonding maps are inclusions and the  $\epsilon_i$ 's converge monotonically to zero. If we fix  $i$  and choose  $\delta$ 's so that  $\epsilon_i < \delta_i < \epsilon_{i+1} < \delta_{i+1} < \epsilon_{i+2} < \delta_{i+2}$ , then for sufficiently large  $j$ , we have:

$$(X, X - \text{int } B_{\epsilon_i}(x)) \leftarrow (X_j, X_j - \text{int } B_{\delta_i}(p_j(x))) \leftarrow (X, X - \text{int } B_{\epsilon_{i+1}}(x)) \leftarrow$$

$$(X_j, X_j - \text{int } B_{\delta_{i+1}}(p_{j+1}(x))) \leftarrow (X, X - \text{int } B_{\epsilon_{i+2}}(x)) \leftarrow (X_j, X_j - \text{int } B_{\delta_{i+2}}(p_{j+1}(x)))$$

with all two-fold compositions homotopic to the appropriate inclusions. This shows that  $X$  is a homology manifold. ■

## Chapter 30. Simple homotopy theory in $\mathcal{M}(\rho, n)$

This section is devoted to proving:

**THEOREM 30.1.** *Every precompact subset of  $\mathcal{M}(\rho, n)$  contains only finitely many simple homotopy types.*

It suffices to show that if  $\{X_i\}$  is a sequence in  $\mathcal{M}(\rho, n)$  with  $\lim_{i \rightarrow \infty} X_i = X \in \mathcal{CM}$ , then  $X_i$  and  $X_j$  are simple homotopy equivalent for sufficiently large  $i, j$ .

**DEFINITION 30.2.** If  $f : K \rightarrow L$  and  $p : L \rightarrow B$  are maps and  $\epsilon > 0$ , then  $f$  is a  $p^{-1}(\epsilon)$ -equivalence if there exists a  $g : L \rightarrow K$  and homotopies  $H : f \circ g \simeq \text{id}$ ,  $G : g \circ f \simeq \text{id}$  so that  $p \circ H$  and  $p \circ f \circ G$  are  $\epsilon$ -homotopies.

We begin by recalling the statements of Theorem 17.2 and Theorem 18.2.

**THEOREM 17.2.** *For every finite complex  $L$  there is a  $\delta > 0$  so that if  $f : K \rightarrow L$  is a  $\delta$ -equivalence, then  $f$  is simple.*

**THEOREM 18.2.** *If  $B$  is a finite polyhedron, then there is an  $\epsilon > 0$  so that if  $K$  and  $L$  are polyhedra,  $p : L \rightarrow B$  is a map and  $f : K \rightarrow L$  is a  $p^{-1}(\epsilon)$ -equivalence, then  $\tau(f) \in \ker(p_* : Wh(L) \rightarrow Wh(B))$ .*

Let  $X_i$  be a sequence of spaces in  $\mathcal{M}(\rho, n)$  with  $\lim_{i \rightarrow \infty} X_i = X \in \mathcal{CM}$ . By Proposition 29.30,  $X \in \text{LGC}(k)$  for all  $k \geq 0$ . If  $X = \varprojlim \{K_i, \alpha_i\}$ , then  $\text{pro-}\pi_n(X)$  refers to the sequence  $\{\pi_n K_i, (\alpha_i)_\#\}$ . A sequence  $\{G_i, \alpha_i\}$  of groups and homomorphisms is *stable* if it is equivalent as a system to a sequence of isomorphisms. The sequence is *Mittag-Leffler* if it is equivalent to a sequence of epimorphisms.

**THEOREM 30.3 [F2].** *A compactum  $X$  is shape equivalent to an  $\text{LGC}(n)$  compactum if and only if  $\text{pro-}\pi_l(X)$  is stable for  $0 \leq l \leq n$  and Mittag-Leffler for  $l = n + 1$ .*

Actually, we only need the  $(\Rightarrow)$  half of this theorem, which is due to Kozłowski-Segal and Borsuk. Since  $X$  is surely shape equivalent to itself (no matter what shape theory might be!), we see from this that our limit compactum has stable  $\text{pro-}\pi_l(X)$  for all  $l$ .

**THEOREM 30.4 [F2].** *A compactum  $X$  with  $\text{pro-}\pi_l(X)$  stable for  $0 \leq l \leq n$  and Mittag-Leffler for  $l = n + 1$  can be represented as an inverse limit  $X = \varprojlim \{K_i, \alpha_i\}$  with  $\alpha_i : K_i \rightarrow K_{i-1}$   $(n + 1)$ -connected. This means that  $\alpha_{i\#} : \pi_{n+1}(K_i) \rightarrow \pi_{n+1}(K_{i-1})$  is an isomorphism for each  $i$  and for  $0 \leq l \leq n$  and that  $\alpha_{i\#} : \pi_{n+1}(K_i) \rightarrow \pi_{n+1}(K_{i-1})$  is epi for all  $i$ .*

It follows from all of this that if  $X \in \text{LGC}(k)$ , then we can represent  $X$  as an inverse limit  $\varprojlim\{K_i, \alpha_i\}$  with  $\pi_l(K_i) = \pi_l(X)$  for  $l \leq k$ . Let  $X_i$  be a sequence of spaces in  $\mathcal{M}(\rho, n)$  with  $\varinjlim_{i \rightarrow \infty} X_i = X \in \mathcal{CM}$  and metrize  $X \amalg \left( \prod_{i=1}^{\infty} X_i \right)$  as before. Write  $X = \varprojlim\{K_i, \alpha_i\}$  with  $\alpha_{i\#} : \pi_1(K_i) \rightarrow \pi_1(K_{i-1})$  an isomorphism for each  $i$ . Let  $p : X \rightarrow K_1$  be the projection from the inverse limit to the first term of the inverse sequence. By the above,  $p_{\#} : \pi_1(X) \rightarrow \pi_1(K_1)$  is an isomorphism. By passing to a subsequence of  $\{X_i\}$  if necessary, Theorem 29.20 allows us to assume that there are  $1/2^i$ -(bi)homotopy equivalences  $f_i : X_i \rightarrow X_{i+1}$ . The sequence of maps  $\left\{ f_j \circ \cdots \circ f_i : X_i \rightarrow X \amalg \left( \prod_{k=1}^{\infty} X_k \right) \right\}$  is Cauchy and converges to a map  $g_i : X_i \rightarrow X$  with  $d(g_i(x), x) \leq 1/2^{i-1}$  in  $X \amalg \left( \prod_{k=1}^{\infty} X_k \right)$ . For large  $i$ ,  $f_i$  is a  $(p \circ g_{i+1})^{-1}(\epsilon)$ -equivalence, where  $\epsilon$  is chosen for  $K_1$  as in Chapman's Improvement. Thus, for large  $i$ ,  $\tau(f_i) \in \ker\{(p \circ g_{i+1})_* : Wh(X_{i+1}) \rightarrow Wh(K_1)\} = \{0\}$ , since  $p \circ g_{i+1}$  is a  $\pi_1$ -isomorphism. This proves the Theorem. ■

There is a related "limiting form" of this result:

**THEOREM 30.5.** *If  $K$  and  $L$  are finite polyhedra and  $c_1 : K \rightarrow X$  and  $c_2 : L \rightarrow X$  are CE maps, then  $K$  and  $L$  are simple-homotopy equivalent.*

**PROOF:** Choose  $p : X \rightarrow K_1$  as above so that the composition  $p \circ c_2$  induces an isomorphism of fundamental groups  $\pi_1(L) \rightarrow \pi_1(K_1)$ . Let  $\epsilon > 0$  be given and choose  $\delta > 0$  so that if  $Q \subset X$  is a set with diameter  $< \delta$ , then  $p(Q) \subset K_i$  is a set of diameter  $< \epsilon$ . By Lemma A on p. 506 of [L], we can find maps  $f : K \rightarrow L$  and  $g : L \rightarrow K$  and homotopies  $F : g \circ f \simeq \text{id}$ ,  $G : f \circ g \simeq \text{id}$  so that  $d(c_1, c_2 \circ f) < \delta$ ,  $d(c_2, c_1 \circ g) < \delta$ , and so that  $c_1 \circ F$  and  $c_2 \circ G$  are  $\delta$ -homotopies. It follows immediately that  $f$  is a  $c_2^{-1}(\delta)$ -equivalence and a  $(p \circ c_2)^{-1}(\epsilon)$ -equivalence. By Chapman's Improvement, this implies that  $f$  is a simple homotopy equivalence.

#### REFERENCES

- [ChF] T.A. Chapman and S. C. Ferry, *Approximating homotopy equivalences by homeomorphisms*, Amer. J. Math. **101** (1979), 583-607.  
[F] S. Ferry, *Homotoping  $\epsilon$ -maps to homeomorphisms*, Amer. J. Math. **101** (1979), 567-582.

- [F1] \_\_\_\_\_, *The homeomorphism group of a compact  $Q$ -manifold is an ANR*, Annals of Math. **106** (1977), 101-120.
- [F2] \_\_\_\_\_, *A stable converse to the Vietoris-Smale theorem with applications to shape theory*, Trans. A.M.S. **261** (1980), 369-386.
- [GLP] M. Gromov, J. Lafontaine, and P. Pansu, *Structures metriques pour les Varietes Riemanniennes*, Cedric/Fernand Nathan (1981).
- [Gr] K. Grove, *Metric differential geometry*, Springer Lecture Notes in Math. **1263**, 171-227.
- [GP] K. Grove and P. Petersen, *Bounding homotopy types by geometry*, Annals of Math. **128** (1988), 195-206.
- [GPW] K. Grove, P. Petersen, and J. Wu, *Controlled topology in geometry*, preprint.
- R.C. Lacher, *[L] Cell-like mappings and their generalizations*, BAMS **83** (1987), 495-552.
- [P] Petersen, P., *A finiteness theorem for metric spaces*, preprint.
- [Q1] Quinn, F., *Resolutions of homology manifolds and the topological characterization of manifolds*, Invent. Math. **72** (1983), 267-284.
- [Q2] \_\_\_\_\_, *An obstruction to the resolution of homology manifolds*, Mich. Math. J. **34** (1987), 285-291.
- [R] T.B. Rushing, *Topological Embeddings*, Academic Press, 1973.



## Chapter 31. Shape Theory

DEFINITION 31.1.

- (i) If  $\{K_i, \alpha_i\}$  is an inverse sequence of compact polyhedra and PL maps, we define the *shape* of  $\{K_i, \alpha_i\}$  to be the equivalence class of  $\{K_i, \alpha_i\}$  generated by passing to subsequences and homotoping the bonding maps. Thus,  $\{K_i, \alpha_i\} \sim \{K_i, \alpha'_i\}$  if  $\alpha_i \sim \alpha'_i$  for all  $i$  and  $\{K_i, \alpha_i\} \sim \{K_{i_j}, \alpha_{i_j i_{j-1}}\}$ .
- (ii) If  $X$  is a compact subset of  $\mathbb{R}^n$  for some  $n$ , we define the *shape of  $X$*  to be the shape of the sequence  $\{K_i, \alpha_i\}$  where  $K_0$  is a PL ball containing  $X$ ,  $K_i$  is a closed polyhedral neighborhood of  $X$  in  $\mathbb{R}^n$ , and  $\alpha_i : K_i \rightarrow K_{i-1}$  is the inclusion.
- (iii) In general, we define the *shape of a compact metric  $X$*  to be the shape of any inverse system  $\{K_i, \alpha_i\}$  with  $\varprojlim \{K_i, \alpha_i\} = X$  and  $K_0$  contractible.