

CIMAC 19
CONGRESS

VANCOUVER, JUNE 10-14, 2019

2019 | 013

Efficiency and Emissions of a High-Speed Marine Diesel Engine Converted to Dual-Fuel Operation with Methanol

5 - Low Carbon Combustion - What Are the Alternative Fuels for the Future

Jeroen Dierickx, Ghent University

Louis Sileghem, Ghent University
Sebastian Verhelst, Ghent University

This paper has been presented and published at the 29th CIMAC World Congress 2019 in Vancouver, Canada. The CIMAC Congress is held every three years, each time in a different member country. The Congress program centres around the presentation of Technical Papers on engine research and development, application engineering on the original equipment side and engine operation and maintenance on the end-user side. The themes of the 2019 event included Digitalization & Connectivity for different applications, System Integration, Electrification & Hybridization, Emission Reduction Technologies, Low Carbon Combustion including Global Sulphur Cap 2020, Case Studies from Operators, Product Development of Gas and Diesel Engines, Components & Tribology, Turbochargers, Controls & Automation, Fuels & Lubricants as well as Basic Research & Advanced Engineering. The copyright of this paper is with CIMAC. For further information please visit <https://www.cimac.com>.

ABSTRACT

Climate change and global warming, a growing maritime sector, and the roadmap away from fossil fuels towards a CO₂ neutral economy are driving innovations and technology developments. Fuel selection criteria such as sustainability, scalability and storability, lead to the selection of methanol as a viable alternative for fossil fuels. In LeanShips, a European Horizon 2020 Innovation Project, the conversion and operation of a high speed marine diesel engine on dual fuel methanol/diesel has been demonstrated. This paper presents the applied conversion solution, its impact on combustion characteristics, and the results of dual fuel methanol/diesel operation on engine performance parameters such as brake thermal efficiency (BTE), NO and soot emissions. The results were recorded at different engine speeds ranging from 1000 to 2000 rpm and for varying loads, in total 28 load points were tested. At each load point the methanol energy fraction was increased until the boundaries for substitution were reached. In dual fuel operation a relative increase of 12% in BTE was recorded and for respectively NO and soot emissions average decreases over the entire load range of 60% and 77%. The maximum obtained methanol energy fraction and diesel substitution ratio amounted respectively to 70% and 67%.

1 INTRODUCTION

Global warming limits and local air quality issues are driving, under increasing pressure of public opinion, the International Maritime Organization, European and local governmental bodies to implement stringent emission regulations. IMO has implemented Tier III limits for NO_x as of 2016 in NO_x Emission Control Areas (ECA) and a sulfur limit of 0.1% in ECA zones as of 2015 and 0.5% globally as of 2020. With regard to global warming, greenhouse gas emissions know less strict regulations, currently governed by IMO's Energy Efficiency Design Index (EEDI) for new ships and a Ship Energy Efficiency Management Plan (SEEMP) for all ships [1]. On the Paris climate conference in 2015, 195 countries have decided as a long-term goal to limit the increase in global average temperature to well below 2°C above pre-industrial levels, with the aim to limit the increase to 1.5°C [2]. Recently the Poland climate change conference has put the 2015 Paris agreement into force by putting a measurement, reporting and verification system in place on emissions-cutting efforts [3]. However, it was not decided on how countries will step up their targets on cutting emissions. At the current rate, the world is set for 3°C of warming from pre-industrial levels in 2100 – currently we are at a global warming level of 1°C. To get to a level of only 1.5°C in 2100 we must decline global net anthropogenic CO₂ emissions by 45% from 2010 levels by 2030, and reach net zero around 2050. For limiting to below 2°C, the necessary decline is 25% by 2030 and net zero by 2070 [4].

Global warming is mainly caused by greenhouse gas emissions of CO₂, methane and nitrous oxides. Of these anthropogenic emissions globally the transportation sector takes a share of 14% [5]. In the EU, road transport (trucks and cars) takes the majority of transport greenhouse gas emissions, about 72%, and the maritime and aviation sector each take a share of around 13% [6]. In the near future, different scenarios exist showing the growth of the maritime sector. DNV-GL projects [7] an increase in seaborne transport with 60% by 2050, based on an increase of 2.2% annual growth over the period 2015-2030 and of 0.6% per year thereafter.

Oil depletion on the other hand seems to be less of a problem. Contrary to the warnings of experts on an impending oil shortage there is still plenty of oil left for the next 50 years, based on the current assumptions. Given the high added value of carbon based fuels, a carbon-free economy is unrealistic, but a CO₂-neutral economy that does not prohibit the formation of CO₂ but rather avoids its net release into the atmosphere is a more realistic goal [8].

On tackling the above mentioned problems there are a few approaches and rationales to be followed. First of all, it is important to note that fuels will be needed in the future of transportation. Electrification of vessels based on battery storage is possible, but this will only break through for the shorter distances as batteries have a low energy density and therefore a low range density, opposite to what is required by vessel operators on longer transport routes. Therefore, fuels will still play an important role in the future for vessel propulsion as they have a high energy density, however given that alternative and sustainable fuels will be used, fuels that enable the CO₂ balance to be restored on our planet. The combustion engine can keep a major role in this because it is made out of cheap resources, out of materials that are recyclable and because engines are scalable using relatively little energy per engine produced. Currently there are more than one billion passenger cars making use of this reliable technology [9] and the majority of maritime transport propulsion is by internal combustion engines [10]. It is a technology that meets in an efficient way the design requirements of different transport applications, and definitely longer distance voyages.

According to Verhelst [9] an alternative fuel that has the potential to replace a majority of the current fossil fuels used, should meet three criteria (also referred to as the “triple S criteria”): sustainability, scalability and storability. Sustainability means that the fuel should make use of a closed cycle of resources and rely on an infinite energy supply. Scalability means that the resources to make the fuel should be cheap and abundantly available on our planet. And storability means that the fuel should have an acceptable energy density that meets the range density needs of vessel applications. Based on these three criteria, methanol comes out on top as an alternative fuel because it is liquid at room temperature making it easy to handle, distribute and store in ships, because it can be made out of an extensive list of feedstocks (natural gas, biomass, renewable electricity), and because it is an excellent engine fuel with higher achievable efficiencies and lower emissions than diesel and gasoline fueled engines [10]. DNV-GL concludes with similar criteria that given the right conditions methanol may develop to play a major role in the future [11].

Therefore the research group Transport Technology of Ghent University got involved in the LeanShips project, a European Innovation Project that aimed to put innovations into practice and ensure market uptake. LeanShips stands for Low Emission And Near to zero emissions Ships and

consisted out of seven demonstrators. In one of its demonstrators, Ghent University cooperated with different industry partners to demonstrate the potential of methanol on a high speed marine diesel engine [12]. This type of engine was chosen for different reasons. First of all, few projects have demonstrated to industry the conversion of a production engine to dual fuel methanol/diesel operation over a wide range of engine speeds and loads and therefore few data is available to simulate efficiencies and emissions on real vessel sailing profiles, a.o.t. for making investment decisions and to develop reliable business cases. Research literature provides about a dozen papers where dual fuel methanol/diesel engines have been tested, but often at limited engine speeds and load points, and with few data on the maximum achievable methanol energy fraction. Secondly, a high speed engine was chosen for demonstration purposes as MAN and Wärtsilä have demonstrated respectively a low speed two stroke engine and a four stroke medium speed engine with dual fuel methanol/diesel operation. Both engine suppliers have developed for their conversion dedicated proprietary components for injection of methanol under high pressure in the cylinder. In LeanShips a non-proprietary solution was chosen where methanol is injected under low pressure in the intake ports, also known as the fumigation technology. This enables retrofitting engines. This technology and its implications on combustion characteristics will be further elaborated in section 2.

In section 3 of this paper the experimental setup of the demonstrated engine in LeanShips is discussed together with the procedure that was used for performing dual fuel methanol/diesel tests. Section 4 discusses the measurement results on the engine and more specifically the maximum obtained methanol energy fraction, the brake thermal efficiency, and soot and NO emissions, and to end, section 5 applies these results on a case study.

2 DUAL FUEL THROUGH FUMIGATION

2.1 Fumigation technology

Several concepts exist to introduce methanol in diesel compression ignition (CI) engines [13,14]. Briefly three type of concepts are distinguished: (1) methanol can be mixed with diesel, (2) methanol can be injected under high pressure in the cylinder chamber, and (3) methanol can be injected under low pressure in the inlet manifold, on a single point, or at each port (fumigation concept). In the second and third concept a pilot diesel is used as an ignition source for combustion of a methanol-air mixture. In the first type

autoignition of the methanol-diesel mixture starts the combustion similar as in a normal diesel CI engine. Unfortunately methanol and diesel have only a limited miscibility, up to a few percent [15]. Mixing improvers help to increase the percentage of methanol, but still the ratio of methanol to diesel has to be low to avoid adverse effects on combustion [16]. Therefore the second and third dual fuel concept are preferred as they allow higher methanol energy fractions and instantaneous changes in fuel fraction during operation, and as it does not require an extra fuel preparation process adding to the cost.

The second concept is used by the engine manufacturers MAN and Wärtsilä in their respective two stroke low speed engine and four stroke medium speed engine. MAN developed a dual fuel concept where two types of injectors are used, one for diesel and one for methanol, and where the methanol injection system can be added for conversion of an existing engine [13]. Wärtsilä chose to develop a single in-house dual fuel injector that is able to inject under high pressure diesel and methanol in the cylinder chamber, given their design requirements such as limiting adaptations to the original engine configuration and their experience with a similar in-house developed system for gas/diesel dual fuel engines [17]. Wärtsilä installed this dual fuel retrofit solution in the four stroke Sulzer ZA40S engines of the Stena Germanica, four converted engines that had in 2017 together already more than 2000 running hours on dual fuel methanol/diesel [18]. MAN's dual fuel solution is installed in seven new-build methanol tankers on 10MW ME-LGI engines, built for Waterfront Shipping, a subsidiary of Methanex Corporation [19].

In LeanShips' Work Package 5, Ghent University and its partners Dredging International, Volvo Marine & Industrie Center, Abeking & Rasmussen, Damen Shipyards and Methanex Europe, chose for using the fumigation concept as a retrofit solution. The design requirements were to provide an easy and cost-effective retrofit solution that makes use of non-proprietary equipment, still providing full redundancy by enabling switching instantaneously between diesel and dual fuel operation. The main advantage of the dual fuel fumigation concept is its low cost, mainly thanks to the low pressure methanol supply system (injectors and pumps).

Figure 1 provides an overview of the three dual fuel concepts demonstrated by LeanShips, MAN and Wärtsilä. In LeanShips' fumigation concept methanol is injected via six methanol injectors on each intake port of the six cylinder Volvo Penta

engine (see section 3 for the experimental setup) and mixed with air before and during the compression stroke and ignited via a pilot diesel around top dead center.

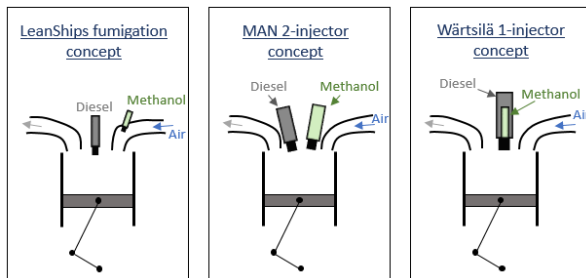

Figure 1: Overview of dual fuel methanol/diesel concepts demonstrated by LeanShips, MAN and Wärtsilä.

2.2 Fumigation characteristics

The difference in combustion mode between diesel-only (DO) operation and dual fuel diesel/methanol (DF) operation has an important impact on engine parameters such as brake thermal efficiency and emissions. On figure 2 the different mass flows to the cylinder are shown during DO and DF operation to illustrate the amount of fuel that is burned in the premixed combustion phase (PMIX) and in the mixing controlled diffusion combustion phase (DIF). For illustrative purposes it is assumed (1) that in DF operation 50% of diesel is eliminated and (2) that the efficiency in DO and DF operation is equal. Therefore as methanol has about half the energy density of diesel, the methanol mass presented is double that of the eliminated diesel. All methanol is fumigated in the inlet manifold and mixed with air, therefore denoted as $PMIX_{MeOH,DF}$ as all fuel will burn premixed. During the compression stroke the mixture is compressed and around top dead center a pilot diesel is injected to ignite the mixture. As known in CI engines, part of the diesel gets premixed during the ignition delay with the mixture present in the cylinder, being respectively air in DO operation and an air-methanol mixture in DF operation, respectively denoted by $PMIX_{D,DO}$ and $PMIX_{D,DF}$. The ignition delay of diesel depends on the temperature and pressure of the compressed mixture at top dead center. As methanol has a high heat of vaporization the intake air charge gets cooled by evaporation of methanol during injection and as a consequence the mixture temperature at the end of compression is lower than in DO operation, prolonging the ignition delay [16]. Therefore when switching from DO operation to DF operation, a bigger fraction of fuel is burned in the premixed combustion phase than in the mixing controlled diffusion combustion phase ($PMIX_{D,DO} < PMIX_{MeOH,DF} + PMIX_{D,DF}$). Soot is typically formed

in high temperature fuel rich zones in the mixing controlled diffusion flame. As the diesel consumption decreases and the amount of diesel burned in the mixing controlled diffusion phase decreases in DF, soot formation decreases. Clearly, other engine parameters such as NO_x formation and brake thermal efficiency, will also be affected by this difference in combustion mode. Soot, NO_x , and brake thermal efficiency will be further elaborated in detail in section 4.

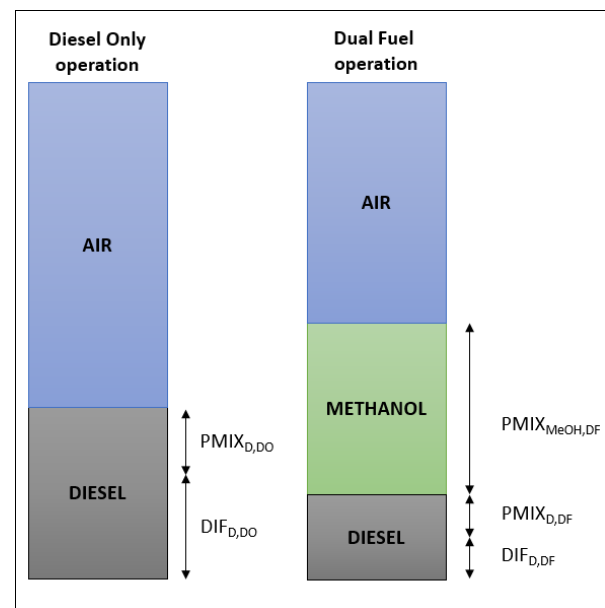

Figure 2: Fuel/air mass flow comparison between DO and DF operation, assuming equal efficiency in both operation modes and an eliminated diesel amount of 50% in DF operation. Ratios between DIF and PMIX (see text), and between fuel and air, are for illustrative purposes only.

3 EXPERIMENTAL SET-UP

3.1 Test engine

The engine that was converted in LeanShips Work Package 5 is a Volvo Penta D7C-TA, a high speed marine diesel engine. Table 1 gives an overview of the main characteristics of the engine. To enable DF operation a methanol supply system with an engine control unit (ECU) was added. For performing tests and to record data, measurement equipment and a data acquisition system was added. The main measurement equipment comprises mass flow sensors (for air, methanol and diesel), pressure sensors (for in the intake, exhaust and cylinder), temperature sensors (for the exhaust, air intake, engine and cooling water) and a load cell for torque measurements. The methanol supply system consists of two methanol fuel filters, a low pressure pump, a pressure regulator, and six methanol injectors. The methanol injectors are controlled via an ECU. The details of the methanol supply and measurement

system are listed in Table 2. The original diesel supply and mechanical engine control system was not changed. The diesel injection amount is altered via a governor that is connected to a speed rod which is manually set by the operator. The load for the engine is determined by the brake power of a water brake connected to the crankshaft of the engine. Figure 3 gives a complete overview of the different gas and liquid flows to the engine and the most important components and measurement equipment.

Table 1: Main characteristics of a Volvo Penta D7C-TA.

Volvo Penta	
Model	D7C-TA Turbocharged & air intercooler
Cylinders	6, in-line
Compression ratio	17.6
Bore x stroke	108 mm x 130 mm
Displacement volume	7,15 l
Diesel injection system	Single Injection Pumps
Diesel injection pressure	1200 bar
Maximum torque / speed	904 Nm / 1500 rpm
Rated power / speed	195 kW / 2300 rpm

Table 2: Details of the methanol supply and measurement system.

Methanol supply system	
Injectors	Magneti Marelli IWPR02
Pump & filters	Fuelab pump (41401c) & filters (60 & 75 μ)
ECU	Motec M800
Measurement equipment	
Mass flow	Bronkhorst M15 (diesel & meoh) & F (air)
Pressure	Keller M5HB (low p) & Kistler 6045B (high p)
Temperature	K-type (high T) & J-type (low T)
Load	Logicontrol H3
Data acquisition	National Instruments

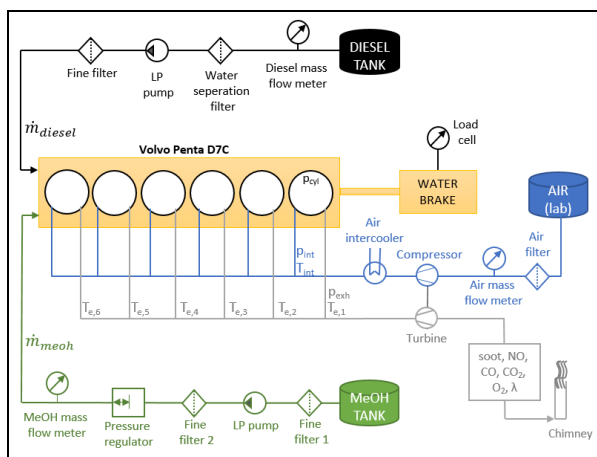

Figure 3: Test set-up showing the main gas and liquid flows to the engine, with the main components and measurement equipment.

3.2 Test conditions and procedure

The measurement campaign that was performed had the objective to make a comparison between DO and DF operation for the main engine parameters such as brake thermal efficiency and emissions. On top the research question was to know how much diesel could be replaced by methanol before limiting phenomena such as knock or misfire occurred (see section 4.1) because this enables to determine an optimal control strategy on DF operation. The objective furthermore was to get a full picture of the engine over the entire load and speed range because this could enable extrapolation of DF operational data to other engines for feasibility study or modelling purposes (e.g. a life cycle analysis). The only limiting factor that was encountered during tests was the water brake power that was limited at some engine speeds. For a follow-up measurement campaign it will be investigated whether it is possible to overcome this limitation. Figure 4 shows the tested engine area as a function of engine speed and torque and compared to the maximum achievable torque, and Table 3 shows the tested engine speeds and loads. The maximum tested load as a percentage of the maximum load at a certain speed are respectively for 1000, 1250, 1500, 1750 and 2000 rpm equal to 50%, 64%, 66%, 56% and 48%. In the next section a distinction is made between low load (<50%) and high load (>50%), so this means that only at the engine speeds of 1250, 1500 and 1750 rpm high load points were tested.

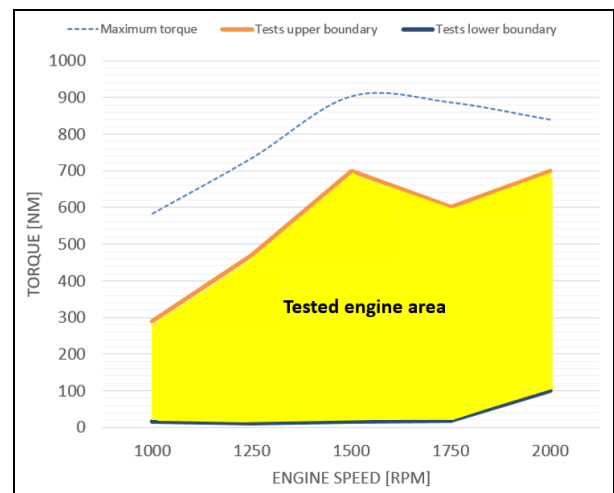

Figure 4: Tested engine area.

Table 3: Tested engine speeds and loads.

Tested engine area	
1000 rpm	16, 100, 200 and 290 Nm
1250 rpm	11, 100, 200, 300, 400 and 470 Nm
1500 rpm	15, 100, 200, 300, 400, 500, 600 Nm
1750 rpm	18, 100, 200, 300, 400, 500 and 600 Nm
2000 rpm	100, 200, 300 and 400 Nm

4 MEASUREMENT RESULTS

In this section four engine performance parameters are discussed: the maximum methanol energy fraction, the brake thermal efficiency, the soot emissions and the NO emissions.

4.1 Maximum methanol energy fraction

The methanol energy fraction (MEF) is defined as the ratio of the methanol energy to the total amount of fuel energy in the cylinder:

$$MEF = \frac{\dot{m}_{MeOH} \times LHV_{MeOH}}{\dot{m}_{MeOH} \times LHV_{MeOH} + \dot{m}_{Diesel} \times LHV_{Diesel}} \quad (1)$$

With LHV standing for Lower Heating Value and \dot{m} for total fuel mass flow to the cylinders.

Other definitions that are used in literature [14] are the Diesel Substitution Ratio (DSR, the ratio of the eliminated diesel mass flow to the diesel mass flow in DO operation) and the Methanol Mass Fraction (MMF, the ratio of the methanol mass flow to the total fuel mass flow in the cylinder). In LeanShips Work Package 5 it was chosen to work with MEF as methanol has a LHV lower than diesel (20.09 MJ/kg for methanol compared to 43 MJ/kg for diesel), and in this way this physical characteristic is taken into account in the equation.

For each load point of the tested engine area the boundaries for MEF were searched. Before starting the measurements, it was concluded from literature [20] that MEF is limited by knock, roar combustion, misfire and partial burn. At low loads partial burn or misfire occurs if the combustion temperature is too low and/or if there is too much excess air in the cylinder (resulting in a mixture below flammability limits). At high loads knock or roar combustion limit the maximum MEF, due to a higher degree of premixed mixture in combination with the high compression ratio of a diesel engine potentially leading to end-gas autoignition [14]. The detection of these limits can be done by monitoring the in-cylinder pressure diagram, the maximum in-cylinder pressure, the pressure rise

rate and the Coefficient of Variation (COV) of imep, and for detection of knock also by listening.

In total 28 load points were tested during the measurement campaign. The boundaries obtained during the measurements were a result of partial burn, misfire, knock or precaution. Precaution was defined as operator's judgement not to further increase the methanol injection so to protect the engine against damage (e.g. in-cylinder pressure sensor). Knock had two degrees, a light knock where only a light pinging noise was observed, and significant knock where a loud pinging noise was observed. Misfire and partial burn were detected by observation of the exhaust temperatures: in the event of a misfire, the exhaust temperature of a certain cylinder dropped instantaneously from for example 280°C to below 100°C while the other exhaust temperatures remained equal. Partial burn was defined as highly diverging exhaust temperatures with increasing MEF, meaning that in some cylinders only part of the total fuel mixture got burned. Knock and precaution were limits as of loads of 44%, and misfire and partial burn at the lower loads.

Wang et al. [20] investigated the operating range of a six cylinder 7.14 l engine at an engine speed of 1400 rpm and reported a DSR that ranges from 0% to a maximum of 76% at a load of 44%. As of this point, the maximum DSR decreased with increasing load to about 10% at 100% load.

Figure 5 shows the results of the maximum MEF as a function of bmep for different engine speeds. As mentioned above only at the speeds of 1250, 1500 and 1750 rpm high load points were tested. At 1500 rpm, a similar engine speed as in [20], the maximum MEF varies between 44% and 58%, where the highest maximum MEF is obtained at the lowest load. To compare these results with [20], in figure 6 the maximum DSR is shown. As can be seen the maximum DSR varies between 24% and 53% and decreases with decreasing load, however not reaching 0% as in [20] for the lowest load. For high loads it can be questioned whether 53% is the maximum DSR or whether at higher loads higher DSR are reachable and also whether a similar decrease for high loads as in [20] would be recorded. This is subject of investigation for a follow-up measurement campaign. Figure 7 shows the ranges for the maximum MEF and DSR as a function of engine speed.

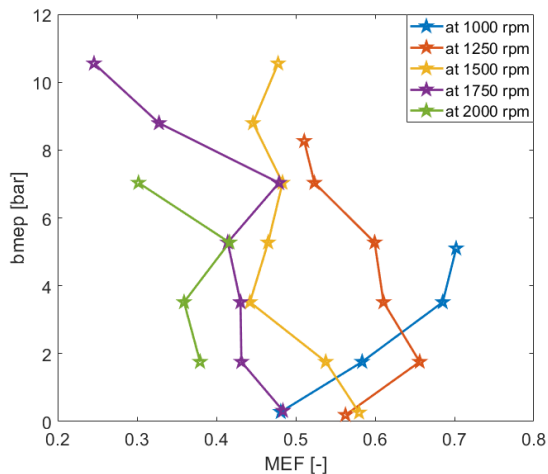

Figure 5: Maximum MEF as a function of load and engine speed.

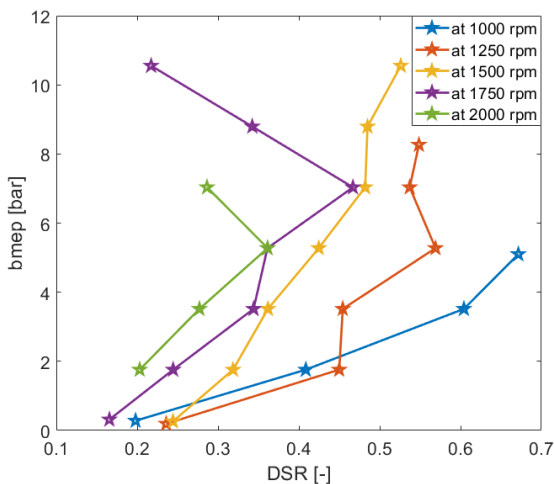

Figure 6: Maximum DSR as a function of load and engine speed.



Figure 7: Ranges for maximum MEF and DSR as a function of engine speed.

4.2 Brake thermal efficiency

The brake thermal efficiency (BTE) is defined as:

$$BTE = \frac{P_e}{\dot{m}_{MeOH} \times LHV_{MeOH} + \dot{m}_{Diesel} \times LHV_{Diesel}} \quad (2)$$

With P_e equal to the brake power measured at the water brake.

From literature [14] a slight decrease in BTE at low loads and a higher BTE at high loads could be expected. At low loads there typically is a lower BTE due to (1) the longer ignition delay (and thus retarded combustion), and (2) a lower burning velocity resulting from a leaner and colder mixture. At high loads, there can be a higher BTE as a result of more fuel burned in the premixed phase in combination with the high flame speed of methanol causing a faster and more isochoric combustion.

On figure 8 the BTE is shown in DO operation. The maximum BTE is 35.8% at 1750 rpm and 8.8 bar and the minimum BTE amounts to 4.9% at 1250 rpm and 0.19 bar. The average BTE over the entire tested area amounts to 27.4%. The BTE in DF operation at maximum MEF is shown in figure 9. The maximum BTE is 39% at 1500 rpm and 600 Nm, a 12% relative increase compared to DO operation. The minimum BTE is 2.5% at 1250 rpm and 0.19 bar. On average the BTE in dual fuel operation amounts to 25.3%, and for 5 of the 28 tested load points, an increase in BTE in DF operation is recorded compared to DO operation, with these higher BTEs being at high load. A clear tipping point is observed at 50% load in the measurement results for BTE. As only 5 of the 28 tested load points are at high load, in a follow-up measurement campaign more high load points will be tested to further validate this statement. From this measurement campaign however it can be said that the results for BTE are in line with literature: a decrease of BTE at low loads, and an increase of BTE at high loads.

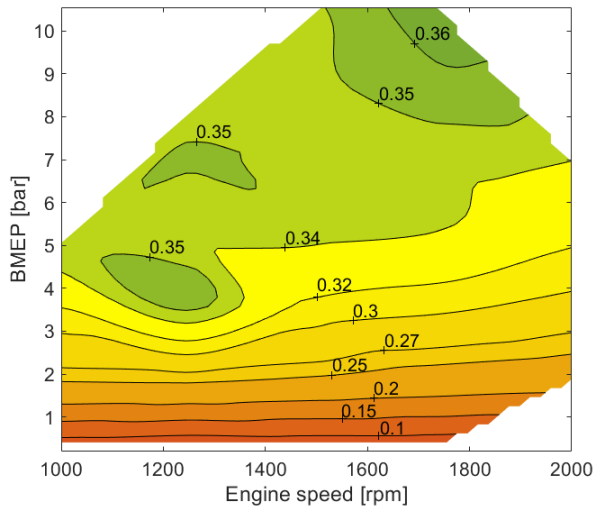

Figure 8: Brake thermal efficiency at DO operation.

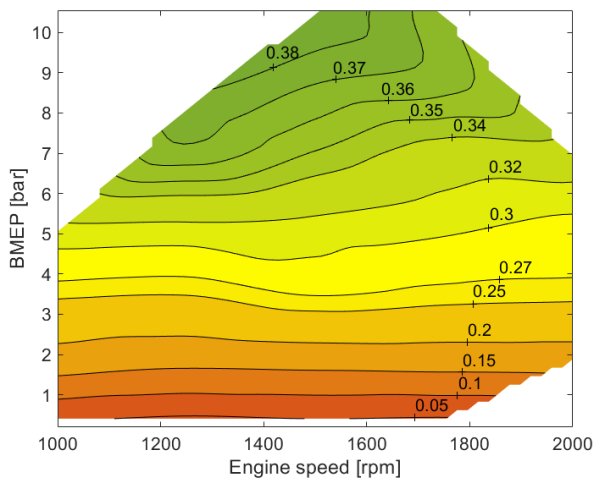

Figure 9: Brake thermal efficiency at DF operation at maximum MEF.

4.3 Specific NO emissions

NO_x emissions depend on three factors: in-cylinder temperature, high temperature residence time and availability of oxygen. The higher the in-cylinder temperature, the longer the high temperature combustion phase and the more oxygen present in the cylinder, the more NO_x formation. Of the three factors the high temperature condition is dominant. NO_x consist of NO and NO₂. According to literature [14] NO₂ emissions increase and NO emissions decrease, but the overall NO_x emissions are reduced. This general drop in NO_x is observed across the entire load and speed range and gets more pronounced with increasing MEF. The main reason reported is the cooling effect of methanol and the resulting lower in-cylinder temperatures. The faster premixed combustion shortens furthermore the

combustion duration, limiting the high temperature residence time during which NO can be formed.

During the measurements presented in this paper only NO was measured. For a follow-up measurement campaign NO_x will be measured to get a more complete picture. All measurements show a decrease in NO emissions with increasing MEF, however at some load points a minimum in NO emissions is recorded at a certain MEF, after which NO emissions increase again with further increasing MEF, as illustrated in figure 10 at an engine speed of 1500 rpm. At a bmep of 3.5 bar there is a continuous decrease of specific NO emissions with increasing MEF and at a bmep of 10.6 bar there is a minimum in specific NO emissions at a MEF of 24%. In total of the 28 tested load points, there are 6 load points at which such a minimum occurs, namely at [1250 rpm and 7.0 and 8.3 bar], at [1500 rpm and 7.0, 8.8 and 10.6 bar], and at [1750 rpm and 8.8 bar], which are all but one high load points.

The observed NO trend can be explained using the combustion phasing shown in figure 11, however it should be noticed that further investigation should (1) validate the below hypothesis, and (2) verify whether the same trend is observed for total NO_x emissions as the discussed measurements concern only NO. On figure 11 the start of the bars denote the value at which 10% of the net cumulative heat is released (NCHR10), the black line the NCHR50, and the end of the bars the NCHR90. The combustion duration is equal to the length of the bar (NCHR90-NCHR10). The combustion duration is shown for the same load points as in figure 10 and for different MEF. At a bmep of 3.5 bar NO emissions continuously decrease with increasing MEF due to the combined effect of (1) the cooling effect of methanol, and (2) more premixed combustion (and thus a leaner combustion than in the mixing controlled diffusion combustion phase). With increasing MEF, both effects increase, resulting in decreasing NO emissions. At a bmep of 10.6 bar the decreasing trend can be explained in a similar way, however as of a certain MEF there is a tipping point because a third effect becomes dominant. As of a certain MEF the combustion duration starts to decrease significantly while NCHR10 increases and NCHR50 only varies slightly. This is a result of a very fast combustion, causing the bulk of the heat release to occur closer to top dead center, resulting in high temperatures and causing an increase in NO formation. As of the tipping point, this effect gets dominant over the above mentioned effects at 3.5 bar.

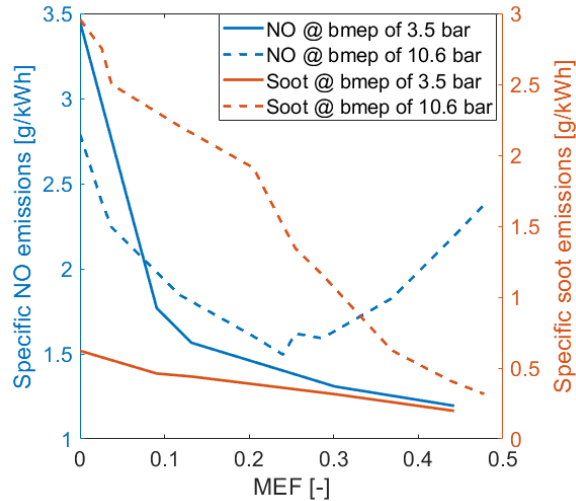

Figure 10: Specific NO and soot emissions as a function of MEF for two different load points at 1500 rpm.

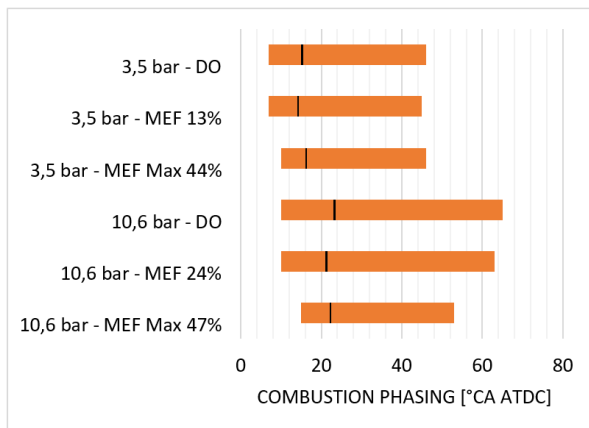

Figure 11: Combustion phasing for two different load points at 1500 rpm.

Figure 12 shows specific NO emissions as a function of engine speed and bmep for diesel-only operation. The average specific NO emissions for loads above and below a bmep of 3 bar amount to respectively 3.4 g/kWh and 13.0 g/kWh. Figure 13 shows specific NO emissions in DF operation where NO is a minimum, which is for some load points at maximum MEF (e.g. at 1500 rpm and 3.5 bar, see figure 9) and for other load points at an intermediate MEF (e.g. at 1500 rpm and 10.6 bar, see figure 9). The average specific NO emissions for loads above and below a bmep of 3 bar amount respectively to 1.3 g/kWh and 5.3 g/kWh. On average over the tested area there is a relative decrease in specific NO emissions between DO and DF operation of 60%, with as a minimum and maximum relative decrease respectively 35% and 76%.

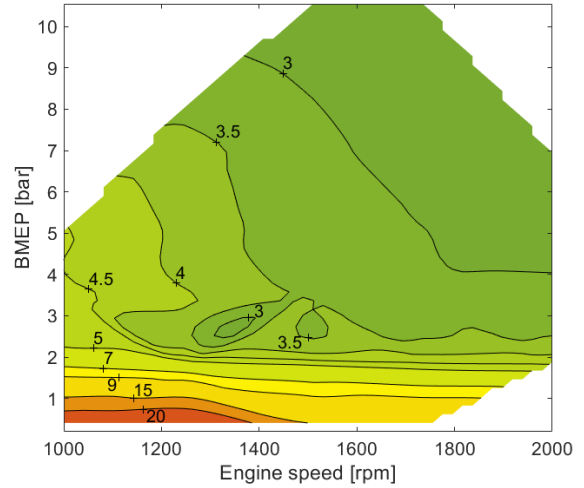

Figure 12: Specific NO emissions (g/kWh) as a function of engine speed and bmep at DO operation.

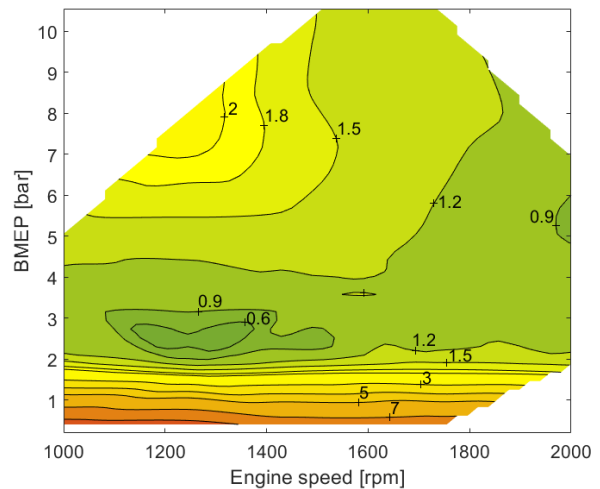

Figure 13: Specific NO emissions (g/kWh) as a function of engine speed and bmep at DF operation.

4.4 Specific soot emissions

Soot formation in dual fuel operation decreases because methanol has no carbon-carbon bonds to form soot, because there is less diesel consumed with increasing MEF, and because the ignition delay increases (adding to the amount of diesel that is burned premixed and thus not during the mixing controlled diffusion combustion phase where rich zones can occur and where soot can be formed, see section 2.2).

The soot concentration [mg/m³] was measured by an AVL415S smoke meter, a device that measures with an optical reflectometer the extent to which soot has blackened a filter paper. Figure 14 shows the measured specific soot emissions as a function of engine speed and load in DO

operation. As can be seen no soot measurements were done at 1000 rpm. On average the specific soot emissions amount to 1.22 g/kWh with a minimum of 0.38 g/kWh and a maximum of 3.30 g/kWh. Figure 15 shows the measured specific soot emissions as a function of engine speed and load in DF operation at maximum MEF. On average the specific soot emissions amount to 0.28 g/kWh with a minimum of 0.09 g/kWh and a maximum of 1.23 g/kWh and in all tested load points there is a continuously decreasing soot emission with increasing MEF, similar as in the example on figure 10. This means that the average relative decrease in soot emissions over the entire tested area amounts to 77% with a minimum and maximum relative decrease of respectively 56% and 95%. It can be noticed furthermore that in DO operation the highest specific soot emissions are at low speed and the higher loads, and in DF operation at high speed and high load.

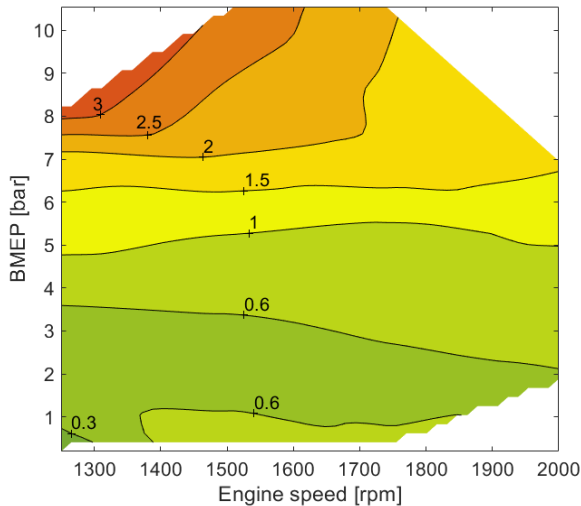

Figure 14: Specific soot emissions (g/kWh) in DO operation.

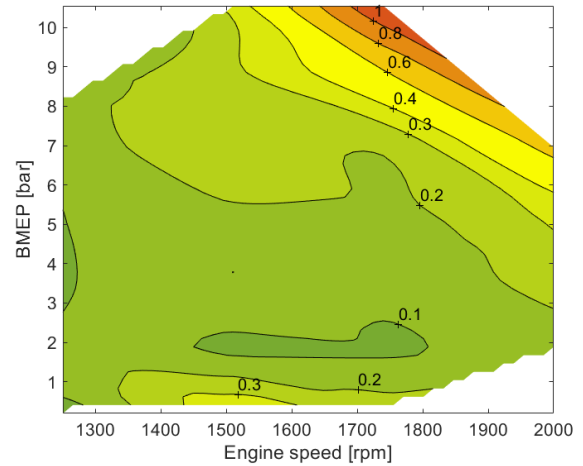

Figure 15: Specific soot emissions (g/kWh) in DF operation.

4.5 Trade-off between NO and soot emissions

At DO operation there is typically a trade-off between measures that minimize NO and soot emissions. When soot is minimized NO emissions increase and vice versa. In dual fuel operation it is observed in literature that this trade-off relation between NO and soot emissions disappears [14].

From the measurements on the Volvo Penta it is observed that in some measurement points the trade-off disappears and in others the trade-off first disappears with increasing MEF but then appears again when NO emissions reached a minimum as a function of MEF (see section 4.3 and figure 10). The measurements indicate a parabolic profile with a minimum for NO emissions at high loads. In a follow-up measurement campaign it will be investigated if this trend is valid as well for other load points.

5 CASE STUDY

In this section the measurement results of section 4 are applied to a fictive propeller curve which is derived from a propeller curve in the Volvo Penta D7C-TA technical datasheet. Both propeller load curves are shown in Table 4.

Table 4: Propeller load curve used for case study.

Propeller load curve [Nm]	Engine Speed (rpm)				
	1000	1250	1500	1750	2000
Technical datasheet	236	286	420	543	659
Derived load curve	200	300	400	500	400

As elaborated in section 4 at some loads the specific NO emissions have a minimum before the maximum MEF is reached and thus there is a trade-off between operation at minimum NO emissions or at minimum soot emissions when

operating a Volvo Penta D7C engine in an operational vessel. Figure 16, 17 and 18 show respectively BTE, specific NO and soot emissions for the case study propeller curve. As can be seen the implemented engine control strategy will have an impact on all three parameters. With regard to NO and soot emissions, dual fuel operation is preferred for all propeller loads. The BTE on the other hand is slightly higher in DF than in DO operation at 1500 and 1750 rpm, meaning that the amount of running hours in each load point will have a determining effect on whether the overall brake thermal efficiency will be beneficial in DF operation.

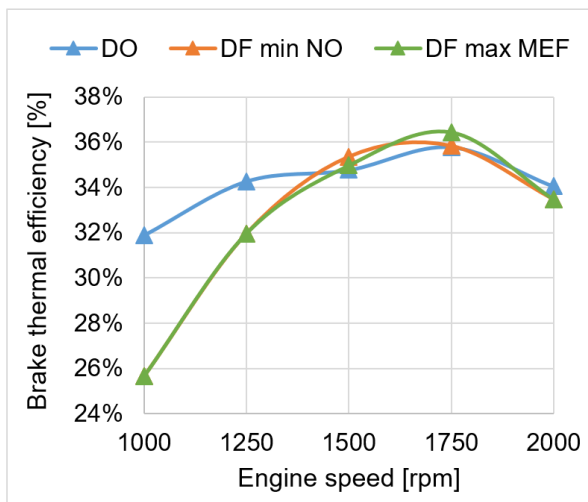

Figure 16: BTE for case study propeller curve.

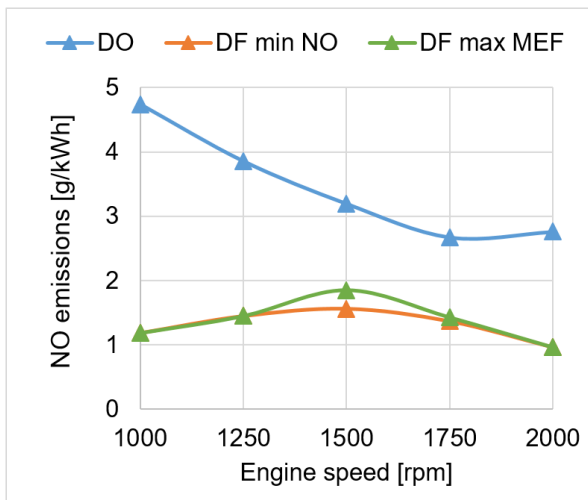

Figure 17: Specific NO emissions for case study propeller curve.

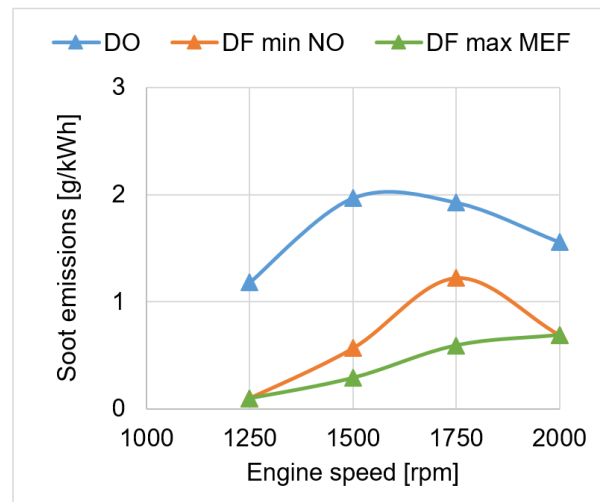

Figure 18: Specific soot emissions case study propeller curve.

6 CONCLUSIONS

This paper reports the results of the measurement campaign on dual fuel methanol/diesel operation performed as part of LeanShips Work Package 5. First the dual fuel fumigation methodology and the main differences in combustion mode between DO and DF operation were discussed. The engine set-up on which the measurements were performed was elaborated, followed by the results for four engine performance parameters: the maximum MEF, the BTE, and the specific NO and soot emissions. The paper was finalized with a case study in order to link the measurements results to a vessel sailing profile. The different sections can be summarized as follows:

- The differences in combustion mode between DO and DF operation has a big impact on engine performance parameters such as BTE, NO and soot emissions. The main difference between both operation modes is that more fuel is burned premixed in DF operation.
- The maximum MEF was limited during the measurements by partial burn, misfire, knock and precaution. The maximum MEFs at the different engine speeds and loads vary between 25% and 70% and the maximum DSR between 17% and 67%.

- The BTE in DF operation is higher and lower than in DO operation for respectively high loads and low loads, which is in line with observations from literature. The maximum relative increase in BTE in DF operation amounts to 12%.
- The specific NO emissions decrease with increasing MEF, but at high loads there is a minimum at a certain MEF after which the specific NO emissions increase again with increasing MEF. The average relative decrease in specific NO emissions in DF operation amounts to 61%.
- The specific soot emissions decrease with increasing MEF. The maximum decrease is obtained when the maximum MEF is reached. The average relative decrease in specific soot emissions in DF operation amounts to 77%.
- The trade-off between NO and soot emissions does not disappear completely, contrary to what is reported in literature. For the tested high loads NO emissions have a minimum at an intermediate MEF, meaning that in these load points there is still a trade-off.
- To apply these measurement results to a commercial application, the sailing profile and propeller load curve should be known. The propeller curve used in section 5 gives in some load points better BTE in DF operation and for some lower BTE. NO and soot emissions on the other hand are for all load points better in DF operation. The sailing profile will determine in this example whether the overall efficiency is better or not in DF operation.

From the measurement campaign presented in this paper questions remain that will be tackled in a follow-up measurement campaign. NO_x emissions will be measured to determine the total amount of NO/NO₂ emissions, and more high load points will be tested to further validate the conclusions of this paper at high loads.

7 ACKNOWLEDGEMENTS

This work has been carried out as a part of LeanShips. LeanShips stands for 'Low Energy and Near-to-zero emission Ships' and is funded in the Horizon 2020 Work Programme of the European Union (Contract NO.: 636146). The authors gratefully acknowledge Koen Chielens, the engine technician of the research group Transport Technology at Ghent University, for

converting efficiently and in due time the Volvo Penta engine to dual fuel methanol/diesel operation.

8 REFERENCES AND BIBLIOGRAPHY

- [1] International Maritime Organization (IMO), MARPOL Annex VI. Air Pollution, Energy Efficiency and Greenhouse Gas Emissions. <https://www.imo.org>.
- [2] European Commission, Paris Agreement, 2015. Key Elements on Paris Agreement. <https://ec.europa.eu>.
- [3] The Guardian, 2018. What Was Agreed at COP24 in Poland and Why Did it Take so Long? Press Release.
- [4] Masson-Delmotte V., Zhai P., Pörtner H.O., Roberts D., et al., 2018. An IPCC Special Report on the Impacts of Global Warming of 1.5°C above Pre-Industrial Levels and Related Global Greenhouse Gas Emission Pathways, in the Context of Strengthening the Global Response to the Threat of Climate Change, Sustainable Development and Efforts to Eradicate Poverty. International Panel on Climate Change (IPCC).
- [5] Edenhofer O., Pichs-Madruga R., Sokona Y., Farahani E., et al., 2014. Mitigation of Climate Change. Contribution of Working Group III to the Fifth Assessment Report of the Intergovernmental Panel on Climate Change. International Panel on Climate Change (IPCC).
- [6] European Environment Agency (EEA), 2018. Greenhouse Gas Emissions from Transport.
- [7] Endresen Ø., Alvik S., Mangset L.E., et al., 2017. Maritime Forecast to 2050. Energy Transition Outlook 2017.
- [8] Martens J.A., Bogaerts A., De Kimpe N., Jacobs P.A., Marin G.B., Rabaey K., Saeys M., Verhelst S., 2017. The chemical Route to a Carbon Dioxide Neutral World. ChemSusChem 2017, 10, 1039-1055.
- [9] Verhelst S., 2013. Future Vehicles Will Be Driven by Electricity, But Not as you Think. Proceedings of the IEEE, Vol. 12, No. 10.
- [10] Verhelst S., Turner J., Sileghem L., Vancoillie J., 2019. Methanol as a Fuel for Internal Combustion Engines. Progress in Energy and Combustion Science 70 (2019) 43-88.
- [11] Cryssakes C., Brinks H., King T., 2015. The Fuel Trilemma: Next Generation of Marine Fuels.

DNV GL Strategic Research & Innovation Position Paper 03-2015.

[12] LeanShips, 2015-2019. Low Energy And Near to zero emission Ships. <https://www.leanships-project.eu/>.

[13] Mayer S., Sjöholm J., Murakami T., et al., 2016. Performance and Emission Results from the MAN B&W LGI Low-Speed Engine Operating on Methanol. CIMAC Congress, Helsinki. Document Number 20160600407.

[14] Coulier J., Verhelst S., 2016. Using Alcohol Fuels in Dual Fuel Operation of Compression Ignition Engines: A Review. CIMAC Congress, Helsinki. Document number 20160600501.

[15] Bechtold R.L., Goodman M.B., Timbario T.A., 2007. Use of Methanol as a Transportation Fuel. Methanol Institute.

[16] Yao C., Pan W., Yao A., 2017. Methanol Fumigation in Compression-Ignition Engines: a Critical Review of Recent Academic and Technological Developments. Fuel 209 (2017) 713-732.

[17] Stojcevski T., Jay D., Vicenzi L., 2016. Operation Experience of World's First Methanol Engine in a Ferry Installation. CIMAC Congress, Helsinki.

[18] International Bunker Industry Association (IBIA), 2017. Alternative fuels: State of play and plans discussed at London forum. Press Release.

[19] Dierickx J., Verhelst S., et al., 2018. Strategies for Introducing Methanol as an Alternative Fuel for Shipping. TRA Conference, Vienna.

[20] Wang Q., Wei L., Pan W., Yao C., 2015. Investigation of Operating Range in a Methanol Fumigated Diesel Engine. Fuel 140 (2015) 164-170.

9 CONTACT

JEROEN DIERICKX
Department of Flow, Heat and Combustion
Mechanics, Transport Technology Research
Group
Ghent University
Sint-Pietersnieuwstraat 41, 9000 Ghent, Belgium

Tel: +32 9 264 33 61
Email: jeroen.dierickx@ugent.be