



POLITECNICO DI TORINO  
Repository ISTITUZIONALE

Guidelines for the study of subsidence triggered by hydrocarbon production

*Original*

Guidelines for the study of subsidence triggered by hydrocarbon production / Benetatos, C.; Codegone, G.; Deangeli, C.; Giani, G.; Gotta, Andrea; Marzano, Francesco; Rocca, V.; Verga, F.. - In: GEAM. GEOINGEGNERIA AMBIENTALE E MINERARIA. - ISSN 1121-9041. - STAMPA. - 152:3(2017), pp. 85-96.

*Availability:*

This version is available at: 11583/2706723 since: 2020-01-18T10:01:34Z

*Publisher:*

Patron Editore S.r.l.

*Published*

DOI:

*Terms of use:*

openAccess

This article is made available under terms and conditions as specified in the corresponding bibliographic description in the repository

*Publisher copyright*

(Article begins on next page)

# Guidelines for the study of subsidence triggered by hydrocarbon production

This study was carried out by the SEADOG Research Center at Politecnico di Torino (Italy). The purpose of this work was to evaluate which complexity degree would be required to reliably approach a subsidence study for different scenarios. The study was based on sensitivity analyses which were performed using a series of 3D synthetic numerical models of which the structural characteristics and geological and mechanical properties were based on available public data of onshore and offshore hydrocarbon fields in Italy. An array of simulations, both one-way and two-way coupled, were carried out to assess the magnitude and extension of subsidence potentially induced by hydrocarbon production. The results allowed the calculation of subsidence indices defined as the rate of compaction propagation (i.e., the ratio between the maximum surface displacement and the maximum reservoir compaction) and as the rate of volume loss (i.e. the ratio between the volume of the subsidence bowl or cone and the volume variation of the reservoir). These indices together with the degree of the underground systems' heterogeneity led to the definition of the Intact Rock Qualitative Subsidence Index (IRQSI), upon which the needed complexity degree of a subsidence study can be discerned.

**Keywords:** subsidence, compaction, hydrocarbon production, safety, mechanical analysis, intact rock.

## Linee guida per lo studio della subsidenza indotta dalla produzione di idrocarburi.

Questo studio è stato condotto dal Centro di Ricerca SEADOG presso il Politecnico di Torino (Italia). Lo scopo del presente lavoro è stato quello di valutare il grado di complessità opportuno per affrontare uno studio di subsidenza in modo affidabile. Lo studio è stato basato su analisi parametriche eseguite implementando una serie di modelli numerici sintetici tridimensionali le cui caratteristiche strutturali e le cui proprietà geologiche e meccaniche sono state ricavate sulla base di dati pubblici relativi a giacimenti di idrocarburi a terra e a mare ubicati in Italia. Le simulazioni, condotte con approccio sia di tipo one-way coupling sia di tipo two-way coupling, hanno permesso di valutare l'entità e l'estensione del cono di subsidenza potenzialmente indotta dalla produzione di idrocarburi. Grazie ai risultati ottenuti è stato possibile calcolare gli indici di subsidenza, definiti come il tasso di propagazione della compattazione (cioè il rapporto tra lo spostamento superficiale massimo e la massima compattazione del giacimento) e il tasso di perdita di volume (cioè il rapporto tra il volume del cono di subsidenza e la variazione di volume del giacimento). Questi indici, insieme al grado di eterogeneità dei sistemi sotterranei, hanno portato alla definizione dell'Indice di Subsidenza Qualitativo della Rocca Integra (IRQSI), in base al quale è possibile discriminare il grado di complessità necessario per valutare la subsidenza in funzione delle caratteristiche del sistema oggetto di studio.

**Parole chiave:** subsidenza, compattazione, produzione di idrocarburi, sicurezza, analisi meccanica, roccia integra.

## 1. Introduction

The aim of this paper is to provide criteria for the forecast of subsidence induced by hydrocarbon production – or storage – by the definition of guidelines, particularly in relation to the Italian offshore context. The study was carried out by the SEADOG Research Center at Politecnico di Torino within the activities regarding the assessment of offshore safety.

Hydrocarbon production induces a pressure variation in the reservoir and the surrounding aquifer, when present, which in turn triggers compaction of the reservoir rocks; this compaction propagates to the surface through the overburden rocks and causes subsidence. Vertical displacements at the surface define a subsidence bowl or cone (Fjær *et al.*, 2008), which can be defined geometrically in terms of maximum vertical displacement and radius;

the latter marks off the area beyond which surface displacement is null or negligible.

The scope of this work was to assess which degree of complexity would be required to approach a subsidence study under different scenarios and which parameters are more critical to achieve reliable results. The study was based on the execution of sensitivity analyses which were made using an array of 3D synthetic numerical models. The numerical models were defined on the basis of the available information about the geological and geometric characteristics and of the production history of both onshore and offshore Italian hydrocarbon fields. This information was collected from technical reports and public data and organized into a comprehensive database; then, it was used to define a reference regional-scale stratigraphy (up to 5 km deep), representative of the Po Valley and Adriatic regions, as well as an appropriate range of values for the most relevant rock properties.

The assessment of induced subsidence for different scenarios was possible by the use of the finite element numerical method (FEM) implemented in a software. The coupling between fluid-dynamic and geomechanical analysis was carried out with an explicit approach (also called one-way coupling) (Tran *et al.*, 2005) in which pressure variations induce changes in the stress state and defor-

C. Benetatos\*  
G. Codegone\*  
C. Deangeli\*  
G. Gianì\*  
A. Gotta\*  
F. Marzano\*  
V. Rocca\*  
F. Verga\*

\* Politecnico di Torino DIATI,  
Torino, Italy

mation of the porous medium, but the latter does not affect the dynamic response of the system. Simulations with an iterative (two-way coupling) approach (Tran *et al.*, 2005) were also carried out to evaluate the combined effects of porosity (thus volume) and permeability variations.

## 2. Database

Information regarding the structural, geometric, lithological, petrophysical and mechanical characteristics of nearly 250 Italian

hydrocarbon fields (Figure 1) and information related to their production history was derived from technical reports, scientific publications and well logs at 1:1000 scale available on the UNMIG website (*Ufficio Nazionale Minerario per gli Idrocarburi e le Georisorse – VIDEPI project @ <http://unmig.sviluppoeconomico.gov.it>*).

All the information was integrated into a comprehensive database and used to define synthetic 3D models representative of the most common Italian reservoir formations. Qualitative and quantitative information was used to (1) iden-

tify a suitable range of values for the geometric characteristics and for the petrophysical and mechanical properties, (2) select a set of stratigraphic sequences representative of the Italian setting, and (3) set up the input of the numerical geomechanical simulations carried out to assess subsidence induced by hydrocarbon production. The study refers to gas reservoirs because most Italian reservoirs are gas-bearing.

## 3. Considerations on faults

During the operations of fluid production or injection, pressure and stress state of the hydrocarbon-bearing formation and surrounding rocks is altered. Structural discontinuities can have an impact on pressure and stress distribution and thus on subsidence phenomena. Furthermore, faults and fractures could potentially be reactivated by a variation of normal and shear stresses.

A systematic assessment of the impact of faults and fractures on subsidence phenomena was not possible because discontinuities represent heterogeneities which may or may not exist in rocks and if present should be characterized in terms of geometry, orientation, mechanical characteristics. Faults are conventionally defined as discontinuity surfaces or narrow zones with detectable shear displacement (Fossen, 2010; Davis *et al.*, 2012); however, in nature they often consist of fractured rock material, they can include subsidiary brittle structures and have a thickness that can vary both laterally and vertically (Childs *et al.*, 2009; Fossen, 2010; Matonti *et al.*, 2012; Choi *et al.*, 2016). In general faults have high internal heterogeneity and complexity and are typically characterized by mechanical and petrophysical properties that differ from the surrounding intact rocks and that can strongly vary even along the same fault segment according to the litho-

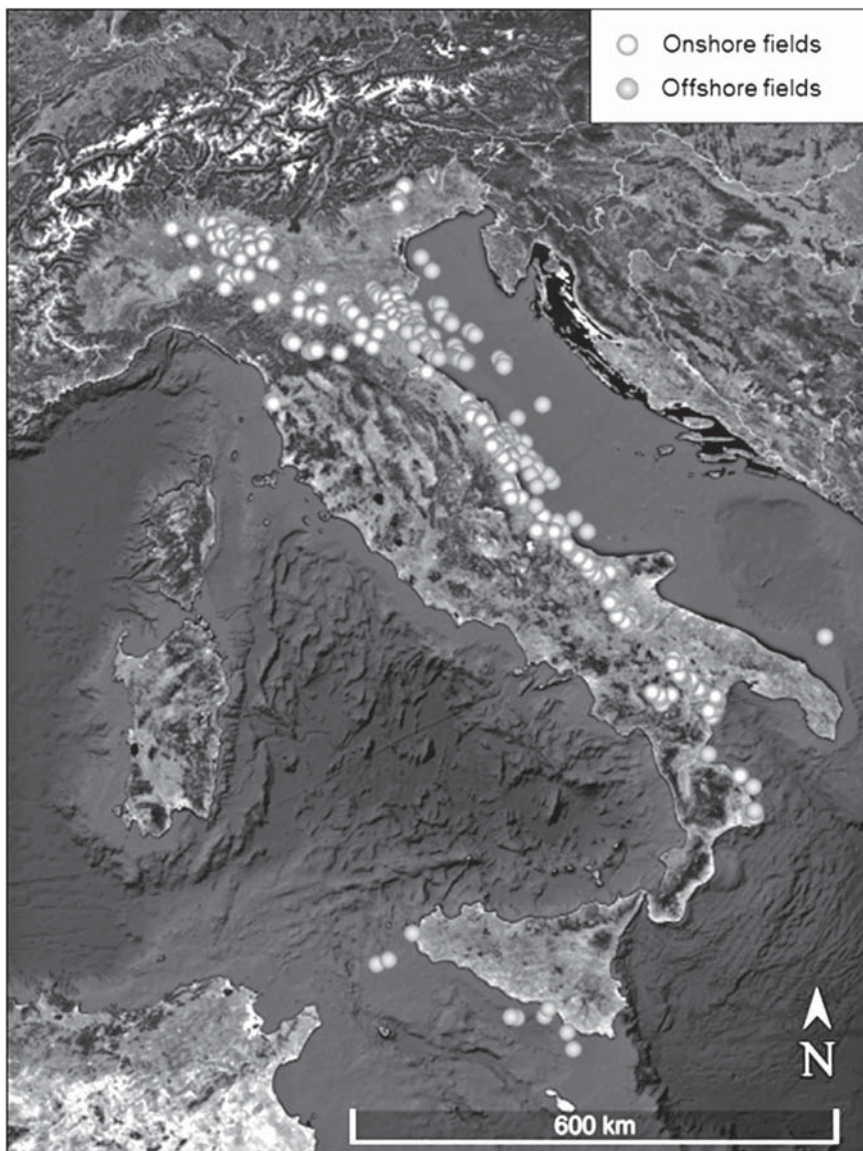

Fig. 1. Location of examined Italian offshore and onshore fields. *Posizione dei campi italiani offshore e onshore analizzati.*



logical/structural characteristics and internal complexity of the deformation zone (Scholz, 1987; Fischer and Knipe, 2001; Fredman *et al.*, 2007; Faulkner *et al.*, 2010).

Reactivation of existing discontinuities induced by hydrocarbon production or injection was out of the scope of this work. However, it is worth mentioning that the reactivation models proposed in the literature usually assume that the fault correspond to a discontinuity plane consisting of two contact surfaces, and shear strength is described with Coulomb's criterion, without considering the contribution of cohesion. In spite of the simplicity of Coulomb's criterion one of the uncertainties found in the analysis of fault reactivation is the value of the friction angle. In fact, the friction angle represents a phenomenological parameter, which takes into account all the complex characteristics and behavior exhibited by faults during shear processes. The values of the friction angle in laboratory tests are affected by the scale effects affecting strength when going from decimetric surfaces to large natural surfaces on site. Byerlee (1978) analysed the results of shear tests carried out on discontinuities in rocks of various lithologies and concluded that at high normal stresses the friction angle is independent of the type of rock. Based on these studies, the scientific literature indicates that the friction angle of a fault is likely to be between 30° and 40°. However, the presence of illite and montmorillonite can significantly reduce shear resistance.

For the reasons outlined above the formation was considered as intact rock material (Brady & Brown, 2004).

#### 4. Subsidence modelling of intact rocks

An array of 3D models was defined to carry out the simulations. The

characteristics of the models, such as the regional stratigraphy, the reservoir/caprock lithology and geometry, the petrophysical and mechanical rock properties, were defined on the basis of the information integrated into the database.

#### 4.1. Geological sequence

The regional stratigraphic setting was reconstructed by cross-referencing the available scientific and technical literature (Pieri & Gropi, 1981; Casero, 2004; Carruba *et al.*, 2006; Bertello *et al.*, 2008, 2010; Ghielmi *et al.*, 2010, 2013; Vezzani *et al.*, 2010; Casero & Bigi, 2013; Cazzini *et al.*, 2015). A simplified regional-scale stratigraphy consisting of continuous and homogeneous geological formations representative of the Po Valley and Adriatic regions was assumed.

The reference geological sequen-

ce extends 5 km in the depth from the seabed (set at 50 m ss) and includes from top to bottom (Fig. 2):

1. an interval of mostly sandy layers representing the late Pliocene – Quaternary marine-delta and the overlying recent marine deposits (average thickness: 450 m);
2. an interval of alternating sand and clay layers representing the Pliocene turbiditic sequence (average thickness: 1500 m);
3. an interval of marl representing the middle Eocene – late Miocene outer platform and slope deposits (average thickness: 1000 m);
4. an interval of carbonate deposits representing the early Triassic – Jurassic dolomite and the early Jurassic – middle Eocene limestones (average thickness: 2000 m).

The reservoir is represented by a sandy natural-gas bearing interval, 100 m thick, belonging to the turbiditic sand-clay alternation. The caprock consists of a 20 m continuous

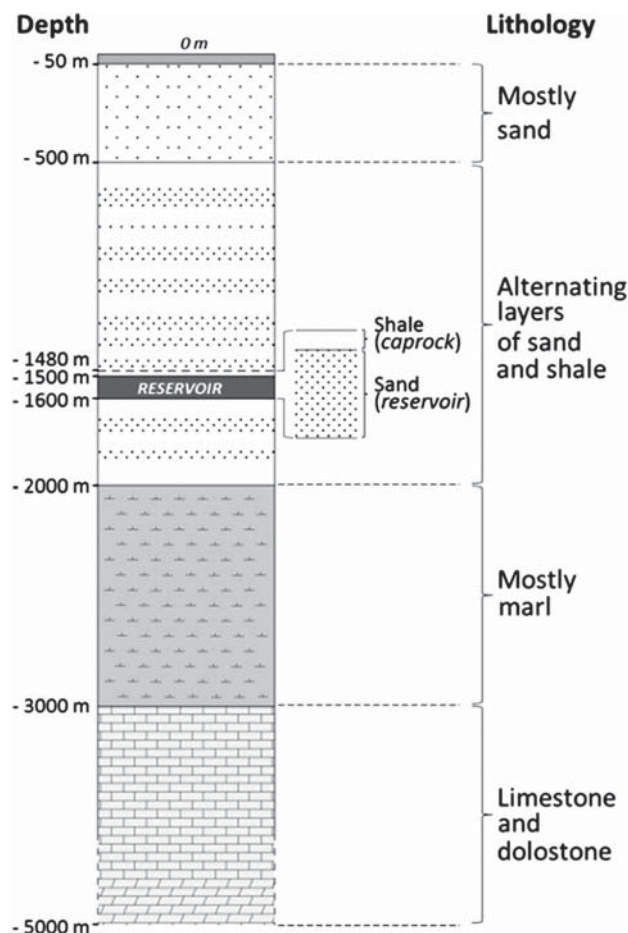

Fig. 2. Schematic stratigraphy (not to scale) of the 3D geological model. Schema stratigrafico (non in scala) del modello geologico 3D.

clay layer belonging to the same turbiditic sequence.

## 4.2. Geometric modelling and characterization

The model dimensions were such to properly describe the reservoir and the surrounding volumetric aquifer (which varied in the different examined scenarios) and to guarantee that undisturbed boundary conditions could exist. As a consequence, model dimensions were set horizontally in the order of dozens of kilometers (as in the example Figure 3) and the

overall thickness was 5 km.

The reservoir embedded in the model is located in an axially symmetric anticline trap (as in the example Figure 4) and is characterized by average values of the petrophysical and mechanical parameters. However, reservoir size was modified to include sensitivities on the volume of hydrocarbons originally in place. The aquifer is bounding the reservoir laterally when present.

A 10-year field production history was simulated for all studied cases to induce pressure disturbance and to reach a final gas recovery factor equal to 65%.

Several constitutive models have been proposed in the literature for the prediction of compaction and subsidence, from the simple linear elastic law to the elasto-plastic and visco-elasto-plastic laws.

The most general and frequently used failure criterion is Mohr Coulomb (Fjær *et al.*, 2008). Furthermore, the Modified Cam Clay model (Roscoe & Burland, 1968), specifically formulated for clays, has been used over the last years for the analysis of the mechanical response of sedimentary rocks (e.g. Cuss *et al.*, 2003; Capasso & Mantica, 2006; Firme *et al.*, 2014).

Even though the Mohr Coulomb elasto-plastic model is undoubtedly a very simple law, it has the advantage of requiring only the knowledge of cohesion, friction angle and elastic parameters of the rock. Since this study had a practical purpose, i.e. the assessment of the complexity degree required to approach a subsidence study and of the parameters having a major impact on results, the stress-strain response of the formations was investigated using a yield function represented by the Mohr-Coulomb failure criterion. Simulations adopting the Modified Cam Clay model with different OCR values were carried out to evaluate the differences

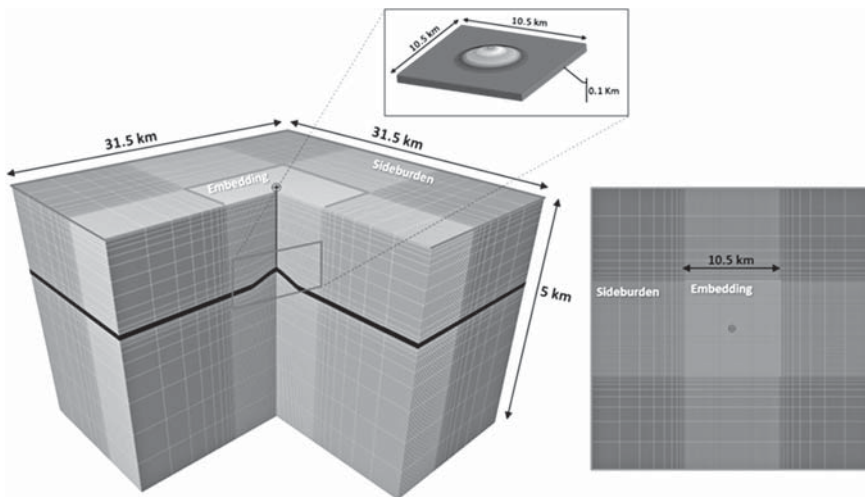

Fig. 3. Example of 3D numerical model for geomechanical simulations.  
Esempio di modello numerico 3D per simulazioni geomeccaniche.

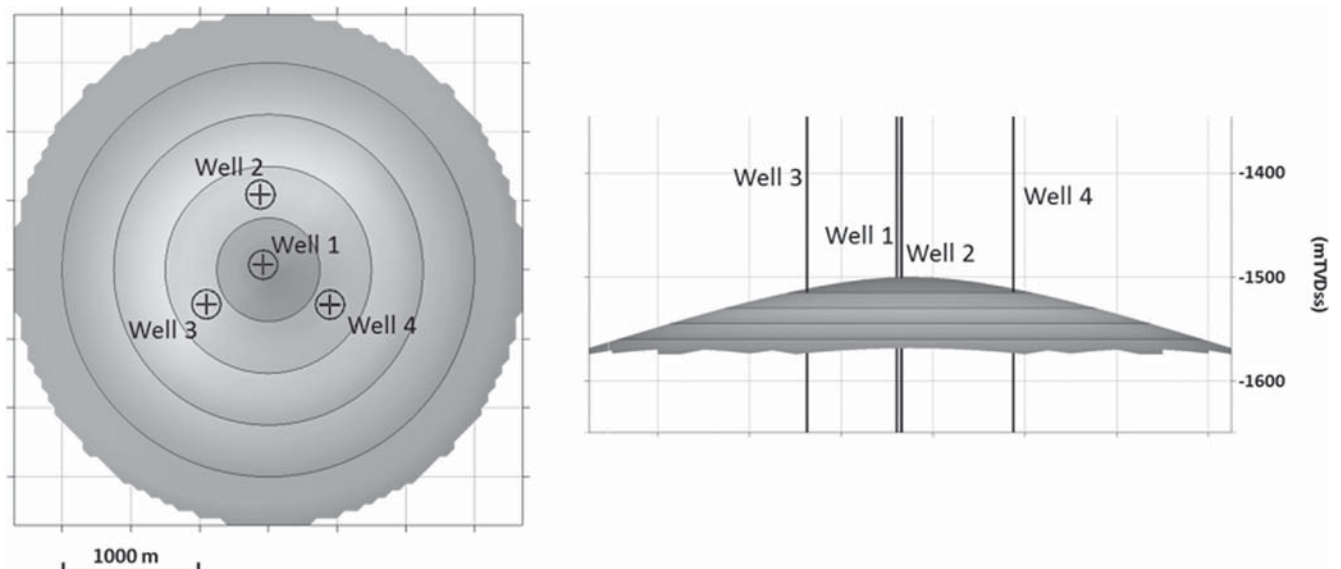

Fig. 4. Top geometry of the reservoir.  
Geometria del top del giacimento.

with the Mohr-Coulomb failure criterion only for a subset of cases for comparison purposes.

Mechanical simulation results refer to maximum variation of the formation static pressure (or depletion) which, under the assumption of a homogeneous and isotropic porous medium and in the absence of viscous deformation (or creep), represents the most critical condition for subsidence (Hettema, 2002).

The compaction coefficient (or uniaxial compressibility),  $C_m$ , changes with depth. For the North Adriatic formations the uniaxial compressibility,  $C_m$ , is correlated to the effective vertical stress ( $\sigma'_v$ ) according to (Baù *et al.*, 2002):

$$C_m = 1.0044 \cdot 10^{-2} \sigma_v'^{-1.1347} [\text{MPa}^{-1}] \quad (1)$$

The uniaxial compressibility is related to the static Young's modulus,  $E'_s$ , and to Poisson ratio,  $\nu'$ , by the following:

$$C_m = \frac{1}{E'_s} \frac{(1+\nu')(1-2\nu')}{1-\nu'} \quad (2)$$

Consequently, in the numerical analyses for subsidence evaluation, the static Young's modulus ( $E'_s$ ) of the sand-clay sequence was defined by combining eq. (1) and eq. (2):

$$E'_s = \frac{(1+\nu')(1-2\nu')}{1-\nu'} \cdot \frac{1}{1.0044 \cdot 10^{-2} \sigma_v'^{-1.1347}} \quad (3)$$

The numerical analyses were also made considering a dynamic Young's modulus ( $E'_d$ ) defined by the interpretation of well logs (both density and sonic). Moreover, a sensitivity analysis was performed accounting for the variation of Young's modulus as a function of the axial strain ( $E' = f(\epsilon_v)$ ) (Jardine *et al.*, 1986).

Young's modulus of other formations (marine sands, marl and carbonates) were defined on the basis of data available in the literature (Fjær *et al.*, 2008; Lancellotta, 2004) as well as the authors' knowledge.

For the Poisson's coefficient typical values for rocks and soils were used (Gercek, 2007).

### 4.3. Simulations

The simulations were performed to investigate the impact of geological and mechanical parameters on

the production-related subsidence.

The geological parameters describe the geometric characteristics of the reservoir (depth, shape, volume) and of the aquifer, when it is present (radius) (Figure 5; Table 1).

The mechanical parameters (Table 1) include the strength ( $c'$ ,  $\phi'$ ) and deformation ( $E'$ ,  $\nu'$ ) properties of rocks and soils, the initial stress

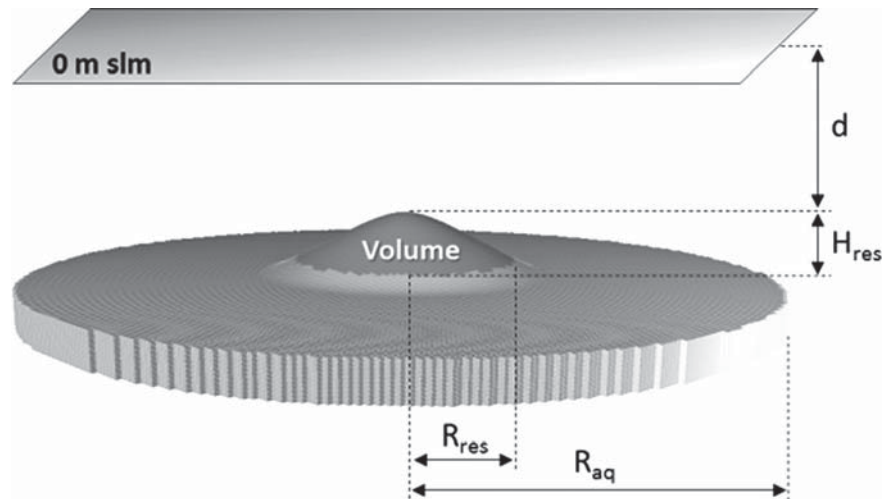

Fig. 5. Scheme of the geometric variables.  $H_{res}$ : total thickness of the hydrocarbon-bearing formation;  $R_{res}$ : reservoir radius;  $R_{aq}$ : aquifer radius;  $d$ : depth.

Schema delle variabili geometriche.  $H_{res}$ : spessore totale della formazione mineralizzata;  $R_{res}$ : raggio del giacimento;  $R_{aq}$ : raggio dell'acquifero;  $d$ : profondità.

Tab. 1. Analysed parameters and intervals.

Parametri analizzati e relativi intervalli indagati.

	Parameters	Interval	Units
Geological	Depth [d]	300-3500	m
	Shape factor [ $H_{res}/R_{res}$ ]	0.01-0.10	-
	Volume [V]	0.8-21.4 $10^9$	$\text{m}^3_{sc}$
	Aquifer [ $R_{aq}/R_{res}$ ]	1-20	-
Mechanical	Young's Modulus <sup>(1)</sup> [ $E'$ ]	1.7 ( $E'_s$ )-6.9 ( $E'_d$ ) $E' = f(\epsilon_v)$ ( $\epsilon_v$ = vertical deformation)	GPa
	Poisson's coefficient [ $\nu'$ ]	0.20-0.45 $\nu' = f(z, \gamma)$ ( $z$ = depth; $\gamma$ = lithology)	-
	Cohesion <sup>(1)</sup> [ $c'$ ]	0.6-1.2	MPa
	Friction angle <sup>(1)</sup> [ $\phi'$ ]	30-38	°
	Initial stress ratio [K]	0.6 + (100 m)/z-0.5 + (1500 m)/z ( $z$ = depth in m)	-
	Coupling degree [A]	NO; A = 2-10	-

<sup>(1)</sup> Values referred to reservoir only



(lateral stress coefficient,  $K$ ) (Brown & Hoek, 1978) and the interaction coefficient ( $A$ ) between petrophysical properties and compressibility in coupled simulations. In particular the interaction coefficient ( $A$ ) correlates permeability variations to porosity (and thus to volume) variations according to (Petunin *et al.*, 2011):

$$\frac{k}{k_0} = \left( \frac{\phi}{\phi_0} \right)^A \quad (4)$$

where  $k$  is permeability,  $\phi$  is porosity and  $k_0$  e  $\phi_0$  are the initial permeability and porosity, respectively. The exponent  $A$  can vary depending on the lithological and mechanical characteristics of the rock. In the case of sandstones  $A$  ranges between 2 and 10 (Santos *et al.*, 2014).

Once the range of the geological and mechanical parameters was defined, the simulations were performed.

Moreover, in order to evaluate the impact of geological heterogeneity on subsidence, sensitivity analyses were performed to simulate complex geological scenarios and/or characterized by significant lithological/stratigraphic differences. Some of the geological scenarios with different characteristics of the reservoir, caprock and overburden rocks are shown in Figure 6. In particular a Young's modulus equal to 40 and 50 GPa was adopted for marly and carbonatic reservoirs, respectively.

### 4.4. Subsidence indices

Downward vertical displacements induced by hydrocarbon production are typically maximum at the top of the reservoir (compaction phenomenon) and are gradually reduced towards the surface (subsidence phenomenon). Vertical displacements (one-dimensional effect of subsidence) are associated with volume

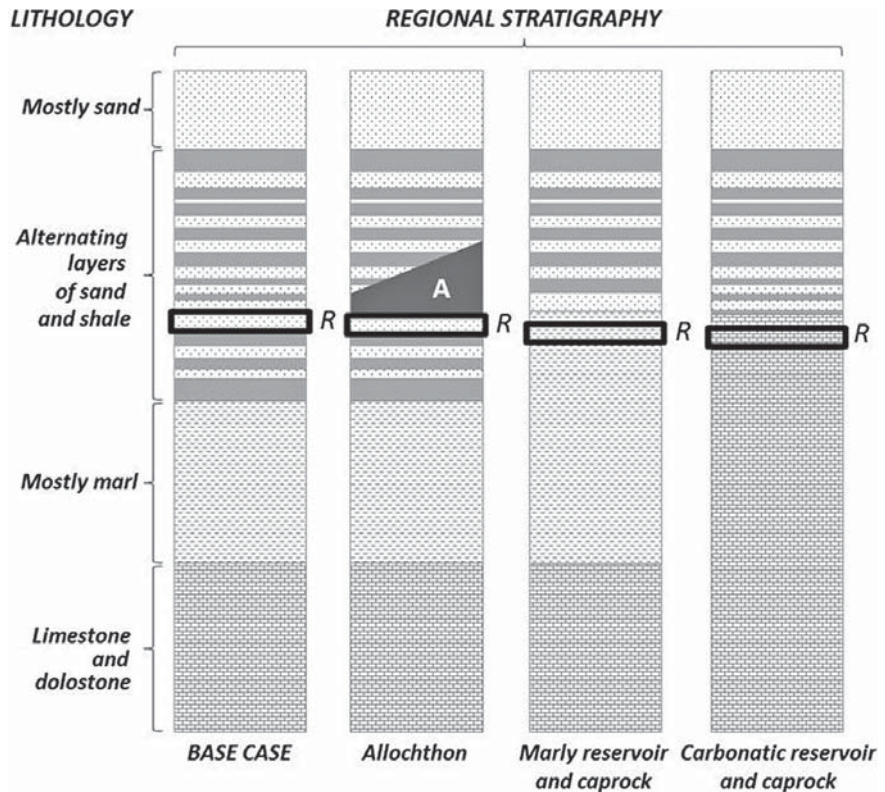

Fig. 6. Schematic examples of the stratigraphy (not to scale) for different geological scenarios. R: reservoir; A: allochthon.

Esempi schematici della stratigrafia (non in scala) per diversi scenari geologici. R: reservoir; A: alloctono.

variation (three-dimensional effect of subsidence) which similarly are maximum at the reservoir and reduce toward the surface (Figure 7).

Subsidence phenomenon calculated through numerical models imposing triaxial loading conditions, was described by means of two subsidence indices. The first index is the Compaction Propagation Rate

(CPR) and it is expressed by the ratio between maximum surface vertical displacement and maximum compaction of the reservoir, as first investigated analytically in oedometric loading conditions by Geertsma (1973a, b):

$$CPR = \frac{\text{Maximum vertical displacement at the surface}}{\text{Reservoir compaction}} \quad (5)$$

The second index is defined as Volume Loss Rate (VLR) and it is the ratio between volume variation caused by subsidence (i.e. volume of subsidence bowl) and the volume variation generated by compaction of the hydrocarbon-bearing formation:

$$VLR = \frac{\text{Volume loss at the surface}}{\text{Reservoir volume loss}} \quad (6)$$

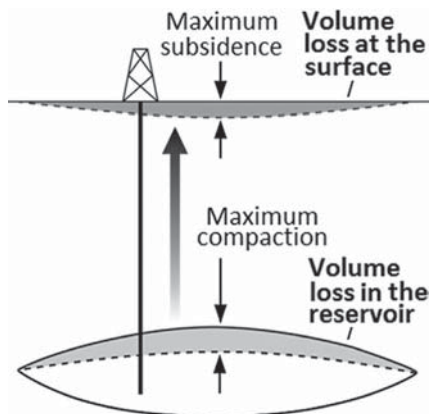

Fig. 7. Compaction and subsidence (adapted from Fjær *et al.*, 2008).

Compattazione e subsidenza (modificata da Fjær *et al.*, 2008).

The reservoir volume loss was calculated considering the rock portion which undergoes pressure variation

during production, that is, the gas-bearing interval and the aquifer connected to it, when present.

If the effect of compaction does not propagate towards the surface, CPR and VLR will be zero. Conversely, when reservoir compaction propagates entirely to the surface and generates a subsidence of the same entity, then CPR and VLR assume unit values; in some cases subsidence/compaction ratio as well as the ratio between the volume of the subsidence bowl and the reduction in reservoir volume may be even higher than 1.

Note that the indices only refer to vertical displacements and do not include horizontal displacements and/or differential displacement. The reason being that the indices are meant to provide an indication of the severity of subsidence. Needless to say, should the indices indicate that subsidence is significant, horizontal displacements and differential displacements should be evaluated to assess their potential impact on existing structures or infrastructures.

## 4.5. Results

Hydrocarbon production generates a variation of the stress conditions and thus deformations.

In Figure 8 and Figure 9 two examples of the calculated compaction and subsidence maps are given for a symmetric and an asymmetric anticline respectively (reference data:  $d = 1500$  m;  $H_{res}/R_{res} = 0.05$ ;  $V = 4.3 \cdot 10^9$  m<sup>3</sup><sub>sc</sub>; no aquifer;  $E' = 1.7$  GPa;  $\nu' = 0.3$ ;  $c' = 0.9$  MPa;  $\phi' = 34^\circ$ ;  $K = 0.8$ ; one-way coupling).

The results of the numerical runs adopting the Mohr-Coulomb criterion indicated that the behaviour of the reservoir rock, in the range of the investigated strength parameters ( $c'$  and  $\phi'$ ), is elastic. It should be said that Young's modulus has a significant impact on the extent of the subsidence but not on the evolution of the stress state, while strength parameters define failure conditions but do not affect subsidence phenomena under elastic conditions. Finally, Poisson's coefficient influences the evolution of both subsidence and stress induced by production.

Reservoir compaction propagates to the surface and induces subsidence, the intensity of which can be accounted for by the two subsidence indices described above. It should be noted that the volume loss at the surface showing in VLR (eq. 6) was evaluated setting a threshold on the minimum detectable vertical displacement.

Even if different compaction and subsidence would be obtained if adopting the Modified Cam Clay model and/or a two-way coupled approach, as verified with the additional simulated cases, the calculated subsidence indices are representative to assess whether any critical situation might arise due to hydrocarbon production from reservoirs. Therefore the analysis of the variation range of the two indices for the examined scenarios (Table 1) allowed the definition of a qualitative reservoir classification, as reported in Table 2.

Based on the indices analyses, reliable forecast of subsidence requires detailed reservoir modelling as well as an accurate reconstruction of the structural and stratigraphic setting of adjacent formations, especially

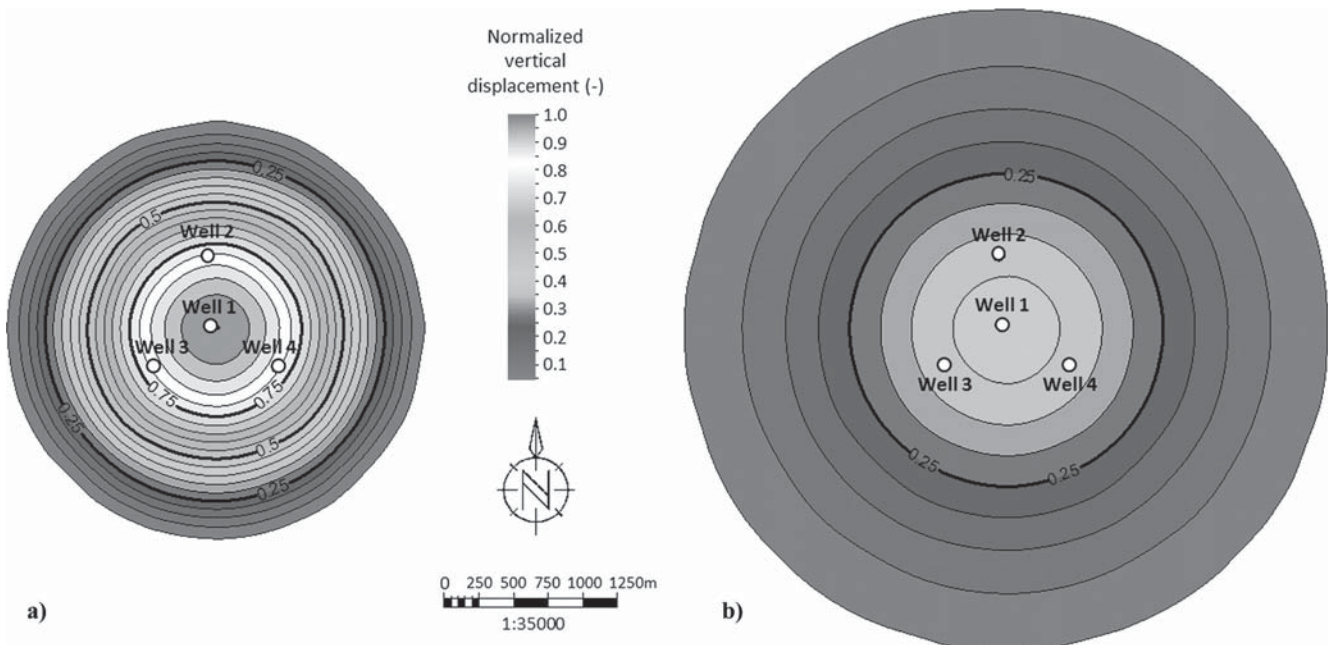

Fig. 8. Example of calculated compaction (a) and subsidence (b) maps for a symmetric anticline. Vertical displacements are normalized wrt the maximum reservoir compaction.

*Esempio di mappe di compattazione (a) e di subsidenza (b) ottenute dal calcolo numerico per un'anticlinale simmetrica. Gli spostamenti verticali sono normalizzati rispetto alla massima compattazione del giacimento.*



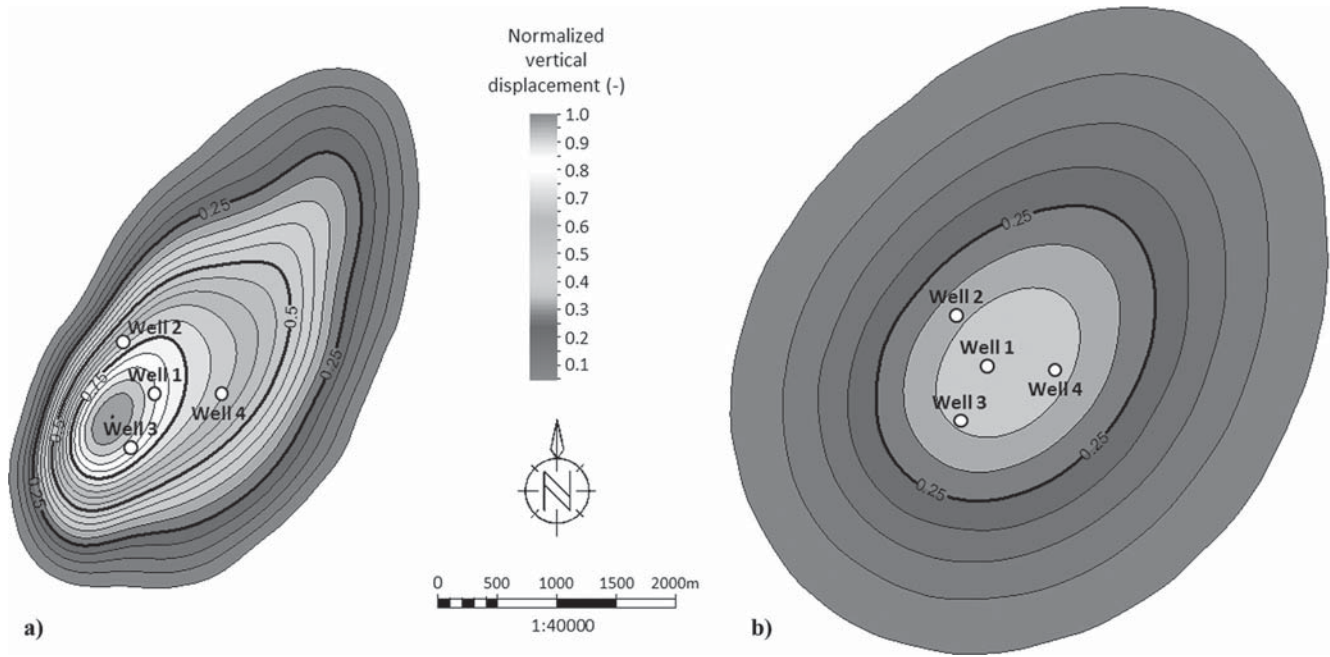

Fig. 9. Example of calculated compaction (a) and subsidence (b) maps for an asymmetric anticline. Vertical displacements are normalized wrt the maximum reservoir compaction.

Esempio di mappe di compattazione (a) e di subsidenza (b) ottenute dal calcolo numerico per un'anticlinale asimmetrica. Gli spostamenti verticali sono normalizzati rispetto alla massima compattazione del giacimento.

Tab. 2. Reservoir classification based on subsidence indices.

Classificazione dei giacimenti sulla base degli indici di subsidenza.

Reservoir characteristics	Subsidence index	Subsidence
– Deep reservoirs with small to medium size, without aquifers or with large aquifers	$CPR, VLR \leq 0.25$	Limited
– Medium depth reservoirs with small to medium size, without aquifer – Deep reservoirs with small to medium size and with small to medium aquifers – Deep reservoirs with medium to large size, without aquifers or with large aquifers	$0.25 < CPR, VLR < 0.8$	Considerable
– Shallow reservoirs – Medium depth reservoirs with small to medium size and with small to medium aquifer – Medium depth reservoirs with large size, with or without aquifers – Deep reservoirs with medium to large size, with small to medium aquifers	$CPR, VLR \geq 0.8$	Significant

in the case of shallow hydrocarbon-bearing formations.

The effects of heterogeneity can be considered negligible or even null in particularly simple geological scenarios, e.g. when the reservoir and the surrounding formations are laterally continuous and with a simple geometry, and/or when the rock petrophysical and mechanical characteristics as well as the pressure distribution within the reservoir are rather homogeneous. On the contrary, the effects of heterogeneity are not negligible in the case of reservoirs with irregular geometry, formations with significant thickness changes, strongly heterogeneous

petrophysical properties and pressure distributions within the reservoir, and contrast between stress-strain properties (Suzuki *et al.*, 2004; Fjær *et al.*, 2008).

When the geometry of the reservoir is very simple and symmetrical, as is the case of the modelled anticline analyzed and described above, and the adjacent formations are horizontal and have uniform thickness, the subsidence volume tends to a regular bowl. When considering more realistic and complex geological scenarios, the distribution of vertical displacements on the surface may be markedly heterogeneous and thus produce irregular subsidence.

For instance this could be the case of asymmetric anticline reservoirs or of more complex geological scenarios involving the presence of an allochthon wedge above the reservoir. Moreover, the presence of a more rigid caprock than the reservoir attenuates the subsidence phenomenon; conversely, the presence of a stiffer layer underlying the reservoir increases subsidence (Geertsma, 1973b).

Reservoir classification based on the values of the subsidence indices together with the degree of heterogeneity led to the definition of the Intact Rock Qualitative Subsidence Index (IRQSI) which allows to qualitatively identify the degree of

accuracy with which it would be desirable to undertake subsidence studies as well as assess underground safety conditions following the alteration of the initial stress state due to hydrocarbon production – or storage (Table 3 and Figure 10).

The definition of a prompt numerical model (IRQSI = 1) allows a quick but approximate evaluation of the phenomenon to be analyzed. The geological characteristics of the reservoir and surrounding formations can be described in a simplified way through regular geometries, sub-horizontal layering and discretization. The effect of production on pressure can be represented by an average depletion value for the reservoir as well as in any hydraulically connected aquifer. Alternatively, if the thickness of the reservoir

Tab.3. Definition of the IRQSI based on subsidence indices and degree of heterogeneity.

*Definizione dell'IRQSI sulla base degli indici di subsidenza e del grado di eterogeneità.*

Subsidence index	Heterogeneity degree	IRQSI	Suggested approach
$CPR, VLR \leq 0.25$	Negligible or nil	1	Prompt numerical or analytical
$0.25 < CPR, VLR < 0.8$	From negligible to non-negligible	2	Simplified numerical
$CPR, VLR < 0.25$	Non negligible		
$CPR, VLR \geq 0.8$	From negligible to high	3	Complex numerical
$CPR, VLR < 0.8$	High		

is small in relation to the radius and in the absence of an active aquifer, an analytic approach may be used which, by nature, represents a prompt analysis. The analytical method proposed by Geertsma (1973a, 1973b), widely used throughout the

oil industry, allows to estimate the extension (albeit in a conservative manner, particularly for scenarios which are far from the assumptions of Geertsma's method) of subsidence induced by hydrocarbon production.

The definition of a simplified nu-

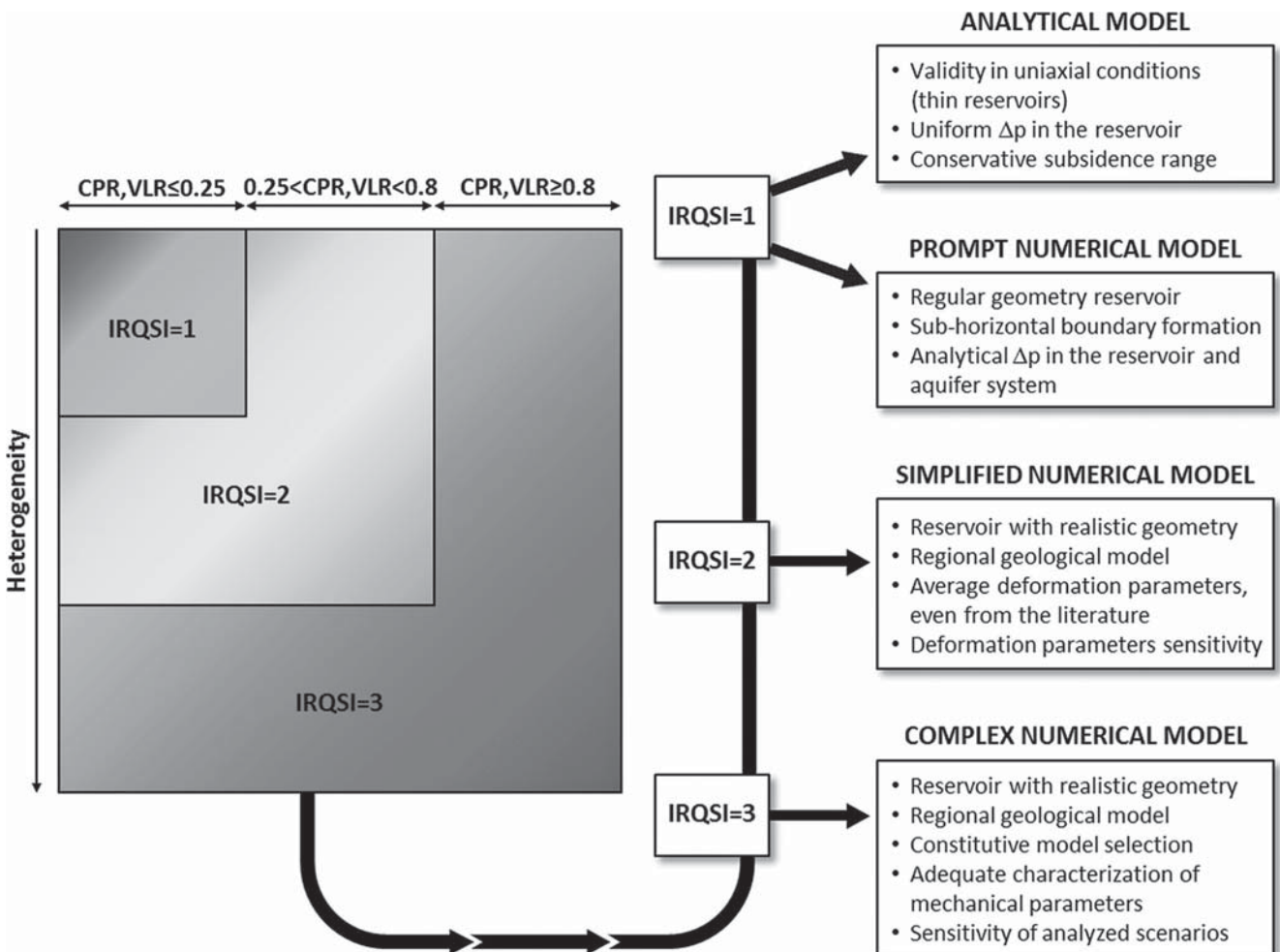

Fig. 10. IRQSI-based subsidence study approach.  
*Approccio allo studio della subsidenza suggerito sulla base dell'ISQRI.*

merical model (IRQSI = 2) makes it possible to refer to the average values of the necessary parameters for the characterization of the underground formations, even values from the existing literature for similar formations can be used. Further study to assess the impact of possible heterogeneities can include a sensitivity analyses on the mechanical parameters. Particular attention must, however, be given to viscous deformation (creep), which may occur in the absence of repressurization of the reservoir after production.

Conversely, the definition of a complex numerical model (IRQSI = 3) requires the development of different analysis scenarios (considering different production strategies, aquifer sizes, constitutive models) and, above all, knowledge of deformation and resistance parameters should be widened by integrating experimental data, appropriately acquired by on-site and laboratory testing.

## 5. Conclusions

Geomechanical analyses show how production induces stress variations resulting in compaction of the reservoir and surrounding aquifer when present.

Compaction of underground formations induces subsidence at the surface which needs proper evaluation. The complexity of the approach to be used for quantifying vertical displacements and extension can be discerned based on the proposed Intact Rock Qualitative Subsidence Index (IRQSI), which relies on CPR, VLR and system heterogeneity. The approach can go from analytical, restricted to thin and homogeneous reservoirs subject to a uniform depletion, to simplified or complex numerical modelling. In the case of numerical modelling, both fluid-dynamic and stress-strain phenomena must be taken into account through the integration of

three reference models: the geological model at regional scale, which allows to describe the stratigraphic-structural features as well as the lithological/ petrophysical properties of the system under examination; the fluid-dynamic model, which integrates production history, PVT fluid parameters and rock-fluid interaction parameters into the geological model and is the basis for analyzing fluid-flow phenomena induced by hydrocarbon production; the geomechanical model, which allows to study stress-strain phenomena through the geotechnical characterization of all modelled formations and the selection of a suitable constitutive model describing rock and soil behavior (Benetatos *et al.*, 2010; Codegone *et al.*, 2016).

The analyses discussed in this paper are based on Mohr-Coulomb's failure criterion which, albeit simple, is one of the most widely used models for studying intact rocks under monotonic loading conditions. The use of complex constitutive models which account for the loading history, non-linear behavior and/or time-dependent (viscous) stress-strain behavior, is sometimes necessary but it must be adequately supported by experimental analysis. It should be noted that the planning and interpretation of laboratory tests, which provide strength and deformation parameters, always imply the assumption of a reference constitutive model. Moreover, the mechanical response of geomaterials to given stresses depends not only on the type and magnitude of the applied stresses but also on the way in which they were applied (stress path). Similarly, fully coupled fluid-dynamic and geomechanical models are recommended in particular situations such as highly compressible (i.e. shallow) and fractured reservoirs and require the characterization of the interdependence between petrophysical properties, mechanical properties and stress state.

In all cases, comparing the results of numerical models with geodetic and/or satellite monitoring provide a way of evaluating the model capability to adequately reproduce the mechanical behavior of the rocks as well as calibrating them through back analysis processes.

## References

- Baù, D., Ferronato, M., Gambolati, G., Teatini, P., 2002. *Basin-scale compressibility of the Northern Adriatic by the radioactive marker technique*. Géotechnique, vol. 52 (8), pp. 605-616. doi: <http://dx.doi.org/10.1680/geot.2002.52.8.605>.
- Benetatos, C., Viberti, D., 2010. *Fully Integrated Hydrocarbon Reservoir Studies: Myth or Reality?*, American Journal Of Applied Sciences, vol. 7 (11), pp. 1477-1486. ISSN 1546-9239.
- Bertello, F., Fantoni, R., Franciosi, R., 2008. *Overview of the Italy's Petroleum Systems and Related Oil and Gas Occurrences*. CD Extended Abstract & Exhibitor's Catalogue, 70th EAGE Conference & Exhibition, A018, pp. 1-4.
- Bertello, F., Fantoni, R., Franciosi, R., Gatti, V., Ghielmi, M., Pugliese, A., 2010. *From thrust-and-fold belt to foreland: hydrocarbon occurrences in Italy*. In: Vining, B.A., Pickering, S.C. (Eds.) *Petroleum geology: from mature basin to new frontiers*. Proceedings of the 7th Petroleum Geology Conference, pp. 113-112. doi: 10.1144/0070113.
- Brown, E.T., Hoek, E., 1978. *Trends in Relationships between Measured In-Situ Stresses and Depth*. International Journal of Rock Mechanics and Mining Science & Geomechanics Abstracts, vol. 15, pp. 211-215. doi: 10.1016/0148-9062(78)91227-5.
- Brady, B.H.G., Brown, E.T., 2004. *Rock mechanics for underground mining*, 3<sup>rd</sup> Edition. Kluwer Academic Publishers, Dordrecht, 2004.
- Byerlee, J.D., 1978. *Friction of Rocks*.



- Pure and Applied Geophysics, 116 (4-5), 615-626.
- Carruba, S., Casnedi, R., Perotti, C.R., Tornaghi, M., Bolis, G., 2006. *Tectonic and sedimentary evolution of the Lower Pliocene Periadriatic foredeep in Central Italy*. International Journal of Earth Sciences (Geologische Rundschau), vol. 95, pp. 665-683. doi: 10.1007/s00531-005-0056-4.
- Casero, P., 2004. *Structural setting of petroleum exploration plays in Italy*. Special Volume of the Italian Geological Society for the IGC 32 Florence-2004, pp. 189-199.
- Casero, P., Bigi, S., 2013. *Structural setting of the Adriatic basin and the main related petroleum exploration plays*. Marine and Petroleum Geology, vol. 42, pp. 135-147. doi: 10.1016/j.marpetgeo.2012.07.006.
- Cazzini, F., Dal Zotto, O., Fantoni R., Ghielmi, M., Ronchi, P., Scotti, P., 2015. *Oil and gas in the Adriatic foreland, Italy*. Journal of Petroleum Geology, vol. 38 (3), pp. 255-279. doi: 10.1111/jpg.12610.
- Childs, C., Manzocchi, T., Walsh, J.J., Bonson, C.G., Nicol, A., Schopfer, M.P.J., 2009. *A geometric model of fault zone and fault rock thickness variations*. Journal of Structural Geology, vol. 31, pp. 117-127.
- Choi, J-H., Edwards, P., Ko, K., Kim, Y-S., 2016. *Definition and classification of fault damage zones: A review and a new methodological approach*. Earth-Science Reviews, vol. 152, pp. 70-87.
- Codegone, G., Rocca, V., Verga, F., Coti, C., 2016. *Subsidence Modeling Validation Through Back Analysis for an Italian Gas Storage Field*. Geotechnical And Geological Engineering, vol. 34 (6), pp. 1749-1763. ISSN 0960-3182.
- Davis, G.H., Reynolds, S.J., Kluth, C., 2012. *Structural Geology of rocks and regions*, 3<sup>rd</sup> edition. John Wiley & Sons, Inc., New York, pp. 1-839. ISBN 978-0-471-15231-6.
- Faulkner, D.R., Jackson, C.A.L., Lunn, R.J., Schlische, R.W., Shipton, Z.K., Wibberley, C.A.J., Withjack, M.O., 2010. *A review of recent developments concerning the structure, mechanics and fluid flow properties of fault zones*. Journal of Structural Geology, vol. 32, pp. 1557-1575.
- Fischer, Q.J., Knipe, R.J., 2001. *The permeability of faults within siliclastic petroleum reservoirs of the North Sea and Norwegian continental shelf*. Marine and Petroleum Geology, vol. 18, pp. 1063-1081.
- Fjær, E., Holt, R.M., Horsrud, P., Raen, A.M., Risnes, R., 2008. *Petroleum related rock mechanics. Development in Petroleum Science (2<sup>nd</sup> Edition)*, vol. 53. Elsevier Science Publishers B.V., Amsterdam.
- Fossen, H., 2010. *Structural geology*, 1<sup>st</sup> edition. Cambridge University Press, p. 480. ISBN-13 978-0-521-51664-8.
- Fredman, N., Tveranger, J., Semshaug, S., Braathen, A., Svenrup, E., 2007. *Sensitivity of fluid flow to fault core architecture and petrophysical properties of fault rocks in siliclastic reservoirs: a synthetic fault model study*. Petroleum Geoscience, vol. 13, pp. 305-320.
- Geertsma, J., 1973a. *Land subsidence above compacting oil and gas reservoirs*. Journal of Petroleum Technology, vol. 25 (6), pp. 734-744.
- Geertsma, J., 1973b. *A basic theory of subsidence due to reservoir compaction: the homogeneous case*. Verhandelingen van het Koninklijk Nederlands Geologisch Mijnbouwkundig Genootschap, vol. 28, pp. 43-72.
- Gercek, H., 2007. *Poisson's ratio values for rocks*. International Journal of Rock Mechanics & Mining Sciences, vol. 44 (1), pp. 1-13. doi:10.1016/j.ijrmms.2006.04.011.
- Ghielmi, M., Minervini, M., Nini, C., Rogledi, S., Rossi, M., 2013. *Late Miocene-Middle Pleistocene sequences in the Po Plain e Northern Adriatic Sea (Italy): The stratigraphic record of modification phases affecting a complex foreland basin*. Marine and Petroleum Geology, vol. 42, pp. 50-81. doi: 10.1016/j.marpetgeo.2012.11.007.
- Ghielmi, M., Minervini, M., Nini, C., Rogledi, S., Rossi, M., Vignolo, A., 2010. *Sedimentary and tectonic evolution in the eastern Po-Plain and northern Adriatic Sea area from Messinian B-537 to Middle Pleistocene (Italy)*. Rendiconti Lincei Scienze Fisiche e Naturali, vol. 21, pp. S131-S166. doi: 10.1007/s12210-010-0101-5.
- Hettema, M., Papamichos, E., Schutjens, P., 2002. *Subsidence Delay: Field Observations and Analysis*. Oil&Gas Science and Technology – Rev. IFP, vol. 57(5), pp. 443-458. doi: 10.2516/ogst:2002029.
- Jardine, R.J., Potts, D.M., Fourie, A.B., Burland, J.B., 1986. *Studies of the influence of non-linear stress-strain characteristics in soil-structure interaction*. Géotechnique, vol. 36(3), pp. 377-396.
- Lancellotta, R., 2004. *Geotecnica*. III edizione. Zanichelli Editore S.p.A., Bologna.
- Matonti, C., Lamarche, J., Guglielmi, Y., Mariè, L., 2012. *Structural and petrophysical characterization of mixed conduit/seal fault zones in carbonates: Example from the Castellas fault (SE France)*. Journal of Structural Geology, vol. 39, pp. 103-121. doi: 10.1016/j.jsg.2012.03.003
- Petunin, V.V., Tutuncu, A.N., Prasad, M., Kazemi, H., Yin, X., 2011. *An Experimental Study for Investigating the Stress Dependence of Permeability in Sandstones and Carbonates*. 45th U.S. Rock Mechanics / Geomechanics Symposium, 26-29 June 2011, San Francisco, California.
- Pieri, M., Groppi, G., 1981. *Subsurface geological structure of the Po Plain, Italy*. Pubblicazione 414. Progetto Finalizzato Geodinamica, C.N.R., pp. 1-13.
- Roscoe, K.H., Burland, J.B., 1968. *On the Generalized Stress-Strain Behaviour of "Wet" Clay*. In Engineering Plasticity Cambridge Univ. Press, Heyman and Leckie Ed., pp. 535-609.
- Santos, E.S.R., Borba, A.M., Ferreira, F.H., 2014. *Stress-Dependent Permeability Measurement of Indiana Limestone and Silurian Dolomite*

- Samples in Hydrostatic Tests*. ISRM Conference on Rock Mechanics for Natural Resources and Infrastructure – SBMR 2014, 9-13 September, Goiania, Brazil.
- Scholz, C.H., 1987. *Wear and gouge formation in brittle faulting*. *Geology*, 15(6), 493-495.
- Suzuki, I., Morita, N., 2004. *Subsidence and Horizontal Earth Surface Movement During Reservoir Depletion for 3D Reservoirs With 3D Earth Surface*. SPE Annual Technical Conference and Exhibition, Houston, Texas, 26-29 September 2004.
- Teatini, P., Castelletto, N., Ferronato, M., Gambolati, G., Janna, C., Cairo, E., Marzorati, D., Colombo, D., Ferretti, A., Bagliani, A., Bottazzi, F., 2011. *Geomechanical response to seasonal gas storage in depleted reservoirs: A case study in the Po River basin, Italy*. *Journal of Geophysical Research*, vol. 116(F2).
- Tran, D., Nghiem, L., Buchanan, L., 2005. *An Overview of Iterative Coupling between Geomechanical Deformation and Reservoir Flow*. SPE International Thermal Operations and Heavy Oil Symposium, Calgary, Alberta, Canada, 1-3 November 2005.
- Vezzani, L., Festa, A., Ghisetti, F., 2010. *Geology and Tectonic evolution of the Central-Southern Apennines, Italy*. Geological Society of America Special Paper, vol. 469, pp. 1-58, accompanying by a CD-ROM including the “Geological-Structural Map of the Central-Southern Apennines (Italy)” at 1:250,000 scale, Sheets 1 and 2. doi: 10.1130/2010.2469. <http://unmig.sviluppoeconomico.gov.it/> (accessed February 2016)

### Acknowledgement

This paper would not have been possible without the sponsorship of the Ministry of Economic Development’s Directorate General for Safety – National Mining Office for Hydrocarbons and Georesources. In particular, authors would like to express their gratitude to the people who have supported this work along all the stages of its realization.