



POLITECNICO DI TORINO
Repository ISTITUZIONALE

Design of electromechanical height adjustable suspension

Original

Design of electromechanical height adjustable suspension / Amati, Nicola; Tonoli, Andrea; Castellazzi, Luca; Ruzimov, Sanjarbek. - In: PROCEEDINGS OF THE INSTITUTION OF MECHANICAL ENGINEERS. PART D, JOURNAL OF AUTOMOBILE ENGINEERING. - ISSN 0954-4070. - (2017), pp. 1-17.

Availability:

This version is available at: 11583/2685846 since: 2017-10-12T11:49:48Z

Publisher:

SAGE

Published

DOI:10.1177/0954407017728633

Terms of use:

openAccess

This article is made available under terms and conditions as specified in the corresponding bibliographic description in the repository

Publisher copyright

(Article begins on next page)

Design of Electromechanical Height Adjustable Suspension

Journal Title
XX(X):1–15
©The Author(s) 2016
Reprints and permission:
sagepub.co.uk/journalsPermissions.nav
DOI: 10.1177/ToBeAssigned
www.sagepub.com/



Nicola Amati, Andrea Tonoli, Luca Castellazzi, and Sanjarbek Ruzimov

Abstract

In the general context of vehicles' fuel consumption and emissions reduction, the minimization of the aerodynamic drag can offer not negligible benefits regarding the environmental issues. The adjustment of the vehicle height is one of the possible ways to provide a reduction of the resistances to vehicle motion, in addition to consequent aspects regarding the increased versatility of the vehicle. The aim of this paper is to present in a systematic way to the state of the art of height adjustment systems for passenger vehicles, summarizing the main modes of operations, working principles and architectures. Particular attention is then given to electromechanical systems, which represent the next trends for future vehicles due to their high reliability and relatively low costs. A design methodology for electromechanical height adjustment systems with the purpose of optimizing their performance is presented. Such procedure is able to reach the most efficient working point even in presence of constraints of different nature. Prototypes have been designed, produced and tested to demonstrate the potentialities of electromechanical height adjustment systems. Furthermore, potential benefits and drawbacks of using such systems are highlighted.

Keywords

Vehicle suspension systems, self levelling, height adjustment, aerodynamic drag, fuel consumption reduction, emission reduction.

Introduction

Road transport is one of the most significant consumer of fossil fuels and source of air pollution. According to the data of the International Energy Agency,¹ in 2013 the road transport was the second largest sector of Carbon Dioxide (CO₂) emissions. Its share in global world CO₂ emissions was 20% (12% in Europe²). This justifies the trend towards more stringent legislative restrictions and standards on vehicle emissions such as, for example, those introduced by European Commission to set targets for new cars.² Such targets require that new cars have to emit less than 130 gCO₂/km by 2015, and less than 95 gCO₂/km by the end of 2020. Considering that between the period 2010-2014 the average emission level decreased² of 17 gCO₂/km, an additional decrease of 35 gCO₂/km for the same time frame seems to be challenging for vehicle manufacturers. The penalties for exceeding the limits on one side and the incentives towards lower emission vehicles² on the other, encourages the application of innovative technologies to reduce emissions.

Technologies that are widely used to reduce fuel consumption and exhaust gas emissions are based on

improving the internal combustion engine (ICE) and the drive train efficiencies, on lowering vehicle weight and on reducing the resistances.^{3,4} The latter can be achieved by optimizing the aerodynamic shape and reducing the frontal area.^{5,6} Since the lowering of the vehicle height could give benefits in both the aerodynamic drag coefficient and reference area, it is then considered a promising feature to be used on a modern vehicle to reduce fuel consumption and CO₂ emission. Considering that one of the trends of the last decade shows a wide use of 4x4 crossover SUV cars (13% share in European market in 2015⁷), especially in city conditions, the implication of height adjustment systems seems to give interesting opportunity to reach a compromise between versatility of the vehicle and fuel consumption.

Mechatronics Lab, DIMEAS, Politecnico di Torino, Italy

Corresponding author:

Ruzimov Sanjarbek, Mechatronics Lab, Department of Mechanical and Aerospace Engineering, Politecnico di Torino, Duca degli Abruzzi, 20, Torino, Italy

Email: sanjarbek.ruzimov@polito.it

In spite of the above mentioned benefits, the design of the height adjustment suspension as a standalone system was not studied previously in the literature. Rather, it is more addressed as an intrinsic feature of an active suspension.⁸⁻¹³ To fill this gap, the present paper investigates the environmental benefits of using such systems and gives detailed critical analysis of existing height adjustment suspensions. Furthermore, the paper describes a methodology to design an electromechanical height adjustment system and to optimize its performance. The prototypes of height adjustment suspension system comprising electric motor, speed reducer and screw-nut mechanism have been built and tested on a vehicle. The validation of the design methodology is lastly described.

Environmental Benefits of Vehicle Height Adjustment Systems

The benefits of adjusting vehicle height are analyzed by using a vehicle model including the longitudinal vehicle dynamics.¹⁴ An average A-segment vehicle was chosen for the analysis. The vehicle data are given in Table 1. The engine torque and the specific fuel consumption maps implemented in the model are experimentally measured by the manufacturer. The aerodynamic drag coefficient of the vehicle at nominal road clearance is 0.35. It has been measured numerically and experimentally, that decreasing the road clearance by 20 mm and 40 mm, this coefficient will reduce to the values indicated in Table 1. Running the vehicle simulator at different road clearances, fuel consumption and CO₂ emission values for New European Driving Cycle (NEDC) and Worldwide Harmonized Light vehicles Test Procedures (WLTP) are obtained. During the simulations, the value of the aerodynamic drag coefficient is decreased from nominal to one of the reduced values (0.33 or 0.31) only on extra urban parts of the homologation cycles. Fuel consumptions obtained by the simulations are then converted in CO₂ emission by using the conversion factor suggested in EC Regulation No 443/2009 for gasoline engine (i.e., 2330 gCO₂ per one l of petrol).¹⁵

The results of simulations are depicted in Figure 1. The fuel consumption reduction at different road clearances compared to the nominal value is in the range of 0.037-0.22 l/100km (0.88 - 4.41 %), which corresponds to reduction of CO₂ emissions by 0.87 - 5.17 g/km. These results justify the use of height adjustment systems on vehicles to achieve lower CO₂ emissions. Besides that, added benefits include possible reductions of body roll^{16;17} and improved vehicle accessibility. By rising the vehicle height, higher versatility,

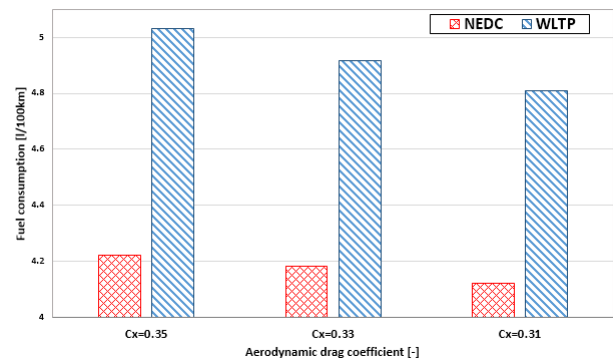

Figure 1. Vehicle fuel consumption at different values of aerodynamic drag coefficient while driving on two homologation cycles.

i.e. adaptability of the vehicle to different road conditions can be achieved.¹⁷

Table 1. The vehicle data used in the simulations.

Parameters	Value
Vehicle mass, kg	1090
Engine volume cm ³	900
Nominal power kW	60
C_x at nominal vehicle height, -	0.35
C_x at 20 mm lowered height, -	0.33
C_x at 40 mm lowered height, -	0.31

Analysis of Existing Systems on Vehicle Height Adjustment.

The main components of a generic suspension systems are primary and secondary elastic and damping members. They damp out the oscillations and isolate the vehicle body from impacts coming from road irregularities, improving ride comfort and to guaranteeing the contact between tire and road surface (i.e. road holding capability).^{8-13;16;19;20;23;24;26}

Based on the operation modes of damping element, vehicle suspensions can be divided into: passive, semi-active and active.⁸⁻¹³ Passive suspensions' components have non-adjustable characteristics, whilst in semi-active suspensions, the damping of the system can be varied according to an input signal. Active suspensions differ from semi-active ones for what the energy injected into the system concerns. In general, in semi-active suspensions the required energy is limited to be enough for actuating control valves.⁸ Vehicle height adjustable suspensions are classified into active suspensions with small actuation bandwidth.^{8;26} A specific type of height adjustable suspension is the self leveling suspension, an architecture in which the vehicle height is in advance set to optimal level and the system maintains this level under different loading circumstances (allowing proper

weight distribution). Basically, height adjustment is fulfilled by increasing or decreasing the relative distance between the vehicle body and the wheel hub. This can be mainly realized by acting on different parts of the suspension strut, such as: upper spring seat, lower spring seat or shock absorber tube (by moving telescopically). Depending on the type of actuation, height adjustment systems can be of a pneumatic, a hydraulic, a hydro-pneumatic and an electromechanical kinds. Here below, summary description and analysis of the state of the art of different typologies of height adjustment systems are reported.

Hydraulic.

Hydraulic height adjustment system (Figure 2) comprises of linear (hydraulic cylinder) or rotary (hydraulic motor) actuators, hydraulic pump (standalone or combined with already existing one), pipes and hydraulic fluid, control valves and sensors. Relative displacement of the piston and cylinder of the actuator unit allows to modify the height of the vehicle.

To improve ride comfort and vehicle stability, Mercedes Benz AG^{18–20} uses an hydraulic active suspension system that features height adjustment capability. A hydraulic linear actuator mounted in series to the helical spring and in parallel to the damper of a traditional suspension system is used (schematically shown in Figure 2(a)). Pressures up to 200 bar are supplied by an engine driven pump (in schemes, **M** is used to denote a driving motor or an engine). The fluid stored in accumulators ensures faster actuation times. Hydraulic servo valves guarantee the independent levelling of each vehicle corner. The upper spring plate is attached to the cylinder of the hydraulic actuation unit while the piston is connected to the vehicle body^{18;19}. Thus, by pumping fluid into the cylinder the piston moves and the relative distance between the vehicle body and the upper spring plate changes.

Van der Knaap²¹ patented an active suspension system in which the linear hydraulic actuator is integrated with the shock absorber. Active control of damping force is accomplished by means of controlled directional valves and an electric motor driven pump, which actuates the piston-cylinder unit of the shock absorber (Figure 2(b)). Using this system, the adjustment of the vehicle height is performed acting on the shock absorber piston, that moves relative to the tube fixed on the wheel hub. Integrating the piston-cylinder unit with the one already existing in the shock absorber, reduces the system cost. However, additional control valves are required to decouple height adjustment feature from damping purposes.

ZF Sachs Nivomat shock absorbers are used in rear suspensions to restore vehicle height to predefined levels at different loading conditions^{9;22}. The system does not require an external pump (hence, motor and pump in Figure 2(b) should not be considered). Upper and lower volumes are separated by the piston of the damper and they are interconnected by means of pipes and valves. The pumping of the hydraulic fluid from one volume to another is realized owing to the relative motion between vehicle body and wheel hub (sprung and unsprung masses, respectively). It is obvious that changing of the level occurs only after traveling some distance²² depending on the load. While the system of Figure 2(a) uses additional actuator unit (cylinder-piston) to conventional spring and shock absorber, other solutions provided by BMW and ZF Sachs Nivomat realize height adjustment systems integrated into the damper (Figure 2(b))^{21;22}.

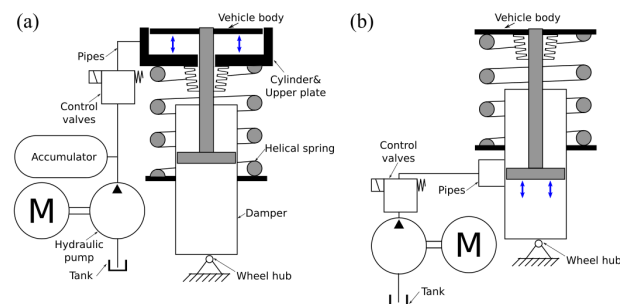

Figure 2. Hydraulic height adjustment system schematics: (a) with additional cylinder-piston unit; (b) with cylinder-piston unit integrated into damper.

The hydraulic height adjustment systems are advantageous when fast actuation of the system is the main requirement. As they deliver control force at high rate allowing fast levelling, thus the active feature can be provided. In addition, the main components of the system can be fixed on vehicle sprung part, leading to slight modification of the unsprung mass^{21;22}. The installation size of hydraulic actuation unit is more compact. However, the presence of hydraulic fluid and high pressures in the system represent main drawbacks of the hydraulic suspension systems. As the hydraulic fluid may cause a corrosion of metallic parts due to fluid moisturization, the prevention of latter requires use of special fluids. Furthermore, due to high pressures in the system the tight tolerances in manufacturing of the cylinder-piston group is mandatory. As a result, high cost of the system components is expected. In fact, the adaptation of hydraulic height adjustment system as a constituent part of a multi-functional active system is more practical.

Pneumatic.

Pneumatic suspensions are mainly used in public transportation buses, heavy-duty vehicles and premium cars where increased passenger comfort is required. They feature height adjustment systems to allow easy entry/exit of passengers. Figure 3(a) lists main components used in pneumatic suspensions. They consist of air springs (usually, reinforced rubber sleeve/bag inflated with pressurized air), high pressure reservoir (tank), air compressors, air dryer (to remove moisture) and control system (including control valves, height and pressure sensors). Adjustment of the ride height is straightforward and can be accomplished by pumping the air into or out of air spring bag.

Hirose et al. in²³ describes Toyota's Electronic Modulated Air Suspension (TEMS) system, which controls suspension spring rate, damping force and vehicle height by means of controlling the amount of air in the air spring as a function of vehicle traveling conditions. During braking and cornering spring rate and damping force are increased to reduce pitch and roll. At high speeds the vehicle height is lowered to increase stability. Height is increased while driving on rough roads to avoid vehicle hits bumps. The system complexity (and cost as a consequence) is high, as it includes sensors (height, steering and throttle position) and actuators to control the spring rate in addition to already expensive pneumatic components.

The application of a pneumatic suspension to the McPherson strut is presented by Tener.²⁴ Rolling lobe variable rate air spring, in parallel with hydraulic damper is used to find a compromise between ride and handling performance with three different settings (Track, Sport and Touring). The height of the vehicle can be decreased to improve the handling performance and by varying the air volume in the rubber sleeve.

Fiat Chrysler Automobiles uses Quadra-Lift® air suspension system on its top line of Grand Cherokee model.²⁵ It features height adjustment system with five different height modes (Normal, Park, Aero, Off road 1 and Off road 2). To allow easy entry/exit of the passengers and loading-unloading of the cargo, the vehicle height is lowered by 40 mm with respect to normal operating height when parked. At high speeds the vehicle height is lowered of 13 mm to reduce aerodynamic drag, which leads to improved fuel economy on highways. Two off road modes increase ground clearance by 25 mm and 53 mm to overcome obstacles and guaranty improved off-road capability.

Self leveling suspension system by BMW is based on a pneumatic actuation.²⁶ When the vehicle loading conditions change, the vehicle height is restored to the preset position

by controlling the air pressure in the pneumatic cylinders mounted on the rear axle. Two electrically operated external compressors work independently from each other, allowing independent actuation of left and right corners.

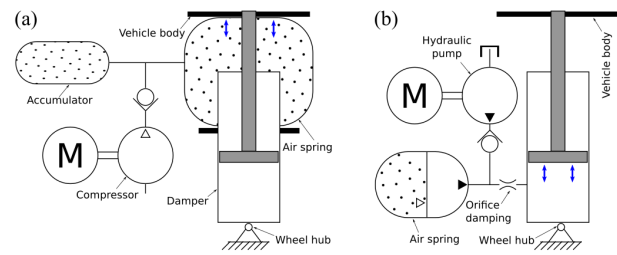

Figure 3. (a) Pneumatic and (b) Hydro-pneumatic height adjustment system schematics.

Off the shelf retrofittable solutions available on the market are mainly based on pneumatic suspensions. Height adjustment is performed to improve vehicle stability, ride comfort and handling under different loading conditions (loaded, towing the trailer and etc.). On these solutions, selection of rational vehicle height depends on driver's experience.

The main advantage of pneumatic suspensions is the possibility of controlling the spring rate of the air springs. It allows to find a good compromise between improved handling performance and ride comfort.^{23–26} Other advantages are those of intrinsically owning the height adjustment feature and a relatively fast actuation speed in presence of stored pressurized air. However, high cost, reduced reliability and robustness (mainly due to failure of rubber air springs) and high maintenance requirements are the main drawbacks of this kind of suspension systems. Moreover, pneumatic suspensions are less efficient when significant changes of the loading conditions take place or fast and frequent height adjustment is required (especially, when pressurized air store is depleted). Due to high cost of the components used in pneumatic suspensions, they are mainly used on top E- and F-segment models.

Hydro-pneumatic.

Hydro-pneumatic suspensions use elements of both hydraulic and pneumatic suspensions. The hydraulic part of the system is responsible for providing damping and can be used for height adjustment, while pneumatic part with high pressure accumulator provides elastic properties to the suspension. Simple schematics of the system is depicted in Figure 3(b).

Industrial pioneer in using hydro-pneumatic suspensions has been Citroen, applying it on the vehicle back in 1950s on its DS model.⁹ The system is still used in luxury

models of Citroen with some upgrades of it's control logic and components. In the early system proposed by Citroen, a high pressure accumulator filled with nitrogen gas (is used to avoid corrosion of components) works as a spring with variable stiffness. The nonlinear behavior of the spring ensures improved ride comfort both when fully loaded (stiffer spring, gas in the accumulator is more compressed) and unloaded (softer spring, gas in the accumulator is less compressed). The accumulator is attached to the end of the hydraulic actuator, where gas and liquid is separated by means of a membrane (Figure 3(b)). Height adjustment is performed hydraulically by pumping fluid into or out from the hydraulic cylinder (thus, by varying volume of the fluid). In addition to the suspension, braking and steering systems are connected to the same pump.

Sarel F. and Els P.¹⁷ studied an application of hydro-pneumatic suspensions to prevent roll over on off-road vehicles. However, the proposed system can be equally adapted for the vehicle height adjustment. The proposed configuration of the system is comparable to one of Citroen. Nevertheless, the particular difference is two nitrogen pneumatic accumulators, that allow a higher flexibility in tuning elastic and damping properties of the suspension. A smaller accumulator with volume of 0.1 l is used to have stiffer spring, while by enabling larger volume accumulator of 0.4 l softer characteristics is obtained. The system uses an increased number of valves (three per corner) which ensures enhanced performance of the suspension.

Summarizing pros and cons of hydro-pneumatic suspensions, it can be highlighted that they combine advantages of both hydraulic and pneumatic suspensions⁹. They allow faster height adjustment speed, higher reliability and robustness of the components, more compact size and improved performance. However, their use is limited to high end segment cars due to high production cost and the need of specialized service of the components.

Electromechanical.

Most of the available literature until late 90s is devoted to hydraulic, pneumatic and hydro-pneumatic vehicle height adjusting devices and they are available commercially on the market. Starting from the mid 2000s, new solutions using electromechanical actuators and electronic control units started to appear in literature, specifically in form of patents. This could be the result of car manufacturers' attempts to find low cost height adjustment suspension systems applicable also on low cost car segments. So far, no solutions using electromechanical system are present on the market. In principle, all the electromechanical height adjustment

systems make use of linear translational part, usually by means of threaded screw-nut mechanism connected to the suspension components and actuated by electric motors directly or through speed reducer (Figure 4).

AUDI AG's patented a solution for electromechanical height adjustment system with ad-hoc electric motor and ball-screw mechanism²⁷. The stator of the electric motor is fixed to the vehicle body through a rubber element comprising low friction bearing while the rotor of the motor is connected to the ball-screw. The nut is connected to upper spring seat (Figure 4(a)) and translates along the axis of the shock absorber providing height adjustment for the vehicle body. Additional to the main spring, a so called compensating spring (not shown in Figure 4(a)) is included between the vehicle body and the nut. It prevents the system components from shock loads. Internally, the hollow ball-screw and the shock absorber tube can move telescopically, relative to each other. The presence of the ball-screw increases the overall system efficiency. Therefore, overhauling may occur under the load of the vehicle body weight. As the locking feature is not intrinsically included in the system, additional locking device must be used (even if is not mentioned in the patent). The presence of the ad-hoc electric motor, the additional spring and the ball-screw sophisticates the system construction, possibly resulting in higher cost of the system.

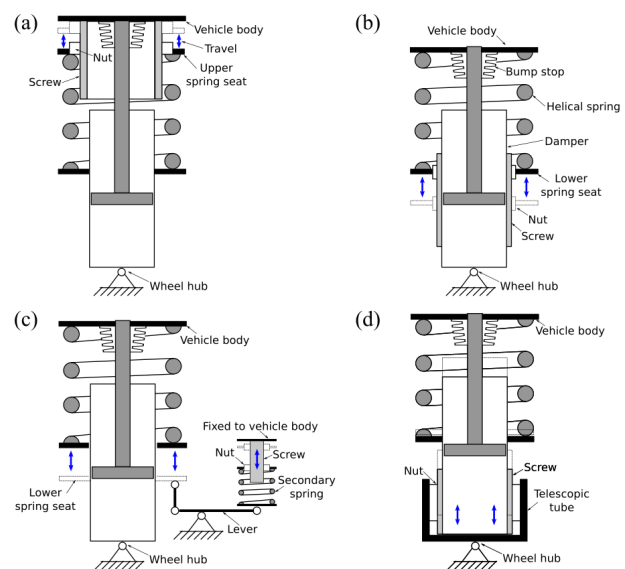

Figure 4. Electromechanical height adjustment system schematics applied to independent suspension: (a) Upper spring seat actuation; (b) Lower spring seat actuation; (c) Actuation by means of lever mechanism; (d) Shock absorber tube actuation.

Hakui T. et al.³⁴ presented a solution of a height adjustment system using electromechanical actuation. The speed reduction stage takes advantage of differential gear

principle to obtain large reduction ratio using two spur gear pairs. The actuation principle of this solution is similar to one depicted in Figure 4(a)). A small locking torque is required to provide self locking owing to the presence of the reduction stage. In this case, the locking torque is provided by shunting the electric motor windings.

Another solution patented by AUDI AG uses a ball-screw connected to an electric motor through reduction stage of gears and a nut, connected to the lower spring seat²⁸. The schematic view of the solution is shown in Figure 4(b). The clearance between a rubber bump stop and the shock absorber tube is varied by connecting the surface to the translating nut to avoid over compression of the spring during bumps. The system is less complex compared to the previously mentioned one, however, the employment of a ball-screw still increases the cost.

In patents²⁹ and³⁰, the actuator group is fixed to the vehicle body as shown in Figure 4(c). The solution described in²⁹ uses a rotary actuator with reduction gear stage and an arm to move lower spring seat. A screw-nut mechanism connected to lower spring seat by means of a leverage mechanism is used in³⁰. Self-locking feature can be included intrinsically in reduction gear stage on the electric motor shaft²⁹, in the screw-nut³⁰ or using the electric motor braking.^{29;30} The main advantage of this kind of system is the compactness. In fact, there is no need to embrace the shock absorber envelope or that of providing further amplification of the lifting force due to presence of leverage mechanism. At the same time, the presence of additional spring and lever system may lead to increased cost.

Kim et al. of Hyundai Motor Company have patented a vehicle suspension system with electronic control to adjust vehicle height in real time during cornering, braking and acceleration.^{31;32} As shown in Figure 4(d), the hollow ball-screw is fixed on the shock absorber tube and moves relatively to wheel hub in a telescopic way changing the vehicle height.³¹ The nut is connected to the output of the electric motor through a reduction gear stage and is supported by radial bearings fixed on the strut brackets of the wheel hub. The nut takes its rotation from the electric motor. The ball-screw translates along the axis of the shock absorber, changing the distance between wheel hub and the vehicle body. Similar solution is described in,³² where a grooved shaft (instead of the ball-screw in previous solution) is connected to the shock absorber tube and a roller element is guided in the groove. The stator of the motor is mounted on the strut brackets fixed on the wheel hub. Interpretation of how overhauling is avoided in the systems is not discussed in the patents. The main drawback of these systems is that

they transmit all the force flowing from the vehicle body to the wheels (and vice versa), leading to accelerated wear of the components. In addition, involvement of ad-hoc electric motor, of rollers and of additional bearings, increase the cost of the system.

An electromechanical system to adjust vehicle height applied to torsion beam suspension is described in patent³³. Usually, torsion beam suspensions are characterized by non coaxial shock absorber and spring. Therefore, actuator dimensions can be more compact compared to the case of McPherson or double wishbone suspensions as the actuator can be located inside the helical spring. As in^{29;30}, suspension coil spring is divided into two parts separated by movable spring seat to prevent the actuator system from impact loads. Different diameters of springs are used to operate in a telescopic way and make the system more compact. The stator of the electric motor slides axially on a splined surface (integrating thereby anti-rotation system). The rotor of the motor is connected to the ball-screw while the nut is fixed on a movable plate and translates axially (Figure 5). Both upper and lower spring seat actuation (Figures 5(a) and (b), respectively) can be applied in this architecture and indeed, both are mentioned in the patent.³³ The system is simple in construction and may be retrofitted to existing suspension relatively easy. However, splitting the spring into two parts may alter suspension characteristics.

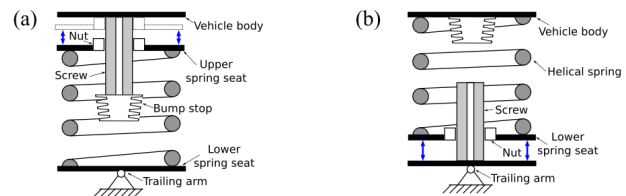

Figure 5. Electromechanical height adjustment system schematics applied to semi-independent twisted beam suspension: (a) Upper spring seat actuation and (b) Lower spring seat actuation.

The main disadvantages of the electromechanical height adjustment systems are lack of ability to vary elastic behavior and lower leveling speed. Since the former disadvantage is inherent to all the modern passive suspensions, it can be omitted. The height adjustment is required only when the driving conditions are changed, for example, from low speed city conditions to high speed highways or from smooth to rough terrains. In these cases, the leveling speed is not critical, as actuation can be performed in a larger time. The following particularities of these systems can be attributed to their advantages:

- Selection of electric motor;
- Application of current and time constraints;
- Definition of geometrical and mechanical parameters.

The power required for the system to behave as desired is the first fundamental parameter to design a power transmission system. It affects the selection of the electric motor and further components design.

The efficiency of the transmission from the shaft of the electric motor **4b** (Figure 6) to the lower spring seat **7** can be computed as:

$$\eta_{\text{total}} = \eta_{\text{sr}}\eta_s = \eta_g\eta_{\text{gb}}\eta_s \quad (1)$$

where, η_{gb} is efficiency of the gearhead **3b**, η_g is efficiency of pinion **3a** and gear reducer **3c**, and η_s is efficiency of power screw-nut mechanism (components **5a** and **5b**). Usually, η_{gb} and η_g are given in the manufacturers datasheets. The power screw efficiency can be computed as:

$$\eta_s = \frac{\tan \lambda}{\tan(\lambda + \phi)} \quad (2)$$

where ϕ is the friction angle, function of the friction coefficient f and thread angle α ($\phi = \arctan(f/\cos\alpha)$). The parameter λ is the screw lead angle and can be defined as function of the screw pitch p and its mean diameter d . For single thread power screws this angle can be computed as:

$$\tan \lambda = \frac{p}{\pi d} \quad (3)$$

The average power required from the electric motor can be computed for a given external load F_n , travel stroke u_z and actuation time t as:

$$P_{\text{req,em}} = \frac{1}{\eta_{\text{total}}} F_n \frac{u_z}{t} \quad (4)$$

Isolines of the screw efficiency η_s computed using Equation 2 are plotted in Figure 7 as a function of screw pitch and diameter. It is showing that the smaller is the screw diameter and the larger is the screw pitch, the higher is the efficiency and, as a result, the required power is smaller.

The procedure of design optimization includes finding the different pairs of d and p which satisfy all the imposed constraints. These constraints are related to the geometry and the performance of the system and can be summarized as:

1. Irreversibility $\eta_s < 50\%$
2. Geometry $d_{\text{min}} > d_{\text{tube}} + s$
3. Current $I_{\text{ss}} < I_{\text{ss,max}}$

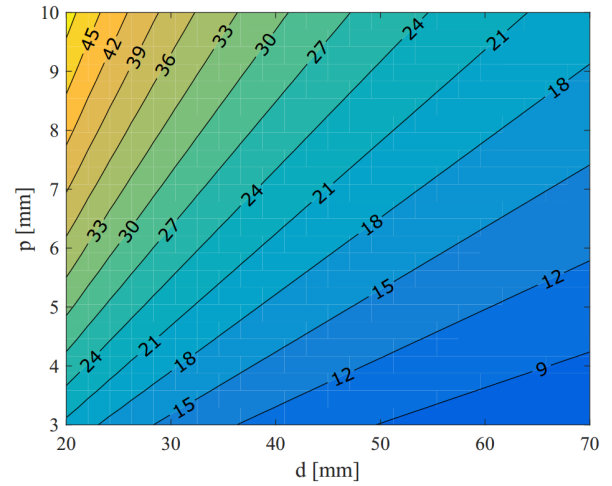

Figure 7. Isolines of screw efficiency η_s , %. Friction coefficient $f=0.2$.

4. Time (or Speed) $t_{50\text{mm}} < t_{\text{max}}$

where d_{min} is minor (root) diameter of the screw, I_{ss} is the current absorption at steady state and $t_{50\text{mm}}$ is the time to cover a given distance (in this case 50 mm).

The first constraint is related to the need of having an intrinsically irreversible actuator at the screw-nut mechanism level. To satisfy this constraint the screw efficiency η_s has to be less than 50 % that is in general the threshold of irreversibility of mechanical transmission systems. The small area indicated with number **1** in Figure 8 must be omitted from further consideration as it does not satisfy this constraint.

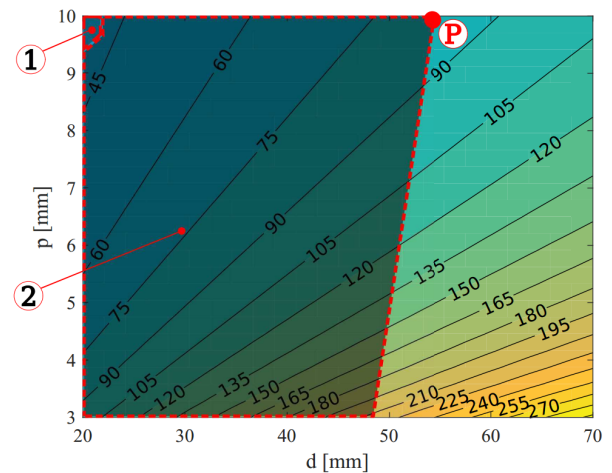

Figure 8. Isolines of required power $P_{\text{req,em}}$, W. Numbered areas are omitted due to imposed constraints (**1** - Irreversibility, **2** - Geometry). Point **P** indicates minimum power after applying the constraints.

The second constraint is related to construction issues. In order to install the screw on the shock absorber tube, the minor diameter of the screw is substantially given. This

consideration is valid for independent suspension schemes. In case of semi-independent suspensions (e. g. twisted beam) the screw can be placed separately from the damper (i.e not coaxial). Therefore, the minimum screw diameter should be defined based on admissible contact pressure developed on the screw-nut contact surface. The screw body diameter can be found as a sum of shock absorber tube diameter d_{tube} and wall diametral thickness s of the screw body. Imposing this constraint (e. g. $d_{\text{tube}} = 46.5$ mm and $s = 2$ mm), the region which does not satisfy it can be defined (the area is indicated with number **2** in Figure 8). As a result, the minimum power of the electric motor can be defined, which is indicated as point **P** in Figure 8. Values of screw pitch and nominal diameter are therefore obtained.

Based on the value of the minimum required power, industrially available electric motor can be selected or a custom one can be designed. Upon the selection of the electric motor, its characteristics (torque and speed constants, winding resistance and inductance, motor nominal speed and rotor inertia) will be defined for further system performance analysis.

The evaluation of the electric motor current absorption and the time needed to cover 50 mm distance depends on the dynamics of the electromechanical system. With reference to the scheme shown in Figure 6, a dynamic model is developed and described below.

The voltage equation for equivalent DC circuit shown in Figure 6 can be written as:

$$V_{\text{DC}} - RI - L \frac{dI}{dt} = k_e \omega_{\text{em}} \quad (5)$$

where V_{DC} is the supply voltage of the vehicle battery, R and L are resistance and inductance of winding respectively, I is the current flowing in the windings, k_e is the motor speed constant and ω_{em} is the electric motor angular velocity.

The torque balance on the electric motor shaft is:

$$k_t I = J_{\text{eq}} \dot{\omega}_{\text{em}} + T_r \quad (6)$$

where k_t is the motor torque constant, J_{eq} is the equivalent moment of inertia of rotating and translating elements, $\dot{\omega}_{\text{em}}$ is the angular acceleration of electric motor shaft and T_r is the resistant torque due to load F_n , reported on the electric motor shaft.

The equivalent rotational inertia J_{eq} is:

$$J_{\text{eq}} = J_{\text{em}} + J_{\text{gb}} + \frac{J_p}{i_{\text{gb}}^2} + \frac{J_n}{i_{\text{gb}}^2 i_g^2} + \frac{m}{i_{\text{gb}}^2 i_g^2 i_s^2} \quad (7)$$

where J_{em} is the electric motor shaft inertia, J_{gb} is the gearbox inertia, J_p is the pinion inertia, J_n is the nut inertia

and m is the corner mass. i_{gb} , i_g and i_s are the speed reduction ratios of the gearbox, of the parallel axis gear stage and of the screw-nut mechanism, respectively.

Similarly, the resistant torque reported at the electric motor shaft is:

$$T_r = \frac{F_n}{i_{\text{gb}} i_g i_s \eta_{\text{total}}} \quad (8)$$

To write Equations 5 and 6 in a matrix form, the system states and inputs has to be defined. The states of the system are motor shaft angular speed ω_{em} and angular displacement θ_{em} , and current I . The inputs are supply voltage V_{DC} and resisting torque T_r . Then, the matrix form is:

$$\{\dot{x}\} = [A]\{x\} + [B]\{u\} \quad (9)$$

and in particular:

$$\begin{Bmatrix} \dot{\omega}_{\text{em}} \\ \omega_{\text{em}} \\ \dot{I} \end{Bmatrix} = \begin{bmatrix} 0 & 0 & \frac{k_t}{J_{\text{eq}}} \\ 1 & 0 & 0 \\ -\frac{k_e}{L} & 0 & -\frac{R}{L} \end{bmatrix} \begin{Bmatrix} \omega_{\text{em}} \\ \theta_{\text{em}} \\ I \end{Bmatrix} + \begin{bmatrix} 0 & -\frac{1}{J_{\text{eq}}} \\ 0 & 0 \\ \frac{1}{L} & 0 \end{bmatrix} \begin{Bmatrix} V_{\text{DC}} \\ T_r \end{Bmatrix} \quad (10)$$

The angular displacement of electric motor θ_{em} can be translated to a linear displacement u_z of the nut considering transmission in between these two elements as:

$$u_z = \frac{\theta_{\text{em}}}{i_{\text{gb}} i_g i_s} \quad (11)$$

where speed reduction ratio i_s of the power screw-nut mechanism can be found using Equation 12:

$$i_s = \frac{2\pi}{p} \quad (12)$$

While the speed reduction ratio of the power screw mechanism is defined using Equation 12, the total reduction ratio of the speed reducer i_{sr} is unknown in Equations 7, 8 and 11. To define it, kinematic link between motor and load can be used. In this case, nominal speed of the motor $\omega_{\text{em,nom}}$ is given in motor specification sheets and linear speed of the system can be derived from requirements (for example speed required to cover 50 mm in 12 s). The equation to define the total reduction is therefore defined from Equations 11 and 12:

$$i_{\text{sr}} = i_{\text{gb}} i_g = \frac{\omega_{\text{em,nom}} t}{u_z i_s} \quad (13)$$

Once i_{sr} is defined, values for i_{gb} and i_g are defined depending on geometrical constraints keeping their product constant and equal to i_{sr} .

Based on above considerations, the optimization procedure can proceed further. By selecting a range of values for screw pitch ($p = p_i$) and mean diameter ($d = d_j$), performing loop cycle all the dependent variables of interest can be computed in the following order:

1. $i_s(i) = 2\pi/p(i)$
2. $i_{\text{total}}(i) = i_g i_{\text{gb}} i_s(i)$
3. $\eta_{\text{total}}(i, j) = \eta_{\text{gb}} \eta_g \eta_s(i, j)$
4. $J_{\text{eq}}(i) = J_{\text{em}} + J_{\text{gb}} + J_p/i_{\text{gb}}^2 + J_n/[i_{\text{gb}} i_g]^2 + m/[i_{\text{gb}} i_g i_s(i)]^2$
5. $T_r(i, j) = F_n/[i_{\text{gb}} i_g i_s(i) \eta_{\text{total}}(i, j)]$

The dynamic model for the electromechanical system described above, runs simultaneously inside the same loop in order to compute the current $I_{\text{ss}}(i, j)$ and the actuation time $t_{50\text{mm}}(i, j)$.

The third constraint refers to a limitation on the electrical power. The steady state current I_{ss} flowing through the electric motor windings has to be smaller than a limit value $I_{\text{ss,max}}$. The latter is set based on maximum current capabilities of the electrical machine and its control board.

The fourth constraint affects J values of both mechanical and electrical parameters. The actuation time is an important design parameter for an height adjustment system, especially in case of active suspensions. The required power is substantially affected by this value. If the travel u_z is considered to be equal to 50 mm, then time to cover this distance $t_{50\text{mm}}$ has to be less than imposed limit t_{max} .

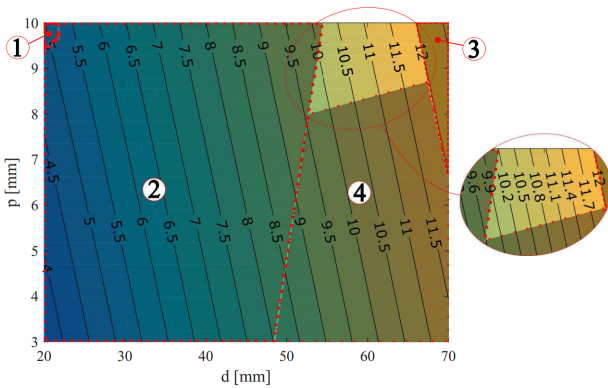

Figure 9. Current isolines, A. Numbered areas are omitted due to imposed constraints: (1 - Irreversibility, 2 - Geometry, 3 - Maximum current absorption, 4 - Maximum actuation time).

Figures 9 and 10 show the steady state current and the actuation time, respectively, when all four constraints are imposed (numbers indicate constraints). Current absorbed by electric motor increases mainly with the increase of mean screw diameter and is less influenced by change of screw pitch (Figure 10). On the contrary, the actuation time is less influenced by the mean screw diameter, but the effect of

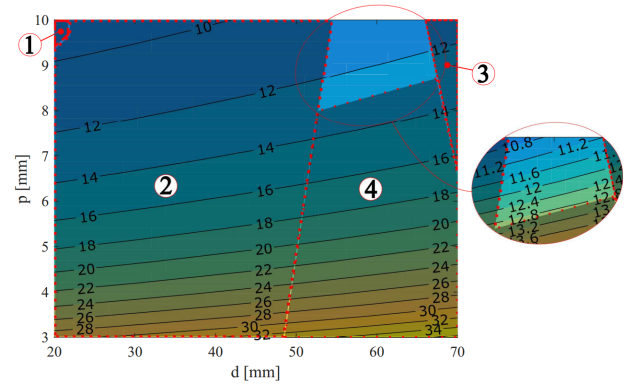

Figure 10. Actuation time isolines, s. Numbered areas are omitted due to imposed constraints: (1 - Irreversibility, 2 - Geometry, 3 - Maximum current absorption, 4 - Maximum actuation time).

screw pitch is more evident (Figure 10). A larger pitch causes a reduction on the actuation time due to an increment of the screw transmission ratio i_s .

Experimental validation

To evaluate the potentiality of using height adjustment systems in the vehicle and to validate the proposed methodology has been adopted to design an electromechanical height adjustment system integrated in a compact vehicle with front McPherson strut and rear twisted beam suspensions. The main design choices were: (1) Retrofit capability of the system; (2) Use of power screw - nut mechanism to intrinsically obtain the system irreversibility and (3) Low cost of the system.

Prototypes of actuators for front and rear suspension

The design methodology was followed to define the optimal values of the system parameters. The main input data for the optimization procedure are reported in Appendix A1. For the front suspension, the minimum power to lift the load $F_n = 3700\text{ N}$ to the distance $u_z = 50\text{ mm}$ in $t = 13\text{ s}$ with the shock absorber tube diameter $d_{\text{tube}} = 46.5\text{ mm}$ can be calculated using the Equation 4. The point **P** in Figure 8 shows that this power is about 83 W. It can be obtained at point where screw pitch $p = 10\text{ mm}$ and diameter $d = 53.5\text{ mm}$. One possible off the shelf motor is Maxon brushed DC RE35 with 90 W nominal power.³⁵ This motor was selected with consequent modification of the screw pitch to $p = 8\text{ mm}$ (hence, d is decreased to 52.5 mm). Similarly, the main specifications of the actuator unit for the rear suspension applying the load $F_n = 2500\text{ N}$ was defined (see Appendix A1). The minimum diameter of the screw in this case was 25 mm, defined by admissible contact pressure developed on the screw thread surface. Maxon brushed DC RE30 with 60 W nominal power was chosen to actuate the rear system.

Based on the initial data and imposed constraints, the design parameters of the systems have been defined. The Appendix A2 shows the values for these parameters. Four prototypes (two for each axle) then have been built.

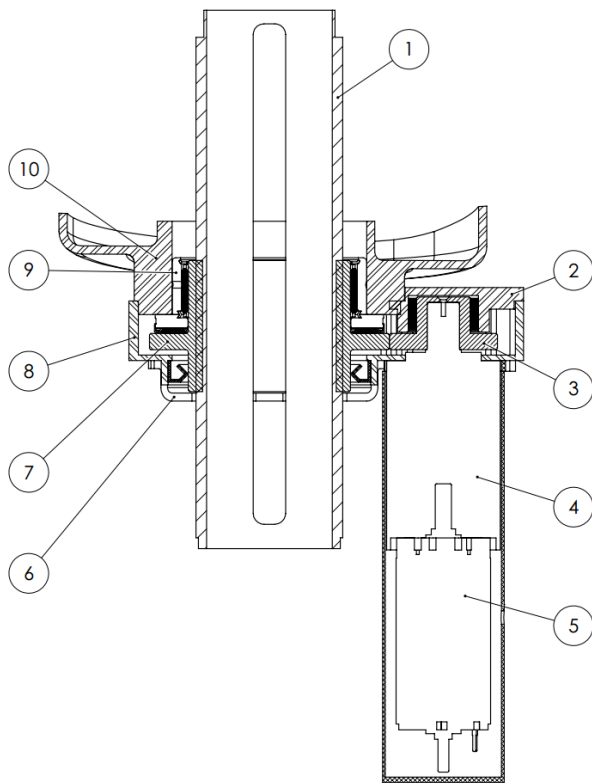

Figure 11. Section view of the front actuator assembly. 1 - Power screw, 2 - Casing cover, 3 - Pinion, 4 - Planetary gearhead, 5 - DC motor, 6 - Anti rotation element, 7 - Integrated gear and nut, 8 - Actuator casing, 9 - Compound bearing and 10 - Lower spring seat.

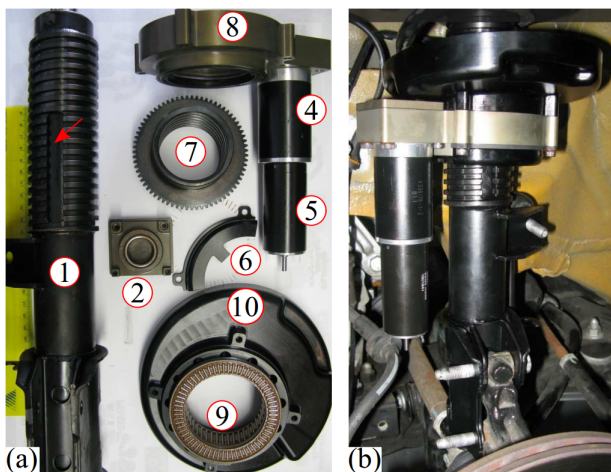

Figure 12. Experimental prototype of the front actuator: (a) components and (b) its integration in the front suspension.

Figures 11 and 12 show, respectively, a section view of the electromechanical actuator and its integration in the vehicle front suspension. The power screw 1 consists of a hollow cylindrical body with trapezoidal threads, fitted and welded on the shock absorber tube (see Figure 12(b)). The DC

electric motor 5 transmits the torque to the pinion 3 by means of a three stage Maxon GP42C planetary gearhead 4. The pinion 3 is mounted on the motor casing cover 2 and is supported radially by a needle bearing to reduce the friction losses (for industrialized solution low friction bushings can be used). The pinion (has 32 teeth) is engaged with part 7 which integrates the nut (inner part of the component) and gear (outer part, has 71 teeth). The rotation of the nut 7 is transformed in axial displacement of the lower spring seat 10. To decouple the rotation of the gear 7 and the lower spring seat 10, a combined radial and thrust bearing 9 is installed between them. A tooth sliding in a groove of the power screw works as an anti-rotation. It prevents unwanted rotation of the system due to reactive torque during the actuation.

Figures 13 and 14 show a section view of the electromechanical actuator and its integration in the vehicle rear suspension. The power screw 1 is fixed on the interface 9 welded to the longitudinal rail of the chassis close to luggage compartment. The DC electric motor 11 transmits torque to the pinion gear 8 by means of three stage Maxon GP32C planetary gearhead 10. The pinion 8 is installed in the motor casing cover 4 (integrated with upper spring seat) and by a needle bearing to reduce the friction losses. The pinion (32 teeth) is engaged with part 3 including the nut (inner part of the component) and the gear (outer part, 71 teeth) of final stage. The rotation of the nut 7 is, in this case, transformed into translation of the upper spring seat 4. A combined bearing 5 decouples the rotation of the gear 3 and the upper spring seat 4. Two anti-rotation elements 7 attached to the casing 5 slide along the groove of the power screw to prevent unwanted rotation of the system due to reactive torque.

The prototypes were assembled on front (Figure 12(b)) and rear (Figure 14(b)) axles of an A segment, 4x4 vehicle.

Five electronic control boards based on Freescale micro-controllers have been used to control the four corners individually. Four of them act as slave boards equipped with an H-bridge and current sensors, to measure current on each corner. One master board has been connected via CAN Bus to manage the slave boards. On the front suspensions ON/OFF switches were installed to limit the travel of actuators. Instead, on the rear suspensions this function is realized by means of mechanical end stops. The height of the vehicle was measured by means of one rotational sensor per each corner. The required position was set by the driver manually on the control panel. In this prototype, the vehicle height could be continuously varied (depending on the need of the driver) and no specific mission profile was defined. A

total stroke of 70 mm was obtained (lifting by 20 mm and lowering by 50 mm).

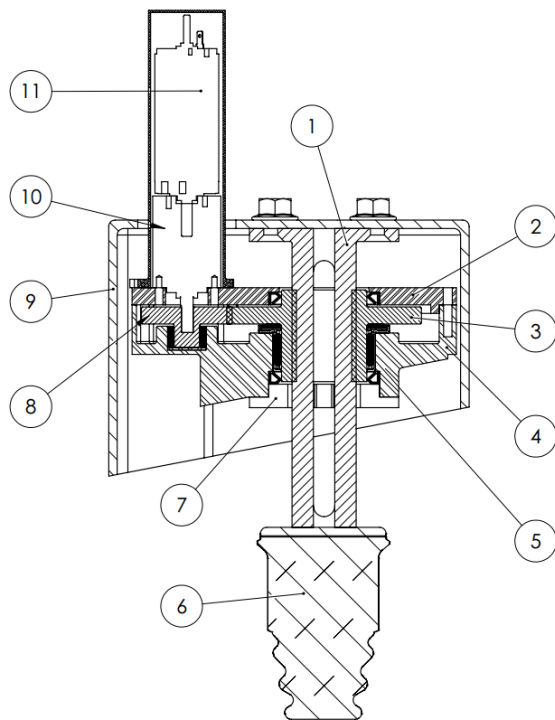

Figure 13. Section view of the rear actuator assembly. 1 - Power screw, 2 - Casing cover, 3 - Integrated gear and nut, 4 - Casing of the actuator (combined with upper spring seat), 5 - Compound bearing, 6 - Bump stop, 7 - Anti rotation element, 8 - Pinion, 9 - Chassis interface, 10 - Planetary gearhead and 11 - DC motor.

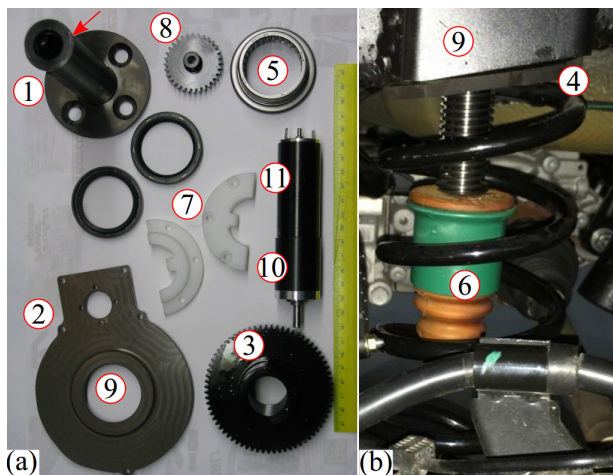

Figure 14. Experimental prototype of the rear actuator: (a) components and (b) its integration in the rear suspension.

Tests for performance validation

Broad tests were carried out on the both front and rear suspensions to assess the system functionality and performance. Figures 15 and 16 show the required values of current to lower and lift the vehicle. Mean values of measured currents show good correspondence with

numerical calculations, when the value of friction coefficient $f = 0.2$ is used. However, lower value of friction coefficient was expected due to lubrication and thread surface coating. The performance of the front and rear systems are summarized in Table 2. Figure 15 shows that the steady current I_{ss} to lower the vehicle for the front actuator is about 9.3 A compared with 6.5 A of the rear actuator. By converse, to lift the vehicle the front actuator requires around 11 A and the rear one 9.3 A (Figure 16). The average power required to lower the front suspension is around 117 W and for the rear 80 W. To lift the vehicle the front actuator requires 140 W and the rear 117 W. In average to perform a cycle the total height adjustment system requires around 500W of power.

EC Regulation No 443/2009 suggests procedure to convert required power of accessories to CO₂ emissions.¹⁵ Assuming an average power of 500 W required to lift and lower the vehicle, the efficiency of the standard alternator equal to 67% and considering the time to perform one cycle of height adjustment equal to 30 s (15 s to lift and the same for to lower) the emission of CO₂ per cycle can be calculated. The result is 3.83 g of CO₂ emitted in one actuation cycle. For an NEDC cycle with around 11 km of total distance, assuming one cycle of height adjustment actuation, then the emission will be 0.35 gCO₂/km. This number is useful to define the mission profile of height adjustment system to maximize potential benefits of using such systems.

To check the irreversibility of the system the road tests were performed. The vehicle was driven at constant speed (30 km/h) on roads with different pavement conditions (including speed bumps). During these tests the system represented total irreversibility, as it was expected.

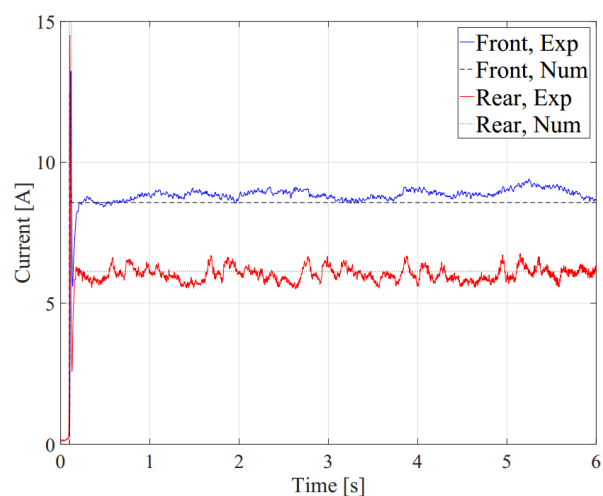

Figure 15. Current absorption to lower the vehicle measured at inputs of front and rear actuators.

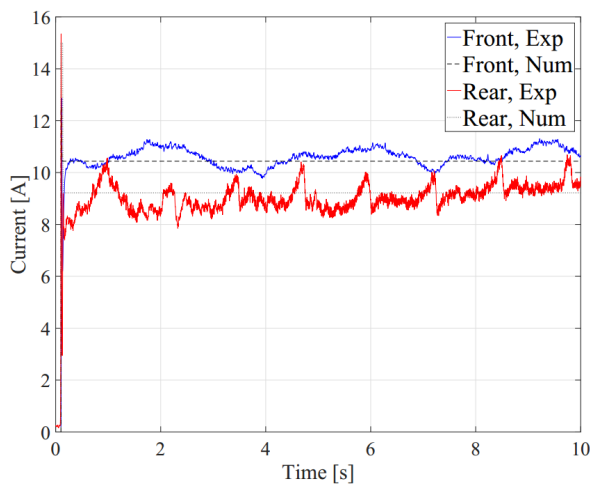

Figure 16. Current absorption to lift the the vehicle measured at inputs of front and rear actuators.

Table 2. The main specifications of the front and rear systems.

Parameters	FRONT	REAR
Mass of the system, kg	2.2	2.1
Dimensions LxWxH, mm	190x140x225	152x100x372
Current to lower, A	9.3	6.5
Current to lift, A	11	9.3
Power to lower, W	117	80
Power to lift, W	140	117
Lowering speed, mm/s	2.7	3.7
Lifting speed, mm/s	1.5	3.2
Total power to lower W:	395	
Total power to lift W:	520	

Conclusions and future work

Height adjustment systems are able to offer not negligible reductions of fuel consumptions and emissions when applied to passenger vehicles. The modification of the vehicle road clearance can introduce benefits up to about 4% of reduced CO₂ emitted with respect to the normal production configuration. In this paper, a literature review regarding different height adjustment technologies has been largely described. The focused attention on height adjustment systems of the electromechanical kind is motivated by the need of meeting functional and economic aspects (high reliability, robustness and compact size vs. low costs of manufacturing). Nevertheless, the literature does not deal with design and optimization issues. To this end, with the aim of optimize the main system parameters while meeting different nature constraints, a design methodology for electromechanical height adjustment systems has been presented. Particular attention has been devoted to its adaptability to different suspension schemes. Based on the described methodology, prototypes for front and rear axle suspensions have been manufactured and installed on a real vehicle. The performed experimental tests highlighted

the low power absorption of such systems, which leads to the possibility of actuating the four corners together. This is the one of the main features of the electromechanical height adjustment systems compared with the hydraulic or the pneumatic ones, where only one axle at a time can be supplied due to power limitations of vehicle battery. In addition, critical issues have also been identified. The anti-rotation system represents a crucial component. For further investigations it will be more advantageous if this feature could be intrinsically present in the system, for example by eccentrically mounting the screw-nut mechanism with respect to the spring seat.

Acknowledgements

The authors would like to thank Ing. Michele Ieluzzi and Ing. Patrizio Turco for providing necessary data during the design process and Dr. Fabrizio Impinna of FLAG-MS for development of the control board and giving support in performing the experimental tests.

References

1. International Energy Agency. Key trends in CO₂ emissions. Excerpt from: CO₂ emissions from fuel combustion (2015 Edition), IEA, 2015
2. European Commission. Reducing CO₂ emissions from passenger cars, http://ec.europa.eu/clima/policies/transport/vehicles/cars/index_en.htm (accessed 11 February 2016).
3. Ott T, Onder C, Guzzella L. Hybrid-electric vehicle with natural gas-diesel engine. *Energies*. 2013 Jul 18;6(7):3571-92.
4. Gabriel-Buenaventura A, Azzopardi B. Energy recovery systems for retrofitting in internal combustion engine vehicles: A review of techniques. *Renewable and Sustainable Energy Reviews*. 2015 Jan 31;41:955-64.
5. Genta G, Morello L. *The Automotive Chassis: Volume 2: System Design*. Springer Science & Business Media; 2008 Dec 26.
6. Howell J, Sherwin C, Passmore M, Le Good G. Aerodynamic Drag of a Compact SUV as Measured On-Road and in the Wind Tunnel. SAE Technical Paper 2002-01-0529, 2002 Mar 4.
7. European Automobile Manufacturers Association. 4x4 Penetration. <http://www.acea.be/statistics/article/share-of-new-cars-4x4s>. (2016, accessed 18 November 2016)
8. Savaresi SM, Poussot-Vassal C, Spelta C, Sename O, Dugard L. *Semi-active suspension control design for vehicles*. Elsevier; 2010 Aug 13.

9. Bauer W. Hydropneumatic suspension systems. Springer Science & Business Media; 2010 Dec 7.
10. Karnopp D, Crosby MJ, Harwood RA. Vibration control using semi-active force generators. *Journal of Engineering for Industry*. 1974 May 1;96(2):619-26.
11. Karnopp D. Active damping in road vehicle suspension systems. *Vehicle System Dynamics*. 1983 Dec 1;12(6):291-311.
12. Karnopp D. Force generation in semi-active suspensions using modulated dissipative elements. *Vehicle System Dynamics*. 1987 Jan 1;16(5-6):333-43.
13. Karnopp D. Active suspensions based on fast load levelers. *Vehicle System Dynamics*. 1987 Jan 1;16(5-6):355-80.
14. Altieri L. Electric and Hybrid Vehicles With Two Prime Movers. Doctoral dissertation, Politecnico di Torino, Italy, 2013.
15. European Commission. Technical Guidelines for the preparation of applications for the approval of innovative technologies pursuant to Regulation (EC) No 443/2009 of The European Parliament and of the Council. February 2013. Brussels.
16. Strassberger M, Guldner J. BMW's dynamic drive: an active stabilizer bar system. *IEEE control systems*. 2004 Aug;24(4):28-9.
17. van der Westhuizen SF, Els PS. Slow active suspension control for rollover prevention. *Journal of Terramechanics*. 2013 Feb 28;50(1):29-36.
18. Sahn D, Von Scarpatti D, Karnopp DC, Beard D, inventors; Daimler-Benz Ag, assignee. Motor vehicle suspension system. United States patent US 5,401,053. 1995 Mar 28.
19. Wirtz J, Luncz H, inventors; Mercedes-Benz AG, assignee. Height adjusting shock absorber strut for a motor vehicle. United States patent US 5,810,335. 1998 Sep 22.
20. Merker T, Girres G, Thriemer O. Active body control (ABC) the DaimlerChrysler active suspension and damping system. SAE Technical Paper 2002-21-0054; 2002 Oct 21.
21. van der Knaap AC, inventor; Bayerische Motoren Werke Aktiengesellschaft, assignee. Active chassis of a vehicle. United States patent US 7,611,152. 2009 Nov 3.
22. http://www.zf.com/na/content/media/united_states/sachs_1/products_3/Nivomat.pdf (accessed 02 December 2015).
23. Hirose M, Matsushige S, Buma S, Kamiya K. Toyota electronic modulated air suspension system for the 1986 Soarer. *IEEE Transactions on industrial electronics*. 1988 May;35(2):193-200.
24. Tener DR. Overcoming the Ride/Handling Compromise-A Cockpit Adjustable Suspension System. SAE Technical Paper 2004-01-1078; 2004 Mar 8.
25. Jeep Grand Cherokee. <http://www.jeep.com/en/grand-cherokee/capability/> (accessed 02 December 2015).
26. BMW Self-levelling suspension. http://www.bmw.com/com/en/insights/technology/technology_guide/articles/self_levelling.html (accessed 27 November 2015).
27. Michel W, inventor; Audi, Ag, assignee. Strut for a wheel suspension of motor vehicles. United States patent US 8,205,864. 2012 Jun 26.
28. Michel W, inventor; Audi Ag, assignee. Height adjustment on a wheel suspension for motor vehicles. United States patent US 7,784,800. 2010 Aug 31.
29. Michel W, inventor; Audi Ag, assignee. Wheel suspension for motor vehicles. United States patent US 8,317,003. 2012 Nov 27.
30. Michel W, inventor; Audi Ag, assignee. Radaufhngung fr Kraftfahrzeuge. European patent EP 2 199 121 B1. 2012 Jan 18.
31. Kim JM, Jang SB, Kim BM, Ko DS, inventors; Hyundai Motor Company, assignee. Electronic control suspension system for vehicles. United States patent US 8,833,775. 2014 Sep 16.
32. Kim JM, Jang SB, Kim BM, Ko DS, inventors; Hyundai Motor Company, assignee. Electronic control suspension system for vehicles. United States patent US 8,844,943. 2014 Sep 30.
33. Ohki T, inventor; Nissan Motor Co., Ltd., assignee. Apparatus for adjusting vehicle height. United States patent US 7,237,780. 2007 Jul 3.
34. Hakui T, Hirata H, Kajiwara H, Nakajima K, Akuta Y, Hatano K, inventors; Honda Motor Co., Ltd., assignee. Vehicle height adjusting system. United States patent US 7,922,181. 2011 Apr 12.
35. Product specifications. <http://www.maxonmotor.com/maxon/view/product/273752> (accessed 20 June 2016).

Appendix

Table A1. The main specifications of the system.

Parameters	Symbol	Unit	FRONT	REAR
Initial data				
Mass to lift	m	kg	370	240
Load to lift	F_n	N	3700	2500
Friction coefficient	f	—	0.2	0.2
Imposed constraints				
Irreversibility	η_{total}	%	≤ 50	≤ 50
Shock absorber tube diameter	d_{tube}	mm	46.5	NA
Absorbed current	I_{ss}	A	12	12
Time to cover 50mm	t	s	13	13

Table A2. System parameters obtained by design methodology.

Parameters	Symbol	Unit	FRONT	REAR
Power screw				
Thread angle (Acme)	α	$^\circ$	14.5	14.5
Pitch	p	mm/rev	8	4
Nominal diameter	d	mm	53	27.5
Electric motor				
Nominal power	P_{em}	W	90	60
Nominal torque	T_{em}	Nm	73.1e-3	51.6e-3
Nominal speed	ω_n	r/min	6500	7630
Winding inductance	L	H	85e-6	34.5e-6
Winding resistance	R	Ohm	0.314	0.196
Torque constant	k_t	Nm/A	0.0195	0.0139
Speed constant	k_e	V/rad	0.0195	0.0139
Rotor inertia	J_{em}	kgm ²	68.1e-7	33.7e-7
Speed reducer				
Gearbox ratio	i_{gb}	—	81:1	51:1
Gearbox efficiency	η_{gb}	%	72	72
Gearbox inertia	J_{gb}	kgm ²	9.4e-7	0.7e-7
Final gear ratio	i_g	—	2.22:1	2.21
Final gear efficiency	η_g	%	95	95
Pinion inertia	J_p	kgm ²	13e-7	20e-7
Gear and nut group inertia	J_n	kgm ²	483e-6	480e-6