



POLITECNICO DI TORINO  
Repository ISTITUZIONALE

Fault Current Detection and Dangerous Voltages in DC Urban Rail Traction Systems

*Original*

Fault Current Detection and Dangerous Voltages in DC Urban Rail Traction Systems / Pons, Enrico; Tommasini, Riccardo; Colella, Pietro. - In: IEEE TRANSACTIONS ON INDUSTRY APPLICATIONS. - ISSN 0093-9994. - STAMPA. - 53:4(2017), pp. 4109-4115.

*Availability:*

This version is available at: 11583/2679613 since: 2020-01-20T12:21:10Z

*Publisher:*

IEEE

*Published*

DOI:10.1109/TIA.2017.2692202

*Terms of use:*

openAccess

This article is made available under terms and conditions as specified in the corresponding bibliographic description in the repository

*Publisher copyright*

(Article begins on next page)

# Fault Current Detection and Dangerous Voltages in DC Urban Rail Traction Systems

Enrico Pons, *Member, IEEE* Riccardo Tommasini, *Member, IEEE* and Pietro Colella, *Member, IEEE*

Dipartimento Energia - Politecnico di Torino

Torino, 10129, ITALY

Email: enrico.pons@polito.it

**Abstract**—In this paper the electrical safety of DC urban traction systems is analysed, with particular focus on fault current detection and on dangerous voltages which could arise in case of fault. For the discussion the tram network of Turin, Italy, is used as a case study. Firstly the structure of the DC traction power supply is described, analysing in detail the different components; then the safety of the system is analysed, examining possible types of fault. In particular, ground faults inside the substation and ground faults along the line are analysed in detail. Fault currents and dangerous voltages are calculated thanks to a simplified steady-state circuital model of the traction system. Finally, the consequent risks for the people are examined and some conclusions and possible solutions are presented.

## I. INTRODUCTION

Urban DC traction systems are common mass transport systems employed in many towns worldwide. The terminology used to identify them may vary, the most common terms being: light rail, street car, tram or trolley. We can consider these terms as synonyms.

The Traction Electrification System (TES) for trams is usually constituted by:

- power substations, containing transformers, AC/DC converters and protective devices;
- an Overhead Contact System (OCS);
- positive feeder cables, connecting the OCS with the positive busbars in the substations;
- negative return conductors, collecting the return current from the rails and bringing it back to the negative busbar in the substation.

The difficulty of protection of DC urban tram systems was studied by the authors in a previous work [1] and is due to the problem of distinguishing a fault current from the currents related to the normal operation, mainly because of the following factors:

- fault currents can be small, due to high impedance ground faults, or due to the position of the fault, which can happen along the line and far away from the substation;
- the tram networks were designed for trams driven by DC motors. Modern trams are instead driven by asynchronous motors, fed by the DC OCS through IGBT DC/AC converters; these trams have completely different absorbed current profiles during acceleration and much higher peak values;
- in standard heavy rail systems the lines are divided in straight sections, and in each section, for safety reasons,

only a few trains are allowed to run at the same time; in urban tram systems, instead, the network is meshed, and also the sections are meshed: many trams can be running at the same time inside the same section, resulting in higher currents and complex current profiles in normal operation.

For these reasons, using standard protection principles, such as instantaneous and time-delayed over-current protections is not sufficient. Different studies have been performed on innovative protection schemes for TES [2], [3], but are mainly focused on railway systems that, as said before, are quite different from tram systems.

Moreover, the risk due to electric hazards in these tram systems, running along public urban streets, is higher than in normal rail systems running on separate rights of way, without public access and with mostly straight sections [4], because of the presence of the public in strict contact with the TES, possibly exposed to dangerous voltages in case of fault.

In Europe the main requirements for what concerns electrical safety in traction systems are provided by Standards EN 50122-1 *Railway applications - Fixed installations - Electrical safety, earthing and the return circuit. Part 1: Protective provisions against electric shock* [5] and EN 50122-2 *Railway applications - Fixed installations - Electrical safety, earthing and the return circuit. Part 2: Provisions against the effects of stray currents caused by d.c. traction systems* [6]. The main problems covered in these Standards are:

- protective provisions against indirect contact and impermissible rail potential;
- stray currents and rail to earth conductance.

The two objectives of reducing both stray currents and dangerous voltages in case of fault are contrasting, and the results depend on the choices regarding the grounding of the different elements of the TES [7], [8].

Object of this paper is the analysis of the electrical safety of DC urban traction systems, with particular focus on fault current detection and on the dangerous voltages which could arise in case of fault. For the discussion the tram network of Turin, Italy, is used as a case study.

The rest of this paper is organized as follows: firstly, in Section II, the structure of the DC traction power supply is described, with reference, in particular, to the Turin tram network; then the safety of the system is analyzed in Section III, examining possible types of fault, fault currents, dangerous

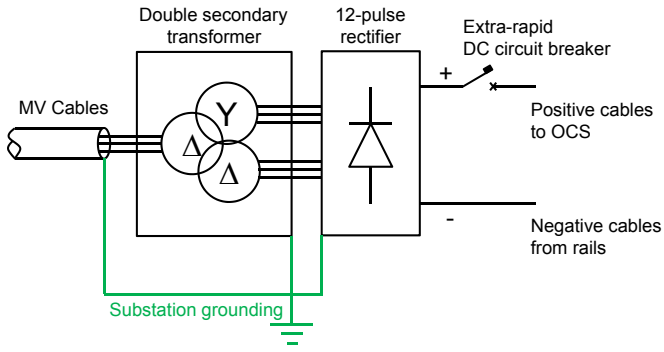

Fig. 1. Power substation for DC traction.

voltages and consequent risks for the people. A simplified circuital model of the system is presented in Section IV. Finally, the results are described in Section V and some conclusions are presented.

## II. STRUCTURE OF THE DC TRACTION POWER SUPPLY

Fig. 1 presents the typical scheme of a substation feeding the DC traction system. MV cables connect the substation to the rest of the urban MV distribution network. A double secondary transformer lowers the voltage to 470 V and feeds a 12 pulse rectifier. The output nominal voltage is 600 V DC.

Each substation can feed 6 or 7 OCS zones: every zone is fed through positive cables and is protected by an extra-rapid DC circuit breaker. The over-current settings of the circuit breakers can vary in the range between 3000 A and 4500 A, depending on the size of the zone and on the forecasted number of vehicles in it.

The negative cables allow the current return to the rectifier, connecting it to the rails. While the OCS is divided in zones, and each zone is fed by only one substation at a time, the rails and negative cables constitute a unique meshed city-wide network. The negative cables are not connected to the substation grounding system, in order to limit the stray currents dispersed by the rails into the ground.

In the tram network in Turin, the positive feeder and negative cables have a typical cross section of 1000 mm<sup>2</sup> (1974 kcmil), while the OCS has a cross section of 95 mm<sup>2</sup> (187 kcmil).

## III. SAFETY OF DC TRACTION SYSTEMS

Different types of faults can happen on the DC urban rail traction systems, among which (Fig. 2):

- 1) ground fault in the substation; it can happen because of a fault on the DC side of the converter or in the DC switchboard, involving the exposed conductive parts (ECPs) that are connected to the grounding system of the substation;
- 2) short circuit in the substation;
- 3) fault to a pole (to ground) along the line; the fault to a pole in the tram system is very unlikely, as all the elements used to hold up the the OCS are made of insulating materials (e.g. parafil ropes), but if the fault happens it constitutes a ground fault because the poles

are not connected to each other and are not connected to the return circuit;

- 4) short circuit along the line (can happen on a vehicle or through a metallic structure connected to the return circuit);
- 5) ground fault along the line (can happen on a vehicle).

When a short circuit happens in the substation, the fault current magnitude will be high enough to make the extra-rapid circuit breaker trip. But in case the short circuit happens outside the substation, for example on a vehicle, or in case a ground fault happens, the current would be limited by the circuit resistances, resulting in a current comparable with normal operation ones. In this case dangerous voltages can last for long periods without any maximum current protection intervention. For this reason new, and more sophisticated, relays are being installed, and should be properly set in order to recognize fault currents. An interesting possibility, that needs to be studied in detail, is the setting of a rate-of-rise threshold for the overcurrent protection. This rate-of-rise threshold must be properly optimized in order to reduce as much as possible nuisance tripping and to expand fault detection range [9].

In general, the workers can be subject to risk of electric shock inside the substation, and people outside the substation, in case a fault is not recognized and interrupted in a time interval shorter than that allowed by Standard EN 50122-1 section 9.3.2.2 [5]. The maximum permissible effective touch voltages  $U_{te,max}$  in d.c. traction systems as a function of time duration are reported in Table I. As it can be seen, if the circuit breaker does not trip, the maximum permissible effective touch voltage is 120 V. If, instead, the circuit breaker recognizes the fault and trips, permissible voltages must be analyzed depending on the fault duration (i.e. on the magnitude of the fault current and on the circuit breaker characteristic trip curve).

For short-term conditions Standard EN 50122-1 considers an additional resistance of 1000 Ω for the calculation of the effective touch voltage. This assumption considers the presence of shoes and, moreover, that the probability of danger is very small within time intervals of less than 1 s. For this reason, if the time duration of the fault is below 0.7 s the permissible effective touch voltages are much higher.

In this paper the focus is on ground faults, inside the substation (fault 1) and along the line (fault 5).

The other types of faults presented in Fig. 2 are not considered in this work, for the following reasons:

- fault 2, the short circuit inside the substation, will certainly trigger the extra-rapid circuit breaker;
- fault 3, the fault to a pole along the line, can be considered equivalent to fault 5, which is analyzed here;
- fault 4, a distant bolted fault, should produce a fault current high enough to trigger the extra-rapid circuit breaker. In case of arcing faults the current magnitude could be smaller than the setting of the extra-rapid circuit breaker. This case is however complicated, and requires a dedicated study.

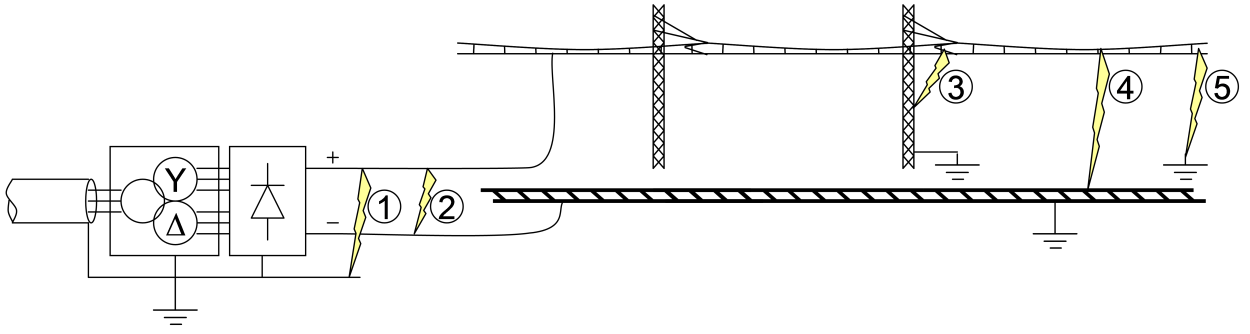

Fig. 2. Possible faults on DC traction systems.

TABLE I  
MAXIMUM PERMISSIBLE EFFECTIVE TOUCH VOLTAGES  $U_{te,max}$  IN D.C.  
TRACTION SYSTEMS AS A FUNCTION OF TIME DURATION

$t$ s	$U_{te,max}$ long-term V	$U_{te,max}$ short-term V
> 300	120	-
300	150	-
1	160	-
0.9	165	-
0.8	170	-
0.7	175	-
< 0.7	-	350
0.6	-	360
0.5	-	385
0.4	-	420
0.3	-	460
0.2	-	520
0.1	-	625
0.05	-	735
0.02	-	870

**Key**  
 $t$  time duration  
 $U_{te,max}$  permissible effective touch voltage

#### IV. CIRCUITAL MODEL OF THE TRACTION ELECTRIFICATION SYSTEM

In order to study fault currents and dangerous voltages, a simplified steady-state model of the TES has been developed, based on literature review and on experimental measurements. In the following sections the models for rails, rectifier and substation grounding system are presented. Finally a simplified fault circuit is described.

##### A. Rails model

Rails can be modelled as a distributed parameters line (Fig. 3), with a longitudinal resistance  $r$  and a shunt conductance to ground  $g$ . For railway tracks with open formation, many studies report typical values for the required parameters [10], [11]. For rails with closed formation (typical of urban traction systems) a few data can be gathered from literature (some data can be found in [12] but the provided range

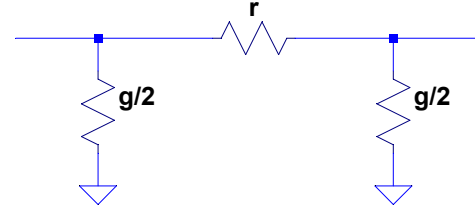

Fig. 3. Pi model of rails track.

TABLE II  
RAIL TO GROUND CONDUCTANCE - MEASUREMENT RESULTS

Rail section	Section length [m]	$g$ [S/km]
1	45	1.48
2	300	2.03
3	85	1.58
4	240	1.77

for  $g$  values is quite wide). The longitudinal parameter can be evaluated knowing the cross section of the rails and the resistivity of the constitutive material. For the rails in Turin, it was calculated  $r = 0.013 \Omega/km$ . For what concerns the conductance to ground, four measurements were performed on four short sections of rails, not used any more and disconnected from the rest of the network. For this reason, the measurements were not performed with the methods suggested by Standard EN 50122-2 in annexes A.3 and A.4 [6] but with the fall of potential method, using two different voltage sources: a DC generator and a square wave generator at 128 Hz. The results obtained with the two sources were in good agreement and are summarized in Table II. The measured values, with an average of  $g = 1.6 S/km$ , are compatible with the reference limit value provided by Standard EN 50122-2 ( $g \leq 2.5 S/km$ ) [6] and are included in the range provided in [12] ( $1 S/km \leq g \leq 10 S/km$ ).

For the study of the ground faults in the substation and along the line, it is also important to evaluate the equivalent ground resistance  $R_{tg}$  of all the city-wide tracks network; the rails and negative cables constitute in fact, as previously described, a unique meshed city-wide network. The value of  $R_{tg}$  changes depending on the considered point and is difficult to evaluate. It is however possible to estimate a range in which  $R_{tg}$  should be included. For the purposes of this

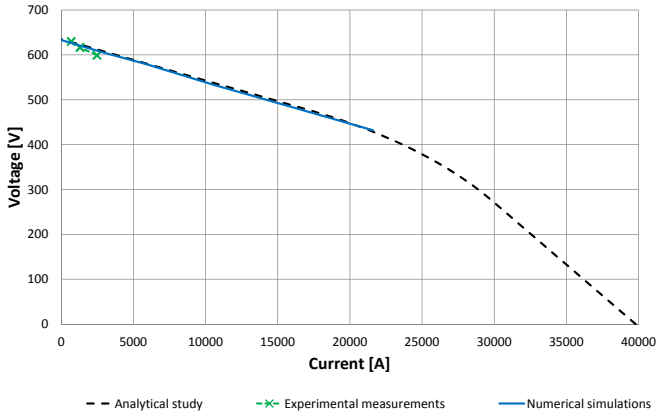

Fig. 4. Transformer-rectifier steady-state characteristic.

study, based on considerations on the rails network structure and on the previously described pi section model, it was estimated  $0.02\Omega \leq R_{tg} \leq 0.2\Omega$ . In the equivalent fault circuit, the city-wide tracks network is therefore represented by the parameter  $R_{tg}$ .

### B. Transformer and rectifier model

For the study presented in this paper, we are interested in the calculation of the steady-state values of fault currents. The steady-state model of the transformer and rectifier group has been determined by means of an analytic study, experimental measurements in a substation and numerical simulations (Fig. 4).

As we are considering ground faults, both in the substation and along the line, that are high impedance faults, the rectifier is always working in the first (linear) part of the characteristic, with relatively high voltages and low currents.

In order to calculate the steady state value of the fault current, the transformer/rectifier group can therefore be modeled as a Thevenin equivalent.

The equivalent voltage source has been set as the rated open circuit voltage determined through the analytic study and the simulations:  $V_{eq} = 635 V$ .

The equivalent series resistance has been instead determined through the experimental measurements carried out in a substation:  $R_{eq} = 0.0167 \Omega$ . The measured equivalent resistance was higher than the theoretical one.

Summing up, for the transformer and rectifier model, the choice was to use a simple Thevenin equivalent, where  $V_{eq}$  is the rated open circuit voltage, while  $R_{eq}$  is the measured resistance.

### C. Substation grounding system

The grounding system of the substations is constituted by a typical configuration of a ring electrode with four rods. The typical ground resistance can vary in the range from  $5 \Omega$  to  $15 \Omega$  depending on the soil characteristics. However, the grounding system of each substation is connected to the neighbouring ones by means of the MV cables sheaths and, in Turin, of bare conductors buried in contact with the soil

TABLE III  
SUMMARY OF MODEL PARAMETERS

Parameter	Value range
$V_{eq}$	635 V
$R_{eq}$	$0.0167 \Omega$
$R_{sg}$	$0.06 \Omega$
$R_{tg}$	$0.02 \Omega \div 0.2 \Omega$
$R^-$	$1.7 \cdot 10^{-4} \Omega \div 1.7 \cdot 10^{-3} \Omega$
$R^+$	$1.7 \cdot 10^{-4} \Omega \div 1.7 \cdot 10^{-3} \Omega$
$R_{ocs}$	$0 \Omega \div 0.1 \Omega$

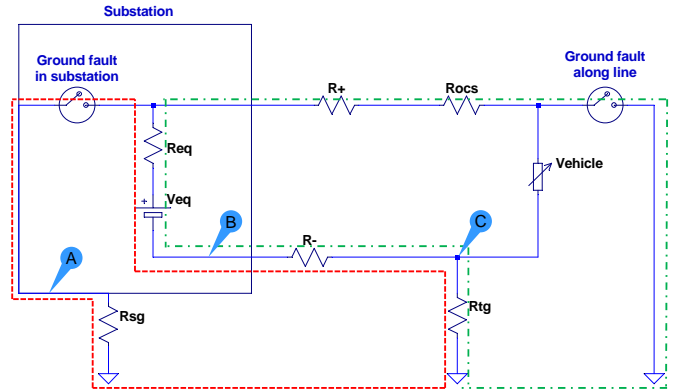

Fig. 5. Fault circuit and fault currents.

together with MV cables [13]. For this reason, the equivalent ground resistance that can be measured from each substation is mostly independent from the ground resistance of the single substation and from the distance between them: it has a typical value around  $R_{sg} = 0.06 \Omega$  [14].

### D. Fault circuit

Having defined the simplified models for the different components of the system, it is possible to draw the equivalent circuit for the ground fault in the substation or along the line (Fig. 5). In the figure,  $R^-$ ,  $R^+$  and  $R_{ocs}$  represent, respectively, the resistance of the negative cables from the substation to the rails, of the positive feeder cable from the substation to the OCS and the resistance of the overhead line.

The ranges for the values of the different parameters are summarized in Table III.

The AC side of the system (distribution network and primary windings of the transformer) are not represented in the equivalent circuit, as the fault currents can circulate only on the DC side.

## V. RESULTS

Currents and voltages have been calculated on the simplified circuit, varying the different parameters in the ranges that have been presented in the previous sections.

In the case of ground fault in the substation, the fault current  $I_F$  is injected into the ground through  $R_{sg}$  and flows through  $R_{tg}$  and the negative conductors back to the rectifier (red dashed line in Fig. 5). In the case of ground fault along the line, instead, the fault current flows to the ground through the fault

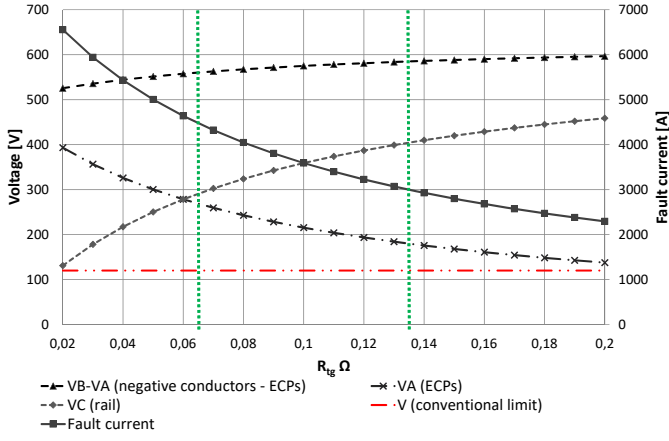

Fig. 6. Ground fault in the substation - results.

and flows back to the substation through the ground resistance of the rails network  $R_{tg}$ , without involving the grounding system of the substation, because the negative cables are not connected to it, in order to limit the stray currents dispersed by the rails into the ground in normal operation (green dash-dot line in Fig. 5). It was noticed that the value of the current absorbed by vehicles (i.e. the pre-fault condition) does not affect considerably the results of the study. The same remarks are valid for the length of the negative and positive cables: the variation of the value of  $R^-$  and  $R^+$  does not affect considerably the results. The main parameters which instead influence the fault current magnitude and the voltages are the resistance  $R_{tg}$  of the rails network and the resistance  $R_{ocs}$  of the OCS.

In Fig. 6 a summary of the results for the ground fault in the substation is presented. The fault current can be compared with the settings of the over-current protection to see if it will trip: typical settings of over-current protections are in the range from 3000 A to 4500 A, marked with the green vertical lines in Fig. 6. On the left side of the vertical lines the circuit breaker trips, while on the right side it does not, as it does not recognize the fault current, leaving dangerous voltages on the ECPs and between ECPs and return conductors inside the substation. Dangerous voltages are also present on the rails, accessible to the public. The conventional limit of 120 V for long-term conditions (to be considered if the circuit breaker does not recognize the fault, see Table I) is in fact highlighted in the figure with the horizontal red line and for all the range of possible values of  $R_{tg}$  the analysed voltages are above this limit. The voltages being discussed, and presented in Fig. 6 and in the following ones, are identified with the subscripts:  $A$  for ECPs,  $B$  for the negative conductors in the substation and  $C$  for rails. The measurement points are highlighted in Fig. 5 with blue probes.

Also the ground fault along the line has been studied. Two different cases are analysed: a ground fault along the line near the substation and a ground fault along the line far from the substation. In particular in the second case, the resistance of the OCS contributes to the limitation of the fault current, making it difficult for the over-current protection to recognize

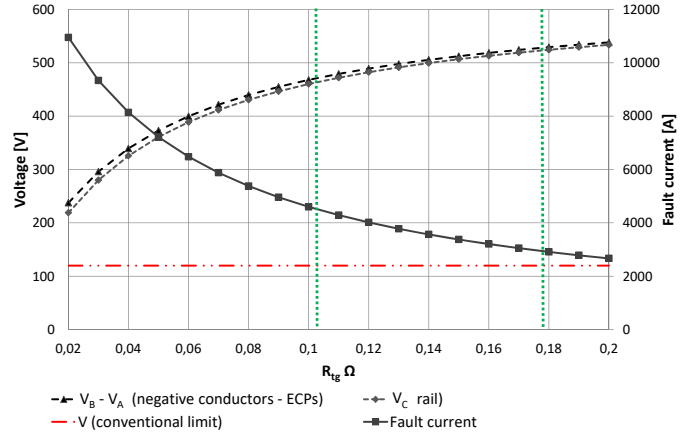

Fig. 7. Ground fault along the line close to the substation - results.

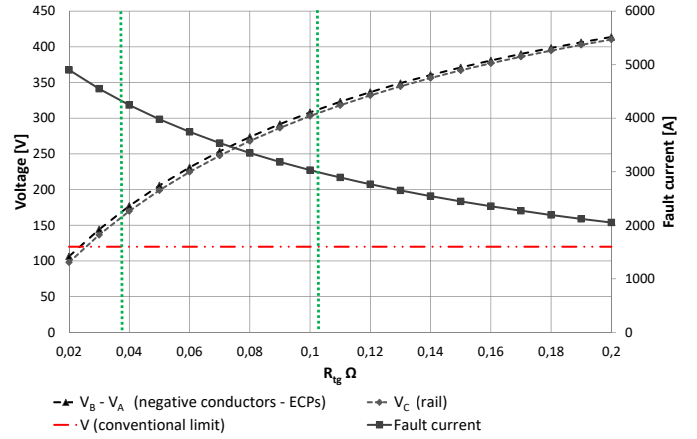

Fig. 8. Ground fault along the line far from the substation - results.

the fault. The two analysed cases are presented in Fig. 7 and Fig. 8.

Following the same scheme described before for the ground fault in the substation, we have highlighted also in Fig. 7 and Fig. 8 the typical setting range of the over-current protections (green vertical lines) and the maximum permissible effective touch voltage (horizontal red line). In the case of fault along the line, if the fault is close to the substation, the fault currents are higher than in the case of ground fault in the substation, as they are not limited by the ground resistance  $R_{sg}$  (Fig. 7). In case instead the fault is far from the substation, as previously said, the resistance of the OCS strongly limits the fault current. In particular in this case, there are again situations in which the fault current is not big enough for being recognized by the over-current protections, and dangerous voltages can last for a long time on the rails and inside the substation between negative conductors and ECPs.

It is interesting to analyse the effect of the variation of the two main parameters,  $R_{tg}$  and  $R_{ocs}$ , at the same time, on the fault current magnitude and on the rail potential, in case of ground fault along the line.

Fig. 9 shows a 3D representation of the variation of the fault current as a function of  $R_{tg}$  and  $R_{ocs}$ . If we assume an average setting of the over-current protection of 4000 A, the

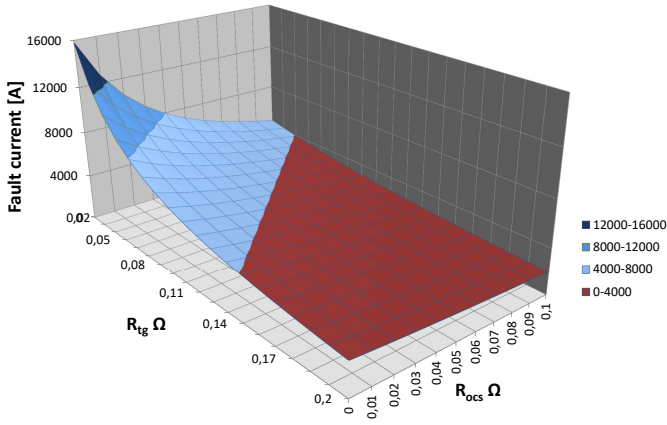

Fig. 9. Fault current for a ground fault along the line.

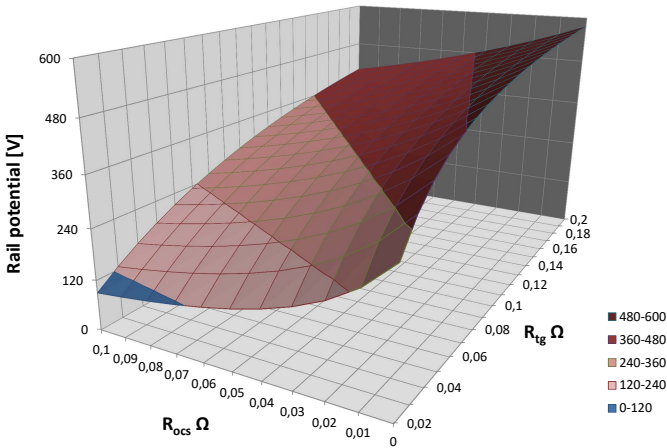

Fig. 10. Rail potential for a ground fault along the line.

circuit breaker will not trip if the fault is in the lower (red) area of the 3D plot. For all the other combinations of  $R_{tg}$  and  $R_{ocs}$ , the circuit breaker will instead detect the fault.

Fig. 10 presents instead a 3D representation of the variation of the rail potential as a function of  $R_{tg}$  and  $R_{ocs}$ . The 3D plot shows that there is only a small portion of the variation range, the lowest part, coloured in blue, where the rail potential is below the safety limit of 120 V.

It is interesting, at this point, to put together the pieces of information provided separately by Fig. 9 and Fig. 10. For this purpose, the two colour plots, projected on the  $R_{tg}$ - $R_{ocs}$  plane, are superimposed exploiting transparency. The result of the combination of the two figures is presented in Fig. 11.

By comparing the fault current magnitude with the setting of the over-current protection and the rail potential with the safety limit, it is possible to identify three different areas, highlighted by the coloured borders in Fig. 11:

- the small area at the top left, surrounded by the green dotted line, where the over-current protection recognizes the fault ( $I_F > 4000 A$ ), and therefore the circuit-breaker trips, even if no dangerous voltages are present because the rail potential  $V_C$  is below 120 V;
- the area on the left, surrounded by the orange dashed line, where dangerous voltages are present because the

rail potential  $V_C$  is above 120 V and the circuit breaker trips because the fault current is above the setting of the over-current protection ( $I_F > 4000 A$ );

- the big area on the right, surrounded by the red solid line, where the rail potential is above the safety limit ( $V_C > 120 V$ ), but the circuit breaker will not trip, as the fault current is too small to be detected by the over-current protection ( $I_F < 4000 A$ ).

Analysing in particular the third area, the one surrounded by the red solid line, it is clear that, in particular in case the ground fault along the line happens far from the substation, dangerous voltages can last for long periods on the rails, accessible to the public, without any tripping of the protections.

For what concerns instead the second area, where dangerous voltages are present but the circuit breaker trips clearing the fault, safety is guaranteed by the interruption time of the extra-rapid DC circuit breaker. It can be noticed, in fact, that the maximum rail potential is lower than 600 V (Fig. 10). The maximum associated time duration is therefore 0.1 s (Table I).

The maximum allowed time duration can be compared with the interruption time  $T_i$  of the circuit breaker, that in general depends on the prospective fault current and on the time constant of the circuit. A detailed analysis of high speed DC circuit breakers behavior is provided in [15].

The manufacturer of the extra-rapid circuit breakers installed in Turin, provides a plot of  $T_i$  against the initial rate of rise of the current, that is reported in Fig. 12 [16].

From this plot it can be seen that the interruption time  $T_i$  guaranteed by the extra-rapid DC circuit breaker is in the range  $10 ms \leq T_i \leq 40 ms$ , depending on the fault current initial rate of rise  $dI_F/dt$ . This range of interruption times, which is also compatible with the results of the simulations presented in [15], guarantees the safety of people.

## VI. CONCLUSION

If only over-current protections are adopted, in urban rail traction systems potentially dangerous situations can be originated. In fact, the ground fault currents can be lower than the protection settings, both for ground faults inside the substations and for ground faults outside the substations, along the line. In these cases dangerous voltages can last for a long time on the rails, accessible to the public, and inside the substations, on exposed conductive parts and between exposed conductive parts and negative conductors. It is therefore of utmost importance that innovative relays are installed and properly set, in order to recognize short circuit currents from normal operation ones.

The analysis that is presented in this paper has been performed considering a negligible fault impedance. In case the fault impedance is not negligible, the fault current could be even smaller, and therefore more difficult to be detected by common over-current protections.

One partial provision that could improve safety, even if not totally sufficient, would be the installation of a voltage limiting device (VLD), which connects the grounding system of the substation with the negative conductors in case the voltage between them is above a certain threshold. This provision

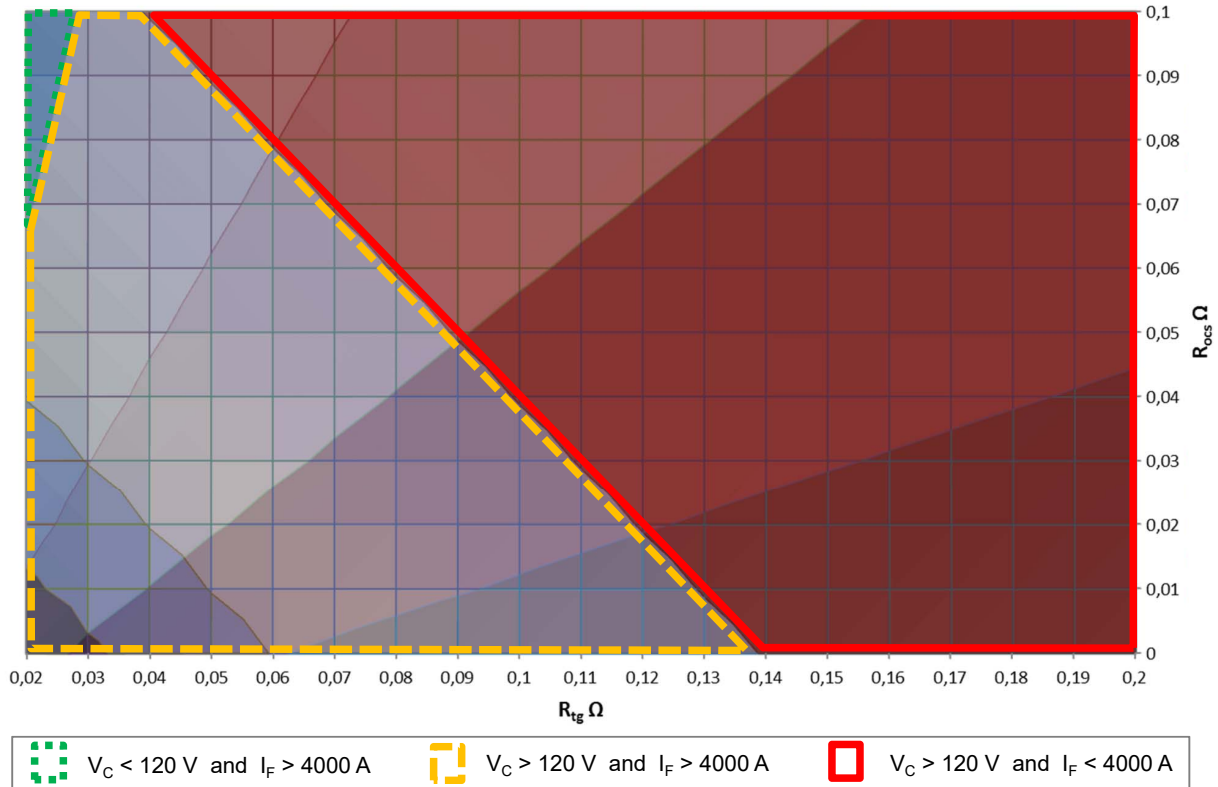

Fig. 11. Fault current  $I_F$  and rail potential  $V_C$  for a ground fault along the line.

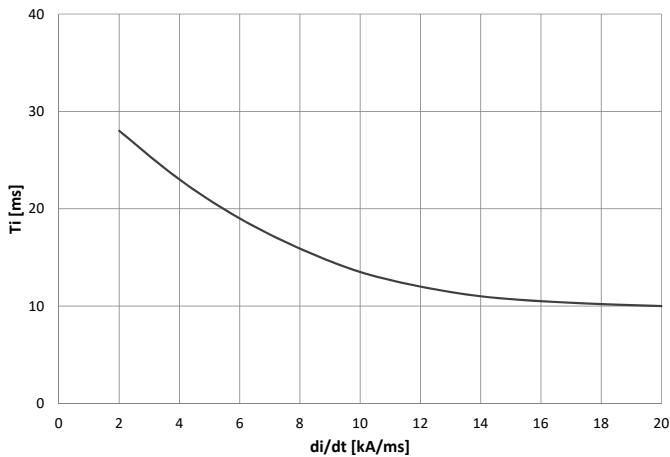

Fig. 12. Extra-rapid DC circuit breaker interruption time against initial current rate-of-rise.

would certainly be beneficial for the ground fault in the substation, as it would transform the ground fault in a short circuit, enabling the over-current protection to detect the fault and trip, but would be partially beneficial also for the ground fault along the line. It would in fact put the equivalent ground resistance of the substation  $R_{sg}$  in parallel with the equivalent ground resistance  $R_{tg}$  of all the city-wide tracks network, increasing the fault current and making it more likely to be detected.

If, on the contrary, the fault current is detected by the relay,

the extra-rapid DC circuit breaker completes the interruption in a time shorter than the time allowed by the Standards.

#### ACKNOWLEDGMENT

The authors would like to thank the personnel of GTT and Infra.To for their valuable support in this research.

#### REFERENCES

- [1] E. Pons, R. Tommasini, and P. Colella, "Electrical safety of dc urban rail traction systems," in *Environment and Electrical Engineering (EEEIC), 2016 IEEE 16th International Conference on*. IEEE, 2016, pp. 1–6.
- [2] E. Cinieri, A. Fumi, V. Salvatori, and C. Spalvieri, "A new high-speed digital relay protection of the 3-kvdc electric railway lines," *Power Delivery, IEEE Transactions on*, vol. 22, no. 4, pp. 2262–2270, 2007.
- [3] M. Li, J. He, Z. Bo, H. Yip, L. Yu, and A. Klimek, "Simulation and algorithm development of protection scheme in dc traction system," in *PowerTech, 2009 IEEE Bucharest*. IEEE, 2009, pp. 1–6.
- [4] K. D. Pham, R. S. Thomas, and W. E. Stinger, "Operational and safety considerations in designing a light rail dc traction electrification system," in *Rail Conference, 2003. Proceedings of the 2003 IEEE/ASME Joint*. IEEE, 2003, pp. 171–189.
- [5] *Railway applications - Fixed installations - Electrical safety, earthing and the return circuit Part 1: Protective provisions against electric shock*. Standard EN 50122-1, 2012.
- [6] *Railway applications - Fixed installations - Electrical safety, earthing and the return circuit Part 2: Provisions against the effects of stray currents caused by d.c. traction systems*. Standard EN 50122-2, 2012.
- [7] D. Paul, "Dc traction power system grounding," *Industry Applications, IEEE Transactions on*, vol. 38, no. 3, pp. 818–824, 2002.
- [8] K. D. Pham, R. S. Thomas, and W. E. Stinger, "Analysis of stray current, track-to-earth potentials and substation negative grounding in dc traction electrification system," in *Railroad Conference, 2001. Proceedings of the 2001 IEEE/ASME Joint*. IEEE, 2001, pp. 141–160.



- [9] M. Reis, "Optimization of dc feeder rate of rise overcurrent protection settings using delta i cumulative distribution," in *Industrial and Commercial Power Systems Technical Conference, 2004 IEEE*. IEEE, 2004, pp. 63–66.
- [10] A. Mariscotti and P. Pozzobon, "Determination of the electrical parameters of railway traction lines: calculation, measurement, and reference data," *Power Delivery, IEEE Transactions on*, vol. 19, no. 4, pp. 1538–1546, 2004.
- [11] R. J. Hill and D. C. Carpenter, "Rail track distributed transmission line impedance and admittance: theoretical modeling and experimental results," *Vehicular Technology, IEEE Transactions on*, vol. 42, no. 2, pp. 225–241, 1993.
- [12] M. Niasati and A. Gholami, "Evaluation of rail potential control devices performance for control of rail potential of dc electrified railway systems," in *Railway Engineering-Challenges for Railway Transportation in Information Age, 2008. ICRE 2008. International Conference on*. IET, 2008, pp. 1–7.
- [13] P. Colella, R. Napoli, E. Pons, R. Tommasini, A. Barresi, G. Cafaro, A. D. Simone, M. L. D. Silvestre, L. Martirano, P. Montegiglio, E. R. Morozova, G. Parise, L. Parise, E. R. Sanseverino, F. Torelli, F. Tummolillo, G. Valtorta, and G. Zizzo, "Currents distribution during a fault in an mv network: Methods and measurements," *IEEE Transactions on Industry Applications*, vol. 52, no. 6, pp. 4585–4593, 2016.
- [14] E. Pons, P. Colella, R. Napoli, and R. Tommasini, "Impact of mv ground fault current distribution on global earthing systems," *IEEE Transactions on Industry Applications*, vol. 51, no. 6, pp. 4961–4968, 2015.
- [15] M. Berger, C. Lavertu, I. Kocar, and J. Mahseredjian, "Performance analysis of dc primary power protection in railway cars using a transient analysis tool," in *Vehicle Power and Propulsion Conference (VPPC), 2015 IEEE*. IEEE, 2015, pp. 1–7.
- [16] *IR 6000 Interruttori extrarapidi*. Ansaldo Industria s.p.a., 2000.