

---

Doctoral Dissertations

Student Theses and Dissertations

---

Fall 2008

## Design and evaluation of a virtual reality training system for new underground rockbolters

David Nutakor

Follow this and additional works at: [https://scholarsmine.mst.edu/doctoral\\_dissertations](https://scholarsmine.mst.edu/doctoral_dissertations)



Part of the [Mining Engineering Commons](#)

Department: Mining and Nuclear Engineering

---

### Recommended Citation

Nutakor, David, "Design and evaluation of a virtual reality training system for new underground rockbolters" (2008). *Doctoral Dissertations*. 2151.

[https://scholarsmine.mst.edu/doctoral\\_dissertations/2151](https://scholarsmine.mst.edu/doctoral_dissertations/2151)

This thesis is brought to you by Scholars' Mine, a service of the Missouri S&T Library and Learning Resources. This work is protected by U. S. Copyright Law. Unauthorized use including reproduction for redistribution requires the permission of the copyright holder. For more information, please contact [scholarsmine@mst.edu](mailto:scholarsmine@mst.edu).

DESIGN AND EVALUATION OF A VIRTUAL REALITY TRAINING SYSTEM FOR  
NEW UNDERGROUND ROCKBOLTERS

by

DAVID NUTAKOR

A DISSERTATION

Presented to the Graduate Faculty of the  
MISSOURI UNIVERSITY OF SCIENCE AND TECHNOLOGY

In Partial Fulfillment of the Requirements for the Degree

DOCTOR OF PHILOSOPHY

in

MINING ENGINEERING

2008

Approved by:

Derek Apel, Advisor  
Jerry C. Tien, Co-advisor  
Larry R. Grayson  
David A. Summers  
Richard H. Hall



## ABSTRACT

The need for development of better training techniques for underground rock bolters is signified by the fact that a large number of experienced miners (Baby Boomers) will be retiring soon. This means that there will be very little interface time between the new miners and the experienced miners, which could have been used for training the new inexperienced miners. A new generation of workers (Nexters), who have grown up with computers and video games will replace the Baby Boomers, and the most efficient way to introduce them to the safety and health issues of the mining industry is to use a new form of training to take advantage of their technological skills.

MinerSIM is an augmented virtual reality system with integrated hypermedia that is suitable for training underground miners in the basics of using a jackleg drill to install rockbolts. The first part of MinerSIM, which is a Web tutorial on underground rockbolting consisting of text material, three-dimensional images, animations, and videos was evaluated using qualitative and quantitative methodologies. Usability experiments performed underscore the need to evaluate a new product to ensure that it meets the requirements of users. Statistical results from comparative experiment to investigate the effectiveness of computer-based training versus the standard or traditional method indicate that a task must be sufficiently complex in order to render a traditional paper-based method less effective than a computer-based method. Additionally, participants in the computer-based group ( $n = 25$ ) rated the task more positively than those in the paper-based group ( $n = 25$ ).

## ACKNOWLEDGMENTS

This dissertation could not have been possible without the guidance of my advisors, committee members, friends, and family. I would like to express my deepest gratitude to my advisors, Drs. Derek Apel and Jerry Tien for their excellent guidance, caring, patience, and providing me with an excellent atmosphere for doing this research.

Special thanks go to Dr. Larry Grayson for his thoughtful criticism, and financial support. This research was funded by National Institute for Occupational Safety and Health (NIOSH). I truly appreciate their generous support.

I would like to thank Drs. Richard Hall and David Summers for their time and attention during busy semesters. They patiently corrected my analyses and guided my research for the past several months. I would also like to thank my colleagues: Michelle Boese, Basanta Tandon, Zyeng Yi, and Zhang Xichen for helping me with the experiments. It would have been a lonely lab without them. Also, special thanks go to the Department of Mining Engineering staff for assisting me with the administrative tasks necessary for completing my doctoral program: Jimmie Taylor, Barbara Robertson, Judy Russell, and Shirley Hall.

Finally, I would like to thank my wife, Esther for her extensive support throughout my graduate program.

## TABLE OF CONTENTS

	Page
ABSTRACT.....	iii
ACKNOWLEDGEMENTS.....	iv
LIST OF ILLUSTRATIONS.....	xi
LIST OF TABLES.....	xv
 SECTION	
1. INTRODUCTION.....	1
1.1. DEFINITION AND COMPONENTS OF VIRTUAL REALITY.....	1
1.2. BACKGROUND OF PROBLEM – NEED FOR VIRTUAL REALITY TRAINING FOR THE MINING INDUSTRY.....	5
1.3. OBJECTIVES AND SCOPE OF RESEARCH.....	10
1.4. STATISTICS OF ROCK FALL ACCIDENTS AND ROCKBOLTING INJURIES.....	11
1.4.1. Scaling Related Injuries.....	13
1.4.2. Injury Review by Rock Drill Type.....	13
1.4.3. Injuries Involving Mechanical Bolting.....	14
1.4.4. Jackleg Rock Drills Injury Review.....	15
1.5. RESEARCH METHODOLOGY.....	17
2. LITERATURE REVIEW.....	19
2.1. GENERAL OVERVIEW OF ROCK STABILIZATION.....	19
2.2. TASK ANALYSIS OF AN UNDERGROUND ROCKBOLTER USING A JACKLEG DRILL.....	22

2.2.1. Manual Scaling.....	23
2.2.2. Drilling.....	26
2.2.3. Bolting.....	31
2.2.3.1. Mechanically anchored rockbolts.....	32
2.2.3.2. Resin anchored rockbolts.....	34
2.2.3.3. Friction rockbolts.....	35
2.2.3.3.1. Split sets.....	35
2.2.3.3.2. Swellex friction rock bolt.....	36
2.3. VIRTUAL REALITY SIMULATORS AND EVALUATION METHODS.....	41
2.3.1. Simulator Developers for the Mining Industry.....	41
2.3.2. Evaluation Methods.....	48
2.3.2.1. Operator opinion method.....	50
2.3.2.2. Assignment of fidelity method.....	50
2.3.2.3. Transfer of training (ToT) method.....	50
2.3.2.4. Self-control transfer method.....	51
2.3.2.5. Preexisting control transfer of training method.....	51
2.3.2.6. Uncontrolled transfer method.....	51
2.3.2.7. Inverse transfer of training method.....	51
2.3.2.8. Simulator-to-simulator transfer method.....	52
3. DESIGN AND DEVELOPMENT OF MINER SIMULATOR.....	53
3.1. MULTIMEDIA SYSTEM.....	53
3.1.1. Addition of Animation.....	57





4.2.2.5. Open-ended questionnaire responses.....	94
4.2.2.6. Video and field representative observations .....	96
4.2.2.7. Evaluation of participants' performance.....	98
4.2.3. Comparison of the Online Tutorial with the Paper-based Version.....	100
4.2.3.1. Participants.....	101
4.2.3.2. General procedure.....	101
4.2.3.3. Post-testing questionnaire.....	102
4.2.3.4. Participants' questionnaire ratings and responses.....	103
4.2.3.5. Quantitative analyses.....	109
4.2.3.5.1. Quantitative analysis of participants' subjective ratings.....	111
4.2.3.5.2. Evaluation of participants' performance.....	113
4.3. EVALUATION OF THE PHYSICAL COMPONENTS OF THE VIRTUAL REALITY SIMULATOR.....	117
4.3.1. Participants.....	117
4.3.2. General Procedure.....	119
4.3.3. Post-testing Questionnaire.....	124
4.3.4. Participants' Questionnaire Ratings and Responses.....	125
4.3.5. Open-ended Questionnaire Responses.....	127
4.3.6. Performance Measurement of Participants.....	128
4.4. PROPOSED EVALUATION OF THE VIRTUAL REALITY COMPUTER SIMULATOR.....	133
4.4.1. Initial Evaluation.....	133

4.4.2. Applied Evaluation.....	133
4.4.3. Initial Evaluation Procedure.....	134
4.4.3.1. Testing and collection of observations.....	134
4.4.3.2. Organizing observations.....	135
4.4.4. Applied Evaluation Procedure.....	135
4.4.4.1. Testing and data collection.....	135
4.4.4.2. Analysis of data.....	136
4.4.4.3. Interpretation of results.....	136
5. DISCUSSION OF RESULTS.....	138
5.1. OVERVIEW.....	138
5.2. INITIAL USABILITY TEST.....	138
5.2.1. Discussion of Participants' Subjective Ratings and Responses.....	138
5.2.2. Discussion of Qualitative Data.....	139
5.2.3. Discussion of Quantitative Data.....	140
5.3. USABILITY TEST WITH THE MORAE RECORDING DEVICE.....	141
5.3.1. Discussion of Participants' Subjective Ratings.....	141
5.3.2. Discussion of Qualitative Data.....	142
5.3.3. Discussion of Quantitative Data.....	143
5.4. COMPARISON OF THE WEB TUTORIAL WITH ITS HARDCOPY VERSION.....	144
5.4.1. Discussion of Participants' Subjective Ratings.....	144
5.4.2. Discussion of Qualitative Data.....	145
5.4.3. Discussion of Participants' Performance Data.....	149

5.5. EVALUATION OF PHYSICAL COMPONENTS OF THE SIMULATOR.....	150
5.5.1. Discussion of Participants' Subjective Ratings and Responses.....	150
5.5.2. Discussion of Participants' Performance.....	151
6. CONCLUSIONS AND RECOMMENDATIONS FOR FUTURE WORK...	154
6.1. CONCLUSIONS.....	154
6.2. RECOMMENDATIONS FOR FUTURE WORK.....	156
APPENDICES	
A. THE DEVELOPMENT OF THE WEB TUTORIAL.....	159
B. EVALUATION OF THE WEB TUTORIAL .....	171
C. EVALUATION OF THE PHYSICAL COMPONENTS OF THE VIRTUAL REALITY COMPUTER SIMULATOR.....	209
D. PROPOSED EVALUATION OF THE VIRTUAL REALITY COMPUTER SIMULATOR.....	219
BIBLIOGRAPHY.....	229
VITA.....	235

## LIST OF ILLUSTRATIONS

Figure	Page
1.1. The Three I's of Virtual Reality (immersion, interaction, imagination).....	2
1.2. The Five Components of a Virtual Reality System.....	3
2.1. Basic Categorization of Rock Reinforcement and Support.....	20
2.2. Metallic Scaling Bars.....	23
2.3. Scaling in a Mine.....	23
2.4. The Four Operating Principles of Percussion Drills.....	26
2.5. Drill Head.....	27
2.6. Telescopic Leg.....	27
2.7. Drill Head Mounted on the Telescopic Leg.....	28
2.8. Parts of a Jackleg Drill.....	29
2.9. Types of Rockbolt.....	31
2.10. A Typical Mechanical Rockbolt.....	33
2.11. A Rebar Rockbolt.....	34
2.12. Slow and Fast-set Resin.....	34
2.13. Split Set Rockbolt.....	36
2.14. Swellex Friction Rockbolt.....	37
2.15. Installing a Swellex Rockbolt.....	38
2.16. The Locking Effect and Friction Bond along the Entire Length of a Swellex Rockbolt.....	39
2.17. In Cab View of the Excavator Simulator.....	42
2.18. A Trainee Using the Excavator Simulator.....	42

2.19. Dozer Simulator Setup.....	43
2.20. Roofbolter Training Simulator.....	44
2.21. Typical Simulated Virtual Environment.....	45
2.22. A Trainee Using a Dragline Simulator in a Virtual Environment.....	45
2.23. Simlog Drill Jumbo Simulator.....	48
2.24. Usability Test Format.....	49
3.1. Rockbolting Cycle.....	55
3.2. Interface of the Web Tutorial Showing the Three Sections and Quizzes... ..	56
3.3. ...Screen View Showing Major Parts of a Jackleg Drill.....	57
3.4. ...Flash Video File Playing Inside an SWF File.....	59
3.5. ...FiRSTE System's Architecture.....	61
3.6. ...Major Components of the VR Computer Simulator.....	63
3.7. ...Trainee (without the HMD) in the Blue-Room.....	64
3.8. ...Trainee (with HMD) in the Virtual Mine Environment.....	64
3.9. ...Trainee (without HMD) Scaling Down Loose Rock from the Roof.....	65
3.10. Magnets Attached to the Blue Room Wall .....	65
3.11. The 2ft Collapsible Drill Steel in its Fully Extended State.....	66
3.12. The Drill Steel Model at its Fully Collapsed State.....	66
3.13. The 6-inch Bolt Cup Installed in the Wall and Roof of the Blue Room.....	67
3.14. The 2ft Rockbolt with a 4.5 x 4.5-inch Plate and 6-inch Cup in its Fully Expanded State.....	68
3.15. Rockbolt Model in its Fully Collapsed State within the Steel Cup.....	69
4.1. .MinerSIM Evaluation Process.....	71
4.2. Quiz Scores of Participants.....	84

4.3. Total Time Taken by the Participants.....	85
4.4. Mean Responses on Questionnaire Items.....	85
4.5. A Typical Usability Testing Configuration with the Morae Recording Device.....	86
4.6. The Morae Recorder’s Screen Shot of a Participant Reading the Tutorial.....	88
4.7. Quiz Scores of Participants.....	98
4.8. Total Time Taken by the Participants.....	99
4.9. Mean Quiz Scores as a Function of Categorical Group.....	99
4.10. The Average Time Taken as a Function of Categorical Group.....	100
4.11. Statistical Decision.....	109
4.12. Subjective Rating Scores as a Function of Participant Group.....	111
4.13. Group Mean Test Score by Section.....	115
4.14. Average Time for Sections by Group.....	115
4.15. Interface of Research Randomizer Program.....	118
4.16. A Participant Undergoing Training in the Blue-Room in the Simulator Laboratory.....	120
4.17. Missouri S&T Experimental Mine Supervisor Explains the Functions of the Parts of a Jackleg Drill to a Participant.....	121
4.18. A Participant is Scaling Loose Rock During the Rockbolting Contest at the Missouri S&T Experimental Mine.....	123
4.19. A Participant Drilling During the Underground Rockbolting Contest Under the Watchful Eye of the Missouri S&T Experimental Mine Supervisor.....	123
4.20. A Participant Installing a Split Set Rockbolt During the Underground Rockbolting Contest.....	124
5.1. Participants’ Quiz Scores and Total Time Taken to Complete Each Section.....	140
5.2. Quiz Score and Time as a Function of Group.....	144
5.3. Average Drilling and Bolting Times as a Function of Participant Group.....	153

## LIST OF TABLES

Table	Page
1.1. Fatalities in Metal/Nonmetal and Coal Mine Industries for the Last Decade.....	6
1.2. Number of Injuries by Rock Drill Type (1973-74).....	14
1.3. Number of Injuries by Mechanical Bolting Routines at the Face.....	15
1.4. Injuries from Jacklegs by Drilling Activity (1973-74).....	16
2.1. Types of Rockbolts and Their Mechanism of Support.....	32
2.2. Comparison of Rockbolt Types.....	40
3.1. Functions of Simulator Components .....	63
4.1. Participants' Ratings and Responses.....	80
4.2. Participants' Ratings.....	92
4.3. Paper-based Group Participants' Mean Ratings.....	103
4.4. Computer-based Group Participants' Mean Ratings.....	103
4.5. Normality Tests on Subjective Ratings of the Paper-based Group.....	112
4.6. Normality Tests on Subjective Ratings of the Computer-based Group.....	112
4.7. Tests of Between-Subjects Effects.....	117
4.8. Normality Tests on Paper-based Group's Performance Data.....	116
4.9. Normality Tests on Computer-based Group's Performance Data.....	116
4.10. Tests of Between-Subjects Effects.....	117
4.11. Participants' Ratings - Experimental Group.....	126
4.12. Task Performance – Experimental Group.....	129
4.13. Task Performance Time Measure – Experimental Group.....	130

4.14. Task Performance – Control Group.....131

4.11. Task Performance Time Measure – Control Group.....132

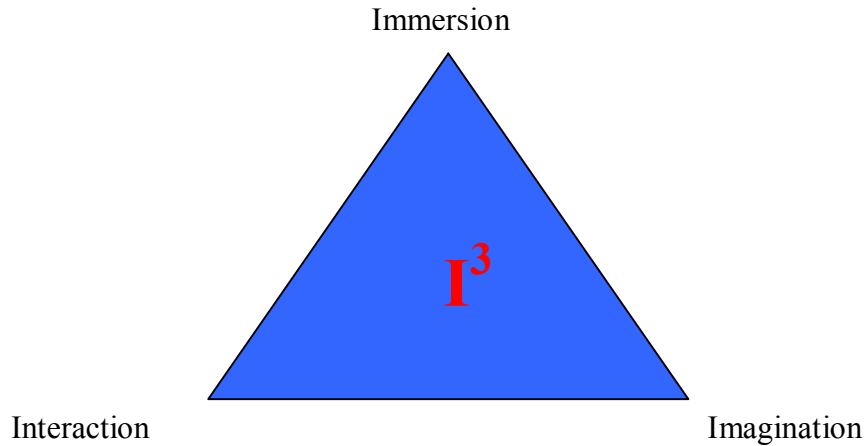


# 1. INTRODUCTION

## 1.1. DEFINITION AND COMPONENTS OF VIRTUAL REALITY

Virtual reality (VR) is a high-end user-computer interface that involves real-time simulation and interaction through multiple sensorial channels including vision, sound, touch, smell, and taste (Budea and Coiffet, 2003). Unlike computer graphics, which use numerical models of real world objects to create artificially created views, virtual reality is the science of integrating humans with information, and it consists of three-dimensional, interactive computer generated environments (Schofield et al. 2001). Computer animation is generally passive and always shows the same sequence, regardless of user action. Virtual reality, on the other hand, is interactive in nature and responds to user actions, such as moving around the virtual world and turning on equipment. It should, however, be noted that many people's definition of virtual reality lies in the underlying processes: the simulations, the reactions, and the behavior of the objects or people within the virtual environment (Schofield et al. 2001).

Virtual reality is an integrated trio of immersion, interaction, and imagination (Budea and Coiffet, 2003). The ability of a computer to detect a user's input (gesture, verbal command, etc.) and modify the virtual world simultaneously accounts for the real-time interactivity in virtual reality. Interactivity and its captivating power contributes to the feeling of immersion of being part of the action on the screen that a user experiences, while imagination refers to mind's capacity to perceive non-existent things (Figure 1.1).



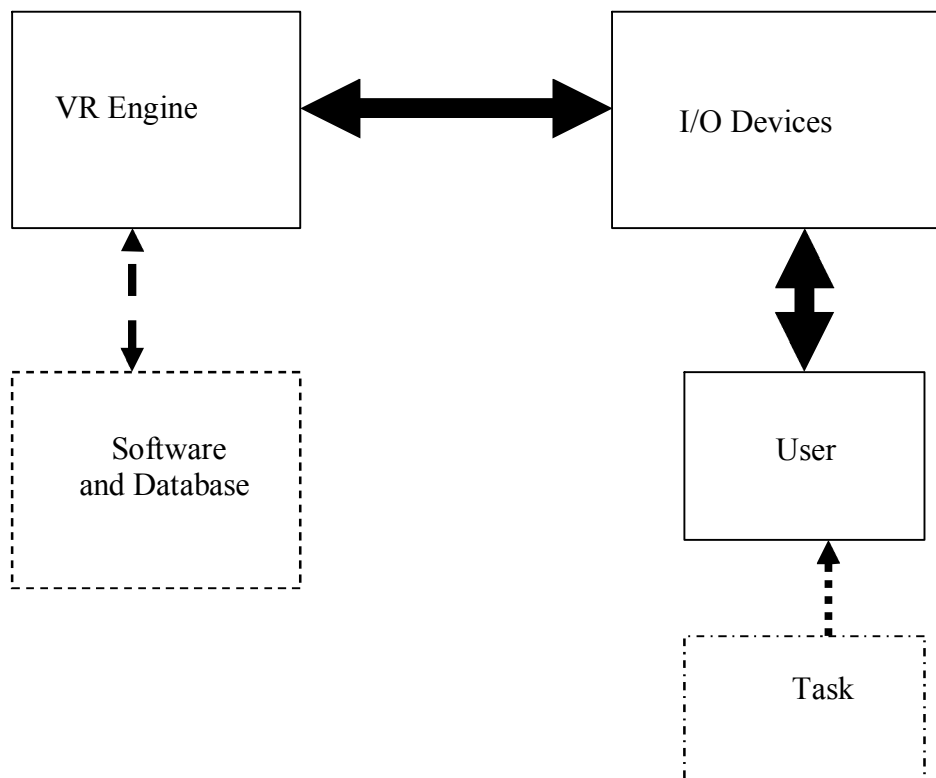
**Figure 1.1.** The Three I's of Virtual Reality (immersion, interaction, imagination).  
Source: Budea and Coiffet (2003).

Thalmann (1994) described virtual reality as the immersion of real humans in a virtual world that is completely created by computer, which means interaction with and manipulation of objects from the virtual world and the feeling that the human user is a real participant in the virtual world. In other words, artificial life and virtual reality are associated in the sense that most virtual worlds will be inhabited by virtual living creatures and users. Real persons, through virtual reality, will then be able to communicate and interact with these synthetic living beings.

The benefits of virtual reality for training purposes include training in a safe and controlled environment, continuous evaluation of the trainee leading to a shorter training period, safety awareness, reduced loss of production during training, enhanced operator skills development, improved application of best practices, increase in production per machine, reduced machine damage with regards to wear and tear, and increased motivation (Fifth Dimension Technologies, 2006).

Additionally, virtual reality training could be used in research and development in which a training simulator may be used to try new procedures in a virtual environment before validating these procedures in reality.

Virtual reality system architecture involves five classic components: VR engine, input/output (I/O) devices, software and databases, the user, and the task. Figure 1.2 is a diagrammatic representation of how these five components interact with each other.



**Figure 1.2.** The Five Components of a Virtual Reality System.  
Source: Burden and Coiffet (2003).

Functions of the five classic components of a virtual reality system are provided below:

- The Virtual Reality engine (VR engine) is a key component of any VR system, which reads its input devices, accesses task-dependent databases, performs the required real-time computations to update the state of the virtual world, and feeds the results to the output displays. The VR engine corresponds to various physical hardware configurations from a single computer to many networked computers supporting a given simulation.
- Input/output devices are devices used to mediate the user's input (trackers, sensing gloves, mice, etc) into and feedback (head-mounted displays, robotic arm, etc) from the VR simulation.
- Databases are developed to populate the virtual world, which involves virtual object modeling (geometrical modeling, kinematic modeling, physical modeling) and object intelligent behavior. In order to manage model size and complexity, software toolkits designed specifically for VR programming are used.
- Human factors in VR take into consideration user performance with respect to system usability, health and safety issues, and VR societal implications. Users' characteristics and simulation dosage issues also play important roles in the effects of VR exposure on the user.
- A large number of tasks adopt the use of virtual reality. It is a suitable training tool for high-risk jobs, as well as for tasks associated with expensive resources. Traditional applications of VR can be found in fields such as medicine, manufacturing, exploration, entertainment, arts and education, and the military.

## **1.2. BACKGROUND OF PROBLEM – NEED FOR VIRTUAL REALITY TRAINING FOR THE MINING INDUSTRY**

Mining (along with agriculture, construction, and transportation) is one of the most dangerous occupations in the United States (Kowalski-Trakofler et al., 2004). A study conducted by National Institute for Occupational Safety and Health (NIOSH) on occupational deaths between 1980 and 1989 indicates an average annual fatality rate of 31.9 per 100,000 workers in the mining industry. Statistics show that underground mine fatalities declined steadily over the years due to implementation of federal safety legislation, safety talks, training programs, company policies, and modifications of tasks and equipment. However, national accident rates indicate that underground mining jobs are still among the most hazardous occupations in the United States, and records have indicated that mine safety and health progress have started taking a downward trend in the coal mining industry since January 2006. In fact, reported year-end total fatalities for 2006 show that the coal industry experienced its deadliest year in a decade, following a record low of 23 fatalities in 2005 (Table 1.1).

**Table 1.1.** Fatalities in Metal/Nonmetal and Coal Mine Industries for the Last Decade

<b>Year</b>	<b>Metal/Nonmetal</b>	<b>Coal</b>	<b>Total</b>
2007	31	33	64
2006	26	47	73
2005	35	23	58
2004	27	28	55
2003	26	30	56
2002	42	27	69
2001	30	42	72
2000	47	38	85
1999	55	35	90
1998	51	29	80
1997	61	30	91

Source: [www.msha.gov](http://www.msha.gov)

Many training methods have been implemented over the years in order to reduce fatalities and injuries. Although improvement is visible, injuries still occur in high numbers, as shown in the Mine Safety and Health Administration (MSHA) nonfatal accident rates database ([www.msha.gov](http://www.msha.gov)). Special training programs (such as multimedia and/or virtual reality) are therefore required for miners who are always exposed to the dangers of dynamic and constantly changing mine environment. A successful training program helps mining personnel acquire the knowledge and the attitude to make them competent and safe in all aspects of work, whatever their positions in the mine. Churchill and Snowden (1996) identified a number of problems with the traditional miner training methods, as listed below:

- A large amount of training is carried out through media that is difficult to transfer (e.g., paper and pencil or verbal games).

- Many teaching methods present a lot of material with little or no opportunity for trainee involvement.
- Trainees frequently fail to attend to the problem at hand, often dividing their attention between what is going on in front of the classroom and interpersonal interactions with those around them.
- Verbal games usually focus on low-level factual recall of information.
- Because the training has a limited number of scenarios, trainees learn to use only the surface features of their training, although they need to learn about the more general underlying features of safe behavior.
- Instructional and training materials often fail to achieve their potential for engineering training.

According to Lampton et al. (2002), virtual reality has great advantages compared to classical (paper and pencil) methods of data collection. First, the amount (temporality and diversity) of data that can be sampled during trials using a VR system is much larger than those obtained by manual recordings. Secondly, VR systems allow researchers to have a comprehensive view of all subjects' actions while immersed in the simulation. Thirdly, the subjects' actions can be recorded online and played back during task debriefing. Lastly, researchers need not be collocated with the subjects due to the use of distributed virtual environments. Virtual reality is also used to allow trainees to go into areas or situations where hazards exist so to evaluate how they should act. A training simulator used in virtual reality allows an instructor to train new operators in a controlled and safe environment. The operation skills of a trainee are developed systematically, and he or she may be exposed to very complex

and/or life-threatening scenarios without risk of injury or risk of damage to equipment. A training simulator is ideal for the evaluation of qualified operators, since all actions performed by the operator may be recorded by the simulator. The skills and performance of a trainee may be analyzed in detail, and re-training or corrective training may be applied to those areas where the trainee exhibited sub-optimal skills and performance. For example, in virtual reality training for equipment operators, a pre-simulation module teaches the user how to optimally use the controls of a relevant machine. The trainee operator is then exposed to several training scenarios, ranging from elementary to very complicated scenarios.

Virtual reality training methods are ideal for training the expected influx of new and less experienced miners and mine operators as the cohort of older workers retire. In general, a wealth of knowledge and experience is lost when experienced professionals retire. It is therefore important to find means to capture a retiring miner's knowledge before an individual leaves, or to consider ways of retaining that knowledge. The number of retirements that will occur globally in the mining industry in coming years will impact the industry. The West Virginia coal industry predicts that it will need 5,000 to 7,000 more miners during the next 10 years to keep up with retirements. In Canada, it is estimated that during the next five years, 14 to 17 percent of the mining workforce is likely to retire with a gap of between 2,700 and 7,000 predicted, while in Australia there will probably be 7,400 fewer employees in the mining industry during the next five years (Muir, 2006). A recent report published in Canada forecasts that the country could lack up to 81,000 workers by 2014 and that new employees to the mining industry could only make up for between 20 to 55 percent of retirees (Morgan, 2006).



The manpower crisis has been caused by a number of factors, as highlighted at the Mines and Money Conference in London (Morgan, 2006), including:

- A prolonged period of low commodity prices.
- Years of cost reduction programs.
- Technological developments increasing productivity.
- Marginalization of the mining industry in the developed world.
- The rapid expansion of mine developments in remote areas.

Other factors compounding the problem include the end of the baby-boom generation, a general trend away from rural/remote communities, reduced interest among young people in heavy industries, and competing industries seem more attractive.

According to the Bureau of Labor Statistics, the median age of the mining workforce in 1998 was 41.2 years, as compared with 38.7 years for the U.S. civilian labor force. Also, the median age of the coal mining work force, estimated at 45.2 years in 1998, was already well beyond the median age (40.7 years) projected for the civilian labor force in 2008 (Fotta and Bockosh, 2000). These differences indicate an emerging problem in the mining industry: many experienced miners will be retiring soon, leaving a big gap in the mining workforce. The implication is that there will be no or very little interface time between the new miners (if available) and the experienced miners, who could have helped train the new, inexperienced miners. An influx of inexperienced miners may result in more fatalities and injuries, similar to what the coal mining industry experienced during the Second World War (1941-45) and after the 1973-74 oil embargo by Organization of Petroleum Exporting Countries (OPEC). The fatal incident rate increased by 16% during World War II and the non-fatal disabling injury rate per million

man-hours increased from 36.38 in 1974 to 53.28 in 1977 due to the rapid influx of inexperienced miners during both periods. It is therefore evident that virtual reality type of training is needed to enhance current training techniques in order to prevent the recurrence of fatalities and injuries in our mines.

The issue is not simply a matter of developing appropriate interventions and training for older workers and new hires. According to the Kentucky Post (April 17, 2001), as referenced by Kowalski et al. (2001), most mining companies are faced with recruitment problems because young people are shunning mining careers and opting for less dangerous jobs. Another factor affecting employment issues in the mining industry is the remote locations of most mining operations, which make them less attractive. Some people are reluctant to live and work in such locations (Muir, 2006). New miners who are trained in a virtual mine environment will have a better idea of what the real mining job will be like before they make key decisions about their careers. Also, virtual reality training could be used to provide a valuable practical experience to new graduates who do not have practical mining experience. According to Lynton (2006), young people in third world countries are highly motivated to study and learn, but only in theory. Therefore, there is no tradition of practical application. Engineers do not go into operations, factories, or mines, and do not really know the machines and conditions for which they are designing.

### **1.3. OBJECTIVES AND SCOPE OF RESEARCH**

Many studies have been conducted on the kinds of education and training experiences that are needed for the aging mine worker or the best way to prepare young

people for work in a mining environment, but no such study has been conducted to establish the key elements that should be considered in training underground rock bolters or develop a model for the transfer of experience from older rock bolters to younger ones. The main goal of this research was to determine how effective virtual environments could be used for training underground rock bolters with an emphasis on training rock bolters using a jackleg drill. Virtual environments are capable of being programmed to allow underground rock bolters to train in numerous scenarios. The study concentrated on establishing step-by-step multimedia and virtual reality training system that could be used to train inexperienced rock bolters with a focus on underground hard rock mining. The training system takes into consideration the effects a hazardous, physically demanding, and continually changing underground mining environment have on the way underground rock bolters interact with their jobs, as well as the actions required to deal with these changing circumstances. It is important to note that this study is not intended to replace reality-based training. However, it is a powerful medium intended to supplement and enhance it.

#### **1.4. STATISTICS OF ROCK FALL ACCIDENTS AND ROCKBOLTING INJURIES**

Rock bolting was chosen for this research because it is one of the most dangerous underground mining jobs. Rock bolters are generally under constant production pressure to install as many bolts in one shift as are necessary to keep up with the mining operation, and they perform their tasks in a confined environment with a limited working height. The restricted work environment forces them to perform tasks that require quick reactions in awkward postures. Also, rock bolters work in newly exposed roof areas, so they are at

greater risk from the unsupported and unknown conditions. A survey conducted by MSHA from 2000 to 2004 revealed that the fall or slide of rock was the second cause of fatalities in underground coal mines and the fourth cause in the metal and non-metal mines ([www.msha.gov](http://www.msha.gov)). MSHA-based statistics also show 10 fatalities and more than 1,000 injuries in underground drilling and bolting operations during the period of 1992 to 1996. Iannacchione et al. (2000) reported that 92 injuries (11 of which were fatal) occurred from fall of roof, rib, or face in about 90 underground stone mines in the U.S. from 1990 to 1996. Although this figure is small in magnitude, its severity value for the reported work force of less than 2,000 miners is very high. Also, injury statistics data from the MSHA show that about 80% of the lost days and 20% of the accidents in the underground stone sector are attributed to ground falls, while three-fifth of all roof, face, and rib fall injuries are related to some kind of lost time accident.

NIOSH-based statistics indicate that more than 100 million roof bolts are installed each year in U.S. underground coal mines to prevent rock falls. Nevertheless, during a typical year, about 55% of operating mines experience at least one roof fall. In 1996, 2,600 roof falls resulting in 711 injuries and 8 fatalities were reported. Approximately 80% of these roof falls were caused by failure of the primary roof bolt support system. Helander et al. (1983) reported that 85% of roof bolting fatalities resulted from roof falls, while less serious accidents involved bolting machines (about 50%) and falling roof rock (about 25%). Drill steels, bolting machine booms, and frames were the components most often involved in nonfatal injuries.

**1.4.1. Scaling Related Injuries.** About 50% of underground mining accidents are attributed to ground collapses resulting from inadequate scaling (Planeta, 1994). Marras et al. (1988a, 1988b) reviewed six years (1978-1983) of US mining injury data in a study that associated the risk of injury in underground mining with the use of various hand tools. Their study revealed that over 26% of hand tool-related lost time accidents in the coal industry during this period were associated with the use of the scaling bar, while over 40% were attributed to the metal/nonmetal mining industry. Relative to other hand tools used in underground mining, the scaling bar ranks highest as a cause of days lost from work in coal mining and second highest in metal/nonmetal mining. Scaling accident information on US underground limestone mines from MSHA records of ground control type accidents showed that scaling accounted for about one-third of a total of 201 ground control related accidents that occurred from 1984 to 1994.

**1.4.2. Injury Review by Rock Drill Type.** Analysis conducted by Oitto (1975) on injuries involving machinery in underground metal and nonmetal mines in the U.S. during 1973-74 has indicated that rock drills accounted for 31 percent of the total injuries reported. Of all the underground rock drills used during that period, jackleg drills caused the most injuries (55 percent), while roof bolting machines accounted for only one percent, which was the lowest number of injuries (Table 1.2).

**Table 1.2.** Number of Injuries by Rock Drill Type (1973-74).

Drill Type	Reported Injuries	
	Number	Percent of Injuries
Jackleg	316	55
Jumbo	101	18
Drifter	42	7
Stoper	35	6
Jack hammer	29	5
Diamond drill	17	3
Roof bolting machine	6	1
*Unknown	29	5
Total	575	100

\* Drill type not provided in injury report.  
Source: Oitto (1975).

Two reasons were given as the cause of the injuries reported. First, there were more jacklegs in use than any other type of drill during that period. The second reason given was that the jackleg allows less margin for inexperience and carelessness than the other rock drills.

**1.4.3. Injuries Involving Mechanical Bolting.** Althouse et al. (1997) examined mechanical bolting accidents reported in the West Virginia Safety Information System (WVSIS) from 1983–1990, categorizing roof bolting tasks into four work routines based on the sequence of activities performed by bolter operators. These routines included preparing face area; tramming, positioning and setting automated temporary roof supports (ATRS); drilling holes; and installing bolts. Of the 2,111 injuries reported at the working faces, drilling holes accounted for the largest percent of injuries, while general face preparation accounted for the lowest percent of injuries, as shown in Table 1.3.

**Table 1.3.** Number of Injuries by Mechanical Bolting Routines at the Face.

Bolting Routine	Reported Injuries	
	Number	Percent of Injuries
Drilling Holes	672	31.8
Installing Bolts	521	24.7
Tram, Position, Set ATRS	492	23.3
General Face Preparation	426	20.2
Total	2,111	100

Source: Althouse et al. (1997).

**1.4.4. Jackleg Rock Drills Injury Review.** Marras et al. (1988b) reported that jackleg injuries were the most frequent injuries (44% of total) and accounted for the highest number of days lost, as a result of injury from the use of underground metal/nonmetal tools and equipment within the period of 1978-1983. According to Oitto (1975), injuries from jacklegs fit into three general categories: setting up the drill, collaring a hole, and drilling a hole. Analysis of jackleg injuries during the time period of 1973-1974 indicated that most of the injuries occurred during hole drilling (71%), while collaring a hole and setting up the drill accounted for 20% and 9%, respectively. Most of the injuries that occurred while the jackleg was being set up were caused by jackleg toppling (13 out of a total of 29 injuries). Forty-six of the 62 total injuries reported during hole collaring were due to the operator losing control of the jackleg, while drill steel changing accounted for most of the injuries during hole drilling (100 out of a total of 225 injuries). Table 1.4 provides details about injuries from jacklegs during the 1973-74 year period.

**Table 1.4.** Injuries from Jacklegs by Drilling Activity (1973-74).

Drilling Activity	Reported Injuries	
	Number	Percent of Injuries
<b>Setting up to drill</b>		
Jackleg toppled	13	9
Slipped and fell while carrying the jackleg	9	
Other	7	
<b>Collaring a hole</b>		
Lost control of jackleg	46	20
Injured by steel puller	10	
Drill steel caught clothing or gloves	3	
Other	3	
<b>Drilling a hole</b>		
Changing a drill steel	100	71
Airleg kicked out striking somebody	29	
Drill steel broke during drilling	26	
Struck by drill or steel when removing stuck steel	20	
Slipped and fell during drilling	17	
Airhose came loose while drilling	12	
Drill steel got stuck causing the jackleg to spin	9	
Other	12	
<b>Total</b>	<b>316</b>	

Source: Oitto (1975).

It was concluded from the jackleg drill analysis that a jackleg drill was inherently unsafe or that most of the miners who used the jackleg were not properly trained, or both. One other interesting outcome of the investigation was that one-half of the total number of miners injured had less than two years experience on the job. This justifies comments made by mine inspectors during the investigation that training programs for workers on new jobs and indoctrination programs for new workers are inadequate. Many mines have on-the-job training in which a novice driller is assigned to a veteran miner. The veteran



miner is often either not interested in the training program or too busy to provide proper instruction.

### **1.5. RESEARCH METHODOLOGY**

The research approach adopted closely follows NIOSH training guidelines, as below:

- training needs assessment,
- specifying training content,
- accounting for individual differences,
- specifying learning conditions,
- evaluating the training, and
- revising the training if necessary.

It is obvious from the above statistics that a new training module is required to reduce injuries to underground rock bolters. The first step of this research was to review available literature on underground rockbolting, and also to collaborate with the underground mining industry to study and review underground rock bolters' tasks to identify the causes of injuries and how they could be prevented. This information was used to develop a lecture-type multimedia tutorial and a virtual reality computer simulator. The multimedia part of the Miner Simulation Training Model (MinerSIM) involved the use of text, photographs, animation, and videos to introduce trainees to basic principles of ground control and manual drilling using a jackleg drill. The section describing the ground control included:

- the discussion of factors affecting ground conditions,

- types of ground failure,
- checking ground conditions, and
- ground control methods.

The section covering manual drilling included:

- manual drilling equipment,
- operating manual drills,
- preparing a face for drilling (including scaling),
- drilling patterns, and
- installing rockbolts.

This lecture part of the training was to be followed by the virtual reality computer simulation, which provides a visually appealing real-time interactive training environment and exposes new miners to simulated hazardous conditions and work situations normally encountered in the mining environment. The second part of MinerSIM is based on the code of the “Half-Life” game, which was developed in collaboration with the Computer Science Department of the Missouri University of Science and Technology (Missouri S&T). This code allows the designation of rooms and corridors, which represent stopes and drives in the real mine environment. Evaluation of the physical components of the prototype system consisting of collection of qualitative data was carried out at the end of the project using Missouri S&T students. Areas requiring improvement have been identified and recommendations to be considered during re-design stage are provided.

## 2. LITERATURE REVIEW

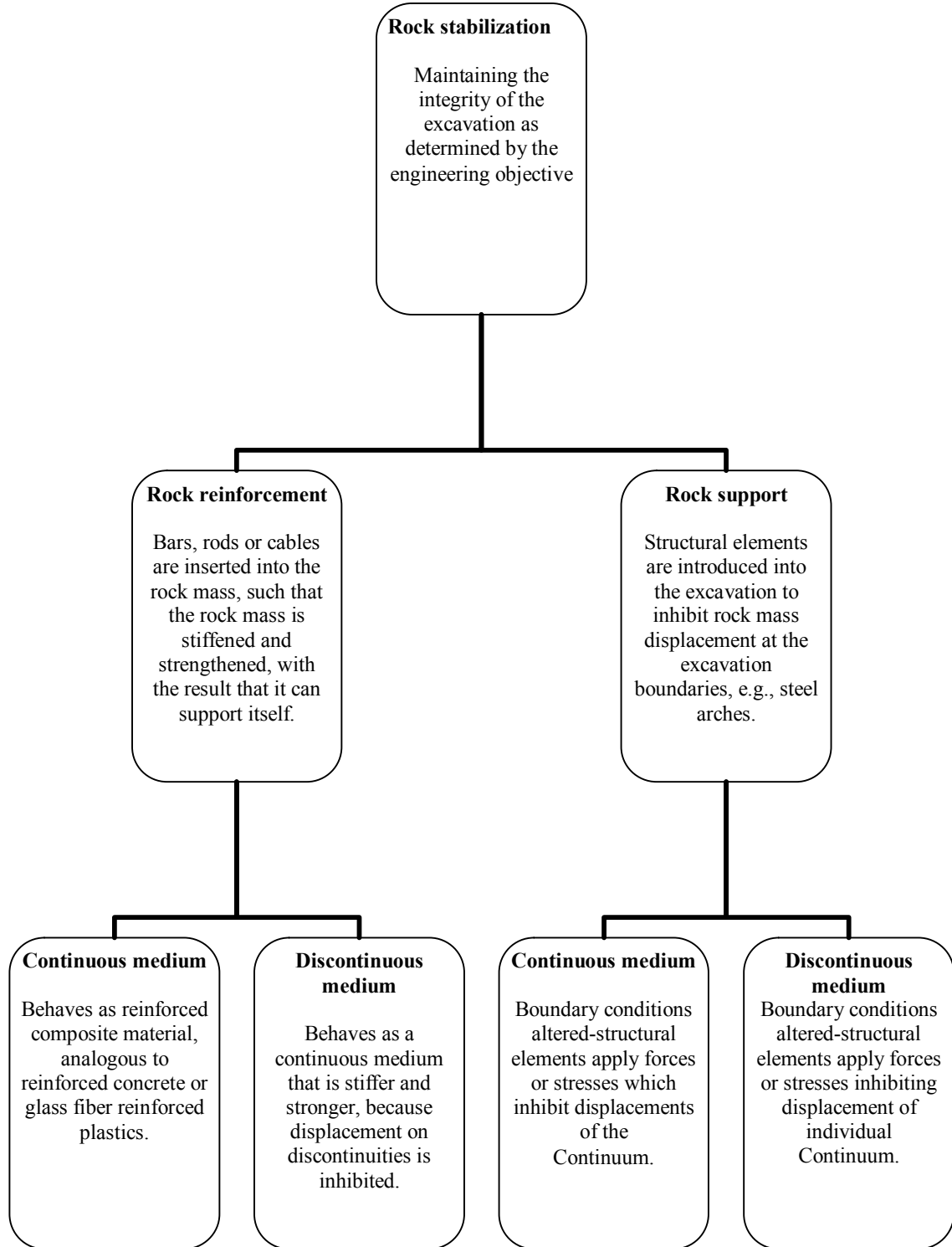
### 2.1. GENERAL OVERVIEW OF ROCK STABILIZATION

Excavations cut into rock masses with several sets of discontinuities may liberate rock blocks of various sizes. The potential movements of the most critically located of these may then undermine neighbor blocks, and the ensuing block falls and slides can menace the integrity of the engineering scheme (Goodman, 1989). If the excavation is unsupported, block movements may unacceptably alter the excavation perimeter and the blocks may cause property damage and personal injury.

Hudson and Harrison (1997) established that if surface or underground failure around an excavation is due to blocks of rock moving into the excavation, then two approach philosophies can be considered for stabilization:

- The block displacements occur because the rock mass is a discontinuum; hence the rock is reinforced so that it behaves like a continuum; or
- Direct support elements are introduced into the excavation in order to maintain block displacements at tolerable levels.

The first option is known as rock reinforcement, which involves insertion of engineering elements within the rock mass, while the second option is known as rock support and entails insertion of elements within the excavation. A categorization of rock reinforcement and rock support in continuous and discontinuous rock is shown in Figure 2.1.



**Figure 2.1.** Basic Categorization of Rock Reinforcement and Support.  
Source: Hudson and Harrison (1997).

A rockbolt is a type of ground support used in underground mines to protect personnel and equipment from ground falls. In many cases, ground support is a significant portion of the total mining costs. The reliability and efficiency of the support system is therefore critical to ensure that mine workers can operate in a safe environment and that this large expenditure is not wasted. The four main areas critical to the success of ground support system, according to Tyler et al. (1999), are

- selection of ground support devices,
- design of the support patterns,
- installation procedure, and
- quality control

Rockbolts are preferred to other types of supports because

- they can be installed as soon as the excavation is made to prevent any appreciable deformation,
- they are not influenced by the shock waves of explosives (especially resin bolts),
- they allow the mine cross-section to be kept open since there are no posts to obstruct the galleries,
- their resistance to airflow is low, improving ventilation; and
- they reduce ore or coal dilution from falling rock.

Rockbolts can be installed on a fixed production pattern (designed according to the rock structure), or the pattern can be varied according to local conditions, or both.

## **2.2. TASK ANALYSIS OF AN UNDERGROUND ROCK BOLTER USING A JACKLEG DRILL**

A rockbolter's typical work sequence includes general preparation of the face, positioning and setting up the drill, drilling a hole, and installing a bolt. General preparation of the face is a miscellaneous category that includes

- washing the face,
- scaling,
- handling ventilation material,
- performing a gas check (if required),
- handling supplies, and
- examining the workplace.

Drilling bolt holes involves

- inserting the drill steel in the chuck,
- adding extension steels if necessary,
- changing the bits,
- drilling the hole, and
- removing the steel.

Bolt installation involves

- making up bolt assemblies,
- inserting resins in the hole if required,
- inserting bolts into the hole,
- aligning the bolts, and
- spinning to mix resin or tightening the installed bolt.

The sequence is repeated until the assigned area is completely secured.

**2.2.1. Manual Scaling.** The scaling bar typically consists of a piece of bar metal with a diameter between 2.5 and 4 cm. A sharp tip is either ground into one end, or a preformed tip is attached to the end of the bar, as shown in Figure 2.2. Figure 2.3 shows a miner undergoing a scaling operation at the Missouri S&T Experimental Mine.



**Figure 2.2.** Metallic Scaling Bars.



**Figure 2.3.** Scaling in a Mine.

These bars, depending on the length and type of material used, are typically between 1.22 and 3.66 m in length and can have a mass greater than 4 kg (Marras and Lavender, 1991). Commercially available scaling bars made of fiberglass are also becoming common in the mining environment. The length of a scaling bar is a critical measure since this determines how close the miner has to be to the loose rock material when scaling.

In underground mining, the scaling bar is a ubiquitous tool commonly used to remove loose rock fragments from roofs and ribs. This tool is used daily by many workers in both coal and metal/nonmetal mining. Miners depend on a roof and rib that has been scaled efficiently and properly for safe work conditions. Likewise, the scaling quality also affects the effectiveness of other support structures (Grau and Prosser, 1997). One of the most frequent causes of accidents in underground excavations is inadequate scaling after a blast. Generally, a scaling crew moves in after the fumes from a blast have cleared and it is the crew members' responsibility to ensure that the working place is safe for subsequent tasks (Hoek and Brown, 1980).

Planeta (1994) states that "scaling is one of the most stressful, labor-intensive and dangerous operations in underground. This is because it is carried out manually and without the use of machines in small mines." Scaling using a conventional bar is comprised of three activities including

- Detection of loose ground. Based on experience by tapping the ground, the miner is able to detect areas where there are loose rocks.
- Penetration of the bar. Using the bar, the miner exerts pressure to penetrate one of the ends of the bar into the opening present or to produce an opening.
- Use of the bar as a prying lever. After inserting the end in the fissure, the miner can then use the bar as a lever to pry loose rocks.

A study of the scaling process conducted at University of Laval's Mouska Mine and reported by Planeta (1994) indicated that loose rock detection represents 20 to 30% of time in the scaling operation, while penetration and prying account for 70 to 80%. It was also noted that the actual time devoted to scaling decreases as the task progresses.

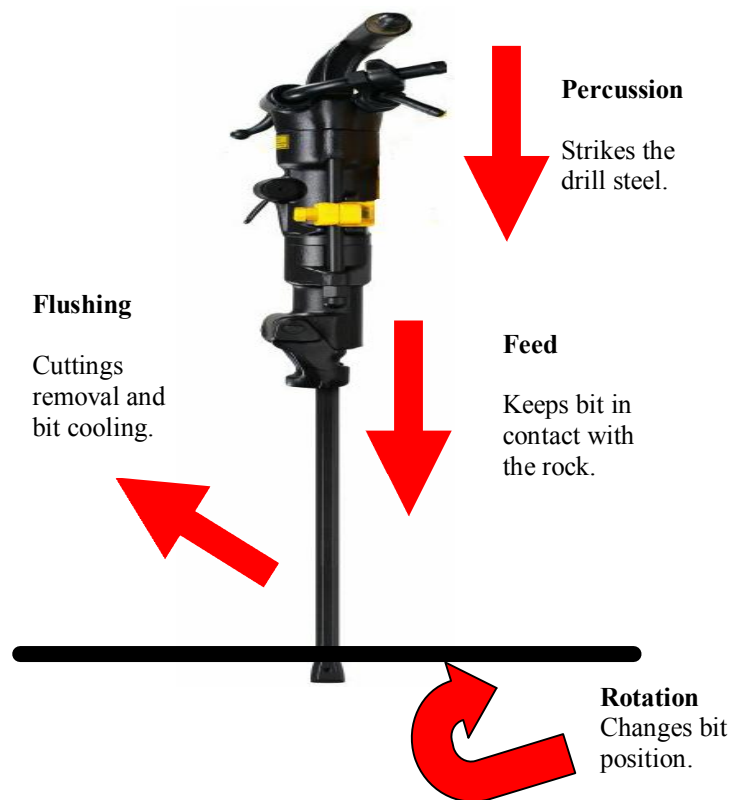


From an ergonomic perspective, scaling is a very demanding task because it entails considerable percussion and traction efforts using a scaling bar, sometimes in awkward positions. Marras and Lavender (1991) identified three possible factors that may affect spine loading and the risk of back over-exertion injuries through the use of the scaling bar including method of scaling, physical properties of the scaling bar, and roof height of the mine. They conducted an experiment in a simulated mine environment involving 14 subjects. Each subject was allowed to perform a scaling task for 4 minutes. Results from this study show that changes in roof height mostly affected the muscular activity required from the latissimus dorsi muscles, the left erector spinae muscles, and the right abdominal muscle. Method of scaling was observed to least affect muscle activities.

An investigation conducted on scaling roof accidents in underground coal mines in the US indicates that the frequency of scaling accidents is related to miner scaling experience (Grau and Prosser, 1997). It has been deduced that scaling is both an art and a technique. Although experience is gained only through time, this study indicates that training, as well as defining proper scaling techniques, might play an important role in reducing injuries while scaling.

Mechanized scaling is now common in the mining industry and is well-suited for scaling large openings, especially in sedimentary rock where the scaling process does not disturb the layers above. According to Hoek and Brown (1980), mechanical scaling is not only safer than manual scaling, but also reduces the need for spot bolting to secure loose blocks. Spot bolting is always expensive because it is generally carried out as an extra activity and may cause delays in the mining schedule.

**2.2.2. Drilling.** In spite of advances in drilling technology (i.e., development of longhole drills, jumbos, etc), hand-held drills are still common in the mining industry. Three main types of manual drills are used in the mining industry: jacklegs, stopers, and pluggers. These drills turn in a counter-clockwise direction and operate on four basic principles: percussion, feed, rotation, and flushing, which are illustrated in Figure 2.4.



**Figure 2.4.** The Four Operating Principles of Percussion Drills.

The jackleg drill is widely used in development and production drilling in many small-scale and narrow-vein underground mining operations in North America

(Paraszczak, 1993). It is an air-powered hand-held rock drill with a retractable telescopic leg. The drill head shown in Figure 2.5 is attached to the top of the retractable telescopic leg shown in Figure 2.6 with a threaded connector.



**Figure 2.5.** Drill Head.



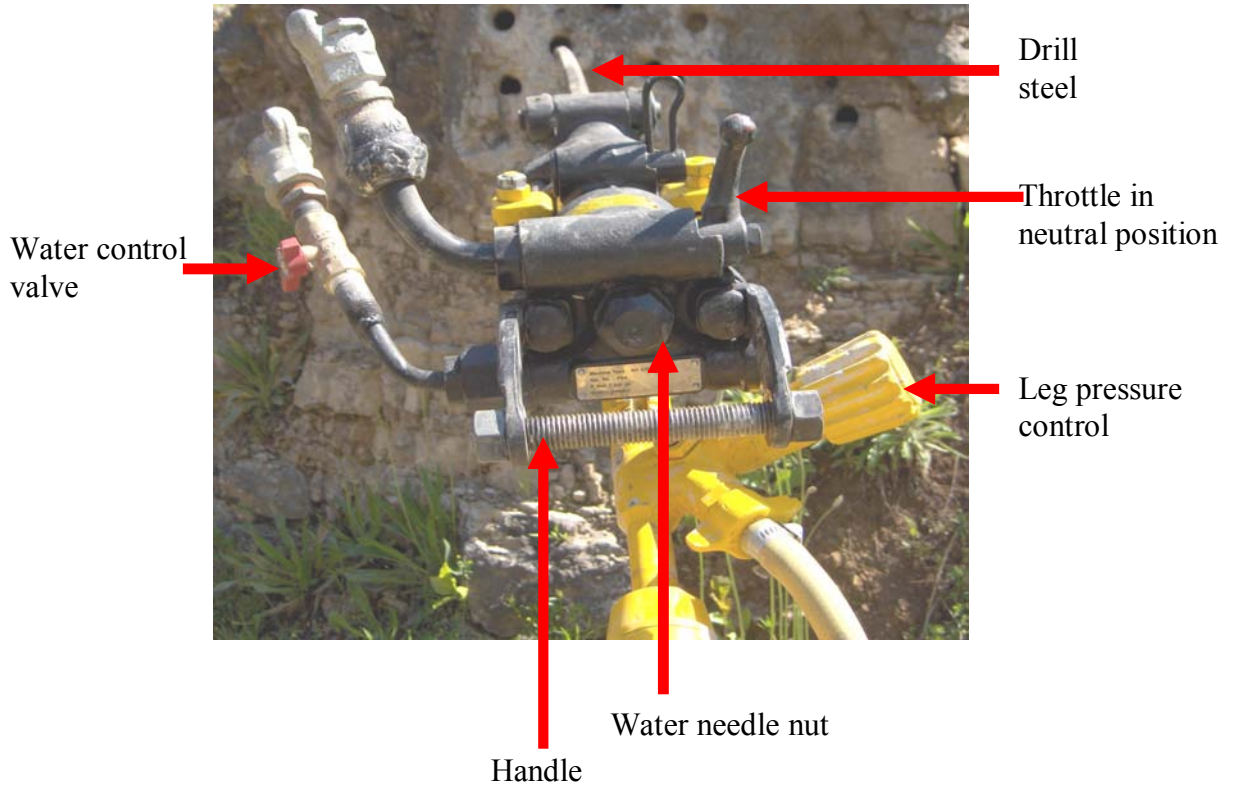
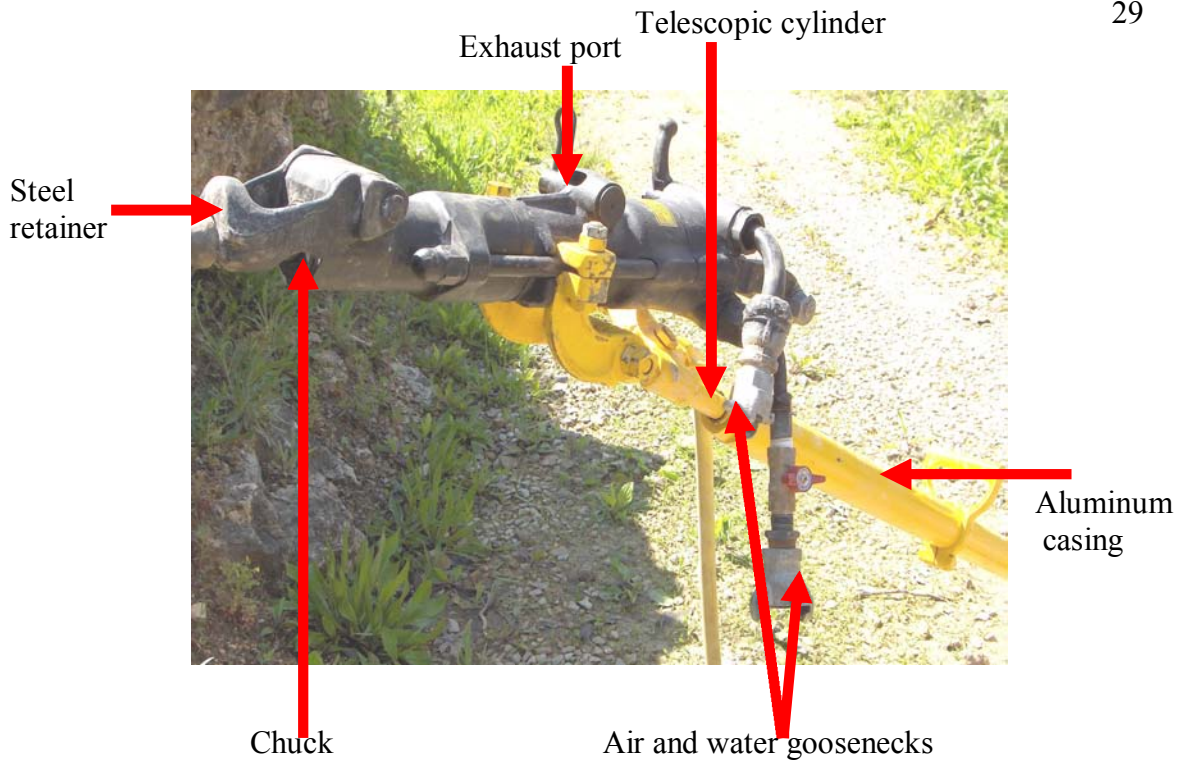
**Figure 2.6.** Telescopic Leg.

A jackleg drill is used to install ground support, especially in walls. It is also used to drill drift rounds in manually-driven drifts, breasts in stopes, and slashes to enlarge underground openings. The drill head produces percussion and rotation during drilling, while the telescopic leg provides feed pressure. The jackleg is the most versatile manual drill because the drill head pivots on the feed leg, which makes its operation more difficult than other manual drills and, therefore, requires a great deal of operator experience for efficient use (SIAST, 2002). Figure 2.7 shows a jackleg drill in its mounted position.



**Figure 2.7.** Drill Head Mounted on the Telescopic Leg.

A jackleg is about 6 ft (1.8 m) long, and the leg extends another 4 ft (1.2 m) when drilling. Some major parts of a jackleg drill and their respective functions, as provided in Northlands College Underground Training Manual are illustrated in Figure 2.8 and listed below.



**Figure 2.8.** Parts of a Jackleg Drill.

- Chuck – the opening in which the drill steel is inserted.
- Air and water goosenecks – the intakes to which the air and water hoses are connected. Removable screens inside the goosenecks filter the air and water before it enters the drill head.
- Water needle (water tube) – runs through the drill head to the base of the chuck to supply water to the drill steel.
- Steel retainer – is attached to the chuck on a swivel hinge, and it prevents the drill from falling off the steel because the flange (collar) near the end of the steel cannot go through the retainer.
- Throttle – controls the drill speed and water flow. It opens air to the hammer, sends water to the water needle, and starts the drill at slow speed. It is useful in collaring holes, as well as blowing water and sludge out of holes.
- Leg pressure control – a rotary control used to regulate the amount of air sent to the telescopic leg.
- Telescopic leg – the leg of a jackleg is a telescopic steel cylinder inside an aluminum casing. As air pressure is sent to the leg, the cylinder is pushed out of the casing. This feed pressure keeps the drill head pushed firmly against the end of the steel.
- Exhaust port – opening on the drill head through which exhaust air escapes during drilling.
- Muffler (not shown in Figure) – reduces the noise level of the drill.
- Drill handle – used to hold the drill in the required position.
- Water control valve – used to adjust the flow of water.

**2.2.3. Bolting.** Rockbolts generally consist of plain steel rods with a mechanical anchor at one end and are normally tensioned after installation. Bolts may be left ungrouted for short term applications. However, the space between the bolt and the rock is filled with cement or resin grout when used for permanent applications. Although the history of rock bolting is relatively short, its use has become widespread in general engineering construction, as well as in mining (Lang, 1961). There are various types of rockbolts (see Figure 2.9), but the major types include mechanical, resin or cement bounded, friction, or a combination of these three types.

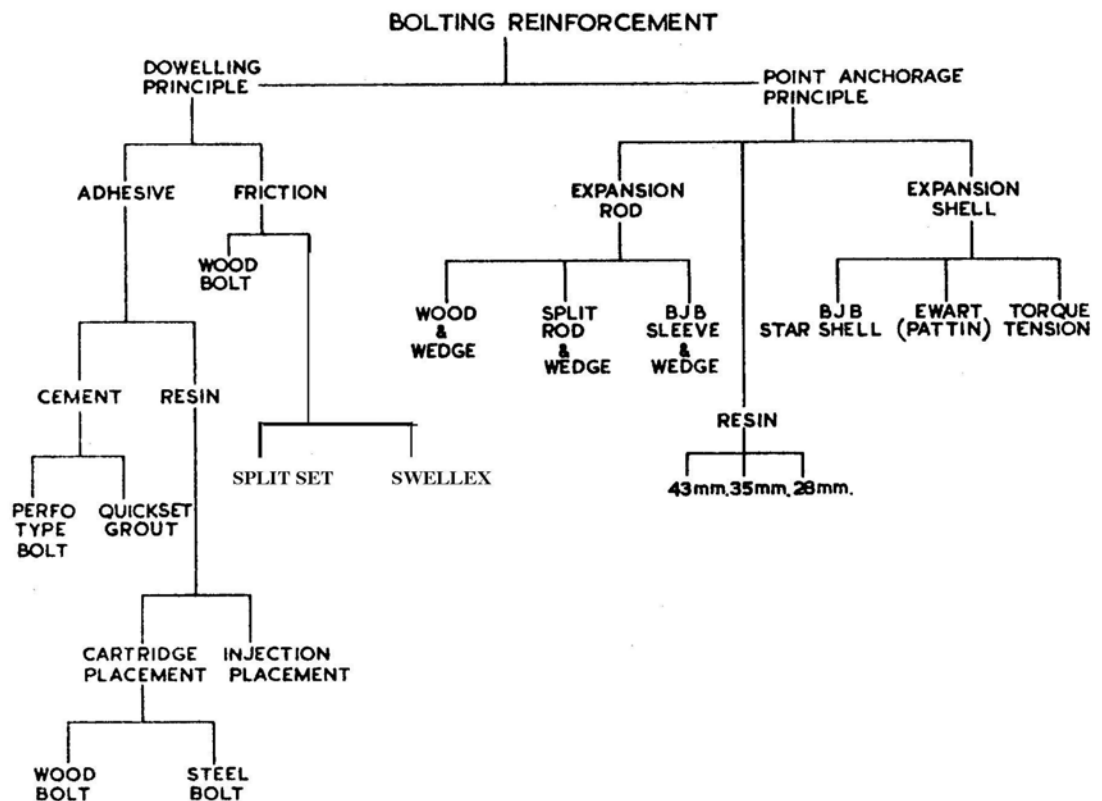


Figure 2.9. Types of Rockbolt.

Each type of rockbolt uses a different mode of support in attempt to restore loosened blocks of rock to their original unloosened positions. The mechanism of support of the major rockbolt types is described in Table 2.1.

**Table 2.1.** Types of Rockbolts and Their Mechanism of Support.

<b>Type</b>	<b>Mechanism of Support</b>
Friction	Frictional force between the rock bolt shaft and rock surface resists ground movement
Rebar	A deformed bar anchored with resin provides compressive force to stabilize the rock (tensioned type). A bar fully encased in resin stabilizes the rock if placed in tension by any slight ground movement (non-tensioned type).
Mechanical	The expandable shell pushes against the rock as the rockbolt is tightened.

Source: Saskatchewan Institute of Applied Science and Technology Training Manual (2002).

**2.2.3.1. Mechanically anchored rockbolts.** Expansion shell rockbolt anchors come in a wide variety of styles, but the basic principle of operation is the same in all of these anchors (Hoek et al., 1997). Components of a typical expansion shell anchor are a tapered cone with an internal thread and a pair of wedges held in place by a bail. The cone is screwed onto the threaded end of the bolt and the entire assembly is inserted into the hole which has been drilled to receive the rock bolt. Figure 2.10 shows a typical mechanical rockbolt.





**Figure 2.10.** A Typical Mechanical Rockbolt.

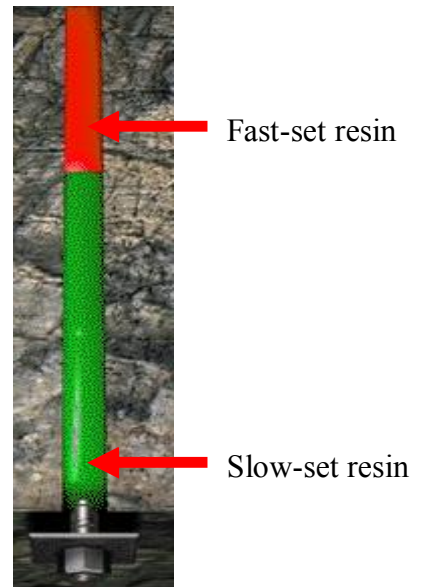
The length of hole for a mechanical rockbolt should be at least 100 mm longer than the bolt so that the bail will not be dislodged by being forced against the end of the hole. A fixed head or threaded end and nut system are used at the other end of the rockbolt. In either case, some form of faceplate is required to distribute the load from the bolt onto the rock face. Additionally, a tapered washer or conical seat is used to compensate for the fact that the rock face is seldom at right angles to the bolt (Hoek et al., 1997). Mechanical rockbolts prevent ground movement by applying pressure to the rock layers. As the rock bolt is tightened, the tapered nut threads downward and pushes the expandable shell against the sides of the hole. The pressure formed between the shell and the rockbolt plate creates a vice-like grip, preventing ground movement. It is recommended that mechanical bolts are tightened to between 160 and 180 foot pounds of torque in order to be effective (SIAST, 2002). Mechanical bolts work well in hard rocks, but are not very effective in closely jointed rocks and soft rocks because of deformation and failure of the rock in contact with the wedge grips.

**2.2.3.2. Resin anchored rockbolts.** A rebar rockbolt, shown in Figure 2.11, is a ground-supporting steel rod grouted in place with resin or wet cement. Although they are usually installed with a steel plate and tightening nut, rebar bolts are effective without a plate (SIAST, 2002).

Rebar bolts can be installed with or without tension. When not tensioned, they do not exert pressure on the rock mass until the rock moves. Once the rock transfers its load to the bolts, they resist further ground movement. This action is referred to as passive ground support. Rebar bolts are usually installed with fast-setting resin at the end of the hole and a slow-setting resin surrounding the remaining length of the bolt, as shown in Figure 2.12.



**Figure 2.11.** A Rebar Rockbolt.



**Figure 2.12.** Slow and Fast-set Resin.

Tension is applied by tightening the nut against the plate after the fast-setting resin cures, but before the slow-setting resin hardens. The bolt then exerts compressional force on the rock mass. This action is called active ground support.

Rebar bolts have a very coarse rolled thread which gives them good bonding and allows the length of the installation to be adjusted easily. Additionally, they are very convenient and simple to use. High strength anchors can be formed in rock of poor quality and, by choosing appropriate setting times, a “one shot” installation produces a fully grouted tensioned rock bolt system (Hoek and Brown, 1980).

**2.2.3.3. Friction rockbolts.** Friction rockbolts (friction stabilizers) differ from other types of rockbolts because the entire length of the bolt makes contact inside the hole. The frictional force between the rock bolt shaft and rock surface resists ground movement in a manner similar to a nail in a wooden board. The two common types of friction bolts are split sets and swellex.

**2.2.3.3.1. Split sets.** A split set is a ground supporting hollow steel tube with a slot along its entire length. One end is tapered for insertion into the hole, while the other end has a ring flange to hold the rockbolt plate, as shown in Figure 2.13.

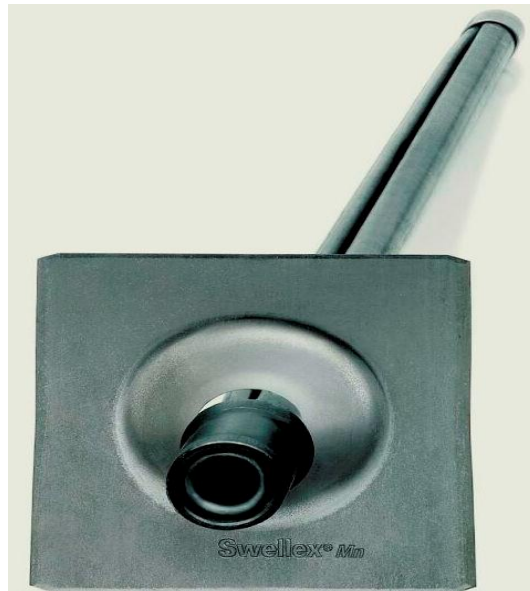


**Figure 2.13.** Split Set Rockbolt.

The bonding power of a split set depends on the drill hole diameter being smaller than the bolt diameter. According to Thompson and Finn (1999), the load transfer of a split set can be improved significantly by pumping cement grout into the borehole to fill the center of the tube. The improved load transfer is attributed mainly to the additional load transfer between the grout and the rock at the slot in the tube. It has been established through testing and associated theoretical considerations that, where large rock mass displacements occur, the improved load transfer may be sufficient to prevent slip of the split set tube relative to the borehole and the axial capacity of the split tube may be exceeded, i.e., the ability of the rockbolt to sustain large rock mass displacements may be lost (Thompson and Finn, 1999).

**2.2.3.3.2. Swellex friction rockbolt.** The Swellex type rockbolt is a ground-supporting hollow steel tube that has been folded inward to reduce its diameter, as shown

in Figure 2.14. Swellex bolts strengthen rock mass through a combination of friction and mechanical interlock at the rockbolt interface.

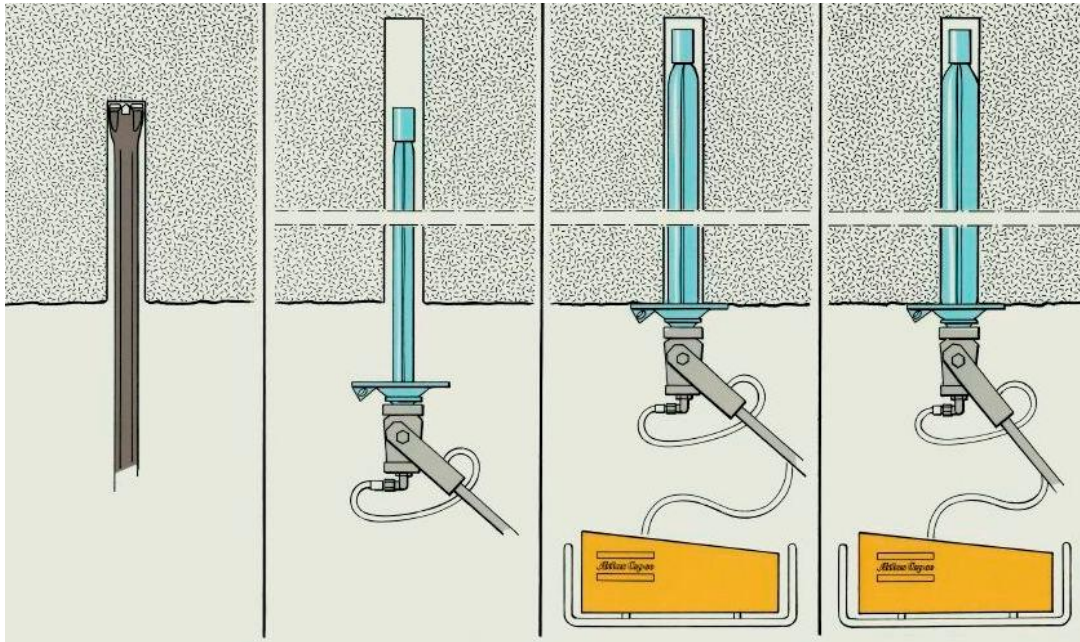


**Figure 2.14.** Swellex Friction Rockbolt.

The anchoring mechanism of the swellex bolt is different for hard and soft rocks. In hard rocks, the secondary contact stress induced by the mechanical interlock of the asperities at the borehole wall plays a major role in the anchoring, whereas the primary contact stress created by the bolt expansion does not contribute much. In soft rocks, it is the friction, and thus the primary contact stress, that determines the anchoring capacity of the bolt (Li and Hakansson, 1999).

Swellex bolts are installed by inflating the bolt using high water pressure from a specially designed pump, as illustrated in Figure 2.15. When the pump is started, the high

water pressure inflates the tube, causing a small elastic expansion of the borehole diameter. The surrounding rock contracts when the pump is stopped to release the water pressure. This action provides the swellex locking effect shown in Figure 2.16.



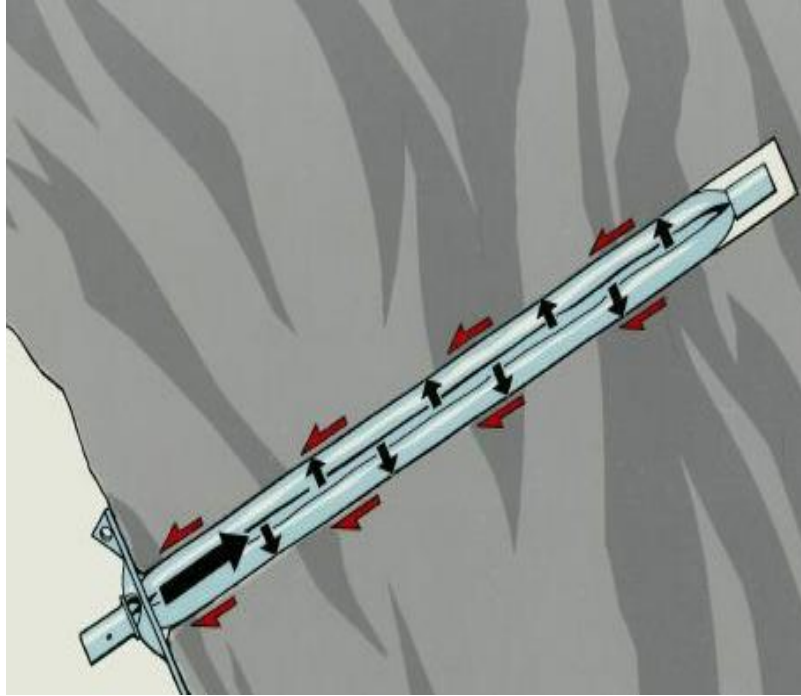
1. Drill hole

2. Insert bolt

3. Expand bolt

4. Bolt secured

**Figure 2.15.** Installing a Swellex Rockbolt.  
Source: Atlas Copco Construction Tools Inc., (2006).



**Figure 2.16.** The Locking Effect and Friction Bond along the Entire Length of a Swellex Rockbolt.  
Source: Atlas Copco Construction Tools Inc., (2006).

The advantages and disadvantages of rockbolt types compared in Table 2.2 are taken largely from the SIAST Training Manual.

**Table 2.2.** Comparison of Rockbolt Types.

<b>Rock Bolt</b>	<b>Advantages</b>	<b>Disadvantages</b>
Mechanical	<ul style="list-style-type: none"> <li>• Relatively inexpensive</li> <li>• Easy to install</li> <li>• Provides immediate support</li> </ul>	<ul style="list-style-type: none"> <li>• Limited to hard rock</li> <li>• Holds only from the tension between the shell and plate</li> <li>• May loosen with blasting or vibration</li> </ul>
Resin anchored rebar	<ul style="list-style-type: none"> <li>• Supports more weight than mechanical bolts</li> <li>• Provides support along the entire bolt</li> <li>• Allows very little ground movement</li> </ul>	<ul style="list-style-type: none"> <li>• More costly</li> <li>• More difficult to install</li> <li>• Tolerates less movement before breaking</li> <li>• Resin has a limited shelf life</li> </ul>
Split sets	<ul style="list-style-type: none"> <li>• Provides immediate support</li> <li>• Provides support along the entire length of the bolt</li> <li>• Tolerates substantial ground movement without failing</li> <li>• Does not loosen over time</li> </ul>	<ul style="list-style-type: none"> <li>• Corrosion is a problem in the long-term</li> <li>• Hole diameter is critical</li> <li>• Installation of longer bolts can be difficult</li> <li>• Careful handling and storage is required</li> </ul>
Swellex	<ul style="list-style-type: none"> <li>• The same advantages as split sets, plus they hold by tension as well as by friction</li> <li>• Operator judgment on tightening is not required because the pump stops automatically</li> </ul>	<ul style="list-style-type: none"> <li>• Corrosion is a problem in the long-term</li> <li>• Installation requires a special pump</li> <li>• Careful handling and storage is required</li> </ul>

Source: SIAST Training Manual (2002).



## 2.3. VIRTUAL REALITY SIMULATORS AND EVALUATION METHODS

There are two major categories of virtual reality software: toolkits and authoring systems (Chakraborty and Bise, 2002). Toolkits are programming libraries, generally for C or C++, that provide a set of functions with which a skilled programmer can create virtual environment. Authoring systems are complete programs with graphical interfaces for creating virtual environment without using any detailed programming method. Although the toolkits' programming libraries are more flexible and have faster renders than the authoring systems, a user must be a skilled programmer in order to use them.

**2.3.1. Simulator Developers for the Mining Industry.** A number of different VR simulators developed for the mining industry are currently in use. Most of these VR simulators were designed to train operators of heavy equipment. A list of companies and research centers that developed or work on VR simulators for the mining industry follows.

1. The University of Nottingham AIMS Research Unit developed VR training simulators that are interactive, graphically programmed through drag and drop modeling software, and provide hazard spotting. Some of their designs include dynamic simulation of backhoe equipment and simulators for operators of hydraulic excavators ([www.aims-solutions.co.uk](http://www.aims-solutions.co.uk)). Figure 2.17 shows the in-cab view of AIMS' excavator simulator, while Figure 2.18 shows a trainee using the simulator.



**Figure 2.17.** In Cab View of the Excavator Simulator.



**Figure 2.18.** A Trainee Using the Excavator Simulator.

2. 5DT (Fifth Dimension Technologies) is a high technology company specializing in virtual reality. 5DT develops, produces and distributes VR hardware and software to the mining industry. They developed simulators for training truck and dozer operators as well as continuous-miner operators, and

operators of mechanical roofbolters. Their roofbolting simulator allows trainees to use roofbolter controls in a virtual mine that accurately resemble roofbolting in the actual mine environment ([www.5dt.com](http://www.5dt.com)). Fifth Dimension Technologies' dozer simulator setup is shown in Figure 2.19 and its roofbolter training simulator is shown in Figure 2.20.



**Figure 2.19.** Dozer Simulator Setup.



**Figure 2.20.** Roofbolter Training Simulator.

Trainees work through a series of training scenarios which vary from elementary to very complex and challenging. The 5DT Roofbolting Training Simulator is used across the globe to train thousands of coal mine operators. Evaluation of the 5DT roofbolting simulator revealed that it is an effective training tool that increases safety awareness and allows accurate monitoring of operator techniques and actions. True-to-life realism enables trainees to transition from the classroom to the workplace quickly and safely. 5DT, however, recommended that roof bolt training can be enhanced by computer multimedia training.

3. Immersive Technologies is the leading global provider of operator training simulators for large surface mining equipment such as haul trucks, excavators, dozers, wheel loaders, and draglines. The simulators are interactive, immersive, and make use of real machine controls. Additionally, they are able

to achieve an advanced level of realism and fidelity through the use of proprietary data and machine technical information ([www.immersivetechologies.com](http://www.immersivetechologies.com)). A typical Immersive Technologies' simulated virtual mine environment is shown in Figure 2.21, while Figure 2.22 shows a trainee operator using a dragline simulator.



**Figure 2.21.** Typical Simulated Virtual Environment.



**Figure 2.22.** A Trainee Using a Dragline Simulator in a Virtual Environment.

Immersive has more than 100 simulator units coupled with more than 300 simulation modules for different machine configurations in operation across 18 countries and has supplied groups such as Phelps Dodge, BHP Billiton, Rio Tinto, Anglo American, Newmont Mining, Xstrata, and Thiess. The company has alliance agreements with five of the world's largest original equipment manufacturers, including Caterpillar and Komatsu, giving it exclusive access to proprietary machine information that ensures the authenticity of the finished simulator product (Forrestal, 2007).

4. NIOSH's Spokane Research Laboratory developed virtual reality software that allows trainees to begin their exercise in a safety room, where safety equipment (dependent on the training scenario) is picked up (Cullen, 2001). Simple or complex problems are presented to the trainees, requiring the interaction of team members who cannot see each other, but who are linked by a computer network. This medium seems to work well for new miner training, 8-hour refresher training, or specific training classes such as mine rescue. Investigations show that this VR training tool is extremely popular with younger miners, but older miners are sometimes reluctant to try it. Older miners prefer training videos to the VR training software.
5. Hadjigeorgiou et al. (1999) developed an interactive multimedia instructional system for underground rock bolters in Quebec underground mines in Canada that provides technical data on the choice and characteristics of rockbolt systems, as well as the methodology for correctly installing different support systems. They made use of graphics and videos, along with a simple

navigation system to make it accessible to people without any prior computer experience. The system covers modules on a general overview of rockbolting, a section containing pertinent information on the different types of rockbolts, and a module including useful data on rock supports used in combination with rockbolts. The system was evaluated by testing trainees before and after using the system to determine how much learning actually took place. Trainees were also interviewed to determine satisfaction levels with the use of the navigation system incorporated with the modules. The results of the evaluation described the system as being very user-friendly and interactive, with ample visual appeal.

6. Caterpillar developed a simulator called the “Virtual Training System,” which comes with a base plate with two arms bearing joysticks or a steering wheel that plugs into a standard personal computer (PC). This system is a handy tool for competency-based training of the novice equipment operator. It covers seven core product families, including hydraulic excavators, off-highway trucks, and motor graders. One of the benefits of this system is that it can easily be swapped from one equipment family to the next by simply changing over the software package in the PC (Forrestal, 2007).
7. Simlog developed a drill jumbo operator training simulator in collaboration with Atlas Copco Construction and Mining North America. The Simlog simulator recreates the essential components of the real drill jumbo control interface using industrial levers, joysticks and pushbuttons. The simulator also includes proprietary interface electronics, a single PC-compatible computer

and video projector to obtain a wide field of view (Freedman, 2001). Figure 2.23 shows a 3D model of a twin boom jumbo in a tunnel.



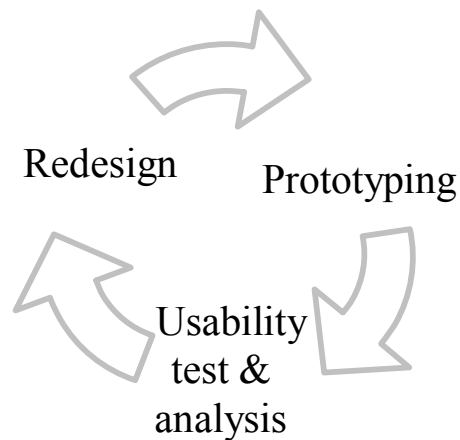
**Figure 2.23.** Simlog Drill Jumbo Simulator.

Although these developers offer high quality simulators, no comprehensive evaluation of the effectiveness of any of the simulators has been conducted.

**2.3.2. Evaluation Methods.** It has been suggested that before the entire user experience with a simulator is evaluated (i.e., after the simulator is fully developed), the individual features of the simulator need to be tested during the development stage, which is referred to as the formative usability testing (Kuniavsky, 2003). Krug (2000) defines usability as a method of making sure a system works well enough that a person of



average (or even below average) ability and experience can use it for its intended purpose without becoming frustrated. Rubin (1994) defines usability testing as a process that employs participants who are representative of the target population to evaluate the degree to which a system meets specific usability criteria. Usability is not a single, one-dimensional property of a user interface, but has multiple components. Usability is traditionally associated with five usability attributes including learnability, efficiency, memorability, errors, and satisfaction (Nielsen, 1993). Benefits of usability testing are associated with the increase of ease of use and productivity, and decrease in human error. Nielsen (1993) states “usability continues as long as a system exists.” The errors learned from the first usability test are used to develop a further prototype for another usability test (Figure 2.24).



**Figure 2.24.** Usability Test Format.

The effectiveness of a simulator, after it is fully developed, is determined by how much an operator's performance of a real-world task is improved due to training in a simulator. Despite the wide acceptance of simulators as valid training tools, few studies exist that actually measure this transfer (Lathan et al., 2002). Evaluation methodologies for measuring the data necessary to assess simulators, as taken from a study undertaken by the NATO Advisory Group for Aerospace Research and Development and reproduced by Lathan et al., (2002) are outlined in the following paragraphs.

**2.3.2.1. Operator opinion method.** The operator opinion method involves operators, instructors, training specialists, and students who are asked to give their opinions on the perceived training value of a simulator or features of a simulator. The method is useful when operational training or performance testing is not feasible. However, the method may fail to recognize whether any improvements in operator performance are due to previous knowledge and experience.

**2.3.2.2. Assignment of fidelity method.** The assignment of fidelity method describes the physical similarity between the simulator and the real-world environment, equipment, interface, or facility. This method assumes that higher fidelity will yield higher transfer. It is commonly used as an assessment tool rather than a training tool. Although high fidelity generates user acceptance, user acceptance does not mean that a device is more effective at training operators.

**2.3.2.3. Transfer of training (ToT) method.** The ToT method involves two groups of trainees: an experimental group which receives simulator training prior to further training for performance testing and a control group which receives all of its training in the real world. Alternatively, the experimental group could be participants

using a newly developed simulator and the control group could use an existing simulator program. The two groups must be equated in terms of relevant prior training and experience. This method is generally the most appropriate method for determining whether simulator training has improved subsequent operational performance.

**2.3.2.4. Self-control transfer method.** The self-control transfer method uses an experimental group to serve as its own control. In this method, operational performance is assessed, then simulator based training is introduced and subsequent operational performance is assessed and compared to the original operational performance. The main disadvantage of this model is that it assumes the trainee's subsequent performance on the operational task has improved as a result of simulator training.

**2.3.2.5. Preexisting control transfer of training method.** The preexisting control transfer of training method is similar to ToT, but a simulator is often introduced after an established training protocol is in place. The model determines transfer of training using the new simulator because performance data already exists for the control group.

**2.3.2.6. Uncontrolled transfer method.** The uncontrolled transfer method simply determines whether naïve subjects can perform a particular task in an operational setting following simulator training. It is a crude method of determining training transfer. However, it is useful for quickly evaluating features of or improvements to a simulator, but does not provide measures for accurately quantifying transfer.

**2.3.2.7. Inverse transfer of training method.** The inverse transfer of training method makes use of experts who perform a task without practicing in a simulator. A positive result assumes that a suitable training program exists for the simulator. Since the

experienced operator is already proficient at the task and may have a highly specialized skill, the simulator can be suitably designed for the evocation of a particular set of behaviors from a skilled operator.

**2.3.2.8. Simulator-to-simulator transfer method.** A lower fidelity simulator is used in part task training in this method, which is then followed by whole-task testing on a higher fidelity simulator. This method assumes that a higher fidelity simulator will yield high transfer and a lower fidelity simulator will yield little or negative transfer. This method is valuable in reducing the use of more complex simulators.

### **3. DESIGN AND DEVELOPMENT OF MINER SIMULATOR**

The Miner Simulator system (MinerSIM) has two parts, the first of which is composed of text, three-dimensional images, animations, and videos to introduce trainees to basic principles of ground control and rock bolting using a jackleg drill. The first part is followed by the virtual reality computer simulation, which allows trainees to install rock bolts in a virtual mine environment and exposes new miners to hazardous conditions, as well as to work situations normally encountered in an actual underground mine environment.

#### **3.1 MULTIMEDIA SYSTEM**

The first part of the training is in multimedia format. Several strategies were used to elicit learner interest, such as

- Stating clear performance objectives at the beginning of each section, with links established between these objectives and their pertinence to the rock bolting task.
- Implementing a logical and easy-to-use structure including simple and straightforward navigation tools which minimize the effort required to achieve the performance objectives.
- Using a variety of stimuli (symbols, images, animation, and videos) representative of the professional interests of the targeted audience.

- Developing a representation of an underground mine to create a user-friendly environment through inclusion of videos and photographs about rock bolting developed at the Missouri S&T Experimental Mine.
- Organization of content into a modular format with quizzes at the end of each section to enable trainees to discuss with their instructor any information they do not understand.

The bulk of the multimedia training tool's technical content is in the section concerning rock bolting using a jackleg drill and involves face preparation including scaling, drilling, and rockbolt installation as shown in Figure 3.1.



a. Washing the Face Area.



b. Scaling Loose Rock.



c. Drilling a Hole.



d. Installing a Rockbolt.

**Figure 3.1.** Rockbolting Cycle (Missouri S&T Experimental Mine, 2006).

The primary development software used for this part of the training module is Macromedia Flash (Flash Professional version 8). Flash allows incorporation of 3D models and animations (generated using Macromedia Fireworks version 8 and Swift 3D version 4.5) into its authoring environment. A Macromedia Flash video codec and Action

Script 2.0 (a programming language in Flash) were used for embedding videos and adding interactivity to the system. Windows Movie Maker and Adobe Premiere were used to edit the video clips prior to importing them into the Macromedia Flash authoring environment. Macromedia Dreamweaver (version 8) was used as a web design tool in order to make this part of the training more accessible to users. Figure 3.2 shows the interface of the first part of MinerSIM, while Figure 3.3 shows a screen view from one of the sections.

**Welcome to the World of Rock Bolting**

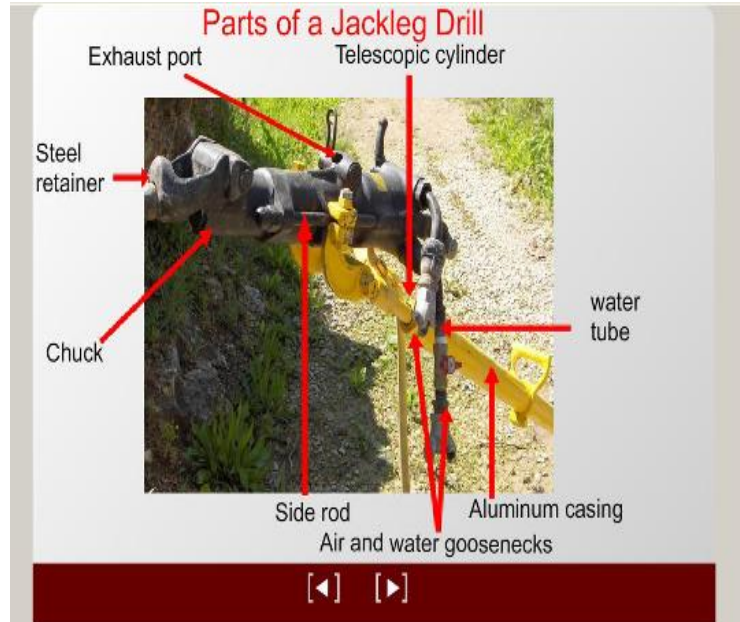
Rock bolts are used in underground mines to protect personnel and equipment from ground falls. Rock bolting is a dangerous mining job, and injuries, fatalities, and downtime are not caused only by roof falls, but also by inexperience in handling drilling and bolting equipment. A five-minute video below describes a typical roof fall accident and also provides some basic information on underground mine safety. It is advisable to watch the video before starting the actual tutorial on underground rock bolting.

This tutorial forms the first part of **MinerSIM**, and it describes the basic principles of underground rock bolting using a jackleg drill. The three major sections include scaling, jackleg drilling, and rockbolt installation. A practice quiz follows each section, and it will be helpful to take the quiz under each section before going to the next section. It is recommended that beginners follow the order provided in the Table of Contents (i.e., starting with scaling through rockbolt installation). If you are within a section, you can always return to this page by using your browser's "back" button.

Table of Contents	A Typical Jackleg Drill	Video on a Roof Fall Accident
Scaling		
Jackleg Drilling		
Rockbolt Installation		
Quiz on Scaling		
Quiz on Jackleg Drilling		
Quiz on Rockbolting		
Contributors		

**Figure 3.2.** Interface of the Web Tutorial Showing the Three Sections and the Corresponding Quizzes.





**Figure 3.3.** Screen View Showing Major Parts of a Jackleg Drill.

**3.1.1. Addition of Animation.** Animation in a Flash document is created by adding content to a timeline, such as the main timeline or a timeline inside a movie clip. When the play head moves across the timeline, individual frames play. When played in quick succession (like a flipbook or succession of frames on a reel of film), an animation is created. Most of the animations used in the multimedia part of MinerSIM were generated using Macromedia Fireworks version 8 and Swift 3D version 4.5. Appendix A1 provides a full description of the generation of 3-D objects and the method used to create the animation.

**3.1.2. Encoding of Flash Videos.** Flash video (FLV) offers technological and creative benefits that allow designers to create immersive, rich experiences that fuse

video with data, graphics, sound, and dynamic interactive control. The advantages of using Flash to present video online include:

(a) Ubiquity - Flash Player runs on a wide variety of platforms and operating systems. It ensures that most visitors view Flash video without downloading additional plug-ins, so it is possible to reach more people with lower development, testing, and support costs.

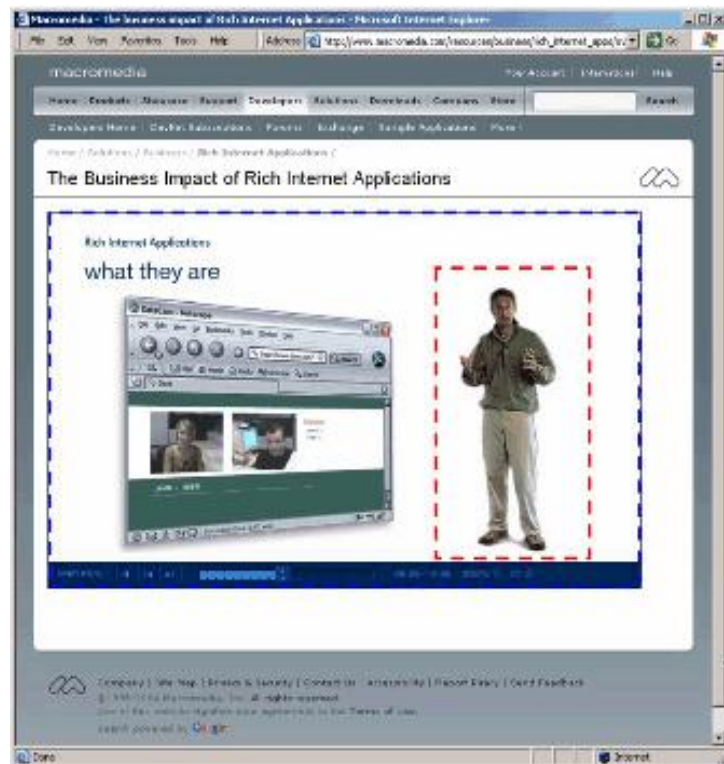
(b) Full creative control - Flash video integrates seamlessly into a website, and a new "skin" can be added to the video content to customize branding and also design unique video playback controls. The size and the aspect ratio of the video can be set, so that it changes dynamically based on a data source, and

(c) Rich, interactive, contextual video - Flash video provides immersive and interactive experiences. Because Flash treats Flash video simply as another media type, it is possible to layer, script, and control video content just like any other object in an SWF file. Additionally, Flash video is an integral part of the viewing experience, as opposed to a separate pop-up window that may interrupt the experience.

Disadvantages of Flash video include (a) the initial ramp up time needed to learn the technology, and (b) its inappropriateness for distribution on a standalone mass scale, unless in web format. Despite the above disadvantages, Flash video is more efficient than other video delivery media (e.g., Windows Media Player, Real Player, or Quick Time) because its benefits heavily outweigh its disadvantages.

Figure 3.4 shows an example of a web page containing Flash video synchronized to text and graphics. The superimposed dotted blue outline shows the boundary of the area where the SWF file is displayed. The dotted red outline shows the boundary of the

area where the Flash video (FLV) file is displayed as part of the SWF content. An SWF file can contain graphics, text, and client logic (for creating video controls, for example). It can refer to an external FLV file, and it plays in Flash Player.



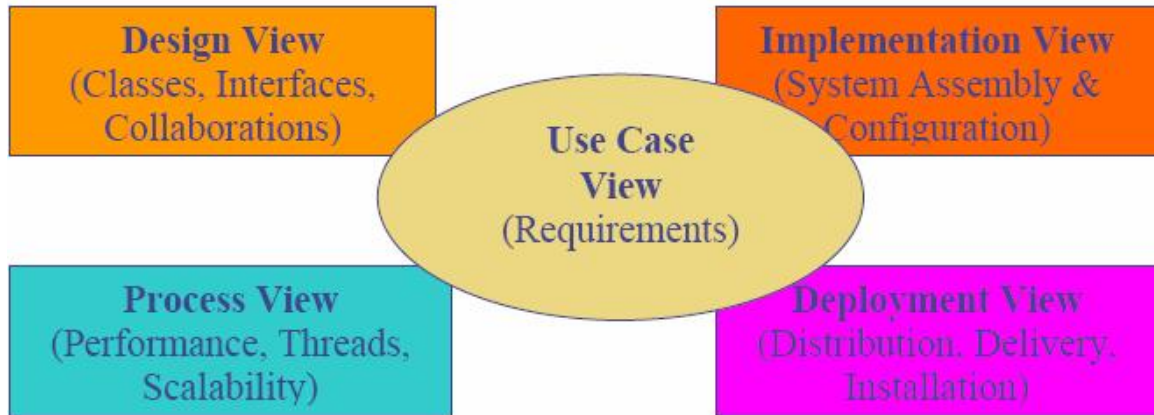
**Figure 3.4.** Flash Video File Playing Inside an SWF File.

An FLV file contains primarily audio and video and plays inside an SWF file, as shown in Figure 3.4. During the development of videos for the first part of MinerSIM, a Flash encoding video tool (ON2 VP6 Video Codec) was used to incorporate videos and Flash Action Script 2.0 was used to add interactivity to the system. Details on the use of ON2 VP6 Video Codec and Action Script 2.0 can be found in Appendix A2.

**3.1.3. Web Page Development.** Macromedia Dreamweaver 8 was used for the web page development. Dreamweaver makes use of Hypertext Markup Language (HTML) files, which contain the tag-based language responsible for displaying a web page in a browser. All photographs used in creating the web page were in the Joint Photographic Experts Group (JPEG) format and Graphics Interchange Format (GIF). The JPEG format is best for digital or scanned photographs, images using textures, images with gradient color transitions, and any images that require more than 256 colors. The GIF format is a popular web graphic format for cartoons, logos, graphics with transparent areas, and animations. GIFs contain a maximum of 256 colors. Cascading Style Sheet (CSS) files were used to format the HTML content and control the positioning of various page elements. The HTML code enables a browser to play the published HTML and SWF files of the contents including the quizzes (see Appendix A3 for details on quiz creation).

### **3.2 VIRTUAL REALITY COMPUTER SIMULATION**

The second part of the training module is based on the code of the HalfLife® game. The code allows the designation of interior rooms and corridors representing stopes and drives of an underground mine. First Responder Simulation Training Environment (FiRSTE) developed at the Computer Science Department of the Missouri University of Science and Technology to help train first responders in dealing with terrorist attacks uses a code similar to the HalfLife® game. Architecture for the FiRSTE system is based on five fundamental views: Use Case View, Design View, Process View, Implementation View, and Deployment View (Hilgers et al., 2004), as shown in Figure 3.5.



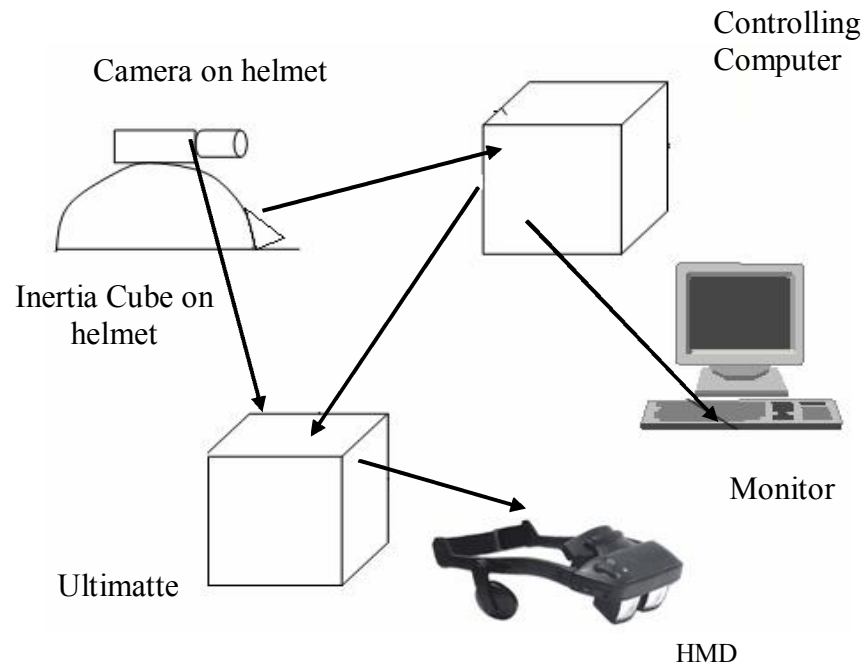
**Figure 3.5.** FiRSTe System's Architecture (Hilgers et al., 2004).

The Case View focuses on the system's value (i.e., what value the system will provide and how it will be used to deliver this fundamental utility). The Design View focuses on the code's structure and how it will communicate within itself and with the outside world. Understanding what will happen when the software runs is the focus of the Process View. The Implementation View focuses on the complexity the system will face when it moves from the development phase into the production environment. The Deployment View considers how to package and install the system for purpose of deployment.

The second part of MinerSIM is an augmented reality system. Virtual reality is formally defined as any system that allows a person to interact with three dimensional graphical objects. The system is considered to be augmented reality if the 3D graphical images are mixed in some way with the physical world. The composition of this mixture can be broadly interpreted.

The VR computer simulator allows trainees to inspect ground conditions in the virtual mine, scale down loose rock, set-up the jackleg, drill holes for rockbolt installation, choose suitable rockbolts (friction, rebar, or mechanical), and install rock bolts. This training is performed in a safe and secure environment under the watchful eye of a trainer. The simulator has several potential advantages beyond safety. Total training time will be shorter than conventional approaches since training can run asynchronously on demand. It can be used in any mining environment, meaning that the setup will allow for switching between the environments typical of an underground coal mine and a hard rock mine with different ground conditions.

The simulator performs the mixture in the following way. The virtual environment is essentially what is called a mod of the HalfLife® game, which means that it uses the game engine as the driver for the virtual environment. The underground world is produced by using a modeling tool called Valve® to develop maps to import into HalfLife®. This approach allows the designation of interior rooms and corridors representing stopes and drives of an underground mine. To achieve the mixture, the system uses hardware and software technologies. Figure 3.6 is a schematic diagram of major system components. The function of each component is shown in Table 3.1.



**Figure 3.6.** Major Components of the VR Computer Simulator.

**Table 3.1.** Functions of Simulator Components.

Components	Functions
Inertia Cube	Tracks the location of the trainee's head and sends data to the controlling computer
Controlling Computer	Produces the virtual environment and sends video to the Ultimatte
Camera	Captures details of the blue-room environment (hands, tools, blue walls) and sends video to the Ultimatte
Ultimatte	Takes the camera video and replaces anything blue with the video from the computer (the virtual environment)
Head-Mounted Display (HMD)	Takes combined video from Ultimatte which enables the trainee to see the virtual environment

The entire system is set up in a “blue room” which is replaced by the virtual environment after a trainee puts on the head-mounted display (HMD). Figure 3.7 shows a trainee in the blue room, while Figure 3.8 shows the trainee using the HMD.



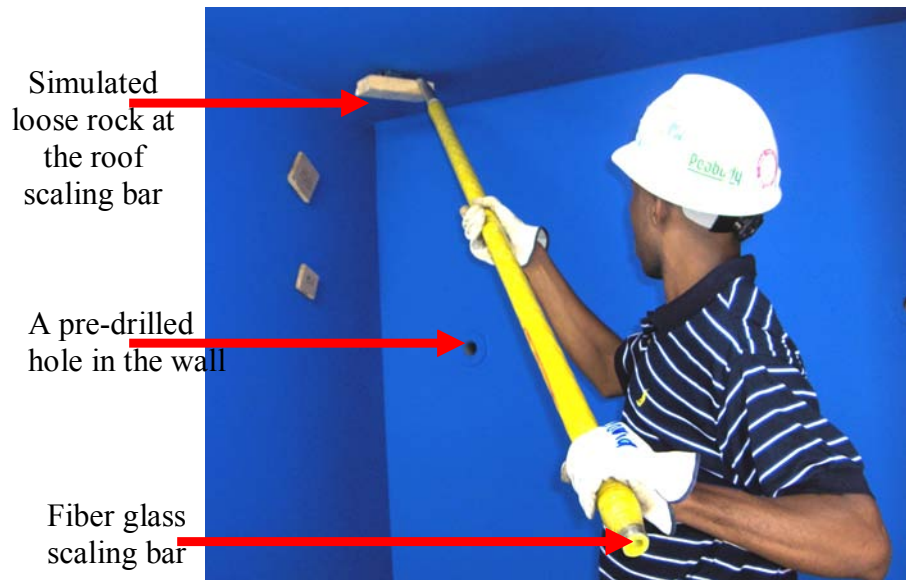
**Figure 3.7.** Trainee (without the HMD) in the Blue-Room.



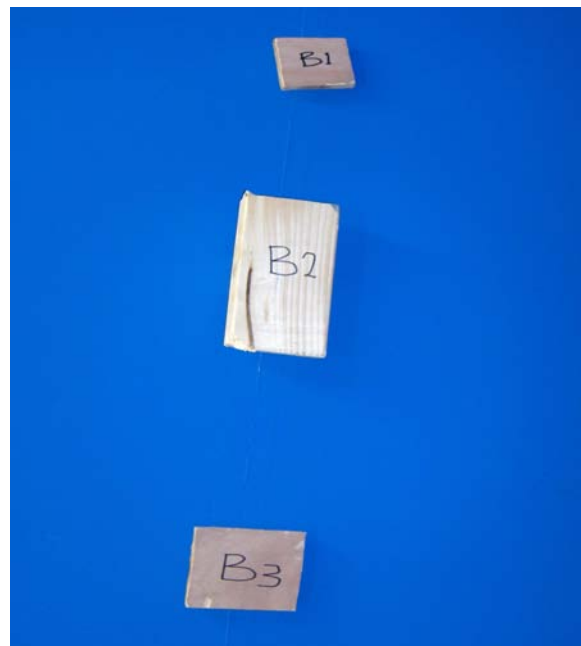
**Figure 3.8.** Trainee (with HMD) in the Virtual Mine Environment.

**3.2.1. Scaling Simulation.** Simulation of the scaling operation involves the use of different types of light magnets with pulling strengths ranging between 20 lbs and 110 lbs attached to the roof and walls of the blue room to simulate the varying resistances offered by loose rocks during scaling in actual underground mine. In order to ensure that the magnets offer the required resistance during removal from the walls or the roof using the fiber glass scaling bar, as shown in Figure 3.9, higher strength magnets (with strengths ranging from 150 to 180 lbs) were installed at pre-determined positions on the walls and the roof of the blue room to attract each of the light magnets shown in Figure 3.10. Because the piece of wood to which each magnet is attached was painted blue, a trainee sees the magnet as a loose rock in the virtual environment when the HMD is worn.





**Figure 3.9.** Trainee (without HMD) Scaling Down Loose Rock from the Roof.



**Figure 3.10.** Magnets Attached to the Blue Room Wall.

**3.2.2. Drilling Simulation.** A real jackleg drill is used in the simulation so that trainees can develop a real feel for the jackleg's weight, sound, and vibration, just as experienced in a real underground mine (see Figures 3.7 and 3.8). However, the rotating portion of the drill was disengaged to prevent damage to the blue room during drilling simulation. A

2 ft collapsible drill steel which uses a compressed air-line (100 psi maximum) was designed to simulate the drilling action. The drill steel, shown in Figures 3.11 and 3.12, has a 6-inch cup at its end into which it collapses during drilling.



**Figure 3.11.** The 2 ft Collapsible Drill Steel in its Fully Extended State.



**Figure 3.12.** The Drill Steel Model at its Fully Collapsed State.

The setup allows a trainee to adjust the air pressure going to both drill steel and the leg by using air-valves installed on the air-line. In addition to the air valves, there is an air regulator attached close to the end of the air-line going into the drill steel to enable

further adjustment of air going through the drill steel. The major advantages of this setup are

- Consistent resistance during collapsing of the drill steel throughout the entire stroke range can be achieved.
- The pressure required for collapsing the drill steel can easily be varied by simply adjusting the air regulator. This adjusted pressure is used to simulate various rock types (in terms of hardness) encountered in the actual underground mine environment.

The method used to simulate drill holes into which a drill steel could collapse was to design 6-inch steel cups, as shown in Figure 3.13, which were installed in pre-drilled holes at the roof and the walls of the blue room. The 2 ft collapsible drill steel is completely collapsed into the steel cup at the end of the stroke.



**Figure 3.13.** The 6-inch Bolt Cup Installed in the Wall and Roof of the Blue Room.

**3.2.3. Bolting Simulation.** Bolting is simulated by using a 2 ft collapsible bolt with a 4.5 by 4.5 inch plate attached to its rear end and uses the same basic design principles as the drill steel, but is not expanded via air pressure. Instead, a hole in the cylinder allows air to escape slowly as it is being collapsed, as shown in Figure 3.14.



**Figure 3.14.** The 2 ft Rockbolt with a 4.5 x 4.5-inch Plate and 6-inch Cup in its Fully Expanded State.

Unlike the simulated drill steel, which is inserted directly into the chuck of the jackleg because of its threaded rear end, an adapter is used to attach the collapsible rock bolt to the drill. The bolt is completely locked into the steel cup installed in the blue room wall or roof once the jackleg telescopic leg has been used to fully collapse it, as shown in Figure 3.15.



**Figure 3.15.** Rockbolt Model in its Fully Collapsed State within the Steel Cup.

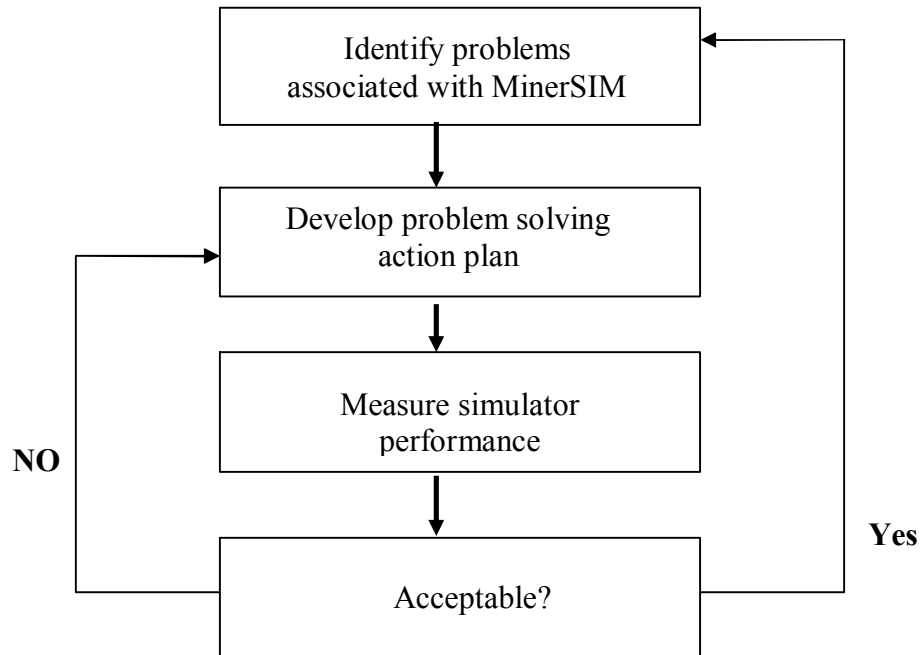
## **4. DEPLOYMENT AND EVALUATION OF MINERSIM**

### **4.1 OVERVIEW**

Technology deployment is the natural objective of any technologist who develops an innovation. However, most organizations are reluctant to adopt a new technology because they are concerned with issues such as the technology's compatibility with the rest of the organization's system and the complexity of using and maintaining the innovation (Gross, 2002). Deployment of a new technology can only be successful if it meets the demands of its users. The development of MinerSIM came about as a result of rock bolter injuries reported in MSHA database, which calls for adoption of an improved training module for rock bolters.

After the MinerSIM system was developed, a prototype was evaluated using Missouri S&T students to identify any usability problems. In the future, the model will be distributed to a few hard rock mining companies, so that their employees' comments and recommendations can be used to further improve the training module before distributing the final prototype leading to cost savings through reusability.

The project assessment and evaluation was carried out based on two principles. First, the evaluation should be iterative, be carried out throughout the development process, and aid in development with constant feedback. Second, the evaluation should consist of multiple methodological measurement approaches and conclusions should be based on the triangulation of these findings. Figure 4.1 illustrates the MinerSIM evaluation process.



**Figure 4.1.** MinerSIM Evaluation Process.

The evaluation initially consisted of a series of usability tests using small sample sizes, in order to address some fundamental usability issues associated with the system. Following this initial evaluation, and system modifications, a comparative experiment was conducted using Missouri S&T students who have no or little experience in mining/underground rockbolting. This experiment consisted of between-subject, experimental and control experiments with control students learning via traditional lecture and text formats.

Missouri S&T's Laboratory for Information Technology Evaluation (LITE) has formerly implemented such a strategy effective with complex VR training systems (Hilgers et al., 2004). It has been established that a minimum of approximately forty participants are required to conduct a traditional comparative study utilizing inferential

statistics to assess outcome differences. However, previous research conducted by the LITE lab on a similar system found that a small sample study with a focus on qualitative outcomes can also yield much practical information about system efficacy when using participants who represent the target population (Hall et al., 2004).

#### **4.2 EVALUATION OF THE WEB TUTORIAL**

Evaluation and assessment of a Website according to Hall et al. (2001) is a basic part of the design process, both formative and summative. Without this accountability component a designer never really knows how effective a given web-based learning environment is, and there is no mechanism for improvement in future design. Laurillard (1993) states, as referenced by Latterell and Deneen (2006), “any teaching innovation must be formatively evaluated if it is to be optimized.” The mere presence of a program does not ensure its success (Ehrmann, 1999).

The goals of evaluation of the Web tutorial were:

- To determine participants’ satisfaction with the online tutorial
- To identify any usability problems with the Web tutorial
- To assess the advantages a Web tutorial has (if any) over the traditional paper-based tutorial.

In order to accomplish these goals, the evaluation process was divided into three main exercises, involving two usability tests and one comparative experiment. Prior to conducting the usability tests, experts in the industry were allowed to review the tutorial and their comments were addressed before conducting the usability tests.



A letter and a questionnaire were sent to three mining companies and two educational institutions. The three mining companies included Turquoise Ridge Mine, Hecla Lucky Friday Mine, and Stillwater Mining's East Boulder Mine. Turquoise Ridge and Boulder Mine responded by e-mail and phone, respectively, but no response was received from the Hecla Lucky Friday Mine. Colorado School of Mine's Edgar Mine and Missouri S&T Experimental Mine were the two educational institutions contacted to review the online tutorial. The former provided comments by phone, while the latter sent comments by e-mail. A copy of the letter and the questionnaire sent to the rock bolting experts can be found in Appendices B1 and B2, respectively. It is important to note that apart from Missouri S&T Experimental Mine, none of the institutions provided direct answers to the survey questions, but rather chose to read the tutorial and summarized their observations. Representative comments and recommendations received are summarized below.

#### Scaling

- The training material says that a bar should be 2 ft shorter than the length of the back. We think this should be the height of the back, not the length.
- Editing of the scaling stuff by an English Professor will help improve the quality of the content. Note that engineers sometimes cannot communicate well, so it is always important to let an English expert review the write-up.
- We don't agree with the statement that says "poor blasting practices normally lead to loose rock formation." We think all blasting leads to loose rock formation.
- We believe most of the mines have gotten away from scaling bars with the sharp point on the other end.

- We use Six Points of Scaling that we got from the Ontario, Canada guys. We are attaching a copy to this message for your information. Maybe you will find it useful.

### Jackleg Drilling

- Some of the jacklegs shown in the tutorial have no muffler, which would make them illegal to drill with according to MSHA regulations because of noise. However, you may not need muffler at this level of your research, but it is something you need to keep in mind if you are finally distributing your product to be used by the mining industry.
- In one of the photographs showing the parts of the jackleg, we think the part labeled “head retraction control” should rather read “leg retraction control.”
- In the pre-operational checks video, we have realized that when the instructor is scaling and hits the rock at the back that obviously has a hollow, drummy sound indicating a loose rock, he continues to scale without offering any explanation for the drummy sound. This video needs to be edited or replaced to avoid any form of confusion.
- We suggest that the animation on drilling has its own slide without a photograph or a video on the same slide. This is because the animation explains a very important concept of the drilling operation.
- The training material says “not to hold your steel while collaring a hole with a jackleg.” Why not? This is a common practice with most jackleg drillers. The only thing we know about is that it is a violation of MSHA regulations to have a partner hold a drill steel for the driller, while the driller is collaring. We

think the driller can reach out and hold his own steel to guide it. We have not heard of anyone getting hurt by this practice.

- The tutorial says to use leg pressure to hold the steel at the face while collaring. Maybe it is better to set the leg in a proper position to lean the steel against the face while collaring, then add leg pressure after the hole is collared. At least this is how we teach our inexperienced drillers.
- Tables under “common problems with jackleg drilling” look too crowded and the outer lines are too faint. We suggest you redraw the tables using thicker outer lines, as well as spreading the information from slide to slide rather than trying to put all the information on a few slides.
- The pages were slow in downloading.

#### Rockbolt Installation

- A video on insertion of a resin cartridge will work great for the rebar bolting section of the tutorial.
- The table under “types of rockbolts and mechanism of support” needs to be re-drawn using thicker lines because the outer lines do not look thick enough.
- If possible, try and include corresponding metric units in parenthesis for measurements in English Units.
- Tables under “comparison of rockbolt types” look too crowded and the outer lines are too faint. We suggest you redraw the tables using thicker outer lines, as well as spreading the information from slide to slide rather than trying to put all the information on a few slides.

- Videos shot at the Missouri S&T Experimental Mine would have been more professional if they were developed in a documentary format similar to NIOSH videos.
- It took sometime for some of the pages to be downloaded.

#### Quizzes

- Some of the “fill-the-blank” questions on jackleg drilling and rockbolt installation are too difficult for a new inexperienced rockbolter. Maybe modifying them in order not to discourage a novice rockbolter could be useful.
- There should be a place within the tutorial where a trainee could check the right answers. For example, one of us got question number 2 under jackleg drilling wrong because he wrote “pressure” instead of “feed pressure.” Since no answers were provided, we had to go back to the tutorial to look for the right answer.

It is important to note that most of the above comments were addressed before the usability tests were conducted. For example, some of the non-documentary videos shot at the Missouri S&T Experimental Mine were replaced with NIOSH videos. Also, the entire tutorial was reviewed by the Missouri S&T Writing Center for any grammatical errors.

Two usability tests were conducted to identify usability problems in the design and provide input for redesign in order to improve usability, while the comparative experiment involving a larger number of participants was conducted to compare the Web-based tutorial with its corresponding paper-based type. The first usability test was

conducted without the Morae recording device, while the second usability test was conducted using the Morae recording device.

**4.2.1. Initial Usability Testing.** Detailed information on the initial usability test (without the Morae recorder) is provided in the following paragraphs.

**4.2.1.1. Participants.** Nielsen and Landauer (1993) provided a mathematical model to argue that five users in a usability test is sufficient to detect 85% of the usability problems associated with any interface. In our study, a total of eight (8) undergraduate mining engineering students (7 male and 1 female) participated in the first usability test in fall 2007. All the eight participants who were American citizens had no previous underground rockbolting experience. The participants were paid, and participation was voluntary. The age of the participants ranged from 18 to 21 years with a mean of 20 years. They were given a consent form (Appendix B3) to fill after which they answered the entry statements of the questionnaire with the following questions:

*How long have you been using the internet?*

- (a) Less than a year*
- (b) 1-2 years*
- (c) 2-5 years*
- (d) 5 years or more*

*Have you ever used an online tutorial to learn a task?*

*(a) Yes*

*(b) No*

**4.2.1.2. Directions.** After completing the entrance questionnaire, the participants were given the following instructions on the task to perform:

*The intent of this study is to test an online tutorial prototype developed for new underground rock bolters. The website for the tutorial will be open and set to the homepage. You are required to follow the ten steps listed below to complete your task.*

- 1. Fill out the pre-tutorial questionnaire (if not already filled).*
- 2. Read the content of the page carefully*
- 3. Watch the video on the home page (see bottom right).*
- 4. Click on Scaling and go through the content of the scaling section*
- 5. Click on Quiz on Scaling. Follow the instructions and complete all the questions.*
- 6. Click on Jackleg Drilling and go through the content of the jackleg drilling section.*
- 7. Click on Quiz on Jackleg Drilling. Follow the instructions and complete all the questions.*
- 8. Click on Rockbolt Installation and go through the content of the rockbolt installation section.*
- 9. Click on Quiz on Rockbolting. Follow the instructions and complete all the questions.*
- 10. Fill out the post-tutorial questionnaire.*

**4.2.1.3. Post-testing questionnaire.** Each participant was given a 5 point (very poor – very good) Likert-scale questionnaire consisting of seven questions/statements, as indicated below:

- (a) How quickly did the pages download?*
- (b) The quality of the videos*
- (c) The visual appearance of the site*
- (d) How easy was it to get around in the site?*

- (e) How satisfied were you in terms of knowledge acquired on rockbolting?*
- (f) How well were the practice questions related to the information provided?*
- (g) Rate the overall effectiveness of this tutorial as a learning tool.*

The participants were also asked to indicate which of the four media (videos, text, photograph, and animation) was most helpful in providing them with information on the underground rockbolting. Additionally, they were asked if they would recommend the Web tutorial for training new inexperienced miners. The participants were finally asked to provide any suggestions for improvement of the tutorial.

**4.2.1.4. Participants' questionnaire ratings and responses.** Table 4.1 shows participants' ratings and responses to the survey questions/statements.

**Table 4.1.** Participants' Ratings and Responses.

Partici.	E1	E2	X1	X2	X3	X4	X5	X6	X7	X8	X9
P1	>5	yes	5	4	4	5	5	5	5	video	yes
P2	>5	yes	5	5	5	5	5	5	5	photo	yes
P3	>5	yes	5	5	4	4	5	4	5	video	yes
P4	>5	yes	5	4	3	5	5	4	4	video	yes
P5	>5	yes	5	4	5	5	4	5	5	text	yes
P6	>5	yes	5	4	4	5	4	4	4	video	yes
P7	>5	yes	5	3	4	5	5	5	5	animation	yes
P8	>5	yes	5	4	3	5	5	5	5	video	yes
<b>Mean</b>			<b>5.0</b>	<b>4.1</b>	<b>4.0</b>	<b>4.9</b>	<b>4.8</b>	<b>4.6</b>	<b>4.8</b>		
E1	How long have you been using the internet?										
E2	Have you ever used an online tutorial to learn a task?										
<b>Rate the following using the scale: 1-very poor; 2-poor; 3-fair; 4-good; 5 – very good</b>											
X1	The rate at which the Web page downloaded										
X2	Quality of the videos										
X3	Visual appearance of the site										
X4	How easily did you get around the site										
X5	How satisfied you are in terms of knowledge acquired on rock bolting										
X6	How well the practice questions are related to the tutorial										
X7	Overall effectiveness of the tutorial										
<b>Rate the effectiveness of video, text, photo, and animation in the tutorial</b>											
X8	Which of the four items listed above did help you most in using the tutorial?										
<b>Recommendation of the tutorial to other users</b>											
Ex9	Will you recommend this tutorial for training new inexperienced miners?										
<b>Partici. – participant      E – entry question      X – exit statement or question</b>											

**4.2.1.5. Open-ended questionnaire responses.** Recommendations from the participants are listed below in response to the following open-ended question from the exit questionnaire:

*Please provide us with any other comments you think could help us improve on our online tutorial.*



**Participant 1**

- *The “fill the blank” questions are difficult because there are multiple ways to input the same answer, and I had to guess how you would like me to word my answer.*

**Participant 2**

- *The “fill the blank questions” are tricky. It was difficult to remember the answers from the tutorial.*

**Participant 3**

- *Maybe putting the practice questions in the presentation to make sure that students understand what they are learning before they start another topic will be great.*

**Participant 4**

- *The questions should have rather been based on judgment calls of what the student just learned from the tutorial.*

**Participant 5**

- *Reinforce things that are really important to know. The scaling part did that very well, but the others had a lot of information and I didn't know what was really important and what was semi –important.*

**Participant 6**

- *I noticed in one of the slides, I believe it was under friction bolts, it says to use 160-180 lb/ft of torque. However, in the video the miner applies 105 torque and says it is okay. These are contradicting statements.*

**Participant 7**

- *This is a very good tutorial. However, apart from the videos being slow, it was difficult to tell what they were doing in some of the videos, especially those not in documentary format.*

**Participant 8**

- *It was a little bit difficult to tell what they were doing in some of the non-documentary videos. It is a good website though.*

#### 4.2.1.6. Responses from post-tutorial interviews. Representative comments

derived when participants were interviewed after the tutorial, are indicated below:

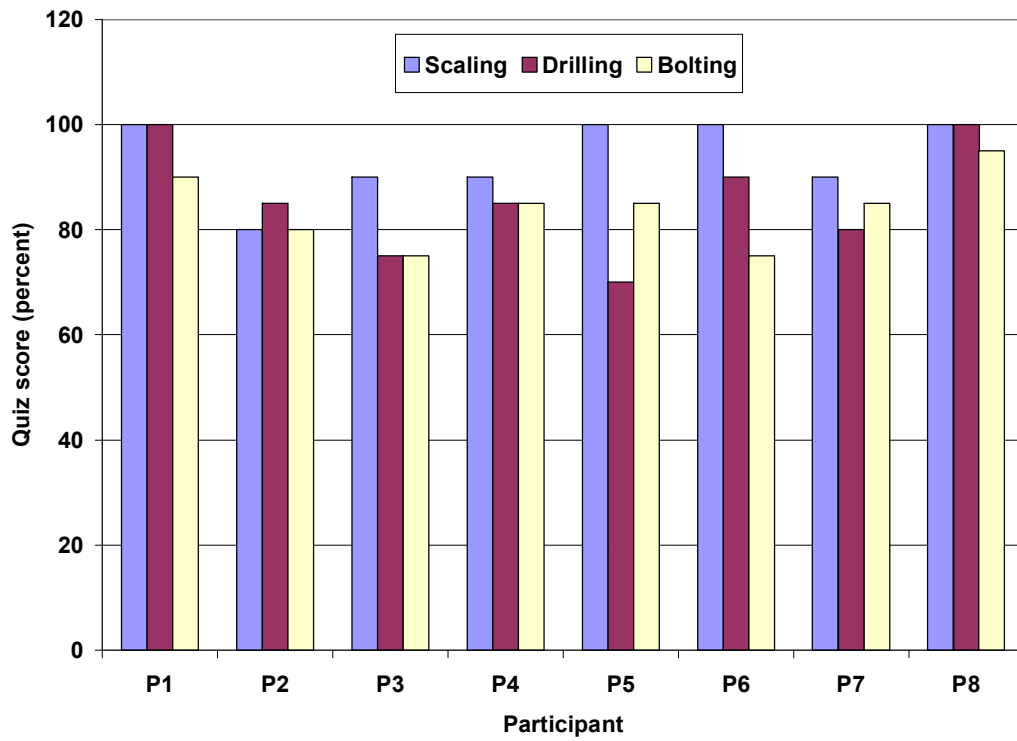
- When participant 7 was asked to explain the reason for rating the videos “fair”, he said that it took too long for some of the videos to download. It was the same participant who prefers “animation” and he explained that the main reason for his action was that the entire drilling and bolting processes were displayed by the animations. He said that he would not have understood the way swellex rockbolts work in the real world without the animation. He jokingly suggested that all videos, photographs, and the text should be replaced with animations in order to improve the effectiveness of the tutorial.
- When participant 5 was asked to explain the reason for choosing “text” as her favorite, she said that she prefers video to text in real life, but the videos in the tutorial gave her a lot of problem in terms of time taken to download. She added that she most at times got all the information from the text before the videos began to play. She also said that the photographs are meaningless without the labels (text) and for that matter she does not see the reason to distinguish the photographs from the text. She did not comment on the animations because she thought there were not a lot of them, as compared to the videos.
- Participant 2, who prefers the photographs, said that the labeling of the parts of the equipment shown in the tutorial was really helpful in terms of understanding the functions of the controls. He, however, expressed his disappointment about the slow download of the videos.

Due to the Website's visual appearance comparatively low rating, each participant was further asked to explain the reason for his/her choice. Five of the six participants (P1, P3, P4, P6 and P8) who did not rate the visual appearance "very good" indicated that the blue background of the videos was boring and suggested using different background colors for the videos. The sixth participant (P7) said that he hates anything red or brown in real life, so there was no way he would have liked the appearance of the Web tutorial. All the six participants suggested using different background for the quizzes.

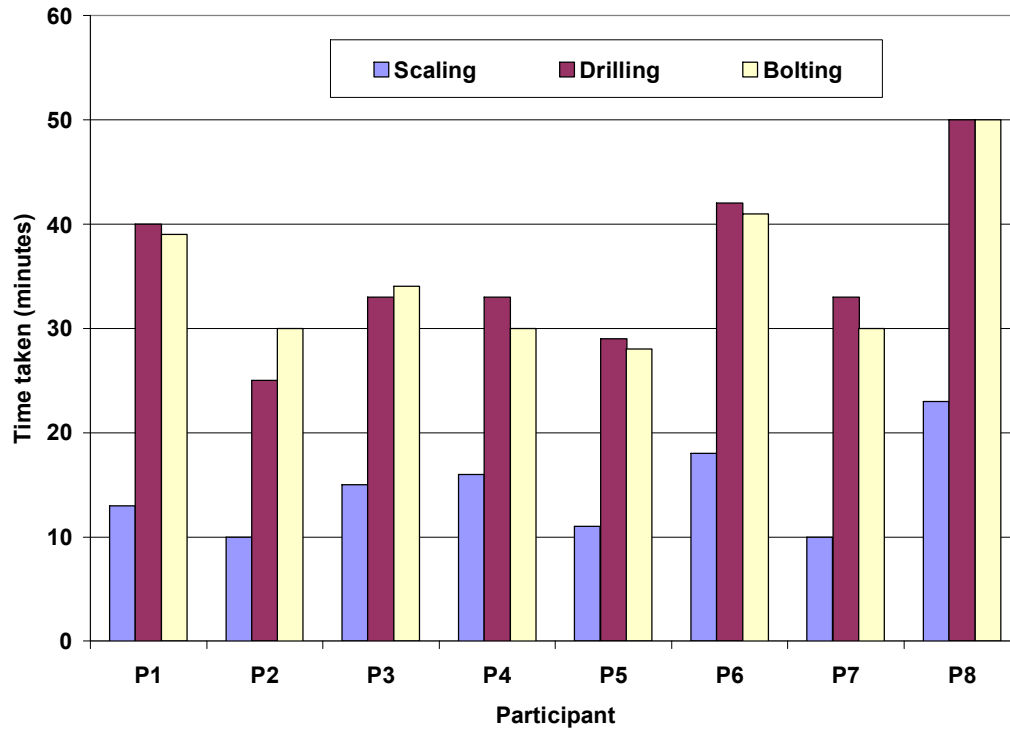
**4.2.1.7. Evaluation of participants' performance.** According to Hagman (1983), testing of participants needs to be emphasized during training in order to promote knowledge retention over time and also enable trainees to begin work with a moderate level of task proficiency. However, Kuniavsky (2003) established that, any form of quantitative measurement (e.g., average numbers) in usability testing is not meaningful in an absolute context, but only provides a way to compare tasks to each other and between designs. In general, the statistical errors associated with small sample of people in a usability test swamps out the accuracy of any form of quantitative measurement.

Participants were asked to answer a total of 50 questions (10 questions on scaling, 20 on jackleg drilling, and another 20 on rockbolt installation) after reading the tutorial. One of the goals of this exercise was to derive any correlation between participants' performances and the questionnaire ratings. The total time taken by the participants to complete each of the three sections was also recorded in order to determine the correlation (if any) between the quiz scores versus time. Figures 4.2 and 4.3 show

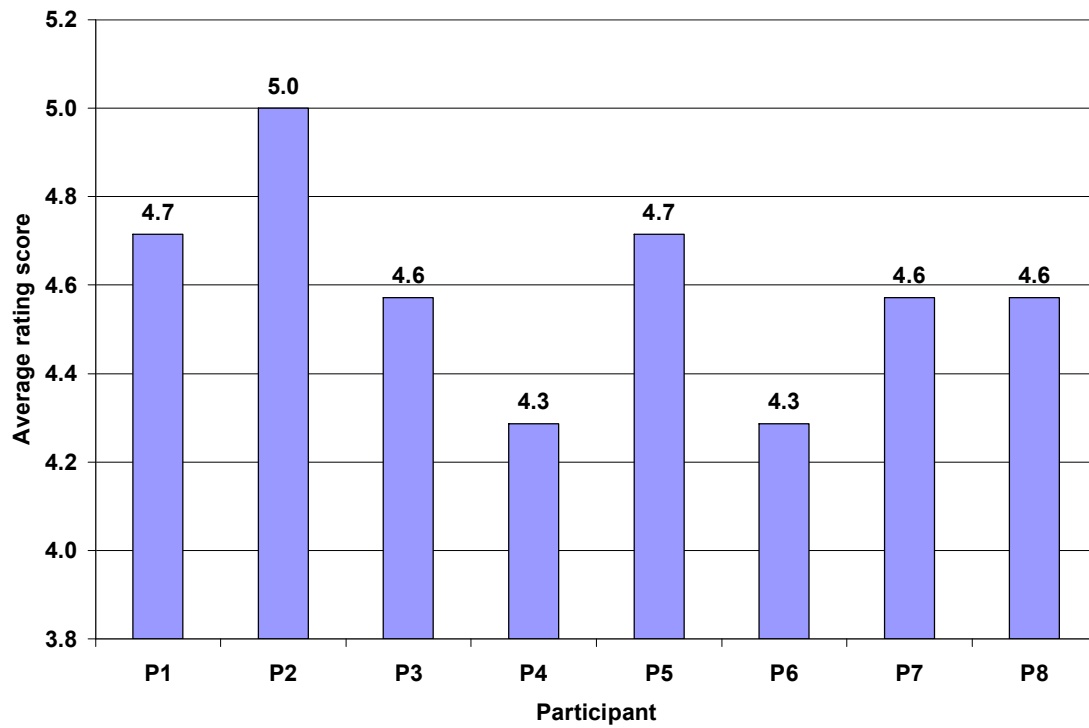
participants' quiz scores and total time taken respectively, while their mean questionnaire rating scores are displayed in Figure 4.4.



**Figure 4.2.** Quiz Scores of Participants.

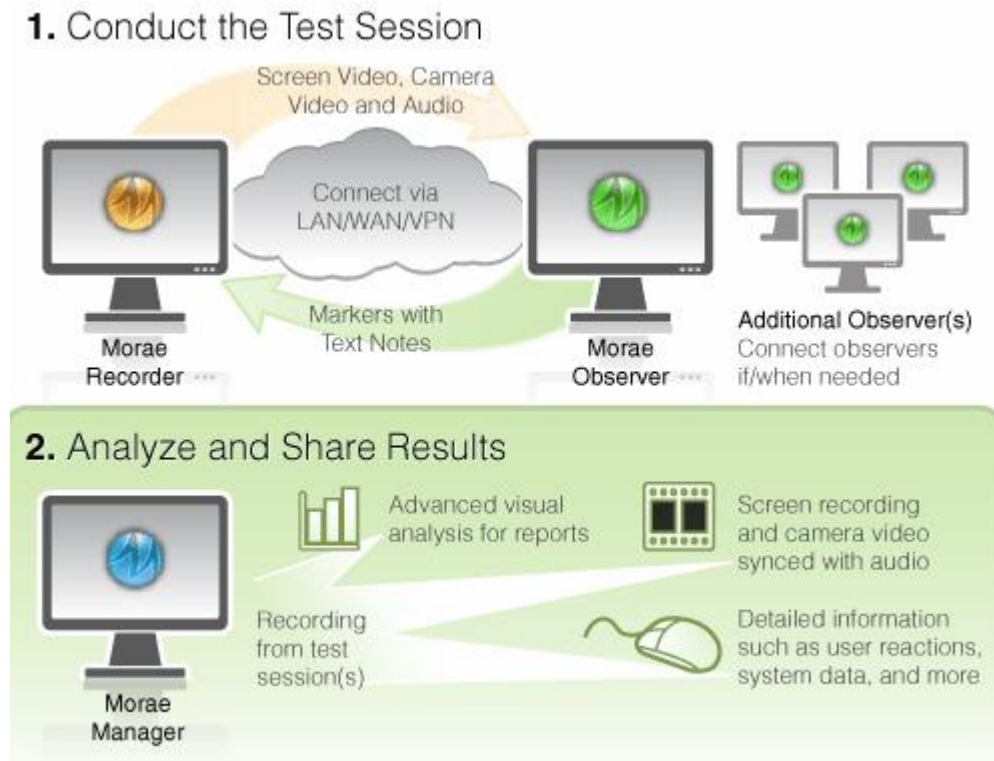


**Figure 4.3.** Total Time Taken by the Participants.



**Figure 4.4.** Mean Responses on Questionnaire Items.

**Usability Testing with the Morae Recorder.** Morae recording device was used for the second usability testing to capture live action feedback regarding usability problems. Morae is a software for usability testing and user experience research that helps identify site and application design problems. It is used to make critical design changes that improve customers' satisfaction. It records all of a user's interactions with a Web site, including desktop activity, audio, video, and a complete chronicle of system events, all synchronized into a single file. Figure 4.5 shows the Morae recorder system setup.



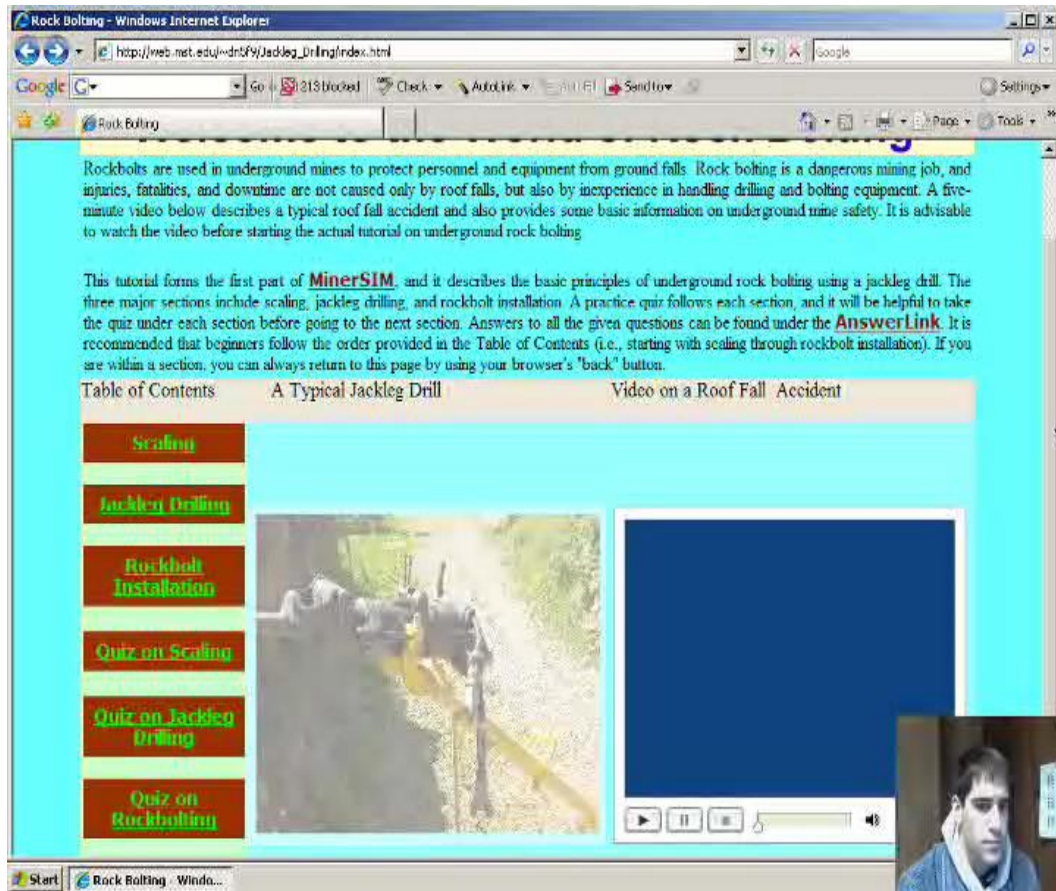
**Figure 4.5.** A Typical Usability Testing Configuration with the Morae Recording Device.

Morae records and captures:

- Screen video – any activity taking place on the participant's screen.
- Screen text – all text on the user's screen during the period of the recording.
- Audio – recording of the participant's voice through a microphone.

- Mouse clicks – left, right, and middle mouse clicks.
- Web page changes – browser events such as when and where a user navigates from one page to another.
- Camera video – webcam video of the participant’s expressions.
- Window events – when a window/dialog is opened, closed, or resized, as captured by the camera.
- Observer input – markers that are entered through an observer station.
- Keyboard activity – every keystroke the user makes.

The Morae recorder runs in the background of the system without affecting user experience and automatically captures the interaction as the user performs tasks. The recorder can be made as inconspicuous as possible by minimizing or hiding it completely during testing. The recorder also allows one or more forms of remote observation. Observers view screen video, user video (picture-in-picture), and audio streams, which are automatically synchronized. Additionally, observers can record a digital video file (WMV) of the displayed content, which can be viewed and shared immediately after the recording session. Figure 4.6 shows a screen shot of one of the participants’ reading the content on the homepage of the tutorial.



**Figure 4.6.** The Morae Recorder's Screen Shot of a Participant Reading the Tutorial.

In this study, only the Morae recorder and the manager were used. The Morae manager allows data to be exported and the results presented in a variety of ways. Video clips can be created and produced as an individual AVI or WMV file for use in other applications, such as a PowerPoint presentation.

**4.2.2.1. Participants.** A total of eleven (11) students including six (6) international and five (5) native students took part in this study in spring 2008. There were two (2) female participants, who were undergraduate petroleum engineering



students. Out of the remaining nine (9) male participants, three (3) were undergraduate petroleum engineering students, one (1) was an undergraduate geology student, two (2) were undergraduate mechanical engineering students, another two (2) were undergraduate mining engineering students and the remaining one was a graduate mining engineering student. Similar to the first usability test, the subjects used for the second usability test were also paid, and participation was voluntary. Their age ranged from 18 to 33 years with a mean of 22 years. Four of the eleven participants (i.e., participants 1, 2, 3, and 11) originally used the hardcopy version of the tutorial and also went through the rockbolting exercise at the Missouri S&T Experimental Mine. They were therefore called “Experienced Rockbolters” in this study and were included purposely to see how participants will tend to rate the tutorial once they have some amount of experience. The participants were given a consent form (Appendix B4) to fill, after which they rated 10 point (strongly disagree – strongly agree) Likert-scale questionnaire consisting of two entry statements, as below. They were also asked to provide open-ended explanations for their ratings.

\_\_\_\_\_ *I am very experienced with computers and the internet.*  
*Explain:*

\_\_\_\_\_ *I have a great deal of experience with online tutorials.*  
*Explain:*

**4.2.2.2. Directions.** After completing the entrance questionnaire, the participants were given instructions to follow in order to perform their task. These instructions were similar to the task instructions given in the first usability test.

**4.2.2.3. Post-testing questionnaire.** Each participant was given a 10 point (strongly disagree – strongly agree) Likert-scale questionnaire consisting of 14 statements, indicated below, and also asked to provide explanations to their ratings.

\_\_\_\_\_ 1) *The pages downloaded quickly*  
*Explain:*

\_\_\_\_\_ 2) *The quality of the videos was very good.*  
*Explain:*

\_\_\_\_\_ 3) *The visual appearance of the site was very good.*  
*Explain:*

\_\_\_\_\_ 4) *The site was easy to navigate.*  
*Explain:*

\_\_\_\_\_ 5) *Each task was covered comprehensively.*  
*Explain:*

\_\_\_\_\_ 6) *I found the practice questions to be strongly related to the information provided.*  
*Explain:*

\_\_\_\_\_ 7) *The tutorial is an effective learning tool.*  
*Explain:*

\_\_\_\_\_ 8) *I learned a great deal from the tutorial.*  
*Explain:*

\_\_\_\_\_ 9) *The tutorial was motivational, in comparison to other methods of learning.*  
*Explain:*

\_\_\_\_\_ 10) *The tutorial did a good job of letting me know what I did and did not know about the subject.*  
*Explain:*

\_\_\_\_ 11) *The videos were the most effective component of the tutorials.*

*Explain:*

\_\_\_\_ 12) *The text materials were the most effective component of the tutorials.*

*Explain:*

\_\_\_\_ 13) *The photographs were the most effective component of the tutorials.*

*Explain:*

\_\_\_\_ 14) *I would recommend this tutorial for training new inexperienced miners.*

*Explain:*

Apart from the above exit statements, participants were asked an open-ended question in which they were to provide any suggestions for improvement of the tutorial.

**4.2.2.4. Participants' questionnaire ratings and responses.** Table 4.2 shows participants' ratings to the statements.

**Table 4.2.** Participants' Ratings

Participant	En1	En2	Ex1	Ex2	Ex3	Ex4	Ex5	Ex6	Ex7	Ex8	Ex9	Ex10	Ex11	Ex12	Ex13	Ex14
P1	5	4	9	8	8	10	10	8	10	8	10	10	8	8	8	10
P2	8	3	5	7	10	10	10	9	10	6	10	3	5	7	8	10
P3	10	8	10	10	9	10	10	10	10	8	10	9	10	7	9	10
P4	10	6	9	10	8	9	8	9	9	8	8	7	10	5	8	10
P5	9	9	10	7	9	9	9	9	9	8	8	10	8	8	5	9
P6	9	9	9	10	9	9	9	9	9	10	5	7	2	10	7	10
P7	9	6	10	10	10	10	10	10	8	9	9	10	10	7	8	9
P8	10	5	10	10	5	10	10	10	9	9	8	9	10	3	10	8
P9	8	1	10	8	9	10	10	10	10	10	10	10	10	10	8	10
P10	4	8	10	10	6	10	5	10	10	10	6	10	10	1	1	10
P11	9	5	9	9	7	7	9	9	9	8	8	9	9	5	6	7
<b>Mean</b>	<b>8.3</b>	<b>5.8</b>	<b>9.2</b>	<b>9.0</b>	<b>8.2</b>	<b>9.5</b>	<b>9.1</b>	<b>9.4</b>	<b>9.4</b>	<b>8.5</b>	<b>8.4</b>	<b>8.5</b>	<b>8.4</b>	<b>6.5</b>	<b>7.1</b>	<b>9.4</b>
En1	I am very experienced with computers and the internet															
En2	I have a great deal of experience with online tutorials															
Ex1	The pages downloaded quickly															
Ex2	The quality of the videos was very good															
Ex3	The visual appearance of the site was very good															
Ex4	The site was easy to navigate															
Ex5	Each task was covered comprehensively															
Ex6	I found the practice questions to be strongly related to the information provided															
Ex7	The tutorial is an effective learning tool															
Ex8	I learned a great deal from the tutorial															
Ex9	The tutorial was motivational, in comparison to other methods of learning															
Ex10	The tutorial did a good job of letting me know what I did and did not know about the subject															
Ex11	The videos were the most effective component of the tutorials															
Ex12	The text materials were the most effective component of the tutorials															
Ex13	The photographs were the most effective component of the tutorials															
Ex14	I would recommend this tutorial for training new inexperienced miners															
<b>Scale : Strongly Disagree 1...2...3...4...5...6...7...8...9...10 Strongly Agree</b>																
<b>En – entry statement: Ex – exit statement</b>																

Table 4.2 shows that the exit statement as to how effective the text material was to the tutorial (i.e., exit statement 12) received the lowest rating. Since one of the objectives of the usability test was to identify any usability problems and improve the effectiveness of the tutorial if possible, the explanations offered by the participants on this particular exit statement are provided below. Detailed responses to the remaining 15 questionnaire statements can be found in Appendix B5.

**Participant 1**

- *Text materials are good, but the videos helped to reinforce the training material.*

**Participant 2**

- *Text materials give more information than the videos, but the videos are able to put the information into context.*

**Participant 3**

- *I do not like reading much.*

**Participant 4**

- *The text was very boring.*

**Participant 5**

- *The message was clear and well presented in a very simple way. However, words like muck pile, bootlegs, etc need to be explained further.*

**Participant 6**

- This participant provided no comment.

**Participant 7**

- *Using text in tables may look better.*

**Participant 8**

- *Videos and photographs are better since people normally learn faster by seeing things in action.*

**Participant 9**

- *But the videos helped to reinforce the training material.*

**Participant 10**

- *Text materials, though very good, were very technical. For instance, where the components of the jackleg are described, it will be good to put photographs to support the description.*

**Participant 11**

- *It was boring to read. Also, there were many numbers you had to remember in order to perform well on the quiz.*

**4.2.2.5. Open-ended questionnaire responses.** Recommendations from the participants are listed below in response to the following open-ended question from the exit questionnaire:

*Please provide us with any further comments that could aid in improving the online tutorial.*

**Participant 1**

- *The “fill- the-blank” questions are vague and can be misinterpreted.*

**Participant 2**

- *Providing the correct answer is more compatible with the Internet Explorer. Also, “type-in” answers must be modified to include other correct answers.*

**Participant 3**

- *The “fill--the-blank” questions should have all the possible answers. Could they also be shorter?*

**Participant 4**

- *Maybe animating the photographs would look great for the tutorial, rather than making photographs static.*

**Participant 5**

- *The videos on each page should start to play immediately the page is opened.*
- *Terms like “gad” discussed, but no picture provided.*
- *It is good to have pictures of unit parts on the corner of the screen if it is discussed. I constantly had to go back to the parts identification screen during the latter pages of the jackleg drilling module.*
- *Practice questions should include less of fill in the word questions, as different understanding can mean different right answers for the question.*

**Participant 6**

- *It looks like some of the videos are not on the correct pages.*

**Participant 7**

- *Having a photograph on the same page the parts are explained is one important thing to consider.*

**Participant 8**

- *Some form of improvement with regard to putting photographs on more slides will be helpful.*

**Participant 9**

- *More photographs of the jackleg drill parts will work fine.*

**Participant 10**

- *Some of the sections were too technical. For example, slides which talk about components of the jackleg were very difficult to understand without having to go back to look at the picture.*

**Participant 11**

- *This participant did not provide any recommendation.*

**4.2.2.6. Video and field representative observations.** The following paragraphs summarized the field and recorded video observations.

### **1. Content**

- One important observation made was that international students (participants 4, 5, 7, 8, 9, and 10) paid more attention to details of the training material than the native students (participants 1, 2, 3, 6, and 11), which reflected in their answers to “fill-the blank” questions. The video recordings, as well as the observation field notes taken indicated that foreign students did better on the “fill-the-blank” questions than the native students. This difference in performance might be due to the fact that all the international students took notes during the tutorial, which they referred to when answering the questions. Only one native student (participant 6) took notes during the tutorial, and he did comparatively better on the “fill-the-blank” questions than his group mates.
- International students were comparatively slower than their native counterparts. International students spent an average total time of 108 minutes on the entire tutorial, while their native counterparts spent an average total time of 83.6 minutes. The reason for this might be that international students went through some of the sections (especially jackleg drilling and rockbolt installation) of the tutorial several times before taking the quizzes. Native students in this usability test, as well as those who took part in the initial usability test did not go back and forth when studying the tutorial.



Surprisingly, this observation did not reflect on the quiz scores of the participants (see Figures 4.7 and 4.8).

## **2. Scaffolding**

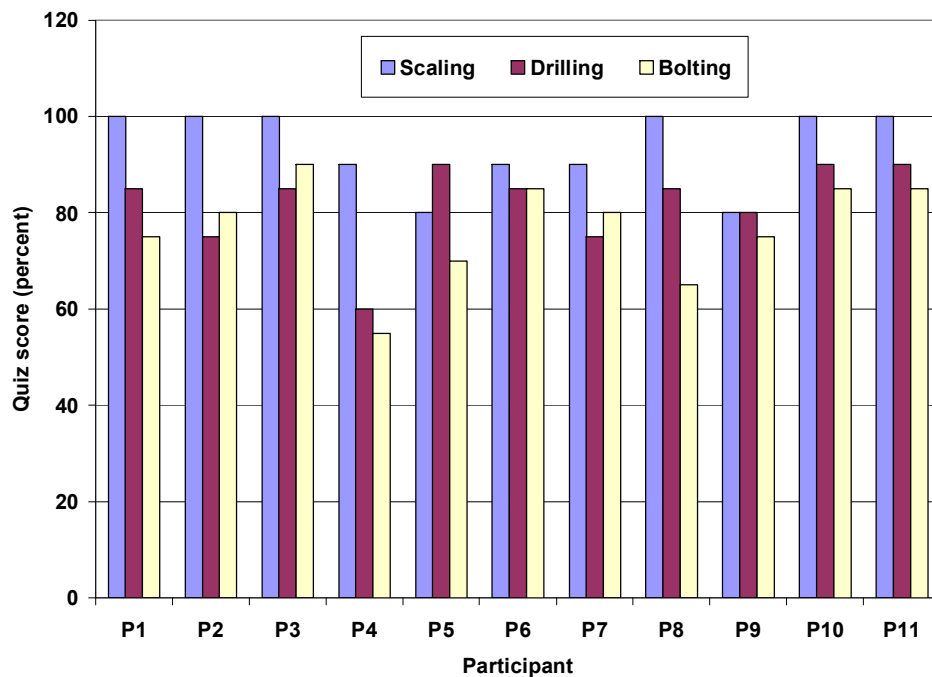
- With regard to the slides on which videos can be found, majority of the users started with lower scaffold of text before switching to the higher scaffold of video. However, native students most at times combined the video with text, while international students strictly followed the order of text first, before video.
- Users' facial expressions from the recorded videos indicated that most of the users tended to dislike the longer text descriptions, especially the long instructions on the homepage of the tutorial. The evidence of this observation was captured in the videos where some of the participants tried to use the tutorial's "back button" to get back to the homepage, instead of using the browser's "back button". It is important to note that information on navigation within the tutorial was provided on the homepage, but if a participant does not read it, he/she will get confused with the navigation buttons.

## **3. Navigation**

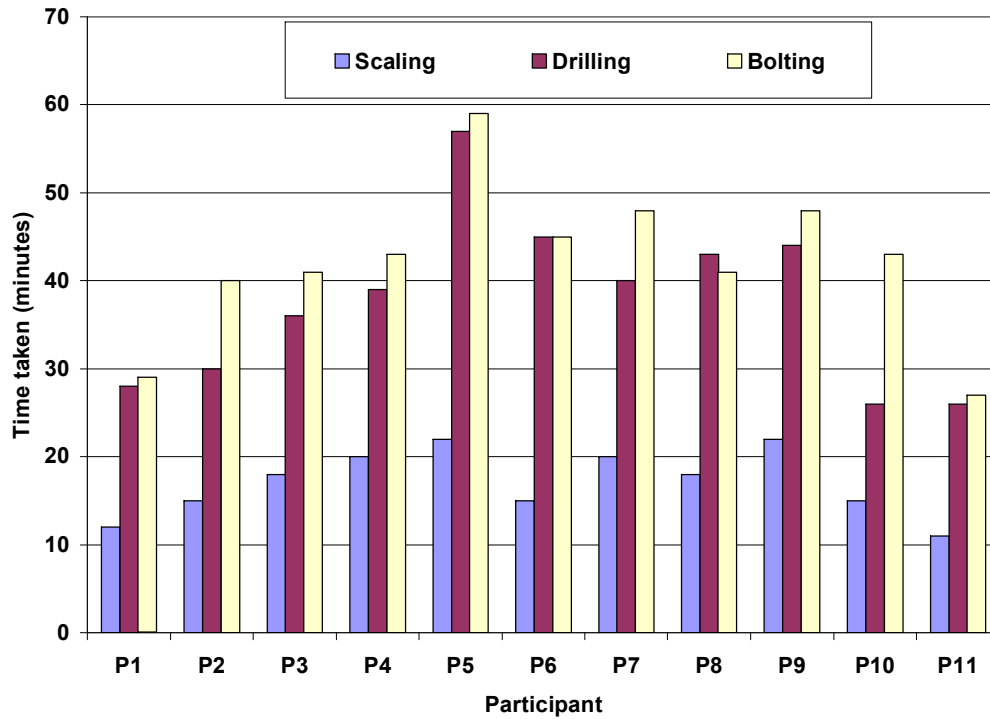
- None of the subjects got lost within any of the sections when going through the tutorial. This observation was confirmed by participants' mean questionnaire scores of the tutorial's navigation tools, which was 9.5 out of

10. Most of the users explained that there were not a lot of tools to confuse a user in terms of navigating the tutorial.

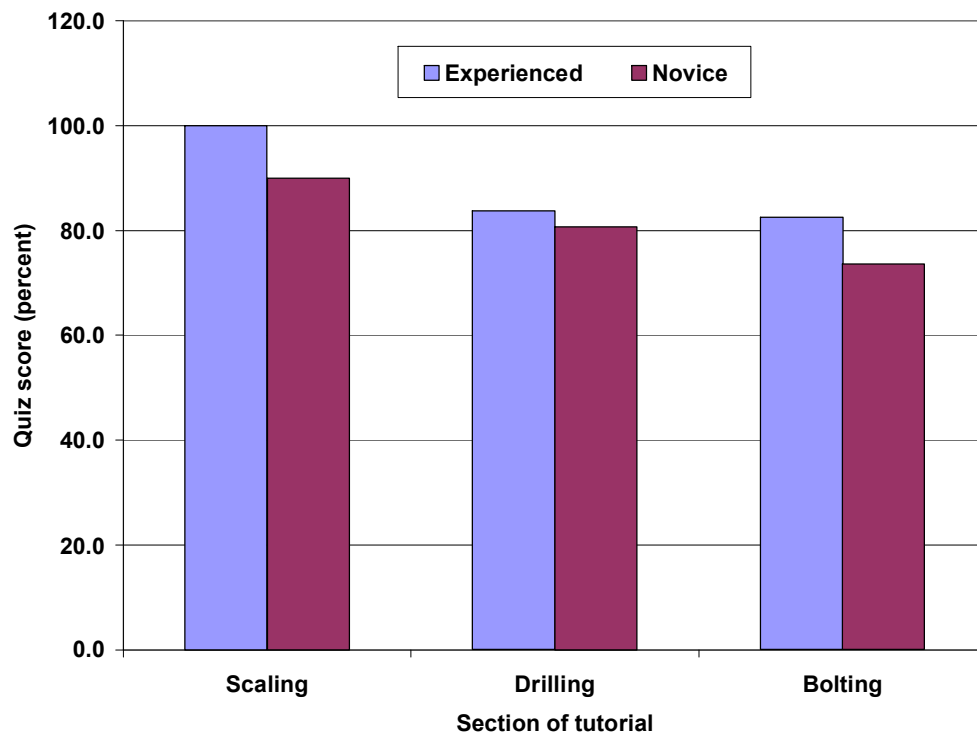
**4.2.2.7. Evaluation of participants' performance.** As in the initial usability test, participants in the second usability test were also asked to answer a total of 50 questions (10 questions on scaling, 20 on jackleg drilling, and another 20 on rockbolt installation) after studying the tutorial. As usual, the two variables considered were the participants' quiz scores and the total time taken to complete each of the three sections. Apart from considering these variables individually, we also looked at the performance of the two categorical groups (i.e., the experienced and the novice rockbolters). Figures 4.7 and 4.8 show participants' quiz scores and total time taken respectively, while corresponding categorical graphs are shown in Figures 4.9 and 4.10.



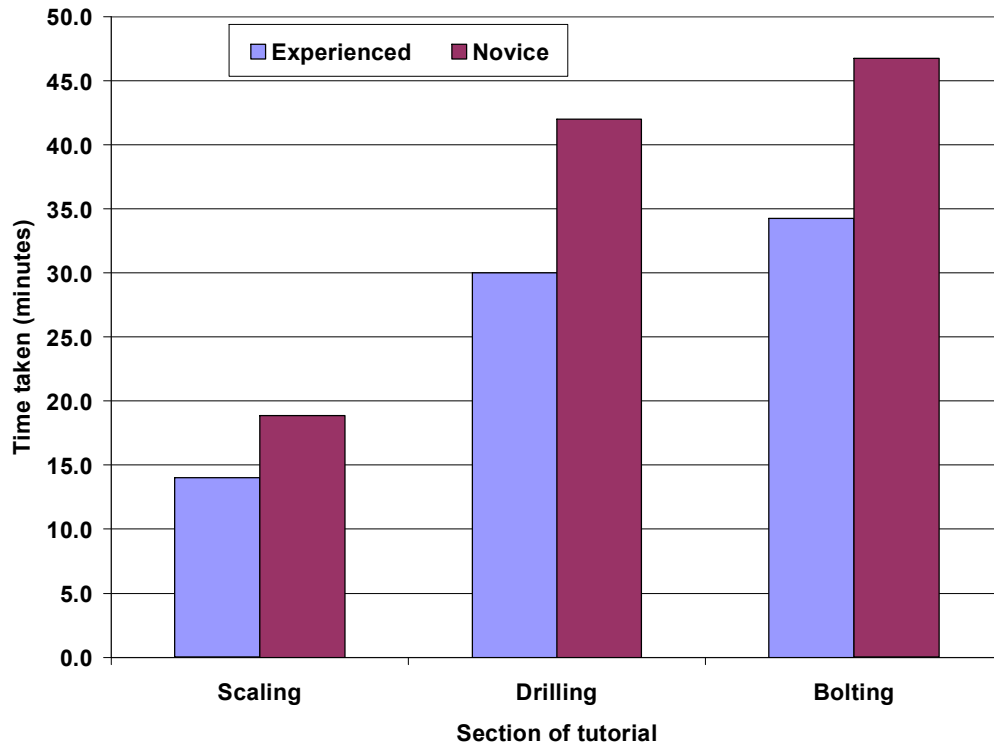
**Figure 4.7.** Quiz Scores of Participants



**Figure 4.8.** Total Time Taken by the Participants.



**Figure 4.9.** Mean Quiz Scores as a Function of Categorical Group.



**Figure 4.10.** The Average Time Taken as a Function of Categorical Group.

#### **4.2.3. Comparison of the Online Tutorial with the Paper-based Version.**

Computer-based learning systems afford us an opportunity to move education to a new level, both to enrich traditional instruction and to provide instruction at a distance, but the vast majority of these systems have not been pilot tested or evaluated prior to their use (Hall et. al., 2004). In this experiment, two instructional delivery systems were compared for effectiveness in the training of new inexperienced underground rockbolters. These were (1) underground rockbolting tutorial in multimedia (text, photograph, animation, and video) format and (2) hardcopy version of the tutorial (text and photograph only). Two evaluation tools were used in this experiment including

- A knowledge test referred to as “identification test”, which was used to compare the performance of the two groups
- A participant questionnaire focused on the desirability of each training method.

**4.2.3.1. Participants.** A total of fifty (50) students of which nine (9) were female served as subjects in this experiment, which was conducted in spring 2008. Subjects were paid, and participation was voluntary. None of them has previous mining or underground rockbolting experience. The age of the subjects ranged from 19 to 34 years with a mean of 24 years. The participants were randomly assigned to the two groups (computer-based and paper-based). The computer-based group used the Web-based tutorial, while the paper-based group used the hardcopy version of the tutorial. Due to large size of participants, the random assignment was done on the day of the experiment by randomly distributing the participants upon arrival. This method was used because the experimenters were not sure if all the participants were going to show up. Surprisingly, they all showed up.

**4.2.3.2. General procedure.** Participants were first introduced to the four experimenters after which a fifteen-minute PowerPoint presentation was given about the nature of the experiment. Each participant was then asked to read and sign a consent form (a copy is reproduced in Appendix B6). Both groups were provided with a detailed instruction they were supposed to follow in reading the tutorial and taking an identification test based on scaling, drilling, and bolting at the end of the experiment. A copy of the instruction given to the computer-based group, which is similar in format to the one given to the paper-based group, is reproduced in Appendix B7. Each participant

was asked to note the time taken to complete each of the three sections of the tutorial, as well as the time spent in answering the identification questions. The identification test was administered in the simulator laboratory, where participants were asked to identify some basic tools/equipment parts used in underground rockbolting. Additionally, they answered a few questions on the basics of underground rockbolting. The difficulty of the identification test resided in the fact that it had to be performed without using any notes taken during the tutorial session. Appendix B8 shows a copy of the questions given in the identification test.

**4.2.3.3. Post-testing questionnaire.** Each participant was given a 10 point (strongly disagree – strongly agree) Likert-scale questionnaire consisting of 5 statements, as indicated below. Participants were also asked to provide open-ended explanations for their ratings.

\_\_\_\_\_ 1) *The tutorial did a good job of letting me know what I did not know about the subject.*  
*Explain:*

\_\_\_\_\_ 2) *Each task was covered comprehensively.*  
*Explain:*

\_\_\_\_\_ 3) *I found the identification questions to be strongly related to the information provided.*  
*Explain:*

\_\_\_\_\_ 4) *The tutorial is an effective learning tool.*  
*Explain:*

\_\_\_\_\_ 5) *I would recommend this tutorial for training new inexperienced miners.*  
*Explain:*

Apart from the above post-experiment statements, participants were asked an open-ended question in which they were to provide any suggestions for improvement of the tutorial.

**4.2.3.4. Participants' questionnaire ratings and responses.** Participants' mean ratings of the Likert-scale items are shown in Tables 4.3 and 4.4 for the paper-based and computer-based groups, respectively. Detailed results are provided in Appendix B9.

**Table 4.3.** Paper-based Group Participants' Mean Ratings.

Statement	Ex1	Ex2	Ex3	Ex4	Ex5
<b>Mean</b>	<b>6.8</b>	<b>8.3</b>	<b>7.5</b>	<b>7.3</b>	<b>6.8</b>
<b>Std. deviation</b>	<b>2.3</b>	<b>1.5</b>	<b>2.3</b>	<b>1.7</b>	<b>2.7</b>
Ex1	The tutorial did a good job of letting me know what I did not know				
Ex2	Each task was covered comprehensively				
Ex3	I found the questions to be strongly related to the information provided				
Ex4	The tutorial is an effective learning tool				
Ex5	I would recommend this tutorial for training new inexperienced miners				
<b>Scale</b>	<b>Strongly Disagree 1...2...3...4...5...6...7...8...9...10 Strongly Agree</b>				

**Table 4.4.** Computer-based Group Participants' Mean Ratings.

Statement	Ex1	Ex2	Ex3	Ex4	Ex5
<b>Mean</b>	<b>8.1</b>	<b>8.1</b>	<b>8.8</b>	<b>8.5</b>	<b>8.6</b>
<b>Std. deviation</b>	<b>1.7</b>	<b>1.4</b>	<b>1.4</b>	<b>1.4</b>	<b>1.0</b>
Ex1	The tutorial did a good job of letting me know what I did not know				
Ex2	Each task was covered comprehensively				
Ex3	I found the questions to be strongly related to the information provided				
Ex4	The tutorial is an effective learning tool				
Ex5	I would recommend this tutorial for training new inexperienced miners				
<b>Scale</b>	<b>Strongly Disagree 1...2...3...4...5...6...7...8...9...10 Strongly Agree</b>				

Participants of the two groups provided various explanations to their rankings of the five Likert- scale items, as well as the open-ended question on the improvement of the effectiveness of the tutorial. Their representative comments are summarized in the paragraphs below.

**(a) Paper-based participants' responses.** Representative open-ended explanations to the Likert-scale statements are:

1. The tutorial did a good job of letting me know what I did not know about the subject.

- *Too much information made it boring and confusing, although the scaling section was okay.*
- *Yes, I have seen and heard only little yesterday. For the first time I learned about it today.*
- *I knew literally nothing at first*
- *I learned a lot about mining, but I think hands-on visuals rather than pictures could help me better.*
- *There were a few terms I did not understand. I knew some of them from construction experience.*

2. Each task was covered comprehensively.

- *Not after reading the tutorial, but after seeing the actual drill when taking the identification test.*
- *But more illustrations are required.*
- *It was maybe too comprehensive for brand new miners with too much information.*
- *The jackleg drilling section was not well covered*

3. I found the identification questions to be strongly related to the information provided.



- *Few tools were easy to identify, but the rest were confusing as reading the material once was not enough to identify all tools and machines.*
- *I was able to see clearly the components in the paper tutorial, but I think the computer tutorial will be better.*
- *Yes, but if photographs were good enough, it would have helped.*
- *The photographs on the slides were terribly unhelpful. There were parts to be identified that were not covered.*

4. The tutorial is an effective learning tool.

- *The tutorial provides good information, but it is too verbose.*
- *I think this is a little bit too much information for a beginner.*
- *Yes, I learnt in detail about something I had no idea about.*
- *I think with practical training, learning will be easier.*
- *A video would have worked better so that I could see an operating machine instead of reading about it.*
- *The student should be given a test at the end of each tutorial and not just three tutorials and a test at the end. Person's retaining capability is too short to remember a lot of stuff at a sitting.*

5. I would recommend this tutorial for training new inexperienced miners.

- *Yes, it would be advisable to recommend, but with the machine and the tools being in front of them.*
- *For a technology graduate like me, it was quiet easy. But some video clipping showing demonstration of operating the equipment and pictures will help in effective training of new inexperienced miners.*
- *Maybe video computer tutorial is effective, but paper-based does no good.*
- *Unless a demonstration of how things work is shown, this tutorial alone does not prepare one to safely use the machines.*
- *As a preliminary training, but not as the majority of the training.*

- *Nope, I would not suggest this tutorial to any new miner. A more lecture-based practical session would be more helpful rather than just giving three sections of tutorial with terrible pictures to study.*

Representative comments on improving the effectiveness of the tutorial are:

- *As it is not possible to train all the miners with simulation and computer graphics all the time, I think this tutorial was very good enough, but with the tools in front of the miner with an instructor would be a better way.*
- *Additional talks/lectures from experienced miners needed.*
- *There is no clear idea of all the terms used.*
- *Bullet points could further enhance understanding.*
- *As in a paper based tutorial, sometimes it becomes really boring to read all the information. It is good to provide video for the subject. The introductory lecture was excellent. The video shown during the introductory presentation was also very good. The tutorial in my suggestion must be provided in video format.*
- *The idea behind the tutorial is VERY VERY GOOD. But the execution of this idea needs a better documentation of what you intent to say. Hence the pictures used in the handouts should be more expressive from visual perspective.*
- *Provide more practical way of teaching students including pictures and videos, but not a paper stuff like this type.*

**(b) Computer-based participants' responses.** Representative open-ended explanations

to the Likert-scale statements are:

1. The tutorial did a good job of letting me know what I did not know about the subject.

- *I learned a lot about a subject I knew nothing about.*
- *The tutorial was very informative, but in some cases I felt loss because of too much information.*
- *The videos were helpful and gave an insight on each process or machinery used.*

- *It uses a lot of jargons, but the videos and photographs explained the pieces nicely.*
- *It was very informative - more than I could remember.*
- *Because I am new to mining, I found it interesting.*
- *Most of the terminologies need to be explained further. For example, “muck pile” “back”*

2. Each task was covered comprehensively.

- *Sure, but too technical.*
- *Each part was talked about and divided into small comprehensible chunks with accompanying videos. However, the drilling section could be explained better with demonstrations.*
- *May include some more visuals/figures for explanation*

3. I found the identification questions to be strongly related to the information provided.

- *The questions were strongly related to the information provided. The same tools used in the tutorial were displayed for identification.*
- *The information in the tutorial was exactly like the identification questions.*
- *It was a little bit difficult to answer some of the questions.*
- *Yes, while I was learning the tutorial I thought I could see real drilling machine, and I did in the identification test.*

4. The tutorial is an effective learning tool.

- *Good tutorial with great videos.*
- *The tutorial was effective mainly because of the videos on each process or machine.*
- *Yes, but improvement can be made with respect to the jargons under the drilling and bolting sections.*
- *Yes, but not easy to keep them in memory.*

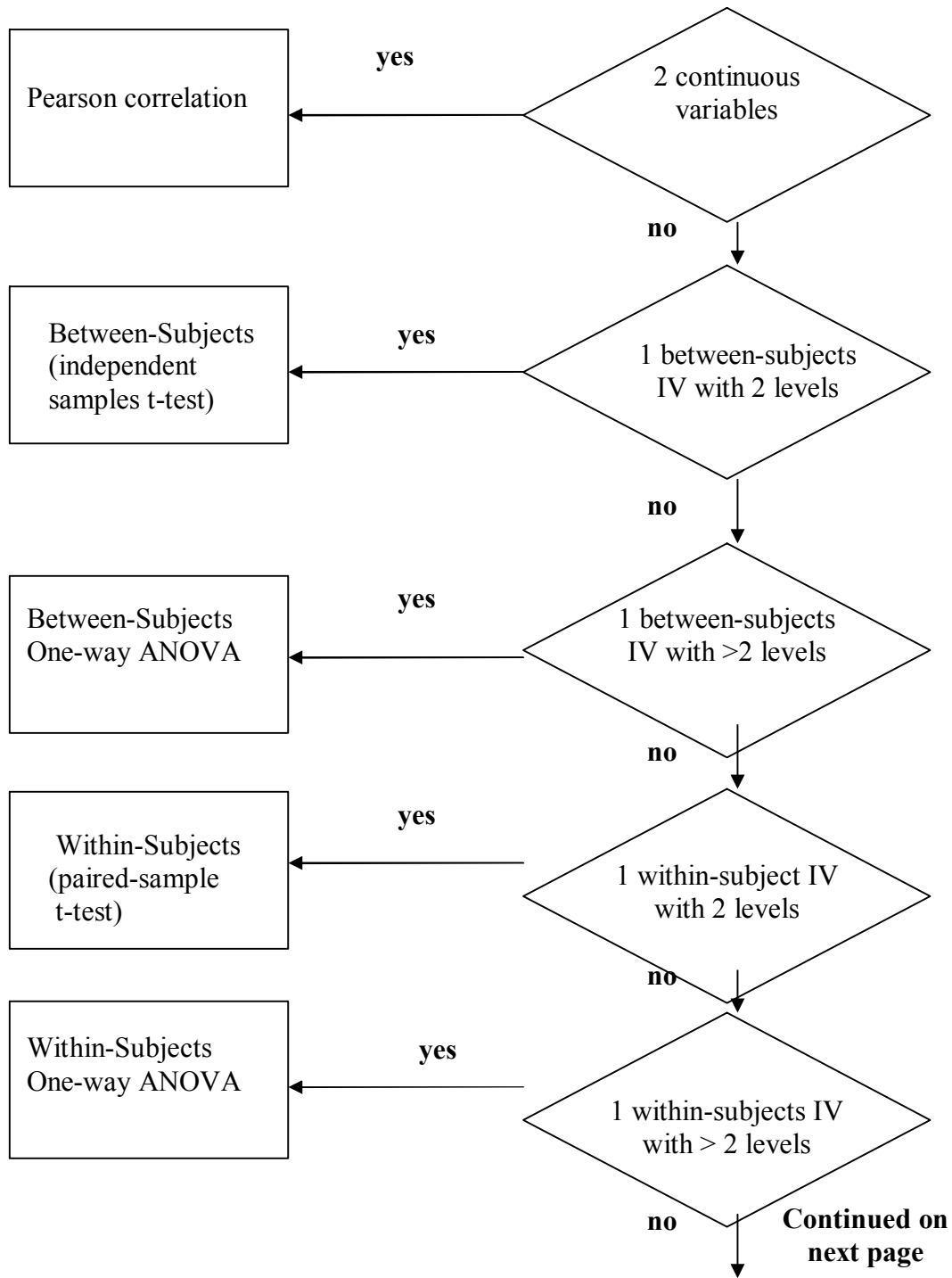
5. I would recommend this tutorial for training new inexperienced miners.

- *I will definitely recommend this tutorial to new miners as it provides a comprehensive and practical exposure to various processes and machinery used.*
- *This tutorial is a good background before hands-on learning.*
- *This is a great teaching tool, especially when supplemented with hands-on experience.*
- *This would be a good tool to introduce miners to what they are going to be doing, but they still need a little further training and supervision to do their job safely.*
- *Most of the terminologies need to be explained further. For example, “muck pile,” “back,” etc.*

The computer-based group’s representative comments on improving the effectiveness of the tutorial are:

- *The tutorial was good and helpful. It teaches the required things, but more interaction sections will be great.*
- *The technical jargon could be seen as overwhelming. The section on rockbolting seemed to drag on and on, especially when trying to understand the tension/compression with the rock.*
- *Maybe having someone to speak to if you do not understand something will be great.*
- *Tutorial should have more videos than words.*
- *Jackleg drilling is too theoretical. I couldn’t understand many terms (technical jargons) used in that. More video examples will help a lot.*
- *The tutorials are a little too much for first one sitting and I am sure that this is not what would happen in the real world.*
- *I found the tutorial on jackleg drilling very lengthy. I started losing interest after a while. The other two sections were very interesting and informative as well.*
- *Tutorial needs to be broken into smaller sections to facilitate easy retention of details.*

**4.2.3.5. Quantitative analyses.** The Statistical methods used in analyzing the data obtained in the comparative experiment were taken largely from Figure 4.11.



**Figure 4.11.** Statistical Decision.

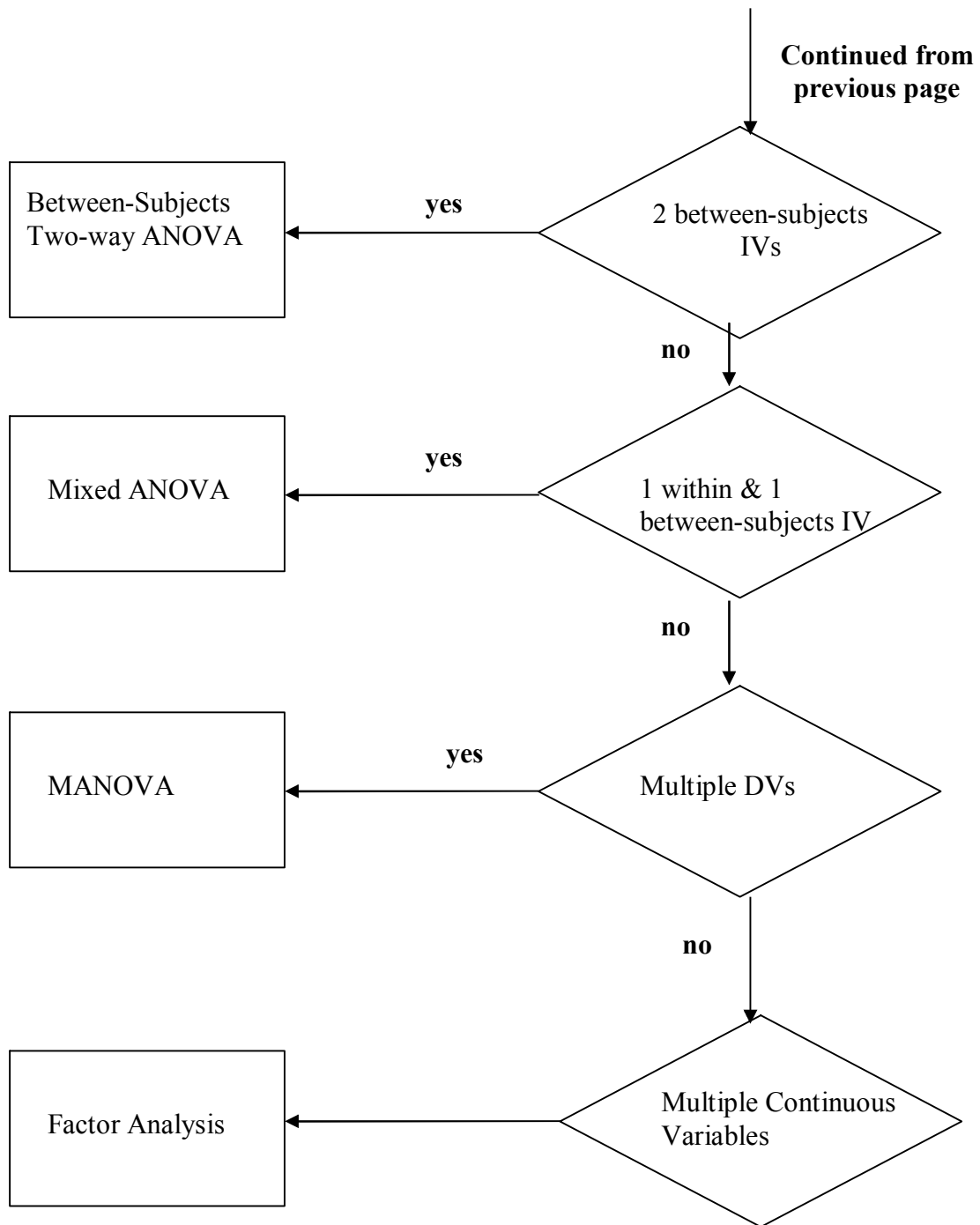
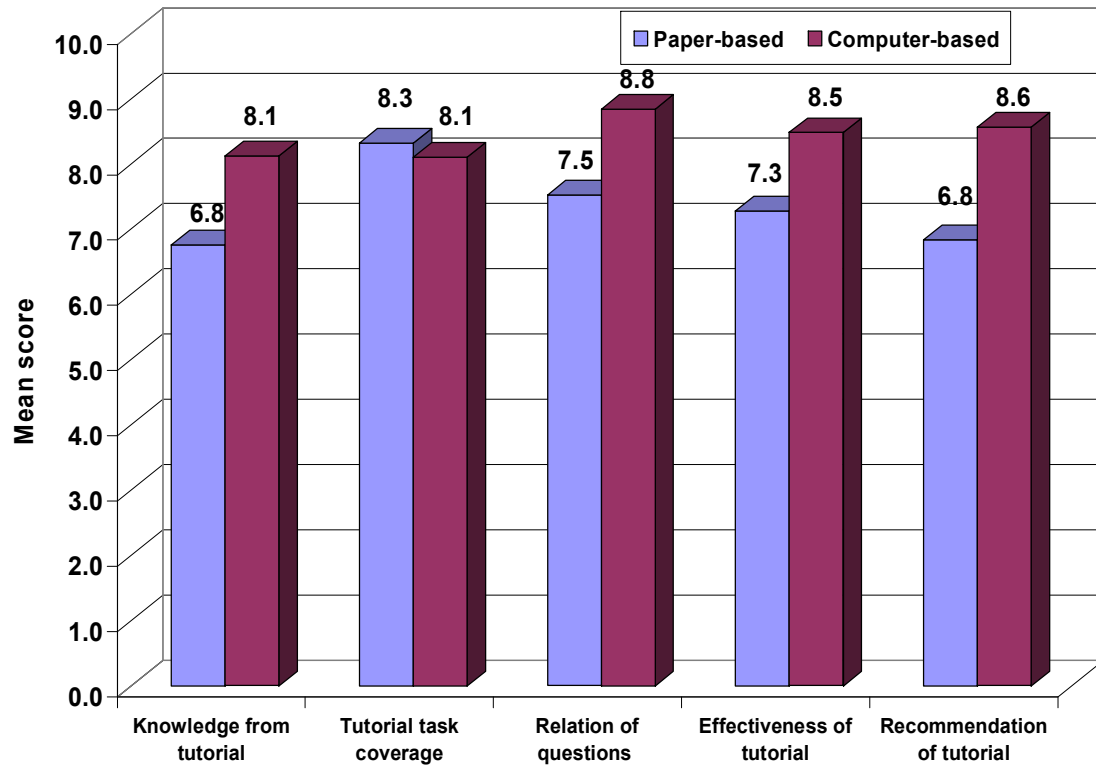


Figure 4.11. Statistical Decision(Cont.).

**4.2.3.5.1. Quantitative analysis of participants' subjective ratings.** The mean scores of subjective responses to the questionnaire are shown in Figure 4.12.



**Figure 4.12.** Subjective Rating Scores as a Function of Participant Group.

Normality tests performed on the subjective ratings using Shapiro-Wilk (W) test indicated that the ratings were either normally distributed or very close to normally distributed at 0.05 level of significance (Tables 4.5 and 4.6). Normal distribution was, however, assumed for all the ratings.

**Table 4.5.** Normality Tests on Subjective Ratings of the Paper-based Group

<b>Statement</b>	<b>W</b>	<b>Significance</b>
Knowledge from tutorial	0.90	0.02
Tutorial task coverage	0.89	0.01
Relation of questions to tutorial	0.89	0.01
Effectiveness of tutorial	0.95	0.22
Recommendation of tutorial	0.89	0.01

**Table 4.6.** Normality Tests on Subjective Ratings of the Computer-based Group

<b>Statement</b>	<b>W</b>	<b>Significance</b>
Knowledge from tutorial	0.80	0.00
Tutorial task coverage	0.89	0.01
Relation of questions to tutorial	0.79	0.00
Effectiveness of tutorial	0.67	0.00
Recommendation of tutorial	0.88	0.01

Quantitative analysis of participants' mean subjective ratings could be carried out using a series of between-subject t-tests with group (paper-based vs. computer-based) serving as the independent variable, or using the One-Way Between Subjects Multivariate Analysis of Variance (MANOVA). The latter is preferred because of the following advantages it has over the former.

- It requires only one test, which is the F-test (but still needs post hoc tests to examine exact differences between means).
- Decreases alpha error (alpha error = probability of finding significant difference when it does not really exist in population). It is important to note that alpha error increases with number of statistical tests.



The values shown in Figure 4.12 indicate differences in the mean, but did not provide any information as to whether the differences were significant or not. According to Johnson (1981), statistically significant experimental results lead to more secure conclusions. In order to determine if these mean scores were significantly different, the data were loaded into the SPSS program after coding the categorical group (1 for paper-based and 0 for computer-based), and MANOVA test was performed using the Wilks' Lambda method. The five Likert-scale statements served as dependent variables in the analysis. The F-ratio ( $F = 3.128$ ), the observed value of the test statistic with probability value of 0.015 (less than 0.05) indicated that at least one of the group mean scores differed. The final step in the analysis involved the use of univariate analysis method of comparison of means. This test determined whether there was statistical significance in the difference of mean scores, or if the difference was due to chance. Table 4.7 presents the F statistic and the significant values at 0.05 level of significance.

**Table 4.7.** Tests of Between-Subjects Effects.

Source	Dependent variable	F	Significance
Group	Knowledge from tutorial	5.628	0.022
	Tutorial task coverage	0.348	0.558
	Relation of questions to tutorial	6.022	0.018
	Effectiveness of tutorial	7.764	0.008
	Recommendation of tutorial	8.987	0.004

**4.2.3.5.2. Evaluation of participants' performance.** Performance measures (dependent variables) used to evaluate the participants were the total score on the identification test and the time spent on reading the tutorial. The total time spent on taking the identification test was also considered. Since the identification test was

designed to cover all the three sections (scaling, drilling, and bolting), we ended up with seven dependent variables and two independent variables. The two independent variables were

- Computer-based group, and
- Paper-based group

The seven depended variables were

- scaling score,
- drilling score,
- bolting score,
- scaling time,
- drilling time,
- bolting time , and
- identification test time

Figures 4.13 and 4.14 show group mean test scores and the average time spent, respectively.

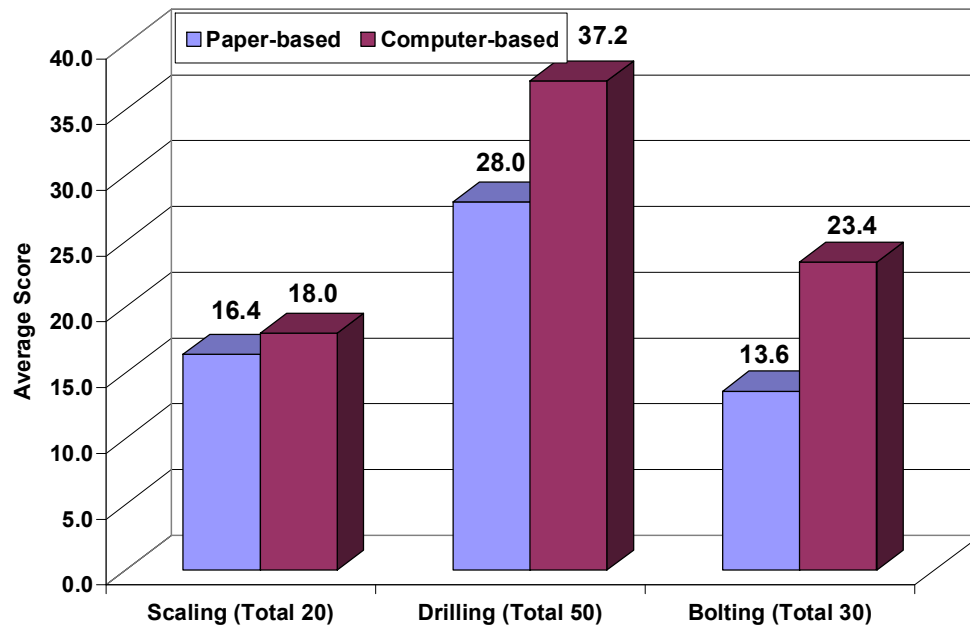


Figure 4.13. Group Mean Test Score by Section.

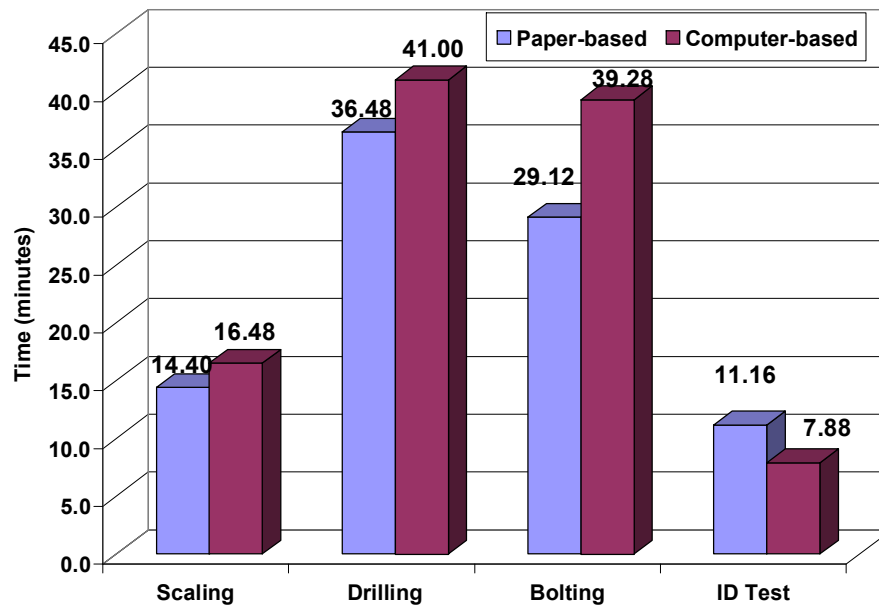


Figure 4.14. Average Time for Sections by Group.

Prior to analyzing the data, normality tests were performed at 0.05 level of significance on all the 7 variables for each of the 2 groups. The results are summarized in Tables 4.8 and 4.9.

**Table 4.8.** Normality Tests on Paper-based Group's Performance Data.

Variable	W	Significance
Scaling score	0.70	0.00
Drilling score	0.92	0.05
Bolting score	0.87	0.00
Scaling time	0.90	0.02
Drilling time	0.96	0.46
Bolting time	0.91	0.03
Identification test time	0.86	0.00

**Table 4.9.** Normality Tests on Computer-based Group's Performance Data.

Variable	W	Significance
Scaling score	0.60	0.00
Drilling score	0.91	0.03
Bolting score	0.88	0.01
Scaling time	0.92	0.05
Drilling time	0.94	0.12
Bolting time	0.97	0.63
Identification test time	0.87	0.01

Standard inferential statistics (assuming a normal distribution) was used to analyze the data in SPSS. A suitable statistical method used was the One-Way Between Subjects Multivariate Analysis of Variance (MANOVA) method, which works well for multiple dependent variables. The F-ratio ( $F = 7.147$ ), the observed value of the test statistic with probability value of 0.000 using the Wilks' Lambda method indicated that the two group levels were significantly different based on the combination of the seven

dependent variables. Table 4.10 shows the F statistic and the significant values at 0.05 level of significance from the univariate analysis of mean comparison.

**Table 4.10.** Tests of Between-Subjects Effects.

Source	Dependent variable	F	Significance
Group	Scaling score	1.659	0.204
	Drilling score	12.374	0.001
	Bolting score	40.810	0.000
	Scaling time	1.468	0.232
	Drilling time	2.947	0.093
	Bolting time	24.718	0.000
	Identification test time	5.083	0.029

#### 4.3 EVALUATION OF THE PHYSICAL COMPONENTS OF THE VIRTUAL REALITY SIMULATOR.

**4.3.1. Participants.** Ten participants took part in this evaluation exercise. They were all American male citizens and had no previous underground rockbolting experience. Hence, they were considered representative of new inexperienced miners. The participants were paid, and participation was voluntary. The age of the participants ranged from 18 to 21 years with a mean of 20 years. Out of the 10 participants, eight were mining engineering students, while the remaining two were mechanical engineering students. They were given a consent form (Appendix B3) to fill, after which they were randomly assigned to two groups (experimental and control) using the Research Randomizer software. Research Randomizer uses “math.random” within the JavaScript programming language to generate its random numbers. It can best be described as a “pseudo-random number generator” because the numbers are generated by the use of a complex algorithm that gives the appearance of randomness (Urbaniak and Plous, 2003).

In order to create two random sets of participants, each participant was given an identification number (P1, P2, P3, etc). Then, the Randomizer Form was used to generate one set of ten non-unique, unsorted numbers with a range from 1 to 2 (representing the condition numbers). Interface of the Research Randomizer program with a typical input values is displayed in Figure 4.15.

**RESEARCH RANDOMIZER**

▶ Randomize    ▶ Tutorial    ▶ Links    ▶ About Us

To generate random numbers, enter your choices below (using integer values only):

How many sets of numbers do you want to generate?  [Help](#)

How many numbers per set?  [Help](#)

Number range (e.g., 1-50): From:  To:  [Help](#)

Do you wish each number in a set to remain unique?  [Help](#)

Do you wish to sort the numbers that are generated?  [Help](#)

How do you wish to view your random numbers?  [Help](#)

**Randomize Now!**

**Site Overview**

**Randomize Now** ▶  
Use the [Randomizer form](#) to instantly generate random numbers.

**Quick Tutorial** ▶  
See [some examples](#) of how Research Randomizer can be used for random sampling and random assignment.

**Related Links** ▶  
Visit [links](#) on random sampling, random assignment, and research methods.

**About Research Randomizer** ▶  
[Learn more](#) about Research Randomizer and read our User Policy.

**Randomizer Box**  
Add this tool to your website and generate your own number sets.

Copyright ©1997-2007 by Geoffrey C. Urbaniak and Scott Plous | Site Statistics

Social Psychology Network

**Figure 4.15.** Interface of Research Randomizer Program.

**4.3.2. General Procedure.** Participants in the experimental group were trained in the simulator laboratory for one hour using the physical components of the virtual reality computer simulator and for a second hour at the Missouri S&T Experimental Mine before actually drilling and installing a split set rock bolt at the mine. Participants in the control group underwent two-hour training at the Missouri S&T Experimental Mine before drilling and installing a split set bolt. Stillwater Mining Company's standard operating procedure (SOP) for jackleg operation, which is reproduced in Appendix C1 was used to train the participants at the experimental mine. Prior to training the participants, the experimental group went through the online tutorial on underground rockbolting, while the control group used a hardcopy version of the tutorial. They answered a few questions after the tutorial and each participant was supposed to get a minimum of 70% in order to continue with the exercise. Experimenters used this method to make sure that each participant had the pre-requisite knowledge of underground rockbolting.

The goals of evaluating the physical components of the VR simulator were:

- To determine the degree to which the physical components provide a realistic training experience.
- To determine the factors that appeared to be most important in mediating the degree to which the components were experienced as realistic.
- To identify additional functions that could be added to increase effectiveness, by soliciting suggestions from the participants.
- To assess the difference in performance of the two groups with emphasis on the individual tasks. Information on representative errors made and time spent

on each job step could help the virtual reality software developers to know the critical areas to consider in developing the software.

In order to accomplish these goals, participants in the experimental group who had experience in both environments were asked to rate their satisfaction with each job step in terms of how realistic the blue room training was perceived in relation to the real mine underground rockbolting. This was supplemented by participants' responses to an open-ended question on how to improve the effectiveness of the simulator. Additionally, the performance of each participant in both groups was graded in terms of how well each job step was performed in the actual mine environment after training, as well as the total time taken to perform each task in qualitative terms. Figure 4.16 shows a participant undergoing training in the blue room in the simulator laboratory, while Figure 4.17 shows a participant and his supervisor during a training session at the Missouri S&T Experimental Mine.



**Figure 4.16.** A Participant Undergoing Training in the Blue-Room in the Simulator Laboratory.





**Figure 4.17.** Missouri S&T Experimental Mine Supervisor Explains the Functions of the Parts of a Jackleg Drill to a Participant.

During the training sessions, participants in both groups were taught how to scale, drill, and bolt. Job steps considered in the scaling training process included

1. wearing of personal protective equipment (PPE),
2. initial site inspection,
3. selecting a scaling bar,
4. holding the scaling bar, and
5. scaling loose rock.

Steps for the drilling training session involved

1. fixing of the safety whip,
2. connecting the air/water hoses,
3. selecting a drill steel,
4. inserting the drill steel in the chuck of the drill head,
5. collaring a hole,
6. drilling a hole, and
7. removing the drill/ drill steel

During bolting training, the participants learned about

1. selecting a bolt (split set),
2. fixing a bolt dolly,
3. inserting a bolt in the hole,
4. installing a bolt, and
5. removing the drill/bolt dolly.

It is important to note that each participant was videotaped during the underground rockbolting contest because videotaping provides an inexpensive record that allows for more nuanced analysis than any other method. Rules for the contest can be found in Appendix C2. Figures 4.18 through 4.20 show a participant from the experimental group scaling, drilling, and bolting, respectively, during the underground rockbolting contest.



**Figure 4.18.** A Participant is Scaling Loose Rock During the Rockbolting Contest at the Missouri S&T Experimental Mine.



**Figure 4.19.** A Participant Drilling During the Underground Rockbolting Contest Under the Watchful Eye of the Missouri S&T Experimental Mine Supervisor.



**Figure 4.20.** A Participant Installing a Split Set Rockbolt During the Underground Rockbolting Contest.

**4.3.3. Post-testing Questionnaire.** Each participant in the experimental group was given a 5 point (very poor – very good) Likert-scale questionnaire consisting of 14 statements on comparison of blue room activities with the corresponding activities in the actual mine. The statements are indicated below:

- *Wearing of personal protective equipment (PPE).*
- *The type of scaling bar used.*
- *Scaling of loose rock.*
- *The jackleg drill used.*
- *Assembling the jackleg drill.*

- *Fixing of the safety whip.*
- *Connection of the air/water hose.*
- *Insertion of the drill steel.*
- *The noise level, vibration, and air pressure of the jackleg drill.*
- *Collaring of a hole*
- *Drilling of a hole.*
- *Fixing the rockbolt dolly.*
- *Insertion of the rockbolt in the hole.*
- *Rockbolt installation.*

The participants were also asked if they would recommend the simulator for training new inexperienced miners. They were finally asked to provide any suggestions for improvement of the simulator.

**4.3.4. Participants' Questionnaire Ratings and Responses.** Table 4.11 shows participants' subjective ratings to the survey statements.

**Table 4.11.** Participants' Ratings - Experimental Group.

Subjects	Ex1	Ex2	Ex3	Ex4	Ex5	Ex6	Ex7	Ex8	Ex9	Ex10	Ex11	Ex12	Ex13	Ex14
P1	4	5	2	4	5	5	4	3	5	1	4	3	5	5
P2	5	5	1	3	4	5	4	2	5	2	4	2	4	5
P3	4	5	1	5	5	5	5	3	4	1	5	2	5	3
P4	4	5	2	5	5	5	5	4	4	2	5	3	5	4
P5	4	4	3	3	5	5	4	3	5	2	4	4	5	5
<b>Mean</b>	<b>4.2</b>	<b>4.8</b>	<b>1.8</b>	<b>4.0</b>	<b>4.8</b>	<b>5.0</b>	<b>4.4</b>	<b>3.0</b>	<b>4.6</b>	<b>1.6</b>	<b>4.4</b>	<b>2.8</b>	<b>4.8</b>	<b>4.4</b>
Ex1	Wearing of personal protective equipment (PPE).													
Ex2	The type of scaling bar used.													
Ex3	Scaling of loose rock.													
Ex4	The jackleg drill used.													
Ex5	Assembling the jackleg drill.													
Ex6	Fixing of the safety whip.													
Ex7	Connection of the air/water hose.													
Ex8	Insertion of the drill steel.													
Ex9	The noise level, vibration, and air pressure of the jackleg drill.													
Ex10	Collaring of a hole													
Ex11	Drilling of a hole.													
Ex12	Fixing the rockbolt dolly.													
Ex13	Insertion of the rockbolt in the hole.													
Ex14	Rockbolt installation.													
<b>Scale: 1-very poor; 2-poor; 3-fair; 4-good; 5-very good    Ex – indicates post-testing statement</b>														

When participants were asked if they would recommend the simulator for training new inexperienced miners; four of the five participants responded “yes” with the fifth participant not providing any comment.

**4.3.5. Open-ended Questionnaire Responses.** Recommendations from the participants are listed below in response to the following open-ended question

*Please provide us with any other comments you think could help us improve on our simulator.*

**Participant 1**

- *The scaling part in the blue room was nothing close to what I did at the experimental mine. The blue room was too small and not realistic. However, I love the way I was able to adjust the air-pressure to simulate the hardness of rock.*

**Participant 2**

- *There was nothing like collaring of hole in the blue room.*
- *The scaling part must be improved.*
- *Simulation of flushing out cuttings from the hole will be great.*

**Participant 3**

- *The blue room was too neat, as compared to the actual mine.*
- *Scaling in the blue room was funny. Maybe some modification is necessary.*
- *Insertion of drill steel was too long, as compared to what I did in the actual mine.*

**Participant 4**

- *I did not like the way scaling was being done in the blue room.*
- *Not enough space to maneuver. I had a lot of space in the mine.*
- *A lot of hoses in the blue room without a water hose, which is important.*

**Participant 5**

- *I will only recommend the simulator if the scaling is improved.*
- *You can spread some rock pieces on the floor of the blue room to make it more realistic.*

**4.3.6. Performance Measurement of Participants.** Due to small number of participants used in this experiment, which is typical of any usability test, it is meaningless to perform any statistical analysis on actual numeric scores of any performance test given. Similarly, it would be statistically incorrect to try and analyze any form of time measurement taken using a stop watch. However, time measurement could be taken to determine the average time used to complete each job step.

In this experiment, a participant's task performance was qualitatively measured using the "Miner Assessment Index", which was developed using the Flow Interactive Limited's Scale of User Experience (2007). It is important to note that the field and video observation notes were helpful in generating the qualitative data. Two different measurements were taken including the quality of task performance and how long it took a participant to complete a task in qualitative terms. The range used for the former is indicated below.

- 0 – indicates that the participant failed because of errors;
- 1 – indicates the participant made many errors;
- 2 – indicates the participant made some errors; and
- 3 – indicates the participant made a few or no errors

The range considered for the task performance time measure is shown below.

- 0 – means that the participant failed and was not able to complete the task;
- 1 – means the participant succeeded very slowly in a roundabout way;
- 2 – means the participant succeeded a little slowly; and
- 3 – means the participant succeeded quickly.



The evaluation results can be found in Tables 4.12 through 4.15.

**Table 4.12.** Task Performance – Experimental Group

<b>Task</b>	<b>Job step</b>	<b>P1</b>	<b>P2</b>	<b>P3</b>	<b>P4</b>	<b>P5</b>	<b>Mean</b>
Scaling	Wearing PPE	3	3	3	3	3	<b>3</b>
	Initial site preparation	3	3	3	3	3	<b>3</b>
	Selecting a scaling bar	3	3	3	3	3	<b>3</b>
	Holding the scaling bar	2	3	3	3	3	<b>2.8</b>
	Scaling loose rock	2	2	3	1	3	<b>2.2</b>
Drilling	Assembling the drill	3	3	2	3	3	<b>2.8</b>
	Fixing of safety whip	3	3	3	3	3	<b>3</b>
	Connecting the air hose	2	3	3	3	2	<b>2.6</b>
	Connecting the water hose	3	3	3	3	3	<b>3</b>
	Selecting a drill steel	3	3	3	3	3	<b>3</b>
	Inserting the drill steel	3	3	3	3	3	<b>3</b>
	Hole collaring	1	1	2	1	3	<b>1.6</b>
	Hole drilling	2	3	3	3	3	<b>2.8</b>
Drill/drill steel removal	2	3	3	3	2	<b>2.6</b>	
Bolting	Bolt selecting (split set)	3	3	3	3	3	<b>3</b>
	Fixing the bolt dolly	2	3	3	3	3	<b>2.8</b>
	Inserting the bolt in the hole	3	3	3	3	3	<b>3</b>
	Bolt installation	2	3	3	2	3	<b>2.6</b>
	Drill/bolt dolly removal	3	2	3	3	3	<b>2.8</b>

Key:

0 – Fail because of errors

1 – Many errors

2 – Some errors

3 – Few or no errors

**Table 4.13.** Task Performance Time Measure – Experimental Group

<b>Task</b>	<b>Job step</b>	<b>P1</b>	<b>P2</b>	<b>P3</b>	<b>P4</b>	<b>P5</b>	<b>Mean</b>
Scaling	Wearing PPE	3	3	3	3	3	<b>3</b>
	Initial site preparation	3	3	3	3	3	<b>3</b>
	Selecting a scaling bar	3	3	3	3	3	<b>3</b>
	Holding the scaling bar	1	3	3	3	3	<b>2.6</b>
	Scaling loose rock	2	2	2	1	3	<b>2</b>
Drilling	Assembling the drill	2	3	1	3	3	<b>2.4</b>
	Fixing of safety whip	2	3	3	1	3	<b>2.4</b>
	Connecting the air hose	2	3	2	3	3	<b>2.6</b>
	Connecting the water hose	3	3	2	3	3	<b>2.8</b>
	Selecting a drill steel	3	3	3	3	3	<b>3</b>
	Inserting the drill steel	2	3	3	3	3	<b>2.8</b>
	Hole collaring	2	3	1	1	3	<b>2</b>
	Hole drilling	2	3	3	2	2	<b>2.4</b>
Drill/drill steel removal	2	3	3	3	3	<b>2.8</b>	
Bolting	Bolt selecting (split set)	3	3	3	2	3	<b>2.8</b>
	Fixing the bolt dolly	3	3	3	3	3	<b>3</b>
	Inserting the bolt in the hole	3	3	3	3	3	<b>3</b>
	Bolt installation	2	2	2	2	3	<b>2.2</b>
	Drill/bolt dolly removal	2	3	2	2	2	<b>2.2</b>

Key:

0 – Fail

1 – Succeed very slowly in a roundabout way;

2 – Succeed a little slowly

3 – Succeed quickly

**Table 4.14.** Task Performance – Control Group

<b>Task</b>	<b>Job step</b>	<b>P6</b>	<b>P7</b>	<b>P8</b>	<b>P9</b>	<b>P10</b>	<b>Mean</b>
Scaling	Wearing PPE	3	3	3	3	3	<b>3</b>
	Initial site preparation	3	3	3	3	3	<b>3</b>
	Selecting a scaling bar	3	3	3	3	3	<b>3</b>
	Holding the scaling bar	3	2	3	3	2	<b>2.6</b>
	Scaling loose rock	3	3	3	3	2	<b>2.8</b>
Drilling	Assembling the drill	3	2	3	3	1	<b>2.4</b>
	Fixing of safety whip	3	3	3	3	1	<b>2.6</b>
	Connecting the air hose	3	3	2	2	1	<b>2.2</b>
	Connecting the water hose	3	3	3	3	2	<b>2.8</b>
	Selecting a drill steel	3	3	3	3	3	<b>3.0</b>
	Inserting the drill steel	3	3	3	3	2	<b>2.8</b>
	Hole collaring	3	3	2	3	3	<b>2.8</b>
	Hole drilling	3	3	3	2	1	<b>2.4</b>
	Drill/drill steel removal	3	2	3	2	2	<b>2.4</b>
Bolting	Bolt selecting (split set)	3	3	3	3	3	<b>3</b>
	Fixing the bolt dolly	3	3	3	3	3	<b>3</b>
	Inserting the bolt in the hole	3	2	3	3	3	<b>2.8</b>
	Bolt installation	3	2	3	2	2	<b>2.4</b>
	Drill/bolt dolly removal	3	3	3	3	2	<b>2.8</b>

Key:

0 – Fail because of errors

1 – Many errors

2 – Some errors

3 – Few or no errors

**Table 4.15.** Task Performance Time Measure – Control Group

<b>Task</b>	<b>Job step</b>	<b>P6</b>	<b>P7</b>	<b>P8</b>	<b>P9</b>	<b>P10</b>	<b>Mean</b>
Scaling	Wearing PPE	3	3	3	3	3	<b>3</b>
	Initial site preparation	2	3	3	3	3	<b>2.8</b>
	Selecting a scaling bar	3	3	3	3	3	<b>3</b>
	Holding the scaling bar	3	2	3	3	2	<b>2.6</b>
	Scaling loose rock	3	2	3	3	2	<b>2.6</b>
Drilling	Assembling the drill	3	1	2	1	3	<b>2</b>
	Fixing of safety whip	3	3	3	3	2	<b>2.8</b>
	Connecting the air hose	3	3	2	2	2	<b>2.4</b>
	Connecting the water hose	3	3	3	3	3	<b>3</b>
	Selecting a drill steel	3	3	3	3	3	<b>3</b>
	Inserting the drill steel	3	3	3	3	1	<b>2.6</b>
	Hole collaring	3	3	3	2	2	<b>2.6</b>
	Hole drilling	3	3	2	1	2	<b>2.2</b>
Drill/drill steel removal	3	3	3	1	2	<b>2.4</b>	
Bolting	Bolt selecting (split set)	3	3	3	3	3	<b>3</b>
	Fixing the bolt dolly	3	3	3	3	3	<b>3</b>
	Inserting the bolt in the hole	3	1	3	3	2	<b>2.4</b>
	Bolt installation	3	1	3	3	1	<b>2.2</b>
	Drill/bolt dolly removal	2	2	3	3	2	<b>2.4</b>

Key:

0 – Fail

1 – Succeed very slowly in a roundabout way

2 – Succeed a little slowly

3 – Succeed quickly

#### **4.4 PROPOSED EVALUATION OF THE VIRTUAL REALITY COMPUTER SIMULATOR.**

The project assessment and evaluation will be carried out under the auspices of the Missouri S&T Laboratory for Information Technology Evaluation (LITE). The primary purpose of LITE is to examine and evaluate the impact of information technologies on people with a particular focus on learning technologies.

**4.4.1. Initial Evaluation.** The evaluation will initially focus on the virtual reality simulation system, with a series of two to three usability tests using small sample sizes, in order to address some fundamental usability issues that are often associated with complex augmented reality interfaces, such as this. The LITE lab has implemented such a strategy effectively with complex virtual reality (VR) training systems in the past (Hilgers et al., 2004). The focus is on logistical implementation and task realism. System modifications will follow each of these iterations.

**4.4.2. Applied Evaluation.** Following this initial evaluation and system modifications, a series of one or more applied-comparative experiments will be conducted using Missouri S&T students who have little or no experience in mining/underground rockbolting. These will consist of between-subject, experimental and control experiments with control students learning via traditional lecture and text formats.

The applied evaluation will culminate with the evaluation of the system as a tool for working minors in collaboration with industry professionals. The nature of the methodology in this applied research will be partly dependent on the number of participants available, since a minimum of approximately forty participants would be

required to conduct a traditional comparative study utilizing inferential statistics in assessing outcome differences. (Hall et al., 2004).

Consistent with the basic LITE evaluation model (Hall, Philpot, & Hubing, 2006), a number of quantitative and qualitative outcome measures will be implemented across all studies focusing on both foundational and applied knowledge. Further, individual differences and processing variables will be examined in an effort to identify the mediational effect of learner and learning factors.

**4.4.3. Initial Evaluation Procedure.** Usability tests will be conducted during the initial evaluation, similar to the ones performed for the evaluation of the Web tutorial and the physical components of the VR simulator. Usability test consists of detailed observation, recording, and analysis of a small number of participants carrying out targeted tasks with the system. In this case participants will carry out core tasks associated with training goals.

**4.4.3.1. Testing and collection of observations.** At least one usability test with five to ten participants is recommended. (More tests may be necessary dependent on the results of this initial usability test). If possible, participants will be allowed to use both the VR environment and the actual mine (i.e., MO S&T Experimental Mine) for the underground rockbolting task, so that they can compare the two environments. Apart from using participant performance sheet (named “miner assessment index”) to collect performance data of the participants, a questionnaire consisting of Likert-scale statements has been developed with emphasis on comparison of the two work environments to solicit participants’ suggestions on improving the system. The miner assessment index form and the Likert-scale statements are shown in Appendices D1 and D2, respectively.

Video and audio recordings will be made of each participant, and researchers will also record observational-field notes. Participants will be informed regarding the nature of the experiment, will then sign a consent form, and participate if they choose. The participants will be required to carry out a series of tasks, consistent with the training goals for underground rock bolting, using a similar script for all participants in both the virtual and “real” mine, with the constraint that half will perform the task in the virtual mine first, and the other will use the “real mine” first.

**4.4.3.2. Organizing observations.** The data from the questionnaires, video/audio recordings, and field notes will be transcribed and categorized, with a focus on the comparison of the two systems, and identification of factors that mediated learning efficacy. In addition, categories and themes will be identified that emerged from the data, in an effort to create a preliminary model for describing cognitive processes associated with learning from the system (Boese, Sheng, & Hall, 2008) . A categorization scheme used in a similar usability test is shown in Appendix D3.

**4.4.4. Applied Evaluation Procedure.** At least forty participants will be necessary for the applied analyses, in order to have adequate statistical power for inferential analyses. The applied evaluation will follow three steps including testing and data collection, analysis of the test data, and interpretation of results. Participants are required to sign and date the consent form before the test, as discussed previously.

**4.4.4.1. Testing and data collection.** The participants will be randomly assigned to two groups of approximately 20 participants each (assuming a total of forty participants), with one-half using the Web tutorial before training with the VR simulator

(experimental group), while the other half uses a hard-copy version of the tutorial before undergoing training at the Missouri S&T Experimental Mine. Previous usability test conducted using the physical components of the VR simulator showed that a new inexperienced participant needs at least two hours of training before installing a rockbolt in actual mine on his/her own (Taylor 2007).

The two groups will then carry out target tasks at the experimental mine in order to determine if there is any significant difference in performance. Two classes of measurements (quality and efficiency) will be used as the primary performance outcomes. A point system of scoring the participants was developed using Planeta's (1994) scaling assessment technique and Oitto's (1975) jackleg drilling task assessment approach. Details of the scoring system, including the number of points allocated for each job step and instructions for the entire contest are shown in Appendix D4. In addition, students will complete questionnaires similar to the first experiment including both qualitative and quantitative (Likert-style) items. If possible, it would be useful to videotape a representative sample of the participants, which would provide more detailed interpretation of the results.

**4.4.4.2. Analysis of data.** The quantitative data analysis will consist of: a) Multivariate analyses that compare the groups, utilizing outcome measures combined and individually; b) Structural analyses, in order to further examine an underlying model for cognitive processes associated with the use of the system.

**4.4.4.3. Interpretation of results.** All of the quantitative and qualitative data will be considered in an effort to determine: a) the relative effectiveness of the learning



system; b) the factors that mediate the system's effectiveness; and c) a model that describes underlying learning processes, particularly as they influence a & b.

## 5. DISCUSSION OF RESULTS

### 5.1 OVERVIEW

It is evident from the evaluation of the Web tutorial and the physical components of the simulator that the usability tests provided enormous amount of technical and usability issues. First, the comments and recommendations received from experts in the industry and academia were used to significantly improve the content of the Web tutorial. For example, the mean score rating of the Web tutorial's download rate was 5.0 out of 5.0 from the first usability test and 9.2 out of 10 from the second usability test. The main reason for achieving these impressive results was due to the fact that the experimenters addressed the comment of slow downloading of the WebPages, as pointed out by experts from the industry before performing the usability tests. In general, there has been a progressive improvement of the tutorial as a result of the iterative usability testing. The following paragraphs discuss the results of the four experiments performed.

### 5.2 INITIAL USABILITY TEST

**5.2.1. Discussion of Participants' Subjective Ratings and Responses.** All the eight participants who served as subjects in the first usability test had more than five years internet experience and had ever used an online tutorial in the past (Table 4.1, columns 2 and 3). With regard to participants' subjective ratings of the tutorial, it is worth noting that apart from the high rating of the overall effectiveness of the tutorial (i.e., 4.8 out of 5.0), participants' rating of navigation of 4.9 out of 5.0 is encouraging because navigation is one of the most critical aspects of browsing. According to Borges

et al. (1998), users spend a significant amount of time in search of information on a Web site and can become lost in hyperspace if the navigation tools are not well designed. Further, all the participants responded “yes” when they were asked if they would recommend this tutorial for training new inexperienced miners.

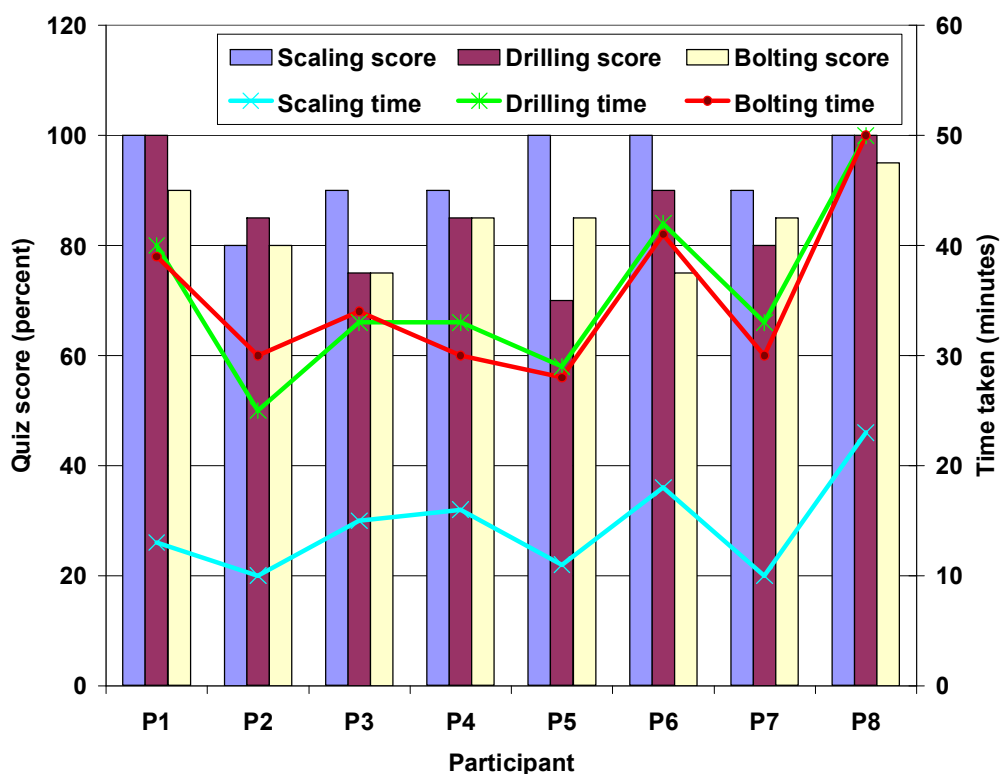
**5.2.2. Discussion of Qualitative Data.** The focus of performing a usability test is generally on solving specific problems to improve the effectiveness of the system. This has been displayed in the initial usability test where there has been a significant improvement on the tutorial after addressing participants’ most repetitive comments. Three major themes were derived from participants’ open ended responses and post-tutorial interviews, as summarized below.

- The videos were perceived to be slow in terms of downloading. Additionally, it was difficult to tell what was happening in some of the non-documentary videos.
- The “fill-the-blank” questions were tricky because there were multiple answers to most of them.
- The blue-background color of the videos was boring. Also, using the same background design for the three quiz sections was perceived to be non-interesting.

The above comments were addressed before conducting the second usability test. The evidence of which is shown in Tables 4.1 and 4.2, where participants’ mean score rating of the video quality in the first usability test was 4.1 out of 5.0 (see Table 4.1, column 5), as compared to 9.0 out of 10.0 in the second usability test (see Table 4.2, column 5). Additionally, the visual appearance in the first usability test was rated 4.0 out

of 5.0 (see Table 4.1, column 6), while the mean rating score in the second usability test was 8.2 out of 10.0 (see Table 4.2, column 6). It can be argued that, comparing two scores on two different measuring scales is meaningless, and for that matter, participants' explanations to ratings were also examined. Deductions from comments/recommendations indicated that participants of the second usability test gave positive comments on the video quality and visual appearance of the site. However, they were not satisfied with the "fill-in-the-blank" questions.

**5.2.3. Discussion of Quantitative Data.** Figure 5.1 shows participants' quiz scores and total time taken to complete each of the three sections of the tutorial.



**Figure 5.1.** Participants' Quiz Scores and Total Time Taken to Complete Each Section.

According to Kuniavsky (2003), quantitative information in usability testing cannot be statistically generalized to the whole target market. However, it is often useful when comparing behavior of subjects. Figure 5.1 shows no strong correlation between quiz score and time, but it can be deduced on total score basis that participants 1, 6, and 8 performed better than the other participants, which might be due partly to more time spent on reading the tutorial. The poor performance of participants 5 and 7 on the drilling section of the tutorial may be attributed to how hurriedly they went through that section. This trend, however, does not apply to participant 2, who spent the lowest time on the drilling section, but still scored comparatively high mark on drilling. Additionally, there was no correlation between participants' quiz scores and mean score from Likert-scale item ratings (Figure 4.4). Maybe more data are needed to establish any meaningful relationships between the variables.

### **5.3. USABILITY TEST WITH THE MORAE RECORDING DEVICE**

**5.3.1. Discussion of Participants' Subjective Ratings.** Participants in the second usability test did not have enough experience with online tutorial, as compared to their experience with computers and the internet. The evidence of this observation can be found in Table 4.2, columns 2 and 3, with 5.8 out of 10.0 for the online experience and 8.3 out of 10.0 for their internet experience. One other thing participants' subjective responses imply is that the main objective of the Web tutorial has been achieved, as indicated by the students' subjective views on videos, text, and photographs. Students rated the videos (mean score of 8.4 out of 10.0) to be more effective in learning than the text (mean score of 6.5 out of 10.0) and the photographs (mean score of 7.1 out of 10.0).

Additionally, when students were asked if they would recommend this tutorial for training new inexperienced miners, they overwhelmingly responded positively (mean score of 9.4 out 10.0).

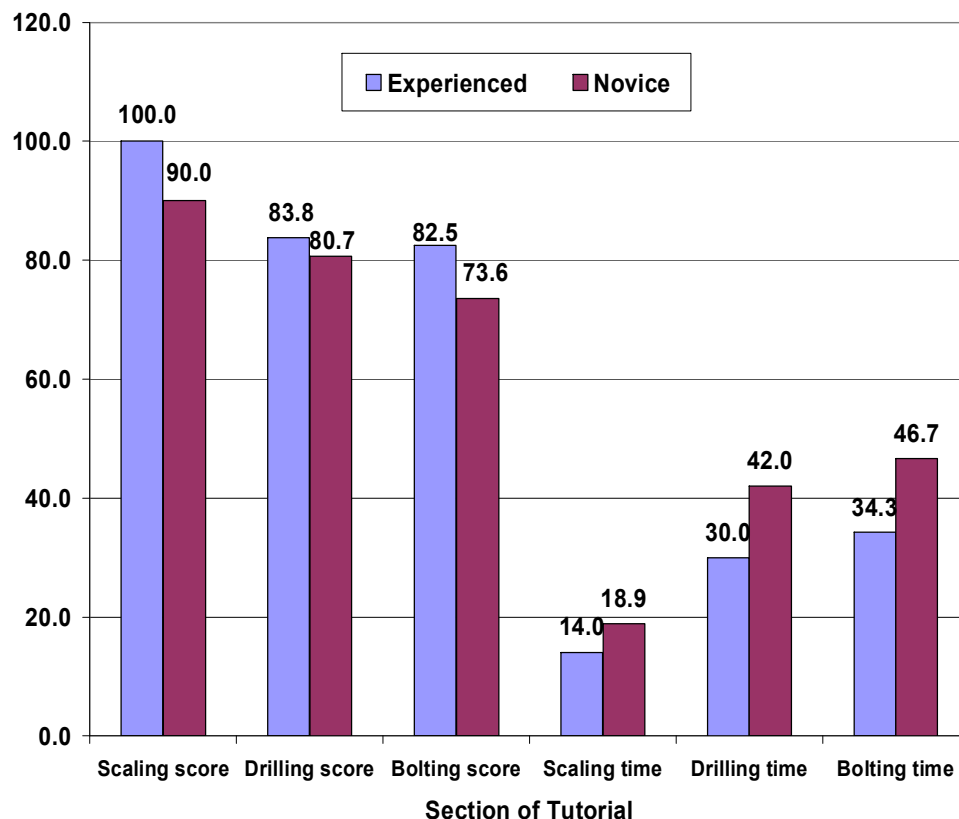
**5.3.2. Discussion of Qualitative Data.** Participants' responses to both Likert-scale items and open-ended questions were examined to derive themes from representative comments. No clear difference between responses of novice learners and experienced learners was observed. The seven major themes that were derived from the qualitative data are provided below.

- The videos were perceived to be very good and most users claimed to have learned and understood the tutorial with the help of the videos.
- The text part of the tutorial was perceived to be boring.
- Participants felt that using the tutorial in the presence of an instructor would help them gain understanding of the technical terms they might not understand.
- They found the “fill-the-blank” questions very confusing.
- They strongly suggested that photographs be provided on each page that a jackleg drill part is discussed.
- The navigation was very easy to use and straight forward because there were very few buttons, which could not confuse a user.
- The correct answer to a question should be known immediately after answering the question.

The representative comments/recommendations, which were technically possible, were addressed before the comparative experiment was performed. It is important to note

that all the “fill-the-blank” questions were modified, especially with regard to the possible answers provided. For example, one of the “fill-the-blank” questions which drew a lot of criticism was a question on the rock bolting rule. Most of the participants were of the view that the answer should not have been limited to “drill one, install one”, but should also include “drill one, bolt one.” This correction, including many others was addressed before conducting the third experiment. The photograph issue was also addressed by providing a photograph on each slide that a part of the jackleg drill is discussed. This was done in a way not to compromise the speed at which the webpage downloads.

**5.3.3. Discussion of Quantitative Data.** Results from the comparison of the two groups’ (novice and experienced learners) quizzes and total time taken to complete each section are consistent with expectation. Experienced learners were expected to perform better and spend less time in using the tutorial. For example, experienced learners had a mean score of 100 percent on scaling and spent a total of only 14 minutes, while novice learners had 90 percent and spent about 19 minutes (Figure 5.2). According to Hagman (1983), task repetition reduces task performance time and errors. It is important to note that due to small and uneven number of subjects involved (7 novice learners and 4 experienced learners), it was not possible to carry out any statistical test to determine if there were any significant differences in performance.



**Figure 5.2.** Quiz Score and Time as a Function of Group.

NB: Score is in percent and time is in minutes.

#### **5.4. COMPARISON OF THE WEB TUTORIAL WITH ITS HARDCOPY VERSION**

**5.4.1. Discussion of Participants' Subjective Ratings.** Since the criterion for the null hypothesis (i.e., the mean scores of the experimental group were significantly higher than the mean scores of the control group) was  $p < 0.05$  in this experiment, the following deductions can be made from Table 4.5.

- The computer-based group rated the statement about knowledge acquired from the tutorial statistically higher than the paper-based group ( $p < 0.05$ ).



- There was no statistical difference in the group ratings of the tutorial task coverage ( $p > 0.05$ ).
- On the statement regarding how the identification questions were related to the tutorial, the computer-based group rated it significantly higher than the paper-based group ( $p < 0.05$ ).
- There was statistically significant difference between the ratings of the statement on the effectiveness of the tutorial as a learning tool, with the computer-based group rating it higher than the paper-based group ( $P < 0.05$ ).
- Finally, the computer-based group rated the statement “I would recommend this tutorial for training new inexperienced miners” significantly higher than the paper-based group ( $P < 0.05$ ).

**5.4.2. Discussion of Qualitative Data.** Participants’ explanations to the subjective ratings of the Likert-scale items and their responses to the open-ended questions were examined with a special emphasis on identifying differences between the two groups. Six major categories that emerged from the representative comments are listed below.

1. The tutorial was perceived to contain too much information for a new miner at one sitting, especially the section on jackleg drilling.

- *(Paper-based group): Too much information made it boring and confusing, although the scaling section was okay.*
- *(Paper-based group): It was maybe too comprehensive for brand new miners with too much information.*
- *(Paper-based group): The tutorial provides good information, but it is too verbose.*
- *(Paper-based group): I think this is a little bit too much information for a beginner.*

- *(Computer-based group): The tutorial was very informative, but in some cases I felt loss because of too much information.*
- *(Computer-based group): The tutorial is effective, but not easy to keep in memory.*
- *(Computer-based group): The tutorials are a little too much for first one sitting and I am sure that this is not what would happen in the real world.*
- *(Computer-based group): I found the tutorial on jackleg drilling very lengthy. I started losing interest after a while. The other two sections were very interesting and informative as well.*

2. The general perception of participants in the paper-based group was to develop the tutorial using videos, while the computer-based group perceived the videos to be the most effective part of the tutorial.

- *(Paper-based group): A video would have worked better so that I could see an operating machine instead of reading about it.*
- *(Paper-based group): For a technology graduate like me, it was quiet easy. But some video clipping showing demonstration of operating the equipment and pictures will help in effective training of new inexperienced miners.*
- *(Paper-based group): I was able to see clearly the components in the paper tutorial, but I think the computer tutorial will be better.*
- *(Paper-based group): Maybe video computer tutorial is effective, but paper-based does no good.*
- *(Paper-based group): As in a paper based tutorial, sometimes it becomes really boring to read all the information. It is good to provide video for the subject. The introductory lecture was excellent. The video shown during the introductory presentation was also very good. The tutorial in my suggestion must be provided in video format.*
- *(Computer-based group): The videos were helpful and gave an insight on each process or machinery used.*
- *(Computer-based group): Good tutorial with great videos.*

- *(Computer-based group): The tutorial was effective mainly because of the videos on each process or machine.*
- *(Computer-based group): Tutorial should have more videos than words.*

3. The tutorial was perceived to provide a new knowledge.

- *(Paper-based group): I knew literally nothing at first.*
- *(Paper-based group): I have seen and heard only little yesterday. For the first time I learned about it today.*
- *(Paper-based group): I learnt in detail about something I had no idea about.*
- *(Computer-based group): I learned a lot about a subject I knew nothing about.*
- *(Computer-based group): Because I am new to mining, I found it interesting.*

4. It has been suggested to use the tutorial only as an introductory lesson to a hands-on experience.

- *(Paper-based group): I learned a lot about mining, but I think hands-on visuals rather than pictures could help me better.*
- *(Paper-based group): I think with practical training, learning will be easier.*
- *(Paper-based group): I would recommend this tutorial, but with the machine and the tools in front of trainees.*
- *(Paper-based group): Unless a demonstration of how things work is shown, this tutorial alone does not prepare one to safely use the machines.*
- *(Paper-based group): As it is not possible to train all the miners with simulation and computer graphics all the time, I think this tutorial was very good enough, but with the tools in front of the miner with an instructor would be a better way.*
- *(Computer-based group): While I was learning the tutorial I thought I could see real drilling machine, and I did in the identification test.*
- *(Computer-based group): This tutorial is a good background before hands-on learning.*

- *(Computer-based group): This is a great teaching tool, especially when supplemented with hands-on experience.*

5. The tutorial was perceived to contain a lot of technical terms, which were not explained. The non-explained technical terms are common with the jackleg drilling and rockbolt installation sections.

- *(Paper-based group): There is no clear explanation of all the terms used.*
- *(Paper-based group): There were a few terms I did not understand. I knew some of them from construction experience.*
- *(Computer-based group): Most of the terminologies need to be explained further. For example, "muck pile," "back," etc.*
- *(Computer-based group): The tutorial uses a lot of jargons, but the videos and photographs explained the pieces nicely.*
- *(Computer-based group) The tutorial covered each task well, but it is too technical.*
- *(Computer-based group): Improvement can be made with respect to the jargons under the drilling and bolting sections.*
- *(Computer-based group): The technical jargon could be seen as overwhelming. The section on rockbolting seemed to drag on and on, especially when trying to understand the tension/compression with the rock.*
- *Jackleg drilling is too theoretical. I couldn't understand many terms (technical jargons) used in that. More video examples will help a lot.*

6. Participants in the paper-based group perceived the photographs to be unhelpful.

- *(Paper-based group): If photographs were good enough, it would have helped*
- *(Paper-based group): The photographs on the slides were terribly unhelpful. There were parts to be identified that were not covered.*
- *(Paper-based group): Nope, I would not suggest this tutorial to any new miner. A more lecture-based practical session would be more helpful rather than just giving three sections of tutorial with terrible pictures to study.*

- *(Paper-based group): The idea behind the tutorial is VERY VERY GOOD. But the execution of this idea needs a better documentation of what you intent to say. Hence the pictures used in the handouts should be more expressive from visual perspective.*

**5.4.3. Discussion of Participants' Performance Data.** From Figure 4.14 and Table 4.6, the following can be deduced:

- Participants in the computer-based group spent significantly more time on rock bolting than those in the paper-based group. The significant time difference might be due to more videos incorporated in this section than scaling and drilling sections, which made the computer group spending more time on this section.
- Majority of the participants in the paper-based group indicated that unlike jackleg drilling and rockbolt installation sections, the section on scaling contains no technical terms and therefore easier to follow. This might be the reason of not seeing any significant difference in the mean scores of the scaling section.
- Participants in the paper-based group spent a lot more time on the identification test than those in the computer-based group. It was observed that they did not understand the basics of underground rockbolting before taking the test. They ended up changing their answers from time to time, which mainly accounted for the delay in answering the identification questions. Most of the participants in the paper-based group stated that it would be extremely difficult for a new miner to understand the terminologies

associated with rockbolting without any form of video or hands-on demonstration.

- Due to the frustration on the part of participants in the paper-based group, their ratings for the tutorial were lower than those of their counterparts in the computer-based group. For example the mean rating score for recommending the tutorial to new inexperienced underground rockbolters was only 6.8 for the paper-based group, while it was 8.6 for the computer-based group (Figure 4.12).

## **5.5 EVALUATION OF PHYSICAL COMPONENTS OF THE SIMULATOR**

**5.5.1. Discussion of Participants' Subjective Ratings and Responses.** The ratings of the Likert-scale items by the experimental group revealed important issues, and notably among them were ratings of scaling of loose rock (rated 1.8 out of 5.0) and collaring of hole (rated 1.6 out of 5.0). Fixing the rockbolt dolly (rated 2.8 out of 5.0) and insertion of drill steel (rated 3.0 out of 5.0) also need to be considered. These ratings were further confirmed by the participants' responses to the open ended question on suggestions regarding the improvement of the simulator, as summarized in the following paragraphs.

Five major themes were derived from the participants' responses to the open ended question, as provided below.

1. Scaling in the blue room environment was perceived to be unrealistic.

- *Participant 1: The scaling part in the blue room was nothing close to what I did at the experimental mine.*
- *Participant 2: The scaling part must be improved.*

- *Participant 3: Scaling in the blue room was funny. Maybe some modification is necessary.*
- *Participant 4: I did not like the way scaling was being done in the blue room.*
- *Participant 5: I will only recommend the simulator if the scaling is improved.*

2. The blue room size and appearance are not realistic.

- *Participant 1: The blue room was too small and not realistic.*
- *Participant 3: The blue room was too neat, as compared to the actual mine.*
- *Participant 4: Not enough space to maneuver. I had a lot of space in the mine.*
- *Participant 5: You can spread some rock pieces on the floor of the blue room to make it more realistic.*

3. There was no simulation of collaring a hole in the blue room.

- *Participant 2: There was nothing like collaring of hole in the blue room.*

4. Simulation of flushing debris from the hole was suggested.

- *Participant 2: Simulation of flushing out cuttings from the hole will be great.*
- *A lot of hoses in the blue room without a water hose, which is important.*

5. Insertion of drill steel into the chuck of the drill was perceived to be unnecessarily too long.

- *Participant 3: Insertion of drill steel was too long, as compared to what I did in the actual mine.*

**5.5.2. Discussion of Participants' Performance.** It is obvious from the mean scores of the performance data that participants in the experimental group had a problem with scaling of loose rock, as compared to their counterparts in the control group (see Tables 4.8 through 4.11). They made some errors and succeeded a little slowly, as

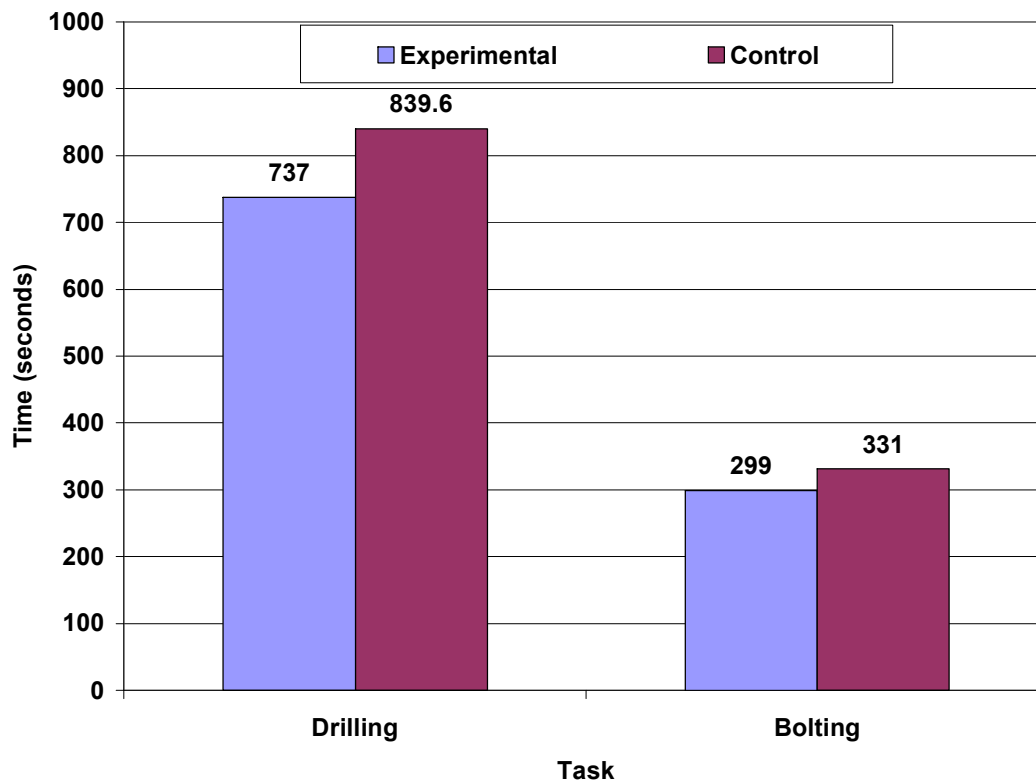
compared to the control group members, who made a few errors and succeeded more quickly. Additionally, participants in the experimental group performed poorly on collaring the hole. While participants in the control group performed this task quickly without making a lot of errors, experimental group members struggled with the hole collaring at a slow rate.

These observations support the earlier comments provided by the participants in the experimental group. However, comments on insertion of the drill steel did not reflect on the performance of the experimental group. They inserted the drill steel quickly without errors, and this might be due to the simplistic nature of this task, as compared with collaring a hole and scaling of loose rock.

One other important information obtained from the performance data was the difficulty associated with rockbolt installation. The bolt installation part was supposed to be one of the simplest tasks, but most of the participants in both groups had a problem with aligning the drill normal to the face, which might either be due to non-experience and/ or the weight of the drill.

In order to have an idea about how long it took the participants to complete each job step, the individual tasks were timed and the average total time computed for each group, as shown in Figure 5.3 for drilling and bolting (see details in Appendix C3). It was not possible to quantify the scaling task because scaling depends on conditions at the face.





**Figure 5.3. Average Drilling and Bolting Times as a Function of Participant Group.**

It can be deduced from Figure 5.3 that the average time spent on drilling by the control group was 14 minutes, while the experimental group spent 12.3 minutes. The respective bolting times were 5.5 minutes for control and 5.0 minutes for the experimental group. It is important to note that these time measurements are not directly related to the qualitative time measurement data collected because a participant could complete a task within a short period, but with assistance of a supervisor.

## **6. CONCLUSIONS AND RECOMMENDATIONS FOR FUTURE WORK**

### **6.1 CONCLUSIONS**

This study has important implications for both the design and use of training devices. The usability tests and the comparative experiment performed are basic experiments within the development cycle. Therefore, the principal purpose of this formative study was to guide further development. Statistical results and user comments from the evaluation of the Web tutorial, suggested that a task must be sufficiently complex (e.g., drilling and bolting, but not scaling) in order to render the traditional paper-based method less effective than computer-based method. Additionally, participants in the experimental group performed comparatively well when the physical components of the virtual reality computer simulation were evaluated. The outcome of the experiments indicated that promising results will be obtained if the VR system is fully developed and evaluated. However, one major limitation with the proposed VR system is that a participant will not be able to refer to any form of task procedure (for example, text material, video, etc) in the virtual environment. This means that any mistake made can only be corrected by the trainer, without giving opportunity to the participant to retry any forgotten step.

Virtual reality type of training seems to be the solution to the improvement of health and safety of underground rock bolters. Fatalities and injuries in underground mines cannot be prevented by addressing events that caused them retrospectively. It is time to prevent the accident from happening by providing miners with effective high-fidelity training to make new miners aware of hazards they will face prior to entering the

real mining environment. The flexibility of MinerSIM (if fully developed) will allow it to be configured quickly and produced relatively cheap. In addition, apart from the provision of a blue-room, the training system will run on standard desktop personal computers; therefore, there is no need to buy any special equipment to run the system.

The ability of computers to create synthetic representations of the real world in virtual reality offers a number of opportunities to enhance current rock-bolting training. It is evident that the training system would allow users to learn within computer-generated environments, giving them an opportunity to make mistakes and suffer the consequences without putting themselves at risk.

Since there is no virtual reality training technology for underground rock bolters using a jackleg drill, this research, is an original research to both mining industry and academia. With the emerging problem of shortage of mine workers (including underground rockbolters) due to the aging mining workforce, any forward-looking mining industry will embrace the proposed training program on safety and cost effective basis. It is important to point out that some mining training centers and educational institutions have already started using the online tutorial, and look forward to using the virtual reality computer simulator when fully developed. The companies/training centers and educational institutions which used (or are using) the Web tutorial are:

- Turquoise Ridge Miner Training Academy, Nevada
- Doe Run Mine (provided on a CD)
- Parts HeadQuarters Inc. used it for writing a training manual for INCO
- Atlas Copco (provided on a CD)
- Missouri S&T Experimental Mine (provided on a CD)

- Colorado School of Mines Edgar Mine
- University of Utah Mining Department
- Mackay School of Mines (provided on a CD)
- Masco Minerals Inc of British Columbia wrote their bolting and scaling procedures for their underground quarries based on the material provided on the website
- West Virginia Labor Training Center uses it to train new miners

One other important conclusion from the experiments, especially the usability tests/comparative experiment is that the payment method used as an incentive in recruiting participants in this study was more effective than the course work credit-exchange method used in other usability studies performed in the past. Some of the experimenters in this study confirmed that participant turn-out was not encouraging in most of the past usability tests in which the latter method was used. It is, therefore, recommended that the payment method be considered, if budget allows and it can be effectively implemented.

## **6.2 RECOMMENDATIONS FOR FUTURE WORK**

The following recommendations are offered based on the experimental results.

- More videos need to be included in the tutorial, especially on explanation of the technical terms associated with jackleg drilling and rockbolt installation.

- When the tutorial is being used in the mine, some form of practical session needs to be incorporated after each section of the tutorial. Also, an instructor must be available to answer any questions the users may have.
- It is recommended that the tutorial is used as an introductory lesson to some form of hands-on practice, e.g., the proposed augmented virtual reality training for underground rockbolters.
- Some of the photographs in the tutorial should be replaced using a better quality photos taken by professional photographers.
- When the final prototype is ready for distribution, a suitable jackleg drill with a muffler should be used in order to meet MSHA requirements.
- Inclusion of hole collaring in the VR simulation is recommended to make it more realistic.
- The scaling part of the VR system needs to be modified or changed completely in order to be more realistic. The evaluation results including participants' comments have already been provided to the software development team to be considered in the development of the VR software.

Additionally, any future related studies should involve the development of virtual reality simulators for other dangerous underground mining jobs including mine rescue, drilling and blasting, mucking, and material handling. Also, another usability test needs to be performed on the Web tutorial using different group of participants to ensure that the problems addressed after conducting the second usability test (i.e., the usability test with the Morae recoding device) have improved the effectiveness of the tutorial. For

example, responses to the “fill -the-blank” questions need to be examined if they require any form of further modification.

**APPENDIX A**

**THE DEVELOPMENT OF THE WEB TUTORIAL**

## APPENDIX A1

### GENERATION OF 3-DIMENSIONAL OBJECTS AND ADDITION OF ANIMATIONS

#### Appendix A1.1. Generation of 3D Objects Using Swift 3D.

Swift 3D comes equipped with a handful of tools including 3D primitives or objects that serve as the fundamental building blocks for modeling and standard cameras that serve as windows into the scene. Figure A1.1 shows the Scene Editor of the Swift 3D program.

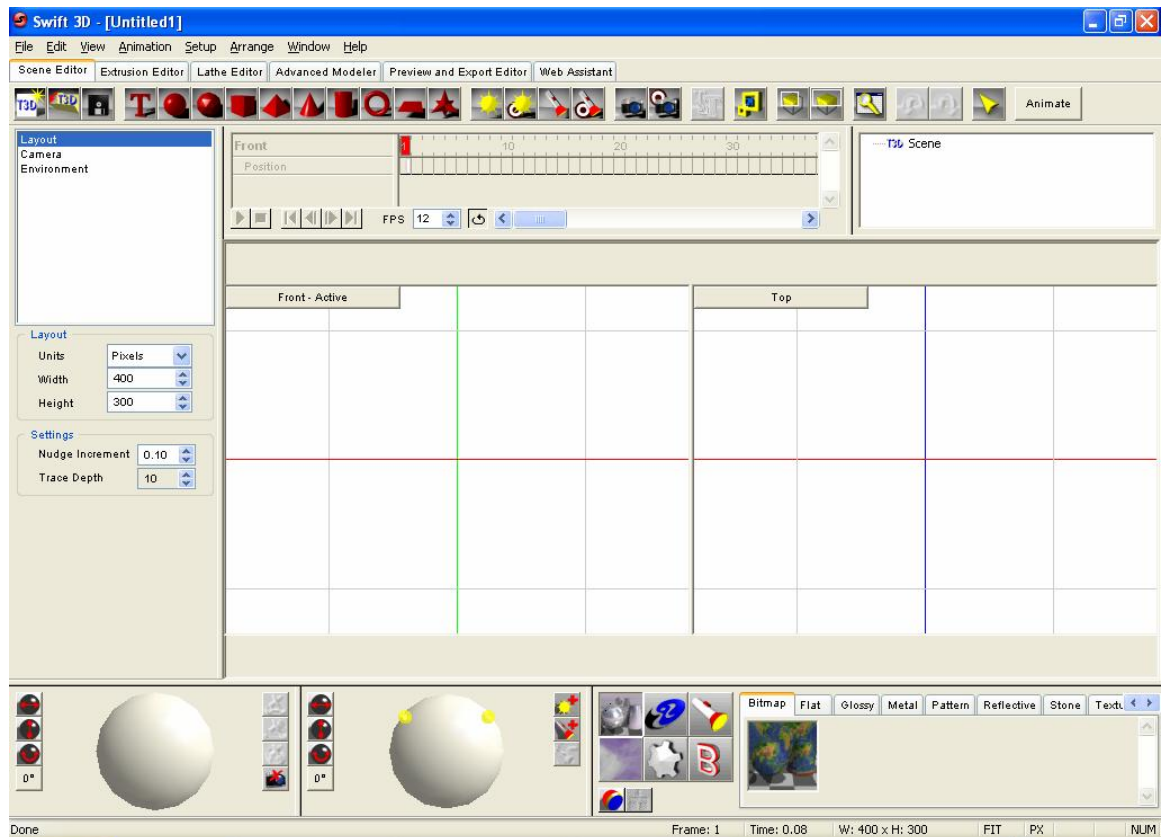


Figure A1.1. Scene Editor of Swift 3D Version 4.5.



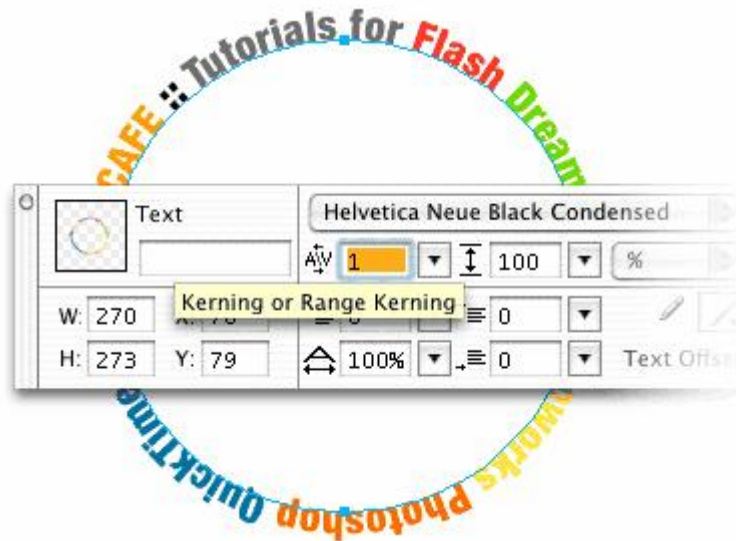
Generation of 3D objects in the Swift program was accomplished by using the following steps:

1. Simple models were built from a variety of primitive shapes such as boxes, spheres, and cones, which were modified and assembled into more complex models.
2. The models were colored using material supplied from Swift 3D's galleries and edited as desired to create optimal visual impact objects.
3. Lights, scene cameras, and animation were applied to create visual effects of the 3D scene.
4. The model was raster rendered and then exported in SWF file format into Flash's timeline. SWF file format provides an excellent transfer of Swift 3D models into Macromedia Flash.

## Appendix A1.2. Generation of 3D Text Objects Using Macromedia Fireworks.

The following steps taken largely from the Macromedia Fireworks tutorial, were used to generate 3D objects for animation in Flash:

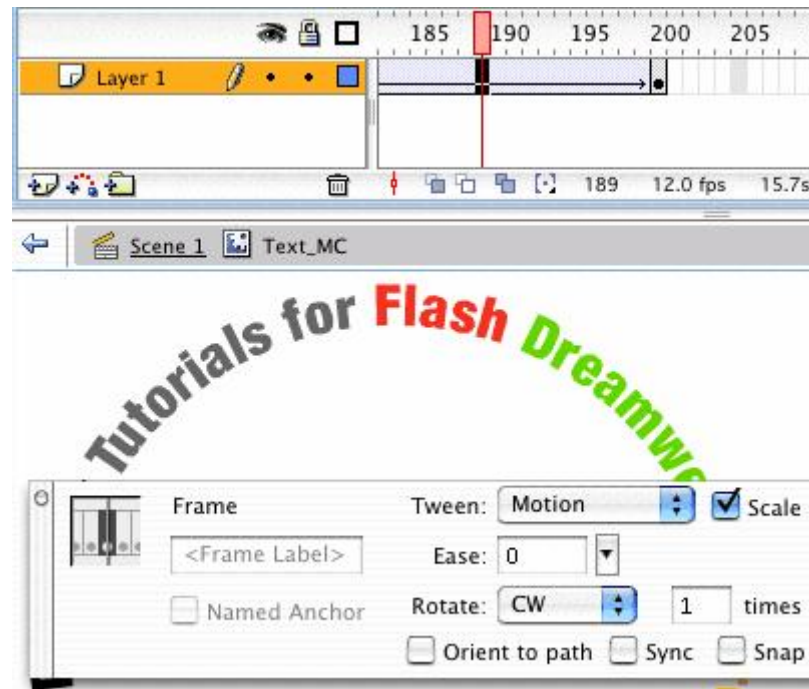
1. Text was typed out as a group of words.
2. The ellipse tool was selected and used to create a perfect circle by holding down the Shift key.
3. Both the text and the circle were selected using the Pointer tool to drag a selection around parts of each object.
4. With both the text and the path (circle) selected, the “Text > Attach to path” command was used to wrap the text around the circle.
5. Spacing between the words was adjusted by using the “Kerning” feature shown in Figure A1.2.



**Figure A1.2.** The Use of the Kerning Feature in Macromedia Fireworks.

6. The “Quick Export” button at the top right corner of Fireworks document was clicked and “Macromedia Flash > Export swf” was selected to export the SWF file to Flash.
7. After exporting to Flash, all the objects on the Flash’s stage were selected and converted to graphic symbols and then to a movie clip.

- To create the rotating animation, a keyframe was inserted at Frame 200 by dragging the Playhead to Frame 200 and pressing F6 at Frame 200. Clicking anywhere in the Timeline between Frame 1 and Frame 200 and setting the Tween to Motion rotates the text in either clockwise or counter-clockwise direction depending on the option selected. Figure A1.3 shows “Tween to Motion” selection in Flash.



**Figure A1.3.** Animation of Fireworks Model in Flash.

### **Appendix A1.3. Animation of Photographs.**

Animation of two photographs involved converting the photos into graphic symbols before animating them as described in the following steps:

1. Photographs were imported and put each on its own layer.
2. Each photograph was converted into a graphic symbol (Modify > Convert to Symbol).
3. The desired frame number in the lower photograph's layer was clicked and Insert > Timeline > Frame was selected.
4. The same action was performed for the upper photograph's layer, but a keyframe was added instead of a regular frame (Insert > Timeline > Keyframe).
5. The second keyframe of the upper photograph was selected and the Alpha color was set to zero.
6. A motion tween was created by clicking anywhere between the two keyframes and selecting "Motion" in the Property Inspector. This action animates the photographs such that upper photograph dissolves into the lower one.

#### **Appendix A1.4: Addition of Transition Behavior to Screens.**

Transition behavior was added to each screen using the following steps:

1. The screen to apply the behavior was selected.
2. In the Behaviors panel, the “Add (+)” button was clicked.
3. Screen > Transition was selected from the submenu.
4. In the Transition dialog box, a transition from the scroll list was selected.

An animated preview of the transition played in the preview window, and a brief description of the transition appeared in the description field. The animation then changed to reflect options that were selected for the transition described in the following steps.

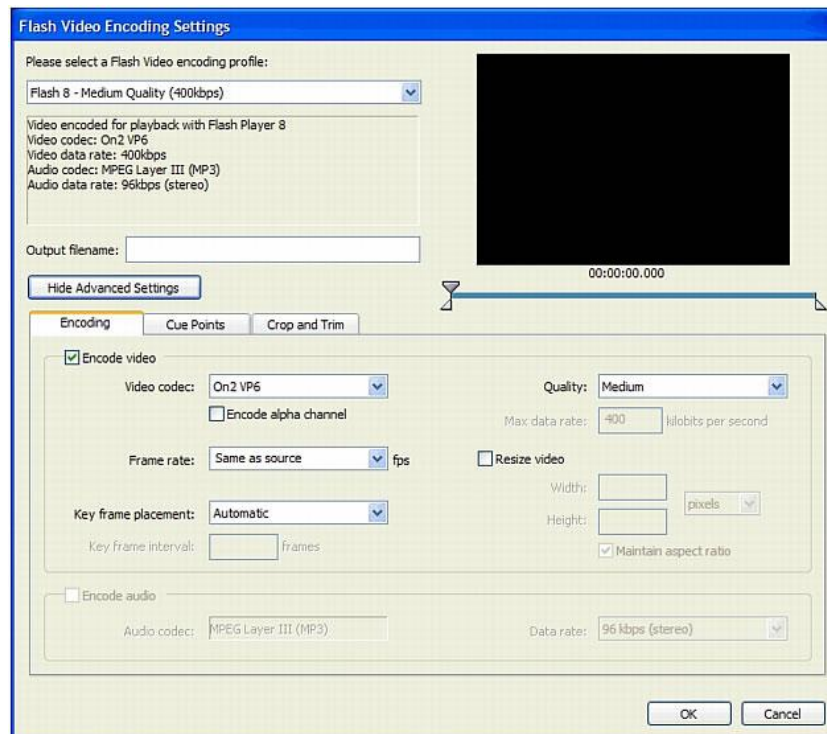
5. For direction, “In to play the transition as the screen appears in the document”, and “Out to play the transition as the screen disappears from the document” were selected.
6. For duration, a suitable time in seconds was entered depending on the rate at which a screen was supposed to transition.
7. For easing, the option of defining the transition style was selected and the “OK” button was clicked.
8. In the event column of the behaviors panel, the row for the new behavior and an event from the list were selected. This action specifies the event that triggers the behavior, such as the mouse pointer moving over the screen.

## APPENDIX A2

### ENCODING A VIDEO FILE

The first action performed in encoding a video file was to convert the Windows Media audio/video file (WMV) to Flash video file (FLV) using the following steps:

1. The Flash Video Encoder application was started.
2. The WMV file was dragged from its folder onto the Flash Video Encoder application window.
3. “Settings” was clicked in the Flash Video Encoder application window and video quality was set to “medium” in the Flash Video Encoding Settings dialog box. This action applies some amount of compression to the file.
4. The video codec was set to ON2 VP6 and an appropriate frame rate and keyframe placement were selected, as shown in Figure A2.1.



**Figure A2.1.** Flash Video Encoding Settings.

5. “OK” and “Start Queue” buttons allowed the Flash Video Encoder to convert the WMV file to FLV file and saved it in the same folder as the original WMV file.

The next step was to add a media playback component to the Flash document’s stage. This component contains the video display and provides playback controls. Components in Flash are pre-built objects that are used in Flash documents. Most components are user interface elements such as buttons and menus. Some are not meant to be seen on the stage and are used instead to perform data-handling functions. Using a component eliminates the need to build complex user interface elements. Components are implemented in Flash as movie clips with their own internal Action Script code. The components panel is used to set the properties of the component. This tells Flash how the component should behave. For the FLV playback component, Flash locates the FLV file to be played and determines how the playback controls appear.

The following procedure was used to add a media component to each video:

1. Window > Components was selected to open the components panel.
2. In the components panel, the plus sign (+) next to the FLV Playback - Player 8 category was clicked.
3. An FLV playback component was dragged onto the stage and its location was set.
4. With the new component still selected on the stage, “Window > Component” was selected to open the Component Inspector.
5. In the component inspector's parameters tab, the content path parameter was used to input the name of the FLV file and the “autoplay” parameter was set to “false”.
6. To prevent the video from playing automatically when a screen is revealed, the code below was placed on the action panel of each screen holding a video:

```
//----- Code placed on screen  
on(reveal){  
    display.seek(0);  
    display.play();  
}  
on(hide){  
    display.stop();  
}  
//-----
```

The above code allows the video to play only if the screen (named “display”) holding it is revealed. The video stops playing when the screen is hidden. Screens are a stack of movie clip symbols in Flash that simultaneously load to frame one. The video component is set to play by default, so it plays when the movie loads. The above code was used to turn the movie off.



## APPENDIX A3

### ADDITION OF AN INTERACTION TO A QUIZ

The following procedure was followed to add an interaction to each quiz in the online tutorial.

1. In the first layer of the Timeline, the frame that precedes the frame number in which the interaction was to be added was selected.
2. The same frame number was shift-clicked on the other layers to select those frames.
3. A selected frame was right-clicked and then “Insert Frames” was selected to extend the timeline evenly across all layers, as shown in Figure A3.1.



**Figure A3.1.** Extension of Timeline across Layers in a Flash Document.

4. On the Interactions layer, the added frame was selected, followed by clicking Insert > Timeline > Blank Keyframe.

5. To add an interaction, the following actions were performed:
  - a. The desired interaction movie clip type was dragged from the Learning Interactions Library (Window > Common Libraries > Learning Interactions) to the blank keyframe. The assets and parameters were edited by breaking the interaction apart (i.e., Interaction>Modify>Break Apart).
  - b. Copying and pasting an interaction that already exists in the Timeline involved right-clicking the keyframe with the interaction and selecting “Copy Frames”. The copied frame was pasted in the blank keyframe that was inserted in step 3. In this copy of the interaction, objects on the stage were modified and the settings in the Component Inspector were adjusted, as desired.

**APPENDIX B**  
**EVALUATION OF THE WEB TUTORIAL**

**APPENDIX B1****A LETTER PREPARED FOR ROCK BOLTING EXPERTS**

Missouri University of Science & Technology  
227 McNutt Hall  
Rolla, MO 65409

Date.....

Company name and address [here]

Dear Sir or Madam:

**Request for Evaluation of an Online Tutorial on Underground Rock Bolting**

My name is David Nutakor, and I am a research assistant at the Mining Engineering Department of the Missouri University of Science & Technology. We are developing a simulator (MinerSIM) for new underground rock bolters using a jackleg drill, and we would appreciate your comments on the first part of the simulator which has just been completed.

Mining records indicate that your company uses a jackleg drill for bolting. It would be helpful if you or any other appropriate person in your organization could complete the attached 10 survey questions after going through the online tutorial which can be found at [http://web.umar.edu/~dn5f9/Jackleg\\_Drilling/index.html](http://web.umar.edu/~dn5f9/Jackleg_Drilling/index.html). Your responses are important for this study because apart from telling us how to improve on this tutorial, we will also know any new online tutorials to develop to assist your company with its training of new miners.

The survey should take about three to five minutes to complete (not including the time spent on going through the online tutorial itself). Your responses will be treated confidential and we will make sure neither individuals nor organizations will be identified. The entire survey results of randomly selected underground mines in the US will be combined and reported as a group data in the final report of this study. We can send you a copy of the final report, if interested.

In case you have any questions or need any further clarification of either the survey questions or the online tutorial, do not hesitate to call David Nutakor at 573-341-7647 or 573-426-5930.

Sincerely,

David Nutakor  
Missouri University of Science & Technology  
227 McNutt Hall  
Rolla, MO 65409  
Tel: 573-341-7647/573-426-5930  
Fax: 573-341-6934  
E-mail: [dn5f9@mst.edu](mailto:dn5f9@mst.edu)

## APPENDIX B2

### SURVEY QUESTIONS PREPARED FOR ROCK BOLTING EXPERTS

**Marking Instructions:** Please fill the gaps where applicable. To indicate your response to a question, please change the **color** of your choice or underline it.

1. Please state your job title\_\_\_\_\_
2. What is your company's average number of employees?\_\_\_\_\_
3. Which method do you currently use to train your rock bolting crew? (underline all that apply)
  - (a) Hands-on training using older experienced miners to teach new miners
  - (b) Classroom training using stories, lecture notes, photographs, and videotapes
  - (c) Simulators
  - (d) Other (please list)\_\_\_\_\_
4. Have you ever used or ever wanted to use an online tutorial to train your new miners?
  - (a) Yes
  - (b) No
5. Which of the sections of our online tutorial did you look at? (underline all that apply)
  - (a) Scaling
  - (b) Jackleg Drilling
  - (c) Rockbolt Installation
  - (d) All
6. How easy it is to get around in the web site, as compared with other web sites that you use?
  - (a) Faster
  - (b) Slower
7. From your experience, how comprehensively is each section covered?
  - (a) Well covered
  - (b) Fairly covered
  - (c) Not well covered
8. Rate how well the practice questions are related to the information provided.
  - (a) Outstanding
  - (b) Very good
  - (c) Good
  - (d) Fair
  - (e) Poor
9. Which of the following aspects of the tutorial do you like most?
  - (a) Videos
  - (b) Text
  - (c) Photographs
  - (d) Animations
  - (e) None

10. Compared to other training materials (like videotapes, lecture notes, overheads, printed materials), how useful is this online tutorial in training a new miner prior to going underground?

- (a) More useful                      (b) Less useful                      (c) As useful as other materials

11. Will you recommend using this online tutorial for training new underground rock bolters in your company?

- (a) Yes                                      (b) No                                      (c) No comment

12. Would you like us to send you a copy of the summary report for this study?

- (a) Yes                                      (b) No

13. May we contact you later to see how others (especially, new miners) responded to our survey?

- (a) Yes                                      (b) No

14. If "Yes," please provide us with your e-mail address. \_\_\_\_\_

15. Please provide us with any other comments you think could help us improve on our online tutorial \_\_\_\_\_

**APPENDIX B3**  
**INFORMED CONSENT FORM**

Date: \_\_\_\_\_

**Research Project:** Virtual Reality-Based Training of New Underground Rock Bolters

**Purpose**

This project will capture the expert knowledge and judgments of rock bolters in an interactive way to validate training content before incorporation in an inexpensive virtual-reality training tool that will be designed to immerse rock-bolter trainees in a real-life work environment. In that environment the miners will be exposed to the dangers of rock bolting in a virtual way, thereby gaining experience in complicated situations and developing expert judgments in an accelerated way. By using this tool, the learning curves for these miners will be greatly reduced, and they will avoid real danger and possible serious injury.

**Procedures to be Followed**

In this research you will use an online tutorial developed on underground rock bolting, after which you will be provided with a series of questions on the overall effectiveness of the tutorial as a training medium. Your evaluation of the online tutorial will help investigators on the aspects to consider during re-design stage.

After using the online tutorial, you will be taken through underground rock bolt installation training using a virtual reality computer simulation. You will wear a virtual-reality, head-mounted display to undergo training through simulation of complex rock bolting tasks. You will be virtually exposed to changing physical conditions and hazardous work situations, and in a task sense, will be responding to the situations using



your best judgment. Your judgment responses will be critical to making the model robust in detail and in validating it for future use. The model itself will be experimental in nature, and a work in progress, but it will be refined through your input to be a good training tool for inexperienced rock bolters and new miners.

### **Reasonably Foreseeable Risks or Discomforts**

The risk in participating in this research is low relative to physical or psychological harm. You will be responding to real-world scenarios and dangers faced by rock bolters, but you will realize them only through a virtual environment. You may become emotionally involved in the scenarios during training/testing, but you should not realize psychological or physical discomfort. If, for some reason, you feel discomforted, then you may stop the testing/training session at any time.

### **Confidentiality Preserved**

Your participation will be kept confidential, known only to the investigator who will allow you to participate on a voluntary basis. Although we are very grateful to you for testing, validating, and/or using the virtual reality model, we will not reveal your identity or role in the project to anyone, unless you specifically request that we do in writing.

### **Notes**

Participation is voluntary, refusal to participate will involve no penalty or loss of benefits to which you are otherwise entitled, and you may discontinue participation at any time without penalty or loss of benefits, to which you are otherwise entitled.

For additional information regarding human participation in research, please feel free to contact the Missouri S&T Campus IRB Office at (573) 341-4305.

It is not the policy of the University to compensate human subjects in the event the research results in injury. The University does have medical, professional and general liability self-insurance coverage for any injury caused by the negligence of its faculty and staff. Within the limitations of the laws of the State of Missouri, the University will also provide facilities and medical attention to subjects who suffer injuries while participating in the research projects of the University. In the event you have suffered injury as the result of participating in this research program, you are to contact the Risk Management Officer at (573) 882-3735 who can review the matter and provide further information. This statement is not to be construed as an admission of liability.

If you should have any questions about this research project, please feel free to contact Dr. Derek Apel, Missouri S&T at 573-341-4838.

### **Agreement**

After reading the information above, and discussing it with a co-investigator, I agree to undergo training by the model. I am 18 years old or older, and have not used a jackleg drill before.

---

Participant

---

Date

---

Investigator

---

Date

**APPENDIX B4****INFORMED CONSENT FORM****Usability Testing of Online Tutorial on Underground Rockbolting**

In this experiment you will learn about underground rockbolting by going through the three sections (scaling, jackleg drilling, and rockbolt installation) of the online tutorial after which you are required to answer a few questions under each section. The experiment will take approximately three hours to complete, and you will be given a questionnaire to fill after the experiment. The experimenter will provide you with a brief overview including details of the task you are required to perform. While you are working, the experimenter will videotape your actions as well as take notes of any observations made. It is important to note that the purpose of this study is to test the interface of the system, not you.

I \_\_\_\_\_ have read the above statement regarding the nature of this experiment and give the researchers permission to use data collected during this experiment for publication and presentation, recognizing that my name will never be associated with these data in scoring, publishing, or presenting. I also understand that I am free to withdraw from this experiment at any time.

Signed

\_\_\_\_\_

Name (Printed) \_\_\_\_\_

Student Number \_\_\_\_\_

## APPENDIX B5

### PARTICIPANTS' SUBJECTIVE RESPONSES TO THE SECOND USABILITY TEST QUESTIONNAIRE

Use the following scale to respond to the statements below

Strongly disagree 1 ... 2 ... 3 ... 4 ... 5 ... 6 ... 7 ... 8 ... 9 ... 10 strongly agree

#### Participant 1

##### Entry statements (En)

  5   1) I am very experienced with computers and the internet.  
Explain:

  4   2) I have a great deal of experience with online tutorials.  
Explain:

##### Exit statements (Ex)

  9   1) The pages downloaded quickly  
Explain:

  8   2) The quality of the videos was very good.  
Explain:

  8   3) The visual appearance of the site was very good.  
Explain:

 10  4) The site was easy to navigate.  
Explain:

 10  5) Each task was covered comprehensively.  
Explain:

  8   6) I found the practice questions to be strongly related to the information provided.

Explain:

  10   7) The tutorial is an effective learning tool.

Explain:

  8   8) I learned a great deal from the tutorial.

Explain:

### **I also learned from the hands-on experience**

  10   9) The tutorial was motivational, in comparison to other methods of learning.

Explain:

  10   10) The tutorial did a good job of letting me know what I did and did not know about the subject.

Explain:

  8   11) The videos were the most effective component of the tutorials.

Explain:

### **They helped**

  8   12) The text materials were the most effective component of the tutorials.

Explain:

### **But the videos helped to reinforce the training material**

  8   13) The photographs were the most effective component of the tutorials.

Explain:

  10   14) I would recommend this tutorial for training new inexperienced miners.

Explain:

### **It is good if used with hands-on and with face-to-face teaching as well.**

### **Open ended question**

Please provide us with any further comments that could aid us in improving our online tutorial.

### **The fill-the-blank questions are vague and can be misinterpreted.**

## Participant 2

**Entry statements (En)**

  8   1) I am very experienced with computers and the internet.

Explain:

**I have experience to get around pretty well.**

  3   2) I have a great deal of experience with online tutorials.

Explain:

**I haven't really done a whole lot.**

**Exit statements (Ex)**

  5   1) The pages downloaded quickly

Explain:

**Slow on internet explorer, but fast on firefox.**

  7   2) The quality of the videos was very good.

Explain:

**A little bit dark sometime.**

 10  3) The visual appearance of the site was very good.

Explain:

**Sweet and easy to operate.**

 10  4) The site was easy to navigate.

Explain:

**Very self-explanatory.**

 10  5) Each task was covered comprehensively.

Explain:

**Questions covered everything.**

  9   6) I found the practice questions to be strongly related to the information provided.

Explain:

**Almost everything is covered with wording changes a little bit.**

10   7) The tutorial is an effective learning tool.  
Explain:

**Gives a lot of information and shows how it is put into use in real life in the videos.**

  6   8) I learned a great deal from the tutorial.  
Explain:

**I learned a lot the first time, with improvement during the second time.**

  10   9) The tutorial was motivational, in comparison to other methods of learning.  
Explain:

**Much better than the paper version.**

  3   10) The tutorial did a good job of letting me know what I did and did not know about the subject.  
Explain:

**It let me know what I missed, but does not provide the answer immediately.**

  5   11) The videos were the most effective component of the tutorials.  
Explain:

**The videos were very helpful, would not make sense without the text.**

  7   12) The text materials were the most effective component of the tutorials.  
Explain:

**Gave more information than the videos, but the videos were able to put it into context.**

  8   13) The photographs were the most effective component of the tutorials.  
Explain:

**They were helpful to identify forces and parts of the jackleg drill. However, they are not good without the text.**

  10   14) I would recommend this tutorial for training new inexperienced miners.  
Explain:

**It gives a very good basic understanding of the safety procedures.**

### Open ended question

Please provide us with any further comments that could aid us in improving our online tutorial.

**Providing the correct answer is more compatible with internet explorer. Also, “type-in” answers must be modified to include other correct answers.**

### Participant 3

#### Entry statements (En)

  10   1) I am very experienced with computers and the internet.  
Explain:

**I am good with computers and the internet.**

  8   2) I have a great deal of experience with online tutorials.  
Explain:

**I have taken a few.**

#### Exit statements (Ex)

  10   1) The pages downloaded quickly  
Explain:

**They were quick.**

  10   2) The quality of the videos was very good.  
Explain:

**The frame rate was good.**

  9   3) The visual appearance of the site was very good.  
Explain:

**It was pretty good.**

  10   4) The site was easy to navigate.  
Explain:

**Not very much buttons, so you cannot get lost.**

  10   5) Each task was covered comprehensively.  
Explain:



**Everything was covered well.**

  10   6) I found the practice questions to be strongly related to the information provided.

Explain:

**They followed well.**

  10   7) The tutorial is an effective learning tool.

Explain:

**Yes, it is.**

  8   8) I learned a great deal from the tutorial.

Explain:

**I already knew some of that stuff from previous experience.**

  10   9) The tutorial was motivational, in comparison to other methods of learning.

Explain:

**I love it because I like computers and videos.**

  9   10) The tutorial did a good job of letting me know what I did and did not know about the subject.

Explain:

**Yes, it did.**

  10   11) The videos were the most effective component of the tutorials.

Explain:

**I like videos in natural life.**

  7   12) The text materials were the most effective component of the tutorials.

Explain:

**I do not like reading much.**

  9   13) The photographs were the most effective component of the tutorials.

Explain:

**Not as good as video, but got the point across.**

  10   14) I would recommend this tutorial for training new inexperienced miners.

Explain:

**I would definitely recommend it.**

### **Open ended question**

Please provide us with any further comments that could aid us in improving our online tutorial.

**The fill–the–blank questions should have all the possible answers. Could they also be shorter?**

## Participant 4

### **Entry statements (En)**

  10   1) I am very experienced with computers and the internet.  
Explain:

**I used it everyday.**

  6   2) I have a great deal of experience with online tutorials.  
Explain:

**I rarely use them.**

### **Exit statements (Ex)**

  9   1) The pages downloaded quickly  
Explain:

**I did not have to wait at all.**

  10   2) The quality of the videos was very good.  
Explain:

**I was able to see the videos clearly.**

  8   3) The visual appearance of the site was very good.  
Explain:

**I could see them clearly, but it was a little bit boring.**

  9   4) The site was easy to navigate.  
Explain:

**But maybe having the back button at the bottom instead of top would be more convenient.**

  8   5) Each task was covered comprehensively.  
Explain:

  9   6) I found the practice questions to be strongly related to the information provided.  
Explain:

  9   7) The tutorial is an effective learning tool.  
Explain:

**It is good for students to see the real work area from the videos.**

  8   8) I learned a great deal from the tutorial.  
Explain:

**I didn't do well on the quiz because it was difficult to concentrate on three different topics at the first time.**

  8   9) The tutorial was motivational, in comparison to other methods of learning.  
Explain:

**Yes, it was very helpful.**

  7   10) The tutorial did a good job of letting me know what I did and did not know about the subject.  
Explain:

**It would have been better if a reason is given for choosing a wrong answer.**

 10   11) The videos were the most effective component of the tutorials.  
Explain:

**I learned a lot from the videos, as compared to the text.**

  5   12) The text materials were the most effective component of the tutorials.  
Explain:

**The text was very boring.**

  8   13) The photographs were the most effective component of the tutorials.  
Explain:

**It would have been better if the photographs were placed on each slide that explains the parts of the equipment. I did not like the idea of scrolling back to look at the photographs in order to follow the part being explained.**

  10   14) I would recommend this tutorial for training new inexperienced miners.  
Explain:

**This is helpful in giving the general idea about how mining looks like and the precautions one needs to take when working in underground.**

**Open ended question**

Please provide us with any further comments that could aid us in improving our online tutorial.

**Maybe animating the photographs would look great for the tutorial, rather than making the photographs static.**

## Participant 5

**Entry statements (En)**

  9   1) I am very experienced with computers and the internet.  
Explain:

**I constantly use computer programs such as Microsoft products, Matlab, etc.**

  9   2) I have a great deal of experience with online tutorials.  
Explain:

**I took numerous classes where online tutorials have been used to teach.**

**Exit statements (Ex)**

  10   1) The pages downloaded quickly  
Explain:

**The speed of delivery was good enough.**

  7   2) The quality of the videos was very good.  
Explain:

**Some of the videos did not zoom onto the major parts discussed in the videos.**

  9   3) The visual appearance of the site was very good.  
Explain:

**The font is large and clear, as well as easy to read.**

  9   4) The site was easy to navigate.

Explain:

**All links were clearly identified.**

  9   5) Each task was covered comprehensively.

Explain:

**I clearly understood almost all the concepts presented.**

  9   6) I found the practice questions to be strongly related to the information provided.

Explain:

**They were directly related.**

  9   7) The tutorial is an effective learning tool.

Explain:

**The tutorial will be of help to beginners.**

  8   8) I learned a great deal from the tutorial.

Explain:

**I feel onsite interaction will provide me with the remaining experience/knowledge required.**

  8   9) The tutorial was motivational, in comparison to other methods of learning.

Explain:

**It serves as a very good introduction and overview of scaling, drilling, and bolting concepts.**

 10  10) The tutorial did a good job of letting me know what I did and did not know about the subject.

Explain:

**I fully understood the new subjects introduced to me.**

  8   11) The videos were the most effective component of the tutorials.

Explain:

**The videos, though not all of them were clear, presented the real life scenario of the topics covered.**

8 12) The text materials were the most effective component of the tutorials.  
Explain:

**The message was clear and well presented in a very simple way. However, words like muck pile, bootlegs, etc need to be explained further.**

5 13) The photographs were the most effective component of the tutorials.  
Explain:

**The photographs were good, but I would have loved to see images on almost any slide that an equipment part is discussed.**

9 14) I would recommend this tutorial for training new inexperienced miners.  
Explain:

**This should serve as a proper introduction to inexperienced miners.**

### **Open ended question**

Please provide us with any further comments that could aid us in improving our online tutorial.

- **The videos on each page should start to play immediately the page is opened.**
- **Things like ‘gad’ discussed, but no picture provided.**
- **It is good to have pictures of unit parts on the corner of the screen if it is discussed. I constantly had to go back to the parts identification screen during later pages of the jackleg drilling module.**
- **Practice questions should include less of fill in the word questions, as different understanding can mean different right answers for the question.**
- **Something like “notches in throttle” under jackleg was discussed at length with no picture to indicate specific part under discussion.**

## Participant 6

### **Entry statements (En)**

9 1) I am very experienced with computers and the internet.  
Explain:

9 2) I have a great deal of experience with online tutorials.  
Explain:

**Knowledge from previous classes.**

**Exit statements (Ex)**

  9   1) The pages downloaded quickly  
Explain:

**One video took a little longer to download.**

 10  2) The quality of the videos was very good.  
Explain:

  9   3) The visual appearance of the site was very good.  
Explain:

  9   4) The site was easy to navigate.  
Explain:

**Yes, for the most part.**

  9   5) Each task was covered comprehensively.  
Explain:

  9   6) I found the practice questions to be strongly related to the information provided.  
Explain:

  9   7) The tutorial is an effective learning tool.  
Explain:

 10  8) I learned a great deal from the tutorial.  
Explain:

**I also took down notes.**

  5   9) The tutorial was motivational, in comparison to other methods of learning.  
Explain:

  7   10) The tutorial did a good job of letting me know what I did and did not know about the subject.  
Explain:

**It did not show me the correct answers to the questions I got wrong.**

  2   11) The videos were the most effective component of the tutorials.  
Explain:

**Videos were demonstration, I love the side notes.**

 10  12) The text materials were the most effective component of the tutorials.  
Explain:

  7   13) The photographs were the most effective component of the tutorials.  
Explain:

 10  14) I would recommend this tutorial for training new inexperienced miners.  
Explain:

### **Open ended question**

Please provide us with any further comments that could aid us in improving our online tutorial.

**It looks like some of the videos are not on the correct pages.**

## Participant 7

### **Entry statements (En)**

  9   1) I am very experienced with computers and the internet.  
Explain:

**I have been using it for several years.**

  6   2) I have a great deal of experience with online tutorials.  
Explain:

**I don't usually use online tutorial.**

### **Exit statements (Ex)**

 10  1) The pages downloaded quickly  
Explain:



**It was very fast.**

  10   2) The quality of the videos was very good.  
Explain:

**The videos were very good.**

  10   3) The visual appearance of the site was very good.  
Explain:

**Just great!**

  10   4) The site was easy to navigate.  
Explain:

**Yes, I totally agree.**

  10   5) Each task was covered comprehensively.  
Explain:

  10   6) I found the practice questions to be strongly related to the information provided.  
Explain:

  8   7) The tutorial is an effective learning tool.  
Explain:

  9   8) I learned a great deal from the tutorial.  
Explain:

**I learned a lot of stuff I have not heard of before.**

  9   9) The tutorial was motivational, in comparison to other methods of learning.  
Explain:

**It is better than reading the stuff from a book.**

  10   10) The tutorial did a good job of letting me know what I did and did not know about the subject.  
Explain:

  10   11) The videos were the most effective component of the tutorials.  
Explain:

**The videos are really good to actually see how the tools are used.**

  7   12) The text materials were the most effective component of the tutorials.  
Explain:

**Using text in tables may look better.**

  8   13) The photographs were the most effective component of the tutorials.  
Explain:

**Providing the photographs along side with the text would make the tutorial better.**

  9   14) I would recommend this tutorial for training new inexperienced miners.  
Explain:

**Absolutely.**

### **Open ended question**

Please provide us with any further comments that could aid us in improving our online tutorial.

**Having a photograph on the same page the parts are explained is one important thing to consider.**

## Participant 8

### **Entry statements (En)**

  10   1) I am very experienced with computers and the internet.  
Explain:

**I have my own laptop and usually use the computer for assignments.**

  5   2) I have a great deal of experience with online tutorials.  
Explain:

**I have experience, but not that much.**

### **Exit statements (Ex)**

  10   1) The pages downloaded quickly  
Explain:

**10**    2) The quality of the videos was very good.  
Explain:

   **5**    3) The visual appearance of the site was very good.  
Explain:

**I think there is a room for improvement.**

   **10**    4) The site was easy to navigate.  
Explain:

   **10**    5) Each task was covered comprehensively.  
Explain:

   **10**    6) I found the practice questions to be strongly related to the information provided.  
Explain:

   **9**    7) The tutorial is an effective learning tool.  
Explain:

**To have someone to ask things you do not understand will be great.**

   **9**    8) I learned a great deal from the tutorial.  
Explain:

   **8**    9) The tutorial was motivational, in comparison to other methods of learning.  
Explain:

**I would like to have someone on my side to ask questions if there is something I do not understand.**

   **9**    10) The tutorial did a good job of letting me know what I did and did not know about the subject.  
Explain:

   **10**    11) The videos were the most effective component of the tutorials.  
Explain:

   **3**    12) The text materials were the most effective component of the tutorials.  
Explain:

**Videos and photographs are better since people normally learn faster by seeing things in action.**

10   13) The photographs were the most effective component of the tutorials.  
Explain:

  8   14) I would recommend this tutorial for training new inexperienced miners.  
Explain:

**Photographs on more slides will be helpful.**

### Open ended question

Please provide us with any further comments that could aid us in improving our online tutorial.

**Some form of improvement with regard to putting photographs on more slides will be helpful.**

## Participant 9

### Entry statements (En)

  8   1) I am very experienced with computers and the internet.  
Explain:

**It is the basic for engineers to do research.**

  1   2) I have a great deal of experience with online tutorials.  
Explain:

**It is the first time for me to experience an online tutorial.**

### Exit statements (Ex)

  10   1) The pages downloaded quickly  
Explain:

  8   2) The quality of the videos was very good.  
Explain:

**The sound is perfect, but the background can be improved.**

  9   3) The visual appearance of the site was very good.  
Explain:

**It is true, but some contents were not emphasized.**

  10   4) The site was easy to navigate.

Explain:

  10   5) Each task was covered comprehensively.

Explain:

  10   6) I found the practice questions to be strongly related to the information provided.

Explain:

  10   7) The tutorial is an effective learning tool.

Explain:

  10   8) I learned a great deal from the tutorial.

Explain:

  10   9) The tutorial was motivational, in comparison to other methods of learning.

Explain:

  10   10) The tutorial did a good job of letting me know what I did and did not know about the subject.

Explain:

  10   11) The videos were the most effective component of the tutorials.

Explain:

  10   12) The text materials were the most effective component of the tutorials.

Explain:

**But the videos helped to reinforce the training material**

  8   13) The photographs were the most effective component of the tutorials.

Explain:

**It would be great if the photographs are arranged with the text material.**

  10   14) I would recommend this tutorial for training new inexperienced miners.

Explain:

**Open ended question**

Please provide us with any further comments that could aid us in improving our online tutorial.

**More photographs of the jackleg drill parts will work better for the tutorial.**

## Participant 10

### Entry statements (En)

  4   1) I am very experienced with computers and the internet.

Explain:

**I go on the internet everyday and use my laptop for work, but things like downloading stuff from the net, as well as computer hardware and software are new to me.**

  8   2) I have a great deal of experience with online tutorials.

Explain:

**Online tutorials are popular in all my classes.**

### Exit statements (Ex)

 10  1) The pages downloaded quickly

Explain:

 10  2) The quality of the videos was very good.

Explain:

  6   3) The visual appearance of the site was very good.

Explain:

**Could be improved**

 10  4) The site was easy to navigate.

Explain:

**Very easy to navigate.**

  5   5) Each task was covered comprehensively.

Explain:

**As I am new to mining, I do not know if each section was covered by the tutorial comprehensively.**

10   6) I found the practice questions to be strongly related to the information provided.

Explain:

**Yes, all questions were covered in the tutorials.**

  10   7) The tutorial is an effective learning tool.

Explain:

**Yes, I do know more about scaling, drilling and rock bolting now.**

  10   8) I learned a great deal from the tutorial.

Explain:

**I can also learn from the hands-on experience**

  6   9) The tutorial was motivational, in comparison to other methods of learning.

Explain:

**The tutorial was quite long, and there is a lot of information to absorb. Section 2, which was on jackleg drilling, was too technical and it could be a source of worry to new inexperienced miners.**

  10   10) The tutorial did a good job of letting me know what I did and did not know about the subject.

Explain:

**Yes, now I know the basic concepts. But I am still unsure about some of the components of the jackleg drill. However, I think I know how to use the equipment because it was well explained in the videos.**

  10   11) The videos were the most effective component of the tutorials.

Explain:

**The videos were VERY good and I believe I learned and understood most of the stuff through the videos.**

  1   12) The text materials were the most effective component of the tutorials.

Explain:

**Text materials, though very good, were very technical. For instance, where the components of the jackleg are described, it will be good to put photographs to support the description.**

  1   13) The photographs were the most effective component of the tutorials.

Explain:

**The videos were the most effective part of the tutorial. Some of the information in the photograph was not well understood without the videos.**

  10   14) I would recommend this tutorial for training new inexperienced miners.

Explain:

**Yes, this tutorial is good for providing basic concepts. But nothing beats real-life experience.**

### Open ended question

Please provide us with any further comments that could aid us in improving our online tutorial.

**Some of the sections were too technical. For example, slides which talk about components of the jackleg were very difficult to understand without having to go back to look at the picture.**

## Participant 11

### Entry statements (En)

  9   1) I am very experienced with computers and the internet.

Explain:

**I use them all the time.**

  5   2) I have a great deal of experience with online tutorials.

Explain:

### Exit statements (Ex)

  9   1) The pages downloaded quickly

Explain:

  9   2) The quality of the videos was very good.

Explain:

  7   3) The visual appearance of the site was very good.

Explain:



**A little blurred when it came to the text.**

  7   4) The site was easy to navigate.

Explain:

**The quiz part in which you need to click before you move on is annoying.**

  9   5) Each task was covered comprehensively.

Explain:

**Lacks a little on the whip checks.**

  9   6) I found the practice questions to be strongly related to the information provided.

Explain:

  9   7) The tutorial is an effective learning tool.

Explain:

**Yes, in terms of book information.**

  8   8) I learned a great deal from the tutorial.

Explain:

  8   9) The tutorial was motivational, in comparison to other methods of learning.

Explain:

**Maybe a little bit boring**

  9   10) The tutorial did a good job of letting me know what I did and did not know about the subject.

Explain:

  9   11) The videos were the most effective component of the tutorials.

Explain:

  5   12) The text materials were the most effective component of the tutorials.

Explain:

**It was boring to read. Also, there were many numbers you had to remember in order to perform well on the quiz.**

  6   13) The photographs were the most effective component of the tutorials.

Explain:

**Good explanation with the photographs.**

7 14) I would recommend this tutorial for training new inexperienced miners.  
Explain:

**But doing it in real world is better.****Open ended question**

Please provide us with any further comments that could aid us in improving our online tutorial.

**APPENDIX B6****INFORMED CONSENT FORM****Underground Rockbolting Comparative Study**

In this experiment you will learn about underground rockbolting by going through the three sections (scaling, jackleg drilling, and rockbolt installation) of the tutorial after which you are required to answer a few questions under each section. The experiment will take approximately three hours to complete. The experimenter will provide you with a brief overview including details of the task you are required to perform. While you are working, the experimenter may videotape or photograph your actions, as well as take notes of any observations made.

I \_\_\_\_\_ have read the above statement regarding the nature of this experiment and give the researchers permission to use any data collected during this experiment for publication and presentation, recognizing that my name will never be associated with these data in scoring, publishing, or presenting. I also understand that I am free to withdraw from this experiment at any time.

Signed \_\_\_\_\_

Date \_\_\_\_\_

Name (Printed) \_\_\_\_\_

Student Number \_\_\_\_\_

Age \_\_\_\_\_

Race \_\_\_\_\_

Gender \_\_\_\_\_

Department/Major \_\_\_\_\_

Level of Education \_\_\_\_\_

## APPENDIX B7

### EXPERIMENTAL INSTRUCTIONS ON THE COMPARATIVE STUDY

#### Purpose of study

The intent of this study is to compare the performance of two groups of participants (computer-based group and paper-based group), who are required to use a tutorial developed for new underground rock bolters to perform a task.

#### Tasks to be completed

The website for the tutorial will be open and set to the homepage. You are required to follow the steps listed below to complete your task.

- Read and fill out the consent form, if not already done.
- Click on **Scaling** and go through the content of the scaling section. Indicate the time taken to complete the tutorial on scaling in the table below.
- Click on **Jackleg Drilling** and go through the content of the jackleg drilling section. Indicate the time taken to complete the jackleg drilling section in the table below.
- Click on **Rockbolt Installation** and go through the content of the rockbolt installation section. Indicate the time taken to complete the tutorial on rockbolt installation in the table below.
- Go to the simulator room (room B36 McNutt) and take the identification test. You will also be provided with a questionnaire to complete. Please make sure you indicate the time taken to complete this step in the table below.

Section	Time taken to complete (minutes)
Scaling	
Jackleg drilling	
Rockbolt installation	
Identification test	

Name \_\_\_\_\_

Student # \_\_\_\_\_

Group ID \_\_\_\_\_

**APPENDIX B8****IDENTIFICATION EXERCISE**

1. Identify the following using the numbers indicated on them:
  - (a) Scaling bar
  - (b) Self rescuer
  - (c) Drill steel retainer
  - (d) Drill head
  - (e) Whip check
  - (f) Exhaust port
  - (g) Gooseneck
  - (h) Throttle
  - (i) Split set
  - (j) Rebar
  - (k) Rockbolt dolly
  - (l) Rockbolt plate
  
2. About how many feet shorter is the scaling bar supposed to be relative to the back of the area you are scaling?

State the acronym used to remember the 8 rules of safe scaling.

3. What provides the driving force of a jackleg drill?
4. Which direction does a jackleg drill turn during drilling?
5. State two functions of the use of water during drilling.
6. State the rock bolting rule.
7. State the two types of friction rockbolts.

## APPENDIX B9

Table B1. Paper-based Group Participants' Ratings of the Likert-scale Statements.

Participant	Ex1	Ex2	Ex3	Ex4	Ex5
P1	8	8	7	9	10
P2	7	9	7	7	8
P3	5	8	6	7	5
P4	7	9	9	6	7
P5	7	7	5	6	7
P6	9	8	9	8	8
P7	8	10	7	8	8
P8	1	5	4	4	4
P9	10	10	10	10	10
P10	9	10	10	9	10
P11	7	9	8	7	7
P12	7	6	8	7	7
P13	8	9	9	9	9
P14	3	8	5	4	1
P15	10	9	10	6	10
P16	4	9	9	6	2
P17	8	9	10	9	9
P18	6	6	6	8	7
P19	5	6	9	7	7
P20	9	10	8	9	6
P21	7	8	10	7	5
P22	7	10	9	10	10
P23	2	7	2	5	1
P24	8	8	3	6	6
P25	7	10	8	8	7
<b>Mean</b>	<b>6.8</b>	<b>8.3</b>	<b>7.5</b>	<b>7.3</b>	<b>6.8</b>
Ex1	The tutorial did a good job of letting me know what I did not know				
Ex2	Each task was covered comprehensively				
Ex3	I found the questions to be strongly related to the information provided				
Ex4	The tutorial is an effective learning tool				
Ex5	I would recommend this tutorial for training new inexperienced miners				
<b>Scale</b>	<b>Strongly Disagree 1...2...3...4...5...6...7...8...9...10 Strongly Agree</b>				

**Table B2.** Computer-based Group Participants' Ratings of the Likert-scale Statements.

<b>Participant</b>	<b>Ex1</b>	<b>Ex2</b>	<b>Ex3</b>	<b>Ex4</b>	<b>Ex5</b>
P26	10	10	10	10	10
P27	9	8	9	8	7
P28	7	9	6	8	8
P29	8	9	10	8	10
P30	7	6	8	7	9
P31	9	9	10	9	9
P32	9	6	6	9	7
P33	7	6	8	9	8
P34	10	10	10	8	6
P35	9	5	6	9	9
P36	8	9	10	9	9
P37	6	8	10	8	9
P38	10	9	10	10	10
P39	9	6	8	9	9
P40	8	8	9	8	8
P41	7	10	10	8	8
P42	8	8	10	10	10
P43	9	9	9	9	9
P44	9	8	9	9	8
P45	8	7	10	9	9
P46	10	9	8	9	9
P47	7	9	10	9	9
P48	9	8	7	9	9
P49	2	7	8	3	7
P50	8	9	10	8	8
<b>Mean</b>	<b>8.1</b>	<b>8.1</b>	<b>8.8</b>	<b>8.5</b>	<b>8.6</b>
Ex1	The tutorial did a good job of letting me know what I did not know				
Ex2	Each task was covered comprehensively				
Ex3	I found the questions to be strongly related to the information provided				
Ex4	The tutorial is an effective learning tool				
Ex5	I would recommend this tutorial for training new inexperienced miners				
<b>Scale</b>	<b>Strongly Disagree 1...2...3...4...5...6...7...8...9...10 Strongly Agree</b>				



**APPENDIX C**

**EVALUATION OF THE PHYSICAL COMPONENTS OF THE VIRTUAL  
REALITY COMPUTER SIMULATOR**

## APPENDIX C1

**STILLWATER MINING COMPANY:**

**DATE: 5/04/04**

### **OPERATIONS PROCEDURE SOP: JACKLEG OPERATION REVISION 0**

#### **1.0 Purpose**

The purpose of this procedure is to provide parameters for and instruction to operators in the safe use of jackleg drill machines. The jackleg drill is a pneumatic device used to drill a variety of multiple-use holes in rock and other hard material. Examples of multiple use holes include blast holes, pinholes, rock-bolt holes and test holes. Other jackleg drill applications include rock bolt installation. The Gardner Denver jackleg drill is representative in size and weight to other manufacturer's drills of similar piston size. GD Model 83 drill machine with muffler weighs 82lbs. GD standard jackleg weighs 40lbs. Hose attachments, drill steel and bolt drivers increase overall operational weight of the jackleg drill.

#### **2.0 Safe Job Procedures**

1. Perform proper work place examination. Correct all hazards found immediately.
  - A. **Never proceed past unsupported ground.** (*The only exceptions to this are: The first bolt installed on raise-up, setting a slusher pin, conventional raises/bean holes and any ground pre-dating the ground support policy*).
  - B. Wet down work area from header to face.
  - C. Assure ventilation sweeps work area.
  - D. Bar down all loose ground and check work area for misfires. Scaling is a continuous process during the bolting cycle and a scaling bar must be present in the heading at all

times. Wash out or re-blast bootlegs and misfires to assure no explosives remain in previously drilled holes. **Never proceed past unsupported ground. (See above A.)**

**E. Remove tripping hazards from scaling before resuming jackleg operation.**

F. Air hose connections shall be secured with whip checks.

G. Drill mufflers must be secure and functioning properly. Malfunctioning drill mufflers require repair prior to drill machine use.

H. Drill steel and bolt driver lengths must be appropriate to the task.

1. Assured location and body position give drill operator the best possible footing and balance. Operator should perform stretching exercises prior to picking up drill to avoid possible muscle strain. Keep body parts away from pinch points.

2. Wear proper personal protective equipment.

A. Hardhat

B. Safety glasses

C. Arm guards

D. Gloves

E. Steel toe footwear

F. Earplugs and earmuffs

**Dual hearing protection is required when operating a jackleg drill**

### **3.0 Tag Outs/Lock Outs Required**

Tag out malfunctioning drills, noting the problem on the tag. Malfunctioning drills should be transported for repair as soon as possible and no later than the end of shift. Attach BO parts to machine or leg before shipping.

### **4.0 Qualifications**

Only persons trained in the proper care and operation will be allowed to operate a jackleg drill. Drill machine operators must have documentation showing completed task training prior to unsupervised operation. A properly completed MSHA 5000-23 form is the only accepted form of documentation.

### **5.0 Equipment Required**

Double hearing protection is required within 50 ft. of operating or assisting jackleg drilling. Whip checks must be in place on the live end of all air hose connections.

### **6.0 Documentation and References**

#### **30 CFR**

#### **57.7028.** Hand clearance

Persons shall not rest their hands on the chuck or centralizer while drilling.

#### **56,57.7052.** Drilling positions

Persons shall not drill from - (a) Positions which hinder their access to control levers;

(b) Insecure footing or insecure staging; or, (c) Atop equipment not suitable for drilling.

#### **56,57.7053.** Moving hand-held drills

Before hand-held drills are moved from one working area to another, air shall be turned off and bled from the hose.

**56,57.7054.** Starting or moving drill equipment

Drill operators shall not start or move drilling equipment unless all miners are in the clear.

**56,57.7055.** Intersecting holes

Holes shall not be drilled where there is a danger of intersecting a misfired hole or a hole containing explosives, blasting agents or detonators.

**56,57.7056.** Collaring in bootlegs

Holes shall not be collared in bootlegs.

**58.620.** Drill dust control

Holes shall be collared and drilled wet or other effective dust control measures shall be used, when drilling non-water-soluble material. Effective dust control measures shall be used when drilling water-soluble materials.

**56,57.13021.** High Pressure hose connections

Except where automatic shutoff valves are used, safety chains or other suitable locking devices shall be used at connections to machines of high – pressure hose lines of  $\frac{3}{4}$  inch inside diameter or larger, and between high-pressure hose lines of  $\frac{3}{4}$  inch inside diameter or larger, where a connection failure would create a hazard.

**48.26.** Training of newly employed experienced miners; minimum courses of instruction

## 7.0 Procedure Steps

### Drilling

1. Each Drill Operator shall, (before drilling and after conducting a work place examination) wash down the area to be drilled and wash out all bootleg holes to inspect for un-detonated explosives. Floors and hard bottom must be inspected also.
2. Only work necessary to remove a misfire shall be permitted in the affected area until the misfire is disposed of in a safe manner.
3. When a misfire cannot be disposed of safely, each approach to the area affected by the misfire shall be posted with a warning sign at a conspicuous location to prohibit entry, and the condition shall be reported immediately to appropriate supervisor.
4. Drill faces shall be mucked low enough to identify the previous lifter holes and assure that misfired holes are not present.
5. Assure proper ventilation. Ventilation shall sweep the face.
6. Drilling in “bootleg holes” (section of hole which did not break during the previous blast) is strictly prohibited.
7. Drilling dry is prohibited; water must travel through the drill steel at all times during operation to control dust.
8. Keep work area clear of tripping hazards and assure safe path-of-retreat.
9. Visually inspect the jackleg drill for loose or damaged parts.
10. Blow air and flush water hoses to clear any debris prior to connecting.
11. Check screen and connections on machine for dirt or damage.
12. Check air, water and feed-leg connections for tightness. Whip checks must be

- in place on all air hose connections. Straight, uncoiled air and water hoses facilitate operator drill control.
13. Fill oiler with recommended rock drill oil and check routinely. Do not use oiler
  14. Dual hearing protection is required when operating or assisting a jackleg drill. A proper muffler must be in place.
  15. Ensure drill machine and feed-leg controls are in off-position before initiating air pressure.
  16. Proper feed-leg positioning achieves best possible balance. Never straddle feed-leg during drilling operation.
  17. Helpers or by-standers should not stand behind or in front of machine.
  18. Standing on feed-leg “D” handle is not accepted practice. Drill machine controls can be shut off from oiler valve or manifold valve if drill controls are out of operator’s reach.
  19. All holes will be collared and drilled wet.
  20. Have proper length scaling bar that is in good condition. Sound and bar down work area with a proper length-scaling bar prior to drilling and remain alert for loose material created by the drilling process.
  21. Examine for and correct any ground support damaged or loosened by blasting or other mining operations before starting new support. Start with back and continue down ribs before advancing.
  22. Both the back and ribs must be supported before new support can be advanced. Under no circumstances will the support in the back be advanced farther than 2 rings past the support of the ribs.

23. Bolts shall be installed within 1 foot of the face in order to provide safe access for drilling, loading, mucking, geology, etc. Constantly monitor for changing ground conditions as drilling operations progress.
24. Wash and scale the face before working near the face.
25. All bootlegs must be identified and painted when a jackleg is used for the purpose of advancing the face. THIS INCLUDES LIFTERS.

**Under no circumstances is a bootleg an acceptable place to collar a hole**



## APPENDIX C2

### RULES ON UNDERGROUND ROCK BOLTING CONTEST

- This is a single man contest of scaling, drilling a hole and installing a split set rock bolt at the Missouri S&T Experimental Mine.
- Each hole must be drilled within the assigned area in the wall of the excavation.
- You are required to wear all safety equipment including work gloves, steel-toe boots, hard hat with a mine lamp, a self rescuer, and safety glasses.
- The jackleg drill will be placed against the wall and each participant is required to assemble the drill and fix the safety whip, and then connect the air and water hoses to the jackleg.
- You will then be required to select a drill steel with drill bit attached prior to drilling.
- Upon the word “Go,” you must start drilling.
- Holes must be collared within the assigned region. Holes collared outside the region must be re-collared or you will be disqualified.
- The hole must be at least 4 feet in depth (i.e. up to the 4 ft mark on drill steel) to enable the subject to install the rock bolt. Drilling must continue in a hole shorter than 4 feet until the required depth is achieved. There is no penalty for lengths greater than 4 feet; however, the hole should be appropriate for the bolt length.
- Drilling into another previously drilled hole will result in disqualification.
- Timekeepers and judges will have full authority, and their decisions on all aspects outside these rules are final.
- Timekeepers and/or judges may remind you of a missed step or help you complete a step with points deducted accordingly. In case timekeepers and judges do not agree on number of points to be deducted for a particular job step, a recorded video of the contest will be played and reviewed by a third party, who will then be the final judge.

## APPENDIX C3

In order to have an estimate of how long it took each task to be performed, we timed each job step for every participant and the average time computed. It is important to note that it was not possible to estimate the time taken for the scaling operation because scaling generally depends on conditions at the face.

**Table C1: Average Time Taken to Perform Each Task (in seconds)**

Experimental Group							
	Job step	P1	P2	P3	P4	P5	Mean
<b>Drilling</b>	Assembling the drill	105	80	180	60	60	<b>97</b>
	Fixing of safety whip	75	65	70	90	60	<b>72</b>
	Connecting the air hose	70	60	75	60	60	<b>65</b>
	Connecting the water hose	60	90	120	60	30	<b>72</b>
	Selecting a drill steel	30	30	45	30	20	<b>31</b>
	Inserting the drill steel	60	60	20	30	60	<b>46</b>
	Hole collaring	135	70	180	180	60	<b>125</b>
	Hole drilling	180	165	120	180	180	<b>165</b>
Drill/drill steel removal	80	60	60	60	60	<b>64</b>	
<b>Bolting</b>	Bolt selection (split set)	30	30	15	45	30	<b>30</b>
	Fixing the bolt dolly	70	30	60	60	60	<b>56</b>
	Inserting the bolt in the hole	60	60	90	30	60	<b>60</b>
	Bolt installation	90	90	90	120	60	<b>90</b>
	Drill/bolt dolly removal	105	30	60	60	60	<b>63</b>
Control Group							
	Job step	P6	P7	P8	P9	P10	Mean
<b>Drilling</b>	Assembling the drill	180	240	210	300	180	<b>222</b>
	Fixing of safety whip	60	60	60	60	60	<b>60</b>
	Connecting the air hose	60	45	180	120	120	<b>105</b>
	Connecting the water hose	60	60	60	60	60	<b>60</b>
	Selecting a drill steel	30	20	45	60	60	<b>43</b>
	Inserting the drill steel	60	60	60	45	60	<b>57</b>
	Hole collaring	60	60	60	120	60	<b>72</b>
	Hole drilling	120	120	165	180	158	<b>148.6</b>
Drill/drill steel removal	60	60	60	120	60	<b>72</b>	
<b>Bolting</b>	Bolt selection (split set)	30	20	15	30	30	<b>25</b>
	Fixing the bolt dolly	60	60	60	60	60	<b>60</b>
	Inserting the bolt in the hole	60	120	60	60	60	<b>72</b>
	Bolt installation	60	180	120	60	180	<b>120</b>
	Drill/bolt dolly removal	60	60	45	45	60	<b>54</b>

**APPENDIX D**

**PROPOSED EVALUATION OF THE VIRTUAL REALITY COMPUTER  
SIMULATOR**

**APPENDIX D1**

## MINER ASSESSMENT INDEX FORM

### Scaling

Task (Job Step)	Errors	Time to complete	Comments
Wearing PPE			
Initial site inspection			
Selecting a scaling bar			
Holding the scaling bar			
Scaling loose rock			

### Jackleg Drilling

Task	Errors	Time to complete	Comments
Assembling the drill			
Fixing of safety whip			
Connecting the air hose			
Connecting the water hose			
Selecting a drill steel			
Inserting the drill steel			
Hole collaring			
Hole drilling			
Drill removal			
Drill steel removal			

### Rockbolt Installation

Task (Job Step)	Errors	Time to complete	Comments
Bolt selection (split set)			
Fixing the bolt dolly			
Inserting the bolt in hole			
Bolt installation			
Drill removal			
Bolt dolly removal			

#### Errors

0 – Fail because of errors

1 – Many errors

2 – Some errors

3 – Few or no errors

#### Time to complete

0 – Fail

1- Succeed very slowly in a roundabout way

2 – Succeed a little slowly

3 – Succeed quickly

### APPENDIX D2

## LIKERT-SCALE QUESTIONNAIRE STATEMENTS

Use the following scale to respond to the statements below

Strongly disagree 1...2...3...4...5...6...7...8...9...10 strongly agree

### Scaling statements

\_\_\_ 1) I found wearing of personal protective equipment (PPE) realistic.

Explain:

\_\_\_ 2) Site inspection in the virtual environment was the same as in the real mine.

Explain:

\_\_\_ 3) I found no difference between the two scaling bars used.

Explain:

\_\_\_ 4) Scaling loose rock in the virtual environment was very similar to scaling loose rock in the actual underground mine environment.

Explain:

\_\_\_ 5) I would recommend the VR scaling method for training new inexperienced miners.

Explain:

### Drilling statements

\_\_\_ 1) The jackleg drill used in the VR environment was the same as the one used in the mine.

Explain:

\_\_\_ 2) I did not find any difference between assembling the drill in the VR environment and assembling it in the actual mine.

Explain:

\_\_\_ 3) Fixing of the safety whip in the VR environment was very realistic.

Explain:

\_\_\_ 4) I was satisfied with the connection of the air/water hose in the VR environment.

Explain:

\_\_\_ 5) The method used to insert the drill still was similar to the method used in the mine.

Explain:

\_\_\_6) I was comfortable with the noise, vibration and air pressure of the jackleg drill in the VR mine, as compared to the actual mine.

Explain:

\_\_\_7) Collaring a hole in both VR and actual mine environments were the same.

Explain:

\_\_\_8) I learned a great deal from drilling in the VR environment.

Explain:

\_\_\_9) My experience with removing the drill/drill steel after drilling was the same in both VR and actual mines.

Explain:

\_\_\_10) I would recommend the VR drilling method for training inexperienced miners.

Explain:

### **Bolting statements**

\_\_\_1) Fixing the bolt dolly in the VR environment was very realistic.

Explain:

\_\_\_2) Inserting of the bolt was the same as the way it was done in the actual mine.

Explain:

\_\_\_3) I learned a great deal from rockbolt installation in the VR environment.

Explain:

\_\_\_4) My experience with removing the drill/bolt dolly after bolting was the same in both VR and actual mines.

Explain:

\_\_\_5) I would recommend the VR bolting method for training inexperienced miners.

Explain

Please provide any further comments that could aid in improving the effectiveness of the simulator.

### **APPENDIX D3**

## REPRESENTATIVE COMMENTS FROM COMPARATIVE STUDY OF THE ONLINE TUTORIAL.

Six major categories that emerged from the representative comments are listed below.

1. The tutorial was perceived to contain too much information for a new miner at one sitting, especially the section on jackleg drilling.

- *(Paper-based group): Too much information made it boring and confusing, although the scaling section was okay.*
- *(Paper-based group): It was maybe too comprehensive for brand new miners with too much information.*
- *(Paper-based group): The tutorial provides good information, but it is too verbose.*
- *(Paper-based group): I think this is a little bit too much information for a beginner.*
- *(Computer-based group): The tutorial was very informative, but in some cases I felt loss because of too much information.*
- *(Computer-based group): The tutorial is effective, but not easy to keep in memory.*
- *(Computer-based group): The tutorials are a little too much for first one sitting and I am sure that this is not what would happen in the real world.*
- *(Computer-based group): I found the tutorial on jackleg drilling very lengthy. I started losing interest after a while. The other two sections were very interesting and informative as well.*

2. The general perception of participants in the paper-based group was to develop the tutorial using videos, while the computer-based group perceived the videos to be the most effective part of the tutorial.

- *(Paper-based group): A video would have worked better so that I could see an operating machine instead of reading about it.*

- *(Paper-based group): For a technology graduate like me, it was quiet easy. But some video clipping showing demonstration of operating the equipment and pictures will help in effective training of new inexperienced miners.*
- *(Paper-based group): I was able to see clearly the components in the paper tutorial, but I think the computer tutorial will be better.*
- *(Paper-based group): Maybe video computer tutorial is effective, but paper-based does no good.*
- *(Paper-based group): As in a paper based tutorial, sometimes it becomes really boring to read all the information. It is good to provide video for the subject. The introductory lecture was excellent. The video shown during the introductory presentation was also very good. The tutorial in my suggestion must be provided in video format.*
- *(Computer-based group): The videos were helpful and gave an insight on each process or machinery used.*
- *(Computer-based group): Good tutorial with great videos.*
- *(Computer-based group): The tutorial was effective mainly because of the videos on each process or machine.*
- *(Computer-based group): Tutorial should have more videos than words.*

3. The tutorial was perceived to provide a new knowledge.

- *(Paper-based group): I knew literally nothing at first.*
- *(Paper-based group): I have seen and heard only little yesterday. For the first time I learned about it today.*
- *(Paper-based group): I learnt in detail about something I had no idea about.*
- *(Computer-based group): I learned a lot about a subject I knew nothing about.*
- *(Computer-based group): Because I am new to mining, I found it interesting.*

4. It has been suggested to use the tutorial only as an introductory lesson to a hands-on experience.



- *(Paper-based group): I learned a lot about mining, but I think hands-on visuals rather than pictures could help me better.*
- *(Paper-based group): I think with practical training, learning will be easier.*
- *(Paper-based group): I would recommend this tutorial, but with the machine and the tools in front of trainees.*
- *(Paper-based group): Unless a demonstration of how things work is shown, this tutorial alone does not prepare one to safely use the machines.*
- *(Paper-based group): As it is not possible to train all the miners with simulation and computer graphics all the time, I think this tutorial was very good enough, but with the tools in front of the miner with an instructor would be a better way.*
- *(Computer-based group): While I was learning the tutorial I thought I could see real drilling machine, and I did in the identification test.*
- *(Computer-based group): This tutorial is a good background before hands-on learning.*
- *(Computer-based group): This is a great teaching tool, especially when supplemented with hands-on experience.*

5. The tutorial was perceived to contain a lot of technical terms, which were not explained. The non-explained technical terms are common with the jackleg drilling and rockbolt installation sections.

- *(Paper-based group): There is no clear explanation of all the terms used.*
- *(Paper-based group): There were a few terms I did not understand. I knew some of them from construction experience.*
- *(Computer-based group): Most of the terminologies need to be explained further. For example, “muck pile,” “back,” etc.*
- *(Computer-based group): The tutorial uses a lot of jargons, but the videos and photographs explained the pieces nicely.*
- *(Computer-based group) The tutorial covered each task well, but it is too technical.*

- *(Computer-based group): Improvement can be made with respect to the jargons under the drilling and bolting sections.*
- *(Computer-based group): The technical jargon could be seen as overwhelming. The section on rockbolting seemed to drag on and on, especially when trying to understand the tension/compression with the rock.*
- *Jackleg drilling is too theoretical. I couldn't understand many terms (technical jargons) used in that. More video examples will help a lot.*

6. Participants in the paper-based group perceived the photographs to be unhelpful.

- *(Paper-based group): If photographs were good enough, it would have helped*
- *(Paper-based group): The photographs on the slides were terribly unhelpful. There were parts to be identified that were not covered.*
- *(Paper-based group): Nope, I would not suggest this tutorial to any new miner. A more lecture-based practical session would be more helpful rather than just giving three sections of tutorial with terrible pictures to study.*
- *(Paper-based group): The idea behind the tutorial is VERY VERY GOOD. But the execution of this idea needs a better documentation of what you intent to say. Hence the pictures used in the handouts should be more expressive from visual perspective.*

## APPENDIX D4

### UNDERGROUND ROCKBOLTING EVALUATION SHEET

Name \_\_\_\_\_ Group ID \_\_\_\_\_

Age \_\_\_\_\_ Gender \_\_\_\_\_ Date \_\_\_\_\_

#### Scaling

Task (Job Step)	Max. No. of Points	Points Scored	Comment
Wearing PPE	5		
Initial site inspection	5		
Selecting a scaling bar	1		
Holding the scaling bar	3		
Scaling loose rock	6		
<b>Total</b>	<b>20</b>		

#### Drilling

Task (Job Step)	Max. No. of Points	Points Scored	Time (seconds)	Comments
Assembling the drill	5			
Fixing of safety whip	5			
Connecting the air hose	3			
Connecting the water hose	3			
Selecting a drill steel	1			
Inserting the drill steel	2			
Hole collaring	10			
Hole drilling	36			
Drill removal	5			
<b>Total</b>	<b>70</b>			

#### Bolting

Task (Job Step)	Max. No. of Points	Points Scored	Time (seconds)	Comments
Bolt selection (split set)	1			
Fixing the bolt dolly	2			
Inserting the bolt in hole	2			
Bolt installation	15			
Drill removal	5			
<b>Total</b>	<b>25</b>			

NB: It is not possible to time scaling because it depends on the conditions at the face.

### **Rules on Underground Rock Bolting Contest**

- This is a single man contest of scaling, drilling a hole and installing a split set rock bolt at the Missouri S&T Experimental Mine.
- Each hole must be drilled within the assigned area in the wall of the excavation.
- You are required to wear all safety equipment including work gloves, steel-toe boots, hard hat with a mine lamp, a self rescuer, and safety glasses.
- The jackleg drill will be placed against the wall and each participant is required to assemble the drill and fix the safety whip, and then connect the air and water hoses to the jackleg.
- You will then be required to select a drill steel with drill bit attached prior to drilling.
- Upon the word “Go,” you must start drilling.
- Holes must be collared within the assigned region. Holes collared outside the region must be re-collared or you will be disqualified.
- The hole must be at least 4 feet in depth (i.e. up to the 4 ft mark on drill steel) to enable the subject to install the rock bolt. Drilling must continue in a hole shorter than 4 feet until the required depth is achieved. There is no penalty for lengths greater than 4 feet; however, the hole should be appropriate for the bolt length.
- Drilling into another previously drilled hole will result in disqualification.
- Timekeepers and judges will have full authority, and their decisions on all aspects outside these rules are final.
- Timekeepers and/or judges may remind you of a missed step or help you complete a step with points deducted accordingly. In case timekeepers and judges do not agree on number of points to be deducted for a particular job step, a recorded video of the contest will be played and reviewed by a third party, who will then be the final judge.

## BIBLIOGRAPHY

- Althouse, R.C., Grayson, R.L. and Klishis, M.J. (1997), “ Microanalysis of Roof Bolter Injuries,” *J. Applied Occupational and Environmental Hygiene*, Vol. 12, No. 12, Proc. 2<sup>nd</sup> Int. Conf. on the Health of Miners, pp. 851 – 857.
- Atlas Copco Construction Tools Inc., (2006), By Courtesy of Vogel, J., Personal Communication (by e-mail).
- Boese, M., Sheng, H., & Hall, R. H. (2008). “Developing a Grounded Theory Model on Collaboration in Learning,” *Proceedings of the Americas Conferene on Information Systems*.
- Borges, J.A., Morales, I., and Rodriguez, N.J. (1998), “Page Design Guidelines Developed Through Usability Testing,” In C. Forsythe, E. Gross, and J. Ratner (eds), *Human Factors and We Development*, Lawrence Erlbaum Associates, New Jersey, pp. 137-152.
- Burdea, G.C. and Coiffet, P. (2003), “Virtual Reality Technology,” 2nd Edition, John Wiley & Sons, Inc., Hoboken, New Jersey.
- Chakraborty, P.R. and Bise, C.J. (2002), “A Virtual-Reality-Based Model for Task-Training of Equipment Operators in the Mining Industry,” *Mineral Resources Engineering*, Vol. 9, No. 4, Imperial College Press, pp 437-449.
- Churchill, E. and Snowden, D. (1996), “Mine Training, Internal Project Report,” University of Nottingham. Nottingham, UK.
- Cullen, E.T. (2001), “Development of NIOSH Hard-Rock Safety Training Materials,” 108th Annual Exhibit and Meeting, Society for Mining, Metallurgy, and Exploration, Denver, CO, Feb. 26-28, 2001; 4 pp.
- Ehrmann, S.C. (1999), “Asking the Hard Questions about Technology Use and Education,” *Journal of Family and Consumer Sciences*, Vol. 91, No. 3, pp. 31-35.
- Flow Interactive Limited’s webpage, available at <http://www.flowinteractive.com/index.php>, accessed December 5, 2007.
- Fifth Dimension Technologies (2006), “Training Simulators for the Mining Industry,” available at [www.5dt.com](http://www.5dt.com), accessed July 28, 2006.
- Forrestal, L. (2007), “Training Simulators,” January 2007 Issue of Australia’s Mining Monthly Magazine.

- Fotta, B. and Bockosh, G. (2000), "The Aging Workforce: An Emerging Issue in the Mining Industry," Proc. 31st Annual Inst. Min. Health and Safety Research, Blacksburg, VA, pp 33-45, NIOSH Publication No. 2002-2037.
- Freedman, P. (2001), "New Jumbo Operator Training Simulator," CIM Bulletin, Vol. 94, No. 10, 3 pp.
- Gonick, L. and Smith, W. (1993), "The Cartoon Guide to Statistics," HarperCollins Publishers, New York, 230 pp.
- Goodman, R.E. (1989), "Introduction to Rock Mechanics," 2<sup>nd</sup> ed., John Wiley & Sons, New York, 562 pp.
- Grau, R.H., and Prosser, L.J., (1997), "Scaling Roof Accidents in Underground Limestone Mines," Rock Products, January, pp 39-41.
- Gross, D.C. (2002), "Technology Management and User Acceptance of Virtual Environment Technology," in K. Stanney (Ed.), Handbook of Virtual Environments: Design, Implementation and Applications, Erlbaum, Mahwah, NJ, pp. 533-542.
- Hadjigeorgiou, J., Hammond, K. and Lemy, F. (1999), "Practical Considerations in the Training of Miners on Rock Bolting," in E. Villaescusa et al (Ed), Rock Support and Reinforcement Practice in Mining, Proc. of the Int. Symposium on Ground Support, Balkema, Rotterdam, Brookfield, pp 373-376.
- Hall, R. H., Philpot, T., & Hubing, N. (2006). "Comprehensive Assessment of a Software Development Project for Engineering Education," Journal of Learning, Technology, and Assessment, Vol. 15, No. 5, pp. 4 - 42.
- Hall, R. H., Philpot, T.A., Hubing, N., Flori, R.E. and Yellamraju, V. (2004), "A Model Driven Multi-Year Assessment of a Software Development Project for Engineering Instruction," Proceedings of the American Society of Engineering Education, [http://www.asee.org/acPapers/2004-1651\\_Final.pdf](http://www.asee.org/acPapers/2004-1651_Final.pdf).
- Hall, R. H., Stark, S. Hilgers, M., and Chang, P. (2004), "A Comparison of Scaffolding Media in a Learning System for Teaching Web Development," Proceedings of the AACE E-Learn Conference, pp. 1906-1913, <http://dl.aace.org/16707>.
- Hall, R.H., Watkins, S.E., Davis, R, Belarbi, A., and Chandrashekakhara, K. (2001), "Design and Assessment of Web-based Learning Environments: The Smart Engineering Project and the Instructional Software Development Center at U.M.R.," in L.R. Vandervert, L.V. Shavinina, & R.A. Cornell (Eds), Cybereducation: The Future of Long Distance Learning, Mary Ann Liebert, Inc., Publishers, New York, pp. 137-156.

- Hagman, J., and Rose, A. (1983), "Retention of Military Tasks: A Review," *Human Factors*, Vol. 25, No. 2, pp. 199 – 213.
- Helander, M.G., Krohn, G.S. and Curtain, R. (1983), "Safety of Roof Bolting Operations in Underground Coal Mines," *J. Occup. Accidents* 5: 161-175.
- Hilgers, M., Leu, M.C., Hall, R.H., Agarwal, S., Lambert, T., Albright, R. and Nebel, K. (2004), "Virtual Environments for Training First Responders," *Proceedings of the Interservice/Industry Training, Simulation and Education Conference (I/ITSEC)*, Paper No. 1766.
- Hoek, E. and Brown, E.T. (1980), "Underground Excavations in Rock," *Institution of Mining and Metallurgy*, London, England, 402 pp.
- Hoek, E., Kaiser, P.K. and Bawden, W.F. (1997), "Support of Underground Excavations in Hard Rock," *Balkema*, Rotterdam, Brookfield, 215 pp.
- Hudson, J.A., and Harrison, J.P. (1997), "Engineering Rock Mechanics: An Introduction to the Principles," *Elsevier Science Inc.*, New York, 444 pp.
- Iannacchione, A.T., et al. (2000), "Roof Monitoring Helps Prevent Injuries in Stone Mines," *Mining Engineering Magazine of the SME*, November 2000 Edition, pp 32 -35.
- Johnson, S.L. (1981) "Effect of Training Device on Retention and Transfer of a Procedural Task," *Human Factors*, Volume 23, No. 3, pp. 257-272.
- Kowalski, K.M. et al. (2004), "Safety and Health Training for an Evolving Workforce: An Overview From the Mining Industry," *Department of Health and Human Services, Center for Disease Control and Prevention, NIOSH Publication No. 2004-155, Information Circular 9474*, 15 pp, Pittsburgh Research Laboratory, Pittsburgh, PA.
- Kowalski, K.M. et al.(2001), "The Evolving Mining Workforce: Training Issues," *Proc. 32nd Annual Inst. Min. Health and Safety Research*, pp 75-90, NIOSH Publication No. 2002-3438, Pittsburgh Research Laboratory, Pittsburgh, PA.
- Krug, S. (2006), "Don't Make Me Think: A Common Sense Approach to Web Usability," 2<sup>nd</sup> ed., *New Riders Publishers*, Berkeley, CA.
- Kuniavsky, M. (2003), "Observing the User Experience: A Practitioner's Guide to User Research," *Morgan Kaufmann Publishers*, San Francisco, CA, 560 pp.

- Lampton, D., Bliss, J. and Morris, C. (2002), "Human Performance Measurement in Virtual Environments," in K. Stanney (Ed.), *Handbook of Virtual Environments: Design, Implementation and Applications*, Erlbaum, Mahwah, NJ, pp. 701-720.
- Lang, T.A. (1961), "Theory and Practice of Rock Bolting," *Trans. Amer. Inst. Mining, Engineers*, Vol. 220, NY, pp 333 – 348.
- Lathan, C.E., et al. (2002), "Using Virtual Environments as Training Simulators: Measuring Transfer," in K. Stanney (Ed.), *Handbook of Virtual Environments: Design, Implementation and Applications*, Erlbaum, Mahwah, NJ, pp. 403-414.
- Latterell, C.M. and Deneen, L. (2006), "Evaluating a Program to Increase Faculty Use of Technology in Teaching and Learning," *E-Journal of Instructional Science and Technology*, Vol. 9, No 2.
- Li, C., and Hakansson, U., (1999), "Performance of the Swellex Bolt in Hard and Soft Rocks," in E. Villaescusa et al (Ed), *Rock Support and Reinforcement Practice in Mining*, Proc. of the Int. Symposium on Ground Support, Balkema, Rotterdam, Brookfield, pp 103-108.
- Lynton, N. (2006), "Chindia's Workforce Worries," *Business News via Yahoo News*, available at [http://news.yahoo.com/s/bw/20060801/bs\\_bw/gb20060731767149](http://news.yahoo.com/s/bw/20060801/bs_bw/gb20060731767149), accessed August 1, 2006.
- Macromedia Studio 8 "Applications Program for Content Authoring," Macromedia, Inc. San Francisco, California.
- Marras, W.S., Bobick, T.G., Lavender, S.A., Rockwell, T.H. and Lundquist, R.L. (1988a), "Risks of Hand Tool Injury in US Underground Mining from 1978 through 1983; Part I: Coal Mining," *Journal of Safety Research*, Vol. 19, No. 2, pp 71-85.
- Marras, W.S., Bobick, T.G., Lavender, S.A., Rockwell, T.H. and Lundquist, R.L. (1988b), "Risks of Hand Tool Injury in US Underground Mining from 1978 through 1983; Part II: Metal/Nonmetal Mining," *Journal of Safety Research*, Vol. 19, No. 3, pp 115-124.
- Marras, W.S. and Lavender, S.A. (1991), "The Effects of Method of Use, Tool Design, and Roof Height on Trunk Muscle Activities During Underground Scaling Bar Use," *Ergonomics*, Vol. 34, No. 2, pp 221-232.
- Mine Safety and Health Administration (2006), "Fatality Statistics and Accident/Injury Information," available at [www.msha.gov](http://www.msha.gov), accessed July 24, 2006.
- Morgan, R. (2006), "Mines and Money 2005 Conference, Exhibition and Gala Dinner," *Online Mining Journal* available at <http://www.mining-journal.com>, accessed August 6, 2006.



- Muir, E. (2006), "Mining Boom is Sustainable," SME Mining Engineering Publication, July 2006, pp 33-41.
- National Institute for Occupational Safety and Health (2006), "Mining Fact Sheets," available at [www.cdc.gov/niosh/mining](http://www.cdc.gov/niosh/mining), accessed July 27, 2006.
- Nielsen, J. (1993), Usability Engineering, Morgan Kaufmann Publishers, San Francisco, CA.
- Nielsen, J., and Landauer, T.K. (1993), "A Mathematical Model of the Finding of Usability Problems," In S. Ashlund, K. Mullet, A. Henderson, E. Hollnagel, and T. White (eds), Proceedings of ACM INTERCHI '93 Conference on Human Factors in Computing Systems, ACM Press, New York, pp. 206-213.
- Otto, R.H. (1975), "Analysis of Injuries Involving Jackleg Rock Drills Underground, 1973-1974," U.S. Department of the Interior, Mining Enforcement and Safety Administration, Health and Analysis Center, Denver, CO.
- Paraszczak, P., Planeta, S. and Ouellet, H. (1993), "Comparative Testing of Water-Powered and Pneumatic Jackleg Rock Drills," SME Nonmeeting Paper 93-319. Manuscript July 1993. 4 pp.
- Planeta, S. (1994), "Progress in Scaling in Underground Mines," SME Nonmeeting Paper 94-312. Manuscript May 1994. 5 pp.
- Rubin, J. (1994), "Handbook of Usability Testing: How to Plan, Design, and Conduct Effective Tests," John Wiley and Sons, New York.
- Sall, J., Lehman, A., and Creighton, L. (2001), "JMP Start Statistics, A Guide to Statistics and Data Analysis," 2<sup>nd</sup> ed., SAS Institute Inc., Canada, 491 pp.
- Saskatchewan Institute of Applied Science and Technology Training Manual on Ground Control, Modules G and E, SIAST Woodland Campus, Prince Albert, SK, April, 2002.
- Schofield, D., Hollands, R. and Denby, B. (2001), "Mine Safety in the Twenty-First Century: The Application of Computer Graphics and Virtual Reality," in M. Karmis (Ed.), SME Publication on Mine Health and Safety Management, Littleton, Colorado, pp. 153-174.
- Swift 3D User's Guide (2005), Electric Rain Inc., Boulder, CO
- Taylor, J. (2007), Personal Communication on the Performance of Underground Rockbolting Participants.

- Thalmann, N.M. and Thalmann, D. (1994), "Artificial Life and Virtual Reality," John Wiley & Sons, New York, USA.
- Thompson, A.G., and Finn, D.J., (1999), "The Performance of Grouted Split Tube Rock Bolt systems," in E. Villaescusa et al (Ed), Rock Support and Reinforcement Practice in Mining, Proc. of the Int. Symposium on Ground Support, Balkema, Rotterdam, Brookfield, pp 91-102.
- Tyler, D.B., et al. (1999), "Development and Implementation of New Ground Support Standards at Mount Isa Mines Limited," Rock Support and Reinforcement Practice in Mining, Proc. of the Int. Symposium on Ground Support, Balkema, Rotterdam, Brookfield, pp 367 – 371.
- Urbaniak, G.C., and Plous, S., (2003), "Using the Research Randomizer," available at [www.randomizer.org](http://www.randomizer.org), accessed November 25, 2007.

## VITA

David Nutakor was born in Ghana, Africa on July 17, 1970 to Leonard and Sabina Nutakor. He obtained his B.S. degree in Mining Engineering from the University of Mines and Technology in Ghana, Africa in June 1996, and his M.S. degree also in Mining Engineering from the University of Nevada, Reno in December 2003. While in Nevada, he had the opportunity to work on the U.S. Department of Energy's Yucca Mountain Project. He also obtained his Engineer Intern certification during that period. In December 2008, he received his Ph.D. in Mining Engineering from the Missouri University of Science and Technology, Rolla, Missouri.

He has been a member of the Society for Mining, Metallurgy and Exploration (SME) since 2001. He won the 2002 and 2003 SME Award in Northeastern Nevada. He authored three technical papers, two conference papers, and two peer-reviewed paper.

David worked for both surface and underground mining companies in Ghana and Nevada. These companies included Ghana Goldfields Limited (underground gold mine), Continental Goldfields (Alluvial gold mine), Ghana Bauxite Company (surface bauxite mine), Anglogold Ashanti Iduapriem Mine (surface gold mine), and Newmont Mining Corporation (surface gold mine). He now works for Rio Tinto's Kennecott Mine in Salt Lake City, Utah.