



“Aircraft Taxi, Tow, or Pushback Gone Wrong – ASRS Review of Maintenance Reports with Unintended Aircraft Movement Outcome”

InfoShare – Maintenance

Baltimore, MD

March 2018

Dennis Doyle
ASRS Program Manager
Booz Allen Hamilton

Becky Hooey, PhD
ASRS Acting Program Director
NASA Ames Research Center

**AVIATION SAFETY
REPORTING SYSTEM**



Discussion Topics

- ASRS Metrics and Alerts
- Maintenance Personnel Report Data
- “Aircraft Taxi, Tow, or Pushback Gone Wrong ”
 - Review of relevant events



ASRS Report Volume Profile

- Approaching 42 years of confidential safety reporting
- Over 1,522,000 reports received
- Over 6,400 alert messages issued
- Over 7,858 reports per month, or 377 per working day
- Total report intake for 2017 was 94,302
- Current rate estimate for 2018 is over 95,000

Monthly Intake
January 1981 – February 2018

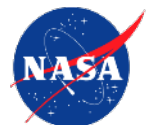
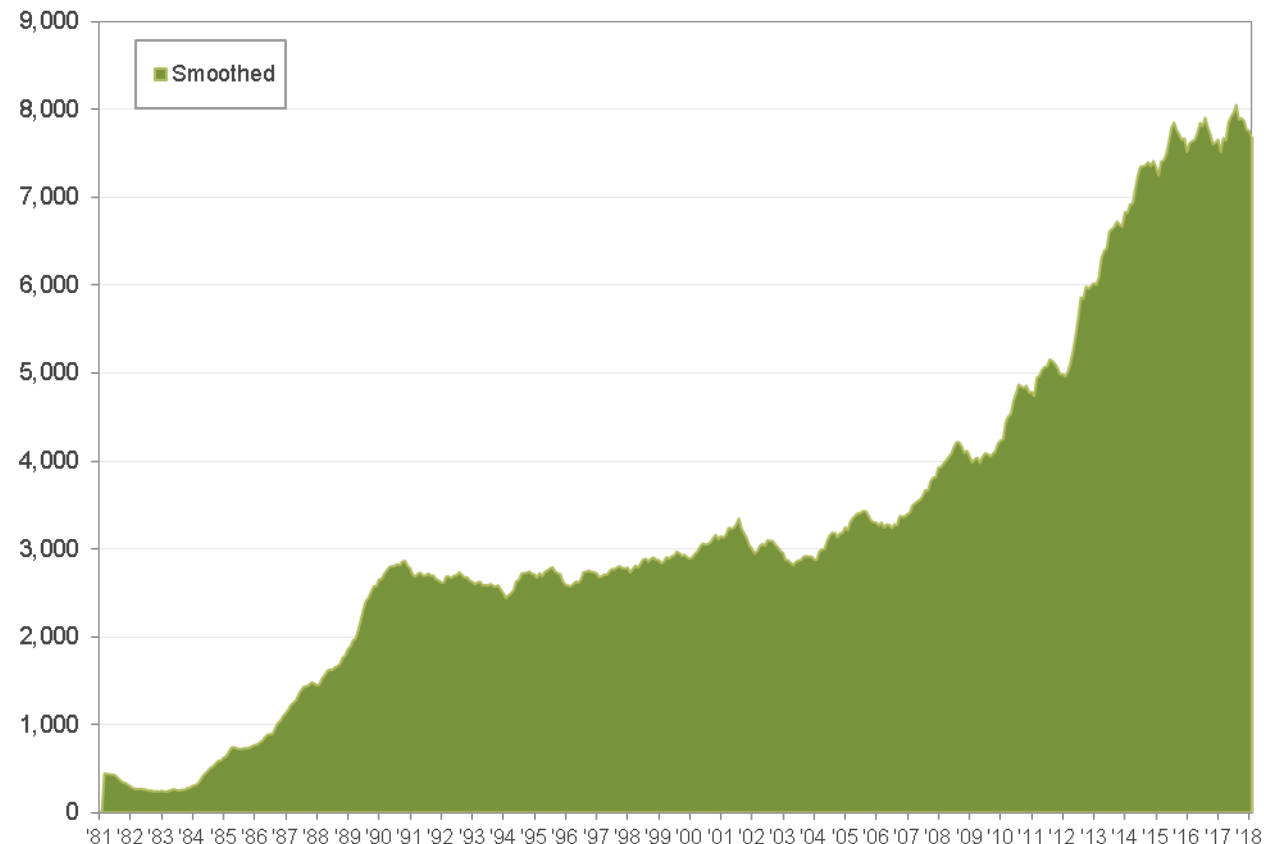

Incident Reporter Distribution

January 2017 – February 2018

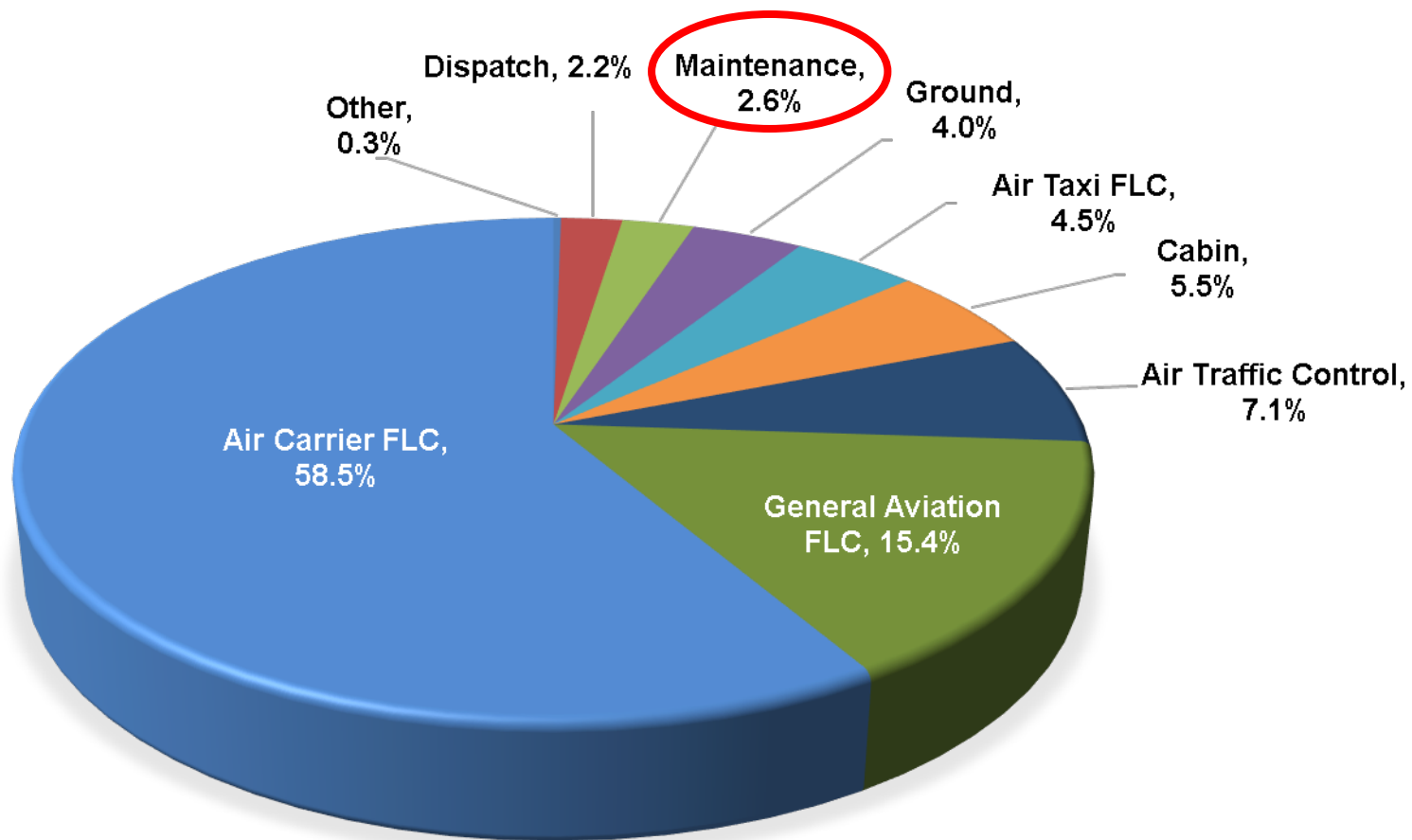

n = 106,961



Source: 100% ASRS Report Data



ASAP Reporting to ASRS

- **ASAP Reporting**

- 243 Total Programs
- 123 Air Carriers/Operators

More programs being added continuously

- **Reporting Groups**

- 117 Pilot
- 57 Maintenance
- 43 Dispatch
- 23 Flight Attendant
- 3 Other (Including Ground Crew, etc.)

ASRS Electronic Transmission Methodology compatible with numerous software platforms

- **Majority are received through Secure Electronic Data Transmission protocols**
- **Paper form submissions continue to be received at ASRS**



27.4% of all reports are matched to unique events in 2017

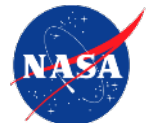

Report Processing Flow

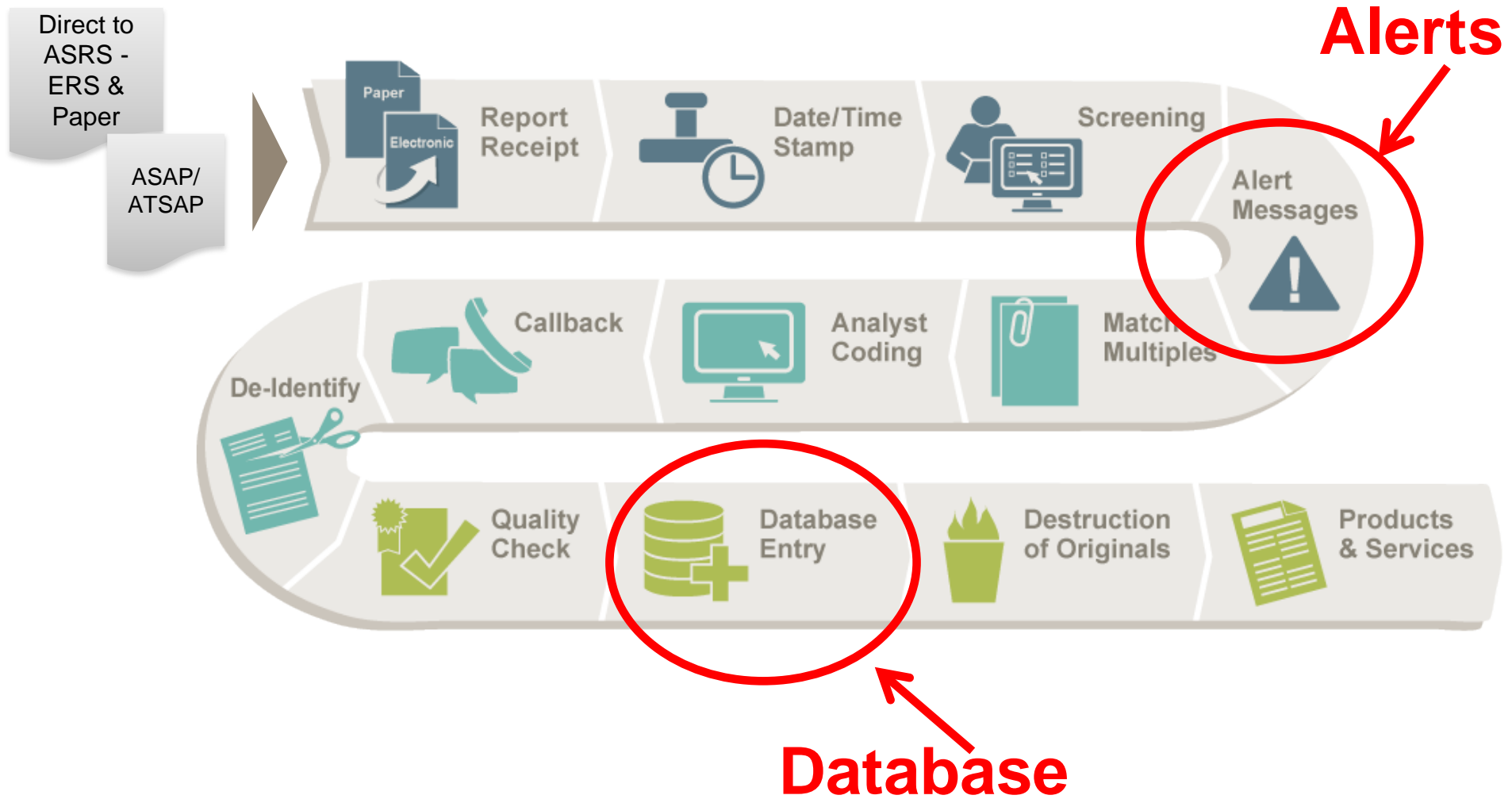

Aviation Safety Reporting System

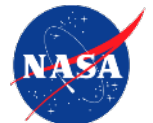

Maintenance Related Alert Messages

■ Maintenance Alert Message Examples

- Possible Virus On Remote Data Station (RDS)
- B767 Cabin Air Quality
- PBE Explosion During Disposal
- Flight Crew Oxygen Mask Issues
- B787 Nose Landing Gear Pin Installation Issue
- B737-800 Loss of Manual and Electric Stab Trim
- Airbus A319 Windshield Inner Pane Structural Failure
- EMB-175 Aileron Anomaly
- A319 Series Nose Gear Steering Anomaly

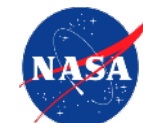

Maintenance Personnel Report Data

100% of Reports Received

- ASRS report data includes Maintenance Personnel incident reports received between Jan 1, 2012 – Feb 28, 2018
- Charts tabulated:
 - Year/Month
 - Aircraft Make Model
 - Event Anomalies



Maintenance Personnel Report Data

100% of Reports Received (Jan 1, 2012 – Feb 28, 2018)

Year

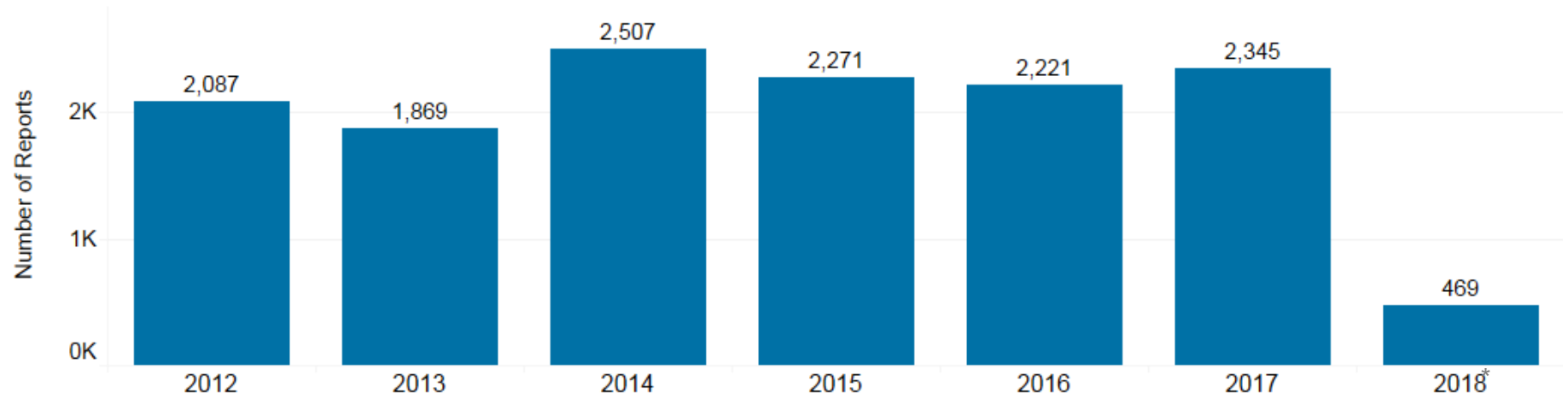

Year and Month

Month of Receive Date	2012	2013	2014	2015	2016	2017	2018*	Grand Total
January	148	124	201	208	156	181	238	1,256
February	193	145	195	210	200	182	231	1,356
March	152	170	239	228	176	173		1,138
April	163	164	195	189	184	179		1,074
May	195	150	245	207	192	220		1,209
June	135	127	215	213	196	223		1,109
July	211	190	199	220	155	204		1,179
August	212	149	219	168	217	203		1,168
September	165	169	192	139	211	188		1,064
October	229	175	218	142	204	200		1,168
November	130	160	201	171	138	199		999
December	154	146	188	176	192	193		1,049
Grand Total	2,087	1,869	2,507	2,271	2,221	2,345	469	13,769

n = 13,769



*2018 data complete through February 28, 2018.
Data references 100% of reports received.

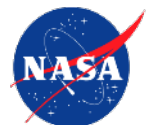

Maintenance Personnel Report Data

100% of Reports Received (Jan 1, 2012 – Feb 28, 2018)

Aircraft Make Models (Top 20)

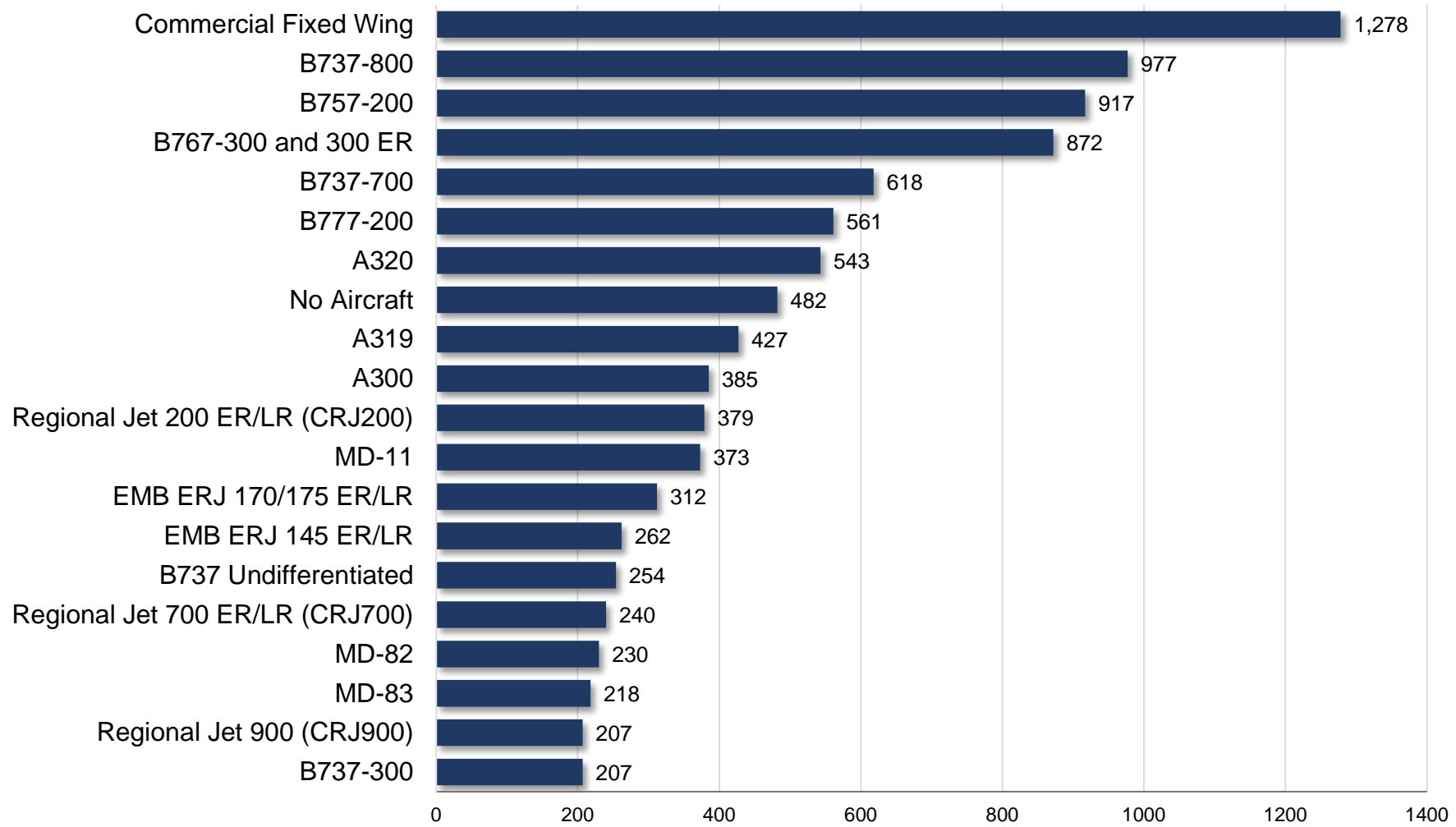

n = 13,769



Data references 100% of reports received.



Maintenance Personnel Report Data

100% of Reports Received (Jan 1, 2012 – Feb 28, 2018)

Event Anomalies	Number of Incidents
Published Material / Policy	11,437
Maintenance Procedure	8,030
Aircraft Equipment Problem - Less Severe	3,843
MEL	1,267
FAR	849
Aircraft Equipment Problem - Critical	236
Ground Event / Encounter with Object	211
Ground Event / Encounter with Vehicle	108
Ground Event / Encounter with Aircraft	68
Clearance	64
Hazardous Material Violation	52
Runway Incursion	44
Aircraft Smoke / Fire / Fumes / Odor	37
Weight and Balance	32
Taxiway Incursion	26

n = 13,769



Categories are not mutually exclusive. Therefore, a single incident may be coded by ASRS analysts as involving more than one anomaly. Data references 100% of reports received.



ASRS Maintenance Personnel Safety Reports

Aircraft Taxi, Tow, or Pushback Gone Wrong – ASRS Review of Maintenance Reports with Unintended Aircraft Movement Outcome



CAST Safety Enhancements (SE002, SE014, SE015, SE026, SE049, SE050, SE051, SE052, SE131, SE169, SE176, SE219, SE221)

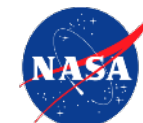

“Aircraft Taxi, Tow, or Pushback Gone Wrong – ASRS Review of Maintenance Reports with Unintended Aircraft Movement Outcome”

- ASRS has received several Maintenance Personnel reports describing Taxi, Tow, or Pushback situations that resulted in undesirable outcome
- Damage to aircraft, equipment and injuries were reported



Unintended Aircraft Movement Outcome

“Runway Excursion”

Technician Reported

*“Control Tower told us that **we were cleared to cross [runway] and expedite as there was another aircraft about to land.** I started to advance engine throttles to expedite runway and saw aircraft getting closer to landing and I heard my taxi partner saying “go ahead, expedite”. . . . **We wanted to cross the runway and clear the path for the aircraft to land (and avoid a collision).** I lost control of the aircraft trying to clear the runway.” (Report 1288221)*



Unintended Aircraft Movement Outcome

“Hangar Impact”

Lead Technician Reported

“... With the engine running and amps at a good level, I started the left engine. I checked the oil pressures and hydraulic pressures. I called ground [control] for clearance to taxi to [FBO ramp]. With clearance I pushed the brake off and started rolling. **I went to turn and had no nose wheel steering. I applied the brakes and had no brakes. I pulled the parking brake handle and had no results.** I was closing in on the hangar in front of me and shut down the engines to avoid damage to the engines. I impacted the hangar right after that. After a bit of time talking to the [airport personnel] I then thought of squat switches as a possible problem and **found the squat switches were manually placed in air mode.**” (Report 1300292)

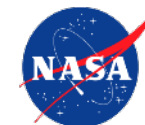

Unintended Aircraft Movement Outcome

“Throw out the anchor!”

Technician Reported

“....aircraft was pushed back from the gate. We performed engine start checks, then started engine. I...called for taxi and we get clearance from Tower. Mechanic Y reports no brakes or steering. I try my brakes, no stop. I then armed thrust reverses and pull back on thrust reverser levers. I saw on the EICAS the thrust reverser did activate but not soon enough to stop us. ... Aircraft damage. Struck against an aircraft.” (Report 1260604)



Unintended Aircraft Movement Outcome

“Tow Team Warning System”

Six Technicians Reported: Tug Driver and Radio Operator, Brake Rider, Left and Right Wing Walkers, and Tail Walker

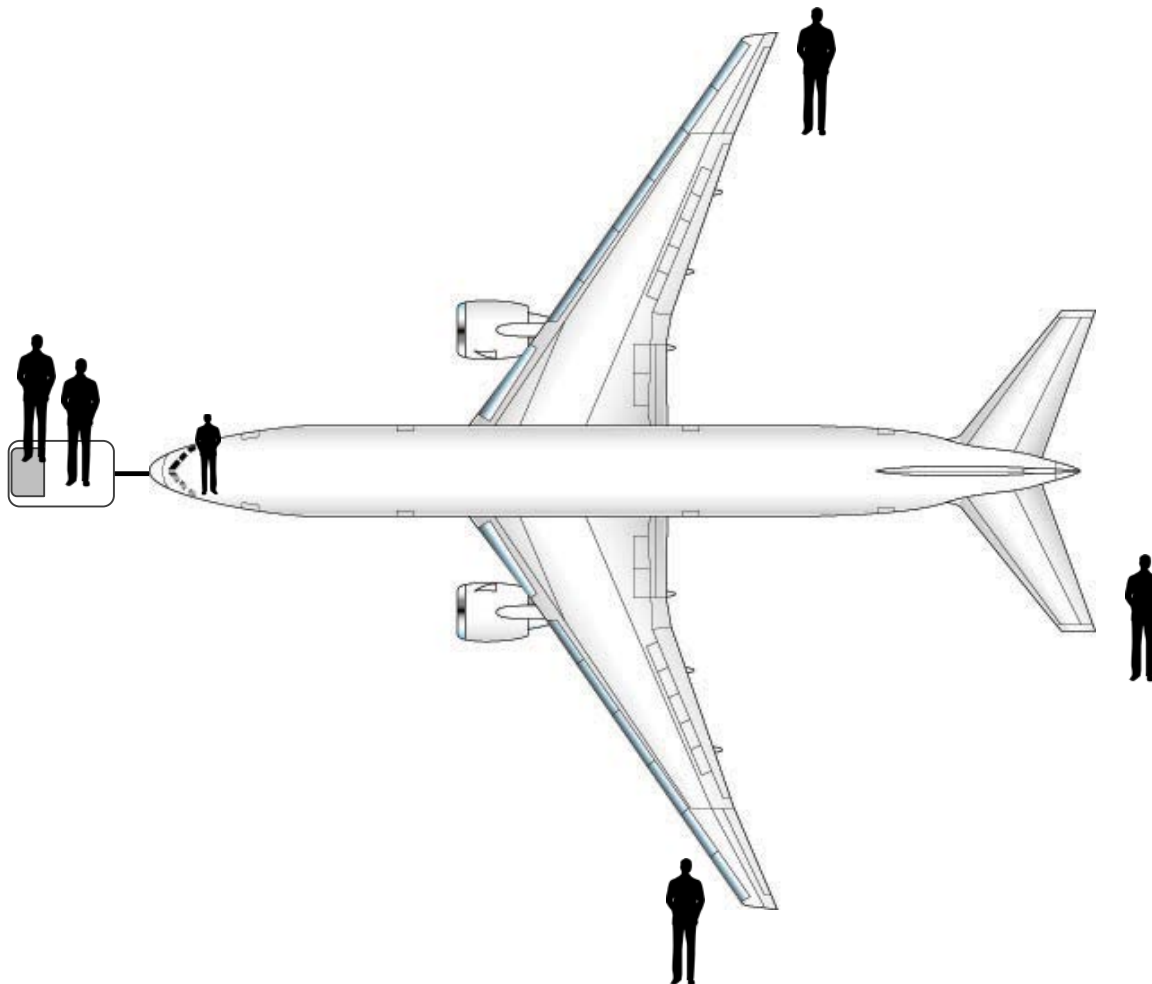

Unintended Aircraft Movement Outcome “Tow Team Warning System”

Technician (Tail Walker): “... We were in process of relocating aircraft and the right wingtip struck the right elevator of [another aircraft]. I did not see that the aircraft was going to hit the other aircraft. I was using the regular wand at the time. Taxi tow warning system failed. I felt rushed and in a time constraint situation. As do all the other team members in the move. I don't think we should be pressured and rushed to accomplish my work in a safe manner. Because they called me to accomplish a move that takes about 1/2 hour I don't think there was enough time afforded me for a safe move.” (Report 1386260)



This graphic is for illustrative purposes only and not to be used for any other purpose.

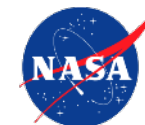

Unintended Aircraft Movement Outcome “Tow Team Warning System”

Technician (Tug driver): “...during pushback struck an aircraft parked behind.... The TTWS is only tested prior to our first move of the day and then left armed until we clock out and leave for the day. The [tug] is shared equipment, and the system was turned off prior to this move. The TTWS should be on and armed once the tug is started. It should not have the ability to be switched off.”

(Report 1386256)

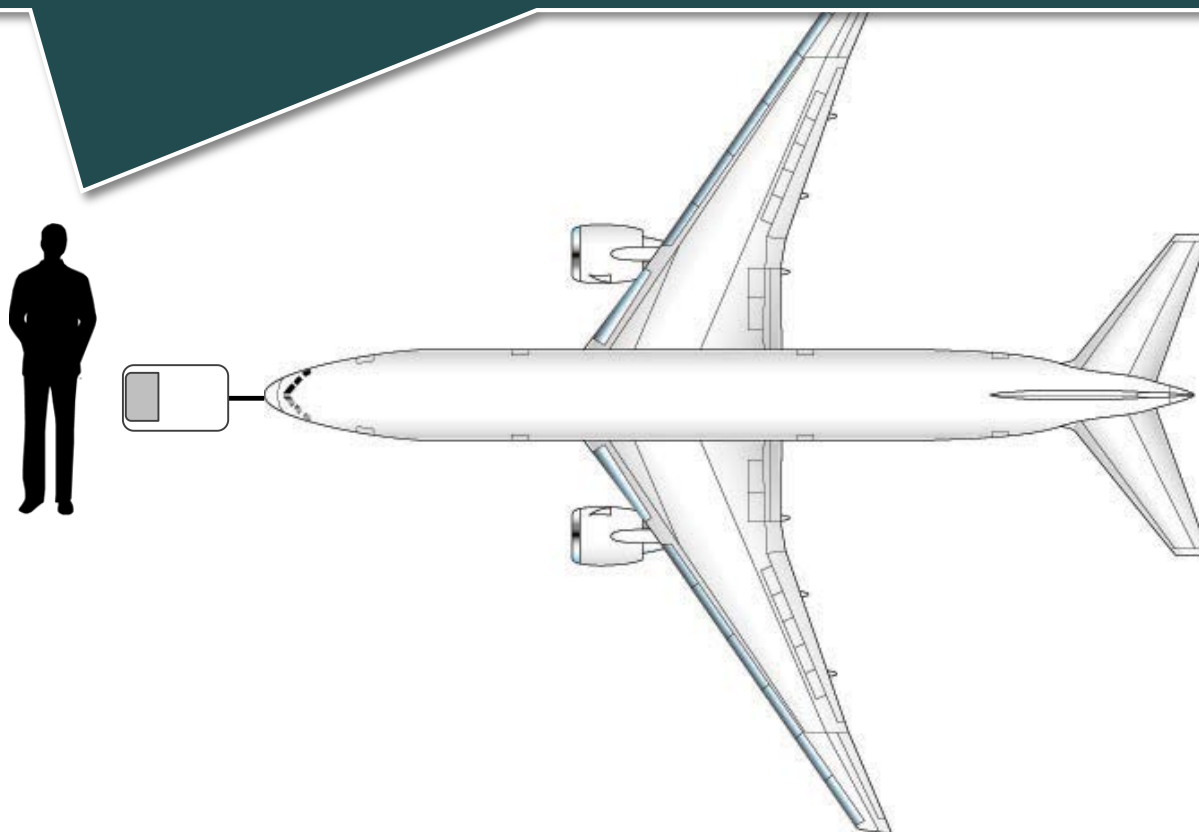

Unintended Aircraft Movement Outcome

“Tow Team Warning System”

Technician (Wing Walker): “... I was wing walking and facing the driver of the tug vehicle but because of the glare on the windshield I could not see the driver's face. I assumed the push was going on as normal. The driver is very skilled and familiar with this area. When I realized he may possibly not see what was going on I pressed the button for the TTWS to warn him that he was getting close. I kept pressing the button as he was not stopping I was not sure if there was failure of his brakes or my wand. It came to the point where I panicked and started waving.... The TTWS system should be tied into the power of the tug so that when the tug is on the system is on. Also maybe a notification on the wand that it is communicating with the tug” (Report 1386261)

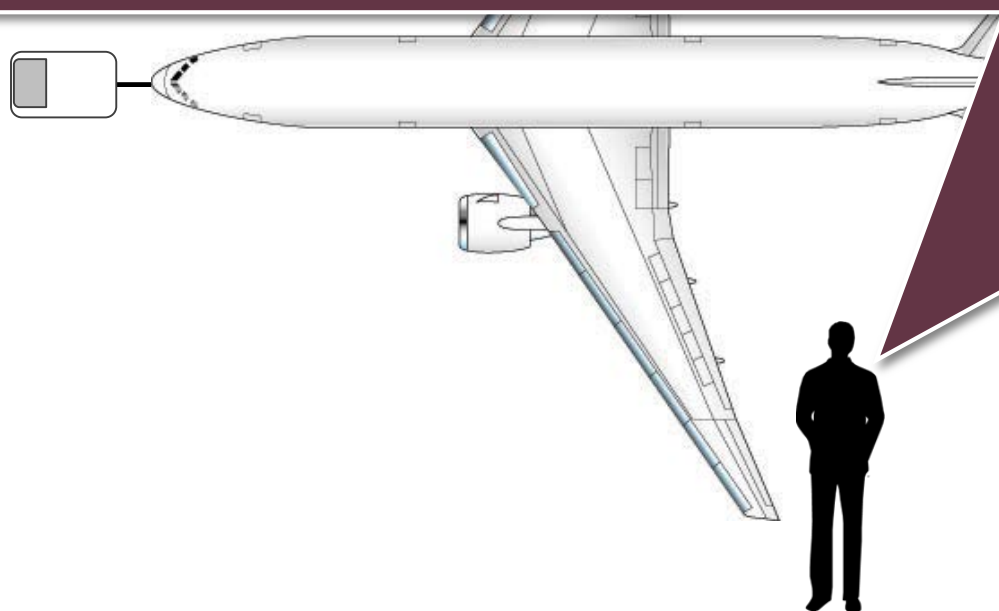

Unintended Aircraft Movement Outcome

“Tail Watch”

Two Technicians Reported

Technician 1 (Brake Rider): “... On our short drive up to the ramp, we noticed the Food Service Truck was still at the aircraft. I commented about it and everyone acknowledged. ... (I) went directly to the cockpit to get the airplane fired up and running while the others get the tug hooked up, pull chocks and ground power. It took a few minutes for me to get the airplane ready and shortly after the call came from the ground crew that they were ready to push. I asked the tug driver ‘are those guys clear’ in reference to the Food Service Truck. The response was we’re clear.... I was told to ‘release brakes’ and give the tower a call. I called and got clearance to reposition and we were given ‘clear to push, KIL0 to the gate’. We started moving and I heard someone yell ‘STOP’. That was the Food Service worker. The tug driver called up, ‘did we hit that truck?’ ... We really should have had our ‘tail watch’ remain with the tug driver until the area was clear....” (Report 1437317)



Unintended Aircraft Movement Outcome

“Tail Watch”

Two Technicians Reported

Technician 2: *“... The north ramp is a very isolated and a dark area with nothing to impede aircraft movement. Normally there isn't any equipment in the area so the food truck was out of the norm. Our normal process is to have a tail watch in the event there's traffic on the service road to block traffic. Our tail watch was at the service road and couldn't contact me quick enough to stop the accident.”* (Report 1437319)





Aviation Safety Reporting System

Home

Contact Us

Program Information

Report to ASRS

Search ASRS Database

Publications/Studies

International

Online Resources

- ASRS Database Online ←
- ASRS Database Report Sets
- Requesting ASRS Data



Confidential. Volun

ASRS captures confidential reports, analyzes the resulting aviation safety data, and disseminates vital information to the aviation community.

CALLBACK

Receive FREE monthly newsletter by email! [\(Please Read\)](#)

[Subscribe to CALLBACK](#)

NOTAM Issues

July 2015, Issue 426

[HTML](#) | [PDF](#)

Select a Form To Submit a Report

- ▶ [General](#) - Pilots, Dispatchers, Others
- ▶ [Air Traffic Control](#) - Air Traffic Controllers
- ▶ [Maintenance](#) - Mechanics
- ▶ [Cabin](#) - Cabin Crew

How to Report Online ▶

- Review proper browser settings, security tips, and provisions.
- ▶ [FAQ for Electronic Report Submission](#)
 - ▶ [Online Security Tips](#)
 - ▶ [Immunity Policy](#)

View Program Briefing ▶

Learn more about ASRS such as report processing and reporting metrics.



<https://asrs.arc.nasa.gov/>

CONTACT INFO

Dennis Doyle
ASRS Program Manager (BAH)
Dennis.J.Doyle@nasa.gov
(408) 541-2831

Becky Hooey, PhD
NASA ASRS Acting Program Director
Becky.L.Hooey@nasa.gov
(408) 541-2827

