

Date of publication xxxx 00, 0000, date of current version xxxx 00, 0000.

Digital Object Identifier 10.1109/ACCESS.2017.DOI

A Millimeter Wave based Sensor Data Broadcasting Scheme for Vehicular Communications

XIAOSHA CHEN¹, SUPENG LENG¹(Member, IEEE), ZUOYIN TANG², KAI XIONG¹ and GUANHUA QIAO¹.

¹School of Information and Communication Engineering, University of Electronic Science and Technology of China, Chengdu 611731, China

²School of Engineering and Applied Science, Aston University, Birmingham B4 7ET, U.K.

Corresponding author: Supeng Leng (e-mail: spleng@uestc.edu.cn).

This work was partly supported by the Science and Technology Program of Sichuan Province, China (No.2019YFH0007), the Fundamental Research Funds for the Central Universities, China (ZYGX2016Z011), the joint fund of the Ministry of Education of China and China Mobile (MCM 0160304), and the EU H2020 Project COSAFE (MSCA-RISE-2018-824019)

ABSTRACT In recent years, vehicles are becoming smart with the aid of various onboard sensing, communication and computing capability, which is helpful to improve road safety and driving experiments. With data fusion technique, a vehicle can even increase the driving safety by obtaining sensor data from other vehicles. The millimeter Wave (mmWave) based Vehicle-to-Vehicle (V2V) communication technology has become a promising technology to transmit sensor data in huge size such as video streams. However, the high radio frequency of mmWave makes it vulnerable to obstacles. Furthermore, the directional propagation property is not efficient to broadcast information among vehicles. In this paper, we propose a broadcasting scheme to guarantee each vehicle to get the sensor data of all other vehicles. Head vehicles are selected to gather the information on the environment and decide those transmission vehicles and receiving vehicles in each time slot. A graph-based routing selection algorithm is proposed with relatively low complexity. Moreover, the upper bound of broadcasting delay for one dimensional platoon is analyzed based on the network calculus theory. Simulation results indicate that the proposed scheme has faster delivery rate compared to the traditional First-In-First-Out (FIFO) scheme. The maximum broadcasting delay of the proposed scheme is less than the traditional schemes about 30% in different scenarios.

INDEX TERMS Beamforming, Broadcast, mmWave, Sensor data, V2V communication

I. INTRODUCTION

With the rapid development of sensor technology and wireless communication, Internet of Vehicle (IoV) has become one of the key technologies to realize the Advanced Driver Assistant System (ADAS) and self-driving [1] [2]. In a complicated driving environment, smart vehicles need to collect a massive amount of sensor data (such as video stream with data rate approximate 1GB/s) and complete many operations of data fusion, information exchange and data processing with very low latency. However, the advanced technologies such as edge computing and fog computing cannot be fully utilized due to the limited bandwidth resources [3] [4] [5].

As a promising technology, mmWave communication can provide very high data transmission rate and satisfy the requirement of low latency by leveraging the mmWave band (10 GHz - 300 GHz) [6]. But the propagation of the mmWave

is directional, which makes it infeasible to transmit in a broadcast manner. As a result, a multi-source broadcasting scheme based on directional transmission is required for the exchange of sensor data among vehicles. However, most of the existing work on V2V mmWave mainly focuses on the point-to-point transmissions case analysis. For example, the V2V beamform alignment scheme proposed in [7] and [8] will have a considerable delay in the sensor data broadcasting scenario because of the flooding problem.

Reliability is another critical problem in sensor data sharing. Vehicles should always share their sensor data for the improvement of driving, which means the broadcasting scheme should not rely on any infrastructures, such as Road Side Unit (RSU) [9]. Moreover, literature [9] only considers broadcasting the information from RSU to vehicles, but ignores the scenario where vehicles share their data with each other.

Although transmission conflict can be detected [10] [11] in a channel contention based wireless sensor networks, this feature also leads to the hidden station problem and the expose station problem. MmWave can overcome these problems because of its directional propagation property, but vehicles in communication is still unable to be detected. As a result, unless scheduling transmissions in advance, vehicles have to use RTS/CTS handshakes to avoid conflict [12], which will generate lots of control signals for sensor data broadcasting. Therefore, the transmission scheme applied in this paper work in a centralized scheduling manner.

As sensor data are generated periodically, once a broadcasting decision is made, the delivery paths can be used repeatedly until the network connections are changed. In this paper, we propose a sensor data broadcasting scheme under the control of a head vehicle. The head vehicle collects the information about the communication environment and make broadcasting decisions. As mmWave channels suffer a lot to the mobility of vehicles, without loss of generality, in this paper it is assumed that the related location between vehicles is fixed during the broadcasting of one message.

To deal with the ultra-high data rate of the mmWave communication, we propose the Graph-Based Routing Selection (GBRS) algorithm to determine the broadcasting paths. The GBRS algorithm also works in the one-way multi-lane scenario. Furthermore, we analyze the computational complexity of the algorithm and determine the upper bound of broadcasting delay for 1D vehicular platoon based on the network calculus theory. The main contributions of this paper are summarized as follows,

- Different from the existing single source broadcasting schemes, we propose a directional transmission based multi-source broadcasting framework for sensor data fusion through mmWave links. Some practical problems are considered in the framework, such as the storing speed limitation of the hardware, the limited number of Radio Frequency (RF) chains, and so on.
- We propose the broadcasting scheme with a very short process delay. Moreover, the algorithm can be easily run with parallel threads, which makes the decision on the broadcasting scheme even faster.
- Regarding the common case in the highway scenario, the upper bound of the sensor data broadcasting delay for 1D platoon is analysed. The numerical results can verify the analysis model.

The rest of this paper is organized as follows. Section II presents the related work. Section III introduces the sensor data broadcasting framework and the system model, and an optimization problem is formulated in section IV. Section V presents the detail of the GBRS algorithm and the analysis results. Simulation results are illustrated and discussed in section VI. Finally, section VII concludes this paper.

II. RELATED WORK

Due to the high dense of sub-6GHz bands used by the traditional wireless system, the 5G reseach groups plan to

use the underutilized mmWave bands [13]. The mmWave communication has been proposed as a promise wireless connection technology for Vehicle-to-Everything (V2X) [14] [15]. A vehicular mmWave technology has been exploited by the European Commission [16]. The multiply bands and links mmWave vehicular network provides opportunity to address some challenges in the high mobility vehicular scenarios [17], [18]. In [19], the influences of the road conditions and vehicle velocity are considered in the mmWave vehicular network. In [20], the authors used 79 GHz V2V to analyze the interference in 3-lane highway. The side-lanes are suffered the mainly interference.

However, the line-of-sight (LOS) communications are always needed in the mmWave links. The mmWave propagation channels are significantly different from microwave channels because of the smaller signal wavelengths. The free-space pathloss of mmWave channels varies inversely with the squared wavelength [6]. It is a huge challenge of the high dynamic vehicular environment [21]. [22] modeled the problem of beam selection in mmWave vehicular systems as the Multi-Armed Bandit problem. But the proposed algorithm is still large time consuming. [23] proposed a Manhattan distance-based pathloss model for mmWave urban V2I communications. Their model revealed that the Manhattan distance-based pathloss models are quite different from the Euclidean distance-based pathloss models. C. Shao et. al analyzed the influence of the connectivity of IoV on the performance of the MAC protocols in [24].

Broadcast protocols in IoVs is a very important wireless application for road safety. S. N. Shaikh and S. R. Patil design a vehicular safety message broadcasting protocol for 2.4GHz radio frequency channel in [25]. [26] selected the next hop as far as possible to minimize the overhead of communication. However, the protocol is only designed for the emergency messages delivery via V2V. In [9], the authors proposed a multi-hop clustering scheme to maintain the stability of the cluster head. Y. Niu et. al proposed an efficient multicast scheduling scheme for mmWave small cells based on a multi-level antenna codebook in [27]. W. Mei, Z et. al design a confidential mmWave based broadcasting scheme from transmitter to two receivers which can guarantee the message security in [28]. Nevertheless, all broadcast schemes are dedicated to the scenario with only one single source, which are not satisfied for the high data rate vehicular sensor data sharing.

III. SYSTEM MODEL

We will introduce the mmWave based broadcasting scheme and the mmWave time sequential beamforming approach. Furthermore, the model of the mmWave link is discussed in this section.

A. MMWAVE BASED BROADCAST

The broadcast scenario is illustrated in Figure 1. In this paper, we call single lane scenario as 1D vehicular platoon where all vehicles in the same platoon have identical speed and direc-

tion. And the scenario illustrated in Figure 1 is a 2D vehicular platoon. Adjacent vehicles are connected by mmWave links. The head vehicle will decide the transmission sources and destinations and transmit contents of each transmission in each time slot. Once the broadcast scheme is determined, it will be performed periodically until the environment is changed.

As vehicles generate a huge amount of sensor data periodically, broadcasting this data for each vehicle to the remaining vehicles requires ultra-high data rate support from the physical layer. Conventional communication method like DSRC is dedicated for the link in 5-6 GHz with data rate less than 10 Mbps. Consequently, for broadcasting with DSRC or other traditional techniques, vehicles lay in the interference range of the other vehicles and one vehicle has to wait to transmit until the transmitting vehicle in the same communication range finishes. Moreover, the low data rate will consume dramatic time to transmit the sensor data, which makes it infeasible to broadcast sensor data with traditional communication techniques.

Although the conventional techniques are not suitable for the sensor data broadcasting, the communication methods still have advantages in the system control process. The proposed mmWave broadcasting scheme needs to gather the environment information and broadcast the calculate results with the control messages. Because of the short wave length of the 60 GHz mmWave, the broadcasting signals will be blocked by the barriers like vehicles and buildings. As the control messages are usually very short, transmitting the control messages with mmWave will need multi-hop without obviously performance increase for the data transmission delay. As a result, the proposed system adopts conventional CSMA/CA based MAC protocol in low radio frequency to transmit the control messages.

The flow of the system is illustrated in Figure. 2. After the selection of the head vehicle, all of the vehicles will measure the mmWave links to their neighbours after receiving the measurement control message from the head vehicle. Then, the head vehicle will ask for the mmWave link information from each vehicle. The head vehicle will conduct the broadcasting scheme after gathering the environment conditions and send the result to the other vehicles. Those vehicles in the platoon will keep broadcasting the sensor data according to the calculated result until the environment is changed. We assume that all the vehicles in a platoon are in the same communication range for control message communication. As a result, we do not consider the hidden node or the exposed node problems. When a vehicular platoon decides to share the sensor data between each vehicle, a head vehicle is selected at the beginning. If there is an RSU, the job of the head vehicle can be performed by the RSU theoretically. However, as the vehicles are usually moving in relatively high speed, the RSU will only stay in the vehicular platoon for a very short period. So, the benefits brought by the RSU cannot make the system choose the RSU as the broadcast manager by re-measuring the mmWave links of each vehicle,

re-calculating and re-transmitting the broadcast scheme. The selection of the head vehicle can be based on the compute capability and geographical position of each vehicle. The head vehicle utility function can be expressed as

$$U_{\text{head}}(v_i) = k_1 cp_i - k_2 \mathbb{E}[d(v_i)], \quad (1)$$

where cp_i is the compute capability of vehicle i and $\mathbb{E}[d(v_i)]$ is the average distance between vehicle i and the other vehicles in the same platoon. $k_1 > 0$ and $k_2 > 0$ are the weight factors of the two parts, which can be adjusted practically. The platoon will select the vehicle with the highest utility function as the head vehicle because it has more computation resources and in the center location of the platoon with the short communication delays.

When a vehicle receives the channel measurement control message from the head vehicle, it will determine its neighbours and the data rate of each mmWave link to its neighbours. After the measurement, the head vehicle will ask the channel information of each vehicle sequentially. After receiving all mmWave channel information of each vehicle, the head vehicle starts to calculate the optimize mmWave beamforming and data routing scheme. Then the head vehicle transmits the result to the other vehicles. The platoon will perform the broadcast scheme until the environment is changed, such as vehicles in the platoon changed or the broadcast speed becomes lower than the threshold because of the mmWave channel states changing.

According to [29], given a modulation and coding scheme (MCS) such as MCS 20, the data rate for 60 GHz mmWave link can achieve 4158 Mbps. The ultra-high data rate for the mmWave link makes the speed of the storage hardware become the system bottleneck. If a vehicle transmits n different packets simultaneously, the speed of the storage hardware needs to be $n \cdot r$, where r is the data rate for each mmWave links. Even the Double Data Rate 4 Synchronous Dynamic Random-Access Memory (DDR4 SDRAM) cannot satisfy this requirement [30]. To control the cost and make the system feasible, we let each vehicle transmit the same content to different vehicles at the same time.

We assume that all of the vehicles use the same MCS and the IEEE 802.11ad protocol, which means that each mmWave link has similar data rate and suffers little from the interference. In addition, the length of the sensor data generated by each vehicle is assumed has equal length. Under these assumptions, the system can decide the length of a time slot easily. Consequently, in the remaining of this paper, the system is studied in a discrete time domain.

B. MMWAVE BEAMFORMING MODEL

This subsection will present the mmWave beamforming system in this paper. The channel models and assumptions will be introduced.

This paper assumes that the frequency of the mmWave is above 60GHz. Therefore, the mmWave channel has high path loss and small wavelength. We consider the transmit

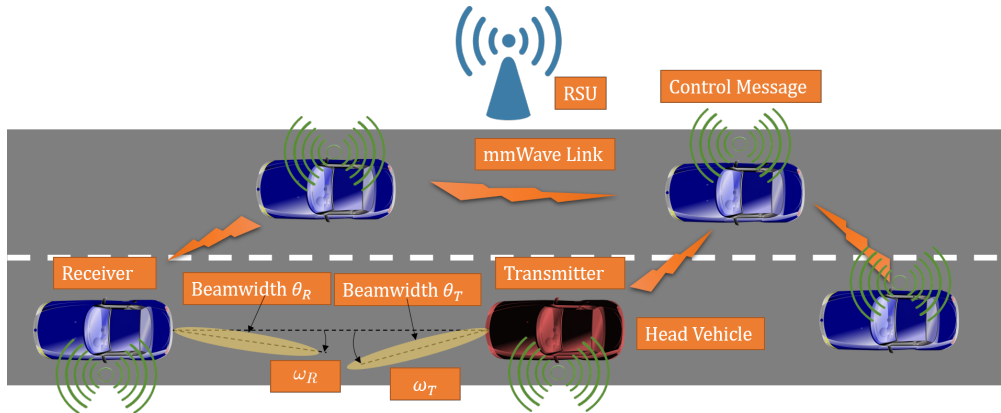

FIGURE 1. Scenario of the mmWave based sensor data broadcasting.

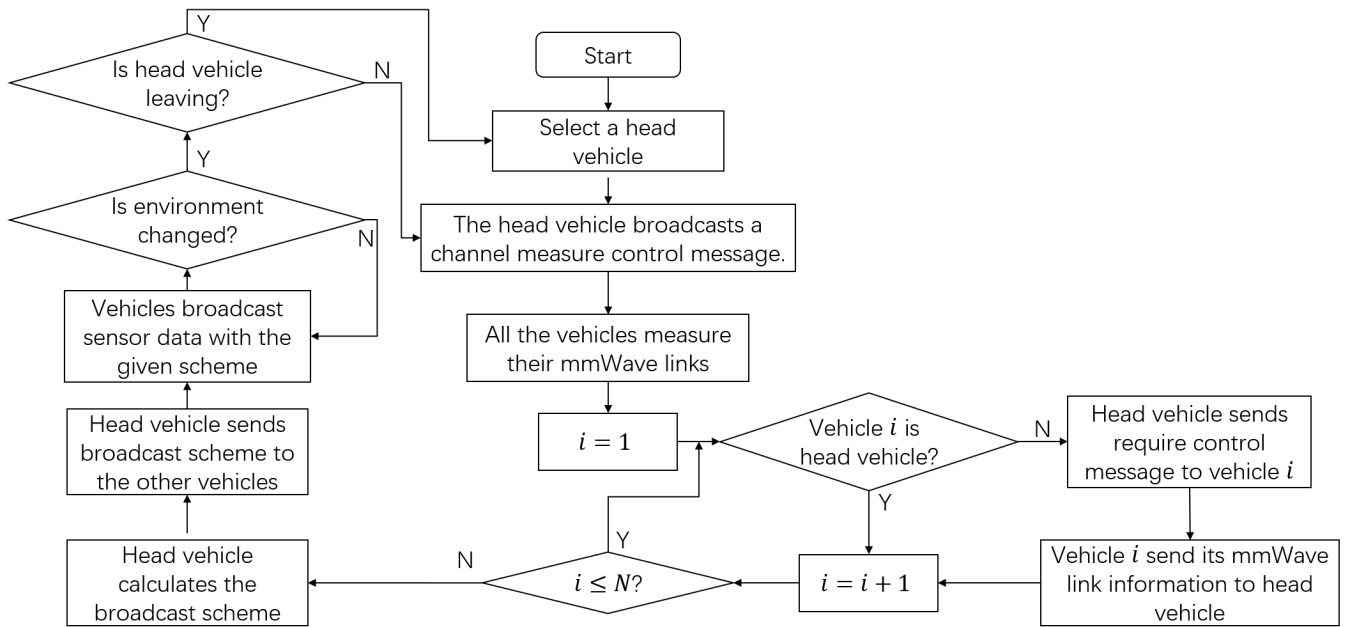

FIGURE 2. Flowchart of the proposed system.

vehicle as the personal base service set (PBSS) central point (PCP), which is defined in IEEE 802.11ad network. Transmit vehicles perform the coordination functions to minimize the interference. As a result, receive vehicles are not seriously affected by the interference. Let G_T , G_R and r_{TR} be the antenna gains of the transmit vehicle, receive vehicle and the distance between the transmitter and receiver, respectively. Then, the average received signal power can be expressed by

$$P_R = G_T + G_R + P_T - X_\sigma - PL_0 - 10\alpha \log_{10} \left(\frac{r_{TR}}{r_0} \right) \quad (2)$$

where P_T , PL_0 and α are the transmission power, the reference path loss at 1 meter and the path loss exponent, respectively. r_0 is the reference distance of 1 meter and the X_σ is a zero mean Gaussian distributed random variable,

whose standard deviation is σ and unit is decibel. The path loss is obtained by the Friis transmission formula:

$$PL = 10 \log_{10} \left[\left(\frac{4\pi}{\lambda} \right)^2 r_{TR}^\alpha \right] \quad (3)$$

where λ is the wavelength of the signal. As for the G_T and G_R , we can calculate the absolute value of them, which is denoted as g_t and g_r , respectively. And then transform them into decibel values. The absolute values can be obtained by the widely used antenna radiation pattern model [31]:

$$g_t(\omega_T, \theta_T) = \begin{cases} \frac{2\pi - (2\pi - \theta_T)\eta}{\theta_T}, & \text{if } |\omega_T| \leq \frac{\theta_T}{2} \\ \eta, & \text{otherwise} \end{cases} \quad (4)$$

$$g_r(\omega_R, \theta_R) = \begin{cases} \frac{2\pi - (2\pi - \theta_R)\eta}{\theta_R}, & \text{if } |\omega_R| \leq \frac{\theta_R}{2} \\ \eta, & \text{otherwise} \end{cases} \quad (5)$$

where ω_T and ω_R represent the angles deviating from the strongest path between the transmitter and the receiver, respectively. And θ_T and θ_R represents the beamwidth at the transmitter and the receiver, respectively. $\eta \in [0, 1)$ is the side lobe gain. In the 60GHz frequency, $\eta \ll 1$ because θ_T and θ_R are very small. Figure. 1 illustrates the meaning of these symbols. If P_R is greater than the receiver sensitivity, then the receive vehicle can receive the data from the transmitter. Given a certain MCS, the data rate of the mmWave link can be obtained according to [29].

In a vehicle platoon, the set of vehicles is denoted as $\mathcal{V} = \{v_1, \dots, v_N\}$, where N is the size of set \mathcal{V} . Each vehicle is equipped with M antennas. And each vehicle can maintain $R_F (< M)$ RF chains and each RF chain supports one stream and each stream transmits sensor data to a receiver. To control the cost, the system adopts half-duplex channel, which means vehicles cannot transmit and receive at the same time. Perfect knowledge of the channel state information (CSI) is assumed at the transmitters, which is a common assumption in mmWave MIMO systems [32]. Because of the storage hardware write speed limitation, we assume that receive vehicle j has only one RF chain with one RF combiner. Consequently, a receiver can only receive data from a single transmitter. Moreover, we assume that each transmit vehicle sends identical content to different receivers because of the limited speed of the storage hardware. A typical transmission case is shown in Figure. 3.

IV. BEAMFORMING AND BROADCASTING PROBLEM

In this section, we will present the problem that how the head vehicle determines the beamforming and broadcasting scheme. There are two sub-problems of the optimization, one is which vehicles should transmit and transmit to which neighbours at each transmission, the other is which packet should be transmitted by each transmit vehicle.

Because the whole broadcast process is determined in a centralized form, the system does not need to follow some rules that widely adopted in the conventional network, such as the First-In-First-Out (FIFO) rule on each router. To make the broadcasting faster, we will optimize the packet selection. There will be several packets in the send queue for each vehicle, optimized selection of the transmit packet will increase the system performance.

We assume that the sensor data generated by each vehicle have identical length, which is denoted by L . We call the packet generated by vehicle i as packet i . The mmWave links and the vehicles in a vehicular platoon form a directed graph, \mathcal{G} . The edge set of graph \mathcal{G} is $\mathcal{E} = \{e_1, e_2, \dots, e_E\}$, where $E = |\mathcal{E}|$ is the number of edges in graph \mathcal{G} . The head node and the tail node of edge e_i is $h(e_i)$ and $t(e_i)$, respectively.

To formulate the broadcast process, we use a $E \times U \times N$ tensor \mathbf{T} to record the whole process, where U is the maximum

transmit times. We can get U by assuming only one vehicle transmits one packet in each transmission, then $U = N \times (N - 1)$. $T_{j,t}^i$ is an indicator that packet i is transmitted on edge e_j at the t -th transmission, 1 is transmitting and 0 is not transmitting. As a result, \mathbf{T}^i is a $E \times U$ matrix which records the broadcast process of packet i . Furthermore, each column of \mathbf{T}^i , which is represented by \mathbf{T}_t^i , is the transmission scheme for packet i at t -th transmission.

One vehicle cannot transmit to more than R_F vehicles simultaneously. We assume each vehicle has the same R_F RF chains. Therefore, the optimization problem should satisfy

$$\sum_{h(j)=v, t=\tau} T_{j,t}^i \leq R_F, \forall v, \tau. \quad (6)$$

In addition, to control the interference and the hardware cost, we assume that each receive vehicle only can receive from one transmitter, which can be expressed as

$$\sum_{t(j)=v, t=\tau} T_{j,t}^i \leq 1, \forall v, \tau \quad (7)$$

Moreover, each vehicle can only transmit the same packet at each transmission. At t -th transmission, packet i transmitted by vehicle v is $\sum_{h(j)=v} T_{j,t}^i$, and there is at most one of these summations can be larger than zero. As a result, this constraint can be expressed as

$$\sum_{i=1}^N \text{sgn} \left[\sum_{h(j)=v} T_{j,t}^i \right] \leq 1, \quad (8)$$

where $\text{sgn}(x)$ is the sign function which equals 1 if $x > 0$, equals 0 if $x = 0$ and equals -1 if $x < 0$.

Because of the half-duplex channel assumption, vehicles cannot transmit and receive at the same time, which means

$$\left(\sum_{h(j)=v, t=\tau} T_{j,t}^i \right) \times \left(\sum_{t(j)=v, t=\tau} T_{j,t}^i \right) = 0, \forall \tau, v. \quad (9)$$

The transmission will finish if all vehicles in the platoon receive all sensor data from the other vehicles, which can be expressed as

$$\sum_{t=1}^U \left(\sum_{t(j)=v, k=i} T_{j,t}^k \right) = 1, \forall v, \forall i \neq v \quad (10)$$

Because that data rates of each mmWave link are assumed identical, we only need to minimize the maximum transmission times. We can express this by $\max_{t=1 \dots U} \left\{ t \cdot \text{sgn} \left[\sum_i \sum_j T_{j,t}^i \right] \right\}$. And the final optimization problem for the beamforming and broadcasting scheme can be wrote as

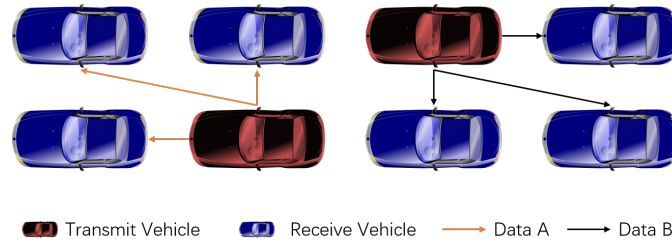

FIGURE 3. A transmitter can send the same messages to multiple receivers while receivers can only receive messages from one transmitter.

$$\begin{aligned} & \underset{\mathbf{T}}{\text{minimize}} && \max_{t=1 \dots U} \left\{ t \cdot \text{sgn} \left[\sum_i \sum_j T_{j,t}^i \right] \right\} \\ & \text{s.t.} && (6), (7), (8), (9), (10) \\ & && T_{j,t}^i \in \{0, 1\}, \forall i, j, t \end{aligned} \quad (11)$$

As shown in (11), the optimization problem is a non-linear integer programming problem, which is an NP-complete problem. It is infeasible to solve this problem in an on-line ultra-high data rate scenario. Moreover, the shape of the platoon is usually linear, which can help the head vehicle make decisions but not considered in the optimization problem. To assist the head vehicle to determine the broadcasting scheme fast enough for the system requirement, we propose the Graph-based Routing Selection (GBRS) algorithm in the next section.

V. GRAPH-BASED ROUTING SELECTION ALGORITHM

In this section, we propose a centralized routing and beamforming algorithm for the head vehicle, which is called Graph-based Routing Selection Algorithm (GBRS). The GBRS algorithm has low computational complexity which makes it suitable for the ultra-high data rate scenario. The main idea of the GBRS algorithm is each vehicle determines the value of its transmission utility function and which packet in the transmit queue will be sent to which of its neighbours if it is selected as transmit vehicle. Then the transmit-receive pair will be determined for current transmission. After several transmissions, all of the packets should arrive all vehicles, which means a broadcast period finishes. Moreover, we analyze the performance of the GBRS algorithm in this section.

A. PACKET SELECTION STAGE

The most critical challenge of the packet selection is determination the definition of the transmission utility function. Figure. 4 (a) shows the impacts of different vehicles. Vehicle A and vehicle B want to transmit packet i . However, because there are three vehicles already have the packet i , the transmission of vehicle A only influence two vehicles but vehicle B can influence five vehicles. Consequently, the transmission utility function of vehicle B should greater than vehicle A.

Figure. 4 (b) shows another common scenario at the packet selection stage. Vehicle A wants to transmit packet i to other vehicles and vehicle B wants to transmit packet j . However, the position of vehicle B is closer to the center of the platoon than the position of vehicle A. In the conventional FIFO routing system, packet j on vehicle B will finish early. To minimize the maximum broadcast delays for each packet, the transmission utility function should give higher priority to vehicle A.

Based on the above considerations, we define the transmission utility function as

$$U_T(i) = \max_{p \in Q_t^i, s \in \mathcal{P}_{\text{Tr}_p^i}(T_i^p)} \{S(s, p, i) + k_3 \text{Tr}_p^i + k_4 W(p, i)\} \quad (12)$$

where Q_t^i is the packet set of the packets in the transmission queue of vehicle i . $\mathcal{P}_a(\mathcal{S})$ is the permutations of set \mathcal{S} with a elements and the ordering is not considered, e.g., $\mathcal{P}_2(\{a, b, c\}) = \{\{a, b\}, \{a, c\}, \{b, c\}\}$. $\text{Tr}_p^i = \min\{|\mathcal{T}_i^p|, R_F\}$, where \mathcal{T}_i^p is the set of candidate receive vehicles for packet p of vehicle i , which can be obtained by $\mathcal{T}_p^i = \mathcal{N}^i \cap \bar{\mathcal{W}}_p$, where \mathcal{N}^i is the set of the neighbours of vehicle i and \mathcal{W}_p is the set of vehicles with packet p in the platoon, $\bar{\mathcal{S}}$ is the complement of set \mathcal{S} . $S(s, p, i)$ is the maximum shortest distance to the other of the vehicles without p for the packet p on vehicle i , which can be obtained by a modified Dijkstra algorithm called Multi-Source Shortest Distance (MSSD) Algorithm which is illustrated as Algorithm 1. $W(p, i)$ is the waiting time for packet p on vehicle i . k_3 and k_4 are weight factors, which can be determined practically.

When calculating the transmission utility function of vehicle i , the transmission packet and the receive vehicles can also be determined. Then, if vehicle i is selected as a transmitter, it will transmit to the corresponding determined receivers.

B. ROUTING SELECTION STAGE

After evaluating the utility function and selecting the transmission packet and beamforming direction of each vehicle, this subsection will determine which vehicle should transmit and which should receive.

To avoid the situation where one vehicle with high utility function transmits many times while its neighbours only can

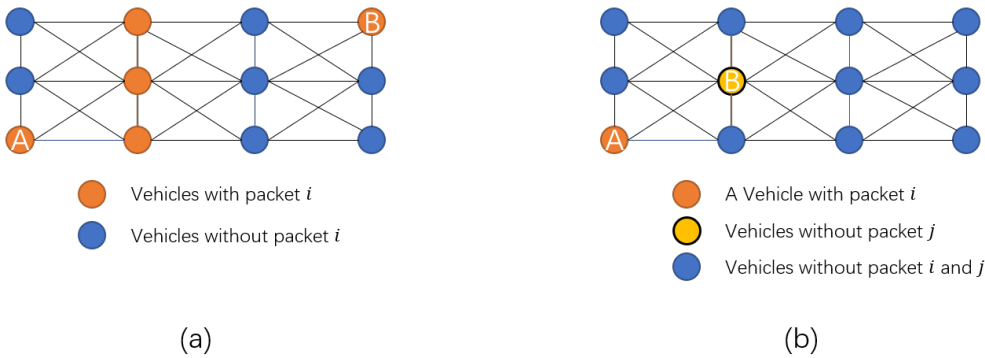

FIGURE 4. Two typical scenarios at packet selection stage.

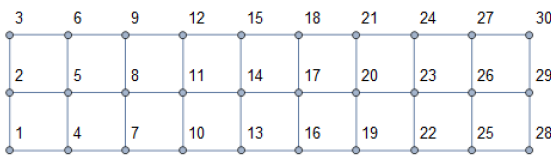

FIGURE 5. Indexes of vehicles in a platoon with grid layout.

wait to send packets, the system counters the waiting time for each vehicle. It will first select the vehicles with the highest waiting counter, then select the vehicles according to the values of utility functions.

To broadcast all sensor data of each vehicle to all vehicles in the platoon, the algorithm needs to record the distribution of the packet with a variable \mathbf{D} , which is a $N \times N$ matrix. $D_{ij} = 1$ means vehicle i has packet j , otherwise $D_{ij} = 0$. When the system finishes one transmission, \mathbf{D} will be updated. Another transmission will start again, until all of the elements in \mathbf{D} become 1. The whole GBRs algorithm is illustrated as Algorithm 2.

C. PERFORMANCE ANALYSIS

1) Computational Complexity

We will analyse the computational complexity of the computing process of each transmission. First, the calculation of the transmission utility function uses the MSSD algorithm. Because the MSSD algorithm is a modified Dijkstra's algorithm, the computational complexity of the MSSD algorithm is $O(n^2)$, where n is the number of vehicles. Vehicles should calculate all the permutations of the neighbours. Therefore, the complexity is $O\left(\binom{|\mathcal{T}_i^p|}{\text{Tr}_p^i} \cdot n^2\right) = O(n^2)$, because $|\mathcal{T}_i^p|$ and Tr_p^i are not related to N . Each vehicle should obtain the value of transmission utility function, so the complexity is $O(n^3)$.

In the transmission determination process, each loop will pick a vehicle, and the loop will finish when all vehicles are picked. In each loop, there are only some set operations with computational complexity $O(1)$. As a result, the computa-

Algorithm 1 Multi-Source Shortest Distance Algorithm

Input: $i, p, s, \mathcal{G}, \mathcal{W}_p$.

Output: Maximum of the shortest distance for s in \mathcal{G} less than ∞ .

```

1: Initialisation:  $D = [\infty, \dots, \infty]$  with  $N$  elements.,  $\mathcal{V} = s$ 
2: Delete  $\mathcal{W}_p$  in  $\mathcal{G}$ .
3:  $D(s_i) := 0, \forall s_i \in s$ ,
4: while  $|\mathcal{V}| < N - |\mathcal{W}_p|$  do
5:    $n = -1, d = \infty$ 
6:   for All nodes  $v$  in  $\mathcal{G}$  but not in  $\mathcal{V}$  do
7:     for All nodes  $s_i$  in  $\mathcal{V}$  do
8:       if  $(s_i, v)$  is an edge in  $\mathcal{G}$  then
9:         if  $D(s_i) + 1 < D(v)$  then
10:            $D(v) = D(s_i) + 1$ 
11:         end if
12:       if  $D(v) < d$  then
13:          $n = v, d = D(v)$ 
14:       end if
15:     end for
16:   end for
17:    $\mathcal{V} = \mathcal{V} \cup \{n\}$ 
18: end while
19: Delete  $\infty$  in  $D$ 
20: return  $\max\{D\}$ 

```

tion complexity of the transmission determination process is $O(n)$. Consider the calculation of the transmission utility functions, the computational complexity is $O(n^3)$.

The transmission times will increase as the number of vehicles grows up. There will be at least $O(n)$ vehicles transmit. As a result, the transmission times will also be $O(n)$. The computational complexity of the GBRs algorithm will be $O(n^4)$.

However, we can find that in the process of the utility function calculation, the vehicles are independent to each other. If the system computes the utility functions with parallel technologies, the real computational complexity will

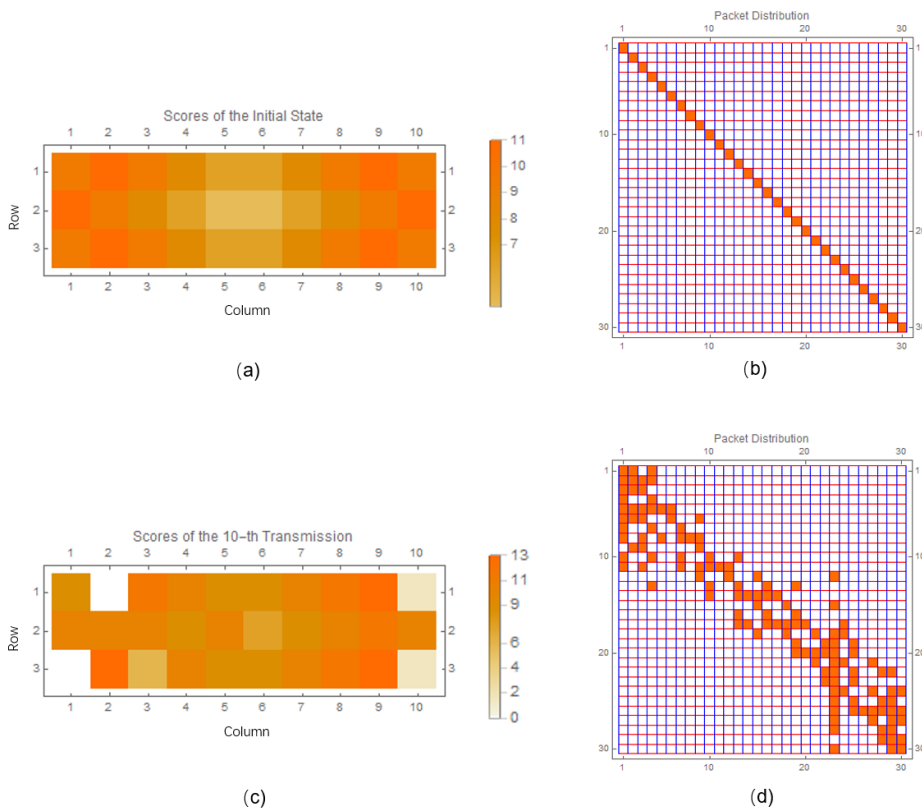

FIGURE 6. Transmission utility functions in different packets distribution.

decrease to $O(n^3)$.

2) Broadcast Upper Bound

We will only analyse the 1D case for the broadcast upper bound with network calculus. The 2D cases can also be analysed in the same manner.

In the analyse of the 1D platoon, we assume that the data transmission from one end to the other has the longest broadcast time. We number the vehicles from source to destination as $1, \dots, N$, respectively. When the data arrives at vehicle i , it has already arrived at vehicle 1 to vehicle $i - 1$. And the result for MSSD algorithm will be $N - i$. It has a higher priority to transmit than i packets, the maximum waiting time will be $2Ci$, where 2 is the number of the neighbours of each vehicle and C is the data rate for mmWave links. According to [33], we can express the service curve for vehicle i as

$$\beta_i(t) = \max\{C \cdot t - 2C \cdot i, 0\}. \quad (13)$$

According to the concatenation property in the network calculus theory, the service for the relay vehicles can be expressed as

$$\beta(t) = \beta_2 \otimes \beta_3 \otimes \dots \otimes \beta_{N-1}(t), \quad (14)$$

where \otimes is the min-plus convolution, which is defined as

$$(a \otimes b)(x) = \inf_{0 \leq y \leq x} [a(y) + b(x - y)]. \quad (15)$$

Based on the delay bound theory, the delay upper bound can be calculated by

$$D(t) \leq h(\alpha, \beta), \quad (16)$$

where $h(a, b) = \sup_{s \geq 0} \{\inf\{\tau \geq 0 : a(s) \leq b(s + \tau)\}\}$ and $\alpha(t)$ is the arrival curve for packet 1, which equals 1 when $t \geq 0$ and equals 0 when $t < 0$.

VI. PERFORMANCE EVALUATION

We adopt a grid layout for the vehicular platoon in the simulation experiments. The indexes of the vehicles are illustrated in Figure. 5. Some critical simulation parameters is illustrated in Table 1. To show the improvements of GBRS algorithm of the conventional broadcasting method, we implement the traditional FIFO algorithm in the proposed framework. However, other broadcast or multicast protocols are not good at broadcast all packets of all vehicles to the others. As a result, we only compare the proposed algorithm to the conventional method in the same framework.

Figure 6 shows the transmission utility function in different stages. Sub-figure (a) is the distribution of the values

Algorithm 2 Graph-based Routing Selection Algorithm

Input: \mathcal{G} .

Output: Broadcast scheme.

- 1: **Initialisation:** $\mathbf{D} = \mathbf{I}_{N \times N}$, time counter $t_c = [0, \dots, 0]$ with N elements.
- 2: **while** $\sum_i \sum_j D_{ij} < N^2$ **do**
- 3: Transmit vehicles: $\mathcal{T} = \emptyset$.
- 4: Receive vehicles: $\mathcal{R} = \emptyset$.
- 5: Free vehicles: $\mathcal{F} = \emptyset$.
- 6: **while** $|\mathcal{T} \cup \mathcal{R} \cup \mathcal{F}| < N$ **do**
- 7: Calculate transmission utility of each vehicle.
- 8: Let \mathcal{C} be the set of vehicles in $\overline{\mathcal{T} \cup \mathcal{R} \cup \mathcal{F}}$ with longest waiting time.
- 9: Select vehicle v in \mathcal{C} with highest transmission utility function.
- 10: The receive vehicles determined by the score calculating process is \mathcal{D} .
- 11: $\mathcal{D} = \mathcal{D} - \mathcal{D} \cap (\mathcal{T} \cup \mathcal{R})$.
- 12: $\mathcal{R} = \mathcal{R} \cup (\mathcal{D} \cap \mathcal{F})$.
- 13: $\mathcal{F} = \mathcal{F} - \mathcal{F} \cap \mathcal{D}$.
- 14: **if** $|\mathcal{D}| > 0$ **then**
- 15: Let \mathcal{D} be the transmission destination for vehicle v .
- 16: $\mathcal{T} = \mathcal{T} \cup \{v\}$.
- 17: $\mathcal{R} = \mathcal{R} \cup \mathcal{D}$.
- 18: **else**
- 19: $\mathcal{F} = \mathcal{F} \cup \{v\}$
- 20: **end if**
- 21: **end while**
- 22: Updating \mathbf{D} according to the transmission scheme.
- 23: **end while**

TABLE 1. Some Critical Simulation Parameters

Parameter	Value
Path loss α	2
Average power of Gaussian noise	28.8 dB
Receive threshold	-54 dBm
Data rate for mmWave link	4158 Mbps
Sensor data packet size	400 Mb
Horizontal distance between vehicles	10 m
Vertical distance between vehicles	2 m

in the initial state and sub-figure (b) is the initial packet distribution. At the initial state, each vehicle only has its own packet and all of the waiting time is zero. Consequently, the transmission utility function only depends on the location and the transmission number. As shown in sub-figure (a), the vehicles at the ends of the platoon have higher utilities than then central vehicles. Sub-figure (c) and (d) show the utility functions and packet distributions at 20-th transmission, respectively. We can find that corner vehicles have small utility, because they have nothing to send. The utility functions at the central vehicles become higher than the initial state.

We compare the broadcast upper bound for 1D platoon in Figure 7. As vehicle number becomes greater, the upper bound becomes inaccurate. This is because more error is

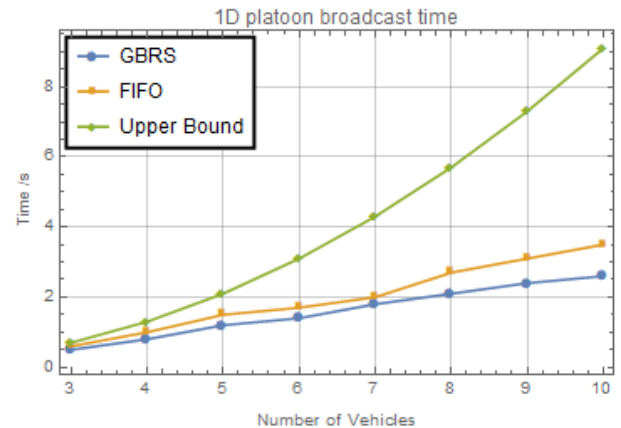

FIGURE 7. Upper bound for broadcast time in 1D platoon.

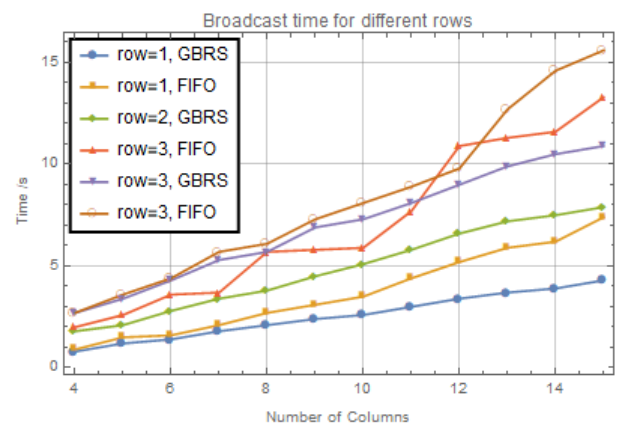

FIGURE 8. Broadcast time for different rows.

introduced by extra vehicles. Furthermore, the difference between the GBRs algorithm and the FIFO protocol becomes larger as the vehicle number growing. The proposed algorithm performs greatly in the large vehicular platoon.

Figure 8 illustrates the performance of the GBRs algorithm and the FIFO algorithm in different rows. The broadcast time for the GBRs is almost proportional to the number of rows. So, the changing of the shapes will not introduce extra loads of the system. Compared to FIFO, the GBRs algorithm even can achieve 2-row performance in the 3-row scenario.

To further present the idea of the proposed algorithm, we compare the different packet finish time in Figure 9. Figure 9 is a 1D platoon, the number is also the location of the vehicles. It is clear that the GBRs algorithm balances the finish times of all packets while the conventional FIFO protocol will first send the central packets, which decreases the final performance of the system.

Figure 10 shows the standard deviation of the packets finish time in different scenarios. We can find that in different shapes of the platoons, the standard deviation of the finish times for GBRs algorithm is much less than it in the conventional FIFO routing scheme. Which implies that the

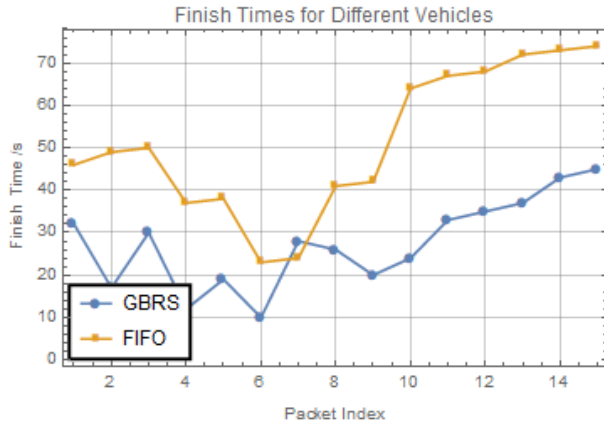

FIGURE 9. Finish time for different packets in a 1D platoon.

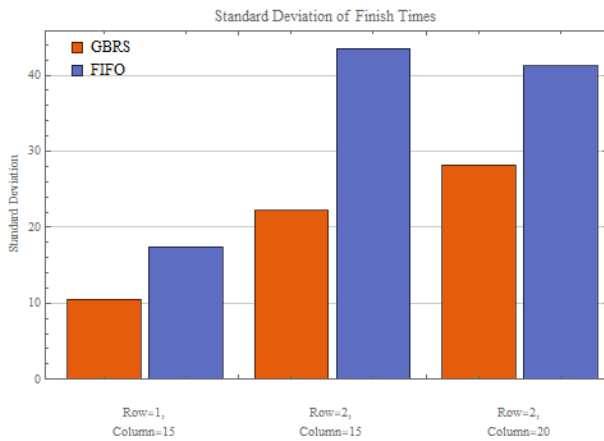

FIGURE 10. Finish time for different packets in a 1D platoon.

GBRS algorithm balance the packet transmission by giving higher priority to the corner vehicles. This mechanism not only works in the 1D platoon, but also works in multi-lane platoons.

As the numerical results have shown, the GBRs algorithm can get a superior broadcast scheme for sensor data than the conventional method. Furthermore, it is easy to be implemented and has a fast speed in engineering.

VII. CONCLUSION

This proposes a vehicular sensor data broadcasting scheme. The system periodically broadcast the sensor data with mmWave technology and send control messages using CSMA/CA based MAC protocol. We formulate the broadcasting problem as a NP complete non-linear integer programming problem. To make the broadcasting decision quickly at the head vehicle, we propose a dedicated algorithm called GBRs. The transmission utility function is designed to make the edge vehicles have a higher transmission priority than the central vehicles. Furthermore, we analyze the algorithm complexity and get the upper bound of broadcasting

delay for 1D platoon based on the network calculus theory. Simulation results are presented and show the advantages of the proposed algorithm over the conventional method in terms of the broadcasting delay.

REFERENCES

- [1] C. Yu, B. Lin, P. Guo, et al., "Deployment and dimensioning of fog computing-based internet of vehicle infrastructure for autonomous driving," *IEEE Internet of Things Journal*, vol. 6, no. 1, pp. 149-160, Feb. 2019.
- [2] B.-J. Chang, J.-M. Chiou, "Cloud Computing-based analyses to predict vehicle driving shockwave for active safe driving in intelligent transportation system," *IEEE Transactions on Intelligent Transportation Systems*. Early Access, pp. 1-15, Mar. 2019.
- [3] ETSI ISG, "Mobile Edge Computing A Key Technology Towards 5G," White Paper, no. 11, Sept. 2015, pp. 1-16.
- [4] M. Peng et al., "Fog-Computing-Based Radio Access Networks: Issues and Challenges," *IEEE Network*, vol. 30, no. 4, July/Aug. 2016, pp. 46-53.
- [5] G. Qiao, S. Leng, K. Zhang and Y. He, "Collaborative Task Offloading in Vehicular Edge Multi-Access Networks," in *IEEE Communications Magazine*, vol. 56, no. 8, pp. 48-54, August 2018.
- [6] G. Jameel, S. Wyne, S. Nawaz, Z. Chang, "Propagation Channels for mmWave Vehicular Communications: State-of-the-art and Future Research Directions," *IEEE Wireless Communications*, vol. 26, no. 1, Feb. 2019, pp. 144-150.
- [7] C. Perfecto, J. Del Ser and M. Bennis, "Millimeter-Wave V2V Communications: Distributed Association and Beam Alignment," in *IEEE Journal on Selected Areas in Communications*, vol. 35, no. 9, pp. 2148-2162, Sept. 2017.
- [8] B. Fan, S. Leng, K. Yang and J. He, "Gathering Point-Aided Viral Marketing in Decentralized Mobile Social Networks," in *IEEE Systems Journal*, vol. 12, no. 2, pp. 1566-1576, June 2018.
- [9] X. Zhang, Y. Li and Q. Miao, "A Cluster-based Broadcast Scheduling Scheme for mmWave Vehicular Communication," in *IEEE Communications Letters*.
- [10] K. Zhang, S. Leng, X. Peng, L. Pan, S. Maharjan and Y. Zhang, "Artificial Intelligence Inspired Transmission Scheduling in Cognitive Vehicular Communications and Networks," in *IEEE Internet of Things Journal*, vol. 6, no. 2, pp. 1987-1997, April 2019.
- [11] S. Mao, S. Leng, J. Hu and K. Yang, "Power Minimization Resource Allocation for Underlay MISO-NOMA SWIPT Systems," in *IEEE Access*, vol. 7, pp. 17247-17255, 2019.
- [12] S. Oh, H. Kim and S. Kim, "Poster: Location-based Directional CSMA/CA for Millimeter Wave V2V Communications," *2018 IEEE Vehicular Networking Conference (VNC)*, Taipei, Taiwan, 2018, pp. 1-2.
- [13] G. H. Sim, S. Klos, A. Asadi, A. Klein and M. Hollick, "An Online Context-Aware Machine Learning Algorithm for 5G mmWave Vehicular Communications," in *IEEE/ACM Transactions on Networking*, vol. 26, no. 6, pp. 2487-2500, Dec. 2018.
- [14] A. Tassi, M. Egan, R. J. Piechocki and A. Nix, "Modeling and Design of Millimeter-Wave Networks for Highway Vehicular Communication," in *IEEE Transactions on Vehicular Technology*, vol. 66, no. 12, pp. 10676-10691, Dec. 2017.
- [15] C. K. Anjinappa and I. Guvenc, "Millimeter-Wave V2X Channels: Propagation Statistics, Beamforming, and Blockage," *Proc. IEEE Vehicular Technology Conf. (VTC2018-Fall)*, Chicago, USA, Aug. 2018.
- [16] "C-ITS Platform," European Commission, Brussels, Belgium, Tech. Rep., Jan. 2016.
- [17] B. Coll-Perales, J. Gozalvez and M. Gruteser, "Sub-6GHz Assisted MAC for Millimeter Wave Vehicular Communications," in *IEEE Communications Magazine*, vol. 57, no. 3, pp. 125-131, March 2019.
- [18] K. Xiong and S. Leng, "Smart Network Slicing for Vehicular Fog-RANs," in *IEEE Transactions on Vehicular Technology*, vol. 68, no. 4, pp. 3075-3085, April 2019.
- [19] J. Blumenstein et al., "Effects of Vehicle Vibrations on mm-Wave Channel: Doppler Spread and Correlative Channel Sounding," *Proc. IEEE Annual Int'l. Symposium on Personal, Indoor, and Mobile Radio Commun. (PIMRC)*, Valencia, Spain, Sept. 2016.
- [20] V. Petrov et al., "The Impact of Interference from the Side Lanes on mmWave/THz Band V2V Communication Systems with Directional Antennas," *IEEE Trans. Vehicular Technology*, vol. 67, no. 6, June 2018, pp. 5028-41.

- [21] T. S. Rappaport, F. Gutierrez, E. Ben-Dor, J. N. Murdock, Y. Qiao, and J. I. Tamir, "Broadband millimeter-wave propagation measurements and models using adaptive-beam antennas for outdoor urban cellular communications," *IEEE Trans. Antennas Propag.*, vol. 61, no. 4, pp. 1850–1859, Apr. 2013.
- [22] A. Asadi, S. Müller, G. H. Sim, A. Klein and M. Hollick, "FML: Fast Machine Learning for 5G mmWave Vehicular Communications," *IEEE INFOCOM 2018 - IEEE Conference on Computer Communications*, Honolulu, HI, 2018.
- [23] Y. Wang et al., "mmWave Vehicle-to-Infrastructure Communication: Analysis of Urban Microcellular Networks," *IEEE Trans. Vehicular Technology*, 2018.
- [24] C. Shao, S. Leng, Y. Zhang, A. Vinel and M. Jonsson, "Performance Analysis of Connectivity Probability and Connectivity-Aware MAC Protocol Design for Platoon-Based VANETs," in *IEEE Transactions on Vehicular Technology*, vol. 64, no. 12, pp. 5596-5609, Dec. 2015.
- [25] S. N. Shaikh and S. R. Patil, "A robust broadcast scheme for vehicle to vehicle communication system," *2016 Conference on Advances in Signal Processing (CASP)*, Pune, 2016, pp. 301-305.
- [26] H. Zhang and X. Zhang, "An adaptive control structure based fast broadcast protocol for vehicular ad hoc networks," *IEEE Commun. Lett.*, vol. 21, no. 8, pp. 1835–1838, Aug. 2017.
- [27] Y. Niu, L. Yu, Y. Li, Z. Zhong and B. Ai, "Device-to-Device Communications Enabled Multicast Scheduling for mmWave Small Cells Using Multi-Level Codebooks," in *IEEE Transactions on Vehicular Technology*, vol. 68, no. 3, pp. 2724-2738, March 2019.
- [28] W. Mei, Z. Chen and S. Li, "Confidential Broadcasting and Service Integration in Millimeter Wave Systems," in *IEEE Systems Journal*, vol. 13, no. 1, pp. 147-158, March 2019.
- [29] IEEE P802.11ad, IEEE 802 Part11: Wireless LAN Medium Access Control 5 (MAC) and Physical Layer (PHY) Specifications - Enhancements for Very High Throughput in the 60 GHz Band, June 2010.
- [30] J. Zheng, K. Yan, Y. Zhang and Z. Chen, "Design and Implementation of DDR4 SDRAM Controller Based on FPGA," *2018 2nd IEEE Advanced Information Management, Communicates, Electronic and Automation Control Conference (IMCEC)*, Xi'an, 2018, pp. 421-424.
- [31] J. Wildman, P. H. J. Nardelli, M. Latva-aho and S. Weber, "On the Joint Impact of Beamwidth and Orientation Error on Throughput in Directional Wireless Poisson Networks," in *IEEE Transactions on Wireless Communications*, vol. 13, no. 12, pp. 7072-7085, Dec. 2014.
- [32] A. Alkhateeb, O. El Ayach, G. Leus and R. W. Heath, "Channel Estimation and Hybrid Precoding for Millimeter Wave Cellular Systems," in *IEEE Journal of Selected Topics in Signal Processing*, vol. 8, no. 5, pp. 831-846, Oct. 2014.
- [33] Boudec J L, Thiran P. Network calculus: a theory of deterministic queuing systems for the internet[J]. *Lecture Notes in Computer Science*, 2001.



SUPENG LENG is a Full Professor and a Vice Dean in the School of Information & Communication Engineering, University of Electronic Science and Technology of China (UESTC). He is also the leader of the research group of Ubiquitous Wireless Networks. He received his Ph.D. degree from Nanyang Technological University (NTU), Singapore. He has been working as a Research Fellow in the Network Technology Research Center, NTU. His research focuses on resource, spectrum, energy, routing and networking in Internet of Things, vehicular networks, broadband wireless access networks, smart grid, and the next generation mobile networks. He published over 180 research papers in recent years. He serves as an organizing committee chair and TPC member for many international conferences, as well as a reviewer for over 10 international research journals.

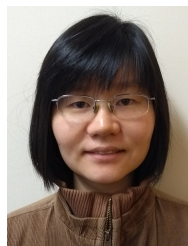

ZUOYIN TANG is currently a Lecturer in the School of Engineering and Applied Science, Aston University, UK. She obtained her PhD degree from University of Bath, UK, in 2008. She has authored and co-authored over 40 technical papers in major international journals and conferences. Dr Tang's main research interests include resource management for cellular networks, Internet of things and wireless sensor networks.

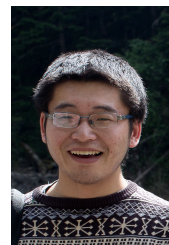

KAI XIONG is a Ph.D. degree candidate in the School of Communication and Information Engineering, University of Electronic Science and Technology of China, Chengdu. His research interests include design and optimization of next-generation wireless networks, Internet of Vehicles, Machine Learning, Mobile Edge Computing, and Communication Theory.



XIAOSHA CHEN received the B.Sc. degree in information and communication engineering from University of Electronic Science and Technology of China, Chengdu, China, in 2016. He is currently working toward the Ph.D. degree in University of Electronic Science and Technology of China. His research interests include handling routing protocols, performance analysis and congestion control in vehicular network.



GUANHUA QIAO is currently working toward the Ph.D. degree at the School of Information and Communication Engineering, University of Electronic Science and Technology of China (UESTC). His current research interests include mobile edge computation, energy efficiency and energy harvesting in wireless heterogeneous network, resource management and network optimization.

...