

May 2014

Enzyme Activity, Maturation and Regulation of Anaerobic Reductases in *Shewanella Oneidensis* MR-1

Kenneth L. Brockman
University of Wisconsin-Milwaukee

Follow this and additional works at: <https://dc.uwm.edu/etd>

 Part of the [Biochemistry Commons](#), [Microbiology Commons](#), and the [Molecular Biology Commons](#)

Recommended Citation

Brockman, Kenneth L., "Enzyme Activity, Maturation and Regulation of Anaerobic Reductases in *Shewanella Oneidensis* MR-1" (2014). *Theses and Dissertations*. 669.
<https://dc.uwm.edu/etd/669>

This Dissertation is brought to you for free and open access by UWM Digital Commons. It has been accepted for inclusion in Theses and Dissertations by an authorized administrator of UWM Digital Commons. For more information, please contact open-access@uwm.edu.

ENZYME ACTIVITY, MATURATION AND REGULATION OF
ANAEROBIC REDUCTASES IN *SHEWANELLA ONEIDENSIS* MR-1

by

Kenneth L Brockman

A Dissertation Submitted in
Partial Fulfillment of the
Requirements for the Degree of

Doctor of Philosophy
in Biological Sciences

at

The University of Wisconsin-Milwaukee

May 2014

ABSTRACT

ENZYME ACTIVITY, MATURATION AND REGULATION OF ANAEROBIC REDUCTASES IN *SHEWANELLA ONEIDENSIS* MR-1

by

Kenneth L Brockman

The University of Wisconsin-Milwaukee, 2014

Under the Supervision of Dr. Daâd Saffarini

Shewanella oneidensis MR-1 is a metal-reducing bacterium capable of using a wide range of terminal electron acceptors. These include oxygen, metal oxides and organic compounds such as dimethyl sulfoxide (DMSO) and fumarate. In addition, several nitrogen and sulfur based compounds can be used as terminal electron acceptors, including sulfite, for which the terminal reductase was recently identified as an octaheme *c*-type cytochrome that contains an atypical heme binding site. In this study, several additional components involved in sulfite reduction were identified. These include SirCD that form a membrane-bound electron-transferring complex with SirA, SirBI that appear to be involved in protein folding and SirEFG that is involved in the specific attachment of heme to SirA. In addition to the heme synthetase SirEF, and apo-cytochrome *c* chaperon SirG, an additional chaperon, CcmI, was shown to be involved in heme attachment to the atypical site of SirA. Surprisingly, CcmI was required for the maturation of the nitrite reductase, NrfA, which contains an atypical heme binding site, and plays a role in maturation of other *c* cytochromes required for respiration. Regulation of the many terminal reductases was also found to be complex and unlike that in other organisms studied to date. Promoter activities, transcript levels and enzyme activities of several terminal reductases were analyzed in cells grown in the presence of different

electron acceptors and revealed regulation that occurs both transcriptionally and post-transcriptionally. It was found that the regulation of some reductases is more tightly regulated than others, and in addition, the availability of some electron acceptors has a more pronounced regulatory affect than others.

TABLE OF CONTENTS

CHAPTER		PAGE
I	Introduction	1
	<i>Shewanella oneidensis</i> MR-1	2
	Cytochrome <i>c</i> maturation in <i>S. oneidensis</i>	3
	<i>S. oneidensis</i> and metal reduction	5
	Sulfite reduction	6
	Nitrite reduction	8
	Anaerobic gene regulation in <i>S. oneidensis</i>	9
II	Materials and Methods	12
	Bacterial strains and growth conditions	12
	Generation and complementation of chromosomal deletion mutants	16
	Protein feature predictions	17
	Endpoint RT-PCR	17
	Detection of reductase activity in native polyacrylamide gels	18
	Mass spectrometry	18
	Sulfite reduction assays	19
	Anaerobic growth assays	20
	Protein detection by western blots	20
	Nitrite reduction assay	21
	Site directed mutagenesis of SirA	21
	Generation of promoter- <i>lacZ</i> fusions	22
	Real-time RT-PCR expression analysis	22
III	Analysis of genes located in the <i>sir</i> operon	
	Introduction	24
	Results	27
	Genes of the <i>sir</i> Locus	27
	Analysis of proteins with sulfite reductase activity by mass spectrophotometry	30
	Reduction of sulfite and respiration of DMSO and fumarate by <i>sir</i> mutants	31
	Role of SirJKLM in sulfite reduction	34
	Enzyme activity and protein stability in wild-type and <i>sir</i> mutants	38

	Discussion	41
	<i>sirABIGCDJKLM</i> constitute an operon	41
	Proteins involved in electron transfer to the terminal sulfite reductase	41
	Role of SirBI in the maturation and conformational folding of SirA	43
	Role of Cu and related proteins in sulfite reduction	44
IV	Specialized components involved in maturation of <i>c</i> -type cytochromes	
	Introduction	47
	Results	50
	Role of <i>ccm</i> and <i>sir</i> genes in nitrite reduction	50
	CcmI is required for optimum anaerobic growth with DMSO and TMAO	53
	Role of <i>ccm</i> and <i>sir</i> genes in the maturation of the sulfite reductase SirA	55
	Sulfite reductase activity and protein stability	58
	Role of SirA atypical heme binding motif in sulfite reduction	61
	Discussion	64
V	Regulation of the <i>Shewanella oneidensis</i> anaerobic reductases	
	Introduction	70
	Results	71
	Promoter- <i>lacZ</i> fusions	71
	Effect of electron acceptor availability on the fumarate reductase	73
	Effect of electron acceptor availability on the sulfite reductase	75
	Effect of electron acceptor availability on the thiosulfate reductase	77
	Effect of electron acceptor availability on the nitrite reductase	79
	Discussion	81
VI	Concluding Remarks	85
	References	88
	Curriculum Vitae	103

LIST OF FIGURES

Figure 3.1	Arrangement of the predicted <i>sir</i> gene operon	27
Figure 3.2	End-point RT-PCR mapping of <i>sir</i> gene mRNA	30
Figure 3.3	LC-MS/MS analysis of the sulfite reductase	31
Figure 3.4	Growth of wild-type and <i>sir</i> mutant strains with fumarate	32
Figure 3.5	Growth of wild-type and <i>sir</i> mutant strains with DMSO	33
Figure 3.6	Sulfite reduction by wild-type and mutant strains	34
Figure 3.7	Sulfite reduction by wild-type and $\Delta sirKL$	35
Figure 3.8	Growth of wild-type and $\Delta sirKL$ with fumarate and TTM	36
Figure 3.9	Sulfite reduction by MR-1 supplemented with TTM	37
Figure 3.10	Sulfite reduction by $\Delta sirKL$ supplemented with TTM	38
Figure 3.11	Sulfite reductase activity by wild-type and <i>sir</i> mutant strains	40
Figure 3.12	Western blot with antibodies against SirA	40
Figure 3.13	Schematic of electron flow through the sulfite reductase complex	43
Figure 4.1	Arrangement of the <i>ccm</i> and <i>sir</i> gene clusters	48
Figure 4.2	Nitrite reduction by wild-type and mutant strains	51
Figure 4.3	Nitrite reductase activity by wild-type and mutant strains	52
Figure 4.4	Anaerobic growth of wild-type and mutant strains with DMSO, TMAO, and fumarate	54
Figure 4.5	Sulfite reduction by wild-type and mutant strains	56
Figure 4.6	Sulfite reduction by $\Delta sirG\Delta ccmI$ complement strains	57
Figure 4.7	Sulfite reduction by wild-type and mutant strains	58
Figure 4.8	Sulfite reductase activity and protein levels of wild-type, mutant, and complemented strains	60
Figure 4.9	Sulfite reduction by wild-type and $\Delta sirA$ expressing the modified sulfite reductase	62
Figure 4.10	Sulfite reductase activity and protein levels of wild-type and $\Delta sirA$ expressing the modified sulfite reductase	63

Figure 4.11	Models of proposed apo-SirA lyase complexes	67
Figure 4.12	Model of proposed apo-NrfA lyase complex	68
Figure 5.1	β -galactosidase activity of the fumarate reductase (<i>fccA</i>) promoter fused to <i>lacZ</i> in pMC10	72
Figure 5.2	β -galactosidase activity of the sulfite reductase (<i>sirA</i>) promoter fused to <i>lacZ</i> in pMC10	73
Figure 5.3	Fumarate reductase transcript and activity levels of cell extracts from wild-type MR-1	74
Figure 5.4	Sulfite reductase transcript and activity levels of cell extracts from wild-type MR-1	76
Figure 5.5	Thiosulfate reductase transcript and activity levels of cell extracts from wild-type MR-1	78
Figure 5.6	Nitrite reductase transcript and activity levels of cell extracts from wild-type MR-1	80

LIST OF TABLES

Table 2.1	List of strains and plasmids used in this study	12
Table 2.2	List of primers used in this study	13
Table 3.1	Comparison of SirJKLM to the copper transport proteins NosLDFY	29
Table 3.2	Predicted location and modifications of SirJKLM	29

ACKNOWLEDGEMENTS

I would like to thank Dr. Daâd Saffarini, my undergraduate and graduate advisor, for all of her support, encouragement, motivation, wisdom and kindness over the past 10 years in her lab. It was her involvement that got me interested in research as an undergraduate and provided me with the passion and drive to pursue this doctoral research. I will be forever indebted to her for the skills she has provided me both in the lab and out.

I want to thank all of the committee members I have had over the course of my time at UWM. Dr. Mark McBride who has been an invaluable resource for me as a committee member and lab neighbor during both my undergraduate and graduate pursuits. His objective feedback during weekly lab meetings, committee presentations and of my writing will be missed. Dr. Sonia Bardy who has provided critical review of my writing and provided a fresh perspective on both my research and career goals. Dr. Gyaneshwar Prasad for his suggestions in research methods and helping me to see my research from a different perspective. Dr. Graham Moran for providing technical assistance in my numerous biochemical pursuits and critical feedback of my molecular methodology. Dr. Owen for all of her assistance with my electron microscopy and always sharing a contagious passion for research through imaging. I would also like to make a special note to recognize all of the faculty and staff who were involved in my many teaching pursuits; Dr. Saffarini, Dr. McBride, Dr. Bardy, Dr. Ching-Hong Yang, Dr. Selva Ramakrishnan and Ching-Liu Wu.

I would like to give special recognition to Dr. Eulandria Biddle and Dr. Sheetal Shirodkar, previous members of the lab, who laid out much of the initial work with sulfur compounds, developing standards and techniques for dealing with these difficult compounds. I am extremely lucky to have also worked with Trevor Croft who was an

amazingly dedicated and hardworking undergraduate in our lab. His work on the maturation of *c*-type cytochromes was instrumental and I wish him the best in his graduate pursuits at UC Davis.

Special thanks to all of the Saffarini lab members who have made my time in the lab as truly special and fun as it was. Current graduate students, Rini & Kristen, for dealing with me during “dissertation writing” mode and the aftermath; I wish them the best in their research endeavors. Rachida for teaching me many of the techniques I learned during my undergraduate research. Moiz, Areen & Namita, all of whom joined and received their PhDs during my time in the lab, were all a source of inspiration and support in my doctoral studies. Pat for his critical review and for accepting my relentless “creeping” into his bench space. Finally all of the amazing undergraduate researchers who have contributed to many aspects of research in the lab.

Last but not least I want to thank my family and friends who have supported me in my life and education. They have accepted me disappearing to “go to the lab” at all hours, day and night, and my frequent “Missing in Action” status during periods of lengthy experiments. My parents for always supporting my decisions with unwavering reassurance, and for instilling me with the idea that there is nothing I am not capable of if I truly want it and put in the effort.

I humbly realize that I would not have been able to accomplish everything I have without each and every one of them.

Chapter 1

Introduction

Cellular respiration is a fundamental process for most organisms in the three domains of life. This process allows organisms to harvest energy from nutrients, such as sugars and amino acids, and generate proton motive force and ATP through the activity of the electron transport chain (ETC). Aerobic respiration, or the use of oxygen (O_2) as an electron acceptor, is one of the most common modes of energy generation in both eukaryotic and prokaryotic organisms. Many bacteria, however, can also respire anaerobically and are able to use alternate electron acceptors that range from soluble organic and inorganic molecules such as fumarate, dimethyl sulfoxide (DMSO), nitrate (NO_3), and sulfate (SO_4), to insoluble compounds such as iron oxides and oxyhydroxides. Examples include the anaerobes *Geobacter*, *Desulfobacter*, and *Desulfovibrio* (1, 2), (3), and facultative anaerobes such as *Escherichia*, *Paracoccus*, and *Shewanella* species (4-6).

In addition to serving as an essential energy generating mechanism in bacterial cells, anaerobic respiration plays an important role in geochemical cycling, especially in aquatic environments. For example, anaerobic reduction of insoluble metals such, as Fe(III) and Mn(IV), plays an important role in metal cycling in sediments and water columns, contributes to the carbon and phosphorus cycles, and may lead to mobilization of toxic elements (7). Similarly, anaerobic respiration of nitrate is an important process in the global nitrogen cycle. Nitrate reduction can provide important sources of ammonia (NH_4) for plants and algae, and may play a role in decreasing high ground water nitrate levels caused by excess agricultural fertilization (8). Bacterial anaerobic respiration also has application in bioremediation and biotechnology. Anaerobic reduction of soluble

radioactive metal ions such as U(VI) and Cr(VI) to insoluble forms, U(IV) and Cr(III), facilitates the immobilization of hazardous waste, thus limiting ground water contamination (9). Bacteria that use metals as terminal electron acceptors during anaerobic respiration are also being developed for use in microbial fuel cells. Bacteria with metal reductases on their outer cell surface allow electrons to be directly transferred from the bacterial ETC to metal anodes resulting in the generation of an electrical current (10, 11).

***Shewanella oneidensis* MR-1**

Shewanella species have received considerable attention in the past decade mainly due to their unprecedented respiratory versatility. They are Gram-negative facultative anaerobes that appear to be ubiquitous in aquatic environments such as the Black Sea, Baltic Sea, Oneida Lake, Lake Michigan, and hydrothermal vents. Due to the environmental significance of these organisms, the genomes of 23 *Shewanella* species have been sequenced to date (12). *S. oneidensis* is the best studied member of this genus. *S. oneidensis* was originally isolated from Oneida Lake, NY, and classified as *Alteromonas putrefaciens* (4), and then reclassified based on 16S rRNA and gyrase gene sequences. *S. oneidensis* MR-1 appears to be the most versatile of the *Shewanella* species with regard to the electron acceptors it can use during anaerobic respiration. These include oxygen, fumarate, dimethyl sulfoxide (DMSO), trimethylamine *N*-oxide (TMAO), nitrate (NO₃), nitrite (NO₂), and insoluble metal oxides. In addition, *S. oneidensis* is able to reduce radionuclides and toxic metals such as Tc, U, and Cr (13-17). The ability of *S. oneidensis* to reduce and immobilize toxic metals makes it an attractive candidate for use in

bioremediation of water supplies contaminated with hazardous metals and radioactive materials (12).

The *S. oneidensis* genome consists of a 4.97 Mb circular chromosome and a 161.6 kb plasmid (18). The genome encodes 42 *c*-type cytochromes (18, 19), which contribute to its ability to respire with a large number of electron acceptors. Some of these cytochromes, such as CymA, function as intermediates in electron transfer to multiple terminal reductases. CymA is a tetraheme *c*-type cytochrome required for the reduction of fumarate, DMSO, metal oxides, and nitrite (20-23). Other *c*-type cytochromes function as terminal reductases or as components of terminal reductase complexes. The enzymes FccA, NrfA, SirA, and MtrC are multi-heme *c*-type cytochromes that reduce fumarate, nitrite, sulfite, and metal oxides, respectively, whereas NapB, TorC, DmsE, and MtrA are *c*-type cytochromes that are subunits of the terminal nitrate, TMAO, DMSO, and metal reductase complexes (20, 24-28). Because *S. oneidensis* relies on respiration for energy production, synthesis of a large number of *c*-type cytochromes allows it to easily adapt and survive in its natural environment where the nature and availability of electron acceptors can fluctuate rapidly.

Cytochrome *c* maturation in *S. oneidensis*

As mentioned above, the *S. oneidensis* genome encodes 42 *c*-type cytochromes. *c*-type cytochromes are characterized by the covalent attachment of heme *b* vinyl groups to the cysteines of the typical CXXCH heme-binding motif (29). In members of the α and γ Proteobacteria, attachment of heme to CXXCH requires the function of the System I cytochrome maturation proteins CcmABCDEFGH (see (29-31) for review). CcmABCD

are required for transport and loading of heme *b* onto CcmE whose function is to provide heme to the heme lyase complex (29, 30). Heme lyases are involved in heme attachment to the cysteine residues of the CXXCH motif of apocytochromes *c*. In *E. coli*, CcmFH form a complex and function as a heme lyase, whereas in other Gram-negative bacteria, such as *Rhodobacter capsulatus*, the heme lyase complex consists of CcmFHI (32).

Similar to other Gram-negative bacteria, maturation of *c*-type cytochromes in *S. oneidensis* requires the product of the cytochrome *c* maturation genes *ccmABCDE* and *ccmFGH* operons (System I cytochrome *c* maturation). Mutations in these genes lead to complete loss of mature *c*-type cytochromes (33, 34). Recently, SO_0265 was identified as *ccmI*, and was determined to have a nonessential role in cytochrome *c* maturation in *S. oneidensis* (34).

In addition to the CXXCH motifs, heme *b* can be attached to atypical sites, such as CXXCK and CX₁₅CH, by specialized heme lyase systems (35, 36). In *E. coli*, heme ligation to the CXXCK site of NrfA requires the heme lyase NrfEFG (35). In *Wolinella succinogenes*, two heme lyases, CcsA1 and NrfI, are required for heme attachment to the CX₁₅CH and the CXXCK heme-binding sites in the sulfite and nitrite reductases, respectively (32-34). Two atypical heme-binding sites have been identified in *S. oneidensis* *c*-type cytochromes. The CXXCK motif is found in the periplasmic nitrite reductase NrfA (37), and the CX₁₅CH motif is found in the sulfite reductase SirA (38). SirA is an octaheme *c*-type cytochrome that is predicted to be the catalytic subunit of the sulfite reductase SirACD (38). The *S. oneidensis* nitrite reductase (NrfA) is a pentaheme *c*-type cytochrome that is similar to NrfA of *E. coli* and other bacteria, and catalyzes the reduction of NO₂ to ammonia. The proteins involved in heme attachment to SirA and NrfA are not known.

Results presented in Chapter 4 identify a role for SirEFG and CcmI in the maturation of these enzymes.

***S. oneidensis* and metal reduction**

Shewanella species are best known for their ability to reduce insoluble metal oxides during anaerobic respiration. With the exception of *S. denitrificans*, all sequenced *Shewanella* genomes encode the metal reductase complex MtrCAB. Metal oxides are insoluble, and as such do not readily diffuse into the cell. To overcome this limitation, *S. oneidensis* MR-1 transfers electrons from the menaquinol pool to these extracellular electron acceptors through the outer membrane *c*-type cytochrome MtrC. Although most *c*-type cytochromes in Gram-negative bacteria are located in the inner membrane or the periplasm, several *S. oneidensis* *c*-type cytochromes are located on the outer leaflet of the outer membrane. Examples include MtrC and OmcA, both of which are decaheme *c*-type cytochromes localized to the outer membrane by the Type II secretion system (39). The metal reductase complex of *S. oneidensis* MR-1 consists of the periplasmic decaheme *c*-type cytochrome MtrA, the outer membrane porin-like protein, MtrB, and MtrC. (28, 40, 41). Although OmcA has been implicated in metal reduction, it does not appear to play a significant role compared to MtrC. The location of MtrC on the outer surface of *S. oneidensis* cells allows direct contact with and extracellular electron transfer to the insoluble metal oxides. This property also allows *S. oneidensis* cells to transfer electrons to electrodes of mediator-free microbial fuel cells (10, 28, 42).

In addition to direct contact with the surface exposed MtrC, two indirect mechanisms have been proposed to explain metal reduction. One mechanism involves the

use of “electron shuttles” such as riboflavins. Addition of riboflavins to microbial fuel cells or to cells growing in the presence of insoluble metal oxides increases the rate of electron transfer to these electron acceptors (43, 44). The second mechanism of indirect extracellular electron transfer in *S. oneidensis* is proposed to involve the use of electrically conductive nanowires (45). The metal reducing *Geobacter* species are also hypothesized to use nanowires for insoluble metal reduction (46). In both *S. oneidensis* and *G. sulfurreducens*, nanowires are thought to consist of type IV pili. However, we have recently generated *S. oneidensis* mutants that lack pili and flagella and confirmed the loss of these appendages by electron microscopy. Further analysis of these mutants indicated that pili do not play a role in metal reduction or electron transfer to electrodes of microbial fuel cells as previously suggested (10).

Sulfite reduction

Sulfur is an essential element for all living organisms and a component of the amino acids cysteine and methionine. Cysteine is the primary source of sulfur used in the biosynthesis of sulfur containing amino acids and cofactors (47, 48). Archaea, bacteria, plants, and algae are able to carry out assimilatory sulfate reduction whereas animals lack this ability and must acquire cysteine from plant sources (49-51). Sulfur has important roles in electron transport and environmental sensing as a component of Fe-S proteins such as ferredoxins (52). Sulfur compounds also play a significant role in anaerobic respiration in many aquatic environments. In aquatic environments rich in sulfur compounds, sulfate (SO_4^{2-}) is a major anaerobic electron acceptor (53, 54). Other sulfur species, such as sulfite (SO_3^{2-}), thiosulfate ($\text{S}_2\text{O}_3^{2-}$) and tetrathionate ($\text{S}_4\text{O}_6^{2-}$), can also be used as electron

acceptors by sulfate and non-sulfate reducing bacteria. *S. oneidensis* does not reduce sulfate, but it can use several organic and inorganic sulfur compounds as electron acceptors for anaerobic respiration. These include DMSO, thiosulfate, trithionate, tetrathionate and elemental sulfur. The ability of *S. oneidensis* to reduce numerous sulfur compounds under anoxic conditions indicates an important role for this organism in biogeochemical cycling of sulfur in aquatic environments.

Some of the *S. oneidensis* enzymes involved in the reduction of sulfur compounds have unusual features that distinguish them from similar enzymes in other bacteria. The DMSO reductase is a molybdoenzyme that consists of a molybdopterin catalytic subunit, a tetraheme *c*-type, and an Fe-S protein. In addition the DMSO reductase includes an outer membrane protein that is similar to the metal reductase protein MtrB described above. Furthermore, the *S. oneidensis* DMSO reductase is localized to the outer membrane (55), similar to the metal reductase. Thiosulfate, trithionate, tetrathionate, and polysulfide appear to be reduced by one enzyme, the molybdopterin-containing PsrABC, in *S. oneidensis* [(56) and Shirodkar, in preparation]. This is in contrast to *Salmonella typhimurium*, which uses TtrABC to reduce tetrathionate and trithionate and PhsABC to reduce thiosulfate and polysulfide (57, 58). Although the octaheme *c*-type cytochrome known as OTR has been shown to reduce tetrathionate in vitro (59), results from our laboratory suggested that this protein was not involved in tetrathionate reduction in vivo (Shirodkar, in preparation).

In addition to the sulfur species mentioned above, *S. oneidensis* also uses sulfite as a terminal electron acceptor. Bacterial dissimilatory sulfite reductases studied to date are siroheme-containing enzymes that catalyze the reduction of sulfite to sulfide (60). Two mechanisms have been proposed to explain dissimilatory sulfite reduction. One suggests

that the reduction occurs through a 6-electron transfer reaction without the formation of metabolic intermediates, whereas the other mechanism proposes multiple reduction steps that involve the production of trithionate as an intermediate. Recent evidence suggests that sulfite reduction in *S. oneidensis* occurs via a 6-electron transfer reaction that does not release a trithionate intermediate (61). The reductase that catalyzes reduction of sulfite was identified as SirACD, where SirA is an octaheme *c* cytochrome that appears to function as the terminal catalytic subunit of the reductase complex. The sequence of SirA contains an unusual motif predicted to bind heme *c*. This motif is also found in the MccA family of *c*-type cytochromes (62). Unlike many sulfite reductases, the *S. oneidensis* sulfite reductase does not appear to require a siroheme cofactor (38). It also does not require the membrane anchored *c*-type cytochrome CymA that transfers electrons from the menaquinol pool to the fumarate, DMSO and nitrite reductases (63). The sulfite reductase components SirCD are thought to function as a menaquinol oxidase and replace CymA in the electron transport chain that leads to sulfite reduction (64). In addition to *sirCD*, several additional genes are located within the *sir* locus, and are predicted to encode proteins involved in protein folding, heme maturation and Cu transport. Analysis of these genes and their role in sulfite reduction is described in Chapter 3

Nitrite reduction

Another important and highly abundant element in the environment is nitrogen. It is commonly found as dinitrogen gas and is the most abundant gas in the earth's atmosphere. Nitrogen is a component of the building blocks of life, such as amino acids, DNA, and RNA, and therefore the biogeochemical nitrogen cycle is of great importance to

all living organisms (65). Microorganisms play a major role in nitrogen cycling, with bacteria acting as key players in nitrogen fixation, ammonification, nitrification and denitrification (66-68). Under anaerobic conditions, many bacteria, including *Shewanella* species, are able to reduce nitrate or nitrite to nitrogen gas or ammonia. *Shewanella denitrificans* and *S. loihica* have the genes that are needed for reduction of nitrate to N₂ in a process known as denitrification (20, 69-71). Other members of the *Shewanella* genus, such as *S. oneidensis*, carry out dissimilatory nitrate (NO₃) and nitrite (NO₂) reduction and generate ammonia (NH₄) as the endproduct (72-74).

The *S. oneidensis* nitrate (NapA) and nitrite (NrfA) reductases are periplasmic *c*-type cytochromes. The nitrite reductase, NrfA, is similar to nitrite reductases from other bacteria, such as *E. coli*, and contains the atypical heme-binding motif CXXCK. In *E. coli*, the nitrite reductase gene *nrfA* is located in an operon that includes *nrfBCD*, subunits of the nitrate reductase complex (75), and *nrfEFG*, which form a heme lyase involved in maturation of the *E. coli* NrfA (35). Interestingly, *nrfA* of *Shewanella* is monocistronic and the *S. oneidensis* genome lacks genes similar to *nrfBCDEFG* that are found associated with and involved in the maturation of NrfA in other bacteria (75).

Anaerobic gene regulation in *S. oneidensis*

Bacterial gene regulation occurs in response to a wide range of internal and external stimuli. Global transcriptional regulators play an important role in the regulation of gene expression in bacteria by controlling the expression of many genes in response to environmental cues. Two well studied global regulators in bacteria are the fumarate nitrate

reductase regulation protein (FNR) and the cyclic adenosine mono phosphate receptor protein (CRP) of *E. coli* (76).

In *E. coli*, and other bacteria, the shift from aerobic to anaerobic respiration requires the activation of the global transcriptional regulator FNR (77, 78). FNR regulates expression of several genes, including those involved in anaerobic respiration, in response to environmental oxygen levels. Under anoxic conditions FNR is able to form an active dimer stabilized by the formation of a [4Fe-4S] cluster (79). In the presence of oxygen the [4Fe-4S] cluster is destabilized resulting in inactive monomeric FNR. The *S. oneidensis* FNR homolog, EtrA, although able to complement an *E. coli* FNR mutant (80), does not function as the primary regulator of the *Shewanella* anaerobic reductases (81, 82). Contrary to expectations, the cAMP receptor protein (CRP), which regulates carbon metabolism in *E. coli*, controls the expression of anaerobic reductases in *S. oneidensis* MR-1 (83). *crp* mutants are deficient in anaerobic respiration with several electron acceptors and the activities of the fumarate, DMSO, and nitrate reductases are either severely decreased or undetectable (83).

Although genetic and phenotypic data clearly implicate CRP in the activation of anaerobic reductases in *S. oneidensis* MR-1, the mechanisms of this regulation remain unclear. CRP lacks obvious redox-sensing domains, and unlike FNR, is not expected to respond to changes in oxygen concentrations. Complementation of the *S. oneidensis crp* mutant with the *E. coli crp* indicated that CRP in both organisms is similarly activated. In *E. coli*, CRP is activated by the secondary signaling molecule cAMP, and addition of cAMP to aerobically growing cultures of *S. oneidensis* MR-1 lead to a significant induction in the activity of the anaerobic fumarate reductase (83). Therefore, transcriptional

regulation by the *S. oneidensis* CRP is likely linked to cAMP production. cAMP is synthesized from ATP by enzymes known as adenylate cyclases (84). The *S. oneidensis* genome contains three genes that encode adenylate cyclases, two of which appear to have a role in regulation of anaerobic reductases (85).

Protein synthesis can also be regulated post-transcriptionally. For example, in *E. coli*, *Salmonella* species, and other Gram-negative bacteria, OmpF mRNA is degraded by micF anti-sense RNA (86, 87), thus reducing the amount of mRNA available for translation. Initiation and progression of translation can also be regulated by formation of base-paired mRNA structures or by binding of mRNA repressor proteins (for review see (88, 89)). Many Gram-negative bacteria also rely on post-translational degradation of proteins as a mechanism to rapidly regulate the level of enzymes in the cell. For example, in *E. coli*, the Lon protein regulates capsule synthesis via degradation of the transcriptional regulator RcsA (90). In *E. coli*, transcriptional regulation of anaerobic reductases is regulated by anoxic conditions (FNR) and by electron acceptor availability (91, 92). In contrast, many anaerobic reductase genes in *S. oneidensis* appear to be expressed under anaerobic conditions regardless of the electron acceptors present, but their enzyme activity varies, suggesting that some of these reductases may be regulated post-transcriptionally. Chapter 5 investigates the regulation of anaerobic reductase components at the transcriptional, translational and post-translational level and aims to elucidate unique regulatory mechanisms in *S. oneidensis*.

Chapter 2

Materials and Methods

Bacterial strains and growth conditions

Bacterial strains and plasmids used in this study are listed in Table 2.1. Luria Bertani (LB) medium was routinely used for aerobic growth of *S. oneidensis* MR-1 and *E. coli* strains. Anaerobic cultures of *S. oneidensis* MR-1 strains were grown in basal medium pH 7.4 supplemented with 50 mM lactate and 0.02% casamino acids (83). Electron acceptors were used at 10 mM unless noted otherwise. Chloramphenicol (20 µg/ml), kanamycin (25 µg/ml), and gentamycin (25 µg/ml), were added as appropriate.

Table 2.1. List of strains and plasmids used in this study.

Strain	Description	Source
<i>Shewanella oneidensis</i>		
MR-1	Lake Oneida <i>S. oneidensis</i> isolate	(9)
SR1207	MR-1 Δ SO_0479 (<i>sirA</i>)	(10)
Δ <i>nrfA</i>	MR-1 Δ <i>nrfA</i>	(6)
SR1518	Δ <i>sirA</i> containing pTC1	This Work
SR1550	MR-1 Δ SO_0265 (<i>ccmI</i>)	This Work
SR1576	Δ <i>ccmI</i> containing pTC2	This Work
SR1566	MR-1 Δ SO_0476 (<i>sirH</i>)	This Work
SR1570	Δ <i>sirH</i> containing pTC3	This Work
SR1542	MR-1 Δ SO_0477-8 (<i>sirEF</i>)	This Work
SR1590	MR-1 Δ SO_0480-1 (<i>sirBI</i>)	This Work
SR1548	Δ <i>sirEF</i> containing pTC4	This Work
SR1593	MR-1 Δ SO_0482 (<i>sirG</i>)	This Work
SR1592	Δ <i>sirG</i> containing pTC5	This Work

Table 2.1. List of strains and plasmids used in this study.

Strain	Description	Source
SR1594	$\Delta ccmI \Delta SO_0482$ (<i>sirG</i>)	This Work
SR1595	$\Delta ccmI \Delta sirG$ containing pTC2	This Work
SR1596	$\Delta ccmI \Delta sirG$ containing pTC5	This Work
SR1441	MR-1 ΔSO_0483-4 (<i>sirCD</i>)	This Work
SR1436	MR-1 ΔSO_0485-8 (<i>sirJKLM</i>)	This Work
SR689	MR-1 ΔSO_0689 (<i>sirR</i>)	(Shirodkar S)
<i>Escherichia coli</i>		
β 2155	pir::RP4, KmR	(37)

Plasmid	Description	Source
pER21	R6K <i>ori</i> , Gm ^R , <i>sacB</i> , <i>lacZ</i> α -fragment	(10)
pJBC1	Cloning and sequencing vector, Cm ^R	(24)
pTC1	SO_0479 _{N589C} in pJBC1	This Work
pTC2	SO_0265 (<i>ccmI</i>) in pJBC1	This Work
pTC3	SO_0476 (<i>sirH</i>) in pJBC1	This Work
pTC4	SO_0477-8 (<i>sirEF</i>) in pJBC1	This Work
pTC5	SO_0482 (<i>sirG</i>) in pJBC1	This Work

Table 2.2. List of primers used in this study.

Name	Sequence	Description
Chromosomal Deletion Primers		
265dUF	CTGTTCTGCGATGCTGAC	ΔSO_0265 Upstream DNA Fragment
265dUR	TACGAATTC CATCTACAATAGCGCTAAGTC	
265dDF	TACGAATTC CACTTTAGTTTGCATAAAAGCG	ΔSO_0265 Downstream DNA Fragment
265dDR	GTCCAGTTACGGAATGCAC	

Table 2.2. List of primers used in this study.

Name	Sequence	Description
476dUF	GATTCTTCCCAAGCAATTGC	Δ SO_0476 Upstream DNA Fragment
476dUR	TACGAATTCTCCCGTAAAGCACGGCG	
476dDF	TACGAATTCTATTCAAAGTATCGAGTCGC	Δ SO_0476 Downstream DNA Fragment
476dDR	ATCCCGCACCTCAAACAAC	
477dUF	GGCGATAAAGTCAATTTACAG	Δ SO_0477-8 Upstream DNA Fragment
477dUR	GATCGGATCCCGATTAACCCATGAAATCTTAC	
478dDF	GATCGGATCCATTAGTTAACGATTTAC	Δ SO_0477-8 Downstream DNA Fragment
478dDR	CGTCTTAGAGTGACGTGAACGTC	
480dUF	TCACTTAGACGGTGGTATCGG	Δ SO_0480 Downstream DNA Fragment
480dUR	CTAAGGATCCTCTTAAGTTCCCGACATCCGAAG	
481dDF	GATCGGATCCGGTTTGGTTTGAGGATAGGTT	Δ SO_0481 Downstream DNA Fragment
481dDR	TACAATCGCCACAACCGACAC	
482dUF	CTGGCGCATGTCAGGAAG	Δ SO_0482 Upstream DNA Fragment
482dUR	GACTGGATCCGAGTGCGATGGTGAACCC	
482dDF	GACTGGATCCCGCGATGCCATCAATAACGC	Δ SO_0482 Downstream DNA Fragment
482dDR	GAGCGACTACTGCGACTAACG	
482IF	CCAGTGCTGTGCAGTGGTG	Δ SO_0483-4 Upstream DNA Fragment
483dUR	TCGAGGATCCTCCGTCTCTATATTTTC	
484F2	GATCGGATCCCAATGTAATAAGGCC	Δ SO_0483-4 Downstream DNA Fragment
484R2	GCTGTCCGTCACAGACTCGAG	
484DF	GCCGCGCCACTGCTACTC	Δ SO_0486-7 Upstream DNA Fragment
nosR1	GATCGGATCCGCTGTCCGTCACAGACTCGAG	
nosF2	GATCGGATCCGTGGTACCGCCGAGTTTGC	Δ SO_0486-7 Downstream DNA Fragment
490R1	CTAAGATCTCTGTGACTCTATACTCAG	
Complementation Primers		
265cF	TGCGCTAAGCCAAGACTTAG	SO_0265 Complementation DNA Fragment
265dDR	GTCCAGTTACGGAATGCAC	

Table 2.2. List of primers used in this study.

Name	Sequence	Description
476cF	AAGCATATCAC <u>CATATGATGAAATCTTACACAGCC</u> AAGC	SO_0476 Complementation DNA Fragment
476cR	CATTTACCGCCGTGCTTTAC	
477cF	GTAAGATTTTCATGGGTTAATCC	SO_0477-8 Complementation DNA Fragment
478cR	TCCTAATTTATCATTAGTT	
482cF	AAGCATATCAC <u>CATATGGCATGGCAAGTTTAGGGT</u> TC	SO_0482 Complementation DNA Fragment
482cR	GGCTAGCGACTTGATTAATATC	
Site Directed Mutagenesis Primers		
479subF	CGGCTTCTGACCACGACGTA <u>ACTGAATGCAAAGG</u> TTGCATAGCCAGTTCCAATC	SO_0479 Site Directed Mutagenesis
479subR	GATTGGA <u>ACTGGCTATGACAACCTTTGCATT</u> CAG TTACGTCGTGGTCAGAAGCCG	
Cistron Mapping RT-PCR Primers		
479subF	CGGCTTCTGACCACGACGTA <u>ACTGAATGCAAAGG</u> TTGCATAGCCAGTTCCAATC	Fragment 1 (607 bp)
479DR	CGTTATAGGGCACCTCTGAC	
482dUF3	CTGGCGCATGTCAGGAAG	Fragment 2 (1032 bp)
482dUR3B	GACTGGATCCGAGTGCGATGGTGAACCC	
482DF	GAGGCAATCGATCATTGGC	Fragment 3 (317 bp)
482DR	GCTTATGGGCGCTGTCAGC	
483IF	CTCGGGTGATCCTTGAGCAG	Fragment 4 (838 bp)
482dDR3	GAGCGACTACTGCGACTAACG	
484DF	GCCGCGCCACTGCTACTC	Fragment 5 (397 bp)
484DR	CACCATGCCGCACAGGTGAC	
Real-Time RT-PCR Primers		
16SrRNARTF	CGTCGTAGTCCGGATTGGAG	16S rRNA RT Product
16SrRNARTR	CCACTTCTTTTGCAGCCCAC	(145 bp)

Table 2.2. List of primers used in this study.

Name	Sequence	Description
fccARTF	CGTATCAGACAAAGGTGGCGTC	SO_970 RT Product
fccARTR	GCTATGGCAAGCATCACAATAAGC	(211 bp)
dmsARTF	CCAATGATGAGTATGGCAACCAC	SO_1429 RT Product
dmsARTR	AACTTCGCTTCCCCACGCTTAC	(130 bp)
napARTF	GGTTTTGGTGGGAATCGTGCC	SO_0848 RT Product
napARTR	GCCAGGTAACAGCCCATTCT	(173 bp)
nrfARTF	GCTAAATCCCAGCGCCATTG	SO_3980 RT Product
nrfARTR	GCCACAGCCAAACCAAAGAG	(201 bp)
phsARTF	CATTGGGTTGGTACGGGACA	SO_4062 RT Product
phsARTR	CGACCAAGTGGAAGAGCAGT	(110 bp)
sirARTF	TCGCTACAGCGCCTATGAAG	SO_0479 RT Product
sirARTR	ATCGACCTCTGGATGTTTCGC	(198 bp)
sirFRTF	CCGCCGAGCATCATGAAAAG	SO_0477 RT Product
sirFRTR	GATCGACCACGGTTTTTGGC	(137 bp)
torARTF	CGCCATCTTTAATGCCACGG	SO_1232 RT Product
torARTR	GAAAAAGCTGAACGCAGCCA	(195 bp)

Generation and complementation of chromosomal deletion mutants

Chromosomal deletions were generated using the suicide vector pER21 (10). Approximately 1 kb DNA fragments that flank these genes were amplified by PCR using primers listed in Table 2.2 and Phusion polymerase (New England BioLabs). The internal primers were engineered to include restriction enzyme sites and allow ligation of the amplified fragments. The ligated fragments were cloned into the SmaI digested pER21, and the recombinant plasmids were transferred into *S. oneidensis* MR-1 cells by conjugation from *E. coli* β 2155 (93). Mutants were isolated following sucrose selection as

described previously (94) and chromosomal deletions were confirmed by PCR. To complement the mutants, DNA fragments that carry the respective genes were generated by PCR using Phusion polymerase (New England BioLabs) and primers listed in Table 2.1. Amplified fragments were cloned into pJBC1 (10) then transferred from *E. coli* β 2155 (93) to *S. oneidensis* MR-1 strains by conjugation.

Protein feature predictions

Protein signal sequence predictions were performed with SignalP version 4.1 (95). Membrane helices were predicted using TopPred 1.10 (96, 97) and confirmed with TOPCONS (98). Default settings were used unless noted. Probable lipid attachment sites were identified using LipopP 1.0 (99) and default setting were used unless noted.

Endpoint RT-PCR

RNA was purified from wild-type MR-1 cells grown anaerobically in the presence of Na₂SO₃ for 24 hours. The cells were then harvested and total cell RNA was extracted using TRI Reagent (Ambion – Life Technologies, Grand Island, NY) per manufacture guidelines. The isolated RNA was subsequently treated with RNase-free DNase I (ThermoScientific, Waltman, WA) followed by ethanol precipitation. RNA concentrations were measured on a Biophotometer (Eppendorf, Hauppauge, NY). Reverse Transcription and cDNA amplification were performed using illustra Ready-to-Go RT-PCR Beads (GE Healthcare, Piscataway, NJ) and primers listed in Table 2.2 per manufacturer guidelines. 20 pmol of gene-specific primers were used to generate cDNA using 100 ng total RNA as

the template. Following heat inactivation of the reverse transcriptase, the resultant cDNA was amplified for 30 cycles.

Detection of reductase activity in native polyacrylamide gels

S. oneidensis wild type and mutant strains were grown anaerobically in basal medium supplemented with 50 mM lactate, 0.02% casamino acids and 10 mM sodium sulfite or 0.5 mM potassium nitrite as electron acceptors. Cell extracts were prepared using B-PER lysis reagent (PIERCE, Rockford, IL). Protein concentrations were determined using the Coomassie Plus Protein Assay kit and 50 µg total protein was separated on 10% native polyacrylamide gels. Enzyme activities were assayed essentially as previously described (100). Gels were transferred to a Coy anaerobic chamber (Coy Laboratory Products, Grass Lake, MI) and stained for 20 min with reduced methyl viologen [38.9 mM methyl viologen dichloride and 57.4 mM sodium hydrosulfite in 10 mM Tris pH 7]. 10 mM of Na₂SO₃ or NaNO₃ was added and the gels were incubated further until bands of clearing, indicating reduction of the electron acceptors, were observed. Gels were imaged using a Kodak DC290 digital imaging system (Eastman Kodak, Rochester, NY).

Mass spectrometry

Protein bands displaying sulfite reduction activity were excised from Native Polyacrylamide gels and rinsed three times in dH₂O to remove excess stain. Gel samples were sent to the University of Wisconsin – Madison Biotechnology Center for trypsin digestion and evaluation on a 4700 Proteomics Analyzer (Applied Biosystems, Foster City,

CA). The resultant spectra were compared against the MR-1 proteome for protein identification.

Sulfite reduction assays

Reduction of sulfite was performed anaerobically in a Coy anaerobic chamber using biometer flasks as described previously (38). The flasks contained 100 ml of deoxygenated basal medium supplemented with 50 mM lactate, 0.02% casamino acids and 10 mM sodium sulfite as the sole electron acceptor. Chloramphenicol (20 µg/ml) was added as appropriate. The side arm of the flasks contained 10 ml of 40% KOH to trap H₂S (101). Overnight cultures of *S. oneidensis* strains grown in LB were used as inocula. Cultures were sampled to measure H₂S and SO₃⁻² every 12 to 24 hrs for up to 120 hrs. H₂S was measured using the mixed diamine assay (102) with modification. Briefly, 0.5 ml of the KOH trap was transferred to 25 ml of dH₂O and 1 ml of mixed diamine reagent [20 g *N, N*-dimethyl-*p*-phenylenediamine sulfate, 30 g ferric chloride (FeCl₃·6H₂O) in 500 ml of 50% hydrochloric acid] was added. The color was allowed to develop for 20 minutes and the absorbance was measured at 670 nm. Hydrogen sulfide concentrations were determined using sodium sulfide as a standard. Sulfite was measured using the fuchsin assay as described previously (103). Briefly, 100 µl of 1.18 mM fuchsin dye (dissolved in 2.25 N H₂SO₄) was added to 20 µl of sample mixed with 870 µl of water. Following a 10 min incubation at room temperature, 10 µl of formalin was added, and the absorbance was measured at 570 nm. Sulfite concentrations were determined using sodium sulfite as a standard.

Anaerobic growth assays

Anaerobic growth of *S. oneidensis* strains was performed in Hungate tubes filled with minimal medium (28) supplemented with 50 mM lactate and 0.02% casamino acids. Fumarate and DMSO were used as electron acceptors at a final concentration of 10 mM. Absorbance at 600 nm was measured for up to 24 hours on a Genesys 20 spectrophotometer (ThermoScientific, Waltham, MA).

Protein detection by western blots

Antibodies against SirA peptides (N'- DGSWGAHGPRYTQKRLD and N'- CHGPQYEKWRRSRHSK) were generated and affinity purified by Biomatik corp. (Cambridge, Ontario). Strains of *S. oneidensis* were incubated anaerobically in basal medium supplemented with 50 mM lactate, 0.02% casamino acids and 10 mM sodium sulfite for 24 hours, unless otherwise indicated. Cells were harvested by centrifugation and aliquots were used for determination of protein concentrations or resuspended directly in SDS loading buffer and lysed by boiling for 10 min (104). Proteins were separated on 10% sodium dodecyl sulfate-polyacrylamide gels and transferred to polyvinylidene difluoride membrane (Thermo Scientific, Rockford, IL). The membranes were incubated with SirA antibodies and developed using Supersignal West Pico Chemiluminescent substrate (Thermo Scientific, Rockford, IL). Blots were imaged using a FOTO/Analyst Luminary FX Workstation (FOTODYNE Inc., Hartland, WI). Protein concentrations were determined using the Coomassie Plus Protein Assay kit (PIERCE, Rockford, IL)

Nitrite reduction assay

Reduction of nitrite was performed anaerobically in a Coy anaerobic chamber. Serum vials containing deoxygenated basal medium supplemented with 50 mM lactate, 0.02% casamino acids, 0.5 mM potassium nitrite, were inoculated with *S. oneidensis* cultures grown overnight in LB. Chloramphenicol (20 µg/ml) was added as appropriate. Cultures were sampled every hour and nitrite concentrations were measured using N-(1-naphthyl)ethylenediamine dihydrochloride and sulfanilic acid. The color was allowed to develop for 10 min, and the absorbance was measured at 540 nm.

Site directed mutagenesis of SirA

The QuikChange II Site-Directed Mutagenesis Kit from Stratagene (Agilent Technologies, Inc., Santa Clara, CA) was used to generate a mutation in the atypical heme-binding site of SirA. The primers (479subF & 479subR; Table 2.2) extend 26 bases upstream and downstream of the corresponding N589 codon in SirA. The N589 codon, AAC, was changed to TGC resulting in an N859C substitution in the translated sequence. The mutagenized fragment was amplified by PCR using PfuUltra HF DNA polymerase and the base substitution was confirmed by DNA sequencing (Eurofins MWG Operon, Huntsville, AL). The mutagenized *sirA* and its native promoter were cloned into the *S. oneidensis* expression plasmid pJBC1 (10). The resulting plasmid was transferred from *E. coli* β2155 (93) into Δ *sirA* by conjugation.

Generation of promoter-*lacZ* fusions

DNA fragments directly upstream of the DMSO reductase operon (*dmsEFAB*; SO_1427-SO_1430), the fumarate reductase gene (*fccA*; SO_0970), the sulfite reductase operon (*sirABIGCDJKLM*; SO_0479-SO_0488) and the thiosulfate reductase gene (*psrA*; SO_2493) were amplified by PCR using the primers listed in Table 2.2 and Phusion polymerase (New England BioLabs). The resulting fragments were digested with HindIII and BamHI and then cloned into pMC10 (85), which carries a promoterless *lacZ*. Following transformation of *E. coli* β 2155 (93), the plasmids were transferred into *S. oneidensis* wild type and mutant strains by conjugation as described above. Recombinant strains were grown anaerobically with 10 mM fumarate, DMSO or TMAO, 1 mM nitrite or nitrate for 4 hours or with 5 mM sulfite or thiosulfate for 24 hours in minimal medium supplemented with 50 mM lactate and 0.02% casamino acids. For aerobic growth, 20 ml cultures were grown in 500 ml flasks with vigorous shaking for 4 hr. Cultures were assayed for β -galactosidase activity as described previously (105).

Real-time RT-PCR expression analysis

S. oneidensis MR-1 wild type was grown anaerobically in basal medium supplemented with 50 mM lactate, 0.02% casamino acids and either 10 mM fumarate, 10 mM DMSO, or 1 mM KNO₂ for 4 hours or with 5 mM Na₂SO₃ or NaS₂O₃ for 24 hours. Cell cultures were pelleted, and total RNA was extracted from the cells using the Tri Reagent (Ambion – Life Technologies, Grand Island, NY) according to the manufacturer's instructions. The total RNA obtained was treated with RNase-free DNase I (ThermoScientific, Waltham, MA) for 1 hr at 37°C and ethanol precipitated to remove

residual enzymes. The absence of contaminating DNA in the RNA samples was confirmed by PCR using primers 16SrRNARTF and 16SrRNARTR (Table 2.2) and 50 ng of the total RNA extracted. RNA concentrations were determined using a Biophotometer (Eppendorf, Hauppauge, NY). Aliquots of the RNA samples were run on a 1% proteinase K treated agarose gel to verify the integrity of the total RNA. To verify primer specificity and relative total RNA concentrations, endpoint RT-PCR was performed using primers 16SrRNARTF and 16SrRNARTR (Table 2.2) and illustra Ready-to-Go RT-PCR Beads (GE Healthcare, Piscataway, NJ).

RT-PCR was performed using the primers listed in Table 2.2 and the iTaq Universal SYBR Green One-Step Kit (Bio-Rad, Hercules, CA) per the manufacturer guidelines. 100 μ g total RNA and 20 pMoles of each primer were used in a 20 μ L total reaction volume in Hard-Shell low-profile 96-well semi-skirted PCR plates (Bio-Rad, Hercules, CA). The reverse transcription, cDNA amplification and fluorescent detection were performed in a CFX96 Touch Real-Time PCR Detection System (Bio-Rad, Hercules, CA). Analysis of the data generated was performed with CFX Manager 3.1 (Bio-Rad, Hercules, CA).

Chapter 3

Analysis of genes located in the *sir* operon

Introduction

Sulfur is an essential element for all living organisms and is a component of amino acids, such as cysteine and methionine, and Fe-S containing proteins such as ferredoxins (52). Sulfur compounds also play a significant role in anaerobic respiration in many aquatic environments. Sulfate (SO_4^{2-}) is the most oxidized form of sulfur and is used for respiration by many anaerobic bacteria. In many environments, SO_4^{2-} is the major anaerobic electron acceptor (53, 54). Other sulfur compounds such as sulfite (SO_3^{2-}), thiosulfate ($\text{S}_2\text{O}_3^{2-}$) and tetrathionate ($\text{S}_4\text{O}_6^{2-}$) can also be used for dissimilatory reduction under anoxic conditions. They are abundant in marine and brackish aquatic environments and are important oxidants for organic matter. Sulfur species with intermediate oxidation states, such as thiosulfate and sulfite, are formed by the oxidation of sulfide and are rapidly consumed by thiosulfate and sulfite reducing bacteria (106, 107). Approximately 80% of the sulfide produced is recycled to sulfate through the formation of sulfur compounds of intermediate oxidation states (108). The low abundance of intermediate sulfur species compared to sulfate is attributed to their rapid use by microorganisms (108). In addition to their role as terminal electron acceptors or energy sources, various sulfur species interact with metals and play an important role in metal cycles. For example, the chemical reduction of Tc, U, Cr, and Co by H_2S and elemental sulfur leads to their immobilization (109-113). H_2S also reduces Fe(III), and the reduced iron is thought to participate in the reduction and immobilization of radionuclides mentioned above (109).

The ability of *S. oneidensis* MR-1 to reduce a wide range of non-metal electron acceptors is essential for its ecological success. Detectable turbidity and robust growth in batch cultures is observed when TMAO, fumarate, DMSO, polysulfide, thiosulfate, and sulfite are used as electron acceptors. It is interesting to note that four of these six anaerobic electron acceptors are sulfur compounds. Despite their importance, little is known about the mechanisms by which S-species are reduced by *S. oneidensis*.

In many bacteria and archaea, the dissimilatory sulfite reductases (Dsr) belong to a family of proteins that also includes assimilatory nitrite and sulfite reductases (114-116). Interestingly, Dsr is also found in the phototroph *Chromatium vinosum* and the sulfur oxidizer *Thiobacillus denitrificans*, where it acts as a reverse sulfite reductase (117, 118). Although *S. oneidensis* can reduce sulfite, its genome lacks the traditional dissimilatory sulfite reductase (*dsr*) genes. We have recently identified the terminal sulfite reductase in *S. oneidensis* MR-1 as an octaheme *c* cytochrome that belongs to the MccA family of proteins, and has been designated SirA (38). Enzyme activity assays using methyl viologen as the electron donor confirmed that SirA is a component of the terminal sulfite reductase. *sirA* is located within a gene cluster that is conserved in the genomes of sulfite reducing *Shewanella* species (38). Sulfite reduction by *S. oneidensis* was analyzed using biometer flasks that allowed removal of toxic H₂S produced during reduction. Intermediates, such as thiosulfate and trithionate, were not detected during sulfite reduction suggesting that the terminal sulfite reductase catalyzes a six-electron reduction reaction (38).

Siroheme is thought to be an important cofactor required by enzymes that catalyze six-electron reduction reactions (119). Analysis of the genome sequence of *S. oneidensis* MR-1 identified two putative siroheme synthetase genes. SO_3108 is predicted to encode

a putative siroheme synthetase, while SO_3278 is predicted to encode a uroporphyrin-III C-methyltransferase that functions in siroheme biosynthesis (120, 121). Results from our laboratory indicated that these genes are not required for sulfite reduction in *S. oneidensis* (122). This is further supported by the observation that the identified *S. oneidensis* sulfite reductase components lack siroheme-binding motifs.

The sulfite reductase gene, *sirA*, is located in a 10-gene cluster that is predicted to form an operon (38). This gene cluster includes *sirCD* that are proposed to encode a menaquinol oxidase, and *sirJKLM* that are predicted to encode an ABC copper transporter. In addition to *sirJKLM*, the *sir* locus encodes a peptidyl-prolyl cis-trans isomerase (SO_0481; SirI) that may play a role in protein folding, and a sulfurtransferase (SO_0480; *sirB*) that exhibits a high degree of similarity to rhodanases. The exact functions of rhodanases are not known, but one of the roles attributed to these enzymes is sulfur transfer to proteins (123). The presence of *sirB* within the sulfite reductase operon allows us to speculate that this rhodanese-like protein may play a role in sulfur transfer to the sulfite reductase. Although NosDFYL, the homologs of SirJKLM, are thought to be involved in copper transport, some reports suggest that these proteins are involved in the transfer of sulfur needed for the formation of a 4Cu-S center, from the cytoplasm to the periplasmic space (124). The function of genes in the *sir* gene cluster is not known and is the subject of the work presented in this chapter.

Results

Genes of the *sir* Locus

Genes involved in sulfite reduction are located in a gene cluster containing 14 genes, designated *sir*. Ten of these genes, including *sirACD* that encode the sulfite reductase are predicted to form an operon based on the proximity of these genes to each other (Fig. 3.1).

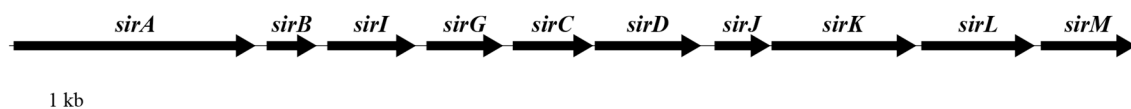

Figure 3.1. Arrangement of the predicted *sir* gene operon on the *S. oneidensis* chromosome.

sirA (SO_0479) encodes a 708 amino acid octaheme *c*-type cytochrome that functions as the terminal sulfite reductase and catalyzes the 6-electron reduction of sulfite to sulfide (38). *sirB* (SO_0480) encodes a protein of 148 amino acid that is annotated as a rhodanese domain containing sulfurtransferase. Sulfurtransferase proteins catalyze the transfer of a sulfane sulfur to a donor molecule and can break the S-S bond of thiosulfate to produce sulfite (125). *sirI* (SO_0481) is predicted to encode a peptidyl-prolyl cis-trans isomerase (PPIase) of 259 amino acids. PPIases have been reported to play important roles as protein folding chaperones (126). *sirG* encodes a cytochrome *c* maturation chaperone and will be discussed in more detail in Chapter 4. *sirC* (SO_0483) encodes a 235 amino acid ferredoxin predicted to contain a [4Fe-4S] center, whereas *sirD* (SO_0484) is predicted to encode a membrane bound menaquinol oxidase of 315 amino acids. SirCD

share 51% identity/70% similarity and 54% identity/72% similarity with NrfCD of *Wolinella succinogenes* respectively. SirCD are also similar to the thiosulfate reductase subunits PhsBC of *S. oneidensis* with 49% identity/65% similarity and 48% identity/61% similarity respectively. *sirJKLM* (SO_0485-8) encode proteins similar to those involved in Cu transport and Cu binding to the nitrous oxide reductase of several bacteria, including *Pseudomonas* and *Rhizobium* species (Table 3.1) (127, 128). SirJ is similar to NosL, a periplasmic Cu chaperone. SirK is similar to NosD, which is responsible for Cu insertion into the active site of the N₂O reductase of *Pseudomonas* and *Sinorhizobium* species (128, 129). Like NosD, SirK is predicted to be a lipoprotein localized to the periplasmic face of the inner membrane (Table 3.2). SirL is similar to NosF, which is thought to be an ATP-binding component of the Cu transport systems in *Pseudomonas* and *Sinorhizobium*. SirL contains an ATP/GTP-binding WALKER A motif/P-loop, (A/G)X₄GK(S/T) (130), which is also found in the NosF of several denitrifying bacteria (128, 131). SirL lacks a predicted signal peptide sequence and is thus likely to be associated with the cytoplasmic face of the inner membrane. SirK is similar to NosY, which in *P. stutzeri* is a transmembrane component suggested to link energy-generation by NosL to the energy-dependent Cu insertion by NosD (129).

Table 3.1 Comparison of SirJKLM to the copper transport proteins NosLDFY (% Identity/% Similarity)

	SirJ	SirK	SirL	SirM
<i>Pseudomonas stutzeri</i> ATCC 17588	NosL (44/59)	NosD (40/57)	NosF (43/62)	NosY (38/58)
<i>Pseudomonas aeruginosa</i> PAO1	NosL (42/55)	NosD (42/59)	NosF (42/62)	NosY (43/61)
<i>Sinorhizobium meliloti</i> 1021	NosL (38/51)	NosD (35/50)	NosF (38/57)	NosY (40/58)
<i>Paracoccus denitrificans</i>	NosL (40/54)	NosD (36/52)	CcmA (39/60)	NosY (35/55)

Table 3.2 Predicted location and modifications of SirJKLM

	Length in Amino Acids	Predicted Signal Sequence	Membrane Helices	Predicted Localization	Predicted Lipoprotein
SirJ	163	MKKFFGLLLLLPLLL GCNKSEAT- DHQH	None	Periplasmic surface of IM	Yes
SirK	424	MLRLLLLCWLCGVS FIGGAQ- ELRV	None	Periplasmic surface of IM	Yes
SirL	348	None	None	Cytoplasmic, IM associated	No
SirM	298	None	6	IM Integral	No

To confirm the prediction that *sirABIGCDJKLM* form a single transcriptional unit, end-point RT-PCR was performed using primers designed to amplify the intergenic regions indicated in Figure 3.2. Bands of the expected sized were obtained confirming the prediction that these genes are organized in an operon. The start sites of *sirKLM* all reside within the coding sequence of the previous gene, and as such no intergenic regions exist.

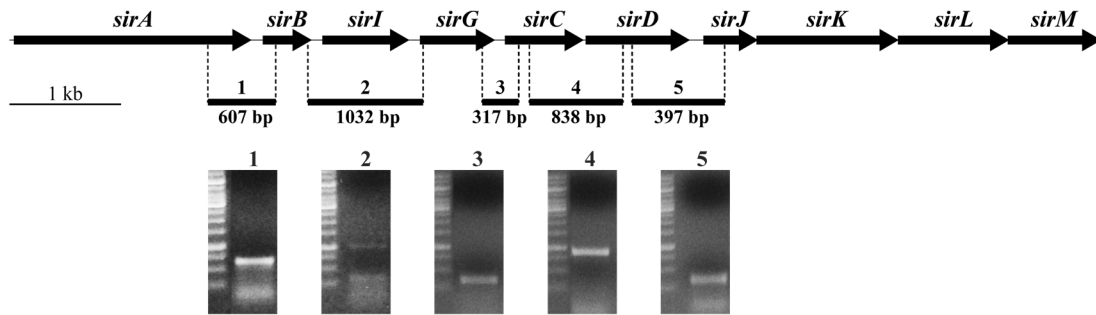

Figure 3.2 End-point RT-PCR mapping of *sir* gene mRNA. Solid black lines indicate location and size of expected RT-PCR products. Images of fragments separated on agarose gels are shown below, 1 kb DNA ladder is shown to the left (250 bp, 500 bp, 750 bp, 1 kb, 1.5 kb, 2kb, 2.5 kb, 3 kb)

Analysis of proteins with sulfite reductase activity by mass spectrophotometry

Sulfite reductase activity can be detected in native polyacrylamide gels using methyl viologen as the electron donor and Na_2SO_3 as the electron acceptor (38). Based on sequence analysis we predicted that SirCD may be components of the terminal sulfite reductase in addition to SirA (38). In an effort to identify proteins that make up the terminal sulfite reductase, wild-type MR-1 cell extracts were used to obtain a sulfite reductase band for sequence analysis. This band was excised from the gel and analyzed by LC-MS/MS. The results revealed five peaks that corresponded to SirA fragments (Fig. 3.3). Because native PAGE was used to isolate the sulfite reductase active band, we expected to detect other components of the sulfite reductase such as SirC or SirD; these proteins were not identified in our analysis.

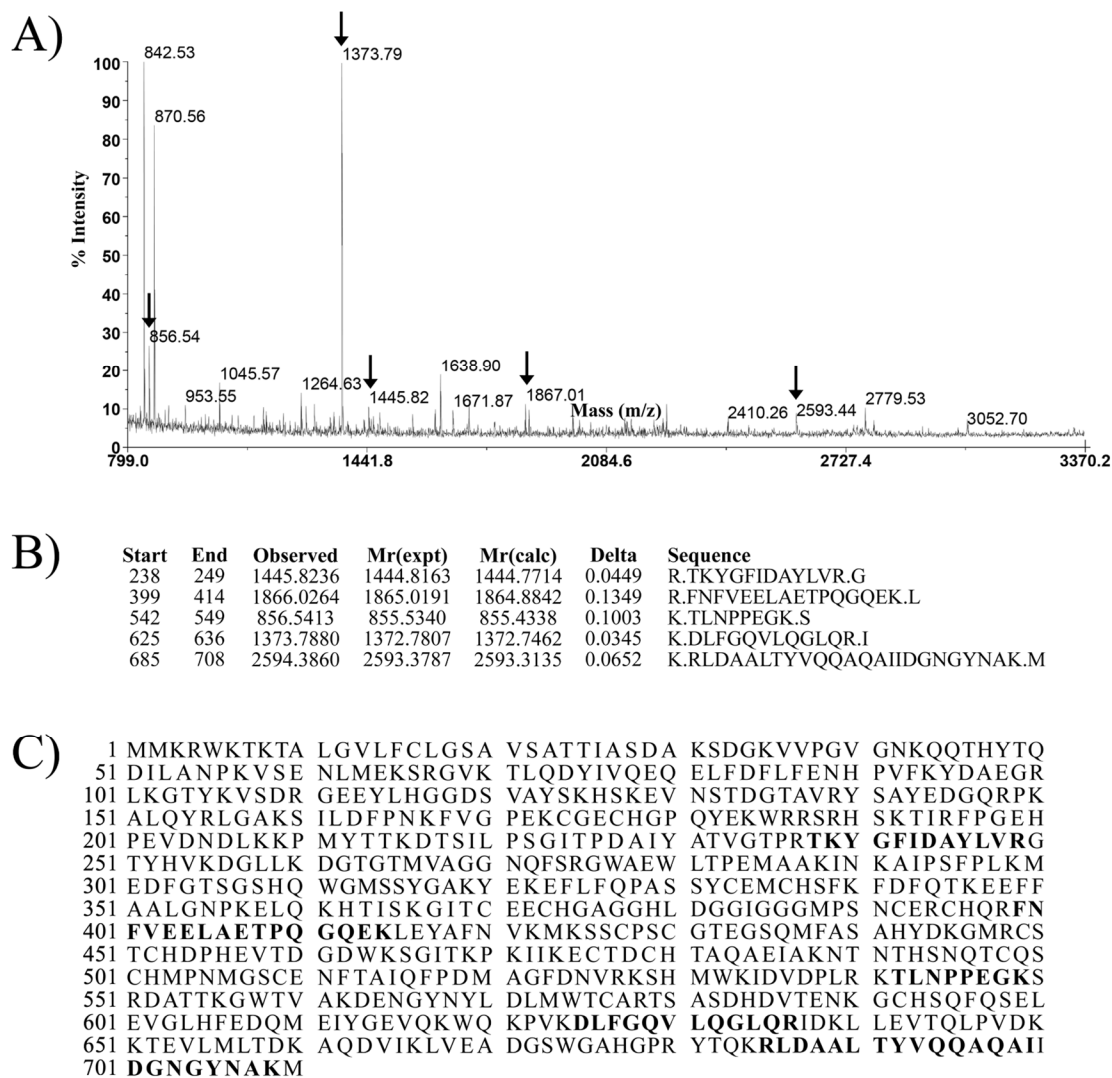

Figure 3.3 LC-MS/MS analysis of the sulfite reductase from native polyacrylamide gel. A) LC-MS/MS spectra; peaks of SirA peptides are indicated by arrows. B) Results of peaks indicative of SirA as indicated by arrows. Start and end site of peptide relative to peptide sequence, observed peak, expected and calculated mass (Mr), mass difference and identified sequence. C) SirA sequence with peptides identified by LC-MS/MS shown in bold.

Reduction of sulfite and respiration of DMSO and fumarate by *sir* mutants

As mentioned above, the *sir* operon encodes 10 proteins that are predicted to be involved in sulfite reduction. Mutants that lack *sirA* and *sirGCD* were generated previously

and determined to be deficient in sulfite reduction (38). The role of additional genes within the *sir* operon in sulfite reduction or anaerobic respiration has not been determined. To test the role of these genes, chromosomal deletions of *sirBI*, *sirG*, *sirCD*, and *sirKL*, were generated and tested for anaerobic growth with fumarate and DMSO. All mutants were able to grow similar to the wild-type indicating that none of the *sir* genes are required for anaerobic respiration with these electron acceptors (Fig. 3.4 and 3.5). These mutants were also tested for sulfite reduction. As expected, Δ *sirBI* and Δ *sirCD* were unable to reduce sulfite and H₂S was not detected in these cultures (Fig. 3.6). Δ *sirG* was able to reduce sulfite following a long lag phase and is discussed further in Chapter 4.

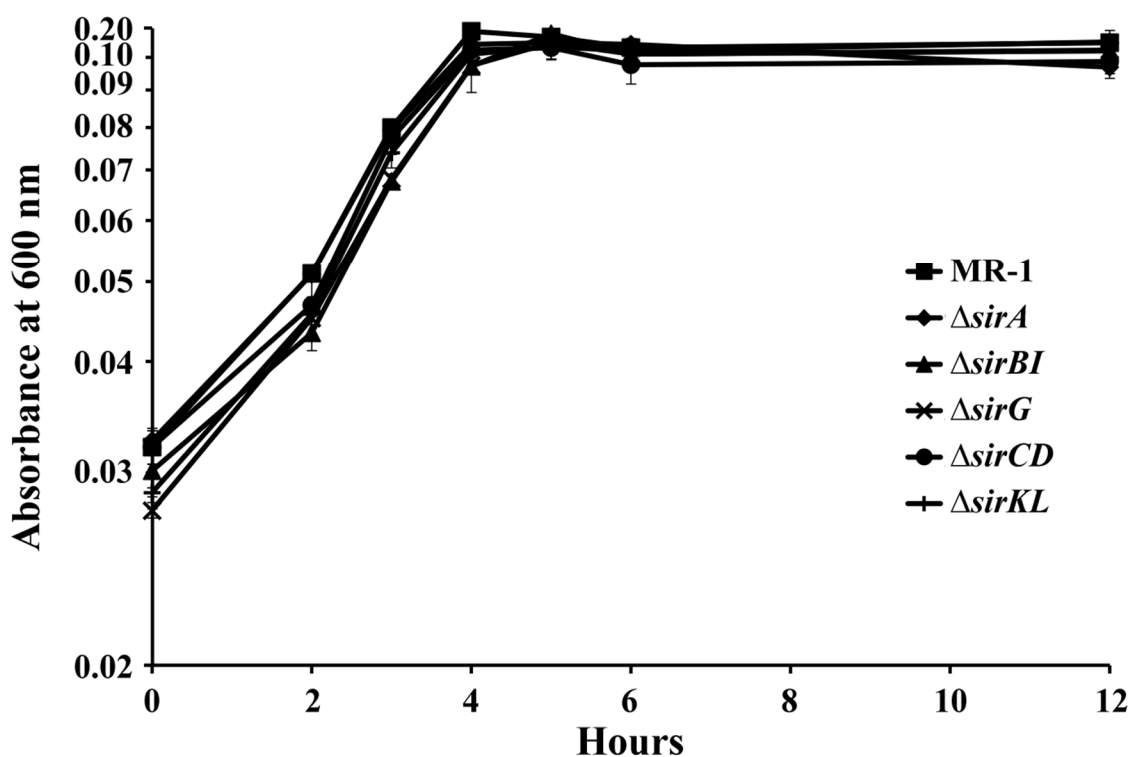

Figure 3.4 Growth of wild-type and *sir* mutants with fumarate as the electron acceptor. None of the mutants exhibited any deficiency indicating that the *sir* genes were not involved in fumarate reduction. Error bars indicate standard deviation across 3 replicates.

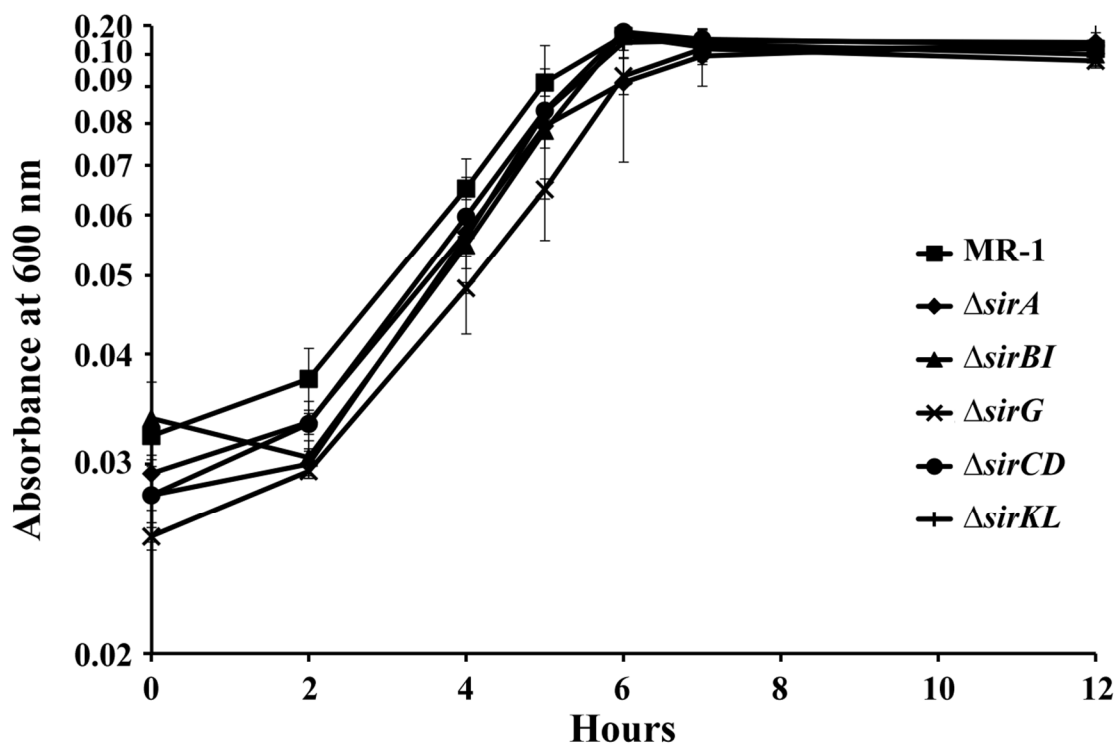

Figure 3.5. Growth of wild-type and *sir* mutants with DMSO as the electron acceptor. None of the mutants exhibited any deficiency indicating that the *sir* genes were not involved in DMSO reduction. Error bars indicate standard deviation across 3 replicates.

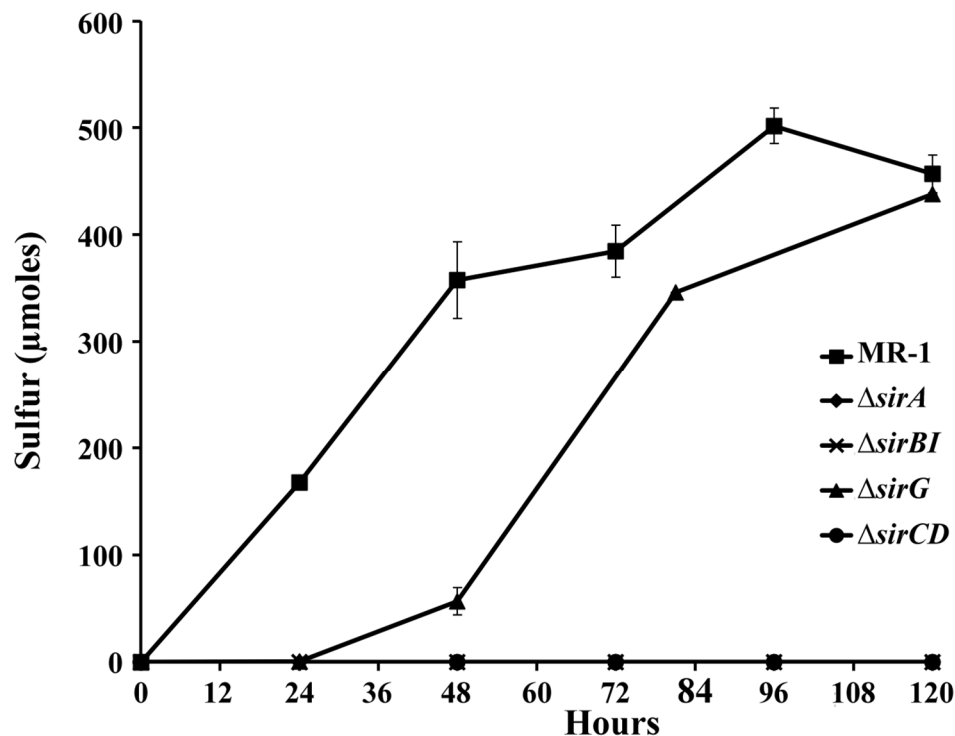

Figure 3.6 Sulfite reduction by wild-type and mutant strains. $\Delta sirA$, $\Delta sirBI$ and $\Delta sirCD$ are all deficient on reduction with sulfite. $\Delta sirG$ shows a lag of 48 hours before H₂S is detected. Error bars indicate standard deviation across 3 replicates.

Role of SirJKLM in sulfite reduction

SirJKLM exhibit similarity to Nos proteins involved in Cu transport and delivery to the nitrous oxide reductase in other denitrifying bacteria. *sirJKLM* are part of the *sir* operon and are predicted to play a role in sulfite reduction. To test this prediction, $\Delta sirKL$ was tested for sulfite reduction in biometer flasks as described in Chapter 2. In contrast to mutants that lack *sirBICD*, the *sirKL* mutant was able to reduce sulfite but after a lag phase of 72 hr (Fig. 3.7).

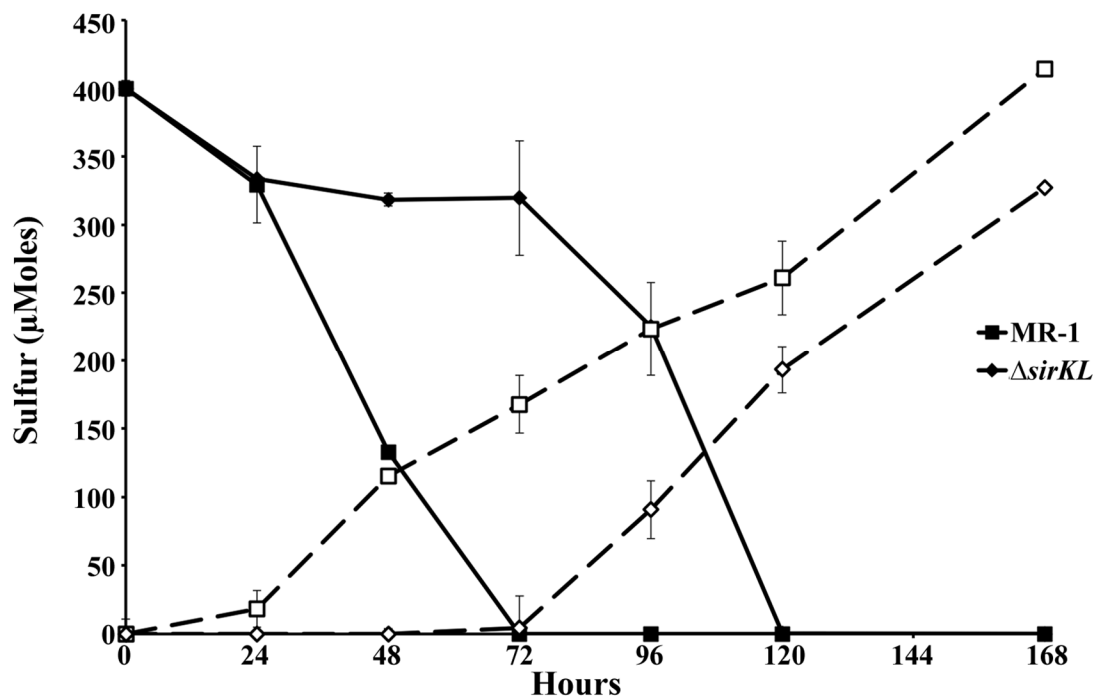

Figure 3.7 Sulfite reduction by wild-type MR-1 and $\Delta sirKL$ mutant. Sulfite in the growth medium (solid lines) was depleted within 3 days of incubation in wild-type cells. H_2S (dashed lines) was detected in wild-type cells after 24 hours of incubation. $\Delta sirKL$ did not reduce appreciable amounts of sulfite during the first 72 hours as evidenced by sulfite and H_2S concentrations in the medium. Error bars indicate standard deviation across 3 replicates.

The role of Cu in sulfite reduction is not known, but the results described above suggested that the predicted copper transport proteins SirJKLM were required for wild-type sulfite reduction levels. To determine if Cu affects sulfite reduction, I used the copper chelator tetrathiomolybdate (TTM) to deplete the growth media of copper. TTM is thought to be a copper specific chelator and has been successfully used to remove excess Cu in patients with Wilson's disease and some cancers (132-134). To determine if TTM has a generalized effect on growth of *S. oneidensis* wild-type or $\Delta sirKL$ strains, up to 5 μM TTM was added to cultures incubated anaerobically with fumarate as the electron acceptor (Fig. 3.8). Both strains were able to grow at similar rates with or without added TTM. These

results suggested that TTM does not have a general effect on anaerobic growth of *S. oneidensis*. TTM was also added to the growth media of wild-type and $\Delta sirKL$ cultures supplemented with Na_2SO_3 as the sole electron acceptor. Surprisingly, addition of $1\ \mu\text{M}$ TTM to wild-type cells resulted in a slight increase in sulfite reduction (Fig. 3.9). Increasing TTM concentrations to 3 and $5\ \mu\text{M}$ resulted in a progressively decreased rate of sulfite reduction (Fig. 3.9). Similar results were seen when $\Delta sirKL$ was grown in media supplemented with TTM. Addition of just $1\ \mu\text{M}$ showed a marked decrease in sulfite reduction and addition of $3\ \mu\text{M}$ TTM or greater completely inhibited sulfite reduction (Fig. 3.10). These results suggest that Cu may be required as a cofactor for optimum sulfite reduction.

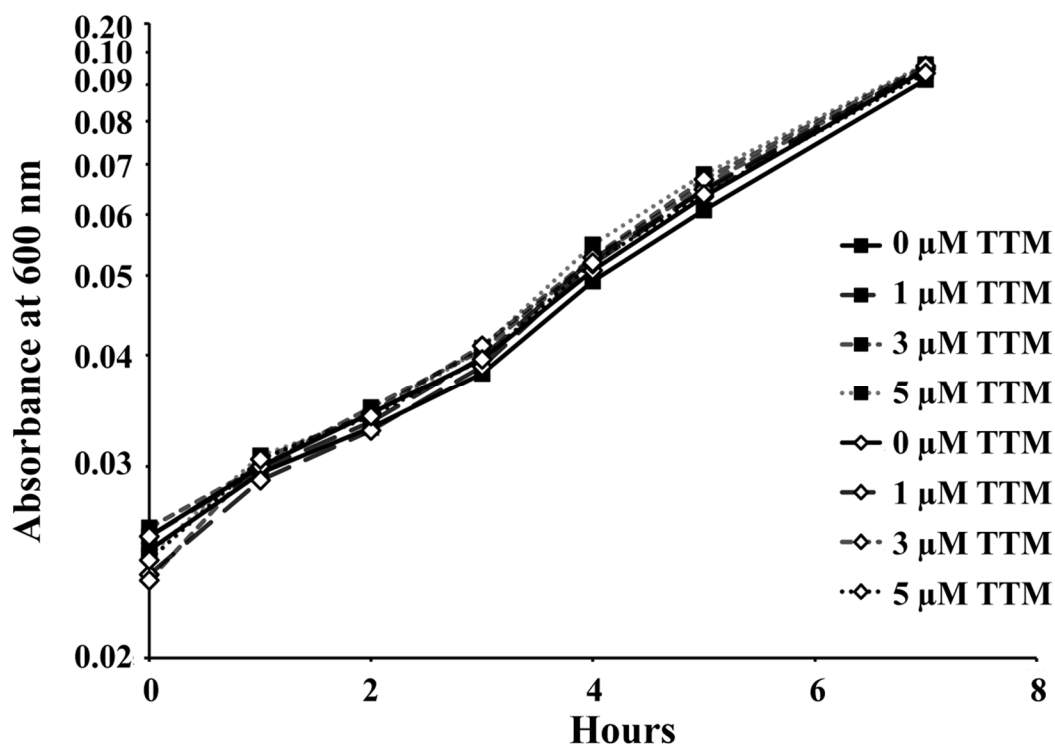

Figure 3.8 Growth of wild-type MR-1 (■) and $\Delta sirKL$ (◇) in Basal Medium supplemented with fumarate and TTM. Addition of up to $5\ \mu\text{M}$ TTM had no effect on the growth rate of wild-type or $\Delta sirKL$.

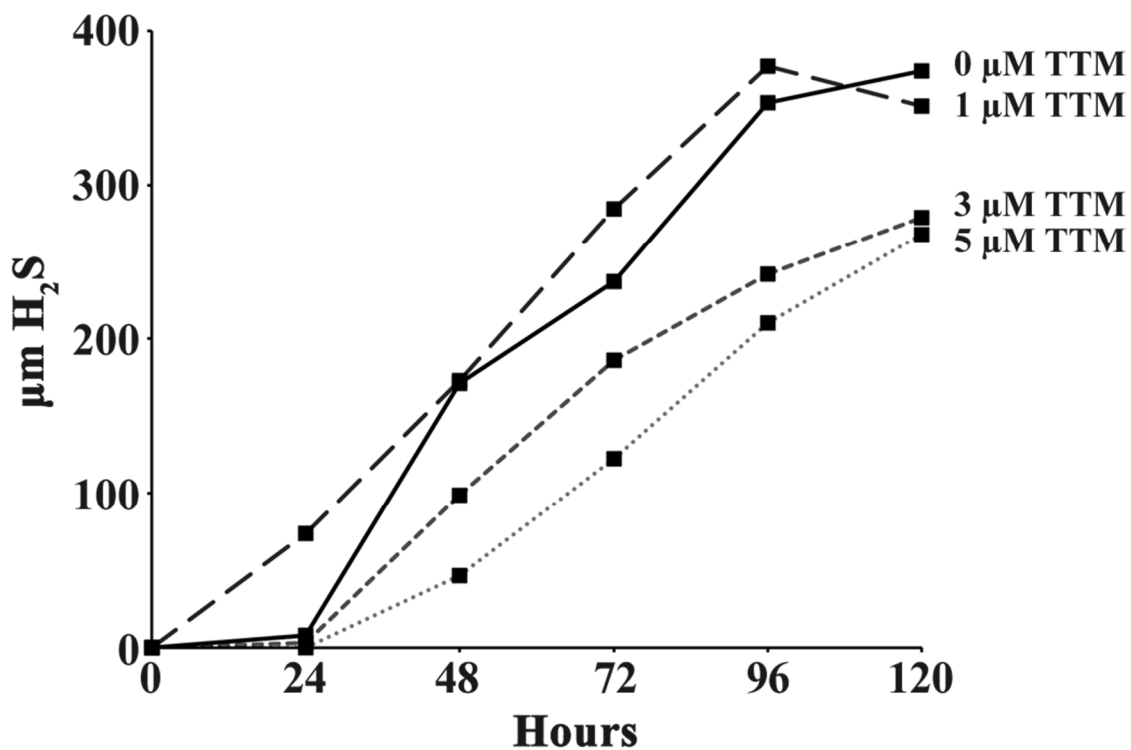

Figure 3.9 Sulfite reduction by wild-type MR-1 in Basal Medium supplemented with TTM as indicated. Addition of 1 μM TMM exhibited a slightly increased rate of reduction compared to non-supplemented medium. Addition of 3 μM or 5 μM TTM resulted in a decreased rate of sulfite reduction.

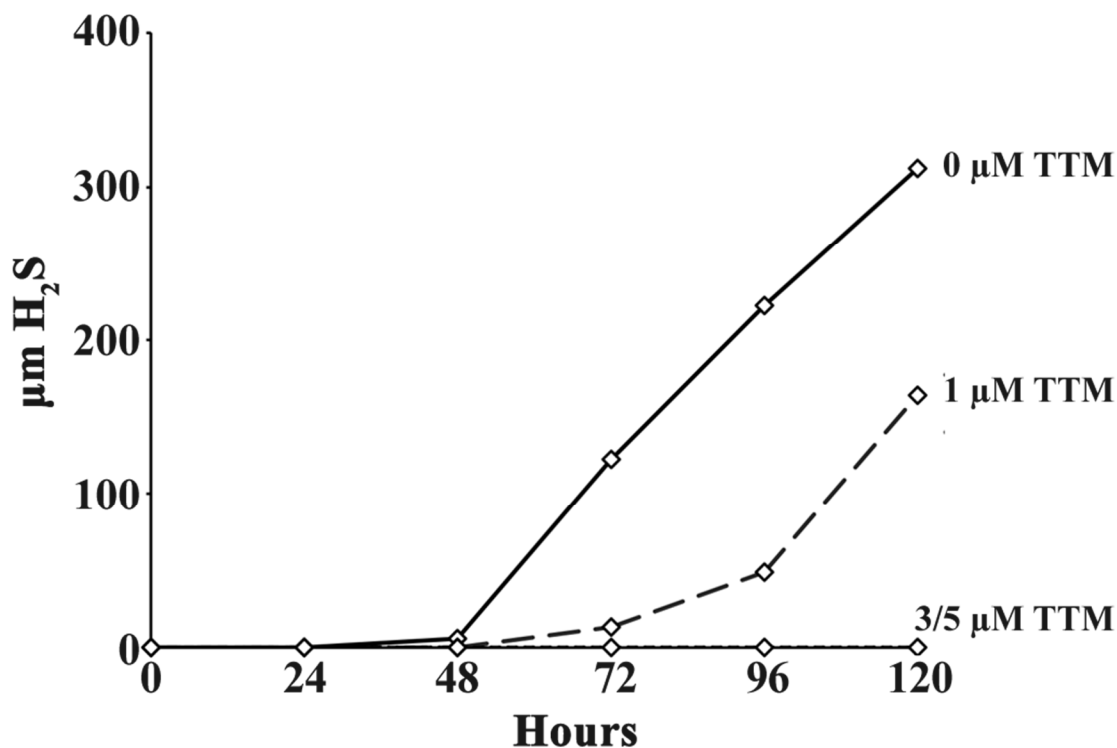

Figure 3.10 Sulfite reduction by $\Delta sirKL$ in Basal Medium supplemented with TTM as indicated. Addition of 1 μM TMM exhibited a decreased rate of reduction compared to non-supplemented medium. Addition of 3 μM or 5 μM TTM resulted in loss of sulfite reduction.

Enzyme activity and protein stability in wild-type and *sir* mutants

To determine if the lack of anaerobic sulfite reduction in *S. oneidensis* mutant cultures was due to loss of enzyme activity or loss of an intermediate component of the electron transport chain, I tested the mutants described above for sulfite reductase activity in native polyacrylamide gels. Cell extracts were tested using methyl viologen as the electron donor and Na_2SO_3 as the electron acceptor. A mutant ($\Delta sirR$) that encodes a transcriptional regulator of the sulfite reductase (S. Shirdkar, unpublished) was included as a control. The results of these experiments indicated that sulfite reductase activity was

absent from $\Delta sirA$, $\Delta sirBI$, $\Delta sirCD$, $\Delta sirG$, and $\Delta sirR$ cell extracts (Fig. 3.11). This suggested that the terminal reductase, SirA, was absent or inactive in these mutants, and that the deficiency in sulfite reduction was not due to loss of other electron transport chain components. A sulfite reductase activity band was detected in $\Delta sirKL$ cell extracts in contrast to cell extracts of *sir* mutants described above. The activity in $\Delta sirKL$ was slightly reduced compared to wild-type (Fig. 3.11). These results are in agreement with the sulfite reduction observed in cell cultures where $\Delta sirKL$ exhibited a longer lag phase than the wild-type.

To distinguish between enzyme activity and protein stability in *sir* mutants, I tested cell extracts of wild-type and mutants for the presence of SirA using peptide antibodies generated against SirA. A reactive band corresponding to SirA was detected in wild-type but not in $\Delta sirA$, $\Delta sirBI$, $\Delta sirCD$, $\Delta sirG$ or $\Delta sirR$ cell extracts (Fig. 3.12). This suggests that the SirA protein is either not translated or is unstable in these mutants. In contrast, $\Delta sirKL$ cell extracts resulted in a band that reacted with SirA antibodies similar to the wild-type, suggesting that the protein is produced in appreciable amounts following a 24 hour incubation with Na_2SO_3 as the sole electron acceptor (Fig. 3.12). These results suggested that the lack of sulfite reduction in $\Delta sirKL$ mutant during the first 24 hr of incubation may be due to deficiency in protein activity and not due to deficiency in SirA protein levels.



Figure 3.11 Sulfite reductase activity by wild-type and *sir* mutants. A band of clearing representative of sulfite reductase activity, indicated by arrow, was seen in wild-type MR-1 cell lysates and to a lesser extent $\Delta sirKL$. Sulfite reductase activity was not present in cell lysates of the other *sir* locus mutants. Cultures were grown for 24 hours with Na_2SO_3 as the sole electron acceptor; 50 μg total protein was loaded per lane.

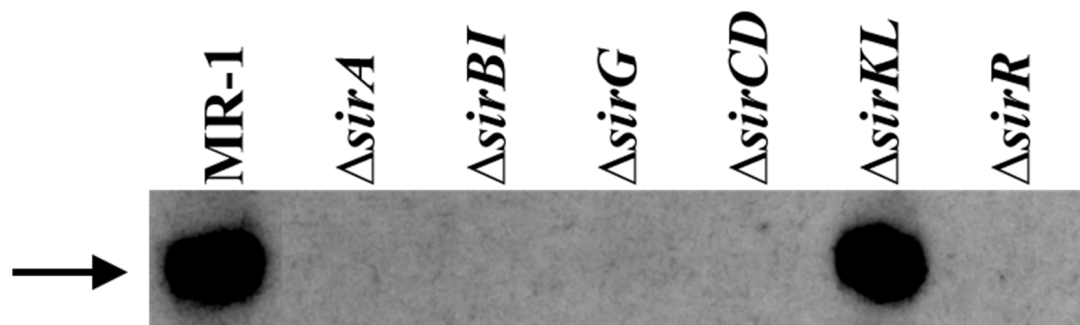

Figure 3.12 Western blot with antibodies against the terminal sulfite reductase SirA. A reactive band at ~ 80 kDa, indicative of SirA, was detected in wild-type MR-1 cell extracts. $\Delta sirKL$ had a reactive band similar to wild-type. Reactive bands were not detected with any of the other mutants. Cultures were incubated anaerobically for 24 hours with sulfite as the sole electron acceptor. 30 μg total protein was loaded in each lane.

Discussion

The sulfite reductase in *S. oneidensis* MR-1 has been identified as an octaheme *c* cytochrome designated SirA. Unlike other sulfite reductase studied to date, SirA is a non-siroheme enzyme that catalyzes a 6-electron transfer reaction similar to siroheme containing-enzymes (38). To further understand the mechanisms that lead to sulfite reduction, I analyzed additional proteins encoded by the *sir* operon and determined their role in sulfite reduction.

***sirABIGCDJKLM* constitute an operon**

Based on proximity of *sirA-M* to each other, they are predicted to form an operon. *sirKLM* each overlap the coding region of the previous gene, and thus lack any intergenic space. However, *sirA-J* all contain small intergenic regions between their coding sequences. The results of end-point RT-PCR confirm the presence of a single *sirA-J* message (Fig. 3.2). Taken together, these results confirm that *sirABIGCDJKLM* form an operon.

Proteins involved in electron transfer to the terminal sulfite reductase

Respiration by *S. oneidensis* with a majority of electron acceptors, fumarate, DMSO, NO₃, NO₂, Fe, Mn and U for example, requires CymA for electron transfer from the menaquinone pool to components of the terminal reductases (63, 135). In contrast, thiosulfate (S₂O₃²⁻) reduction is CymA-independent (Shirodkar, Biddle, Saffarini, Manuscript in preparation), and based on sequence similarity to the *Salmonella typhimurium* enzyme (56, 58), it is likely that PhsBC function in place of CymA in electron

transfer from the menaquinol pool to the thiosulfate reductase. Sulfite reduction, similar to thiosulfate reduction, is CymA-independent (38). The *S. oneidensis sirCD* are predicted to encode a ferredoxin and membrane bound menaquinol oxidase, similar to PhsBC of *S. oneidensis* and NrfCD of *Wolinella succinogenes*. In *Wolinella*, NrfCD are members of the nitrite reductase complex and function as a membrane-bound quinol oxidase (136). Cordova et al, has shown that overexpression of SirCD in a *cymA* mutant can partially restore reduction of fumarate, DMSO and Fe (III) (64). These finding further support the predicted role of SirCD as a menaquinone oxidase (38). To experimentally test the role of SirCD in sulfite reduction, a $\Delta sirCD$ mutant was generated and tested for sulfite reduction and for SirA activity and stability. As predicted, the mutant was not able to reduce sulfite indicating the requirement for SirCD (Fig. 3.6). Surprisingly, sulfite reductase activity was absent in cell extracts of the $\Delta sirCD$ mutant and Western blot analysis failed to detect SirA in the mutant cell extracts (Fig. 3.11 and 3.12). It appears that, in the absence of SirCD, SirA is not stable and is likely degraded by periplasmic proteases. SirA is predicted to be a periplasmic protein that is anchored in the membrane by interactions with SirC and the membrane-protein component SirD (Figure 3.13), and it is possible that maturation of SirA involves interactions with SirD and SirC. In an attempt to determine the components of the terminal sulfite reductase, we analyzed the make up of the sulfite reductase active band obtained on native polyacrylamide gels by LC-MS/MS. Analysis of protein in the sulfite reductase band indentified SirA (Fig. 3.3), but not SirC or SirD. These results suggest that while SirCD are required for in vivo sulfite reduction and likely the maturation of SirA, mature SirA is stable and active in the absence of SirCD.

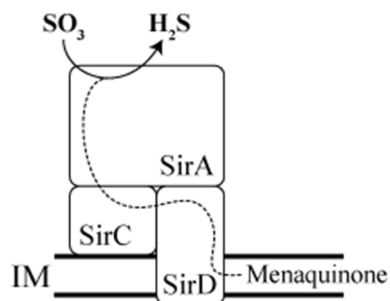

Figure 3.13. Schematic of electron flow through the sulfite reductase complex. Dashed line represents electron flow from the menaquinone pool to the terminal sulfite reductase, SirA.

Role of SirBI in the maturation and conformational folding of SirA

sirBI are located in the *sir* operon directly downstream of *sirA*. SirB is predicted to be a rhodenase domain containing sulfurtransferase, which functions in the transfer of a sulfane sulfur. SirI is predicted to be a peptidyl-prolyl cis-trans isomerase involved in protein conformation and folding. Loss of SirBI leads to complete loss of sulfite reductase activity and SirA protein (Fig. 3.11 and 3.12). It is possible that SirB is needed for the transfer of sulfur that is required for proper maturation or conformational stability of SirA. Loss of this transferase activity may prevent attachment of a required cofactor or lead to general protein instability. SirI, predicted to be a peptidyl-prolyl isomerases (126) may be involved in proper folding of the sulfite reductase, and its absence would result in loss of protein due to degradation by periplasmic proteases. In *E. coli*, the periplasmic protease DegP is responsible for the degradation of improperly matured apocytochromes *c* (137). *S. oneidensis* lacks a *degP* gene, but has *degQS* which are predicted to encode proteins similar to DegP. In *E. coli*, DegQ also acts as a periplasmic protease and can functionally complement loss of DegP (138). Future experiments using *degQS* mutants will allow us to

determine if the lack of SirA in $\Delta sirBI$ mutants is due to degradation of the protein due to misfolding.

Role of Cu and related proteins in sulfite reduction

The *sir* operon encodes a set of genes predicted to function in copper transport and attachment. SirJKLM are homologues of the NosLDFY found in *Pseudomonas* and *Rhizobium* species, which are involved in maturation of the nitrous oxide (N₂O) reductase. In *Pseudomonas stutzeri* the nitrous oxide reductase has been identified as NosZ. NosZ contains two Cu centers, Cu_A and Cu_Z. Cu_A is involved in electron transfer to the Cu_Z center, which is the active site of N₂O reduction (131). Attachment of Cu to the Cu_Z site requires several enzymes including the ABC transporter NosDFY, which use cytoplasmic ATP to facilitate the insertion of Cu in the periplasmic apo-NosZ (129). Protein sequence analysis of SirKLM suggested the formation of a trans-cytoplasmic membrane complex similar to that of NosDFY. SirM is predicted to be an inner membrane protein with 6 transmembrane helices and SirL is predicted to be a cytoplasmic protein. Based on the location and predicted function of these proteins we suggest that SirL interacts with the cytoplasmic portion of SirM, and transfers the energy from ATP hydrolysis to SirK through SirM. SirK, a lipoprotein located on the periplasmic face of the inner membrane, is predicted to function in the energy-dependant attachment of Cu to either SirA or to a yet to be identified protein. The *nosDFY* operon in *Pseudomonas* and *Rhizobium* also contain a fourth gene, *nosL*. NosL is not essential for N₂O reduction, but data suggests it may function as a Cu chaperone and deliver Cu to the NosDFY-Z complex (139). SirJ, the NosL homologue, is predicted to be a lipoprotein localized to the periplasmic surface of the inner

membrane. If SirJ were responsible for delivery of Cu to SirK, as predicted in other organisms, it would make sense that they localize together on the inner membrane. Unlike *nosDF* in other organisms, *sirKL* are not required for sulfite reduction in MR-1. However, Δ *sirKL* exhibits a 72 hour lag in the start of sulfite reduction compared to wild-type (Fig. 3.7). It remains unclear if SirA requires Cu as a co-factor; if so, it is possible that the observed lag in sulfite reduction is a result of the action of another Cu processing enzyme or spontaneous attachment of Cu to SirA or a related enzyme.

The involvement of Cu in sulfite reduction was tested by removal of free Cu from growth media using the chelator tetrathiomolybdate (TTM). TTM has been shown to specifically chelate Cu and has been used in the treatment of Wilson's disease to remove excess Cu build up in the body (132). Addition of exogenous TTM to *S. oneidensis* cultures did not affect the rate of anaerobic growth with fumarate (Fig. 3.8) indicating that the chelator does not have a generalized effect on anaerobic growth. However, addition of TTM had a significant adverse effect on sulfite reduction by wild-type and Δ *sirKL* (Fig. 3.9 and 3.10). This effect was observed when TTM levels exceeded 1 μ M. Contrary to expectations, the addition of 1 μ M TTM had a slightly positive effect on sulfite reduction by wild-type cells. This may be due to the effect of excess Cu in the basal medium that is used to grow *S. oneidensis* with certain electron acceptors. *S. oneidensis* cells exhibit a shorter lag phase when grown in basal medium not supplemented with Cu in the presence of DMSO or sulfite (140) (data not shown). Addition of Cu to media treated with > 1 μ M TTM restored sulfite reduction, further supporting the hypothesis that Cu may be a cofactor in sulfite reduction (data not shown).

Sulfite reductase activity and Western blot analysis were used to determine levels of SirA in the $\Delta sirKL$ mutant (Fig. 3.11 and 3.12). The results indicated that SirA protein levels in the mutant were similar to wild-type levels. Sulfite reductase activity, however, was decreased in mutant cell extracts. This suggests that the lack of SirKL does not affect translation of SirA, but does affect its activity. Based on the results presented here, I suggest that a Cu-cofactor is required for optimum activity of the sulfite reductase SirA, and that SirJKLM are involved in transport and delivery of Cu to the sulfite reductase. Future experiments to elucidate the structure of SirA should provide additional information regarding the metal-cofactor that is needed for its optimal activity.

Chapter 4

Specialized components involved in maturation of *c*-type cytochromes

Introduction

c-type cytochromes are characterized by the covalent attachment of heme *b* vinyl groups to cysteines of the typical CXXCH heme-binding motif (29). In members of the α and γ Proteobacteria, attachment of heme to CXXCH requires the function of the System I cytochrome *c* maturation proteins CcmABCDEFGH (see (29-31) for review). CcmABCD are required for transport and loading of heme *b* onto CcmE, whose function is to provide heme to the heme lyase complex (29, 30). Heme lyases, also called cytochrome *c* synthases, are involved in heme attachment to the cysteine residues of the CXXCH motif in apocytochromes *c*. In *E. coli*, CcmFH form a complex and function as a heme lyase, whereas in other Gram-negative bacteria, such as *Rhodobacter capsulatus*, the heme lyase complex consists of CcmFHI (32).

The *S. oneidensis* MR-1 genome contains two gene clusters, *ccm* and *sir*, which encode proteins predicted to play a role in cytochrome *c* maturation (Fig. 1). The *ccm* genes are organized in three transcriptional units and encode components of System I. *ccmABCDE* and *ccmFGH* encode proteins that are similar to CcmABCDEFGH from other bacteria, and are required for maturation of *c*-type cytochromes in *S. oneidensis* MR-1 (33, 34). Recently, SO_0265 was identified as *ccmI*, and a mutant was generated and tested for anaerobic respiration. The results indicated that CcmI was involved in anaerobic growth with TMAO and DMSO, but the extent of its involvement was not significant (34). *ccmI* encodes a protein of 415 amino acids with two predicted membrane spanning domains. It belongs to a family of tetratricopeptide (TPR)-domain containing proteins that function as

chaperones and facilitate protein-protein interactions (for review see (141)). The *S. oneidensis* CcmI is 29-32% identical to CcmI proteins from *Pseudomonas* species such as *P. putida*, *P. aeruginosa*, and *P. stutzeri*. It also shares a high degree of identity with CcmI proteins of other *Shewanella* species such as ANA-3 (94%), MR-4 (93%), and W3-18-1 (89%). CcmI proteins from *Rhodobacter sphaeroides* and *P. aeruginosa* are thought to act as apocytochrome *c* chaperones and constitute a heme ligation complex along with CcmFH (142, 143).

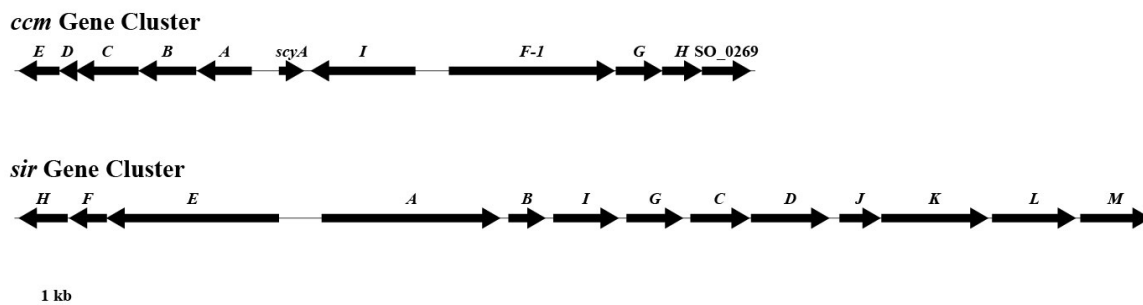

Figure 4.1. Arrangement of the *ccm* and *sir* gene clusters on the *S. oneidensis* chromosome. Letters correspond to *ccm* or *sir* genes unless indicated otherwise.

In addition to CXXCH motifs, some *c*-type cytochromes contain atypical sites, such as CXXCK and CX₁₅CH, which require specialized heme lyase systems for maturation (35, 36). In *E. coli*, heme ligation to the CXXCK site of NrfA requires the heme lyase complex NrfEFG (35). In *Wolinella succinogenes*, two unique heme lyases, CcsA1 and NrfI, are required for heme attachment to the CX₁₅CH and the CXXCK heme-binding sites in the nitrite and sulfite reductases, respectively (32-34). Two atypical heme-binding sites have been identified in *S. oneidensis* *c*-type cytochromes. The CXXCK motif is found in the periplasmic nitrite reductase NrfA (37), and the CX₁₅CH motif is found in SirA (38).

The second set of genes predicted to be involved in cytochrome *c* maturation in *S. oneidensis* MR-1 is located in the *sir* gene cluster (Fig. 1). *sirG* (SO_0482), originally annotated as *nrfG*, lies within a 10 gene operon that includes the terminal sulfite reductase genes *sirACD* and encodes a protein of 224 amino acids predicted to contain TPR and membrane spanning domains. SirG is 35% identical to the N-terminus (amino acids 102-283) of the *S. oneidensis* CcmI described above and 35% identical and 52% similar to NrfG of *E. coli*. The *E. coli* NrfG is an apocytochrome *c* chaperone and subunit of the NrfEFG heme lyase complex required for maturation of the NrfA nitrite reductase (35, 144).

The proteins involved in heme attachment to the atypical sites of NrfA and SirA in *S. oneidensis* have not been previously identified. In this chapter I describe the role of SirEFG and CcmI in the maturation of these enzymes. *sirEFH* (SO_0478 - SO_0476) lie directly upstream of the *sirABIGCDJKLM* operon (Fig. 1) and encode proteins of 685, 149, and 194 amino acids, respectively. SirE shares a high degree of sequence identity with CcmF from *S. oneidensis* (47%), *E. coli* (42%), and *P. aeruginosa* PAO1 (42%), and with the *E. coli* NrfE (44%). It is predicted to be an inner membrane protein containing the conserved tryptophan rich domain ELGWGGWWFWDPVEN that is found in the cytochrome *c* synthetase CcmF of *S. oneidensis* and other bacteria (27). SirF, which was previously annotated as NrfF, also appears to be an inner membrane protein and is similar to CcmH from *P. aeruginosa* and *S. oneidensis* (41% and 37% identity respectively), NrfF from *E. coli* (38% identity), and the N-terminal region of CcmH from *E. coli* (35% identity). CcmH proteins are thought to be involved in reduction of apocytochromes *c* prior to heme ligation (25,27). Interestingly, the second conserved Cys in the LRCXXC motif present in CcmH and NrfF proteins (145, 146) is absent in SirF. This second cysteine

is also missing in SirF sequences of other *Shewanella* species. The significance of this substitution remains to be determined. The third gene in the *sirEFH* operon, *sirH*, encodes a protein that is similar to thioredoxin-like proteins of the TlpA – DsbE – ResA family (147). It is predicted to be a periplasmic protein with 38% identity and 63% similarity to the protein encoded by SO_0269, which lies downstream of *ccmH* (Fig. 1). SirH also shares similarity with *P. aeruginosa* thioredoxins (NP_251167.1 and NP_249644.1) with 29% identity/54% similarity and 29% identity/49% similarity, respectively. To determine the role of these genes in the maturation of sulfite and nitrite reductases, I generated chromosomal deletion mutants and tested them for growth, enzyme activity, and protein stability. Contrary to expectations, our results indicated that the NrfE homolog, SirE, which is predicted to act as a cytochrome *c* synthetase, is required for maturation of SirA but not NrfA. Furthermore, the putative apocytochrome *c* chaperone, CcmI, appears to participate in the maturation of *c*-type cytochromes containing all three heme-binding motifs.

Results

Role of *ccm* and *sir* genes in nitrite reduction

Although several genes that belong to the *ccm* or *sir* clusters described above were tested for cytochrome *c* maturation (33, 34), genes specifically required for the maturation of the nitrite reductase NrfA were not previously identified. Mutants with chromosomal deletions of *ccmI*, *sirG*, *sirEF*, and *sirH* were generated and tested for nitrite reduction. Δ *sirG*, Δ *sirEF*, and Δ *sirH* mutant strains were able to reduce nitrite similar to the wild-type (Fig. 4.2). Similar results were obtained when cell extracts from these mutants were tested for nitrite reductase activity using methyl viologen as the electron donor (Fig. 4.3),

indicating a lack of involvement of SirEFGH in NrfA maturation. In contrast, $\Delta ccmI$ was completely deficient in nitrite reduction (Fig. 4.2). Complementation of the mutant by introduction of $ccmI$ on a plasmid restored its ability to reduce nitrite (Fig. 4.2). Nitrite reductase activity was detected in cell extracts of the complemented $\Delta ccmI$ mutant, but not in cell extracts of $\Delta ccmI$ or of the $\Delta nrfA$ mutant, which lacks the nitrite reductase gene (Fig. 4.3).

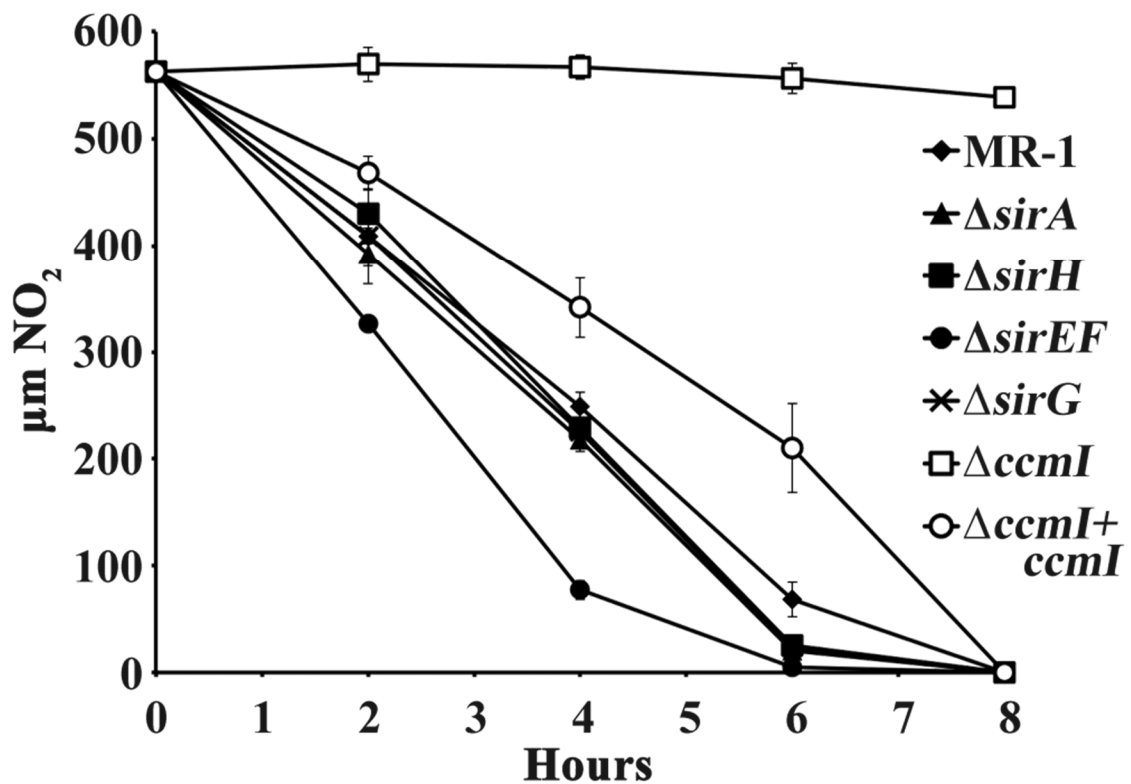

Figure 4.2. Nitrite reduction by wild-type and mutant strains. Deletion of $sirEF$, $sirG$, or $sirH$ did not have a significant effect on nitrite reduction. Deletion of $ccmI$ resulted in complete loss of nitrite reduction, which was restored by complementation with $ccmI$ on a plasmid ($\Delta ccmI+ccmI$). $\Delta sirA$, which lacks the sulfite reductase, was included as a control.

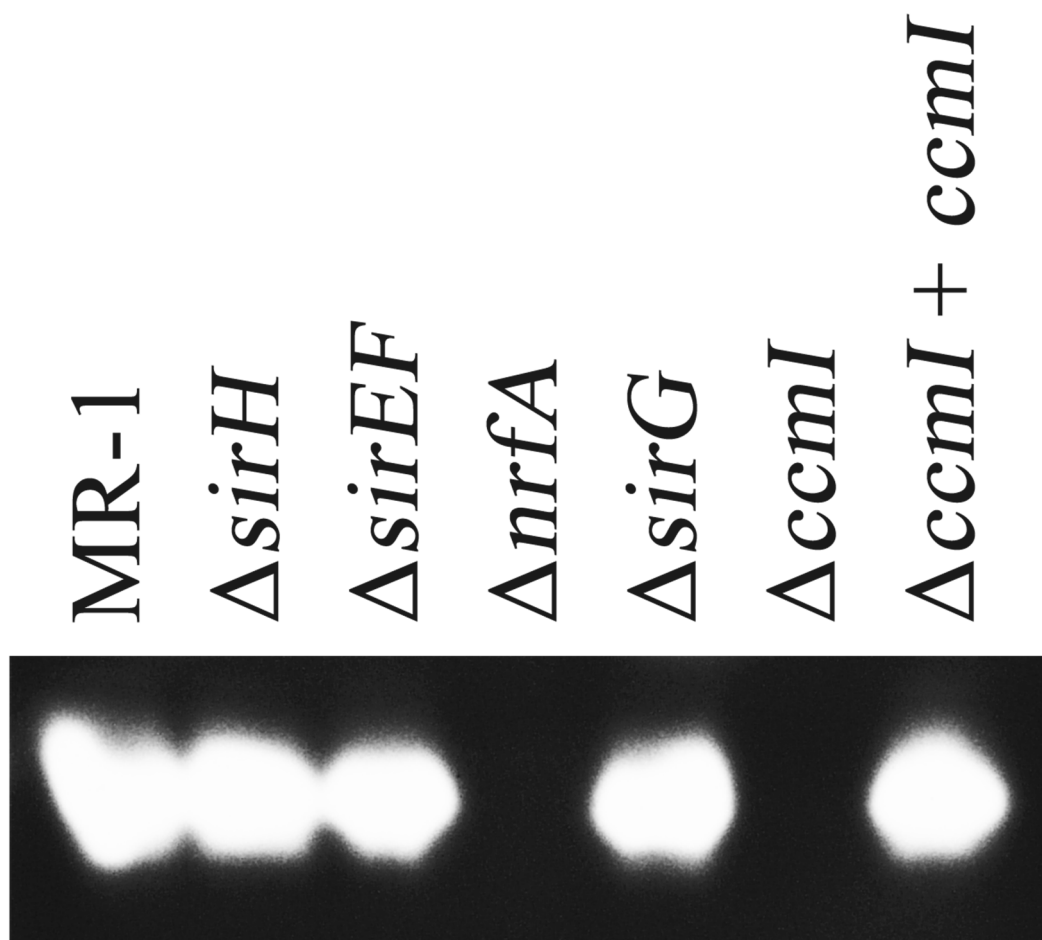

Figure 4.3 Nitrite reductase activity of cell extracts using methyl viologen as electron donor and nitrite as electron acceptor. Cell extracts from wild-type (MR-1), $\Delta sirH$, $\Delta sirEF$, and $\Delta sirG$, resulted in nitrite reductase activity bands that were absent from $\Delta nrfA$ mutant, which lacks the nitrite reductase gene. Nitrite reductase activity was also absent in cell extracts of $\Delta ccmI$ but present in the complemented mutant ($\Delta ccmI + ccmI$). Cultures were grown for 4 hours with nitrite as the sole electron acceptor before harvesting. 30 μg of protein was loaded in each lane.

CcmI is required for optimum anaerobic growth with DMSO and TMAO

To determine if the cytochrome maturation genes described above were required for maturation of *c*-type cytochromes involved in anaerobic respiration with other electron acceptors, mutants lacking these genes were tested for growth with fumarate, DMSO and TMAO. Deletion of *sirG*, *sirH* or *sirEF* did not have an effect on anaerobic growth with any of these electron acceptors (Fig. 4.4). This is similar to the results reported recently by Jin *et al.* (34). In contrast, deletion of *ccmI* led to slower growth and a longer lag phase when DMSO (Fig. 4.4A) or TMAO (Fig. 4.4B) were used as the terminal electron acceptors. Complementation of $\Delta ccmI$ restored growth with both electron acceptors to wild-type levels. Interestingly, $\Delta ccmI$ was able to grow anaerobically with fumarate similar to the wild-type (Fig. 4.4C). Sequence analysis of *c*-type cytochromes involved in fumarate, TMAO, and DMSO respiration indicated that they contain only typical CXXCH heme-binding domains. For reasons not yet clear, it appears that CcmI has a differential effect on the maturation of *c*-type cytochromes involved in these respiratory pathways.

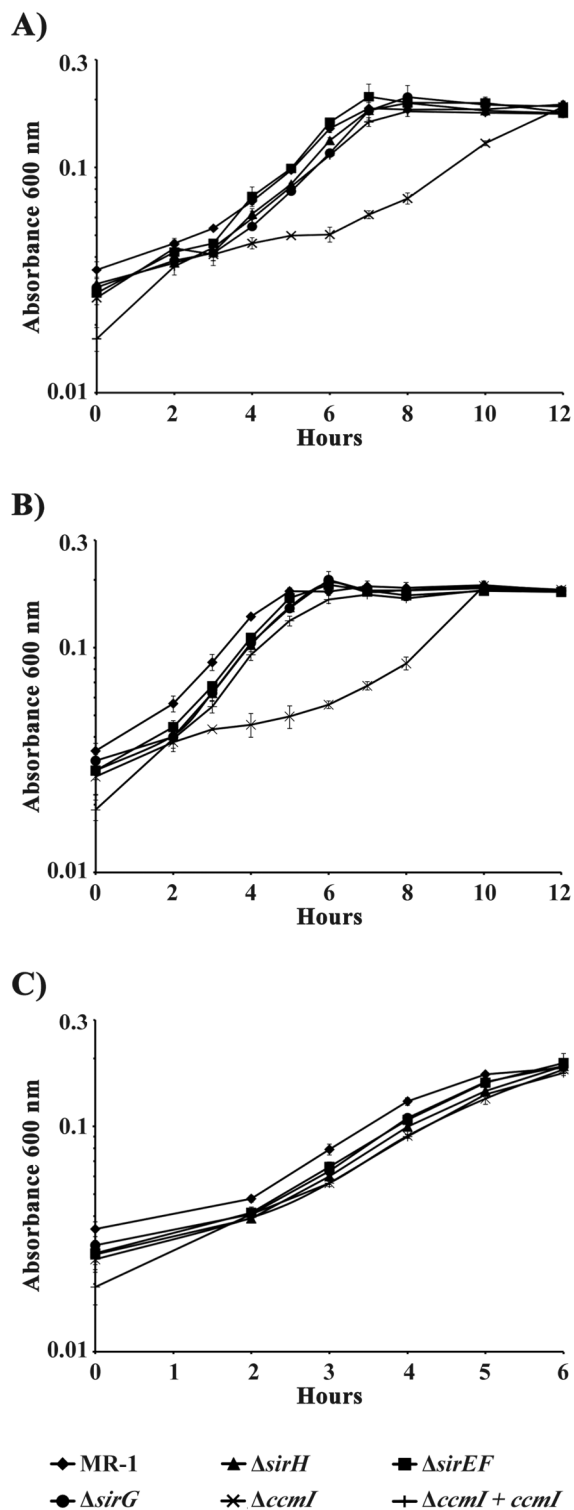

Figure 4.4. Anaerobic growth of wild-type and mutant strains with DMSO (A), TMAO (B), and fumarate (C). $\Delta ccmI$ was deficient in growth with DMSO and TMAO, and complementation of the mutant restored growth with these electron acceptors to wild-type levels. Deletion of $ccmI$ did not have an effect on anaerobic growth with fumarate.

Role of *ccm* and *sir* genes in the maturation of the sulfite reductase SirA

The *S. oneidensis* sulfite reductase SirA contains a CX₁₂NKGCH heme-binding site. Based on studies of heme maturation systems in other bacteria, such as *E. coli* and *W. succinogenes*, it is hypothesized that heme ligation to this atypical site of SirA should require a specific and dedicated heme lyase complex. To identify proteins involved in maturation of SirA, $\Delta ccmI$ and $\Delta sirG$ were tested for sulfite reduction in anaerobic cultures supplemented with 10 mM sulfite. Mutants lacking either *sirG* or *ccmI* were able to reduce sulfite, although a lag phase of 24 and 48 hours respectively was observed before H₂S production was detected (Fig. 4.5). To determine if SirG and CcmI, both apocytochrome *c* chaperones, may have partially redundant roles in maturation a double deletion was generated. The double mutant $\Delta sirG\Delta ccmI$ was completely deficient in sulfite reduction (Fig. 4.5). Complementation of $\Delta sirG\Delta ccmI$ with *sirG* on a plasmid restored sulfite reduction similar to the single the $\Delta ccmI$ mutant. Similarly, complementation of the double mutant with *ccmI* allowed the cells to reduce sulfite similar to the $\Delta sirG$ mutant (Fig. 4.6). These results indicated that, contrary to nitrite reduction where CcmI was essential, neither CcmI nor SirG were essential for sulfite reduction. They appear to have a partially redundant function, and complete loss of sulfite reduction was observed only when both proteins were absent.

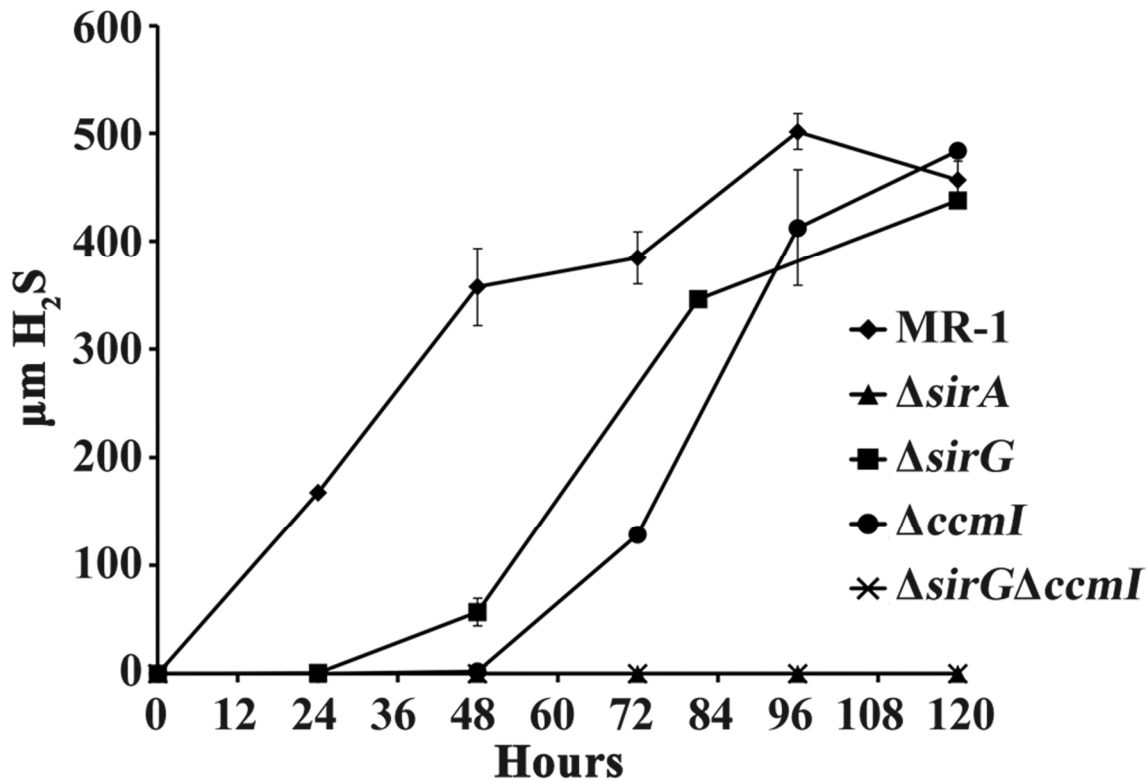

Figure 4.5. Sulfite reduction by wild-type and mutants. As expected, H_2S was not produced by $\Delta sirA$, which lacks the terminal sulfite reductase gene. $\Delta sirG$ and $\Delta ccmI$ were able to reduce sulfite but the start of reduction was delayed by 24 and 48 hours, respectively. A double mutant that lacks $ccmI$ and $sirG$ was completely deficient in sulfite reduction.

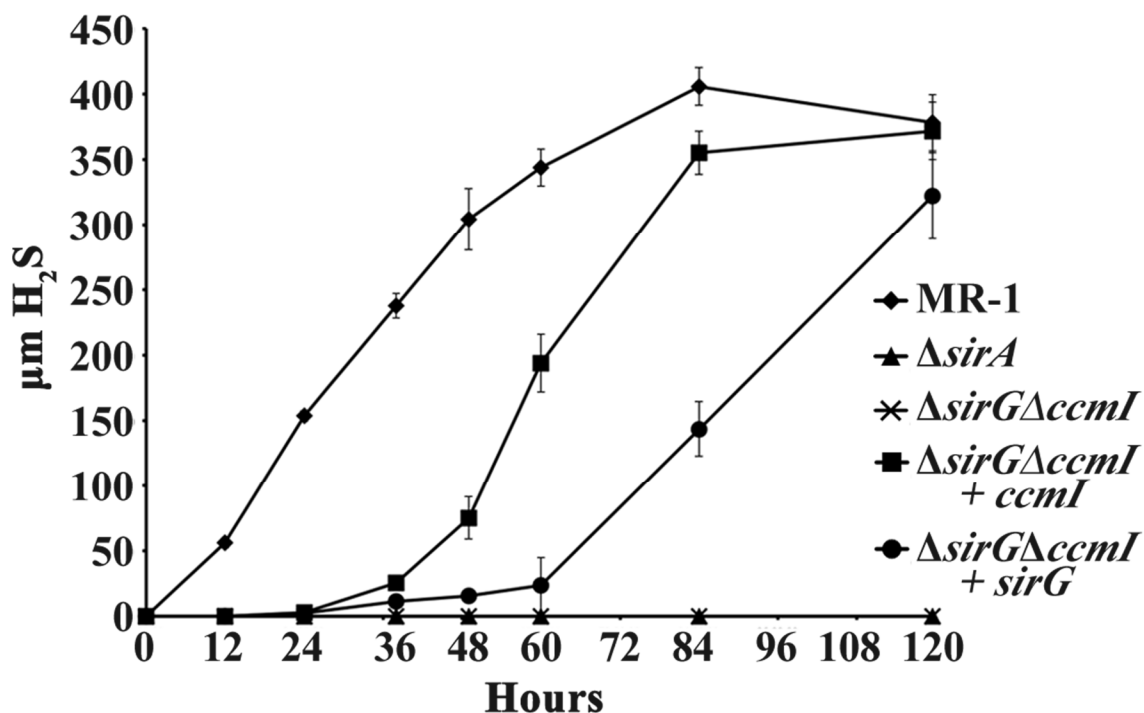

Figure 4.6. Sulfite reduction by $\Delta sirG\Delta ccmI$ complemented with *ccmI* or *sirG*. Wild-type, $\Delta sirA$ and $\Delta sirG\Delta ccmI$ were included as controls. H₂S was not produced by $\Delta sirG\Delta ccmI$. Addition of $\Delta ccmI$ ($\Delta sirG\Delta ccmI + ccmI$) resulted in a delayed reduction, similar to $\Delta sirG$. Addition of $\Delta sirG$ ($\Delta sirG\Delta ccmI + sirG$) resulted in a delayed reduction, similar to $\Delta ccmI$.

As mentioned above, *sirEF* encode proteins similar to the Nr_rEF cytochrome *c* synthetase and thiol-oxidoreductase that are required for heme ligation to the CXXCK site in Nr_rA (31). Deletion of these genes resulted in complete loss of sulfite reduction similar to $\Delta sirA$, which lacks the catalytic subunit of the sulfite reductase (Fig. 4.7). Complementation of $\Delta sirEF$ with a plasmid that carries *sirEF* and its native promoter restored sulfite reduction to wild-type levels (data not shown). In contrast, deletion of *sirH*, which appears form an operon with *sirEF*, was able to reduce sulfite at a rate similar to the wild-type after a lag period of 48 hours (Fig. 4.7). This delay in reduction may be due to

inefficient maturation of the sulfite reductase, suggesting that SirH is important for this process but not essential.

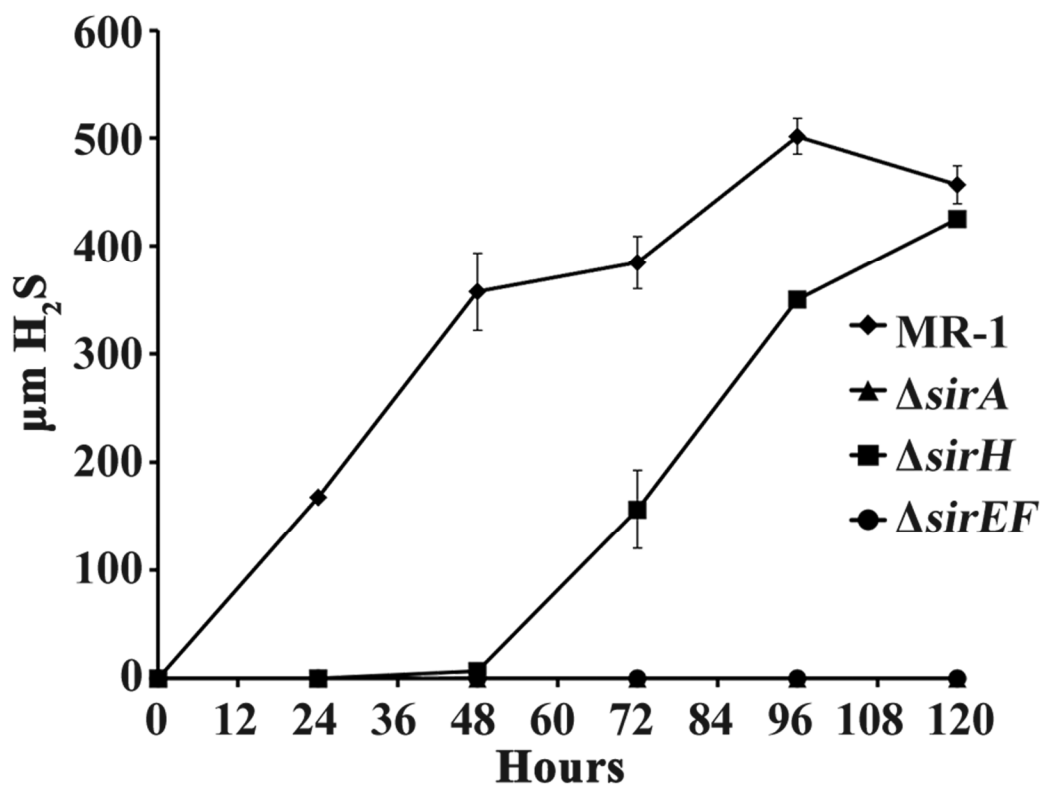

Figure 4.7. Sulfite reduction by wild-type, $\Delta sirA$, $\Delta sirH$, and $\Delta sirEF$. Sulfite was reduced to H₂S by wild-type MR1 but not in the $\Delta sirEF$ mutant. Sulfite reduction by $\Delta sirH$ was delayed 48 hours, and then proceeded at a rate similar to the wild-type.

Sulfite reductase activity and protein stability

To further elucidate the effects of the heme lyase proteins described above on the maturation of the terminal sulfite reductase, cell extracts from wild-type and mutant strains grown for 24 hours with Na₂SO₃ were tested for sulfite reductase activity on native polyacrylamide gels using methyl viologen as the electron donor. As expected, $\Delta sirA$ was completely deficient in sulfite reductase activity (Fig. 4.8A). $\Delta sirH$ and $\Delta sirG$ cell extracts

exhibited a decreased sulfite reductase activity that was restored to wild-type levels by complementation. In contrast, $\Delta sirEF$ completely lacked sulfite reductase activity (Fig. 4.8A), further supporting our observation above that SirEF were essential for sulfite reductase maturation. Cell extracts from $\Delta ccmI$ cells were also deficient in sulfite reductase activity. This is in agreement with our results above (Fig. 4.5) that indicated lack of sulfite reduction by $\Delta ccmI$ cells during the first 24 hours of incubation.

As expected from the results obtained with cell cultures (Fig. 4.5), cell extracts of the double mutant $\Delta ccmI\Delta sirG$ completely lacked sulfite reductase activity (Fig. 4.8A). Complementation of this mutant with *ccmI* on a plasmid resulted in a sulfite reductase activity band that was not detected when $\Delta ccmI\Delta sirG$ was complemented with *sirG* (Fig. 4.8A). These results support the findings above (Fig. 4.5) that CcmI plays a more prominent role in sulfite reductase maturation than SirG during early stages of reduction. The above observations indicated that sulfite reduction by whole cells in mutant strains is proportional to sulfite reductase activity detected in cell extracts, and further suggested that the observed sulfite reduction deficiency in the mutants was not due to loss of other *c*-type cytochromes that are part of the electron transport chain that leads to sulfite reduction.

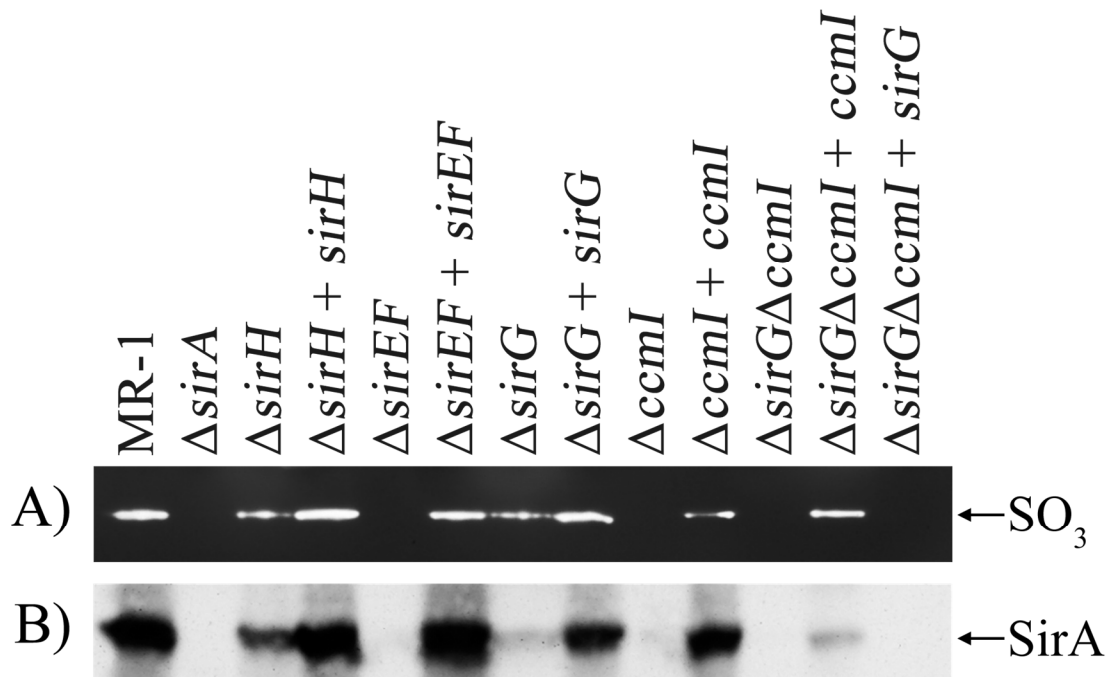

Figure 4.8. Sulfite reductase activity and protein levels of wild-type, mutant, and complemented mutant cell extracts. A) Sulfite reductase activity using methyl viologen as the electron donor. Cells were grown for 24 hours with sulfite as the sole electron acceptor. Bands of clearing correspond to sulfite reductase activity. 50 μ g total protein was loaded in each lane. B) Western blot analysis of cell extracts in panel A using SirA peptide antibodies. Reactive bands corresponding to SirA are indicated. 10 μ g total protein was loaded in each lane.

The observed decrease or absence of sulfite reductase activity in cell extracts of *ccmI* and *sirEF*, *sirG*, and *sirH* mutants may be due to a decrease in catalytic activity or to reduced protein levels. To distinguish between these two possibilities, wild-type and mutant cell extracts were tested for SirA levels using peptide antibodies generated against SirA. A reactive band of around 80 kDa that corresponded to the predicted size of SirA was detected in wild-type and to a lesser extent in $\Delta sirH$ and $\Delta sirG$ cell extracts (Fig. 4.8B). This band was absent in cell extracts of $\Delta sirEF$ and $\Delta ccmI$ and was restored by

complementation. Similar to the results obtained for enzyme activity (Fig 4.8A), $\Delta sirG\Delta ccmI$ lacked SirA, presumably as a result of protein degradation. In cell extracts of $\Delta sirG\Delta ccmI$ complemented with *ccmI*, a faint band that reacted with SirA antibodies was observed, but was absent in cell extracts of the mutant complemented with *sirG* (Fig. 4.8B). These results indicated that the sulfite reduction deficiency observed in the cytochrome *c* maturation mutants was due to decreased protein levels, likely due to protein instability and degradation (137).

Role of SirA atypical heme binding motif in sulfite reduction

The *S. oneidensis* sulfite reductase SirA belongs to the MccA family of *c*-type cytochromes and contains a CX₁₂**NKGCH** motif predicted to bind heme (148). A CX₁₂**AKGCH** motif was found to be essential for the activity of the *W. succinogenes* sulfite reductase (36). It is hypothesized that this atypical heme-binding motif is essential for the *S. oneidensis* SirA sulfite reductase activity. To test this, a SirA mutant, SirA_{N589C}, was generated in which the asparagine in the CX₁₂**NKGCH** motif was replaced with a cysteine to generate a typical heme-binding site (CX₁₂**CKGCH**). The ability of SirA_{N589C} to restore sulfite reductase activity to the $\Delta sirA$ mutant was tested by measuring H₂S production in cultures supplemented with 10 mM sulfite. Our results indicated that SirA_{N589C} was completely deficient in sulfite reduction (Fig. 4.9). Furthermore, we did not detect sulfite reductase activity by SirA_{N589C} in native gels using methyl viologen as the electron donor (Fig. 4.10A). This deficiency appears to be due to loss of protein as evidenced by the lack of a band that reacted with SirA antibodies (Fig. 4.10B). These results support the

prediction that CX₁₂NKGCH is essential for active SirA, as observed in its *W. succinogenes* counterpart.

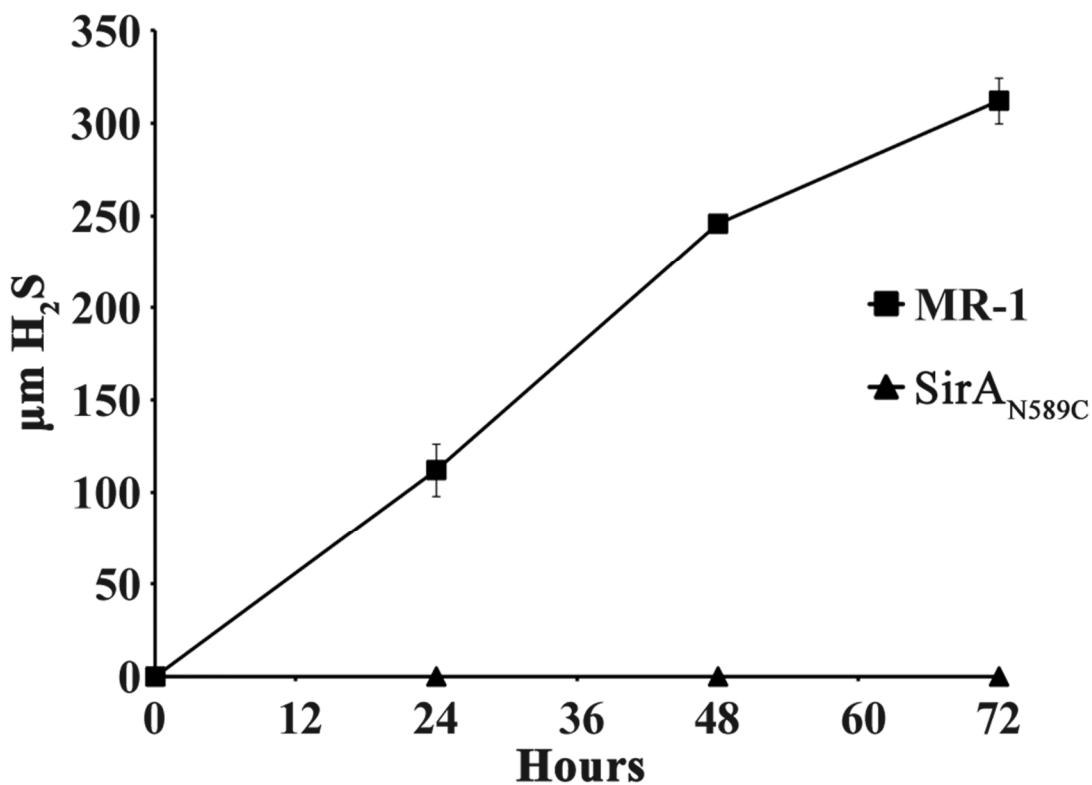

Figure 4.9. Sulfite reduction by wild-type and $\Delta sirA$ expressing the modified sulfite reductase SirA_{N589C}. Introduction of the modified *sirA* did not result in complementation of the mutant as evidenced by lack of hydrogen sulfide production.

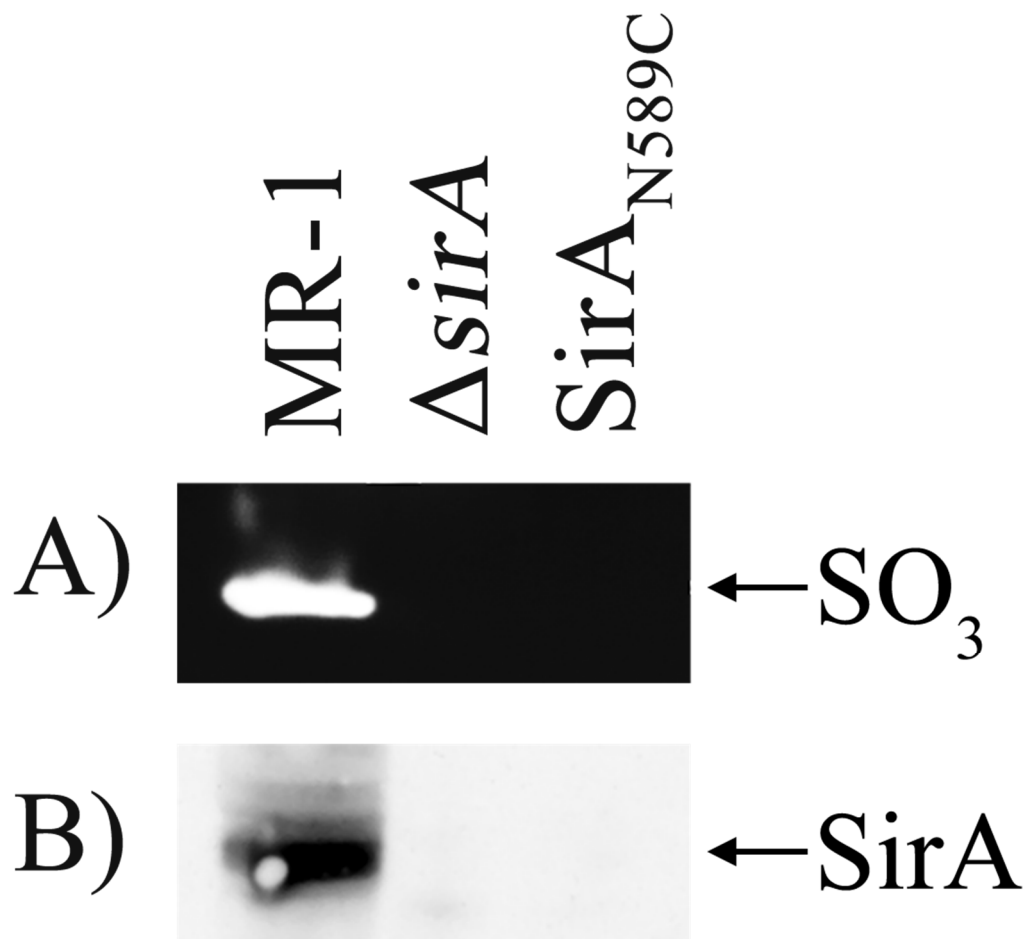

Figure 4.10. Sulfite reductase activity (A) and Western blot analysis (B) of cell extracts from wild-type, $\Delta sirA$, and $SirA_{N589C}$. Cultures were grown for 24 hours with sulfite as the sole electron acceptor. A band that reacted with SirA antibodies was detected in the wild-type but not in mutants cell extracts. A band of clearing indicating sulfite reductase activity was also seen only in wild-type cells. 50 μ g and 10 μ g total protein loaded per lane, activity and western respectively.

Discussion

Maturation of *c*-type cytochromes requires specialized systems for the covalent attachment of heme *b* to CXXCH motifs in apocytochromes *c*. In bacteria, System I (Ccm) or System II (Ccs) is required for holocytochrome *c* maturation with the step involving an apocytochrome *c* chaperone and a cytochrome *c* synthetase. In bacteria such as *Rhodobacter capsulatus* and *P. aeruginosa*, CcmI and CcmF fulfill these roles, while in *E. coli* CcmF appears to be a fusion protein that carries out both functions (29, 31, 142, 143). For *c*-type cytochromes with atypical heme-binding motifs, such as CXXCK found in the nitrite reductase of *E. coli* and other bacteria, specific heme lyases are required for heme attachment to these non-conventional sites. The genome of the metal reducer *S. oneidensis* encodes 42 *c*-type cytochromes (18, 19), many of which serve as terminal reductases during anaerobic respiration and all contain the typical CXXCH motif. The System I proteins CcmABCDEFG were found to be essential for maturation of all *c*-type cytochromes in *S. oneidensis* (33, 34), but none of these proteins were predicted to act as the apocytochrome *c* chaperone component of the heme lyase. Recently, CcmI_{So} (SO_0265) was identified as a cytochrome *c* maturation protein (33, 34) that we predict functions as an apocytochrome *c* chaperone. In contrast to an *R. capsulatus ccmI* null mutant that is completely deficient in mature *c*-type cytochromes (149), an *S. oneidensis ccmI* mutant was able to grow anaerobically similar to the wild-type with some electron acceptors, but failed to grow with others (33, 34). This mutant, however, was not tested for anaerobic sulfite or nitrite reduction. To further investigate the role of CcmI_{So} in cytochrome *c* maturation, we generated $\Delta ccmI_{So}$ and determined that it completely lacked nitrite reductase activity. The mutant, however, was able to produce mature sulfite reductase, but more slowly than the

wild-type. We consistently observed a lag phase of 48 hours in sulfite reduction by $\Delta ccmI_{So}$ (Fig. 4.5). This suggested that unlike its essential role in the maturation of the nitrite reductase NrfA, CcmI was involved in, but not required for, maturation of the sulfite reductase SirA. $\Delta ccmI_{So}$ was also deficient in DMSO and TMAO respiration but was able to grow to wild-type levels after a long lag phase. In contrast, growth with fumarate was not affected by loss of *ccmI*. The $\Delta ccmI_{So}$ phenotypes described here were surprising for several reasons. First, all *c*-type cytochromes involved in TMAO, DMSO, and fumarate reduction contain only typical CXXCH heme-binding motifs and a differential role for CcmI in the maturation of these proteins was unexpected. Second, the atypical heme-binding sites of the nitrite and sulfite reductases (CXXCK and CX₁₂NGKCH respectively) are different from one another, yet CcmI was involved in the maturation of both proteins, but was only essential for the maturation of NrfA. Finally, if CcmI and SirG are the only chaperones encoded by the *S. oneidensis* genome, and which do not appear to be involved in cytochrome *c* maturation of the fumarate reductase FccA, then how is the apocytochrome delivered to the heme-ligation site of this protein? It is possible, although unlikely, that a chaperone is not needed for the maturation of some *c*-type cytochromes in *S. oneidensis*. Alternatively, a third apocytochrome *c* chaperone may be encoded by the *S. oneidensis* genome but cannot be detected by sequence analysis due to its low similarity to known chaperones such as CcmI and SirG.

The *S. oneidensis* sulfite reductase subunit, SirA, is an octaheme *c*-type cytochrome with 7 CXXCH heme-binding motifs and an atypical CX₁₂NKGCH site (38). Similar atypical sequences have also been identified in the sulfite reductase of *W. succinogenes* and in the MccA family of *c*-type cytochromes (36, 148). In *S. oneidensis*,

this site appears to be important for the activity and stability of SirA, and may be the catalytic site of the enzyme. Substitution of the asparagine residue in CX₁₂NKGCH with a cysteine, to mimic the typical CXXCH heme-binding motif, resulted in complete loss of the sulfite reductase. These findings are similar to previous reports where amino acid substitutions in the heme-binding site or deletion of *ccm* genes lead to instability and degradation of the apocytochromes (35, 36, 150, 151). To date, the maturation of the MccA family of *c*-type cytochromes has been studied only in *W. succinogenes*. In this bacterium, a specific heme lyase system is responsible for heme attachment to the CX₁₅CH motif (36, 152). In *S. oneidensis*, I have identified SirEFG as a heme lyase that appears to be specific for the maturation of SirA. SirEFG are similar to the *E. coli* proteins NrfEFG that make up the heme lyase required for maturation of the *E. coli* NrfA (35, 75). SirEF, which are similar to cytochrome *c* synthetases (CcmF) and thiol oxidoreductases (CcmH) (153), appear to be essential for sulfite reductase activity and stability. This suggests that SirA requires a dedicated cytochrome *c* synthetase for its maturation. However, unlike other *c*-type cytochromes studied to date, which only require one apocytochrome *c* chaperone for their maturation, SirA appears to require both SirG and CcmI_{so} for this process. Single mutants lacking either of these chaperones were able to express an active SirA enzyme more slowly than the wild-type, whereas the double mutant $\Delta ccmI\Delta sirG$ mutant completely lacked sulfite reductase activity and the SirA protein. Based on these results, I propose that SirEFG along with CcmI constitute a 4-subunit heme-lyase complex that functions in the maturation of SirA (Fig. 4.11 A). I further propose that loss of SirG results in a less efficient maturation complex composed of SirEF and either a single CcmI or a CcmI homodimer (Fig. 4.11 B). Likewise, loss of CcmI would result in formation of an even more inefficient

maturation complex composed of SirEF and either a single CcmI or possibly a CcmI homodimer (Fig. 4.11 C).

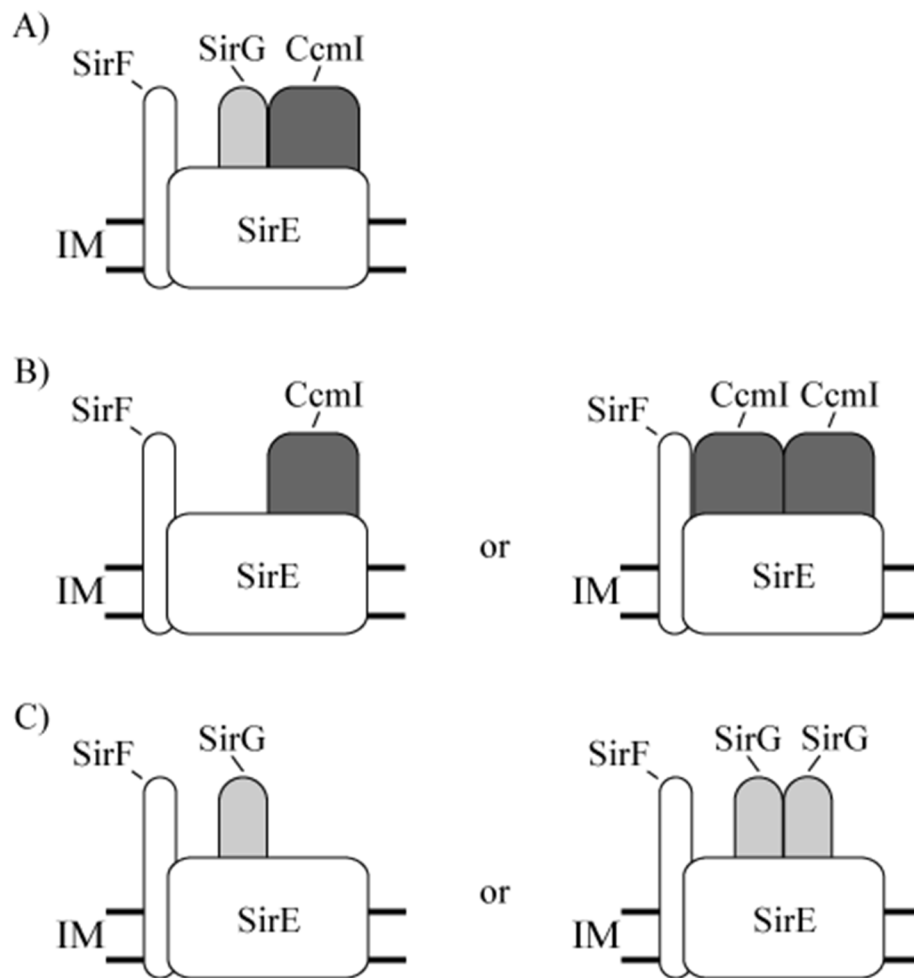

Figure 4.11. Models of proposed apo-SirA lyase complexes. A) Wild-type heme lyase complex, resulting in optimal production of mature SirA. B) Heme lyase complexes lacking SirG, resulting in a lag of 24 hours. C) Heme lyase complexes lacking CcmI, resulting in a lag of 48 hours.

The *S. oneidensis* nitrite reductase, NrfA_{so}, is a pentaheme *c*-type cytochrome with 4 CXXCH and one CXXCK heme-binding sites (37), and is similar to the NrfA proteins

of *E. coli* and *W. succinogenes* (35, 75, 154, 155). Maturation of NrfA in *W. succinogenes* and *E. coli* requires the dedicated heme lyases NrfI and NrfEFG, respectively (35, 144, 152, 156). Our results suggested that, unlike these bacteria, *S. oneidensis* does not appear to have a dedicated heme lyase system for the maturation of its NrfA_{So} protein. Although CcmI_{So} was essential for the maturation of NrfA_{So}, it also participated in the maturation of other *c*-type cytochromes. Furthermore, we did not identify a cytochrome *c* synthetase similar to CcmF or SirE that is specific for the maturation of NrfA_{So}. The lack of a dedicated cytochrome *c* synthetase system for maturation of the nitrite reductase in *S. oneidensis*, suggests that CcmFHI may form the heme lyase complex responsible for heme attachment to the CXXCK site (Fig. 4.12). If this is the case, then it further suggests that the same heme synthetase CcmF of *S. oneidensis* is able to ligate heme to apocytochromes *c* with both CXXCH and CXXCK heme-binding motifs.

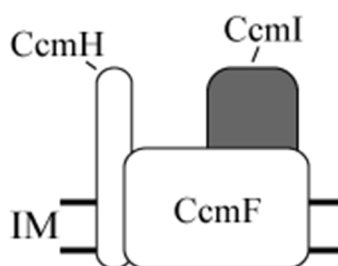

Figure 4.12. Model of proposed apo-NrfA lyase complex.

In summary, *S. oneidensis* has two predicted heme synthetases, CcmF and SirE and two apocytochromes *c* chaperones, CcmI and SirG. I predict that multiple combinations of these proteins in *S. oneidensis* can form heme lyase complexes depending on growth

conditions. For example, CcmI may interact with CcmF and CcmH when nitrite and DMSO are used as electron acceptors. CcmI may also interact with SirEFG when cells are grown with sulfite. Unlike other bacteria studied to date, *S. oneidensis* does not appear to have a dedicated and specific heme lyase complex for each of the heme-binding motifs found in its *c*-type cytochromes. These findings add another twist to the already complex mechanism of cytochrome *c* maturation in bacteria.

Chapter 5

Regulation of anaerobic reductases expression and activity in *Shewanella oneidensis*

Introduction

Shewanella oneidensis MR-1 is a facultative anaerobe that can use a large number of electron acceptors such as oxygen, nitrate, fumarate, dimethylsulfoxide (DMSO), Fe(III) oxides, uranium, and chromium (7, 13, 157). *S. oneidensis* is dubbed an “interface organism” because it lives at the boundary between the aerobic and anaerobic zones where the availability of electron acceptors can fluctuate rapidly. It cannot ferment, and rapid adaptation to changes in oxygen tensions is essential for its survival. This is perhaps one of the reasons why many terminal reductases are expressed in the absence of their substrates upon oxygen limitation (158). This level of expression is modulated further by electron acceptor availability, and cells incubated with different electron acceptors exhibit differential regulation of reductase and cytochrome genes indicating specific responses (85, 159). For example, the DMSO reductase genes are expressed when cells are incubated anaerobically with fumarate or thiosulfate, but are induced further in the presence of DMSO (85, 159).

In most bacteria, the oxygen-sensing FNR regulates the expression of respiratory genes in response to oxygen limitation (78, 160). However, in *S. oneidensis*, with the exception of the TMAO reductase, the cAMP receptor protein (CRP) regulates the expression of all anaerobic reductases and most *c* cytochrome genes (83, 85). A similar mechanism of regulation was also found to operate in the related *Shewanella* sp. ANA-3 (161). *S. oneidensis crp* mutants are deficient in anaerobic respiration of fumarate, DMSO,

Fe(III), Mn(IV), and nitrate. Furthermore, fumarate, DMSO, and nitrate reductase activities are either severely decreased or undetectable in Δcrp , indicating that CRP regulates the expression of these anaerobic reductases (83). Activation of CRP requires the synthesis of cAMP by adenylate cyclases. In *S. oneidensis*, two adenylate cyclases, CyaA and CyaC, are required for expression of anaerobic reductase genes (85).

In addition to CRP, additional regulatory systems that control the expression of anaerobic reductase genes have been identified in *S. oneidensis*. The two-component system TorSR positively regulates the expression of the TMAO reductase genes in the presence of TMAO (162). TorSR appear to be active when TMAO is present irrespective of oxygen availability (163). The second system, ArcB1/HptA/ArcA regulates the expression of the *S. oneidensis* DMSO reductase genes (164, 165), but the mechanisms that lead to activation of ArcB1/HptA/ArcA are not clear. Recent evidence from our laboratory identified SirR as a positive regulator of sulfite reductase gene expression (Shirodkar, manuscript in preparation). Although several regulatory systems that control the expression of anaerobic reductase genes have been identified, many aspects of the regulation of *S. oneidensis* anaerobic respiration are unclear. In this chapter, I investigate the transcriptional regulation of sulfite reduction and the possible post-transcriptional regulation of several anaerobic reductases.

Results

Promoter-*lacZ* fusions

To assess the expression of anaerobic reductase genes, promoter-*lacZ* fusions were generated and assayed for β -galactosidase activity under different growth conditions. As

anticipated, the fumarate reductase promoter was active under anaerobic conditions with all electron acceptors tested (Figure 5.1). Under aerobic conditions, the fumarate reductase promoter showed a 70% decrease in expression compared to anaerobic conditions (Fig. 5.1). The DMSO reductase promoter shows a similar expression pattern to the fumarate reductase promoter with the exception that it was not expressed under aerobic conditions (data not shown). However, when the *sirA* promoter was fused to *lacZ*, hardly any β -galactosidase activity was detected even in the presence of sulfite (Fig. 5.2). This suggested that the use of *lacZ* fusions might not be ideal for measuring promoter activity under all growth conditions. Furthermore, interpretation of β -galactosidase assay may be complicated by the stability and half-life of the enzyme.

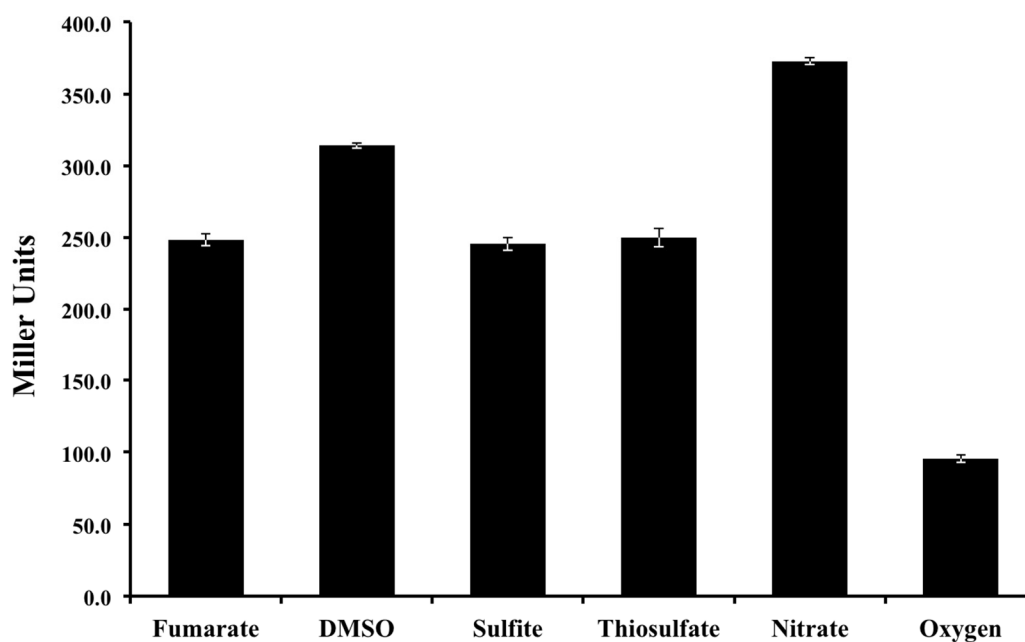

Figure 5.1. β -galactosidase activity of the fumarate reductase (*fccA*) promoter fused to *lacZ* in pMC10. Cells were grown to mid-log phase with fumarate, DMSO, sulfite, thiosulfate, nitrate or oxygen as the sole electron acceptor.

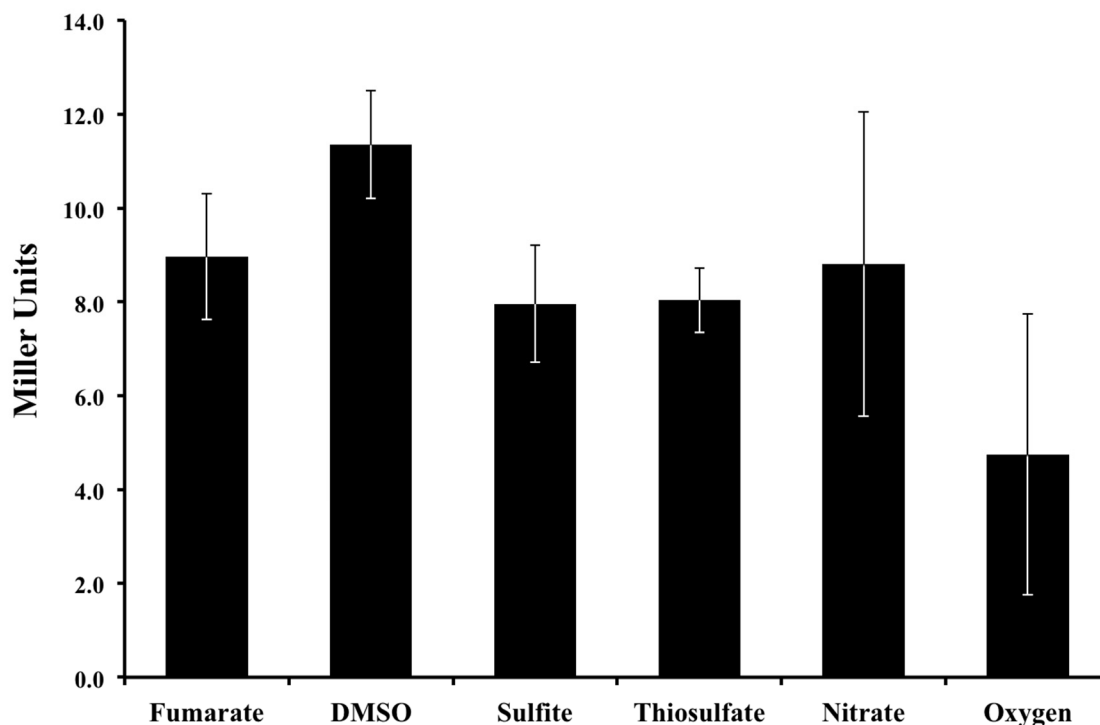

Figure 5.2. β -galactosidase activity of the sulfite reductase (*sirA*) promoter fused to *lacZ* in pMC10. Cells were grown to mid-log phase with fumarate, DMSO, sulfite, thiosulfate, nitrate or oxygen as the sole electron acceptor.

Effect of electron acceptor availability on the fumarate reductase

To overcome the problems associated with using *lacZ*-fusions described above, I used real-time RT-PCR to get a more accurate measure of mRNA levels in cells grown in the presence of different electron acceptors. Expression of the fumarate reductase gene was determined using primers designed to amplify a 211 bp fragment of *fccA* (SO_0970, Table 2.2). Similar to promoter activity (Fig. 5.1), I did not detect appreciable differences in *fccA* mRNA levels when cells were grown with different electron acceptors (Fig. 5.3 A). Aliquots of the same cultures used for RNA extractions and quantitative RT-PCR were used to test for fumarate reductase activity in native PAGE. Similar to *fccA* expression, fumarate reductase activity was detected in all cell extracts tested. However, cells grown

with DMSO and nitrite displayed markedly less fumarate reductase activity than cells grown with fumarate, sulfite or thiosulfate (Fig. 5.3 B). As expected, $\Delta fccA$ lacked fumarate reductase activity (Fig. 5.3 B).

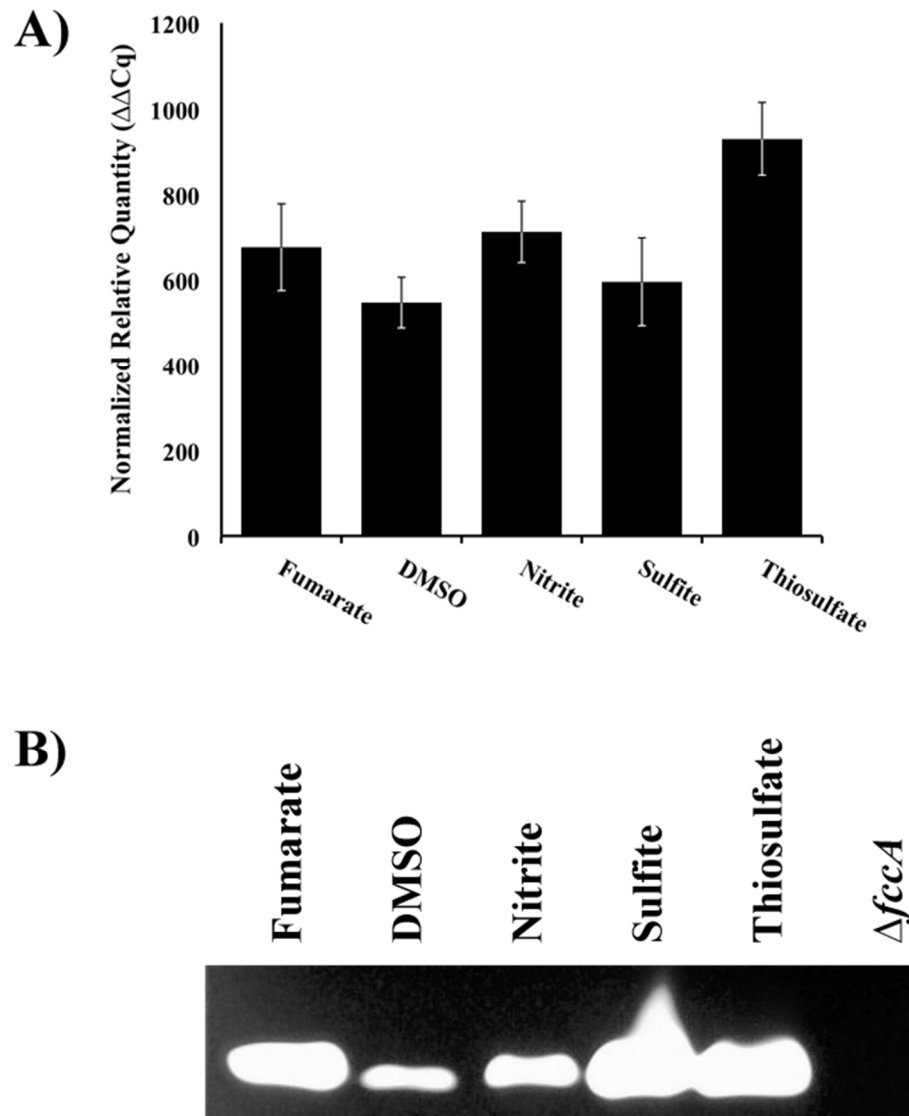

Figure 5.3. Fumarate reductase transcript and activity levels of cell extracts from wild-type MR-1 grown anaerobically with fumarate, DMSO, NO_2 , SO_3 and S_2O_3 . A) Real-time RT-PCR detection of *fccA* message. Relative message levels are normalized to 16S rRNA transcript. B) Fumarate reductase activity using methyl viologen as the electron donor and fumarate as the electron acceptor. Bands of clearing correspond to fumarate reductase activity. $\Delta fccA$ grown anaerobically with fumarate was loaded as a control. 10 μg of total protein was loaded in each lane.

Effect of electron acceptor availability on the sulfite reductase

As mentioned above, the use of promoter-*lacZ* fusions to test the expression of *sirA* was not successful. I therefore used quantitative RT-PCR to determine the level of *sirA* mRNA in MR-1 cells grown with different electron acceptors. *sirA* mRNA was measured using primers designed to amplify a 198 bp fragment of *sirA* (SO_0479, Table 2.2). *sirA* mRNA was detected in cells grown in the presence of sulfite and thiosulfate (Fig. 5.4 A). Very low levels of *sirA* mRNA were detected in cells grown with nitrite, and none was detected in cells grown with either fumarate or DMSO (Fig. 5.4 A).

Sulfite reductase activity was tested on native polyacrylamide gels using methyl viologen as the electron donor and sulfite as the electron acceptor. Similar to mRNA levels, sulfite reductase activity was observed in extracts of cells grown in the presence of sulfite and thiosulfate. A sulfite reductase activity band was not observed in extracts of cells grown in the presence of nitrite, DMSO, or fumarate. Sulfite reductase activity was also absent from Δ *sirA* cell extracts, which lack the sulfite reductase SirA (Fig. 5.4 B). These results suggest that anaerobic conditions in the absence of sulfite or thiosulfate, which is reduced to sulfite, are not sufficient for sulfite reductase expression.

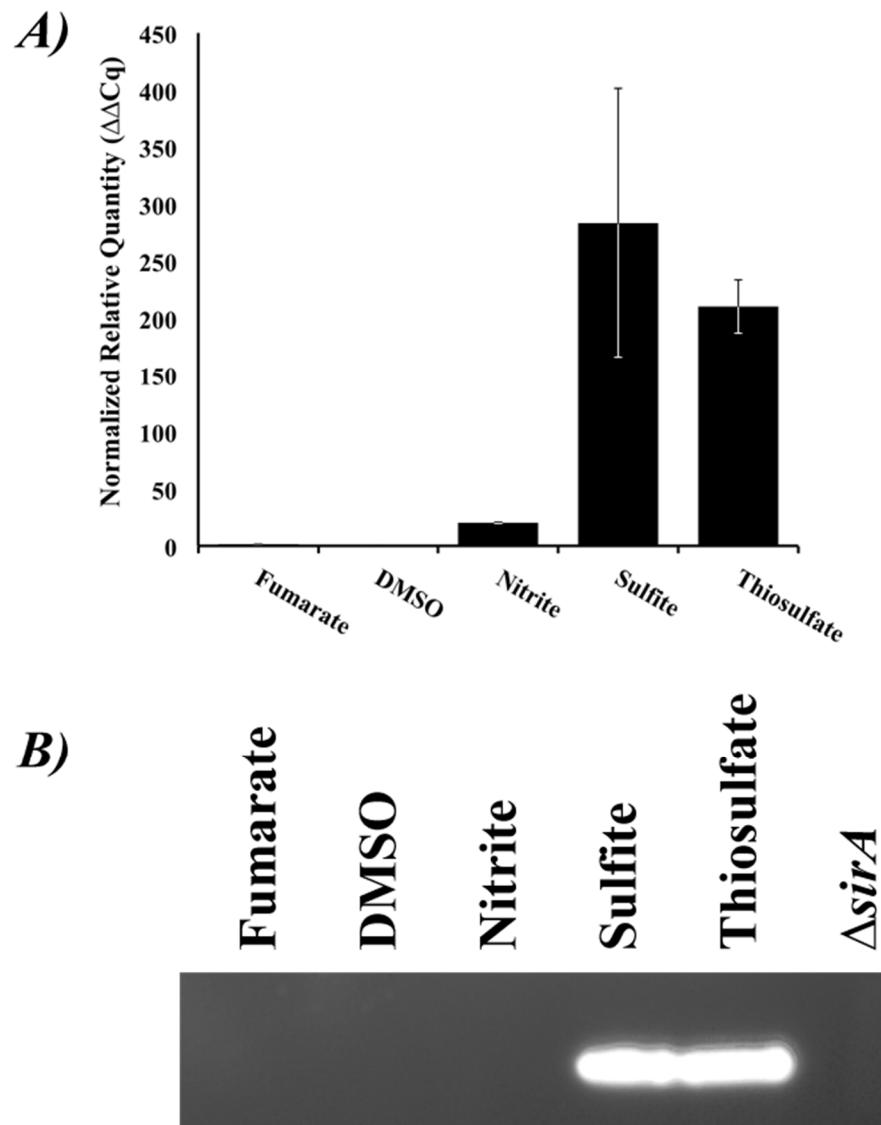

Figure 5.4. Sulfite reductase transcript and activity levels of cell extracts from wild-type MR-1 grown anaerobically with fumarate, DMSO, NO_2 , SO_3 and S_2O_3 . A) Real-time RT-PCR detection of *sirA* message. Relative mRNA levels are normalized to 16S rRNA transcript. B) Sulfite reductase activity using methyl viologen as the electron donor and Na_2SO_3 as the electron acceptor. Bands of clearing correspond to sulfite reductase activity. $\Delta sirA$ grown anaerobically with Na_2SO_3 was loaded as a control. 50 μg of total protein was loaded in each lane.

Effect of electron acceptor availability on the thiosulfate reductase

Thiosulfate reductase gene expression was tested in *S. oneidensis* cells grown anaerobically with different electron acceptors using quantitative RT-PCR. mRNA levels of *phsA*, which encodes the catalytic subunit of the thiosulfate reductase, were determined using primers designed to amplify a 110 bp fragment of *phsA* (SO_4062, Table 2.2). Relative to the other anaerobic reductase genes, *phsA* transcript was very low under all growth conditions. The highest level of *phsA* mRNA was detected in cells grown with thiosulfate, and to a lesser extent in cells grown with sulfite. A significant decrease in message was found in cells grown with fumarate, DMSO or nitrite (Fig 5.6 A). Thiosulfate reductase activity was detected in cell extracts of MR-1 grown with thiosulfate. No activity is seen when grown with fumarate, DMSO or nitrite. Extremely low levels of thiosulfate reductase activity are present in cells grown with sulfite (Fig. 5.5 B). These results are intriguing because *phsA* mRNA is detected in cells grown in the presence of sulfite, but enzyme activity is almost absent, suggesting that thiosulfate reductase expression may be subject to post-transcriptional regulation.

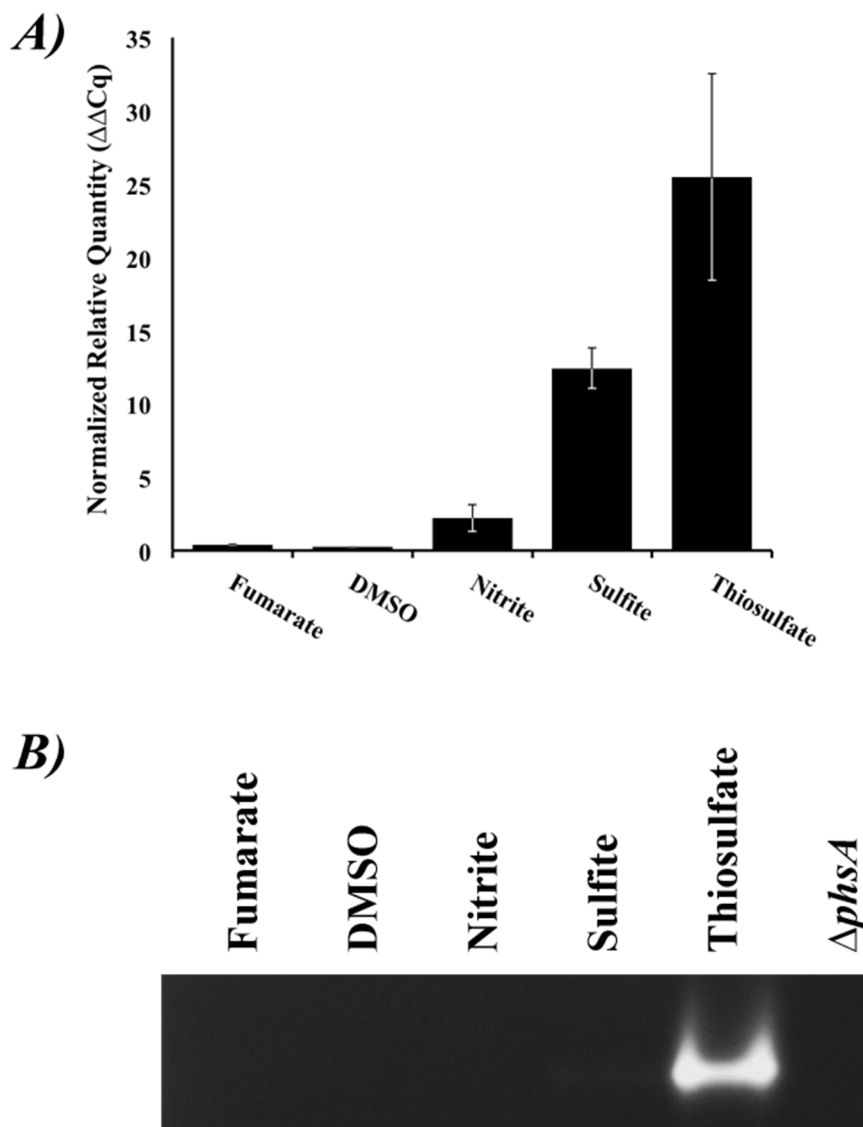

Figure 5.5. Thiosulfate reductase transcript and activity levels of cell extracts from wild-type MR-1 grown anaerobically with fumarate, DMSO, NO_2 , SO_3 and S_2O_3 . A) Real-time RT-PCR detection of *phsA* message. Relative message levels are normalized to 16S rRNA transcript. B) Thiosulfate reductase activity using methyl viologen as the electron donor and NaS_2O_3 as the electron acceptor. Bands of clearing correspond to thiosulfate reductase activity. $\Delta phsA$ grown anaerobically with NaS_2O_3 was loaded as a control. 50 μg of total protein was loaded in each lane.

Effect of electron acceptor availability on the nitrite reductase

The results described above indicated that the fumarate reductase was expressed in cells grown anaerobically with different electron acceptors, whereas the sulfite and thiosulfate reductases were expressed only when their respective electron acceptors were available. To determine if constitutive expression under anaerobic conditions is unique to the fumarate reductase, I measured *nrfA* transcript levels in cell extracts of wild-type MR-1 grown with fumarate, DMSO, nitrite, sulfite and thiosulfate (Fig. 5.6 A). I also tested nitrite reductase activity. Nitrite reductase activity was detected in extracts of cells grown with nitrite but was absent in $\Delta nrfA$, which lacks the nitrite reductase gene (Fig. 5.6 B). Interestingly, nitrite reductase activity was also detected in extracts of cells grown in the presence of sulfite and thiosulfate (Fig. 5.6 B). Nitrite reductase activity was greatly diminished in extracts of cells grown in the presence of DMSO or fumarate grown cells (Fig. 5.6 B).

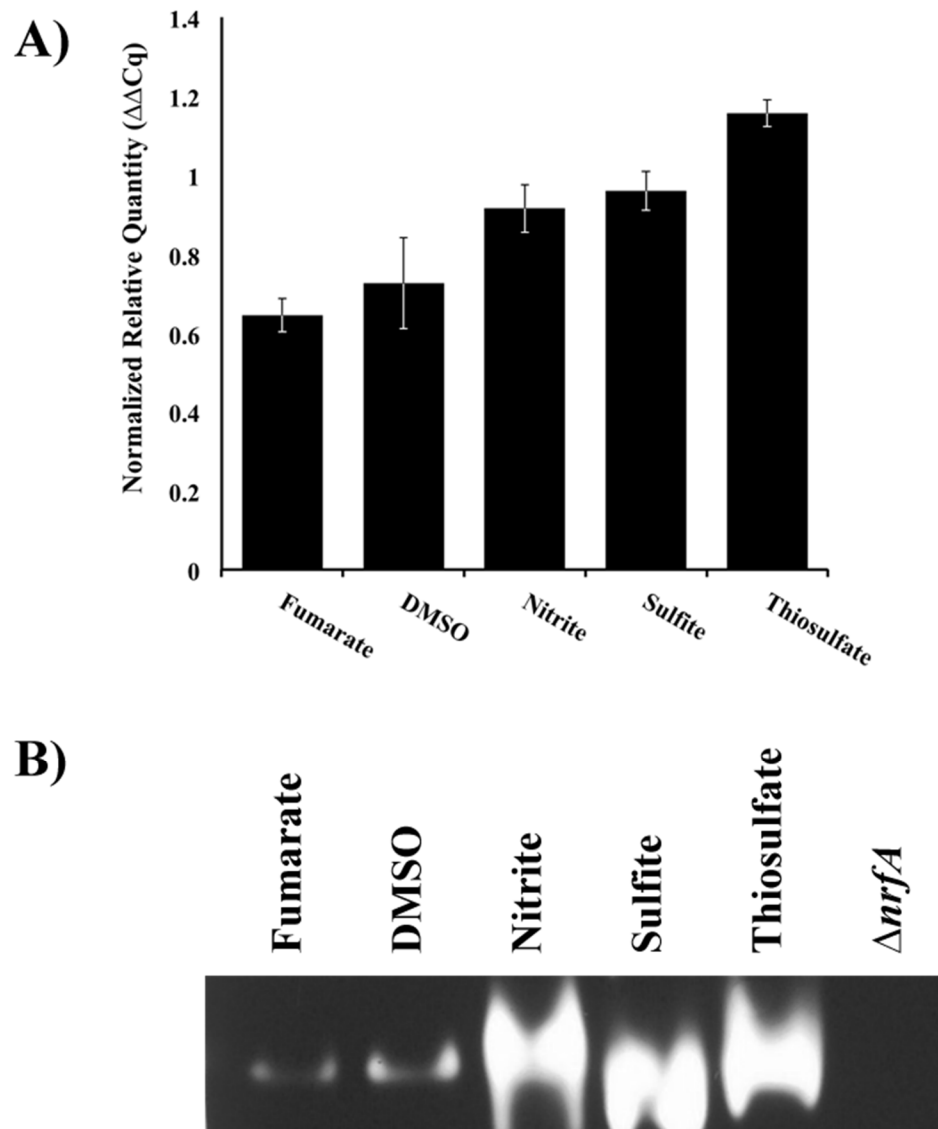

Figure 5.6. Nitrite reductase transcript and activity levels of cell extracts from wild-type MR-1 grown anaerobically with fumarate, DMSO, NO_2 , SO_3 and S_2O_3 . A) Real-time RT-PCR detection of *nrfA* message. Relative message levels are normalized to 16S rRNA transcript. B) Nitrite reductase activity using methyl viologen as the electron donor and NaNO_2 as the electron acceptor. Bands of clearing correspond to nitrite reductase activity. $\Delta nrfA$ grown anaerobically with NaS_2O_3 was loaded as a control. 50 μg of total protein was loaded in each lane.

DISCUSSION

Regulation of gene expression and enzyme activity is of critical importance in all living cells. Cells are constantly assessing and responding to a plethora of internal and external stimuli and signals. Most bacteria experience frequent changes in their environment and need to be able to quickly adapt. For facultative anaerobes, the transition between oxic and anoxic conditions is crucial for survival. In *E. coli* the transition from aerobic to anaerobic growth requires a series of regulatory events that begin with the global regulator FNR. FNR responds to anoxic conditions by forming a homo-dimer that then regulates the expression of many genes involved in aerobic respiration, anaerobic respiration and fermentation. *E. coli* further regulates gene expression based on nutrient availability.

In *S. oneidensis*, FNR does not regulate the transition to anoxic conditions, rather the cyclic AMP receptor protein (CRP) regulates transcription of anaerobic respiration genes. Unlike FNR, CRP does not contain an oxygen-sensing domain, but responds to levels of the secondary signaling molecule cAMP. Production of cAMP is regulated by activity of three adenylate cyclases (*cya*). We have reported previously on the effect of adenylate cyclases and CRP on gene expression when cells are shifted from oxic to anoxic growth conditions (85). The work described here investigates further the growth conditions that affect expression and activity of anaerobic respiratory enzymes.

We have used β -galactosidase activity measurements as a proxy for promoter activity using promoter-*lacZ* fusions. The fumarate reductase promoter was active under anaerobic growth conditions with different electron acceptors. Some activity was detected also in the presence of oxygen. These results are in agreement with previous findings that

the fumarate reductase of *S. oneidensis* is expressed at low levels in aerobic cultures, and this expression is increased under anaerobic conditions (80, 83). The use of sulfite reductase promoter-*lacZ* fusions, however, did not reveal useful information. β -galactosidase activity in these experiments was very low and similar to the activity obtained in strains that carry a promoterless *lacZ*. To get a more accurate measure of gene expression, I used real time RT-PCR to determine mRNA levels of the fumarate, sulfite and thiosulfate reductases. *fccA* mRNA levels were high and were similar in cells grown with different electron acceptors. These results were similar to results obtained with *fccA* promoter-*lacZ* fusions. Fumarate reductase activity was also detected on native polyacrylamide gels regardless of the electron acceptor that was present during cell growth. However, a moderate decrease in fumarate reductase activity was observed in cells grown in the presence of nitrite and DMSO. This decrease in activity did not correspond to mRNA levels in cells grown with these electron acceptors. *fccA* mRNA levels were similar in nitrite and fumarate grown cells, and only slightly reduced in DMSO grown cells. These results suggest that, in addition to transcriptional regulation by CRP, the fumarate reductase may be subject to additional regulation, either at the translational or enzyme activation level. Alternatively, the fumarate reductase, FccA, may be less stable under certain growth conditions. Further experiments are required to determine any post-transcriptional regulation of the fumarate reductase enzyme.

The sulfite reductase, SirA, appears to be regulated more stringently than the fumarate reductase. *sirA* mRNA was abundant in cells that were grown anaerobically in with sulfite or thiosulfate (Fig. 5.4 A). However, low levels of *sirA* mRNA were present in cells grown with fumarate, DMSO or nitrite (Fig 5.5 A). It is possible that *sirA* transcription

occurs at low levels under anaerobic conditions and is further induced by sulfite or thiosulfate. Alternatively, *sirA* transcripts may be unstable or degraded in the absence of these electron acceptors. A similar finding was obtained when levels of the thiosulfate reductase gene *phsA* were measured. *phsA* transcripts were present at high levels in cells grown with sulfite and thiosulfate, but were either absent or low in cells grown with fumarate, nitrite, or DMSO. Sulfite reductase enzyme activity appeared to correlate well with *sirA* mRNA levels. In contrast, thiosulfate reductase activity was detected in thiosulfate grown cells, and an activity band was barely detectable in sulfite grown cells in spite of the presence of relatively high levels of *phsA* transcripts in these cells. Based on these results we hypothesize that translation of the *phsA* mRNA or activity of the thiosulfate reductase enzyme may be inhibited in the presence of sulfite. Future experiments are planned to determine levels of PhsA and identify the reason for loss of thiosulfate reductase activity in sulfite grown cells.

It is interesting to note that the sulfite and thiosulfate reductase genes, in addition to being regulated by CRP, are also subject to additional regulation by SirR and TsaSR respectively (Shirodkar, Biddle, and Saffarini, in preparation). Regulatory proteins that control the expression of the fumarate reductase gene have not been identified. The tight regulation observed in gene expression of *sirA* and *phsA*, compared to the constitutive expression of *fccA*, may be due to the activity of additional regulatory proteins mentioned above. As mentioned in Chapter 4, *S. oneidensis* expresses a nitrite reductase gene, *nrfA*, which is also regulated by CRP, as well as, the two-component system NarQP (166). To determine if the nitrite reductase enzyme is active only in the presence of nitrite, I tested its activity in native polyacrylamide gels as described above. A band of nitrite reductase

activity was detected in cells grown with nitrite, sulfite, and thiosulfate. Low levels of activity were detected in cells grown with fumarate and DMSO. This suggests that the nitrite reductase is expressed at low levels and further induced in the presence of nitrite. It is intriguing that this level of activity was also present in cells grown with sulfite and thiosulfate. The reason for this is currently not known. However, because all tested enzymes were either expressed or active in the presence of sulfite and thiosulfate, this suggests that these electron acceptors do not have a negative effect on the expression of the fumarate and nitrite reductases. In contrast, DMSO appeared to have a negative effect on the expression or activity of all reductases tested in this study. The results presented here suggest regulation of the anaerobic terminal reductase in *S. oneidensis* is not only at the level of promoter activation. However, it appears that other factors, in addition to transcriptional regulatory proteins, may be involved in controlling anaerobic respiration in *S. oneidensis*. Additional experiments that investigate in more detail gene expression, proteins levels, and enzyme activities are needed to fully understand the mechanisms that control anaerobic respiration in *S. oneidensis* MR-1.

Chapter 6

Concluding Remarks

Shewanella oneidensis is of interest due to its ability to respire on a vast range of electron acceptors. Respiration with some electron acceptors such as Fe oxides, fumarate and DMSO has been well studied. Respiration on sulfur containing compounds is not as well understood and is the topic of this study.

The terminal sulfite reductase has been identified as SirA, an octaheme *c*-type cytochrome. In this work I present several additional components involved in sulfite reduction. The ferredoxin and menaquinol oxidase SirCD form a complex with and function in electron delivery to the terminal sulfite reductase SirA, accounting for the CymA independent nature of sulfite reduction. Two proteins involved in folding and stability of SirA were also identified. SirBI likely play a role in folding about the atypical cofactor attachments sites of SirA. These proteins, coded for by genes in the *sir* operon, are essential for SirA stability and sulfite reduction. An additional set of proteins, SirJKLM are proposed to be involved in delivery and attachment of Cu as an enzyme cofactor. SirJKLM are not strictly required, but are needed for optimal sulfite reduction.

The sulfite reductase also requires complex and specialized machinery for its maturation. In addition to the typical CXXCH heme-binding motif found in all *c*-type cytochromes, two atypical heme-binding sites are found in *S. oneidensis*. SirA codes for a CX₁₂NKGCH heme attachment site which requires the function of the heme synthetase SirEF and the chaperones SirG and CcmI for maturation. This is the first report of a maturation system where two chaperones are involved in apocytochrome *c* maturation. CcmI is also unique in its involvement in the maturation of all three heme attachment sites.

All other bacterial cytochrome maturation systems reported have dedicated and specific maturation machinery for each different heme-binding motif.

The other atypical heme site, CXXCK, is located in the *S. oneidensis* nitrite reductase, NrfA. In other bacteria, NrfA maturation requires NrfEFG for heme attachment to the CXXCK site. The *S. oneidensis* genome lacks genes that encode NrfEFG. Instead NrfA maturation requires CcmI, which takes the place of NrfG as the apo-NrfA chaperone. It is likely that the role of NrfEF is carried out by an unidentified synthetase and future work will be required to identify the CXXCK specific synthetase. Generation of a strain deficient in apocytochrome degradation will allow for analysis of unmaturred reductases permitting greater insight into the details of the highly complex *c*-type cytochrome maturation in *S. oneidensis* MR-1.

Regulation of anaerobic reductases in *S. oneidensis* is different than in other organisms such as *E. coli* and is quite complex. Transcriptional regulation of the expression of genes involved in anaerobic respiration only appears to be a part of the regulation scheme in *S. oneidensis*. Levels of transcript play an import role, possibly through alterations in message stability or regulation of degradation. Additional post-translational regulation is suggested and may occur through regulation of enzyme maturation or protein degradation and turn over. This work provides a platform for the further study of these complex regulatory mechanisms in *Shewanella*.

In this work I describe the role of genes involved in sulfite reduction and provide a basis for further study of the roles of Cu and the Cu processing SirJKLM in sulfite reduction. I also identify and describe novel cytochrome maturation systems of *S. oneidensis* MR-1. Future work to identify additional cytochrome chaperones and

synthetases should be performed to elucidate the intricacies of this complex maturation. Future work to identify possible methods of post-transcriptional regulation is needed. I believe future results will continue to reveal a link between the regulation, maturation and activity of the *S. oneidensis* reductases.

REFERENCES

1. **Lovley DR, Giovannoni SJ, White DC, Champine JE, Phillips EJ, Gorby YA, Goodwin S.** 1993. *Geobacter metallireducens* gen. nov. sp. nov., a microorganism capable of coupling the complete oxidation of organic compounds to the reduction of iron and other metals. *Archives of Microbiology* **159**:336-344.
2. **Widdel F.** 1987. New types of acetate-oxidizing, sulfate-reducing *Desulfobacter* species, *D. hydrogenophilus* sp. nov., *D. latus* sp. nov., and *D. curvatus* sp. nov. *Archives of Microbiology* **148**:286-291.
3. **Mogensen GL, Kjeldsen KU, Ingvorsen K.** 2005. *Desulfovibrio aerotolerans* sp. nov., an oxygen tolerant sulphate-reducing bacterium isolated from activated sludge. *Anaerobe* **11**:339-349.
4. **Myers CR, Nealson KH.** 1988. Bacterial manganese reduction and growth with manganese oxide as the sole electron acceptor. *Science* **240**:1319-1321.
5. **Baumann B, Snozzi M, Zehnder AJ, Van Der Meer JR.** 1996. Dynamics of denitrification activity of *Paracoccus denitrificans* in continuous culture during aerobic-anaerobic changes. *Journal of Bacteriology* **178**:4367-4374.
6. **Cole J.** 1996. Nitrate reduction to ammonia by enteric bacteria: redundancy, or a strategy for survival during oxygen starvation? *FEMS Microbiology Letters* **136**:1-11.
7. **Nealson KH, Saffarini D.** 1994. Iron and manganese in anaerobic respiration: environmental significance, physiology, and regulation. *Annual Review of Microbiology* **48**:311-343.
8. **Moreno-Vivián C, Cabello P, Martínez-Luque M, Blasco R, Castillo F.** 1999. Prokaryotic nitrate reduction: molecular properties and functional distinction among bacterial nitrate reductases. *Journal of Bacteriology* **181**:6573-6584.
9. **Anderson RT, Vrionis HA, Ortiz-Bernad I, Resch CT, Long PE, Dayvault R, Karp K, Marutzky S, Metzler DR, Peacock A, White DC, Lowe M, Lovley DR.** 2003. Stimulating the in situ activity of *Geobacter* species to remove uranium from the groundwater of a uranium-contaminated aquifer. *Applied and Environmental Microbiology* **69**:5884-5891.
10. **Bouhenni R, Vora G, Biffinger J, Shirodkar S, Brockman K, Ray R, Wu P, Johnson B, Biddle E, Marshall M, Fitzgerald L, Little B, Fredrickson J, Beliaev A, Ringeison B, Saffarini D.** 2010. The role of *Shewanella oneidensis* outer surface structures in extracellular electron transfer. *Electroanalysis* **22**:856-864.

11. **Bretschger O, Obraztsova A, Sturm CA, Chang IS, Gorby YA, Reed SB, Culley DE, Reardon CL, Barua S, Romine MF, Zhou J, Beliaev AS, Bouhenni R, Saffarini D, Mansfeld F, Kim BH, Fredrickson JK, Nealson KH.** 2007. Current production and metal oxide reduction by *Shewanella oneidensis* MR-1 wild type and mutants. *Applied and Environmental Microbiology* **73**:7003-7012.
12. **Fredrickson JK, Romine MF, Beliaev AS, Auchtung JM, Driscoll ME, Gardner TS, Nealson KH, Osterman AL, Pinchuk G, Reed JL, Rodionov DA, Rodrigues JL, Saffarini DA, Serres MH, Spormann AM, Zhulin IB, Tiedje JM.** 2008. Towards environmental systems biology of *Shewanella*. *National Reviews Microbiology* **6**:592-603.
13. **Myers J, Myers C.** 2000. Chromium (VI) reductase activity is associated with the cytoplasmic membrane of anaerobically grown *Shewanella putrefaciens* MR-1. *Journal of Applied Microbiology* **88**:98-106.
14. **Bencheikh-Latmani R, Williams SM, Haucke L, Criddle CS, Wu L, Zhou J, Tebo BM.** 2005. Global transcriptional profiling of *Shewanella oneidensis* MR-1 during Cr(VI) and U(VI) reduction. *Applied and Environmental Microbiology* **71**:7453-7460.
15. **Liu C, Gorby YA, Zachara JM, Fredrickson JK, Brown CF.** 2002. Reduction kinetics of Fe(III), Co(III), U(VI), Cr(VI), and Tc(VII) in cultures of dissimilatory metal-reducing bacteria. *Biotechnology and Bioengineering* **80**:637-649.
16. **Marshall MJ, Beliaev AS, Dohnalkova AC, Kennedy DW, Shi L, Wang Z, Boyanov MI, Lai B, Kemner KM, McLean JS, Reed SB, Culley DE, Bailey VL, Simonson CJ, Saffarini DA, Romine MF, Zachara JM, Fredrickson JK.** 2006. *c*-Type cytochrome-dependent formation of U(IV) nanoparticles by *Shewanella oneidensis*. *PLOS Biology* **4**:e268.
17. **Marshall MJ, Plymale AE, Kennedy DW, Shi L, Wang Z, Reed SB, Dohnalkova AC, Simonson CJ, Liu C, Saffarini DA, Romine MF, Zachara JM, Beliaev AS, Fredrickson JK.** 2008. Hydrogenase- and outer membrane *c*-type cytochrome-facilitated reduction of technetium(VII) by *Shewanella oneidensis* MR-1. *Environmental Microbiology* **10**:125-136.
18. **Heidelberg JF, Paulsen IT, Nelson KE, Gaidos EJ, Nelson WC, Read TD, Eisen JA, Seshadri R, Ward N, Methe B, Clayton RA, Meyer T, Tsapin A, Scott J, Beanan M, Brinkac L, Daugherty S, DeBoy RT, Dodson RJ, Durkin AS, Haft DH, Kolonay JF, Madupu R, Peterson JD, Umayam LA, White O, Wolf AM, Vamathevan J, Weidman J, Impraim M, Lee K, Berry K, Lee C, Mueller J, Khouri H, Gill J, Utterback TR, McDonald LA, Feldblyum TV, Smith HO, Venter JC, Nealson KH, Fraser CM.** 2002. Genome sequence of the dissimilatory metal ion-reducing bacterium *Shewanella oneidensis*. *Nature Biotechnology* **20**:1118-1123.

19. **Meyer T, Tsapin A, Vandenberghe I, de Smet L, Frishman D, Nealson K, Cusanovich M, van Beeumen J.** 2004. Identification of 42 possible cytochrome *c* genes in the *Shewanella oneidensis* genome and characterization of six soluble cytochromes. *OMICS* **8**:57-77.
20. **Gao H, Yang Z, Barua S, Reed S, Romine M, Nealson K, Fredrickson J, Tiedje J, Zhou J.** 2009. Reduction of nitrate in *Shewanella oneidensis* depends on atypical NAP and NRF systems with NapB as a preferred electron transport protein from CymA to NapA. *ISME* **3**:966-876.
21. **Murphy JN, Saltikov CW.** 2007. The *cymA* gene, encoding a tetraheme *c*-type cytochrome, is required for arsenate respiration in *Shewanella* species. *Journal of Bacteriology* **189**:2283-2290.
22. **Myers CR, Myers JM.** 1997. Cloning and sequence of *cymA*, a gene encoding tetraheme cytochrome *c* required for reduction of iron(III), fumarate, and nitrate by *Shewanella putrefaciens* MR-1. *Journal of Bacteriology* **179**:1143-1152.
23. **Myers J, Myers C.** 2000. Role of the tetraheme cytochrome CymA in anaerobic electron transport in cells of *Shewanella putrefaciens* MR-1 with normal levels of menaquinone. *Journal of Bacteriology* **182**:67-75.
24. **Cruz-Garcia C, Murray AE, Klappenbach JA, Stewart V, Tiedje J.** 2007. Respiratory nitrate ammonification by *Shewanella oneidensis* MR-1. *Journal of Bacteriology* **189**:656-662.
25. **Leys D, Tsapin A, Nealson K, Meyer T, Cusanovich M, Van Beeumen J.** 1999. Structure and mechanisms of the flavocytochrome *c* reductase of *Shewanella putrefaciens* MR-1. *Nature Structural & Molecular Biology* **6**:1113-1117.
26. **Morris CJ, Black A, Pealing S, Manson F, Chapman SK, Reid G, Gibson D, Ward. FB.** 1944. Purification and properties of a novel cytochrome: flavocytochrome *c* from *Shewanella putrefaciens*. *Biochemical Journal* **302**:587-593.
27. **Dos Santos J, Iobbi-Nivol C, Couillault C, Giordano G, Mejean V.** 1998. Molecular analysis of the trimethylamine N-oxide (TMAO) reductase respiratory system from a *Shewanella* species. *Journal of Molecular Biology* **284**:421-433.
28. **Beliaev AS, Saffarini DA, McLaughlin JL, Hunnicutt D.** 2001. MtrC, an outer membrane decahaem *c* cytochrome required for metal reduction in *Shewanella putrefaciens* MR-1. *Molecular Microbiology* **39**:722-730.
29. **Sanders C, Turkarslan S, Lee D-W, Daldal F.** 2010. Cytochrome *c* biogenesis: the Ccm system. *Trends in Microbiology* **18**:266-274.

30. **Kranz R, Richard-Fogal C, Taylor J-S, Frawley E.** 2009. Cytochrome *c* biogenesis: Mechanisms for covalent modifications and trafficking of heme for heme-iron redox control. *Microbiology and Molecular Biology Reviews* **73**:510-528.
31. **Travaglini-Allocatelli C.** 2013. Protein machineries involved in the attachment of heme to cytochrome *c*: protein structures and molecular mechanisms. *Scientifica* **2013**:505714.
32. **Sanders C, Turkarslan S, Lee D, Onder O, Kranz R, Daldal F.** 2008. The cytochrome *c* maturation component CcmF, CcmH, and CcmI from a membrane-integral multisubunit heme ligation complex. *Journal of Biological Chemistry* **283**:29715-29722.
33. **Bouhenni R, Gehrke A, Saffarini D.** 2005. Identification of genes involved in cytochrome *c* biogenesis in *Shewanella oneidensis*, using a modified mariner transposon. *Applied and Environmental Microbiology* **71**:4935-4937.
34. **Jin M, Jiang Y, Sun L, Yin J, Fu H, Wu G, Gao H.** 2013. Unique organization and functional features of the cytochrome *c* maturation system in *Shewanella oneidensis*. *PLOS ONE* **8**:e75610.
35. **Eaves D, Grove J, Staudenmann W, James P, Poole RK, White S, Griffiths L, Cole J.** 1998. Involvement of products of the *nrfEFG* genes in the covalent attachment of haem *c* to a novel cysteine-lysine motif in the cytochrome *c552* nitrite reductase from *Escherichia coli*. *Molecular Microbiology* **28**:205-216.
36. **Kern M, Klotz M, Simon J.** 2011. The *Wolinella succinogenes* *mcc* gene cluster encodes an unconventional respiratory sulfite reduction system. *Molecular Microbiology* **82**:1515-1530.
37. **Youngblut M, Judd E, Srajer V, Sayyed B, Goelzer T, Elliott S, Schmidt M, Pacheco I.** 2012. Laue crystal structure of *Shewanella oneidensis* cytochrome *c* nitrite reductase from a high-yield expression system. *Journal of Biological Inorganic Chemistry* **17**:674-662.
38. **Shirodkar S, Reed S, Romine M, Saffarini D.** 2011. The octahaem SirA catalyses dissimilatory sulfite reduction in *Shewanella oneidensis* MR-1. *Environmental Microbiology* **13**:108-115.
39. **Shi L, Deng S, Marshall MJ, Wang Z, Kennedy DW, Dohnalkova AC, Mottaz HM, Hill EA, Gorby YA, Beliaev AS, Richardson DJ, Zachara JM, Fredrickson JK.** 2008. Direct involvement of type II secretion system in extracellular translocation of *Shewanella oneidensis* outer membrane cytochromes MtrC and OmcA. *Journal of Bacteriology* **190**:5512-5516.

40. **Beliaev AS, Saffarini DA.** 1998. *Shewanella putrefaciens mtrB* encodes an outer membrane protein required for Fe(III) and Mn(IV) reduction. *Journal of Bacteriology* **180**:6292-6297.
41. **Myers JM, Myers CR.** 1998. Isolation and sequence of *omcA*, a gene encoding a decaheme outer membrane cytochrome *c* of *Shewanella putrefaciens* MR-1, and detection of *omcA* homologs in other strains of *S. putrefaciens*. *Biochimica et Biophysica Acta* **1373**:237-251.
42. **Ross DE, Ruebush SS, Brantley SL, Hartshorne RS, Clarke TA, Richardson DJ, Tien M.** 2007. Characterization of protein-protein interactions involved in iron reduction by *Shewanella oneidensis* MR-1. *Applied and Environmental Microbiology* **73**:5797-5808.
43. **von Canstein H, Ogawa J, Shimizu S, Lloyd JR.** 2008. Secretion of flavins by *Shewanella* species and their role in extracellular electron transfer. *Applied and Environmental Microbiology* **74**:615-623.
44. **Marsili E, Baron DB, Shikhare ID, Coursolle D, Gralnick JA, Bond DR.** 2008. *Shewanella* secretes flavins that mediate extracellular electron transfer. *Proceedings of the National Academy of Sciences of the United States of America* **105**:3968-3973.
45. **Gorby YA, Yanina S, McLean JS, Rosso KM, Moyles D, Dohnalkova A, Beveridge TJ, Chang IS, Kim BH, Kim KS, Culley DE, Reed SB, Romine MF, Saffarini DA, Hill EA, Shi L, Elias DA, Kennedy DW, Pinchuk G, Watanabe K, Ishii S, Logan B, Nealson KH, Fredrickson JK.** 2006. Electrically conductive bacterial nanowires produced by *Shewanella oneidensis* strain MR-1 and other microorganisms. *Proceedings of the National Academy of Sciences of the United States of America* **103**:11358-11363.
46. **Lovley DR, Fraga JL, Coates JD, Blunt-Harris EL.** 1999. Humics as an electron donor for anaerobic respiration. *Environmental Microbiology* **1**:89-98.
47. **Lill R, Mühlenhoff U.** 2006. Iron-sulfur protein biogenesis in eukaryotes: components and mechanisms. *Annual Review of Cell and Developmental Biology* **22**:457-486.
48. **Brosnan JT, Brosnan ME.** 2006. The sulfur-containing amino acids: an overview. *Journal of Nutrition* **136**:1636S-1640S.
49. **Stroupe ME, Getzoff ED.** 2001. Sulfite reductase hemoprotein. *Handbook of Metalloproteins*. Albrecht Messerschmidt, Robert Huber, Thomas Poulos and Karl Wieghardt (eds):471-485.
50. **Hell R.** 1997. Molecular physiology of plant sulfur metabolism. *Planta* **202**:138-148.

51. **Jez JM, Dey S.** 2013. The cysteine regulatory complex from plants and microbes: what was old is new again. *Current Opinions in Structural Biology* **23**:302-310.
52. **Py B, Barras F.** 2010. Building Fe-S proteins: bacterial strategies. *National Reviews Microbiology* **8**:436-446.
53. **Howarth R.** The ecological significance of sulfur in the energy dynamics of salt marsh and coastal marine sediments. *Biogeochemistry* **1**:5-27.
54. **Miao Z, Brusseau ML, Carroll KC, Carreón-Diazconti C, Johnson B.** 2012. Sulfate reduction in groundwater: characterization and applications for remediation. *Environmental Geochemistry and Health* **34**:539-550.
55. **Gralnick JA, Vali H, Lies DP, Newman DK.** 2006. Extracellular respiration of dimethyl sulfoxide by *Shewanella oneidensis* strain MR-1. *Proceedings of the National Academy of Sciences of the United States of America* **103**:4669-4674.
56. **Burns JL, DiChristina TJ.** 2009. Anaerobic respiration of elemental sulfur and thiosulfate by *Shewanella oneidensis* MR-1 requires *psrA*, a homolog of the *phsA* gene of *Salmonella enterica* serovar typhimurium LT2. *Applied and Environmental Microbiology* **75**:5209-5217.
57. **Hensel M, Hinsley AP, Nikolaus T, Sawers G, Berks BC.** 1999. The genetic basis of tetrathionate respiration in *Salmonella typhimurium*. *Molecular Microbiology* **32**:275-287.
58. **Heinzinger NK, Fujimoto SY, Clark MA, Moreno MS, Barrett EL.** 1995. Sequence analysis of the *phs* operon in *Salmonella typhimurium* and the contribution of thiosulfate reduction to anaerobic energy metabolism. *Journal of Bacteriology* **177**:2813-2820.
59. **Mowat CG, Rothery E, Miles CS, McIver L, Doherty MK, Drewette K, Taylor P, Walkinshaw MD, Chapman SK, Reid GA.** 2004. Octaheme tetrathionate reductase is a respiratory enzyme with novel heme ligation. *Nature Structural & Molecular Biology* **11**:1023-1024.
60. **Dahl C, Kredich NM, Deutzmann R, Trüper HG.** 1993. Dissimilatory sulphite reductase from *Archaeoglobus fulgidus*: physico-chemical properties of the enzyme and cloning, sequencing and analysis of the reductase genes. *Journal of General Microbiology* **139**:1817-1828.
61. **Akagi JM.** 1983. Reduction of bisulfite by the trithionate pathway by cell extracts from *Desulfotomaculum nigrificans*. *Biochemical and Biophysical Research Communication* **117**:530-535.

62. **Hartshorne RS, Kern M, Meyer B, Clarke TA, Karas M, Richardson DJ, Simon J.** 2007. A dedicated haem lyase is required for the maturation of a novel bacterial cytochrome *c* with unconventional covalent haem binding. *Molecular Microbiology* **64**:1049-1060.
63. **Marritt SJ, Lowe TG, Bye J, McMillan DG, Shi L, Fredrickson J, Zachara J, Richardson DJ, Cheesman MR, Jeuken LJ, Butt JN.** 2012. A functional description of CymA, an electron-transfer hub supporting anaerobic respiratory flexibility in *Shewanella*. *Biochemical Journal* **444**:465-474.
64. **Cordova CD, Schicklberger MF, Yu Y, Spormann AM.** 2011. Partial functional replacement of CymA by SirCD in *Shewanella oneidensis* MR-1. *Journal of Bacteriology* **193**:2312-2321.
65. **LeBauer DS, Treseder KK.** 2008. Nitrogen limitation of net primary productivity in terrestrial ecosystems is globally distributed. *Ecology* **89**:371-379.
66. **Halbleib CM, Ludden PW.** 2000. Regulation of biological nitrogen fixation. *Journal of Nutrition* **130**:1081-1084.
67. **Ward BB.** 1996. Nitrification and ammonification in aquatic systems. *Life Support & Biosphere Science* **3**:25-29.
68. **Gruber N, Galloway JN.** 2008. An Earth-system perspective of the global nitrogen cycle. *Nature* **451**:293-296.
69. **Simpson PJ, Richardson DJ, Codd R.** 2010. The periplasmic nitrate reductase in *Shewanella*: the resolution, distribution and functional implications of two NAP isoforms, NapEDABC and NapDAGHB. *Microbiology* **156**:302-312.
70. **Kraft B, Strous M, Tegetmeyer HE.** 2011. Microbial nitrate respiration--genes, enzymes and environmental distribution. *Journal of Biotechnology* **155**:104-117.
71. **Gao H, Obraztova A, Stewart N, Popa R, Fredrickson JK, Tiedje JM, Nealson KH, Zhou J.** 2006. *Shewanella loihica* sp. nov., isolated from iron-rich microbial mats in the Pacific Ocean. *International Journal of Systematic and Evolutionary Microbiology* **56**:1911-1916.
72. **Payne WJ.** 1973. Reduction of nitrogenous oxides by microorganisms. *Bacteriological Reviews* **37**:409-452.
73. **Caskey WH, Tiedje JM.** 1980. The reduction of nitrate to ammonium by a *Clostridium* sp. isolated from soil. *Journal of General Microbiology* **119**:217-223.
74. **Smith MS.** 1982. Dissimilatory Reduction of NO₂ to NH₄ and N₂O by a Soil *Citrobacter* sp. *Applied and Environmental Microbiology* **43**:854-860.

75. **Hussain H, Grove J, Griffiths L, Busby S, Cole J.** 1994. A seven-gene operon essential for formate-dependent nitrite reduction to ammonia by enteric bacteria. *Molecular Microbiology* **12**:153-163.
76. **Grainger DC, Busby SJ.** 2008. Global regulators of transcription in *Escherichia coli*: mechanisms of action and methods for study. *Advances in Applied Microbiology* **65**:93-113.
77. **Spiro S, Guest J.** 1990. FNR and its role in oxygen-regulated gene expression in *Escherichia coli*. *FEMS Microbiology Reviews* **75**:399-428.
78. **Guest J, Green J, Irvine A, Spiro S.** 1996. The FNR modulon and FNR-regulated gene expression, p. 317-342. *In* Lin EC, Lynch S (ed.), *Regulation of gene expression in Escherichia coli*. Chapman & Hall, New York.
79. **Kiley PJ, Beinert H.** 1998. Oxygen sensing by the global regulator, FNR: the role of the iron-sulfur cluster. *FEMS Microbiology Reviews* **22**:341-352.
80. **Saffarini D, Nealson K.** 1993. Sequence and genetic characterization of *etrA* an *fnr* analog that regulates anaerobic respiration in *Shewanella putrefaciens* MR-1. *Journal of Bacteriology* **175**:7938-7944.
81. **Maier TM, Myers CR.** 2001. Isolation and characterization of a *Shewanella putrefaciens* MR-1 electron transport regulator *etrA* mutant: reassessment of the role of EtrA. *Journal of Bacteriology* **183**:4918-4926.
82. **Beliaev AS, Thompson DK, Fields MW, Wu L, Lies DP, Nealson KH, Zhou J.** 2002. Microarray transcription profiling of a *Shewanella oneidensis* *etrA* mutant. *Journal of Bacteriology* **184**:4612-4616.
83. **Saffarini DA, Schultz R, Beliaev A.** 2003. Involvement of cyclic AMP (cAMP) and cAMP receptor protein in anaerobic respiration of *Shewanella oneidensis*. *Journal of Bacteriology* **185**:3668-3671.
84. **Yang JK, Epstein W.** 1983. Purification and characterization of adenylate cyclase from *Escherichia coli* K12. *Journal of Biological Chemistry* **258**:3750-3758.
85. **Charania M, Brockman K, Zhang Y, Banerjee A, Pinchuk G, Fredrickson J, Beliaev A, Saffarini D.** 2009. Involvement of a membrane-bound class III adenylate cyclase in regulation of anaerobic respiration in *Shewanella oneidensis* MR-1. *Journal of Bacteriology* **191**:4298-4306.
86. **Delahas N, Forst S.** 2001. MicF: an antisense RNA gene involved in response of *Escherichia coli* to global stress factors. *Journal of Molecular Biology* **313**:1-12.

87. **Esterling L, Delihans N.** 1994. The regulatory RNA gene *micF* is present in several species of gram-negative bacteria and is phylogenetically conserved. *Molecular Microbiology* **12**:639-646.
88. **Kozak M.** 2005. Regulation of translation via mRNA structure in prokaryotes and eukaryotes. *Gene* **361**:13-37.
89. **Lindahl L, Hinnebusch A.** 1992. Diversity of mechanisms in the regulation of translation in prokaryotes and lower eukaryotes. *Current Opinions in Genetics & Development* **2**:720-726.
90. **Gur E, Biran D, Ron EZ.** 2011. Regulated proteolysis in Gram-negative bacteria--how and when? *Nature Reviews Microbiology* **9**:839-848.
91. **Stewart V, Bledsoe PJ, Chen LL, Cai A.** 2009. Catabolite repression control of *napF* (periplasmic nitrate reductase) operon expression in *Escherichia coli* K-12. *Journal of Bacteriology* **191**:996-1005.
92. **Moore JO, Hendrickson WA.** 2009. Structural analysis of sensor domains from the TMAO-responsive histidine kinase receptor TorS. *Structure* **17**:1195-1204.
93. **Dehio C, Meyer M.** 1997. Maintenance of broad-host-range incompatibility group P and group Q plasmids and transposition of Tn5 in *Bartonella henselae* following conjugal plasmid transfer from *Escherichia coli*. *Journal of Bacteriology* **179**:538-540.
94. **Wan X, VerBerkmoes N, McCue LA, Stanek D, Connelly H, Hauser L, Wu L, Liu X, Yan T, Leaphart A, Hettich R, Zhou J, Thompson D.** 2004. Transcriptomic and proteomic characterization of the Fur modulon in the metal-reducing bacterium *Shewanella oneidensis*. *Journal of Bacteriology* **186**:8385-8400.
95. **Emanuelsson O, Brunak S, von Heijne G, Nielsen H.** 2007. Locating proteins in the cell using TargetP, SignalP and related tools. *Nature Protocols* **2**:953-971.
96. **von Heijne G.** 1992. Membrane protein structure prediction. Hydrophobicity analysis and the positive-inside rule. *Journal of Molecular Biology* **225**:487-494.
97. **Claros MG, von Heijne G.** 1994. TopPred II: an improved software for membrane protein structure predictions. *Computer Application in the Biosciences* **10**:685-686.
98. **Bernsel A, Viklund H, Hennerdal A, Elofsson A.** 2009. TOPCONS: consensus prediction of membrane protein topology. *Nucleic Acids Research* **37**:W465-468.
99. **Juncker AS, Willenbrock H, Von Heijne G, Brunak S, Nielsen H, Krogh A.** 2003. Prediction of lipoprotein signal peptides in Gram-negative bacteria. *Protein Science* **12**:1652-1662.

100. **Lund K, DeMoss J.** 1976. Association-dissociation behavior and subunit structure of heat-released nitrate reductase from *Escherichia coli*. *Journal of Biological Chemistry* **251**:2207-2216.
101. **Haschke RH, Campbell LL.** 1971. Thiosulfate reductase of *Desulfovibrio vulgaris*. *Journal of Bacteriology* **106**:603-607.
102. **Cline JD.** 1969. Spectrophotometric determination of hydrogen sulfide in natural waters. *Limnology and Oceanography* **14**:454-458.
103. **Kletzin A.** 1989. Coupled enzymatic production of sulfite, thiosulfate, and hydrogen sulfide from sulfur: Purification and properties of a sulfur oxygenase reductase from the facultatively anaerobic archaeobacterium *Desulfurolobus ambivalens*. *Journal of Bacteriology* **171**:1638-1643.
104. **Laemmli UK.** 1970. Cleavage of structural proteins during the assembly of the head of bacteriophage T4. *Nature* **227**:680-685.
105. **Miller J.** 1972. Assay of β -galactosidase, p. 352-355, *Experiments in Molecular Genetics*. Cold Spring Harbor, New York.
106. **Barrett EL, Clark MA.** 1987. Tetrathionate reduction and production of hydrogen sulfide from thiosulfate. *Microbiological Reviews* **51**:192-205.
107. **Tuttle J, Jannasch H.** 1973. Dissimilatory reduction of inorganic sulfur by facultatively anaerobic marine bacteria. *Journal of Bacteriology* **115**:732-737.
108. **Zopfi J, Ferdelman T, Fossing H.** 2004. Distribution and fate of sulfur intermediates - sulfite, tetrathionate, thiosulfate, and elemental sulfur - in marine sediments., p. 97-116. *In* Améend J, Edwards K, Lyons T (ed.), *Sulfur Biogeochemistry Past and Present*. The Geological Society of America, Inc, Boulder.
109. **Boonchayaanant B, Gu B, Wang W, Ortiz M, Criddle CS.** 2010. Can microbially-generated hydrogen sulfide account for rates of U(VI) reduction by a sulfate-reducing bacterium? *Biodegradation* **21**:81-95.
110. **Fredrickson J, Zachara J, Kennedy D, Kukkadapu R, McKinley J, Heald S, Liu C, Plymale A.** 2004. Reduction of TcO_4^- by sediment-associated biogenic Fe(II). *Geochimica et Cosmochimica Acta* **68**:3171-3178.
111. **Kim C, Zhou Q, Deng B, Thornton E, Xu H.** 2001. Chromium (VI) reduction by hydrogen sulfide in aqueous media: stoichiometry and kinetics. *Environmental Science & Technology* **35**:2219-2225.

112. **Moon H, McGuinness L, Kukkadapu R, Peacock A, Komlos J, Kerkhof L, Long P, Jaffe P.** 2010. Microbial reduction of uranium under iron- and sulfate-reducing conditions: Effect of amended goethite on microbial community composition and dynamics. *Water Research* **44**:4015-4028.
113. **Zhong L, Thornton E, Deng B.** 2007. Uranium immobilization by hydrogen sulfide gaseous treatment under vadose zone conditions. *Vadose Zone Journal* **6**:149-157.
114. **Crane B, Siegel L, Getzoff E.** 1997. Structures of the siroheme- and Fe4S4-containing active centers of sulfite reductase in different states of oxidation: Heme activation via reduction-gated exogenous ligand exchange. *Biochemistry* **36**:12101-12119.
115. **Huang C, Barrett E.** 1990. Identification and cloning of genes involved in anaerobic sulfite reduction by *Salmonella typhimurium*. *Journal of Bacteriology* **172**:4100-4102.
116. **Huang C, Barrett E.** 1991. Sequence analysis and expression of the *Salmonella typhimurium asr* operon encoding production of hydrogen sulfide from sulfite. *Journal of Bacteriology* **173**:1544-1553.
117. **Schedel M, Truper H.** 1979. Purification of *Thiobacillus denitrificans* siroheme sulfite reductase and investigation of some molecular and catalytic properties. *Biochimica et Biophysica Acta* **568**:454-467.
118. **Schedel M, Vanselow M, Truper H.** 1979. Siroheme sulfite reductase isolated from *Chromatium vinosum*. Purification and investigation of some of its molecular and catalytic properties. *Archives of Microbiology* **121**:29-36.
119. **Rabus R, Hansen T, Widdel F.** 2006. Dissimilatory sulfate- and sulfur-reducing prokaryotes, p. 659-768. *In* Dworkin M, Falkow S, Rosenberg E, Schleifer K, Stackebrandt E (ed.), *The Prokaryotes*, vol. 2. Springer.
120. **Raux E, McVeigh T, Peters S, Leustek T, Warren M.** 1999. The role of *Saccharomyces cerevisiae* Met1p and Met8p in sirohaem and cobalamin biosynthesis. *Biochemical Journal* **338**:701-708.
121. **Woodcock S, Raux E, Levillayer F, Thermes C, Rambach A, Warren M.** 1998. Effect of mutations in the transmethylase and dehydrogenase/chelatase domains of sirohaem synthase (CysG) on sirohaem and cobalamin biosynthesis. *Biochemical Journal* **330**:121-129.
122. **Shirodkar SS.** 2010. Characterization of a novel sulfite reductase system and its regulation in *Shewanella oneidensis* MR-1. PhD in Biological Sciences. University of Wisconsin-Milwaukee.

123. **Cipollone R, Ascenzi P, Visca P.** 2007. Common themes and variations in the rhodanase superfamily. *IUBMB Life* **59**:51-59.
124. **Wunsch P, Herb M, Wieland H, Schiek U, Zumft W.** 2003. Requirements for Cu_A and Cu-S center assembly of nitrous oxide reductase deduced from complete periplasmic enzyme maturation in the nondenitrifier *Pseudomonas putida*. *Journal of Bacteriology* **185**:887-896
125. **Green JR, Westly J.** 1961. Mechanism of rhodanese action: polarographic studies. *Journal of Biological Chemistry* **236**:3047-3050.
126. **Schiene C, Fischer G.** 2000. Enzymes that catalyse the restructuring of proteins. *Current Opinions in Structural Biology* **10**:40-45.
127. **Honisch U, Zumft WG.** 2003. Operon structure and regulation of the *nos* gene region of *Pseudomonas stutzeri*, encoding an ABC-Type ATPase for maturation of nitrous oxide reductase. *Journal of Bacteriology* **185**:1895-1902.
128. **Holloway P, McCormick W, Watson RJ, Chan YK.** 1996. Identification and analysis of the dissimilatory nitrous oxide reduction genes, *nosRZDFY*, of *Rhizobium meliloti*. *Journal of Bacteriology* **178**:1505-1514.
129. **Zumft WG, Viebrock-Sambale A, Braun C.** 1990. Nitrous oxide reductase from denitrifying *Pseudomonas stutzeri*. Genes for copper-processing and properties of the deduced products, including a new member of the family of ATP/GTP-binding proteins. *European Journal of Biochemistry* **192**:591-599.
130. **Saraste M, Sibbald PR, Wittinghofer A.** 1990. The P-loop--a common motif in ATP- and GTP-binding proteins. *Trends in Biochemical Sciences* **15**:430-434.
131. **Zumft WG.** 2005. Biogenesis of the bacterial respiratory Cu_A, Cu-S enzyme nitrous oxide reductase. *Journal of Molecular Microbiology & Biotechnology* **10**:154-166.
132. **Brewer GJ, Hedera P, Kluin KJ, Carlson M, Askari F, Dick RB, Sitterly J, Fink JK.** 2003. Treatment of Wilson disease with ammonium tetrathiomolybdate: III. Initial therapy in a total of 55 neurologically affected patients and follow-up with zinc therapy. *Archives of Neurology* **60**:379-385.
133. **Kumar P, Yadav A, Patel SN, Islam M, Pan Q, Merajver SD, Teknos TN.** 2010. Tetrathiomolybdate inhibits head and neck cancer metastasis by decreasing tumor cell motility, invasiveness and by promoting tumor cell anoikis. *Molecular Cancer* **9**:206.
134. **Juarez JC, Betancourt O, Pirie-Shepherd SR, Guan X, Price ML, Shaw DE, Mazar AP, Doñate F.** 2006. Copper binding by tetrathiomolybdate attenuates angiogenesis and tumor cell proliferation through the inhibition of superoxide dismutase 1. *Clinical Cancer Research* **12**:4974-4982.

135. **Marritt SJ, McMillan DG, Shi L, Fredrickson JK, Zachara JM, Richardson DJ, Jeuken LJ, Butt JN.** 2012. The roles of CymA in support of the respiratory flexibility of *Shewanella oneidensis* MR-1. *Biochemical Society Transactions* **40**:1217-1221.
136. **Einsle O.** 2011. Structure and function of formate-dependent cytochrome *c* nitrite reductase, NrfA. *Methods in Enzymology* **496**:399-422.
137. **Gao T, O'Brian MR.** 2007. Control of DegP-dependent degradation of *c*-type cytochromes by heme and the cytochrome *c* maturation system in *Escherichia coli*. *Journal of Bacteriology* **189**:6253-6259.
138. **Waller PR, Sauer RT.** 1996. Characterization of *degQ* and *degS*, *Escherichia coli* genes encoding homologs of the DegP protease. *Journal of Bacteriology* **178**:1146-1153.
139. **Chan YK, McCormick WA, Watson RJ.** 1997. A new *nos* gene downstream from *nosDFY* is essential for dissimilatory reduction of nitrous oxide by *Rhizobium (Sinorhizobium) meliloti*. *Microbiology* **143**:2817-2824.
140. **Banerjee A.** 2012. Regulation of anaerobic respiration and the effects of cAMP & copper on DMSO respiration in *Shewanella oneidensis* MR-1. PhD in Biological Sciences. University of Wisconsin-Milwaukee.
141. **D'Andrea L, Regan L.** 2003. TPR protein: The versatile helix. *Trends in Biochemical Sciences* **28**:655-662.
142. **Di Silvio E, Di Matteo A, Malatesta F, Travaglini-Allocatelli C.** 2013. Recognition and binding of apocytochrome *c* to *P. aeruginosa* CcmI, a component of cytochrome *c* maturation machinery. *Biochimica et Biophysica Acta* **1834**:1554-1561.
143. **Verissimo A, Yang H, Wu X, Sanders C, Daldal F.** 2011. CcmI subunit of CcmFHI ligation complex functions as an apocytochrome *c* chaperone during *c*-type cytochrome maturation. *Journal of Biological Chemistry* **286**:40452-40463.
144. **Han D, Kim K, Oh J, Park J, Kim Y.** 2008. TPR domain of NrfG mediates complex formation between heme lyase and formate-dependent nitrite reductase in *E. coli* O157:H7. *Proteins* **70**:900-914.
145. **Di Matteo A, Gianni S, Schinina M, Giorgi A, Altieri F, Calosci N, Brunori M, Travaglini-Allocatelli C.** 2007. A strategic protein in cytochrome *c* maturation: Three dimensional structure of *ccmH* and binding to apocytochrome *c*. *Journal of Biological Chemistry* **282**:27012-27019.
146. **Monika E, Goldman B, Beckman D, Kranz R.** 1997. A thioredoxin pathway tethered to the membrane for periplasmic cytochrome *c* biogenesis; *in vitro* and *in vivo* studies. *Journal of Molecular Biology* **5**:679-692.

147. **Crow A, Brun N, Oubrie A.** 2004. The role of ResA in type II cytochrome *c* maturation. *Biochemical Society Transactions* **3**:149-151.
148. **Hartshorne S, Richardson D, Simon J.** 2006. Multiple haem lyase genes indicate substrate specificity in cytochrome *c* biogenesis. *Biochemical Society Transactions* **34**:146-149.
149. **Sanders C, Boulay C, Daldal F.** 2007. membrane-spanning and periplasmic segments of CcmI have distinct functions during cytochrome *c* biogenesis in *Rhodobacter capsulatus*. *Journal of Bacteriology* **189**:789-800.
150. **Thony-Meyer L, James P, Hennecke H.** 1991. From one gene to two proteins: The biogenesis of cytochrome *b* and *c*₁ in *Bradyrhizobium japonicum*. *Proceeding of the National Academy of Sciences of the United States of America* **88**:5001-5005.
151. **Gao T, O'Brian M.** 2005. Iron-dependent cytochrome *c*₁ expression is mediated by the status of heme in *Bradyrhizobium japonicum*. *Journal of Bacteriology* **187**:5084-5089.
152. **Kern M, Eisel F, Scheithauer J, Kranz R, Simon J.** 2009. Substrate specificity of three cytochrome *c* haem lyase isoenzymes from *wolinella succinogenes*: unconventional haem *c* binding motifs are not sufficient for haem *c* attachment by NrfI and CcsA1. *Molecular Microbiology* **75**:122-137.
153. **Richard-Fogal C, Frawley E, Bonner E, Zhu H, San Francisco B, Kranz R.** 2009. A conserved haem redox and trafficking pathway for cofactor attachment. *EMBO Journal* **28**:2349-2359.
154. **Bamford V, Angove H, Seward H, Thomson A, Cole J, Butt J, Hemmings A, Richardson D.** 2002. Structure and spectroscopy of the periplasmic cytochrome *c* nitrite reductase from *Escherichia coli*. *Biochemical Journal* **41**:2921-2931.
155. **Einsle O, Stach P, Messerschmidt A, Simon J, Kröger A, Huber R, Kroneck P.** 2000. Cytochrome *c* nitrite reductase from *Wolinella succinogenes*: Structure at 1.6 Å resolution, inhibitor binding, and heme-packing motifs. *Journal of Biological Chemistry* **275**:39608-39616.
156. **Pisa R, Stein T, Elchler R, Gross R, Simon J.** 2002. The *nrfI* gene is essential for the attachment of the active site haem group of *Wolinella succinogenes* cytochrome *c* nitrite reductase. *Molecular Microbiology* **43**:763-770.
157. **Moser D, Neelson K.** 1996. Growth of the facultative anaerobe *Shewanella putrefaciens* by elemental sulfur reduction. *Applied and Environmental Microbiology* **62**:2100-2105.

158. **Myers C, and K. Nealson.** 1990. Respiration-linked proton translocation coupled to anaerobic reduction of Mn(IV) and Fe(III) in *S. putrefaciens* MR-1. *Journal of Bacteriology* **172**:6232-6238.
159. **Beliaev AS, Klingeman DM, Klappenbach JA, Wu L, Romine MF, Tiedje JM, Nealson KH, Fredrickson JK, Zhou J.** 2005. Global transcriptome analysis of *Shewanella oneidensis* MR-1 exposed to different terminal electron acceptors. *Journal of Bacteriology* **187**:7138-7145.
160. **Green J, Scott C, Guest J.** 2001. Functional versatility in the CRP-FNR superfamily of transcriptional factors: FNR and FLP., p. 1-34. *In* Poole RK (ed.), *Advances in Microbial Physiology*, vol. 44. Academic Press, San Diego.
161. **Murphy J, Durbin K, Saltikov C.** 2009. The functional roles of *arcA*, *etrA*, cyclic AMP (cAMP)-cAMP receptor protein, and *cya* in the arsenate respiration pathway in *Shewanella* sp. strain ANA-3. *Journal of Bacteriology* **191**:1035-1043.
162. **Bordi C, Ansaldi M, Gon S, Jourlin-Castelli C, Iobbi-Nivol C, Méjean V.** 2004. Genes regulated by TorR, the trimethylamine oxide response regulator of *Shewanella oneidensis*. *Journal of Bacteriology* **186**:4502-4509.
163. **Gon S, Patte JC, Dos Santos JP, Méjean V.** 2002. Reconstitution of the trimethylamine oxide reductase regulatory elements of *Shewanella oneidensis* in *Escherichia coli*. *Journal of Bacteriology* **184**:1262-1269.
164. **Shroff NP, Charania MA, Saffarini DA.** 2010. ArcB1, a homolog of *Escherichia coli* ArcB, regulates dimethyl sulfoxide reduction in *Shewanella oneidensis* MR-1. *Journal of Bacteriology* **192**:3227-3230.
165. **Gao H, Wang X, Yang ZK, Palzkill T, Zhou J.** 2008. Probing regulon of ArcA in *Shewanella oneidensis* MR-1 by integrated genomic analyses. *BMC Genomics* **9**:42.
166. **Dong Y, Wang X, Fu H, Zhou G, Shi M, Gao H.** 2012. A Crp-dependent two-component system regulates nitrate and nitrite respiration in *Shewanella oneidensis*. *PLOS ONE* **7**:e51643.

CURRICULUM VITAE

Kenneth L Brockman

Education

- 2009 – 2014 Ph.D., University of Wisconsin Milwaukee, Milwaukee, WI
Concentration: Microbiology, Electron Microscopy
- 2003 – 2006 B.S., University of Wisconsin Milwaukee, Milwaukee, WI
Major: Biology with focus on Microbiology; Minor: Chemistry

Awards and Honors

- 2012 – 2013 Distinguished Dissertator Fellowship
University of Wisconsin Milwaukee, Graduate School
- 2009 – 2014 Chancellor's Graduate Student Award
University of Wisconsin Milwaukee, Biological Sciences
- 2008, 2011 Ruth Walker Grant-in-Aid
University of Wisconsin Milwaukee, Biological Sciences

Professional Society Membership

American Society of Microbiologists

Publications

Brockman KL, Saffarini DA. Unusual regulatory mechanisms of anaerobic reductases in *S. oneidensis* MR-1. Manuscript in preparation.

Brockman KL, Saffarini DA. Components involved in the regulation and reduction of sulfur compounds in *S. oneidensis* MR-1. Manuscript in preparation.

Brockman KL, Croft TC, Saffarini DA. Components of a dedicated heme lyase system required for the maturation of the atypical heme-binding motif of the sulfite reductase SirA in *Shewanella oneidensis* MR-1. Manuscript submitted.

Bouhenni RA, Vora GJ, Biffinger JC, Shirodkar S, **Brockman KL**, Ray R, Wu P, Johnson BJ, Biddle EM, Marshall MJ, Fitzgerald LA, Little BJ, Fredrickson JK, Beliaev AS, Ringeisen BR and Saffarini DA. The role of *Shewanella oneidensis* MR-1 outer membrane structures in extracellular electron transfer. *Electroanalysis* 2010 Apr; 22(7-8):856-864.

Charania MA, **Brockman KL**, Zhang Y, Banerjee A, Pinchuk GE, Fredrickson JK, Beliaev AS, Saffarini DA. Involvement of a membrane-bound class III adenylate cyclase in regulation of anaerobic respiration in *Shewanella oneidensis* MR-1. *J. Bacteriol.* 2009 Jul; 191(13):4298-306.

Presentations and Abstracts

Ken Brockman. Analysis of the Sulfite Redutase of *Shewanella oneidensis* MR-1. Presentation at the 2013 Department of Biological Sciences Colloquium Series, University of Wisconsin Milwaukee, Milwaukee, Wisconsin, October 25, 2013.

Ken Brockman, Daad Saffarini. Sulfite Reduction in *Shewanella oneidensis* MR-1. Poster presented at the 2011 American Society of Microbiology General Meeting, New Orleans, Louisiana, May 21-24, 2011.

Dilini Kumarasigne, **Ken Brockman** and Daad Saffarini. Phenotypic Characterization of *Shewanella oneidensis* MR-1 Mutants with Deletion of Two Component Systems. Poster presented at the 2011 Biological Sciences Symposium, Milwaukee, Wisconsin, April 28, 2011.

Jose Fragoso, **Ken Brockman** and Daad Saffarini. PsrS is an oxygen sensing histidine kinase that regulates thiosulfate reduction in *S. oneidensis* MR-1. Poster presented at the 2010 Biological Sciences Symposium, Milwaukee, WI, April 27, 2010

Justin C. Biffinger, Lisa A. Fitzgerald, Gary J. Vora, Peter Wu, Jeffrey W. Baldwin, Brenda J. Little, Rachida Bouhenni, Sheetal Shirodkar, **Ken Brockman,** Daad Saffarini, and Bradley R. Ringeisen. Comparing current generation from *Shewanella oneidensis* MR-1 and candidate nanowire deletion mutants in a microbial fuel cell. Poster presented at the 238th ACS National Meeting, Washington DC, August 16-20, 2009

Areen Banerjee, Moiz Charania, **Ken Brockman.** Role of adenylate cyclases and phosphodiesterases in anaerobic respiration of *Shewanella oneidensis* MR-1. Talk at the *Shewanella* Federation Fall Meeting, Asilomar, California, October 5-7, 2008.

M. A. Charania, **K. Brockman,** A. Beliaev and D. Saffarini. Role of Adenylate Cyclases in Anaerobic Respiration of *Shewanella oneidensis* MR-1. Poster presented at the 107th General Meeting of American Society for Microbiology, Toronto, Canada, May 21-25, 2007